

CIRCULATION LARGER THAN THAT OF ANY OTHER RADIO PUBLICATION

RADIO PHONE
WRNY
STATION

RADIO NEWS

REG. U. S. PAT. OFF.

25 Cents

OCTOBER

Over 200
Illustrations

Edited by HUGO GERNSBACK

PARLOR MAGIC WITH YOUR RADIO SET

SEE PAGE 420



IN THIS ISSUE:

- General G. Ferrie
- Dr. Lee DeForest
- Prof. R. A. Fessenden
- Prof. C. B. Bazzoni
- Dr. E. F. W. Alexanderson

RADIO'S GREATEST MAGAZINE

EXPERIMENTER PUBLISHING COMPANY, NEW YORK, PUBLISHERS OF

SCIENCE and INVENTION

THE EXPERIMENTER

MOTOR CAMPER & TRAVELER

MacMillan demands

for Life
and Death
Service

Cunningham RADIO TUBES

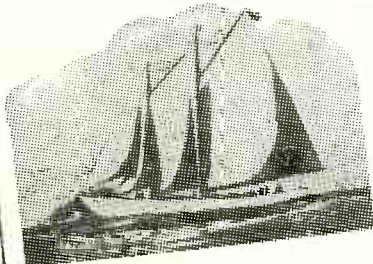

THE MACMILLAN ARCTIC ASSOCIATION

HERBERT L. BRIDGMAN,
PRESIDENT

M. J. LOOK,
VICE-PRESIDENT

EDWIN W. SPARKS,
VICE-PRESIDENT

GEORGE F. CARY,
TREASURER

EDWARD N. GODING,
SECRETARY

DONALD B. MACMILLAN,
MANAGING DIRECTOR

626 TREMONT BUILDING, BOSTON, MASS.

April 19th, 1925

Mr. E. F. McDonald, Jr.,
332 S. Michigan Avenue,
Chicago, Illinois.

My dear Gene:

I have had so much success and long life with the Cunningham tubes in my set, and I have heard such favorable reports during my lecture tour throughout the United States, that I have decided that we should equip the Expedition with Cunningham receiving tubes exclusively.

You will therefore please arrange to purchase these tubes, per the attached order, and have it shipped to the Bowdoin in time for the tests before the sailing at Wiscasset.

Sincerely yours,

Donald B. Macmillan



Home Office, 182 Second Street
SAN FRANCISCO

CHICAGO
NEW YORK

E. J. Cunningham Inc.

Since 1915—
Standard for all sets

Types C-301A : C-299
C-300 : C-11 : C-12

In the Orange and Blue Carton

In that white and silent Northland with its glistening ice, driving blizzards and endless, relentless cold Cunningham Radio Tubes deliver the same efficient, well-rounded service that makes them valued so highly in the shelter of the American home.

MacMillan's
choice may well
be yours





Tower

Scientific

LOUD SPEAKER

\$8.50

All Tower Loudspeakers equipped with adjustable units

**Smashes Every Precedent
—In Performance and Value**

Looks and performs under every condition like a \$25.00 Speaker, but actually costs a fractional part. Its wonderful tone is due in part to the gooseneck horn, as graceful in appearance as it is scientifically correct. Meets the requirements of every type of broadcasting and Receiving Set.

*Wherever there are ears that hear there is a Tower.
Quality Product to Fit your Taste and Pocketbook*

SOLD BY GOOD RADIO DEALERS EVERYWHERE

**TOWER MFG. CORPORATION
98 BROOKLINE AVE. BOSTON MASS.**



\$4.95
Little Spitfire Loudspeaker

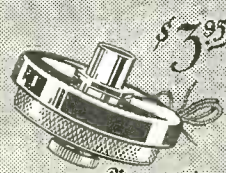

\$3.95
Phonograph Attachment



\$15.00
The Meistersinger Speaker



Tower Scientific
\$2.95

WORLD'S GREATEST LOUDSPEAKER VALUES

RADIO NEWS

Published by EXPERIMENTER PUBLISHING COMPANY, INC.
 Publishers of "Radio News," "Science and Invention,"
 "The Experimenter" and "Motor Camper & Tourist."
 Editorial and General Offices: 53 Park Pl., New York City
 H. GERNSBACK, President. S. GERNSBACK, Treasurer
 R. W. DEMOTT, Secretary
 MEMBER: AUDIT BUREAU OF CIRCULATIONS

CONTENTS

OCTOBER, 1925

VOLUME 7

NUMBER 4

In Our Next Issue

Further Applications in Vacuum Tubes.

This is another of the series of articles by Dr. Bazzoni showing the wide adaptability of the vacuum tube to human needs.

* * *

Straight-Line Frequency Dials, Explained by Sylvan Harris.

This is perhaps the latest development that has occurred in popular radio applications this year.

* * *

Multiple Grid Vacuum Tubes.

Multi-grid vacuum tubes have attained wide popularity in Europe, but are practically unknown here in America among the B. C. I.'s. An article by Theodore H. Nakken describes the application and use of these highly efficient tubes.

* * *

A Two-Range Receiver, Designed by RADIO NEWS Laboratories Staff.

This is another of the multi-range sets designed to cover a range of 600 to 150 meters, at the same time eliminating the crowding of the stations.

In This Issue

Editorial. By Hugo Gernsback	409	The Radio Hook at WRNY	438
The Behavior of Radio Waves. By Dr. E. F. W. Alexanderson	410	\$370 Radio Play Contest..	438
Radio In Germany. By Eugene Nesper	412	Radio Set Directory	439
The Life And Work of Lee DeForest	414	The Balanced Interflex Circuit. By Hugo Gernsback	440
Radio Stereophony. By Ludwig Kapeller	416	A New Super-Heterodyne. By McMurdo Silver	444
Superpower Broadcasting..	418	Extending The Broadcast Range. By Sylvan Harris	446
Parlor Magic With Your Radio Set. By Hugo Gernsback	420	Does a Straight-Line Frequency Condenser Exist? By Sylvan Harris	447
The Times Flies. By Marius Logan	425	Another Three-Range Receiver. Laboratory Staff of Radio News	448
The Vacuum Tube And Photo-Electric Cell. By Gen. Gustave Ferrié	426	With the Amateurs. By A. P. Peck	450
The Inventions of Reginald A. Fessenden	428	The Radio Beginner. By A. P. Peck	451
New Ideas In Receivers. By G. C. B. Rowe	430	All About Filters. By Edward W. Berry	452
International Radio	432	Radio Wrinkles	454
Esperanto Broadcast Lessons. By James Denson Sayers	433	Radiotics	456
Hard Tubes And Soft Tubes As Amplifiers and Detectors. By Dr. C. B. Bazzoni	434	Standard Hook-ups	457
The Luminotron. By Theodore H. Nakken	436	New Radio Patents. By John B. Brady	459
		Radio News Laboratories..	460
		Correspondence From Readers	462
		I Want To Know. By R. D. Washburne	463

RADIO NEWS is published on the 10th of each preceding month. There are 12 numbers per year. Subscription price is \$2.50 a year in U. S. and possessions, Canada and foreign countries, \$3.00 a year. U. S. Coin as well as U. S. Stamps accepted (no foreign coins or stamps). Single copies, 25 cents each. A sample copy will be sent gratis on request. Checks and money orders should be drawn to order of EXPERIMENTER PUBLISHING CO., INC.

All communications and contributions to this journal should be addressed to Editor, RADIO NEWS, 53 Park Place, New York, N. Y. Unaccepted contributions cannot be returned unless full postage has been included. All accepted contributions are paid for on publication. A special rate is paid for novel experiments; good photographs accompanying them are highly desirable.

RADIO NEWS, Monthly. Entered as second class matter, July 12, 1924, at the Post Office at New York, N. Y., under the Act of March 3, 1879. Additional entry at Long Island City, N. Y., and San Francisco, Calif. Title registered U. S. Patent Office. Copyright, 1923, by E. P. Co., Inc., New York. The Experimenter Publishing Co., 53 Park Place, New York. The Contents of this magazine are copyrighted and must not be reproduced without giving full credit to the publication. Copyright in Germany. Reproduction of articles in Germany is reserved for Radio, Berlin 12.

New York City
 General Advertising Dept.
 53 Park Place

Western Advertising Representatives
 Fineman & McClure
 720 Cass St., Chicago, Ill.

New England Advertising Representative
 T. F. Magrane, Park Square Building, Boston, Mass.

RADIO NEWS is for sale at all newsstands in the United States and Canada. European agents, S. J. Wise Et Cie, 40 Place Verte, Antwerp, Belgium.

HOW TO SUBSCRIBE FOR RADIO NEWS. Send your name, address and remittance to Experimenter Publishing Co., 53 Park Place, New York. Mention the name of the magazine you are ordering. We also publish SCIENCE AND INVENTION, THE EXPERIMENTER and MOTOR CAMPER & TOURIST. Write clearly. RATES AND TERMS. The subscription rate for RADIO NEWS is \$2.50 per year. (12 numbers). When remitting go so by check, money order, or registered letter if cash is enclosed. Avoid sending cash through the mail if possible. Subscriptions for less than one year are not accepted. Subscription may be made in combination with SCIENCE AND INVENTION or the EXPERIMENTER.

POSTAGE. We prepay postage in all parts of the United States, Mexico and island possessions. For foreign or Canadian subscriptions we require 50 cents in addition to the subscription price for additional postage charges.

CHANGE OF ADDRESS. Notify us as far in advance as possible. It requires several weeks to make an address change on our records. Always write clearly.

ON EXPIRATION of your subscription we enclose a renewal blank in our last number to you; we stop our delivery to you on expiration.

Pacific Coast Advertising Representatives
 A. J. Norris Hill Co.
 Hearst Bldg., San Francisco, Calif.

Kansas City Advertising Representative
 Davies and Dillon
 15 W. Tenth St., Kansas City, Mo.

Detroit Advertising Representative
 Roy Buell, Donovan Bldg., Detroit, Mich.

*The Train
you want
to meet —*

*and what it
brings to you with
the Day-Fan Superadio*

(Copyright 1925)

Day-Fan Superadio is like a great railroad station into which run a hundred tracks.

The train from San Francisco comes in on track 47. Pittsburgh's train rolls in on track 17. A long distance express from Nebraska comes in on track 13. A big New York special comes in at 65.

These tracks belong to these trains. They always come in on them. You know where to meet them. So for a hundred other trains from all over the United States.

Yes, you have guessed it. The trains are the music, the speeches, the songs that travel through space to your radio. The hundred tracks are the hundred lines on your Day-Fan dial.

Instead of running from track to track, know in advance where your train comes in. The Day-Fan Air Telephone Directory will tell you. No other set can do this. If you are using a Day-Fan 5 Tube Set it also has the newspaper numbers right on its dial. You need never again miss the "music train" you had planned to meet and enjoy.

Day-Fan owners take distance for granted, just as they speak across the continent by telephone. They take selectivity for granted, and as a matter of course expect to cut out one station and get another. The thing that they are never able to take for granted is Day-Fan's sound beauty, for in this radio sets differ as a fifteen dollar violin differs from a fifteen thousand dollar Stradivarius.

Magnificent as Day-Fan is in volume, exact as it is in its arrow-like flight to the music you seek, marvelous as it may be in simplicity and sureness, its outstanding feature must always be its beauty of tone. The more sensitive your ear may be, the more you will enjoy Day-Fan. The more you have said "I can never enjoy Radio," the more surely you will enjoy Dan-Fan.

Go hear a Day-Fan today and prove these things to yourself right away. If you do not know who is your nearest Day-Fan dealer drop us a line and we will tell you, or write us addressing Dept. RN and we will send you complete Day-Fan catalogue.

Have the Day-Fan Air Telephone Directory mailed to your home. A complete list of all stations revised monthly from Government Reports. Send fifty cents in money order to The Dayton Fan & Motor Co. for six months' subscription.



OEM 12, \$75.00
4 Tube

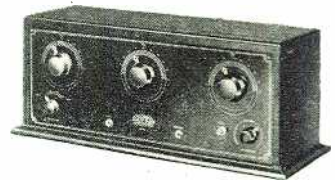

OEM 7, \$98.00
4 Tube
Super-selective



Day-Fan 5, \$115.00
5 Tube
Single dial control



Day Craft, \$145.00
5 Tube
Self contained loud speaker
and room for B batteries.
With Legs, \$165.00
Legs Separate, \$20.00

Other Models, including
consoles, to \$300.00

Here's where they always are on the

Day-Fan
RADIO
Dial

See the Day-Fan Air Telephone Directory

THE DAYTON FAN & MOTOR CO.
Dayton, Ohio

For more than 36 Years Manufacturers of
High Grade Electrical Apparatus



INDEX TO ADVERTISERS

	Page		Page		Page		Page
A							
A-C Electrical Mfg. Co., The.....	549	DeWitt LaFrance Co., Inc.....	532	Kenman Electric Co., Inc.	533	Radio Specialty Co.	537
Aalco Radio Labs	550	Diamond Elec. Specialties Corp.....	557	Kewol Radio Co.	555	Radio Television Co., The.....	496
Acme Apparatus Co.	489	Dubilier Condenser & Radio Corp.	478-557	Keystone Products Co., The.....	540	Radio Units, Inc.	470
Acme Products Co.	496	Duplex Condenser & Radio Corp.	544	Kimley Electric Co., Inc.....	566	Randolph & Company.....	534
Aero Products, Inc.	467			Kinley Radio Co.	554	Rathbun Mfg. Co., Inc.....	493
Aerovox Wireless Corp.	508			Kirtland-Engel Co.	506	Rice & Hochster.....	494
Alden Mfg. Co.	484			Klosner Radio Corp.	502	Richardson Radio, Inc.	543
All-American Radio Corp.	529			Kodel Radio Corp., The, 406-407-551		Rola Co., The.....	509
All Radio Co.	546			E			
Allen-Bradley Co.	568						
Inside Back Cover							
Ambassador Sales Co.	553						
American Bosch Magneto Corp., The.....	404-405						
American Electric Co.	554						
American Hard Rubber Co.....	491						
Amplion Corp. of America, The.....	492						
Amsco Products, Inc.	488						
Andrews Radio Co.	492						
Antennaphone Co.	468						
Apex Electric Mfg. Co.	558						
Arrow Battery Co.	544						
Atwater Kent Mfg. Co.	473						
B							
Bakelite Corp.	399						
Barawick Co.	559						
Barkelew Electric Mfg. Co., The.....	532						
Bastian Bros. Co.	538						
Belden Mfg. Co.	513						
Bell Mfg. Co.	466						
Benjamin Elec. Mfg. Co.	502						
Big Three Radio Corp'n.....	531						
Black Bros. Co.	559						
Bluebird Tube Co.	482						
Bodine Electric Co.	518						
Boice, W. B. & J. E.	544						
Brady, John B.	498						
Branston, Inc., Chas. A.	510						
Brant Battery Co.	540						
Braun Co., W. C.	498						
Bristol Company, The.....	481						
Brownlie, Roland	486						
Buescher Band Inst. Co.	566						
Buss Radio Service, Leo E.....	502						
C							
C. E. Mfg. Company, Inc.	520						
California Radio Minerals.....	486						
Carborundum Company, The.....	526						
Carter Radio Company.....	490						
Chemical Inst. of N. Y., Inc.....	539						
Chicago Electric Devices Co.	502						
Chicago Salvage Stock Stores.....	566						
Clark & Tilson, Inc.	544						
Cleveland Engineering Labs. Co., The.....	514						
Collytt Laboratories	486						
Conrad Company, Inc., The, 478-522-534-541-542-560-564							
Continental Fibre Company.....	538						
Cooper Corp., The.....	498						
Coyne Electrical School.....	472						
Crain Bros. Radio Shoppe.....	480						
Crescent Braid Co., Inc.....	512						
Crescent Radio Supply Co.	526						
Crosley Radio Corp.	515						
Crowe Name Plate & Mfg. Co.....	534						
Cruver Mfg. Co.	550						
Cunningham, Inc., E. T., Inside Front Cover							
Cutler-Hammer Mfg. Co., The.....	501						
D							
D X Instrument Co.	518						
Daven Radio Corp.	561						
Dayton Fan & Motor Co., The.....	395						
F							
F							
G							
H							
I							
J							
K							
L							
M							
N							
O							
P							
R							
S							
T							
U							
V							
W							
X Y Z							



Earn \$50 to \$250 a Week in RADIO



Easy to Become a RADIO EXPERT at Home in Spare Time

Big Jobs Waiting In the Radio Business

Up-To-Date Receiving Sets Given with Course

IF YOU are making less than \$50 a week—if you want to get into the big pay class in the world's fastest growing industry—get into Radio—NOW. Coupon brings you full information.

You learn by doing—through the N. R. I. Course. All materials and equipment necessary are furnished you along with your course. You are sent receiving sets to build and install—real sets for experimental work and pleasure. This is a practical course that teaches you to get the practical results that big pay jobs demand.

Big jobs are open for trained men, in every section of the country. Radio manufacturers—distributors—dealers—broadcasting and receiving stations—railroads and steamship companies and branches of the Government, need trained Radio Experts NOW! Opportunities are open everywhere for men to go into business for themselves as Radio Experts. The pay is big. Thousands are now making \$50 to \$250 a week in Radio. This great industry is making new millionaires almost over night.

Helpful Employment Service

We are constantly in touch with openings for trained Radio men. The men we train get first chance at these fine jobs through our Employment Department—at no extra cost. When you complete our training we help you until you get the job you want.

Learn Quickly at Home by Tested Method

You can become a Radio Expert quickly, and easily, in your spare time at home, with the help of the National Radio Institute—America's first and largest home study Radio school. This famous, tested course makes Radio as simple as ABC—and so fascinating you will scarcely realize that you are mastering one of the world's most important industries. In a few short months you may become the Radio Expert of your town or wherever you wish to locate. You get the benefit of our years of experience and you learn Radio RIGHT when you learn our way.

This Is the Course That Pays for Itself

We mean every word of it! We have developed the famous method that makes it unnecessary for your training to be an expense. Instead of making any man "scrimp" to get his training, our system makes your course pay you returns practically from the start. When you learn our proven way your course will pay for itself, and more—much more! Get the details of these amazing methods.

Don't Worry About Age or Education

It makes no difference what your age is or what your previous training has been. Radio is a field in itself. It calls men of all ages from youth to settled middle age. Success does demand training in Radio and the N. R. I. course gives you training necessary to Success.

Mail Coupon Quick for FREE BOOK and Special Offer

The coupon below will bring you the most amazing book of Radio, ever written. It will open your eyes to the opportunities for you in this established, big pay field and tell you how to become a Radio Expert in your spare time at home. It has helped thousands of men to success in Radio.

Important: We have a Special Limited Offer for those who act quickly. Mail the coupon or write a letter NOW.

**NATIONAL RADIO INSTITUTE
Dept. 13 MB, Washington, D. C.**

**Get this
FREE BOOK**



NATIONAL RADIO INSTITUTE, Dept. 13MB
Washington, D. C.

Without obligation send me your book, "Rich Rewards in Radio," which tells all about the opportunities in Radio, how spare time study at home will qualify me quickly as a certified Radio-trician so I can get one of these splendid positions, and how your Employment Service helps me to secure a big pay job.

Name Age.....
Street
City..... State.....

Proof that Radio Pays

See What These N. R. I. Men Are Doing



Buy's New Car With Earnings
Anyone, regardless of age or sex, should have no trouble in mastering Radio from the N. R. I. course. I am at present employed as Service Manager for the Geo. F. Dent Radio Service Co. and I am still taking the course.

I have had great success selling, building, repairing and installing all kinds of Radios. At present I am getting a salary and commission which, although I have only been with the firm for 3 months, has enabled me to purchase a new car.
Richard E. Jones,
Bay City, Michigan.

Makes \$25 a Week MORE in Radio

I am making about \$25 a week more than before taking your course. As you can see by our letterhead, Mr. Bartlett (one of your graduates) and I are in business for ourselves. We build 6-tube radio frequency sets and have a ready market for them. This was only made possible through your course. Your instruction and service is a great help. It is impossible for me to estimate its value in dollars and cents. I think Radio offers better opportunities than any other field.
Allen N. Birtell,
Knox, Pa.



Makes \$50 to \$80 a Week More

Your course leads so much further ahead than practical electricity that there is nothing left to say. Since I took your course I have earned from \$50 to \$80 a week more.
Preston Fowler,
Gordon, Nebraska.



Increase Pay 160 Per Cent

I was just receiving \$3.00 per 8 hours when I enrolled with N. R. I. and now I am receiving \$1.00 an hour (160 per cent increase). That is where N. R. I. put me. The course has been worth \$2500 a year to me and in another year it will be worth \$3500 a year. While taking the course I did assembling, repairing and installing and made about \$900. This made my course pay for itself many times even before I graduated. The N. R. I. way is the Right Way.
Andrew M. Shurie,
Latrobe, Pa.



Earn \$50 to \$250 a week in Radio

RADIO NEWS READERS' BUREAU

Time and Postage Saver

IN every issue of RADIO NEWS you undoubtedly see numerous articles advertised about which you would like to have further information. To sit down and write an individual letter to each of these respective concerns, regarding the article on which you desire information, would be quite a task.

As a special service to our readers, we will write the letters for you, thus saving your time and money.

Just write the names of the products about which you want information, and to avoid error the addresses of the manufacturers, on the coupon below and mail it to us.

If the advertiser requires any money or stamps to be sent to pay the mailing charges on his catalogue or descriptive literature, please be sure to enclose the correct amount with the coupon.

We will transmit to the various advertisers your request for information on their products.

This service will appear regularly every month on this same page in RADIO NEWS.

If there is any Manufacturer not advertising in this month's issue of RADIO NEWS, from whom you would like to receive literature, write his name, address and the product in the special section of the coupon below.

TEAR ALONG THIS LINE

READERS' SERVICE BUREAU,
 Experimenter Publishing Co., Inc., 53 Park Place, New York, N. Y.

RN-10-25

Please advise the firms listed below that I would like to receive detailed information on their product as advertised in the issue of RADIO NEWS.

 **DO NOT USE THIS COUPON FOR TECHNICAL QUESTIONS**

NAME	ADDRESS (Street — City — State)	List here specific article on which you wish literature.	If Catalogue of complete line is wanted, check in this column.
.....
.....
.....
.....
.....
.....
.....
.....

Use this space if you desire information from a manufacturer whose advertisement does not appear in this month's issue.

NAME	ADDRESS (Street — City — State)	
.....
.....
.....

Your name Dealer's name

Your address His address

If you are dealer check here. City State City State

It's mahogany to the eye- but in fact it's Bakelite

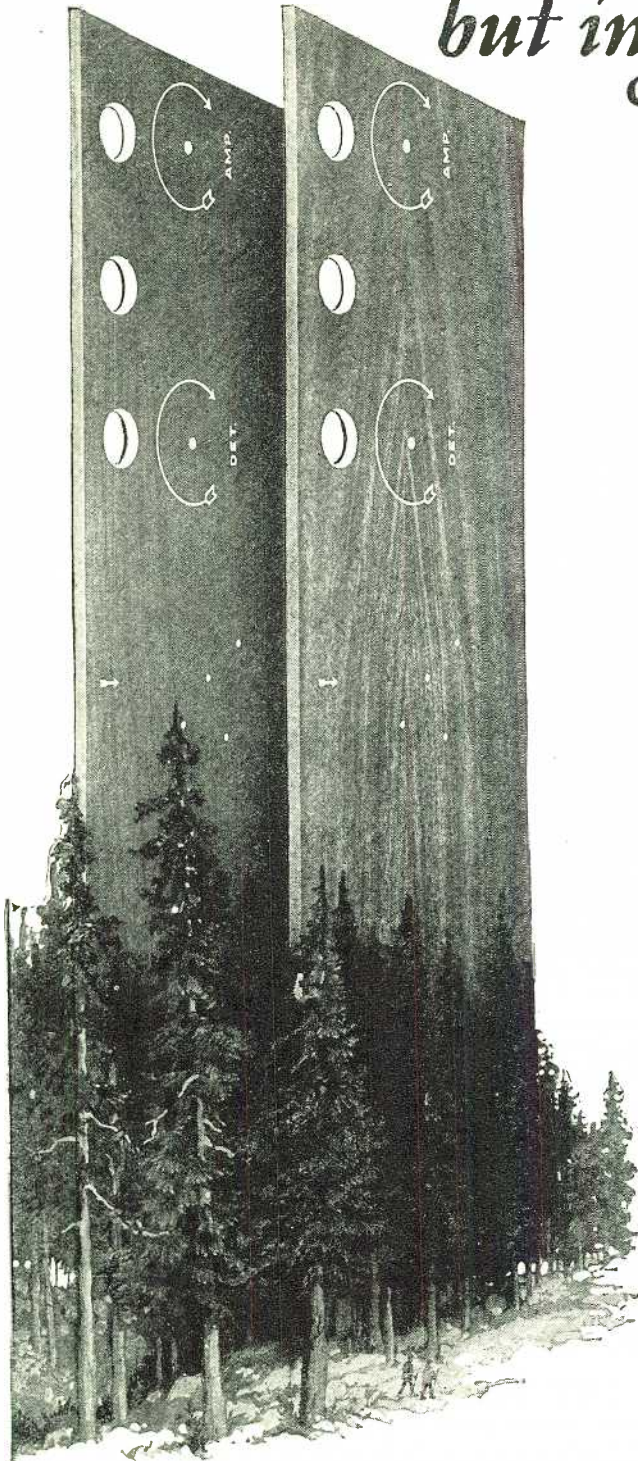

So perfectly is the grain and color of mahogany and walnut reproduced in these Bakelite Radio Panels, that the eye cannot distinguish them from the natural woods.

By using a Bakelite Panel that matches the wood in the cabinet, your finished set will be far more handsome than if a plain panel is used.

Rigid and strong, Bakelite Panels support the weight of heavy instruments without sagging. They will not compress, or cold-flow, under pressure of binding screws. Because of their resistance to extremes of heat, cold and moisture, they will not warp nor split. These properties and their insulation value, color and finish are permanent.

Be sure to ask your dealer to show you these wood finish Bakelite Panels—obtainable under any of the following trade-names:

TORMICA CELORON **Dilecto**
Spaulding Fibroc **Micarta**

A Bakelite Panel on a set is an indication that the manufacturer has used the best.

Write for Booklet 24

BAKELITE CORPORATION

247 Park Avenue, New York, N. Y.
Chicago Office: 636 West 22nd Street

Bakelite is an exclusive trade mark and can be used only on products made from materials manufactured by the Bakelite Corporation. It is the only material which may bear this famous mark of excellence.

BAKELITE

REG. U.S. PAT. OFF.



BAKELITL is the registered trade mark for the phenol resin product manufactured under patents owned by the Bakelite Corporation.

THE MATERIAL OF A THOUSAND USES



Selectivity means more with the Valleytone

Potential Balance exclusive in the Valleytone

The potential balance method of suppressing oscillation and preventing distortion is used for the first time and exclusively in the Valleytone Radio Receiver.

Reception is clear and mellow—free from the thin, hard, metallic sound and the howls and squeaks which have been the plague of radio.

Toroidal Coils

The Valleytone is the first manufactured set to use Toroidal coils. The Toroidal winding allows a greater coupling ratio between primary and secondary. The result is an appreciable increase in volume over the old solenoid winding.

Appearance

The Valleytone is mounted in a solid walnut cabinet, finished in two tones with inlaid gold stripes. It may also be procured in beautiful console models. Special Valley tables with built in loud speaker may be obtained for the cabinet model.

Finer tuning becomes a reality . . . selectivity means more with the Valleytone Radio Receiver.

For instance: The Valleytone has regularly received and separated clearly and distinctly, radio programs broadcast simultaneously from stations on wave lengths from four to five meters apart.

Such selectivity is attained in the Valleytone by the exclusive potential balance. The Valleytone circuit brings in stations sharply, clearly, and free from distortion.

With the Valleytone, you can enjoy radio as never before. You can get a station if it is on the air and transmitting strongly enough to reach you. You can choose your stations by the clock and hear them with the Valleytone.

The Valleytone is a five-tube set. It is manufactured by an old established company with the experience and the resources to assure you always the utmost in radio value.

Before you buy a radio, see the Valleytone. Hear it. Let an authorized Valley dealer give you a demonstration.

VALLEY ELECTRIC COMPANY, Radio Division, ST. LOUIS, U.S.A.

Branches in Principal Cities

Valleytone
Receiving Sets

Valley
Battery Chargers

Valley
B-Eliminators

Valley Electric

For radio at its best you need these, too

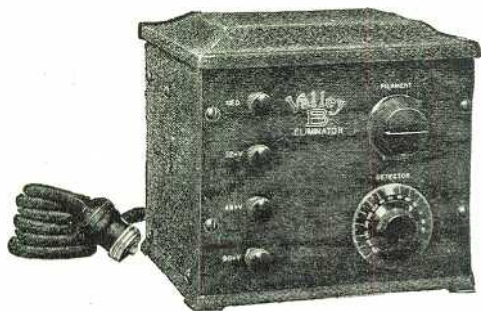

Valley B-Eliminator

The Valley B-Eliminator is made for receiving sets of from one to eight tubes. Binding posts and control rheostats are mounted on Bakelite panel. The unit is enclosed in a handsome black case.

It costs less at the start than wet B batteries and less in the long run than dry cells, too. Much more satisfactory than either.

Like new B batteries every night

Here is a new and better way of supplying B voltage for radio reception.

B batteries wear out. They cannot be the same two nights in succession. As they decrease in strength, volume decreases, too. Furthermore, they become noisy as they wear out.

The absolutely ideal B battery current can be obtained only by the use of fresh new B batteries every night. The same ideal results can now be obtained by the use of the Valley B-Eliminator as your source of B voltage. In its performance, the Valley B-Eliminator is like a new set of B batteries every time you tune in and every second you are tuned in.

The Valley B-Eliminator is more than a substitute for B Batteries. It is a new and better way of supplying B voltage for radio reception. It operates on the house lighting circuit and provides B current *at a constant voltage all the time.*

Hence reception is always at its best. There is never any decrease in the strength of signals and none of the frying noises or hum which are due to low B batteries. Volume is maintained. Reception is uniformly good.

The charger with ten points of superiority

The Valley Battery Charger has a reputation for results. It is based on principles which were proven successful long before radio became popular.

It is the only charger needed for all radio batteries:—6 volt A batteries; 24, 48, 72 or 96 volt B batteries; and 2 volt batteries.

It has ten points of superiority

- 1 No bulbs.
- 2 No liquids.
- 3 Quiet in operation.
- 4 Cannot harm your battery.
- 5 Efficient. Takes about a dime's worth of current for a full charge.
- 6 Correct 6-ampere charging rate enables you to recharge your battery overnight.
- 7 Ammeter mounted flush with panel shows if battery is receiving charge and if charging rate is correct.
- 8 Special switch for B batteries. Voltages: 24, 48, 72, 96.
- 9 Has only two wearing parts, the contacts, which can be replaced easily and cheaply. Average life of these contacts about two years.
- 10 Built in handsome black case with grained and engraved Bakelite pane and clear glass top which shows simple patented working parts. Harmonizes with the finest receiving set.

These features are all essential. Be sure of them by getting only a Valley Battery Charger.



Valley Battery Charger

VALLEY ELECTRIC COMPANY, Radio Division, St. Louis, U. S. A.
Branches in Principal Cities

Valleytone
Receiving Sets

Valley
Battery Chargers

Valley
B-Eliminators

Valley Electric

What's new
in
Radio
?

R.E. Lacault

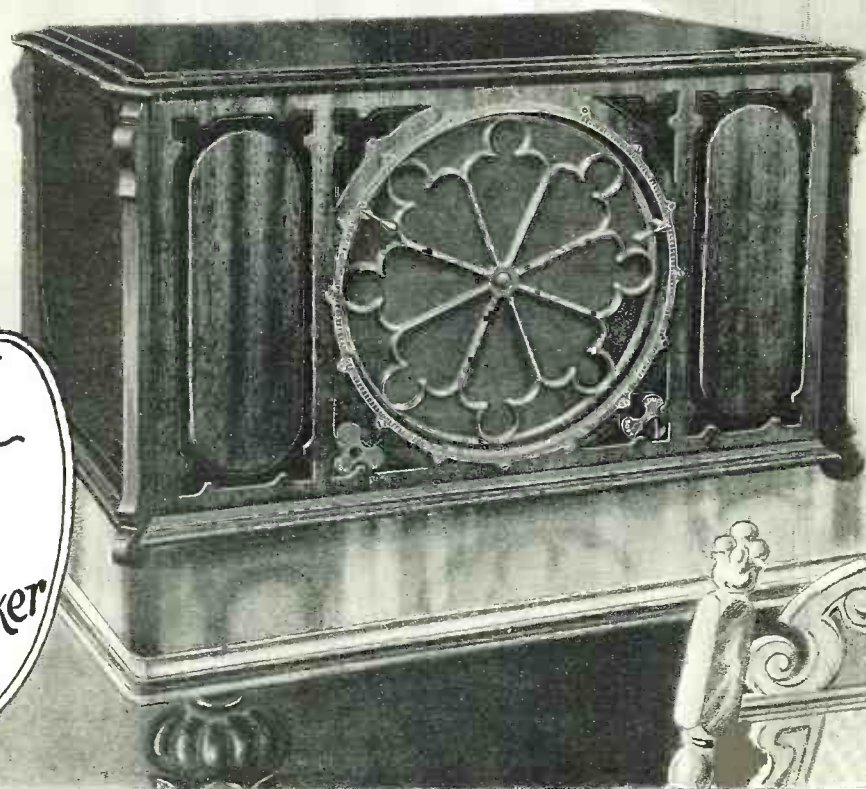
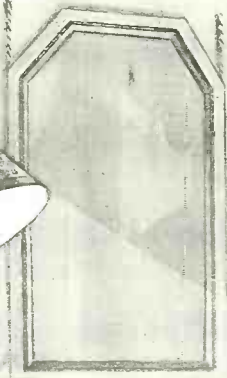

no panel-
no dials-
built in
loud speaker
\$135



Leads Again

The Greatest Advances in Radio Design are Embodied in the

new

ULTRADYNE

MODEL L-3

IF the Ultradyne Model L-3 were merely another new receiver, its influence in the industry would be little felt.

But it is in reality the first step in the general revision of radio receiver design which is bound to follow its advent.

For the new Ultradyne Model L-3 is an entirely new type of receiver—radically different in appearance and method of operation—gives finer results from finer engineering. Employs 6 tubes, is completely assembled and wired ready for the tubes and batteries.

It has no dials—no panel—no needless controls. Two levers, an exclusive Ultradyne feature, give you control of the entire broadcast program. Its operation is practically automatic—simply slide the pointer to the station you want and adjust the volume control, soft or loud as you like.

Loud Speaker and "B" Batteries self enclosed in a beautiful cabinet that is far from mechanical in design and an ideal mahogany furniture piece for the most charming home.

This new Ultradyne Model L-3 gives you the best there is in radio—truer reproduction than you have ever known before.

Ask your dealer for a demonstration. The contrast between the Ultradyne and other receivers is so marked that the desire to own one will be bred there and then.

Write for descriptive folder

ULTRADYNE

MODEL L-3

PHENIX RADIO CORPORATION

114 East 25th Street :: :: New York City



R. E. Lacault

Developments which have taken place in our plant over a period of a year, under the personal direction of R. E. Lacault, E.E., formerly radio research engineer with the French Signal Corps Research Laboratories, now stamp the new Ultradyne as the most remarkable radio receiver—remarkable in uniqueness of design, method of tuning, compactness, selectivity, clarity and volume.

To protect the public, Mr. Lacault's personal monogram seal (R. E. L.) is placed on the assembly lock bolts of all genuine Ultradyne Model L-3 Receivers. All Ultradynes are guaranteed as long as these seals remain unbroken.



BOSCH BUILDS RADIO

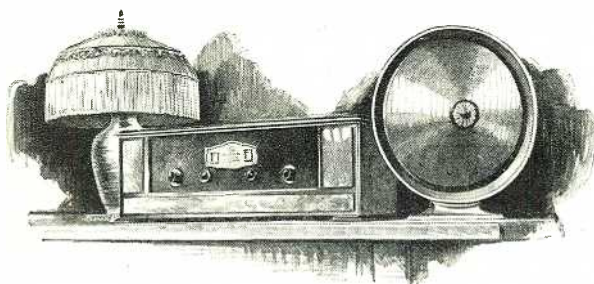

THE AMERICAN BOSCH MAGNETO CORPORATION PRESENTS "THE AMBOROLA," THE BOSCH RECEIVING SET AND "THE AMBOTONE," THE BOSCH REPRODUCER. THESE INSTRUMENTS HAVE BEEN BUILT TO THE FAMOUS BOSCH LINE OF PRECISION AND ALL THE EXPERIMENTATION ON THEM HAS BEEN ACCOMPLISHED IN THE BOSCH LABORATORIES RATHER THAN IN THE HOMES OF THEIR PURCHASERS.

THE AMERICAN BOSCH MAGNETO CORPORATION
SPRINGFIELD, MASS.

BOSCH RADIO POLICY

1. BOSCH PROTECTION FRANCHISE

NO DISCOUNTS TO OTHER THAN AUTHORIZED DEALERS HOLDING THE BOSCH FRANCHISE.

2. BOSCH TERRITORIAL PROTECTION

TERRITORIAL FRANCHISE DEFINED AND ALL RIGHTS PROTECTED

3. BOSCH PRICE GUARANTEE

THE DEALERS PROFITS ARE PROTECTED BY GUARANTEE AGAINST PRICE REDUCTIONS UNLESS DEALER IS REBATED

4. BOSCH RATIFIES DEALER CONTRACTS

ALL CONTRACTS MUST BE RATIFIED BY THE MANUFACTURER

5. BOSCH CO-OPERATION

EXTENSIVE CONSUMER AND TRADE ADVERTISING IN NATIONAL PUBLICATIONS. CLOSE LOCAL NEWSPAPER CO-OPERATION.

6. BOSCH STABILITY

THE BOSCH RADIO POLICY MAINTAINS THE SAME ETHICAL STANDARDS WHICH HAS BEEN THE BOSCH PRACTICE FOR 15 SUCCESSFUL YEARS

7. THE BOSCH DEALER

THE BOSCH FRANCHISE IS A MAN SIZED, TWO FISTED OPPORTUNITY FOR ONE RECOGNIZED BUSINESS MAN IN A LOCALITY--WHO IS ABLE TO CONDUCT AN INTELLIGENT SUCCESSFUL BUSINESS OVER A COURSE OF YEARS.

ARE YOU THE MAN?

THE AMERICAN BOSCH MAGNETO CORPORATION
SPRINGFIELD, MASS.

KODEL RADIO

The Emblem of  Worth in Radio

Setting a New Radio Standard



LOGODYNE *\$90⁰⁰*
"BIG FIVE"

Five tubes, self-balanced tuned radio frequency; sloping panel gold engraved; beautiful, massive, Adam brown mahogany cabinet; compartment for batteries; stations already logged for easy tuning.

Radio for years to come will not offer a better receiver than the LOGODYNE Big Five. Combining the utmost in performance with striking beauty of cabinet design, the LOGODYNE Big Five represents a triumph in radio engineering and artistry of manufacture.

No receiver could better express or exemplify the high standard to which the entire KODEL RADIO line is built—for KODEL RADIO is, without a doubt, the best that radio offers.

Free Send for the new edition of our free booklet "The Secret of Distance and Volume in Radio". Gives helpful interesting information on radio operation.

THE KODEL RADIO CORPORATION
501 East Pearl Street Cincinnati, Ohio



LOGODYNE "Big Five" Console Model—the Aristocrat of Radio; built-in loud speaker; compartment for batteries and charger a masterpiece in furniture design. \$275



LOGODYNE "Standard Five" Console Model—beautiful brown mahogany; built-in loud speaker; compartment for A and B batteries and charger..... \$165



LOGODYNE "Standard Five"—five tubes self-balanced tuned radio frequency; gold engraved panel and sub-panel; battery compartment; handsome brown mahogany cabinet..... \$70

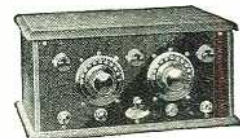

KODEL "Gold Star" Models—Radio's greatest set values;
Three Tube "Gold Star" Model. \$30
Two Tube "Gold Star" Model.. \$20
One Tube "Gold Star" Model... \$12
"Gold Star" Crystal Set..... \$ 6

The slow 2-ampere battery charger is as obsolete today as the old "one-lunger" of 1903



Buy nothing' but an up-to-date 5-ampere charger!

The New Improved
5 AMP. A & B
GOLD SEAL
HOMCHARGER
\$19⁵⁰

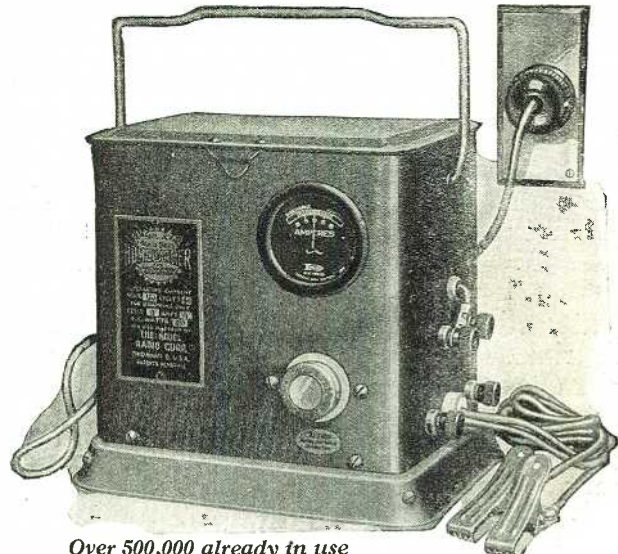

Over 500,000 already in use

Charges 150% Faster!

Better Because:—

New micrometer adjustment, hinged lid, and carrying handle.

No bulbs to buy or break.

Can be used anywhere—contains no acids or other harmful liquids to spill.

Approved by underwriters—trouble-proof, shock-proof and fireproof.

Beautiful cabinet in maroon and gold.

It takes only one-third as long to charge a battery with the New Improved GOLD SEAL HOMCHARGER. The big, healthy 5-ampere charging rate does away with the long bothersome waits that were necessary when the obsolete slow 2-ampere charger was the best that radio offered.

The New Improved GOLD SEAL HOMCHARGER charges 150% faster—will charge your battery overnight! And it charges both A and B batteries without additional equipment.

Don't let anybody sell you a slow 2-ampere charger—they are obsolete—out-of-date. You need a modern charger with a full 5-ampere rate. Insist on the GOLD SEAL HOMCHARGER.

Free Write for new edition of our instructive booklet on radio operation "The Secret of Distance and Volume in Radio."

The Kodel Radio Corporation
501 East Pearl Street Cincinnati, Ohio





AN attractive cabinet can never make an Ozarka out of any other radio. Far too many radio buyers pay more attention to the outer appearance and not enough to the

inside. The service behind the radio you buy is even more important than the inside or outside—your satisfaction depends on it. Let us see just what radio service is.

When your automobile runs as the manufacturer intended it should, it is a real pleasure to drive it. But what do you do when something goes wrong? Do you immediately condemn the car?—no. Do you call in some handy man who can fix anything?—no.

You send for a service man who is trained in repairing your make of car. To correct the fault is easy for him because he knows. Some other mechanic might have to tear the car apart to locate the trouble.

The same is true of radio, no matter what price you pay—you will sometimes need the service of a service man. If he is factory trained and experienced he can and will deliver the kind of service you know you ought to have.

Ozarka instruments are only sold by direct factory representatives who are required to take a complete course of instructions of Ozarka service directly under Ozarka engineers. By so doing we are

assured that every purchaser of an Ozarka will have an experienced service man within his reach at all times. 3100 such men today comprise the Ozarka service organization—more are being added daily. Ozarka service does not add a single cent to the price you pay for your radio—then why not benefit by it? And remember, Ozarka is a radio instrument built of the finest units, carefully and correctly designed exteriorly and interiorly. Cabinets are ultra modern, finely finished—a most attractive addition to the appointments of the beautifully furnished home.

Ozarka circuits have proved themselves for four years by comparison with other high grade receiving sets. Whether you plan on installing a radio in your home, now or later, you deserve to hear the Ozarka. The Ozarka man will demonstrate the Ozarka to you right in your own home—under exactly the same conditions you will continue to use your set. Then there can be no disappointment later.

Ozarka instruments are only sold in competition side by side with others—you do your own tuning and therefore decide for yourself just what an Ozarka will do for selectivity, distance, volume and above all, tone.

Send for the book Ozarka Instruments No. 200; please give name of your county and we'll gladly have our Ozarka representative arrange a demonstration for you in your own home.

We Need a Few More Ozarka Representatives

RADIO offers a wonderful opportunity to men who wish to get into business for themselves. It is work that can be done, at the start, in the evenings and in your spare time. You can hold your present position and learn radio under our plan. Ozarka instruments have been on the market for four years—they have successfully met all competition. Ozarka representatives have made good, not only because Ozarka Instruments are right but because our training in both selling and service is the most complete possible.

All we ask is that you are willing to purchase your demonstrating instrument and willing to learn what we are willing to teach you.

We have proven with 3100 men that with this training you can make good in radio. The Ozarka sales course consists of twelve lessons—a real course in salesmanship that costs you nothing—our training in service is so complete that you will know Ozarka Instruments in every detail.

The man we want is somewhat mechanically inclined—he is steady, industrious, has lived in his community some time. He stands well, not because he has money but because he has conducted himself in a manner to gain the respect of his fellow men. He may not have much money but he is not broke. He has a job but may still be having trouble in making both ends meet. He really wants a business of his own.

Send Coupon for FREE Book

To such a man, who will freely tell us something about himself we will gladly send a copy of the Ozarka Plan No. 100, a rather unusual book. You'll find it interesting because it proves why some men are millionaires and how others made them so—why some men get to the top while others don't—best of all it will show you how you can make more money and become really independent. Send for it today, but please mention the name of your county.

OZARKA

122 Austin Avenue E
Chicago, Illinois



INCORPORATED

122 Austin Avenue E
Chicago, Illinois

Gentlemen: Without obligation send book "Ozarka Instruments No. 200" and name of Ozarka representative. 9-25-122E

Name.....
Address..... City.....
County..... State.....

Gentlemen: I am greatly interested in the FREE book "The Ozarka Plan" whereby I can sell your radio instruments. 9-25-122E

Name.....
Address..... City.....
County..... State.....



RADIO NEWS

H. GERNSBACK, Editor and Publisher
SYLVAN HARRIS, Associate Editor

EDITORIAL AND GENERAL OFFICES, 53 PARK PLACE, NEW YORK

Vol. 7

OCTOBER, 1925

No. 4

ADVANCES IN RADIO

By HUGO GERNSBACK

WE have always with us that element which tends to speculate on revolutionary discoveries in radio. As the writer has pointed out many times before, if there are revolutions in radio they surely will not be on the receiving end for some time to come, but will be, rather, on the broadcasting end.

Radio sets follow a close parallel with the phonograph and the automobile, where, to be sure, changes are made every year in minor improvements, but all three remain, roughly, the same. Last year's model, or the model of two years ago, whether phonograph, automobile or radio, will serve just as well this year and the year after. The next few years will see improvements in the physical appearance of radio sets, as well as greater simplicity of controls. The tendency seems to be to have as few knobs as possible, or, if there is more than one control, to greatly simplify the other-controls.

But out in the broadcast field great changes are coming about, and we may say that revolutionary changes will be effected in many phases during the next year. To be sure, none of these changes will affect the listener, except that he will have better programs, and that there will be less confusion than there is today. What radio engineers are trying to accomplish is to do away with confusion and interference. Little by little, we are learning how to overcome a great many natural defects of radio broadcasting. In a very interesting article in this issue, we are reporting on some of Dr. Alexanderson's revolutionary work. He proposes to do away with one of radio's greatest enemies—fading—by using a polarized wave—a brand new thing in radio.

We all know how some of our most popular stations, if we are more than 100 miles away from them, will come in strong one second and will fade out almost entirely the next. The two pioneer stations, KDKA and WGY, are possibly the best examples of this fading nuisance.

Then Dr. Alexanderson hopes, by a new combination, to do away with, or reduce static, one of the greatest banes of radio today. Sooner or later the secret of "anti-static" will be discovered and we shall then be able to listen to our sets in the summertime without having our reception spoiled by this greatest of nuisances. There is one remedy for static which is almost certain, and that is to bury the transmitting and receiving antenna underground. The experiments of Dr. Rogers, of underground wireless fame, point this way, and the writer has no doubt that sooner or later one of our great stations will have underground transmission, which will make for clearer and better transmission, and will also give an additional range to such a station.

On the receiving side this is not such a simple matter. If you are located in the country and can bury your antenna in a 75-foot insulated duct, the reception will be greatly improved. Unfortunately, such an underground aerial is also highly directive. If it points west, you will receive sta-

tions from the east at maximum strength, while those on the north and south and west will come in very poorly. The next best thing, then, would be to have a number of buried aerials radiating to the different points of the compass and connect all of them together. This remedies the directional effect, but unfortunately it is too costly an antenna for the average broadcast listener, and besides, he doesn't have sufficient real estate, as a rule, to install such a system. Furthermore, in the city it is practically out of the question. Of course, in the city, even in steel apartments, we can use a loop antenna, but it is found that a loop antenna still picks up a good deal of static, particularly when a thunderstorm is near, and while static is not as serious as with the outdoor aerial, still there is enough to spoil many a good program.

The tendency of our bigger stations seems toward greater power. Up until now, the first class stations averaged 500 watts, with a few at 1,000 and 1,500 sprinkled sparsely among them. During the summer, a number of 5,000-watt stations have made their appearance, and one of these has gone to 50,000 watts. The latter, WGY, of Schenectady, is now experimenting with this superpower. Several hundred miles away from this station its signals come in as loud as those of a local but still fade as before. This will probably be remedied sooner or later if the new Alexanderson polarized wave is used.

While superpower may help somewhat when there is little static, yet, even with stations of 50,000 watts or over, an approaching thunderstorm will be sufficient to spoil the program. What superpower does is to make it possible for the listener within a thousand miles to use a less sensitive set than he would need otherwise. With superpower the intensity of the signals is such that a good 4-tube set does what the super-heterodyne did before. People with crystal sets within a radius of several hundred miles will be enabled to listen in, where heretofore 25 miles was the maximum.

The next important thing with which our engineers are troubling themselves is the crowding of the stations. At the present time it is almost impossible to separate some of the stations on account of this crowding. Engineers are now hopeful of partly remedying this trouble by making the tuning at the sending end much sharper, so that each station will take up less room on the dial than it does now.

As we all know, a radio station has its actual wave, then there are side bands, and it is these side bands that cause heterodyning with other stations that are on the same wavelength. If the transmitting stations did not require any side bands at all and could operate on their exact waves, we should rarely have such a thing as interference from other stations. As a matter of fact, we could operate a great many more stations than we do now without interference. While no actual solution for this has as yet been found, engineers are hopeful that there is a remedy.

Mr. Hugo Gernsback speaks every Monday night at 9 P. M. from Station WRNY on various radio and scientific subjects.

The Behavior of Radio Waves

By DR. E. F. W. ALEXANDERSON

Dr. Alexanderson, who has been associated with radio for many years, is an authority in this field whose name is well known to the reading public. RADIO NEWS takes great pleasure in presenting this special authorized interview with him on a new and very interesting phenomenon in radio—the behavior of polarized waves.



IN the future we shall point our radio transmitters at the receiving station we wish to speak with, and then fire them as we do our big guns today. We are constantly learning more and more concerning the nature of the propagation of radio waves, and as soon as our knowledge is more nearly complete we shall be able to determine just what frequency, what power, what type of antenna should be used for the greatest possible efficiency at any time of day or night and in any direction from the transmitter.

This branch of radio science has been, in the past, very reluctant to give up its secrets. The engineers have, of course, learned that under certain conditions a radio wave will do certain things. With this knowledge they have erected and put into operation the great industry we use so constantly.

But the point is that the physicists and the laboratory engineers whose business it is to investigate the natural phenomena without reference to their practical applications have been unable to collect very much data concerning the why and wherefore of the action taking place in an antenna when it gives rise to the radiation of power into space and the exact nature of the action in that space, as the signal is carried to the receiving station.

Investigations of the last ten years have only been complicated by the work of Einstein and others by their taking away the ether, upon which so much of the previous theories had been founded. This deletion

of the ether has not changed the actual operation of radio waves, of course. It has simply changed our conception of the problems involved.

THE ELECTRON, THE BASIC PROBLEM

At the foundation of the whole problem is the electron. We know pretty well that

And here is as far as we may go with certainty. But in order to visualize to ourselves just what is happening, so that we may have some idea as to what actually takes place when we set a current in motion in an antenna and obtain a resultant force radiation, we must imagine, as nearly as possible, the purely physical reactions oc-

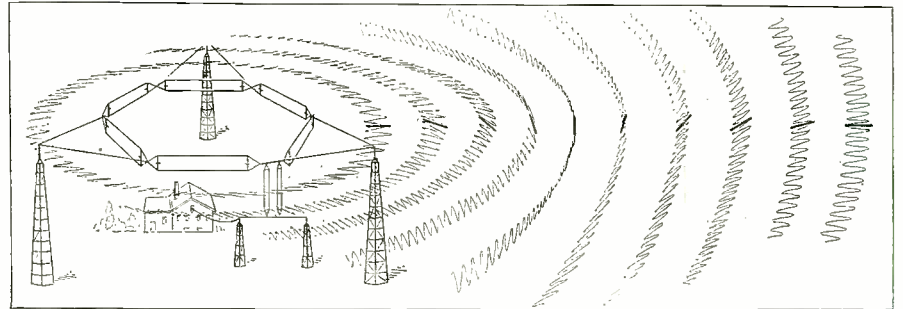

How polarized radio waves act when they are sent out into space from a horizontal multiple tuned loop antenna.

any passage of electrical current through a conductor is accompanied by a movement of the electrons in that conductor. This point is generally accepted among the scientists as fairly well proved.

The same thing occurs when the high frequency, high tension current is sent into an antenna. The electrons in the wire move in it according to the half-cycle passing through.

curing in the conductor and in the space.

Since the deletion of the ether hypothesis, there has been a tendency among the physicists to accept the electron as a center of a field of force. Some—including Einstein—go further and say that the electron is nothing more than a field of force. However, to be a bit more conservative, let us suppose for the moment that the electron is as it has always been considered, the negative unit charge, with mass. The next step in the new line of thinking is that the electron, being a center of force, drags a tentacle-like effect with it in its travels. That is, when the electron moves, being the center of a force, it carries a field of strain with it. It must be considered that the strain always follows the electron.

So it should be quite possible for the electrons, moving in the antenna, to impart their force to the space around the antenna. In fact, this is probably what happens.

How this power travels through space must remain somewhat of a mystery until we discover something more of the nature of "action at a distance" or the properties of "space." At present, under the Einstein view and the hypotheses of other scientists and mathematicians subscribing to the same sort of notions, we must take the view that it is a matter of simply stirring up the "force" which pervades the universe. This is all very disorganized, however, and must remain in that state, pending the further investigations of the pure physicist.

But we do know that we are gaining a more thorough knowledge of the immediate effect on transmission efficiency of certain types of antennae and their consequent wave forms.

PECULIARITIES OF SHORT WAVES

The coming of the high frequencies or short wave-lengths has introduced a whole new field of investigation, which has brought us much more closely in touch with the problems and theories mentioned above. We now know that the short waves are effective almost entirely through the agency of their high angle radiation, that is, their transmission is almost solely through waves which leave the antenna, travel upward into the higher strata of atmosphere and are re-

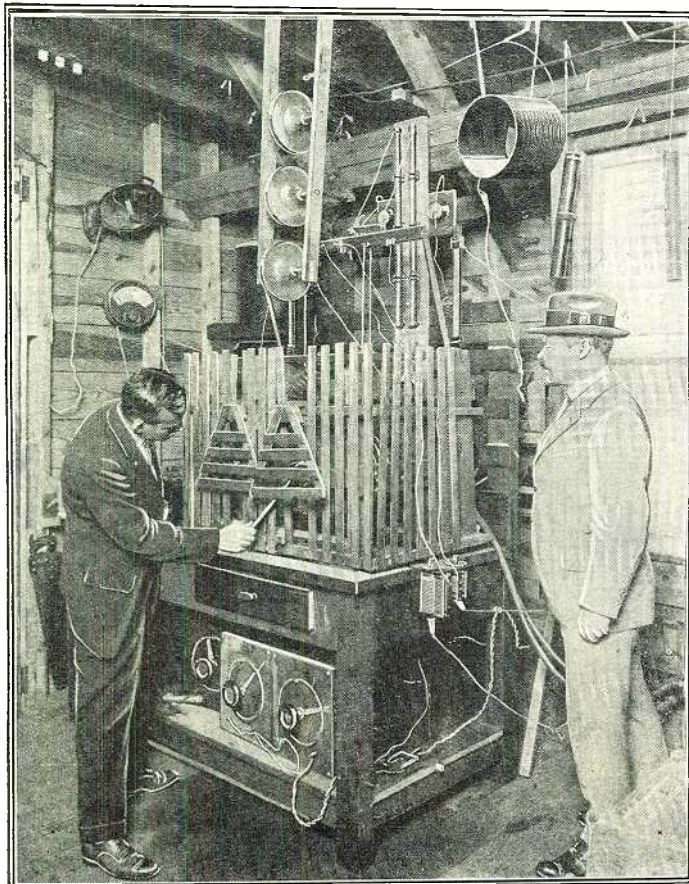

Dr. Alexanderson (on the right) in the laboratory where the transmitting apparatus for the short waves is housed.



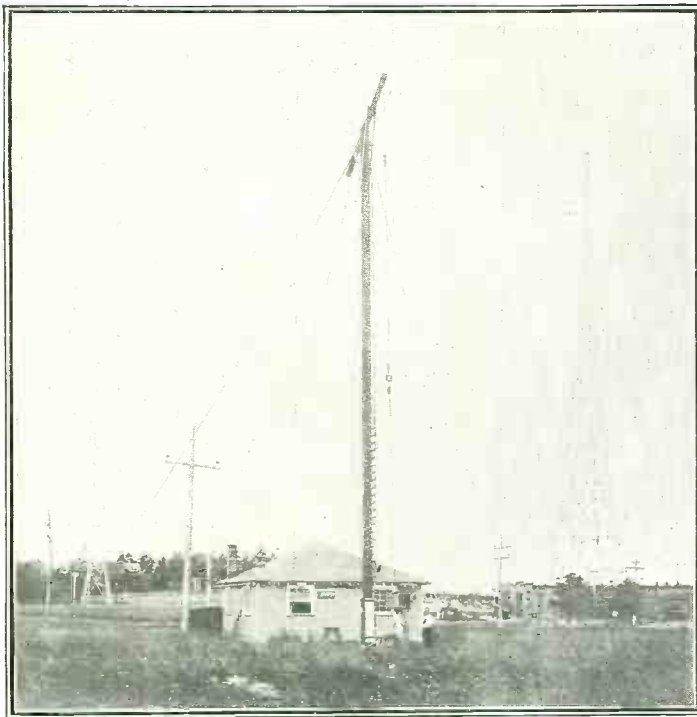

←←←
The meter in the vertical leg of the antenna which is such an important factor in the generation of the polarized waves. In each vertical section of the antenna there must be an absolute balancing of the current for maximum results.

→→→
The portable receiving meter is shown on the right being inspected by Dr. Alexanderson. It is with a meter of this type that the polarized effects of waves are studied.

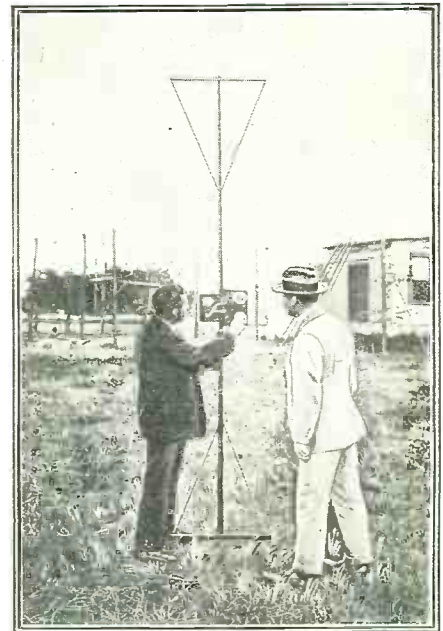

THE ANTENNA

A word concerning the antenna: It is built to radiate at the shorter wave-lengths and consists of six tuned units. The current from the oscillator is carried to each end of the closed loop. In these high frequency leads there are two meters, one in each lead. In the erection of the antenna and the balancing of the circuits it is very necessary to see that they both have the same reading, that is, to arrange the circuits and their constants in such a way that there will be as much current coming out of the antenna as there is going into it.

It is all these considerations which lead me to believe that the future will find us taking the bearing of the receiver, looking at the clock for the hour of day and night, and at both the transmitter and receiver, and that the engineer at the transmitter will then select the proper wave-length, the proper hour and the proper type of antenna for his work. It will be just as if he were pointing a big gun at the receiver.

(Continued on page 554)

flected downward to the receiving station.

This path is very much on the order of a trajectory. That is, the path of the wave of the transmitter follows pretty much the Larmor theory of propagation. And I think these same short waves will show, before we are finished with them, that the Larmor theory, rather than the Heaviside layer theory, is correct. The upper layer is not necessarily a conducting one, but may, as brought out in the Larmor theory, be of such a nature as to reflect the waves in the form of a shell orbit. The proof of this will be mathematically adduced from experimental results with the new short waves. What data is already available seems to point to the correctness of these assumptions.

The exact nature of these waves, even, is not known. Along this same line of development and attack, which may throw a great deal of light on the action of waves, is the new horizontal polarization effect noted in the use of a horizontal loop. It has recently been observed that waves passed into space from a multiple tuned loop, supported in a horizontal direction, will radiate a peculiar wave, polarized in the plane of the loop.

The discovery of these waves may interest the reader. While we were engaged in some field test measurements, with different types of antennae, we noted one day that there was apparently no signal being radiated. The field test apparatus, which consisted of a short vertical antenna, was being carried around the station within a mile of the antenna. The meter in the receiving set, which registered the received current, showed that there was no radiation. Immediately we returned to the operating room to see if something had gone amiss with the generators. Upon arriving there we found that observation stations a couple of hundred miles distant were picking up the signals with ease.

This necessitated the postulating of the horizontally polarized waves.

Preliminary tests seem to show that as these waves travel further and further from the source, they change their plane in the manner of a cork-screw. This makes possible the reception of them, with the ordinary antenna, only at certain distances. This distance is dependent on quantities which are not yet thoroughly understood. However, from the experimental station of the

General Electric Company, where the first of the experiments were tried and where the phenomenon was first noted, the distance for the first turn seems to be in the neighborhood of fifteen miles.

A very interesting point in connection with the construction of antennae was also brought out in similar experiments with this particular type of wave. On one occasion, two vertical loops were employed as radiators. The meter current in the vertical legs of the loops was zero. The receiving station of the Radio Corporation of America at Riverhead, L. I., received signals with good strength and little difference from the usual reception. This was surprising until we took into consideration the generation of the horizontal waves. It happened that the vertical legs of the loops were neutralizing themselves while the horizontal portions were acting as good radiators of the new polarized type.

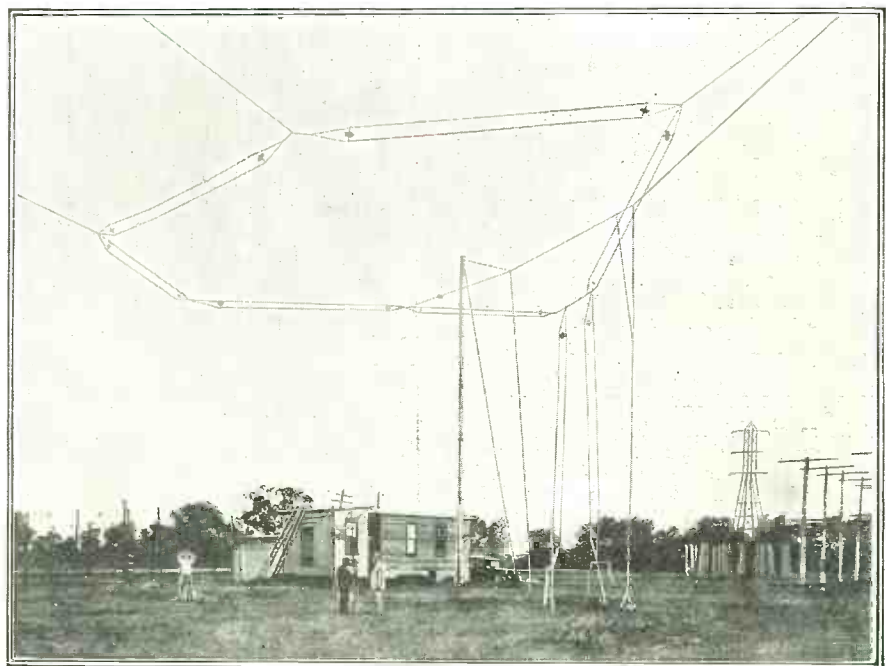

The antenna which is employed for the propagation of the polarized high frequency waves. Note the six sections of the horizontal loop.

Radio in Germany

By DR. EUGENE NESPER

A resumé of the latest occurrences in German radio circles, which should be of great interest to American fans.

SINCE the time when, about a year ago, the regenerative circuits represented the most popular receivers not only on the part of most of the leading radio manufacturers, but also on the part of amateurs and experimenters in Germany, a change had taken place. Influenced largely by the United States, the high economy circuits have come more and more into use. The tendency towards distortionless and highly selective circuits has also become manifest to an increasing extent.

In view of the fact that for the radio amateur time is no consideration and that he can consequently delve as deeply as he likes into radio technique, it is not surpris-

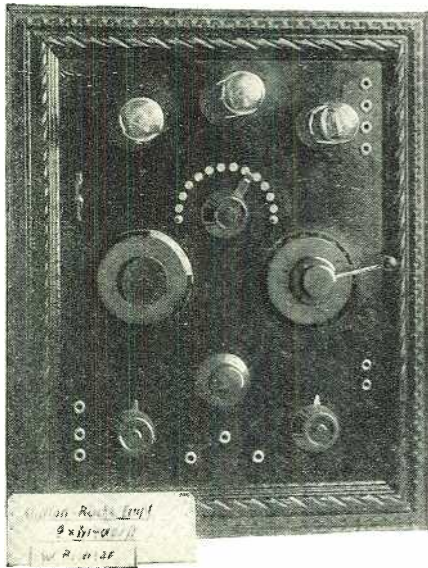

Fig. 1. A regenerative receiver with two steps of A.F. amplification.

ing that it is just in the field of complex radio circuits that amateurs have achieved remarkable success. The radio exhibit which the Cottbus Branch of the German Radio Clubs, under the leadership of Dr. Brühl, held on the 4th and 5th of June, 1925, displayed, therefore, very highly developed radio equipment. There were at this exhibit seventeen neutrodynes and about the same number of super-heterodyne sets which were built exclusively by amateurs and which could not be surpassed, even by the very best manufactured sets. In addition to this, the exhibit at Cottbus showed last year's developments in receiver construction.

In particular the following sets were noteworthy:

THE EVER-POPULAR REGENERATIVE

The regenerative receiver with two audio frequency steps shown in Fig. 1 meets the demands of the commercial designs fully. This apparatus, in addition to being highly efficient, is very ornamental. Here special emphasis was also placed on delicate adjustments.

In connection with this apparatus, as with all of those following, a schematic circuit diagram was displayed so that those interested could gain an immediate insight into the construction of the set.

A four-tube Reinartz receiver, similarly

fulfilling all aesthetic and technical requirements, is shown in Fig. 2.

Among the numerous reflex circuits displayed at the exhibition, the two-tube reflex, Fig. 3, deserves special notice. The inductances are arranged to give very fine tuning over the largest possible range. Among the devices for fine adjustment the specially designed short-circuiting plug is to be noted, as indicated in the figure.

Special interest was aroused by the neutrodyne receivers. Most of these, as well as most of the other apparatus, are designed for wave-lengths of 200 to 700 meters.

A very interesting neutrodyne receiver is shown in Fig. 4. This is similar to the Halenz apparatus, but unlike the latter has its tubes protruding through the top of the cabinet. In addition, this set has a feature which should be embodied in all highly efficient sets, that is, measuring instruments by which the current and voltage may be continuously observed and so maintained constant.

While the sets so far described were mounted in the usual cabinet, the Cottbus exhibit also displayed a number of receivers constructed in larger furniture pieces, especially in gramophone style. One four-tube Flewelling circuit in a gramophone cabinet is shown in Fig. 5. The tubes, dials and coils, etc., are mounted on a hard rubber panel, while the measuring instruments and binding posts are arranged in the rear. Below, within the gramophone cabinet, are the batteries.

Still more flexible equipment is provided in an experimental receiver (Fig. 6) which, by means of a few switches, can set up a number of different circuits.

In addition to these constructional and experimental activities, the Cottbus radio group maintains a short-wave broadcast station of about 90 meters and a capacity of 100 watts.

THE RADIO EXHIBITION

The first of September ushered in a new period in German broadcasting. On this day the regulations and prohibitions that had interfered with the free development

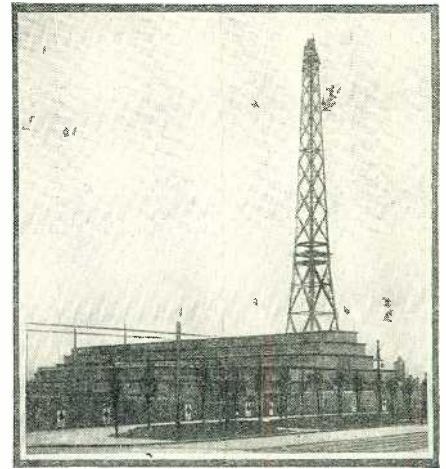

The exhibition hall built especially for radio in Berlin. The tower is the highest in Germany used for radio.

of the radio industry were abolished, and listeners and amateurs in Germany now enjoy the same freedom as those in the U. S. A.

Before this time the building of stronger receiving sets by the listeners themselves had been made practically impossible through stringent regulations by the postal authorities who admitted only certain types of sets specially approved by them. The sale of parts was a paying proposition for the manufacturers only so far as these parts were suitable for detector crystal receivers, which were not subject to restrictions. The manufacture and the sale of tube receiving sets was only a small one in this country, as listeners were not permitted to exceed a wave-length of 700 meters and the regeneration had to be very limited. All these restrictions disappeared September 1. The regulations for transmitting by amateurs, which had been practically identical with prohibition, have been relaxed as well.

The fact that, in spite of all these difficulties, the number of listeners in Germany has reached one million, of whom 38,000

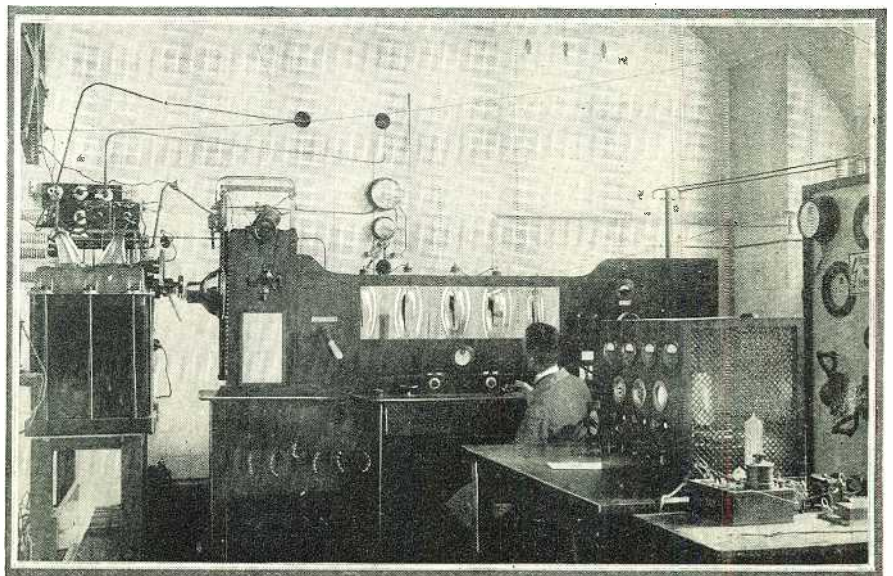

The 5 K.W. transmitter in the Königswusterhausen station, one of the largest broadcast stations in the world.

are residents of Berlin and its suburbs, is a sign of the keen interest of the people in radio. It must not be overlooked that broadcasting altogether has been given free in Germany only since the end of 1923 so that she is the youngest among the big nations in radio. On the other hand, very early broadcasting did take place in 1920, from January till June, in Berlin. Here the opera "Madame Butterfly" was taken through microphones in the state opera house, transmitted by an ordinary overland line to the sender 27 miles distant in Königswusterhausen and thence broadcast with a power of 10 kilowatts at the aerials and on a wavelength of 2,800 meters. This opera was heard at a distance of 1,900 miles. Later private Sunday concerts were broadcast from this sender for some time. Though the apparatus used were property of the postal authorities, the whole enterprise may be considered to be the first amateur broadcasting as it was due exclusively to the initiative of the manager of the station. The same sender opened the official German broadcasting in 1923 and is, at present, working nightly with 10 k.w. efficiency on a wavelength of 1,300 meters.

The organization of the German broadcast service is different from that of other countries in so far as all the transmitting stations are owned by the postal authorities. The broadcast service is in the hands of private companies which are quite indepen-

dent in their programs. The post supplies the transmitting machinery and in return participates in the capital of the companies to the extent of half the shares. There are, at present, nine broadcast companies in Germany with their stations in the main towns: Berlin (wave-length 505 meters), Breslau (418), Frankfurt (470), with relay transmitter Cassel (288), Hamburg (395), with relay transmitters, Hanover (296) and Bremen (279), Königsberg (463), Leipzig (455), with the relay transmitter, Dresden (292), Munich (485), with the relay transmitter, Nuremberg (340), Münster (410), and Stuttgart (443). A tenth broadcast company, with headquarters at Cologne, will be formed as soon as broadcasting is given free in the Rhinelands.

The power of the individual senders varies between 1 and 4 kilowatts, but preparations are being made to increase them to 8 k.w. and to interconnect them by cables so that, if required, the same program can be broadcast simultaneously from several stations.

Anybody may become a listener, the only formality being the payment of a license of two marks monthly at the nearest post

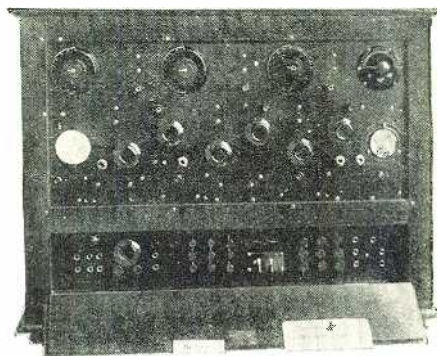

Fig. 6. Any number of different circuits may be connected by plugs and cords in this receiver.

150 feet, in the record time of three months, was quite an interesting architectural feat. The hall contains annexes for a special lecture hall, restaurant, recreation rooms, offices, etc. A special feature of the grounds is the enormous radio tower, a framework of steel 450 feet high, with an elevator to

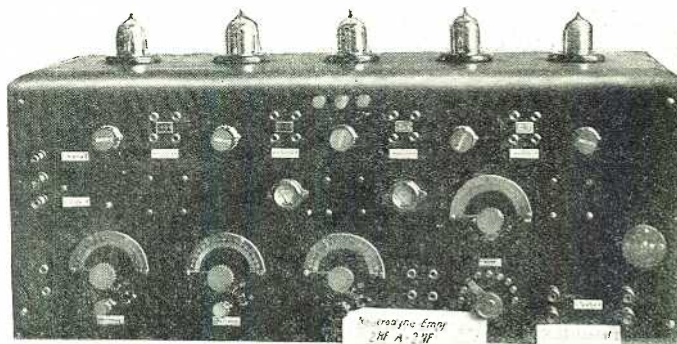

Fig. 4. A neurodyne receiver having two stages of radio frequency amplification, detector and two stages of audio frequency amplification. The indicating meters were considered a unique feature.

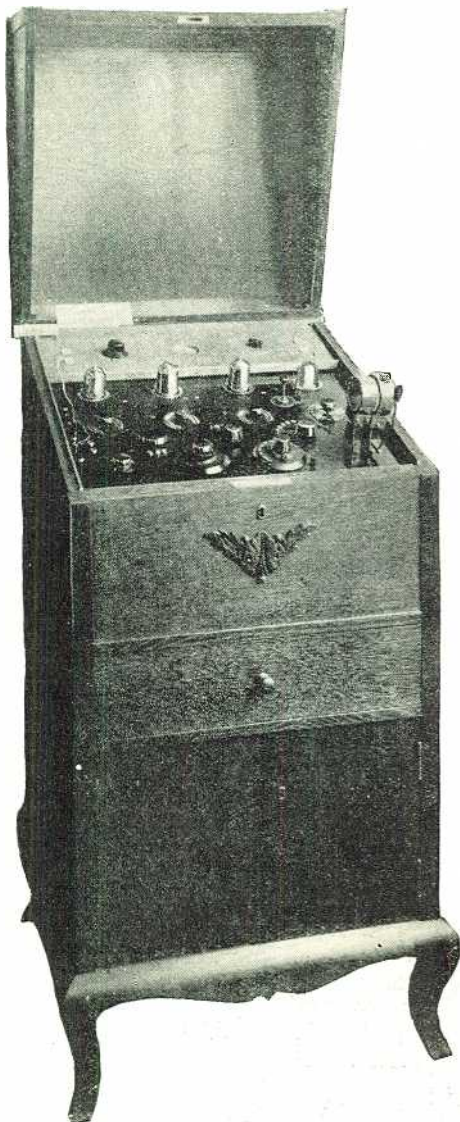

Fig. 5. This four-tube receiver, installed in a phonograph cabinet and using the Flewelling circuit attracted much attention at the exhibit.

office, of which amount the post retains 90 pfg. and hands 1 mark and 10 pfg. to the companies.

The German radio industry is organized in an association, the "Verband der Radio-industrie" which forms a kind of clearing house for the payment of the royalties to the owners of the different patents. They are charged according to the number of sockets built in the set, thus facilitating the most general application of patented devices to the best advantage of their owners, of the manufacturers and of the general public.

There exists also in Germany quite a number of radio periodicals of high standing, the *Deutsche Rundfunk* having the largest circulation. It has its own laboratory and an advisory office where thousands of inquirers get assistance and advice.

FIRST EXHIBITION

Considering the handicaps under which the German radio world was suffering, the first radio exhibition in the fall of 1924 must be considered a great success. Twenty-four manufacturers exhibited and the number of visitors was 200,000, so that the radio association decided to repeat the exhibition every year. This year, after all restrictions have fallen, the products of the German radio industry can compete with those of other countries on equal footing, and special provisions have been made that this be done under absolutely fair conditions. Indeed standard aerials will be mounted in the hall and sound-proof cabins provided. The "Radio Hall" of the Berliner Messe Amt, where the exhibition is being held again this fall, was built last year expressly to suit the special conditions of a radio exhibition. No steel or iron has been used in its construction. Brick and concrete and wood have been employed throughout so that no loss will be sustained through large masses of metal. The building of this hall, which is 400 by

the top platform, in which will be installed a restaurant accommodating 200 persons. Here the aerials for the official transmitting and receiving station are suspended.

Berlin is the center of the German electrical and radio industry. The majority of all concerns have their administration and shops there, which is one of the main reasons why Berlin has been chosen for this exhibition. Every manufacturer of consequence—dealers are not admitted as exhibitors—is represented, so that the exhibition gives a comprehensive idea of the development of the German radio industry. American radio experts who have recently visited the big wireless and broadcast stations at
(Continued on page 544)

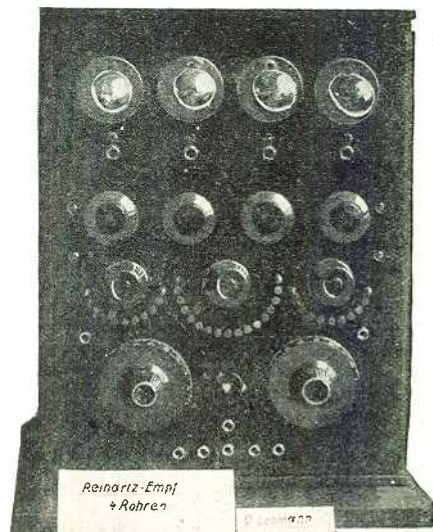

Fig. 2. A four-tube receiver employing the Reinartz circuit.



The Life and Work of Lee DeForest



PART XIII

AFTER the patent rights to the three-electrode amplifier had been duly sold for the sum of \$50,000, DeForest rushed back to his laboratory at High Bridge and started again his investigations, as of old. This had been his goal for some time, and back at the old routine again, wherein he could follow whatever lines of investigation he thought best, life again brightened.

As soon as possible, DeForest wired for Logwood to come on from California and take a position as assistant. This Logwood did gladly. It was only a short time before the laboratory was in full working condition and things were again progressing as before.

However, his fight with the ever-present bludgeon of circumstance must not be forgotten. The nine months he had spent getting an answer from the telephone company on the patent affair, his return to California for a short time and the final culmination of events, were such as to leave him not quite in his usual easy frame of mind.

RADIO TELEPHONE CO. REVIVED

But as swiftly as possible he resuscitated the old Radio Telephone Company, opened the laboratory and returned again to the improvement of the recently discovered oscillating audion. In the original discovery of the principle, of course, little had been learned of the characteristics of its operation, save that it was a generator of oscillating current. All the technique had yet to be worked out and the necessary mechanical and electrical details noted and put into shape for practical application. This was his first problem.

By the spring of 1914 things were again ship-shape and the laboratory was working on two very important developments in the radio field. The first was, of course, that just spoken of—the oscillating audion. The second was the construction of high frequency alternators with a quenched spark discharge for telephony. This latter part of the work was progressing with extreme rapidity and the laboratory engineers had

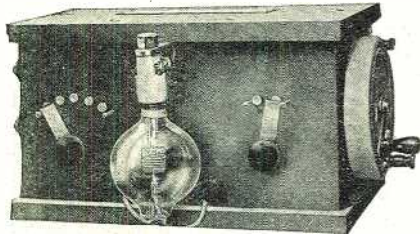

The first audion detector that the old-timers should remember.

succeeded in erecting a set which worked very well. The carrier frequency—the quenched spark discharge—was of such low frequency as to be audible at the receiver, but for the purposes of ordinary telephone, that is, the use of voice alone, an intelligible conversation could be carried on without the slightest trouble. The generators were built to operate at about 3,000 cycles.

For a number of months this field of investigation proved so profitable that some of the other engineers in the laboratory thought it held a great deal more promise than the audion in the rôle of generator. DeForest, however, did not think so. It held several important leads over the audion as it was

developed at that particular time, though, so work was continued on it.

Of course, the audion was hardly looked upon as an important development in the transmitting field as yet. But ever since DeForest had made his demonstration of the usefulness of the oscillating audion in the reception of arc and other undamped signals in preference to the old-time tikker method, there had been a considerable demand for the new type of detector. By the spring of 1914 all the large commercial stations in the country were using it almost exclusively in their receivers.

In April of that year DeForest thought the time was ripe for submittal of the device to the Bureau of Standards. Accordingly, he sent them one of the instruments and it was put on exhibition.

Another step in the advancement and perfection of this development was reached when DeForest took two of them and set them into oscillation, at the same time connecting their output circuits to a loud speaker. The two high frequencies which were generated, of course, caused a beat note which could be plainly heard in the loud speaker.

NAVY INSTALLS AUDION

It was shortly after a public demonstration of this stunt that the Navy became interested in the apparatus and desired complete data and information upon the construction and operation of sets using the DeForest audions. The demonstrations were a success and the Navy immediately ordered twenty of the DeForest receivers. A little later they sent in a second order for ten "drivers," as the oscillators were called.

With the constant advance of the mechanical staff in the manufacture of the tubes, by the early summer of the same year DeForest was able to take to London with him the first 110-volt Oscillon, as he called the oscillator. This tube proved to be a strong oscillator and a husky tube for commercial work. It was so good that water had to be used for cooling it while in operation.

Here a note must be made of a fact which has been too little stressed all the way through this treatise. It is that DeForest always—without a single exception—took each of his new inventions first to the Army and Navy for their examination so that they could be included in the defense and armament schemes of the country. This seemed, and still seems, to be a sort of religion with him. Though he has received little of the proper recognition for the fact, in every instance he has given the Government the fullest co-operation in the use of his apparatus.

The case just cited above of his giving the Navy and Army all the help they desired in connection with the Oscillon is just another case in point. Ofttimes the apparatus they ordered had to fulfill certain specifications. The new designs necessitated were always made, although at times they involved the greatest difficulty.

And while we are on the subject of co-operation, a word might be added about the catering of the various DeForest Companies to the amateur trade. In each of the organizations—and DeForest had a number of different companies at different times—the commercial heads insisted that there was absolutely no money in such small mail order business, and each time the charge was made, DeForest tried to explain that the idea was

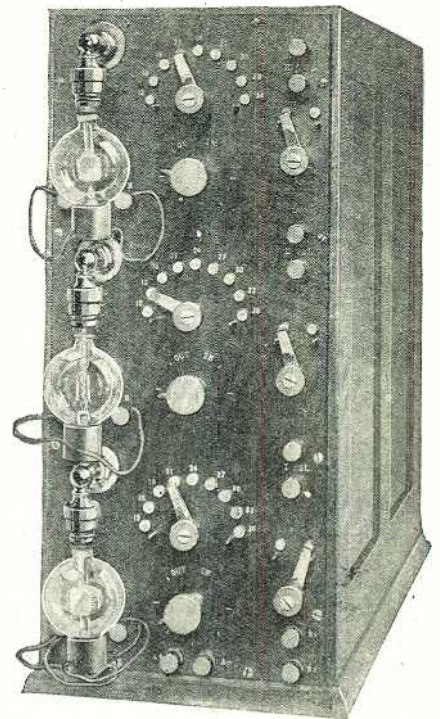

One of the first three-step audio frequency amplifiers.

not to make money, but keep the experimenters interested and to give them all the help possible in their hobby. The commercial entourage thereupon always showed the same lack of understanding, but allowed catalogues to be issued, just to please the Doctor.

This was particularly the case after the commercialization of the audion. There was no end of trouble in manufacturing it and the company had little capital to spare for stock on hand. DeForest, however, put up the usual fight and finally caused the directors to issue the usual catalogue.

PANAMA-PACIFIC EXPOSITION

Another of DeForest's *péchants* was the attendance of himself and his company at all expositions of world-wide interest. So, of course, plans were made—and rather complete ones—for the exhibit which was to be held at San Francisco, the Panama-Pacific Exposition. And thereby hangs one of the most interesting episodes of the relations between DeForest and the telephone company.

But let us parenthetically state that this affection for expositions may be well founded in DeForest's case. Those who followed the earlier chapters of this biography will remember the summer he spent at the Chicago World's Fair, early in his career. Almost a boy at that time and craving all the knowledge of engineering he could lay his brain to, the mechanical and engineering exhibits held him in thrall every evening after he had completed his work of pushing wheeled chairs about the grounds. It was one of the most enjoyable summers of his youth—and they were few. It might be that his attendance on these events in later years was simply an attempt to recapture some of the thrill and enthusiasm of his youth.

A ONE-FARAD CONDENSER

Comparative Sizes of a One-Farad Condenser and the Woolworth Building

HOW WOULD YOU LIKE TO OWN
A 117,300 PLATE CONDENSER?

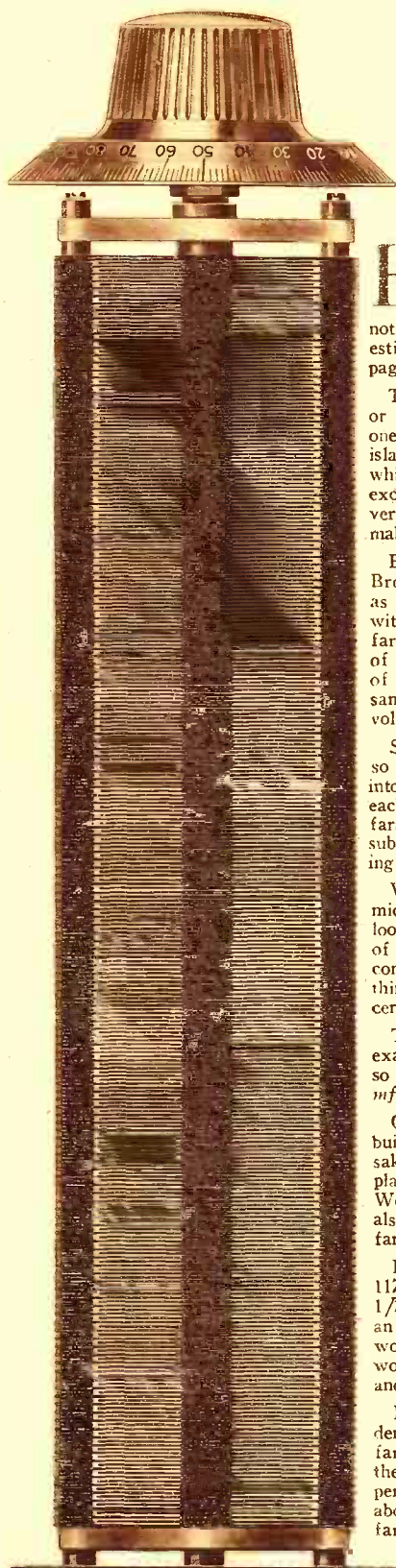

HAVE any of you the slightest idea of how big a one-farad condenser would be if it were possible to build one? Most likely you have not, especially if you have never tried to estimate its size, as we have done on this page.

To tell the truth, whether a farad is large or small depends a great deal on the way one looks at it. When Gulliver went to the island of Lilliput he found the pygmies which he called Lilliputians. They looked exceedingly small to him, but to them, Gulliver was a giant of size heretofore unimaginable.

But when Gulliver went to the land of the Brobdingnagians he looked as small to them as the Lilliputians looked to him. So it is with the unit of capacity—the farad. The farad was defined originally as the capacity of a condenser which could hold a charge of one coulomb of electricity and at the same time have a terminal voltage of one volt.

Such a thing, however, is impracticable, so we have imagined the farad as divided into a million equal parts and have called each part a microfarad. Even the microfarad is rather large, so we have further subdivided it into another million parts, giving us the micro-microfarad.

We are accustomed to dealing with the microfarad in radio calculations, so the farad looks enormously big, just as the inhabitants of Brobdingnag looked to Gulliver. On the contrary, if we were accustomed to such a thing as the farad, the microfarad would certainly appear insignificant.

Take the 0.0005 microfarad condenser, for example. This is $1/2,000$ of a microfarad, so that it would take 2,000,000,000 0.0005 mf. condensers to make a farad of capacity.

On the other hand, suppose we wanted to build a one-farad condenser, and for the sake of argument made the area of each plate nearly equal to the ground area of the Woolworth Building shown here. Suppose also we wanted it to equal the height of this famous building.

In that case, there would be required 117,300 plates, if these plates were spaced $1/25$ of an inch apart, and were $1/25$ of an inch thick. The height of the condenser would be 792 feet, the same as the Woolworth Building, exclusive of the end-plates and dial.

It is well known that a sphere is a condenser. To show how extremely large the farad really is, it will be well to note that the capacity of the earth, assumed to be a perfect sphere of conducting material, is about $72/100,000$ of a farad or 720 microfarads.

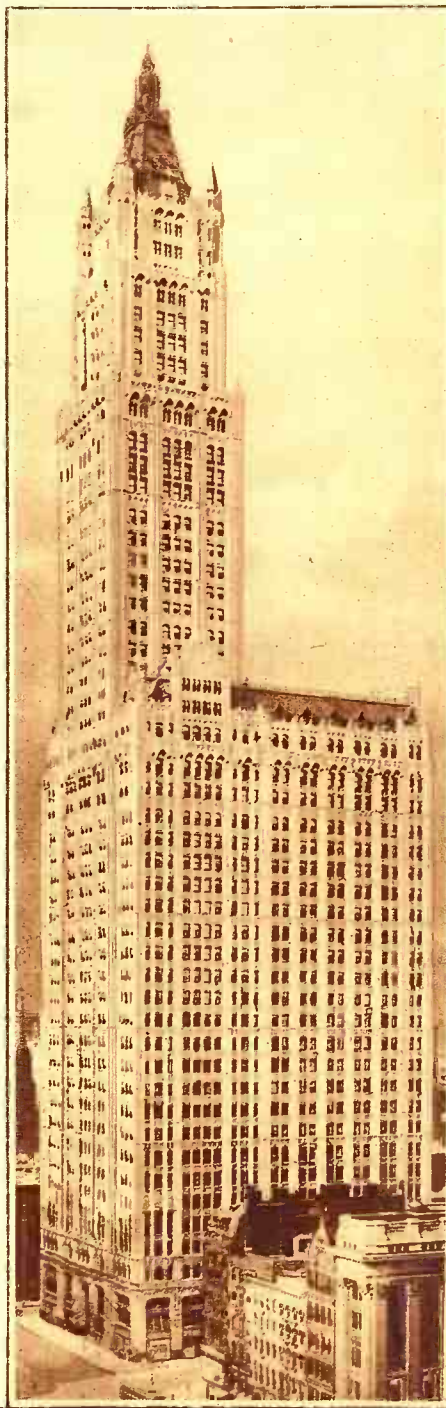

Superpower

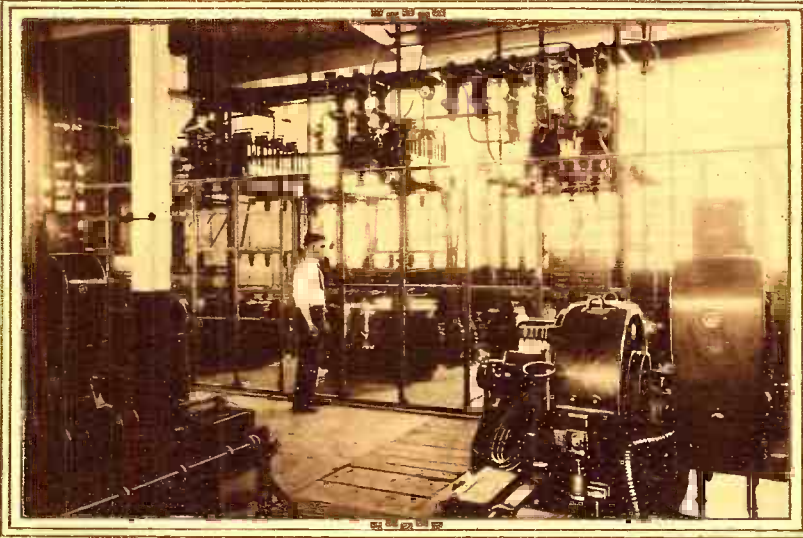

POWER GENERATING PLANT. These powerful generators supply the power for the transmitting station at the Schenectady plant of the General Electric Co. The bus bars for carrying the current to the transmitter may be seen in the top of the picture.

FOR the past six months there has been a great deal of discussion in the radio and general press concerning the use of superpower in broadcasting. For the most part it was mere discussion, sprinkled here and there with an account of some new station adding a few kilowatts which brought its total power to a possible five or six kilowatts.

At last we have the real thing in superpower—50 kilowatts. The first week in August the writer visited, with a number of other technical writers and correspondents, the new superpower station of the General Electric Company at Schenectady, New York.

SUPERPOWER STILL EXPERIMENTAL

Although the new, powerful transmitters are installed and in working condition—in fact, every day except Sunday the WGY program is also put on the air through the new stations—the engineers in charge of the work still classify the project as an experimental one. There are a large number of questions involved which are still to be answered, and the engineers at the station, the Department of Commerce and the general public cannot, in truth, come to any final opinion as to the efficacy or efficiency of the use of superpower until it has been given a thorough test.

It is the object of the technicians to settle these questions scientifically and finally through the new installations and the reports of their operation.

The whole question of superpower is bound up with propagation formulas, wave forms and the comparative efficiency of the added power as compared with lower output. The limit of reception is set, strangely enough, by the noise level and the static level. The power of the received signal must, in all cases, be an appreciable per cent. above the noise-static level for the program to be received.

The second consideration, and probably the most important one, is the mathematical quantity in the transmission formula which is called the "attenuation constant" and governs the amount of effective signal at any distance from the transmitter, depending on the wave-length used and other constants. The current in the receiving antenna is proportional, not to the total power output at the transmitter, but to the current in the transmitting antenna.

This is a field which is still more or less new—that is, there is not a great deal definitely known about it—and the new stations, among other things, hope to discover more about it.

THE SUPERPOWER ANTENNA SYSTEM. Several miles from the studio is erected this antenna system, under which may be seen the buildings that house the transmitting equipment.

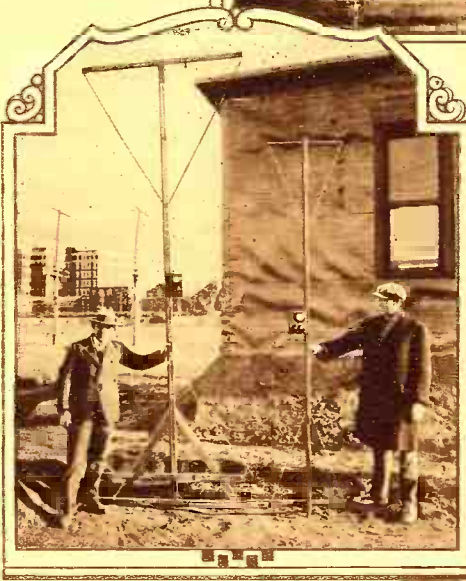
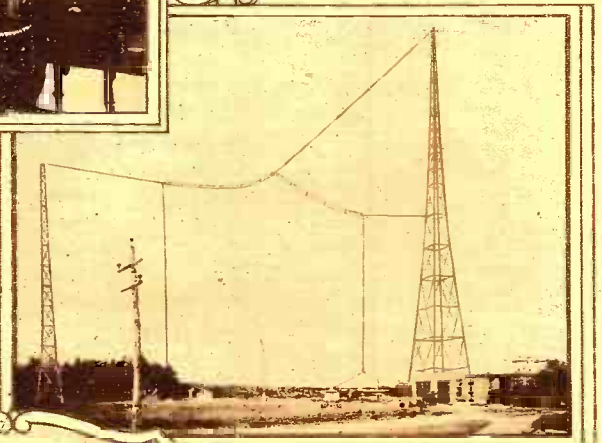

THE ANTENNA METER. This meter is in the lead that goes from the transmitter to the antenna and is quite a distance from the building where the transmitter is located, so that the readings are taken with the aid of a telescope.

EXPLORING METERS. These portable meters are for determining the field intensity of the radiated output of the giant antennae at the South Schenectady station.

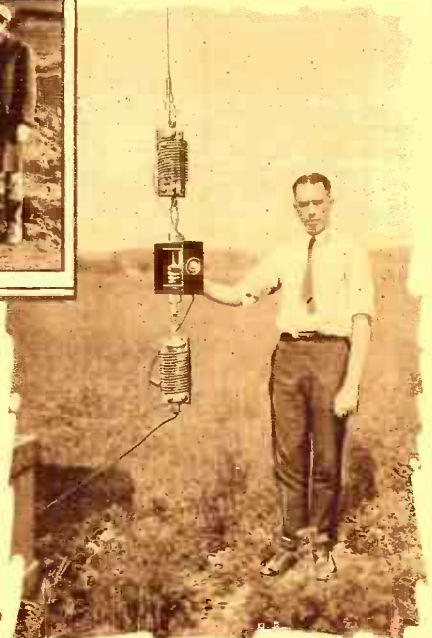

Broadcasting

THE SUPERPOWER TUBES. These three units house the water-cooled tubes with their attendant step-up tubes and transformers. The two solid panels at the side are the terminal boards for the land lines that come from the studio in Schenectady.

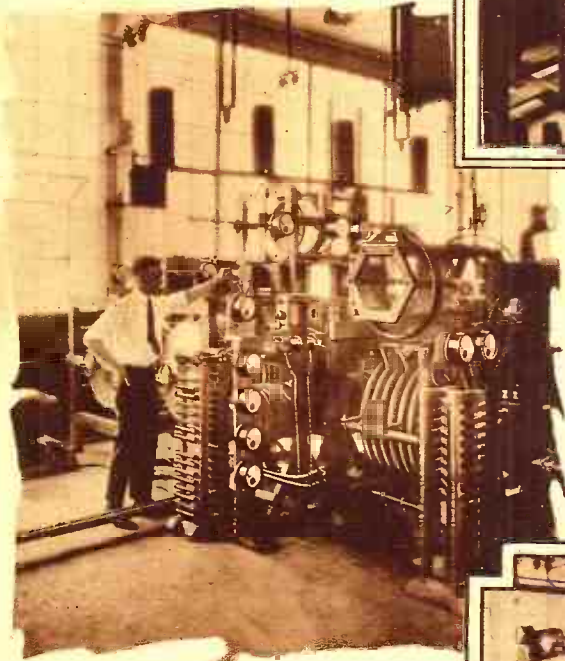

THE SUPERPOWER TRANSMITTER. At the left are shown the transmitting inductances and condensers that are used in the superpower broadcasting from station WGY.



meters and is equipped to care for a maximum output of 50 kilowatts and a second one which broadcasts at 1,560 meters and is capable of putting 40 kilowatts into the antenna.

All programs for these stations will come through the regular WGY studio control and are transmitted from the Schenectady station by land line to the high-power station at South Schenectady. Here the land line current is first stepped up through a small amplifier and then delivered to the station modulator panel. This unit consists of three banks of modulators, each consisting of two of the 20-kilowatt tubes with the necessary amplifier tubes to bring the signal to proper

As to the stations themselves, the accompanying photographs give a pretty thorough idea of the size and scope of the equipment. The transmitters are all of the master oscillator type and employ the 20-kilowatt, water-cooled tubes. The buildings containing the transmitter and the antenna are placed several miles out of Schenectady in order to minimize the interference in the shock excitation area around the transmitter. It is fairly certain that all superpower stations erected will follow the same plan of erection at some miles from the populous centers which they are supposed to serve.

There are two main transmitters, one which operates on a wave-length of 379.5

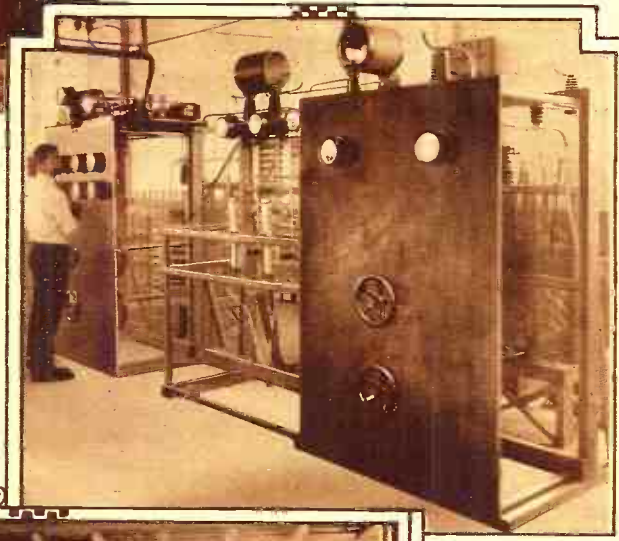

POWER CONTROL PANELS. At these panels the enormous power that is used for transmitting is regulated.



ONE OF THE SHORT-WAVE TRANSMITTERS. Below, to the left, is shown one of the transmitters that can be switched into operation in a very short time merely by manipulating a few switches and plugs.

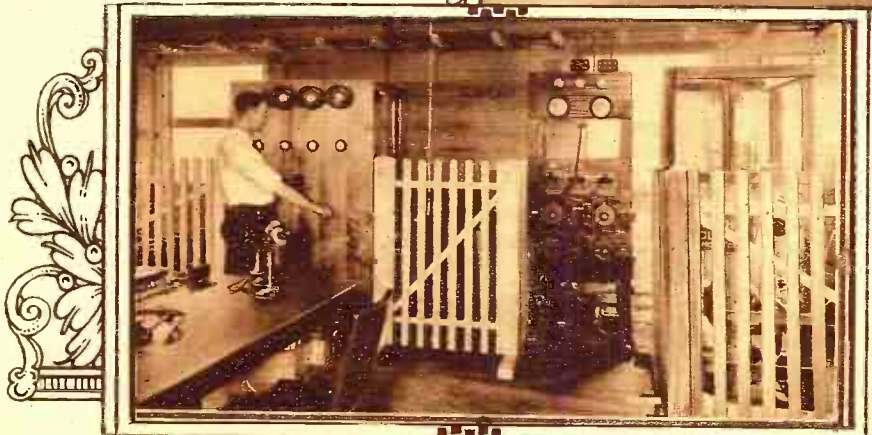

intensity for placing it on the grids of the large tubes.

By an extremely flexible arrangement of connectors, any one of these panels, any selection or combination of them or all of them may be used in conjunction with any one of the transmitters.

One of the accompanying illustrations shows this arrangement. The three rather open units house the water-cooled tubes and the necessary transformers and step-up tubes, the connections and the grid-biasing leads. The two solid panels at the side are the terminal boards for the land lines coming in from the studio in Schenectady.

All high frequency leads and connectors in oscillating or high tension circuits
(Continued on page 558)

Parlor Magic with

By HUGO

Member American



FIG. 1

Fig. 1. The "Radio Kiss." This photograph shows how this mysterious experiment is performed. Every time the performer kisses the lady's hand, music issues from the horn. A most astonishing and amusing experiment. Fig. 1A shows the connections clearly.

FIG. 1A

Using your radio outfit for parlor magic and novelty stunts is a brand new idea. In this article the author shows how your set can be used to entertain your friends in an entirely novel manner.

THOSE of you who think that a radio receiving set is good only for listening to the various broadcast programs are mistaken. Aside from giving its customary entertainment, a radio outfit, under certain circumstances, can become an excellent entertainer of the parlor magic variety. The stunts which are described below are all original so far as I am aware, and have not been described before. Many variations may be made, and we now have a new source of entertainment from our versatile radio set.

In order to perform any of the experiments and entertainments herein described it is necessary to have at least a 3-tube, or, better, a 5-tube set. The first stunt, which never fails to evoke surprise, might be termed "The Radio Kiss" although this may not be an exact name for it. It is shown as our front cover illustration, as well as in illustrations Nos. 1 and 1A.

In the first entertainment it is necessary to have for the surprise element a metallic chair, as pictured on the front cover. This iron chair is of the garden variety, and while it is not so evident in cities, most country houses boast several of them. In order to make the experiment, it is necessary to have a metallicly conducting chair. Should it not be possible to get a metallic chair like the one pictured, then the next best thing would be to get an ordinary wooden armchair, and fit it with metallic handles, arm rests, or otherwise wrap tin—or copper-foil—around the arm rests, although this is not quite so good, because such a chair will al-

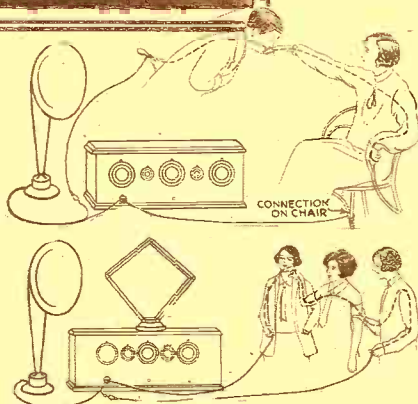

FIG. 2A

Fig. 2. A variation of the "Radio Kiss," which might be entitled "The Touch down." Here we have a chain of girls touching various portions of each other's skin. Music comes from the radio horn only when the chain is unbroken and when the girls actually touch each other. Fig. 2A shows how the connections are made.



FIG. 2

ways arouse the suspicion of the party to be initiated.

If a metallic chair is used, one wire from the loud speaker is run to one of the chair legs and connected with it. This may be done under a rug or carpet so the connection will not show. In this manner, there will be no possible suspicion and the surprise effect is consequently heightened. The other end of the cord from the loud speaker goes to the 'phone plug, as shown, while the other pole of the plug connects to a cord or wire, which may be wrapped around a spoon or other metallic object, in order to make good contact with the performer's hand. It will now be seen that if the performer kisses the lady's hand, providing the radio set is turned on and there is a station going, the instant he touches the hand, the music, or whatever program there is from that station, will issue from the horn.

In this experiment the current flows through the performer's body, thence through the lady's hand and arm, while her other hand or arm is grounded on the chair, from which part of the current goes back to the loud speaker, thereby completing the circuit. It will be noted that music can issue from the horn only so long as contact is made between the performer and the one entertained, nor is the music or sound weakened, as a rule. So long as a good contact is made, the high frequency currents pass readily through the body, almost as if there were a solid metallic connection throughout.

As a rule, the lady being entertained will be skeptical that it is the contact between mouth and hand that causes the music. If she is, just ask her to touch your face or your hand herself. At every contact thus made, music will, of course, be heard.

An added interest is given the experiment by touching a sensitive part of the subject's face, such as, for instance, her ear, or her lips, lightly with the finger. If a 3- or 5-

Your Radio Set

GERNSBACK

Physical Society

tube set is used, a slight tingling sensation will be experienced, which, if the set is powerful enough, will sometimes be felt as harmless little shocks, such as are given off by a weak shocking machine. *This occurs only if the touch is very light.* If the finger is pressed solidly against the skin this effect will not be noticed.

Of course the entire success of this experiment hinges upon the "victim's" not seeing the one wire running to the performer's body. Variations of this can be made as follows:

The performer may have a few short nails run through his shoes, in which case a hole has to be cut from the sock, so that his foot makes contact with the heads of the nails. Then metallic plate may be put under the rug and connected with the one end of the loud speaker cord. The performer has then only to step upon the plate, and the nails will pierce the rug and make good contact with the brass plate. This will be very mysterious and afford an opportunity for quite a good deal of fun.

There are, of course, many other variations that will readily suggest themselves to any clever performer. If a wooden chair with metallic arms is used, it is, of course, necessary to run the wire up to these metallic arm-rests, and I need not state here that the lady always has to make contact with the arm-rests, otherwise the horn will remain silent.

Illustrations 2 and 2A show another variety of the same idea. Here we have a number of persons connected in a chain in (Continued on page 559)

Fig. 3. When kid gloves become a radio head-set. In this experiment the performers grasp the two bare wires coming from the radio set, while their gloved hands are held over the listener's ears. She will hear the sounds as well as with a regulation head-set. Fig. 3A shows how to make the connections.

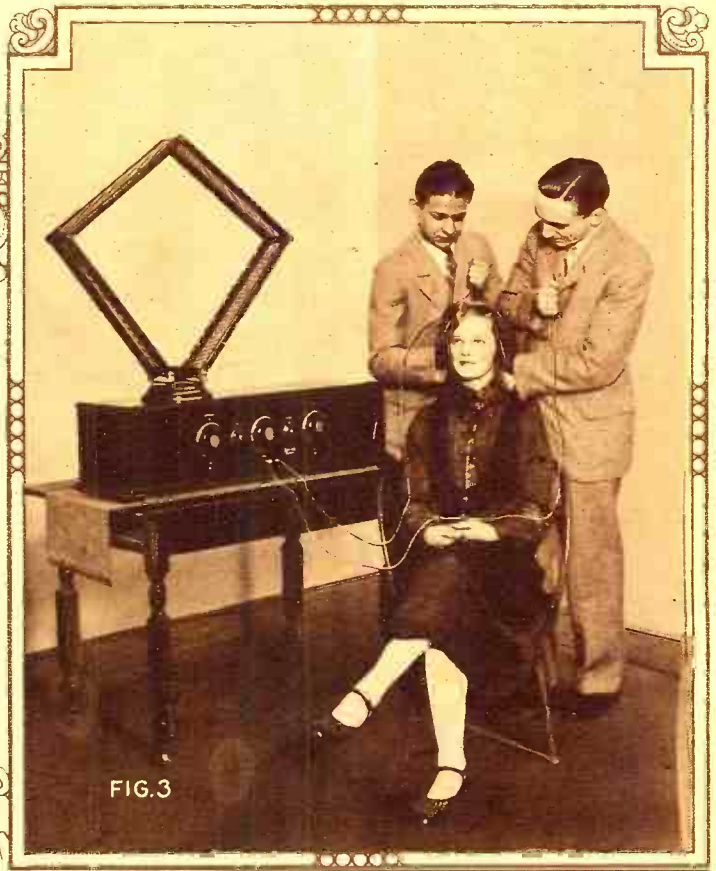

FIG. 3

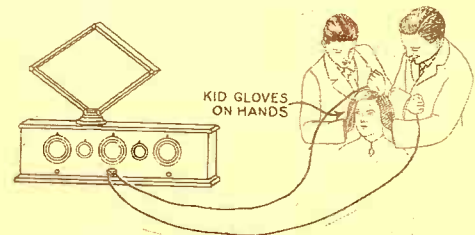

FIG. 3A

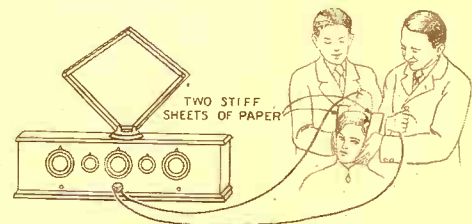

FIG. 4A



FIG. 4

Fig. 4. Here we have a variation of the experiment shown under Fig. 3. Perhaps you do not believe that two sheets of letterhead paper may become a good radio head-set, but hearing is believing, and if you don't believe it, try it and you will have the surprise of your life. Here we have the two performers grasping the two wires coming from the radio set, while their bare hands rest against two letterheads pressed tightly against the young lady's ears. Evidently she is enjoying it, because the sounds are coming through loud and clear with no distortion, and fully as well as with a good head-set. The principle, by the way, is that of Dolbear's Condenser Telephone. Fig. 4A indicates the connections.

News and Views

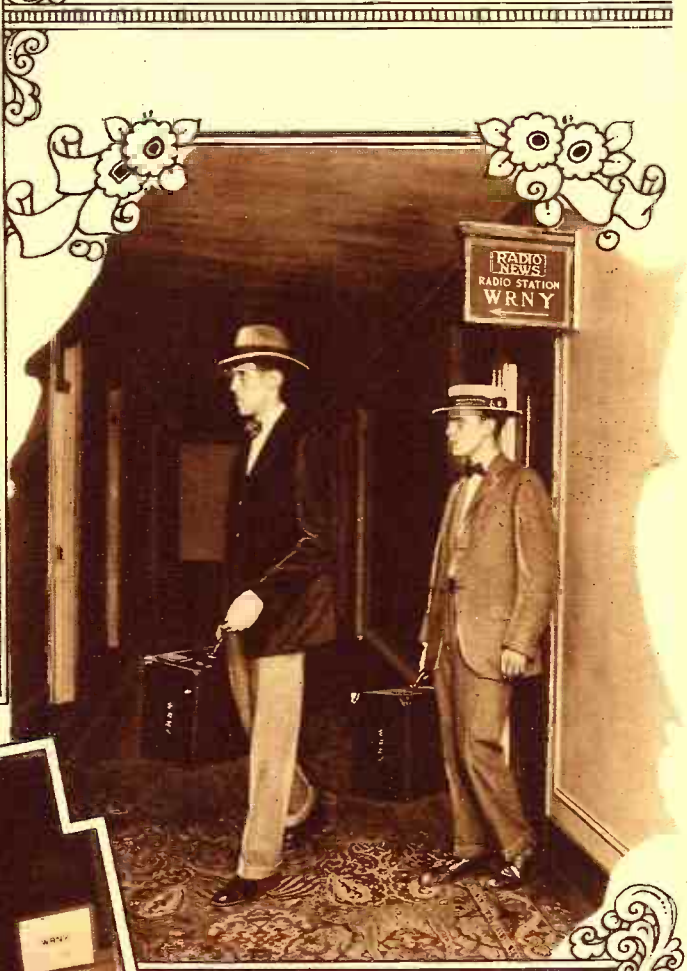

↑ —RALPH CHRISTMAN AT THE KNABE GRAND." Above at the left is shown the gentleman who acts in the capacity of accompanist at Station WRNY.

↑ THE REMOTE CONTROLLERS. Here are two of the station's staff of operators leaving the studio for some point where an event is to be picked up and sent over land wires to the station, where it is put on the air. The suitcases contain the microphones, amplifiers and other necessary apparatus.

↑ THE WRNY TROUBADOURS. The happy quartette in the above photograph is composed of members of the station's staff who "sing sweet songs and happy" whenever a visiting artist fails to keep his or her engagement.

THE VOLGA TRIO. These three young musicians, who have but recently left England where they were heard many times through station 2LO in London, were introduced to the American radio audience by Station WRNY. The announcer is Paul Dumont.

of Station WRNY

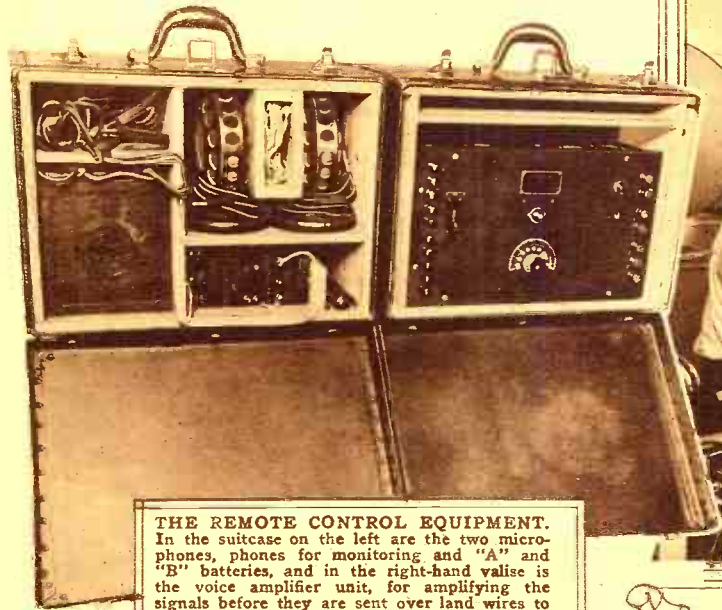

THE REMOTE CONTROL EQUIPMENT. In the suitcase on the left are the two microphones, phones for monitoring and "A" and "B" batteries, and in the right-hand valise is the voice amplifier unit, for amplifying the signals before they are sent over land wires to be put on the air at WRNY.

THE CONTROL ROOM OF WRNY. This shows the power amplifier and transmitter.



BATTERY-CHARGING PANEL. This panel, which was built by the station's staff of engineers, controls the charging of any or all of the storage batteries used in transmitting.

THE TRANSMITTER AND CONTROL PANELS. In the transmitter can be seen the large tubes and tuning apparatus and on the right is the panel on which is mounted the apparatus which controls the motor generator set.

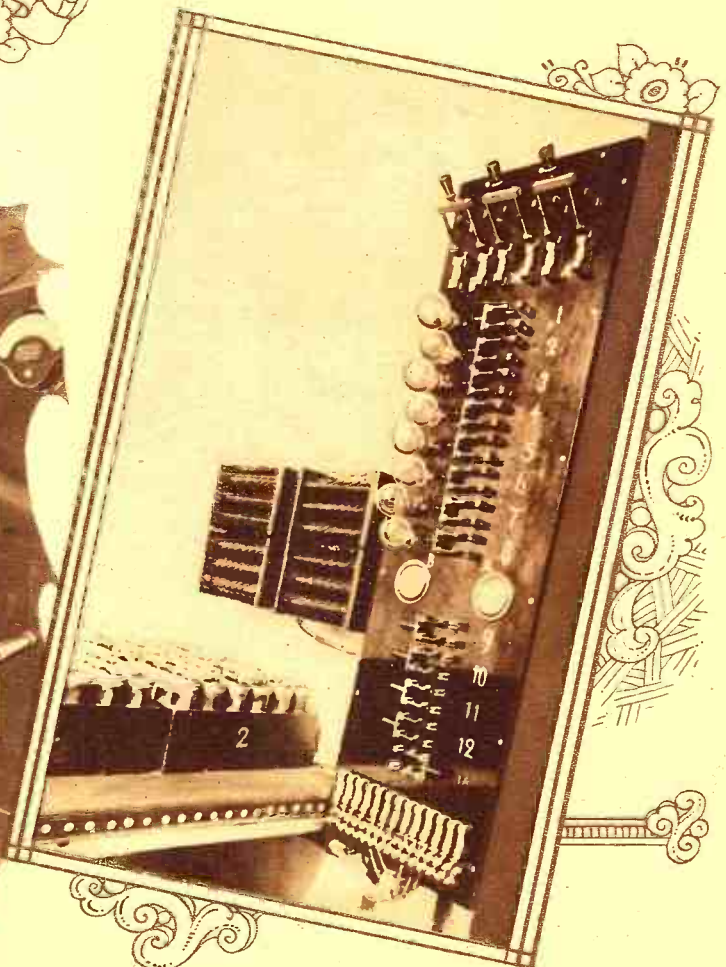



NAVY AIDS BY RADIO AFTER EARTHQUAKE. After the earthquake that recently occurred in Santa Barbara, California, an emergency transmitting and receiving station was installed by the United States Navy for communicating with other cities until repairs could be made on the telegraph and telephone lines. © Underwood & Underwood.

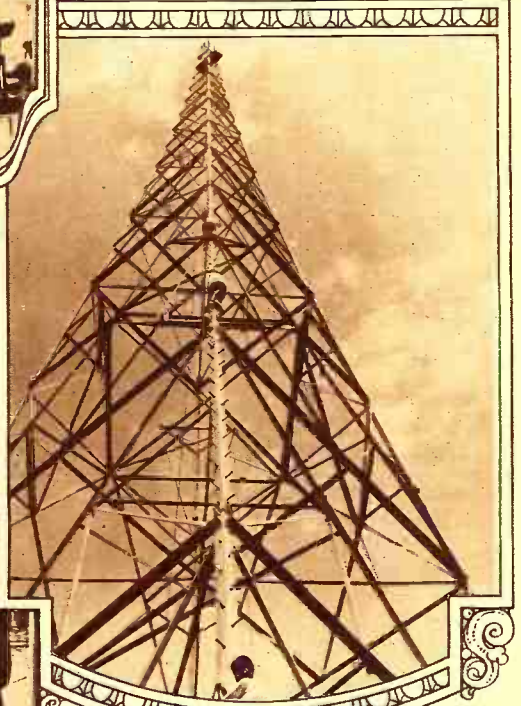

AN ANTENNA MAST OF STATION WJZ. Above is shown one of the 300-foot masts that will support the antenna of the new superpower station located at Bound Brook, N. J. Below is shown the base of one of the towers. The man is pointing to the porcelain insulators. © Kadel & Herbert.



RADIO COMMUNICATION IN SANTA BARBARA. Within a few hours after the California disaster this radio set was hooked up with a microphone in the circuit and communication established with the warships and California cities. © United.

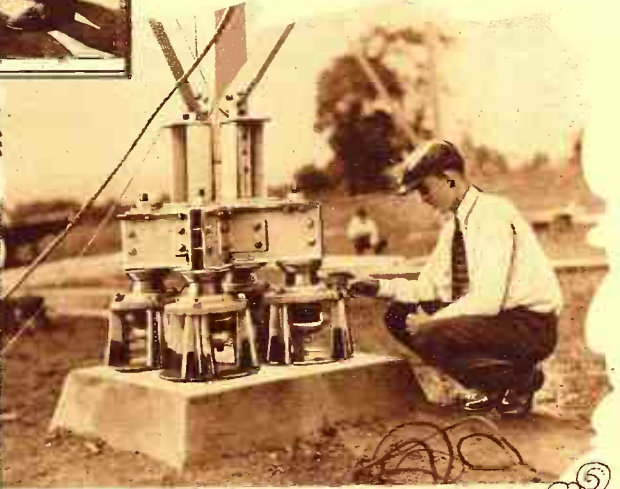

GIANT WATER-COOLED TUBES AT STATION WPL. This station, which is one of the newest in New York City, will be a duplicate of Station WEAJ and will broadcast with a power of five kilowatts. © Kadel & Herbert.



The Times Flies

By MARIUS LOGAN

THERE were two things that classified those two and set them apart from all other radio and editorial men I have ever seen. They had the worst bad luck followed by the best good luck and the greatest proclivity for doing the unsuspected that ever blossomed in a couple of ordinary, everyday individuals.

How Michael H. Muldoon and Isadore Schwartzberg ever struck up the fellowship which kept them together for the long term of years I do not know. No matter what the circumstances, they could not have been matched better had they had the same god-father and been twins.

Of equal mystery is how they let themselves into radio. They did, however, and thereby hangs this tale.

But it does not alone hang on their falling into radio. Had it not been for the Old Man—otherwise the Skipper, officially known as the Publisher and Managing Editor of the Holden *Times*—and his enthusiasm, which was as unlimited as Einstein's space, and his unholy craving for something to fill the front page on Monday mornings, Micky and Izzy would probably not have pulled the stunt of the ages, as the headlines called it, cost the Old Man the loss

of his dignity and themselves three good nights of sleep.

Life had been rather uneventful—too uneventful—for some time and so Michael and Isadore were seriously considering a change of climate and working conditions. But before they could raise the proper will power and the money, radio came along. That is, the Old Man decided that radio would be a grand and glorious scheme for the increasing the circulation and thereby the advertising rates.

He informed Izzy and Micky they would be, on and after the following Monday, the editors of the paper's regular daily radio section and also the Sunday radio supplement. This was, of course, nothing extraordinary, for most newspapers have radio editors recruited from all sources, including the copy boys and the linotypers.

But this pair differed very much from the usual run of pre-empted editors, for Izzy had a grander fund of usually useless information than any other man in nine states, and Micky could, under the proper stimulus, do himself fairly noble writing about anything, whether he was conversant with the exact facts or not. Izzy could talk with fair ease on anything from Pleistocene Man to the latest method of carbonizing steel. Micky could, likewise, tell a tale over the dinner table, after the coffee, which would

equal and oftentimes surpass anything of Jules Verne or Baron Münchhausen.

At once it becomes evident that they were the ideal journalists to edit a good, up-and-coming radio section.

Once they had started on the job they became interested in it. The week-end after they had been given the assignment, Izzy spent several hours in the sanctum of his room at Mrs. Brady's Elite Private Hotel with several heavy tomes, which, according to their prefaces, told thoroughly the tale of radio. After he had absorbed Flemming, a bit of Van Der Bijl and some miscellaneous authors of less note and less mathematics, he came into the office on Monday morning with a new glow in his eye and a new enthusiasm in his heart.

With Micky, the situation was somewhat different. He read a couple of Jules Verne's accounts of exploits in the various sciences. He topped it off with some stories in the popular magazines and read one or two simple treatises on radio—written in words of one syllable, with a *demi-tasse* of Radio News. He, also, was under the impression that he was a thoroughly capable radio editor.

During the following week Izzy built exactly five radio sets. Four of them worked. The first ones were rather amateurish in their appearance and little more could be said for the operating characteristics. By the time he had completed and put into oper-

(Continued on page 514)



"There was a lurch as Izzy brought the plane in control of the short-wave set."

The Vacuum Tube and Photo-Electric Cell

By GENERAL GUSTAVE FERRIÉ



The author of this article is one of the world's foremost authorities on radio tubes. In this article he describes several new and interesting applications of vacuum tubes.



THE developments undertaken to perfect radio electric devices, and in particular three- and four-electrode vacuum tubes, have found very effective and numerous applications in various departments of science.

We shall describe briefly certain arrangements associating the properties of the three- and four-electrode tubes with photo-electric cells, particularly in connection with certain optical applications, and then discuss some of these latter.

It is not necessary to review here the characteristics of three- and four-electrode vacuum tubes, which are well known, but it will perhaps be useful to recall very briefly the properties of photo-electric cells.

When light is allowed to fall on a surface covered with a light-sensitive metal and placed in a vacuum, it produces an emission of electrons whose intensity depends upon the quantity of violet rays in the beam directed on the surface. Potassium, in particular, gives very interesting results.

The apparatus utilizing this property, notably those which were designed by Mr. Rougier of the Strassbourg Observatory, were constructed as follows:

On the interior surface of a glass bulb, A, (Fig. 1) a layer of potassium is deposited except on that part of the surface forming a window through which the light enters. The wire, *f*, sealed into the glass, makes contact with the potassium. In the center of the bulb a wire loop, *p*, is mounted, insulated from the potassium and connected to the outside by

Gen. Ferrié in his research laboratory. This noted experimenter has contributed greatly to the advance of radio.

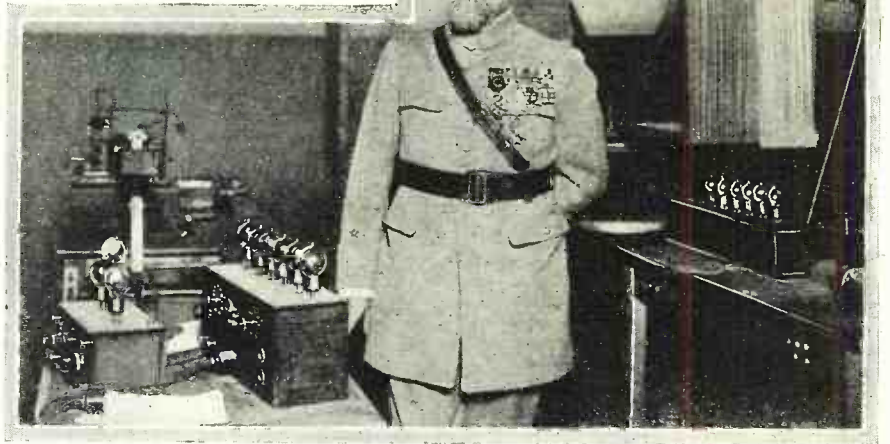

a second wire, *i*, also sealed into the glass.

Under the influence of the light the potassium emits electrons. When it is connected to the negative pole of the battery, P, the central loop being connected to the positive pole, the latter attracts the electrons and a current is established in the battery surface. This current persists during the time that the cell is under action of light. In addition, this effect is instantaneous or at least takes place in an extremely short period.

The effect can therefore be used to determine the beginning of some luminous phenomena.

The current of a very low intensity is increased by introducing argon gas into the bulb under a pressure of a few millimeters.

The electronic current is then increased through ionization by collision. But even for very intense illumination it never reaches a current of a microampere. In order to utilize this current practically, it is therefore necessary to amplify it a great deal.

One means of amplification consists of increasing the potential of the batteries con-

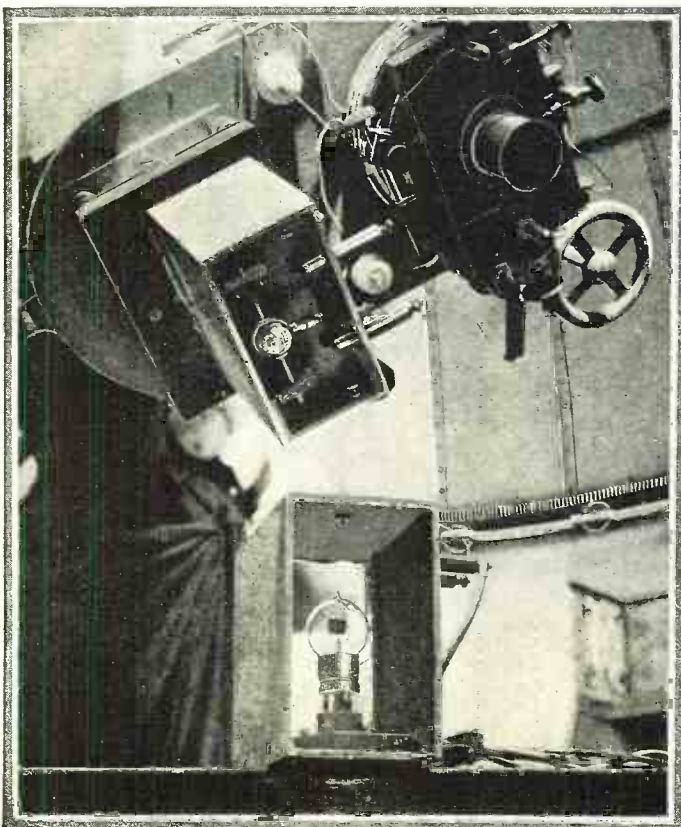

The end of the giant telescope which is equipped with a photo-electric cell for determining the exact instant that a star passes the center of the field of vision of the telescope.

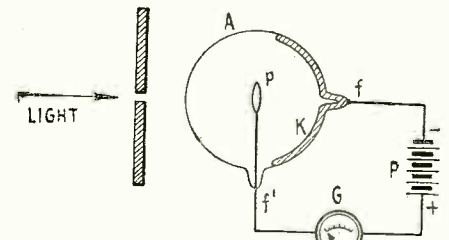

Fig. 1. The photo-electric cell designed by Mr. Rougier. The side of the bulb, K, is coated with potassium, which acts as an electron source.

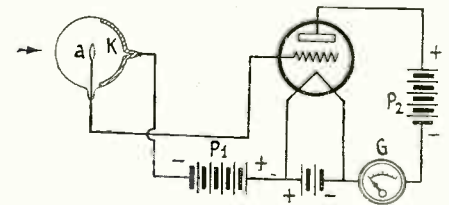
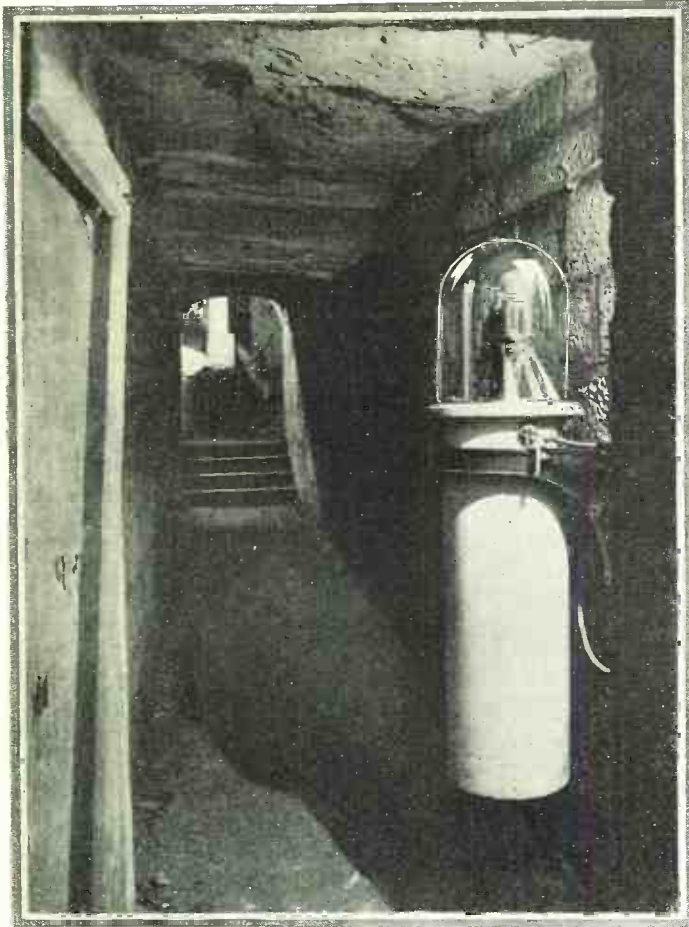

Fig. 2. How the photo-electric cell is used in conjunction with a standard three-element vacuum tube for amplifying the variations in light intensity.

nected between the potassium and the anode of the cell. This method, however, is limited practically to about 150 volts, for above this value there is a risk of producing the glow discharge on the inside of the cell, and even of causing discharges capable of seriously damaging the cell. In order to achieve the necessary amplification, it was necessary to resort to three- and four-electrode tubes.



A photograph of the apparatus shown diagrammatically in Fig. 6. Under the glass cover is the delicate pendulum apparatus to which is attached a mirror which reflects a beam of light back to a white box, which can be seen through the opening at the end of the passage. The light is then reflected to the floor above, where it is put through the photo-electric cell apparatus.

Fig. 4 Below. The addition of a three-electrode vacuum tube to the circuit of Fig. 3 increases the output to the galvanometer, making the variations easier of detection.

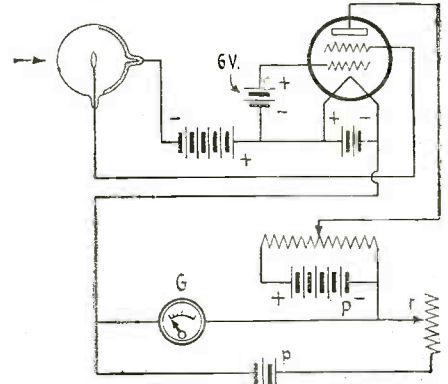
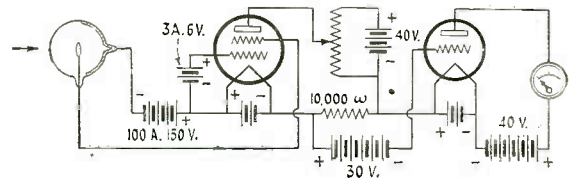

Fig. 3. By using a vacuum tube having two grid elements, a lower plate voltage than with the standard three-element tube, so facilitating the use of the photo-electric cell.



With a three-electrode tube (Fig. 2), the anode, *a*, of the cell is connected to the grid of the tube. When the cell is illuminated, the electrons emitted by the potassium charge the anode connected to the grid.

Because of this charge, the grid acquires a small negative potential with reference to the tube filament which produces a large diminution of the plate current. It is this diminution which is utilized instead of the photo-electric current itself. Since the three-electrode tube is not completely evacuated, the electrons emitted by the filament produce ionization by collision with the gaseous molecules which remain in it. The positive ions so produced will partly discharge the grid, whose remaining potential will be considerably smaller than that considered above. In order to avoid this diminution of potential, it is necessary to prevent the formation of positive ions, and to this end to reduce the plate voltage to a value below that of the ionization potential of the gas; that is to say, to about 20 volts. The consequence of this diminution in plate voltage is unfortunately a considerable reduction in amplification.

The difficulty disappears on making use of four-electrode tubes, which do not require a plate voltage higher than 20 volts. The circuit is indicated in Fig. 3. A potential of 6 volts is applied between the first grid and the filament. Everything happens as though the electrons were emitted by the first grid. The latter being extremely close to the second grid, the tube has a very high coefficient of amplification. In order to obtain the best possible operation, it is necessary to use a potentiometer in connection with the battery, *P*, in such a manner as to enable an accurate adjustment of the plate voltage. The measuring instrument, *G*, is brought to zero by a battery, *p*, and a resistance, *r*. It is possible to obtain with such arrangement of a single amplifying

tube, in cases of intense illumination of the cell, sufficient action to effect measurements by means of a needle galvanometer giving a maximum deflection of one milliamper. (This arrangement of galvanometer, battery and resistance is the "zero shunt" described by Dr. Bazzoni in the July, 1925, issue of *RADIO NEWS*.—Editor.) It is generally necessary to increase the amplification by adding an ordinary three-electrode vacuum tube, connected as shown in Fig. 4. Experiments show that the maximum sensitivity

in order to still further amplify the current. Under the influence of a sudden illumination of the cell, the movement of the needle of the measuring instrument is always very sudden and rapid, while the return to normal position after the light is cut off is very slow. This is due to the negative charge collected by the second grid of the first tube, a charge which can be dissipated only slowly because of the high insulation. If this charge is very much re-

(Continued on page 540)

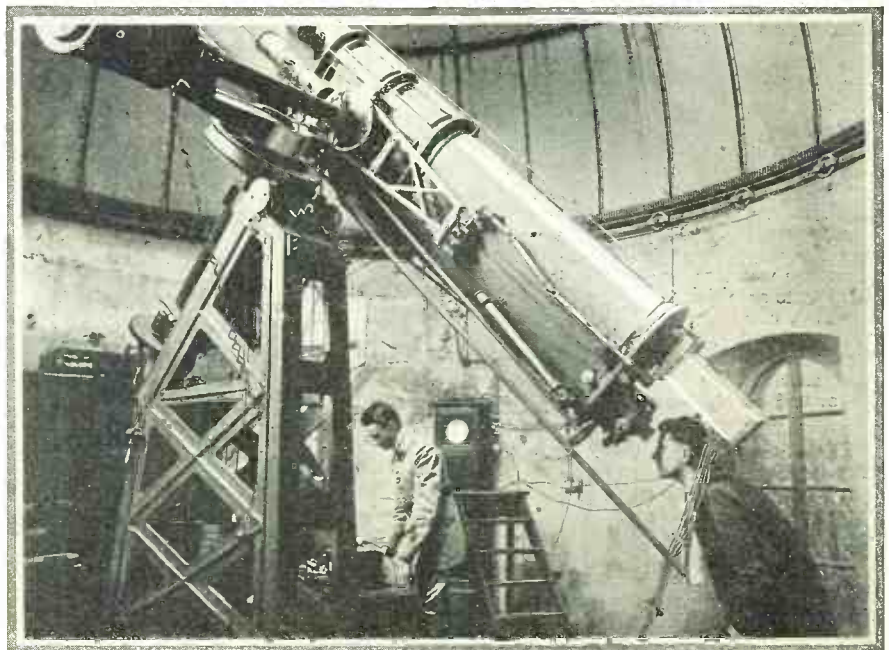

The giant telescope in the French observatory to which is attached the photo-electric cell apparatus used in astronomical observations and calculations.

The Inventions of Reginald A. Fessenden

PART X

THE financial difficulties of the Edison Machine Works at Schenectady and of the Edison Light Companies, which were the cause of their inability to continue to pay for the solution of commercial problems by the Edison Laboratory, were not straightened out until 1892, when Mr. C. A. Coffin, a man who had demonstrated very exceptional business ability, first as a shoe manufacturer and then in connection with the Thomson-Houston Company, combined the Edison and Thomson-Houston Companies to form the General Electric and quickly transmuted the semi-bankrupt aggregation into an extremely sound and profitable organization.

VACUUM BOILED VARNISH

But, in the meantime, a number of us had to look for work elsewhere, and the date of my wedding with Miss Helen Trott had been set for September, so it was necessary to act quickly. About a year before, Mr. Pratt, of the Pratt and Lambert Company, had come to Edison in connection with some trouble he was having with blackening of varnish gums. Edison, busy, had sent him down to me. In connection with my work on elasticity, referred to in my preceding article, I had distilled great numbers of flexible and elastic substances, including fossil gums, in vacuum and under pressure, and had formulated certain conclusions as to their behavior, decompositions, etc. So I was able to show Mr. Pratt at once how to remove the blackening of the gums, and also how he could use the cheaper Zanzibar fossil gums in place of the more expensive copals, and at the same time get clearer, tougher and harder varnishes.

About a month later Mr. Pratt had called again, after consultation with his partner, to offer me a one-third interest in his company, guaranteed at not less than \$10,000 per annum. This was a magnificent offer; for \$10,000 then was equivalent in purchasing power for rent, clothes, food, etc., as my house account books show, to \$40,000 now, and I suppose any sensible man would have accepted it. But I wanted to continue my work with Edison, and have never regretted turning down that and similar invitations received later, from the Carnegie Company, Baldwin Locomotive Works and others. At times it has seemed to me that it might have been more fair to my wife if some of them had been accepted, but, on the whole, I think not. The richness and fullness of life depends on the amount and character of its experiences. My dear mother used to say that the only difference between a rut and the grave was that the rut was longer. And I am quite sure that the years of good, clean hardship, of wide experience and varied interests, together, effect a welding between husband and wife which is the best personal thing that life can give; and that early marriages and simple living are best.

WESTINGHOUSE COMPANY

The position in the varnish works had, of course, been filled by the time the Edison companies' difficulties came to a head, and though arrangements could no doubt have been made with some of the other varnish companies, there was the feeling that more practical experience in the design of dynamos and other electrical machinery was to be sought, to round out the mathematical studies. A position as assistant to J. F. Kelley, electrician for the United States

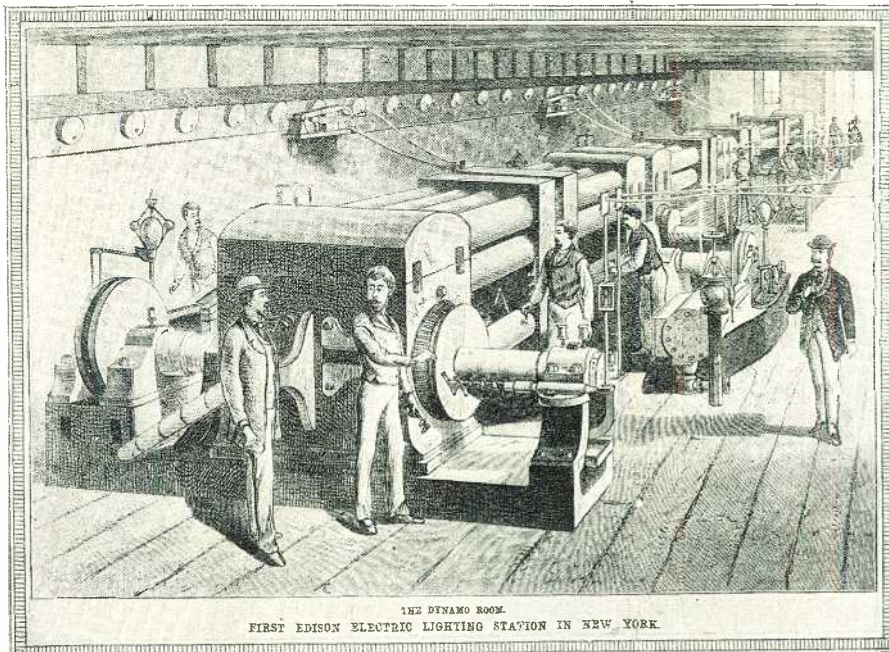

THE DYNAMO ROOM.
FIRST EDISON ELECTRIC LIGHTING STATION IN NEW YORK.

By Courtesy of New York Edison Co.
A quaint instance of the type of electrical machinery employed at the time shortly preceding the period of which Professor Fessenden writes in this article.

Company, the eastern branch of the Westinghouse Company and which handled all the D.C. work of that company, offered the opportunity. Zimmermann was the general manager, a very able man. Nassoy, the shop superintendent, was also very capable. Kelley was brilliant and remarkably well up in his subject. He would have made a name for himself had he not been interested almost solely in sociology and rather disinclined to take trouble. He seldom came into the laboratory, leaving me entirely to plan and carry out the experimental work.

SAWYER, MANN, MAXIM, WESTON, CHESNEY, STANLEY

The incandescent and arc lamp work had been taken to Pittsburgh, so part of the plant was vacant. A Mr. Stanley, who had sold the Westinghouse Company a type of arc lamp, applied for a portion of the space, to develop an arc light machine. While not an inventor himself, Stanley was a very good business man and had several very able assistants, notably Mr. C. C. Chesney, now head of the General Electric Works at Pittsfield, Mass.

The laboratory, of which I was given charge, was one of traditions, for Sawyer and Mann, Maxim and Weston had worked there. Sawyer and Mann had been among the first to use carbonized paper for incandescent lighting, but failed to make a practical lamp, and, still more important, failed to discover the method of "subdividing the electrical light," which formed such a problem to the early workers, and which Edison solved by making the lamp have a very high resistance, so that but little current was needed per watt, and so the amount of copper needed for the distributing mains was reduced to a practicable amount.

Maxim, later the inventor of the first practical rapid-fire gun and of cordite, the first practical nitrocellulose rifle powder, and who did some very important work on flying was, I believe, responsible for the

use of nitrocellulose for lamp filaments.

Weston, the greatest of them all, had worked out a system of electroplating which was long, and still is, used. Also an efficient type of dynamo and an extremely efficient arc lamp. But his great work was the invention and perfection of electrical instruments, in which field he occupies the eminence that Edison does in that of electric lighting. The crudeness of the electrical measuring instruments prior to his work is almost inconceivable now. I think it safe to say that the average error then amounted to $7\frac{1}{2}$ per cent. in commercial instruments. By elaborate research and experiment Weston produced a type of iron alloy which, after "aging" by a method he discovered, would retain its magnetic strength unchanged by shock or temperature variation. He then produced copper wire in a pure state, and free from the minutest trace of iron. Then by refinements in construction, a new type of jeweled bearing, etc., he finally gave electrical engineers D.C. voltmeters and ammeters which could be depended upon to within $\frac{1}{10}$ of one per cent. instead of the 5 to 10 per cent. previously obtainable.

MANGANIN AND THE WESTON CELL

Since the resistance of the copper wire changed with temperature, the circuits of his instruments had to be kept at the same resistance by some means. He did this by discovering an entirely new alloy with hitherto unheard-of and at first unbelievable properties, *i. e.*, one whose resistance diminished with temperature instead of increasing. This he called manganin, but it should be called "Weston." Then as a standard of voltage he invented a standard cell which did not change its voltage with change of temperature. Later he produced the first satisfactory A.C. instruments.

This work made possible, for the first time, the accurate commercial measurement of electricity, and it is of interest to note that all the steps are due to one man.

WORK IN LABORATORY. "EMPIRE CLOTH." SILICON IRON

The first thing done was to put the laboratory, which had been allowed entirely to run down, into shape so that quantitative measurements could be accurately made, for quantitative work is one of the main secrets of success in inventing. Then after solving some bearing metal problems, the matter of insulation came up. Shellac and nitrocellulose varnish and japan were in use then, and the dynamos would not stand up, as the shellac, etc., cracked and became hygroscopic. Here my researches on oils and gums came in. It had been of course evident to many that linseed oil would be suitable if it could be dried quickly and would still insulate. But the raw oil took weeks to dry and when driers were used it would not insulate. So at the Edison laboratory our practice had been to dip cloth in oil, hang up for two or three weeks in a warm room, and then cut the cloth into strips for use.

But dynamos in those days were not coil wound, so this could not be used in place of the shellac, japan, etc., as the dynamos could not be held up for weeks for drying.

The first step, obviously, was to see why, the chemical driers, lead oxide, etc., spoiled the insulation of the linseed oil when used. This was soon traced down to the formation of hygroscopic or water soluble metallic soaps, by the union of the driers with the oil. All the driers used appeared to form such soaps. It was then noticed that one or two substances which had not been used commer-

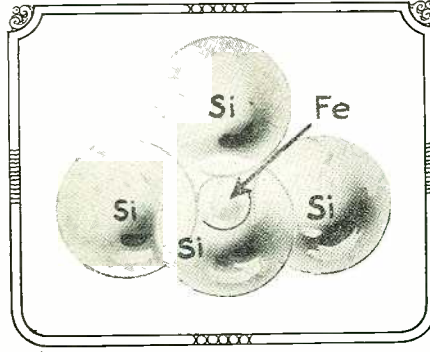

On the basis of Fessenden's theoretical considerations, it was shown that iron alloyed with some element whose atoms were larger than the iron atoms and which were nearly spherical would have lower hysteresis losses than carbon steel. That the conclusions derived from Fessenden's theory were valid is evidenced by the high magnetic efficiency of silica iron.

tained, similar to what is now known as Empire cloth, which proved very durable, samples now 35 years old still being apparently unchanged.

The results were in a way almost too good, for Nassoy came in one day and complained that it was cutting down the profits of the repair department as of all the dynamos insulated this new way during the past year only two had come in for repairs, and one of these had been struck by lightning. However, the reputation built up covered this loss many times over and orders came in so fast that there was difficulty in filling them.

INSULATION FOR DYNAMOS FOR MAKING ALUMINUM

Hall had invented the first practical method of making aluminum by electrolysis, the method which is used today. We got orders for the dynamos. These were low voltage, about 30 volts if I remember, and 200 hp., which was a large dynamo in those days. The overload was at times excessive, amounting to a short circuit, and the mechanical stress on the windings was very high. It was clear that no organic insulation would do. I had noticed some years previously that if cord made of pure asbestos was soaked in silicate of soda, dried and heated, the whole turned to a sort of opaque glass but retained a certain degree of flexibility, and of fair insulating quality. I gave instructions that the large copper straps, three or four inches deep and about a half-inch wide, should be insulated in this way and laid in their grooves in the armature sheets, and the dynamos shipped so. This horrified the testing department, accustomed to measuring dynamo insulation in megohms, especially when it was found that a whole bank of several hundred lamps would light up between adjacent windings. However, an inventor must never be intimidated by what appear to be facts, when he knows they are not, so the dynamos were shipped and nothing heard from them, except orders for two more, and the report that they worked all right, but that the brushes used to get red hot.

JOB ORDER SYSTEM. BALDWIN LOCOMOTIVE WORKS

The new types of dynamos and motors we were putting out developed problems which could not be solved by the regular field men, so a great deal of outside duty was thrown on my shoulders, straightening out the working of street railways, lighting plants, paper mills, manufacturing plants, etc. In addition to this, having unfortunately some spare time after fixing up an incandescent and street lighting plant, I volunteered to go over the books of the plant and find out why they were not making money. Here my early banking experience came in handy

and the quite undesired result was that in a very short time they were sending me all over the country to doctor up financially sick plants, and this cut very badly into the time available for scientific work in the laboratory. About this time also I introduced a new system of accounting into the office, what I called the "Job Order" system, which later came into general use in works, as it enabled jobs to be kept track of much better than with the old classical system of accounting.

One interesting outside job was at the Baldwin Locomotive Works, which had installed our motors on some new 100-ton cranes, much larger than anything previously used, and had bought some compound dynamos to drive them. Vauclain was the works manager (he is now the president) and a very fine engineer and the inventor of the method of making locomotive driving wheels by forging dies. When the cranes were working Vauclain, whom I liked very much in spite of his insisting on calling me "the parson," said he was using altogether too much coal to drive the works; how could he save it?

Looking things over and making a few calculations on the emissivity of the steam pipes used in carrying steam to the great number of small engines scattered all over the plant and on their efficiency, etc., I told him that the only way was for him to throw out all his steam drive system, as two-thirds of the steam energy was being lost from condensation and from the inefficiency of the small engines, and that he should put in motors driving groups of machine tools and furnished with electricity from large dynamos and engines located next the boilers. He asked how much it would cost. I made a careful estimate, an appalling amount. But Vauclain was game, and asked me to work out the details, offered me the job of superintendent of motive power for the works at four times the salary I was getting, and when this, with real regret, was declined, told me to take the matter up with my company and to tell them he wanted such a plant put in. This was installed a few years later and I had the satisfaction of seeing Vauclain's statement, in his paper on the working of the big electrical drive which he had had the nerve to put in, that it had saved him over 60 per cent. of the
(Continued on page 555)

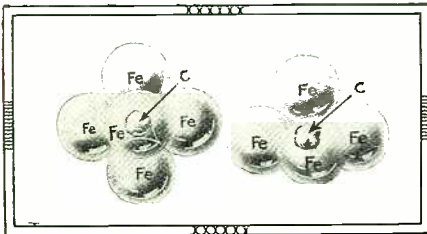

Fessenden's early theory of the structure of matter explained the hysteresis of iron by the irregularity of the atoms filling the interstices between the iron atoms. The illustration shows this hypothetical structure of carbon steel. The irregularity of the carbon atom is here supposed to hinder the free magnetic alignment of the iron (Fe.) atoms.

cially as driers, particularly borate of manganese, acted, even in minute quantities, very actively. From the work done in developing my electrostatic doublet theory of cohesion the conclusion had been reached that cohesion and chemical union differed only in the presence or absence of ionic charges, and that, to quote from my paper before the Newark Electrical Society in 1890:

"The difference between cohesion and chemical combination is that in cohesion the atoms are charged similarly in every way except as regards position, while if any third substances short-circuit the atoms they become chemically combined. This is the explanation of a law which will probably be found true in the near future, i.e., that no two substances can combine without the presence of a third, thus making all chemical combinations the result of catalysis; plexed forms of the substances being capable of acting as third substances."

Borate of manganese then (and others of this type discovered later) was simply a powerful catalyser for oxygen, and might give a dried oil having high insulation. It was tried and found to work perfectly. The dynamos could be wound and soaked with this borated oil and placed in a drying oven and the oil would dry in a comparatively few hours. By the addition of suitable gums in proper proportion, determined by experiment, 100 samples at a time, a fine flexible highly insulating cloth and tape was ob-

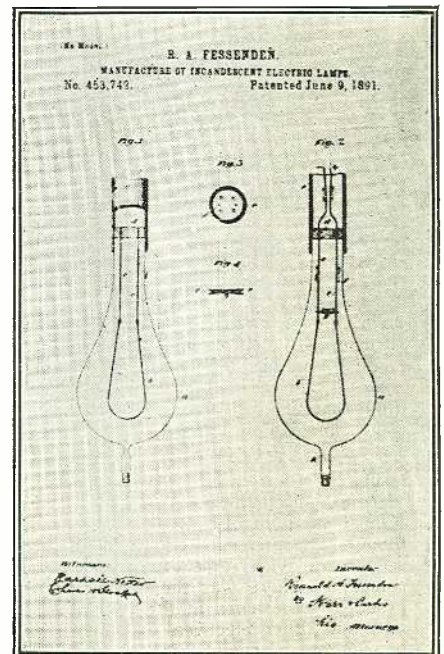

One of Fessenden's important inventions is the use of silicon iron wire for leading-in conductors in incandescent bulbs. The illustration is a reproduction of the drawing for this patent.

New Ideas In Receivers

By G. C. B. ROWE

The two receivers described in this article are the latest in modern radio engineering design. These illustrate the first attempt to get away from the use of the ordinary dials, such as we now use.

WITHIN the last year there have been improvements beyond number in the design of radio receivers. The work of the radio engineers has, however, been concentrated mainly on improvements in the circuits used and the apparatus and instruments, with comparatively little attention paid to the outward appearance of the cabinet. However, in the receivers that will appear

How the "dial-less" receiver is tuned. The cover turns on a shaft at 1 and on the rim of the cover is space provided for the stations' call letters. This receiver was invented by Mr. C. C. Blackmore.

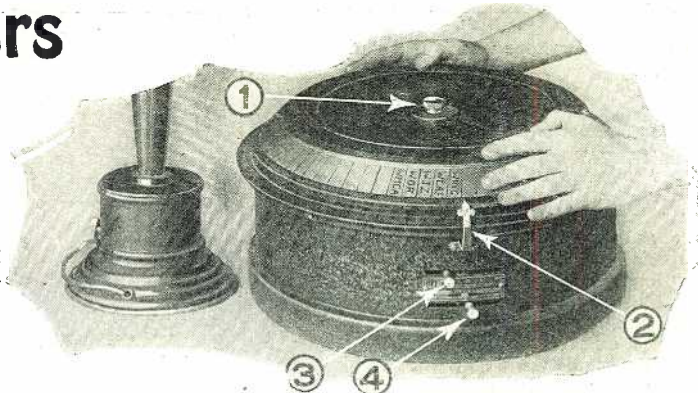

cover. Once the rheostats are set, they need no further adjustment and so are hidden by the cover.

On the side of the set are two handles; one controls the volume and the other is an adjustment for the variable condensers. The volume control lever, when placed on the left side of the slot, disconnects the "A" battery from the filaments of the tubes, and when moved across to the right side, operates a rheostat that controls the filament current. The second lever moves

plates of the other, the settings remain in a fixed relation throughout the whole range of capacity.

As has been mentioned above, the top cover of the receiver rotates, and is fastened to the shaft on which is mounted the gear train that operates the two variable condensers. Around the perimeter of the cover is a flat, gilded strip on which may be written the call letters of the different stations. As each station will come in at a different point on the perimeter of the cover, there is sufficient space for a great number of call letters.

The apparatus is mounted on the under side of the wooden panel, which is, in turn, covered by the revolving lid. The receiver is 16 inches in diameter and is 8½ inches in height. There are two binding posts on the opposite side of the set from the control levers for the antenna and ground connections and also two jacks for phone or loud speaker connections.

There are numerous radio engineers that have been working for many months to get the correct combination of circuit and cabinet. One receiver, which is the result of the work of Robert E. Lacault, is shown in some of the accompanying illustrations. It seems that the goal of the designers last year was to make the tuning of a receiver as simple a matter as possible and, therefore, Mr. Lacault has his receiver tuned with but two controls. These controls are two levers that project through the front of the cabinet and travel around the central grill work, which covers the horn of the loud speaker that is inclosed in the cabinet. As may be seen in the photograph of

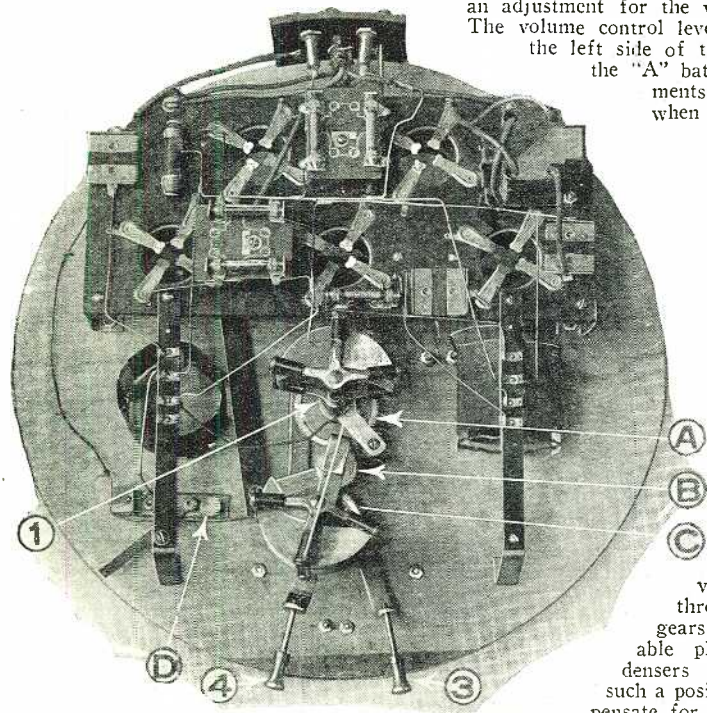

How the set operates. The spindle, 1, turned by the cover rotates gear, A. This turns the upper condenser and also the lower condenser through the floating gear train B and C. Lever 4 equalizes the capacities and 3 controls the rheostats.

one of the two variable condensers through a system of gears so that the movable plates of the condensers can be placed in such a position that they compensate for any changes in the

on the market this fall, not only are the circuit and its necessary instruments improved, but more attention than ever before has been given to the appearance of the set as a whole.

A departure from conventional receiving equipment design is shown in the set illustrated in the accompanying photographs. The main feature that is stressed is that there are no dials to turn in order to tune in different stations, there being but one adjustment to make.

This adjustment is made by rotating the cover of the set. Attached to the knurled knob shown in the center of this movable cover is a pin attened to a rotating shaft which controls two variable condensers that tune the one stage of radio frequency amplification and the detector unit. There are five tubes used. As mentioned above, there is one stage of radio frequency amplification, detector and three stages of audio frequency amplification. the last two of these being resistance coupled.

The rotating cover is removable. Under this there is a sub-panel of wood on which is mounted an adjustable resistance and the top of a rheostat. As may be seen, the vacuum tubes are inserted through this panel with their tips just clearing the movable

the radio frequency transformer or the fixed coupler. When the movable plates of one condenser are set in relation to the

The revolving cover is supported by the plate, 1, which is attached to the shaft to which is fastened the variable condenser gears. The pointer, 2, indicates the call letters written on the rim of the cover. The controls, 3 and 4, are the condenser phase adjustment and volume control respectively. Photos on this page Courtesy Ohio Stamping and Engineering Co.

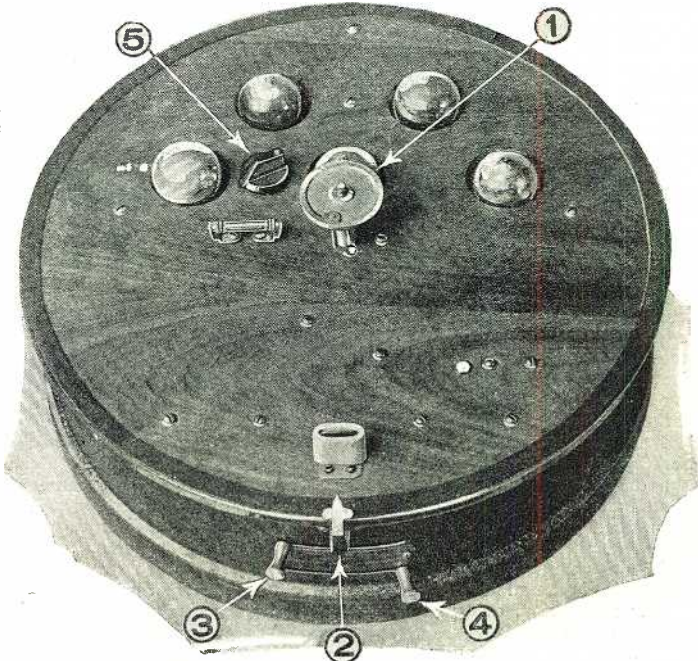

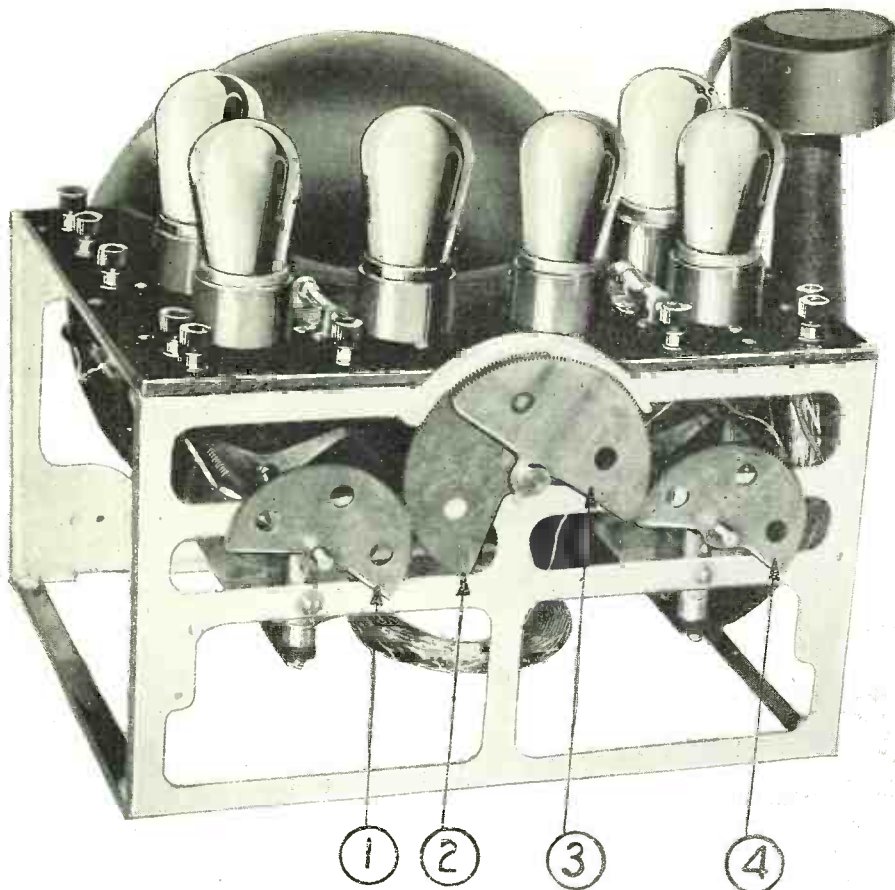

Rear view of Lacault's receiver, showing the gears that drive the variable condensers. Gears 2 and 3 are on the shaft attached to the levers and those numbered 1 and 4 are on the condenser shaft.

the exterior of the cabinet, the periphery of this grill work of bronze is marked off by a scale so that the operator of the receiver can at all times get a station that he wishes by the method of logging the set.

The only other control is a small knob to regulate the volume of the set and which, when turned full to the left, disconnects the "A" battery from the filaments of the vacuum tubes. There is also a telephone jack for the use of head-phones, if the operator wishes to try for DX. The amount of current that is supplied to the filaments of the tubes is regulated by automatic filament controls, so that the operator does not have to worry about their adjustment.

The receiver employs six tubes of the storage battery type, three of them functioning as radio frequency amplifiers, the fourth as a detector and the last two as audio frequency amplifiers. Two of the radio frequency stages are tuned, but the third stage is fixed. In two of the radio frequency

Front view of the receiver. The loud speaker unit on the left leads to the bell of horn, A. The levers, 1 and 4 are shown connected to the shaft carrying the gears that operate the variable condensers. The position of the volume control is indicated at 3.

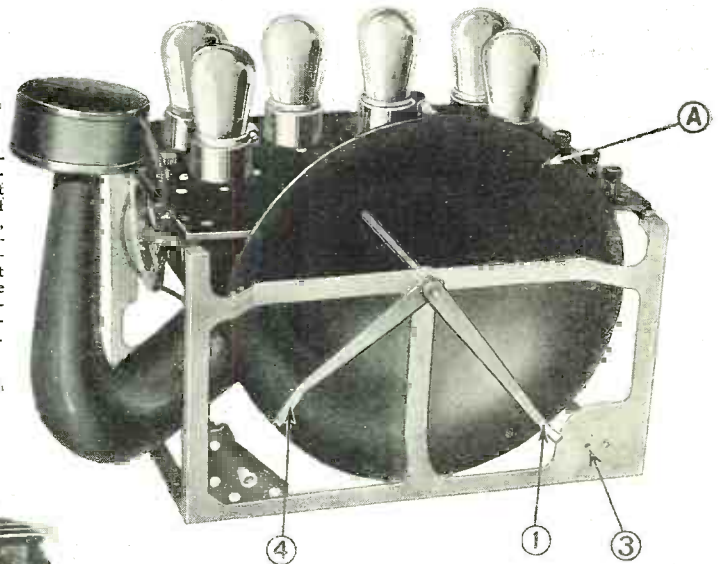

Front view of the six-tube receiver that has but two tuning controls, indicated at 1 and 4. These levers move along the periphery of the grill work, on which is engraved a scale to be used for logging. The number 3 indicates the volume control.

Photos on this page Courtesy of Phentix Radio Corp.



stages an innovation is introduced in the way of two resistances in the grid circuits of the tubes. These resistances prevent these circuits from "spilling over," or oscillating, at resonance points and at the same time increase the selectivity of the whole radio frequency amplifier unit.

The variable condensers used in this receiver are of the straight-line wave-length type, which adds a great deal to the simplicity of tuning, as the points at which the levers are set to pick up the stations are separated more widely than they would be with the ordinary type of condenser. The loud speaker unit used is electrically matched with the audio frequency amplifier, so that the impedance is the same. By this means distortion is eliminated to a considerable extent, with a corresponding increase in volume.

The cabinet is 24 inches in length, 14 inches wide and is the same height. There is space inside the cabinet for "B" batteries and the antenna and ground connections are made to terminals at the rear of the cabinet.

The loud speaker system is the result of careful research work, not only in connection with the unit, as has been mentioned above, but also in connection with the horn, the contour being adopted after many trials. This horn is of a special composition which reduces to a minimum all extraneous vibrations and renders the music and speech output of the highest grade.

There may be used with this receiver either an indoor or an outdoor antenna system. By an indoor antenna is meant a short stretch of wire inside the room, not a loop antenna. An antenna of the loop type will operate satisfactorily on local reception, but will not give the results on DX work that the other type will.

The two types of receivers described above are designed especially for the person who "knows nothing about radio," for they are

made in such a manner that tuning in stations is reduced to the fewest possible actions.

Such radio receivers as are herein described are but the forerunners of instruments that will tend to make radio a greater indoor sport than it already is. As quickly as designers and manufacturers learn that the present-day radio fan wishes a set that not only is efficient, but also adds to the appearance of the room in which it is placed, the sooner will the industry be placed on a more stable foundation. A great deal of credit is due those persons who have experimented along the lines mentioned above, because it is only by careful research work and experimenting that radio will finally take its rightful place among the great inventions of this age.

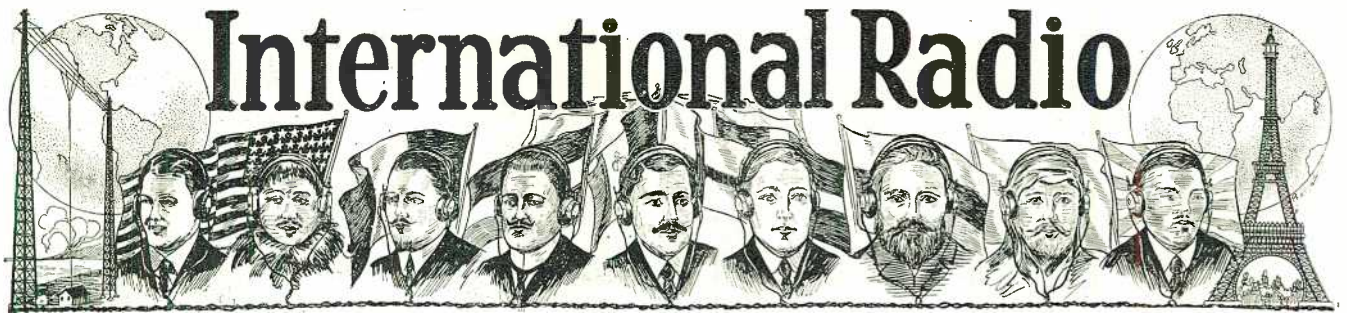

CHINA

Chinese Conditions

Radio in China being under government control, broadcasting is permitted only under special license. Changes in legislation permitting a lifting of the radio equipment embargo are daily expected. Only in two treaty ports is there any broadcasting. In Hong Kong there is a 1,500-watt government station operating on 350 to 360 meters. The Hong Kong Hotel Company operate a 100-watt station, the wave-length of which we do not know.

There is some phone transmission by department stores and hotels, but it is sporadic.

The Ministry of Commerce has been working for a year on regulations which may be acceptable to the Chinese powers-that-be. When these regulations are completed to the satisfaction of all parties concerned, China may be expected to couple its interest (at this rather late date) to that of the rest of the world in this field of endeavor.

RECENT RADIO PROGRESS ABROAD

COLOMBIA

The development of a radio market in Colombia which has no broadcast station, is largely dependent upon the completion and satisfactory operation of the proposed broadcast stations in Venezuela, Peru and Costa Rica.

AFRICA AND FAR EAST INDIA

It is necessary in India for one desiring to import radio apparatus to obtain an import license from the Indian Government. Contrary to previous reports, once this license is obtained, there are no restrictions whatever on the quantity of receiving sets which the licensee may import. Further, the purchaser of a re-

ceiving set must have a license from the government permitting him to operate it, but this license need not be obtained prior to the importation of his receiver. These regulations also apply to Burma.

NEW ZEALAND

New Zealand is well supplied with broadcast stations and offers a good market for receiving apparatus. American radio manufacturers and exporters shipped to this distant market \$23,680

of other foreign countries, to develop the Tunisian market. These advantages are: a preferential tariff, which admits French radio apparatus duty free, the present favorable rate of exchange and the nearness of the two countries to one another.



ENGLAND

New Type Inductance Coil and Mounting

Many more radio experimenters would use inductances of the honeycomb and similar types, if the construction were more solid. As made at

the present, these coils stand up very well at first, but tend to loosen in their windings when used for a considerable period. In addition, they are easily affected by mechanical damage, for instance when they are dropped or otherwise roughly handled by the experimenter.

An English maker has now brought out a new style of inductance coil, which is claimed to be more solid than any other type, and is not likely to suffer from mechanical breakdown.

Fig. 1 on the left shows a coil of the new design; the winding is contained in the interior, and is protected by the stout hard rubber discs shown in the illustration. The central portion of these discs is engraved with circular lines, so that the coil is easily held and not liable to slip.

The interior construction and the method of fitting the plug-in pins in the lower ends of the hard rubber discs is clearly shown in Figs. 2 and 3.

—C. A. Oldroyd.

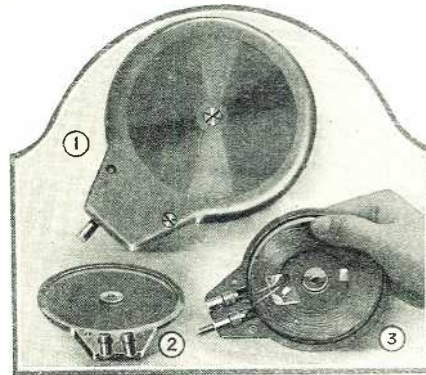

The new type of English inductances with protective casing.

worth of their goods during the first quarter of 1925.

SYRIA

Radio enthusiasts residing in Syria are dependent upon distant broadcast stations for their entertainment. It is practically impossible to determine what the possible market for radio apparatus in Syria will be but it is certain that, until broadcasting stations are erected and placed in operation within a relatively short distance of Syria, only high-priced receiving sets will be worthy of consideration.

TUNIS

There is one broadcast station in Tunis—located in the city of Tunis—but radio fans are not dependent on this station for their entertainment as they can readily receive from several European cities. Permission to erect and operate a broadcast station in Tunis must be obtained from the government.

It is not required that individuals owning and operating receiving sets procure a license from the government, but they must notify the Postal authorities of their actions.

The principal radio dealers in Tunis are the electrical firms. Most of the receiving sets and radio parts offered for sale and in use in that territory are of French origin. The average price of a 5-tube set in Tunis is 1,500 francs, approximately (\$75.00), and loud speakers retail at approximately 600 francs (\$30.00) each. French manufacturers and exporters of radio apparatus are in an advantageous position, relative to those

Under-water Transmission

An attempt was recently made by engineers of the British Broadcasting Co. to broadcast from under water. The experiments were made in one of the large tanks in the London Zoo Aquarium. The aim of the experiment was

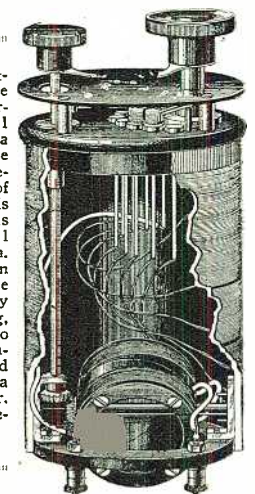

The antenna inductance with a variable antenna reaction arranged for panel mounting covers a wave-length range from 175 to 4,000 meters. On one end of the tube, on which is wound the coil, is mounted a special dead-end tap switch. The antenna reaction is operated from the front of the panel by means of a gearing, allowing adjustment to a fine degree. The instrument, when used in conjunction with a variable condenser, forms a complete receiving circuit.

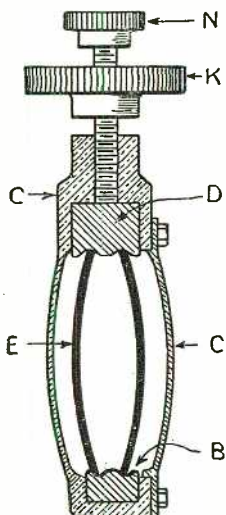

The main difference between the type of English condenser shown in the accompanying sketch and others on the market is that the pressure is applied to the movable plates in a vertical direction. The metallic casing, C, of the condenser forms one plate of the condenser, the other being the two mica-covered plates, E. These plates are sprung into position between the two insulating plates, B and D. When the screw, N, is turned by the handle, N, it presses down on D, which springs the plates, E, nearer the outer casing, so varying the capacity. A fine adjustment is provided in the knob, K, which is finely threaded.

to ascertain, not whether fishes speak, but whether they actually communicate by means of any special sounds. The results of this most interesting experiment have not, as yet, been divulged to the eager thousands who were not so fortunate as to hear this program.



Broadcast vs. Perifonia

SPAIN

On page 99 of the July number of "El Exportador Americana," the Spanish issue of *The American Exporter*, appears an interesting article discussing the Spanish translation of the English word *broadcasting* and its derivatives. It is pointed out that the distinguished Spanish philologist, D. Julio Casares, published a treatise on the question in the Spanish newspaper, *A B C* on June 6, 1924.

It is said that the Spanish word "radiodifusión" has made little headway toward replacing the English "broadcasting." The English term is so much mutilated in print

and speech in the Spanish-speaking countries that the "purists" are crying for an authorized Spanish form. The Spanish Academy, slow and conservative, has not acted. Dr. Casares proposes *perifonia* and its derivatives. *Perifonia* is composed of the Greek elements *peri*, around, in every direction, and *fonic*, sound. It would make a better international word than the English term, it is claimed. The English forms would be: To broadcast, *perifone*; by broadcast, *by perifone*; broadcaster, *perifonist*, etc.

(The words are analogous to our words *telephone*, *telephoned*, etc.—Ed.)

Since Esperanto is winning recognition as the world radio language, perhaps a more generally acceptable international word for *broadcast* would be the Esperanto: *disauidigi*—*dis*, to scatter in all directions; *audi*, to hear; *ig*, the suffix which means to *cause to be done*, thus: *disauidigi*, to cause to be heard in all directions, pronounced: *Dees-ou-dee-gee*. Derivations: *disauidigi*, to broadcast; *disauidigado*, broadcasting; *disauidiganto*, broadcaster; *disauidiga anoncisto*, announcer, etc.—*J. D. Sayers*.

ADJUSTABLE SCREW AND LOCK NUT TO ADMIT ANY SIZE CRYSTAL

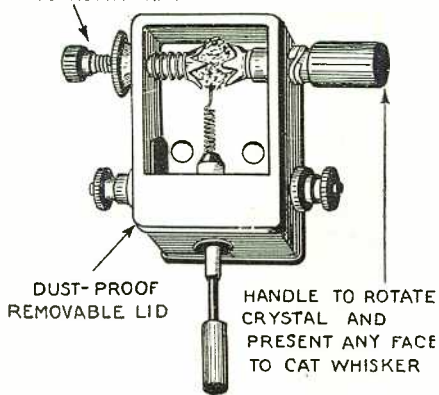

The feature of this English crystal detector is that both the crystal and the catwhisker can be adjusted. The crystal is held between two jaws and can be rotated so that any part of it may be presented to the catwhisker, which is held in a chuck attached to the handle that works in a ball-and-socket joint.

Esperanto Broadcast Lessons

By JAMES DENSON SAYERS*

**PART I
ALPHABET**

The five vowels have the international sound, practically the same as Spanish or German: a, ah; e, eh; i, ee (always as i in machine); o, oh; u, oo (as u in Ruth).

Those consonants which have only one sound in English are the same in Esperanto: b, d, f, k, l, m, n, p, r, t, v, z. The r should be slightly trilled.

q, w, x, y are not used.
c, tso; ĉ, cho; g, go; ĝ, jo; h, ho (same as English); ĥ, hho (as the German or Scotch ch, strongly aspirated; appears in but few words); j, yo (as j in hallelujah); ĵ, zho (as s in pleasure or measure, or French j in je); s, so; ŝ, sho.

aj as ai in aisle; ej as ei in vein; oj as oy in boy; uj as uj in hallelujah; aŭ as ou in house; eŭ, eh-oo said quickly like ehw.

ACCENT

Always accent next to last vowel: Es-pe-ro, Es-pe-ran-to, ju-na. Eŭ-ro-po.

There are three combinations of letters which need a little special attention for English-speaking students: Kv, kvar, kvin, kvieta. Kn, knabo, knedi. Sc, scio (sts-ee-o), sceno (stse-no), eksцитi (eks-ee-tee).

As it is of first importance in the study of any language to correctly master the pronunciation at the beginning, I cannot overemphasize the need of each student following me closely in all the Esperanto text, diligently pronouncing after me all words and text which I indicate for that purpose.

WORD ENDINGS

Each class of words in Esperanto has its distinctive letter ending, so that you know at once to which class a word belongs: Nouns (names of things) end in o: patro, father, domo, house; adjectives (words that describe things) end in a: bona patro, good father; granda domo, large house; verbs (infinitive) end in i: kuri, to run, vidi, to see; adverbs end in e: rapide, rapide, slowly, malrapide; present tense of verbs end in as: kuras, runs, vidas, sees; past tense in is: kuris, ran, vidis, saw; future tense in os: kuros, will run, vidos, will see; imperative in u: Portu al mi la libron, Bring me the book, Ni iru kun li, Let us go with him;

The following is the first of a series of three condensed lessons in Esperanto, prepared especially to be broadcast from WRNY by Mr. Sayers in order that all readers of RADIO NEWS, wherever situated, may have ORAL PRACTICE in correct pronunciation of the World Radio Language. After these three lessons students following them will be well prepared for reading, writing and beginning conversational practice. This first lesson will be given from WRNY at 10:00 P. M SEPTEMBER 24, on 258.5 meters. This will be followed by a lesson a month later till the series of three is completed.)

subjunctive in us: Se mi estus sana, mi estus feliĉa, If I were well, I would be happy.

When more than one of anything is indicated it is called the plural. The plural is shown in Esperanto by the ending j: patroj, (pah-troy), fathers, domoj (dohm-oy) houses. Adjectives describing plural nouns must also take the plural ending: bonaj patroj, grandaj domoj.

Pronouns are: Mi, I; ni, we; li, he; vi, you; (ili, they; ŝi, she; ĝi, it; oni, one, they, people (abstract); ci, thou (used familiarly in family or with intimate friends); si reflexive pronoun; see below.)

To form the possessive with any pronoun, add the adjective ending a: Mia libro, my book; miaj libroj, my books; lia domo; ŝia patro; iliaj patroj.

Oni is used for one, they, people, when these words are used indefinitely: Oni diras ke li estas riĉa, One says (or, they say, people say) that he is rich.

Si is a very valuable pronoun in Esperanto, preventing ambiguity where such often exists in national languages. It always refers back to the subject of the sentence. In "John loves his brother and his children" we can't tell from the English text whose children, but in "Johano amas sian fraton kaj siajn infanojn" we see at once means the children are John's, not his brother's.

Mem is used to emphasize pronouns: Li batis sin mem, He struck himself (his own self); Si mem venis, She herself came.

The sign of the accusative, n, in Esperanto is of first importance. Many persons, not understanding its usage, denounce it, but once understood and used easily, its great value is seen. It is of such importance because the syntax, or sentence structure, of different national languages differs greatly. Therefore, in a universal language, the German may put his verb wherever he pleases, anyone can place the subject at the end of the sentence, but as long as the "n" is used to indicate the object in the sentence it is clear. "La patron mordis la hundo" means, with instant clarity, "The dog bit the father"; La bildon pentris la pentristo, The painter painted the picture.

N renders clear such ambiguous English structure as: "John loves Mary more than George," "Johano amas Marion pli ol Georgo" which can mean nothing but "John loves Mary more than George (loves Mary)."

The accusative n is not used after prepositions: Sur la tero kuŝas ŝtono, On the ground lies a stone; Antaŭ la domo staras arbo, Before the house stands a tree. But if motion toward something is to be indicated, the accusative of motion is used: Li iris en la domon, He went into the house. The three prepositions ĝis, till, as far as, until, up to, al, to, towards, and tra, through, can mean nothing but motion, therefore it is not necessary to use n following them: Mi iris ĝis la rivero, I went as far as the river; Li venis al mi, He came to me; Ni vojaĝis tra la mondo, We traveled through the world.

Names of days of the week and months of the year (usually written with small letters as is the custom in most countries) are: Dimanĉo, lundo, mardo, merkredo, ĵaŭdo, vendredo, sabato, Januaro, februaro, marto, aprilo, majo, junio, julio, aŭgusto, septembro, oktobro, novembro, decembro.

NUMBERS

Cardinal numbers: 1, unu, 2, du, 3, tri, 4, kvar, 5, kvin, 6, ses, 7, sep, 8, ok, 9, naŭ, 10, nulo, 11, dekunu, 12, dekdu, 15, dekkvin. Multiples of ten are simply "ten" plus the desired multiple of ten, thus. 20, dudek, 40, kvardek, 90, naŭdek.

(Continued on page 482)

* President New York Esperanto Club.

Hard Tubes and Soft Tubes As Amplifiers and Detectors

By PROF. C. B. BAZZONI, Ph. D. *

The first part of an article telling about the fundamental characteristics and functions of different types of electron tubes.



THE three-electrode tube is the heart of the radio set. Every radio user knows that these tubes contain a filament which can be heated to glowing by a current passed between two of the plugs in the base, a metal plate connected to a third plug and an intermediate wire grid connected to the fourth plug. These details of construction can be observed easily by peering through thin places in the silvery lining of the tube, especially when the filament is glowing. Very few amateurs, however, even those expert in making and operating sets, have definite notions as to how and why tubes act as they do when inserted in the various hook-ups, and still fewer are familiar with the scientific principles underlying the design of the tubes. The experimenter interested in the advancement of radio performance ought, nevertheless, to study these matters diligently, since improvements in any device can be made only after an adequate understanding of its present construction and operation has been acquired.

The fact that the tubes of today are in all essentials, except degree of vacuum, practically identical with those introduced by DeForest back in 1907 might be thought to indicate that room for improvement exists in this field. Let us consider briefly certain of the fundamental characteristics of present-day tubes. In this survey we shall consider those characteristics which belong, not only to the three-electrode tubes, but also to the two-electrode and four-electrode tubes used in certain special connections in the radio art.

HOT CATHODE AND COLD CATHODE TUBES

The practical uses of vacuum tubes depend on the movement through them of streams of electrons—those elementary particles which constitute negative electricity. This movement is maintained by an electric field between a positively charged electrode in the tube called the *anode* and a negatively charged electrode called the *cathode*. One method of classifying vacuum tubes is based on the nature of the cathode: 1, *cold cathode tubes*, where the cathode is merely a metal plate or wire and, 2, *hot cathode tubes*, where the cathode is a filament which can be heated to incandescence. It is evident that all the ordinary radio tubes belong in class 2. However, readers of this periodical will recall that the September issue con-

tained (page 293) a description of a new cold cathode tube which has been used as a rectifier in a "B" battery eliminator and for other radio purposes.

HARD TUBES AND SOFT TUBES

In hot cathode tubes electrons are produced continuously from the hot filament itself (the so-called thermionic emission) and, being drawn over to the anode, produce a relatively heavy current through the tube, which would be maintained even if the air or other gas were completely removed. In cold cathode tubes, on the other hand, no electrons are produced directly from the cathode. The electron stream on which the current flow depends is built up through an electrical "break-down" (ionization) of the gas atoms in the tube. Cold cathode tubes must, therefore, contain a certain amount of gas.

A second useful classification of vacuum tubes is made on the basis of degree of vacuum, that is, on the amount of gas in the tube. From this point of view tubes are either "soft" that is, with a considerable amount of gas in them or "hard" with as good a vacuum, i.e. as little gas, as is possible with present-day air-pump facilities. It is plain from what we have already said that cold cathode tubes must be *soft*, while hot cathode tubes may be *either hard or soft*.

HARD VACUUM, HOT CATHODE TUBES

The hard vacuum, hot cathode tube is in principle the simplest of all vacuum devices although, on account of the mechanical difficulties of producing and maintaining the hard vacuum, it was the latest type to attain any sort of perfection. The 201A and 301A tubes are examples of this type. In the filament of such tubes, as in all electrical conductors, there are many millions of free electrons, that is, of electrons which circulate freely amongst the atoms of tungsten which make up the filament. These free electrons move about in the cold filament at high average speeds—say about thirty miles per second—on paths rendered very short, broken and irregular by frequent collisions with the tungsten atoms. Each time an electron hits an atom it stops or bounces off in another direction, but the speed averaged over a second is nevertheless high. At the surface of the filament certain skin forces act sufficiently to prevent any electrons which come up to the surface with these velocities

from escaping through it. If now heat be applied to the filament the electron speeds will be increased—the heat energy being, in fact, merely the energy of motion of the electrons and atoms—and some of them will then be able to work out through the surface of the filament into the surrounding space. The hotter the filament, the more electrons will work out in each second.

THE THERMIONIC EMISSION

These electrons make up the *thermionic emission*, so named by O. W. Richardson, who first explained the effect in 1903. If there is no positively charged electrode in the neighborhood of the emitting cathode, the electrons will merely form a cloud around the hot wire and will act to repel the electrons coming up to the surface back into the filament, thus putting a stop to the emission after a certain density of the cloud is reached. This, for example, is the condition in an incandescent lamp where we have a glowing wire but no second electrode. In radio tubes the plate is kept 45 to 90 volts positive, referred to the filament, by the "E" battery and consequently the electrons, coming out of the filament as a result of its high temperature, fly over to the plate making up the "plate current." If the filament is made very hot, as for instance when a tungsten filament is raised to 2,000 to 2,500 degrees Centigrade (as is usual in radio sets), an enormous number of electrons is given out in each second; enough, at the highest temperatures, to make up a current as large as four amperes for each square centimeter of filament. Under these conditions there will be a very large number of electrons on their way over in each unit of volume of the space between filament and plate at any instant.

SPACE CHARGE

This distributed cloud of electrons is, of course, a distribution of negative electricity and is referred to as "negative space charge" or merely "space charge." This space charge, being negative, will evidently act to repel fresh electrons coming out of the filament so that when it becomes dense enough, it will stop or, rather, limit the thermionic emission. For any given plate voltage a definite upper limit is thus put on the plate current. Consequently, the plate current cannot become greater as the filament rheostat is turned out, since the space charge prevents

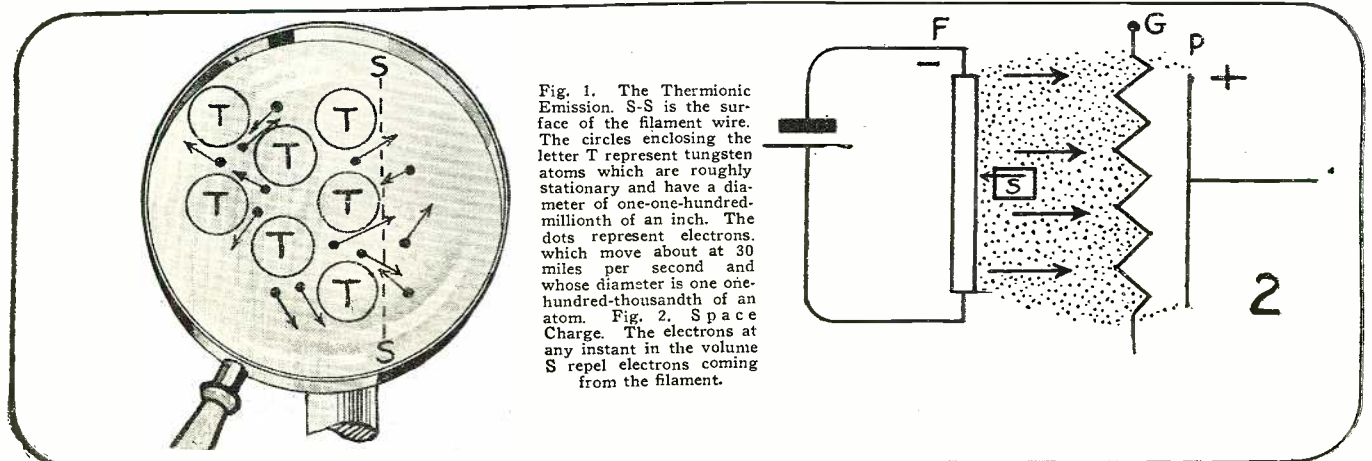

Fig. 1. The Thermionic Emission. S-S is the surface of the filament wire. The circles enclosing the letter T represent tungsten atoms which are roughly stationary and have a diameter of one-one-hundred-millionth of an inch. The dots represent electrons, which move about at 30 miles per second and whose diameter is one-one-hundred-thousandth of an atom. Fig. 2. Space Charge. The electrons at any instant in the volume S repel electrons coming from the filament.

*Professor of Experimental Physics, University of Pennsylvania.

any more electrons getting away from the filament in any case. If now the space charge be in any way reduced while the filament temperature is above the saturation value, the plate current will immediately increase, due to the extra electrons which are thus enabled to get away from the filament. This simple fact is the fundamental principle which explains nearly all of the mysteries of the radio tube.

ACTION OF THE GRID

The wires of the grid serve merely to increase or decrease the space charge and thus to alter the strength of the plate current through the tube. If the grid wire be made negative, the space charge effect is reinforced and the plate current may be completely cut off—if the grid wire be made positive the space charge is more or less neutralized and the plate current may be enormously increased. Since the fluctuations in grid potential necessary to produce these effects are very small, the tube is useful as a relay or detector and since the fluctuations in plate current follow the fluctuation in grid potential very accurately, it has its wide application as a non-distorting amplifier.

THE NECESSARY VACUUM

It is seen that the theory of the "hard tube" involves no mention of gas. Gas must, in fact, be reduced to a point where the number of gas atoms between filament and plate is not large enough to offer any serious impediment to the passage of the electrons across. In first-class hard tubes the air is pumped out by efficient air pumps while all the metal and glass parts are being heated and then the residual air is taken up by certain chemicals called "getters," which combine with the gas atoms to form solid compounds. It is the action of these chemicals which produces the silvery film seen on the inside of the glass in commercial tubes. By this means the gas pressure is reduced to perhaps one ten-thousand-millionth (1/10,000,000,000) of the normal atmospheric pressure. Now there will still be about one thousand million of atoms in each cubic centimeter of the space at this pressure so that such a vacuum, nearly the best attainable at present, is very far from perfect.

However, the atoms are so small and the electrons so much smaller that the chance of collisions occurring is really very slight at these pressures. It can be shown that whereas, at ordinary pressure, an electron can travel only about one one-hundred-thousandth of a centimeter without hitting an air particle it will, under the pressure conditions in a hard vacuum bulb, travel on the average a thousand meters (three-fifths of a mile) without hitting an atom. Since the distance, filament to plate, is only perhaps five millimeters (a sixth of an inch) it is evident that the gas atoms in the hard bulb will not interfere in any important way with the electron stream.

THE PURE ELECTRON DISCHARGE

An electron discharge of this character in which gas plays no important part is called a "pure electron discharge." We have here the simplest, most easily controlled and best understood type of electron current. It is possible to design tubes using this type of discharge so that they will amplify weak signals into intense ones without introducing irregularities or distortion. For straight amplification work the hard tube has, therefore, the widest use at the present time.

Although the hard tube gives satisfactory service as an amplifier it leaves much to be desired when used as a detector in radio circuits. It is, in the first place, entirely too insensitive to come up to the demands of modern practice. Compared to galvanometers and similar detecting devices used for analogous purposes in the laboratory, the tube detector must be ranked very low indeed in sensitivity. Numerous attempts have been made to remedy this defect. The regenerative receiver is one of these attempts. The gas-filled or "soft" detecting tube is another.

SOFT VACUUM TUBES

The "soft" or low vacuum tube was the type in general use for all radio purposes prior to 1914. The soft tube was used in those early days merely because, with the air pumps then at hand, hard tubes could not be manufactured. They were in subsequent years almost completely abandoned in practice, so that the present generation of radio amateurs has had little experience with them. Experimentation has, however, demonstrated that such tubes have some really valuable properties different from those of hard tubes, properties which people are now beginning to make use of by deliberately introducing gas into otherwise hard tubes. This new line of development is one with which the amateur experimenter ought to be familiar.

STRUCTURE OF GAS ATOMS

In order to understand the effect of gas on the electron current through a vacuum tube we must first bring up a few facts about the construction of the gas atoms themselves. Atoms are extremely minute particles of matter, far too small ever to be perceptible even under the most powerful microscopes, yet they are known to have a beautifully complex structure—being composed of electrons, the elementary particles of negative electricity, and of protons, the elementary particles of positive electricity. The electric charge on a proton equals that on an electron but in mass they are very different—the proton weighing about 1,800 times as much as the electron. Most of the atoms in a tube from which the air has been pumped and which has been treated with a "getter" are probably nitrogen atoms. Each nitrogen atom consists of a small central part, the nucleus, containing fourteen protons and seven electrons (and having, therefore, a net positive charge of seven units) and of an outer shell containing seven electrons. This

aggregation is seen to be neutral, electrically. It is held together by electrical forces of a definite character and has consequently a definite structural strength. This means that a certain definite amount of work must be done on the atom in order to break it apart in any particular way. For instance, a definite amount of work must be done to knock off or pluck away one of the seven exterior electrons. This particular amount of work is the smallest that could produce any effect on the atom, since tearing out any of its inner parts would evidently be more difficult and would therefore require more work.

ELECTRON PROJECTILES

Now an electron drawn over from the filament to the plate by a 90-volt "B" battery picks up considerable speed and therefore acquires considerable energy, being similar in this respect to a brick dropped over the cornice of a high building. If this projectile, the moving electron, strikes a nitrogen atom before it has fallen far enough to have enough energy to knock off one of the exterior electrons it will bounce off without changing the atom. If, however, it strikes the atom after having picked up the necessary energy in its fall toward the plate, it will disrupt that atom by knocking off one of the seven exterior electrons. This will convert the single uncharged atom into two charged particles called ions—one negatively charged ion, the dislodged electron, and one positively charged ion, the remainder of the atom. The atom is then said to be "ionized."

The positive ion will be very heavy compared with the negative ion. Since the nucleus contains seven protons, as stated above, the positive ion will be, in fact, more than 12,000 times as heavy as the single electron knocked off. As soon as these ions are formed they will begin to move, the positive ions falling toward the filament and the negative ions toward the plate. If there are a great many atoms in the tube so that many are being struck each second, the extra electrons liberated will evidently contribute considerably to the strength of the electron current. The positive ions, on the other hand, are very heavy and therefore clumsy, so that they do not move as fast as the negative ones, yet they will exert a most important influence since, by their presence in the space between the filament and the plate, they will neutralize the space charge and thus cause an increase in the electrons getting away from the filament.

DETECTING ACTION

If the potential across from filament to plate is not great enough to give the electrons the energy necessary to ionize the atoms then the discharge will go on very much like the pure electron discharge described above but, if the potential rises, then at the instant the critical value is passed and ionization begins the two causes mentioned—the contribution of the negative ions

(Continued on page 551)

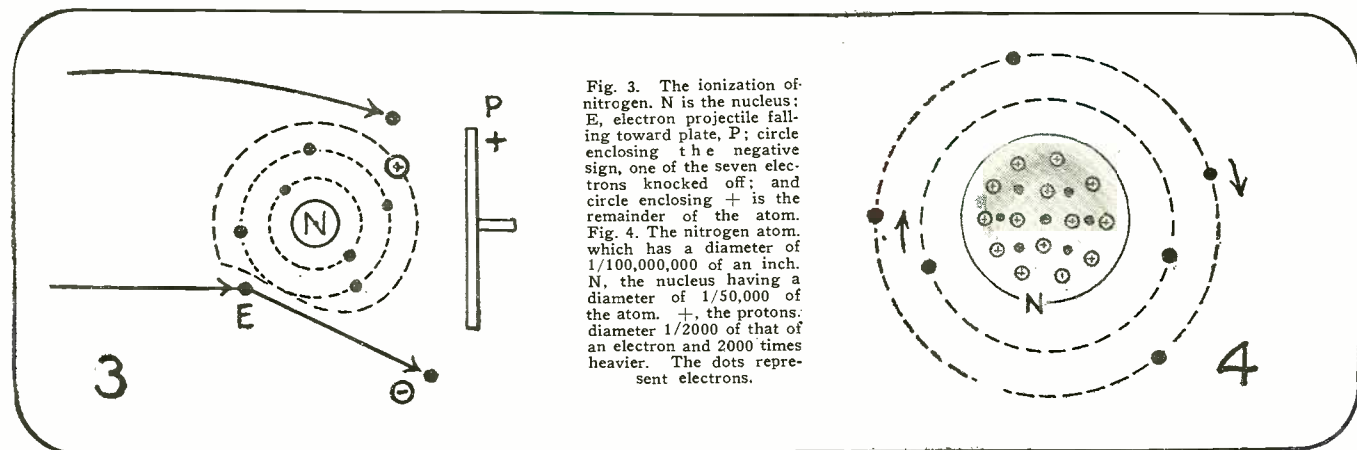

Fig. 3. The ionization of nitrogen. N is the nucleus; E, electron projectile falling toward plate, P; circle enclosing the negative sign, one of the seven electrons knocked off; and circle enclosing + is the remainder of the atom. Fig. 4. The nitrogen atom, which has a diameter of 1/100,000,000 of an inch. N, the nucleus having a diameter of 1/50,000 of the atom. +, the protons; diameter 1/2000 of that of an electron and 2000 times heavier. The dots represent electrons.

The Luminotron

By Theodore H. Nakken*

PART I

The photo-electric cell and its applications are here described in a manner that should prove interesting to students of television.

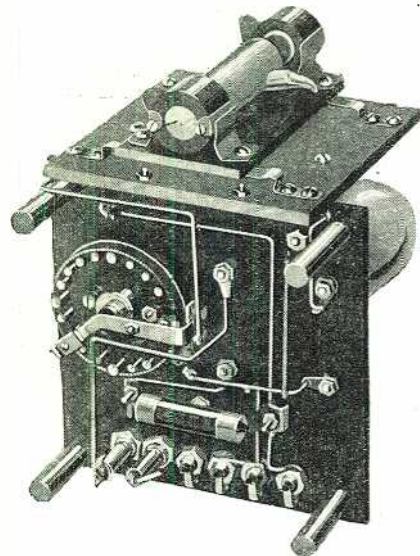

Bottom view of the apparatus used for the transfer of light energy into electrical energy.

ONE of the most neglected and yet most interesting branches of research can be found in the subject of photo-electricity, photo-electric cells, and the possibilities of their application in different apparatus.

The possibilities of a satisfactory photo-electric cell would be extremely far-reaching, as, after such a cell has been constructed, the solution would be given for quite a number of problems that now await their complete answer and satisfactory solution. Of the problems that might be solved I will name only the following:

1. Automatic registration of light intensities at various moments.
2. Automatic signal apparatus.
3. Automatic apparatus for lighting buoys.
4. Measurement of the intensity of different light rays.
5. Reproduction of sound photographed upon a film.
6. Talking motion pictures.
7. Telegraphing photographs, etc.; at high speed by wire or by means of radio.
8. Television.

As is generally known, the element selenium exhibits to a marked degree the peculiar property of lowering its electrical resistance when it is illuminated by light rays. This property seemed to promise at once the complete solution of the various problems named, and it may be said that if the selenium cell had only fulfilled its original promises, most of these problems would have been actually solved, as the mechanical and electrical details of the apparatus involved in several inventions on this subject are of the greatest ingenuity.

The selenium cell, however, has a sharply defined frequency limit. Cells made in the most careful manner are scarcely able to follow light modulations faithfully in variations above a thousand a second. Even if cells of much better quality are produced, the limit remains far below the frequency which would be required for most of the above problems.

A second disagreeable property is the so-called inertia of the cells. By this it is

meant that the cells, after being illuminated, do not return immediately to the resistance they possess when in complete darkness. Means for circumventing this property have been devised, but these, at best, constitute a compromise.

Another drawback is the fact that for no apparent reason they can suddenly change their properties, so that they are, therefore, entirely unable to act as the controlling member in apparatus of which a certain reliability must be demanded.

It was with these facts in view that much thought and labor have been given to some kind of photo-electric cell that would be able to take over the functions of the selenium cell.

THE HALLWACHS EFFECT

The most beautiful line of attack was given after the discovery of the so-called Hallwachs effect. This effect may be briefly described as the property of metals to emit electrons when light, especially ultraviolet light, falls upon them while charged negatively. This emission of electrons seems to be practically instantaneous.

The alkaline metals, like potassium or rubidium, show this phenomenon to a marked degree and even emit electrons when illuminated by the visible spectrum.

We are indebted to the German scientists Elster and Geitel for much of our knowledge of the actual properties of these metals and their amalgams and hydrides, which possess the Hallwachs effect to a still higher degree than the metals themselves.

The photo-electric cell, as built by Elster and Geitel, consisted of a glass bulb which was silvered over a great part of the surface on the inside, so that only a small aperture in the silver coating was left open. A contact was brought through the glass bulb so that the silver coating could be brought into electrical contact with a terminal on the outside of the cell. A platinum wire was fused in the glass where it was free of the silver coating and formed the second contact (see Fig. 1). After the glass bulb had been prepared, pure potassium, or rubidium, was distilled into the bulb, and upon condensation the entire silver-coated inner surface was covered with the metal. After a sufficient deposit of alkaline metal had

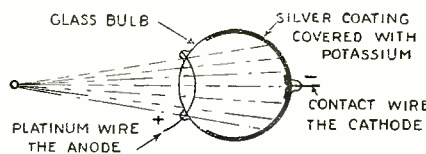

ORIGINAL ELSTER AND GEITEL PHOTO ELECTRIC CELL

FIG. 1

An early photo-electric cell.

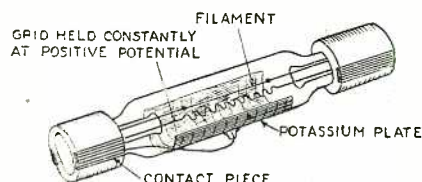

LATER FORM OF THE CELL CALLED LUMINOTRON

FIG. 4

By varying the intensity of light on the plate of this cell, the potential of that plate can be varied through wide limits.

been secured, the bulb was filled with hydrogen, which caused potassium or rubidium hydride to form.

To bring this layer to its highest point of sensitivity, an electrical discharge was then caused to pass through the tube, usually by means of a spark coil. This discharge caused the hydride to assume a reddish, bluish or greenish color, depending upon the alkaline metal used and the degree of intensity of discharge. After this process had been completed, the tube was evacuated and an inert gas, like helium or argon, was introduced into the tube at very low pressure, which again seemed to serve to increase the sensitivity and also to make the cells more stable in performance.

To obtain the best results from these cells the platinum wire in the opening (see Fig. 1) was made positive and served as anode, while a negative potential was applied to the coating. To secure the greatest response it was at all times necessary to bring the potential difference to the highest possible point. This practice was very dangerous, as the potential was always held to the point of breakdown. Consequently, the one operating the cell had, to say the least, to have great experimental ability. There-

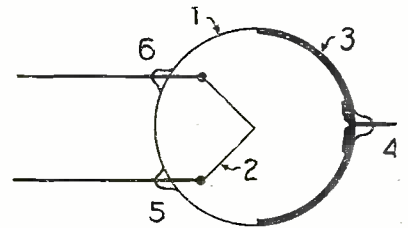

THE AUTHORS FIRST CELL

FIG. 2

1, glass container; 2, filament; 3, photo-electric plate; 4, cathode terminal; 5 and 6, filament terminals.

fore, the use of the cell for other than purely scientific purposes, for instance, the measurement of the light intensity of stars, has very rarely been attempted.

The cells had an additional disadvantage in that they were subject to fatigue. It seems that the photo-electric properties of such surfaces depend upon the presence of what might be called free electrons, *i. e.*, electrons that can be easily loosened from the atoms to which they belong.

On the other hand, it may be said that the cells had apparently no appreciable inertia, as it has been proven experimentally by Wilson that they possess the capability of following up to 1,500,000 light fluctuations per second.

WORKING PRINCIPLES

In his work upon the improvement of photo-electric cells, the author paid the greatest attention to the above properties of the alkaline cells and built upon this foundation. The underlying thoughts were the following:

1. Some kind of cell must be devised in which it is possible to retain all the desirable qualities of the alkaline hydrides.

2. No attempt should be made to use the actual photo-electric currents, as these require tremendous amplification to be of any appreciable use.

*Research Engineer, Radiall Co.

3. Means must be provided for constantly supplying free electrons to the sensitive hydride.

The very first cell constructed in the course of the experiments is shown diagrammatically in Fig. 2. We see there a glass container (1) in which is inclosed a filament (2), and a photo-electric plate (3). Contacts 4, 5 and 6 were brought to the outside. This tube was connected as shown in Fig. 3, where we see the tube connected to a battery (7) for lighting the filament, which can be regulated by means of a rheostat (8). If we connect the sensitive plate by means of a wire (10) to the stem of a sensitive electrometer (9), we see that the gold leaf (11) takes a position, depending upon the electronic charge which accumulates upon the photo-electric plate (3), as a result of the thermionic emission from the filament. If light now falls upon the cell, the photo-electric emission will come into play, and therefore the plate will lose some of its charge, with the result that we see the gold leaf fall down and take a second position, as indicated by the dotted line. As soon as the light source is removed, the gold leaf takes its original position. We can make this effect even stronger by interposing between the filament and the sensitive plate a grid, which is held at a constant positive potential, as is shown in Figs. 4 and 5.

In the patent obtained on this invention (U. S. Patent No. 1,522,070), there are indicated other forms worked out to a higher degree of perfection than the figures given above, but in practice it was found that the cell as described is perfectly capable of all that is necessary to conduct different experiments successfully. The cell in its various forms was called the Luminotron.

If we take a cell of the form as shown in Fig. 4 and connect the sensitive plate directly to the grid of an ordinary thermionic valve, it will be clearly seen that if we cause the plate of the photo-electric cell to vary its potential by varying intensities of light, we shall thereby vary the potential of the grid in the valve, which in turn will vary the magnitude of the plate current, according to the well-known properties of these valves.

WHAT HAS BEEN DONE

We have now succeeded in doing the following:

If the filament of the photo-electric cell is lighted, it emits electrons, which, by the action of the positive grid, are projected upon the sensitive plate, which therefore assumes a negative charge. Here, it may be added, this constant electronic bombardment, taking place within the tube, seems to have the very useful effect of constantly resensitizing the photo-electric surface. It

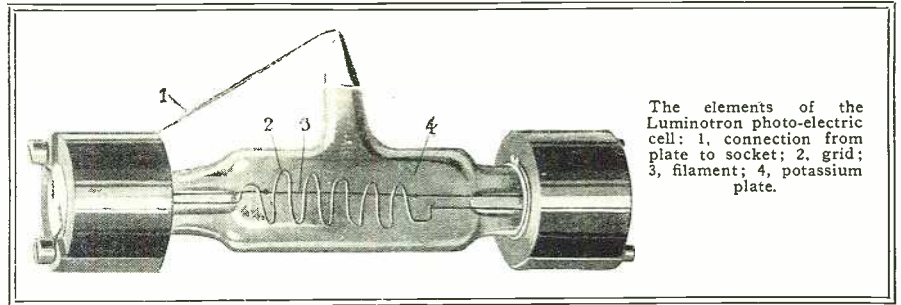

The elements of the Luminotron photo-electric cell: 1, connection from plate to socket; 2, grid; 3, filament; 4, potassium plate.

was pointed out that the original alkaline cells were made highly sensitive by means of an electric discharge through the tube, which really amounts to an electronic bombardment. The same sensitizing seems to be going on constantly in the cells of this construction; in fact, it was often found that cells which were only slightly sensitive after they had been constructed needed only to be left for about half an hour with lighted filament to reach the same degree of sensitivity as the very best specimens.

Now, when light of varying intensity is projected upon the plate, the latter will, of

thor hopes to go more deeply into this hypothesis to see whether or not this novel effect actually exists.

It is evident that it is a fairly easy matter to combine the different functions of this photo-electric cell and the thermionic valve in one and the same tube. Different ways of doing this have been given in the patent referred to above, but all the cells described there function only as light detectors by means of the varying potentials of a photo-actinic plate, which at the same time acts as grid in a thermionic valve arrangement.

The author wants to express here his great appreciation for the work done and the assistance given in this development work by his friend, Prof. Chr. Ries, in Munich, Germany, who was so good as to undertake the actual construction of the cells, and who, as one of the greatest experts in photo-electric phenomena, assisted in all phases of the experiments conducted.

This is the first of three articles, the following of which will deal with the application of the described photo-electric cell to a system for recording and reproducing sound, leading up to the final application in talking motion pictures, while the third article will deal with a system of telephotography, either by wire or by means of radio, in which article the author will also deal with the problem of television.

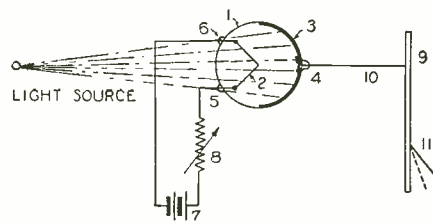

FIG. 3 DEMONSTRATION CIRCUIT

A charge of electricity is carried from the plate (3) by a wire (10) to an electrometer (9), which causes the gold leaves (11) to spread.

its own accord, emit electrons, and this emission is greatly facilitated by the fact that the grid is held at a positive potential and therefore acts as an anode with regard to the sensitive plate. The charging effect of the filament remains constant, of course, and therefore the potential of the plate varies in direct proportion with the intensity of the light rays.

As was pointed out, the electronic emission is absolutely instantaneous, as is testified by the measurement of the possible number of fluctuations that can be followed by a sensitive plate of this description. As this plate is connected to the grid of a thermionic valve, the plate current in the latter will be an exact electric reproduction of the varying intensities of the light source.

It is the conviction of the author that in these cells there appears a phenomenon that has not heretofore been established. If a photo-actinic plate under the influence of light rays emits electrons, it may be safely concluded that such a plate under the same circumstances should show a tendency to resist the depositing of electrons on its surface from outside sources, i. e., the filament. If this be true, we should see a second reason for the great sensitivity of the cell. Not only does the actinic plate emit electrons and thus lose part of its charge, but the plate resists the tendency of the filament to instantly replace that charge, which should be of the greatest benefit to the sensitivity of the cell.

At some future time the au-

RADIO REACHES THE PHILIPPINES

Radio has finally reached the Philippine Islands in both its commercial and popular forms. Two rival organizations are fighting for control of local commercial and broadcast rights. With the advent of broadcasting the total number of fans listed in the Islands jumped from about 100 to about 2,000. No definite estimate of fans can be

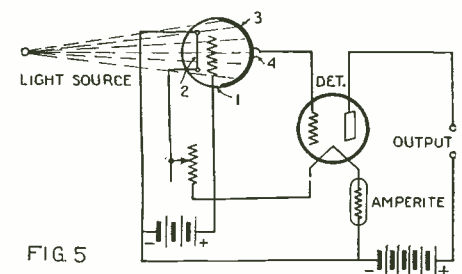

FIG. 5

Circuit of the apparatus shown in the photograph at the left.

secured, but it is believed that the craze is now started and that broadcast listeners will soon be legion, despite the difficulties of reception in that climate.

At the end of 1924 the Bureau of Posts and Telegraphs reported that there were 41 private radio stations, 39 amateur wireless licenses and about 85 radio receiving sets in operation. Of the latter class, 50 receiving sets were said to be located in and around Manila.

Mr. Nakken's photo-electric cell and vacuum tube amplifier.

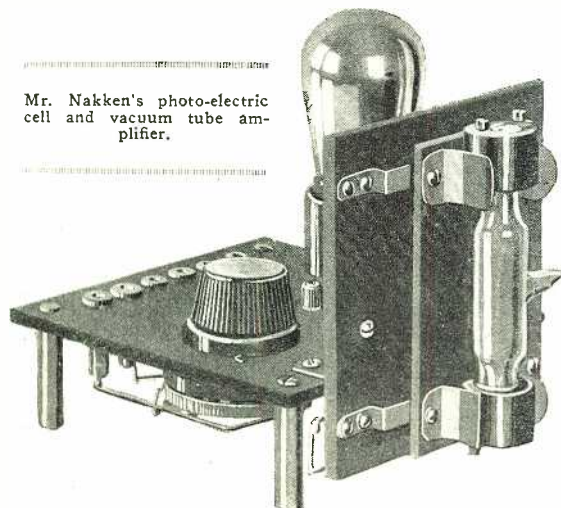

The Radio Hook at WRNY

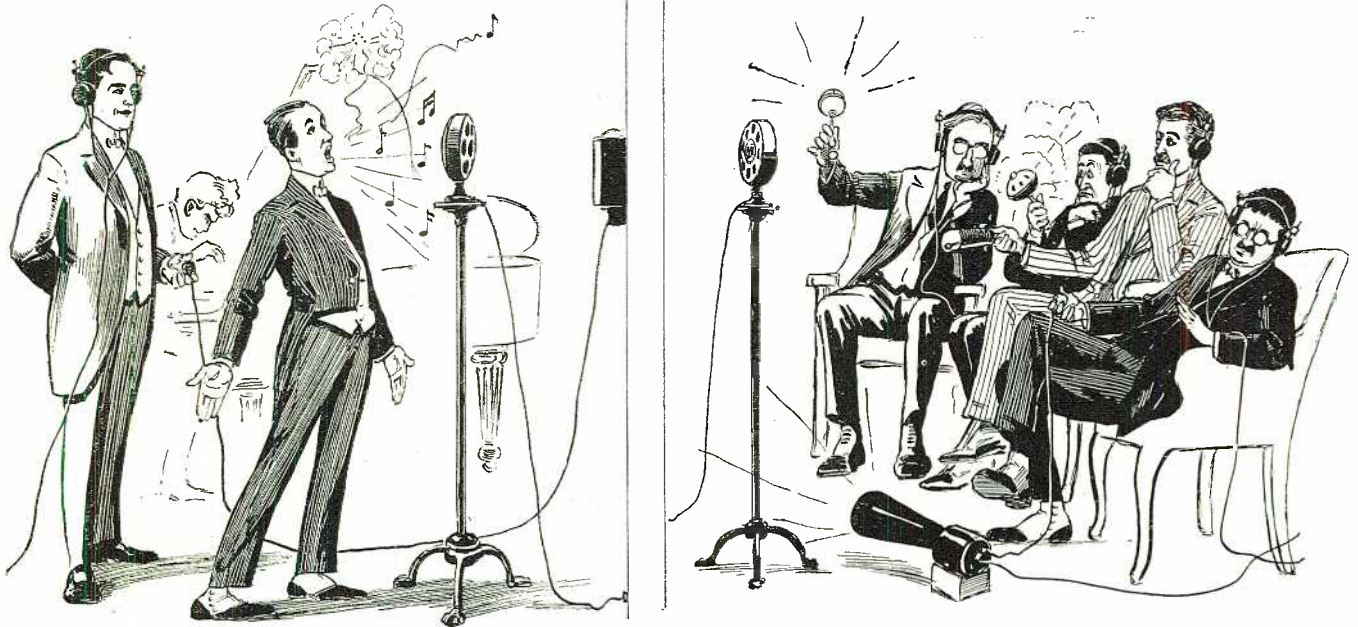

If the performance of the amateur is very bad, the judges on the right indicate their disapproval by the noise-making implements. But the performer hears nothing.

FEW things have made such a great hit as the radio hook at Station WRNY, now used on all Amateur Nights. The radio hook is the invention of Mr. Hugo Gernsback, editor of RADIO NEWS, and it works as follows:

On Thursday nights, during the presentation of the Amateur Night feature, the radio hook is applied just as the old-fashioned hook, that yanked the amateurs off the stage on the Bowery, was used in the good old days, except that the radio hook is more humane, in that the performer never knows that it is being used on him.

Its *modus operandi* is as follows: Several hundred feet away from the WRNY studio, securely locked into a room, there are anywhere from six to ten musical and literary critics. The critics are never twice the same people, but are usually recruited from the desks of newspaper critics. These critics are seated and wear telephone head receivers, with which they listen in to the program from the studio. They have in front of them a regular broadcast microphone, which is on the air at all times, the same as the studio "mike." Anything that the critic says, or any noise that he makes,

goes on the air along with the amateur's performance. The critics have all sorts of weird noise-making contrivances, such as cowbells, Klaxon horns, rattles, horns and many others. In the studio the announcer also wears a head receiver for reasons which will become apparent later.

The amateur goes on the air and does his stuff. If it is good, the radio audience hears only the undiluted program of the amateur. But let it be bad, and immediately the critics begin their noise-making inferno, which drowns out the poor amateur who, blissfully
(Continued on page 551)

\$370 Radio Play Contest

IN connection with Station WRNY, owned and operated by the publishers of RADIO NEWS, the following should be noted by playwrights and all those competent to write playlets. During the fall and coming winter, Station WRNY will organize its own group of players, who will, once or twice a month, broadcast a number of RADIO playlets.

There are, of course, many broadcast plays at the present time, but this is not at all what is wanted. Station WRNY requires *radio playlets*. In other words, the theme must have something to do with radio. It may be of scientific, or other radio interest. It may have to do with broadcasting itself, or it may incorporate any other radio feature. But it is quite essential that radio itself be played up big in some way or other.

It should also be noted that the technique of a play broadcast is wholly different from that of the usual play. Where the entire play appeal is to the ear only it is necessary, in order to create the illusion, to resort to all sorts of sound effects, which it is left to the ingenuity of the playwright to employ to the best advantage. The more of these there are, the better, as a rule, is a play of this kind.

Furthermore, when the audience cannot see the play, the cast should always

be confined to very few players. The more players there are, the more difficult it is for the audience, who can distinguish the players only by their voices, to follow their actions. There should not be more than five players in any event.

When submitting manuscripts for radio

the action, and the greater the number and diversity of musical sounds and noises there are, the better.

This competition is open freely to all, with the exception of the employees of The Experimenter Publishing Company and their families.

RULES OF THE CONTEST

All manuscripts must be typewritten, or in ink. Pencil matter cannot be considered.

All manuscripts must be delivered flat, not rolled.

A number of prizes are listed here-with, which will be paid to the winners at the close of the contest. In case of a tie, identical prizes will be given each contestant.

Manuscripts cannot be returned unless return postage is enclosed.

The publishers have the option of producing any play submitted, even if it does not win a prize. But they will pay the sum of ten dollars (\$10.00) each for any playlets produced that do not win prizes.

This competition closes on October 15, by which time all manuscripts must have been submitted.

Address all correspondence to Editor, Radio Playlets, in care of this magazine, 53 Park Place, New York.

CASH PRIZES

First Prize	\$150.00
Second	“	75.00
Third	“	50.00
Fourth	“	35.00
Fifth	“	25.00
Sixth	“	20.00
Seventh	“	15.00
Total	\$370.00

playlets, the playwright should bear in mind that each playlet must be so arranged that it may be played in not more than twenty minutes to a half hour.

Remember, in this particular competition, that there must be a good deal of the radio element interspersed through

RADIO SET DIRECTORY

RADIO has now arrived at the stage where receiving sets have become stabilized to a very high degree. Inasmuch as there is continuous discussion as to various features of sets produced in the United States, RADIO NEWS has taken the initiative to present, month by month, a complete picture of the entire set industry.

In presenting the various sets in a directory of this kind, it is naturally only possible to touch the high points, and we have therefore listed all outfits under a simple classification that will, we hope, be of great service to the public, as well as to the trade. We have

attempted in this issue to list every set manufactured in this country, and although we have written a number of letters to all manufacturers, not all have replied. In order to make the directory complete, all sets manufactured by any one manufacturer listed have been included.

The Directory will be kept up to date, month to month. All manufacturers are invited to send monthly corrections as to the various features of the sets which they produce.

Manufacturer:
A-C ELECTRICAL MFG. CO.,
E. Fourth St., Dayton, Ohio
Trade Name: A-C Dayton XL-10
Circuit: Tuned radio frequency
Batteries: Dry cell or storage
Antenna: Outside
Loud Speaker: Separate
Controls: Three
List Price: \$115

Trade Name: A-C Dayton glass-encased
Circuit: Tuned radio frequency
Batteries: Dry cell or storage
Antenna: Outside
Loud Speaker: Separate
Controls: Three
List Price: \$125

Trade Name: A-C Dayton Phono-Set
Circuit: Tuned radio frequency
Batteries: Dry cell or storage
Antenna: Outside
Loud Speaker: Phonograph
Controls: Three
List Price: \$95

Trade Name: A-C Dayton XL-15 Console Model
Circuit: Tuned radio frequency
Batteries: Dry cell or storage
Antenna: Outside
Loud Speaker: Built-in
Controls: Three
List Price: \$185

Trade Name: A-C Dayton XL-5 Knock-Down Set
Circuit: Tuned radio frequency
Batteries: Dry cell or storage
Antenna: Outside
Loud Speaker: Separate
Controls: Three
List Price: \$72.50

Manufacturer: ADLER MFG. CO., INC.,
881 B'way, N. Y. City
Trade Name: Adler-Royal Model 199
Circuit: Neutrodyne
Batteries: Dry cell (All batteries enclosed)
Antenna: Outdoor or indoor
Loud Speaker: Separate
Controls: Three
List Price: \$125

Trade Name: Adler-Royal Model 201A
Circuit: Neutrodyne
Batteries: Storage
Antenna: Outdoor or indoor
Loud Speaker: Separate
Controls: Three
List Price: \$125

Manufacturer: AIRO MASTER CORP.,
227-239 W. 17th St., New York City
Trade Name: Airo Master No. 60 Chest
Circuit: Tuned radio frequency
Batteries: Storage
Antenna: Outside
Loud Speaker: Separate
Controls: Three
List Price: \$60

Trade Name: Airo Master No. 75, Concert
Circuit: Tuned radio frequency
Batteries: Storage
Antenna: Outside
Loud Speaker: Built-in
Controls: Three
List Price: \$75

Trade Name: Airo Master No. 130, Console Table
Circuit: Tuned radio frequency
Batteries: Storage
Antenna: Outside
Loud Speaker: Built-in
Controls: Three
List Price: \$130

Trade Name: Airo Master No. 150, Console Highboy
Circuit: Tuned radio frequency
Batteries: Storage
Antenna: Outside
Loud Speaker: Built-in
Controls: Three
List Price: \$150

Manufacturer: AJAX ELEC. SPEC. CO.,
1926 Chestnut St., St. Louis, Mo.
Trade Name: Ajax Marv-yellow
Circuit: Tuned radio frequency
Batteries: Storage recommended
Antenna: Outside recommended
Loud Speaker: None furnished
Controls: Three
List Price: \$45

Trade Name: Ajax-A.C.S. Crystal Set
Circuit: Crystal
Batteries: None
Antenna: Outside or socket
Loud Speaker: None
Controls: One
List Price: \$5

Trade Name: Ajax A.-C.S.T. Junior. Crystal Set
Circuit: Crystal
Batteries: None
Antenna: Outside or socket
Loud Speaker: None
Controls: One
List Price: \$3

Manufacturer: ALADDIN MFG. CO.,
Muncie, Indiana
Trade Name: Aladyne Plain Cabinet
Circuit: Non-oscillating tuned radio frequency
Batteries: Storage
Antenna: Outside
Loud Speaker: Separate
Controls: Two
List Price: \$75

Trade Name: Aladyne Semi-Console
Circuit: Non-oscillating tuned radio frequency
Batteries: Storage
Antenna: Outside
Loud Speaker: Built-in
Controls: Two
List Price: \$100

Manufacturer: AMERICAN RADIO & RESEARCH CORP.,
Medford Hillside, Mass.
Trade Name: Amrad Model T-5

Circuit: Neutrodyne
Batteries: Storage (Dry cells fair)
Antenna: Outside
Loud Speaker: Separate
Controls: Two
List Price: \$85

Trade Name: Amrad Cabinet
Circuit: Neutrodyne
Batteries: Storage
Antenna: Outside
Loud Speaker: Built-in
Controls: Two
List Price: \$185

Trade Name: Amrad Jewel
Circuit: Neutrodyne
Batteries: Storage
Antenna: Outside
Loud Speaker: Built-in
Controls: Two
List Price: \$285

Manufacturer: THE AMERICAN SPEC. COMPANY
135-165 Holland Ave., Bridgeport, Conn.
Trade Name: "Electrola" Model 40
Circuit: Tuned radio frequency
Batteries: Storage
Antenna: Outdoor or indoor
Loud Speaker: Separate
Controls: Three
List Price: \$85

Trade Name: "Electrola" Model 60
Circuit: Tuned radio frequency
Batteries: Storage
Antenna: Outdoor or indoor
Loud Speaker: Separate
Controls: Five
List Price: \$60

Manufacturer: AMSCO PRODUCTS, INC.,
416 Broome St., New York City
Trade Name: Melco Supreme 5
Circuit: Tuned radio frequency
Batteries: Storage
Antenna: Either (indoor recommended)
Loud Speaker: Separate
Controls: Three
List Price: \$165

Trade Name: Melco Supreme 25
Circuit: Tuned radio frequency
Batteries: Storage
Antenna: Either (indoor recommended)
Loud Speaker: Separate
Controls: Three
List Price: \$150

Manufacturer: ANDREWS RADIO COMPANY,
Tribune Tower, Chicago, Ill.
Trade Name: Andrews Deresnadyne Model M
Circuit: Deresnadyne
Batteries: Storage
Antenna: Outdoor or indoor
Loud Speaker: Separate
Controls: Three
List Price: \$125

Trade Name: Andrews Deresnadyne De Luxe Model
Circuit: Deresnadyne
Batteries: Storage

Antenna: Outdoor or indoor
Loud Speaker: Separate
Controls: Three
List Price: \$165

Manufacturer: APEX ELECTRIC MFG. CO.,
1410 West 59th Street, Chicago, Ill.
Trade Name: Apex Super Five
Circuit: Tuned radio frequency
Batteries: Storage
Antenna: Outside
Loud Speaker: Separate
Controls: Three
List Price: \$95 without accessories

Trade Name: Apex De Luxe
Circuit: Tuned radio frequency
Batteries: Storage
Antenna: Outside
Loud Speaker: Built-in
Controls: Three
List Price: \$135

Trade Name: Apex Baby Grand Console
Circuit: Tuned radio frequency
Batteries: Storage
Antenna: Outside
Loud Speaker: Built-in
Controls: Three
List Price: \$225

Manufacturer: ARGUS RADIO CORP.,
25 West 18th Street, New York City
Trade Name: Power Electric Radio Standard
Circuit: One stage untuned, two transformer-coupled radio freq.
Batteries: Direct from A.C. or D.C. current
Antenna: Outdoor or indoor
Loud Speaker: Separate
Controls: Two
List Price: \$160

Trade Name: Power Electric Radio Model 235
Circuit: 1 stage untuned 2 transformer-coupled radio frequency
Batteries: Direct from A.C. or D.C. current
Antenna: Outdoor or indoor
Loud Speaker: Built-in
Controls: Two
List Price: \$235

Trade Name: Power Electric Radio Model 300
Circuit: 1 stage untuned 2 transformer-coupled radio frequency
Batteries: Direct from A.C. or D.C. current
Antenna: Outdoor or indoor
Loud Speaker: Built-in
Controls: Two
List Price: \$300

Trade Name: Power Electric Radio Phono Radio Panel
Circuit: 1 stage untuned 2 transformer-coupled radio frequency
Batteries: Direct from A.C. or D.C. current
Antenna: Outdoor or indoor
Loud Speaker: Separate
Controls: Two
List Price: \$145

Manufacturer: ATWATER KENT MFG. CO.,
4700 Wissahickon Ave., Philadelphia, Pa.
Trade Name: Atwater Kent Model 10
Circuit: Tuned radio frequency
Batteries: Storage
Antenna: Outdoor or indoor
Loud Speaker: Separate
Controls: Three
List Price: \$80

Trade Name: Atwater Kent Model 12
Circuit: Tuned radio frequency
Batteries: Storage
Antenna: Outdoor or indoor
Loud Speaker: Separate
Controls: Three
List Price: \$100

Trade Name: Atwater Kent Model 20 compact
Circuit: Tuned radio frequency
Batteries: Storage
Antenna: Outdoor or indoor
Loud Speaker: Separate
Controls: Three
List Price: \$80

Trade Name: Atwater Kent Model 24
Circuit: Tuned radio frequency
Batteries: Storage
Antenna: Outdoor or indoor
Loud Speaker: Separate
Controls: Three
List Price: \$80

Trade Name: Atwater Kent Model 19
Circuit: Tuned radio frequency
Batteries: Storage
Antenna: Outdoor or indoor
Loud Speaker: Separate
Controls: Two
List Price: \$60

Manufacturer: AUDIOLA RADIO CO.,
430 So. Green Street, Chicago, Ill.
Trade Name: Audiola "Big Six"
Circuit: Tuned radio frequency
Batteries: Either (storage preferred)
Antenna: Outdoor
Loud Speaker: Separate
Controls: Three
List Price: \$90

Trade Name: Audiola "Midget"
Circuit: Special non-regenerative
Batteries: Dry cell WD-12
Antenna: Outdoor
Loud Speaker: Head-set separate

Controls: One
List Price: \$10

Trade Name: Audiola "Sealed Five"
Circuit: Tuned radio frequency
Batteries: Either (storage preferred)
Antenna: Outdoor
Loud Speaker: Separate
Controls: Three
List Price: \$60

Manufacturer: BALTIMORE HUB WHEEL & MFG. CO.,
222 N. Gay Street, Baltimore, Md.
Trade Name: Hubco Baby Grand—portable
Circuit: Tuned radio frequency
Batteries: Dry cell or storage
Antenna: Outdoor only
Loud Speaker: Separate
Controls: Three
List Price: \$60

Trade Name: Hubco Super Five—Portable
Circuit: Self-balancing neutrodyne
Batteries: Dry cell or storage
Antenna: Aerial only
Loud Speaker: Separate
Controls: Three
List Price: \$150

Trade Name: Hubco Baby Grand Portable De Luxe
Circuit: Tuned radio frequency
Batteries: Dry cell or storage
Antenna: Aerial only
Loud Speaker: Separate
Controls: Three
List Price: \$70

Trade Name: Hubco Baby Grand Console
Circuit: Tuned radio frequency
Batteries: Dry cell or storage
Antenna: Aerial
Loud Speaker: Built-in with space for "A" and "B" batteries
Controls: Three
List Price: \$100

Manufacturer: BILTMORE RADIO CO.,
Jamaica Plain, Boston, Mass.
Trade Name: Biltmore Master R-F Model T-5
Circuit: Tuned radio frequency
Batteries: Dry cell or storage
Antenna: Outdoor or loop
Loud Speaker: Separate
Controls: Three
List Price: \$68

Trade Name: Biltmore Master R-F Model T-5-C
Circuit: Tuned radio frequency
Batteries: Dry cell or storage
Antenna: Outdoor or loop
Loud Speaker: Built-in
Controls: Three
List Price: \$160

(Continued on page 566)

The Balanced Interflex Circuit

By HUGO GERNSBACK
Member American Physical Society

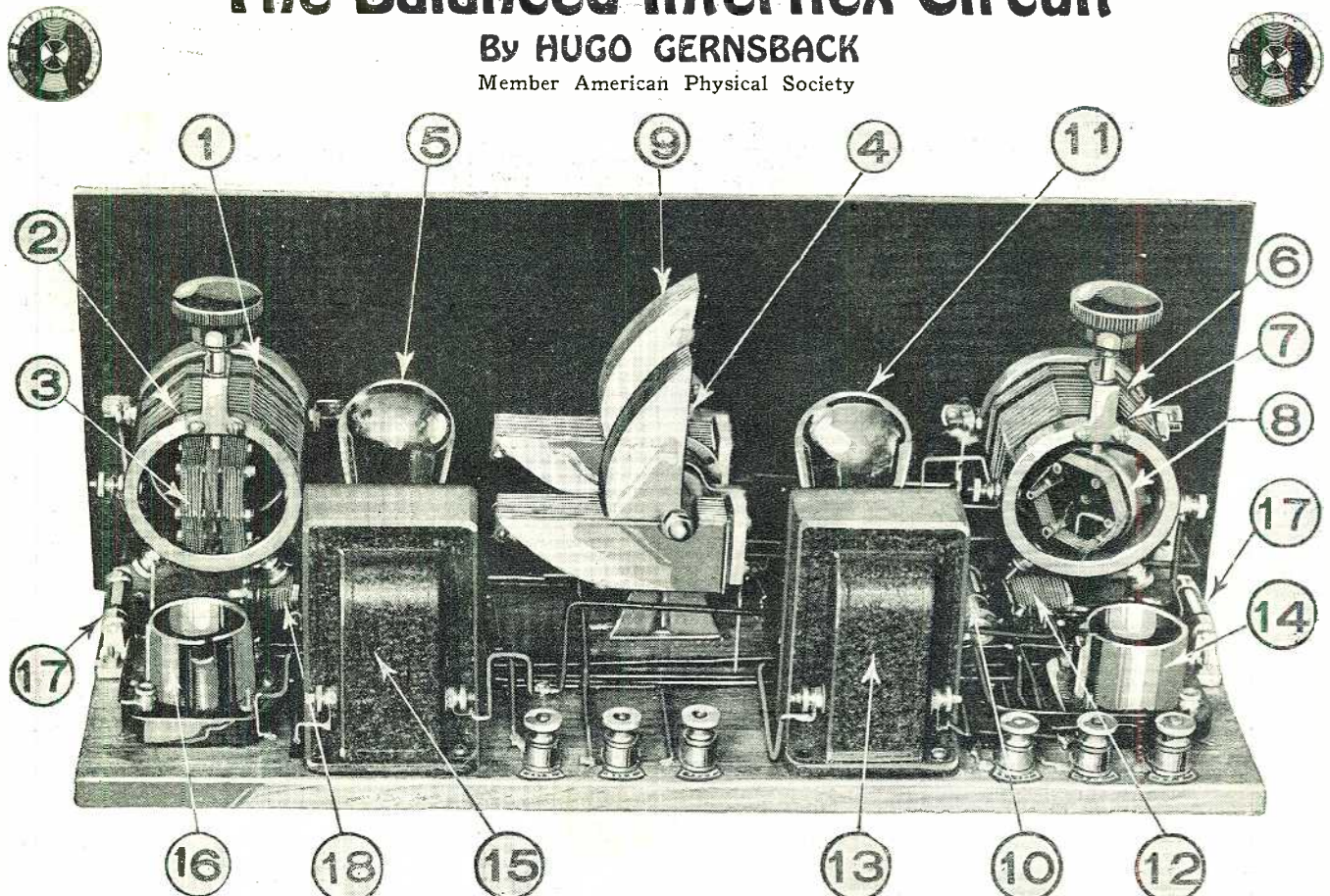

Rear view of the Balanced Interflex. (1) and (6), aperiodic primary; (2) and (7), secondaries of main inductances; (3) and (8), adjustable lossers; (5), (11), (14), and (16), tubes and sockets; (17) automatic resistances; (12) and (18), automatic filament control jacks; (10) crystal detector; (13) and (15), audio frequency transformers; (4) and (9), straight-line frequency condensers, linked.

IN our August issue I described the Interflex Four. This, as will be recalled, constitutes a circuit wherein a crystal detector is placed right in the grid circuit of a vacuum tube.

Excellent as this circuit is for quality, quantity and DX ability, it still has two controls; namely, the condenser tuning control

and then, stuck away in some obscure corner, some potentiometer or some compensating condenser control, or what-not.

The Interflex Balanced Single-Control Set described here is the result of ideas on single-control sets which I have cherished ever since I wrote an editorial on the subject, which appeared in the February, 1923, issue of RADIO NEWS. I believe sooner or later all sets will have to come to real honest-to-goodness single control, by which I mean *just one knob*, and nothing else.

The ideal set should not oscillate; that is, it should not howl and produce shrieks from 200 meters up to 600 meters. Stations should come in without any disturbing noises, and all the time there should be only one control or one knob to accomplish this.

In all tuned radio frequency circuits, if the set howls and squeals on regeneration, it is necessary to provide losses. There are several methods of obtaining such losses, but the one most customary now is to place the inductances in the magnetic field of the condenser in such a way that there are certain absorption losses. But it is apparent that this is a very crude way of accomplishing these losses. In the first place, moving the coils even 1/64 of an inch closer to or further from the condensers will make a tremendous difference in signal strength. Furthermore, the losses are not always fully

realized, and in spite of some constructors' claims, the majority of the sets thus made squeal and howl most annoyingly.

The coils could, of course, be made adjustable so that they could be moved toward or from the condenser. This, however, would necessitate a number of extra controls, which are not wanted. Furthermore, *no two sets ever work alike*, because there are variations

IN this article we describe the first real single-control tuned radio frequency set described so far. It has but one dial or one single control—no compensation of any kind. Its volume is tremendous. It does not howl or squeal, and brings in the distant stations, all merely by turning one lone knob. It is a set which should be particularly popular with the old folk who do not wish to be bothered with more than a single knob. Stations can be logged with a single row of figures.

and the potentiometer control. Ordinarily, in radio parlance, the Interflex Four would be called a 1-dial set. Where two controls are used, however, it requires a stretch of the imagination to call two controls one control.

It has always been my secret ambition to produce a multi-tube circuit which has but a single control, not just a single tuning con-

THEORY OF THIS SET

The Balanced Tuned Interflex Four-A comprises one stage of tuned radio frequency, crystal detector and three stages of audio frequency amplification, of which the two last stages are transformer coupled.

In all tuned radio frequency circuits, if the set howls and squeals on regeneration, it is necessary to provide losses. There are several methods of obtaining such losses, but the one most customary now is to place the inductances in the magnetic field of the condenser in such a way that there are certain absorption losses. But it is apparent that this is a very crude way of accomplishing these losses. In the first place, moving the coils even 1/64 of an inch closer to or further from the condensers will make a tremendous difference in signal strength. Furthermore, the losses are not always fully

ONE NIGHT'S PERFORMANCE OF THE BALANCED INTERFLEX:			
Station	City	Dial Setting	Wave-length
WNYC	New York	92	526
WEAF	New York	89	421.5
WJZ	New York	85	454.3
WQJ	Chicago, Ill.	74	447.5
WTAM	Cleveland, O.	73	389.4
WSAI	Cincinnati, O.	55	325.9
WGR	Buffalo, N. Y.	54.5	319
WGBS	New York	53.5	315.6
WAHG	Richmond Hill, N.Y.	52.5	315.6
KDKA	Pittsburgh, Pa.	50	309.1
WTAS	Elgin, Ill.	49	300.8
WPA	Atlantic City, N. J.	48	299.8
WCAU	Philadelphia, Pa.	40	278
WMAK	Lockport, N. Y.	39.5	273
WJAZ	Chicago, Ill.	39	268
WRNY	New York	32	258.5
WGCP	New York	30	252
WNJ	Newark, N. J.	28	233
WOKO	New York	19	234
WIDA	Paterson, N. J.	17	224
WIBJ	Chicago, Ill.	13	215.17

The Balanced Interflex takes in the entire broadcast range

differences of tubes, differences of condensers, differences in coils, and a hundred other points which are apt to throw the set out of balance, with no means of rebalancing it.

I have thought of overcoming all these defects by using an original method which, to the best of my knowledge, has not been described before.

Granted that we must have certain losses

in order to do away with excessive oscillations, and that a set works best just below oscillation, the following method was adopted: Fig. 1 shows the fundamental circuit, where we have an ordinary variocoupler, in which L is the untuned aperiodic primary, 4 is the secondary, 2 the tickler. It will be noticed that the connections are rather novel and that the tickler, 2, in connection with condenser, C3, is used as an ADJUSTABLE "LOSSER." By means of this arrangement it now becomes possible to adapt the set not only to whatever local conditions there may be, such as aerial, ground, as well as tubes, batteries, but to dozens of others, which we all know vary in every locality and in every set.

Referring again to Fig. 1, it will be noticed that the circuit from the grid of the tube to D, through coil 4 and through connection wire A, back to filament, is a closed oscillatory circuit, while the "losser" circuit is independent and does not enter directly into the workings of the regular circuit. The tickler circuit 2, with its condenser, might just as well be disconnected from the closed oscillatory circuit, if this were desired, and although the results will then not be quite as good in all cases, the principle still remains the same.

In this particular circuit, if the tickler coils, of which two are used in the Balanced Interflex, are correctly adjusted, this set does a most surprising thing. The ticklers can be adjusted at the lowest available wave, say 200 meters, so that the circuit is on the point of oscillation. If correctly adjusted, impossible as this sounds, the same condition will prevail through the entire broadcast range up to 600 meters.

In other words, stations of 200 meters up to 545 meters will come in with the same intensity, with the stations in between as well.

In Fig. 2 the complete circuit is shown. It will be seen that we have two ticklers, 3 and 8, shunted with .005 fixed condensers.

In order to produce a circuit with but a single control it was necessary to link the

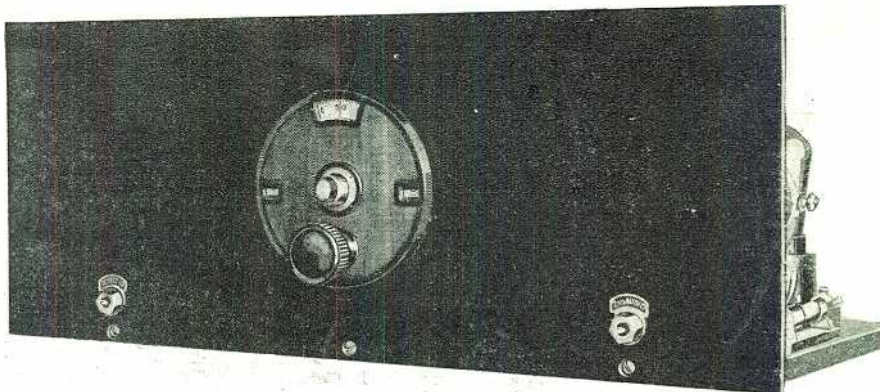

Note the pristine appearance of the real one-control Balanced Interflex. No make-believe controls stuck away in a corner here. Phone and loudspeaker jacks left and right respectively.

two variable condensers, as is shown in the photographic reproductions. The connection is also indicated in the dotted line, S-1 in Fig. 2.

Reverting to Fig. 2, it might be thought that the tickler 8, with its condenser 19,

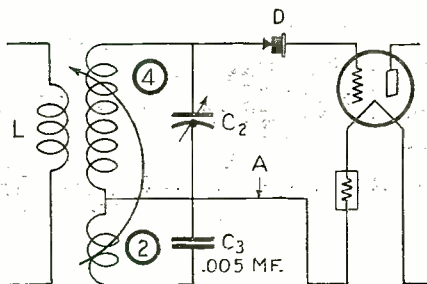

Fig. 1. Theoretical circuit of the Balanced Interflex. L 4 and 2 constitute variocoupler. 2 and C-3 represents the adjustable losser grounded to the filament. Crystal detector D is in the grid circuit, making the first tube a detector-coupled amplifier. Tuning is accomplished by condenser C-2.

should be grounded to the filament of the second tube at 17. The connection exists, although it is not immediately apparent. You may trace the connection from condenser 19 through connecting wire A to the rotor of condenser 9, then through the connecting link of the two condensers S-1 to the rotor of condenser 4. Thence the circuit goes down through tickler 3, which you will notice is grounded on the filament 17. Tickler 8 might, therefore, be said to be in series with tickler 3.

The photographic illustrations show this set as it appeared when completed. The variocouplers used here are factory-made, but for the constructor who wishes to build his own, I have shown in Figs. 3 and 4 how the variocoupler can be built at little expense. It should be remembered, as will be seen further down, that once the ticklers are adjusted they are never touched again. Hence, the construction of the ticklers need not be extraordinarily good, because they are used only when the set is first put into operation. The illustrations 3 and 4, I believe, are clear enough to give all the details. Ordinary well-seasoned cardboard tubing, which has been either shellacked or dipped in hot paraffin, should be used. The tickler construction is very simple. Merely use a 1/2-inch piece of tubing, through which passes a threaded 6/32 or 8/32 rod, which is attached to the tube by means of ordinary hexagon nuts, as shown. The bearings can be punched right into the cardboard and no fear need be felt that they will wear out, because the ticklers are not used enough, as has been mentioned. Flexible leads go from the rotor to binding post, as shown in Fig. 3. I believe the drawings are so complete that nothing else need be said about this.

THE DOUBLE VARIABLE CONDENSER

We now come to the next important consideration, and that is the double variable condenser. In the Balanced Interflex I found it advisable to use a straight-line frequency condenser, which for many reasons is the most desirable. Two of these were coupled on one shaft, as will be seen by the photographic illustrations. Of course, you can use either a straight-line frequency condenser or any other condenser, for that matter, to suit your needs. In Fig. 5 I have shown the means of coupling the two condensers. The only piece which you will need is the connecting sleeve, which any machinist will be glad to make for you at small cost. When buying the condensers it is necessary to be on the alert to see that you select one in which the shaft extends not only on the side which carries the dial, but on the opposite side as well, because if it does not, you cannot make a connection to the second condenser.

Quite a few condensers on the market have a shaft that is extended, and which usually has a slot at the end. If it has not, you can

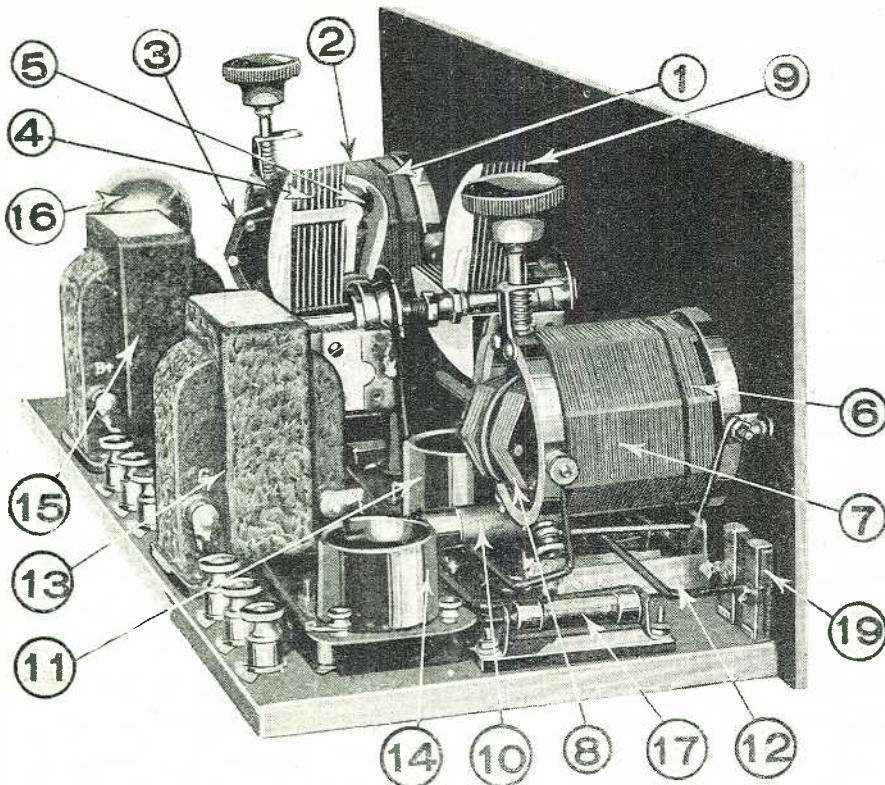

This is a side view of the Balanced Interflex Circuit, giving a good idea of the mounting of the variocouplers and the adjustable lossers. The figures used are the same for all illustrations. (19) here is the condenser C-3 shown above in Fig. 1.

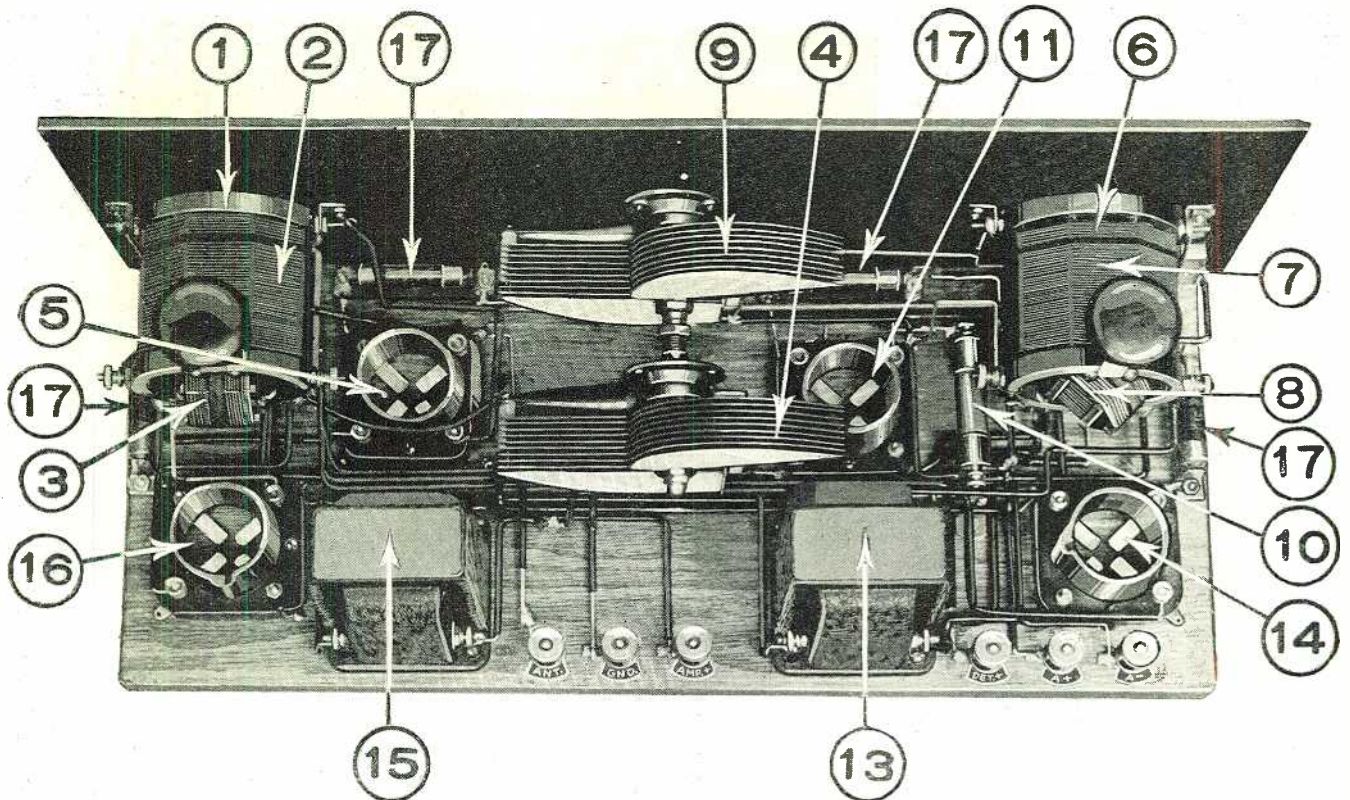

View of the new circuit, taken from above, showing arrangement of the various parts. The same figures are used throughout and are also repeated in the circuit below. Note the mechanical linking between the straight-line frequency condensers (4) and (9) and the neat arrangement of all the components.

easily provide one with a hack-saw so that it will fit the tenon of the sleeve, as shown. The set-screw is quite important, for reasons which will be apparent later.

There are also on the market today condensers in gangs of two that you may buy ready-made, and if you use them, it is, of course, not necessary to provide any connecting sleeve, because such double condensers are usually built upon a single shaft. The adjustable sleeve method is the better, however, as you will see below.

The two condensers shown in the illustrations are supported by means of a bracket between the two. In other types of condensers it would be better to have an end bracket, as some of these condensers are

rather heavy and should be supported from the end.

The set shown here was made with a panel 7 x 18 inches while the baseboard measures 7 x 17 inches. This was done to save space and make a compact set. I do not, however, recommend these measurements to the average builder, because there is too much cramping; the panel should be at least 7 x 21, with a sub-base 7 x 20, if possible. Or even 7 x 24 panel with base 7 x 23 can be used. It will be noticed that the variocouplers are mounted right on the panel. This necessitates drilling holes in the front panel, which have to be filled up afterward. If this feature is not desired, the variocouplers may be placed upon the baseboard, but in that case we must use the larger baseboard, be-

cause with the smaller size there would be no room left. The set can then be wired as shown in our wiring diagram.

This wiring diagram, by the way, also shows a new wrinkle: the connecting lines are drawn in a peculiar manner, with a purpose in mind. As connections are made, a colored pencil is run over the lines, which will show you which connections are completed. If you follow this procedure, you will leave out no connecting wires.

A front view of the set is also given, which shows the simplicity of the set. There is only one knob and the turning of this knob will not only bring in the locals, but the DX (distant) stations as well, without

(Continued on page 547)

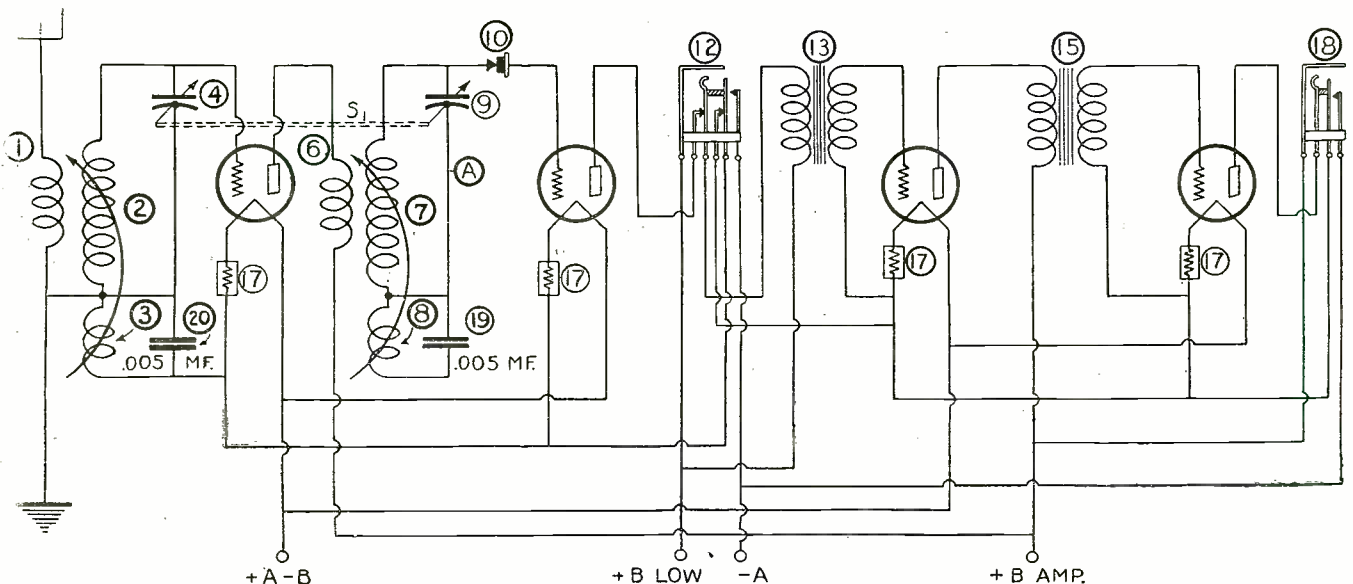
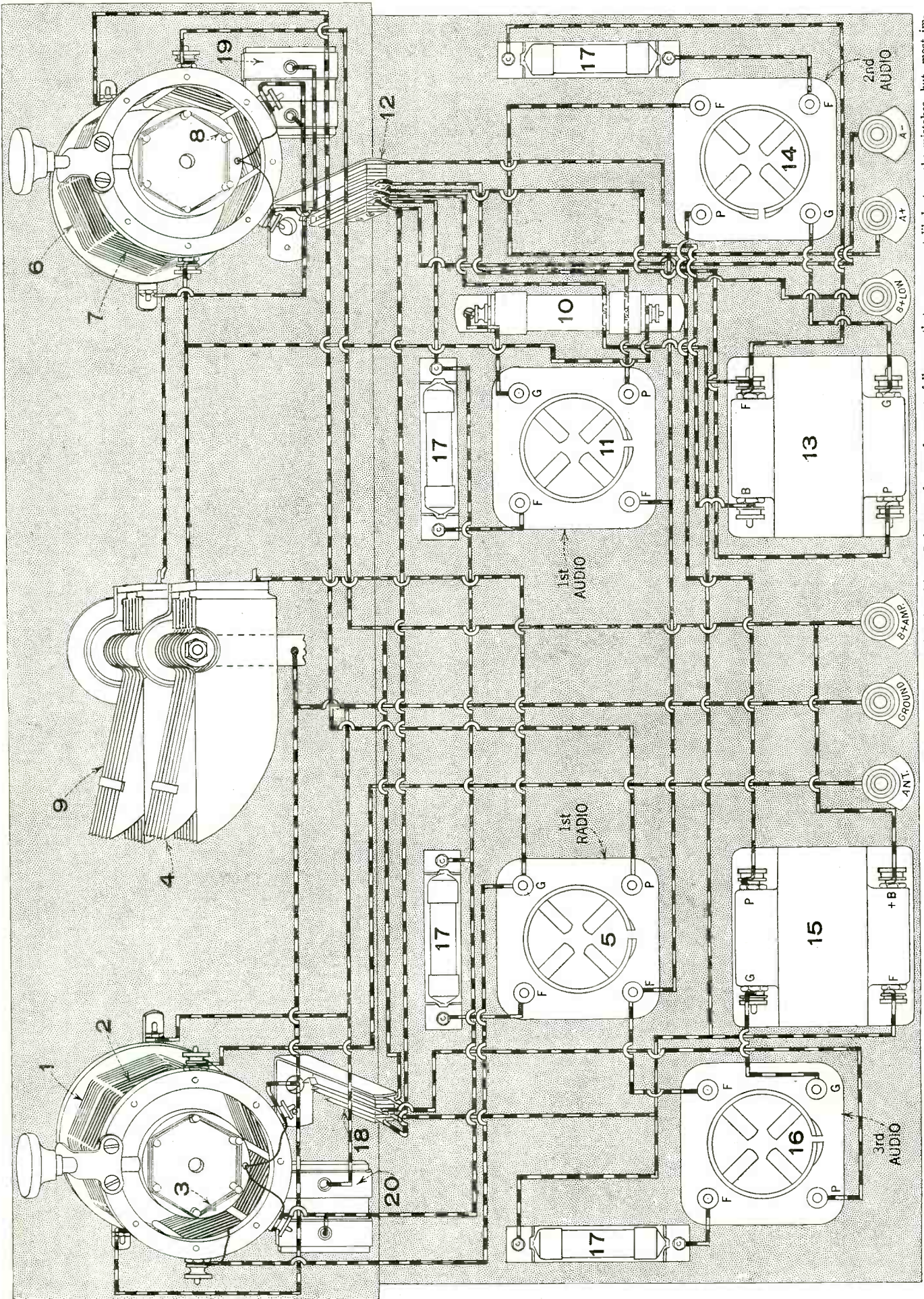

Fig. 2. The complete circuit of the Balanced Interflex. (1) is the aperiodic primary; (2) secondary; (3) adjustable loss; (4) and (9) mechanically linked condensers; (6) untuned radio frequency primary; (7) tuned radio frequency secondary; (8) adjustable loss; (10) crystal detector; (12) and (18) automatic filament control jacks; (13) and (15) audio frequency transformers; (17) automatic resistances (Amperites); (19) and (20) fixed condensers.



Complete wiring diagram of the Balanced Interflex Circuit. Particular attention is called to the new method of showing the wiring. It is not only easy for you to follow, so that you are not likely to make mistakes, but, most important of all, when you complete two connections, you can run a colored pencil over the dotted tracer line connecting them, as a check on your work. By the time all the lines have been traced, your set is completely wired. Try it and see how well it works out. No chance of mistakes or omitted wires. NOTE: For best results make no sharp turns, but keep the corners of all wires well rounded.

A New Super-Heterodyne

By McMURDO SILVER, A.I.R.E.



In this article is described a super-heterodyne receiver of a new type, which can be built in a very compact style.



THIS latest six-tube super-heterodyne has been called the "super-autodyne" since this name is justified by the use of but a single tube functioning as both detector and oscillator rather than the customary separate detector and oscillator tubes heretofore employed. This tube is termed the "autodyne" tube, whereas the separate oscillator is generally called a "heterodyne" tube. From this the derivation of "super-autodyne" follows logically. The entire circuit is still of the "supersonic" type, since the frequency of the incoming signals is changed to that of the long-wave intermediate R.F. amplifier.

The circuit of the super-autodyne is shown in Fig. 1. The first tube, marked V1, is the combination detector-oscillator, connected in a balanced bridge circuit. Tubes V2 and V3 are the two intermediate frequency amplifiers, functioning at sixty kilocycles, and feeding into the second detector, V4, and then into the customary two audio amplifiers, V5 and V6.

AUTODYNE FREQUENCY CHANGER

The first portion of the circuit that appears to be radical is the autodyne frequency changer, the circuit of which may best be considered when isolated in Fig. 2. The problem which has been satisfactorily solved here is the prevention of the oscillator section of the circuit from reacting upon the loop or antenna circuit. This is somewhat difficult, since the two circuits must be arranged to feed into the same tube, which must oscillate at one frequency and "detect" at another, the actual separation of these two frequencies being but sixty kilocycles throughout the broadcast range. In terms of wavelength, the oscillator must be operated at ten meters away from the loop circuit at 200 meters, and about sixty-five meters away at 550 meters in order to produce the necessary beat for the long-wave amplifier.

The solution of the problem by the use of a bridge circuit is due to a Signal Corps engineer, Jackson H. Pressley, and is very effective. Condenser C1 tunes the oscillator grid circuit, made up of coils L2 and L3, which are really a continuous winding tapped at the center. This circuit is caused to oscillate by means of the tickler, L1, coupled inductively to L2, L3 in the usual fashion. The grid condenser and leak R1,

C3, aid detection, but do not interfere with the oscillator circuit. The loop or antenna circuit, represented by B1, B2, tuned in condenser C2, is connected to the mid-point of L2, L3 and at the joint between CX and CX. If we assume a condition of balance to exist between what may be considered the bridge elements, L2, L3, CX, CX, then energy induced into this circuit from B1, B2, C2 will divide equally across the arms of the bridge, all going to waste except the voltage drop across condenser CX, across which is connected the tube's grid and filament. Further, since the loop circuit is connected to the bridge circuit at points of neutral potential, the bridge or oscillator circuit will not react upon the loop system.

With this arrangement, radiation due to the oscillator energy feeding into the loop

efficiency to be made up, since in the autodyne circuit less than half the signal voltage is applied to the tube, the balance being lost in the bridge?

USE OF REGENERATION

That this efficiency is made up is evident in a comparison of the autodyne frequency changer with a standard separate detector and oscillator frequency changer, for the signal strength is equal from either system, and frequently in favor of the autodyne. The actual manner in which this occurs appears to be due to regenerative amplification caused by the tickler, L1, the original purpose of which was to cause the bridge to oscillate. However, at the same time as it accomplishes this, it feeds a portion of the signal energy back into the bridge circuit

Panel view of the six-tube super-heterodyne receiver, which is remarkably compact, being but 18 inches in length.

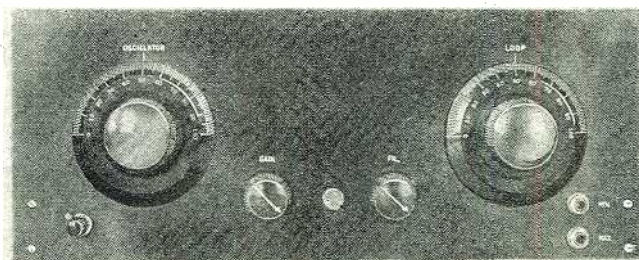

circuit is automatically eliminated, since the system is so balanced that this cannot occur, unlike the usual "super" circuit where a separate oscillator feeds directly into the detector grid circuit. With a properly designed super, radiation at its worst is not a very serious problem, however, since the oscillator-to-loop coupling is, for best results, so loose as almost to preclude radiation from the loop or antenna system.

So far this system looks excellent, except for the single point brought out above, *viz.*, that the incoming signal is divided and only a small portion used to cause detection. Since the detecting efficiency of a tube is proportional to the square of the applied signal voltage, it is vitally important that maximum potential be delivered to the tube terminals. How, then, is the apparent de-

where it reinforces that portion of the signal in the bridge circuit used for rectification, resulting in an even stronger signal than would at first glance be expected from the system.

Were this regenerative amplification to be carried out to the limit, it would be necessary only to feed the signal energy in the plate circuit back into the loop circuit directly by means of an additional tickler in series with L1, but coupled to the loop or antenna coupling coil at B1, B2. The result of such an arrangement, carefully carried out, is a tremendous increase in the sensitivity of the receiver as a whole, as well as an increase in selectivity. This latter condition is due to neutralizing, in the usual fashion, the loop circuit resistance by regeneration, a condition which does not occur in the original balanced circuit of Fig. 2, since the loop circuit is so balanced as not to react or be reacted upon by the oscillator circuit. Hence, any regenerative amplification obtained in a balanced condition is merely through the reinforcing of that portion of the original signal in the bridge circuit utilized for rectification.

Having decided to use regenerative amplification in the autodyne, we see that a second tickler is necessary, or some other means of feeding the signal in the plate circuit back into the loop circuit. A simple method at once presents itself—a slight unbalancing of the bridge, allowing a portion of the signal energy feed from L1 into the L2, L3, CX, CX circuit to get into the loop circuit. Of course, along with this comes a portion of the oscillator energy, but it is indeed a simple matter so to adjust one of the balancing condensers, CX, CX, that just the required value of unbalance be obtained.

This results in sharpening up the loop tuning condenser and considerable strengthening

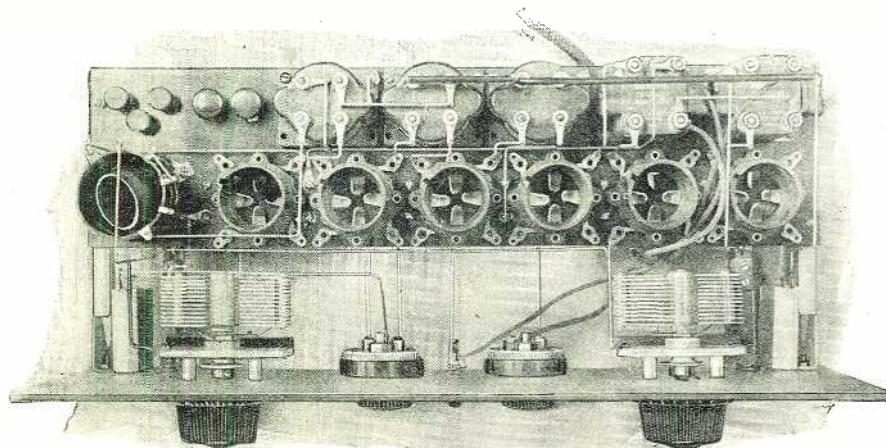

This top view of the receiver shows how the gang vacuum tube sockets are placed in relation to the transformers on the shelf.

of the received signal, at the expense of a slight (but entirely negligible) tendency to radiate. The tuning, as a whole, is broadened slightly, due to reaction of the various circuits, but this is easily controlled by one of the balancing condensers, and is rather desirable, since the system is astonishingly sharp when perfectly balanced.

The only other unusual feature about the super-antodyne illustrated is the intermediate amplifier, which uses but two intermediate stages rather than the conventional three. This is made possible by the use of exceptionally efficient intermediate transformers, operating in a highly regenerative condition. This two-stage amplifier gives practically the same over-all voltage gain as could be obtained from three stages, though it would be possible to obtain proportionately the same results from any good transformers.

THE OSCILLATOR COUPLER AND GENERAL ASSEMBLY

The oscillator coupler may be made by winding two sections separated 1/16 inch on a 2 1/4-inch tube, each section containing 28 turns of No. 28 D.S.C. wire. The rotor coil also consists of 28 turns of the same size wire on a 1 1/2-inch tube, rotatable with in the stator tube.

Constructional data on the intermediate transformers and filter may be found in Fig. 3. It is suggested, though, that unless the builder has adequate measuring facilities that he purchase these already tested and matched.

In wiring the receiver, a well-tinned iron should be employed in conjunction with resin-core solder. A small amount of paste

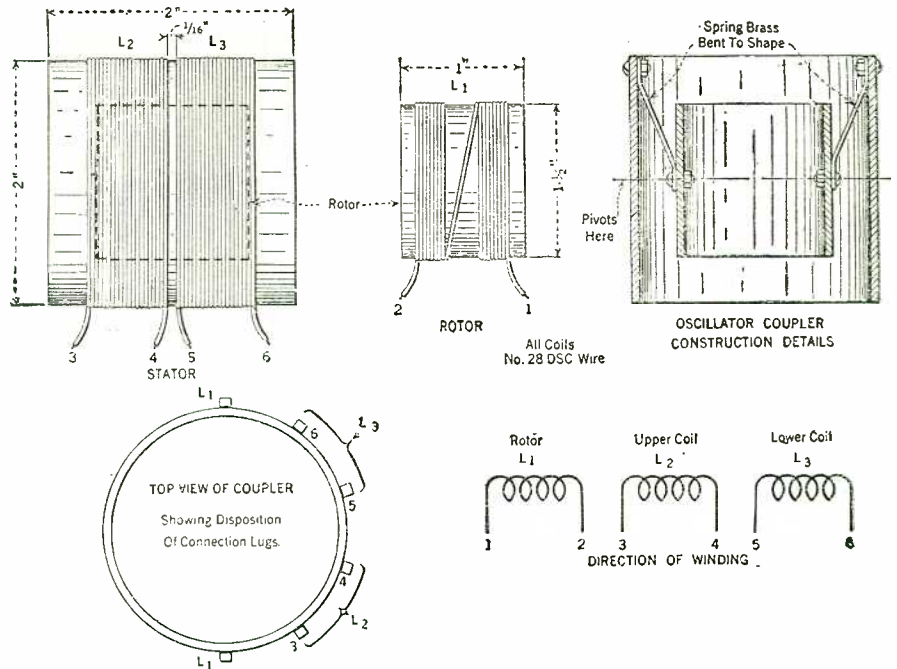

Constructional details of the oscillator coupler. These plans should be carefully followed to obtain maximum efficiency.

panel alone. These are a connection between the rheostat and potentiometer and one between the potentiometer and S1. Bus-

reaches the other lug to which it is to be soldered. Each piece should be bent to fit properly, cut to size and then soldered in place.

CONNECTIONS

The "A" battery should be connected to its lead, one tube inserted in a socket, switch closed, and rheostat R4 just turned on. If the tube lights, it should be moved from socket to socket to see that all "A" connections are correct. The positive battery lead should then be connected to the B-45 and B-90 posts. If the tube lights, the wiring or assembly is faulty and should be checked. The tube should light only when the "A" battery is connected to the "A" leads.

The remaining batteries may be connected and the loop leads run to posts B1, B2 and B3. If the loop is spiral, B1 goes to the outside lead, B2 to the center tap and B3 to the inside end. Any standard loop may be used.

The tuning is quite simple. The tubes should be adjusted to proper brilliancy by means of the rheostat, and the potentiometer set just to the positive side of that

(Continued on page 532)

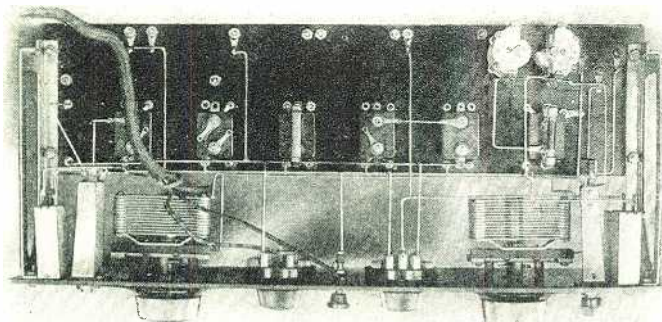

The under side of the shelf that supports the gang tube sockets and the intermediate and audio frequency transformers. This method of arranging the instruments makes for short wiring.

may be used on each connection if desired, but not on any of the fixed condensers. Here, connections may be soldered to lugs or to the condensers directly.

Only two connections can be put on the

bar should be used, straightened, carefully bent and cut to proper length before any attempt is made to solder it in place. A long piece of bus-bar should not be soldered to a lug and then bent and twisted until it

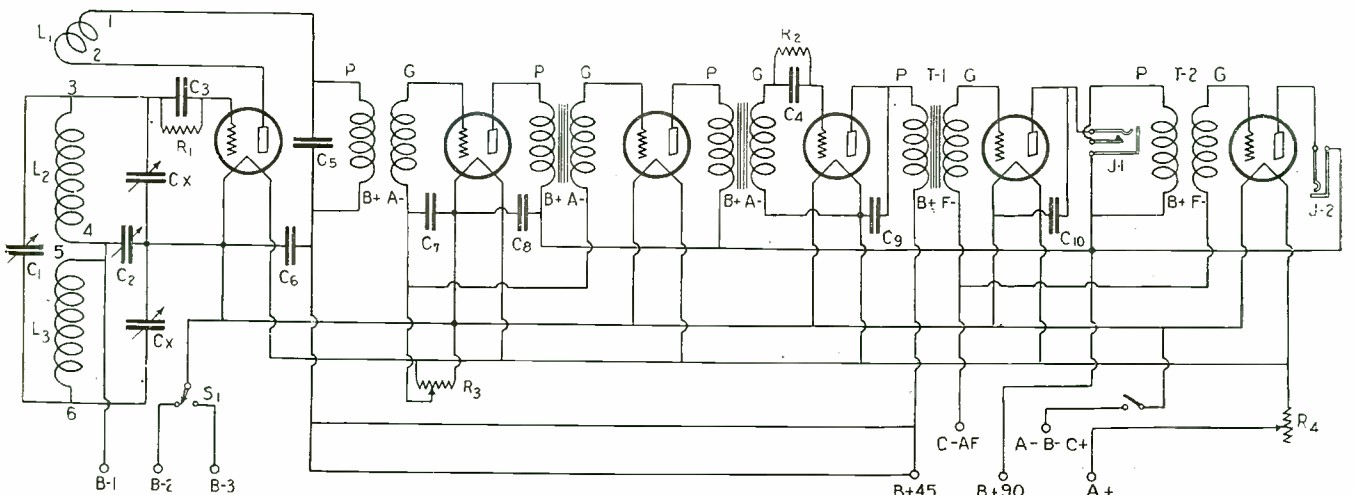

Fig. 1. Circuit diagram of the six-tube super-heterodyne receiver. The first tube on the left is the combination detector-oscillator, then come two tubes used as intermediate amplifiers, a detector and two A.F. tubes.

Extending the Broadcast Range

By SYLVAN HARRIS

Rather than bemoan the inability of his set to cover the complete broadcast range, let the radio fan read Mr. Harris' remarks on the subject.

THERE is not a shadow of a doubt that there will be considerable consternation on the part of many radio fans when the broadcast wave-lengths are lowered. There is also no doubt that the wave band will be lowered. There is nothing else to be done to clear up the conges-

tion which now exists in the ether. Everyone is expecting it to happen soon. RADIO NEWS, in its May issue, first made the announcement of the extension.

THE BASIC PRINCIPLES

The first of these three is the idea of *capacity ratio*. This is very simple. It is merely the maximum capacity of the condenser divided by the minimum. In other words, if the maximum capacity of the condenser is 500 micromicrofarads and the minimum capacity is 20, then the capacity ratio of the condenser is 500/20 or 25 to 1. This is generally written 25:1.

The next idea, that of wave-length ratio, is just as simple. It is merely the longest wave-length we are considering, divided by the shortest. If we are considering a range of 600 to 200 meters, the wave-length ratio is 600/200 or 3:1.

The third, and—thank goodness—the last of these ideas needed here, is that which considers the relation between the capacity in the tuned circuit of a receiver, and the wave-length to be received. This is generally known; the wave-length is given by the formula

$$\lambda = 1884 \sqrt{L \times C}$$

in which L is the inductance in the circuit in microhenries, and C is the capacity in

analyzing our problem. Suppose we are considering a wave-length range of 600 to 200 meters. This is a wave-length ratio of 3 to 1. Since the capacity is proportional to the square of the wave-length, we should then require a capacity ratio in our tuning condenser of 9 to 1 to completely cover the range.

It is a relatively simple matter to cover a 3-to-1 wave range with a coil and condenser isolated in space. But when the coil is coupled to another coil, as our secondary tuning coils are coupled to the antenna coil, there is another consideration. This is that the mutual inductance between the antenna coil and the secondary reduces the effective inductance connected across the tuning condenser.

This was shown recently in RADIO NEWS LABORATORY. A simple single-layer coil was connected in series with a condenser and thermo-galvanometer. This coil had a primary of a few turns wound directly upon the secondary winding. The circuit was then excited by a small oscillator, and the wave-length range of the coil and condenser noted for both the maximum and minimum settings of the condenser.

This was done by placing the condenser at the desired dial settings and measuring the wave-length with a wave-meter at which the galvanometer deflections were a maximum.

The primary coil was then connected to the antenna and ground, and without making any other changes in the circuits, similar measurements of the wave range were taken. These measurements are given in the following table:

	Maximum Capacity	Minimum Capacity
Without antenna	550	215
With antenna	507	198

This was not done for the purpose of expounding a new theory. The principles have been known for a long, long time. But it

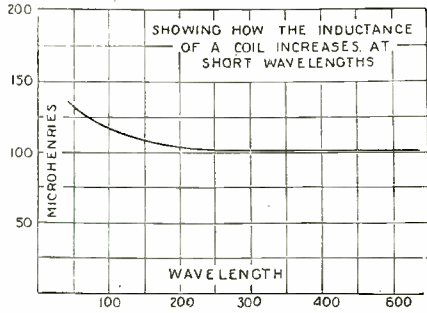

FIG. 2

A curve taken in a three-circuit tuner, showing the change of inductance with frequency.

There will probably be a great hue and cry when the extension comes. People will say: "It has been difficult enough up to now to cover the range of 550 to 220 meters. How will it be possible to cover a range of 550 to 150?"

There will be many arguments pro and con, but in the end, no matter how much arguing is done, ways and means will be found to overcome the difficulties. At least, if the total range cannot be covered in a single step, as is now done, it will have to be done in two or more steps.

In the July issue of RADIO NEWS, a means of overcoming this difficulty was presented in the form of a three-range receiver, in which a total wave range of 600 to 140 meters was covered in three steps by means of a single switch. These ranges were, approximately, 600 to 400, 420 to 220, 240 to 140 meters.

This not only made possible the covering of the whole range conveniently, but at the same time, completely eliminated the crowding of stations on the dial, thus simplifying tuning considerably.

As to the possibility of covering such a wide wave band—that is another question. Let us look at the problem from the point of view of the variable condenser, which is generally employed for tuning. But first there are three ideas which we must get

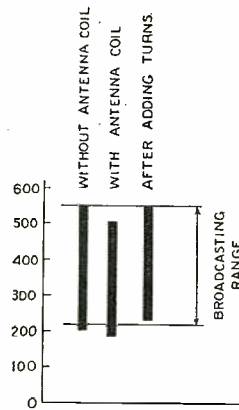

FIG. 1

This sketch shows plainly how the range shifts with the addition of the antenna coil and the extra turns.

microfarads. The point that is of importance in connection with all this is that the wave-length is proportional to the *square root* of the capacity in the circuit.

That is to say, we shall have to quadruple the capacity to double the wave-length, or increase the capacity nine times to triple the wave-length. Or to look at it another way, we may regard the capacity as proportional to the square of the wave-length: to double the wave-length we shall have to quadruple the capacity, etc.

Having assimilated these basic ideas, let us now co-ordinate them for the purpose of

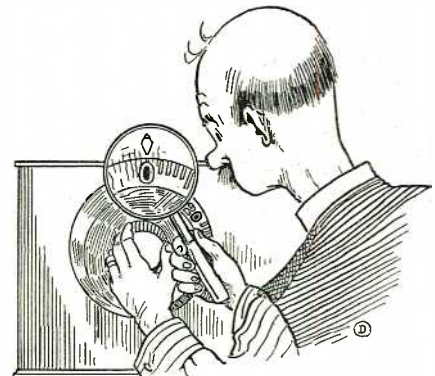

How to keep from growing old! Separating the short-wave stations.

is surprising how much the antenna-coupling coil can affect the wave range.

Now, it was noted above that the antenna coupling has maximum wave-length to 507 meters. This will not permit us to tune in stations above 507. The present wave band extends to 550 meters. Suppose we add a few turns of wire to the coil to make up for this deficiency. What will happen?

To begin with, we shall reach our 550 meters, of course. But, at the same time, we shall raise our lower wave-length limit and instead of being able to tune as low as

(Continued on page 506)

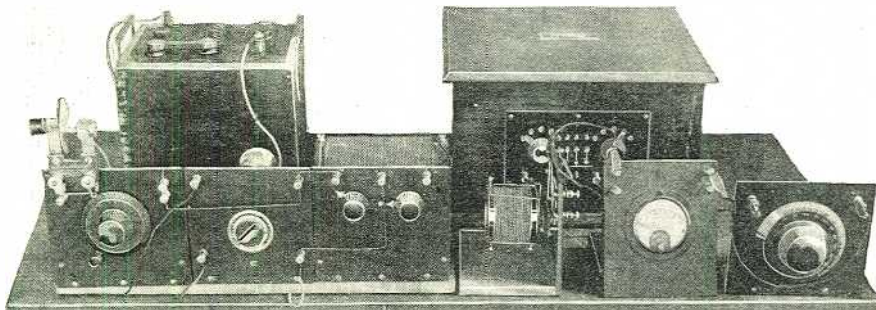

The apparatus used in making this study consisted merely of an oscillator, on the left, and a simple receiving circuit, on the right.

Does a Straight-Line Frequency Condenser Exist?

By SYLVAN HARRIS

ARTICLES dealing with the straight-line frequency condenser were presented exclusively to our readers in the August and September issues of RADIO NEWS. These articles by no means told the whole story about them; in this article I shall endeavor to explain a few points that will be sure to arise shortly, after the fans become accustomed to this type of condenser. In fact, some of the difficulties have already arisen, in spite of the fact that these condensers have been obtainable only a short time.



Sylvan Harris at his desk.

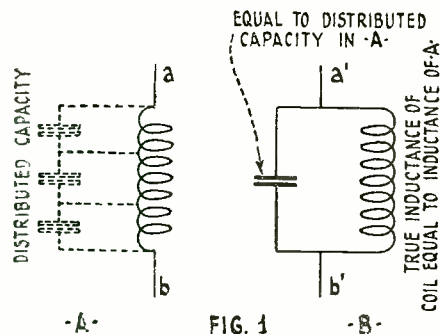

FIG. 1

A coil having capacity as shown in (A) is equivalent to the circuit in (B), the inductance of (B) equal to the true inductance in (A) and the capacity in (B) equal to the coil capacity in (A).

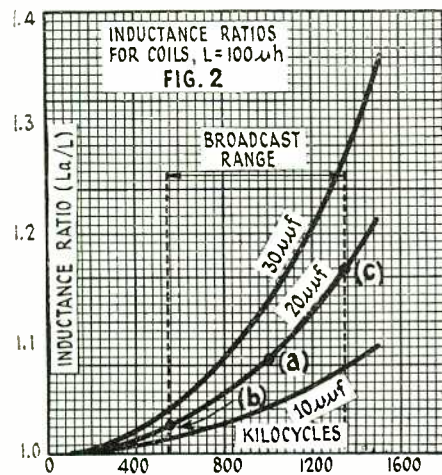

FIG. 2

How the apparent inductance of a coil depends on the coil capacity is shown in this chart.

A radio fan came to me a few days ago and asked if it would be possible for the straight-line frequency condenser to eliminate what he called heterodyning between stations. By this he meant the interference which occurs from the overlapping of the side bands emitted by two stations. Everyone knows that broadcast stations are allocated in channels separated by a frequency of 10 kilocycles. That is, their carrier waves differ in frequency by 10 kilocycles (or 10,000 cycles). If now, the side bands of two stations separated by 10 kilocycles exceed 5 kilocycles each, it is evident that some of these modulation frequencies will overlap, and some frequencies will be received simultaneously from both stations.

No condenser—in fact, no tuning appa-

ratus—can correct this evil. The difficulty lies outside the scope of the receiving set; it is not possible for the receiver to separate overlapping side frequencies.

A MISREPRESENTATION

The next thing I wish to talk about comes as a result of a short article in one of our contemporary radio periodicals in which it is stated that "there is not at the present time (and never will be) any such instrument." The writer of that article bases his statement on the fact that the characteristics of coils, which are used with the condensers in tuning circuits, vary considerably.

Well, without going much further, I might say that this is a serious misstatement. Why this is so will be shown as we proceed. For the moment, however, I might say that the design of a straight-line frequency condenser does not depend at all upon the coil. If the calibration of the condenser departs from the linear because of coil capacity, then the trouble is with the coil, and not with the condenser. In such case, why blame the condenser? The poor condenser has already been blamed for enough trouble.

However, we are not interested in such pedantic quibbling. We are entirely interested in the practical side of the matter, and it is this side that we shall consider here in detail. Let us state the problem, first recalling a few essential facts that were explained in our August issue. The design of an S.L.F. condenser is based upon the assumption of constant inductance in the circuit. It is based upon the formula:

$$f = \frac{159.3}{\sqrt{LC}}$$

in which f is the circuit frequency in kilocycles, L is the inductance in microhenries and C is the capacity in microfarads. By assuming L constant, we can take the square root of L and divide it into the number 159.3 and obtain a constant, K . Then if C is proportional to $1/d^2$, in which d is the dial reading, we have

$$f = Kd,$$

and this formula plotted on graph paper will give a straight line.

Now, remember that this involves the assumption of a constant inductance. If the coil which is used with the condenser has some capacity (distributed), the inductance will not remain constant. We may consider the coil having capacity as equivalent to a coil which does not have capacity connected in parallel with a small condenser equal to the coil capacity. For example, in Fig. 1 we have shown at A a coil which has considerable inductance and a small distributed capacity. As measured between the terminals a and b , the coil has a certain inductance which is called the "apparent" in-

ductance. This is to be distinguished from the "true" inductance, which is the inductance the coil would have if it did not possess distributed capacity.

In B of Fig. 1 we have shown an equivalent arrangement. We have taken the true inductance of the coil at A (which is the inductance we should measure between the terminals a and b if the coil had no capacity) and have shunted around it a condenser having a capacity equal to the coil capacity. Such an arrangement would give a measured inductance across its terminals a' and b' , exactly equal to that across a and b , if the measurements were made at the same frequency.

The arrangement at A in Fig. 1 is converted into the equivalent circuit at B simply for purposes of convenience. We can easily perform computations with circuit B. We shall now consider how the apparent inductance between the a' and b' varies. We shall call the true inductance of the coil L , and the capacity of the coil C .

We shall now introduce a new idea to our readers. Many of them have probably heard of the "resistance ratio" that is considered in studying the high frequency resistance of conductors. It is the ratio of the resistance of the conductor at high frequencies to its resistance at low frequencies, and is symbolized as R/R_0 . So we can have the "inductance ratio," which is the ratio of the "apparent" inductance (as measured at high frequencies, taking account of the coil capacity), to the inductance as measured at low frequencies (where the effect of coil capacity is negligible). We may symbolize this as L_a/L , where L_a is the apparent inductance and L is the true inductance. The formula showing the relation between these two quantities is:

$$\frac{L_a}{L} = \frac{1}{1 - 39.48f^2 LC \times 10^{-6}}$$

in which f is the frequency in kilocycles and C is the coil capacity in microfarads.

(Continued on page 562)

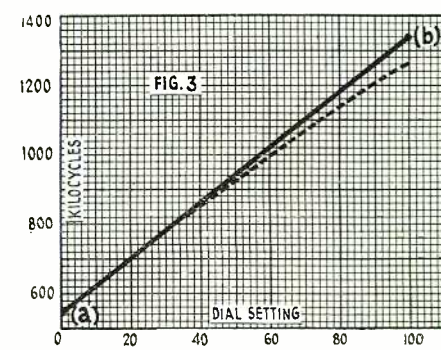

FIG. 3

The calibration curve of an S. L. F. condenser is bent slightly by the circuit capacity.

Another Three-Range Receiver

By the Staff of Radio News Laboratories

Here is described another receiver with a multiple range. It will tune from 40 to 555 meters and uses two stages of radio frequency.

IN an article by W. B. Arvin in the June issue of RADIO NEWS, our readers were advised of changes in the broadcast wavelengths which may be considered, and which, in fact, are necessary to obviate the difficulties we now have in tuning, due to the great congestion in the ether.

RADIO NEWS, realizing the great importance of familiarizing its readers with ways and means of building sets that will cover the whole range, from 600 to 150 meters, at the same time eliminating the crowding on the dials, started a series of articles in the June issue, describing sets which will meet the requirements. The first of the series was the three-range receiver described in that issue, which is a three-circuit tuner. The arrangement of coil and condensers in the circuits is such that by means of the special switch described, it is possible to separate the whole range into three portions. This has the effect of spreading the whole range out over three circumferences of the dial. Furthermore, the whole thing is accomplished by means of one switch, which is a very novel idea.

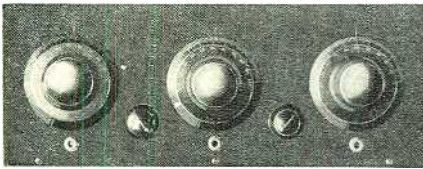

Panel view of the three-range receiver.

Multi-range receivers have been designed in the past, but as far as the writer knows, all of them have required a number of switches.

The problem is rather simple when there is only one tuned circuit to consider, but when we try to make a tuned radio frequency amplifier tune over several ranges, it means that a great deal of convenience and beauty of design will be lost. This is because the coils used must be either tapped or replaceable. If they are to be tapped, this means a multitude of switches, for it is obvious that all the taps cannot be brought into one switch. If they were, there would be considerable coupling between the stages which would result in decreased amplification.



By using tube bases as coil mounts, very serviceable interchangeable inductances are obtained. Coils of this type are used in the three-range receiver described below.

If the coils are to be replaceable, as they used to be in the days when so many experimenters used the honeycomb coils, there is the same inconvenience that applies to manipulating so many switches in the case of the tapped coils. The tendency nowadays is to make the operation of the sets as simple as possible, and certainly a half-dozen switches or coils does not by any means add to the simplicity of the set.

How the problem will finally be overcome in the commercial form of set is problematical. Of course, there is the possibility of using several switches behind the panel, all operated by a long shaft, or interlocked in some way by wires or toothed racks so as they can be operated simultaneously by a single knob or lever. This method, however, is a little complicated for the average person to build, but I believe that manufacturers of sets may have to adopt it.

RADIO NEWS will bring out sets in the near future employing these methods of range control.

There are many experimenters who are laboring under the impression that the wave range can be increased merely by lowering the minimum capacities of the tuning condensers. The wave range certainly can be lowered by doing this, but it can be lowered only a very little. If you don't believe me, try this yourself. Connect two variable condensers in series, and set both of their dials at zero. Having the two minimum capacities in series will give a minimum capacity somewhere near half what it was. It will be found that if the set operates at all satis-

factorily, the wave range will be lowered only by a few meters.

The set described in this article is the usual radio frequency amplifier connected to a detector and two stages of audio frequency amplification. Regeneration is controlled by a potentiometer, as shown in the wiring diagram Fig. 1.

The three wave-length ranges are obtained by means of the replaceable coils, which are shown in the accompanying photographs. These coils are of the basket type, which anyone can wind himself very easily. The method of winding is shown in the accompanying sketch.

When finished, the coils are mounted onto an ordinary tube base, which can be heated and removed from an old burnt-out electron tube. A bit of sealing wax suffices to hold the coil in place. Coils made in this fashion may be bought at the radio stores, if the reader does not wish to go to the trouble to "roll his own."

The dimensions of the coils are all the same, these dimensions being given below. They differ only in the number of turns employed. The primary and secondary coils are wound and tied together by the lacing string.

The method of winding inductance coils that is described below will be found to be one of the easiest for the home set constructor.

The set, as described, will give a total wave range of 40 to 555 meters, and will be divided into the following ranges with a 0.0005 mfd. condenser:

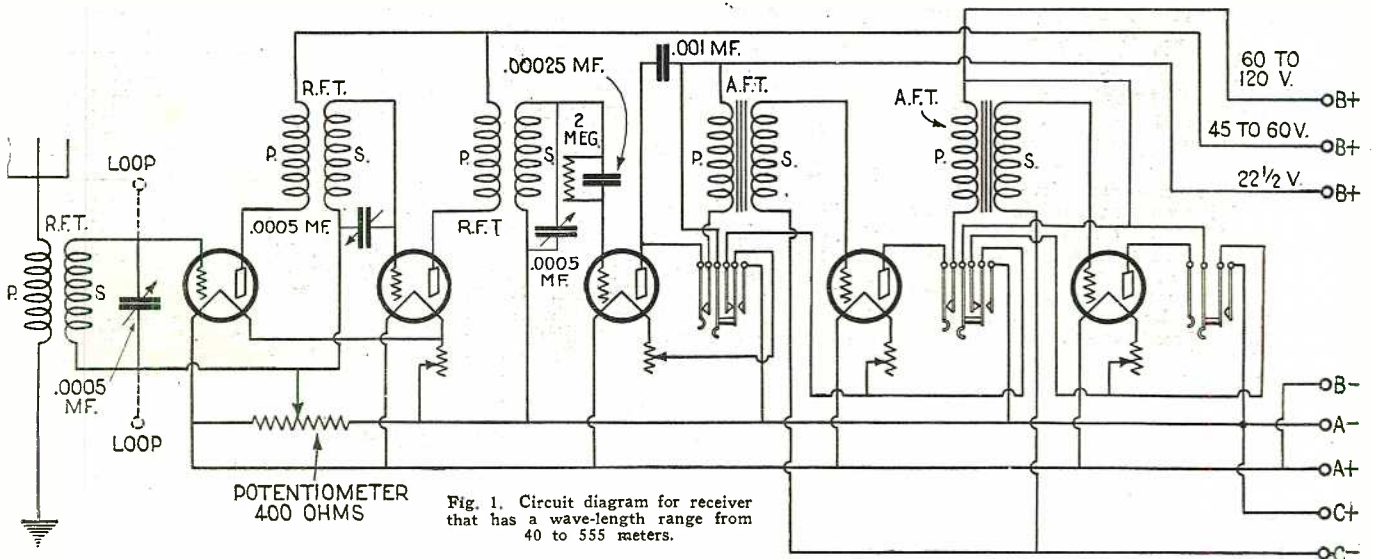
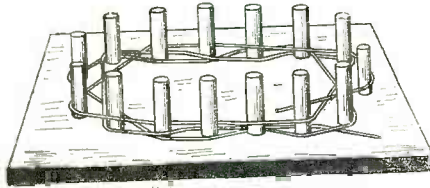

Fig. 1. Circuit diagram for receiver that has a wave-length range from 40 to 555 meters.



This figure illustrates the method of winding the rectangular coils which are shown in the photograph below. The pegs are not laid out in a circle as is usual, but follow a rectangular path, as suggested in the text.

- Coil No. 1..... 40-180 meters.
- Coil No. 2.....100-300 "
- Coil No. 3.....224-550 "

The coils used have the following numbers of turns:

	Primary.	Secondary.
Coil No. 1.....	4	8
Coil No. 2.....	8	16
Coil No. 3.....	10	40

As a result of thus dividing the range into three parts, it will be a very easy matter to tune to the short-wave stations, where the ether congestion is very bad at the present time. Many stations will be tuned in which it was heretofore impossible to hear. It is advisable to use straight-line frequency condensers in this set, as well as in any other, for additional ease in separating the stations. The set is remarkably selective and sensitive, as all multi-stage tuned R.F. receivers should be. We take great pleasure in recommending this circuit to our readers as the second of the series of multi-range receivers. All those parts of the receiver

which have not been described in detail in this article are the same as those in the usual tuned R.F. set, so that no one should have any difficulty in following the wiring diagram and building the set. To be a little different, the audio frequency amplifier has been mounted directly behind the radio frequency amplifier, instead of on a line with it. This has the advantage of keeping the set within small space limits and, furthermore, utilizes a considerable amount of space of the baseboard which generally goes to waste.

METHOD OF WINDING COILS

The coils used in this receiver are more or less rectangular in shape. The reason for this is that in the set for which they were designed the apparatus was arranged as compactly as possible, in order to have the leads connecting the different instruments at a minimum length; if the coils had been circular in shape they would have been too near the interfering magnetic fields of the transformers.

The coils are 3 inches in length and are 1½ inches wide. They are wound with No. 22 D.S.C. wire. The winding form that is used for the construction of these coils is laid out as shown in the accompanying sketch, but with dimensions that are the length and width of the coil. The pegs on which the wire for the coils is wound are spaced approximately one-half inch apart. There are fifteen of these pegs, which should be ⅛ inch in diameter and smooth enough for the wire to be easily slipped off after the coils have been wound.

The Laboratory Staff of RADIO NEWS has developed another receiving set that will tune to the lower wave-lengths as well as the present broadcast band. The receiver described in the following article tunes from 40 to 555 meters, which is one of the broadest ranges RADIO NEWS has ever presented to its readers.

The receiver is not difficult to construct, as there are no complicated switches incorporated in its make-up, the variation of wave-lengths being obtained by interchangeable coils that are easily constructed.—EDITOR.

The primary and the secondary of these radio frequency transformers are wound on the same form and should have the number of turns noted in the table above. After the primary and the secondary are wound, they are then bound together with thin, strong string, so that the coils will retain their shape. The completed coil is then placed in the top of an empty tube socket and the leads soldered to the prongs of the tube socket. The coil is fastened in place with sealing wax, which may be obtained from an old discarded "B" battery.

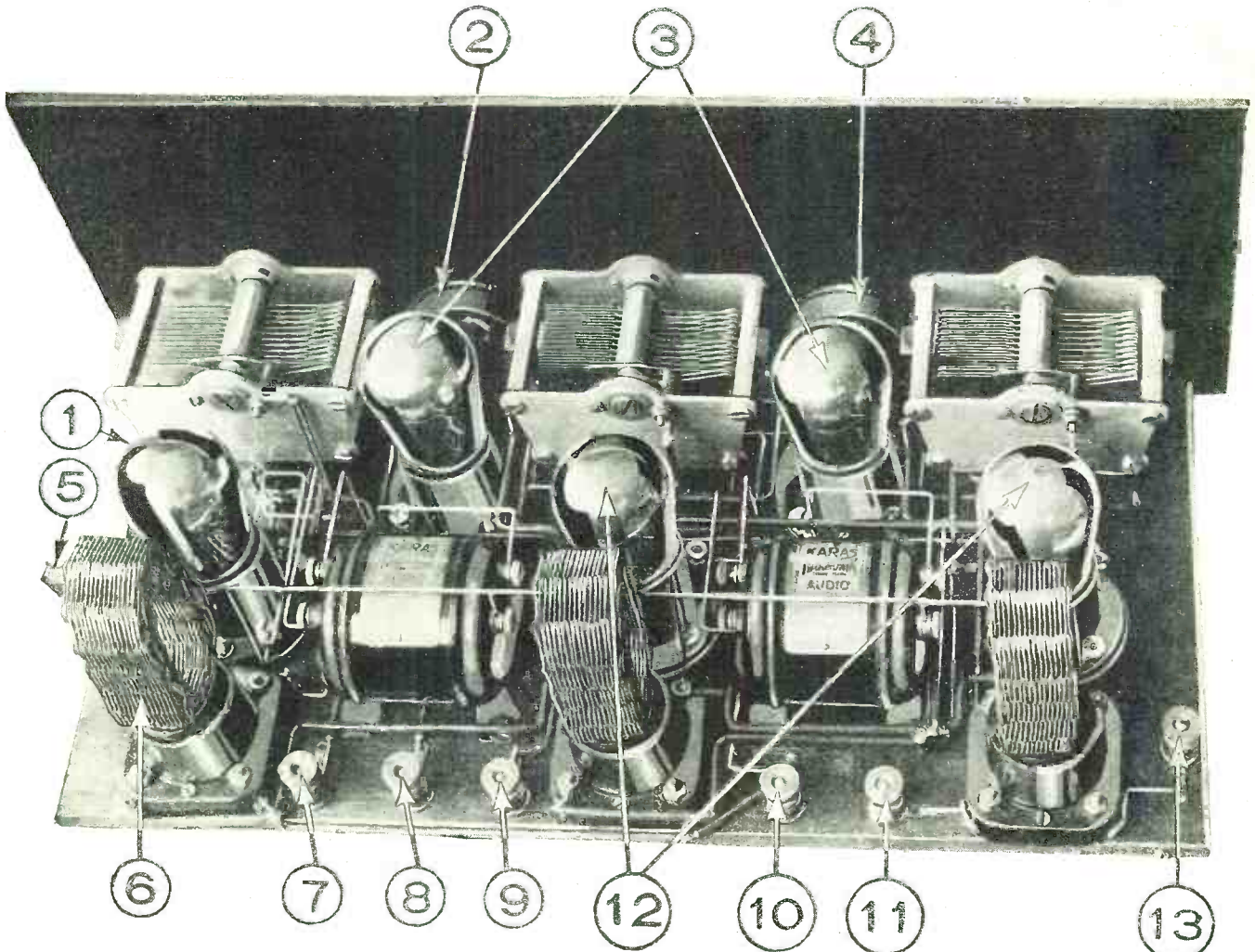

Rear view of the three-range receiver. 1 is the detector tube; 2, a potentiometer; 3, radio frequency amplifier tubes; 4, a rheostat; 5, the gridleak; 6, removable coil for different wave-lengths; 7, +45 volts; 8, —"A" and —"B"; 9, —"A"; 10, +90 volts; 11, antenna binding post; 12, audio frequency amplifier tubes; 13, the ground binding post.



Ham Co-operation—Is It Dead?

By A. P. PECK

WHERE, oh, where has the type of transmitting amateur gone that some of us were familiar with just before the recent World War? Is there some Sargasso Sea of the ether to which these souls have been irresistibly drawn and taken away from the ham game, or is there some limbo to which they have strayed? A few moments listening in on the air any evening during the present time will quickly convince anyone who has been in touch with amateur activities for a period of ten years or more that some such abode must have robbed the game of the best men that ever kept the ball rolling by good operation and co-operation. Of course, this is not to say that there are not *any* good operators today and that there is an absolute lack of co-operation among the active amateurs.

There are some good fists left, but evidences of co-operation are few and far between. Co-operation throughout this editorial is to mean not only co-operation between individual amateurs who are in personal contact with each other, but co-operation on the air as well. In the good old days before the war, the writer at one time was making plans for the erection of a new aerial mast. As things went along he spoke to several other hams about the proposition and many meritorious suggestions were put forward. When the plans were finally completed, and the day for the erection of the mast came around, there were at least a dozen other hams on hand to aid. The mast went up in jig time and with little, if any, trouble. Compare this with the present-day situation. The writer again had occasion to design a mast for another ham and supervise its erection. Several days before the date slated for raising the mast, many hams were asked both personally and via the air to assist. Some of them assented and others excused themselves. Possibly a total of ten said that they would be on hand. On the day of the raising, just two of them came around to assist and they seemed to be a lot more willing to stand around and give

advice than actually lend a hand. Before the mast was put up they stood around and discussed various methods by which masts could be constructed rather than the one being put into practice. Finally, after much argument and dissension, the mast was put into place, but the arguments which were put forth created so much hard feeling among those present that the writer decided that never again would he ask the assistance of hams in such work as this. He would rather go out and hire a couple of husky ditch-diggers who could not even talk English. Then he would be sure that no personal feelings would be hurt during the work.

And not only in the erection of masts can we help each other. Exchanging dope of all kinds is of great help. When a new ham starts up, go over and offer to help him get started right. We are sure that he will appreciate your offer and some day he may reciprocate to your own advantage.

Another instance that will strike nearer home to the radio amateur fraternity in general is the case of the little private war that is going on at present within the confines of the second district. It seems that recently some of the Jersey boys became dissatisfied with the way the Second District Council was being run and instead of exercising their prerogative of representation in the council, they suddenly decided to withdraw from that governing body. The writer has talked with several hams, both members of the council and of New Jersey clubs. It seems that mob rule is the only thing that is responsible for the secession of the clubs from the council. Certainly not one of the club members has been able to state any single valid reason why the clubs should secede. Their representatives certainly do not seem to be performing their duty correctly if they cannot uphold the clubs whom they represent at the council meetings. Those members of the council who are blamed by the outsiders for incompetence are, as far as it is possible to find out, performing their duties to the best of their ability. The

council is an up-and-going organization and certainly has done much for amateur radio in the eastern section of the United States.

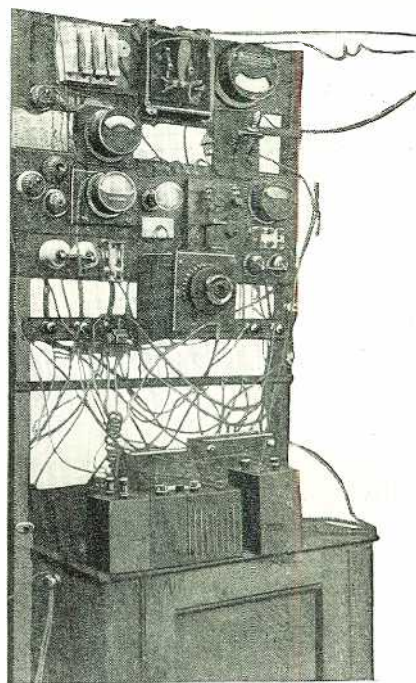

A typical European transmitter showing a Mul-lard 7/50 transmitting tube.

Imagine what would happen if the inhabitants of a town located in any one of the states of the Union were to decide suddenly that they did not like the way the state was being run, and that they were going to withdraw from the rule of that state. If this mob rule were to spread, another Civil War would undoubtedly ensue. (Continued on page 528)

Curve No. 7943 By HE
Model 5Va Date JUN 25 1925

File V. 5 Plate V. 90
Filament Amperes 2.4

Mutual Conductance 840
The Mutual Conductance is the most important measurement in determining the excellence of a tube. It shows the value of the accompanying characteristic curve, or the relation between voltage applied on the grid and the resulting plate current.
5-Volt tubes should test 600 micro or more on 90-V plate.
3-Volt tubes should test 370 micro or more on 90-V plate.

Amplification Constant 8.1
This reading is a valuable index to the quality of a tube as an amplifier. It is the ratio between the changes in plate and grid voltage necessary to produce the same variation in the plate current.
5-Volt tubes should read 7.5 Amp. Con. or more.
3-Volt tubes should read 5.5 Amp. Con. or more.

Plate Resistance 9400
This is the ratio of the change in plate voltage to the change in plate current.
5-Volt tubes should read minimum 8000 Ohms.
3-Volt tubes should read minimum 10000 Ohms.

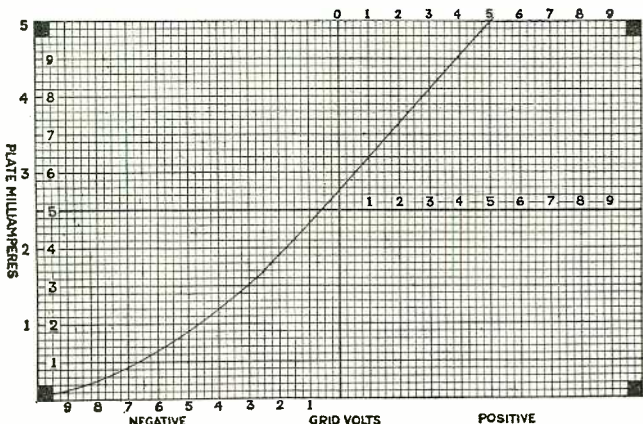

Copyright, 1925, by A. J. Musselman

A characteristic curve of the vacuum tube is supplied with every tube, so that the purchaser will know exactly how to operate his receiver or transmitter.

At Last—Individual Tube Ratings

By JOSEPH RILEY

MANY users of tubes have by this time become acquainted with the great variations that are often found in them. Sometimes a tube bought from the local radio dealer will work. Many times it won't. Many times, also, it is desirable for the user or experimenter to know what the characteristics of the individual tube are, but if he has not the necessary apparatus with which to run the characteristic curve, he naturally has to do without it.

Since the advent of many independent manufacturers of electron tubes into the radio market some unreliable tubes have come to our notice. There is no way in which defects in tubes can be detected at the dealer's counter, and the purchaser has to take the dealer's word for the reliability of the product. All that he can generally (Continued on page 553)



The Radio Beginner

How Does Your Set Get Its Power?

By A. P. PECK

WHEN you sit listening to a concert as it comes in on the loud speaker, do you realize where the power is coming from? And there certainly is some power coming from the speaker. Enough of it, in fact, to set the atmosphere of the room into vibration with the sound of the voice or music, and this is no mean quantity. But the power which comes into the antenna is almost infinitely small.

Let us take some illustration which will show by comparison just how much energy is received by the set and how much is

second. This illustration is taken from an ordinary commercial five-tube set and is nothing extraordinary.

THE TUBE A TRIGGER

Now let us see where all this power has been picked up in the travels of the signal through the set. Almost every one knows without being told that it comes from the vacuum tube. These little instruments work very much like a gun. A hunter of big game knows that he can pull a small trigger, exerting very little power and bring down the largest lion or tiger. He knows also that with his finger alone he would not have the slightest chance of killing the beast. His finger and the little force it exerts on the trigger of the gun simply serve to release the power held in the cartridge of the gun. The case is the same in the vacuum tube. The infinitely small power picked up by the antenna simply serves to "trigger" the power which the tube is able to release.

We may compare the trigger of the gun to the grid of the vacuum tube, and the calibre of the gun to what the engineers call the amplification factor of the tube. The hunter spoken of above would know better than to go into the wilds of an African jungle armed with a .22, because he knows that the trigger, pulled ever so hard, would not release sufficient power to kill some of the beasts with which he is sure to come in contact. He takes a larger gun—one which will surely do the desired work.

Simply stated, the amplification factor of the tube means how hard it will shoot when the grid is "triggered." In the ordinary type of tube, the so-called 201-A or 301-A type, this power ratio is 5 or 6. That is, if we put so much power into it at the grid, we shall receive five or six times that much power at the output or plate end of the tube.

Now in our set which gave power sufficient to raise the pack of cigarettes we had

five tubes. Into the first one we placed an infinitely small power. After it passed through the first one, the resultant power which came out at the plate and was delivered at the grid of the next tube was five

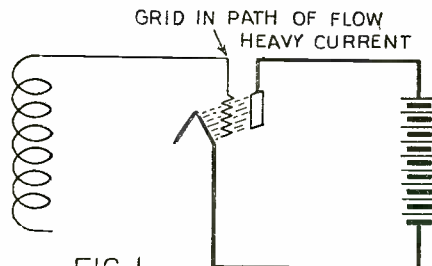

FIG. 1
This illustration shows graphically how the grid stands in the path of the heavy "B" battery current.

or six times what passed into the first one. At the second tube, this increased power was again amplified five or six times, thus giving 25 times the original power. Through each of the following tubes the power was again multiplied by the amplification factor so that when we passed the final output through the loud speaker we had 3,000 or 4,000 times the original power, depending on what the engineers call the efficiency of the set, or plainly, "how good it is."

An instrument which will increase power in such proportions certainly is an interesting device. Last month, in this place, we told you of what the engineers and radio-tricians call the "characteristic" of the tube. But at that time we did not tell how the tube worked. After showing what the tube is able to do in the line of increasing power, we may as well explain how this amplification is performed. In other words, we shall

(Continued on page 494)

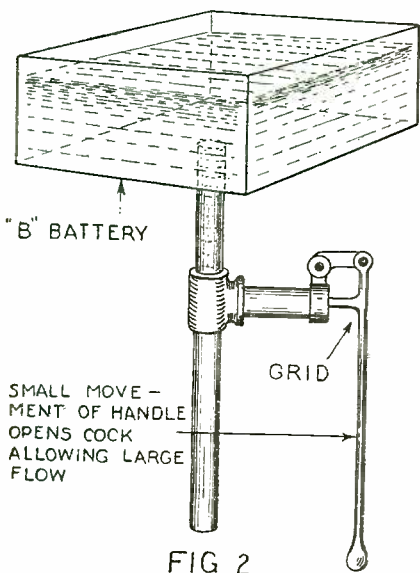

FIG 2

An hydraulic representation of the grid action is given above.

given out by it, so that we may appreciate just what the set is adding to the incoming signal.

The ordinary antenna, at average distance from a broadcast station of the standard Class "B" type—that is, a station with an output rating of, say, 500 watts—will pick up and deliver to the first tube of the set less than ten microwatts. An appreciation of this power may be gained when we say that it isn't sufficient to raise an ordinary human hair a thousandth of an inch in one second. Very little power, to say the least.

But when the signal comes out of the loud speaker, a great deal of power has been gained in the passage of the signal through the tube. In fact, at the terminal of the speaker, the power is on the order of .15 watts, which by comparison is some power. Following the example given above as to what this power is able to do, a little figuring will show that the loud speaker power is sufficient to raise a pasteboard box containing twenty cigarettes one foot in one

Because the "B" battery current is carried through the tube by the infinitesimal electrons, the minute voltages of the grid are enabled to control a current of many times their own magnitude.

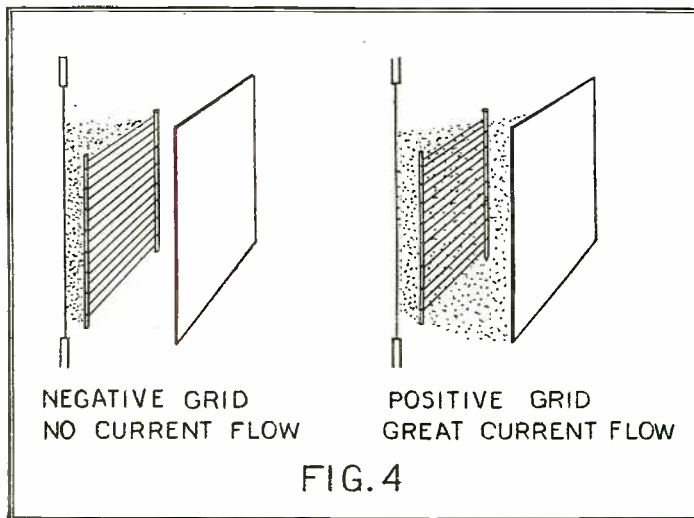

FIG. 4

All About Filters

By EDWARD W. BERRY

This article will doubtless be greatly appreciated by the transmitting amateur who is not thoroughly familiar with the theory of filters.

TELEPHONY has today reached such a state of development that not only must the voice be carried in an intelligible manner, but it must also be a true reproduction of the original, free from distortion and unaccompanied by disturbing noises. Even the modern practice of telegraphy is beginning to demand the pure wave. Consequently, it has become necessary to provide, as nearly as possible, a pure direct current for excitation. To accomplish this filters have been employed. At the present time the most practical source of plate supply in general use is either the D.C. generator or chemically rectified A.C.

In a previous article—*RADIO NEWS* for August, 1924—the writer undertook the study of the wave forms of the predominant ripples in the generator. Here we found that the composite ripple consists of its two fundamental waves, slot ripple and commutator ripple. The slot ripple frequency was equal to:

$$F_s = \frac{\text{No. of slots} \times \text{R.P.M.}}{60}$$

and the commutator ripple was equal to:

$$F_c = \frac{\text{No. of segments} \times \text{R.P.M.}}{60}$$

That is, a generator having 16 armature slots and 48 commutator segments revolving at a speed of 3600 R.P.M. would have a slot ripple frequency per second of 960 and a commutator ripple of 2,880. We also learned that the composite wave form could be greatly changed by various brush settings and, in the case of the double commutator machine, the brushes might be so set that one commutator ripple tends to neutralize the other. The slot ripples at both commutators always remain in phase with each other and no amount of brush shifting will alter them. The use of the uneven number of slots doubles the frequencies and also reduces the amplitude of the various ripples. Besides these well-defined ripples there is present a small amount of disturbance due to the sliding contact of the brushes on the commutator. These latter impulses have no definite form and are, in the properly functioning generator, very minute in comparison with the main ripples. The sum of all the disturbing impulses in a well-designed generator is small, usually a fraction of one

per cent. of the total voltage of the machine.

The chemically rectified A.C. is an entirely different proposition. The proper use of an even number of tubes in so-called self-rectifying circuits eliminates the half-cycle interruptions in transmission. That is, the tubes alternate, one tube or group of tubes working, while the others are idling. Every tube is idle for half a cycle. The ripple in this case is one frequency only, disregarding, of course, harmonics which in modern power supplies are negligible.

DIRECT AND RECTIFIED SUPPLY

The D.C. generator and the rectified A.C. supply present the following propositions: In the D.C. generator supply there is a large D.C. component with a small A.C. component superimposed. Our aim here should be to pass as much of the D.C. as possible and to completely block out the A.C., or, more exactly speaking, the fluctuating voltage. If in the case of the A.C. supply we blocked the ripple, there would be no supply

component from the pulsating output of the rectifier, the proper use of a "resonant" type of filter will, practically speaking, eliminate all traces of A.C. that remain.

We shall assume that the reader has a working knowledge of the functioning of condensers and inductances and therefore will not burden him with it here. If he has not, it may be obtained from any one of a number of standard textbooks. Furthermore, a knowledge of complicated formulæ and higher mathematics is not necessary to

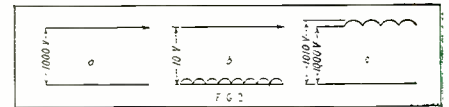

In "a" is shown D. C. voltage and in "b" a ripple voltage. "c" shows the sum of these two voltages.

effectively filter plate supply from either a transformer or a generator. A knowledge of the results obtained by different combinations is a great help in intelligently applying filters. We shall, then, discuss filters more from a physical than from a mathematical standpoint.

In Fig. 1 we have what we might call a "raw" supply. There is no attempt here at any filter. Both the direct current and the ripple current are flowing in the plate circuit. The resistance of the path between the plate and the filament is so large that it will allow only a small amount of direct current to flow. The ripple current is subject to this same resistance. If we had a constant voltage of 1,000 volts at the supply and the resistance of the path between the filament and the plate were 10,000 ohms, the plate current would be .1 ampere. If the ripple voltage had been 10 volts, the ripple current would have been .001 ampere. Right now it would be well to settle one thing; that is, that there are not two kinds of current flowing through the plate. Fig. 2a is the conventional method of showing a constant voltage. In this case, it is our D.C. plate supply of 1,000 volts. Fig. 2b shows, in addition, a fluctuating voltage of 10 volts. This is the ripple voltage. These two are in series and the actual voltage across the plate is the sum of the two as indicated in Fig. 2c. The voltage in our example keeps changing from 1,000 volts to 1,010 (Fig. 2c). Likewise, the current through the plate circuit keeps changing from .100 ampere to .101 ampere. It is this fluctuating current, .001 ampere, that is called the ripple current. Removing this ripple current means removing the voltage fluctuation across the plate. There are two ways of going about this: Remove it in the supply, or reduce it after it has left the supply. That is, there will still be the fluctuation across the supply terminals, but the fluctuation across the plate itself will have been reduced by the addition of a filter between the two. With the A.C. supply in any of its forms such as "raw," chemically or mechanically rectified, reducing the ripple of the supply is out of the question. With the D.C. generator the proper application of filters will not only reduce the ripple across the plate but in the machine as well.

CHOKE COILS

In Fig. 3 we have placed an inductance in series with the plate. This inductance is no more or less than the common variety of choke coil familiar to the newest of amateurs. Its resistance is usually fairly small.

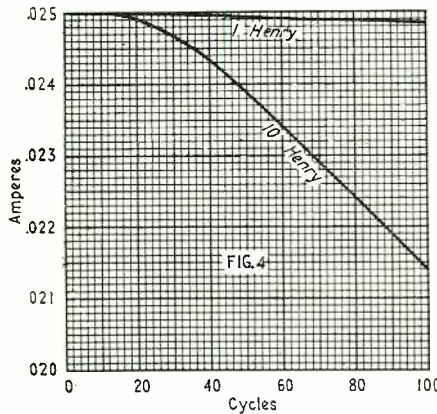

These curves show the reduction in a 250-volt ripple, with a plate impedance of 10,000 ohms.

left. This means that first it will be necessary to obtain a D.C. component that does not drop to a small fraction of the maximum or peak voltage every half-cycle. We must smooth off the peaks and fill in the valleys, so to speak. This is accomplished by the "smoother" type of filter, to be described below. Having obtained an effective D.C.

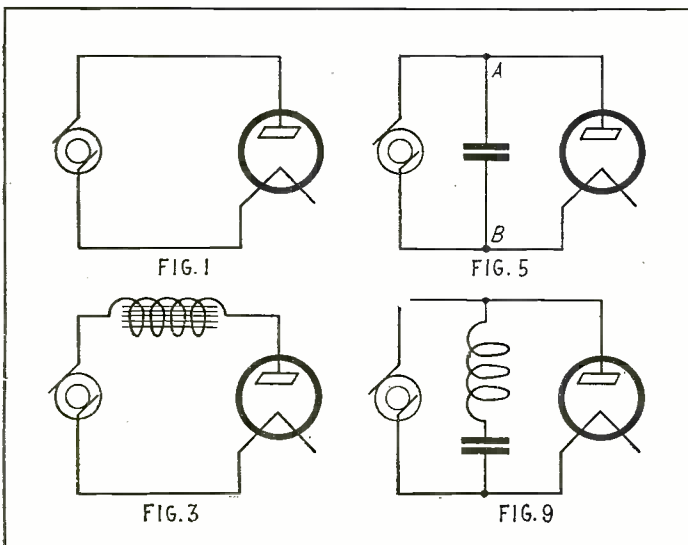
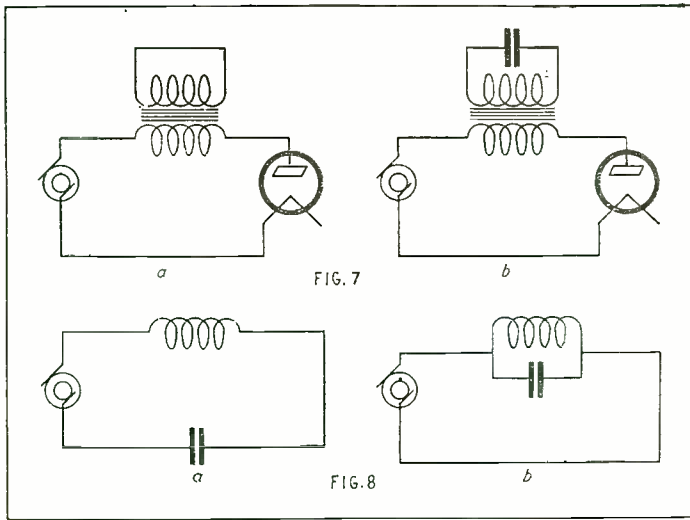

Fig. 1 shows a raw supply of current impressed on the plate of the tube. Fig. 3 shows a choke coil between the plate and the supply. In Fig. 5 the condenser shunted across the supply is also across the resonant circuit plate or load. Fig. 9 shows the series resonant circuit across the supply.



7a and 7b show two schemes using the primary of an A. F. transformer for a filter. Fig. 8a is a series resonant circuit, and 8b is a parallel resonant circuit.

Therefore, it makes but a small voltage drop in the direct current circuit. But to the small fluctuating ripple current it is a big hindrance. Before it can force its way through the coil, the ripple voltage has dropped and is trying to force it back again. The actual amount of the ripple current that does pass the coil depends upon the frequency of the ripple and the inductance of the coil. The inductance of the coil in this case is, we may say, a measure of its choking effect. Without worrying our heads over the "whys" of the matter, this slowing up of the varying current is accompanied by a reduction of the fluctuating or ripple voltage across the plate. If it is reduced in the choke, then only the remainder can pass through the plate. Which is which, is as immaterial to the functioning of the filter as is the priority of existence of the hen or the egg to the digestion of a good omelette. That is, each comes from the other.

The curves of Fig. 4 indicate the reduction in a 250-volt ripple, such as might come from the chemical rectification of a 500-volt supply, plotted against frequency. For convenience, we have assumed a plate impedance of 10,000 ohms. Here it is particularly noticeable that the inductance used alone does not discriminate. That is, it does not suppress any particular frequency or band of frequencies. It simply tends to lower the ripple current more and more as the frequency increases. At the lower frequencies, such as 60-cycle, the one-henry choke, as seen from the curves, is a very poor excuse for a filter. Even the 10-henry choke does not make an effective filter. Besides the suppressing action, there is another characteristic peculiar to chokes, more especially the larger types. They store up energy while the ripple is rising to a peak and tend to discharge it as the ripple voltage tends to decrease. In this way, figuratively speaking, they take some of the current from the peaks and use it to fill in the valleys. That is to say, the chokes not only stop some of the ripples, but also iron out some of the kinks in the ripple that do get through. Even with this second characteristic the choke used alone cannot be classed as a filter.

CONDENSERS

In Fig. 5 a condenser has been placed across the supply. This condenser is also across the plate or load. Let us forget for a moment the supply and consider that the ripple remains constant, regardless of what takes place in the filter or plate circuit. The condenser, of course, is able to pass an alternating or fluctuating current. The amount which it passes depends upon the frequency and the voltage of the ripple and also upon the capacity of the condenser. When the

direct current comes to point A, it finds but one path to travel. That is through the plate. The condenser does not affect it in any appreciable way. When the fluctuating current comes to point A it finds two paths—one through the plate and the other through the condenser. Some of the ripple current will be bypassed through the condenser. A and B are still at ripple potential. Then, in spite of our bypassing some ripple current, as long as there is more where it came from, there will be no reduction in ripple current. One of the most common examples of this is the lighting system in a house. In a properly wired house, the lighting of one light will not dim one that is already lighted. For the condenser to have any filtering effect from bypassing, it will be necessary to bypass so much current that the source of supply begins to show signs of weakness. This is what takes place in the case of the generator.

To get a better understanding of this let us consider a generator with a ripple of 10 volts, a plate impedance of 10,000 ohms and a 1 mfd. condenser across the generator terminals. The impedance of the path through A-B at zero frequency, or direct current, is infinite. By impedance we mean the resisting properties that the condenser has to both A.C. and D.C. By infinity we simply mean a very enormous number. The impedance of this condenser decreases very rapidly with increase in frequency. So rapid is this decrease that the 1 mfd. condenser at 100 cycles will have an impedance of only 1,595 ohms. This would mean that the im-

pedance through the plate would be about six times that of the condenser. In other words, at 100 cycles there would be six times as much ripple current flowing through the condenser as through the plate. This ripple is being bypassed, but it is not affecting the ripple through the plate unless it is lowering the ripple voltage across the generator terminals, which in this case is also the voltage across the plate. The ripple frequencies in most generators are very much higher than 100 cycles with the result that the ripple flow through the condenser may tend to become even larger than D.C. plate current.

All this time we have been considering that the ripple voltage has remained constant. In a generator the great load caused by the condenser has a short-circuiting effect on the fluctuating voltage. This action is quite similar to the drop in the secondary voltage of an overloaded transformer. This then is a very important step for filtering generators. In the case of the rectified A.C. supply with its very much larger percentage ripple, this breaking-down process, due to the large load required by the filter to do it and the resulting inefficiency of the complete set, would be out of the question. There is, however, a characteristic shown by the condenser quite similar to the second characteristic of the inductance that we have overlooked. The condenser will store up energy on the peaks and deliver it to the load when the ripple voltage is at the bottom of the valleys. In the case of R.A.C., the condenser, like the inductance, does not make a satisfactory filter when used alone.

Let us sum up the actions of these two when working alone in a circuit. The inductance is actually suppressing a certain per cent. of the A.C. component dependent upon the frequency and the value of the inductance. The ratio of this suppressed current to the A.C. current that would flow if the inductance were omitted may be called the efficiency of suppression. The curves of Fig. 6 show this for a 10-volt ripple on one of the smaller tubes, using a one-henry and a ten-henry choke. For comparison the ratio of bypassed ripple current to total ripple current with a 1-mfd. condenser under the same conditions has been plotted on the same sheet. It is rather difficult to compare the curves for inductance and for capacity on the same sheet as that for the inductance shows actual per cent. efficiency. The insert curve shows that, at about 8 cycles per second, the bypassed current has become equal to the plate ripple. At 100 cycles the curve shows that 92 per cent. of the total ripple current flowing is passing through the condenser. From the foregoing we may con-

(Continued on page 466)

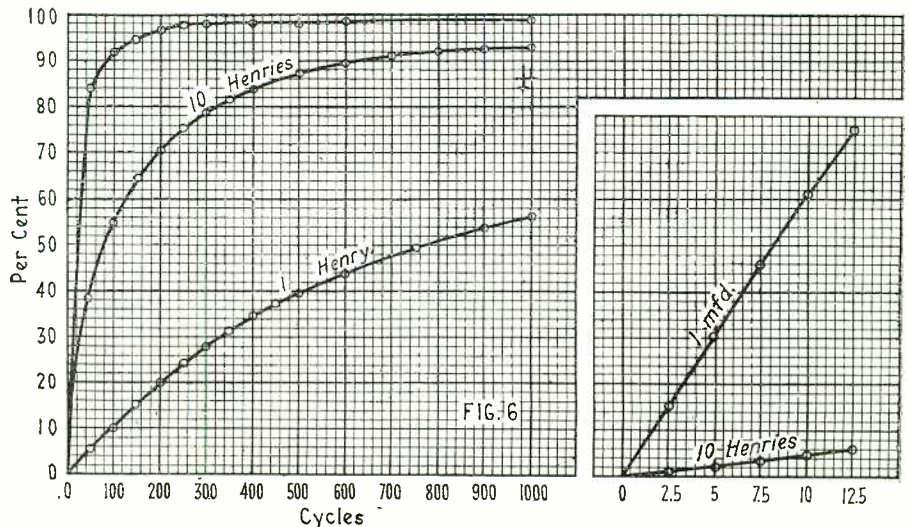

Curves showing the ratio of the suppressed part of the A. C. component to the total A. C. This may be called the efficiency of suppression.

Radio Wrinkles

SPREADING DIAL READINGS

To most of the fans experienced in tuning the old-style condensers with most of the station wave-lengths jammed in the first quarter of the dial, the arrival of the straight-line frequency condensers is a great relief. However, many set owners have two things to consider; there may be some of the old-style condensers on hand that are too good to throw away and the outlay of money for new condensers, even though they will facilitate tuning, may not always be possible. While the resulting condensers described below are not absolutely the straight-line frequency type, they will do the work in a most satisfactory manner and do not involve a great deal of labor in their construction.

To make an 11-plate condenser, that size being needed in a special circuit built by the writer, a 17-plate condenser was cut down. As will be seen later on, the extra number of plates are necessary, in order to give the desired capacity, to compensate for the material that is removed from the rotor plates. The rotor plates of the condenser were removed and taken off the shaft. Then, with

will fan out and mesh in the sequences of the above table. This gives an eccentric rotor in which the smallest capacities are on the low waves and load up progressively in inverse proportion to the frequencies producing the straight-line effect.

In tuning: From 0 to 15 is a 3-plate vernier condenser, from 15 to 27 is equivalent to a 15-plate condenser with only an 11-plate range, thus the kilocycles are spread out on the low waves and close together on the high, with fairly equal divisions over the whole range of the condenser, which remains the same total capacity of the old-style 11-plate condenser. It should be noted that great care must be taken in the preparation of the plates. *Do not bend them.* Also be sure, when replacing the plates, that the same number of washers are in the same positions.

Contributed by Chas. H. Stagg.

AN EAR-PHONE CONDENSER

Procure an old receiver of the moulded type—the metal shell type will not do in this case—and remove the magnets, etc., from the interior. Insert a piece of copper A into the shell, so that it fits firmly in the back, as shown in the diagram, leaving a lug on this plate long enough for the screw D to pass through. This screw will form one terminal of the condenser.

Next obtain a piece of sheet mica B, the thickness of which will depend on the capacity which is desired in the condenser. The thinner the mica, the greater will be the capacity of the condenser; about .002 of an inch serves well. Cut the mica so that it entirely covers the copper sheet A, to which it should be fastened by means of a little shellac.

The movable plate C may be a piece of aluminum which is drilled and tapped to take a 1/8-inch machine screw with countersunk head, which screws into a tapped hole in the end of the adjusting screw E. Be sure that the head of the screw is countersunk a shade below the surface of the plate C, as it will otherwise bear on the mica and keep the plates further apart than is intended, thus causing the maximum capacity of the condenser to be considerably less than is desired.

By means of the machine screw, screw plate C tight against the end of screw E, which should be turned off square. Then run some solder around the joint on the upper end, so that it will not work loose.

The center hole in the ear-piece of the receiver should then be enlarged, if necessary, and tapped out to take the brass bushing F, which is screwed on the outside and tapped inside to suit the thread on the adjusting screw. To obtain fine adjustments, this thread should be as fine as possible.

All the pieces should then be assembled as shown in the diagram, particular care being taken here to make sure that plate C is absolutely parallel to plate A. This is important.

The diagram shows a type of panel mount-

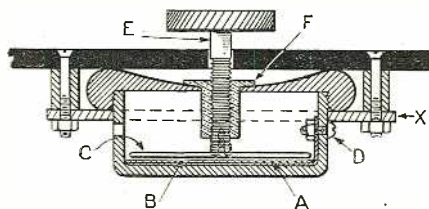

A variable condenser which is made in the moulded form of an old receiver should be handy for the experimenter.

ing in which X is a piece of insulating material, such as hard rubber or bakelite, with a hole cut in it, into which the phone should be a "push in" fit. This sub-panel is attached to the main panel by means of four machine screws and spacing washers, as shown, one at each corner of the sub-panel.

A condenser such as this, if carefully made, will be very useful about the laboratory or work bench and will well repay the trouble of constructing it. This instrument may be used in any number of experiments, and its maximum capacity may always be readily calculated for different thicknesses of dielectric that may be used.

Contributed by T. A. Vincent.

GROUNDING A LIGHTNING SWITCH

Many radio fans use an ordinary double-pole, single-throw knife-switch for connecting the antenna and ground to their receiving set. Then another switch is employed between the antenna and ground for lightning protection. Now why not let the double-pole switch serve also as a lightning switch? This would be an advantage as the lightning switch is sometimes forgotten—and the cost of a lightning switch is saved, as well.

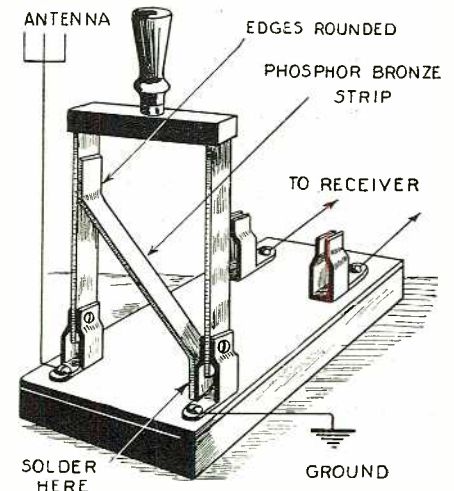

By adding a strip of copper or bronze to a D.P.S.T. switch, an efficient lightning switch can be made.

A small strip of phosphor bronze or copper about 1/2 or 3/4 inch wide and about 1/32 inch thick is bent to the shape shown in the illustration and soldered to the ground-point of the switch, so that the strip will just touch the antenna blade when the switch is in the open position. It is easily seen that this will interfere in no manner with the proper functioning of the switch. It is well to round off the edges of the strip so that the blade will make an easy sliding contact with it.

When the switch is left in the open position, which it ordinarily is, the antenna will be grounded, but when the switch is closed, the ground circuit is automatically opened.

Contributed by Oliver Kirchner.

ELIMINATING VIBRATION FROM THE TRANSMITTER

While installing a local transmitter, considerable annoyance was experienced from the vibrating of the transmitting panel when the motor-generator unit was set in operation. After numerous experiments with several types of cushioning, including felt, hair, soft rubber, rubber sponges, and so

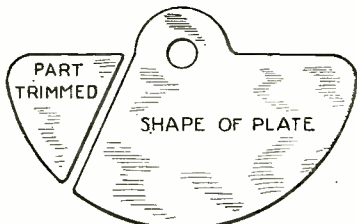
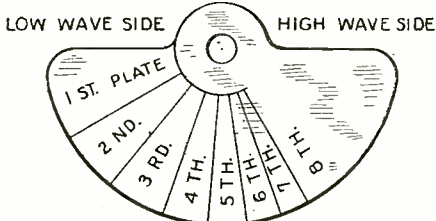

FIG. 1



ROTOR PLATES ASSEMBLY

FIG. 2

By trimming off a portion of the movable plates, a circular plate condenser may be converted into a straight-line wave-length type.

a small pair of shears, a file and emery paper to finish off, pieces were trimmed in sizes as follows:

- 1st plate was left full size.
- 2nd plate sector removed equal to 15 dial divisions.
- 3rd plate sector removed equal to 27 dial divisions.
- 4th plate sector removed equal to 37 dial divisions.
- 5th plate sector removed equal to 45 dial divisions.
- 6th plate sector removed equal to 52 dial divisions.
- 7th plate sector removed equal to 58 dial divisions.
- 8th plate sector removed equal to 63 dial divisions.

It might be said here that more time and closer calculations might produce a truer curve, but the idea is the same and can be worked out for any size condenser for any curve.

The rotor is then assembled and the unit replaced. The edges of the high-wave side will be even, while on the low side the edges

forth, the novel system sketched here was tried and proved to be all that could be desired. It did completely eliminate all traces of vibration from the transmitter and was less expensive than any other style used. Small motor-generator units can be cushioned in the same way, employing more balls, of course, because of the added weight.

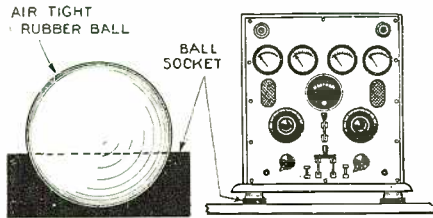

The lowly rubber ball can be used efficiently for removing vibration from a set, as shown above.

The turned wood sockets for the balls are much cheaper than the cast-lead or glass caster-holder type, but, for best results, one of the latter types is advised, inasmuch as they hold their form better and have no tendency to split (which is not the case with the wood sockets unless a very hard wood is used in construction). However, for the average amateur, either type will be found very serviceable. The rubber balls may be secured in any novelty store at from five to ten cents apiece, but inspect each closely for any signs of puncture or rotting cracks.

When this system is assembled and in place it will be found to be all that could be desired to eliminate vibration.

Contributed by Louis A. Cummings.

A RADIO FREQUENCY TRANSFORMER

For those fans who want to experiment with a combination of tuned and untuned radio frequency amplification, with a view to a reduction of the number of controls on their receivers, here is an untuned radio frequency transformer that can be made easily, quickly and cheaply, and mounted anywhere in a jiffy.

The only materials required are a tallow candle—regardless of previous condition of servitude—and a spool of enameled copper wire, any size from No. 24 to 30.

Cut off a piece of the candle, preferably a large-sized candle, to about three inches in length. Now cut two adjacent slots, as shown in the illustration, all the way around the candle, to a depth of about half an inch, being careful not to cut the candle in two, nor to break down the quarter-inch partition between the slots.

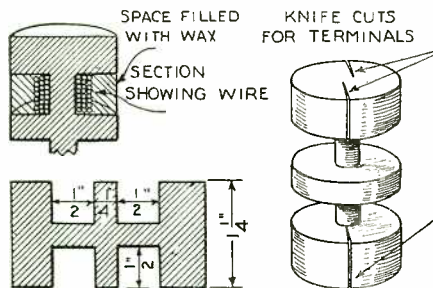

By placing the turns of a transformer on a candle cut as shown above, a simple and inexpensive coupling device will be constructed.

Now wind from 150 to 175 turns of wire in each slot, bringing out the terminals through small knife cuts at either end of the piece of candle. After winding, light the piece of candle that was left over and drop the hot paraffin over the knife cuts and over the windings, to serve as a binder.

Some experimenting may be required to determine whether or not the leads to one side of the transformer should be reversed,

but this is easily effected. To mount this transformer, hold a match under one end of it until it begins to melt and then stick it onto any part of the baseboard that is convenient.

Contributed by Frank Savage.

METHOD FOR SUPPORTING ROTORS

Any experimenter who makes his own variocouplers or variometers knows that it is a difficult job to make a rotor that is firm and will not slip. As these parts of the instruments are most essential, the following idea is recommended for making a rotor as strong as necessary.

All rotors have two windings that are divided in the middle for anchoring the shaft, except the 180-degree type of couplers. For the average rotor, make one hole between the windings in the center and another in line with it about 1/4-inch away. These holes should be of a size to accommodate the average bus bar. Then bend a piece of bus bar in a U shape, the distance between the two holes in the rotor being equal to the bottom part of the U. Solder one end of the bus bar to the middle of the other side, after passing the wire through the holes, and solder the other end to the shaft to which is attached the dial for rotating the rotor.

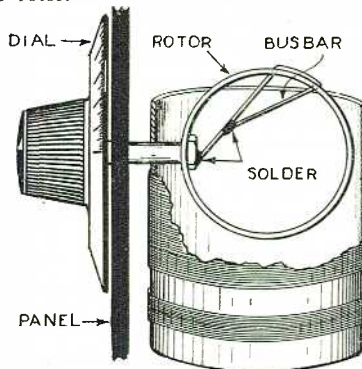

Another easy method of mounting the rotor of a coupler. This scheme employs only bus bar and a shaft.

This method gives a firm connection and makes it impossible for the rotor to slip when the dial is turned. With other types of couplers the bus bar can be connected outside the windings in the usual manner.

Contributed by Dr. C. R. Doyne.

HOME-MADE R. F. TRANSFORMER

Radio frequency transformers can be easily wound on certain forms, but the main trouble is that few experimenters are lucky enough to possess a lathe for turning the forms. A substitute for the usual form may be devised from a porcelain insulator of the type shown in the sketch. There should be five ridges around the circumference and a hole through the center for mounting purposes; this type of insulator may be purchased in almost any electrical shop. Be sure that the diameters of the different sections are approximately the same.

The primary winding, consisting of 80 turns of No. 40 S.C.C. wire, is wound in the second and fourth sections as shown, i. e., there are 40 turns of wire in each section. The secondary winding consists of 169 turns of the same size wire wound on the other three sections, with 56 turns in the first and last sections and 57 in the center one. The inside ends of the primary winding are connected and the inside ends of the two outside coils are attached to the ends of the coil wound in the middle section. The transformer may be mounted as shown in the sketch and the four leads may be brought out to the top of the small panel binding posts.

This type of transformer will be found

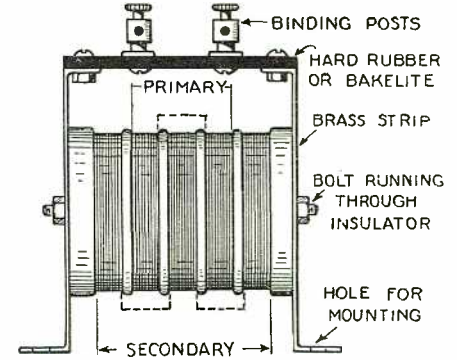
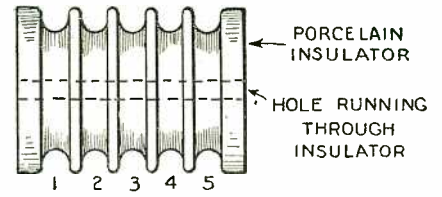

A porcelain insulator makes an excellent form on which to build a transformer, the grooves making natural slots for the wire.

to operate in a very satisfactory manner and the cost of it is much less than any other which may be obtained on the market today.

Contributed by Edward Gerour.

FASTENING A PRIMARY COIL

The fan who builds his own is often confronted with the problem of winding a small, untuned primary coil over the secondary coil and fastening the ends so that they will be permanently fixed. Cut from heavy paper a strip like that shown in the sketch. Make it as wide as the primary coil will be and leave several half-inch strips attached to one side. This is fastened to the secondary coil with collodion, the tabs extending to one side. Wind on two turns of wire before starting to wind the coil, these being the leads. After winding the first turn, bend the strips back over it and then wind on the rest of the coil over the strips, which should be previously coated with collodion. After finishing the coil, wind on two more turns for leads. Bend the tabs back

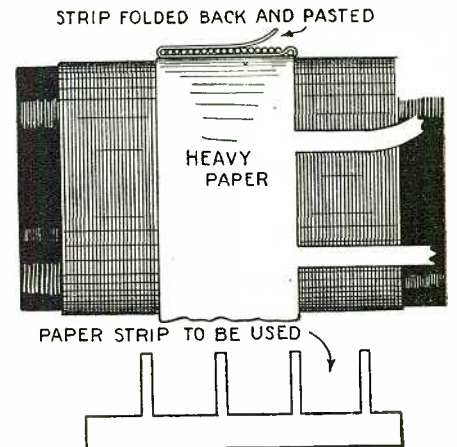

One of the best methods yet devised for fastening a primary coil that is wound over a secondary.

over the coil and fasten them down as shown in the sketch. In a few minutes the wires can be clipped loose at the ends and the coil will be complete, with long leads.

Contributed by Clyde D. Williams.

AN EXTERNAL VOLUME CONTROL

Many of the sets purchased to-day have the internal wiring sealed so that there can be no changes made in the circuit and, sometimes, there is poor provision made for

(Continued on page 504)

- Radiotics -

QUITE A FEET



The radio section of the *New York Evening Journal* on July 23 advises the unsuspecting radio fan that there is a new horn on the market which will produce the soft TOES which come from an expensive wooden horn. Some horn? Is it a Houdial or a chirpodist? Contributed by H. E. Fields.

A HELUVA SET!

The *Santa Barbara Daily News*, Santa Barbara, Cal., on May 2, shows a hook-up of "a SUPER-HOT receiver." Ah, this must be the set which the Master of Ceremonies in Hades uses for the special delectation of the onetime owners and operators of "sneal-back" circuits. We hope so, anyway!



Contributed by W. E. Cary.

HOW DO THEY GET THAT WAY?

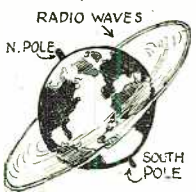

The *Portland Telegram*, Portland, Ore., announces a new radio set which has "a sending range of FIFTEEN THOUSAND miles." When those navy waves get around to the antipodes and meet themselves coming the other way with 2500 miles apiece to spare, take it from us, there sure will be war!

Contributed by Ellsworth Price.

UNREASONABLE

A subscriber writes to the March 7 issue of *Radio Dings* of Los Angeles, Calif., to ask advice on improving his "four-tube radio FREQUENTLY DOESN'T WORK" receiver. Some people are never satisfied! After all, "frequently" reception is a pretty good average, and you can't expect a radio set to often —er, frequently—rise above its average and never fall below it.



Contributed by Salina M. Weller.

THE WOMAN'S INFLUENCE AGAIN



The July *Radio World* makes mention, in course of one of its articles, of "three-dial PAINTERS." This is a new one on us, but we suppose that the wimmin have been up to their tricks again, having the radio sets prettied up. Yes, brother, it's an awful life for the radio fan.

Contributed by Raymond Madill.

YOUR NOSE KNOWS

An advertisement from the *Boston American*, Boston, Mass., of Jan. 19 announces "ONION plate condensers." Now why hasn't somebody thought of this before? Just the thing to make those weak signals stronger. But we can't help wondering whether the e waves will suffer much from "skin effect" in getting through these condensers.



Contributed by Thomas Gilmore.

FOR "BOOTLEG" TUBES?



Among the opportunity ad-lets in the May, 1925, issue of *Radio News* appears this gem: "LIGHTNING STRANGE BATTERY COMPOUND. Charges and discharges battery instantly. Eliminates old method entirely. Gallon Free to Agents." What's this? A new kind of Jersey "lightning"? Most of it sure is a "strange compound." And a "gallon free!"—we wouldn't mind being an agent. But maybe it's only for use with "bootleg" tubes.

Contributed by John F. Inderdohren.

HORSE-PLAY!



In an article on "B" batteries in the *Calgary Daily Herald* of Alberta, Canada, on Feb. 21, the radio fan is advised that "twelve COLTS is a good voltage for the plate of the first detector." A charge of twelve colts certainly ought to put a "kick" into any set but would there, we wonder, be any "horse" notes heard in the loud speaker?

Contributed by J. L. Donaldson.

"LONESOME" PLEASE NOTICE

In the January, 1925, issue of *Radio News* appeared the following advertisement: "You can dance any night WITH A SUPER-HILCODYNE RECEIVER." Just the thing for the lonely and bashful radio fan. We'll bet she's a good dancer—probably a "two-step" amplifier.



Contributed by William Franciszy.

MUST BE AUTO-SUGGESTION



An advertisement in the April *Radio News* announces a radio set that is "AUTO-BALANCED" and has "SELF-STARTING coils." Here is the perfect set for the motor camper. All you need is four wheels and you can "reach the Coast" in your own car!

Contributed by F. A. Pledger.

Cash for Radiotics

If you happen to see any humorous misprints in the press, we shall be glad to have you clip them out and send to us. No RADIOTIC will be accepted unless the printed original giving the name of the newspaper or magazine is submitted. We will pay \$1.00 for each RADIOTIC accepted and printed here. A few humorous lines from each correspondent should accompany each RADIOTIC. The most humorous ones will be printed. Address all RADIOTICS to

Editor RADIOTIC DEPARTMENT, c/o Radio News.

MUST BE RHEO-STATIC



In the *Philadelphia* (Pa.) *Inquirer* of March 15 is the following curious instruction in regard to building a radio set: "Mount your instruments on your panel and WIFE up the rheostat." Now, this might, or might not be good practice. Anyhow, if we hear any unseemly noise in the set, we shall know the wife is throwing currents at her husband, who is putting up considerable resistance.

Contributed by J. F. Cullen.

FOR CLEANER RADIO

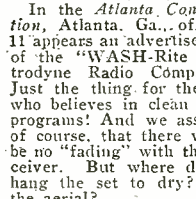

In the *Atlanta Constitution*, Atlanta, Ga., of Jan. 11 appears an advertisement of the "WASH-Rite Neutrodyne Radio Company." Just the thing for the fan who believes in clean radio programs! And we assume, of course, that there would be no "fading" with this receiver. But where do we hang the set to dry? On the aerial?

Contributed by Joseph F. Greatheart.

FOOD FOR THOUGHT



The *Aroostook Pioneer*, Houlton, Me., of Jan. 10, informs a hungry world that "to get FOODS RESULT out of a loop antenna, a set should be used that is designed especially for the purpose." This set would undoubtedly be a boon to the tired housewife and probably comes with various capacities for large, medium and small families.

Where can we buy one?

Contributed by Gerow.

WHY THE OCEAN'S NEAR THE SHORE



In the July issue of *QST* is an advertisement of a 5-watt transmitting tube "guaranteed at least 750 volts adaptable for SHORE wave." We have heard of "damped waves" but a "shore wave" is a little too deep for us. But surely it should "reach the Coast."

Contributed by Ralph F. Hunter.

A HOT ONE!

The following valuable suggestion appears in the *Pittsburgh* (Pittsburgh, Pa.) *Press* for May 17: "If you have troublesome oscillations in your radio frequency set, try varying the angle of the COALS." We are thinking of building one of these "sure-fire" sets with first quality hard coal, when the cold weather comes, and wonder whether we should use hard tubes, too.

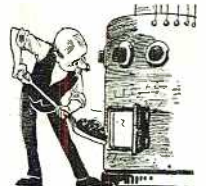

Contributed by W. K. Klingensmith.

NOW WE KNOW

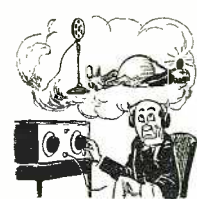

In the April 4 issue of the *Sun Radio Section*, New York, N. Y., appeared the following sentence: "Dr. Rogers attributed the dead SPORTS often noticed in radio broadcasting to certain geological formations of the earth." We have often thought that some of the sports who broadcast sounded as if they were dead—at least from the neck up—but suppose they were merely under the influence of the ether, and not stone dead, geologically speaking.

Contributed by H. C. Barter.

FOR INSPIRATION

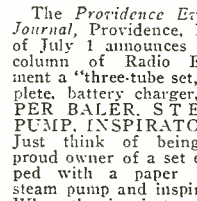

The *Providence Evening Journal*, Providence, R. I., of July 1 announces in its column of Radio Equipment a "three-tube set, complete, battery charger, PAPER BALER, STEAM PUMP, INSPIRATOR." Just think of being the proud owner of a set equipped with a paper baler, steam pump and inspirator! Why, the inspirator alone should be worth the price of admission!

Contributed by A. R. Poirier.

THE "GOLD DRAIN"

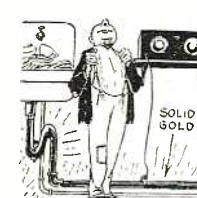

On July 25 that bloated plutocrat (it must be!) *Everybody's Radio Weekly*, casually informs the radio reader that "GOLD water pipes make the best ground." The Golden Age of radio has arrived! But alas! As ever, only the plumbers, bootleggers and other millionaires will be able to enjoy it. Gosh, ain't life hard!

Contributed by S. J. Smith.

IN NEW ZEALAND, BUT NOT HERE

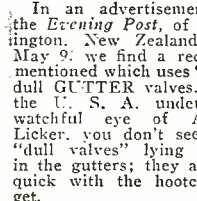

In an advertisement in the *Evening Post*, of Wellington, New Zealand, for May 9, we find a receiver mentioned which uses "dull GUTTER valves." In the U. S. A. under the watchful eye of Aunty Licker, you don't see any "dull valves" lying about in the gutters; they all die quick with the hootch we get.

Contributed by A. M. Sales.

WHAT A COIL! WHAT A COIL!



The *Buffalo* (N. Y.) *Evening News*, of June 6, printed the following information in their Question and Answer Dept.: "I have increased the size of the coils so that they now reach KYW." As the gentleman who wrote this lives in North Tonawanda, N. Y., we consider those coils about the world's biggest effort.

Contributed by L. Campbell.

STANDARD HOOK-UPS

EVERY month we present here standard hook-ups which the Editors have tried out and which are known to give excellent results. This leaf has performance marks on the left-hand margin and can be cut from the magazine and kept for further reference. These sheets can also be procured from us at the cost of 5c per sheet to pay for mailing charges. RADIO NEWS has also prepared a handsome heavy cardboard binder into which these sheets may be fastened. This binder will be sent to any address, prepaid on receipt of 20c. In time there will be enough sheets to make a good-sized volume containing all important hook-ups. Every year an alphabetical index will be published enumerating and classifying the various hook-ups.

Handy Reference Data for the Experimenter

CIRCUITGRAMS BROADCAST FROM STATION WRNY

OUR readers are familiar with the circuitgrams, the first blanks of which were published in the July issue of this magazine. Since that issue appeared, Mr. H. Gernsback, Editor of Radio News, has broadcast through WRNY five different circuitgrams, which are given below. These were broadcast not only from WRNY, but also from Station WMAQ, of Chicago, in conjunction with the Daily News of that city.

In this way a large part of the country was listening in to the various circuitgrams. Thousands of letters, have been received by the two stations, indicating that the radio fans are well pleased with this novelty, the advent of which, in June, 1925, made possible, for the first time, broadcasting of any hook-up. The system is copyrighted and patents are pending on the circuitgram idea.

It is of interest to note that each of the five diagrams shown in this department were broadcast in a very few minutes—not only the circuitgram itself, but also the necessary information which appears in these pages.

It should be understood that if any new and important hook-up makes its appearance, it will be broadcast immediately from Station WRNY, and possibly from other stations as well.

We have prepared a handsome tablet containing a goodly quality of blank circuitgrams, which can be used by anyone for making his own hook-ups. These blanks will be found to be a valuable aid to keeping a neat and efficient record. It is also possible by this means to save considerable time, as all the radio symbols are contained in the circuitgram blanks, so that to complete the circuit it is necessary only to draw the lines connecting the proper numbers.

This tablet will be sent to anyone on receipt of 25 cents. Address Radio News, 53 Park Place, New York City.

INTERFLEX CIRCUIT

Circuit No. 119. One of the most interesting circuits that has been presented to radio fans recently is the one shown in Fig. 119. Although there is but one tube employed, the results that may be obtained with this circuit are of the best.

A radical departure from practice was made when the crystal detector was placed in the grid connection of the vacuum tube. Just how this arrangement acts cannot be told, but a careful examination of this circuit will show that it is like no other hitherto published.

The inductance coil (7-8) in the antenna circuit is made by winding about 55 turns of ordinary bell wire on a 3-inch bakelite or hard rubber tube. The variable condenser in the antenna circuit should have a capacity of .0005 mf. (23 plates) and should, for best operation, be a

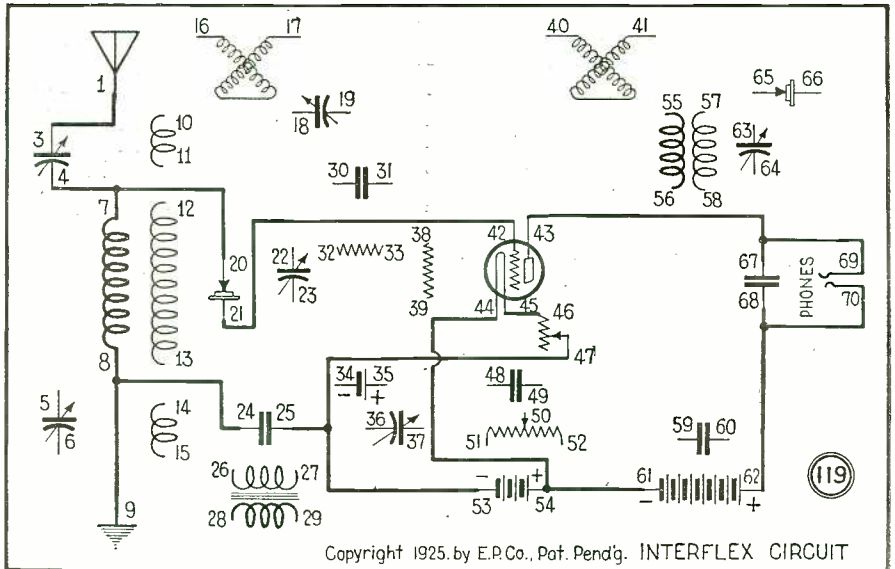

Copyright 1925, by E.P.Co., Pat. Pend'g. INTERFLEX CIRCUIT

A new adaptation of a circuit that gives exceptional results in the way of clarity and volume. It was developed by Mr. Hugo Gernsback.

straight-line frequency type. With the use of such a condenser there will be no crowding of the wave-lengths at the lower end of the dial. The plate voltage of the tube should be between 60 and 90 volts for best results. The fixed condenser (24-25) has a capacity of .25 mf. and is essential for any DX work. The crystal detector (20-21) may be any good crystal, but a carborundum one of the fixed type was found to give very fine results. If the circuit does not function properly, try reversing the leads of the detector.

The volume that this circuit will deliver will be astonishing; local stations have been received on a loud speaker and DX stations give excellent phone reception.

ULTRA-AUDION REINARTZ CIRCUIT

Circuit No. 120. The circuit shown in the

accompanying diagram, while it is not exactly new, has some excellent features that are not generally known. It is a combination of two circuits that are familiar to most radio experimenters and should prove of interest to them.

The inductance (12-13) is 50 turns of bell wire wound on a tube that is 3 inches in diameter. On the same tube and at a distance equivalent to the width of one wire, wind on 16 turns of the same wire in the same direction for the inductance (14-15). The two variable condensers (16-17 and 30-31) have a capacity of .0005 mf. The fixed condenser (47-48) has a value of .006 mf. and that indicated at 127-128 has a capacity of .05 mf. The variable resistance at 71-72 has a range from 10,000 to 100,000 ohms and it might be mentioned here that both the valuable resistances in the grid circuits control the output volume. The variable condenser that is shunted across the large inductances (12-13) is the wave-length control.

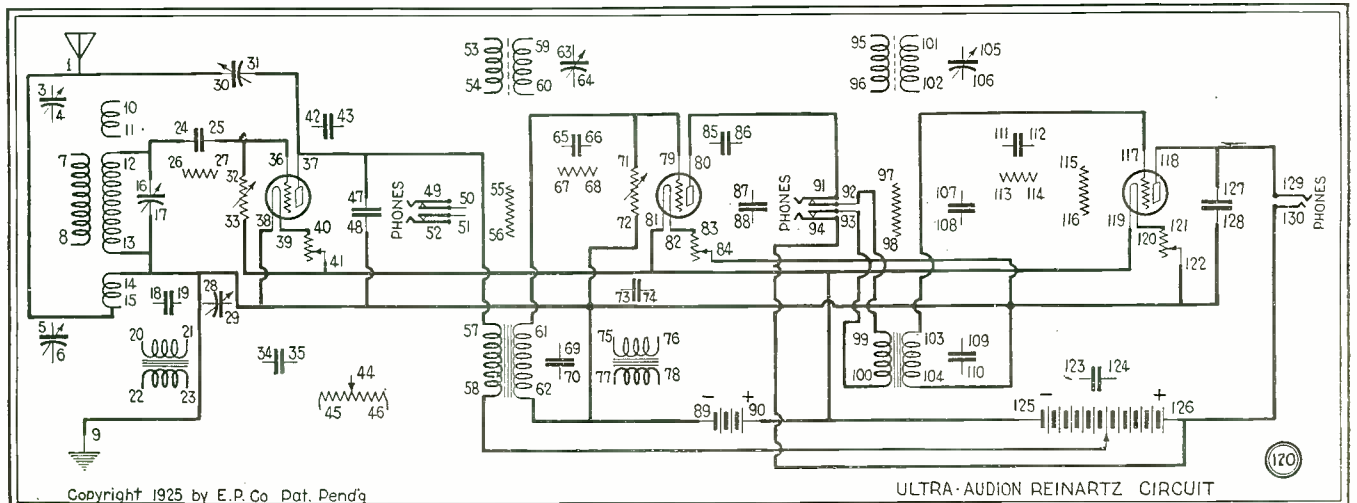

Copyright 1925 by E.P.Co. Pat. Pend'g

ULTRA-AUDION REINARTZ CIRCUIT

This combination of two well-known circuits, the Ultra-Audion and the Reinartz, should give the experimenter exceptional reception.

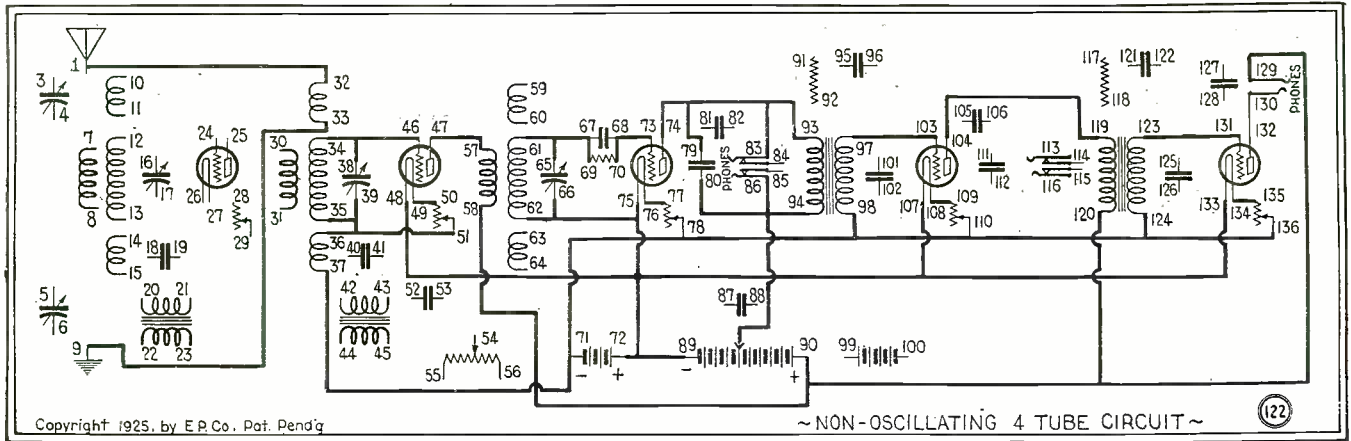

Copyright 1925, by E.P. Co. Pat. Pendg

~NON-OSCILLATING 4 TUBE CIRCUIT~

(122)

Above is shown a four-tube circuit that will not be a source of annoyance to the neighborhood, as it was primarily designed to be non-oscillating.

REGENERATIVE REFLEX CIRCUIT

Circuit No. 121. There are few experimenters who have not at some time or other contracted the reflex craze and then discarded it to follow some other wiring diagram. However, there are some reflex circuits which have a combination of principles that is very interesting. The circuit shown in Fig. 121 is one of these.

The inductance in the antenna circuit is the primary winding and consists of 10 turns of No. 18 D.C.C. wire wound over the secondary winding (12-13) which is 50 turns of the same size wire wound on a 3-inch tube. The inductances 53-54 and 61-62 are the same as coils 7-8

mf. and the grid condenser has a capacity of .00025 mf.

In operating this circuit it will be found that the rotor coil (59-60) can be set in such position that it will need no further adjustment, the regeneration being controlled entirely by the potentiometer (42-43-44). There should be a filament switch placed in the lead between 65, the negative "A" battery terminal, and 44 and 39, so that there will be no drain on the battery.

NON-OSCILLATING 4-TUBE CIRCUIT

Circuit No. 122. One of the greatest disadvantages of a regenerative receiving circuit is that

denser (67-68) has the usual value of .00025 mf. The grid leak (69-70) may be variable or may be a fixed resistance of 2 megohms. The "B" battery should have at least 67.5 volts for the amplifier tubes, and should have a tap at 22½ volts for the detector tube plate voltage.

For the grid coil (34-35), wind on a 3-inch tube about 70 turns of No. 20 D.C.C. wire. By changing the number of turns in this coil, the wave-length may be varied. Over the middle of the grid coil wind 12 turns of the same size wire, which is the coil (32-33). The rotor coil (36-37) is made by winding about 6 turns of No. 18 bell wire on a 2½-inch tube or rotor form. This is arranged to rotate at the end of the grid coil. The second tuning unit requires another 3-inch tube. The grid coil (61-62) consists of about 70 turns of No. 20 D.C.C. wire, and over the center of the coil is wound the inductance (57-58), which has 6 turns of the same size wire. As was noted in connection with the first coil (34-35), changing the number of turns in the coil (61-62) will vary the wave-length obtainable.

TROPADYNE SUPER-HETERO-DYNE CIRCUIT

Circuit No. 123. The principle underlying the operation of the Tropadyne receiver is not given here, as it appeared several times previously in these pages. The fixed condenser (3-4) has a value of .0005 mf. and the variable condensers (7-8 and 34-35) have a capacity of .0005 mf. The inductance (12-13) is the stator winding of a standard variocoupler and consists of 49 turns of No. 22 S.C.C. wire, wound on a 3-inch tube. This coil is tapped at the middle, or the 25th turn. Coil (10-11) is the rotor and consists of 24 turns of No. 28 S.C.C. wire that is wound on a 3-inch tube or rotor form. The potentiometer (67-68) has a resistance of 400 ohms. The three transformers shown with dotted lines for cores are Tropatransformers, or intermediate frequency transformers. It is not necessary to use this type of transformer in these stages, but if others are used the circuit will have to undergo some modification before it will function properly. The fixed condenser (122-123) has a capacity of .005 mf.

On account of its great amplifying properties, this receiver will operate in a satisfactory manner with only a loop antenna, which should be connected at the terminals (5-6). Any good loop will suffice.

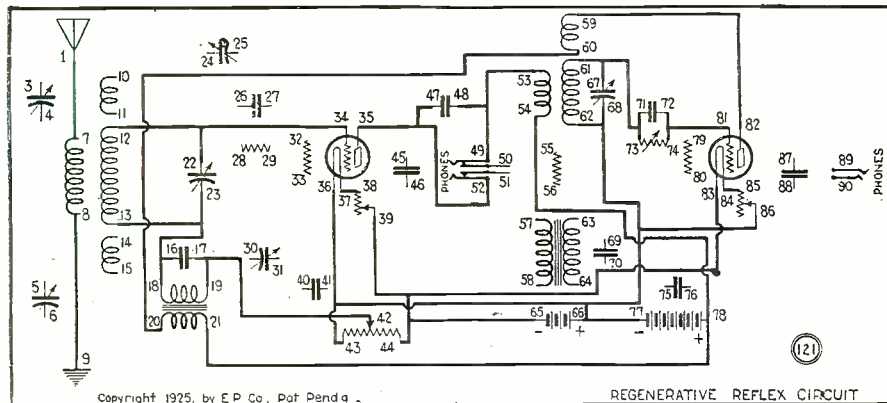

Copyright 1925, by E.P. Co. Pat. Pendg

REGENERATIVE REFLEX CIRCUIT

(121)

An interesting combination of two types of circuits, the regenerative and the reflex.

and 12-13, respectively. However, in this second pair there is the rotor (59-60), which consists of 18 turns of No. 24 D.C.C. wire wound on a tube that is small enough to revolve easily inside the 3-inch tubing supporting the other two inductances. The variable condensers (22-23 and 67-68) have a capacity of .0005 mf. The grid leak has a value that may be varied from .25 to about 3 megohms. The fixed by-pass condensers 16-17 and 47-48, have a value of .001

it tends to radiate, unless properly handled. Fans who own such sets should adjust the circuit so that it will not oscillate and spoil their neighbors' pleasure. The circuit shown in Fig. 122 is recommended for the fan who has consideration for those in the vicinity; it is non-oscillating.

The variable condensers (38-39 and 65-66) may have a value of .00025 mf. and the fixed condenser (79-80) is .001 mf. The grid con-

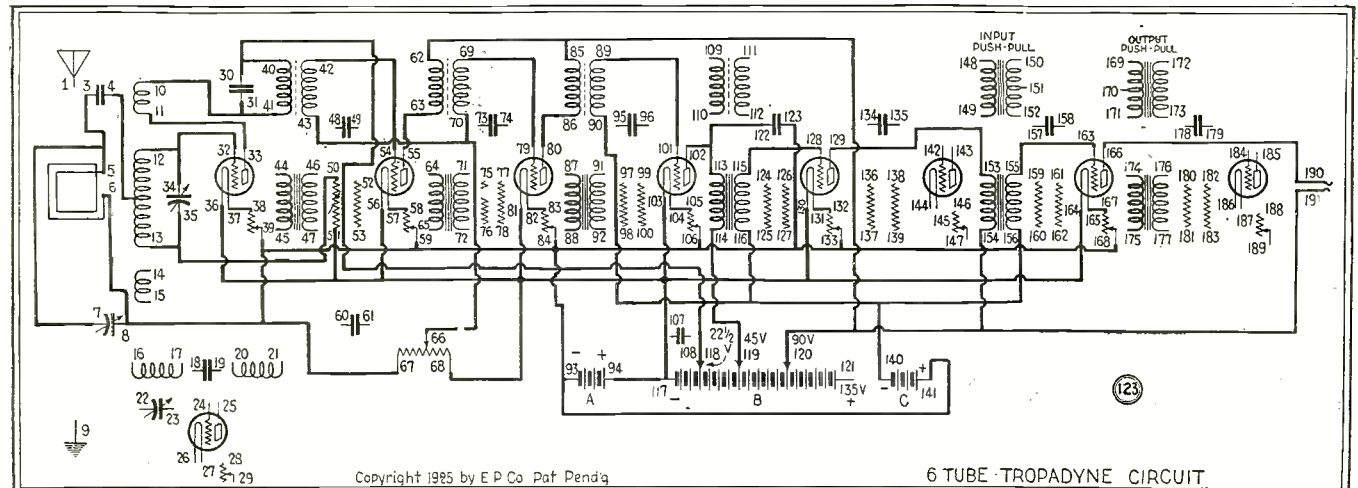

Copyright 1925 by E.P. Co. Pat. Pendg

6 TUBE TROPADYNE CIRCUIT

(123)

The six-tube super-heterodyne circuit shown above, when properly constructed, should give results equivalent to a circuit employing more tubes.



By JOHN B. BRADY*

(1,541,845, M. I. Pupin. Filed December 11, 1915; issued June 16, 1925. Assigned to Westinghouse Electric & Mfg. Co.)
Electrical wave receiving system in which the antenna circuit is connected with the receiving

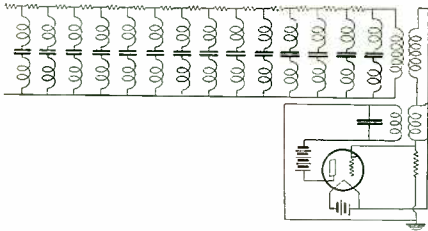

circuit through a recurrent network of similar sections. The network contains damping resistances in each section. The object of the invention is to exclude from the receiving circuit all waves which are not intended to be received.

(1,538,570, L. Cohen and J. O. Mauborgne. Filed June 16, 1920; issued May 19, 1925.)
Electrical signaling system for receiving radio signals where an antenna is connected to one end

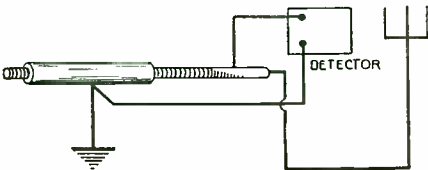

of a resonance wave-coil with an adjustable grounded metal tube operatively associated with the wave-coil. A secondary take-off circuit is coupled with the wave-coil for operation of receiving apparatus.

(1,537,609, J. V. L. Hogan. Filed May 19, 1922; issued May 12, 1925. Assigned to Westinghouse Electric & Mfg. Co.)
Arc transmission system, wherein the purpose is to increase the radiation of the system. A non-sinusoidal generator is employed and the frequency

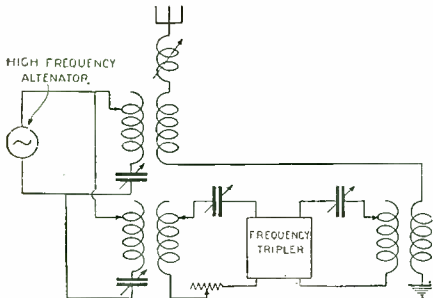

of the main wave multiplied and the multiplied frequency fed in phase with a harmonic of the output of the generator to the antenna circuit. In this way the full power of the several frequencies is radiated.

(1,543,325, F. Dietrich. Filed December 8, 1923; issued June 23, 1925. Assigned to C. Brandes, Inc.)

Head-band for telephone head-sets wherein seamless fabric webbing is provided over the wire members which form the head-band. The



seamless fabric webbing is readily manufactured and serves for a comfortable construction of head-band, at the same time considerably reducing manufacturing costs.

(1,544,136, F. Dietrich. Filed November 5, 1923; issued June 30, 1925. Assigned to C. Brandes, Inc.)

Electrical connection for telephone head-sets where a flexible metallic shield surrounds the telephone conductors with connections between telephone conductors and the magnet bobbins within the receiver. The flexible shield terminates in a stay cord which is utilized to remove the strain

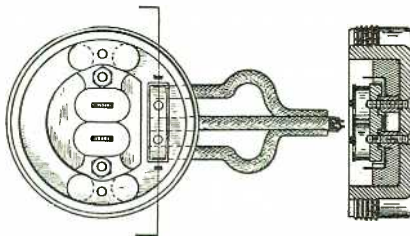

from the telephone conductors which lead into the telephone receiver casing.

(1,543,475, W. S. Lemmon. Filed January 14, 1920; issued June 23, 1925.)

Resonant converter for producing oscillations for use in radio signaling systems where a direct current source is provided and inductance and capacity elements connected across the terminals of said source with an interrupter in parallel therewith. An oscillatory circuit tuned to the frequency of the alternating current to be produced is connected in series between the source and the inductance and capacity elements and arranged to co-operate with the interrupter for producing oscil-

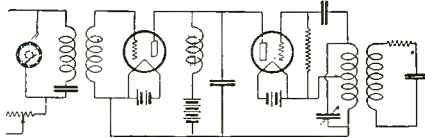

lations which may be impressed upon the signaling circuit.

(1,538,466, Louis Cohen and J. O. Mauborgne. Filed October 25, 1920; issued May 19, 1925.)
Electrical signaling for the reception of signals without interference arising from static. The re-

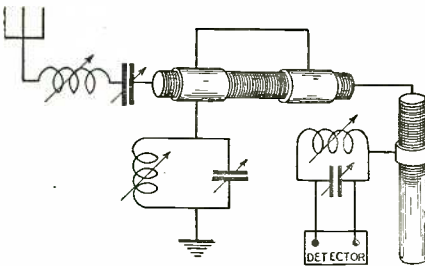

ceived energy is caused to act upon an ungrounded antenna system and pass through a wave-coil for producing a wave development on the wave-coil. The wave-coil is operatively associated with adjustable metal tubes which are changed in position along the wave-coil for the best signal reception.

(1,538,975, F. K. Vreeland. Filed August 6, 1919; issued May 19, 1925.)

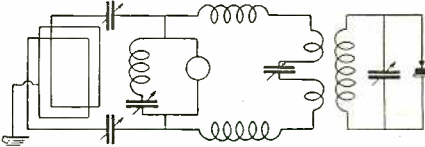

Stray elimination in radio receivers, in which a baffle circuit tuned to the signal frequency is provided with a by-pass circuit including a reactance and an intensity selector co-operating to divert preferentially stray energy from the receiving system. The receiving apparatus is connected with the baffle circuit.

(Patent No. 1,530,169, W. F. Grimes. Filed June 7, 1923; issued March 10, 1925.)

Radio signaling system in which the signaling frequency of a transmitting station may be maintained constant. The antenna circuit of the transmitter is coupled with a pair of balanced circuits which at normal frequency remain in balanced condition. In the event that the frequency of the transmitter shifts, the control circuits become

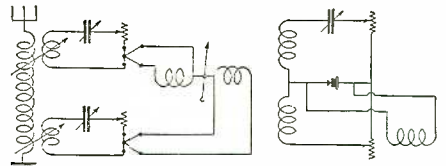

operative to adjust the antenna circuit to the normal frequency.

(1,538,472, P. Crosley, Jr. Filed May 23, 1921; issued May 19, 1925.)

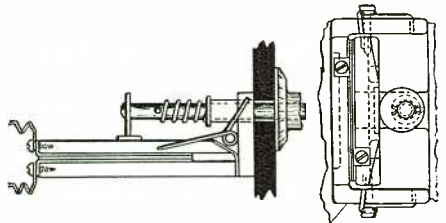

Condenser of the book type in which one plate is hinged mounted with respect to another plate by means of a cam actuated by a shaft member extending through an instrument panel.

(Patent No. 1,530,129, E. H. Loftin and H. H. Lyon. Filed April 5, 1920; issued March 17, 1925.)

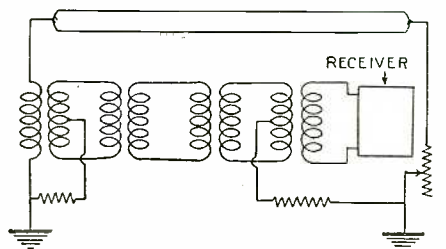

Radio signaling system utilizing low extended antennae. The optimum length of the low horizontal antennae is described as being of the order of one-tenth the wave-length of an operating signal and adjusted in resonance with the signaling wave. The invention is described with reference to underground and underwater antenna systems.

(Patent No. 1,534,720, E. W. Kellogg and C. W. Rice. Filed May 18, 1921; issued April 21, 1925. Assigned to General Electric Company, New York.)

Radio receiving system employing a uni-directional horizontal receiving antenna for the reception of desired signals free of interference from disturbing waves coming from another direction. A long, horizontal, receiving antenna is provided with a transmission line running parallel with the antenna for conveying signaling currents from a selected point in the antenna to a distant receiving station.

*Patent Attorney, Ouray Building, Washington, D. C.



**APPROVED
RADIO NEWS
LABORATORIES
1922**

RADIO NEWS LABORATORIES



RADIO manufacturers are invited to send to RADIO NEWS LABORATORIES, samples of their products for test. It does not matter whether or not they advertise in RADIO NEWS, the RADIO NEWS LABORATORIES being an independent organization, with the improvement of radio apparatus as its aim. If, after being tested, the instruments submitted prove to be built according to modern radio engineering practice, they will each be awarded a certificate of merit, and a "write-up" such as those given below will appear in this department of RADIO NEWS. If the apparatus does not pass the Laboratory tests, it will be returned to the manufacturers with suggestions for improvements. No "write-ups" sent by manufacturers are published on these pages, and only apparatus which has been tested by the Laboratories and found to be of good mechanical and electrical construction is described. Inasmuch as the service of the RADIO NEWS LABORATORIES is free to all manufacturers whether they are advertisers or not, it is necessary that all goods to be tested be forwarded prepaid, otherwise they cannot be accepted by the Laboratories. Apparatus ready for the market or already on the market will be tested for manufacturers, as heretofore, free of charge. Apparatus in process of development will be tested at a charge of \$2.00 per hour required to do the work. The Laboratories will be glad to furnish readers with technical information available on all material listed here on receipt of a stamped envelope. The Laboratories can furnish resistances of the various instruments, amplification curves of transformers, losses in condensers, etc., and other technical information. Address all communications and all parcels to RADIO NEWS LABORATORIES, 53 Park Place, New York City.

LOUD SPEAKER

This loud speaker, submitted to the RADIO NEWS LABORATORIES by the Peter Grassman Co., 366 Madison



son Avenue, New York City, gives very fine reproduction with regard to both quality and volume. It is well made and presents an attractive appearance.

AWARDED THE RADIO NEWS LABORATORIES CERTIFICATE OF MERIT NO. 853.

HARCO SHELLAC

This shellac, submitted by the Harco Laboratories, 312 Quincy Ave.,



Long Beach, Calif., comes in handy in many cases of construction of radio receivers.

AWARDED THE RADIO NEWS LABORATORIES CERTIFICATE OF MERIT NO. 851.

BRANSTON VERNIER DIAL

The vernier dial, shown in the illustration, was submitted by Chas. A. Branston, Inc., 815 Main St., Buffalo, N. Y. This dial is well made and can be used satisfactorily



in all cases where a vernier dial is required.

AWARDED THE RADIO NEWS LABORATORIES CERTIFICATE OF MERIT NO. 868.

C-B CRYSTAL SET

This crystal set, submitted to the RADIO NEWS LABORATORIES for test by the Crain Brothers, 2304 Tele-

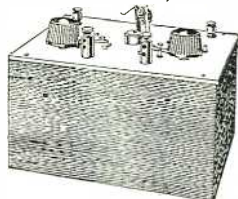

graph Avenue, Oakland, Calif., is shown in the illustration. This set operates satisfactorily on local stations and for short distance work.

AWARDED THE RADIO NEWS LABORATORIES CERTIFICATE OF MERIT NO. 865.

ROVIM PHONE POST

This phone post was submitted by the Rovim Mfg. Co., 318 Friendship St., Providence, R. I. It is de-

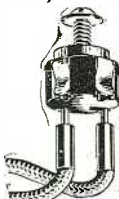

signed to accommodate the tips usually found on the end of receiver cords. It presents a good appearance on the panel, and is very certain as regards electrical contact. The phone posts are easily mounted.

AWARDED THE RADIO NEWS LABORATORIES CERTIFICATE OF MERIT NO. 900.

ERLA RHEOSTAT

The precision rheostat, submitted by the Electrical Research Laboratories, Inc., 2500 Cottage Grove Avenue, Chicago, Ill., has a re-



sistance of 25 ohms. It is well made and will do reliable work in radio receivers.

AWARDED THE RADIO NEWS LABORATORIES CERTIFICATE OF MERIT NO. 842.

KANT-BLO SIGNAL

The illustration shown below is of the Kant-Blo Signal which is de-



signed to give the operator warning whenever excessive drain of current occurs from the "B" battery. When

excessive current flows from the battery, the bulb lights up, indicating that something is wrong in the set. It is made for panel mounting and presents an attractive appearance. Manufactured by the Gano-Kramer Co., Inc., 238 West 53rd St., New York City.



AWARDED THE RADIO NEWS LABORATORIES CERTIFICATE OF MERIT NO. 866.

ERLA VARIABLE CONDENSER

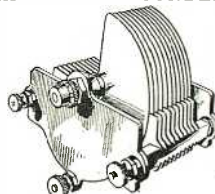

The variable condenser shown in the illustration, submitted for test to the RADIO NEWS LABORATORIES by the Electrical Research Laboratories, Inc., 2500 Cottage Grove Avenue, Chicago, Ill., has 11 plates. It is very ruggedly made and will give satisfactory operation in radio sets.

AWARDED THE RADIO NEWS LABORATORIES CERTIFICATE OF MERIT NO. 844.

WINDHAM WIRE-FORMER



The Windham Wire-Former, furnished by the Goyer Company, Wilimantic, Conn., to the RADIO NEWS LABORATORIES, is shown in the illustration. This wire-former can be used satisfactorily in the construction of radio sets, provision being made for forming loops in the wire, for cutting and for stripping insulation.

AWARDED THE RADIO NEWS LABORATORIES CERTIFICATE OF MERIT NO. 859.

BELDENAMEL AERIAL WIRE



The Stranded Enameled Aerial Wire, submitted to the RADIO NEWS LABORATORIES for test by the Belden Mfg. Co., 2300 S. Western Ave., Chicago, Ill., is shown in the illustration. It consists of seven strands of No. 22 copper wire. It can be used satisfactorily for antenna construction.

AWARDED THE RADIO NEWS LABORATORIES CERTIFICATE OF MERIT NO. 860.

UNCLE SAM TUNING COIL

This tuning coil, shown in the illustration, was submitted to the RADIO NEWS LABORATORIES for test by the Uncle Sam Electric Company, Plainfield, N. J. It is of the



usual three-circuit tuner type, having a primary, secondary and tickler winding. It operates very satisfactorily in three-circuit tuners.

AWARDED THE RADIO NEWS LABORATORIES CERTIFICATE OF MERIT NO. 863.

SPARTAN LOUD SPEAKER

This loud speaker, submitted to the RADIO NEWS LABORATORIES for test by the Spartan Electric Corp.,



99 Chambers St., New York City, is shown in the illustration. It affords very good reproduction of radio concerts, without disturbing distortion and with sufficient volume for all ordinary purposes.

AWARDED THE RADIO NEWS LABORATORIES CERTIFICATE OF MERIT NO. 871.

ERLA BEZEL

This bezel was submitted to the RADIO NEWS LABORATORIES for test by the Electrical Research Labora-



tories, Inc., 2500 Cottage Grove Ave., Chicago, Ill. It is very easily mounted on the panel and adds to the appearance of the set.

AWARDED THE RADIO NEWS LABORATORIES CERTIFICATE OF MERIT NO. 834.

BLAX A. C. POLARIZER



The Blax Polarizer shown in the illustration was submitted to the RADIO NEWS LABORATORIES for test by Black Brothers, Inc., 502 Black Bldg., Los Angeles, Calif. This polarizer consists of a resistance winding having terminals, as shown, at both ends and the middle. It is to be used in conjunction with a door-bell transformer for illuminating the electron tube in a radio receiving set. It is designed for the purpose of reducing or removing a 60-cycle hum by adjustment of the middle point of this resistance. This is accomplished by attaching an ordinary rheostat to one side of this resistance, thus making it variable.

AWARDED THE RADIO NEWS LABORATORIES CERTIFICATE OF MERIT NO. 895.

LOMBARDI CONDENSER

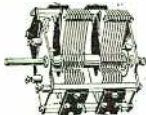

The condenser shown in the illustration was submitted to the RADIO NEWS LABORATORIES for test by the Lombardi Radio Mfg. Co., 67 Minerva St., Derby, Conn. This condenser is of the tandem type, is sturdily built and each of the sections has a maximum capacity of .0005 mfd. The Lombardi single condenser has also been approved.

AWARDED THE RADIO NEWS LABORATORIES CERTIFICATE OF MERIT NO. 892.

SITTMANN CONDENSER



The condenser shown in the illustration was submitted by G. Sittmann & Sons, 105 Liberty St., Brooklyn, N. Y. This condenser is sturdily built, has a rated capacity of .0005 and is equipped with a set of gears for obtaining slow motion of the moving parts. Soldered end plates are used in the construction.

AWARDED THE RADIO NEWS LABORATORIES CERTIFICATE OF MERIT NO. 896.

SUPERSPEAKER

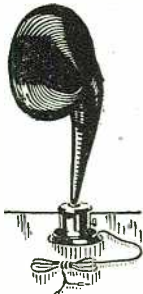

The Superspeaker, submitted by the Jewett Radio & Phonograph Co., 6500 12th Street, Detroit, Mich., is shown in the illustration. This Superspeaker reproduces radio concerts very satisfactorily without appreciable distortion.

AWARDED THE RADIO NEWS LABORATORIES CERTIFICATE OF MERIT NO. 891.

"NIFTY" LEAD-IN



This lead-in was submitted to the RADIO NEWS LABORATORIES for test by the Amoroso Mfg. Co., 14 Scars Street, Boston, Mass. This lead-in forms a convenient method for bringing the electrical connection to the antenna system and other small openings where very little space is available. It is made of flat copper.

AWARDED THE RADIO NEWS LABORATORIES CERTIFICATE OF MERIT NO. 903.

FERI COILS



The coils shown in the illustration were submitted to the RADIO NEWS LABORATORIES for test by the Feri Radio Mfg. Co., 1167 Bedford Ave., Brooklyn, N. Y. This coil is of the diamond-weave type and will tune satisfactorily in radio receivers over the broadcast range with a .0005 mfd. condenser. Is well made and easily adaptable to any set.

AWARDED THE RADIO NEWS LABORATORIES CERTIFICATE OF MERIT NO. 898.

ALL-HENRY COIL



The coil shown in the illustration was submitted to the RADIO NEWS LABORATORIES for test by the All-Henry Coil Co., 3101 12th Ave. S., Minneapolis, Minn. This coil is of the Lorentz type of winding and will tune satisfactorily in radio receivers over the broadcast range. It is well made and easily adaptable to any set.

AWARDED THE RADIO NEWS LABORATORIES CERTIFICATE OF MERIT NO. 902.

POLYGRID AND CONDENSER



The Polygrid and condenser, submitted by the Polymet Mfg. Co., 599-601 Broadway, New York City, is shown in the illustration. Tongues for holding the grid resistance are fastened onto the condenser, furnishing a convenient mounting for the leak.

AWARDED THE RADIO NEWS LABORATORIES CERTIFICATE OF MERIT NO. 907.

E-Z STAT



This rheostat, submitted by the Polymet Mfg. Co., 599-601 Broadway, New York City, is shown in the illustration. The instrument is well constructed and safely carries the current required for it.

AWARDED THE RADIO NEWS LABORATORIES CERTIFICATE OF MERIT NO. 909.

E-Z OMEETER



This potentiometer, submitted by the Polymet Mfg. Co., 599-601 Broadway, New York City, is shown in the illustration. The instrument is very well made. It is wound with high resistance wire and contact is made with this wire by means of a light spring so that excess wearing will not occur with continued use.

AWARDED THE RADIO NEWS

LABORATORIES CERTIFICATE OF MERIT NO. 910.

VALLEY BATTERY CLIP



This clip, submitted to the RADIO NEWS LABORATORIES for test by the Valley Electric Co., 3157 S. Kings Highway, St. Louis, Mo., is shown in the illustration. It is very sturdy in construction and can be used satisfactorily for making connections to the storage batteries.

AWARDED THE RADIO NEWS LABORATORIES CERTIFICATE OF MERIT NO. 906.

KEYSTONE AUDIO TRANSFORMER

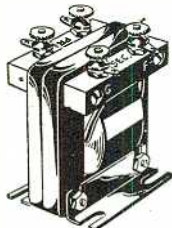

The transformer shown in the illustration was submitted to the RADIO NEWS LABORATORIES by the Keystone Radio Laboratory, 4245 Lincoln Ave., Chicago, Ill. This transformer has a 3 1/2 to 1 ratio and can be used satisfactorily in audio frequency amplifiers, reproducing with satisfactory volume and quality.

AWARDED THE RADIO NEWS LABORATORIES CERTIFICATE OF MERIT NO. 923.

SCHAFFER CRYSTAL



This crystal, submitted by Geo. W. Schaffer, 911 Linden St., Allentown, Pa., is shown in the illustration. It is very sensitive and easily adjusted.

AWARDED THE RADIO NEWS LABORATORIES CERTIFICATE OF MERIT NO. 911.

AERO-LOOP

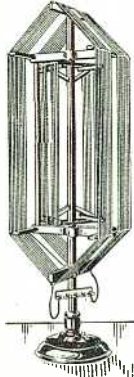

The loop shown in the illustration was submitted to the RADIO NEWS LABORATORIES by the Ut-Williams Electrical Products Co., Santa Ana, Calif. It has rather low resistance and is very directional when used in sets operating on a loop. The loop consists of two windings, one of which may be used with an out-door antenna so that the loop as a whole may be used very efficiently as a very low resistance antenna coupling unit.

AWARDED THE RADIO NEWS LABORATORIES CERTIFICATE OF MERIT NO. 894.

SUB-BASE SOCKET



This socket, submitted by the Crafton Studios, 646 North Michigan Ave., Chicago, Ill., is shown in the

illustration. It is fitted with a threaded ring so that it can be mounted on a sub-panel from beneath, permitting the wiring and terminals to be hidden from view.

AWARDED THE RADIO NEWS LABORATORIES CERTIFICATE OF MERIT NO. 925.

PERFECTION VERNIER DIAL

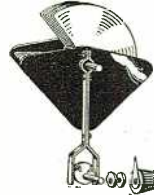

This dial, shown in the illustration, was submitted by the Perfection Radio Mfg. Co., 24th and Race Streets, Philadelphia, Pa. This vernier acts on the principle of an eccentric engaged in a stirrup at the end of a rod. This rod is held by a friction collar at the shaft of the condenser.

AWARDED THE RADIO NEWS LABORATORIES CERTIFICATE OF MERIT NO. 921.

APOLLO LOUD SPEAKER



This loud speaker, submitted by the Apollo Radio Horn Co., 355 W. Ontario St., Chicago, Ill., is shown in the illustration. It reproduces radio concerts very satisfactorily without appreciable distortion.

AWARDED THE RADIO NEWS LABORATORIES CERTIFICATE OF MERIT NO. 897.

QUADRAFORMER KIT



The kit of Quadraformers was submitted by the Gearhart-Schlueter Radio Corp., of Fresno, Calif., to the RADIO NEWS LABORATORIES for test. These quadraformers operate satisfactorily in radio frequency amplifiers. They have a tendency to reduce magnetic coupling between stages.

AWARDED THE RADIO NEWS LABORATORIES CERTIFICATE OF MERIT NO. 890.

POLK BINDING POST



This binding post, furnished by J. L. Polk, 443 So. Madison Ave., La Grange, Ill., has provision made on it for slipping down a collar which is held in place by a spring. The wire is then placed under the teeth of the head and the spring, bringing the collar up, makes good contact certain.

AWARDED THE RADIO NEWS LABORATORIES CERTIFICATE OF MERIT NO. 922.

AMALGAM SOLDERING PASTE



This soldering paste, submitted by R. E. Wyatt Co., Syracuse, N. Y., is very satisfactory for use in radio sets.

AWARDED THE RADIO NEWS LABORATORIES CERTIFICATE OF MERIT NO. 913.

(Continued on page 565)

Correspondence from Readers

ABOUT RADIO TUBES

Editor, RADIO NEWS:

I cannot help but comment on your article on page 1874 of RADIO NEWS, issue of April, by D. C. Wilkerson. This article relating to high vacuum, giving to Messrs. Langmuir and Arnold credit for high vacuum, I must dispute.

I have been in the incandescent lamp industry for the past thirty-eight years, or since 1887, and all of my work has been along the line of exhaust, not only for incandescent lamps, but for radio tubes and thermos bottles also. I cannot understand Mr. Wilkerson's article giving Langmuir and Arnold credit for having the only methods for producing high vacuums.

The first real high-vacuum tube made was probably produced by Crookes or Roentgen along about 1894, in the production of the now well-known X-ray tube. Mr. Wilkerson forgets the fact that previous to the experiments of Roentgen and Crookes, Geissler had produced very high vacuums, in fact, the Geissler pump today will produce a vacuum high enough for radio tubes. It will probably take a little longer than with the so-called Langmuir method, but a very high vacuum is produced, nevertheless.

Another very good pump that was known long before Langmuir and Arnold was the Sprengle continuous fall mercury pump, also the Bobo and Goede rotary mercury pumps. I have no doubt of the possibilities of Langmuir or Arnold procuring a patent on the methods of producing high vacuum by use of mercury vapor. I am, however, inclined to believe that even this is not new, because you will find in the first book of physics, generally used by first year pupils at high school, that the method used by Langmuir is demonstrated, and this book that I mention was published more than twenty years ago. In later editions of this first book, you will find that both Langmuir and Dr. Goede are given credit for mercury vapor pumps.

The writer did a lot of experimenting with mercury vapor, arsenic, various and sundry oxides, phosphor, iodine, magnesium, thalium and the like, more than twenty years ago, and you will find that the phosphor method was patented along about 1896, by a Magaleny or some such Italian name.

Mr. Wilkerson's article further states that the General Electric Company has all claims on thoriated tungsten filament. I believe this is an error. If you will look up the patents of the General Electric Company, you will find that their patent calls for pure, homogeneous tungsten, and their sole right is in incandescent electric lamps. Tungsten and thoriated tungsten were thought of and used back in 1902, and there are several German patents on such, whereas the General Electric Company purchased the Just and Hannaman patents sometime about 1907.

The article further states that the independent tube manufacturer will probably have some trouble in getting this thoriated tungsten. The mere fact that the only two concerns outside of the General Electric Company who manufactured tungsten filament are now out of business is no good reason why some others, when they realize the magnitude of the market, will not go into manufacturing it. In the meantime, this material of a very good quality can be purchased in abundance in Germany, Switzerland and other countries.

Now, my real object in writing this letter as I do and taking exception to this article written by Mr. Wilkerson is that it seems to me that RADIO NEWS has tried to

scare the independent tube manufacturer, as this article would lead one to believe that to manufacture radio tubes now would be an infringement on various patents; this is not necessarily true.

The writer is an engineer for one of the largest independent tube manufacturers in the United States, and he wishes to state that they are not using the Langmuir mercury vapor for high vacuums in any sense, and are producing a tube as good as the one produced, if it is produced, under the Langmuir mercury vapor system. Articles of this nature lead one to believe that no one except the large corporation may go into the manufacture of tubes—which I believe to be erroneous. In a periodical such as yours, read by so many, I believe that a little more thought should be given the subject before it goes to press, and some of the facts looked into, as, in my opinion, such statements have a tendency to retard the industry.

W. R. ARMSTRONG,
4049 Diversey Ave.,
Chicago, Ill.

(RADIO NEWS is never responsible for the statements made by its authors. Such statements are usually made in good faith, but if an occasional error does creep in, RADIO NEWS is always ready to correct it.—EDITOR.)

THREE-CIRCUIT REGENERATORS AND NEUTRODYNES

Editor, RADIO NEWS:

In regard to Mr. Sarec's letter on the advantages of the Neurodyne and the shortcomings of the regenerative set, I should like to stand up for the three-tube, three-circuit set of the two variometer, coupler and condenser type. I have experimented with nearly every type of set in use for the last three years, and find that outside of the super-heterodyne class there is not a set to compare with a three-circuit set.

During the summer, signals from WEAP, WBZ, WGY and other such stations have been heard 900 feet away from a Magnavox loud speaker of the A3 type. During this winter England, France and Spain were heard and nearly every night in the week signals from KPO have come in through KDKA at 10 o'clock when KPO has been broadcasting stock market reports. And all of this on a loud speaker.

The set is absolutely distortionless and clear and, regarding simplicity, only the grid and plate variometers are used in tuning. Nearly 300 stations have been logged in about 10 months of operation. It might be well to state that no power or radio frequency amplifiers were used at any time and that all of the above statements can be amply backed.

G. HERBERT RILL, JR.,
Buckwood Avenue,
Catonsville, Md.

RADIO BROADCAST ANNOUNCERS

Editor, RADIO NEWS:

As a constant reader of your excellent magazine, I am taking the liberty of sending you this letter. No doubt, in the past you have received several letters regarding the many radio station announcers' shortcomings in giving the station's call letters properly.

I have just finished reading Mr. Carl H. Butman's article, "What'll I Do When I Can't Get the Call?" which appears on page 1442, the February issue.

His article is very clear and no doubt he expresses 90 per cent. of the radio audi-

ences' opinion. Undoubtedly, some change will be absolutely necessary in the very near future for better call letter identification. However, his idea of the "Dit Dah Dah" seems practically useless to me. One could say WNYC practically five times over while someone gave the same letters in the "Dah Dit" way. Of course, some people of the radio audience may be somewhat hard of hearing or have radio sets that are not powerful or selective enough to bring in the DX, and though they may hear a band concert from a far station fairly loud enough to know that it is a band concert, they get peevish at the announcer for not yelling his head off when he tells the station's call letters. It would take some announcer to give all letters with a voice of the same power and volume that a band can give! Why not give him a megaphone? The other day I heard one of Thomas A. Edison's phonographs of the 1890 model, using cylinder records, while I was at the home of a friend. Everyone who has had one of these relics will remember how the selection was announced. There was no feeling in the words spoken, and the voice seemed as if spoken by someone in a trance, or under the influence of some of the stuff our bootleggers peddle around in this era of Science and Invention! There are many announcers in our best broadcast stations today who announce their call letters and programs with the same dead feeling as the announcers on the old Edison records.

In my estimation, a good announcer is 70 per cent. of the radio program. If he has a pleasant voice and can talk understandable English, the radio audience can overlook some of the terrible stuff put on the air occasionally. I have heard that there has been a complaint made about Roxy's announcing. He is original, his style is well liked, and this is the first time I ever heard of any complaint against him. Roxy has a personality all his own, and his announcing is what saves those programs which would otherwise be a failure. I would suggest that Mr. J. A. Halman, Broadcasting Manager of WEAJ, take a trip to Zion, Ill., where the "blue laws" are still in effect, and all those who support them are welcome there. Let Roxy announce in his own good way, as everyone loves a breezy and cheerful announcer. Let's have more of them.

As I don't want to hurt anyone's feelings, I will not say here who is and who is not a good announcer. However, I am glad to say there are more good ones than bad ones.

I should be happy if you could find enough space in RADIO NEWS for this letter so that we may hear from others on this subject. Best wishes to RADIO NEWS and three cheers for Roxy.

E. PENDERGAST,
22 Harris St.,
Webster, Mass.

MR. HOWE HAS STARTED SOMETHING

Editor, RADIO NEWS:

Permit me as a one-time member of England's largest radio magazine to criticize one or two of the points in Mr. Howe's letter which appeared in your May issue.

Mr. Howe sets out from the beginning to condemn British broadcasting, and if we are to believe him I really don't understand why the B.B.C. should continue its efforts having, as it appears, so dismally failed in what it set out to do. First of all, let it be understood that America had some two years' start over England and perhaps there
(Continued on page 536)

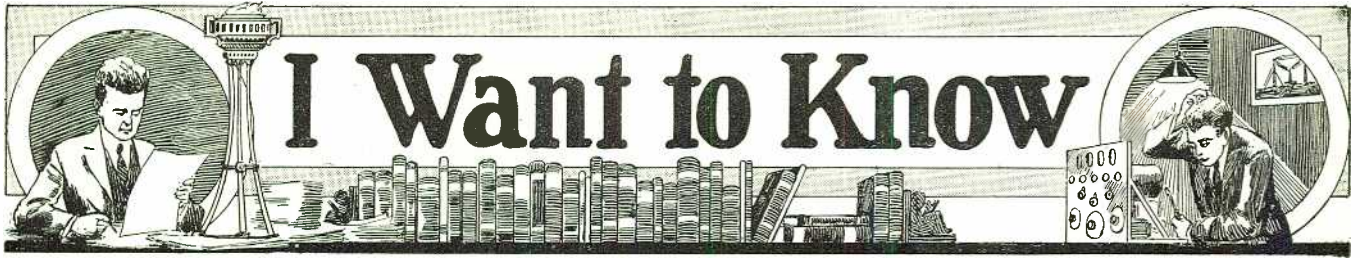

Conducted by R. D. Washburne

THIS Department is conducted for the benefit of our Radio Experimenters. We shall be glad to answer here questions for the benefit of all, but we can publish only such matter as is of sufficient interest to all.

1. This Department cannot answer more than three questions for each correspondent. Please make these questions brief.
2. Only one side of the sheet should be written upon; all matter should be typewritten or else written in ink. No attention paid to penciled matter.
3. Sketches, diagrams, etc., must be on separate sheets. This Department does not answer questions by mail free of charge.
4. Our Editors will be glad to answer any letter, at the rate of 25c for each question. If, however, questions entail considerable research work, intricate calculations, patent research, etc., a special charge will be made. Before we answer such questions, correspondents will be informed as to the price charge.

Mr. Washburne answers Radio questions from WRNY every Thursday at 8:30 P. M.

A MODIFIED REINARTZ SET

(2143) Mr. R. W. Adams, Muskogee, Okla., asks:

Q. 1. Is the enclosed diagram a satisfactory one? This appeared in a foreign publication and exceptional results were claimed for it.

A. 1. We have modified the schematic circuit somewhat, as you will see (Q. 2143). Better operation results when the 200-turn choke coil is used. This may be wound with No. 30 S.S.C. or S.C.C. wire, on a two-inch form. This choke coil must be in non-inductive relation to the other coils in the set. Note the absence of a phone condenser—this is characteristic of Reinartz receivers.

This modified Reinartz will be found one of the finest sets for all-round good operation. It is easy to tune (the .0005 mf. variable condenser controlling the wave-length to which the set will respond). Oscillation control is positive and easy (this is all in the setting of the .00025 mf. variable condenser). Sensitivity is assured by proper adjustment of the grid leak resistance and the detector "B" potential.

The 16-turn aerial coil serves a double purpose: it couples the aerial to the grid, and the plate to the grid.

A simple coil construction is shown in "Q2143-A." End "4" goes to the aerial and lead "1" connects to the .00025 mf. fixed grid condenser. A "lower loss" (Ye gods, this is becoming a habit we used the same two words last month; probably will next month. Here's hoping they strike bottom sometime, on this "low loss," "lower loss," "lowest loss" business) coil would result if the wire is wound over one-eighth or one-quarter inch square strips of celluloid laid lengthwise on the coil so as to prevent the wire touching the tube. If this design is followed, cardboard, Bakelite, Radion (hard rubber), Formica or wood may be used as the form. Otherwise, it is best to use hard rubber.

Q. 2. How can a Diode be used in place of a crystal, in a reflex set?

A. 2. Circuit "Q.2143-B" shows how to use the 2-element "Fleming Valve" type of rectifier.

The same coil construction is followed in this receiver, as in the one described in your first in-

quiry above, with the exception that aerial coil "A" will necessarily consist of a good many turns, since a periodic, or tuned aerial circuit is being used, instead of an aperiodic, or untuned one. Winding "A" (having leads Nos. 3 and 4, with "4" being the aerial connection) will have about 45 or 50 turns and coil "B" will contain the same

A. 3. Whether you have a 2-amp. or a 5-amp. tube charger, you should find no difficulty in following circuit "Q.2143-C." The voltage distribution in the auto-transformer is shown.

Knowing the charging rate of your "B" battery, you may determine the size lamp required to pass

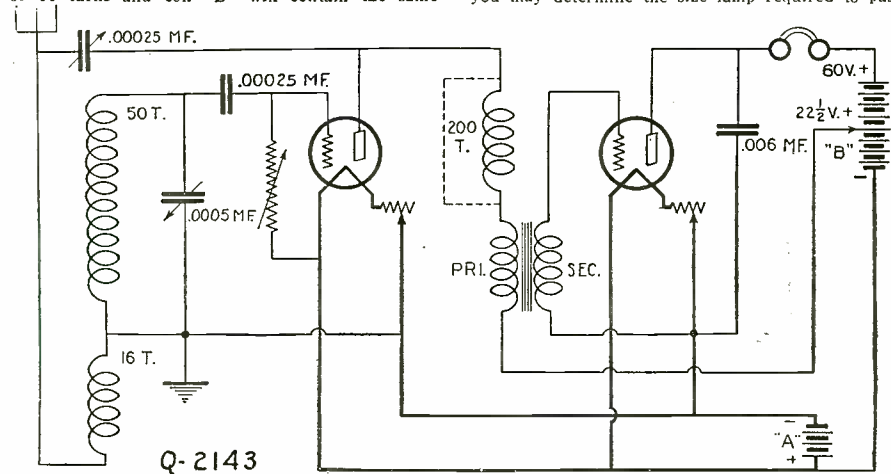

An excellent two-tube diagram. In this circuit the feed-back coil and the antenna coil are combined in one winding. Any convenient form of coil winding may be used.

count, connection "1" being the grid connection. The second radio frequency unit (C and D) has a primary of about eight turns, the exact value to be determined by experiment, with "4" being the plate lead. The secondary, "D" will have about 45 or 50 turns, with "1" connecting to the plate of the 2-element tube.

Q. 3. How are "B" batteries charged from an "A" battery charging tube rectifier?

the correct charging current by a glance at this table:

Lamp Wattage	Charging Rate, Amps. (A single 12-cell unit)	Charging Rate, Amps. (Two units in series)
25	.075	...
40	.125	.090
60	.165	.125
75	.250	.175
100	.275	.225
150	.350	.275

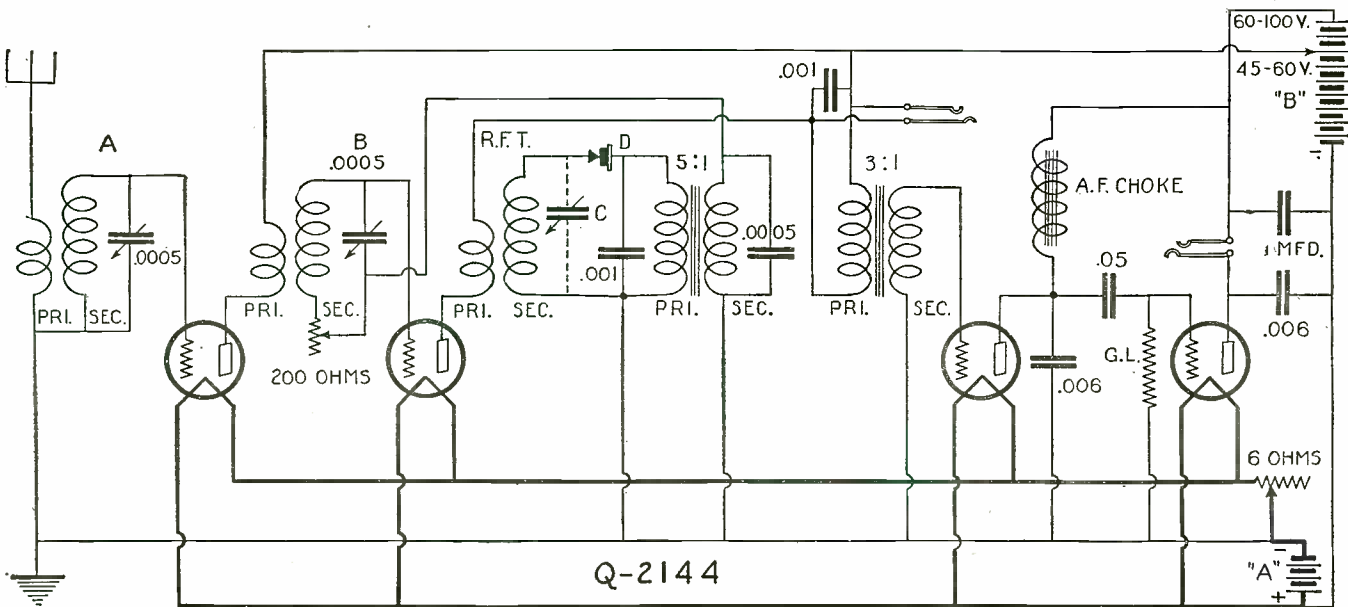

The Double Selector Multiflex circuit of Victor Greiff. This diagram shows two stages of tuned radio frequency amplification and three stages of audio frequency amplification, using a crystal detector instead of the usual tube detector. The second radio frequency tube circuit is reflexed for one stage of audio frequency amplification.

THE DOUBLE SELECTOR MULTIFLEX

(2144) Mr. Virgin Aldrich, Beaver City, Neb., asks:

Q. 1. Some time last year Victor Greiff developed a peculiar reflex circuit using a crystal detector and a "losser" control of circuit oscillation. Please give the constants of this circuit.

A. 1. The Double Selector Multiflex circuit about which you inquire is being shown in these columns.

A potentiometer will furnish the necessary 200 ohms.

The three radio frequency transformers are called "Tunads."

An A.F. transformer secondary, or a Ford spark coil secondary will work admirably as the A.F. choke.

A variometer may be substituted for the first 2-coil radio frequency transformer.

The value of "G.L." will be about 50,000 ohms, but a "C" battery should be used, and a higher grid leak resistance.

Tunads have 64-turn secondaries to be used with variable condensers of .0003 mf. capacity (and 12 turns in the aerial coil—primary of "A"—and eight turns in the first plate coil—the primary of "B"), but the coil described in answer to the second question of Mr. R. W. Adams, above, may be constructed. The data in the latter instance would be: coil "A," 10-turn primary and 50-turn secondary; coil "B," 6-turn primary and 50-turn secondary. Instead, "R.F.T." may be a standard radio frequency transformer designed to work without a variable condenser. The capacity range of "C" will be determined by the particular coil construction decided upon for "R.F.T."

The crystal detector "D" may be fixed or adjustable.

Be sure to maintain a non-inductive relation of the three R.F. coil units.

40 TO 205 METER RECEIVER

(2145) Mr. A. R. Leygue, à Ox, près Muret. Hte, Garonne, France, asks:

Q. 1. Please describe the construction, and show the circuit, of a receiver designed to cover the entire amateur wave-length operating band.

A. 1. We are not prepared to furnish such a diagram, particularly since the amateurs have been licensed to operate on wave-lengths as low as three-fourths of 2 meter. The design of such a receiver would require a great deal of experimental work and we do not know of anyone having undertaken the task. However, we are very pleased to refer you to *The Experimenter* magazine of April, 1925, where will be found the circuit diagram and complete constructional details of the amateur receiver in use at Station 3MO, in the serial article "Getting On the Air," by A. P. Peck. The receiver, described covers the exceptionally wide wave-length range of 40 meters to 205 meters, and is a thoroughly practical radio receiver for the reception of phone or code signals within this band. One is not required to change coils. The article in this issue, "Another Three-Range Receiver," describes a 40-to-555-meter set using a group of three removable coils for covering this range, instead of the "tapped inductance" principle used in the receiver at 3MO.

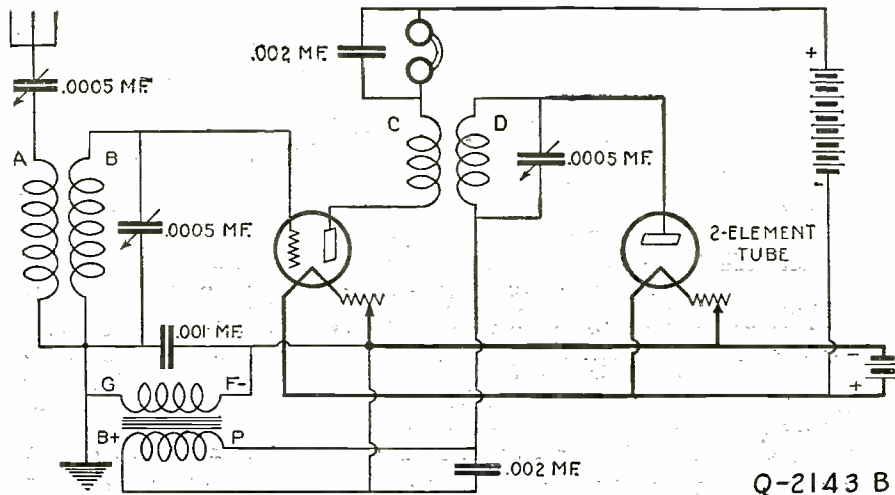

Q-2143 B
A two-tube reflex. In this circuit a two-element tube supplants the usual crystal detector or three-element tube detector. The descriptive text is quite complete. Battery potentials and condenser values should be varied for best results.

THE TYPE 4DL REFLEX SET

(2146) Mr. P. Raja Chett, Bangalor City, India, asks:

Q. 1. How is the Inverse Duplex form of reflex circuit different from any other kind of reflex circuit? I am particularly interested in the Inverse Duplex circuit as incorporated in the Grimes Type 4DL Inverse Duplex reflex receiver, a set having



Exterior view of the Renaissance Model, Grimes Inverse Duplex Receiver, incorporating the 4-DL circuit described in these columns.

a tube detector, two stages of tuned radio frequency amplification and three stages of audio frequency amplification, using only four dry cell tubes.

A. 1. The schematic diagram of the connections of a Type 4DL Grimes Inverse Duplex receiver is shown in "Q. 2146." This is one of the most up-to-date and efficient reflex circuits

known to the radio art. By "efficient" we mean the reproduction is loud (there are three stages of audio frequency amplification), quite clear (probably due, in the main, to the use of the reflexing principle, since most sets would not be very clear reproducing with the same audio frequency transformers used in a straight audio amplifier circuit), the set is very compact (UV-199, or C-399 dry cell tubes are used and "battery compartments" in the set encase all batteries), sensitive (explained by the tube detector and two stages of radio frequency amplification) and selective (secured by extremely careful design, as it is not usual for sets using "astatic" inductances to be very sharply resonant, and a good part of the selectivity must be attributed to the two stages of tuned radio frequency amplification.) The general statement has been made; from time-to-time, that a set will necessarily be sensitive if it is selective. That these two conditions are not synonymous, anyone can appreciate when it is remembered that, by means of certain extremely sharp-tuning circuits, a crystal receiver can be made as selective as most tube sets. However, the crystal sensitivity will not approach the tube sensitivity. On the other hand, circuit selectivity is required if long distance reception is to be expected while powerful local stations are broadcasting, although this long distance reception cannot be secured, even though the set is selective, if the detector is not sufficiently sensitive to respond to minute current variations.

The Principle

Detail Q. 2146-A represents four radio vacuum tubes used in a standard reflex circuit, wherein a tube detector is used. The amplification sequence is as follows: three stages of radio frequency
(Continued on page 476)

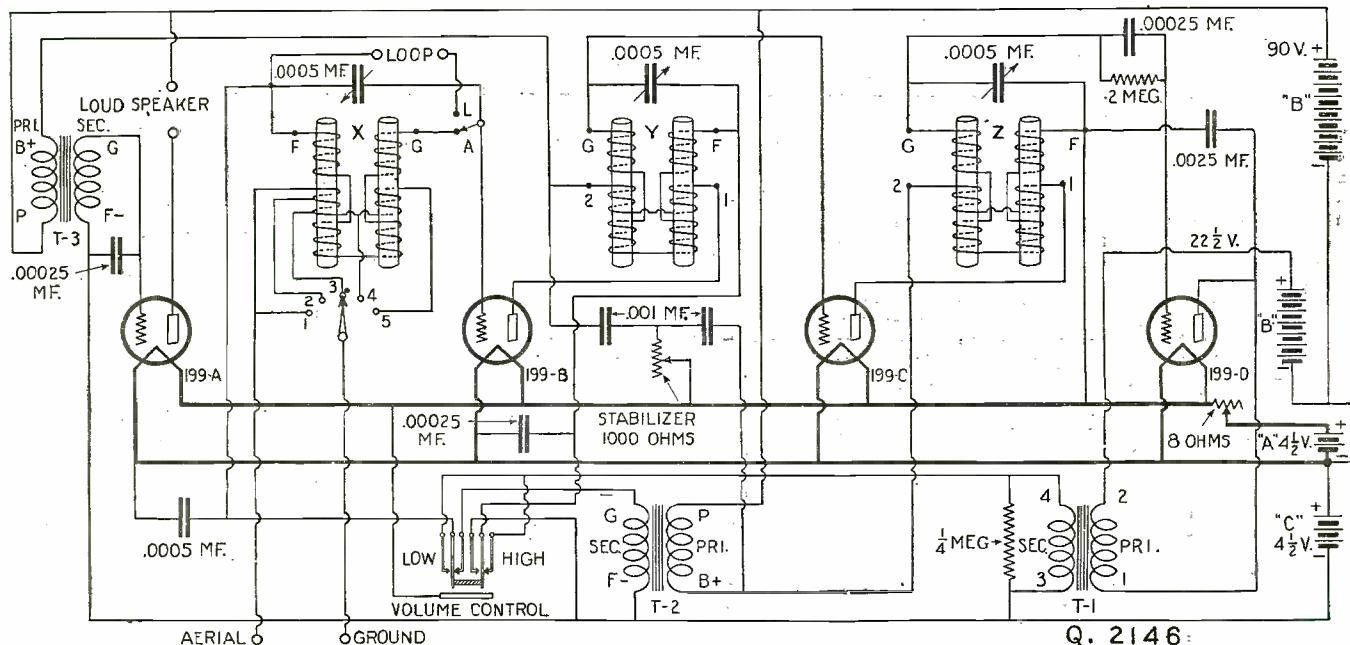

Q. 2146

The type 4-DL Grimes Inverse Duplex (reflex) circuit. This is one of the latest developments of the reflexed principle. There is wide room for experiment in this field. Note the "C" battery biasing all amplifier tube grids, resulting in low "B" battery consumption.

NOTE—The Viking Receiving Set has been tested and approved by Radio News Testing Laboratory.



\$29.50

5 Tube Radio!

Tuned radio frequency, 2 stages radio, detector, 2 stages audio. Mahogany finish cabinet. Dull rubbed panel. 3 low loss condensers. 3 low loss coils. 5 bakelite sockets for 201A or 301A tubes. Thordarson transformers.

Send No Money

We trust you! Just fill out the order blank below and we will send this wonderful VIKING 5 TUBE RADIO RECEIVER to you, express collect. Simply pay the express office the astonishing low price of \$29.50 plus small delivery charge. They will hold your money for 6 days. You keep the set for 6 days—try it—test it under any and all conditions.

Results are what count! By results we mean distance, tone, volume. Prove to your own satisfaction that the VIKING will give the results you want. Don't take our word for it—let the instrument talk for itself! Install it in your home for 6 days at our expense. Test it every way you know how.

Then, if you are not satisfied that it is the most remarkable radio bargain ever offered — if you are not delighted with the

sweet tone, volume and distance it receives— then, just pack it up and return to your express office. They will return you \$29.50 to you without question or quibble.

No two men seem to agree as to just what a radio instrument should do. There is only one way for any man to satisfy himself about the VIKING—try it out! We could tell you many marvelous things about the VIKING — but would it really mean anything to you? We believe you know what to expect from radio. The question in your mind is, will the VIKING give the results I expect? There is only one way to find out.

Send in the coupon! You have absolutely nothing to lose. We take all the risk because we know by comparison this is the most astonishing radio value on the market today. That is why we can afford to make this wonderful FREE trial offer. This receiver is entirely assembled and wired—complete in every respect except for accessories.

Try it for 6 Days FREE

Remember you run a...olutely no risk! If you decide any time within 6 days that the VIKING 5 TUBE RECEIVER is not just what you want a radio to be, get your money back from your local express office. You will find it hard to duplicate such a wonderful chance again. All you have to do is fill in the coupon below. Don't send a penny with your order. Your instrument will be immediately shipped to you by express. Act NOW.

VIKING
Radio Laboratories
435 N. LaSalle St.
CHICAGO
ILL.

Use this Order Blank

VIKING RADIO LABORATORIES,
435 N. La Salle St., Chicago, Ill.

Date

Gentlemen:—I want to place my order for a \$29.50 VIKING TUBE RADIO INSTRUMENT (with-out accessories) as described above which I understand as follows:

- 1 Upon receipt of this order you are to ship one VIKING \$29.50 — FIVE TUBE INSTRUMENT, completely wired, without accessories, express collect, C. O. D. When this instrument arrives at my express office, I have the right to examine it. If I am not thoroughly satisfied, I will instruct the Express Co., to return to you at once. You to pay all charges.
- 2 If I decide to keep this instrument I will pay the express office \$29.50 plus express charges, with the understanding that the Express Agent will

keep my money for 6 days. If at any time within 6 days I am not satisfied with the VIKING for any reason whatsoever, I will return it, packed just as I received it and if it is in good condition the Express Co., is to return my money and return the instrument to you.

- 3 If I do not return it to Express Co. within 6 days, you can consider I am perfectly satisfied with the VIKING.
- 4 Please ship as soon as possible and advise me when you have shipped.

Name.....

Address..... City and State.....

Occupation..... Employed by..... Age.....

Don't Send a Penny!



56 Points of Contact

New! THE BELL "Shockproof" Socket

Fourteen points of contact on the side of each prong in this new socket. A straight push seats the tube; no twist needed. Tube is supported by contact springs (not the socket shell). It "floats" on springs, perfectly shockproof. Suitable for sub-panel or base mounting.



The 2-in-1 Vernier Dial

A sensitive, easily-controlled dial giving coarse or 15 to 1 vernier tuning without lifting the hand from the big knurled knob. Handsome polished bakelite, with enclosed dial scale.



The BELL 3-Phone Plug

With this plug you can hook up one to three head sets in series. Plainly marked connections show how to plug in phones without confusion.

Dealers—Write for prices and information.

BELL MANUFACTURING CO.
11 Elkins St., Boston, Mass.
Makers of the famous BELL TIMER

All About Filters

(Continued from page 453)

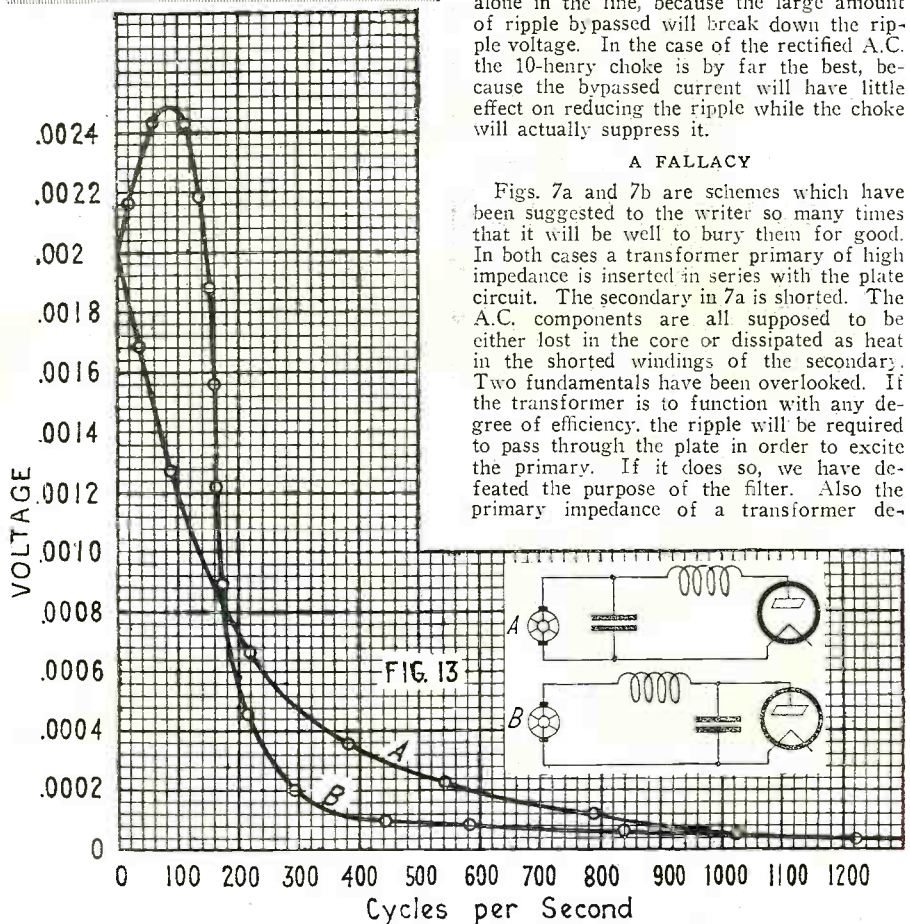

Curve A shows the by-pass effect and B the change in voltage across the plate in the circuit shown in Fig. 12.

This graph shows how the voltage across a condenser rapidly changes with the frequency near the resonant point.

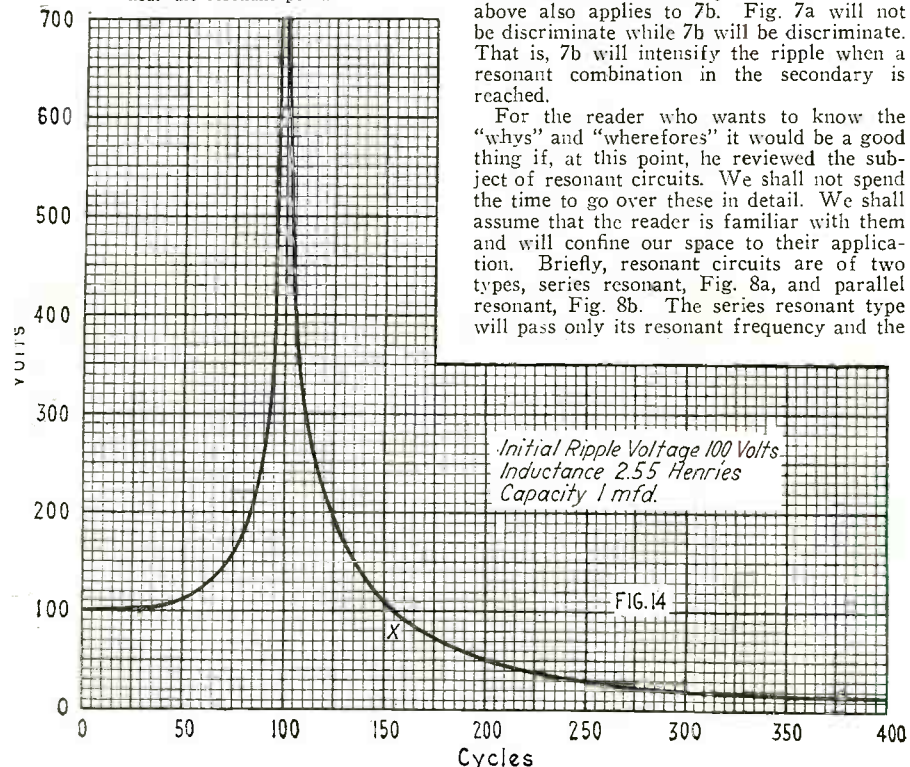

clude that in the case of the generator, a 1-mfd. condenser across the terminals is at both the higher and the very low frequencies superior to a 10-henry choke used alone in the line, because the large amount of ripple bypassed will break down the ripple voltage. In the case of the rectified A.C. the 10-henry choke is by far the best, because the bypassed current will have little effect on reducing the ripple while the choke will actually suppress it.

A FALLACY

Figs. 7a and 7b are schemes which have been suggested to the writer so many times that it will be well to bury them for good. In both cases a transformer primary of high impedance is inserted in series with the plate circuit. The secondary in 7a is shorted. The A.C. components are all supposed to be either lost in the core or dissipated as heat in the shorted windings of the secondary. Two fundamentals have been overlooked. If the transformer is to function with any degree of efficiency, the ripple will be required to pass through the plate in order to excite the primary. If it does so, we have defeated the purpose of the filter. Also the primary impedance of a transformer de-

creases with the load on the secondary. If a test were to be made with the secondary open and with the secondary shorted it would be found that the ripple would actually increase when the secondary was shorted. The above also applies to 7b. Fig. 7a will not be discriminate while 7b will be discriminate. That is, 7b will intensify the ripple when a resonant combination in the secondary is reached.

For the reader who wants to know the "whys" and "wherefores" it would be a good thing if, at this point, he reviewed the subject of resonant circuits. We shall not spend the time to go over these in detail. We shall assume that the reader is familiar with them and will confine our space to their application. Briefly, resonant circuits are of two types, series resonant, Fig. 8a, and parallel resonant, Fig. 8b. The series resonant type will pass only its resonant frequency and the

Initial Ripple Voltage 100 Volts
Inductance 2.55 Henries
Capacity 1 mfd.

FIG. 14

Tuned Radio Frequency Kit
\$12.00
Complete with Brackets

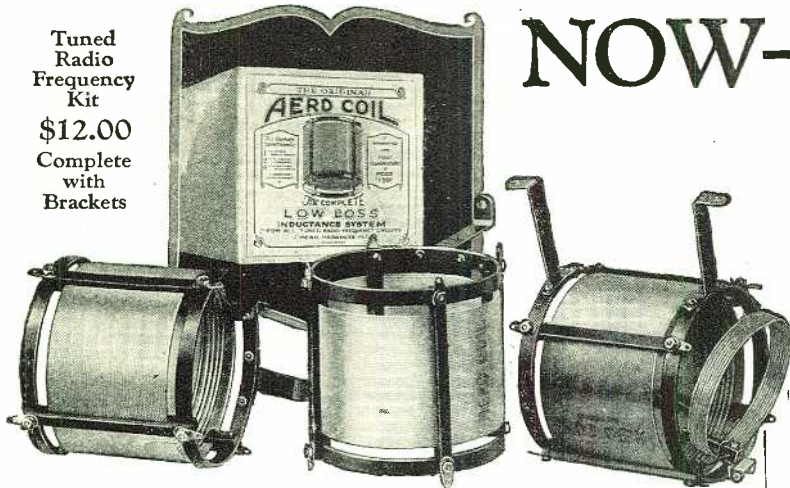

The complete Low Loss Inductance System, comprising two tuned circuit transformers and an antennae coupler with a uniquely constructed variable primary for governing the selectivity of the antennae circuit.

NOW—All the world can have it!

The sensational favor which Chicago and New York showered upon the AERO COIL has prompted its designers to make it available to every fan in the Nation. Vigorous plans are, therefore, under way to place the Aero Coil where every city and village can see it and witness its markedly superior performance.

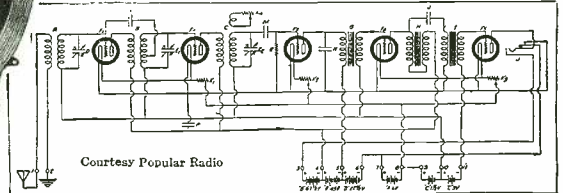

Declared by Chicago and New York the most SELECTIVE, most POWERFUL Inductance Ever Designed!

Enjoy the "knife-edge" selectivity with which Aero Coils cut through the tangled mass of Chicago and New York broadcasting at will! Enjoy the uncanny sensitivity with which sets built of Aero Coils pick up the far off, small, low-wattage stations that you never thought existed! Be thrilled by the amazing volume with which Aero Coils amplify for the loud speaker, reception which you have always had to listen to on the head phones! Build a 5-Tube Tuned Radio Frequency Set with Aero Coils the true low loss inductance system.

PATENTS PROTECT ITS SUPER-EFFICIENCY

Its lower circuit resistance, its lower high frequency resistance, its lower distributed capacity, and the fact that its dielectric is 95% air are the reasons why the Aero Coil tunes so sharply into resonance—and why it actually uses the energy which other types of inductances waste. Hence, Aero Coil is the inductance of today—and tomorrow, and you can be assured that it is—for the construction which makes it the ideal inductance is patented, and no inductance can be made so good as Aero Coil unless in violation of these patents!

95% Air dielectric windings—No dope on air-spaced—Solonoid (cylindrical) windings—Variable primary
Engineers recognize cylindrical winding to be superior to any other. The Aero Coil is the only Air dielectric cylindrical inductance with a variable primary. Aero Coil patents prevent imitation.

Build Your Set Now!

The construction which makes possible the far superior results obtained from Aero Coils also makes them cost a bit more—but, performance considered, their price is low. \$12.00 for a set of three, complete with nickel plated mounting brackets which fit any condenser. Go to your dealer's today and obtain a set of three. A circular containing complete hookups for building the most selective, most sensitive, most powerful five-tube receivers ever designed is enclosed in each package.

If your dealer has not yet obtained his stock of Aero Coils, order direct, enclosing price with your order.
Free Booklet showing new circuits and giving full constructional information of help to any fan or set builder—mailed on request.
Write for the Aero Booklet.

AERO PRODUCTS, Inc.
217 North Desplaines Street, Chicago, Illinois

Successors to HENNINGER RADIO MFG. CO. Pacific Coast Representative S. A. WINSOR, 1221 W. 16th St., Los Angeles

AERO COIL

All Aero Coils embrace a patent-protected method of construction which makes possible a far more efficient inductance performance than is possible with any other type of coil.

Use AERO COILS

Wherever An Inductance Is Required

THE ONLY AIR DIELECTRIC COILS HAVING VARIABLE PRIMARIES IN ANTENNAE CIRCUITS

The Aero Coil 3-Circuit Tuner

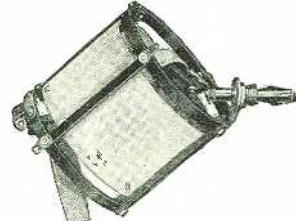

Another adaptation of the patented protected Aero-Coil construction and for that reason the most efficient three-circuit tuner ever offered. More than covers the broadcast wave band when shunted with a good .0005 condenser. This is the tuner which in a 3-tube set brought in Havana, Cuba, in the day-time in Chicago. Price \$9.00

The Aero Coil Radio Frequency Regenerative Kit

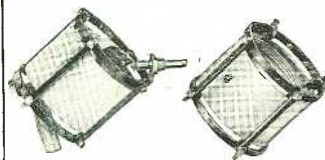

Consists of one AERO COIL 3-Circuit Tuner and one AERO COIL Antennae Coupling Transformer. Makes the most powerful, most selective 4-tube, non-radiating set possible to build. Price \$11.00

The Aero Coil Wave Trap Unit Also for Crystal Sets



By reason of the characteristics made possible by the Aero Coil construction, this unit makes a very efficient wave trap or crystal set. Price \$4.00

The Aero Coil Oscillator for Super Heterodynes



The characteristics achieved through the use of the Aero Coil principle make of this instrument the ready means to tremendously increase the efficiency of the oscillator circuit in any Super Heterodyne receiver. Pr. \$5.50

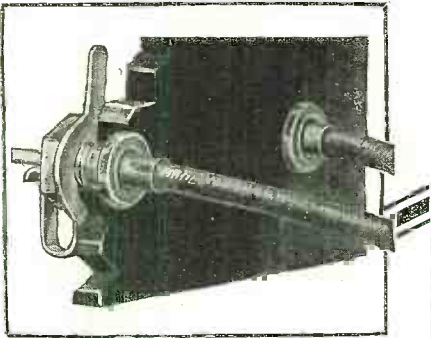

—for experimental hook-ups

—for permanent circuits

UNION RADIO TIP JACKS

Only 25c a pair

Handy for temporary connections, ideal for permanent mountings.

The superiority of Union Radio Tip Jacks over binding posts appeals to all set builders. Easy to attach, positive in their action. Nickel plated and substantial, nothing to chip, break or get lost. Firmly grip any size wire from No. 11 to No. 24 B & S gauge. Easily reamed to hold antenna or loading coils. These Jacks have been adopted as standard equipment by leading set manufacturers.

Three sizes for all mountings.

TYPE A for panels $\frac{3}{16}$ " to $\frac{1}{4}$ " thick.

TYPE B for panels, cabinet walls, partitions $\frac{5}{16}$ " to $\frac{1}{2}$ " thick.

TYPE C for panels up to $\frac{1}{8}$ " thick.

Other Guaranteed Union Radio Parts

TUBE SOCKETS—Moulded condense site highly polished. Phosphor bronze contact springs. Reinforced bayonet slot. For all standard tubes.

Price 70c

DIAL ADJUSTERS—Necessary for fine tuning. Make minute dial adjustments easy. Price 60c

At your dealer's or sent on receipt of price

RETAILERS—WHOLESALE

Send for literature and samples of our reasonably priced—Guaranteed Radio Products. Get details of our attractive proposition. Ask for illustrated pamphlet C.

UNION RADIO CORPORATION
124 SUSSEX AVENUE, NEWARK, N.J.
NEW YORK OFFICE: 116 WEST 32nd STREET

parallel resonant type will tend to pass all frequencies except resonant frequency. The resonant frequency is equal to:

$$f = \frac{1}{\sqrt{LC}}$$

where f is the resonant frequency, L is the

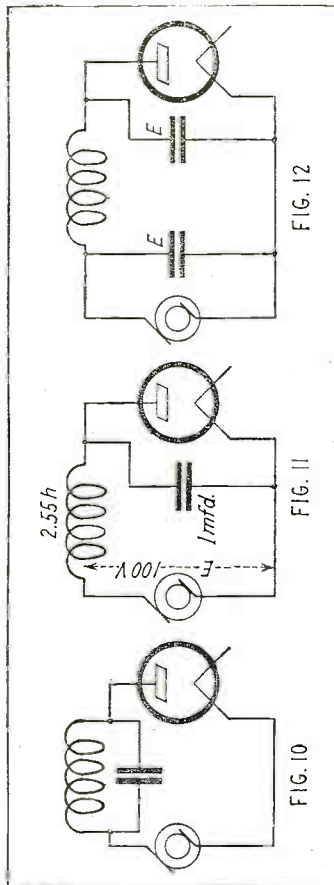
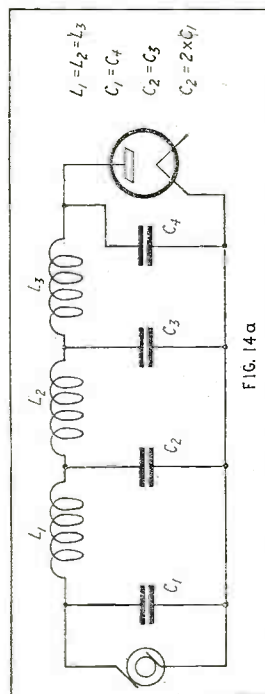

Fig. 10 shows the parallel resonant circuit in series with the plate of the tube, which tends to pass all frequencies except resonant frequency; Fig. 11 shows a series resonant combination that has a dual action; Fig. 12 is a theoretical diagram that makes clear the action of the circuit in Fig. 11 and the curve of Fig. 14.

inductance of the choke in microhenries and C is the capacity of the condenser in microfarads.



By placing several sections of coils and condensers in series, as shown above, ripples can be eliminated to a greater extent than in any of the previous circuits, because the different sections reduce the ripple that is passed on from one to the other. As stated at the right of the diagram, the inner condensers must have a capacity equal to twice the outer, or end condensers.

Fig. 9 shows the series resonant circuit across the line. This would be very effective for bypassing one particular frequency. As this type will pass very little current

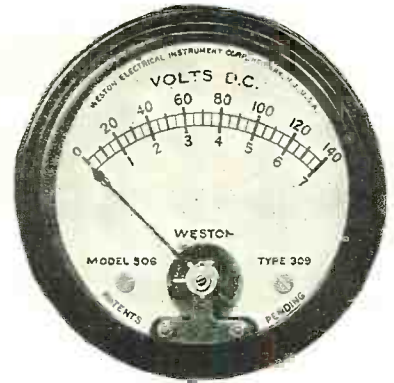

A NEW Two-Inch Radio Panel Voltmeter of WESTON Standard Quality

THESE Model 506 instruments fill a long felt need for small Panel Voltmeters for radio receiving sets. They have all the precision, craftsmanship of assembly and ruggedness of the famous Weston line. Made in single and double ranges for measuring filament and battery voltages, they have an exceptionally high internal resistance—125 ohms per volt. Regularly made with a black finish and narrow flange type of case; fastened to the panel with a special type of clamp supplied with each instrument.

For further information address

Weston Electrical Instrument Corporation

173 Weston Ave., Newark, N. J.



NO AERIAL NO LOOP

THE Antennaphone

REPLACES THE AERIAL

INCREASES SELECTIVITY

Gives wonderful results with any radio set. Not attached to, but merely placed under the telephone. Price One Dollar. Complete with insulated wire and simple instructions. At Your Dealer or Mailed C.O.D. on 3 days approval.

ANTENNAPHONE CO.
90 West St. New York City

Insure your copy reaching you each month. Subscribe to RADIO NEWS — \$2.50 a year. EXPERIMENTER PUB. Co., 53 Park Pl, N. Y. City

**EVEREADY HOUR
EVERY TUESDAY AT 9 P. M.**
Eastern Standard Time

For real radio enjoyment, tune in the "Eveready Group." Broadcast through stations—

WEAF New York	WSAI Cincinnati
WJAR Providence	WWJ Detroit
WEEI Boston	WWJ Minneapolis
WFI Philadelphia	WCCO St. Paul
WGR Buffalo	WOC Davenport
WCAE Pittsburgh	

ECONOMY

No ONE size or type of battery can be economical on every type of receiving set. That's why Eveready Radio Batteries are made in different sizes and types—so that every radio user can enjoy the economy that is to be had by fitting exactly the right Eveready Battery to his receiver. Even owners of sets with five, six, eight or more tubes, and power amplifiers, can realize Eveready economy to the full by using the new, radically different Eveready *Layerbilt* "B" Battery No. 486. There is an Eveready dealer nearby.

Manufactured and guaranteed by

NATIONAL CARBON COMPANY, Inc.
New York San Francisco

Canadian National Carbon Co., Limited, Toronto, Ontario

EVEREADY Radio Batteries

- they last longer

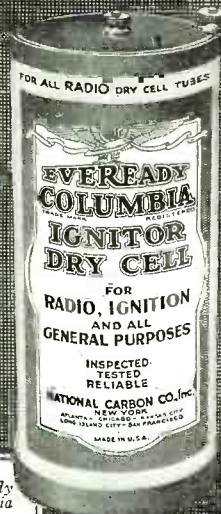

Eveready Columbia Ignitor "A" Battery, the proven dry cell for all radio dry cell tubes 1½ volts

No. 766
22½-volt
Large
Horizontal
Price
\$2.00



No. 486
45-volt
Layerbilt
Extra-Large
Vertical
Price
\$5.50

Announcing The Wilson "B" Radiopower Unit

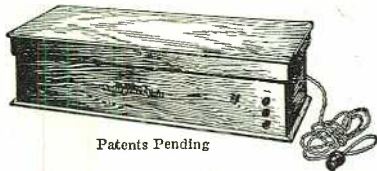

Patents Pending

This new unit will eliminate all "B" battery troubles. It is guaranteed not to set up the slightest hum.

Supplies uniform voltage at all times, insuring better reception. Nothing to adjust. No moving part to get out of order. No acid to spill. Will not affect your neighbor's set. Requires no attention whatever, except to switch it on and off as you want to use your receiver. In handsomely finished solid walnut case. Price \$35.

The Andrews Paddlewheel-Coil

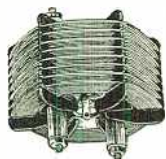

Pats. Pend.

The coil of ideal characteristics. Has exceptionally high ratio of inductance to resistance. Losses are negligible.



Gives maximum range and volume with entire freedom from distortion. Increases selectivity and greatly improves tone quality. This coil is employed in such well-known receivers as the Andrews DERESNADYNE and the BUCKINGHAM and can be used in all standard hook-ups where a high grade transformer-inductance is required. Provided with nickel plated bracket for mounting. Price \$3.00.

Our Technical Dept. will answer questions relative to the Paddlewheel Coil and its use in any hook-up. Get blueprints of well-known receivers and circuits from your dealer or write direct.

Duo-Spiral Folding Loop

Handsomely finished in silver and mahogany. Neat and compact. An ornament to your set—not an eyesore. Folds readily and can be used anywhere.



Price \$8.50

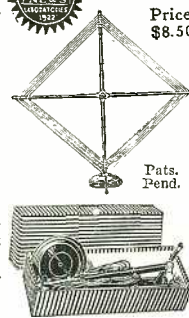

Pats. Pend.

Ideal for portable sets. Has silvered dial graduated in degrees. Helps to reduce static and cut out undesired stations. A special model for every circuit.

Write direct if your dealer is unable to supply these standard products.

Radio Units Inc.

1301 First Ave. Maywood, Ill
PERKINS ELECTRIC, LTD.,
Montreal Toronto Winnipeg

above and below resonance, it would not be adaptable to changes in speed caused by changing load and would not be practical for the generator. Neither would it be practical when used alone for rectified A.C. as the load of the filter at resonance would probably be far greater than that of the tube and the actual reduction of the ripple would be very small.

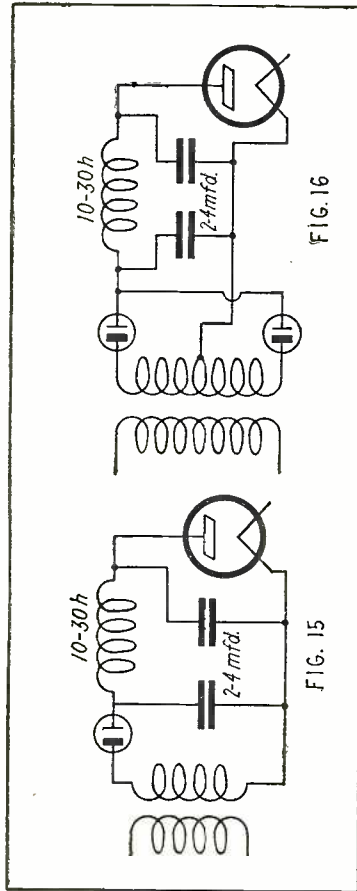

FIG. 16

FIG. 15

In the diagram there is a half-cycle rectification and in the diagram on the right full-cycle rectification.

PARALLEL CIRCUITS

Fig. 10 is the parallel resonant circuit in series with the plate. This will, of course, tend to pass all frequencies except resonant frequency. For this one frequency it will be a dead stop, except, of course, to supply the losses in the filter. For the D.C. generator it is not at all practical, as it would be necessary to have one for slot ripple and another for commutator ripple, neither of which would effectively take care of the

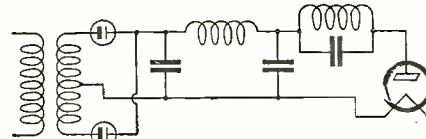

Fig. 17. To the circuit of Fig. 16 a parallel resonant circuit has been added in order to suppress any ripple that might get through to it.

moving contact disturbances. Used alone for rectified A.C., it would tend to have too great a stopping power. Used in conjunction with a smoother type filter, which has ironed out a good share of the ripple, it is ideal in removing the small A.C. component that remains.

Fig. 11 is our first approach to a good filter. It is the series resonant combination, so applied that its action is two-fold. It forms a series circuit which will readily bypass its resonant frequency. The choke tends to stop other frequencies and the condenser bypasses those that do pass through. There is another very important action that takes place in this type, an intelligent discussion of which will require us to go a

FREE!

To Each Purchaser of a WORLD 6 V. Auto or Radio BATTERY

12-Cell — 24-Volt Storage 'B' Battery

Positively given free with each purchase of a WORLD "A" Storage Battery. You must send this ad with your order. WORLD Batteries are famous for their guaranteed quality and service. Backed by years of successful manufacture and thousands of satisfied users. Equipped with Solid Rubber Cases, an insurance against acid and leakage. You save 50 per cent and get a

2-Year Guarantee

Bond in Writing Every owner "tell their friends." That's our best proof of performance. Send your order in today.

Solid Rubber Case Radio Batteries

6-Volt, 100-Amperes	\$11.25
6-Volt, 120-Amperes	13.25
6-Volt, 140-Amperes	14.00

Solid Rubber Case Auto Batteries

6-Volt, 11-Plate	\$11.25
6-Volt, 13-Plate	13.25
12-Volt, 7-Plate	16.00

Send No Money Just state battery wanted and we will ship day order is received, by Express C. O. D. subject to your examination on arrival. **FREE "B" Battery included.**

Extra Offer: 5 per cent discount for cash in full with order. Buy now and get a guaranteed battery at 50 per cent saving to you.

Approved and Listed as Standard by Leading Authorities including Radio News Laboratories, Popular Science Institute of Standards, Radio Broadcast Laboratories, Radio and Lexaf, Inc.

WORLD BATTERY COMPANY
1219 So. Wabash Ave., Dept. 10 CHICAGO, ILL.

World STORAGE BATTERIES

Set your Radio Dials at 219 meters for the new 1600 watt World Storage Battery Station, WSBG, Chicago. Watch for announcements.

WOKA - WFAF - WGN - WJS - KLU - RGO - KFAP - WJY - KOPJ

\$3 brings you this genuine AMPL-TONE Loud Speaker Unit

Ten days' free trial. Your Three Dollars unconditionally returned if at the end of ten days you are not perfectly satisfied with this Phonograph Attachment and do not find it to be of exceptional value for volume and clear reproduction.

Reverse the tips and note the difference in pitch. Will not demagnetize. Phonograph people spent years perfecting the acoustic. Take advantage and use our unit on your phonograph.

UNION FABRIC CO.
(Makers of the French Headset)
DERBY, CONN.

The Traffic Cop of the Air

FERBEND Wave Trap

Add a Ferbend Wave Trap to your Radio Set and "Police" your reception. Regulate traffic. Guaranteed to tune out any interfering station. Widely imitated but never equalled. The original and only successful WAVE TRAP. Now in its third year. Sent Postpaid upon receipt of \$8.50 or C. O. D. plus postage. Send for Free Booklet.

FERBEND ELECTRIC CO.
25 E. So. Water St. Chicago

PWX

is easy to get with the right kind of set. Profits are easy to get with the right kind of goods. Dealers write for facts.

**HUDSON-ROSS—116 S. Wells St.
Chicago**

Music Master
Resonant Wood
Insures Natural
Tone Quality

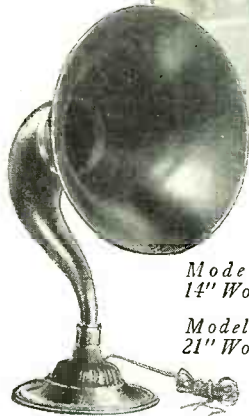

Model VI, \$30
14" Wood Bell

Model VII, \$35
21" Wood Bell

Radio, too, is now Standardized

PIONEER owners of automobiles had to try out larger magnetos, different carburetors, more accurate timers and what not else, to get some degree of motoring satisfaction!

Pioneer owners of radio receiving sets likewise experimented with different tubes, more powerful batteries, condensers and all sorts of "loud speakers," trying to balance the power of the set with the quality of the amplifier. And they found that, no matter how good their set might be, Music Master Reproducer made any good set better.

Music Master Receivers provide efficiency of radio reception equal to the quality of Music MASTER reproduction. Music MASTER makes no claim to have developed new and sensational radio "hook ups." Standardization is the accepted principle of New Era Radio, and Music Master Receivers embody the demonstrated principles of radio research and electrical science.

An authorized MUSIC MASTER dealer will demonstrate—in your home if you wish—MUSIC MASTER's power of distance, clarity and volume, ease of operation—and above all, its faithful reproduction and superb musical tone quality.

See MUSIC MASTER—hear—compare—before you buy ANY radio set.

Music Master Corporation

Makers and Distributors of High-Grade Radio Apparatus
128-130 N. Tenth Street

NEW YORK CHICAGO PHILADELPHIA PITTSBURGH MONTREAL
Canadian Factory: Kitchener, Ontario



TYPE 60

Five Tubes. Two stages of radio frequency, detector and two stages audio frequency. Selective, good volume and distance. Brown mahogany art finish cabinet. Price \$60

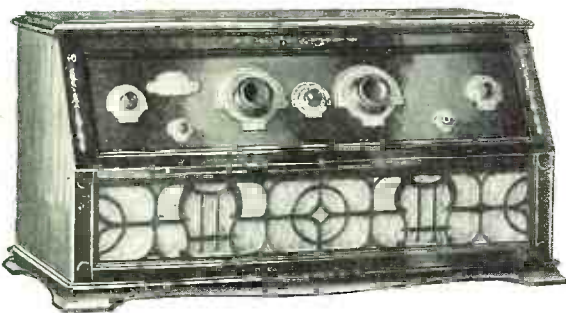

TYPE 175

Six Tubes. Special Music Master Circuit. Very selective, long distance and splendid tone quality. Built-in Music Master Reproducer. Solid mahogany cabinet in brown mahogany art satin finish \$175
Price

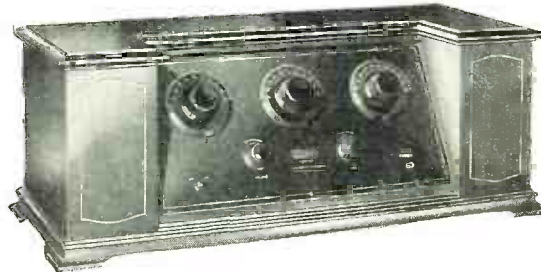

TYPE 100

Five Tubes. New Music Master Circuit, involving special adaptation to radio frequency. Very selective, good volume and distance. Solid mahogany cabinet in brown mahogany art satin finish. Price . . . \$100

Ten Models—\$50 to \$460
Guaranteed Unconditionally

(Canadian Prices Slightly Higher)

Music  **Master**
RADIO PRODUCTS

Rouse Your Bigger and Better Self to Action!

I'll help you prove to the world that you CAN succeed!



ELECTRICITY

Remember, there is no substitute for personal training in great shops.

-Will Fascinate You!
-Will Thrill You!
-Will REWARD You!

12 Happy Weeks at Coyne provides Complete Electrical Training

WHY LEAD AN INFERIOR EXISTENCE! No need to drag through life with little or nothing of this world's goods in return for your hard, earnest labor. The chances are 100 to 1 you've got the right stuff in you. You're simply got to APPLY IT IN THE RIGHT DIRECTION!

EVERY HONEST, SINCERE, WORTHY, AMBITIOUS FELLOW is entitled to an even break in life. Right now is the time to solemnly promise yourself to get rid of the jinx that's chasing you through life!

Hundreds of COYNE-Trained Men Earn \$60 to \$200 a Week

I have perfected an unusual course of instruction in Electricity, a course that is absolutely thorough, is easy to master, covers every single phase and factor of the subject, fits men for big electrical jobs—HIGH-SALARIED jobs.

RAILROAD FARE TO CHICAGO

from any point in the U. S., also extra courses in Radio Electricity and Auto, Truck and Tractor Electricity included WITHOUT EXTRA COST if you get promptly. Remember, Chicago is a wonderful city to see at any time of the year. It is a city of opportunities and the great electrical center of the world. Clip the Happiness Coupon below at once

Tune in on COYNE Radio Station WGCS

COYNE ELECTRICAL SCHOOL
 H. C. LEWIS, President Established 1899
 1300-10 W. Harrison St., Dept. 5947, Chicago

COYNE does not teach by correspondence, but by personal, practical training in the wonderfully-equipped COYNE Shops

Get full details of Special Offer of Railroad Fare and Two Extra Courses. Send the coupon at once

H. C. LEWIS, President
 COYNE ELECTRICAL SCHOOL
 1300-10 W. Harrison St.
 Dept. 5947, Chicago, Illinois

Dear H. C.: You can just bet I want one of those big handsome FREE 12x15 books with 151 actual photographs of electrical operations and shop scenes, printed in two colors. Send it quick, before the supply is exhausted. Be sure and tell me all about Special Offer of Extra Courses and Railroad Fare.

Name _____
 Address _____

little into the theory of A.C. circuits. The D.C. resistance of a good condenser is very large, usually many million ohms. Now let us consider that in Fig. 12 there is a D.C. voltage of 100 volts impressed across E. The reactance of the condenser is infinite so that, practically speaking, there is no current flowing through it. Since there is no current flowing through the inductance, there will be no IR drop through the coil and the voltage E_c will be the same as E or 100 volts. The resonant frequency for this combination 2.55 henries and 1 mfd. is 100 cycles. Now in the place of the D.C. voltage, let us substitute 100 volts A.C. Keeping the 100 volts constant, let us slowly increase the frequency. As the frequency begins to increase, the condenser begins to pass current. Very little at first, but as the resonant frequency, 100 cycles, is neared the current rises rapidly until at resonance it has become very great. As we pass beyond resonance, the current through the condenser rapidly decreases. It finally becomes even less than the very minute current that did flow when the 100-volt D.C. was applied. As resonance is approached the voltage across the condenser becomes many, many times that of the original voltage. Reaching its peak at resonance, it rapidly decreases as resonance is passed. As the frequency is increased beyond resonance, the voltage across the condenser continues to decrease, soon reaching a value that is even less than the initial ripple E. The curve of Fig. 14 shows how this voltage across the condenser changes. It is at the point marked X that the series resonant circuit may be used as an effective filter. If the load is connected across the condenser, as shown in Fig. 11, the decrease in the ripple voltage across the condenser means a decrease in the ripple across the plate. It is evident from the curve 14 that the effective application of this type requires as low a resonant frequency as possible, consider-

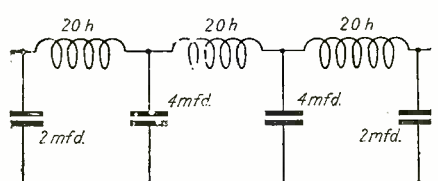

Fig. 18. The sections shown above are easier of construction than the circuit shown in Fig. 17.

ably lower than the frequencies to be filtered out. Supposing that in Fig. 11 we desired to filter out a bothersome 90-cycle ripple. The values that we have used here would not be at all practical. For at 90 cycles the ripple voltage across the condenser, which, of course, is the same as the ripple across the plate, is much greater than the ripple of the supply. That is, instead of reducing the ripple we are increasing it. It would have been much better if 20 to 30 henries had been used and at least 2 mfd. condensers. This particular type of filter is equally effective for both rectified A.C. and the D.C. generator. When so designed that the resonant frequency is far below that of any frequency to be eliminated, it is known as a "smoother" filter. It tends to reduce all frequencies above a certain point. The larger the inductances and the capacities, the better will be the filtering. The addition of a load across the condenser will change the shape of the curves of 14—but the general results will be the same.

A FILTER

In Fig. 12 we have added a condenser before our filter. This gives us practically the same performance as in Fig. 11, but, in addition, we have the unhindered short-circuit effect of the first condenser. With the generator this helps materially in the breaking-down process of the ripples in the generator. In the rectified A.C. this first

At Last!

—an indoor aerial that works even better than an outside wire!



Add hundreds of miles to your best distance records with this scientifically designed antenna. Consists of 100 wire strands insulated from one another and from moisture—covered with parchment, it rolls up.

Cuts Down Static Gives Louder Signals Greater Selectivity

Equipped with special fixed condensers, EFFARSEE gives range and volume of long aerial—selectivity and freedom from interference of short antenna. Write for testimonials from enthusiastic users.

Type IXL (large).....\$4.00
 Type BXL (small).... 2.50

At any radio dealer, —or write direct.

FISHWICK RADIO CO.
 500 Edwards Bldg., Cincinnati, O.

Obsolete

Take the "GUESS" Out of Tube Control

with **AMPERITE** \$1.10 Everywhere

Amperite automatically controls tube current, eliminates hand rheostats, filament meters, guessing and all tube worry. Simplifies wiring, tuning and operation. Permits the use of any type of tube or any combination of tubes. Tested and used by more than 50 set manufacturers and in every popular construction set.

RADIALL COMPANY
 Dept. RN-15, 50 Franklin St., New York City

Write for FREE Hook-ups

The "SELF-ADJUSTING" Rheostat

HB ONE DAY BATTERY CHARGING

Charging radio and auto batteries pays \$150 to \$300 clear monthly profits. No experience needed to operate HB One Day Battery Charging Unit. \$35 cash brings complete HB outfit. Easy terms—money back guarantee. Write for free bulletin No. 95.

HOBART BROS. CO.
 Box R9 : : : Troy, Ohio

EASILY CLEARS \$150 to \$300 MONTHLY PROFIT

ATWATER KENT RADIO

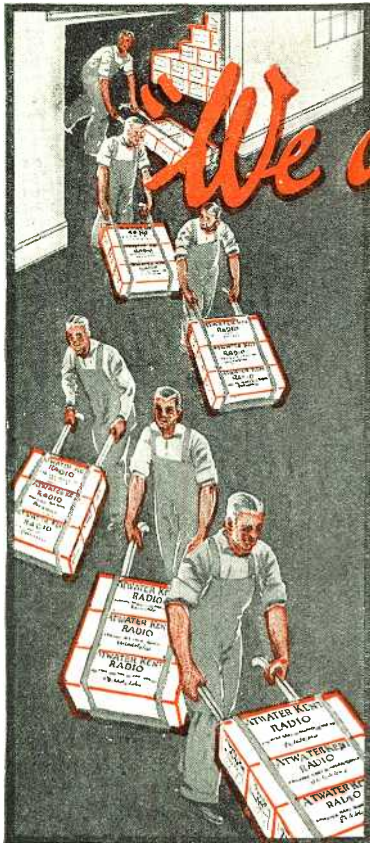

"We don't open the box"

DEALERS have been telling us what they most like about Atwater Kent Radio.

"This sums it up," one of them said: "We send the sets to our customers' homes without opening the boxes. We know they're all right. 'Inspected' means inspected when Atwater Kent says it."

Other dealers gave similar testimony. Although we advise all to open the boxes and make sure there has been no accident in transportation, it is gratifying to know that they regard it as unnecessary.

The word "Inspected" on the pink tag attached to the bottom of every Atwater Kent set is a certificate of character. It means that every set has been subjected to no less than 140 gauge and physical inspections and nineteen electrical tests. All along the line of manufacture the smallest defect is a death warrant.

Even after the "final" inspection we are constantly picking Receivers from the finished array and testing them again.

Visitors at the factory sometimes think we are too fussy. That we regard as a compliment. Every dealer knows that "fussiness" at the plant relieves the customer from fussing in the home, and makes Atwater Kent Radio easy to sell.

"It is not our fault that we sell most of that make," a dealer told us. "The people take them away. Atwater Kent Radio has a good name, fastened to the people's mind with the glue of quality."

We believe in being fussy and shall continue to be.

Write for illustrated booklet telling the complete story of Atwater Kent Radio

ATWATER KENT MFG. COMPANY
A. Atwater Kent, President
4713 WISSAHICKON AVE. PHILADELPHIA, PA.

Dealers, did you know—

THAT the farmers of the country have set down in writing their preference for Atwater Kent Radio?

The Meredith Publications and the Capper Publications recently asked the farmers: "What make of radio set do you expect to buy?" In the answers Atwater Kent was FIRST.







If you have prospects in rural districts, there's a tip for you.

Every Thursday Night—the potential audience of the Atwater Kent Radio Artists, who broadcast from ten stations every Thursday evening from 9 to 10 (Eastern Standard Time) is estimated at more than 10,000,000. These are the stations:

- | | |
|-------------------------------------|---------------------------|
| WEAF New York | WCAE Pittsburgh |
| WJAR Providence | WGR Buffalo |
| WEEL Boston | WWJ Detroit |
| WFI Philadelphia | WSAI Cincinnati |
| WCCO Minneapolis-St. Paul | WOC Davenport |

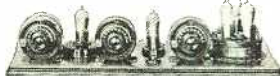

Prices slightly higher from the Rockies west, and in Canada.

				
Model L, with 9' flexible cord, \$17	Model 20, without tubes, \$80	Phonograph Attachment, with 9' flexible cord, \$8	Model 24, without tubes, \$100	Model H, with 9' flexible cord, \$22
				
Model 10, including battery cable, but without tubes, \$80	Model 20 Compact, including battery cable, but without tubes, \$80	Model 12, built on special order, including battery cable but without tubes, \$100		



Make Big Money as a Radio Expert

\$3,000 to \$10,000 a year

Yes—\$3,000 to \$10,000 a year! These are the opportunities. The chance of a lifetime. Investigate! Look into the amazing possibilities of Radio. Become the Radio expert in your neighborhood. The Radio Association of America now makes it easy for you to train for a big job, or to go into business for yourself. If you want to get away from poor pay and jobs with no future, here's your big opportunity.

We want ambitious men everywhere—to learn Radio operation, construction, installation, repairing and selling. Be our representative in your neighborhood. Find out how you can qualify in a few short months, and receive our marvelous 1000 Mile Radio Outfit given as part of your training.

Train at Home—In Three Months

Find out how, in your spare time at home, by mail, without giving up your present position or losing a dollar of pay, you can become a Radio Expert in a few short months. No previous experience necessary. The possibilities for big salaries or to go in for yourself are unlimited. In no other line have ambitious, wide-awake men the chance that Radio offers. You can now train under one of America's leading Radio authorities. Read Mr. A. G. Mohaupt's offer to train you personally in everything about Radio. By enrolling with us now, you get the benefit of the direct personal guidance of this well-known expert.



"I pledge my personal attention to every member enrolling in our Association at this time. Your individual problems and questions will be answered by me, and I will work with you at every stage of the course, guiding you till fully trained, including Government examinations for Operator's license."

A. G. MOHAUPT

A. G. MOHAUPT

Mr. Mohaupt, head of Radio Association of America, is a Graduate Electrical Engineer, University of Wisconsin; former Radio Instructor for the U. S. Government; author of "Practice and Theory of Modern Radio."

1000-Mile Radio Outfit GIVEN TO EVERY STUDENT

Mail the coupon now for all the facts and free information. Let us prove to you that Radio is easier to learn and offers bigger money than any other business or profession that you can get into. Don't wait. Act while our Special Offer of a 1000-mile receiving outfit is still in effect.

RADIO ASSOCIATION OF AMERICA, 4513 Ravenswood Ave., Dept. 1510, Chicago.

Please send me details regarding your Expert Home-Training Plan and offer to representatives, also your offer of a 1000-mile Radio Set.

Name
 Address
 City State

condenser acts as a bypass for ripple, and also returns energy to the circuit during the half-cycle interruptions caused by the rectifying action. This particular type of filter has worked out to be the most practical for both the D.C. generator and the rectified A.C. supply. The curves of Fig. 13 show the comparative effects of the two parts of this filter. A is the bypass effect and B is the change in the voltage across the plate. They were taken with a 1-henry choke and a 1-mfd. condenser. A great deal of improvement in this last type may be obtained by placing several similar sections in series. That is, taking what ripple is left from one section and further reducing it in another section. When this is done, the inner capacities must be equal to twice the outer or end capacities. See Fig. 14a. The mid-condensers may be two of the outer type in parallel or may be single condensers of twice the capacity of the end condensers.

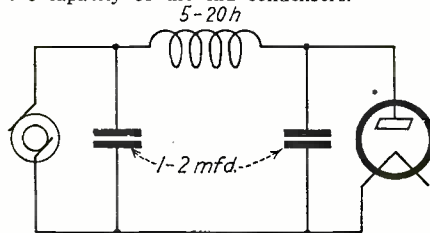

Fig. 19. The "pi" type of filter, used with a generator. Small values of capacity and inductance may be used, because of the higher frequency of the ripples.

There are a countless number of composite filters that can be made by using the various types of sections. The limit in variation is governed by the pocket-book. However, the more complicated may not, by any means, be the most efficient. The writer has purposely avoided mention of several other popular types of sections which, while good, have not worked out in practice as well as the "pi" type of section described above.

PRACTICAL APPLICATIONS

Figs. 15 to 21 show some practical applications of the foregoing. In 15 we have the half-cycle rectification and in 16 the full-cycle rectification. In 17 a parallel resonant circuit has been added. The resonant frequency of this should be that of the supply. This then acts as a trap for what little ripple the main section does pass. For 60 cycles the product of LC would be approximately 7.02, if L is in henries and C is in microfarads. Unless one is in a position to make his own inductances, or has a small choke of about 2 to 3 henries with an adjustable air-gap, this type of trap will be difficult to make. It would probably be easier to resort to sections as shown in Fig. 18, than try to obtain a ripple trap. The average amateur requirements will rarely necessitate more

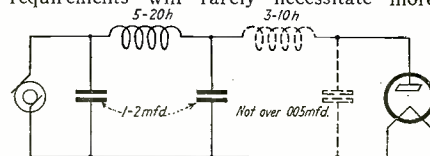
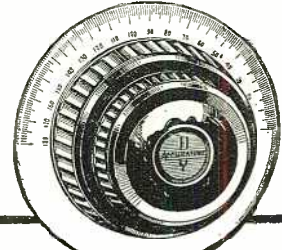

Fig. 20. An audio frequency choke may be used to reduce the higher voice frequencies. A small R.F. bypass condenser should also be used as shown.

than one section. Fig. 19 shows the "pi" type of filter used with a generator. Here, of course, it is not necessary to have such large values of inductance and capacity as the ripples are all of fairly high frequency, usually above 300 cycles. A fairly large choke is usually required to take care of the moving contact noises. If the Heising system of modulation is to be used, large condensers across the supply will tend to short-circuit the higher voice frequencies. This applies to both generator and R.A.C. supply. The difficulty may be overcome by the addition of an audio frequency choke, as shown



Patented April 21, 1925
 Other U.S. and Foreign Patents Pending

The last word in tuning devices

When a micrometer control is so delicately geared that it seeks out and brings in the most elusive stations within the scope of your set with deadly accuracy, and with ease, we feel that it fully deserves to be referred to as "the last word in tuning devices". Such is the Accuratune. Incidentally, it can be quickly substituted for ordinary dials without alteration of your set.

MYDAR RADIO CO.
 7 CAMPBELL ST., NEWARK, N.J.



PATENTS

To the Man with an Idea

I offer a comprehensive, experienced, efficient service for his prompt, legal protection and the development of his proposition. Send sketch or model and description, for advice as to cost, search through prior United States patents, etc. Preliminary advice gladly furnished without charge. My experience and familiarity with various arts frequently enable me to accurately advise clients as to probable patentability before they go to any expense. Booklet of valuable information and form for properly disclosing your idea free on request. Write today.

RICHARD B. OWEN
 PATENT LAWYER
 2 Owen Building, Washington, D. C.
 41A Park Row, New York City

The EAGLE Neutrodyne RECEIVER

is "King of The Air"



Write for literature.

Insure your copy reaching you each month. Subscribe to RADIO NEWS—\$2.50 a year. Experimenter Publishing Co., 53 Park Place, N. Y. C.

Balkite

Radio Power Units

the ideal power supply for any radio set

FOR THE "A" CIRCUIT

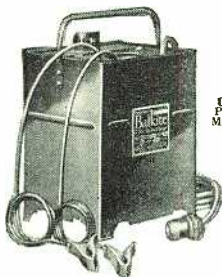

U. S. Patent
May 27, 1924

The Balkite Battery Charger

The most popular battery charger on the market. It can be used while the radio set is in operation. If your battery should be low you merely turn on the charger and operate the set. Charging rate 2.5 amperes. Operates from 110-120 AC 60 cycle current. Special model for 50 cycles.

Price \$19.50
West of Rockies, \$20
In Canada \$27.50

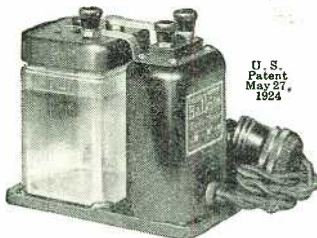

U. S. Patent
May 27, 1924

The Balkite Trickle Charger

Charges both 4 and 6 volt radio "A" batteries at about .5 amperes. Usable in 3 ways: (1) As a regular charger with a low capacity storage battery for sets now using dry cells. (2) With storage battery sets of few tubes. Furnishes more current than used by 6 dry cell or 2 storage battery tubes, so that if used during operation it need be used at no other time. (3) As a "trickle" or continuous charger for storage battery sets of as many as 8 tubes. Sizes 5 1/2 in. long, 2 1/2 in. wide, 5 in. high. Operates from 110-120 AC 60 cycle current.

Low capacity batteries especially adapted for use with this charger with sets now using dry cells are being offered by practically all leading battery manufacturers this fall.

Reputable manufacturers are also offering this fall for use with this charger special switches which turn on Balkite "B" and turn off the charger when you turn on your set. This makes the current supply for both "A" and "B" circuits automatic in operation.

Price \$10
West of Rockies, \$10.50
In Canada, \$15

Balkite Radio Power Units are the ideal power supply for any radio set. They simplify and improve radio reception. They reduce the amount of attention you must give your set. With their use your current supply is always exactly what is required for each circuit.

For the "A" circuit there are the Balkite Chargers. Because of its obvious advantages the Balkite Battery Charger is the most popular charger on the market. Entirely noiseless—it is the only charger commonly used while the set is in operation.

For sets of smaller "A" current requirements—any dry cell set or sets of few storage battery tubes—there is the Balkite Trickle Charger. With a low capacity storage battery it enables owners of sets now using dry cells to make a most economical installation.

For the "B" circuit there is Balkite "B"—the outstanding development in radio. It eliminates "B" batteries entirely and supplies plate current from the light socket. It fits any set of 5 tubes or less. For sets of six tubes or more there is Balkite "B" II, the same popular model offered last year.

Noiseless—No bulbs—Permanent

All Balkite Radio Power Units are based on the same principle. All are entirely noiseless in operation. They have no moving parts, no bulbs, and nothing to adjust, break or get out of order. They cannot deteriorate through use or disuse—each is a permanent piece of equipment with nothing to wear out or replace. They require no other attention than the infrequent addition of water. They do not interfere with your set or your neighbor's. Their current consumption is remarkably low. They require no changes or additions to your set.

An "A" battery, a Balkite Charger and a Balkite "B" constitute the most advanced power equipment on the market, one that is economical, unailing in operation, and eliminates the possibility of run-down batteries.

Manufactured by FANSTEEL PRODUCTS COMPANY, Inc.
North Chicago, Illinois

FANSTEEL

Balkite

Radio Power Units

FOR THE "B" CIRCUIT



U. S. Patent
May 27, 1924

Balkite "B"

Eliminates "B" batteries. Supplies plate current from the light socket. Operates with either storage battery or dry cell tubes. Keeps "B" circuit always operating at maximum efficiency, for with its use the plate current supply is never low. Requires no changes or additions to your set. No bulbs—nothing to replace. Requires no attention other than adding water about once a year.

A new model, designed to serve any set of 5 tubes or less. Size 8 1/4 in. long, 8 in. high, 3 1/4 in. wide. Occupies about same space as 45 volt dry "B" battery. Operates from 110-120 AC 60 cycle current.

Price \$35
In Canada, \$49.50



U. S. Patent
May 27, 1924

Balkite "B" II

The most outstanding development in radio last season. Same as the new Balkite "B" but will fit any set including those of 10 tubes or more. Current capacity 40 milliamperes at 90 volts. Size 9 in. high, 6 1/4 in. wide, 7 1/2 in. deep. Operates from 110-120 AC 60 cycle current. Special model for 50 cycles.

Price \$55
In Canada, \$75

The Unipower, manufactured by the Gould Storage Battery Company, is equipped with a special Balkite Radio Power Unit.

Practicoat



AMERICA'S GREATEST
KNIT JACKET VALUE!

Practicoat

IT'S worth broadcasting—the story of the Practicoat. Tune in on this manly garment and enjoy its comfort, its sturdiness, its good looks.

A chummy, friendly garment that fits snug and wears long. Only \$5.00—and guaranteed to satisfy you.

If your dealer hasn't it, order direct through us.

Manhattan

KNITTING MILLS
8-14 West 30th Street
New York City

Mens
Sizes
\$5

Boys
Sizes
\$4

in Fig. 20. A small radio frequency bypass condenser should be used, as shown. Fig. 21 shows the application of the filter to the double commutator generator.

The basic principles for an effective filter for either the generator or rectified A.C. supply are:

1. Use a low-pass smoother filter with a resonant frequency as low as possible, at least one-third of the lowest frequency to be filtered.
2. Have the inductance as large as is practical from an economical and resistance standpoint.
3. Add another smoother section, if necessary, rather than a tuned section to a smoother filter.

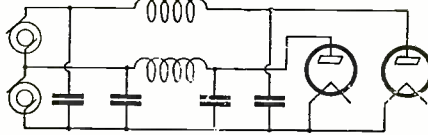

Fig. 21. The application of the filter to a double commutator generator.

The rapidly increasing popularity of the distributed field winding type of generator, which is usually separately excited, perhaps warrants a last-minute note on separately-excited generators. The separately-excited generator adds several more ripples to the plate supply. These are slot and commutator ripple of the exciting machine and the resultant beat wave of the four ripples. Bonding the two negative terminals of the generator and exciter and grounding will help. A bypass condenser should be placed across the fields of both generators for protection. If the exciting generator is coupled to the high voltage generator shaft so that the two slot ripples bear the same phase relation to each other at all times, the resulting beat ripple may be materially changed by reversing the polarity of the exciting field. This is especially noticeable where both machines have the same number of slots in the armature. The proper setting of the coupling and the polarity of the field will reduce the ripple an amazing amount.

I Want to Know

(Continued from page 464)

amplification (shown in dotted lines) detection, three stages of audio frequency amplification (shown in solid lines). A unit of tube amplification of two has been assigned. That is, one volt on the grid of the first tube becomes two volts on the plate, because of the "amplification constant" of the tube being (assumed) two. Two volts on the grid of the second tube becomes four volts on the plate of that tube. (The two volts

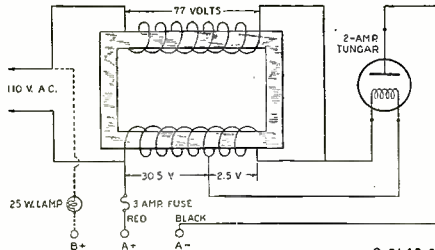

Charging "B" batteries by means of an "A" battery-charger of the regular 2-ampere or 5-ampere type.

grid input, amplified by the "amplification constant" of two, becomes four volts, or the amount of voltage at the plate.)

It must be understood at the start that the values shown in Q. 2146-A, Q. 2146-B, Q2146-C and Q. 2146-D are not actual values secured in practice, but arbitrary figures taken to give a representation of the relative conditions existing in four types of reflex circuits. For example, we have shown that the same rate of amplification progression is being used for currents at both radio frequency and audio frequency, which is not the case in practice. To give practical figures would not convey the relative information in quite the desired manner.

From careful consideration of Q. 2146-A it is

100 RADIO HOOK-UPS

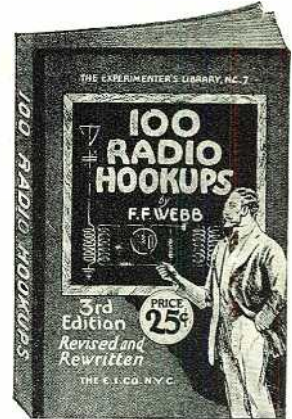

3rd Edition

Completely revised
rewritten and
enlarged.

16 Pages of the
Latest Hook-ups Added

The most complete, practical and up-to-date radio hook-ups book obtainable. Revised and brought up to the minute by one of the foremost radio engineers in the industry.

Contains only practical, efficient hook-ups. Crystal sets, one tube sets, reflex, regenerative, radio frequency, and super circuits.

Gives complete wiring diagrams and full instructions on each and every set so that nothing further is needed in the way of patterns or diagrams.

One of the finest books to have on hand at all times for reference as to the various types of hook-ups and the most practical way of constructing each. Send for or buy a copy today.

All Orders Filled
Within 24 Hours
You Can Obtain a Copy
at All Reliable Radio
and Newsdealers



Prepaid

E.I. Company

CONSRAD COMPANY, Inc.

Selling Agents

233 Fulton St., New York

Selling Customer Satisfaction

When you sell a set of both "A" and "B" Willard Radio Batteries you have given your customer:

- 1 Batteries which with an occasional recharge will last for years.
- 2 Batteries which maintain their voltage throughout the charge, and can be easily recharged.
- 3 Batteries which are an absolutely even source of power.
- 4 Batteries in which there is practically no electrical leakage from cell to cell or from cell to ground.
- 5 Batteries which are easy to hook up, for Willards have standard Fahnestock clips.
- 6 Batteries which are entirely free from shelf wear.

WILLARD

RADIO

BATTERIES

In addition you have made a clean sale which will not involve further attention or service on your part.

Read the details of our new and practical plan for merchandising storage batteries through radio dealers. These are given in the small print at the side of this advertisement.

Willard Storage Battery Co.
Cleveland, Ohio

The Right Selling Plan for Radio Dealers

Your local Willard Service Station will act as your jobber on Willard Radio Batteries.

This means a quick source of supply of strictly fresh, well charged batteries which you can turn over to your customers in the pink of condition.

No servicing problems for you. Your local Willard Service Station assumes the responsibility for service.

Willard Radio Batteries will be advertised more extensively than ever this fall. Have your local Willard Service Station show you

this advertising and explain the details of this new and practical plan for selling radio storage batteries. The advertisements will be signed:

Sales and Service thru
The Willard Battery men
— and their —
Associate Radio Dealers

Appropriate signs and window cards will identify you as an Associate Dealer. Booklets and other valuable selling helps will also be furnished.

Your Nearest Willard Service Station is Your Nearest Willard Jobber



PRICE
\$47.50

Perfected with specially designed RCA Tube

The Super-Ducon replaces the "B" battery, operates from the light socket (110 to 125 volts 60 cycle A.C.) and is absolutely noiseless when properly installed.

Every radio man knows the results he gets when his "B" battery is at its best. The Super-Ducon gives him this top-notch volume *all* the time.

As now furnished, the Super-Ducon has a specially designed R.C.A. tube—Rectron U.V. 196, which has an average life of more than 1,000 hours.

Tested and listed by the National Board of Fire Underwriters

Dubilier

CONDENSER AND RADIO CORPORATION

Write for descriptive booklet. Address 4377 Bronx Blvd., New York City

ROBISON'S Manual of RADIO TELEGRAPHY and TELEPHONY 6th Edition Recently Revised

This book, written for the U. S. Navy, first appeared in 1907, the author being Lieutenant (now Admiral in command of the U. S. Fleet) S.S. Robison, U. S. Navy. This edition has been revised and brought up to date by Commander S. C. Hooper, U. S. Navy, Radio Officer of the U. S. Fleet. A review of this book (which contains 895 pages covering the entire subject of radio) appears in this issue of Radio News.

Price \$8.50 Postpaid

Send checks or money orders to Secretary-Treasurer, U. S. NAVAL INSTITUTE, ANNAPOLIS, MARYLAND, U. S. A.

SPECIAL OFFER: Send \$2.00 additional and the "Storage Battery Manual, Including Principles of Storage Battery and Design, 1920," by Lieut.-Comdr. L. C. Dunn, U. S. Navy, will be sent postpaid. This book of 391 pages ordinarily sells for \$7.00.

RADIO BOOKS AND PATTERNS

The Consrad Company has a complete line of radio books and patterns for every man who owns or operates a radio receiver or transmitter.

WRITE FOR FREE CATALOG

The Consrad Company, Inc., 233 Fulton St., New York City.

seen that the last amplifier tube, the third from the left, is carrying the maximum radio frequency load, the load due to the successive and cumulative amplification of the first two tubes. And that third amplifier tube is also carrying the maximum audio frequency load, due to successive and cumulative amplification by the same first two tubes, of the detector output (which output is current at audio frequency). This is a representation of straight reflex operation, using a tube detector. If a crystal detector is used, the general operation is identical. It is claimed by the Inverse Duplex exponents that the total power handled by the third amplifier tube is so great as to cause inefficient operation; that the loads being unbalanced, the operation of the circuit must of necessity be poor, as compared to a circuit containing an equal number of tubes operating in a more balanced manner, such as when the Inverse Duplex circuit is used. This contention we will not pass judgment upon now. At a later date we expect to state the arguments of the "ayes" and "nays."

Q. 2146-B shows the action in the Acme reflex, a receiver that has proved very efficient in practice. It is seen that there are only two reflexed tubes, the second and third, to carry a dual load. Although the third tube carries the maximum radio frequency current, it does not carry quite the maximum audio current. The fourth tube does nothing but amplify at audio frequency and it is this tube that carries the maximum audio frequency current. A crystal detector is used in place of a tube detector, for various practical reasons. Theoretically, a tube detector can be used, but practically it is, generally, inadvisable. The first tube amplifies only at radio frequency.

Q. 2146-C illustrates the principle of the Inverse Duplex system. A tube detector is shown, but it is extremely difficult to construct a practical receiver using a tube detector, for the (unstated) reasons obtaining in the previous cases. That the commercial Grimes set does this is a feather in the manufacturer's cap. It is seen that the first of

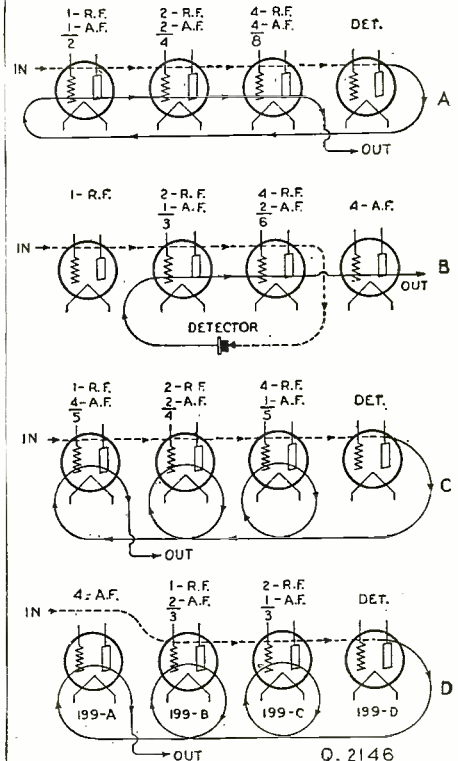

The sequence of amplification in four different circuits is depicted above.

the amplifier tubes, of which there are three, carries the minimum radio frequency current and the maximum audio frequency current; the last amplifier, the third tube, carries the maximum radio frequency current and the minimum audio frequency current, thus, it is claimed, equalizing the load imposed on the tubes.

Q. 2146-D illustrates the principle involved in a more practical design of the apparatus (the set to be described), still using the Inverse Duplex principle of "balanced amplification." Only two tubes are reflexed (the UV-199 or C-399 tubes marked "199-B" and "199-C"), one tube being used only for amplification at audio frequency ("199-A") and the advantages of a tube detector being secured through the use of "199-D" as such, through very careful circuit design.

The Schematic Diagram

This is Q. 2146. The first radio frequency amplifier tube is "199-B," reflexed as the second audio frequency amplifier tube. The second radio fre-



**THE WONDER SETS
5-TUBE RADIO FREQUENCY**

TYPE A
\$60
No. 1050

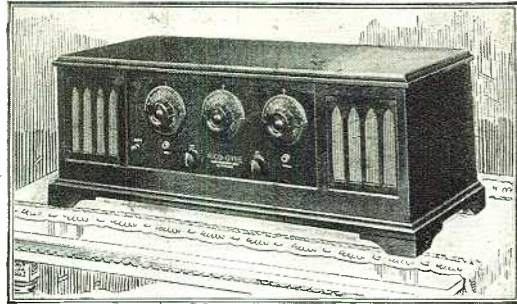
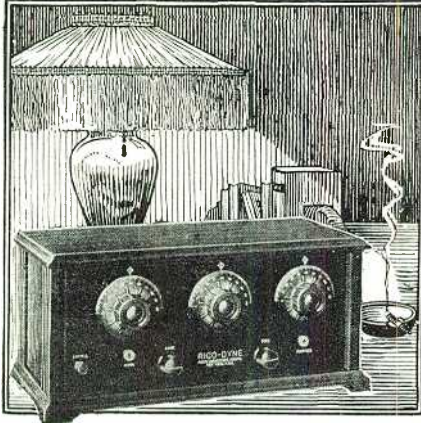

TYPE B
De Luxe
\$75
No. 1080

De Luxe Model

**The Marvelous Tone Inexpensive Receivers
in Solid Mahogany Cabinets**

The combination of Rico Celluweld Low Loss Coils and Variable Condensers is made mechanically perfect. The Coils are welded firmly to the support of the rotor plates, a new principle. (Patents Pending.)

Selective and non-oscillating, the Rico "Auto-Balanced" Tuned Radio Frequency Set accomplished by carefully setting the neutralizing angle of the Coils at the factory; remains permanent due to the Celluweld process.

These and other features are all combined to give the radio buyer the very finest in improved 1925 Receivers.

Type A—RICO-DYNE STANDARD

The Rico-Dyne Standard embodies all the features listed above and is enclosed in a beautiful solid mahogany cabinet, presenting a beautiful appearance in any home.

Type B—RICO-DYNE DE LUXE

The De Luxe Model is also enclosed in a beautiful mahogany cabinet, but extra space is provided for the wonderful "Melotone" loud-speaker unit and all batteries—what more could one ask?

The Masterpiece of Them All

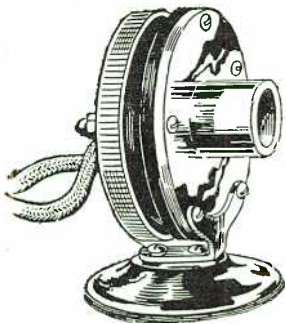

Melotone Unit

Melotone—the perfect reproducing unit—for loud speakers, phonographs, etc.—is a standard Rico-Dyne product that is guaranteed by the complete success of thousands now in use. Melotone is known throughout the radio trade. It is used everywhere. It has all the qualities of \$10 and \$12 units.

Price - - - \$7.50

Rico-Phones

None Better—
Don't pay more—
A headset of real
value.

Price - - - \$2.95



DEALERS—JOBBER—DISTRIBUTERS

Wire immediately for our interesting new sales proposition

RADIO INDUSTRIES CORP., 131-133-137 Duane Street, New York, N. Y.
Export (Ricotrade, N. Y.) Cable Address Bently Code Used

The HAMMARLUND Straight-Line-Frequency Condenser

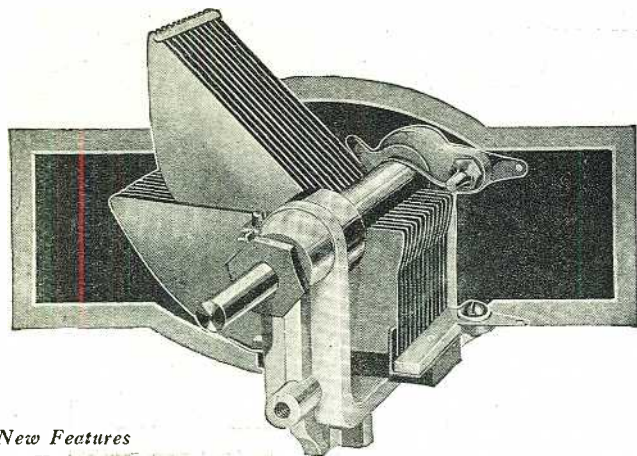

These New Features Maintain Hammarlund Leadership

Straight-line Frequency, spacing stations equally over dials.

Single-hole mounting.

Only one small strip of highest quality insulation, placed outside of electrostatic field.

Ball-bearings at both ends of rotor shaft.

Soldered brass plates, chemically treated against corrosion.

Heavy aluminum non-warping frame, grounded through rotor.

Separate "hand-capacity" shield, supplied for use if needed.

New adjustable balancing device.

Tie bars on rotor and stator plates assure permanent accuracy of spacing.

Distributes Stations Evenly Over Your Dials

THE great radio development for 1926 is the S-L-F Condenser. It was inevitable, owing to the multiplicity of broadcast stations and the inability of old-type condensers to separate them properly.

The public erroneously classifies radio stations according to wave-lengths, whereas they operate actually on particular frequencies allotted by the Government, ten kilocycles apart. The peculiar shape of the S-L-F Condenser plates is designed to separate and evenly distribute these frequency groups over the dials.

The new Hammarlund S-L-F Condenser is an engineering masterpiece, with that superior neatness of design and electrical efficiency always distinguishing Hammarlund workmanship.

It is more compact and will stand more abuse than any condenser of similar type.

Made in all standard capacities
Write for descriptive folder

HAMMARLUND MANUFACTURING COMPANY
424-438 West 33rd Street New York



quency tube, "199-C," acts also as the first audio frequency amplifier. "199-D" is the detector, while "199-A" is a third stage audio frequency amplifier, to be used only on weak signals; strong signals easily overload this tube, causing considerable distortion. Standard storage battery tubes could probably be used, but entirely different coil and (fixed and variable) condenser capacities would be required, values not known at this writing.

The Audio Frequency Circuit

The first audio frequency transformer, "T-1," of special make, has a voltage step-up ratio of 2:1. Any other transformer having the same ratio can be tried. Jefferson "Star" transformers, the ratio of which is 3:1, are the second and third audio frequency transformers (respectively, T-2 and T-3). The "Star" is obtainable in a 6:1 ratio, but is not the one desired in this circuit.

The first thing most people will notice is that audio frequency transformers "T-2" and "T-3" do not have their primaries connected as indicated by the letters on the transformers. The primary connections have been reversed. This is usually called "changing the phase." The makers of this set call it "timing the audio frequency current phase with respect to the radio frequency current phase." This proceeding seems to be essential in reflex circuits and is done in, for example, the Acme reflex mentioned above. The proper connection for the primary of transformer "T-1" is most easily determined by reversing the two primary leads and noting the result.

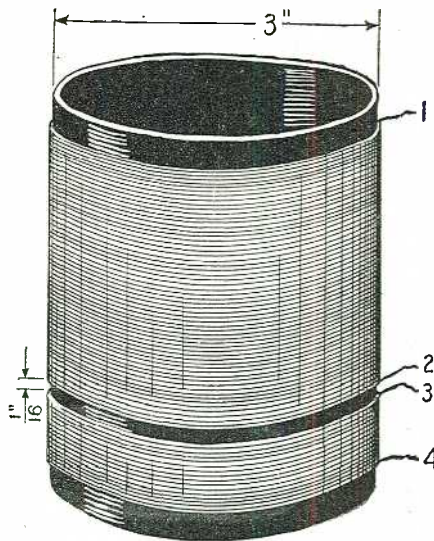

Q-2143 A

A standard two-coil unit. This may be used in a great many different circuits and sets. This is a convenient coil for tapping or otherwise altering.

The one-quarter megohm leak connected across the secondary of "T-1" may need to be of a different value. Making this resistance variable results in a flexibility much to be desired (in an experimental receiver).

The Radio Frequency Circuit

"Astatic" coils are used in this receiver. They are probably recognized more quickly when stated to be of the "Binocular" type. Each tuned radio frequency transformer presents the appearance of a couple of misplaced steamboat smokestacks (of rather small dimensions). "Binocular" is the trade name used by a different manufacturer of coils of the same general appearance. The particular ones to be described, not to be outdone in the matter of trade name, are known as "Twin Cylinder" coils. This "automobilish" effect is further heightened by calling the volume control switch the "Gear Shift Switch"! By the way: Although a nice, expensive switch is used for "Volume Control," a regular double-pole, double-throw switch can be used in a "breadboard" receiver (a receiver built on a baseboard and sans cabinet, sans panel and sans everything else but the essentials).

The principle of the astatic coil was quite fully discussed on pages 1876 and 1877 of the April, 1925, issue of RADIO NEWS. Some makes of astatic coils have the secondary wound on two different tubes, and the primary wound on only one. All the Grimes coils, however, have not only 2-section secondaries, but 2-section primaries as well. The advantages of the astatic coil are mainly two: The units X, Y and Z do not pick up the radiations of local broadcast stations (an objection to large-dimensional, solenoidal transformers), and there is no inductive transfer of energy from unit X, Y or Z to unit X, Y or Z; no "radiation" from a unit. (These points hold also for toroidal windings, but these are a higher loss type of inductance than these twin-cylinder coils.) The astatic coil is a high-loss form of inductance, as judged by our present standards, but it seems from the performance

Aeriola X Crystal Set

\$12 Complete with

100 ft. aerial wire, 25 ft. ground and lead-in wire, aerial insulators, porcelain tube, lead-in strip, ground clamp, nail-tite knobs, set head phones. (Without accessories, \$6.00.)



MONEY BACK GUARANTEE

Send for FREE Descriptive Booklet.

CRAIN BROS. RADIO SHOPPE

2304 Telegraph Avenue : : Oakland, Calif.

\$3 DOWN AFTER TEN DAYS TRIAL FOR THIS LONG WEARING BALL BEARING **L.C. SMITH**

NO RED TAPE - NO DELAY
Test this wonderful typewriter in your home or office 10 days. *Send No Money.* If you are not satisfied it is the best buy you ever made, your express agent will refund your \$3 deposit.

LOWEST PRICES ever made on the world famous L. C. Smith - full size - all late style operating conveniences - absolutely highest quality rebuilt - 5 Year Guarantee. *Small Monthly Payments.*

FREE: Course of Instruction, Tools, Waterproof Cover, all free to you now. Send today for New Special Offer and Booklet of valuable typewriter information. Smith Typewriter Sales Corp. 237-360 E. Grand Av., Chicago

Insure your copy reaching you each month. Subscribe to Radio News—
\$2.50 a year. Experimenter Publishing Co., 53 Park Place, N. Y. C.

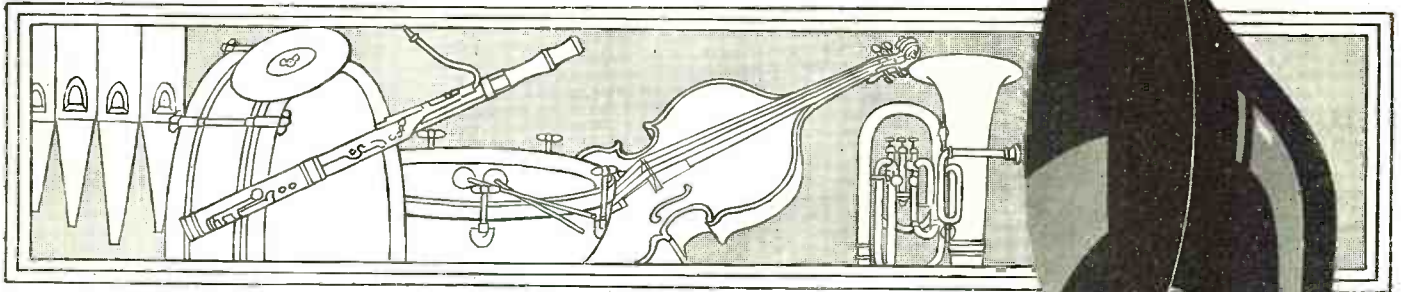

The New Large Diaphragm



Bring in the Deep Bass Notes

THE new Super Unit is a diaphragm of broad pitch range, especially designed by Bristol engineers. It reproduces the high and low notes with equal truthfulness, and, therefore, evens up the entire musical scale of either voice or instrumental music. Often the harmonics of a wonderful ensemble have been destroyed by the persistent loss of high or low notes, and the annoyance attributed to a faulty receiver when, in fact, the trouble lay wholly with the loud speaker. The Bristol Audiophone Loud Speaker with its new Super Unit of broad pitch range, and its exceptional voice of scientific development, tells the whole tonal truth and nothing but the truth.

There are four Bristol Loud Speaker models both horn and cabinet type, priced at \$15.00 to \$30.00.

If your dealer does not carry the Bristol line, send for our illustrated folder 3025-S. We will also send free a most instructive booklet, "How To Select Your Loud Speaker."

The Super Unit with the new Low Pitch Diaphragm.

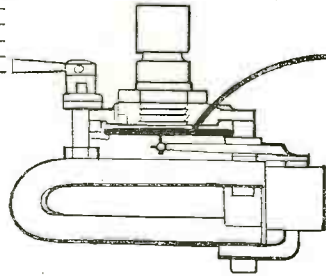

Model S Audiophone \$25.00

Rubber horn 14½ inches in diameter. Black mat finish with silvered base decoration.

Models S and C (the Cabinet Model), are equipped with the new Super Unit.

BRISTOL TRADE MARK AUDIOPHONE REG. U.S. PAT. OFFICE Loud Speaker

The Bristol Company Waterbury, Connecticut

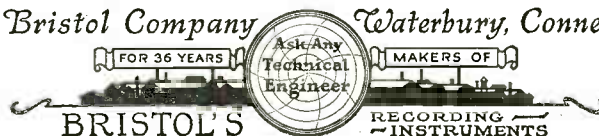



TRIMM Entertainer is a high quality speaker at an intermediate price. Its full throated Volconite Horn tapers gently from a diameter of 1/2 inch at the opening to that of 12 inches at the bell. The diaphragm of the unit is extra large, and this combination insures that all the tones, from high of violin to low of organ, are reproduced with a fidelity comparable only to those of the concert being broadcast.

Excellence of performance is an outstanding mark of a TRIMM product. That it is guaranteed to you for a lifetime means full protection. Be sure to investigate the complete TRIMM line before purchasing any reproducer.

TRIMM	
Superior Reproducers	
HEADSETS	
Professional - -	\$5.50
Dependable - - -	4.40
PHONODAPTERS	
Giant Unit - - -	\$10.00
Little Wonder - -	4.50
SPEAKERS	
Home Speaker - -	\$10.00
Entertainer - - -	17.50
Cabinette - - - -	17.50
Concert - - - - -	25.00
Chello - - - - -	30.00



of this radio receiver that proper design of the equipment can overcome, in great part, the objectionable features of the construction.

Now for the data: Primary, No. 28 S.C.C. wire. Secondary, No. 26 enameled. Winding directions are clearly indicated. All secondaries consist of 128 turns, 64 turns on each hard rubber. 1 1/2-inch tube. Of course, there are two tubes to a unit. Only the secondary turns are wound in a 40-to-the-inch thread, or groove. The experimenter may try D.C.C. wire, closely wound, instead of enameled wire, groove-spaced. Each secondary is split evenly so as to make room for the primary winding, which is spaced from the secondary by the distance of only one turn of wire. The first transformer, X, has a primary of 32 turns (16 turns on each tube, with 32 sec-

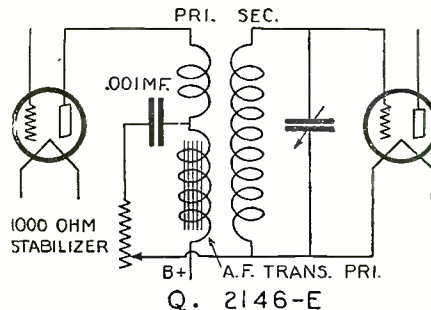

The method of oscillation control used in the type 4-DL reflex set.

ondary turns on one side and 32 secondary turns on the other), tapped start-4-8-16-32. This is the antenna compensator and the switch arm position for best results will depend upon individual aerial installations. The primary of unit Y consists of 24 turns evenly divided between the two tubes. Unit Z has a 32-turn primary similarly apportioned, one-half to each tube. Each two coils may be placed in any convenient manner, just so they parallel one another, with a 1/2-inch separation between each two coils comprising a radio frequency transformer unit.

195 to 350 meters is the range of this coil (and .0005-mfd. variable condenser) design.

We are more accustomed to reading of four, five and six turns as comprising the primary winding of the average tuned radio frequency transformer. Thirty turns seems an astonishingly large number. Circuit oscillation due to feed-back, and consequent radiation of a shrill whistle, is prevented by normal coil loss and by the 1,000-ohm stabilizing resistance, a Central Radio Laboratories unit, non-inductive and of the lowest possible capacity. From a study of detail "Q. 2146-E" it is seen that the circuit is so arranged that a .001-mfd. fixed condenser is connected from the plate side of one of the audio frequency transformer primaries, to "C" minus. This by-passes the radio frequency currents around this transformer winding and around the "B" battery. However (that word comes in mighty handy), the by-passed radio frequency energy is compelled to go through the 1,000-ohm stabilizer and the loss, or energy absorption, in this instrument is made sufficient to prevent strong circuit oscillation, but not so great as to prevent a certain amount of regeneration (that mysterious genius that hides in vacuum tube circuits and, assisted by the "B" battery, makes mighty watts out of tiny micro-micro-watts), the saving feature of 95 per cent. of the circuits of today.

Feature Summary

Summed up, the special points of the Renaissance Model, Grimes Inverse Duplex Receiver, incorporating the 4-DL circuit, will "stack up" about like this:

1. Designed for UV-199 or C-399 type tubes.
2. Tube detector.
3. Astatic tuned radio frequency transformers.
4. Separate detector "B" battery.
5. Aerial length compensation.
6. Three stages of audio frequency amplification.
7. Self-contained (excepting aerial, ground and loud speaker).
8. Non-radiating circuit.
9. Double duty (reflex) operation of two of the tubes, in the Inverse Duplex manner.
10. Negative grid bias (high "C" potential) on all amplifier tube grids.
11. Optional use of loop or antenna.
12. Circuit radiation control ("Stabilizer").

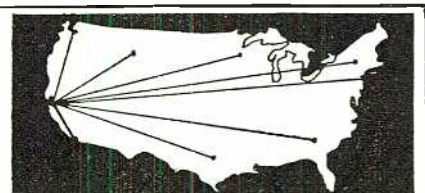

ON ONE TUBE

BIG FREE BOOKLET tells the story. California users of CROSS COUNTRY CIRCUIT hear Atlantic Coast, Canada, Mexico, Cuba and Hawaii. Our new plan makes this set easiest and cheapest to build. One hour puts in operation. One tuning control. No soldering. Any Novice can do it. BOOKLET FREE or complete instructions 25c.

Vesco Radio Co., BOX DRN-117, OAKLAND, CALIF.

9-825



BLUEBIRD RADIO TUBES

— are powerful — sensitive for distance, give clear volume and long service.

GUARANTEED

to work in Radio Frequency, Neutrodyne, Super Heterodyne and Reflex.

WITH BAKELITE BASE

Type 401A All Standard Types
Type 400 \$2.00
Type 499
Type 412

Also 499A with Standard Base 202-5 Watt Transmitter \$3.00

When ordering mention types Shipped Parcel Post C.O.D.

BLUEBIRD TUBE CO. 200 Broadway Dept. N New York

Esperanto Broadcast Lessons

(Continued from page 433)

100, cent; 1,000, mil; 1,000,000 miliono, 1,000,000,000, biliono, etc. 123, centdudektri; 294, ducentnaudek kvar, 1925, mil naŭ cent dudek kvin.

Ordinal numbers simply add the adjective ending, a, to the cardinals: Unua,

Insure your copy reaching you each month. Subscribe to Radio News— \$2.50 a year. Experimenter Publishing Co., 53 Park Place, N. Y. C.

"THE TUBE WITH A PEDIGREE"

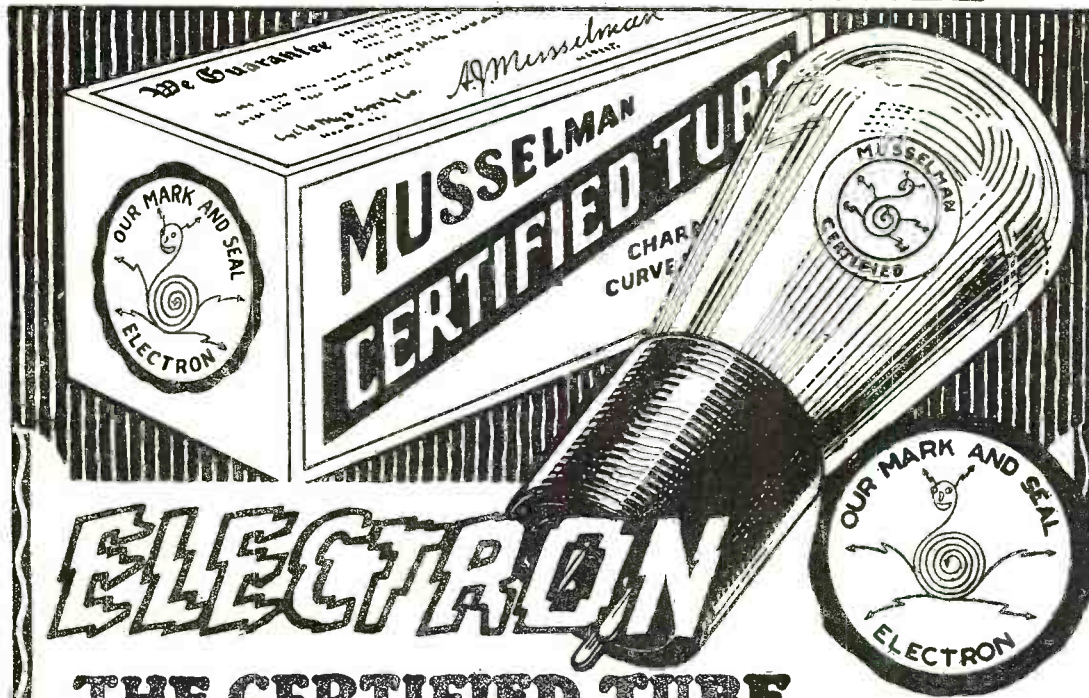

ELECTRON

THE CERTIFIED TUBE with the characteristic curve inclosed

NOW science has taken the last vestige of guesswork out of tube buying. No longer need you select your radio tubes with your eyes shut. You may today choose tubes with an exact knowledge of such important factors as mutual conductance, plate flow, amplification constant and output impedance—if you buy MUSSELMAN Certified Electron Tubes. No other tube offers you so large a measure of satisfaction or of known value for your money.

The MUSSELMAN Certified Tube is called "the tube with a pedigree" because you will find inclosed in the carton a characteristic curve slip which gives the exact operating data on that particular tube. You do not need to take the dealer's word for the tube's quality—it's right on the curve slip, an individual record for every tube that leaves our factory. This curve shows graphically the record of the tube in the five all-important tests which determine tube efficiency.

No tube ever carried so strong a guarantee as the MUSSELMAN Certified Tube. Your dealer is authorized to return your money instantly, without question or quibble, if this tube does not prove even better than we claim.

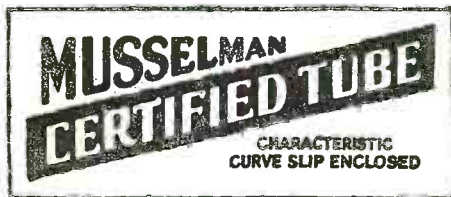

Over 14 years' experience is back of every MUSSELMAN Certified Tube. Care and precision heretofore undreamed of in the manufacture of radio tubes is a part of routine MUSSELMAN production.

MUSSELMAN Tubes cost a trifle more. They are worth more. Go to your dealer today and secure one or more of these tubes. Pay your dealer \$3.00 each for them. If, after a thorough test you are not satisfied they are the best tubes you ever tried, return them to your dealer and receive your money back. Make this test today and solve your tube problem.

Obviously, so fine a tube must give finer results. Experts who have tested these tubes have been amazed at their superiority. For every type of set and circuit—for volume—clearness—amplification and purity of tone—they are matchless. Test a MUSSELMAN Certified Tube in comparison with your very best tube of any make—note the vast difference in favor of this better product, with its "pedigree" attached.

A. J. MUSSELMAN

The Van Horne Company

547 Washington Blvd., Chicago

State type tube wanted:
 Our 5VA corresponding to type 201A.
 Our 3VB corresponding to type 199.

Enclosed \$..... for which send me..... Musselman Certified tubes, each \$3.00.
 I was unable to obtain these from my dealer whose name is.....
 address..... I am purchasing these tubes with the understanding
 they are guaranteed to be satisfactory to me otherwise you are to replace them or refund amount paid.
 (Signed)..... (Address).....

A. J. MUSSELMAN,
 547-51 Washington Blvd., Chicago.



Partners for Power

If you want distance and clear tone from your radio set, your storage battery must have its partner—the Tungar Battery Charger.



The Tungar is a G-E product developed in the great Research Laboratories of General Electric.

The new Tungar charges 2, 4, 6 volt "A" batteries; 24 to 96 volt "E" batteries, in series; and auto batteries, too. No extra attachments needed.

Two ampere size (East of the Rockies) . \$18.00

60 cycles—110 volts

Two clips and a plug to connect to the house current. That's all there is to it. Or you can make permanent connection and *just throw a switch.*

The Tungar charges while you sleep—it makes no disturbing noise—keeps your batteries at top notch. For power there is nothing like a good storage battery—with a Tungar to keep it good.

Tungar

REG. U. S. PAT. OFF.

BATTERY CHARGER

Tungar—a registered trademark—is found only on the genuine. Look for it on the name plate.

Merchandise Division
General Electric Company, Bridgeport, Conn.

GENERAL ELECTRIC

PLIODYNE-6

One of the most selective receivers on the market—Consistent range of 1500-3000 miles. Two stages radio frequency detector, and three stages of balanced audio amplification. Beautiful Fabrikoid-covered Cabinet. Price Without Accessories.....\$60.00
RADIO PARTS CO., LABS., 8 S. AUSTIN BLVD., OAK PARK, ILL.

SPECIAL NOTICE

We are franchising dealers for territorial rights under Sidson A. C. Receiver, the new Super-Hetro Magnetic, tuning from 5 meters to 1500, and the Harold Belevedere Receiver. Give us full details when requesting catalogue.
MERCURY ELECTRIC CORP.
2030 Grand Avenue New York, N. Y.

NA-ALO

Na-ald DeLuxe Sockets are the only ones with these three exclusive features—lowest loss, lowest capacity and positive side-scraping contact. Send for booklet and laboratory test. Alden Manufacturing Company, Dept. K10, Springfield, Mass.

FREE MONEY

in extra profits if you enjoy our discounts. Dealers write for them now. Also for a copy of the Salespeaker.
HUDSON-ROSS—116 S. Wells St.
Chicago

first, sepa, seventh, deka, tenth, centra, hundredth, la cent-kvardek-kvina psalmo, the 145th psalm, la cent kvardek oka paĝo, the 148th page, thus adding a to the last word only of a compound group.

Adverbs of numerals are formed thus: firstly, unue, secondly, due, fifthly, kvine, tenthly, deke, etc. Fractions by suffix on: duono, a half, kvinono, a fifth, dekonono, a tenth, etc.

The definite article "the" is la. There is no indefinite article "a" or "an"; birdo, a bird, mi vidas domon, I see a house.

Words used and explained in above lesson will not be in the following vocabulary.

VOCABULARY

legi, to read; letero, letter; se, if, mono, money; infano, child; ol, than; post, after, after, affair, matter, nun, now; mnotri, to show; doni, to give; kaj, and ke, that; libro, book; veni, to come; havi, to have; esti, to be; familio, family; iri, to go; alveno, arrival; preta, ready; tuta, whole, entire; nova, new; birdo, bird; pardoni, to pardon; tre, very; morgaŭ, tomorrow; multo, much; knabo, boy; pli, more; lernejo, school; diskuti, discuss; povi, to be able to, can; persono, person; vesto, coat, dress; akvo, water; diri, to say.

READING EXERCISE

Mi legas la libron. Li skribis du leterojn. I-liaj patroj venos morgaŭ. Mi mem vidis vin en la domo. Se mi havus multan monon mi estus riĉa. La knabon mordis la hundo. Dek kvin infanoj estas en la familio. Pli ol duono iras al la lernejo. Unue, post via alveno, ni diskutos la aferon. Se vi estus preta, ni povus diskuti ĝin nun. La tuta grupo de sep personoj iras en la domon. Montru al mi vian novan veston. Donu al la birdoj akvon. Ni iru al li kaj mi pardonos lin. Oni diras ke li estas tre riĉa. Tri estas duono de ses, ok estas kvar kvinonoj de dek.

(To be continued)

Esperanto-English Vocabulary

(Continued from April, 1925, issue)

N

Natural oscillation, fundamenta oscilo. negative, negativa. neon, neono; neon tube, neona tuba. node, nodo; current—, n. de tensio; potential—, n. de tensio. non-inductive shunt, neindukta, senindukta, ŝunto. note magnifier, sonfortigilo, malalfrekvenca, amplifikatoro.

O

Ohm, omo; megohm, megomo. operate, to, funkciigi; wireless operator, senfadenisto, radiisto. open radiating circuit, nefermita radianta cirkuito. oscillate, to, oscili. oscillation, oscilo; to break into—, ekoscili; fundamental (natural)—, fundamenta o.; self—, mem-o.; —transformer, oscila transformatoro; open— circuit, nefermita oscila cirkuito; closed—circuit, fermita o. cirkuito. oscillator, oscilatoro, oscililo. outer primary (of transformer), eliro de primario. outer secondary (of transformer), eliro de sekundario. output, elmeto. overload, troŝarĝo.

P

Panel, panelo; control—, kontrolpanelo.

Insure your copy reaching you each month. Subscribe to Radio News—\$2.50 a year. Experimenter Publishing Co., 53 Park Place, N. Y. C.

"as Good as Zenith"

"I WANT a radio set which will give me the same true quality of tone—the same selectivity—the same volume without distortion—the same long distance range as Zenith." That is the expressed desire of thousands and thousands of radio enthusiasts.

The reason for their ambition is simply this: Zenith radio sets are never offered to the public until all laboratory experiments have been carried to a satisfactory conclusion—until in side-by-side tests with other radio sets Zenith supremacy has been completely demonstrated.

Zenith radio sets will never be produced on a quantity basis at the sacrifice of quality.

But—which is better: to be distinguished merely for volume of production—or to be distinguished for a degree of excellence so high that it sets the standard throughout the industry? Ask your nearest Zenith dealer for a demonstration.

ZENITH RADIO CORPORATION
Straus Building, Chicago

Again Commander Donald B. MacMillan has chosen Zenith exclusively for his expedition to the Arctic. When human lives may depend upon the reliability of radio performance, only one reason can explain his choice: Zenith has proved to be the best obtainable, at any price.

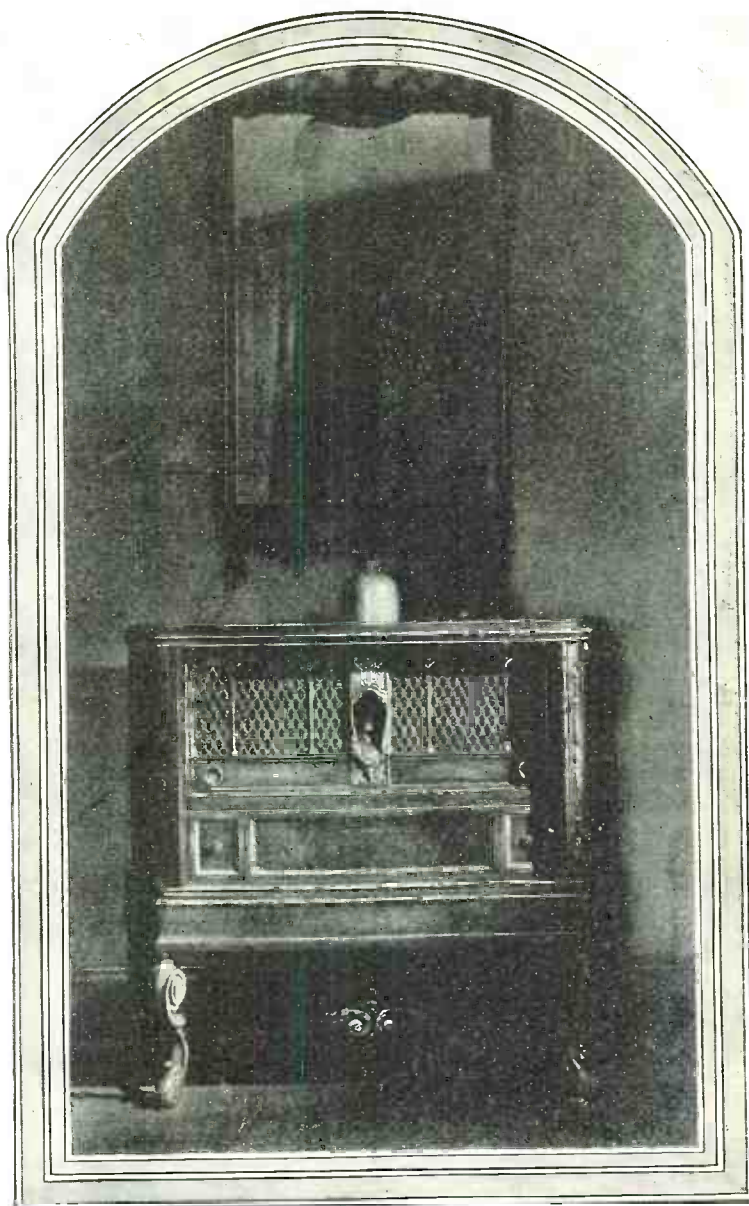

Super-Zeniths are priced at from \$240 to \$2,000. Each instrument is sold under a quality guarantee. Above is shown the De Luxe Italian model.

ZENITH
TRADE MARK REG.
→LONG DISTANCE←
TRADE MARK REG. **RADIO**

Costs More—but Does More!

Build with the New Models of U.S. TOOL CONDENSERS

Better Condensers Make Better Receivers

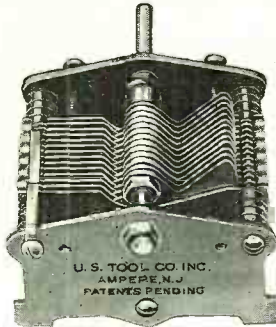

The same superiorities that have induced many reputable manufacturers to adopt U. S. Tool Condensers for their receivers are the points that will greatly improve your set. Chosen by these manufacturers after careful testing; you can use them with the same confidence and satisfaction.

Model 8

An efficient condenser made with new and patented one-piece stator, guaranteed to give sharp tuning at the lower broadcasting wave lengths.

Capacity, Max. .00025, Min. .0000076	\$2.70
Max. .00030, Min. .000008	2.85
Max. .00035, Min. .0000086	2.95
Max. .00050, Min. .000011	3.75

Model 9

Same as Model 8, but with Vernier and Kurz-Kasch Dial.

Capacity, Max. .00025, Min. .0000076	\$3.75
Max. .00030, Min. .000008	3.85
Max. .00035, Min. .0000086	4.10
Max. .00050, Min. .000011	4.75

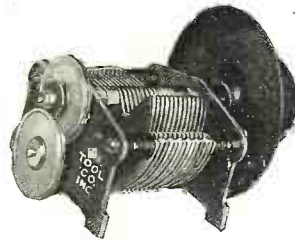

MULTIPLE CONDENSER

For Single
Control
Receivers

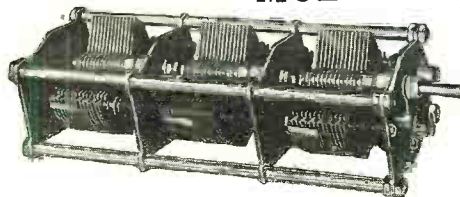

Simplify your receiver by operating two or more U. S. Tool Condenser units with only one dial—the greatest step thus far in radio reception.

Made under
Hogan Patents,
Jan. 9, 1912—Pat.
No. 1,014,002.

WRITE FOR LITERATURE

See These New Models at Your Dealer's
U.S. TOOL CO., INC. AMPERE, N.J.

connected in—, konektita paralele.
parallel, paralela.
perikon, perikono.
phase, fazo.
plate, plato, anodo; —circuit, plata cir-
cuito.
plug, ŝtopilo; coil—, bobena ŝ.
plug-in, to, enŝtopi; plug-in coil, en-
ŝtopa bobeno.
pole, poluso.
polyphase, multfaza.
porcelain, porcelano.
positive, pozitiva.
potential, tensio; —loop, ventro de t.;
—node, nodo de t.
potentiometer, potenciometro.
power factor, faktoro de potenco.
primary, primario, primaria.
propagation of waves, propagado de
ondoj.

Quenched spark, estingita sparko;
—gap, estinga sparkilo.

Radiate, to, radii, radiadi; radiating,
radianta.

radiation, radiado.
radio, radio; —amateur, r.-amatoro,
radiulo; —"fan", radiamanto; —operator,
radiisto; —telegraphy, r.-telegrafo;
—telephony, r.-telefonio; —station, r.-
stacio, radiejo.

radio frequency, radio frekvenco, alta
frekvenco.

radiogoniometer, radiogoniometro.

range, trafpovo.

ratio, proporcio.

reactance, reaktanco.

reaction, reakcio.

receiver (*person*), ricevanto, ricevisto.

receiver (*object*), ricevilo, ricevaparato;

balanced—, kompensita r.; continuous
wave—, r. por kontinuaj ondoj.

receiver arrangement, riceva arango.

receiving apparatus, set, ricevilo, rice-
vaparato.

reception, ricevo, ricevado.

recorder, recording apparatus, mem-
skribanta aparato, mem-skribilo.

rectification, rektifio, rektifado.

rectifier, rektifikatoro, rektifilo.

rectify, to, rektifi.

reflex, refleksa.

regeneration, reakcio.

regulating resistance, reostato de
kampo.

rejector (*adj.*) rejeta.

relay, to, relaji.

relay, relajo; high tension—, altatensia
r.; key—, r. de la manipulatoro, senda
klavo.

resistance, rezistanco; grid—, krada r.;

high, low—, alta, malalta r.; insulation—,
izola r.; regulating—, reostato de kampo;

variable—, varia r., reostato; starting—,
starta reostato.

resonance, resonanco; —curve, reson-
anca kurvo.

resonator, resonatoro.

rheostat, reostato; filament—, filameta
r.

ripple, subondeto; —elimination, subon-
deta elimino.

root mean square (value), efika (val-
oro).

rotary spark gap, turna sparkilo.

rotor, rotoro, turnbobeno.

Saturation, satureco.

screened, ŝirmita.

secondary, sekundario, sekundaria.

selective, selektiva; selectivity, selekti-
veco.

self-excited dynamo, mem-ekscita di-
namo.

self-capacity, mem-kapacito.

self-induction, mem-indukto.

self-oscillation, mem-oscilo.

ELGIN SUPER-REINARTZ New 1926 Model

Embodies all the features of the 1915 ELGIN, the
set reaching many European stations on 1 tube, with
striking improvements in appearance.

FREE working drawings and complete informa-
tion sent for 2c stamp.

ELGIN RADIO SUPPLY CO.
Dept. C, 207-E Chicago St., Elgin, Ill.

Increase Distance, Volume, Clarity

"Colytt" adjustable grid leak improves receiving. Gives
proper value of leak in grid circuit, and holds it. Simple,
compact, easy to install, only one hole
in panel. Tunes any tube perfectly.

\$1.00

Complete

Try the "Colytt" on
Money-back guarantee.

\$1.00 complete, with full
directions. — 3301

R. N. COLYTT LABORATORIES
565 Washington Blvd., Chicago

APPROVED
RADIO
NEWS
VENDOR
1925

YOU CAN GET

Greater reflex or crystal set
reception if you use the

BROWNLIE

VERNIER DETECTOR

\$2.00 At your dealer or Direct.

ROLAND BROWNLIE & CO.

20 Saunders St. Medford, Mass.

Trade Mark

A-1

SPECIAL
CATWHISKERS

Reg. U.S. Pat. Off.

Twenty-five Cents Package of Ten

Two Cent Postage Stamp brings FREE SAMPLE

CALIFORNIA RADIO MINERALS

HARRY GRANT, JR.

904 Oak Grove Ave., Burlingame, Calif.

Tested and Approved—POPULAR RADIO

Insure your copy reaching you each month. Subscribe to Radio News—
\$2.50 a year. Experimenter Publishing Co., 53 Park Place, N. Y. C.

- 1 —better color
—lasting luster
- 2 —lower free sulphur
—no discoloration
- 3 —higher softening point
—no warping

RUBBER is the best Material electrically for Radio Panels!

This is a known fact, but—

Due to discoloration in certain makes of hard rubber panels after a period of time, some people have the idea that age impairs their high electrical qualities.

An excess of the sulphur necessary in compounding hard rubber will cause discoloration and does ultimately lower electrical efficiency.

Goodrich Silvertown Hard Rubber panels will not discolor or lose their electrical efficiency. They contain less than one per cent of free sulphur.

Distinctly superior to other hard rubber panels. Specify them for maximum range and selectivity. Also the following for greatest all around satisfaction—

- Goodrich V. T. Sockets — Goodrich Variometers unwound — Radiophone Ear Cushions — Spaghetti Tubing — Battery Mats.

THE B. F. GOODRICH RUBBER COMPANY
ESTABLISHED 1870
Akron, Ohio



Goodrich

Rubber Radio PRODUCTS

“Best in the Long Run”

AMSCO

ANNOUNCES A
SPACE - SAVING
S.L.F. CONDENSER

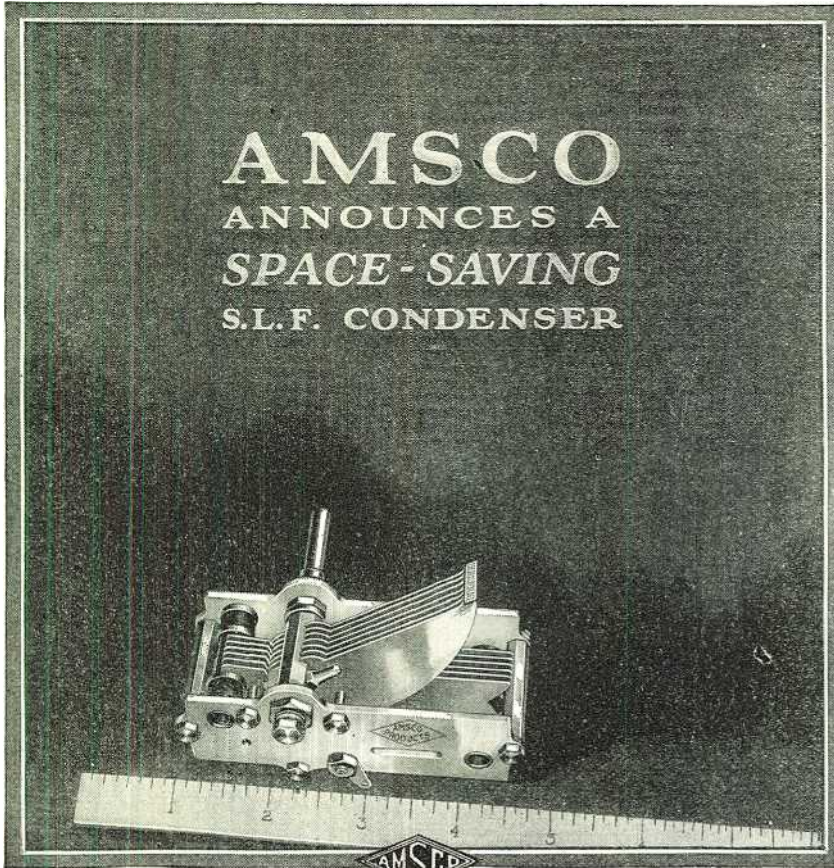

Solved! The space problem of the straight-line frequency condenser. The new AMSCO Allocating Condenser is ingeniously designed to save room in the cabinet, yet spreads the stations evenly around the dial, according to frequency. Greatly improves the selectivity of the set, and simplifies tuning. Three sizes, Single or Siamese.

Ask your dealer or write Dept. F

AMSCO PRODUCTS, INC.
Broome and Lafayette Streets, New York City
MAKERS : MELCO SUPREME RADIO RECEIVERS

Half a Heart is the secret. Half a Heart is the shape of the rotor plates.



Half a Heart is the new symbol for efficient S.L.F. variable condensers.

send out waves, to, elsendi ondojn.
sending apparatus, sendilo, sendaparato.
sending key, manipulatoro, senda klavo.
series (*adj.*), seria; connected in—, konektita serie.
sharp tuning, akuta agordo.
shellac, ŝelako.
short circuit, mallonga cirkuito.
shunt, ŝunto; highly inductive—, altindukta ŝ.; non-inductive—, neindukta, senindukta ŝ.
signals, signaloj; balancing—, kompen-sitaj, ekvilibrataj, s.
sliding contact, ŝova kontakto.
smooth, to, glatigi.
solder, to, soldo, brazo.
span, vanto.
spark, sparko; quenched—, estingita s.; rotary—, turna s.
spark, gap, sparkilo; multiple—, multopla s.; quenched—, estinga s.
sparking distance, sparka distanco.
specific inductive capacity (dielectric constant), dielektrika konstanto.
spindle, spindelo.
spreader, apartiga stango.
stable, stabila; stability, stabileco; stabilizer, stabiligilo.
standard, normo; to standardize, normigi.
starter, startilo.
static, atmosferaĵoj.
station, stacio.
stator, statoro, fiksobeno.
storage battery, akumulatoro.
strays, atmosferaĵoj perturboj, atmosferaĵoj.
strength, firmeco, forteco; dielectric—, dielektrika f.
stress, streĉo; dielectric—, dielektrika s.
super-heterodyne, super-heterodino.
super-regeneration, super-reakcio.
supersonic, supersona.
sustained wave, kontinua ondo.
switch, to, (*general term*), ŝalti, (*change over*) komuti, (*cut out*) interrupti.
switch (*general term*), ŝaltilo; change-over—, komutatoro, komutilo; cut-out—, interuptoro, interuptilo; automatic—cut-out, aŭtomata-i.; charging—, ŝarĝ-i.; field break—, i. de kampo; high tension—, altatensia i.; double-pole—, dupolusa k.; double-throw—, duvoja k.; wave-changing—, ondŝanĝa k.; rotary—, turna k.
switchboard, ŝalta, komutatora, interuptora, tabulo.
synchronous discharger, sinkrona sparkilo.
synthetic, sinteza.
syntonization, sintonizo, agordo.
syntonize, to, sintonizi, agordi.
syntony, sintonio.

T

Tap, to (a coil), spili, tapi; tappings, pilaĵoj, tapaĵoj.
tapper, frapilo.
teleautograph, telaŭtografo; telegraph, telegrafo.
telephone, telefono; —receiver, telefonilo.
tension, tensio; high, low—, alta, malalta t.; high— relay, altatensia relajo.
terminal, binding post, borno, klemo.
tetraode (*four-electrode valve*), tetraodo.
thermionic, termiona.
thermo-couple, termo-kuplo.
Thomson's formula, formulo de Thomson.
three-electrode valve, trielektroda valvo, triodo.
tickler, tiklilo.
transformer, transformatoro, transformilo; air-core—, aerkerna t.; high frequency—, altfrekvenca—; low frequency—, malaltfrekvenca; high ratio—, altproporcia t.; low ratio—, malaltproporcia t.; oscillation—(jigger), oscila t. (ĝigero); plug-in—, enŝtopa t.

JUST THE BOOK YOU WANTED

"Radio News"

AMATEUR'S HANDBOOK

Volume No. 1 (Fourth Printing)

Chock full of radio constructive and instructive articles from cover to cover. Written by foremost radio authorities, in plain everyday language which everyone can understand. Sections include articles on Receiving Sets and Sundry Apparatus, Transmitters and Accessories, Radio Theory, Vacuum Tube Data, and Practical Hints for the Amateur. A book which also serves as a ready reference and should find a place in the library of every amateur. It contains 224 pages and over 375 illustrations, diagrams, and photographs, bound in a multi-colored heavy board. On sale at all leading radio stores. If your dealer cannot supply you, send a dollar bill and the book will be forwarded to you postpaid.

EXPERIMENTER PUBLISHING CO., Inc.
53 Park Place, New York

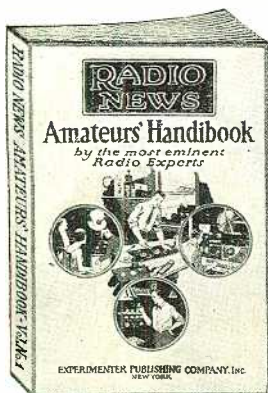

Price \$1.00

after all



**“HOW WELL YOU CAN HEAR”
is the only thing that really counts**

FOR a few weeks after we get a new radio set we all have the “logged 57 varieties of stations last night” feeling in our blood. Then we get tired and want to sit back and have some real entertainment. For, after all, “How well you can hear” is the only thing that really counts—no matter whether the entertainment is coming from a local station or one a thousand miles away.



Acme M A-2 Audio Frequency Transformer—more amplification without distortion.

howls. *Anything which fails to give you an exact reproduction of the human voice is distortion.* Here is how you can test your own set. Start your radio and at the same time keep up a conversation with two or three friends.

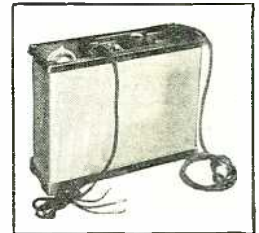

Acme B-eliminator for elimination without distortion.

“How well you can hear”

IN THIS “how well you can hear” proposition is where quality comes in—and so does Acme. The Acme Apparatus Company, pioneer radio and transformer engineers and manufacturers, have long made both transmitting and receiving apparatus of only the highest efficiency. Specialists in amplification, even before the days of broadcasting, this company has perfected “amplification without distortion.”

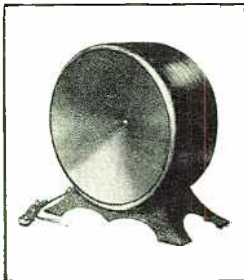

Acme “Double Edge Cone” Loud Speaker—for reproduction without distortion.

Unless you can understand the voice over the radio as easily as that of a friend several feet from you, and without any more concentration and effort than is ordinarily required in talking with him, then you have distortion.

The reason you have to concentrate when listening to a voice speaking over the ordinary radio (an action unnecessary in ordinary conversation) is simply this. The individuality of the voice is lost because distortion has blurred out the overtones which give this vitality and individuality. Monotones are always hard to understand.

The whole story of distortion and how it can be overcome is carefully and fully explained in “Amplification without Distortion,” a book on radio reception which is invaluable because it is written by a famous radio engineer in language even the radio novice can completely understand. Over two hundred thousand radio enthusiasts can vouch for the service it will give you. Thousands have written us their thanks. The 9th edition is just off the press. Send for your copy.

Make this test with your set
DISTORTION does not mean merely squeals and

Claude Cairns

CLAUDE F. CAIRNS
President, Acme Apparatus Co.

*9th edition of this famous book just off press
—send for your copy.*

A 40 PAGE book—over 200,000 of which have been sold at 10c a copy—gives the complete story of “Amplification without Distortion.” Use coupon.

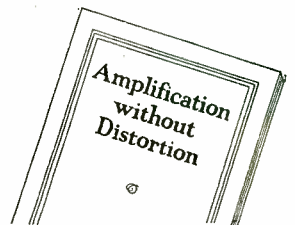

ACME
~for amplification

ACME APPARATUS CO.,
Dept. K8, Cambridge, Mass.
Enclosed find 10c (coin) (stamps) to cover mailing of one copy of 40 page book, “Amplification without Distortion.”

Name
Street
City..... State.....

UNIVERSAL PLIO-6

The Only Set That Tunes All Wave Lengths.

35 TO 3600 METERS

3AR Melbourne 480—WGY 109—2FL Sydney 770—WKAQ San Juan 360—2BL Sydney 350—PCFF Amsterdam 2000 Ka-achi—Bombay—KOP—WGY 1660—6KW Tinnucun 340—Bankok—NSF Hilversum 1050—WLW—KDKA 64—KYW—SNO New Castle 400

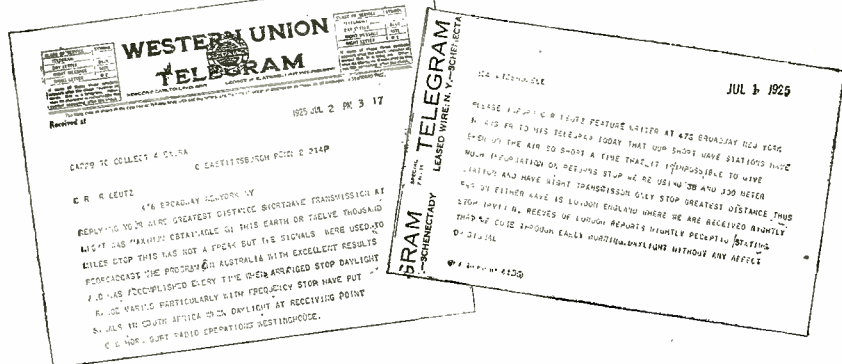

WOC—CYL Mexico City 510—2FC Sydney 1100—KFI—PA5 Amsterdam 1050—Vienna—Colombo—WWJ—WCX Lakehurst 80—ICE Rome 470—5PY Plymouth 330—Voxhaus 430—CNRC Calgary 440—Madras—Stuttgart 437—BAV Brussels 1100—6FL Sheffield 303—WGY 38—PCGG Hague 1050—Otschiski—KGW—CFAC 430—CHXC Ottawa—EBX Cartagena—NAA 2500—PCMM Ymuiden 1050—SBR Brussels 262—KHJ—LOX Palermo 375—OXE Lyngby 2400—KOA—2SB Sydney—OKP Kbely 1150—2BE Belfast 435—KGO—YN Lyons 470—I Nice 360—FL Eiffel Tower 2600—PTT Paris 450—SXX Chelmsford 1600—LZ Monte Grande 425—2LS Leeds 346—SMA Adelaide 850—2LO London 365—PWX Havana 400—RAS Vladivostok—WMBF—CJCM Mont Joli—LOR Buenos Aires 400—LP Berlin 2370—VTR Rangoon—3LO Melbourne 1720—6BM Bournemouth 385—5WA Cardiff 350—PRG Prague 1800—2ZY Manchester 375—HB2 Lausanne 850—JJC Funabashi—JSB Chemulpo—3FL Melbourne 400—6VL Liverpool 318—HBI Geneva 1100—KDKA 64—POZ Berlin 2800—2EH Edinburgh 325—5IT Birmingham 475—Munich 485—Leipzig 452—2BD Aberdeen 495.



THE NEW UNIVERSAL PLIO-6

Six tube, 2 Stages Non-Regenerative Tuned Radio Frequency Amplification, Detector and 3 Stages Distortionless Radio Amplification. Receiving range from 1,000 to 12,000 miles depending upon location, station transmitting, wave-length received and other variable factors.

FULL DETAILS NOW AVAILABLE FROM MANUFACTURERS

GOLDEN-LEUTZ INC.

476 BROADWAY :: NEW YORK CITY

Manufactured under Hogan Patent 1,014,002—Other Patents Pending CABLES "EXPERINFO" NEW YORK

transmission, sendo, elsendo, sendado, elesendado.
transmit, to, sendi, elsendi.
transmitter (person), sendanto, sendisto.
transmitter (object), sendilo, sendaparato.
transmitting apparatus, sendaparato, sendilo.
trembler, martela interuptoro.
triode (three-electrode valve), triodo.
tube (valve), valvo, tubo, lampo.
tune, to, agordi, sintonizi; to re-tune, reagordi; to tune out, foragordi, mala-gordi.
tuned, agordita, sintonzita; flatly—, neakute a.; sharply—, akute a.; untuned, neagordita.
tuner, agordilo, sintonizilo.
tuning, agordo, sintonizo; coarse—, kruda a.; fine—, delikata, (or) subtila; flat—, neakuta a.; sharp—, akuta a.; —coil, agorda bobeno.
turn (of a coil), volvo (de bobeno).

U
Undamped wave, kontinua ondo.

V
Vacuum tube, vakua tubo.
valve; valvo, tubo, lampo; 2-electrode—, diodo; 3-electrode—, triodo; 4-electrode—, tetraodo; bright emitter—, hela v.; dull emitter—, malhela v.
variable, varia, variigebla, alĝustigebla.
variometer, variometro; vario-coupler, vario-kuplilo.
vary, to, varii.
velocity, rapideco.
vernier, verniera.
volt, volto; voltage, tensio.

W
Watt, vato; kilowatt, kilovato.
wave, ondo; carrier—, portanta o.; continuous waves, kontinuj ondoj; damped—, amortizaj o.; electromagnetic —s, elektromagnetaj o.; Hertzian —s, Hert-zaj o.; undamped —s, kontinuj o.
wave frequency, ondfrekvenco.
wavemeter, ondometro.
wire, fadeno, drato; bare—, nuda f.; flexible—, fleksebla f.; insulated —, izolita f.; solid —, solida f.; stranded —, dividita f.

wiring (collection of wires), fadenaro; (method of wiring), fadenarango; (action), fadenado.
wireless, senfadena.

X
X's atmosferaĵoj.

Lessons in Esperanto

(Concluded from July, 1925, issue)

In concluding these lessons in Esperanto, I want to urge upon all who have followed them (and from the correspondence I have received, I believe a satisfactory proportion of the RADIO NEWS readers are studying Esperanto) the highly important follow-up activity of a wide correspondence in Esperanto. This is not a suggestion intended only for the idler who has no activity, who has little interest in anything serious in life, but it is meant more for the already active radio fan and others who wish to gain more valuable knowledge, and to extend their perspective in many ways. It is intended for the person who wishes to write professionally, for from all corners of the earth, by the expenditure of a few stamps, you can gather unusual features that your home paper or magazine will want, and you can, by the same correspondence, get

CARTER New "IMP" Rhoestat

(Pat. Pend.)



\$1.00

6 OHMS OR 25 OHMS

Smallest rheostat made. Diameter only 1 3/8 in. Projects only 3/8 in. back of panel. One hole mounting. Complete with pointer knob. New exclusive Carter method of contact. Positive, smooth, silent. Same high Carter quality and standard of workmanship you know so well. See one at your dealer's today. Write for information on other Carter original Radio products.

In Canada, Carter Radio Co., Limited—Toronto



Any dealer can supply

Insure your copy reaching you each month. Subscribe to Radio News—\$2.50 a year
Experimenter Publishing Co., 53 Park Place, N. Y. C.

The latest developments in low-loss parts

Built of this special insulation made to order for radio



Ask for Radion Panels by name; look for the stamp on the panel and the name on the envelope.

NOW you can get a *complete line* of low-loss parts made of Radion, the special insulation which our engineers created for radio purposes exclusively. These parts embody the very latest developments in radio; they are as efficient as the well-known Radion Panels.

From the earliest days of radio, the experience of thousands of amateurs has proved that Radion Panels give the most satisfactory results. The complete line of Radion parts have the wonderful Radion finish smooth and high-polished. This finish eliminates those losses caused by moisture gathering on the surface of ordinary insulation, causing leakage paths. The high-resistant characteristics found only in Radion Panels also mark these new parts.

Radion Panels, made in Black and Mahoganite come cut in standard sizes for whatever set you wish to build. And, in addition, you can now get the new Radion Sockets, Radion Dials, Radion Loud Speaker Horn, Radion Tubing, Radion Binding Post Strips, Insulators, etc.



Radion Built-in Horn takes up small space in the cabinet.

Radion Built-In Horn

IN any set you build, you may put in a Radion Horn, which takes up small space, gives clear rounded tones, and eliminates the bother of an unsightly awkward horn outside the set. Price \$3.00 including cap to fit most makes of headphones or loud speaker unit.

Radion Close-Tuning Dial No. 10

THE new No. 10 4-inch Radion Dial is built to conform to the fingers, helping you to get close tuning. May be used for single mounting condensers. We believe it is the most beautiful dial yet designed. Nine other styles of Radion Dials, in several sizes to meet your requirements.



This is new No. 10, 4-inch Radion Close-Tuning Dial, built to conform to the fingers.

Send for Booklet

OUR booklet, "Building Your Own Set," gives wiring diagrams, front and rear views, shows new set with slanting panel, sets with the Radion Built-in Horn, lists of parts and directions for building the most popular circuits. Send coupon with 10 cents today.



This is Radion No. 2 Socket designed for both new and old tubes.

New Radion Sockets for the new style tubes

In line with our policy of keeping all Radion parts abreast of the very latest developments, we announce new Radion Sockets No. 4 and No. 5 for the new style tubes. Neither of these sockets has collars or side bosses. No. 4 is equipped with binding posts, No. 5 without.

Universal Sockets for both new and old tubes

Radion Sockets No. 2 and No. 3 are designed to take the old or standard tubes, as well as the new tubes just on the market. No. 2 is equipped with binding post, No. 3 without.

All Radion Sockets are highly efficient, due to the principle of their construction and the low-loss characteristics of Radion. Ask your dealer to show them to you.

AMERICAN HARD RUBBER COMPANY,
Dept. A10, 11 Mercer St., New York City.

Please send me your booklet, "Building Your Own Set," for which I enclose 10 cents in stamps.

Name

Address

RADION

The Supreme Insulation

Made to order for radio purposes exclusively



AMERICAN HARD RUBBER COMPANY
Dept A10, 11 Mercer Street, New York City

Amplions chosen to reproduce Papal Ceremonies throughout Saint Peters, Rome



His Holiness the Pope seated on his throne upon the occasion of the recent canonization of Sister Teresa. The microphone is on the right arm of the throne.

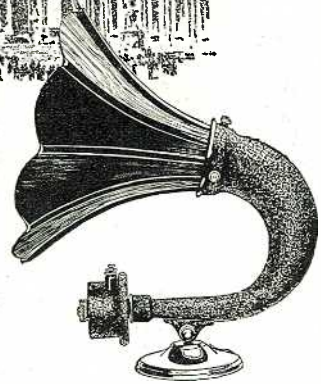

Of ALL loud speakers, Amplions enjoy the honor and high compliment of having been installed throughout the famous Cathedral of Saint Peters, Rome, that important ceremonies conducted by His Holiness the Pope may be clearly audible to great multitudes of people.

Supreme clarity of reproduction was the prime requisite. It is only logical that The Amplion—creation of the actual originators and oldest makers of loud speakers—should have been chosen. Amplions outsell any other loud speaker throughout the world, chiefly because of unrivaled clarity of tone. "The clearness of the reproduction of the Pope's voice was an outstanding feature," writes a witness to the first ceremonies.

Hear The Amplion in comparison with any or all other reproducers. Prove to your entire satisfaction that it is the world's finest loud speaker. Amplion Loud Speakers, \$12.00 up. Phonograph units in two sizes. Write for interesting literature and dealer's address.

THE AMPLION CORPORATION OF AMERICA
Executive Offices: Suite W, 280 Madison Ave., New York City
Canadian Distributors: Burndopt of Canada, Ltd., Toronto
Alfred Graham & Co., London, Eng., Patentees

AMPLION

The World's Standard Loud Speaker

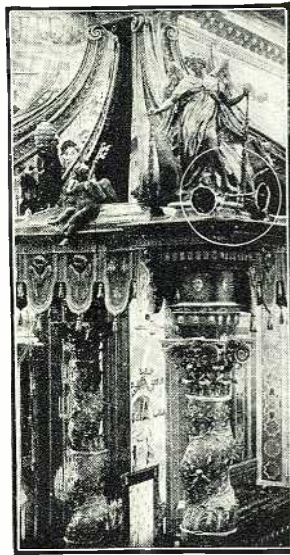

A portion of the magnificent canopy over Saint Peter's Tomb, showing two of many Amplions installed for amplifying Papal services to vast assemblages of pilgrims.

the photographs to illustrate those features. I speak on this point from personal experience. It is intended also for the collector of stamps, or of souvenir cards, or of any kind of curios, of folk lore and of people's customs of different lands. Whatever be your hobby or your main interest in other parts of the world and other peoples, you will find Esperanto correspondence a marvelous tool, ready and easy, even delightful to use.

Don't be afraid that your letter won't be understood. Put the words on paper according to the simple rules you have learned here, and be sure it will be easily understood, just so it is written legibly. One student of these lessons living at Hannibal, Mo., after six weeks' study, using additional reading text, has written me letters that any Esperantist, even students like himself, of any other nationality could instantly read and comprehend.

HOW TO GET CORRESPONDENTS

There are thousands of others, like yourself, in all countries who wish to correspond in Esperanto. You can get in touch with the kind you will like best to correspond with, those who have similar hobbies to your own, by inserting a little ad in any one of the leading international Esperanto publications. Such an ad will cost about 25c and will bring you anywhere from ten to one hundred offers of correspondence. You are morally obligated to reply, at least by one postal card, to each respondent who answers your ad, telling those with whom you do not wish to carry on correspondence, that you cannot keep it up. But out of those who write, you will find the kind you will wish to become better acquainted with. You can word your ad something like this:

John Doe,
2 East Court St., Pendleton, Oregon,
U. S. A., deziras korespondadi kaj interŝanĝi PM, PI kaj L pri radio-aferoj.

PM is abbreviation for "Poŝtmarkoj", stamps, PI Poŝtkartoj ilustritaj, illustrated post—or souvenir cards, L, leteroj, letters.

There are many excellent Esperanto publications of wide circulation in which an ad similar to the above could be inserted with excellent results, but the two leading ones of most general, world-wide circulation are:

ESPERANTO, 12 Boulevard du Theatre, Geneva Switzerland. It is monthly, beautifully printed in best Esperanto, and is the official organ of the **Universala Esperanto Asocio**, the world organization, \$2.00 per year.

HEROLDO DES ESPERANTO, Herrem bei Koeln, Germany, semi-weekly newspaper, illustrated, excellent Esperanto, \$1.00 three months, \$4.00 yearly.

For Esperanto literature and up-to-date information about the Esperanto-radio movement of Europe, write British Esperanto Association, 17 Hart Street, London, W. C. 1., England.

It will be of interest to every student of these lessons and all Esperantists in North America who see this to write me, giving at least names and addresses. Address Box 223, City Hall Station, New York.

The following reading exercise with which we close these lessons, is taken from an illustrated Esperanto technical article on Radio, sent out by the **Internacia Radio Asocio**, 97 rue Royale, Versailles, France, as a feature of their service for Esperantists interesting themselves in radio who have not in their native languages adequate technical information on the subject. For the radio terms in this exercise, see the Esperanto-

Andrews
Deresnadyne
DE-RES-NADYNE PATENTS PENDING
Radio Receiving Set
ANDREWS RADIO CO.

Tribune Tower

Chicago

The SATURN
Perfect Jack and Automatic Plug.
Your order filled by mail promptly.
Every article absolutely guaranteed.
The SATURN Mfg. & Sales Co., Inc.
48 Beekman St.
New York, N. Y.
Dept. R.N.
Write for Literature

**LATEST WHOLESALE
RADIO CATALOG**
FREE Simply send name
TODAY for big
48 - page catalog
of latest radio goods at Wholesale.
Live dealers and agents wanted.
STANDARD RADIO CO., 108 East 13th, Kansas City, Mo.

SALESPEAKER
is the name of the most interesting
radio bulletin published. If you are
a dealer, we will mail you a copy, on
request.
**HUDSON-ROSS—116 S. Wells St.
Chicago**

Insure your copy reaching you each month. Subscribe to Radio News—\$2.50 a year.
Experimenter Publishing Co., 53 Park Place, N. Y. C.

ANNOUNCING

the

new

RATHBUN STRAIGHT LINE FREQUENCY CONVERTER

THE modern radio receiver has abundant tone, volume and power — now it may have perfect, simplified control.

The Rathbun Straight Line Frequency Converter is adapted for use on your receiver—every receiver—without change of equipment—except the condenser dials. Each station is given a distinct reading at a uniform distance from the next. Real logging becomes a fact. The stations are distributed with flawless precision over 360° — one complete revolution of the Dial. There is no limitation or crowding as on controls using only half a dial. Radio control is simplified.

The Rathbun Straight Line Frequency Converter provides straight line frequency tuning with ordinary capacity condensers. It is interchangeable with any condenser—on any receiver. It is sold with the guarantee of reliability and satisfaction attached to all Rathbun Radio Apparatus.

See and Try it—at Your Dealer's

If your dealer cannot supply you, send Money Order (\$3.50 each) and your order will be shipped promptly by Parcel Post prepaid.

Rathbun Manufacturing Co., Inc.
Jamestown New York

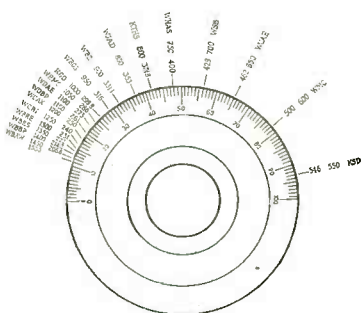
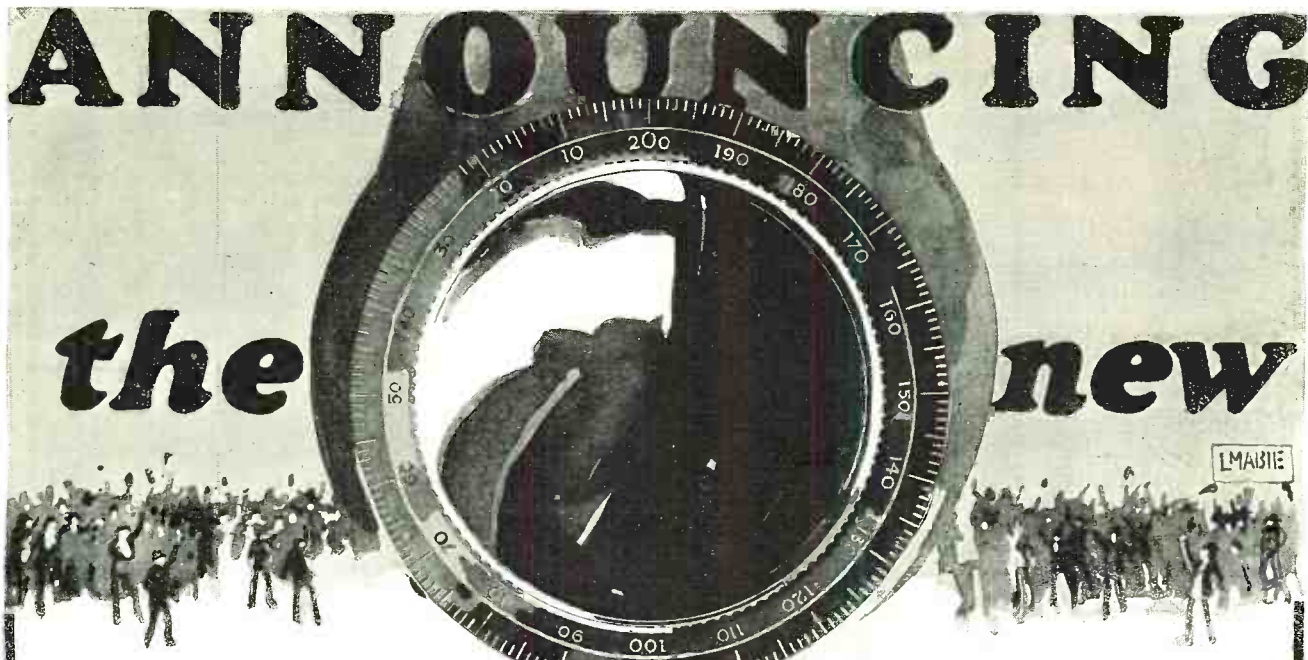

Stations indicated in kilocycles and wavelengths showing crowding with an ordinary capacity condenser.

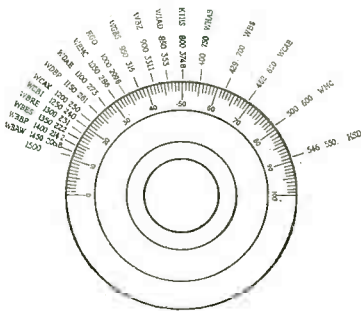

Stations partially separated and tuning slightly improved with a Straight Line Wave Length Condenser.

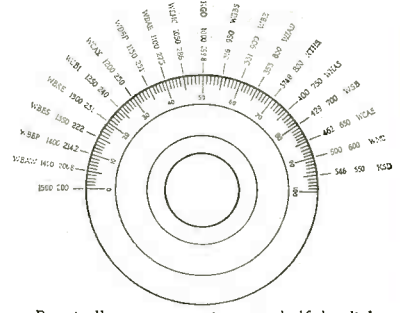

Practically even separation over half the dial with a Straight Line Frequency Condenser.

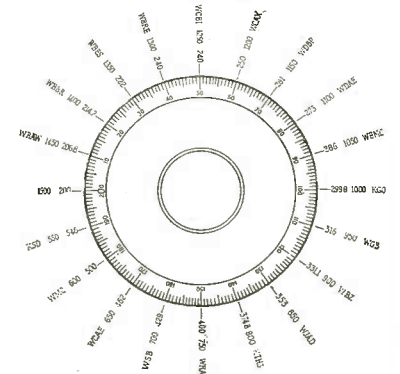

Complete and equal separation of stations over the entire dial with the Rathbun Straight Line Frequency Converter.

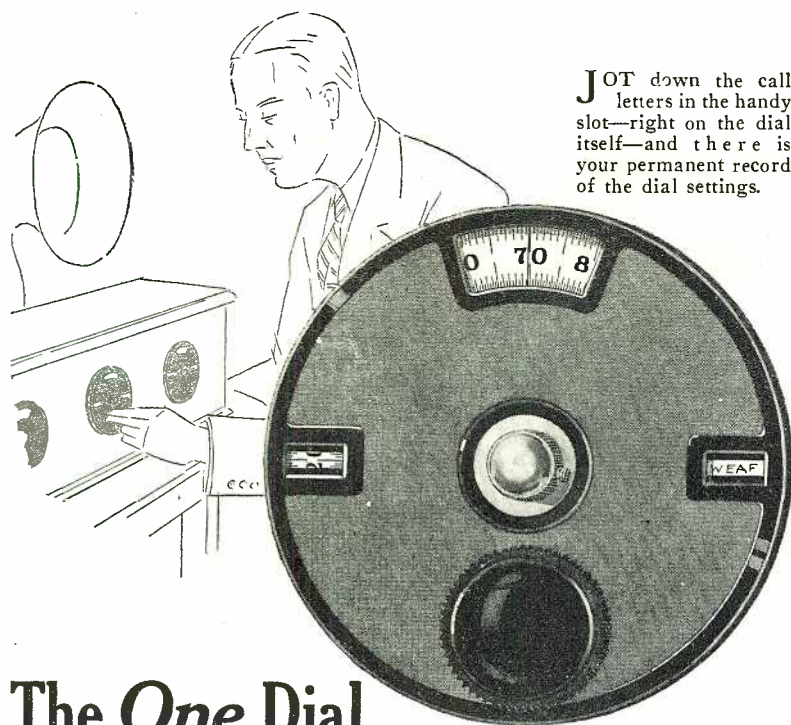

JOT down the call letters in the handy slot—right on the dial itself—and there is your permanent record of the dial settings.

The One Dial That's All a Dial Should Be

You'll never know how much difference a dial can make until you actually get your hands on the new Mar-Co. It splits a single degree into hair's breadth divisions. It responds to your slightest touch with no suggestion of backlash.

Smooth—precise—and strikingly handsome—built for your present set and for your next year's set as well—it is what you'd expect of Mar-Co—see it at your dealer's.

MARTIN COPELAND COMPANY
Providence, R. I.

Nickel
Plated
\$2.50

Gold
Plated
\$3.00

MAR-CO Vernier Dial



The Radiophan Adapter
A "2 in 1" Crystal Detector
Improves Reflex and Crystal Sets

Permits the use of two crystals in contact or one crystal with cat-whisker. Nothing like it. Distributors. Jobbers—Dealers—Wanted. Circular free.

TUERK MFG. CO.
561 W. Washington St. Chicago, Ill.



Reflectone

THE MIDGET LOUD SPEAKER WITH THE GIANT VOICE

Registered
Only 5 Inches High—\$8.00
RICE & HOCHSTER
134 Washington Place New York City

radio vocabulary published in April RADIO NEWS. The following vocabulary includes only those non-technical words not yet used in these lessons.

VOCABULARY

kunveno, convention, meeting.
ingeniero, engineer.
firmo, firm.
klarigis, explained.
principo, principle.
interesa, interesting.
longa, long.
ĝenerale, generally.
uzi, to use (uzata, being used).
taŭgas, fit for, suitable.
bedaŭrinde, regrettably.
prezentas, presents.
ĉefa, chief.
difektas, defects.
ĝenante, troubling.
samtempe, at the same time.
najbara, neighbor.
aŭskultanto, listener.
delikata, delicate.
ambaŭ, both.
malhelpis, hindered.
enmeto, putting in.
malfacilaĵo, difficulty.
venkis, conquered.
sola, single, lonely.
efektivigis, brought about, realized.
efika, efficacious.
facile, easily.
cetere, moreover, besides.
sendube, doubtless.
siaflanke, for his part.

PRAKTIKA AMPLIFIO ALTRĜKVENCA

Dum la januara kunveno de la «Société des Amis de la T. S. F.» s-o Rouge, ingeniero de la firmo "G. M. R.", en Parizo, klarigis la principon de tre interesa ricevilo por amatoroj. Por la mallongaj ondoj, nun ĝenerale uzataj en radiotelefonaj sendoj, altfrekvenca amplifio per rezistancaj amplifikatoroj ne tre taŭgas. Multe pli taŭgas rezonancaj amplifikatoroj, sed, bedaŭrinde, ili prezentas du ĉefajn malbonaĵojn. Unue, kiam ili enhavas kelajn ŝtupojn, kontinuaĵoj osciloj estiĝas en la cirkvitoj, kiam la sinsekvaj ŝtupoj estas agordo de ĉiuj ŝtupoj. S-o Rouge forigis ambaŭ tiujn malbonaĵojn. La estiĝon de ante samtempe najbarajn aŭskultantojn. Due, tre delikata estas la samtempa agorditaj laŭ sama ondolongo, kaj tio difektas la aŭdadon de radiotelefonio, ĝenkontinuaĵoj osciloj en la cirkvitoj li malhelpis per enmeto de rezistanco en la oscilan cirkvito de ĉiu ŝtupo. La malfacilaĵoj de samtempa alĝustigo de ĉiuj ŝtupoj li venkis, aranĝante la aparaton liel, ke per unu sola butono ĉiuj ŝtupoj estas samtempe alĝustigeblaj. Tiel li efektivigis aparton samtempe tre efikan kaj tre facile uzeblan de radio-amatoroj.

Amatoroj cetere povas provi mem tiun principon, el kiu ili sendube ricevos tre bonajn rezultatojn.

Siaflanke, S-o Scott-Taggart provis tiun sistemon kaj favore rekomendis ĝin en "Modern Wireless" de oktobro 1924.

Where Does Your Set Get Its Power?

(Continued from page 451)

Prices For You

Boys and Young Men—You can earn dandy prizes and liberal commissions by selling and delivering our popular magazines in your spare time. No experience or money is necessary. We furnish all supplies and tell you just how to start. *Write to-day.*

E. J. FOLEY, Department RN-10,
Experimenter Publishing Company, 53 Park Place, New York City

explain just how a vacuum tube acts as a trigger to add a lot of power to a very weak signal so that, in the end, it is audible to a large number of people sitting in a room.

Put in the simplest possible terms, the tube simply controls the flow of current from the "B" battery. This battery is in

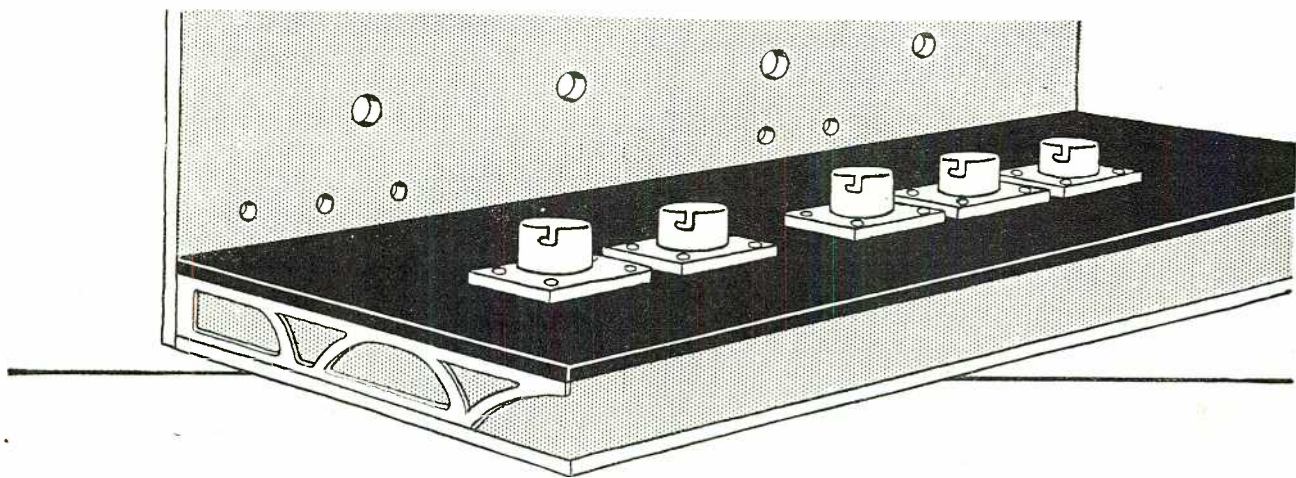

You need Quality in the Base Panel

THE use of a base panel makes possible shorter, neater and more efficient wiring. But the panel must be an insulator of the first quality that will not deteriorate with time. It must be free from any tendency to absorb water to function properly in damp, humid weather. It must not warp or distort, disturbing the angle of the coils and the arrangement of the apparatus.

There is one panel material in which you are sure of getting all of those essential qualities—and that is Formica.

For years it has been accepted by the vast majority of leading radio manufacturers, as mechanically and electrically the best available material for radio panels. It also is the most handsome, and its finish is entirely permanent. It does not check, crack or lose its lustre with time.

Formica is evidence of quality, durability and genuine worth in any radio apparatus.

VERI-CHROME PANELS

By the purchase of a controlling interest in the Veri-Chrome laboratories, the financial and production resources of the Formica Insulation Company have been placed behind this remarkable new process for decorating radio panels. Elaborate decorations can be produced much more rapidly and more economically than by engraving. Decorations designed by the leading American artists are offered. Tuning scales may be marked directly on the panel eliminating the standard dial and substituting pointers instead. The reduction in cost is large. Write for prices on complete panels finished in this way in quantity.

Dealers: Home set builders who want the best results want Formica. It has been for years a highly profitable line for thousands of dealers.

THE FORMICA INSULATION COMPANY

4618 Spring Grove Avenue, Cincinnati, Ohio

- | | |
|---|---|
| <ol style="list-style-type: none"> 1 Formica is used by nearly all the leading set makers — and has for years been used by more set makers than any other material. 2 Formica is unaffected by weather and time — it lasts forever. 3 Formica in appearance is the finest of all panel materials and always remains so. 4 Formica's electrical qualities of every kind far exceed any possible requirement. | <ol style="list-style-type: none"> 5 Formica has high mechanical strength and will not break in use. 6 Formica will not sag from heat or cold flow under pressure. It retains its dimensions. Everything you fasten to it stays tight and precisely where you put it. 7 Formica panels are sold in neat craft paper envelopes which assure you that you are getting the genuine. 8 Formica is one of the most widely approved materials in radio. |
|---|---|

SALES OFFICES

50 Church Street.....	New York, N. Y.	1026 Second Avenue.....	Minneapolis, Minn.
9 South Clinton Street.....	Chicago, Ill.	725 Bulletin Bldg.....	Philadelphia, Pa.
516 Caxton Bldg.....	Cleveland, Ohio	708 Title Building.....	Baltimore, Md.
327 Cutler Bldg.....	Rochester, N. Y.	585 Mission Street.....	San Francisco, Cal.
422 First Avenue.....	Pittsburg, Pa.	419 Ohio Building.....	Toledo, Ohio
6 Beacon Street.....	Boston, Mass.	309 Plymouth Bldg.....	New Haven, Conn.
55 Calle Obispo.....	Habana, Cuba	Whitney Central Bldg.....	New Orleans, La.



FORMICA

Made from Anhydrous Bakelite Resins

SHEETS TUBES RODS

Hear the Formica Orchestra over WLW every Tuesday evening from 9 to 10 Central Standard Time.

RTC RADIO PRODUCTS

"Always First—Always Best"

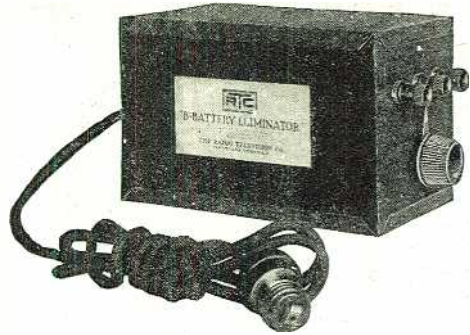

RTC "B" Battery Eliminator

To obtain the best results from a radio set a steady constant supply of plate voltage is necessary. The RTC Eliminator meets these requirements. Merely plug into any A-C electric light socket, and attach the radio set to the binding posts of the Eliminator as you would B Batteries. Nothing to wear out or give trouble. No moving parts. No acid to spill or require attention. Device uses either standard C-301-A tube (or 201-A) or a special full wave rectifier tube. One hundred volts DC is supplied for the amplifier tubes, with a variable voltage of 0 to 100 volts for the detector tube. The unit is small and compact, and can be placed directly inside any set now using dry batteries, as

the size of the unit is less than B Batteries. Size 4 1/4 x 7 3/8 x 4 3/4 inches.

Model RT-40 "B" Battery Eliminator - - - \$35.00

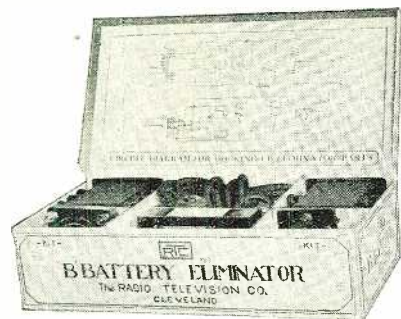

RTC "B" Battery Eliminator Kit

This kit consists of the following parts: One model RT-21 Eliminator transformer; one model RT-22 Audio Reactor; two model RT-70, five mf. condensers; one model RT-71 1 mf. condenser; one standard socket; one model RT-60 high resistance potentiometer; two model RT-50 vacuum fuses; one model RT-50M fuse mounting, and one attachment plug and cord. All parts in the kit are handsomely finished and can be built directly in as a part of the set. All parts are specially shielded to prevent interference when the parts are placed close to parts of the radio set. No moving parts. Nothing to wear out. Uses standard C-301A or 201-A tubes or full wave rectifier tube. Folder supplied with

kit gives several circuits that can be used for different purposes with the kit parts. Absolutely no hum from this Eliminator to its parts. Can be assembled in one half hour.

Model RT-40K "B" Battery Eliminator Kit - - - \$20.00

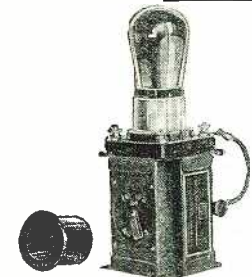

RCT Tube Re-Activator

Are your tubes run down and in-operative? Has your set quit working as well as it once did? If so, undoubtedly one or more of your tubes need rejuvenating. The filament has become inactive and lost its emitting properties. Restore this emitting property by using the RTC Reactivator for 10 minutes. Also remove the gas from your gassy tubes. Some UV-200 tubes can be made more sensitive by the use of this device also. Dealers who wish to reactivate several tubes at one time can do so by the addition of other sockets. When not in use for reactivating tubes, this device may be used as a toy transformer to light Xmas tree lamps, or any other purpose requiring a source of low voltage. Four different voltages are obtainable. Write for literature.

Model RT-20 Tube Reactivator - - \$6.50

THE RADIO TELEVISION CO.

9410 St. Catherine Avenue CLEVELAND, OHIO
Full information on request. Prices F.O.B. Factory.

—ONEY BACK IF NOT SATISFIED



Radio Tubes

All types, guaranteed

\$1.50 Each

ACME PRODUCTS CO.,
Dept. 107
903 Broad St. Newark, N. J.

WADE SQUARE LAW CONDENSER AND DIAL

All sizes complete with 4-inch vernier dial, for:
Short wave .00125 mfd. \$7.50
Tuned Radio Frequency .00025 mfd. 7.75
Super-Heterodynes .0005 mfd. 8.00
At your dealers, otherwise send purchase price and you will be supplied postpaid.

WADE MFG. CO., Inc., 1819-A Broadway, N. Y. City

HEATH CONDENSERS

For Real Radio Reception

Write for Literature

HEATH RADIO & ELECTRIC MFG. CO.,
206 First St., Newark, N. J.

Filament and Plate Types



FAMOUS "BH" TRANSFORMERS

TWO NEW MODELS
The Only Audio Amplifying Transformers Having Low Loss Shields
PANAPHONIC (Registered)
Amplifies Entire Range of Sound
VIVAPHONIC (Registered)
Greatest Value Ever Offered for Set Production

Transformer BENJAMIN HUGHES ELEC. CO.
Builders Since 1910 298 LaSalle Street St. W., Montreal, Can.

the same relation to the set that the powder is to the hunter's gun. The amplification of 3,000 or 4,000 times obtains its current from this battery. Without this source of supply, the set could do nothing. Referring to the hunter again—no matter how hard he might press the trigger, the gun would be worthless unless there were powder in the cartridge.

A FEW "BRUTE FACTS"

How the grid controls this power of the "B" battery is a very interesting story. We shall explain it in the easiest possible manner. At some points we shall make several statements which Sir Oliver Lodge has so aptly classified as the "brute facts of science," those things which are found by the physicist and mathematician to be true, but for which we have, at the same time, no thorough explanation. In other words, they are just facts which we know do exist, but do not know why. We shall label all these brute facts and the reader will simply have to take them for truths founded on proofs and theories which are too long and complicated to be completely detailed here.

First, we shall say that a current is always flowing through the tube from the filament to the plate so long as the filament is lighted and the "B" battery connected properly with its positive pole to the plate and the negative pole to the filament.

This current is important, but the most important point is the fact that the little grid which is placed between the filament and the plate has complete control over it. The grid may stop the current entirely or allow all of it to pass. It may even cause more than the ordinary amount of current to take the path from the "B" battery through the tube—through the space between the plate and the filament—and then down the filament lead and back to the negative pole of the battery.

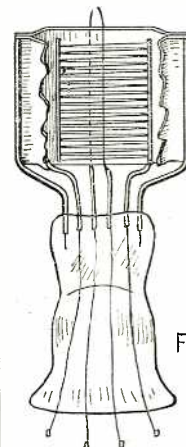

The skeleton view of the elements of a vacuum tube shown here with will give the reader a clearer idea of the relation between the various parts.

FIG. 3

As we said above, this is the all-important characteristic of the tube, this ability of the grid to control so easily the passage of the current of the high voltage battery.

How this is done is an interesting process. It all depends upon the way the current passes through the tube. Ordinarily, we think of current as passing along a wire or some other metal path. But, in the final analysis, the current passes through a tube just as it passes along the copper leads from the light company's mains in the street to the lamps which light your home.

We will not go into great detail as to just how a current travels, but will simply say that whenever there is a movement of current in any direction, there is a flow of electrons accompanying it. That is, there is a real and measurable stream of these little particles of matter flowing in a definite direction and at a definite speed through the conductor and in the space through which the current is passing.

A word of explanation here as to just

Get a Handy Binder for your RADIO NEWS. Holds and preserves six issues, each of which can be inserted or removed at will. Price 65c. Experimenter Pub. Co., Inc., Book Dept., 53 Park Place, N. Y.



\$25

The SAAL Soft SPEAKER

combines volume with a velvet tone

SAAL Jr.

The same in every respect as the Saal Soft Speaker, except it measures 18½ instead of 21¼ inches in height.

\$20

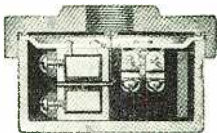

The Saal Soft Speaker Unit is an example of the care with which the entire speaker is manufactured. The diaphragm is connected to the armature by a pin which transmits the action of the armature to the diaphragm as a push and pull movement. There are no springs to snap the diaphragm back into place. This explains why the unit cannot be blasted and cannot get out of order. In attaching the pin to the diaphragm it is threaded for a nut. These threads, 200 to the inch, are finer than a jeweler's standard.

IN buying a radio reproducer you need no longer choose between volume and tone quality. You can now buy a speaker with both. The Saal Soft Speaker combines volume with a velvet tone. And tone quality is what counts after you have owned a set a while.

The Saal has no blare, no blast, no metallic ring. It is not a fad. It is a faithful reproducer of radio programs. It is properly constructed for the accurate reproduction of sound. It is not straight-necked like a trumpet. The neck is curved like a saxophone, the most melodious of all instruments. From the reproducing unit to the edge of the bell is one unbroken taper—one even, unbroken enlargement of sound.

The reproducing unit of the Saal Soft Speaker is of all-metal construction, and cannot be harmed or "blasted" by the loudest receiver. It maintains its tone with any volume. There is no adjustment knob to complicate tuning.

The Saal Soft Speaker is made to last a life-time. The neck is of aluminum, a porous and non-vibrant metal with no tinny ring. The bell is of genuine Bakelite, the most perfect and most resonant of all radio materials. There is no wood, no tin, no composition. It has nothing to warp, crack, wear out or deteriorate. It is guaranteed to give you satisfaction.

In appearance the Saal, with its large black bell, black crackle throat and graceful lines is the aristocrat of horns. Also furnished with a brown bell and gold or silver stippled throat at \$5 extra. Hear it at your dealer's today.

SAAL *Soft* SPEAKER

VOLUME WITH TONE QUALITY

Manufactured and guaranteed by H. G. SAAL COMPANY, 1800 Montrose Ave., Chicago, Ill.

Just like having Radio Batteries fresh every day!

IMAGINE the high quality in reception if your radio batteries were *always* brand new! Imagine having radio batteries that never need replacement!

The man who owns a Cooper A-n-B has just such radio power at his disposal. Using the same light socket as an electric lamp, it supplies, year in and year out, the *exact* current requirements of any radio circuit.

The Cooper A-n-B *never* wears out. Its usefulness is constant—its current precisely the same whenever you pull the switch of your set.

For a 5-tube receiver an entire evening's entertainment costs about five cents for current.

Having a Cooper A-n-B is just like having radio batteries fresh every day.

The COOPER CORPORATION
CINCINNATI, OHIO
Founded - 1904

COOPER

A-n-B

Radio Battery Eliminator

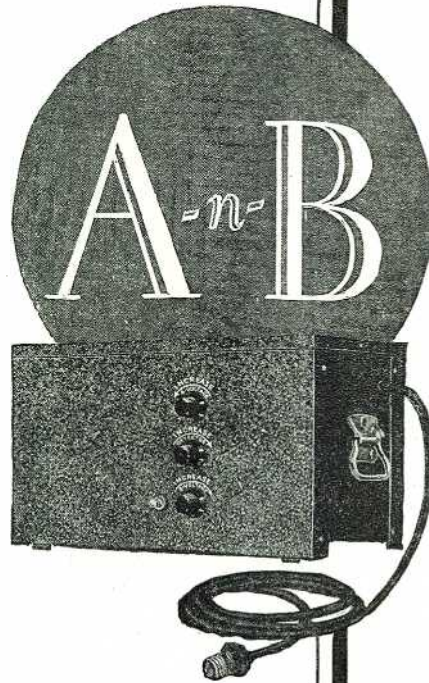

The advantages of the Cooper A-n-B are too numerous to put into an advertisement. We have explained its benefits in an interesting booklet. May we send you a copy?

ADV. PICARD-SOHN, INC., N. Y.

exactly what these little electrons are may not be amiss. Those who have studied the latest ideas in physics and chemistry will, of course, find this a repetition of what they already know, but those who are not so well acquainted with these sciences will need this explanation to understand the operation of the tube.

All matter is composed of electrons and protons. Just what the electrons are is hard to say. Some scientists think that they are simply small charges of electricity, while others think that they constitute the last indivisible foundation of matter carrying an electric charge. In either case, all we need to know is that the electron is negative electricity and that the proton is positive electricity and that the two of them compose the atoms of matter. Now, as in ordinary electrical work, unlike charges attract each other and like charges repel. That is, a positive and a negative particle of electricity will rush together with great haste and force while two positive or two negative particles will rush apart with just as great enthusiasm.

THEORY OF MATTER

All matter is, of course, made up of atoms which are, in the last analysis, nothing more nor less than an orderly array of electrons. According to the latest view the proton is at the center of the atom and the electron revolves around it in much the same fashion as the moon revolves around the earth.

How and why this is so is one of the brute facts of science spoken of above. It must be taken for what it is worth without further worry. It may be difficult at first for the reader to accustom himself to thinking of matter in this way, but time will give him the proper conception.

Nevertheless, all matter is composed of these tiny particles, and thereby hangs the tale of the vacuum tube's operation.

Now, in a metal like copper, all the atoms are composed of the same number of electrons and protons. But, at the same time, between them there are a number of loose electrons not attached to any particular proton. Ordinarily, all the electrons have their particular nucleus of protons, or protons and electrons, around which they revolve and which they never leave, except under some extraordinary circumstance. The passage of electrical current through a wire may, of course, be considered an extraordinary happening, so far as the electrons are concerned—and they are what we are concerned with.

Now in copper—and this is another of the brute facts of science—there are some of the loose electrons spoken of above. Also, the passage of a current through copper may rob some of the nuclei of their electrons and make them (the electrons) travel along in some particular direction in the wire, depending upon which is the positive end of the wire, or rather to which end of the generator is attached the positive pole of the generator or source of current.

In case the material substance has all its electrons tied tightly to their nuclei, so to speak, so that a current may not move them, we have an insulator instead of a conductor. The passage of a current along any substance depends on the flow of electrons alone. The nature of the conductor has nothing to do with the passage of the current, except as it contains electrons which may be easily dislodged and moved from place.

Now, with a clear idea as to the necessity for moving electrons for the carriage of current, it does not look so preposterous for a current to flow through a vacuum tube when we learn that there is a constant stream of electrons flowing through it.

How this necessary stream is created and kept up in the vacuum tube is another interesting point. It is accomplished very simply by heating the filament until it "boils

Special Library of Information
on
RADIO PATENTS
and
TRADE MARKS

JOHN B. BRADY

Patent Lawyer

Ouray Building Washington, D. C.

Cable address:
RADIOPAT

Telephone:
Main 4806

**BIG DISCOUNTS
TO
DEALERS**

Write us—if you want
to make more money on standard
kits, sets, parts. Get our
BIG FREE CATALOG
which is the most complete dealers'
catalog ever compiled. Standard
lines at big discounts.

WRITE FOR IT NOW!

W.C. BRAUN CO.
32-56 S. Clinton St., Chicago

Dealers
Catalog
PARTS
SETS
KITS

Insure your copy reaching you each month. Subscribe to Radio News—\$2.50 a year.
Experimenter Publishing Co., 53 Park Place, N. Y. C.

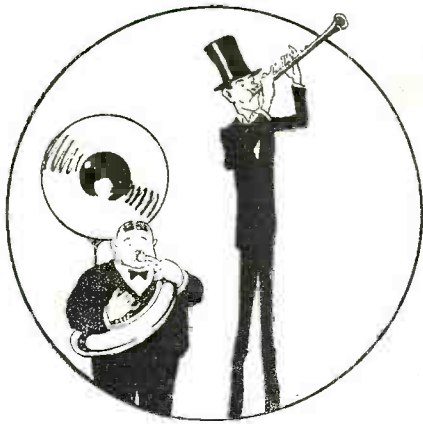

Plays No Favorites

Amplifies both Low and High Tones

YOU want more from your loud speaker than noise, distortion, howls and squeals. You want pure tones, clear and mellow, whether high, low or of medium pitch. You expect faithful reproduction.

Such reproduction is made possible by resistance coupling amplification. Lower initial and operating costs, simpler assembly, and superior results make this method of amplification most popular.

"ELECTRAD" 3-STEP RESISTANCE COUPLED AMPLIFIER KIT No. 1-C—A big \$6.75 value. Contains the necessary Resistor Couplers, Certified Mica Condensers, Condenser Mounting, Certified Grid Leaks and Resistors. Nothing else needed except sockets, rheostat and bus bar.

Ask your dealer or write for FREE
Resistance Coupled Amplification Folder

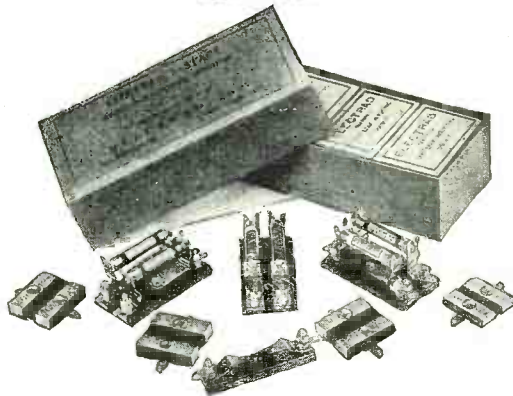

ELECTRAD, Inc.

428 Broadway New York City

Variotoms, Audiotoms, Lightning Arresters, Lead-Ins and many other "Electrad" radio products are on sale at your dealers. Sent direct if he can't supply.

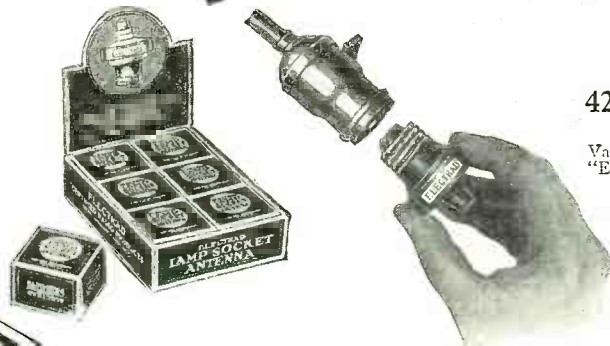

"ELECTRAD" LAMP SOCKET ANTENNA—Price 75c. Plugs in on any light socket. Reduces static and other interference. No outdoor aerial needed.

ELECTRAD

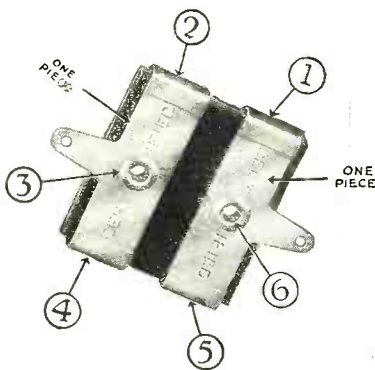

"The Six Point Pressure Condenser"

THE "Electrad" Certified Fixed Mica Condenser is a revelation in accuracy and design. Ingenious, rigid binding and firm riveting fastens parts securely at Six different points insuring positive electrical contact. Impervious to temperature and climatic variations. Exerts even pressure upon the largest possible surface—can't work loose. Binding strap and soldering lug in one piece. Accuracy and quietness assured always. Value guaranteed to remain within 10% of calibration. Standard capacities, 3 types. Licensed under Pat. No. 1,181,623, May 2, 1916, and applications pending. Price 30c to 75c in sealed dust and moisture proof packages.

Sterling TUBE REACTIVATOR

Renews your tubes, and tests them, too.



Read the Meter

Don't Throw Away Weakened Tubes!

Make Old Tubes Perform Like New and Keep Reception Good By Testing and Re-activating

The quality of reception you get from your set varies in proportion to the strength or weakness of individual tube filaments—a set is no better than its weakest tube.

You can now test the filament strength of each tube, reactivate one or all tubes in your set and know just how good each tube is after the treatment.

The Sterling Tube Reactivator is equipped with a filament emission meter which shows whether a tube needs reactivation and exactly how much its amplification has been improved by the treatment. This combination of meter with the reactivator is essential to the matching of tubes in sets to get the best results. A table showing what different types of tubes should test before and after reactivation makes the Sterling instrument simple to operate and sure in its results.

If you are interested in better reception and economy of tube expense, ask for our ten page booklet, which tells the whole story.

Sterling "Home" Tube Tester

In less than half a minute this neat little instrument tests the plate current of tubes. A convenient table furnished with the instrument tells at a glance whether a tube is "good," "fair" or "poor." Also helpful in locating transformer, wiring and socket troubles.



PRICE \$8.50

Sterling Tube Reactivator
For use with UV-201-A, C-301-A, UV-199 and C-299 types of vacuum tubes.
A promoter of good reception.
A tube and time saver for the set owner.
A money maker for the radio dealer and service man.

Size—6x7½x5".
Portable.
5 foot lamp cord with plug.
Tests both large and small tubes.
Meter equipped.

PRICE \$12.50

Other Sterling Radio Equipment

Pocket Meters
Rheostats

Transformers

Panel Meters
Potentiometers

Battery Chargers
Microcondensers

The Sterling Manufacturing Company

2831-53 Prospect Ave.,

Cleveland, Ohio

off" the electrons. Here we come again to the construction of matter from electrons. When a metal is heated, the scientists have found that it throws off these electrons in much the same way as water throws off steam when it is heated. This "boiling" of electrons from an incandescent filament makes the working of a vacuum tube possible.

As said above, all electrons have a negative electrical charge. And of course they will be attracted to anything which has a positive charge. And further, all those who have had anything to do with a radio set know that the plates of the vacuum tubes must be connected to the positive pole of the "B" battery. As a matter of fact, the "B" battery is used as much to put a positive charge on the plate as it is to furnish the current which is triggered off by the grid.

Now we must make another explanation regarding the flow of electrons before we get too far away from the subject. Just above we told how the passage of current depended upon the free electrons in the wire or conductor for its path. Somewhat the same is the situation with the filament. Some elements have an ability to throw off electrons with greater ease than others. For that reason they are selected for use as filaments. With the smaller type tubes, for instance the 199 and the 299 types, the filament is made of a special so-called thoriated wire. This name comes from a certain compound of thorium which will throw off electrons at a very low temperature. With ordinary tungsten it is necessary to heat the wire to bright red.

THE GRID ACTION

If we had only a filament and a plate in a tube, the flow of current through it would be constant. That is, the positive plate would have an uninterrupted attraction for the electrons constantly being boiled off the filament and, there being nothing to stop them or change the number of them reaching the plate, the current would be almost constant through the tube. That is, it would vary little, if any, in quantity from second to second.

But here, for the uses of radio, we interpose a grid between the plate and the filament to control the flow of electrons. It was the grid which Dr. Lee DeForest invented which has made radio, as we know it today, possible, for it is through the use of this grid that we are enabled to control the flow of current from the "B" battery in accordance with the incoming signal which we wish to receive.

It is very necessary that we begin to think of the tube merely as a sort of valve which controls the flow of current from the "B" battery in accordance with the incoming signal. The battery is the reservoir and the tube is the controlling outlet. The incoming signal acts as a workman turning the valve.

The explanation of how the grid is enabled to control all this power is simple in one way and quite complicated in another. The mathematical part of it is very complicated, and may be studied only by those who have a thorough foundation in the higher branches of that complicated science. Luckily, however, the mathematical reasons may be put in simple language that anyone may understand.

An examination of a vacuum tube will show that the grid is very close to the filament—much closer than the plate. This placement of the grid must be taken into consideration in figuring out how it controls the flow of electrons. It is perfectly plain that the speed of the electron should increase as it approaches the plate. Maybe it is not so plain, but it is a brute fact of science, anyway, and will have to be taken for granted. It is easily seen, however, that as the electron approaches the plate, the

National Airphone Corp.
MANUFACTURERS OF
Somerset—the Ultimate in
Radio Frequency Receivers
18 Hudson Street — New York City

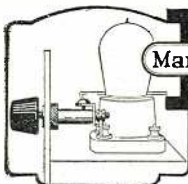

Price \$1.50

THE IDEAL RADIO RHEOSTAT

Mfd. by Marshall Electric Co.,
3235 Locust Boul., St. Louis, Mo.



"Lighting Fixtures"
READY TO HANG
(Direct from Manufacturer)
Completely wired including glassware
Send for new Catalogue No. 27
(Just reduced prices)
Special Proposition to Dealers
ERIE FIXTURE SUPPLY CO.
STATION R ERIE, PA.

Authorized Cockaday Coil - \$5.50
Precision Autodyne Coupler - \$3.50

PRECISION COIL CO., Inc.
209 CENTRE ST., NEW YORK CITY

Specialists in the manufacture of all types of radio coils

Now! **CH** Quality at a New Low Price

The Perfected C-H Rheostat

Designed to radio engineers' specifications. Revolving drum type with one hole mounting. All spring tensions adjusted at factory and undisturbed by mounting. Instrument cannot turn on panel. Very small size—less than 1/4 inch back of panel and narrower than standard socket. Operation smooth and quiet. 6 ohms, 15 ohms, and 30 ohms—perfect control for all tubes and their combinations.

C-H Radio Potentiometer

Similar in construction to the perfected rheostat. 400 ohms and only a little larger than a silver dollar. Perfect, smooth operation—no back lash or sticking. Price \$1.00.

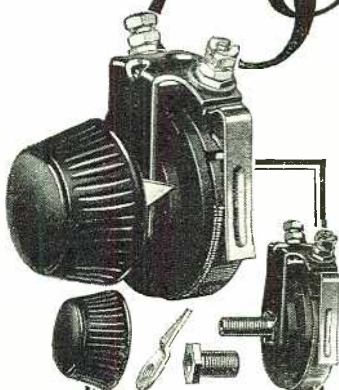
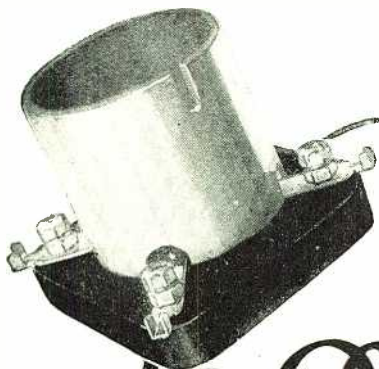

Operating parts built as unit—the C-H Perfected Rheostat is not dismantled for mounting on panel. Rheostat is locked in place and knob positioned without a single set screw.

The C-H Low Loss Socket

The revolutionary socket design that created a sensation everywhere. Thin ORANGE Bakelite shell. Base of heatproof Thermoplox—terminals cannot loosen under heat of soldering iron. Contacts grip both sides of each tube prong and are SILVER plated to prevent corrosion losses. Preferred by careful builders at 90¢—now 60¢ because of huge production savings.

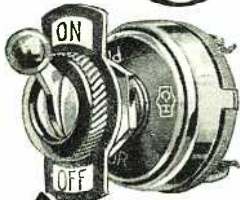

C-H Radio Toggle Switch

The newest idea in panel switches. ON or OFF with a flip of the finger. Beautiful appearance and simple one hole mounting—neat etched plate for panel provides definite indication. Quiet, easy operating switch mechanism.



The C-H Radio Switch

The original radio switch. Millions in use. One hole mounting—high capacity mechanism. The only radio switch approved for 110 volt circuits by the Underwriters Laboratories. Ideal for batteryless sets or higher voltage circuits. Many switches now have buttons to look like the C-H but the patented mechanism cannot be duplicated. Demand the orange and blue box for satisfaction.

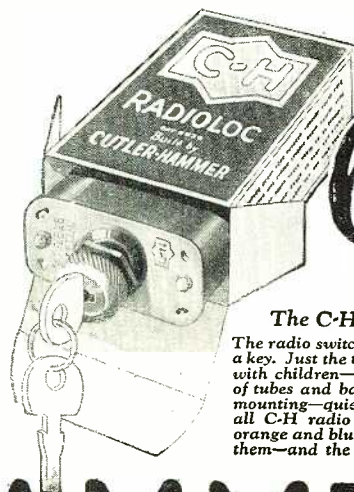

The C-H Radioloc

The radio switch that locks with a key. Just the thing for the home with children—for the protection of tubes and batteries. One hole mounting—quiet operation. Like all C-H radio parts, packed in orange and blue boxes. Look for them—and the C-H trade mark.

The name Cutler-Hammer has held an enviable position in radio. Consistently from the earliest days has the C-H trade mark been synonymous with proper design and unequalled precision. Radio builders everywhere justly had faith in these foremost engineers and millions of their radio parts in the orange and blue boxes have helped build receiving sets of quality.

Better Sets at Lower Cost

These millions of sales have brought down manufacturing costs and today this quality carries no premium. Demanding the C-H trade mark now not only insures satisfaction, but provides a saving. Dealers everywhere are ready to serve you. If yours has not yet stocked any C-H part you desire, send us his name and we will see that you are supplied.

THE CUTLER-HAMMER MFG. CO.

Member Radio Section, Associated Manufacturers of Electrical Supplies
MILWAUKEE AND NEW YORK

CUTLER-HAMMER

Buy Your Radio Parts by Name

Vital Parts of Leading Radio Sets

Nowhere is the axiom "an article is no better than the parts it contains" more true than in the radio world. So it is not surprising that leading manufacturers of radio sets choose the accessories for their hookups only after gaining a full technical knowledge of their make-up and the results they give.

In full consideration of this, the choice of Benjamin Radio Products, above all others, by the manufacturers of many of the finest modern radio sets, bespeaks eloquently of their worth as practical radio parts made by one of the oldest manufacturers of electrical goods.

Each has been made a super radio part—to secure for the owner of the set the purest, loudest and clearest radio signals possible. Used together, their total efficiency spells the acme of selectivity, tuning range, the elimination of disturbance and distortion, and the reduction of radio losses. And, the logical total of these many worthy features is "Better Radio."

**Benjamin
Electric
Mfg. Co.**

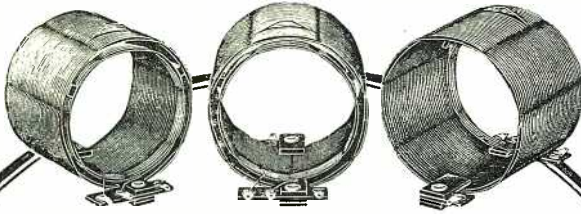

120-128 S. Sangamon
St., Chicago
241 W. 17th Street
New York
448 Bryant Street
San Francisco
Manufactured in Canada by:
The Benjamin Electric Mfg.
Co., of Canada, Ltd.,
Toronto, Ontario

BENJAMIN Tuned Radio Frequency Transformers

Low Resistance—Low Distributed Capacity

Wires are space wound, adjacent coils are parallel, air insulated and so separated that while capacity is reduced to a minimum, inductance is maintained at a high point of efficiency.

Greater Tuning Range—Greater Selectivity

These coils are very uniform, both in inductance and distributed capacity, so that if desired they may be geared for single control of the three tuned stages. A minimum amount of material is used in the field of the coil, and an anti-capacity cement is used only where the wires cross. Coils are coupled so as to reduce capacity coupling to a minimum. Green double silk covering provides high insulation and gives a fine appearance to the coil.

Benjamin Cle-Ra-Tone Sockets

Benjamin Cle-Ra-Tone Sockets prevent the transmission of outside vibrations into microphonic disturbances. Four delicately adjusted double springs support the socket—"float" it above the base—and absorb all jars and shocks. An absolute necessity in portable sets. Used by leading manufacturers and recommended by radio engineers in their most popular hookups. There are no rubber parts to deteriorate. Bakelite is used wherever possible to insure sturdiness, long life and high insulation. Handy lugs make soldering easy. Stiff bus wiring does not affect the flexibility of the Cle Ra-Tone springs. Furnished also in gangs on Bakelite sub panels for compact set building, as when mounted on Benjamin brackets there is plenty of space underneath for mounting accessory equipment.



SPRING SUSPENDED
SHOCK ABSORBING

Benjamin Low-Loss, Long-Range Condensers

Straight line type. Definite and positive control of minute changes in condenser capacity. Spreads the broadcast range on the higher frequencies, and eliminates bunching of stations on the lower side of the dial. Aids sharp tuning and increases selectivity. Minimum insulation is used and leakage must go through long paths outside of strongest field. Unpolished silver plate finish. Small size of condenser makes it adaptable to any set, regard-

less of crowding of apparatus on sub-panel. Friction disc on rotor shaft adjusts tuning tension without throwing rotor plates out of alignment. Drilling ten plate furnished with each condenser. Made in three sizes:

- 13 plate for .00025 Mfd.
- 17 plate for .00035 Mfd.
- 25 plate for .0005 Mfd.

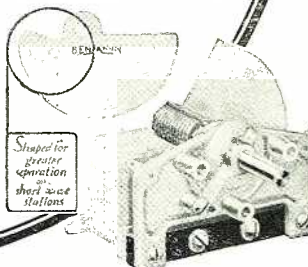

power of the plate over it will become greater and greater on account of the nearness of the electron to the plate. This increase in speed of the electron as it comes closer to the plate is called its acceleration.

Now, consider the closeness of the grid to the filament and the comparatively large distance to the plate. That is, the distance is extremely large compared to the size of the electron. (The writer has tried to keep away from any reference to the size of the electron because it is so small that there is no clear example which can be given in explanation of it. Just let us say that it is so small that several billions of them would be required to stretch across the finest needle point ever made.)

Mathematically, these mites travel very slowly at first, gradually attaining speed. Of course, their power is directly proportional to their speed. This point may be illustrated by reference again to the gun. The power of the bullet to penetrate an object is calculated by multiplying the weight of the bullet by the speed at which it is traveling. The same is the case with every moving thing. This is one of the first laws of mechanics. We shall state it again:

The power or energy of any object is equal to the weight of the object multiplied by half the velocity at which it is traveling.

This law is stated in order that the reader may get a clearer idea of how the grid works. This is done because we commented in the first few paragraphs on how extremely minute the incoming signal really is. The reader might become confused as to how this minute current can control the great attractive power of the plate for the electrons if we did not go into this discussion.

We have seen what gives the electrons their force. This force is controlled by the amount of positive charge on the plate of the tube and the distance between the filament and the plate. We have also seen that the power of the electron increases as it approaches the plate, and we have seen how the grid is placed as close to the filament as is consistent with mechanical problems involved in the manufacture of the elements and the electrical properties of the tube.

When the electron is first boiled off the filament, it has little preference as to which way it will go. That is the case when there is no charge on the plate. If a battery is connected to the plate so that there is a positive charge to attract the electrons, they will, of course, lay their path toward it, immediately they are free of the filament.

Now the manufacturers of tubes specify certain voltages for the plates of their tubes. This is done so that the pull of the plate just throws the slightest attraction for the electrons, so that it is just sufficient—measured at the surface of the filament—to start the electrons toward the plate. By measured at the filament we mean, of course, that the attraction of the positive plate for the negative electrons at the outside of the filament wire is just enough to start them in the general direction of the plate. We must constantly keep in mind that the power of the plate to attract the electrons is, as the mathematicians say, a function of the distance. Simply stated, this means that the further away from the plate we go, the less the attraction becomes.

When the electron is first released it starts toward the plate very slowly. For some time it travels with very little power, gradually picking up speed and power as it comes closer and closer to the plate. The grid is so placed that it intersects the path of the electrons before they gain any appreciable power. Therefore, it takes only the smallest change in the grid to effect a mighty change in the current at the plate.

The grid, of course, controls the electrons in the same way that the plate does. The

TUBES

REPAIRED OR EXCHANGED

All Work Done in Our Own Laboratory **\$1.25**

Thousands of tubes come to us for re-newing solely upon the recommendation of satisfied radio operators. Don't take chances. Send your tubes to us. Your satisfaction guaranteed. Broken or burned out tubes made like new for only \$1.25. UV202 or C302—\$2.75. Send them in today. No need to buy new tubes.

Tubes Exchanged—One Type for Another

If you want another type of tube send in your old one; good, burned out or broken, and we will send you any other standard type of tube for \$1.25. UV202 or C302 for \$2.75 and your old tube. Satisfaction Guaranteed.

CHICAGO ELECTRIC DEVICES CO., Dept. 28
70 E. 22nd St. Chicago

RADIO CATALOG

New 1925-26 Edition.
Contains nationally
advertised high quality
Sets, Kits and
parts.

Western Radio Co. MFG.
134-136 W. Lake St. Chicago, Ill.

SAVE YOUR TUBES

Don't throw away "dead" radio tubes. You can rejuvenate them quickly at home and without expense by a very simple process. Send 10 cents in coin and a self addressed stamped envelope for full and complete directions.

LEO E. BUSS RADIO SERVICE
Centerline Mich.

BUILDING A SET?

You must have rheostats of correct ohmage. Insist on the genuine

KLOSNER RHEOSTATS

Made by pioneer makers of the vemier. FREE.—Send for valuable Rheostat Chart and information on the care and operation of vacuum tubes. Mention dealer's name.

KLOSNER RADIO CORPORATION
1024 East 178th St. Rheostat Specialists. N. Y. C.

Insure your copy reaching you each month. Subscribe to Radio News—\$2.50 a year. Experimenter Publishing Co., 53 Park Place, N. Y. C.

*A type for
every need
or preference:*

S 01-A

S-99 Large Base

S-99 Small Base



If you want to get down to bed-rock or the tube situation

THIS tube or that tube—a cheap, questionable product that quickly wears down “B” batteries and gives little that is worth while in return or a downright quality product that brings out the best in your set—its an important question many fans are asking themselves today.

If you want to quit speculating with radio tubes—if you want to get down to bed-rock and get all out of your set that its possible for a tube to get—then install Sylvania. Immediately you will notice a big difference in performance: better tone, greater sensitivity, more volume, longer life.

There is no compromise in Sylvania performance because there is no compromise in Sylvania manufacture. There is one standard only—the best it is humanly possible to produce. Yet the price is no more than you will pay for any other tube.



A Note to Dealers

¶ Sylvania tubes are made by a close-knit organization that knows, from long years of experience, the intimate relationship of quality to profits. You should, by all means, get full particulars about the dealer franchise now. You are invited to investigate the Company's responsibility through any of the commercial agencies. Write or wire today.

Sylvania

Sylvania Products Company
Emporium, Pa.

Convert Your Old Condensers to Straight Line Frequency

WALBERT
made it first.

WALBERT SLF VERNIER DIAL

Construction Data

1. Easily installed
2. Concentric mounting
3. Takes standard shaft-projection
4. No friction mounting (no slippage)
5. Heavy gears (smooth action)
6. All bakelite knob
7. Nickel-silver dial (not plated)
8. Precision graduations
9. Hairline pointer

WALBERT engineers have developed a new VERNIER DIAL that imparts Straight-Line-Frequency characteristics to any semi-circular plate condenser.

No more crowding of stations at low-wave lengths. The SLF VERNIER DIAL separates stations at low wave-lengths just as easily as at high wave-lengths.

The strong, positive and ingenious mechanism contained in the knob gives small increases in capacity at low wave-lengths and progressively greater increases at higher wave lengths while knob and pointer revolve at uniform speeds.

A standard 12-to-1 VERNIER DIAL giving SLF characteristics to any ordinary condenser. Write for prices.

JOBBERS AND DEALERS: Deliveries September 10th. Orders filled in rotation as received. Catalog copy and cuts ready August 15th

WALBERT MANUFACTURING COMPANY
933 Wrightwood Avenue, Chicago, U. S. A.

small incoming signals place a small positive or negative voltage of the grid in accordance with the transmitted voice or music. This voltage is infinitely small, as we said in the beginning, but on account of the position of grid in connection with the filament and plate these minute voltages are able to deflect or help the electrons in their path to the plate.

The working of the grid is just the same as that of the plate. A positive charge on the grid will help the electron stream along by overcoming the resistance offered to it within the tube and the filament. When the grid turns negative on account of a negative signal, it at once repels the electrons and acts as an effective bar to their passage, thus shutting off the flow and therewith the current.

Now we understand that the grid, by becoming alternately positive and negative as the incoming signal becomes alternately positive and negative, controls the flow of current from the "B" battery because it is much closer to the filament than the plate and because there is a balance between the voltage on the plate and the construction of the tube.

We shall explain the reason for the vacuum. Everyone knows that there is a near-vacuum in the electric lights we use in our homes. Were it not for this exhaustion of the air in the bulb, the filament would be burned up as soon as it was lighted. This is also one reason for the vacuum in the vacuum tube—to keep the filament from burning up.

The second and most important reason is that the molecules of the air, if left in the tube, would impede the progress of the electrons in their flow from the filament to the plate. The so-called "hard" tubes are those which have a high degree of exhaustion, that is, the very last vestige of air possible has been taken from them so that there will be the least interference possible offered to the electrons.

The degree of vacuum in a tube is very much higher than in the ordinary electric lamp. In fact, the exhaustion of the air and other gases from such tubes is one of the stiffest problems now confronting manufacturers. They have developed all sorts of special pumps and other apparatus for this purpose, and there are no end of patents on them. The company which controls the best pumping apparatus will be in a position to put out the best tubes, all other things being equal.

Last month we explained the "characteristic curve" of a vacuum tube. In order to tie that explanation up with this one, it will only be necessary to say that the characteristic curve is nothing more nor less than the Bertillon measurement of the particular tube for which the curve is drawn. The curve is simply the engineer's method of telling on paper what the tube will do. From the characteristic we can obtain the proper plate voltage to use on it, the amplification factor—or the calibre of the tube—and many other interesting and extremely important facts concerning what the tube will do when it is hooked up to a radio set.

Radio Wrinkles (Continued from page 455)

varying the intensity of the output of the receiver. The apparatus here described may be applied to any set, as it is placed across the phone terminals or connected to a plug that is inserted in the phone jack.

The apparatus needed for this control can be found in nearly every junk box. There are needed a resistance, which may be varied from 500 to 1500 ohms, two single-circuit jacks, and a mounting panel or small box. The parts are connected as



Price, \$1.10

The JEWELL Lightning Arrester

has been approved by the underwriters for indoor and outdoor installations (No. E-5403) as complying with their radio code.

"Each lead-in wire shall be provided with an approved protective device properly connected and located (inside or outside the building) as near as practicable to the point where the wire enters the building. The protector shall not be placed in the immediate vicinity of easily ignitable stuff, or where exposed to inflammable gases or dust or flyings of combustible materials. The protective device shall be an approved lightning arrester which will operate at a potential of five hundred (500) volts or less."

Install an approved Jewell Lightning Arrester and avoid possibility of having your entire insurance policy questioned. Buy from Dealer

Jewell Electrical Instrument Co.

1650 Walnut St., Chicago

Unconditionally Guaranteed

THORDARSON

Super
AMPLIFYING TRANSFORMERS
Standard on the majority of quality sets

K E N N E D Y



Writes: "We are cranks on audio-frequency transformers and our engineers are constantly running comparative tests on them. The fact that we continue to use Thordarson's exclusively, in ever increasing numbers, simply means that we believe that it is the best available at this time."

Thordarsons are Absolutely Uniform!
They always "match up" perfectly

One reason that leading builders of fine sets use *more* Thordarsons than all competitive transformers combined is because Thordarsons run *absolutely alike, absolutely uniform*: always "match up" perfectly.

Daily we hear from fans who paid high prices for musically named, fancy-looking transformers only to discover that their old stand-bys—Thordarsons—were the *real* musical instru-

ments. For the benefit of others we therefore repeat "when better transformers can be bought they will be Thordarsons."

Few, if any, transformers actually cost as much to make as Thordarsons. Why, then, pay more? Follow the lead of the leaders—build or replace with Thordarsons. Any store can supply you. If dealer is sold out, order from us.

Thordarson Types and Prices

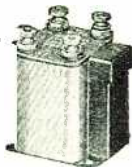

Thordarson Super Audio Frequency Transformers, sub-panel or top mounting types: 2:1, \$5; 3½:1, \$4; 6:1, \$4.50.

The Thordarson INTERSTAGE



Power Amplifying Transformer. Provides two stages of POWER amplification when inserted in circuit between Input and Output Power Amplifying transformers. Four tubes are required, but the quality of the reception more than repays you. Only Thordarson builds a transformer of this type. Each \$8.

Thordarson Power Amplifying Transformers give best results when preceded by two stages using 3½-1 Thordarson A. F. Transformers. Pair \$13.



Thordarson AUTOFORMER

the All Frequency Amplifier, amplifies clearly the *lowest* notes of any instrument as perfectly as the highest notes. Autoformer amplification is an adaptation of impedances, resistances and capacities—developed and perfected by Thordarson. Write for the Autoformer Hook-up Bulletin. Autoformers are \$5.00 each.



Write for latest Thordarson bulletins on amplification.
Thordarson Dealers Everywhere.

THORDARSON ELECTRIC MANUFACTURING CO.
Transformer specialists since 1895
WORLD'S OLDEST AND LARGEST EXCLUSIVE TRANSFORMER MAKERS
Chicago, U.S.A.

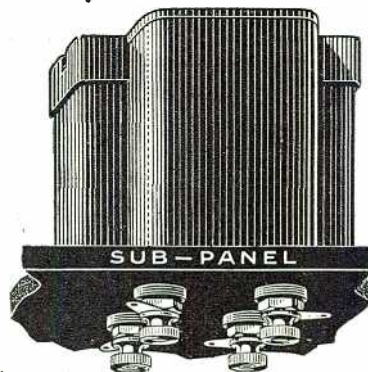
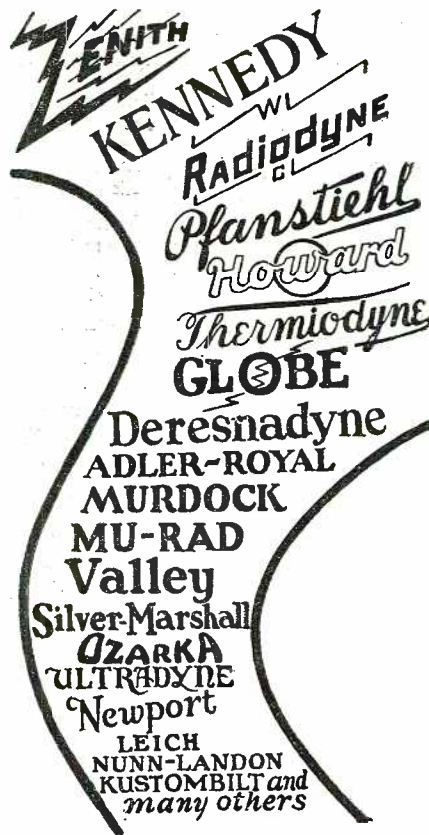

SUB-PANEL MOUNTING THORDARSONS ON SALE

They permit a neater assembly, the shortening of leads and the concealing of wiring—as in factory built sets. Same ratios—same prices—as standard type Thordarsons. If dealer cannot supply, order from us.

Super-Het Builders

For the "Best" 45,000 Cycle Super-Heterodyne "Radio" and other leading authorities recommend in highest terms the Thordarson 2:1 Ratio Transformers. Take no others.

SUCCESSFUL RADIO ADVERTISING

THE difference which makes your radio product better than another is technical. Yet an advertisement which confines itself to statement of the technicality cannot yield sales. Nor can an advertisement which ignores the technical difference.

The radio advertising which we prepare is successful for two reasons:

We know Radio, and therefore understand our clients' radio products.

We know Advertising, and consequently are able to interpret into impressionable language, the technical individualities of the radio products about which we write.

If you are interested in finding out how much more effective your advertising can be made when it is prepared by an advertising agency which is able to appreciate your product technically, we invite your correspondence.

This advertisement is directed to reputable, established manufacturers

KIRTLAND-ENGEL COMPANY ADVERTISING

ESTABLISHED 1913

646 North Michigan Boulevard, Chicago

shown in the sketch. Such a control as this may be used as a remote control for the volume, as a long lead may be run to the control panel, which may be close to

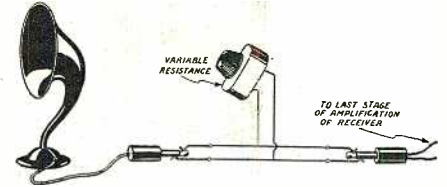

By the use of two plugs and jacks and a variable resistance connected, as shown above, in the output of a radio receiver, the volume of the signals received may be varied to any intensity desired by varying the amount of resistance.

the loud speaker. In this way it will not be necessary to make several trips between the receiver and the loud speaker to adjust the volume by means of rheostats.

Extending the Broadcast Range

(Continued from page 446)

198 meters, we may be able to go only to, say, 220 meters, or even 240 meters. How low we shall be able to tune depends upon how closely the antenna is coupled to the secondary, and also upon the other capacities existing in the circuit, and whether or not the inductance of the coil changes with the frequency.

This is illustrated graphically in Fig. 1. The vertical black column on the left indicates the range of wave-length obtainable without connecting the antenna and ground to the primary coil. This range is 550 to 215 meters. When the antenna and ground are connected, the wave-length range is lowered to 507 to 198 meters. This makes it impossible to reach the longer wave-lengths, although we can reach the shorter ones. This is indicated by the middle black column in Fig. 1.

When we add a sufficient number of turns to the secondary coil to make up for this loss of inductance, the wave-length is raised to 550 to 240 meters. We are now able to tune to the upper wave-lengths as before, but are not now able to tune to the lower ones.

The reason for this is that the coupling of the antenna circuit to the secondary lowers the upper limit more than it lowers the lower limit, whereas the addition of the extra turns of wire changes both limits to nearly the same extent. This is indicated by the right-hand vertical column in Fig. 1.

INDUCTANCE VS. FREQUENCY CHANGES

When a coil has considerable capacity, as is the case with multi-layer coils, the inductance changes as the frequency (or wave-length) changes. See Fig. 2. Over the longer wave-lengths, say from 600 to 300 meters, the inductance does not change appreciably, but it is likely to increase very rapidly as the wave-length is made shorter and shorter. This will add to our difficulties in getting down to the low wave-lengths.

Now let us consider what difficulties we shall meet when we try to get down to 150 meters. The total range of 600 to 150 meters represents a wave-length ratio of 600/150 or 4 to 1. As has been explained above, this would require a capacity ratio of 16 to 1. In the old case, where we covered a range of 600 to 200 meters, there would have been no difficulty in covering the range, although there are many sets on the market which

Standard Adjustable AERIAL BASES

Fits any pitch of roof.

Eliminates unsightly aerial.

No wind resistance.

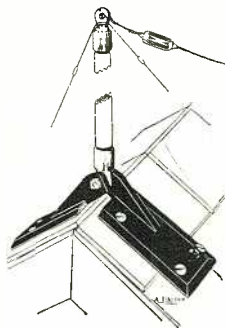

Absolutely protects your building from lightning.

Lasts a life time.

Will not blow down.

Pat. Pend.

Price \$2.00

Ask your dealer to install your aerial with these new Standard Aerial Bases. Get the best and the cheapest at the same time.

STANDARD AERIAL BASE CO., 227 W. 2nd St., POMONA, CALIF.



The Rectigon recharges BOTH "A" and "B" batteries easily and quickly. There's no muss or fuss; no acids or chemicals to bother with—
 No moving parts, and no noise.

No storage-battery radio is complete without a
RECTIGON!

Westinghouse
Rectigon Battery Charger

WESTINGHOUSE ELECTRIC & MFG. COMPANY
 South Bend, Indiana

© 1925, W. E. & M. Co.



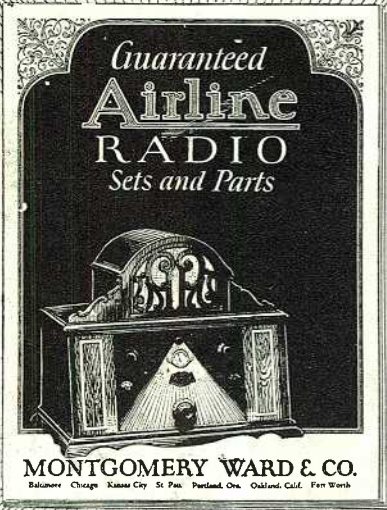

Ward's New Radio Catalogue Is Yours Free

Yours Free—the newest, most interesting book published on Radio. A book prepared by Radio experts—a complete Radio manual.

52 fully illustrated pages showing what is new in Radio and what has been approved by the best experts.

It shows sets from one tube to five tubes, the new one dial control, parts and supplies, batteries and cabinets. It gives a list of stations, a radio log for recording stations.

Headquarters for Radio

Ward's is today one of the greatest Radio stores in the world—selling

Write for your free copy of Ward's new Radio Catalogue
Address Dept. 2-R

ESTABLISHED 1872
Montgomery Ward & Co.

The Oldest Mail Order House is Today the Most Progressive
Baltimore Chicago Kansas City St. Paul Portland, Ore. Oakland, Calif. Ft. Worth

everything in Radio without the usual Radio Profits. And besides, we sell only the tested and approved equipment—selected and tested by our own experts, who are up to the minute in Radio. Thousands of customers write us of their delight and saving on Ward's Radio sets.

Our 53 year old Policy

For 53 years we have sold only quality merchandise under a Golden Rule Policy. You can rely absolutely upon the quality of everything shown in this Radio Catalogue.

cannot cover it. The secret of the problem lies in employing loose coupling between the primary and secondary, and in using coils with low distributed capacity.

The two cases are compared in the table below.

Wave-Length Range Desired	Wave-Length Ratio	Capacity Ratio Required
600-200	3:1	9:1
600-150	4:1	16:1

On account of the high capacity ratio required to cover the 600-150 range, it will hardly be possible to cover the range with the .0005 microfarad condenser which was used in making the measurements given in the first table. This condenser has a maximum of 500 and we cannot count on a minimum lower than about 25 micromicrofarads, because of the wiring, etc. Furthermore, it is not well to use the condenser at the very low dial settings, as it is very inefficient at these points. The resistance of a condenser increases to very high values at the low dial settings.

The capacity ratio was, therefore, 500/25 or 20 to 1. It is very interesting to note that although we require a capacity ratio of 9 to 1 to cover the 600-200 meter range, and although we have condensers having capacity ratios of 20 to 1, still many have not been able to cover the range completely. It is quite a mystery to the writer why this has been so difficult. He has constructed many radio receivers, and has not had any difficulty at all in covering the total broadcasting range.

But to take care of the range of 600-150 meters we should have to keep things in the same proportion. So, if we could cover the range 600-200 with a 20-to-1 condenser, requiring only a 9-to-1 ratio, then to cover a range 600-150, requiring a capacity ratio of 16 to 1, which is about twice the 9-to-1 ratio, we should have to have a capacity ratio of about twice 20 to 1, or 40 to 1. This high capacity ratio is not obtainable in the small-sized condensers. A 0.001 microfarad condenser may fill the bill, however, for this can be counted on to have a capacity ratio of at least 40 to 1. Thus, a condenser having a maximum of 1000 micromicrofarads and a minimum of 25, will have a capacity ratio of 1000/25 or 40 to 1.

There will be difficulties involved here, however, which will make it necessary to go to other means of extending the range. The main difficulty lies in the great congestion of stations which will be found on the lower half of the condenser dial. Besides this, it will be difficult to tune the set sharply, as everyone knows who has tried to tune with large condensers.

We come to the end of our journey, therefore, with the tentative conclusion that the only way in which the difficulty can be satisfactorily overcome is by the use of tapped coils in the tuned circuits. A very good example of this will be found in the three-range receiver described in the July issue of RADIO NEWS. Of course, it is not entirely necessary to use three ranges. Two ranges will be satisfactory for most purposes. But the advantage of spreading out the stations as much as practicable is, of course, the elimination of crowding.

Much ingenuity will have to be exercised in keeping down the number of switches and controls. But difficulties such as this will be overcome, for there is scarcely anything for which a suitable switch cannot be designed.

Book Review

MANUAL OF RADIO TELEGRAPHY AND TELEPHONY FOR THE USE OF NAVAL RADIOMEN. By Commander S. S. Robison, revised by Commander S. C. Hooper, both of the U. S.

AEROVOX

is accurate because

The AEROVOX process insures electrical contact with the entire surface of end plates. This prevents leakage. Other makes depend on eyelet contact only. Convince yourself by trying it.

IMPREGNATION with our secret formula (patent pending) predetermines and controls capacities. Result—capacities are exact.

Endorsed by Radio News, Popular Radio, Popular Science, and Professor Wheeler of Yale. Approved and used by over 100 set manufacturers.

Made in all capacities. Write for particulars of complete line including Resistors, Rheostats, and Grid Leaks.

Chicago Office:
53 W. Jackson Boulevard

AEROVOX WIRELESS CORP.
493 Broome St., New York City

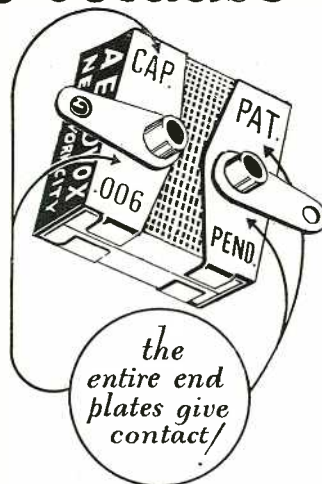



Rola

RE ★ CREATOR

\$36

Re*Creation — *the triumph of genius*

RE*CREATION could not come in a day. Nor in a year. Mere mechanical skill could not produce it. Just as no wonderful painting can be turned out by any machine. For re*creation is something intangible—subtle.

Mechanics and acoustics enter in, but artistic genius, itself, must guide the creation of an instrument capable of re*creating the tonal arts of the world. That instrument must be in intimate sympathy with every expression of music and voice.

Rola is the one Re*creator. And once you hear it, you too will say: "Here is a truly marvelous thing. Now I can get all I have longed for from the miracle of radio." The Rola Company, 4250 Hollis Street, Oakland, California. Marketed nationally through Baker-Smith, Inc. Head offices, Call Building, San Francisco. Branch offices in principal cities.

A Set Is As Good As Its Dials

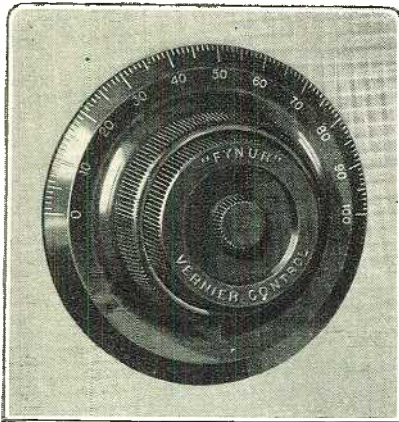

The Fynur Vernier Control is accurate to a hair's breadth. There is positively no backlash or lost motion.

PRICE
\$350

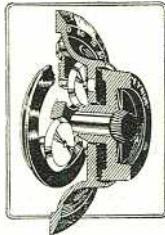

OPERATES BY TRACTION

The New Fynur tuning dial operates on beveled wheels instead of gears, so that forward or backward there is not the slightest break or interruption.

NO BACKLASH is possible in the new Fynur Vernier Control. There are no gears to mesh, so there can be no lost motion, and the movement is always smooth and free.

If you want the utmost accuracy in reception, and unless you have it you cannot expect the best results from your set, use Fynur dials. They'll give you perfect selectivity and a greater and more lasting satisfaction than any other dial on the market. Simple in construction (can be mounted without disassembling), beautiful in appearance, (black or mahoganite Bakelite). If your dealer cannot supply you, write us.

Your set can be no better than its dials, so have the best set by having the best dials.

AUGUST GOERTZ & CO., Inc.
270-286 Morris Ave., Newark, N. J.

SET MANUFACTURERS will find that Fynur dials will improve the appearance as well as the efficiency of their products. Inquiries are invited.

FYNUR VERNIER CONTROL

BRANSTON RADIO

Hetorus—the Final Achievement!

A new and improved type of tuned R. F. transformer with isolated field coils.

IT DOES THREE THINGS:

1. Increases selectivity for precise tuning.
2. Improves tone and volume of distant stations.
3. Reduces static and interference to a minimum.

Because: The Hetorus Coil has no pick-up quality of its own and amplifies only the signals to which the antenna is tuned. Being "fieldless" there can be no interaction either between the coils themselves or adjacent apparatus. They can therefore be mounted in any position or angle.

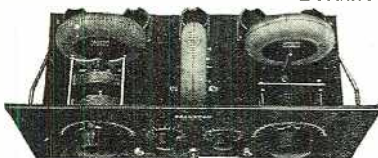

This is a completely equip 5-tube tuned R. F. Receiver using Hetorus Coils. It is giving phenomenal results equal or superior to any 5-tube receiver on the market.

Whether you give your present set the advantage of this latest forward step in radio or build a new receiver, Hetorus Coils will afford you results in keeping with the best radio developments of 1926.

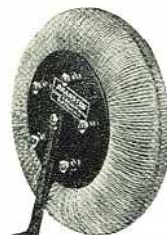

Write at once for free information on this outstanding sensation.

Chas. A. Branston, Inc. 817 Main St., Buffalo, N. Y.

Prices For You

Boys and Young Men—You can earn dandy prizes and liberal commissions by selling and delivering our popular magazines in your spare time. No experience or money is necessary. We furnish all supplies and tell you just how to start. *Write to-day.*

E. J. FOLEY, Department RN-10,
Experimenter Publishing Company, 53 Park Place, New York City

Navy. Buckram cover, 7 x 10 inches, 895 pages, illustrated. The sixth revised edition, published by the United States Naval Institute, Annapolis, Md., is dated 1924.

Although this book is not generally well known, there is no reason why it should not be, for it contains as complete a description of radio theory and practice as any student, experimenter or engineer could want for purposes of either study or reference. All superfluous mathematics is avoided, excepting in the first few chapters, where a clear and complete exposition of general electrical principles is presented.

An exceptionally fine chapter of the book is devoted to a description of the methods used in making the many and varied measurements required in radio practice.

We take great pleasure in recommending this book to our readers.

THE RADIO GUNNER. Stiff paper cover, 5 x 7½ inches, 318 pages, illustrated. Published by Houghton Mifflin Co., 2 Park Street, Boston, Mass. Price \$2.00.

When an author describes an action that will occur 20 years or more in the future, the result is often a weird concoction of ideas that even children have difficulty in believing. However, in "The Radio Gunner," though a war that rages in 1937 is described, there appear no wild assumptions, the author being content with naval armament as we know it today.

The story concerns the boyhood friendship of Evans, who during the war with the Mediterranean Powers aids the Navy with their radio equipment, and Mortimer, who becomes Secretary of State. Their life at school and college is as full of adventure as the average youth's. When the war breaks out, Evans, who is now a searcher into the mysteries of radio, is urged by his friend Mortimer to enlist in the Navy and give them the benefit of his research work. Evans works for a time in Washington, in the Bureau of Standards, and then goes to the great Naval base in the Azores, where he suggests plans for attacking submarines, using the radio compass. To make the war atmosphere complete, a spy or two wanders through the pages.

The book is written in a style that is not generally characteristic of authors of boys' books; in fact, it is a story that would doubtless intrigue some older boys. Scattered throughout the tale are bits of a philosophy that are excellent, in that they should suggest to the young mind with unformed opinions a wholesome outlook on life.

"The Radio Gunner" might well be termed a modern version of "The Knights of the Round Table." The knights in this case, instead of riding fiery steeds, travel through the air or over the water on modern craft. The various "valorous deeds" that are performed individually by King Arthur's men are more than equalled by those performed by the men who man the submarine-chasers, torpedo-boat destroyers, scouts and cruisers that have parts in the engagements. As there should be in every book that is written, especially for boys, the men who work against the well-being of the Government get the usual reward that is the villain's just due. In short, we can recommend this story to anyone who wishes to place it in the hands of a real boy. It is a book that is interesting and worth reading.

RADIO YEAR BOOK. Second Edition, 1925. Over 1,000 pages, cloth-covered cardboard covers. Price 30 francs. (25 francs if ordered before publication.) Edited and published by Etienne Chiron, 40 rue de Seine, Paris, France.

The Radio Year Book, which is published in French, is undoubtedly the biggest radio year book published. The second edition, 1925, will have over 1,000 pages and will contain the addresses of all the firms manufacturing and selling radio apparatus in every country of the world. In addition, this book contains the radio legislation of every country, a dictionary of radio terms in five languages, useful tables, formulae and general information useful to the amateurs and commercial operators. The various calls of ships and land stations are also published with the list of all the amateur radio clubs, a feature which should prove useful to the amateurs.

RADIO MANUEL. By Orrin E. Dunlap, Jr., Radio Editor of the New York Times. Hard cloth cover, 5¼x7¾ inches, 267 pages. Diagrams and illustrations. Published by Houghton & Mifflin Co., 2 Park Street, Boston, Mass. Price \$2.00.

There are always arising certain little circumstances in radio reception that are followed by two large question marks, one following the query "Why?" and the other "Where can I find it?" Mr. Dunlap's book supplies the answer to both questions. Of course, we do not say that everything pertaining to radio is treated in the manual, but we did find a great number of interesting and useful facts.

Mr. Dunlap first hits some of the high spots in the history of radio's development and then in

The Newest and Best Thing In Radio Utmost Simplicity!

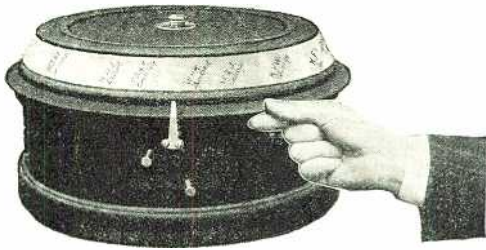

Brings them in

NO-DIAL

5 Tube Receiver

Using Storage or Dry Batteries

Years ahead of other radio receivers by its patented design—but already hailed by scores of happy users as the ideal radio set for every home—this great achievement of design and workmanship is now available to you! Think of a receiver *without dials*—so simple that any child can operate it; fool-proof—trouble-proof; That's NO-DIAL, the newest thing in radio:

Features You Have Waited for

Greatest Simplicity without sacrifice of other desirable features has been attained by NO-DIAL engineers through the most careful correlation of all parts. Adjustments which the listener, himself, in ordinary sets must make are in NO-DIAL completed at the factory.

Better Tuning is made possible because the condensers are permanently kept in step. The cover of NO-DIAL is rotated, bringing in station after station loud and clear, far and near. That is all the listener need do—even filament control is automatic.

No Log Book Necessary! The entire edge of the cover is a Station Register, on whose ample surface dozens of call letters, wave length and station names can be written in either ink or pencil, without crowding. Stations always come in at the same places where you locate and mark them.

Sensitivity of NO-DIAL is equal to that of highest priced receiver. In many tests it has received stations from coast-to-coast with loud speaker volume and fine tonal quality. Tube for tube, it recognizes no superior.

We Stand for Conservative Statements in Radio Advertising

No-Dial is licensed under Blackmore patents and patents pending Hogan patent No. 1,014,002.

The OHIO STAMPING & ENGINEERING COMPANY
DAYTON, OHIO, U. S. A.

Tone Quality—powerful yet silky-smooth throughout the entire musical scale—is due to the superior design and workmanship of NO-DIAL'S audio frequency transformers. High and low notes of voice and any musical instrument are reproduced with life-like fidelity. NO-DIAL does not re-radiate.

Cabinets of NO-DIAL Receivers are of spun aluminum, finished in mahogany brown crystal-line, matching the most beautiful loud speakers and harmonizing with distinctive furniture in any home. Since NO-DIAL has no dials it needs no panel; consequently it is compact and damage-proof.

Circuit of the five-tube NO-DIAL is the latest and newest radio hook-up, a most remarkably efficient combination of tuned radio frequency and resistance coupling.

USE THE COUPON IF YOUR DEALER CANNOT SHOW YOU NO-DIAL or FOR FURTHER DETAILS

OUR GUARANTEE

We guarantee NO-DIAL Receivers against defects in workmanship or material, and will promptly replace any receiver which in our judgment is defective, or refund the purchase price.

THE OHIO STAMPING & ENGINEERING COMPANY,
Dayton, Ohio. Dept. R.N.10.
I am a (distributor) (dealer)
my part, send me full details of NO-DIAL Receivers. without any obligation on
Name
Street & No.
City & State

A Radio Cabinet of Beauty and Elegance Direct to You at Lowest Cost

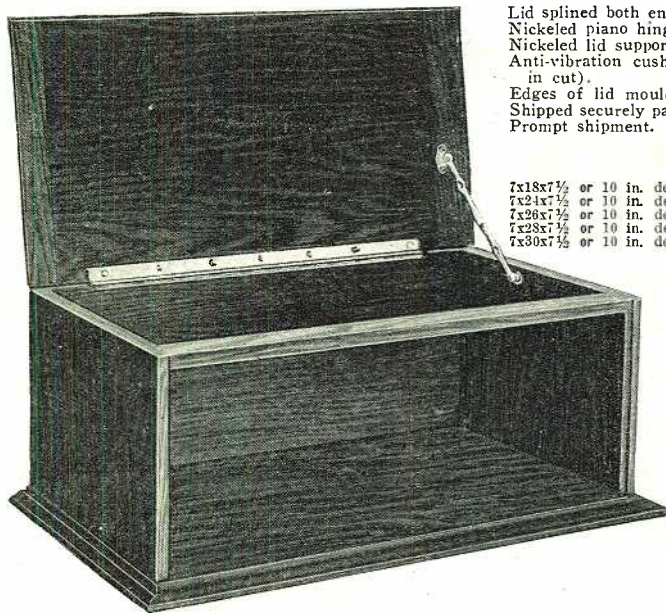

Lid splined both ends to prevent warping.
 Nickeled piano hinge.
 Nickeled lid support of artistic design.
 Anti-vibration cushion feet (not visible in cut).
 Edges of lid moulded to match bottom.
 Shipped securely packed in strong carton.
 Prompt shipment.

	Hardwood Rubbed Mahogany Finish	Solid Black American Walnut
7x18x7 1/2 or 10 in. deep	\$3.50	\$5.00
7x24x7 1/2 or 10 in. deep	4.00	5.50
7x26x7 1/2 or 10 in. deep	4.75	6.25
7x28x7 1/2 or 10 in. deep	5.50	7.00
7x30x7 1/2 or 10 in. deep	6.00	8.00

CASH WITH ORDER or C.O.D. if 1/4 of price is sent with order. Prices F. O. B. Hickory, N. C.

Order express shipment, often cheaper than mail and much safer from damage.

FREE WITH EACH CABINET a glued-up stock non-warping 1/2-inch Baseboard.

Free Catalogue.

Ivey Loud-Speaker In Cabinet Form At a Reasonable Price

We have at last perfected a Reproducer that we honestly believe has no superior as to EFFICIENCY, PRICE AND BEAUTY. We make no foolish and extravagant claims, but our reputation for fair-dealing earned during three years

should mean something to you. SOLID BLACK WALNUT CABINET highly finished. The most powerful telephone unit procurable. All ready to attach to your set. PRICE \$15.00 F. O. B. Hickory, N. C.

SEND FOR FREE CATALOGUE

THE SOUTHERN TOY CO., Dept. N. Hickory, North Carolina

What Is the Radio Dealer to Do?

THAT is a question thousands of radio dealers,—real business men, all over the country are asking themselves to-day. They are wondering, and they have a right to wonder, if the radio business is a fair one—whether it is safe—whether it is honest.

The dealer works hard all Fall and Winter,—makes some money only to find, in the Spring, that the sets he recommended to his friends are now dumped on the market at prices much less than his cost. Not only does he lose on his inventory, but the sets sold on time come back, and, what hurts an honest dealer more, his friends lose confidence in him, because the sets he sold them only a few weeks before at a certain price may now be bought at half off or more.

What is the dealer to do? How can he guard against this? Ludwig Hommel & Company has always felt the dealers' troubles very keenly, because our Company sells only to dealers, and radio is a main line with us,—not a side line.

We urge the dealers, for their own safety and profit, to watch the lines they carry. Be guided by the past performance of the manufacturers and jobbers. That is what we do and how we determine the lines we carry.

Ludwig Hommel & Company carries only lines that are quick moving, that have reputable factories behind them, and that will make most money for the dealer—with the firm promise to him that we will not knowingly carry a line or recommend any item on which he will lose money because of factory dumping, price drop or obsolescence.

It is to the advantage of every dealer to tie up with Hommel. Our illustrated catalogue 366 S is free. Ask for it.

WHOLESALE EXCLUSIVELY
LUDWIG HOMMEL & CO
 929 PENN AVENUE ————  ———— PITTSBURGH, PA.

Prizes for You

Boys and Young Men—You can earn dandy prizes and liberal commissions by selling and delivering our popular magazines in your spare time. No experience or money is necessary. We furnish all supplies and tell you just how to start. Write to-day.

E. J. FOLEY, Department RN—10,
 EXPERIMENTER PUBLISHING COMPANY
 53 PARK PLACE :: :: :: :: NEW YORK CITY

a clear and non-technical style explains the theory of ether waves and their propagation. Explanations of the functions of different pieces of apparatus used in the reception of broadcast signals are done in a similar interesting manner. There is a chapter devoted to the theory of broadcast transmission and chapters on radio beacons and how time signals and weather reports are broadcast. A dictionary of radio terms concludes the book.

Mr. Dunlap's experience in radio has made him capable of answering beforehand many unasked questions. The phases of radio reception that are covered are those that must arise many times daily and, as a reference, we can recommend this radio manual.

40 Non-Technical Radio Articles

every month for the beginner, the layman and those who like radio from the non-technical side.

SCIENCE & INVENTION, which can be bought at any newsstand, contains the largest and most interesting section of radio articles of any non-radio magazine in existence.

Plenty of "How To Make It" radio articles and plenty of simplified hook-ups for the layman and experimenter. The radio section of SCIENCE & INVENTION is so good that many RADIO NEWS readers buy it solely for this feature.

Interesting Radio Articles to Appear in the October Issue of "Science and Invention"

Hints to the Radio Builder, Part II.

By Leon L. Adelman, Assoc. I. R. E. Superpower—Is It Here To Stay?

By Jack Milligram.

Converting Tuner to Short Waves.

By Herbert E. Hayden.

The Radio Constructor—How to Build a Low-Powered C. W. and Phone Transmitter.

By A. P. Peck, Assoc. I. R. E.

Radio Hazards—How They May Be Avoided.

Radio As An Aid To Humanity.

DRY BATTERY RADIO ON AIRPLANE

The following was recently printed in the New York "Times":

Radio history was written at the Great Lakes station today when a message was flashed from apparatus on a navy airplane to Prof. C. M. Jansky in the department of electrical engineering at the University of Minnesota, who replied to it.

Officers in charge of the experiments said its success marked a new radio triumph, in that it is the first time such a message has been sent on a machine which works without a generator and simply on dry batteries.

They pointed out that this is extremely important to the army and navy, since with the old form of machine messages might be sent only while the plane was in the air and while its propeller furnished the power for a generator, while now an operator may send messages when the plane is on the ground.

Immediately after the test Lieut. Commander E. F. McDonald, Jr., who had a hand in perfecting and building the new instrument, announced that he will take such an outfit with him when he goes in June on the polar expedition into the Arctic regions with Daniel MacMillan.

The following letter was printed subsequently in the "Times":

To the Editor of The New York Times:

The writer notes with interest the article in this morning's Times entitled "Dry Battery Radio Works on Airplane." The statement is made that this is a new radio triumph in that it is the first time that such a message has been sent on a machine which works without a generator and simply on dry batteries.

Permit the writer to state that as far back as 1905 he was manufacturing a dry



Don't cheat your radio set! —use a Beldenamtel Aerial

Important Facts about Beldenamtel Aerial Wire

It is endorsed by leading radio engineers as the most efficient type of outdoor aerial.

It offers maximum surface to radio-frequency oscillations.

It is not a trick aerial, but a real, scientific development.

It is furnished in 100 and 150 foot lengths to provide sufficient length for lead-in without joint.

THE volume and range of your radio set depends largely upon the condition of your aerial. An ordinary bare copper aerial wire soon corrodes, due to the smoke and fumes in the atmosphere, and its resistance increases rapidly. When this happens, less energy is transmitted to your detector and you lose volume and range. *It cheats your set!*

A Beldenamtel Aerial is coated with many layers of baked Beldenamtel, which protects the copper surface from corrosion, and the aerial resistance does not increase. A Beldenamtel Aerial insures maximum range and volume, year in and year out. *It lasts indefinitely!*

*Mail the Coupon
for Free Illustrated
Booklet*



BELDEN MANUFACTURING CO.
2314E South Western Ave., Chicago

Please send me your booklet entitled "Helpful Hints for Radio Fans."

Name.....

Address.....

Belden

There's a Position for YOU in RADIO



Guglielmo Marconi as he appears today. Signor Marconi is Honorary Chairman of the Radio Institute of America.



Elmo N. Pickerell, Chief Radio Officer, S S Leviathan—a former Radio Institute of America man.

THE Radio Industry today holds forth more and better opportunities than ever before. Radio operating and manufacturing companies are constantly employing new radio operators, mechanics, assemblers, testers, repairmen and designers. Truly, this is a radio era.

Are you neglecting these opportunities?

Start to prepare now for an interesting and profitable career in radio. The instruction offered by the Radio Institute of America has in the last sixteen years enabled 7,000 graduates to obtain lucrative positions in radio. A competent staff gives special attention to the requirements of each student.

Our Home Study Department permits those who cannot attend classes to study radio at home in spare time. Check the course in which you are most interested and mail the coupon to the

RADIO INSTITUTE OF AMERICA

Formerly Marconi Institute

Established in 1909

324 Broadway

New York City

CUT HERE

RADIO INSTITUTE OF AMERICA, 324 Broadway, New York City.

Please send me full information about your Home Study Course of radio instruction.

- I am interested in the complete course, including code instruction, which qualifies for the U. S. Government Commercial or Amateur Radio License.
- I am interested in the technical course for radio dealers, jobbers and salesmen.

Name.....

Address.....



STORAD

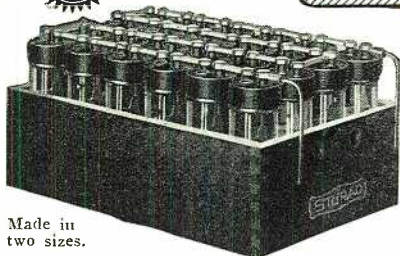

Made in two sizes.

No. 4548—4500 Milleamp. Hr. Cap.—48 volts.
No. 4524—4500 Milleamp. Hr. Cap.—24 volts.

"B" BATTERIES

A dependable battery that will solve your "B" circuit power problem on multi tube sets once and for all. It holds its charge for months.

STORAD "A" BATTERIES

Full capacity reliable storage batteries made of highest grade materials and having rubber case and rubber insulated connectors. Made in three sizes:—R-3-60 amp. hr.; R-4-80 amp. hr.; R-5-100 amp. hr.

Ask your dealer about Storad products or write direct for literature.

Distributors territory still available.

THE CLEVELAND ENGINEERING LABORATORIES CO.

2138 Superior Viaduct, N. W., Cleveland, Ohio

Get a Handy Binder for your RADIO NEWS. Holds and preserves six issues, each of which can be inserted or removed at will.

Price 65c.

Experimenter Pub. Co., Inc., Book Dept., 53 Park Place, New York

battery set using a one-inch spark coil and six dry batteries, and that amateurs in those days were successful in transmitting from three to fifty miles with this set.

There was even a case of an amateur on the Pacific Coast transmitting ninety miles with such a set.

This, as you will note, took place exactly twenty years ago.

H. GERNSBACK,
Editor RADIO NEWS.

The Times Flies

(Continued from page 425)

ation his first neutrodyne and spent a profitable evening neutralizing the condensers, he began to take a real interest in radio. By the middle of the following week he was building super-heterodynes with crystal oscillators and in less than another two weeks he was discussing the phase angle of the voltage and current with the town's chief radio engineers.

Before the third of the radio supplements had come out, Micky was writing the most weird and imaginative stuff the town had ever seen.

Then the Old Man began to take an interest in radio other than as a circulation-getter. He began to imagine himself as the director of the destinies of a great broadcast station. The action was no sooner taken in his mind than it was put into practice. There was a more or less indigent radio merchant in the town who had, when the craze first started, erected a station. Some months since it had lapsed into desuetude because the broadcast studio's staff found it necessary to eat occasionally.

A few inquiries and an astute promise of free advertising and an advance of some pay-roll money put another half-kilowatt, class B station on the air as the ethereal voice of the Holden Times—"The best paper of the West," according to its own admission.

Now it is a standard trait of human nature that man has a great failing for those things in which he has money invested. And the Skipper was human, even as you and I. As soon as the opening night program was ready and the announcement published in the first edition, he came to Izzy with an order for a good radio set. Izzy took him at his word and built the best super-heterodyne that could be made. He put three stages of resistance-coupled amplification at the aft end of the set and a couple of stages of radio frequency on the starboard side of the first detector.

It was a good set, only it was so sharp in tuning that the Old Man ruined his temper and almost sent his wife into a nervous breakdown before he was able to hear even a local.

Once started on the road to bugdom, he was entirely helpless in combating the bacillus. Gradually he became more and more addicted until, as the station became of some consequence, it soon reached a more important place in his mind—and the minds of his employees, perforce—than anything else, even including the feature section of the Sunday.

And as he took more interest in radio it behooved the editors of the radio section of the paper to look to their copy. It became incumbent upon them to produce more and better stuff. As the Old Man grew to understand the intricacies of the art he turned down a great deal of the stuff they had been printing before. This cut greatly into the radio editors' loafing time. They found themselves face to face with the necessity of working a great deal harder. Everything has its compensations, though, and

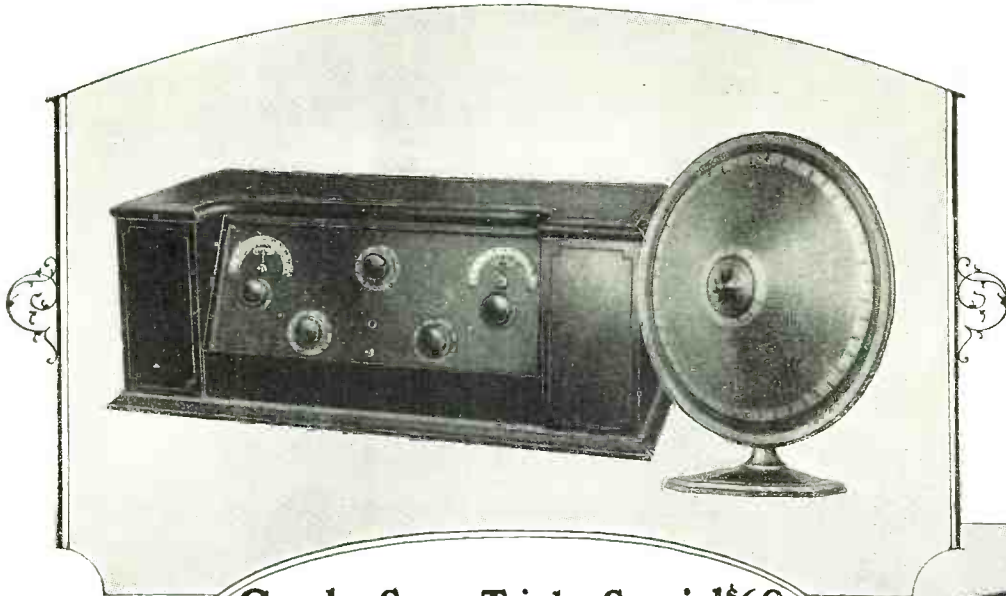

Crosley Super-Trirdyn Special \$60.
Crosley Musicone \$17⁵⁰

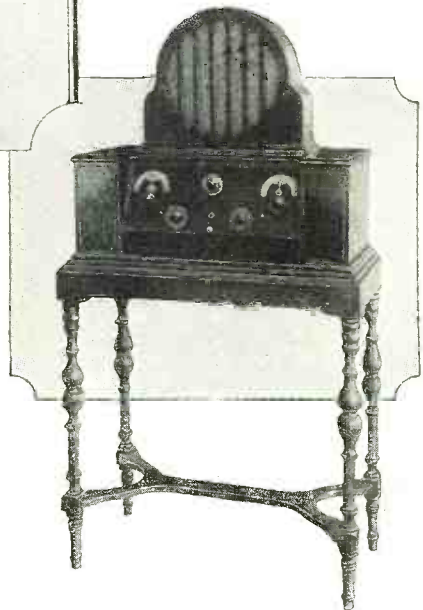

Better Results from 3 Tubes Than from 5

Sounds improbable doesn't it? But it is a scientific truth, first demonstrated in the Crosley laboratories and then confirmed by the performance of thousands of Trirdyns the country over.

Employing but 3 tubes, the Crosley Super-Trirdyn consistently equals, and in fact surpasses, the more costly 5 tube sets in performance.

These astonishing results are simple to explain. Instead of passing the incoming signal *once* through each of 5 tubes, Crosley design passes it through two of the three tubes *several times*, each time building up its strength and adding to its volume.

Even the technically uninitiated can see the advantages: simplicity instead of complexity; fewer dials to adjust; sharper accuracy in selecting stations; greater clarity; greater volume.

Yet that is not all. Simplicity of design and fewer parts make manufac-

turing costs lower and bring about a lower cost to you. This, combined with the economies of gigantic production, makes the Super-Trirdyn the lowest priced quality radio ever offered. For Crosley is the world's largest builder of radio sets—owning and operating parts factories, cabinet woodworking and assembly plants.

Listen to a Crosley Super-Trirdyn under the most exacting conditions. Make an unbiased comparison with the most costly receiver you have ever heard. Forget the radical difference in price.

Then will you understand why the Crosley Super-Trirdyn represents a genuine achievement in radio performance and value which all America was quick to recognize and reward with increasing sales.

Write for attractive illustrated catalogue. Authorized sales and service stations everywhere.

Super-Trirdyn DeLuxe Combination

Super-Trirdyn De Luxe \$60.00
 Musicone De Luxe 27.50
 Console Table 25.00

Complete \$112.50
 Add 10 per cent to all prices
 West of Rocky Mountains

Crosley manufactures receiving sets which are licensed under Armstrong's U. S. patent No. 1,113,110 and priced from \$9.75 to \$60.00 without accessories.
 Crosley owns and operates W.L.W., first remote control super-power broadcasting station.

CROSLEY

Better—Costs Less

RADIO

THE CROSLEY RADIO CORPORATION - CINCINNATI, OHIO

SUPER SM PARTS



The famous Silver-Marshall parts were used exclusively in the 7-tube portable super-heterodyne that won the grand sweep-stake prize in the recent Los Angeles Radio Show. They were also the predominating feature of the new Super-Autodyne Receiver described in this issue of RADIO NEWS. S-M Parts are daily setting new standards of electrical excellence. Send for circulars of complete line of S-M parts and reprints describing the Super-Autodyne and the new S-M self-compensating inductances for single control sets.

The New Line of S-M Super Parts

Silver - Plated Straight - Line - Wavelength Con- denser.	S-M 210 and 211 matched and charted Intermedi- ate transformers, with Bakelite case. Supplied in sets of two 210's and one 211. Each...\$8.00	S-M 101B Coup- ling Unit, recom- mended for use with Transformers to increase efficien- cy of any super by 75%. Each...\$2.50
305 — .0005 \$6.00		
306 — .00035 5.75		
307 — .00025 5.50		

Silver-Marshall 116 S. Wabash Avenue
Chicago, Ill.

BOYS! We Will Pay You Liberal Com- missions and Award Dandy Prizes —For Your Spare Time.

YOU can easily earn all the money you want by becoming a member of our Young Men's Sales Association. It's easy. Simply sell and deliver our four popular magazines—*Radio News*, *Science and Invention*, *The Experimenter*, and *Motor Camper & Tourist*—in your neighborhood.

There are many boys just like you who are turning their spare time into cash by taking advantage of this pleasant way of making money. You can do the same. No experience or money is necessary. There is no obligation.

Take your pencil *now* and fill in your name and address on the coupon below. Then mail it *to-day*. It will bring you everything you need to start making money and earning dandy prizes right away.



Thomas Lathrop of Michigan, one of the many members of our Young Men's Sales Association, who earns all the extra money he needs through selling and delivering our four popular magazines.

Use Scissors Here

E. J. FOLEY, Department R-10,
Experimenter Publishing Co.,
53 Park Place, New York City.

I would like to make money and earn prizes. Please tell me how I can do so and become a member of your Young Men's Sales Association.

Name

Address

City..... State.....

they found that larger and larger expense accounts for parts, labor and what-not would pass unquestioned. The result of the Skipper's interest, on the whole, was simply about four nights of extra work for the boys and a couple of new suits each—which they sorely needed.

After the first spurt, other things gradually made the Old Man pay a little less attention to radio and so only the four nights of work a week were necessary—no more. Few of his demands on them could not be fulfilled.

Periodically, he desired a new set which had to be the *ne plus ultra* in radio, but there were always new circuits which could be relied upon to satisfy him. But periods of great calm, as they say, simply forbode a storm of equal intensity, and it certainly worked out in the case of the Old Man. One bright Friday as he was okaying the pages for the feature section for the Sunday pup (which was printed on Thursday) he conceived a brilliant idea of having the radio editors find something which would furnish a good column for the Monday edition.

Now as all good editors know, the Monday morning edition is the bane of editorial existence. All the courts and business houses are closed—and these are the chief sources of news—and it invariably seems that people generally are better behaved on the Lord's Day than during the remainder of the week. Also, since the European countries worship the same deity, they likewise cease their discussions on such weighty matters as Labor Government and the international debt. This leaves quite a hole on the front page. The Old Man, knowing all this only too well, decided that it would ease his night's sleep if he could rest confident that the Radio Department would furnish at least one column of stuff for the Monday edition regularly.

The Old Man gave orders and expected them to be carried out. Therefore, Micky found it necessary to visit Henri's every Sunday. Henri's, be it known, sold some stuff in tea-cups which gave Micky the inspiration for the ideas which he promptly repeated to Izzy, who just as promptly supplied the technical details to make the scheme plausible and interesting reading to the radio fan.

The first Monday after the order was given, the front page column told of a new method for catching all the bootleggers in one week, by using a radio beam direction-finding device. The next week the column told how radio could be used to lighten the work of doing the family wash. From that time on the syndicates began to ask for the reproduction rights of the front page radio stories which appeared regularly on Monday morning.

Then the Old Man had the grand idea. Ever since he had been the owner and managing editor of the *Times* he had been carrying on a rather unsuccessful fight with the *Argus*, published in Hayttsville, the town across the river. He wanted to outsell the *Argus* in its own town, but thus far his best circulation efforts there had been fruitless. The chief difficulty was a matter of transportation, for although both Holden and Hyattsville were prosperous little cities, they had not yet been able to agree on the terms of joint responsibility in the building of a bridge. As a result, a slow ferry service was the only direct link. This slow method of carrying papers, and the necessity for a couple of extra handlings took minutes out of the *Times* and seconds count in selling papers.

Considering the imagination Izzy and Micky had shown in the other exploits they had attempted, the Old Man was perfectly justified in believing they could carry another one through successfully. So when he got the grand idea of beating the *Argus*

Continuous, unfailing "A" Power

—in a single compact unit . . . that
automatically replenishes itself

THE new Gould Unipower asks for a place in your set on this basis—that it will contribute more than anything else to the convenience, perfection and economy of operating your set—that it will give you the most that your money can buy—that it will banish "A" battery failure, the most frequent cause of poor radio reception.

Here are the facts about Unipower.

A new kind of "A" power

Unipower is a single compact "A" power unit that fits *inside* most radio cabinets. It takes the place of dry "A" batteries or of separate storage battery and charging units.

Unipower is quickly and easily installed. Just connect two wires to your set, plug in on your light current, and the job's done! Unipower is equipped with an exclusive Balkite charger of special design. Unipower will last you for years, and there are no tubes, bulbs, lamps or working parts that require frequent and expensive replacement.



With Unipower, you insure your set against "A" battery failure—the most frequent cause of poor radio reception

Off when it's on—On when it's off

A unique feature of Unipower is the single master-control switch that governs the operation of your entire set. When the switch is ON, Unipower feeds your set rich, quiet power that gives ideal reception, with neither hum nor noise. When the switch is OFF, Unipower *automatically* replenishes itself on a low trickle charge and with a minimum consumption of current—a few cents a month.

The most your money can buy

When you also consider that Unipower banishes the cost and inconvenience of dry "A" battery renewals, or the bother of charging a storage battery, increases the life of your tubes, and in addition, gives you the finest kind of continuous, unfailing "A" power, you see how economical Unipower really is. You'll

find that it pays for itself over and over again.

Decide to see the new Unipower today. The nearest radio dealer has it. Ask him for a demonstration. Then make your decision! The Gould Storage Battery Company, Inc., 250 Park Avenue, New York.

Unipower operates from alternating current, 110-125 V-60 cycle. It is supplied in two types. The 4 Volt type is for sets using U V 199 tubes or equivalent and retails for \$35.00. The 6 Volt type is for sets using U V 201-A tubes or equivalent and retails for \$40.00. West of the Rockies, prices are slightly higher.

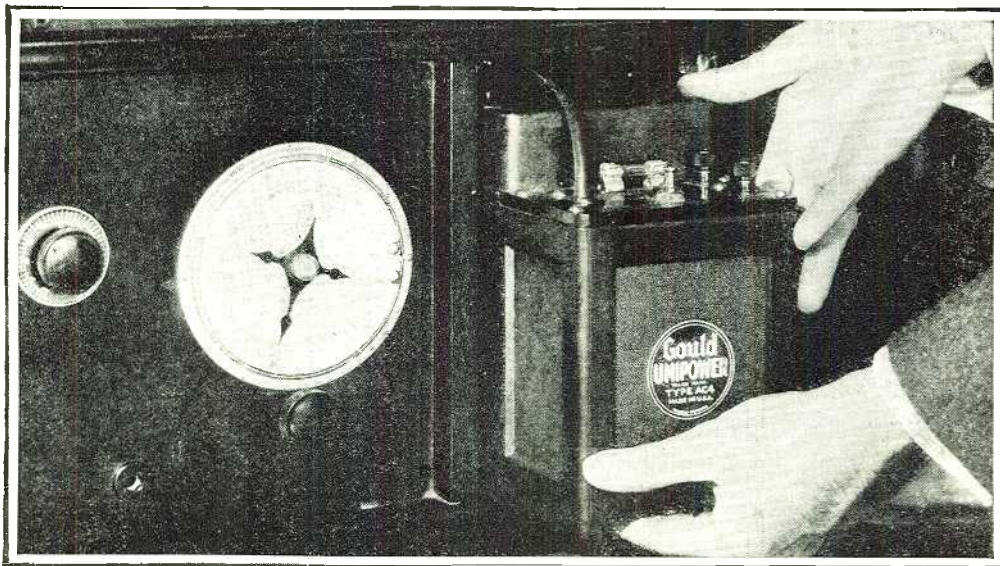

Unipower fits comfortably inside most set cabinets. It is quickly and easily installed. Just connect two wires to your set, plug in on your house current and you have continuous, unfailing "A" power instantly at your command.

Unipower

Off when it's on—On when it's off

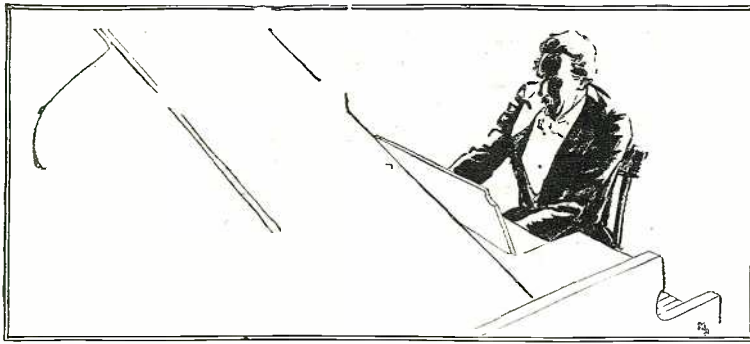

A Revelation In Tone—Volume—Clarity

Here is a "loud speaker" that brings the artists into your very room so realistic is its reproduction.

Piano music, the most difficult to reproduce, sounds so natural that you are carried away by its beauty.

Vocal selections retain all of the colorings of the artist.

Orchestra music is a treat; every instrument can be heard, clear and full.

Magnetic diaphragm control—used exclusively in the Kellogg Unit—is the new principle that performs these wonders in radio reception.

No excess vibrations, no chattering, every tone true.

The Kellogg Unit is available for use with a phonograph and will reproduce voice or music with a full, sweet, clear tone.

A popular instrument: The Kellogg Symphony Reproducer is a revelation in Tone—Volume—Clarity.

At your dealers for \$20.00—Hear one today.

KELLOGG SWITCHBOARD & SUPPLY COMPANY, CHICAGO, ILLINOIS

Kellogg Symphony Reproducer

With every Kellogg Radio part, Use—Is The Test



At all good dealers
"Not Merely a Loud
Speaker."

out of half of its circulation, and raising his own advertising rates proportionately, he called on his two radio editors to perfect the mechanical details of his scheme. The idea was simple in the extreme to an ordinary radio engineer who was thoroughly trained and sober. Izzy was always that and Micky fulfilled requirements some of the time—but not always. There was the worry.

The *Times* was the better paper by far. It had more wire news, a better equipped printing shop and a higher class staff. But all of this was of no avail when the river, and the lack of a bridge providing fast and dependable service—the two hours necessary to make the trip simply prohibited the *Times* getting to Hyattsville with the news while it was still news—was considered. As a matter of fact, the people of Hyattsville had to read the less desirable *Argus* because of the two-hour lapse. By the time workers were going home in the evening, the *Argus* would have the complete box scores while the *Times*, on the newsstand beside it, still concluded its accounts of the games in the fourth or fifth inning. The *Times* would easily sell if it could get on the streets an hour or so sooner. Although the distance between the towns as the crow flies was less than forty miles, it was more than two hundred by rail, because the connecting line ran down the river a hundred miles to the nearest bridge, and then back up to Hyattsville after passing a junction point. The papers could likewise not be sent across the ferry both on account of the extreme expense and the time limit.

The Old Man, scientist as he had become, therefore decided to carry the papers in the only way by which he could be sure of a speedy, direct service at the proper time. He would transport them by airplane.

But that was only half of the idea. Since he had become such a thorough radio bug he bethought himself of some method through which he could gain a little "house" advertising at the same time he inaugurated the service. Even in that part of the West, airplanes with pilots were more or less common. Everyone had seen airplanes. In fact, there was a fellow out at the park who made his living taking people for rides in one of them.

But a riderless, radio-controlled airplane was a thing apart for any community and could be calculated to attract plenty of attention.

And that is what the Old Man visioned after reading one of Micky's Monday morning dreams. Such a plane would, of course, be controlled from one end of the flight or the other, or possibly both. The stunt would have to continue for only a week or so, in order to get the publicity value, then a regular airman could be engaged to carry the papers. So the Old Man called on Micky and Izzy to make the necessary arrangements.

The evening after the Skipper had made them privy to their little job, they adjourned to Henri's around the corner to figure out a few ways and means.

"Izzy, me buck, this is the largest order yet," said Micky. "Now the question is: are we going to do it?"

"You mean, can we?" said the ever-serious Izzy.

"No, I mean, will we? If we can't, of course we won't. If we don't, we look for some nice newspaper that needs a couple of good radio editors."

"Well, it can be done, and if we can't do it, we can make it cost the Skipper so much he will tire of his stunt."

It was a very few minutes until Micky was drawing weird diagrams and handing them to his accomplice. Izzy looked them over, shaking his head at the first dozen or so. Then his face lightened.

"You've got it," he said and immediately

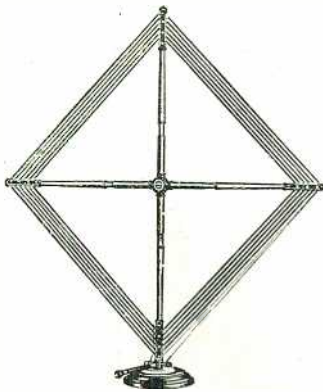

Take the Bodine anywhere. Easy to set up, and folds to fit into a box 3½ x 6 x 18 inches in size. All loops are two feet square, have green silk covered wire, are handomely finished in brown mahogany, with insulated handle for turning loop.

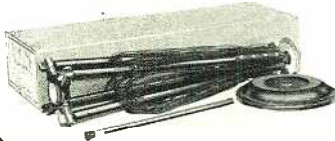

The Preferred Aerial

More and more the users of today's popular types of radio sets are turning from unsightly, inconvenient outside aerials to the more selective, easily controlled,

BODINE BASKET WEAVE FOLDING LOOP

Reception is astonishingly improved through the exclusive basket weave method of winding the silk-insulated stranded wire.

There is a Bodine Loop that will give perfect service with your particular set. The Bodine is exceptionally fine for the Remmler Superheterodyne and Grebe Synchrophase. Consult your Radio Dealer. Price, \$8.50-\$10.

BODINE ELECTRIC COMPANY
2256 W. Ohio Street, Chicago, Ill.

PATENTS

C. L. PARKER
Formerly Member
Examining Corps,
U. S. Patent Office.
PATENT - LAWYER
McGill Bldg., Wash., D. C.

Patents, Trade Marks, Copyrights, Patent Litigation
Handbook for Inventors, "Protecting, Exploiting
and Selling Inventions," sent upon request.

for Improved Reception—

—build with **FIL-KO-PARTS**
Cut down interference and get stations you
never heard before through scientific tube tun-
ing. Ask your dealer, or write to Dept.
RX 10 25.
D X INSTRUMENT CO. Harrisburg, Pa.

FIL-KO-PARTS

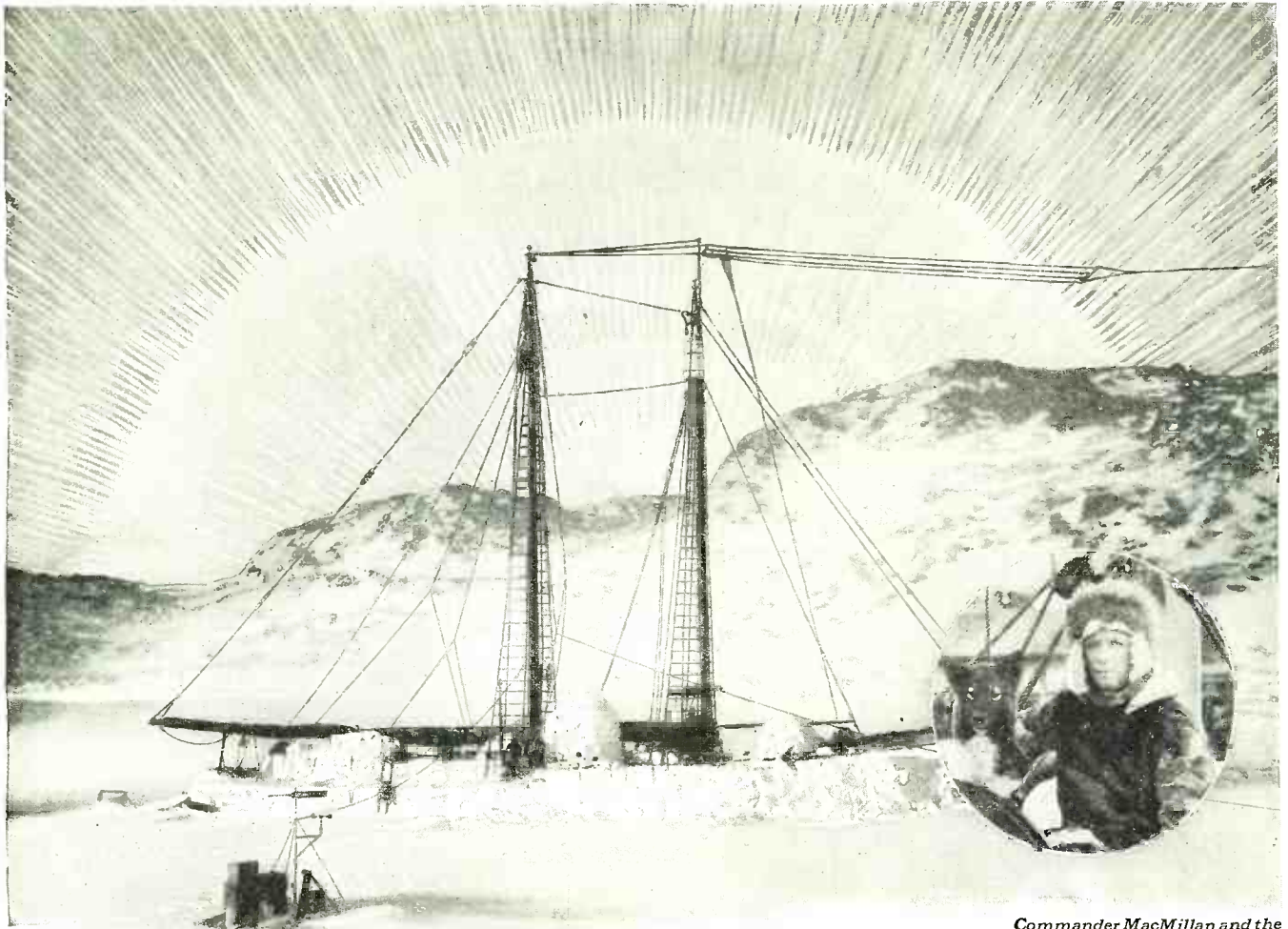

Commander MacMillan and the Bowdoin in the Frozen North

With MACMILLAN in the ARCTIC

ONCE again that intrepid explorer, Donald MacMillan, has gone into the Frozen North. And once again—for the fourth time—he relied on Exide Batteries to serve him, without flinching, through the extreme rigors of the Polar region.

Each item of equipment on such an expedition is chosen with utmost care, for life or death hangs in the balance. On previous voyages to the Arctic with MacMillan, Exide Batteries have been through shipwreck, blizzard and incredible cold and never once have failed.

On this latest adventure all the storage batteries are

Exide—for radio sending and receiving, for electric light aboard ship and on shore, for operating the sensitive scientific instruments. The three U. S. Navy airplanes that accompanied MacMillan's two vessels are equipped with Exide Batteries. Wherever radio must not fail,

you will almost always find Exide Batteries have been installed—in government and commercial plants—on the giant ship Leviathan, on the Navy dirigible Shenandoah, on the new British airship R33; on every continent and the seven seas speeding up communication through the modern world.

The same qualities that make Exide the choice where lives are at stake are built into the Exide Batteries that you can have with your own receiving set. Staunch and dependable, the Exide gives uniform current through a long period of discharge and assures the clearest reception of which your set is capable. There is a type for every tube and a size for every set, obtainable at radio dealers and all Exide dealers.



Exide 6-volt "A" battery in one-piece case

There are also Exide "A" batteries for 2-volt and 4-volt tubes and "B" batteries, 24 and 48 volts, of 6000 milliampere capacity. The Exide line includes a most economical "B" battery rectifier.

THE ELECTRIC STORAGE BATTERY COMPANY
Philadelphia

In Canada, Exide Batteries of Canada, Limited
153 Dufferin Street, Toronto

Exide

RADIO BATTERIES

FOR BETTER RADIO RECEPTION USE STORAGE BATTERIES

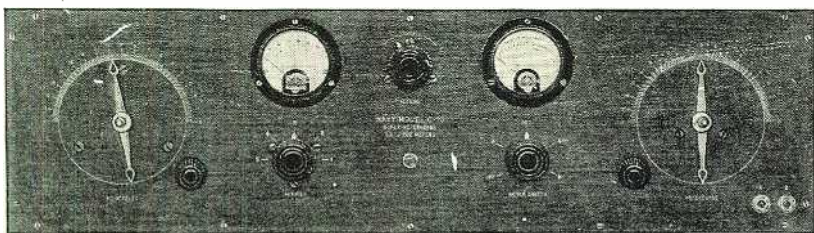

NAVY MODEL C-10 Super-Heterodyne

The Highest Class Receiver in the World

Wave length range 50-600 meters with removable Coils.
 Panel Dimensions 28 3/16 in. x 8 in. x 1/4 in.
 Only two major tuning adjustments.
 Total amplification almost 2,000,000 times.

For any Circuit

Prompt shipment can be made on tested, standard apparatus of the following manufacture:

- E. I. S., Inc.
- General Radio
- Willard
- Benjamin Electric
- All n Cardwell
- Dubilier
- Western
- Jewell
- Western Electric
- Radio Corporation
- Music Master
- Cutler Hammer
- Federal
- Formica
- Magnavox
- Amer Tran
- Acme
- Frost
- Kellogg

A high powered 10-tube Broadcast Receiver capable of receiving over 3,000 miles under favorable conditions, and having a degree of selectivity far in advance of others.

We believe the Navy Model C-10 represents final superiority over any receiver now being manufactured or even contemplated for broadcast reception.

Attractive illustrated literature gladly mailed upon request. Write direct to

NORDEN-HAUCK, INC.
Engineers

1617 Chestnut Street, Philadelphia, Penna.

began making sketches of his own. The plan was simple. The broadcast station was in a pretty straight line between the two landing fields in the towns. This would save the Old Man money. The distances to be covered were short and the half-kilowatt of the transmitter could be used for the long trip between the two fields, while small short-wave transmitters could be used at the two landing fields.

The old army differential loop beacon system would be employed to keep the plane on its course. One side would be set to transmit dashes, great long ones, and the other one would have an automatic high-speed dot-maker for a key. One receiver on the plane would be sufficient. The output of the power amplifier would be connected to two relays.

Both of them would have time relays controlled by an air leak valve. This would make it possible to keep the plane within a ten-degree course. It could not get far enough off the line of flight to be out of control of the small transmitters, which were to be installed at both the landing fields for bringing the plane down and controlling the take-off.

The time relay selector idea appealed to both of them as a stroke of genius. If the plane went too far to the right, the dots would set the relay for that side off, connecting the small motor to the horizontal rudder. This would bring the plane back into course and, as soon as the center point was reached where the dots and dashes were of equal strength, the connector would be held in a neutral position.

A couple of gyroscopes in the plane would attend to the matter of equilibrium. The short-wave transmitters would work to a special short-wave receiver. This receiver would, in reality, be five different receivers, each working on a slightly different wave-length. One wave-length would control the vertical path of the plane; a second would control the contact; the third would cut out the beam receiver and the other two would control the side-to-side course of the ship in lieu of a beam transmitter. These would all work direct to motor relays, doing away with the complication of switches. The short-wave transmitters would have wave-changing devices which would give instant control.

Many nights they worked over the technical plane. In a couple of weeks they had drawings with fine flourishes to show the Old Man. He was rather skeptical at first because it seemed too easy. However, they had always produced before and he had little reason to doubt them. The only thing remaining was to get a plane and the necessary parts for the radio installation. The thing was so much cheaper than he had figured that his enthusiasm rose almost to a point equalling that of the two radio editors.

The plane was an easy matter. The fellow at the park was not doing a land office business and was willing enough to be rid of the thing. This detail completed, Izzy and Micky started immediately upon the construction of the sets necessary.

At the first test, nothing at all happened. The Skipper was ready to give them both the so-called gate when Micky remembered that he had left the ignition of the plane as it was. Each of the spark plugs was sending out its own brand of static, so that the short waves had no effect whatever on the relays and the plane-operating devices.

The Old Man went home to dinner thoroughly disgusted with radio. Izzy and Micky spent a pleasant evening putting yards of copper screening around the engine and grounding it to the engine frame and the frame of the plane.

The next afternoon the plane took off beautifully, fulfilling the dreams of even the enthusiastic Micky.

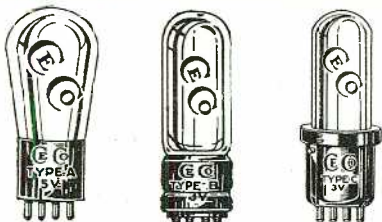

Filament Volts...	5.0	3.0	3.0
Filament Current...	0.25	.06	.06
Plate Voltage...	20 to 120	20 to 80	20 to 80

Made with Brass and Bakelite Bases

Best by Test

Three types—one quality—the BEST!

"CeCo" Tubes prove their worth by performance! Clarity of tone, rich volume, long life—CeCo has them all to a degree that will surprise you.

Serve equally well as radio frequency amplifiers, detectors, oscillators and audio frequency amplifiers.

CeCo Tubes make any good circuit better.

Every tube backed by a guarantee that's backed by a company of established reputation and responsibility.

C.E. MANUFACTURING COMPANY, Inc.
 702 Eddy Street, Providence, R.I.

Trade Supplied through Jobbers Only!

Jobbers—Write for details and prices.
 Set Manufacturers—Ask us about our SPECIAL MATCHED tubes.

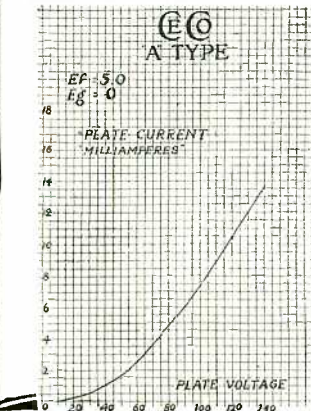

TO THE RADIO DEALER

Let us explain how you can make the sale of our publications a worth while, well paying part of your business. Write now and prepare for the Fall and Winter trade.

EXPERIMENTER PUBLISHING COMPANY, 53 PARK PLACE, NEW YORK CITY

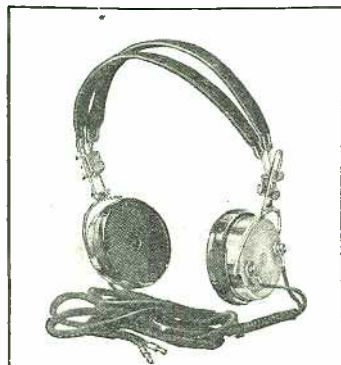

DYMAC Type E Headset

The same quality headset with improved headband at low price to meet popular demand. 2,200 or 3,000 ohms as preferred.

List, \$3.00



DYMAC Vernier Dial

Same as on DYMAC Selecto Five Receiver. Provision for both coarse and fine tuning. 4" diameter; vernier ratio 12 to 1. Easily mounted on any condenser. Adds much to the performance and appearance of any set.

List, \$1.50

Other DYMAC Accessories and Parts

- Loud Speaker Unit, \$5.00
- Audio Frequency Transformers \$2.50 to \$4.00
- Soldering Set (standard), \$2.50
- Sub-Panel Socket, 75c
- Jacks, 50c to 90c



**A Marked Contribution
to Radio Reception
The DYMAC Selecto Five**

This is the new set that has surprised by its performance even radio engineers who have been striving for years for improvement in reception.

The DYMAC Selecto Five is a new type receiver made by the manufacturers of the DYMAC guaranteed radio products. It is not a neutrodyne; it is not a super-heterodyne; it is not a regenerative set. In rigid tests, under difficult conditions, it has outperformed them all for accurate rendition of tonal values.

For best results with the DYMAC Set, use a DYMAC Speaker (\$8.50) and DYMAC Type G Ear Phones (\$5). These DYMAC accessories improve the reception of any set.

**PRICE
\$75**

But let it talk for itself. Put it in your home on trial. If you have had difficulty in getting satisfactory results because of peculiar local conditions, you are the one we most want to try it. For through the Selecto Five you get the fullest enjoyment of the improved broadcasting.

Encased in a handsome mahogany cabinet finished in walnut, with ebonized panels and base, and with DYMAC black and silver finish dials, the DYMAC set will harmonize with the finest interiors.

If unable to obtain quick delivery of a DYMAC Selecto Five from your dealer, write us. We shall see that you are supplied promptly.

Every DYMAC product guaranteed for one year

ELECTRICAL PRODUCTS MFG. CO.
PROVIDENCE RHODE ISLAND

New York Office: Metropolitan Tower

Export Office: Ad. Auriema, Inc., 116 Broad St., New York City

**DYMAC
Factory
Sales Agents**

- Chicago—E. V. Finsen.
- Cleveland—Factory Sales Co.
- Boston—Hastings Elec. Sales Co.
- Washington—W. Lester Baker.
- Atlanta—Barnes & Co.
- Minneapolis—Twin City Radio Sales Co.
- St. Louis—H. F. Bisbee Co.
- Kansas City—Wm. S. Reid Sales Co.

- Denver—Schmidt Sales Co.
- Omaha—Leonard Kohn.
- Fort Worth—Savage & Schmid.
- Seattle—Fred L. Tomlinson Co.
- San Francisco—Fred L. Tomlinson Co.
- Los Angeles—Fred L. Tomlinson Co.
- Vancouver, B. C.—John E. T. Yewdall.

The SUPER-HETERODYNE

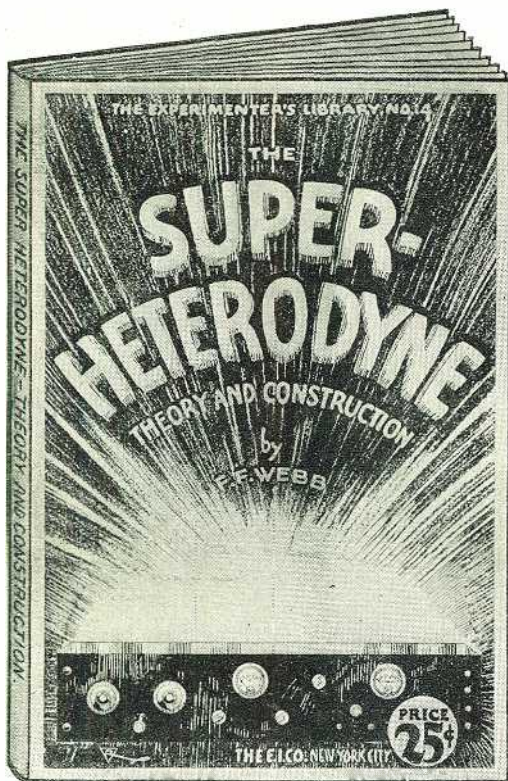

Here's the finest, most complete book of data and information ever compiled on the Standard Super-Heterodyne.

This is the big book of instruction and information on the various standard "supers" in common use today; a complete, up-to-the-minute, impartial 64-page book covering all the builder or user of this type of set might want to know. The Super-Heterodyne is written by a radio authority who not only has years of trade and practical experience but is constantly designing modern radio apparatus. It is a handy, useful size, $5\frac{1}{2} \times 7\frac{1}{2}$ inches, printed clearly, profusely illustrated, easy to read and bound with a handsome two-color cover. This is the very latest of the complete library of Experimenters' Handbooks on radio. These books are complete practical guides to almost every important phase of radio transmission and reception.

You can get any of these books at your radio or news dealer or direct from us.

The CONSRAD COMPANY

Sole distributors for the E. I. COMPANY

233 Fulton St.

New York, N. Y.

Then the war began between the two papers. The editor of the *Argus* was a gentleman of the old school, a hater, with all his heart, of the fads of modern civilization. The first edition containing the announcement that the *Times* would be delivered in Hyattsville by a radio-controlled plane simply served to send him to his sanctum in high wrath. The wrath, however, became tinged with a pink fear when the business manager came running into his office with a huge placard which stated that at last Hyattsville was to get its news *on time* and that the very latest scientific device would bring it.

The gentleman of the *Argus* had distinct feelings on the subject of science generally, and radio in particular. He classified the latter as simply the latest device of a jazz-mad age to beat up its flagging emotions and mental powers. Radio, he said, was simply a fad, had been since its inception, and would remain that as long as there were fools left to sink thousands of dollars in useless broadcast stations and other fools to listen nightly to the drivel they flooded God's good, clean heavens with.

Furthermore, he put his thoughts into an editorial, with the result that the advertising manager told him a day later, when the tallies were made, that he had cut off several thousands of his circulation and permanently eliminated several cash-paying radio advertisers.

This served only to force the old war-horse to renewed efforts to quash this latest device of the devil. The same day another editorial appeared and another drop in circulation was reported in due time. It was apparent that the readers had their own ideas.

But there was at least one man in the *Argus* organization who believed that radio would be successful in spite of the editorials which said that the stunt with the plane, "announced by our contemporary across the marshes," would be a great and ignominious failure.

The chap who believed in radio was one Taylor, a cub of the rankest sort, who had been on the paper less than a month—been with newspaper men briefly enough still to hold the old ideas concerning newspaper men generally, and star reporters particularly.

He knew that the plane would fly, and being assigned to the *Argus*' staff in Holden, bethought himself of ways for turning the *Times*' stunt to the glory of the *Argus*. The *Times*, he thought, had no business to attempt to take the circulation of the *Argus* in Hyattsville. Lost circulation, lost revenue, lost job. This was his sequence of thought.

The day of the premier flight was less than two weeks off. And then Taylor had a grand idea. It would be quite simple to journey over to his own town, stop at his office, get fifty or a hundred of his own beloved *Argus*, wrap them in a bundle similar to the *Times*, carry them to Holden, slip them into the plane while no one was looking and so send the *Argus* back to Hyattsville by the *Times* plane.

Of course, if on the opening day of the service, with the Old Man making his grand speech, they should haul forth a few copies of the *Argus* instead of the *Times*, there would be a grand howl of derision and the entire scheme would appear extremely ridiculous.

As the time grew near, the Old Man of the *Times* grew more and more enthusiastic. He wrote a long speech which he planned to deliver at the first landing of the plane in Hyattsville. He would tell the multitudes who would gather to witness the stunt that at last they were to get their news *on time*, etc., etc., etc., and *ad infinitum*. It would be the valedictory of science as against "mossbackism." In fact, it would be the greatest victory for the *Times* in years.

Pacent Engineering Achievements

More Improved "PACENT" Essentials for the Season's Better Receivers

RHEOSTATS and POTENTIOMETERS

The Pacent Genuine Bakelite Rheostat and Potentiometer are the last word in resistance devices. The finger-fitting, fluted, mushroom knob of genuine Bakelite conveys the velvety feel of the smooth running positive edged contact without click or noise and is a joy to the eye. The Pacent two unit construction simplifies installation and preserves the accurate factory adjustment. Every rheostat adaptable to one or two hole mounting. Made in all standard ohmages and supplied with silvered dials and black knob or with gold dial and mahogany knob. PRICE.....\$1.00

Pacent Porcelain and Moulded Rheostats and Potentiometers made with Porcelain Base, edge contact and 3/16 inch shaft, or Black Moulded base, side contact and 1/4 inch shaft—provided with elongated mounting holes to accommodate varying spaced panel borings. Two Unit construction, Pacent type knob. Made in all standard ohmages and supplied with same dials as Bakelite Rheostats above. PRICE.....65c

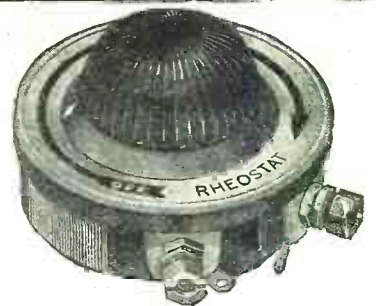

RADIOGLASS SOCKETS

Pacent Radioglass sockets—for UV199 type tubes and for standard 201A types. Made of glass *specialy prepared* for radio purposes and used when low dielectric losses are desired. One piece direct contact members with exclusive Pacent self-cleaning feature. Special pieced and formed soldering lug ends for easy soldering. PRICE either size .40c Also made of Pyrex for UV199 type tubes. PRICE.....\$1.00

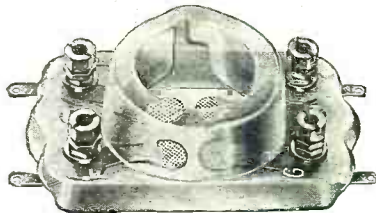

RADIOFILE and RADIODYLE

The Pacent Radiofile provides a new and convenient means of recording stations by name, wave length and frequency. With this device several stations of the same wave length can be permanently logged without difficulty. Insulating disc and mounting pins are supplied, and by grounding one mounting pin an electrostatic shield is provided. Made to fit standard 3 and 4 inch dials and to accommodate all standard condenser shafts. Beautifully finished in Satin—Silver or Gold. PRICE—Silver or Gold finish for 3" dials 40c, Silver or Gold finish for 4" dials. PRICE.....50c

The Pacent Radiodyle is one of the finest and most practical dials on the market today. It presents a beautiful appearance. There is a pleasing contrast of the fluted black knob with the silver-finished metal back. The knob is made of *genuine Bakelite*, shaped for the fingers. PRICE—Silver or Gold.....40c

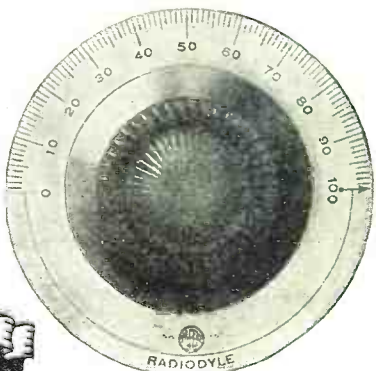

This attractive, illustrated booklet, giving complete information on all new PACENT essentials, mailed free on request.

MANUFACTURERS, JOBBERS and DEALERS
Write or Wire for Particulars and Prices

Pacent Electric Co., Inc.

91 Seventh Avenue New York, N. Y.

OFFICES: CHICAGO—MINNEAPOLIS—BUFFALO—BOSTON—PHILA.—WASH., D. C.—
SAN FRANCISCO—ST. LOUIS—PITTSBURGH—JACKSONVILLE—DETROIT
CANADIAN LICENSEE—WHITE RADIO LTD., HAMILTON, ONTARIO

"DON'T IMPROVISE — PACENTIZE"

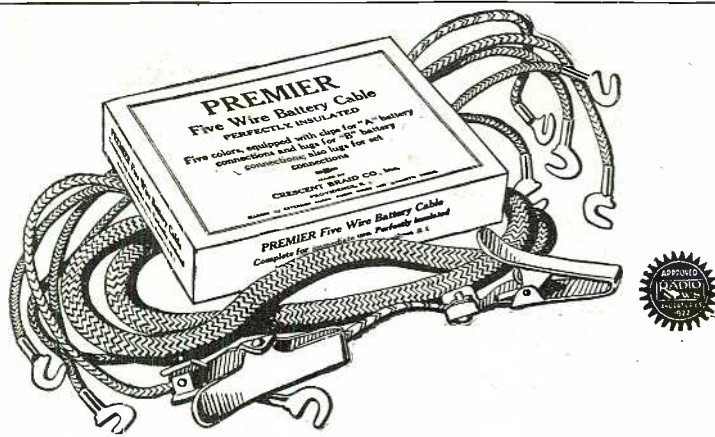

To insure the right hook-up:

GET a PREMIER 5-Wire Battery Cable. Keeps wires neatly concealed, untangled and out of the way. Five different colored wires insure proper battery and set connections. With a flip of your finger you can unhook "A" battery and hook on the charger. In attractive carton..... **\$1.00**

At your dealer's—or write

Crescent Braid Co., Inc., Providence, R. I.

Makers of Premier "Blue Ribbon" Extension Cords, Premier, Jr. Extension Cords and Phone Cords for headsets and loud speakers.

Important Back Issues of "Radio News" available

The back issues of "RADIO NEWS" contain many important and valuable articles on Radio Circuits and General Information. Here is a list of important back issues on hand.

JULY, 1924 ISSUE How to Make and Use a Wavemeter. By L. W. Hatry A Local V.T. Transmitter. By H. S. Pyle Reflex Receiver with Neutrodyne Control. By A. D. Cowper	FEBRUARY, 1925 ISSUE A Good Short Wave Receiver.
AUGUST, 1924 ISSUE The Solodyne Principle. By Dowding & Rodgers The Tropadyne Circuit. By Clyde Fitch Reflexing a Tuned Radio Frequency Receiver.	MARCH, 1925 ISSUE How to Build an Ultra Short Wave Receiver. Some Super-Heterodyne Notes. By W. Taylor The Radio "Uni-Set." By H. M. Towns
SEPTEMBER, 1924 ISSUE Neutrodyne Receivers. By Groves A 6-Tube Receiver of Advanced Design.	APRIL, 1925 ISSUE Low Loss Short Wave Set.
OCTOBER, 1924 ISSUE A.R.F. Solodyne Receiver. By Dowding and Rodgers	MAY, 1925 ISSUE The Monophase Circuit. By F. H. Dalet A 5-Meter Transmitter. By W. B. Arvin An Efficient Crystal Detector. By R. Hutchison "B" Battery Eliminator from Standard Parts. By D. E. Learned
NOVEMBER, 1924 ISSUE A 100-Watt Master Oscillator Transmitter. By J. E. Fetzer A Cascade Regenerative Receiver.	JUNE, 1925 ISSUE The Radio Micrometer. By C. B. Bazzoni Uncrowding The Air. By W. A. Bruno McCa's Static Eliminator. By Patterson and Biles
DECEMBER, 1924 ISSUE A Short Wave Adapter for the Broadcast Receiver. By J. L. Cassell	JULY, 1925 ISSUE New Uses for the Vacuum Tube. By C. B. Bazzoni A 3-Range Receiver. By F. R. Hoyt The Hoyt Augmentor Circuit.
JANUARY, 1925 ISSUE Experimenting with 5 Meters. By W. A. Bruno An Ideal Low-Loss Broadcast Receiver. By Clyde Fitch	

Price 25c Each
PREPAID

EXPERIMENTER PUBLISHING CO., Inc.
53 Park Place
New York, N. Y.

Hyattsville was literally covered with posters telling of the great event.

The editor of the *Argus* behaved like a mad bull. He wrote scathing editorials on the whole business, and a week before the big event his attacks became actually libelous.

Each morning the Skipper, just as emphatically, wrote another story, telling that the plane would mark a new era. The good citizens of the two towns heartily enjoyed the fireworks. They saw the battle as another form of the old defying the new, and opinion hung pretty much on the result of the flight.

Micky and Izzy enjoyed it all fully. Every day they spent at the hangar. Aside from a trial trip now and then, just to keep their hands in, they had nothing to do and enjoyed it immensely.

The cub, Taylor, was so nervous and excited over his well-planned coup that he passed up two or three small stories he was supposed to get.

Then the great day arrived.

At the pressroom, long before time, Taylor stood waiting at the door for the circulation manager to appear and give him regular early editions. But, being a hard-boiled gentleman, the circulation manager paid no attention to the cub when he did appear, and Taylor began to fear for time. While no one was looking he grabbed a bundle of fifty papers wrapped for delivery and piled on a long bench. He ran out, jumped into a friend's car and set out for the landing field at Holden and the *Times* plane.

Fearing detection, he slipped the papers into the plane at the first instant possible, on top of the *Times* bundles. He went on to Henri's, drank two cups of "coffee" in celebration and talked more loudly than necessary to his field boss. He then sped back to Hyattsville to watch the fun from a safe distance. He selected a point near the platform from which the Old Man was to make his speech.

The Old Man was on the platform and Izzy was at the short-wave landing-control set. Everything was in readiness. The plane was to start at high noon.

In his excitement, Micky, at the Holden station, pulled the wrong switch to start. The plane would not take off; one of the tuning inductances had been thrown off at the early morning test. The crowd at the field—it was a small one—became nervous. There were a few swift strokes at one of the relays and a test. It seemed to work, but there was nothing steady about it. It was the left turn relay.

Micky moved the starting point of the plane a little further to the right and so avoided the necessity of using it again on the start if it should fail. A second try and the plane took off beautifully. By breaking the contact just as it was being straightened out, he caught it with the beam transmitter and held it in line after making a quick shift to release the short-wave landing control. At the Hyattsville end, the crowd was enormous. All the chief citizenry had been issued special invitations and were in attendance. They had come early. The Old Man was anxious. The platform was the only place he could stay. He could not get down and consent to mere talk. He wanted to see the plane. It would probably not arrive before a quarter of one.

The spectators were beginning to look at their watches and then turn to the sky. At five minutes of one, they were beginning to shift from one foot to the other and show signs of laughter. The Old Man was upset. He tried to go over the first few paragraphs of his speech. It would be the final blow to the old fossil at the *Argus* who had contended that the whole thing was a joke. A little twinge of fear seized him. It was

KARAS HARMONIK

AUDIO FREQUENCY

AMPLIFYING TRANSFORMER



The Triumph of a Masterpiece!

—A Marvel of Transformers that Brought Real Musical Quality to Radio Reception

JUST one year ago the Karas Harmonik Audio Frequency Transformer took the radio world by storm.

Nothing like it had ever been known before. For the first time, scientific study had been devoted to perfecting an audio transformer for the reception of broadcast music. The problem of amplifying high, low and medium frequencies to equal degree was finally solved. Bass notes were poured from the speaker in full strength and rich tone quality. The vital harmonics in rich overtones, formerly lost, were brought out in their full beauty by this marvel of audio transformers.

Music critics, who had always condemned radio music as false and distorted, approved the results of Karas Harmonik amplification with great enthusiasm. Prominent radio engineers subjected Karas Harmoniks to exhaustive laboratory tests—and pronounced it a technical masterpiece. Technical editors who promoted the season's most successful hook-ups specified Karas Harmoniks in their circuits. The triumph of the Karas Harmonik was complete!

But, for all of this, the enjoyment of Karas Harmonik amplification was too greatly confined to one class of radio enthusiasts. Home set builders bought Karas Harmoniks by the tens of thousands. They were free to pick and choose. *They* were most exacting in their demands for the newest and best developments.

It was the owners of factory-built sets who missed the

delightful pleasure of real, true radio music in their homes. Set manufacturers were prevented by price from adopting Karas Harmoniks for their sets. So the ready-made set-buyer, unless he undertook to switch transformers, had to do without Karas Harmoniks.

Today there are in use, hundreds of thousands of sets—good sets—which could be vastly improved in musical quality by the simple operation of replacing the old transformers with Karas Harmoniks. Perhaps *you* own one of these sets. It may be all you desire from the standpoint of selectivity, of range, and other tuning qualities. But, if it is not equipped with Karas Harmonik Audio Frequency Transformers, you are NOT getting *nearly* the musical quality you can just as well enjoy. Are you going to be content with anything short of the best?

You can install Karas Harmoniks yourself. It's a short, easy job. Or, any radio repair man can do it for you. Make up your mind to do it now—at once. Get a pair of Karas Harmoniks TODAY!

In large cities, most good dealers carry Karas Harmoniks—and in many small towns. If your dealer is out of them, order direct from us. Send no money. Just use the coupon below!

Karas Electric Co.,
4039 N. Rockwell St.,
Chicago, Ill.

The Distinctive Qualities that Elevate Karas Harmonik Transformers to the Highest Pinnacle of Success in the Radio World.

1. Many thousands of turns of wire
2. Low ratio of turns
3. Extra large quantity of special formula iron in core
4. Controlled air gap
5. No core saturation
6. Minimum of Reluctance
7. Least Hysterisis and Eddy Current Loss
8. Low Distributed Capacity
9. Scientifically circular shielding preventing intercoupling of electrostatic and electromagnetic fields
10. Very High Primary Impedance
11. Extremely High Inductance
12. High and even Amplification of all Audio Frequencies.

Karas Electric Co.,
4039 N. Rockwell St., Chicago, Ill.

Please send me _____ pairs of Karas Harmonik Audio Frequency Transformers. I will pay the postman \$7 apiece, plus postage, on delivery. It is understood that I am privileged to return the transformers any time within 30 days if they do not prove entirely satisfactory to me, and my money will be refunded at once.

Name _____

Address _____



\$1.50 IN U.S.A.
FROM YOUR DEALER OR DIRECT

No Need to Hunt for the Sensitive Spot
The Carborundum Detector Unit is Fixed—Permanent

FROM the first moment you hook up the Carborundum Detector Unit in your Reflex or Crystal Set you get a positive sensitivity that is permanent. ¶ There are no adjustments. This is one Detector Unit that retains its sensitivity indefinitely. It will not burn out. ¶ The Carborundum Detector Unit comes to you laboratory tested and it's made with a special Carborundum created for Radio use. ¶ It will give you clear, true, tones—increased selectivity—greater volume and distance.

Sold under a Guarantee by All Dealers

MADE ONLY BY
THE CARBORUNDUM COMPANY, NIAGARA FALLS, N. Y.
New York, Chicago, Boston, Philadelphia, Cleveland, Detroit, Cincinnati
Pittsburgh, Milwaukee, Grand Rapids

Carborundum Detector Unit



Patented Mar. 31, 1925

THE "DOUBLETOROID" COIL

"Doubletoroids" can be mounted at any angle or spaced at any distance.

"Doubletoroids" make more selective sets possible, since they do not form miniature loop aerials.

"Doubletoroids" hold static and other disturbances to a minimum since no current from an external source can influence them.

Outstanding Features of the Doubletoroids.

Both primary and secondary are true toroids.

The magnetic path is shortest.

It is the most compact.

RADIO FOUNDATION, Inc.
25 West Broadway New York



It's Variable

The Noise Gridleak improves reception because it can be adjusted for every station. Fits standard brackets. Absolutely noiseless. At all dealers and in the better sets.
NONOISE GRIDLEAK

A Laboratory Product

CRESCENT LAMPE RESISTANCES
for Distortionless Amplification

12,000, 48,000, 50,000, 100,000 Ohms. List \$1.50 each. Special Sizes to Order \$2.50 each. Dealers write for discounts. When Better Resistances are made they will be Crescents.
Crescent Radio Supply Co., 1-5 Liberty St., Jamaica, N. Y.

PATENTS

DON'T LOSE YOUR RIGHTS
Before disclosing your invention to anyone send for free blank form "EVIDENCE OF CONCEPTION" to be signed and witnessed.
LANCASTER & ALLWINE
Reg. Pat. Attys. in U. S. and Canada
270 Quary Bldg., Washington, D. C.
Originators of the form "Evidence of Conception"

Young Men—Turn Your Spare Hours Into Money!

Earn big profits, prizes, and awards selling RADIO NEWS, SCIENCE AND INVENTION, THE EXPERIMENTER, and MOTOR CAMPER & TOURIST in your neighborhood. We train you as our salesman and pay you liberally for your time. Write at once and we will help you to get started.
M. BRIDWELL

THE EXPERIMENTER PUBLISHING CO., 53 Park Place, New York, N. Y.

one o'clock and the plane was not yet in sight.

Suddenly Izzy began to work frantically with the short-wave set. In a few seconds his work was seemingly rewarded. There was the faintest hint of a roar. In another two minutes the plane was in sight and the people had forgotten their jokes and the Old Man again went over the first paragraphs of the talk.

Izzy became more animated than ever. He was trying to get the plane out of the path of the beam transmitter. He threw the inductance to the left and closed the key. The plane gave a lurch as if it were tugging at something and then settled back into its path. It was headed straight over the heads of the spectator. Why wouldn't the thing do what it was supposed to? He shifted to the right and again depressed the key. The same result followed his attempt. He looked suddenly at the plate milliammeter and found that the tubes were working only on half a load. The plane was within two hundred yards of the field. Quickly he put the whole load on the plates, caring little whether he melted them down or not.

Again the key was depressed and the plane almost fell because of the sharpness of the turn it made. At last it was safe from the beam transmitter and the landing relays were working. He drove it around a huge circle and, with a little maneuvering, it landed as easily as if it had been in the hands of a pilot. The throng waiting for the papers thought it was just a grand-stand stunt and commented on the excellence of Izzy's workmanship.

There was a final volplane and Izzy released the contact with another depression of the key. Several men rushed out to bring the plane to a dead stop and fetch the papers. An involuntary cheer went up from the throng.

The papers in bundles were thrown at the Old Man's feet. There were several yells, one or two grunts. He started on his speech and while growing more and more eloquent reached down to the topmost bundle for one of the sheets which he intended exhibiting at the climax of his talk. He was just reaching his climax, when—he had not yet looked at the paper—he unfolded it to full size, gripping it in his hand at his side. He was about to raise it for the gaze of the multitude when, out of the corner of his eye, he caught the line across the top of the first page. It read, *The Hyattsville Argus!*

He dropped it like a hot cake. The climax of his speech had been ruined, the victory of science had been turned into defeat by some crude horse-play. He thought fast. He thought of feinting a faint, of suicide, of murdering the person responsible.

Izzy saw something was wrong and from the edge of the platform reached for the paper. He scanned the front page. A smile lighted his face. Jumping in front of the Old Man, he held the paper up for all to see. There was a titter at first, now and then a gasp and finally a roar of laughter.

Beneath *The Hyattsville Argus* in letters filling almost the top of the page there was a banner reading, "Paper Plane Fails in First Flight." And below, in almost as large letters, "Publicity Stunt a Deserved Failure."

The Old Man was spluttering about in an attempt to learn the cause of the commotion. As he was behind Izzy, he could not read the headline. Almost instantly Izzy took another paper from a second bundle. Another roar went up—a roar of approval. This time the paper was the *Times*. The bundle opened, the especially invited guests were extracting themselves from the throng and coming forward for their copies as promised on the invitations. The Old Man was looking dazed, there were two pages of his speech yet that had to be delivered.

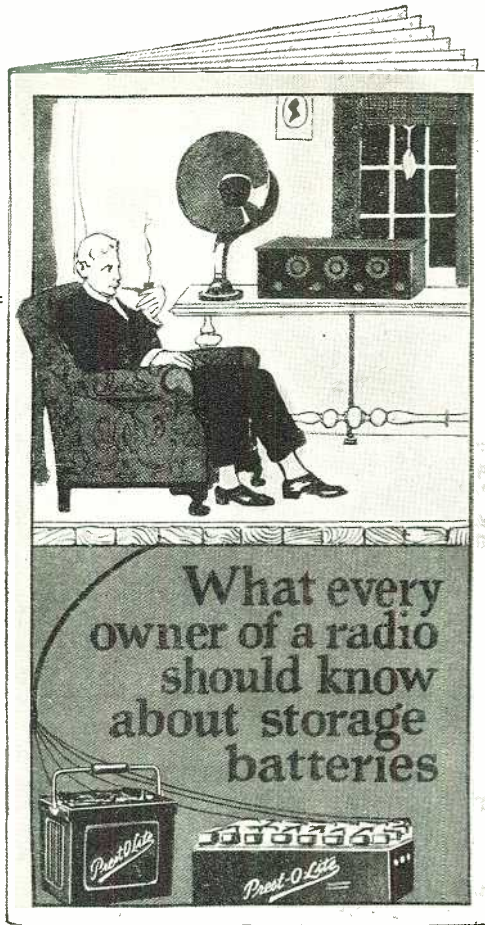

Write today

for your FREE copy of this valuable book

EVERY radio fan, every owner of a receiving set and, above all, everyone who is contemplating the purchase of a set this fall, should have a copy of this new book on radio storage batteries.

It explains fully just what service storage batteries perform in the operation of a set and which types of batteries are best suited to the various kinds of radio sets on the market.

You naturally want to secure the kind of batteries that will give you the best results. Then this book will be indispensable to you, for it gives the information you need to make a wise selection.

The book also explains the best methods of caring for storage batteries to insure their long life, how to charge batteries properly, how to connect batteries to a radio set, and how to arrange them so that recharging is reduced to a very simple, easy matter.

Write for this FREE book today. The facts it contains will save you time and money and add greatly to your enjoyment of radio. A post-card will bring it to you by return mail.

THE PREST-O-LITE CO. INC.
DEPT. 107 INDIANAPOLIS, IND.
New York San Francisco
In Canada:
Prest-O-Lite Company of Canada, Ltd., Toronto, Ont.

Prest-O-Lite "A" and "B" Batteries offer truly remarkable savings. Although standard in every respect, they are low priced. They will last for years and are all easily rechargeable. See them at your dealer's.



611 R H R K
"A" Storage Battery



23 M R R
"A" Battery

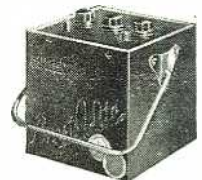

69 W H R
"A" Battery



48 L R R
"B" Battery

Prest-O-Lite



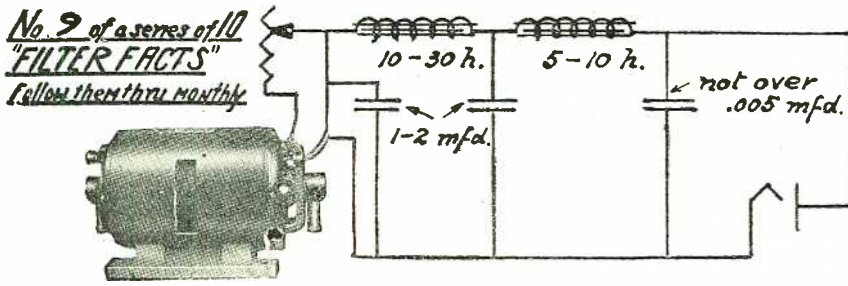

No. 9 of a series of 10
"FILTER FACTS"
Follow them thru Monthly

The "pi" type of filters described in numbers 7 and 8 of this series while excellent for C. W. and some forms of phone modulation are not suitable for Heising modulation. The large condensers tend to short circuit the modulating frequencies. This may be overcome by the addition of a small choke, 5-10 henries, in the plate lead directly after the filters, followed by a small condenser not over .005 mfd. across the line.

Bulletin No. 237-B lists over three hundred motor-generator combinations that will give the maximum miles per watt. Write for your copy to-day.

ELECTRIC SPECIALTY COMPANY

TRADE "ESCO" MARK

211 South Street.

Stamford, Conn.

This complete series with other valuable motor-generator information may be obtained in pamphlet form. Write for your copy.

100 Volt Storage "B" Battery for \$1000!

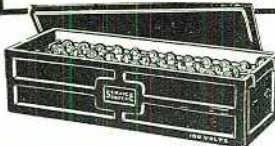

Everybody can now enjoy the benefits of Storage "B" Batteries—more power, quieter reception, greater economy. Rubber case prevents leakage or shorting. Easy to recharge. Will last for years with ordinary care.

SERVICE Rechargeable "B" Batteries
in all-rubber cases
50 VOLT \$5.50
100 VOLTS \$10.00
125 VOLT \$12.50

Prices in Canada
50 VOLT \$7.75
100 VOLT \$14.50
125 VOLT \$17.00

SERVICE Double-Duty CHARGER

Charges 6-volt "A" or Auto Batteries or up to 125 volts of "B" Battery IN SERIES. Noiseless in operation. Extremely economical. The height of convenience.



Complete with Bulb \$14.50

Service "A" Batteries
Indestructible rubber case. Two year guarantee.
6 volt, 100 amp. hr. \$14.00
6 volt, 120 amp. hr. \$16.00

SERVICE BATTERY CO. of Canada, 137 Roncesvalles Ave. Toronto, Ontario

SERVICE BATTERY CO.
704 East 102nd Street Cleveland, Ohio

The best part of it was missed. Two or three times he started to finish. No one paid any attention to him.

It was not until Izzy jerked at his coat-tails, almost pulling him off the platform, that he finally came to himself again. Once down on the ground and listening to Izzy's explanation he was again the swift-thinking managing editor. The victory of science was secondary to a good story.

Izzy explained: "Taylor, a cub on the *Argus* did it," he said. The cub intended to put his first regular morning edition in the plane, not knowing that the *Argus* editor, mad as a hornet, thinking that the whole thing would be a flop, had had the special article written telling about the failure of the plane set up, and a special run of the paper made.

He was following the regular newspaper custom of telling about an event before it happened, keeping the specially printed copies in the office until the news was flashed, then turning the papers out for circulation. The *Argus* had them on trucks all the time the plane was in flight, waiting for official word that the plane had failed, which of course it didn't, and which of course caused the joke on them. They took 'em off the trucks as soon as the plane landed. They had a special reporter here.

"Micky heard one of the *Argus* men—Taylor's boss at the Holden office—talking about it while the plane was in the air and he sent me a message just as you were opening the bundle. I had to wait a second to get myself organized before I jumped on the platform."

"Serves the old fossil right," cut in the Old Man. "Hurry back to Holden fast as you can and write a page one, line story on this business and be sure you tell the *Argus* story. Say that such procedure is often done in prize fights and the Kentucky derby—the extra copies—but say, and be sarcastic, that the result always happens in such case. And tell the *Argus* staff to train their cubs. Don't mention his name in the story, though. Now git!"

And Izzy got.

Ham Co-operation—Is It Dead?

(Continued from page 450)

The A. R. R. L. may be likened to the national government of this country, where in the district councils would correspond to the states and the separate clubs to the cities.

Amateur radio is due for one grand explosion if the separate clubs persist in their short-sighted methods. The district councils are just as necessary for the promotion of amateur radio activities as the states of the Union are for the self-government of the people. If the amateurs cannot be represented in this way, they will never be represented at all. One point that proves this is the activity of the Second District Council representative at Washington at the time the White bill was under consideration. Thousands of letters from individual hams could never have exerted the pressure that the personal appearance of this one representative accomplished. In the future, the amateur is going to need representation of this type more than ever. Years ago it was not necessary at all, inasmuch as legislators did not concern themselves particularly with the amateur. Today, however, with the millions of broadcast listeners throughout the country, many of whom misunderstand the amateur and his activities, representation for the ham is a crying need. If we do not have it, we shall soon go the way of the dodo, and ham radio will be as extinct as that bird. If in every district

LEARN THE CODE AT HOME

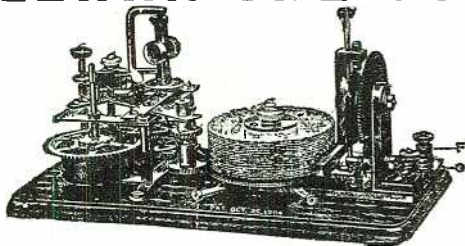

WITH THE OMNIGRAPH

THE OMNIGRAPH Automatic Transmitter will teach you both the Wireless and Morse Codes—right in your own home—quickly, easily and inexpensively. Connected with Buzzer, Buzzier and Phone or to Sounder, it will send you unlimited messages, at any speed, from 5 to 50 words a minute.

THE OMNIGRAPH is not an experiment. For more than 15 years, it has been sold all over the world with a money back guarantee. The OMNIGRAPH is used by several Depts. of the U.S. Govt.—in fact, the Dept. of Commerce uses the OMNIGRAPH to test all applicants applying for a Radio license. The OMNIGRAPH has been successfully adopted by the leading Universities, Colleges and Radio Schools.

Send for FREE Catalog describing three models. DO IT TODAY.

THE OMNIGRAPH MFG. CO., 15 HUDSON STREET, NEW YORK CITY

If you own a Radio Phone set and don't know the code—you are missing most of the fun

Young Men—Turn Your Spare Hours Into Money!

Earn big profits, prizes, and awards selling RADIO NEWS. SCIENCE & INVENTION, THE EXPERIMENTER, and MOTOR CAMPER & TOURIST in your neighborhood. We train you as our salesman and pay you liberally for your time. Write at once and we will help you to get started.

M. BRIDWELL

THE EXPERIMENTER PUBLISHING CO.,

53 Park Place, New York. N. Y.

This Year —
Better, But Crowding Still Troublesome

Last Year —
Bad Crowding of Shorter-Wave Stations

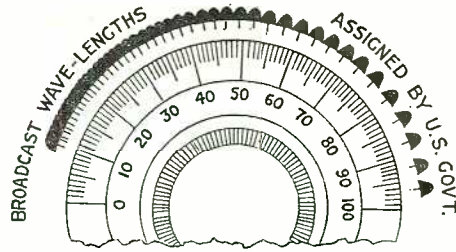
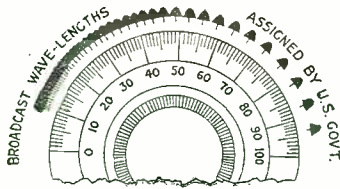

Next Year —
No Crowding!

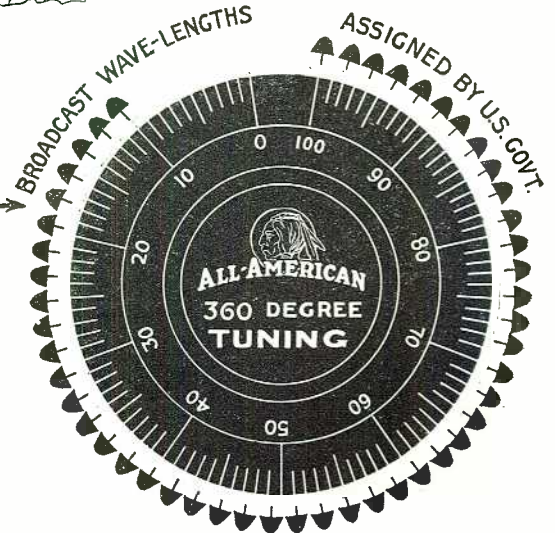

Straight-Line-Frequency Means —

That the distance on your dials from one station to the next adjacent one is uniform — throughout the short-wave stations, as well as the longer waves.

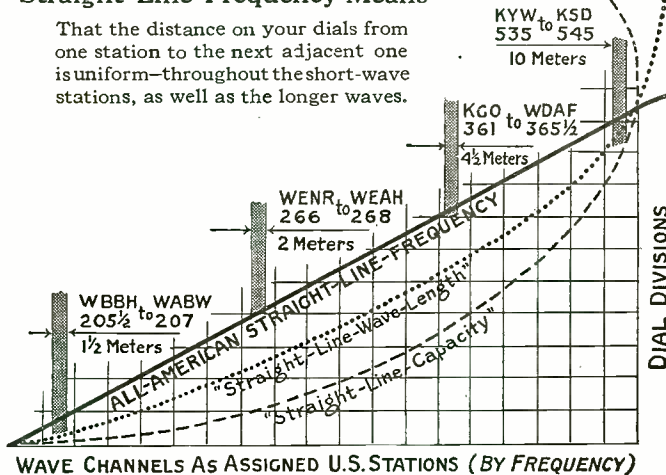

ALL-AMERICAN STRAIGHT-LINE-FREQUENCY TUNING

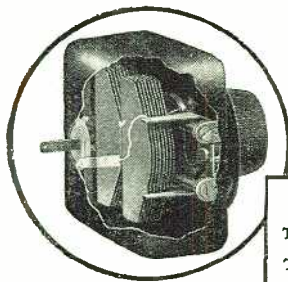

All-American Straight-Line-Frequency Condensers
Type C-35 Max. 350 micromicrofarads (Min. 10.5 mmf.) \$4.50
Type C-50 Max. 500 micromicrofarads (Min. 11.8 mmf.) 5.00

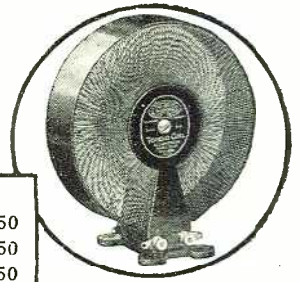

All-American Toroid Coils
Type T-1 Antenna Coupler \$3.50
Type T-2 R.F. Transformer 3.50
Set of 3 Coils complete . . 10.50

Ease and certainty in tuning — no more crowding of short-wave stations — no need to buy vernier dials — no gears or other back-lash makers — body capacity absolutely *not distinguishable* — electrical efficiency unsurpassed — on one-half the panel space: that is the ALL-AMERICAN Straight-Line-Frequency Condensers.

New power for distance reception through close coupling — tuning of arrow-like sharpness — elimination of all oscillation worries through the self-enclosed endless magnetic field — non-radiating reception: that is ALL-AMERICAN Toroid Coils — Antenna Coupler and Radio Frequency Transformers. *See them at your dealer's.*

A new edition of the famous RADIO KEY BOOK, together with complete information about the new ALL-AMERICAN Straight-Line-Frequency TUNING, is yours for 10 cents, coin or stamps. Send for it today sure!

ALL-AMERICAN RADIO CORPORATION, E. N. Rauland, *President*, 4207 Belmont Ave., CHICAGO

OWNING AND OPERATING STATION WENR—266 METERS

ALL-AMERICAN *Pioneers in the Radio Industry*

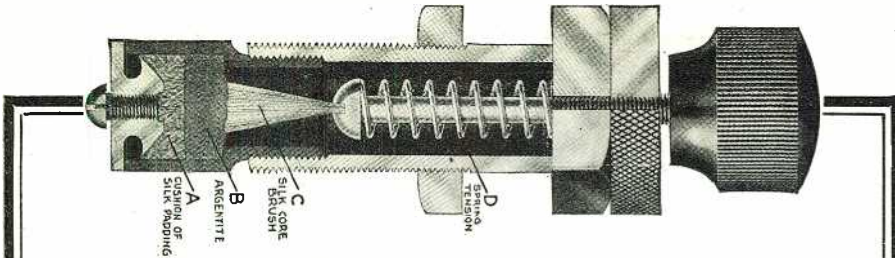

The G. & S. Silk Core Detector

A Greatly Improved Crystal Detector

TO give this detector a thorough and gruelling test, we sent samples to the leading testing laboratories of the United States. We asked the engineers to do their worst in attempting to burn out or buff the G. & S. Silk Core Detector. NOT ONE WAS ABLE TO HURT IT! They reported it to be unexcelled in volume, tone and selectivity. The distinctive feature of this detector is a brush, made of silk cord, covered with tinsel, which allows more

heat expansion and provides a greater capacity and larger surface for picking up the waves.

MONEY BACK GUARANTEE

Try the G. & S. Silk Core Detector at our risk. If not satisfied, return it and your purchase price will cheerfully be refunded. Sent C. O. D. or on receipt of money order for \$1.50.

DEALERS WRITE



G. & S. RESEARCH LABORATORY

1269 Cochran Avenue : : : : Los Angeles, Calif.

Our Marvel Cabinet

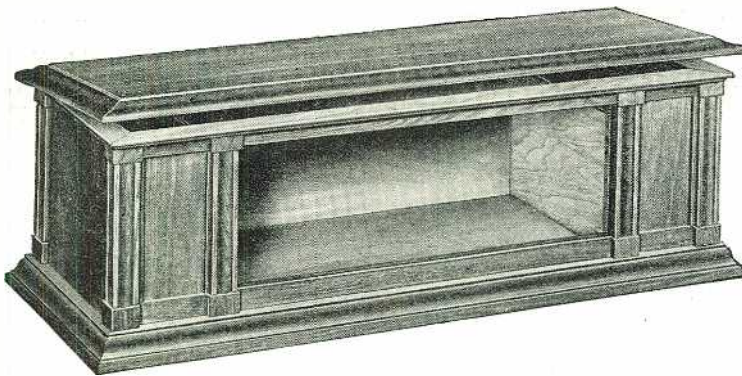

See our other Styles. 9 styles for 14 sizes of panels

If you want to see the prettiest line of radio cabinets at "Factory to User" prices send for 1925 catalog

UTILITY CABINET CO.

'PHONE 721

WAUKESHA, WIS.

Any Radio Map a Month Old Is

OUT OF DATE

Unless it has a monthly supplementary service THE AIR-LINE RADIO MAP AND LOG never becomes obsolete because it has a patented movable mile-scale. Lists stations by call letters and wave lengths. LOG shows location; difference in time; power, meters and kilocycles; spaces to list dial settings; time heard; distance and signal strength. Whether you use outdoor aerial or loop; direction of loop; phones or loud speaker. It enables you to have a complete and

Individual Log for Every Station

If you do not find this the most complete serviceable RADIO MAP and LOG published, we will refund your money.

PRICE 50 CENTS

At your dealers, or sent postpaid. Dealers and Jobbers write at once.

MULTIVIDER COMPANY, 3600 St. John Ave. Kansas City, Missouri

FAHNESTOCK CLIPS

"Popular Wherever Radio Is Used."



PRESS DOWN HERE

FAHNESTOCK Connectors are used by nearly every manufacturer of standard radio sets. On all batteries made by the National Carbon Co. FAHNESTOCK makes connec-

tors for every radio purpose.

"THE IDEAL CONNECTOR"

Catalog sent upon request

FAHNESTOCK ELECTRIC COMPANY Long Island City, New York

there should be organized an efficient and active district council, and if every club would belong to that council and have a voice in the doings of it, amateur radio would be far better off. Organizations of this type are an absolute necessity, so let's have them!

This phase of amateur radio is just another instance of the lack of co-operation among us. Can we not do something about it and get ham activities on an organized basis, where everyone will co-operate and pull together for our mutual benefit?

For our own protection and for the advancement of ham radio in general, we must organize! The time is coming when we shall need this protection. Broadcast promoters are casting longing eyes at the upper ham band between 150 and 200 meters. If we want to keep this good old space in the ether, we may have to fight for it, and to fight we need organization and co-operation. Let's get it now and keep it!

Now that we have considered two cases of more or less personal co-operation, let us for a moment consider the type of communications that we hear over the air every night. Listen in at any time and you will probably hear something like this. "9XXX, 9XXX, 9XXX u 2YYY, 2YYY, 2YYY."

This will be repeated for about ten minutes and then possibly 9XXX will respond, asking 2YYY if there is anything doing. Nine hundred and ninety-nine times out of a thousand the 2 station will come back with something like this: "No OM. Nil hr. QSB? QSA?" The ninth district station will then give him the desired information, whereupon the 2 will probably come back with: "TKS OM Cul 73 Gn." And if you listen in on that same 2 station for a while, you will probably hear him go through the same process half a dozen times or more. Is this sort of thing helping ham radio at all? Decidedly not. It is permissible for an operator after retuning his apparatus, to call somebody to get a report on his note and other characteristics of his wave. But why must this be done a dozen times a night and every night, week in and week out? And then again we have the CQ hound. His sole mission in life seems to be to raise DX and, incidentally, hell in general, among the amateur wave bands. Does this seem to be co-operation, particularly when a man will sit down at the key and pound off a continuous CQ for ten minutes at a time without even signing? The rules call for three CQs and three signs repeated three times and then followed by a period of listening. If this procedure were followed by everyone, there would be less jamming on the air and more room for those few loyal hams who actually try to handle some traffic.

Two things are the backbone of the amateur organization and are the only reasons for its existence. They are experimental work of a constructive nature and the handling of traffic. Those amateur stations who do not accomplish either of these feats are merely run for the pleasure and pastime of their owners and do not contribute anything toward the advancement of radio, as applied particularly to the ham. So let us all try to get together and do the following things. They will help greatly toward promoting co-operation.

First, promote personal co-operation among nearby hams, by assisting each other whenever possible and necessary.

Second, promote good feeling between the local clubs and the district council and the A. R. R. L. You will have to do this if you want to keep ham radio going.

Third, promote co-operation on the air. Eliminate the interminable CQ hound and the "Nil hr OM" type of operator who never seems to have any traffic to start or to relay. The more hams that handle traffic, the more ham radio in general will be kept

You Don't Need a New Set You Don't Need Straight Line Frequency Condensers All You Need Is the New

*Gets Straight Line Frequency Results
from Any Type Condenser*

S L F
"STRAIT LINE DIAL FREEK"

*S L F Dials should not be confused with the
ordinary vernier dial. S L F works
on an entirely different
principle.*

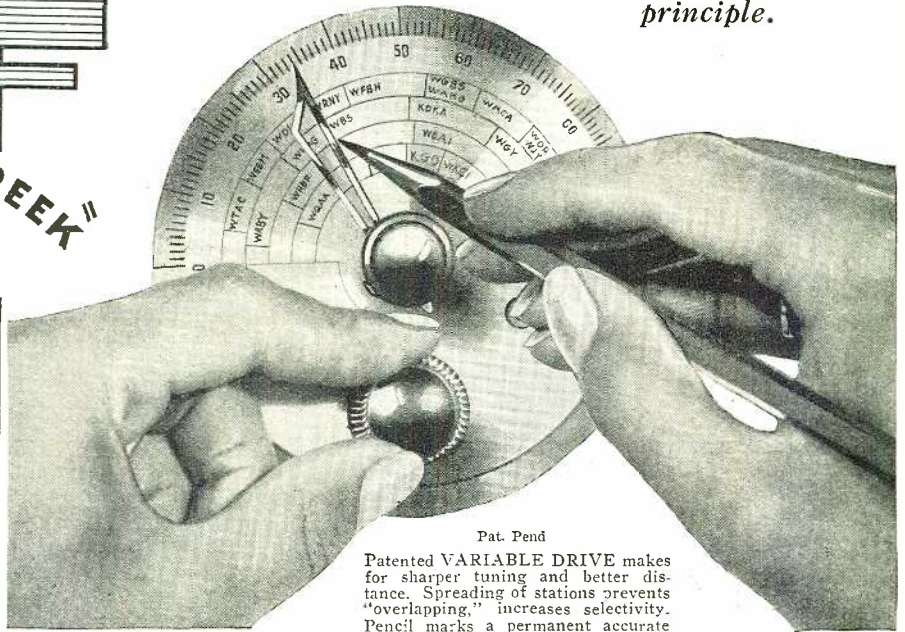

Pat. Pend

Patented VARIABLE DRIVE makes for sharper tuning and better distance. Spreading of stations prevents "overlapping," increases selectivity. Pencil marks a permanent accurate log. Four log segments provide plenty room for all stations. No backlash, lost motion or play. Handsome gold or silver face easily cleaned with a damp cloth. Carefully and honestly made. Easily attached.

A Dial and a Log in one

- If your set dissatisfies you because it is no longer selective—
 - If it fails to bring low wave stations—
 - If it crowds many stations between 0 and 50—
 - And "gets" very little between 50 and 100—
 - If it requires nerve-racking, hair-trigging tuning—
- Then you need S L F Dials!*

\$3⁵⁰ Each
Gold or Silver Face

Radio Fans

S L F Dials are being stocked by America's Best Retailers with vision to see the waiting market.

Dealers and Jobbers write or wire for details

There are ONLY Two Ways to Bring a Set Up-to-Date!

1--The Expensive and Impractical Way
Rewire entire set and replace old condensers with costly straight line frequency type.

2--The Inexpensive and Simple
Just remove old dials and replace with the Marvelous S L F Dials.

BIG THREE RADIO CORP'N
16-22 HUDSON ST., NEW YORK, N.Y.

AT LAST YOU CAN TELL WHAT YOUR TUBES WILL DO

SUPERADIO VACUUM TUBE DYNAMETER



THIS revolutionary Meter measures easily, with positive accuracy, the power of any vacuum tube on the market. No more do you have to buy a "pig in the poke." Now, you can get that "best" audio or radio frequency amplifier or that "right" detector tube. And you can always duplicate your tubes when it comes to renewals. Insist on **TESTED TUBES.**

Every Set or Tube Manufacturer, every Jobber and Dealer will want this necessary Meter. Reliable Representatives wanted. Write for details.

SUPERADIO KIT only SUPER-HETERODYNE \$17.50

Here is the ideal Kit to build, the new Super-heterodyne. Marvelous results. Contains 1 Antenna Coupler, 1 Oscillator Coupler, 1 Special Variable Condenser, 1 Tuned Filler Transformer, 3 Matched Intermediate Transformers and all necessary hardware with diagrams, layouts and complete Super-heterodyne Treatise by Louis C. Billotte. Write today for information.



DE WITT LA FRANCE CO., INC.
54 Washburn Avenue, Cambridge, Mass.

Boston Representative: **MARTIN, HARTLEY & FOSS, 99 Bedford St.**
Chicago Representative: **WILLIAM A. WELTY & CO., 36 So. State St.**

BARKERLEW

Screw Grip DONT SOLDER Cord Tips!



Looks Right - Holds Tight.

A CORD TIP that requires no solder, no wrapping of the insulation and no tools other than a pen knife and a small screw driver. Anyone can attach it quickly and have a factory finish.

The internal thread of the Universal Sleeve "A" draws inside all loose ends of insulation.

The Wood screw "B" inserts in the wire core of the cord until the head seats (see B-2) making an excellent electrical contact. This screw also wedges the cord into the internal thread of "A" making a firm mechanical joint.

All parts are of brass, nickel plated.

See our Bulletin No. 36 at your Dealers. If he hasn't his copy, we have one for him

The Barkelaw Electric Mfg. Co.
Middletown, Ohio, U. S. A.

Any of our Standard Tips shown below will run on the same Universal Sleeve.

N° 630 PRICE 5¢

N° 631 PRICE 7½¢

N° 632 PRICE 7½¢

JUST A MINUTE!



PAT. PENDING

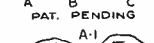

The Universal Sleeve "A" has an internal thread. Screw it on end of wire.



Expose 1/8" of bare wire. Insert wood screw "B" locking wire to sleeve.

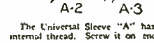

Screw on any of our standard Screw Grip Tips shown at left.

NEW YORK, 157 Chambers St. CHICAGO, 15 S. Clinton St. SEATTLE, 1041 Sixth Ave. S.
BOSTON, 31 Bedford St. DENVER, Denham Bldg. SAN FRANCISCO, 75 Fremont St.
WASHINGTON, D. C., 514 Bldg. MINNEAPOLIS, 1017 Lumber Bldg. LOS ANGELES, 443 S. San Pedro St.
TORONTO, No. 7 Craft Ave. MONTREAL, 298 St. Paul St. W.

before the public and the greater will be the benefit to those most interested.

In experimental work more than in any other phase of the ham game does co-operation become necessary. Where would we be if there were not an exchange of ideas between us? The development of the short wave bands, for instance, would not be progressing with the speed that it is if a few of the more enlightened and ambitious did not go a little out of their way to provide their ham brothers with the results of their work. Would that more of the hams were of this type! Sometimes it is as hard as pulling teeth to get information from a ham. And then he is usually not sure of his stuff. He has probably followed in someone else's footsteps and so, of course, has only a superficial knowledge of what he is discussing. Let's get away from this sort of stuff, fellows. It only retards the game. Study radio so that you have at least a basis to work on. Then get away from the beaten track and try to do something original. Better still, bring co-operation into play and get together with one or two other hams and conduct experimental work. You will soon find that the results of pooling your thoughts will be much better in the long run than individual work could ever be. And then, try to help others who may not know as much as you do. Show them the right way to go about doing the things that they are trying to accomplish, rather than look down on them just because they do not know as much about radio as you do. Remember, we all had to start somewhere; not one of us was born with a full knowledge of radio. By letting the other fellow in on what you know, you will experience that feeling that comes from doing a good deed and, at the same time, you'll be helping to advance ham radio. Let's go!

A New Super-Heterodyne *(Continued from page 445)*

adjustment where a "plunk" is heard as it is turned to the right or negative side. When it is properly adjusted, no squeals at all will be heard—when improperly adjusted, many will be heard. Reference to the tuning chart will show approximately how the dials should be set for different wavelengths.

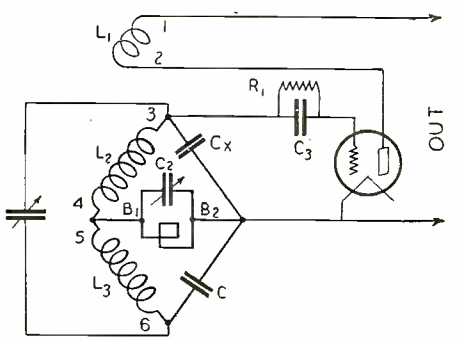



Fig. 2. The autodyne frequency changer, part of the circuit which oscillates at one frequency and detects at another.

Balancing is done by first setting both small condensers all the way in. Then, as the tuning dials are rotated, clicks will be heard. If one of the balancing condensers is turned out, a point will be found where no clicks can be heard. The condenser connected from grid to filament will generally have a low setting, while the other balancing condenser will be all the way in. Once the receiver has been balanced, it should be tuned for several days and then gradually

The Standard Radio Textbook

WIRELESS COURSE 20 LESSONS

by
S. GERNSBACK
ALEXANDER
& H. W. SECOR



12th Edition
Generously Revisions
and Enlarged

EXPERIMENTER PUBLISHING CO.
NEW YORK, N. Y.

The Standard Radio Text Book

12th EDITION

264 Pages of Radio—500 Illustrations.
Size 6 x 9 Inches—DeLuxé Binding.
Genuine Gold Stamped—Round Corners.

PRICE \$2.00

Experimenter Publishing Co., Inc.
53 Park Place :: :: New York, N. Y.

COMPARE!

KENMAN 5—MODEL 1926

Since 1913, twelve years, we have been manufacturing the finest grades of radio apparatus. This is the reason why you, as a discriminating radio buyer, should prefer the Kenman 5 Receiver.

- For artistic design See it.
- For the fine quality of its engineering..... Examine it.
- For Power, selectivity, and distance Try it.
- For clearness without howls, squeals or distortion Hear it.

Then for price, with any other 5-tube set—Compare it

Compare the Kenman 5 1926 model with any 5-tube receiver at any price. Under equal conditions, its performance will compare with or excel any receiver of its kind on the market. You can pay more but you cannot buy more.

Your Money Back If Not Satisfied

Any Kenman dealer will be glad to demonstrate the exceptional properties of this receiver without any obligation on your part, or if your dealer cannot supply you we will ship you direct on receipt of price with a full money back guarantee if you are not satisfied.



Features of the Kenman Receiver.

Genuine Westinghouse Bakelite throughout, synchronized low loss condensers, calibrated transformers, and other parts in keeping with the high standard we have set. The cabinet, 16" x 9", is a work of art, not alone a radio cabinet but a beautiful piece of furniture, two tone mahogany finish equipped with piano hardware. We have done away with the bothersome binding posts, all outside connections and loud speaker hook-up are made by clips, installation is a matter of seconds. Another novel feature is the A—, B— and Ground all on one connection, doing away with howls, squeals and distortion. Rheostats control voltage and volume, also filament control jack for phone use.

Dealers Needed to Distribute Sets Already Sold

We have on hand many customer orders for which dealers will be required for distribution. Write for complete details and terms.

\$ **29⁷⁵**
"A little buys a lot"

KENMAN ELECTRIC CO. Inc., 296 Broadway, New York, N. Y.

Radio Manufacturers Since 1913

CROWE Etched Metal PANELS

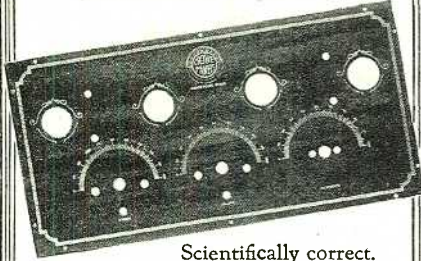

Scientifically correct.
Leading authorities in radio give them
the highest rating as a paneling medium.

Among the Leaders
in quality receiving sets
now equipped with Crowe
panels, are the following:

Super-ZENITH

OZARKA

ERLA

Pearson

MARVELO

Beckley-Ralston

and Others.

Furnished to manufacturers, completely
engraved and machined, ready for use.

**CROWE NAME PLATE
& MANUFACTURING CO.**
1749 Grace Street •• Chicago



PATENTS

If you have an invention and desire to secure a patent, send for our Evidence of Invention Blank and free guide book, "HOW TO GET YOUR PATENT". Tells our Terms, Methods, etc. Send model or sketch and description of your invention for INSPECTION and INSTRUCTIONS.

No Charge for the Above Information

RANDOLPH & CO., Dept. 459 Washington, D. C.

Insure your copy reaching you each month. Subscribe to Radio News—\$2.50 a year. Experimenter Publishing Co., 53 Park Place, New York City.

unbalanced by adjusting one of the condensers (CX). If this is done on a weak station, an increase in signal strength will be noticed. If the set is too far unbalanced, however, the selectivity will suffer.

CONSTRUCTION

The practical construction of a receiver embodying the super-autodyne circuit, with either a balanced or slightly unbalanced bridge circuit, is extremely simple and will readily be understood by reference to the various photos and diagrams accompanying this article. The actual list of parts necessary is given below. They may be of standard manufacture, but should be carefully selected to conform with the general specifications, since for the design illustrated the electrical and mechanical requirements have been very carefully worked out to give best results.

2 (C1, C2)	.0005 condensers.
2	4-inch moulded dials. vernier type preferably.
1 (R4)	6-ohm rheostat.
1 (R3)	240-ohm potentiometer.
3 (B1, B2, B3)	Insulated top binding posts.
1 (J2)	1-spring jack.
1 (J1)	2-spring jack.
1 (C5, 211)	60 K.C. filter with matched tuning condenser.
2 (210, 210)	60 K.C. matched intermediate transformers.
1 (L1, L2, L3)	Coupling unit.
1	6 gang 199 or 201A socket shelf.
2 (T1, T2)	3½:1 audio transformers.
2 (C7, C8)	.5 mfd. by-pass condensers.
2 (C3, C4)	.00025 mica condensers with leak clips.
2 (C9, C10)	.002 mica condensers.
1 (C6)	.0075 mica condensers.
2 (Cx, CX)	.000025 balancing condensers.
1 (R1)	.25- or .5-megohm leak.
1 (R2)	2-megohm leak.
1 (S2)	On-off switch.
1 (S1)	S.P.S.T. switch.
1	5-lead color cable.
1	Pair shelf brackets.
1	Panel 7x18x¾ in.
29	6/32 R.H.N.P. ¾-inch machine screws.
2	6/32 R.H.N.P. 1½-inch machine screws.
31	6/32 N. P. nuts.
1	length spaghetti.
10	lengths bus-bar.
25	soldering lugs.

Tools required: 1 hand-drill with drills and countersink; 1 soldering iron with resin-core solder and non-corrosive paste; 1 side-cutting pliers; 1 screw-driver, hammer and centerpunch.

As soon as the material has been procured, each item should be carefully examined to see that all screws and nuts are tight, and lugs placed as shown in the photographs, so that those on the various instruments will point in the best directions for short leads. Socket springs should be bent up to make good contact with the tube pins. Condenser bearings should be adjusted to give the desired tension.

The front panel may be laid out with the



A Super Pattern for Super-Heterodyne Set Builders

The simplest, greatest and most revolutionary Radio Pattern ever designed. The complete super-heterodyne as shown above can be built with this pattern by anyone. The secret of the marvelous simplicity is the gigantic blueprints that are drawn the full size of the super-heterodyne itself. The blueprint of the wiring diagram measuring 19½" x 44" is drawn by a master radio engineer, every conceivable measurement is given right on the pattern so that you need not measure a single wire.

The price of the complete pattern, comprising two blueprints, size 19½" x 44", and a 16 page booklet size 8" x 12" and enclosed in an extra heavy cardboard box printed handsomely in two colors is only \$1.00.

Here is the most wonderful opportunity for every radio amateur to have the finest set yet designed for radio receiving.

GET YOUR ORDER IN EARLY OR SEE YOUR DEALER TODAY



PRICE \$1.00

At All Radio or News Dealers

The Consrud Company, Inc.
233 Fulton St., New York City

Consrud

"PILOT" **1** Straight Line FREQUENCY Condensers

13 Plate
MAX. CAP.
.0003

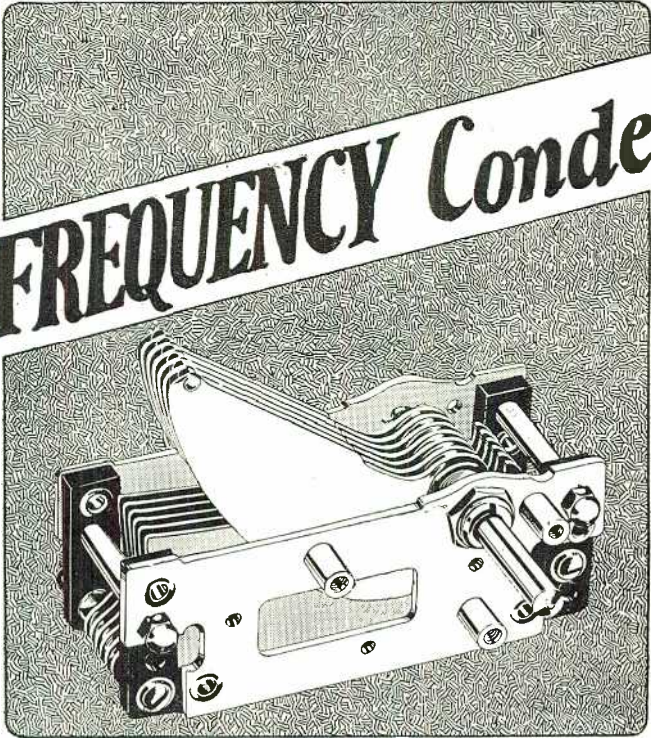

The Greatest Condenser value in the world

COVERS 200 to 600 Meters

This new PILOT Straight-line FREQUENCY Condenser is presented only in the universally-recommended 13-plate model (.0003 maximum capacity), as specified by all authorities for use in all tuned radio frequency circuits. The PILOT Condenser is superior to similar condensers being offered at many times the price.

"UNCROWDS" THE DIAL

PILOT Straight-line FREQUENCY Condensers spread the stations evenly over your dial, eliminating the present congestion in the lower wave-lengths, making it easy to tune in DX (i.e.: KDKA at 53 instead of at 17). It will pay you to replace your present condensers with this NEW Pilot Straight-line FREQUENCY Condenser.

Rigid, accurate, precise construction.

Extra-heavy plates, .032 inches thick.

Genuine bakelite insulation.

Pierced end-plates to minimize eddy currents.

Braced rotor-plates prevent shorting.

Low loss, minimum insulation.

MADE, BOUGHT, SOLD IN VOLUME

Quantity production in America's greatest Radio Parts factory, plus direct mass purchases by the enormous S. S. Kresge Co.'s nation-wide organization of chain stores, eliminating all in-between profits, makes possible the production of this finest-quality Straight-line FREQUENCY condenser to retail at \$1.00—the world's greatest condenser value! The PILOT Straight-line FREQUENCY condenser is being used as standard equipment by a large number of manufacturers of high-grade radio receivers.

PILOT PARTS USED EVERYWHERE

Manufacturers, amateurs and experimenters everywhere are using PILOT Radio parts. They have learned it is not necessary to pay more for perfect performance. PILOT parts are superior because they are designed by leading engineers and built by experts. PILOT parts are low in price because PILOT produces more parts than any other Radio manufacturer in America.

ON SALE AT ALL S.S.KRESGE CO. STORES

This new PILOT Straight-line FREQUENCY Condenser can be purchased complete for \$1.00 at any S. S. KRESGE CO. store. Or if no Kresge store is convenient send \$1.00, plus ten cents postage, for each condenser ordered in cash or Money Order direct to

PILOT ELECTRIC MFG. CO., Inc.
323 Berry Street Brooklyn, N. Y.

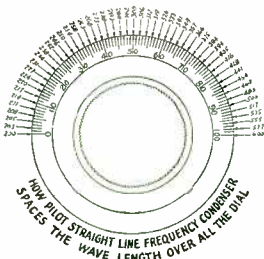

Made By America's Greatest Radio Parts Manufacturer

Do You Need More Money?



A busy Pennsylvanian who increases his income regularly every month through our spare-time, money-making plan.

Sell Us Your Spare Time At a Big Profit!

THOUSANDS of busy men and women in all sections of the country are turning their spare time into money—easily earning from \$5 to \$25 a week through our practical money-making plan. What they are doing, you can do too.

No experience or investment is necessary. Age, education or where you live does not matter. All you need do is take orders for renewal and new subscriptions to our four popular magazines—*Radio News*, *Science and Invention*, *The Experimenter*, and *Motor Camper & Tourist*.

We furnish all supplies and instructions absolutely free. You begin earning money just as soon as you start. All particulars will be sent you immediately on receipt of the coupon below. Simply fill in your name and address, clip out and

----- Mail To-day -----

E. J. Foley, Box R-10,
Experimenter Publishing Co.,
53 Park Place, New York City.

Please send me immediately, without obligation, full particulars about your spare-time, money-making plan.

Name

Address

City..... State.....

aid of a rule and scribe, after which the hole locations should be punched with a center-punch or nail, and a hammer. After drilling the holes, the panel may be grained with fine sand-paper and oil, rubbing in one

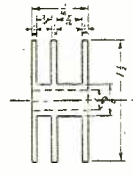

INTERMEDIATE TRANSFORMER.
PRIMARY 1400 TURNS
#36 S S E WIRE
INSIDE-"B", OUTSIDE-"PLATE"
SECONDARY: 3300 TURNS
#36 S S E WIRE
INSIDE-"A", OUTSIDE-"GRID"
FIG 2

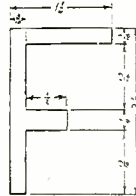

CORE .007" SILICON STEEL
1 PIECE AS SHOWN, 1 PIECE WITHOUT CENTER PROJECTION.
MOUNT WITH PROJECTION UNDER PRIMARY COIL
IMPREGNATE IN ROSIN-BEEESWAX COMPOUND.

FIG 3

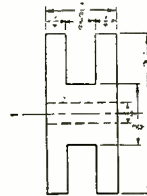

FILTER
PRIMARY 250 TURNS
#36 D S C WIRE
INSIDE-"B" OUTSIDE-"PLATE"
SECONDARY 1500 TURNS
#36 D S C WIRE
INSIDE-"A", OUTSIDE-"GRID"
IMPREGNATE IN ROSIN-BEEESWAX COMPOUND.

Fig. 3. Details of intermediate frequency transformers and filter.

direction until the original polished finish has disappeared. After wiping the panel off with alcohol, indicating marks for the dials may be scratched as in Fig. 1 and filled with Chinese white. The sub-panel should not be grained.

Correspondence from Readers

(Continued from page 462)

would be some excuse if the British apparatus was not so efficient. However, this is not the case. We in England were able to profit by American experience when we took up broadcasting on the other side just about two years ago.

I saw one and one-half years of broadcasting in England before coming to this country and I have done my share of listening-in over here during the last eight months.

Most of my listening in England was done from a spot some twenty-five miles out of London while here, as you will see, I am a little closer to the locals. In England I made it a point not to use more than two tubes for DX work, a straightforward radio frequency and detector circuit. Here I am using four tubes at present. There was nothing special about my circuit over there, and it was long before the low-loss craze was the vogue. The radio frequency coupling was of the tuned plate type, the tickler coil being variably coupled to the plate coil of the R-F tube. My aerial was about 100 feet in length, 25 feet high and my house in a valley—the Thames valley.

In spite of the low aerial and the fact that I was using only two tubes, I managed to log KDKA, WGR and WMAS (the latter at Dartmouth, Mass. I may have the call wrong)—if I remember correctly—October, 1923. Reception of these stations was verified. This speaks very well of the broadcasting but without question the apparatus at the receiving end must necessarily have been pretty efficient to receive at this range.

Hundreds of amateurs on the other side—fans, you would call them—have received American stations on only one tube during

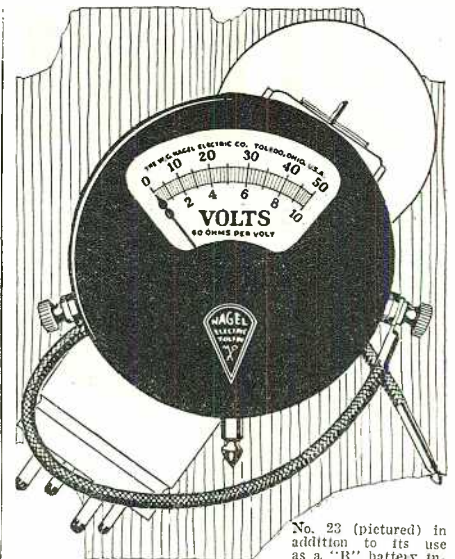

No. 23 (pictured) in addition to its use as a "B" battery instrument is being used extensively for "A" battery testing in place of hydrometers.

Test accurately and safely

There's no substitute for high resistance in a voltmeter for testing radio batteries, tube voltage, or experimental work. 60 ohms per volt is the Nagel standard, assuring accurate readings and safety against battery drainage under touch contact or continuous service. See your dealer or write The W. G. Nagel Electric Co., 512 Hamilton Street, Toledo, Ohio.

If you own a "Super-Het" you can test your "A" and "B" batteries with one instrument—the Nagel No. 62 Voltammeter

NAGEL
Manufacturers of
**DRY CELL TESTERS • AMMETERS
HIGH-RESISTANCE VOLTMETERS
and VOLTAMMETERS • BAKELITE
HOT MOULDED INSULATIONS**

GET A Handy Binder
for your
RADIO NEWS

Holds and preserves six issues, each of which can be inserted or removed at will.

Price 65c.

EXPERIMENTER PUBLISHING CO., Inc.,
BOOK DEPT.
53 Park Place, New York

Send for this Big Catalogue

CONTAINS THE NEW, EASY WAY TO BUILD YOUR RECEIVER

Book contains 36 pages 7x10 inches packed full of the most useful and interesting matter ever put into a radio catalogue.

THIS KIT CATALOGUE FREE



Kits Shipped on APPROVAL
Send No Money
Quick Shipment
Transportation Paid
Lowest Prices

"No-Sod-er"
 MAKES SET-BUILDING EASY

Revolutionary Method to "Build Your Own"



SHALL WE SEND YOU ALSO
New 1925 "Rasco" Catalog No. 12
 CONTAINS 75 VACUUM TUBE HOOK-UPS, 300 ILLUSTRATIONS, 500 ARTICLES, 100 PAGES
 All Armstrong Circuits: These important circuits are explained clearly, all values having been given, leaving out nothing that could puzzle you. Just to name a few of the Vacuum Tube circuits: The V.T. as a detector and one-step amplifier; all Armstrong circuits; one-step radio frequency amplifier and detector; three-stage audio frequency amplifier; short wave regenerative circuits; 3-stage radio frequency amplifier; radio and audio frequency amplifier; inductively coupled amplifier; all Reflex Circuits.

This Free Book Tells

About the Marvels of Radio—How it Helps All and Brightens Every Home—Gives List of Broadcast Stations—Specimen Programs—And How Programs are Made UP—Answers the Questions, "What Set Shall I Buy," and How Much to Pay—Describes "No-Sod-er" Wiring System—Explains How to Get Your Own Radio Outfit Without Money—How to Save \$65.00 in Five Hours—How to Make Money by Going Into Business for Yourself and Building Sets for Others—Tells Where Orders are Awaiting You—Where and How You Can Transact Your Business—CONTAINS DETAILED DESCRIPTIONS AND FINEST ILLUSTRATION OF LARGE NUMBER OF BEST KITS IN EXISTENCE AND QUOTES LOWEST PRICES—Lists Full Line of Radio Parts and Accessories—Explains Our Fair, Easy, Liberal, Golden-Rule Plan of Doing Business. You Need It. Send Coupon or letter NOW.

Book explains what you want to know

About new revolutionary way of assembling your radio set from our many kits—no solder, no bus bar, no poor connections, no waste of time, no skill required, no dissatisfaction, no tools needed except common screwdriver and pliers. Even a boy can quickly assemble a complicated kit.

DON'T EVEN THINK OF BUYING A SET OR KIT BEFORE YOU SEE OUR KIT CATALOG

RADIO SPECIALTY CO., Kit Div. 679X, 245F Greenwich St., New York.
 You may send me, without charge or obligation, your KIT CATALOG NO. 14 () RASCO CATALOG NO. 12 (). I am interested chiefly in

.....
 Name

.....
 Street

.....
 P.O. State

RADIO SPECIALTY CO. Kit Div. 245F, GREENWICH ST. 679X NEW YORK CITY

LOOK HERE FOR THE RED STRIPE

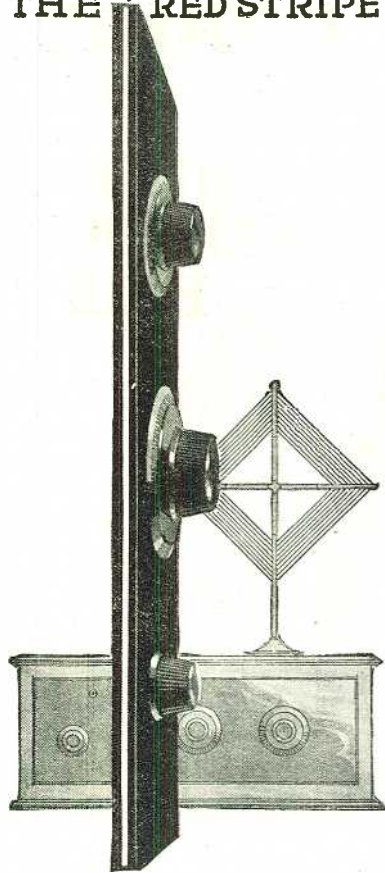

Used by the United States Navy and Signal Corps for over nine years. Dilecto is the strongest, safest radio panel that can be made. Look for the identifying "Red Stripe" that sets apart Dilecto from its imitators.

THE CONTINENTAL FIBRE CO.
FACTORY: NEWARK, DELAWARE

Service on Dilecto, also Contex, Conite, and Vulcanized Fibre, from:

NEW YORK 250 Park Ave. CHICAGO Wrigley Bldg. PITTSBURGH Farmers Bank Bldg.	SAN FRANCISCO 75 Fremont St. SEATTLE 1041 6th Ave., So. LOS ANGELES 307 So. Hill St.
---	---

Offices and Agents Throughout the World

Dilecto
(distinguished by its red stripe)

Y. M. C. A. Radio Institute

Courses in Radio Operating and Radio Construction. Expert Instructors—Thorough Courses. Employment Service. Dormitories—Restaurant—Club Privileges.

Write for booklet
"Opportunities in Radio"

158 East 86th Street, New York City

CLASS 25¢ PINS

BUY DIRECT FROM THE MAKER
CATALOG FREE
GHS 25 VICTORS
Either pin shown made with any 3 letters and 2 figures. 1 or 2 colors enamel. Silver plate. 25¢ ea. \$2.50 doz. Sterling silver. 40¢ ea. \$4.00 doz.
BASTIAN BROS. CO.
3490 637 Bastian Bldg., Rochester, N. Y.

the past winter. Both broadcaster and receiver must be pretty good to accomplish this.

Some pretty good crystal records have been made over there, too, which all points to "efficient transmitting gear."

Mr. Howe overlooks the fact that conditions on both sides of the Atlantic may differ, although it may be the same day of the week. The fact that he sailed down the middle of the Atlantic and received American stations and not British stations proves nothing. I have at times received WGR in England better than Berlin. On occasion I have sat up and listened to American transmissions for hours, but in attempting to do so on the following evening, have failed to detect even a faint carrier wave, although apparently atmospheric conditions were O.K. WBZ has been heard in London every day for a week this last winter and on the following week another American station altogether would come in well, to the total exclusion of WBZ. There are too many unknowns in radio yet to criticize one another's apparatus by individual results.

Some weeks ago the R. C. A. relayed 5XX about five times better than I ever heard KDKA relayed in London. That—if I took Mr. Howe's attitude—would prove that 5XX is better than KDKA and that American receiving apparatus is not consistently satisfactory because it failed to get 5XX the following week. But instead—I think that it was the finest piece of radio work ever accomplished. It required the best of apparatus and operators at both ends.

When I came over here I brought British tubes with me and these I used until they one day came to an untimely end. I substituted them for American tubes and have noticed not the slightest difference. As I said above, I am using a four-tube set. My aerial is 200 feet in height—not badly screened, but I have failed in eight months to get out further than Dallas, Tex. I don't blame American apparatus—it is fine, the same as is the British—but I blame local conditions which cannot be helped.

Mr. Howe may be interested to know that I spent eighteen months answering on an average 2,000 questions a week addressed to the radio publication for which I was working and no charge whatever—not even postage—was made for this service.

The American method of mounting the tubes and so forth on a baseboard behind the panel is rapidly spreading over on the other side. We must all live and learn. Mr. Howe's remarks re the British tube socket—which I'll admit I don't care for as much as the American socket—are grossly exaggerated and only the clumsiest person would burn out his filament when inserting the tube. People often judge from their own experience only.

He adds, or rather gives the impression, that a good pair of phones sell for \$15. I paid \$2 for a very good pair before leaving London.

American radio fans are probably more advanced technically than their British brothers—taken as a whole, that is, owing to the fact that they have had two years more experience at the job. Very few amateurs in England use more than four tubes and the super-heterodyne is hardly ever seen on the other side.

I hope that these few remarks will interest you—Mr. Howe.

L. W. CORBETT,
N. Y. Representative, *Popular Wireless*.
106 West 81st St., N. Y. C.

IT IS, AT THAT!

"Pa, what is meant by three stages of amplification?"

"Oh, that's when your mother and two of her neighbors get together."

Contributed by *William A. Heitler*.

ORCHESTRION De Luxe
With Tone Arm of Bent Wood



Certificate No. 870



\$37.50

WONDERFUL REPRODUCTION!

Orchestron de Luxe is a superb musical instrument for radio reception. Tone arm built entirely of bent wood from the best tone-reproducing spruce-pine and maple. Designed and perfected by an expert violin maker and now built for you under his personal supervision.

With Orchestron de Luxe you are free from all the rasping, tinny sounds so often found in metal or moulded-plastic loud speakers. Reception is clear as a bell. All the beautiful tones reach you as sweet and lovely as when they enter the microphone at the broadcasting station.

You will never attain complete enjoyment and fullest benefit from your radio until you have listened to a Program through Orchestron de Luxe. Hear Orchestron de Luxe demonstrated at your favorite radio store. If your dealer cannot supply you with Orchestron de Luxe send direct to our factory. Our guarantee lets you be the judge of its superiority. Write for free literature. Radio Dealers: Write for our attractive proposition. Quantity production insures prompt delivery.

RADIO CABINET COMPANY
2123 Olney Street Indianapolis, Indiana
Radio News Laboratories Certificate of Merit No. 870

What Your Father Should Know

If Your Father Is 40 Years or More of Age, You Should Call His Attention Immediately to This Important Message Which Will Help Him to Live Longer and Happier

When Men reach the prime of life, 65% of them—according to medical authorities—are victims of a disorder that robs them of much of their energy, mental and physical vigor, and general well being. This disorder is often confused with bladder trouble, because frequent, nightly risings is one of the symptoms. Other symptoms often include chronic constipation, aches in back, feet and legs, headaches, increasing blood pressure and dizzy spells. In the past these conditions have been often misconstrued as merely signs of approaching age. But now a well-known American scientist has shown in over 20,000 cases that prostate gland disorder was quite often the real cause of this trouble—and that a simple, drugless home treatment would give quick, positive relief in a simple, drugless, hygienic manner. Prostate gland trouble yearly brings thousands of men to the operating table, causes thousands of deaths. An ethical organization is spreading the news of this great scientific step forward and has already brought amazing relief to thousands of men. You may be saving the life of your father, or an older friend, by reading this notice to them. And if they are interested, you should see that they write at once for the free book. Just send a post-card or letter to the Electro Thermal Company, 6049 Main Street, Steubenville, Ohio, or their Western Office, Dept. 60-P, 711 Van Nuys Bldg., Los Angeles, Calif.. The concern that is distributing these books free. But act at once for the edition is limited.

The "Windham" Wire Former

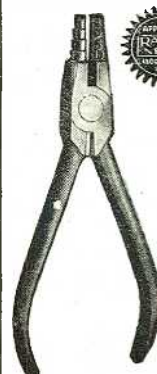

A Handy Tool for Electricians, Radio Fans and Mechanics

This rugged little tool not only makes accurate loops or eyes for No. 4, 6, 8 and 10 screws but will make either sharp or easy radius right angle bends and the sharp cutter will cut the toughest wire as well.

It is drop forged of the very best steel and carefully tempered in oil.

Retails for \$1.25. Dealers and Jobbers send for full information. Desirable territory still open.

THE GOYER COMPANY
Willimantic, Conn.

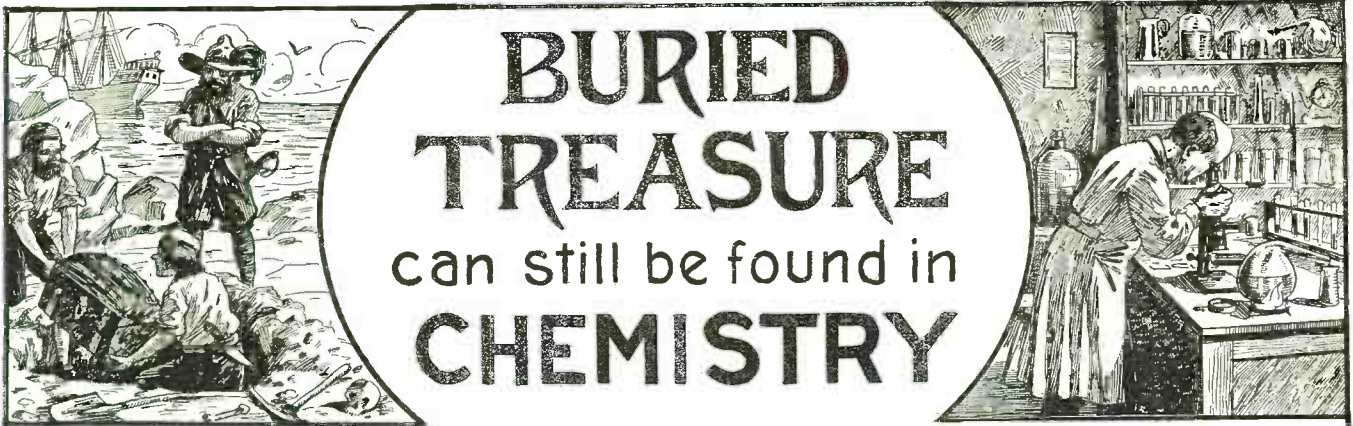

Good Chemists Command High Salaries

and you can make yourself independent for life by unearthing one of chemistry's yet undiscovered secrets.



T. O'CONOR SLOANE,
A.B., A.M., LL.D., Ph.D.

Noted Instructor, Lecturer and Author. Formerly Treasurer American Chemical Society and a practical chemist with many well known achievements to his credit. Not only has Dr. Sloane taught chemistry for years but he was for many years, engaged in commercial chemistry work.

Do you remember how the tales of pirate gold used to fire your imagination and make you want to sail the uncharted seas in search of treasure and adventure? And then you would regret that such things were no longer done. But that is a mistake. They *are* done—today and everyday—not on desert islands, but in the chemical laboratories throughout your own country. Quietly, systematically, the chemist works. His work is difficult, but more adventurous than the blood-curdling deeds of the Spanish Main. Instead of meeting an early and violent death on some forgotten shore, he gathers wealth and honor through his invaluable contributions to humanity. Alfred Nobel, the Swedish chemist who invented dynamite, made so many millions that the income alone from his bequests provides five \$40,000 prizes every year for the advancement of science and peace. C. M. Hall, the chemist who discovered how to manufacture aluminum made millions through this discovery. F. G. Cottrell, who devised a valuable process for recovering the waste from flue gases, James Gayley, who showed how to save enormous losses in steel manufacture, L. H. Baekeland, who invented Bakelite—these are only a few of the men to whom fortunes have come through their chemical achievements.

What Some of Our Students Say of This Course:

I have not written since I received the big set. I can still say that it far exceeded my anticipations. Since I have been studying with your school I have been appointed chemist for the Scranton Coal Co. testing all the coal and ash by proximate analysis. The lessons are helping me wonderfully, and the interesting way in which they are written makes me wait patiently for each lesson.—MORLAIS COUZENS.

I wish to express my appreciation of your prompt reply to my letter and to the recommendation to the General Electric Co. I intend to start the student engineering course at the works. This is somewhat along electrical lines, but the fact that I had a recommendation from a reliable school no doubt had considerable influence in helping me to secure the job.—H. VAN BENTHUYSEN.

So far I've been more than pleased with your course and am still doing nicely. I hope to be your honor graduate this year.—J. M. NORRUS, Jr.

I find your course excellent and your instruction, truthfully, the clearest and best assembled I have ever taken, and yours is the fifth one I've studied.—JAMES J. KELLY.

From the time I was having Chemistry it has never been thus explained to me as it is now. I am recommending you highly to my friends, and urging them to become members of such an organization.—CHARLES BENJAMIN.

I shall always recommend your school to my friends and let them know how simple your lessons are.—C. J. AMDALL.

I am more than pleased. You dig right in from the start. I am going to get somewhere with this course. I am so glad that I found you.—A. A. CAMERON.

I use your lessons constantly as I find it more thorough than most text books I can secure.—W. M. ILTBBS.

Thanking you for your lessons, which I find not only clear and concise, but wonderfully interesting. I am—ROBT. H. TRAYLOR.

I received employment in the Consolidated Gas Co. I appreciate very much the food service of the school when a recommendation was asked for.—JOS. DECKER.

Now Is the Time to Study Chemistry

Not only are there boundless opportunities for amassing wealth in Chemistry, but the profession affords congenial employment at good salaries to hundreds of thousands who merely follow out its present applications. These applications are innumerable, touching intimately every business and every product in the world. The work of the chemist can hardly be called work at all. It is the keenest and most enjoyable kind of pleasure. The days in a chemical laboratory are filled with thrilling and delightful experimentation, with the alluring prospect of a discovery that may spell Fortune always at hand to spur your enthusiasm.

You Can Learn at Home

To qualify for this remarkable calling requires elaborate specialized training. Formerly it was necessary to attend a university for several years to acquire this training, but thanks to our highly perfected and thorough system of instruction, you can now stay at home, keep your position, and let us educate you in Chemistry during your spare time. Even with only common schooling you can take our course and equip yourself for immediate practical work in a chemical laboratory. Dr. Sloane gives every one of his students the same careful, personal supervision that made him celebrated throughout his long career as a college professor. Your instruction from the very beginning is made interesting and practical, and we supply you with apparatus and chemicals for performing the fascinating analyses and experimental work that plays such a large part in our method of teaching, and you are awarded the Institute's official diploma after you have satisfactorily completed the course.

Easy Monthly Payments

You don't have to have even the small price of the course to start. You can pay for it in small monthly amounts—so small that you won't feel them. The cost of our course is very low, and includes everything, even the chemistry outfit—there are no extras to buy with our course. Our plan of monthly payments places a chemical education within the reach of everyone. Write us and let us explain our Plan in full—give us the opportunity of showing you how you can qualify for a highly trained technical position without even giving up your present employment.

Special 30 Day Offer

Besides furnishing the student with his Experimental Equipment, we are making an additional special offer for a short while only. You owe it to yourself to find out about it. Write today for full information and free book "Opportunities for Chemists." Send the coupon right now while it is fresh in your mind. Or just write your name and address on a postal and mail it to us. But whatever you do, act today before this offer is withdrawn.

DON'T WAIT—MAIL COUPON NOW!

CHEMICAL INSTITUTE OF NEW YORK
Home Extension Division 10
66-R—West Broadway
New York City

Please send me at once, without any obligation on my part, your free Book "Opportunities for Chemists," and full particulars about the Experimental Equipment given to every student. Also tell me about your plan of payment and your special 30 day offer.

NAME
ADDRESS
CITY STATE

R.N., Oct. '25



Experimental Equipment Furnished to Every Student

We give to every student without additional charge this chemical equipment, including forty-nine pieces of laboratory apparatus and supplies, and forty different chemicals and reagents. These comprise the apparatus and chemicals used for the experimental work of the course. The fitted heavy wooden box serves not only as a case for the outfit but also as a useful laboratory accessory for performing countless experiments.

CHEMICAL INSTITUTE OF NEW YORK, Inc.

HOME EXTENSION DIVISION 10

66-R—WEST BROADWAY NEW YORK CITY

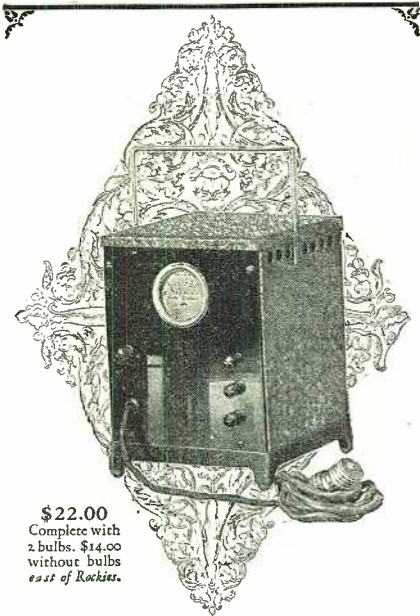

\$22.00
Complete with
2 bulbs. \$14.00
without bulbs
cost of Rockins.

Charges all Storage Batteries

Quickly, Quietly, Safely
The New TWIN BULB

HANDY CHARGER

Chargers as well as other radio equipment have been improved. That is why we have the New Twin Bulb Handy Charger. It is the last word in battery chargers. Regardless of make or voltage it will charge your "A" and "B" Storage Batteries at a fast rate and without the slightest noise. The Twin Bulb Charger cannot discharge or overcharge your battery, therefore it is particularly adaptable to overnight charging.

The "push-pull" method of charging is employed by this new Twin Bulb HANDY, using both halves of the AC wave. This advanced principle accounts for the fast rate of charge. See your nearest radio dealer about this new charger.

INTERSTATE ELECTRIC CO.
4341 DUNCAN AVE. - - ST. LOUIS

**SAVE \$1000
a Year**
\$35 to \$50 a Week

After short course in RADIO. LICENSES a specialty. Instruction in all branches. FALL term begins SEPT. 14th. Positions secured for graduates.

Send for free Sample Code Lessons. FREE Scholarships for a few lucky ones. FREE catalogue and full details from

MASS. RADIO SCHOOL
18 Boylston Street
Boston, Mass.

Insure your copy reaching you each month. Subscribe to RADIO NEWS—\$2.50 a year. Experimenter Publishing Co., 53 Park Place, N. Y. C.

The Vacuum Tube and Photo-Electric Cell

(Continued from page 427)

duced (as in the case of slight illumination of the cell), this dissipation may, on the contrary, be as rapid as the collection of the charge.

In these circuits the insulation of all parts play an important rôle. In particular, if the exterior grid of the two-grid tube is not perfectly insulated, a time will be reached when the quantity of electricity so lost will equal the quantity of electricity carried by the photo-electric current. The potential adjusts itself to a value corresponding to this state of equilibrium, and from this results a limitation of the system. With a very well insulated tube, a condition could be established in which, during the instant following illumination, the maximum current produced by positive ions arriving at the exterior grid is of the order of 10^{-13} ampere.

It is necessary to note that if the photo-electric current is only slightly greater than 10^{-13} amperes, the variations in potential of the outer grid are slow because of the capacity of this grid. This is also true of the variations of the inner grid current. The value of the current to be measured is therefore determined, not by the total variation of current between the inner grid and filament (since this variation will be the same in all cases, the current reaching zero), but by the speed of variation of this current. One notes, for example, the variation of current during a time, t.

Here are some brief indications of the applications to which this new device has been put. The realization of these applications is due chiefly to Mr. Jouaust, for it is he who finally developed the apparatus after having taken an important part in establishing the basic principles.

It is of very great interest in astronomy and in geodesy to be able to register with very great precision the instant when a pendulum passes a particular position during each of its oscillations. Generally an electric contact is employed for this purpose; a metal strip or a drop of mercury, with which the pendulum makes contact at each oscillation. Now a material contact, light as it may be, between the pendulum and another body, causes a disturbance in its oscillations. If it is a clock movement which closes the electric contact, experiments have shown that variations of about a hundredth of a period are produced. By placing a small mirror on the rod of a pendulum, in such a manner that at each oscillation a luminous ray is reflected during an extremely short time onto the photo-electric cell connected, as has been described, to amplifiers, a graphic register of the photo-electric current is easily obtained by means of a recording instrument. A sudden indentation of the line drawn by the recording pen of the instrument is produced at each oscillation of the pendulum.

The first application of this device was made jointly by Colonel Perrier and Captain Schermer, of the Geographic Service of the French Army, on a geodetic pendulum for the measurement of the gravitational constant. This application was communicated at a meeting of the International Geodetic and Geophysical Union in Madrid in 1924.

Another application was made on a master pendulum at the International Time Bureau (Paris Observatory) situated in a shaft at a depth of 27 meters. Fig. 6 represents the optical arrangements of the installation designed and constructed with the assistance of Mr. L. Joly. The cell and the amplifying devices could not be placed in the shaft because of dampness. It was necessary to arrange them at the top of the shaft.

Is Your "B" a Worker or a Drone ?

Your Set Deserves

The Brant B Battery

\$26.00

100 Volts
In One
Compact
Unit

Guaranteed
TWO
YEARS

As Good as It Looks

All the advantages of a good storage battery combined with cleanliness and compactness of dry battery.

Ask Your Dealer

BRANT BATTERY CO.
1622 W. 16th St., Los Angeles, Cal.

IMPROVE YOUR RECEPTION

X-L VARIO DENSERS

FOR GREATER DISTANCE, VOLUME
and CLARITY

Endorsed and Used by the Foremost Radio Engineers
MODEL N—Capacity range 1.8 to 20 micro-microfarads, for balance in Roberts two tube, Brown-Drake, McMurdo Silver's Knockout, Neutrodyne and tuned radio frequency circuits. Price \$1.00
MODEL G—Two capacity ranges, .00016 to .00055 and .0003 to .001 Microfarads, for the Coekaday circuit, filter and intermediate frequency tuning in super-heterodyne and positive grid bias in all sets. Price \$1.50

X-L RADIO LABORATORIES
2426 Lincoln Ave. CHICAGO

THE CRYSTAL FOR POWER VOLUME

LOUD EVERYWHERE. A SIZABLE
CHUNK—SENSITIVE ALL OVER.
ATTRACTIVELY MOUNTED

PRICE 50c POSTPAID

NION

FIXED DETECTORS— ARE LOUD AND CLEAR.

NICKEL
PLATED

Especially Adapted
for
REFLEX

DURABLE

PAT APPLIED FOR

THE KEYSTONE PRODUCTS CO.
168 Gardenia Avenue,
ROYAL OAK, MICHIGAN

Build Better Radio Sets with Ragemco Tools



SEND FOR
THIS FREE
TOOL
CIRCULAR

YOU cannot do good work without the proper tools. We ship, direct to your door, any of our tools especially made for radio uses. Many of these tools are different from any you have ever seen.

Tools of Every Description for Every Conceivable Purpose

- | | |
|------------------------------------|----------------------------|
| Long Sharp Nose Side Cutting Plier | Radio Tool Set |
| Side Cutting Nipper | Tool Chest |
| Combination Plier | Hollow Handle Tool Set |
| Wire Bending Tool | "Yankee" Hand Drill |
| Set of Three Screw Drivers | "Hollow Handle" Hand Drill |
| Three-in-one Nut Wrench | Circle Cutters |
| Screw Starter Driver | Bench Vise |
| Tool Users Book | Radio Drill Set |
| Scriber and Marker | Electric Soldering Iron |

SAVE MONEY AND TIME

Send for our Special Tool Circular "A". You will be astonished at the remarkable tools we have for your work, that simplify set building, and you will be delighted at our low prices.

**SAVE
TIME
AND
MONEY**

**Radio
Tools of
every des-
cription
for every
purpose**

THE RADIOGEM CORPORATION, 66 W. Broadway, New York, N. Y.



The TROPADYNE

The Superadio—the Only Receiver with "Tunable" Intermediate Transformers

**Every
Circuit a
Separate
Color**

The new Consrad Patterns contain every possible idea that will be of assistance to the user of these patterns while constructing the receiver. The latest innovation is the printing of the wiring diagram on the new patterns in four colors: thus, GREEN for the Tuner-Oscillator circuit, YELLOW for the low potential wiring or "A" battery circuit, RED for the plate and "B" battery circuit and WHITE for the grid circuit.

The new Tropadyne circuit is spreading like wildfire. Front pages of many radio magazines and newspapers are featuring this circuit. The secret of its tremendous popularity is in the TUNABLE Intermediate transformers called Tropaformers. Tropaformers enable you, after the set is built, to tune the intermediate transformers so that you have no worries about balance. They take a big question mark out of your Super-Heterodyne.

Consrad is again right up to the minute by publishing in its usual complete form a pattern on the authentic Tropadyne circuit. This pattern contains two extra large sized blueprints (19 by 22 inches). The blueprint of the wiring diagram is printed in the latest Consrad method explained elsewhere on this page. With these blueprints comes a large 16-page booklet complete in every detail, fully illustrated and written in plain understandable English.

Altogether every modern aid toward making a radio diagram easy to understand and easy to follow is incorporated in this latest Consrad Pattern.

SOLD BY ALL RADIO AND NEWS DEALERS

PRICE 50c EACH

Published and Distributed by

The Consrad Company, 233 Fulton St., New York, N. Y.

The SUPER-HETERODYNE

USE THIS BLANK TO ORDER

Just clip out this coupon, check the patterns or books you want and mail it to us with full remittance.

The Consrad Co., Inc.
233 Fulton St., New York, N. Y.

Gentlemen: I have checked below the patterns and books I desire. Enclosed find \$....., the full price. Kindly send me the items checked postpaid.

Consrad Patterns—50c each

-No. 2. How to Make a Two-Stage Amplifier.
-No. 4. How to Make a Reinartz Receiver.
-No. 5. How to Make a Reflex Receiver.
-No. 6. How to Make a Cockaday Receiver.
-No. 7. How to Make a Neutrodyne Receiver.
-No. 8. How to Make the Autoplex Receiver.
-No. 9. How to Make the S. T. 100 Receiver.
-No. 10. How to Make the Ultradyne Receiver.
-No. 11. How to Make a Five Tube Cockaday Receiver.
-No. 12. How to Make a Portable Receiver.
-No. 13. How to Make a Harkness Receiver.
-No. 14. How to Make the Original Genuine Super-Heterodyne. List \$1.00.
-No. 15. How to Make a Low Loss Receiver.
-No. 16. How to Make a Tropadyne Superadio.
-A. Radio Map of the U. S. on Cloth.
-B. 20 Radio Diagrams and Hook-ups. New Edition.
-C. All About Aerials and Their Construction.
-D. Radio Amateurs Practical Design Data.

Radio Books—25c each

-No. 1. Tips for the Radio Constructor.
-No. 2. How to Make Practical Radio Receivers.
-No. 3. Radio Questions Answered.
-No. 4. Radio Frequency Amplification.
-No. 5. Loud Talkers and How to Build Them.
-No. 6. How to Tune Your Radio Set.
-No. 7. One Hundred Radio Hook-ups. New Edition.
-No. 8. All About Radio Parts.
-No. 9. History and Operations of Vacuum Tubes.
-No. 10. The Neutrodyne and All About It.
-No. 11. How Radio is Received.
-No. 12. How to Locate Troubles in Your Radio Set.
-No. 13. Reflex Radio Receivers.
-No. 14. The Super-Heterodyne Theory and Construction.

Special Books

-Radio News Amateurs' Handbook.....\$1.00
-Radio Log Book......50
-Wireless Course in 20 Lessons—Leather Binding 2.00
-The Radio Instructor..... 1.00
-The Radio Listeners' Guide & Call Book..... .35
-The Radio Review, 35c the copy.....\$3.50 the year

Name

Address

City State.....

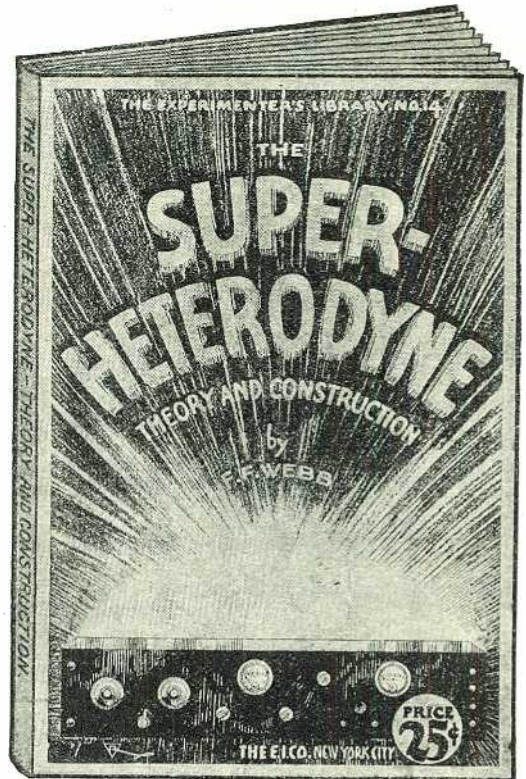

Here's the finest, most complete book of data and information ever compiled on the Standard Super-Heterodyne.

This is the big book of instruction and information on the various standard "supers" in common use today; a complete, up-to-the-minute, impartial 64-page book covering all the builder or user of this type of set might want to know. The Super-Heterodyne is written by a radio authority who not only has years of trade and practical experience but is constantly designing modern radio apparatus. It is a handy useful size, 5½ x 7½ inches, printed clearly, profusely illustrated, easy to read and bound with a handsome two color cover.

This is the very latest of the complete library of Experimenters Handbooks on radio, a list of which is printed on this page. These books are complete practical guides to almost every important phase of radio transmission and reception.

The famous Consrad patterns are also listed on this coupon for your convenience. They are radio's finest patterns for the building of the most successful standard receivers.

You can get any of these books or patterns at your radio or news dealer or direct from us by using the coupon attached to this page.

The CONSRAD COMPANY

Sole distributors to the E. I. COMPANY
233 Fulton St. New York, N. Y.

L_1, L_2, L_3 and L_4 represent lenses. M and N , mirrors, D_1 and D_2 , screens provided with narrow slits, F_1 and F_2 .

For the requirements of the International Time Bureau which must compare the movements of six pendulums by means of hourly telegraphic signals transmitted by the Eiffel Tower station and by stations at Lyon, Bordeaux, Saigon and Annopolis, U. S., etc., it is necessary to dispose the amplifying apparatus in such a manner that it is possible to record the illuminations due to the oscillations of the pendulum and to listen by telephone to the tick produced by the currents generated by these same rays of light. By this means it is possible to use the method of coincidence of these ticks when it becomes necessary (Fig. 7). This arrangement presented no serious difficulty and the system was put into regular use at the end of January, 1925. Measures are being taken to verify, with a high degree of precision, the isochronism of the successive illuminations due to the pendulum.

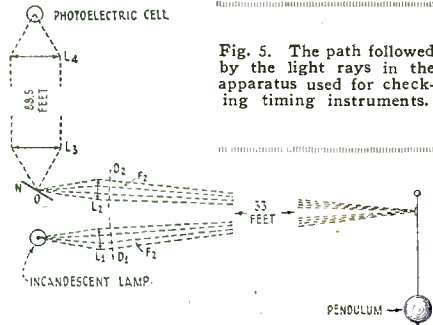

Fig. 5. The path followed by the light rays in the apparatus used for checking timing instruments.

All the timing instruments of the International Time Bureau will be provided with optical recording devices such as that just described. Although the pendulums of these time-pieces sustain only the extremely small force of the spring maintaining the vibrating clock movement, it is certain that this force cannot be rigorously constant, and is the cause of little irregularities in the period of oscillations. We have therefore developed a pendulum in which the clock movement is eliminated and which consists simply of a pendulum on the rod of which is fixed a small mirror designed to train a small ray on the photo-electric cell. The current of this latter after amplification actuates an electromagnet which maintains the pendulum in vibration. The oscillations of the pendulum are therefore maintained without any material contact other than at its point of suspension.

In the case of the geodetic pendulum for the measurement of the gravitational constant, the amplified photo-electric current, which serves to record the oscillations of the pendulum, can be employed at the same time to actuate a small electric pendulum which serves to count the number of oscillations, as in the preceding device.

The astronomer, determining the time by means of a meridian telescope, observes the instant when a particular star passes the cross-hair of his telescope, and at each such instant closing an electric contact with his hand would send the current through the recording instrument (chronograph) on which, at the same time, the oscillations of the clock pendulum are recorded. There is evidently an interval between the instant when the star passes the cross hairs and the instant when the record is made on the chronograph. In addition, this interval is variable. This, then, is a source of serious error.

We have tried to record, by the action of the light of the star itself on a potassium cell, the instant when the star is eclipsed by the cross-hairs of the telescope. Interesting results have already been obtained with

Results and Prices never before achieved. —

SENSATIONAL NEW MODELS BY

RICHARDSON

Reg. U.S. Pat. Office

\$38.50 to \$150.00

The Richardson Console



A beautiful mahogany console, artistically and unostentatiously constructed, that will enhance the appearance of any room.

\$75 with the 3-dial, 5-tube tuned radio frequency set.

\$95 with the 2-dial binocular coils, 5-tube tuned radio frequency set.

\$150 with the 7-tube, 2-dial control, binocular coils, 3 stages of tuned radio frequency, detector, 3 stages of audio frequency amplification and self-contained loop set.

(Neutralized by Boyd Phelps method)

The Richardson Imperial

\$75 with the 2-dial control, binocular coils, 5-tube tuned radio frequency set.

\$125 with the 7-tube, 2-dial control, binocular coils, 3 stages of tuned radio frequency, detector, 3 stages of audio frequency amplification and self-contained loop set.

(Neutralized by Boyd Phelps method)

The Richardson Sophomore — a year ahead

\$38.50 A 5-tube, tuned radio frequency set with 3-dial control, rigidly constructed and wired with the famous Richardson "Can't go wrong" wiring system.



Two-tone mahogany cabinet with sloping panel and enclosing loop for set.



Sloping panel cabinet, mahogany finish, shows same care and result of skill applied to all Richardson products.

RICHARDSON RADIO INCORPORATED

LOS ANGELES PHILADELPHIA CLEVELAND CHICAGO BUFFALO
Executive Office and Factory—128 University Place, New York City, N. Y.

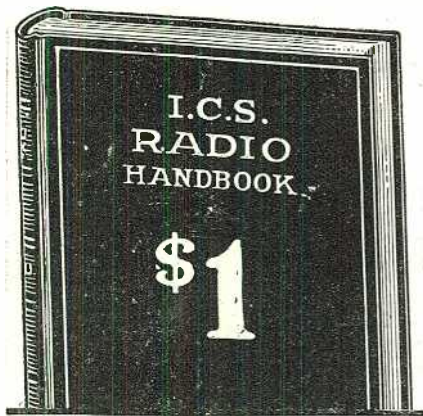

Every Radio Fan Should Have This Book

Price Only



514 pages. Pocket Size

Compiled by HARRY F. DART E.E.

Formerly with the Western Electric Co., and U.S. Army Instructor of Radio.

Technically edited by F. H. DOANE

LIKE a little radio encyclopedia, this I.C.S. Radio Handbook is packed with concise, sound information useful to everybody — from beginner to veteran hard-boiled owl. It starts with simple explanations of radio phenomena and leads you along gently until you can understand the most technical diagram.

You may dip into it at random, or hunt up special information you want, or read it right through. Different types of receiving and sending hook-ups are explained; electrical terms and circuits; antennas; batteries; generators and motors; electron tubes, etc.

Just mail the coupon with a dollar bill and your name and address, and we will send you this 514-page I. C. S. Radio Handbook by return mail. Note the other good books listed below and the low prices.

INTERNATIONAL CORRESPONDENCE SCHOOLS

Box 8282-F, Scranton, Penna.
I enclose \$..... for which send me, post-paid, the Handbooks marked X, at \$1 each. It is understood that if I am not entirely satisfied I may return them within five days and you will refund my money.

- RADIO HANDBOOK, 514 PAGES, \$1
- Automobile Handbook, 354 pages - \$1
- Electrical Handbook, 414 pages - \$1
- Chemistry Handbook, 348 pages - \$1
- Pharmacy Handbook, 324 pages - \$1
- Traffic Man's Handbook, 336 pages - \$1
- Building Trades Handbook, 409 pages - \$1
- Machine Shop Handbook, 335 pages - \$1
- Salesman's Handbook, 352 pages - \$1
- Advertising Handbook, 445 pages - \$1
- Bookkeeper's Handbook, 302 pages - \$1
- Civil Engineer's Handbook, 411 pages - \$1
- Steam Engineer's Handbook, 298 pages - \$1

Name.....

Address.....

Get Boice Prices Before You Buy!

Buy Now Pay Later
As the World's largest builders of small Bench Machines, Boice offers greater values at lower prices with a positive money-back guarantee. Whatever you build, there's a Boice-Crane Bench Machine to do your work: Circular Saws, Band Saws, Lathes, Jointers and Drills.



Write for literature, prices and the Boice E-Z Pay Plan before you buy.
W. B. & J. E. Boice, Dept. 810A Toledo, O.

To the Radio Dealer

Let us explain how you can make the sale of our publications a worth while, well paying part of your business. Write now and prepare for the Fall and Winter trade.
EXPERIMENTER PUBLISHING CO.
53 Park Place : : New York City

brilliant stars (Vega) with a telescope of 28 centimeters diameter. The deflection of the recording instrument due to the passage of the stars has an amplitude in the neighborhood of a centimeter. It is to be hoped that the new devices under construction which are provided with more amplifiers and better electrical insulation will give equally good records with stars less brilliant than Vega.

Radio In Germany

(Continued from page 413)

Nauen and Königswusterhausen have expressed their appreciation at the quality of the equipment and the smooth working of the organization.

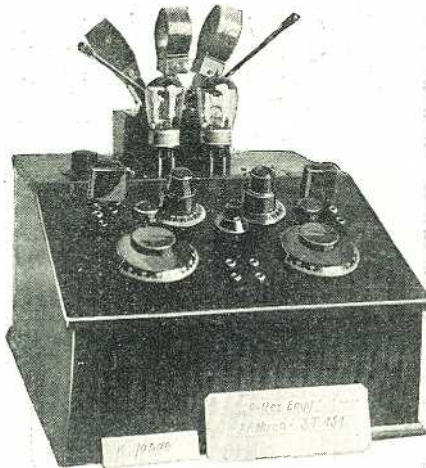

Fig. 3. A two-tube reflex that attracted great attention.

It has been the special endeavor of the management of the Berliner Messe Amt to make the exhibition in every respect a live affair, full of practical demonstrations—the whole process of broadcasting is shown in all details from the studio of the broadcast station to the home listener or the loud speaker in a big hall.

MORE RADIO SHOWER PRIZES

The D. X. Instrument Company, whose invitation to participate in the Radio News Shower Party was unfortunately miscarried in the mail, announces at this time a contribution of twenty-four prizes to the Shower Party. These prizes, which will be distributed among the twelve zones, are twelve Fil-ko variable grid leaks and twelve Fil-ko resistors.

Radio Stereophony

(Continued from page 416)

LAWS OF ACOUSTICS

The physical laws of acoustics were investigated some time ago. We will give a very brief explanation and draw an example from wireless compass technique. To determine the position of a ship on the ocean, wireless may be used. From two different points, A and B, we determine the angle between AB and BX and between AB and AX. In this way, a triangle is formed of which two angles and the included side are known so the other two sides and the altitude of the triangle may be computed very easily with the aid of trigonometry. Another example: In order to measure the distance of an inaccessible point, we have to measure the angle of sight between the

DUPLIX CONDENSERS



DUPLIX STANDARD

"None better made." Conforms to Bureau of Standards specifications for lowest losses. Automatic bearing take-up and rugged construction assure permanent alignment. All capacities—plain, vernier. Fully guaranteed.

Duplex Matched Condensers Afford Uniform Dial Settings

Always Read Alike Only One Number to Log

Or eliminate logging — Dial by call letters or wave lengths. Specially tested and guaranteed. Matched, packed and sealed, to remain unopened until used.

Literature on request
DUPLIX CONDENSER & RADIO CORP.
52 Flatbush Ave. Extension, Brooklyn, N.Y.

Lack some of the refinements of the Duplex Standard but are "best at the price." Ideal for portable sets. All capacities—plain and vernier.

DUPLIX JUNIOR

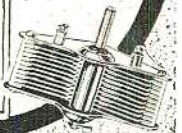

WRITTEN 2-YEAR GUARANTEE

Battery Prices SMASHED!

To Consumers Only
Here is a real battery quality, guaranteed to you at prices that will astound the entire battery-buying public. Order Direct From Factory. Put the Dealer's Profit in your own pocket. You actually save much more than half, and so that you can be convinced of true quality and performance, we give a **Written 2-Year Guarantee**. Here is your protection! No need to take a chance. Our battery is right—and the price is lowest ever made. Convince yourself. Read the prices!

Auto Batteries	Radio Batteries
6 Volt, 11 Plate, \$9.50	6 Volt, 100 Amp, \$9.50
6 Volt, 13 Plate, 11.50	6 Volt, 120 Amp, 11.50
12 Volt, 7 Plate, 13.00	6 Volt, 140 Amp, 13.00

Buy Direct—Send No Money
We ask no deposit. Simply send name and address and style wanted. Battery will be shipped same day we receive your order Express C.O.D. subject to your examination on arrival. Our guarantee accompanies each battery. We allow 5% discount for cash in full with order. You cannot lose! Send your order today—NOW!

ARROW BATTERY CO.
Dept. 6 1215 So. Wabash Ave., Chicago

DEALERS!

Complete stock of nationally known parts and accessories. Send for illustrated catalog and discount sheet.
Radio Exclusively Since 1921
CLARK & TILSON, Inc.
552 Seventh Ave. : : New York
The Nationally Known House

Insure your copy reaching you each month. Subscribe to RADIO NEWS—\$2.50 a year. Experimenter Publishing Co., 53 Park Pl., N.Y.C.

point in question and two different points, the distance between which is known; *i. e.*, we construct a triangle similar to that referred to above, by means of which we can compute the unknown distance. Now we can imagine that every observation we make with our two eyes represents such a series of measurements. Each eye receives a certain picture and automatically determines the angle its axis has to be turned to look at a certain point. Then, a busy slide rule in our brains quickly computes the distance to that point by the aid of the triangle whose base is the line between the two eyes and whose vertex is at the point under observation. This computation never comes into consciousness; we are only aware of the final result: plastic seeing, *i. e.*, we have an idea of depth in space, because we determine the distances by intuition, that is, we feel the perspective.

Our ears determine distances and directions in a similar way, but here three different phenomena are at work to form the impression of "plastic" hearing in the brain. First, there is an extremely small interval of time between the instance when the two ears receive the sound waves. For instance, if the sound comes directly from the left side, the left ear will receive it earlier than the right one, the right ear receiving the sound as much later as the sound requires to travel from the left to the right ear, a distance of approximately eight inches. That is, the velocity of sound is 1,090 feet per second. This time interval will be .66 foot (8 inches) divided by 1,090, or .0006 of a second. This difference in time represents the maximum and decreases if the source of the sound approaches a position directly in front of us. In this position, the distance of the source is the same from both ears. As a matter of fact, in order to locate the origin of a sound, we always turn the head into such a position that both ears are equally distant from the source.

Sound travels in waves, the length of which depends upon the pitch of the tone. Suppose we have a source of sound on the left side, then the left ear at some instant might receive a wave at its maximum amplitude while the right ear, being eight inches more remote, might receive it at its minimum amplitude. This difference of phase offers a new method to the ear for determining distance and location of the source of sound, and since no sound, no tone, is of constant intensity, one ear will feel differences in intensity compared with the other ear, thus enabling the brain to get the impression of plastic hearing.

The photographic camera can be considered as a crudely constructed human eye. If we take a picture using two similar "eyes" of this simple model placed at a distance from each other corresponding to the distance of the human eyes, we get a stereoscopic picture. That is to say, we see a plastic or depth-effect in the picture because the camera "saw" the object under the same circumstances as the human eye would have seen it.

The microphone corresponds to the human ear. Suppose we placed two microphones in front of a sound-producer and at distances from each other corresponding to the distance between the human ears. Receivers connected to this system of microphone will give a "plastic" impression. This procedure is called Stereophony. In theory, it would therefore be best to place two distinct microphones at the proper distance from each other and at considerable distance away from the stage above the orchestra seats. This, of course, would be very inconvenient and the sound would necessarily need amplification at the receiving end, because one would be obliged to dampen the microphone in order to avoid an interfering echo.

INSTALLATION AT THE OPERA HOUSE

So they placed the following installation

MOZART GRAND

The Manufacturers of *Fine Instruments* Co.

255-49 Elizabeth Ave., Newark, N.J., U.S.A.



**Mozart
Upright
Speakers**

9 inch . . .	\$6.00
10 inch . . .	9.00
12 inch . . .	12.00
14 inch . . .	15.00



**Baby Grand
Loud Speaker**

Complete with
Unit A
\$9.00

Complete with
Unit B
\$12.00

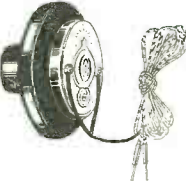

**Phonograph
Loud Speaker
Unit**

Type A . . .	\$4.00
Type B . . .	6.00



**Mozart Radioceive
Superior Headset**

Price \$5.00

ITS extraordinary reproducing qualities, its low center of gravity with resultant steadiness, its general beauty of outline, and, the fact that it will harmonize perfectly with any furnishings from the simplest to the most pretentious, have maintained for it a worthy place amongst all that is superlative in Radio necessities today.

Our Baby Grand "Appreciation" folder cheerfully mailed on request.

Miller AMPLIFYING HORNS 41 Different Models

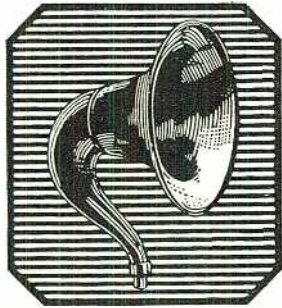

The Proof of Quality and Service

Miller Amplifying Horns carry the seal of approval of this country's largest and finest radio manufacturers. These concerns use Miller Horns as standard equipment. Surely this fact is sufficient proof of Miller superiority.

No radio company that has built up a nation-wide reputation for making a product of high quality would risk that reputation by equipping their product with anything but the best. Such companies use Miller Horns and depend upon Miller to make deliveries according to their requirements. They know that our vast experience and tremendous production facilities have made it possible for us to offer amplifying horns of highest quality, at a competitive price. Write us today for complete information.

The Miller Rubber Co.
Akron of N. Y. Ohio

RADIO CATALOG

New 1925-26 Edition.
Contains nationally advertised high quality Sets, Kits and parts.

Western Radio Co. MFG
134-136 W. Lake St. Chicago, Ill.

EVERYTHING IN RADIO
AT ATTRACTIVE PRICES
SETS OR PARTS
Mail order only
ALL RADIO COMPANY, 417 North Clark St., Chicago

in the Berlin Opera House: At the edge of the stage six microphones are placed as A, A₁, B, B₁, C, C₁. Three of these A, B and C are connected to one pair of wires and A₁, B₁, C₁ to another pair. From each pair of wires there is a cable leading to the receiver, where one supplies the receiver on the left, the other the receiver on the right ear. From each set there is a cable leading to the subscriber, each receiver of the headphone being connected to a separate cable.

Whoever has an opportunity to hear this stereophonic transmission is surprised by the effect. The sound seems much fuller and sharper in every detail. The different voices of a chorus become notably more distinguishable from each other and from the orchestra. The simple method of transmission can never produce these effects, just as a photo can never reproduce the perspective of a landscape.

DIFFICULTIES

However, we cannot overlook the difficulties of the stereophonic transmission. It is impossible to furnish every hearer with two separate cables going into his home. Such increase of wires would become an unbearable burden on the telephone system of a big city like Berlin. We see, however, that there is a possibility of improving the radio service of today by using stereophonic transmission. The transmission is certainly possible. There could be two microphones in the broadcast studio instead of one, connected to two distinct transmitters which broadcast the performance stereophonically on two different wave-lengths. In the receiver, each phone of the head-set could be connected to a distinct receiving system tuned to the two stereophonic transmitters. It is needless to say that this arrangement gives rise to numerous difficulties and makes reception considerably more expensive than does the simple method. The difficulties are apparently not insurmountable. The Berlin broadcast station has already transmitted stereophonically on waves of 430 and 505 meters.

In the United States this system of transmitting has been tried with fair results at Yale University in New Haven, Conn. Two transmitters of about 20 watts power were employed to broadcast stereophonically, the wave-lengths being about one hundred meters apart.

This subject of stereophonic broadcasting is referred to on page 233 of the March, 1924, issue of the *Journal of the A.I.E.E.*, a particularly pertinent paragraph of which is quoted below:

"In picking up material for broadcasting, that is, in getting the sound energy into electrical energy, the general requirement would seem to be to get to the high quality microphone the sounds in the form in which a skilled listener would wish to hear them if he were free to choose his location with respect to the source of these sounds. In this respect, the skilled listener would be largely governed by hearing the sounds under the accustomed conditions with all undesirable noises, echoes and abnormal reverberations removed. In considering the pick-up of material for broadcasting it should be noted, however, that it corresponds to listening with one ear, that is, the binaural sense of direction, which is normally obtained in hearing the sounds directly, is lacking. With binaural audition, it is possible to concentrate on one sound source and to disregard somewhat the effect of other sounds coming from different directions or distances. Because of the monaural character of broadcasting it is necessary, therefore, to go even further in reducing noises and reverberation at the transmitter than would be the case for an observer using two ears at the same location."—*Funk*.

YAXLEY

The New
YAXLEY
Panel Light
50¢
Bulb Extra

At your dealer's. If he cannot supply you send his name with your order to
YAXLEY MFG. CO.,
Dept. N, 217 No. Desplaines St., Chicago

Stop Trying to Wind Your Coils on Your Finger Tips—
IT CAN'T BE DONE!

WIZARD WIRE WINDER

Automatic Adjustable Feeder. Simple to Operate. Assures Absolute Accuracy in Winding and Spacing. A new economical device that saves time and money. The winder can be fed and ready to operate in a few seconds.

The WIZARD WIRE WINDER, a light, durable and well-finished device, nicked throughout, has regulations which will insure the proper handling of all thicknesses of wire and does away with the most difficult of all tasks connected with the building of radio receiving sets. It winds the largest coil required in thirty seconds. An automatic wire feeder makes the device mechanically perfect and renders it impossible to make a rough or uneven coil. The winder is adjustable to any size coil from three-eighths inch to four and one-half inches in diameter. PRICE \$9.50.

Subject to money back guarantee.
DEALERS INVESTIGATE
WIZARD WIRE WINDER CO.
3812 Central Ave., Los Angeles, Cal.

PATENTS WRITE for our Four Guide Books and "REC. ORD OF INVENTION BLANK" before disclosing inventions. Send model or sketch and description of your invention for our INSPECTION and INSTRUCTIONS FREE. TERMS REASONABLE. Electrical and Radio Cases a specialty.

VICTOR J. EVANS & CO.
919 NINTH ST., WASHINGTON, D. C.

Insure your copy reaching you each month. Subscribe to RADIO NEWS — \$2.50 a year. Experimenter Publishing Co., 53 Park Pl., N. Y. C.

The Balanced Interflex Circuit

(Continued from page 442)

any other control whatsoever. The 'phone jack for head-phones is at the left, while the jack for loud speaker is at the right. When through using the set, the listener pulls out the plug, which automatically disconnects all the vacuum tubes. There is no switch on this receiver.

OPERATION OF THE SET AND SPECIAL INSTRUCTIONS

This is a world in which you cannot hope to get anything for nothing. By this I mean that when you have reduced the usual six or seven controls in your set to a single one and still expect to get exactly the same results, if not better, than with the old controls, you must of necessity compensate for this. **AND IT IS IN THE FULL COMPENSATION OF THIS SET THAT ITS SUCCESS LIES.** As I mentioned in the Interflex Four, described last month, I recommended the Carborundum detector because to me it seemed most stable of many tried. I recommend to the builder of this set that he try this detector as well as several others. As a matter of fact, it becomes necessary to have several fixed detectors, because it will be found that not all of them are suitable for this set. Not every detector will work, and I have found that the detector that is too sensitive will make the set howl and squeal, which is exactly what it is not supposed to do, and does not do if the detector is well chosen.

You will understand, of course, that the "B" battery minus goes to plus "A." This saves one binding post in the set when you connect it.

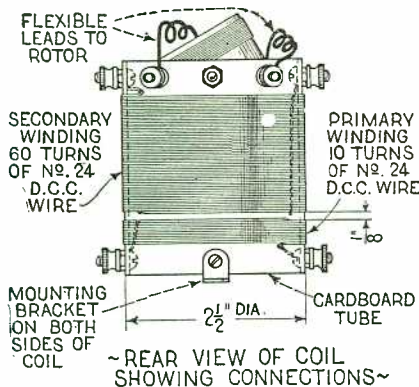

Fig. 3. This shows the constructional details of the variocoupler, which can be made readily by any experimenter.

As will be seen, no rheostats are used in the set. These are supplanted by automatic resistances or Amperites, which work very nicely. If the set is completely wired as per instructions, and if the correct materials have been used, we are now ready to tune the set.

It will be found that on locals the set, if the connections are right, will work immediately, although it may squeal and howl. It now becomes necessary to adjust the tickler controls. **THE WHOLE SECRET OF THE SET LIES RIGHT IN THESE TICKLER CONTROLS.** As I said before, in a world in which you cannot hope to get anything for nothing, it will be found that a little work must be put in to adjust these two coils in proper relation. Proceed as follows:

Tune in the lowest possible station, say around 210 or 220 meters. Adjust your tickler controls in such a way that the station comes in loudly without squealing. By turning both tickler controls **VERY** slowly you will find a point which is just below the oscillation. That is the correct point.

Logged 204 stations with the Harkness Counterflex!

USING a two-foot loop as antenna, Mr. E. F. Cassel of Washington, D. C., reports the reception of 204 stations with the 3-tube Harkness Counterflex. He writes:—

"My log shows 204 stations, approximately one-third of them on the loudspeaker and I am not a DX chaser. The stations include everything from Denver east and from Montreal south. Most of the log has been received from eight to ten in the evening when the locals were on. . . . I have a number of friends with super-heterodynes and multi-tube sets but I know of no set in this town that has been giving the consistent satisfactory reception of mine."

The Counterflex Circuit was developed by Kenneth Harkness, whose knock-out Reflex was the sensation of 1924.

The remarkable results obtained with this set are due to a novel principle which enables tremendous amplification to be secured and eliminates the squeals of self-oscillation.

After experimenting with the Counterflex for more than a year, Mr. Harkness has now written a booklet giving a thorough explanation of its fundamental principles and a complete description of different models of Counterflex receivers. We will send you a **FREE COPY** of this booklet on request. Just mail the coupon below, enclosing 10 cents to cover postage and cost of mailing.

KENNETH HARKNESS RADIO CORPORATION
Dept. A2, Newark, N. J.



With this complete kit of genuine Harkness parts you can assemble the 3-tube Counterflex in just a few moments—with only a screwdriver. A series of special step-by-step diagrams shows how to wire the set. It is not necessary to understand or follow the usual type of circuit diagram.

COMPLETE 3-TUBE KIT . . . \$36.00

GENUINE HARKNESS RADIO PRODUCTS

Mail this coupon for **FREE BOOK** now!

KENNETH HARKNESS RADIO CORP.
Dept. A-2, 727-739 Frelinghuysen Ave.,
Newark, N. J.

Please send my free copy of your booklet explaining the new Harkness Counterflex Circuit. I enclose 10c. (coin or stamps) to cover cost of mailing.

Name

Address

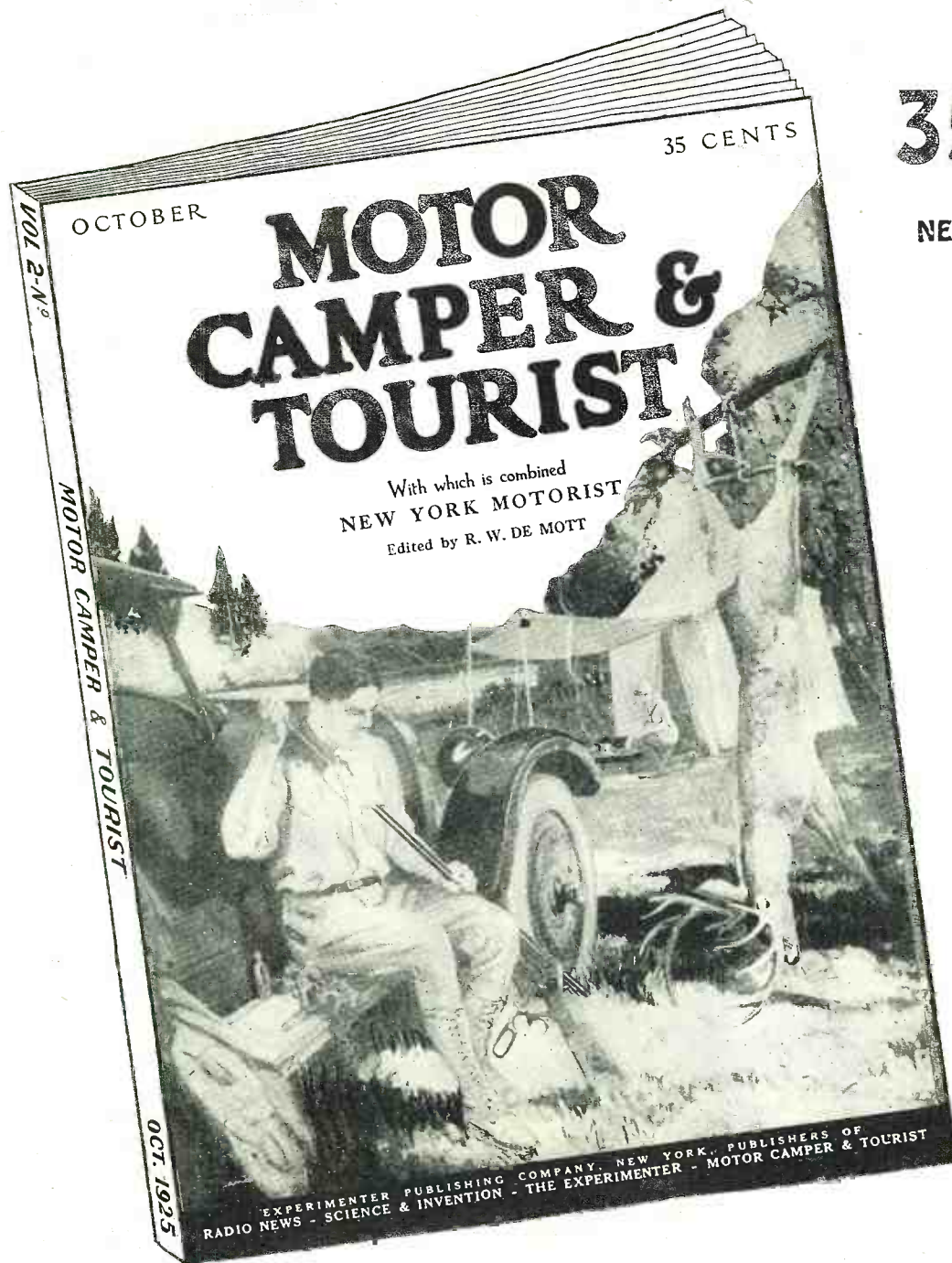

35 Cents
ON ALL
NEWSSTANDS

Now Bigger and Better than ever— COMBINED WITH THE NEW YORK MOTORIST

MOTOR CAMPER & TOURIST, the only national magazine for the man on tour, has acquired the NEW YORK MOTORIST and combined it with MOTOR CAMPER & TOURIST.

The number of pages of interesting reading matter and beautiful pictures has been greatly increased and many attractive improvements have been added.

The art work is the finest that can be obtained and the entire magazine is printed in colors.

New departments have also been added, together with a larger and more varied number of articles on camping and touring.

MOTOR CAMPER & TOURIST is a bigger and better magazine in every way. A helpful, interesting and essential magazine for every motorist. Buy your copy today, it is a complete guide for every tourist.

GERMOTT PUBLISHING CO., Owners

Licensed Publishers—EXPERIMENTER PUBLISHING COMPANY, Inc., 53 Park Place, New York, N.Y.

It will be found that, as you turn the condenser tuning control, the stations will snap in with a startling loudness without being accompanied by any squealing or howling throughout the entire range of 200 to 545 meters. If there should be howling or squealing at any of the higher stations, the ticklers are not adjusted correctly. It may be necessary to turn one tickler all the way around and try working it back the other way. Sounds should come in not only loudly but without distortion of any kind. *If distortion exists, the ticklers are incorrectly adjusted.*

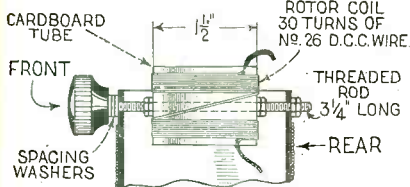

~ CROSS SECTION OF COIL SHOWING ROTOR CONSTRUCTION ~

Fig. 4. Constructional details of the adjustable described in the article which can be readily made by any constructor.

It will take you a little while to become familiar with this adjustment, but once you "get the hang of it," you will be astonished at the power and selectivity of the set.

If, despite everything, the set still howls, then the trouble lies in the coupling between the two condensers. In other words, the condensers do not balance the inductances. In that case the condenser sleeve, as shown in Fig. 5, should be loosened and one of the rotors of one of the condensers advanced or retarded $\frac{1}{8}$ of an inch more or less. This can best be determined by experiment. In the set which we see illustrated here it was found that for best operation the outside rotor was almost $\frac{1}{8}$ of an inch out of step with its mate. With a little experimenting you can find the correct point, after which the sleeve may be tightened. This should stop all squealing, and the set may now be said to be perfectly balanced.

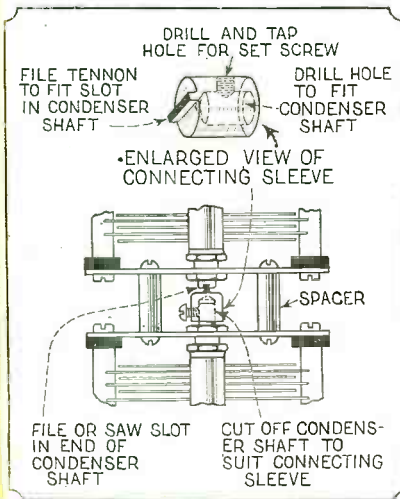

Fig. 5. Full instructions on how to link the two tuning condensers described in this article. Note particularly instructions in the article.

There may be other reasons for squealing and before attempting to adjust the condensers, please bear the following important considerations in mind: No two tubes are alike. It will be found necessary in most cases to switch around the four tubes; this often remedies the trouble. Also, as stated before, the fixed crystal detector may be at fault. A detector that is too sensitive causes howls. You will also notice that as you insert a new detector into its holding brackets, you have to retune the set slightly.

Just Listen to It!

THE A-C DAYTON asks but one thing—a chance to prove its performance ability in actual test! Just listen to it—compare it with any other set on the market under equal conditions—and buy as your ears tell you!

The A-C DAYTON has always sold on performance and performance alone—for it is a receiver that makes its own claims. Ask your local dealer for a demonstration in your own home—or write direct.

THE A-C ELECTRICAL MFG. COMPANY
Dayton, Ohio

Makers of Electrical Devices for more than Twenty Years.

The A-C DAYTON is a five tube receiver based on the tuned radio frequency circuit, refined and developed by our own engineers. But one circuit is included in the entire line, this circuit representing the utmost in radio engineering.

The Receiver is available in four models—the Standard Cabinet, as shown; the Glass Set—a cabinet model encased in heavy French plate glass; the Console—a model of entirely new console design; and the Phono-Set—for installation in practically any phonograph. All models have the convenient sloping panel with three tuning dials for absolute precision. The standard cabinet and console models are both finished in two-toned mahogany with hand rubbed finish.

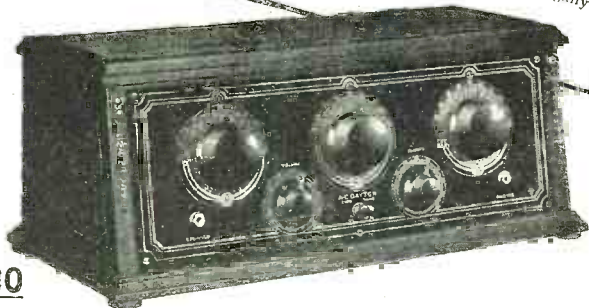

\$115.00

(\$120 west of Denver)

Based on a price of \$115.00 for the Standard Cabinet, A-C DAYTON prices represent the most that need be paid for complete radio enjoyment and the least that should be paid with certainty of quality throughout.



A-C DAYTON RADIO

"for the man who believes his own ears"

New!

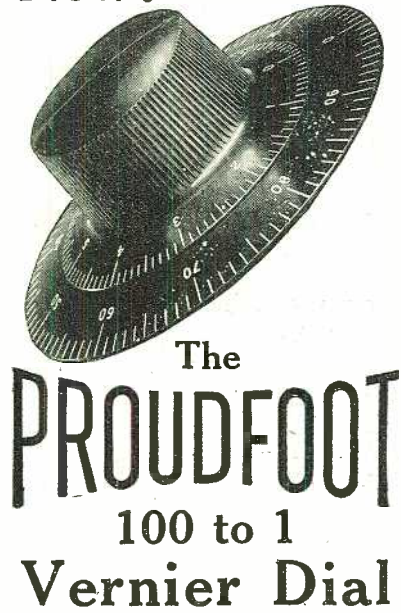

The PROUDFOOT 100 to 1 Vernier Dial

At last, a 100 to 1, 4 in. genuine bakelite vernier dial that matches up with all standard dials on the market. Entire mechanism fitted into a small metal case in the knob. Nothing complicated about it, but extremely fine readings can be obtained.

The Proudfoot 100 to 1 Vernier Dial fits all condensers—both screw and locknut mounting types. Easily attached. See one at your dealers. If he cannot supply you, write us. Complete **\$3.00**

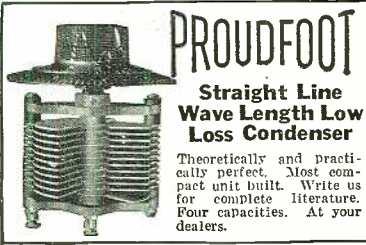

PROUDFOOT Straight Line Wave Length Low Loss Condenser

Theoretically and practically perfect. Most compact unit built. Write us for complete literature. Four capacities. At your dealers.

CRUVER MANUFACTURING CO.
2456 W. Jackson Blvd., Chicago, Ill.



\$3.25 (COP) **RADIO Storage "B" Battery**
Lasts Indefinitely—Pays for Itself

Economy and performance unheard of before. Recharged at a negligible cost. Approved and listed as Standard by leading Radio Authorities, including Pop. Radio Laboratories, Pop. Sci. Inst. Standards, Radio News Lab., Lefco, Inc., and other important institutions. Equipped with **Solid Rubber Case**, an insurance against acid and leakage. Extra heavy glass jars. Heavy, rugged plates. Order yours today!

SEND NO MONEY Just state number of batteries wanted and we will ship day order is received. Extra Offer: 4 batteries in series (96 volts), \$12.75. Pay expressman after examining batteries. 5 per cent discount for cash with order. Mail your order now!

WORLD BATTERY COMPANY
1219 So. Wabash Ave., Dept. 75 Chicago, Ill.
Makers of the Famous World Radio "A" Storage Battery
Prices: 6-volt, 100 Amp. \$11.25; 120 Amp. \$13.25; 140 Amp. \$14.00.
All equipped with Solid Rubber Case.

World STORAGE BATTERIES

Set your Radio Dials at 210 meters for the new 1000 watt World Storage Battery Station, WSBG, Chicago. Watch for announcements.

KDKA • WEAZ • WGN • WJS • KHJ • KGO • KFAF • WJY • KOP

Insure your copy reaching you each month. Subscribe to **RADIO NEWS** — \$2.50 a year. Experimenter Publishing Co., 53 Park Pl., N. Y. C.

The detector may work better if reversed. Try this and you will find that when it is operated in one position, reception is louder.

Of what good is the crystal detector? It gives an amplification factor of about 8 to 10. This may not be so apparent on locals, but if you short-circuit the detector on distant stations, you will find that the signals are in all cases practically killed. Besides, the detector in the grid circuit makes for great clarity of signals.

Another important point is the detector voltage. With the set shown here, the particular voltage for best results was 21. This means that you should use a tapped "B" battery on the detector side. Forty-five volts on this particular set practically killed all signals, except powerful local stations.

Try reversing aerial and ground. Very often this makes a big difference. If your aerial is 100 feet or longer, it is quite necessary to place a .00025 fixed condenser in series with the antenna.

The set may be said to work normally when, by turning the tuning control, the stations snap in with a loud clucking sound at their full power. *There should be no howl or squeal through the entire broadcast range.* When the set is finally adjusted and works at its best, it may be noticed that during the month it develops a squeal. This is a sure sign that the batteries are running down. With a new battery the ticklers may need a slight retuning. If new tubes are used or tubes are switched around, retuning of the ticklers is, of course, necessary.

- A complete list of materials for the Balanced Interflex:
- 2 Straight-line Frequency Condensers
 - 2 Variocouplers
 - 4 Amperites
 - 2 Audio Frequency Transformers, 3½ to 1
 - 4 Sockets
 - 1 Fixed Detector
 - 2 .005 Fixed Condensers
 - 1 Vernier Dial
 - 2 Automatic Filament Control Jacks
 - 1 Panel
 - 1 Baseboard
 - 6 Binding Posts

RESULTS

This particular set, on a 60-foot aerial, brings in KDKA at a dial setting of 50, and the volume is tremendous—stronger than some of the locals. This in midsummer, with lots of static prevailing and transmitting conditions notoriously poor. The locals, of course, come in with tremendous volume over the entire range. Distant stations that have been heard on a single evening are given in the list. This should by no means be considered a record, because receiving conditions in New York are poor. Besides, the log represents that of a sultry August night, with a great deal of static which made it impossible to get the calls of many more stations that otherwise could have been logged.

This receiver should be of particular appeal to those who wish the simplest possible control of a radio set.

The policy of **RADIO NEWS** is such that it is impossible to recommend certain parts that go into the making of any set. The writer will, however, be glad upon receipt of a stamped addressed envelope, to forward a list of the particular parts used in the set described here. The writer will also be glad to give his attention to correspondence from those readers who have constructed the Interflex-Four, or who wish to have further particulars about it.



The Aalco Loop

MARVELOUS NEW LOOP
Folds to any position—Wires always taut
GUARANTEED FOR LIFE!

The newest addition to the line of quality Radio Accessories. Made of the highest grade materials throughout in a new and masterly design. Specifications: Length, 24 inches, Normal Ht., 30 inches, Wavelength range 120 to 600 meters. The AALCO is different both in appearance and operation. You will find that this new loop adds to the performance of your set. If your Dealer cannot supply you send money order, and we will ship direct. LIST PRICE, \$15.00.

JOBBERS: Write for our proposition
AALCO RADIO LABORATORIES
6346 Cottage Grove Avenue CHICAGO

The Famous Truly Portable TELMACO P-1 Receiver
Four Tubes Do the Work of Seven

The peer of portables in size, weight, ease of tuning, selectivity, distance, volume, workmanship and price. Aerial, loud speaker and batteries self contained. Complete with tubes and batteries. **\$125.00** \$143.50. Receiver only

P-1 Kit Saves You Money!

Our offer of the Telmaco P-1 Receiver in kit form has met with enthusiastic reception. This contains all parts, as built by us, including case, drilled and engraved panel, and illustrated instructions. **\$80.00** Complete kit. Ask your dealer or write us. Descriptive folder free.

Radio Division:
Telephone Maintenance Co.
20 So. Wells St. Dept. B Chicago, Ill.

TELMACO
Quality Radio Exclusively • Established 1918

OWN A TYPEWRITER

\$3 and it's yours if you clip this now

The ace of writing machines—at a bargain price! A free trial, and easiest monthly payments if you buy! This Underwood No. 5—rebuilt from top to bottom—five-year-guaranteed—removes the last reason for not owning your own machine. Get our proposition with new and valuable Typewriting Manual, free.

FREE! Typewriting Manual, large catalog, and full particulars of free course in touch writing, if you mail this to SHIPMAN-WARD MFG. CO., 1937 Shipman Bldg., Chicago.

Name.....
Address.....

The Radio Hook at WRNY

(Continued from page 438)

ignorant of all this, goes on to the end; that is, if the announcer lets him. If the amateur is palpably bad, the announcer, who listens in to the din from the critics' room by means of his head-phones, politely informs the amateur that the critics would like to give someone else a chance. Immediately the next amateur goes on.

Why do the critics wear head-phones? Simply because if they had a loud speaker in the critics' room this loud speaker would talk into the microphone and the radio audience would hear nothing but a howl. Hence the head-phones are needed.

A patent is pending on this arrangement.

The Experimenter

has come back! If you are one of the one hundred thousand readers of the old ELECTRICAL EXPERIMENTER, you will no doubt be glad to hear that the EXPERIMENTER has come back BIGGER AND BETTER THAN EVER.

Experimental Radio

Nothing but experiments, written by the foremost radio authorities, also a monthly editorial by H. Gernsback. A fine roto-gravure section to brighten up the magazine. But best of all for you radio readers, is the big radio section of over twelve pages of some fifty radio experimental articles—and mind you, NOTHING BUT EXPERIMENTS.

INTERESTING ARTICLES TO APPEAR IN THE EXPERIMENTER FOR OCTOBER, 1925

- Thermit Fusions for Experimenters
By T. O'Connor Sloane, Ph.D.
- Audio Frequency Amplifying Transformers
By Theodore H. Nakken
- A Broadcast Type Microphone Remote Control
By A. P. Peck
- Meters and Their Use
By Leon L. Adelman
- Maps of Electricity on Airplanes
By H. T. Wilkins
- Electric Water Tank Heater

Hard Tubes and Soft Tubes

(Continued from page 435)

to the electron stream and the simultaneous reduction of the space charge by the positive ions—will together produce a most marked increase in the current passing through the tube.

These facts explain the extreme sensitiveness as detectors in wireless of tubes containing a certain amount of gas. If the grid potential is set so that the driving potential on the electron stream is just too small to produce ionization and the grid is then connected to an aerial any potential surge in the aerial, even if extremely small, will cause ionization to set in and the plate current will leap up to a value much higher than would be reached if a hard tube were connected to the same aerial.

INSTABILITY OF GAS TUBES

Practically, the trouble with these tubes has always been instability of the critical voltage point for the setting in of ionization. This point depends on the number of atoms present, that is on the pressure, and, if the gas is merely the residual gas from the evacuation of the tube, the pressure does not remain constant while the tube is in use. It follows from this that although a tube may display extraordinary sensitivity at a given moment it may slip off and be almost

The Season's Sensation

\$15.00

The KODEL MICROPHONE LOUD SPEAKER

Design Patented

THE KODEL MICROPHONE LOUD SPEAKER is an exact replica of the transmitting microphone used in broadcasting.

The efficient Kodol reproducing unit, with an ingenious new snail-shell horn, mounted inside the microphone case, produces a remarkably clear, full-toned volume. Non-vibrating tone chamber eliminates distortion.

The \$15 model incorporates the new Kodol, Jr. unit; with the large Kodol unit, \$20.

Radio dealers everywhere have them
THE KODEL RADIO CORP.
 501 E. Pearl St., Cincinnati, O.

To the Radio Dealer:

Let us explain how you can make the sale of our publications a worth while, well paying part of your business. Write now and prepare for the Fall and Winter trade.

The Experimenter Publishing Co.

53 Park Place, New York City

HOOK-UPS VIA RADIO



Get a Big "Circuitgram Book" and Receive the Latest Hook-Ups by Radio

The book contains five sets of blanks, called Skeleton "CIRCUITGRAMS." "CIRCUITGRAMS" are a patented novelty in Radio and Radio Broadcasting, covering several important uses.

"CIRCUITGRAMS" are the handiest things ever published for the man who makes his own hook-ups, the student, the radio engineer, and all those who wish to draw a hook-up or a circuit in a minimum of time.

The Skeleton "CIRCUITGRAM" blanks are of five different kinds: for one, two, three, five and nine tube Radio receiving sets. When making your own hook-up, all you need to do is to draw the connections between the symbols representing the different parts of the Radio set. With this book you can receive any hook-up being broadcast from different radio stations throughout the country. Every fan interested in new radio circuits should have one of these books on hand.

Price 25c

Our "CIRCUITGRAM" books are sold by All Radio and Newsdealers. If your dealer cannot supply you, send us 25c and we will mail you a book postpaid.

PUBLISHED BY THE EXPERIMENTER PUB. CO. N.Y.

EXPERIMENTER PUBLISHING COMPANY

53 Park Place - NEW YORK, N. Y.

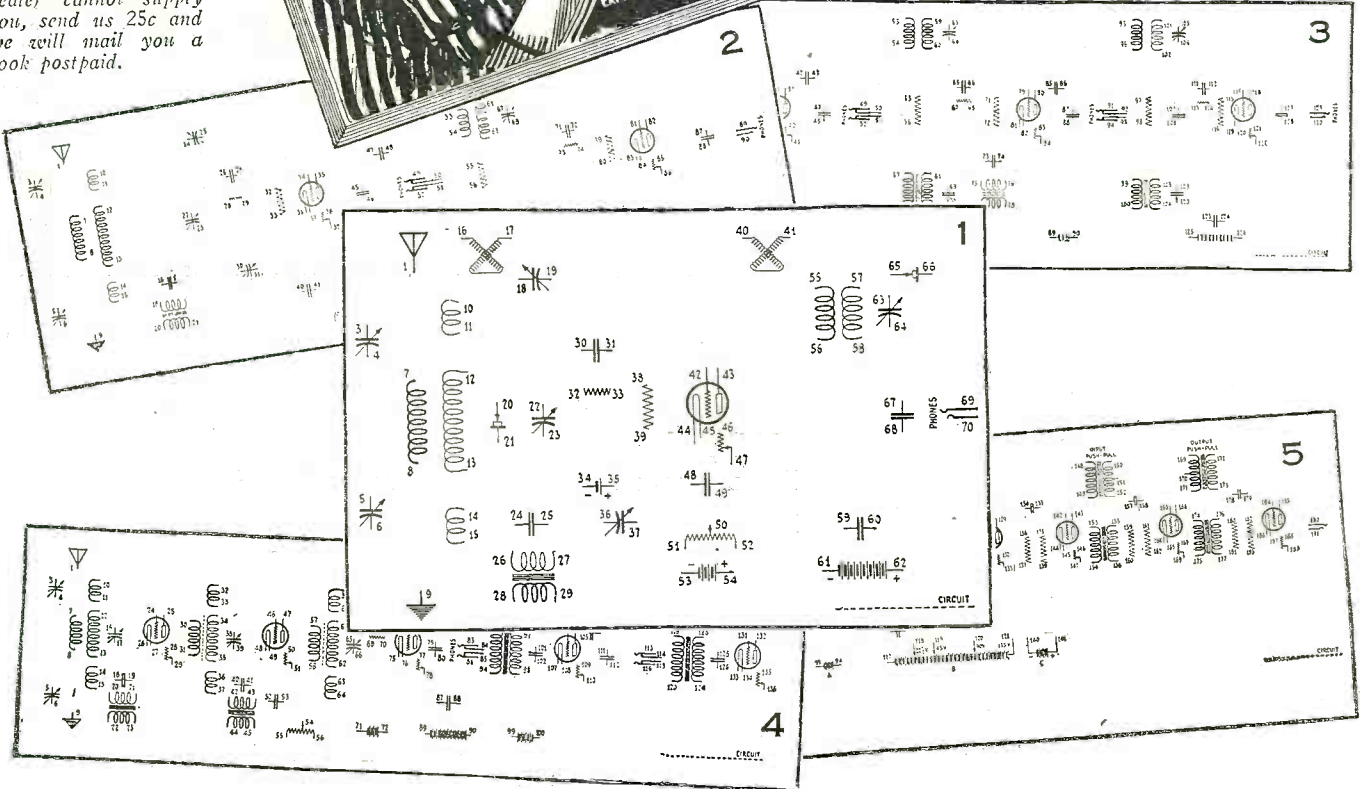

useless a few minutes later. Such tubes require continual adjustment and are, therefore, not practical.

METALLIC VAPOR TUBES

Various attempts have been made by inventors and by commercial corporations to attain stability by introducing special gases or vapors like argon gas or neon gas or sodium vapor. In these attempts the greatest success has been attained in the use of metallic vapors like that of sodium. The pressure of metal vapor, depending, as it does, on the temperature of the tube, can be maintained constant much more easily than can the pressure of a gas. This is in part due to the fact that gases are readily absorbed in the metal of the electrodes and on the walls of the glass tube, to be subsequently given out in an irregular fashion. Tubes employing metal vapors have shown a sensitivity equal to that of the best regenerative receivers—and yet, being incapable of oscillating over the range used, they cannot reradiate and thus produce interference with other receivers. They have also proven to be stable in operation. Such tubes, therefore, represent a step forward. Their somewhat peculiar properties can be explained by reference to the principles we have been discussing above. This matter we will take up in detail in our next article, in which several new and strange tubes will be described.

THE BLUE GLOW

Before closing this article it will be worth while to refer to another feature of gas tube operation—the “blue glow” or “haze” generally observable in them. This blue glow when examined with a spectroscope is found to be made up of the colors characteristic of the atoms which are being broken up by the electron projectiles. We have seen above that the space between the filament and the plate in these tubes contains many positive ions and many negative electrons, the former moving slowly, the latter moving rapidly. Whenever a pair of these oppositely charged particles approach closely enough they draw together and combine into a neutral atom. This act of combination will release energy, just as energy is released when a stretched spring contracts. This energy comes out of the atom in the form of light energy and, taken together from all the atoms, makes up the glow. When the tube contains mercury vapor, as is nearly always the case, the glow will be bluish but in the presence of other gases or vapors it may be pinkish or orange. Some of the most peculiar properties of gas tubes depend on the appearance of this glow, as we shall see more definitely in the succeeding article.

At Last—Individual Tube Ratings

(Continued from page 450)

find out about the tube at the time of making the purchase is whether or not the filament will light.

One manufacturer of tubes has realized the need for giving further information to the purchaser and so struck upon the novel idea of furnishing the characteristic of the individual tube in the sales carton with it.

In each box containing a tube sold by this manufacturer is inclosed a chart like the one in the photograph shown herewith. On this sheet is sketched, individually for each tube, its characteristic curve. There are also listed on the left-hand end of the sheet other quantities which are of importance in furnishing a complete rating. These quantities are the mutual conductance, the am-

new items of FROST-RADIO

Ask Your Neighborhood Dealer



\$3.00

\$3.50

Light Weight Type

FROST-RADIO

\$6.00

Genuine Bakelite Moulded Type



FROST-RADIO

No. 142—Single Fone Automatic Plug... 40c

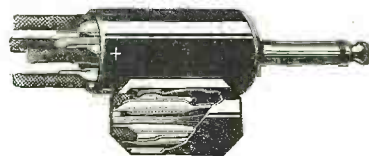

FROST-RADIO

No. 143—Double Fone Automatic Plug... 50c



FROST-RADIO

New Standard Jacks... 45c to 70c

SEE these new items of **FROST-RADIO** at the store of your neighborhood dealer. They represent high quality, plus excellent value. Notice especially the two new metal shell **FROST-FONES**, No. 174, 2,000 ohms, \$3.00, and No. 175, 3,000 ohms, at \$3.50. These new fones not only are extra-sensitive, but are extremely light in weight. The new Standard Jacks are of superb design and construction. Our Pan-Tab line of jacks has been reduced in price, the new list ranging from 65c to 90c. These remain the finest jacks on the market, regardless of price. **FROST-RADIO** Rheostats and Potentiometers now are equipped with the new Semi-Dial Knob—a marked improvement and an outstanding **FROST-RADIO** achievement in dial design.

48-Page Book of all **FROST-RADIO** Apparatus FREE!

If you wish a copy of our free catalog of all items we manufacture, write Dept. 10F510, at our Chicago address.



HERBERT H. FROST, Inc.

314-324 WEST SUPERIOR STREET, CHICAGO

NEW YORK CITY CLEVELAND KANSAS CITY LOS ANGELES

EXPORT OFFICE: 314 WEST SUPERIOR STREET, CHICAGO

AMBASSADOR
SOLID MAHOGANY SPEAKER



\$20

This is a real piece of furniture, being made in dark, rich mahogany with a Duco finish. The patented double reflex principle of sound is used, giving perfect reproduction of music and voice. A sensation.

Write for Free 4-Page Loud Speaker Folder
Consigned to Selected Dealers

AMBASSADOR SALES COMPANY
108 Greenwich St., New York
326 W. Madison St., Chicago

How to pass U.S. Govt. Radio Examination

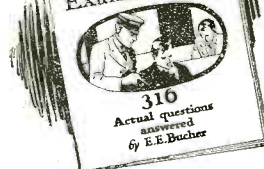

60c

For a short time only

RADIO INSTITUTE OF AMERICA
324 Broadway New York City

PASS the U. S. Government Commercial or Amateur Radio License examination! This book will help you do it! Send sixty cents in stamps or coin for your copy—postage prepaid in any point in the U. S., Canada or Mexico.

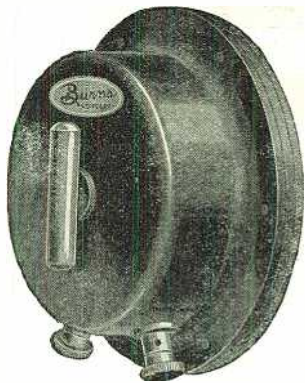

Burns LARGE CONCERT UNIT *The Heart of the Speaker*

Large size of this unit gives great range with tone of most pleasing quality which, combined with the amplifying properties of the Burns Horn, produces remarkable results.

Horn is of distinctive design with pyralin flare in several handsome finishes. It pleases the eye as well as the ear.



Made by
American Electric Company
CHICAGO, U. S. A.

plification constant and the plate resistance. It must be understood, of course, that each tube is put through its paces separately. The characteristic curve is measured and all the other data found separately for each individual tube. And the best part of it all is that the tubes measured in the Laboratories of RADIO NEWS were found to have values of these quantities in accordance with the values given by the manufacturer on these graphs furnished with the tubes. The tubes which were tested were selected at random from a batch of 100 furnished by the manufacturer.

ARE you interested in motoring, touring or camping? If you are, do not fail to read the October issue of

MOTOR CAMPER AND TOURIST

Here is a magazine that tells you things in connection with your car—things that you never even suspected.

Are you just running around the country or are you getting the full benefit of your car? MOTOR CAMPER & TOURIST shows you the way. On all newsstands.

CONTENTS FOR OCTOBER ISSUE

- Hunting with the Automobile. By Capt. Paul A. Curtis
- Why Motorists Like Wisconsin. By May L. Bauchle
- Springs in Missouri. By Mabel Henderson Malone
- What I Wear When Camping. By A. Pearl McPherson
- A Trip to the Berkshires. By Louise A. Haadin
- Hunting a Good Place to Camp on a Ninety-Day Ramble. By B. F. Clark
- The Bluenose Trail. By Lorraine Wallace Gould

The Behavior of Radio Waves

(Continued from page 411)

Some of these things have been brought out from time to time in RADIO NEWS in the forecasts of the future. These prophetic articles are extremely interesting to me and should be to all those who have imagination and are interested in the future of the world's youngest science.

And one point which should not be overlooked by the other sciences in the advance of radio is that before all the present enigmas are solved, there will be a wealth of material found in the exploration of radio that will throw no end of light upon problems now confronting the workers in other fields.

One of these which seems to be of great importance is in this same wave work which we have been describing. Before all is known concerning the nature of propagation of waves from an antenna, the physicist will find a great deal of data valuable to him in finally reaching a thorough explanation of the passage of currents over ordinary conductors, a problem which is by no means settled as yet.

Already radio has taught us a great many things concerning the electron, and it certainly will tell us much more as time goes on.

HOT DOG!

HOPE: So that radio friend of yours doesn't approve of your crystal set?

LESS: No, that DX hound even barks at the catwhisker!

Contributed by Moses M. Allen.

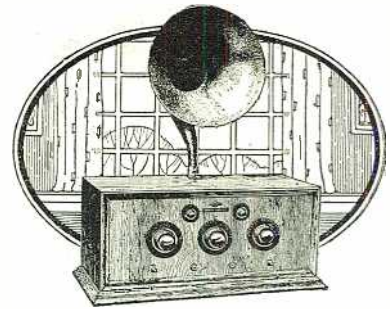

Hear the Murdock Neutrodyne

COMPARE the Murdock Five Tube Neutrodyne for the quality of its tone; for the beauty of its cabinet; and for its reasonable \$100. price!

There is space in the cabinet for the "B" batteries. The only accessories necessary are batteries and tubes. A "Murdock" set is backed by twenty years of successful experience in making radio apparatus.

\$100.

with built-in Loudspeaker

\$92.50 without

WM. J. MURDOCK CO.
Dept. A3, Washington Ave.
Chelsea, Mass.

MURDOCK NEUTRODYNE



The MOLLIFORMER "B" UNIT REPLACES "B" BATTERIES

SEND FOR complete description of this powerful "B" Unit that you can build in an hour at most reasonable cost. Uses the current from the light socket—Excellent for Supers and all TRF Sets—Assures greater Clarity—DX and Volume—Noiseless—No Tubes nor Acids—Utilizes full wave rectification. Guaranteed to Give Complete Satisfaction or Your Money Refunded

PRICE
Complete Kit—**\$22.50**
60 Cycle Unit.....
Complete Kit—**24.50**
25 Cycle Unit.....

Kits include Rectifiers
Parts sold separately if desired.
DEALERS—Write for our Proposition.
C. E. JACOBS, Sole Mnfr.
2806 N. Kedzie Ave. CHICAGO

Build a Single Control Receiver Don't Use a Multitude of Dials

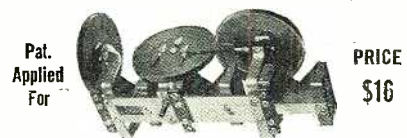

The KINLEY Tuned Radio Frequency Unit

GIVES BETTER RESULTS WITH ONE DIAL
Single dial control has been obtained without sacrificing sensitivity. The unit consists of 3 low-loss coils and 5 low-loss condensers of the straight-line wave-length type. The 3 sets of movable condenser plates are all mounted on the same sliding bar. This arrangement gives the most simple and efficient construction possible.

Instructions for building a five-tube set furnished with each unit.

PRICE **\$16.00**

At your dealers otherwise send purchase price and you will be supplied postpaid.

Send for descriptive circular.
KINLEY RADIO COMPANY
45 Elmhurst Ave. : : : : Detroit, Mich.

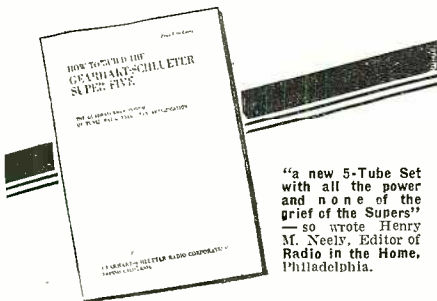

"a new 5-Tube Set with all the power and none of the grief of the Supers" — so wrote Henry M. Neely, Editor of Radio in the Home, Philadelphia.

How to Build the SUPER-FIVE

Write today for the QUADRAFORMER BOOK. It will bring you a new radio experience. Profusely illustrated with photographs, drawings. It takes you step-by-step through the making of the SUPER-FIVE, an exceptional 5-Tube Receiver developed by engineers of the Gearhart-Schlueter Radio Corporation.

Inclose 25c and you'll have it by return mail.
Gearhart-Schlueter Radio Corporation
Dept. 711
Fresno, California

Young Men—Turn Your Spare Time Into Money!

Earn big profits, prizes, and awards selling RADIO NEWS, SCIENCE & INVENTION, THE EXPERIMENTER, and MOTOR CAMPER & TOURIST in your neighborhood. We train you as our salesman and pay you liberally for your time. Write at once and we will help you to get started.

M. BRIDWELL

THE EXPERIMENTER PUBLISHING CO.
53 Park Place, New York, N. Y.

The Inventions of Reginald A. Fessenden

(Continued from page 429)

power formerly used, i. e., just a little better than my estimate.

A.C. MOTOR. SILICON IRON FOR LOW A.C. LOSSES

Meantime, whenever there was a chance, my experimenting was going on. Alternating current work was coming up and the mathematics of this as given by Kapp and others was carefully studied. Some work was done on an a.c. motor, a commutator type run by a.c. currents. This was a dead failure. The sparking was cut down pretty well, but it got altogether too hot. This was traced to the high hysteresis and eddy current loss, with a.c. currents. The thing to do, therefore, was to get a kind of iron with lower hysteresis and higher ohmic resistance. Here the electrostatic doublet theory of cohesion came in useful again. I am not dead sure now that this particular application of the theory was correct, but it gave the results, which was the important thing then. Why did iron have hysteresis? But first, what happened when iron was magnetized? Ewing's book on magnetism had been published and it then seemed fairly certain that the iron molecules aligned themselves in some way when magnetized. Hysteresis meant loss of energy, so it seemed that elements which caused iron to have large hysteresis, when alloyed with it, hindered the iron molecules from aligning freely. Looking back at the figure given for the explanation of the contraction of chemical compounds it will be seen that if the inter-space filling element was small or irregular in shape it would do this. Also an irregularly shaped element had a high melting point, and mercury had a low melting point because its atoms were nearly round.

Now the carbon atom was small and with sharp corners and carbon had a high melting point, so this would explain why high carbon steel had high hysteresis. The thing to look for then was some element whose atoms were larger than the carbon atoms and which did not have too high a melting point and which was cheap and easily alloyed with iron. Silicon seemed to be what was wanted, as its atomic volume was considerably larger than iron and it melted at a lower temperature and was easily obtained.

So, through the kindness of Mr. Perrine, former electrician for the company and then, (1890) engineer for the Roebing's works, samples of low carbon iron alloyed with different amounts of silicon were obtained. They were tested and found to give low hysteresis and eddy current loss. I think now that the result may have been pure luck and that the rotation is of a more complex nature, but the result has been of so much use to the electrical industry that I have not, perhaps, the proper amount of shame in telling of it. Arrangements were then made for obtaining it in quantity and in sheet form for armature discs.

ELECTRODELESS GAS LAMPS

When fixing up the laboratory photometer and correcting it for color of source, some vacuum tubes which were lying about were tested and the results suggested that quite efficient vacuum tubes might be made by making the tube long enough, because the voltage drop at the electrodes was independent of the length and formed a very small fraction of the total drop when the tube was long. So some tubes were made up about twenty feet long, my glass-blowing experience coming in useful here, and the results were good. But the current had a bad habit of jumping to and running through the walls of the tube when the tube got hot, leaving the gas without current. So

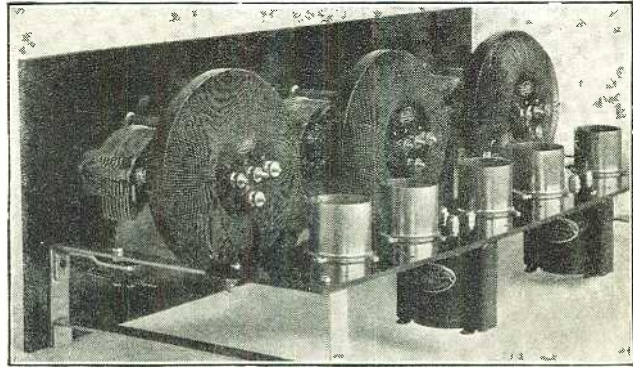

Amazing new receiver

NOW anyone can build it in an amazingly short time this new easy way. Experts assemble it at factory. You simply wire. Note revolutionary new principle it contains.

NO excuse now for not having a fine radio. At a surprisingly low cost, too. For a remarkable plan is showing thousands a new way to build their own. It is so easy that anyone can do it in an hour's time. So fascinating that many continue to build them for others. No wire bending or soldering. Merely attach a few ready-cut, flexible eyeletted leads, and the job is done.

And in addition to the fun and pride of building your own, the finished receiver actually contains a phenomenal feature not yet found in the most expensive sets; that brings results otherwise impossible.

This feature follows the discovery of a new inductance principle that overcomes many vital weaknesses of present day sets. It is based on an entirely new type coil—the Erla *Balloon *Circluid.

Circluids are the backbone of the Erla kit and are largely responsible for the striking improvements this kit alone offers. Note these four advantages in particular:

1. **Greater distance.** Circluids have no measurable external field to affect adjacent coils or wiring circuits. This makes possible higher amplification in each stage, with increased sensitivity and greater range.

2. **More volume.** Higher r.f. amplification enables Circluids to bring in distant stations scarcely audible in

ordinary sets with volume enough on the loud speaker to fill an auditorium.

3. **Increased selectivity.** Circluids have absolutely no pick-up qualities of their own. Only signals flowing in the antenna circuit are built up.

4. **Finer tone quality.** The self-enclosed field positively prevents stray feed-backs between coils. Hence no blurring or distortion. Tones are crystal clear.

Circluids are sold singly and in sets of three; also in kits containing three Circluids and three .00035 condensers.

Write for free information on kit—also book

See how a few minutes of fun will give you the newest and most nearly perfected set known to radio science. Examine it at any Erla dealer's, or send the coupon for full information, illustrations and diagrams contained in the remarkable new book, "Better Radio Reception," describing the sensational new Circluid principle. Enclose 10c for mailing and postage on book.

*Trade Mark Registered.

Electrical Research Laboratories, 2500 Cottage Grove Ave., Dept. 17-A, Chicago, U. S. A.



Send me free information on kit. Enclose 10c for postage for book, *This sign identifies authorized Erla distributors. All are equipped to give "Better Radio Reception." complete radio service.*

Name

Address

City..... County..... State.....

Dealers—Exclusive franchises are available to high class dealers in localities still open. Write or wire immediately.

The Sensational Buy of the Year—Radio Set, Lot, Subscription
A GENUINE

HARKNESS COUNTERFLEX KIT

3 Tube Reflex and Better Than the Average 5 Tube Set

Instruction booklet illustrates and explains assembly and wiring step by step.

SECOND: A FREE Warranty deed for a LOT 20 x 100 at or near Port Jefferson, Long Island, New York.

THIRD: A year's subscription to this magazine—RADIO NEWS.

ALL FOR

\$36.00 C. O. D.

THE REGULAR PRICE OF THE HARKNESS' LATEST MASTERPIECE

KEWOL RADIO COMPANY, 286 Broadway, New York City.

Gentlemen—I am enclosing check or money order for \$36.00 or ship C. O. D. the genuine HARKNESS KIT along with the FREE WARRANTY DEED and Year's Subscription to Radio News.

Name

Address

City..... State.....

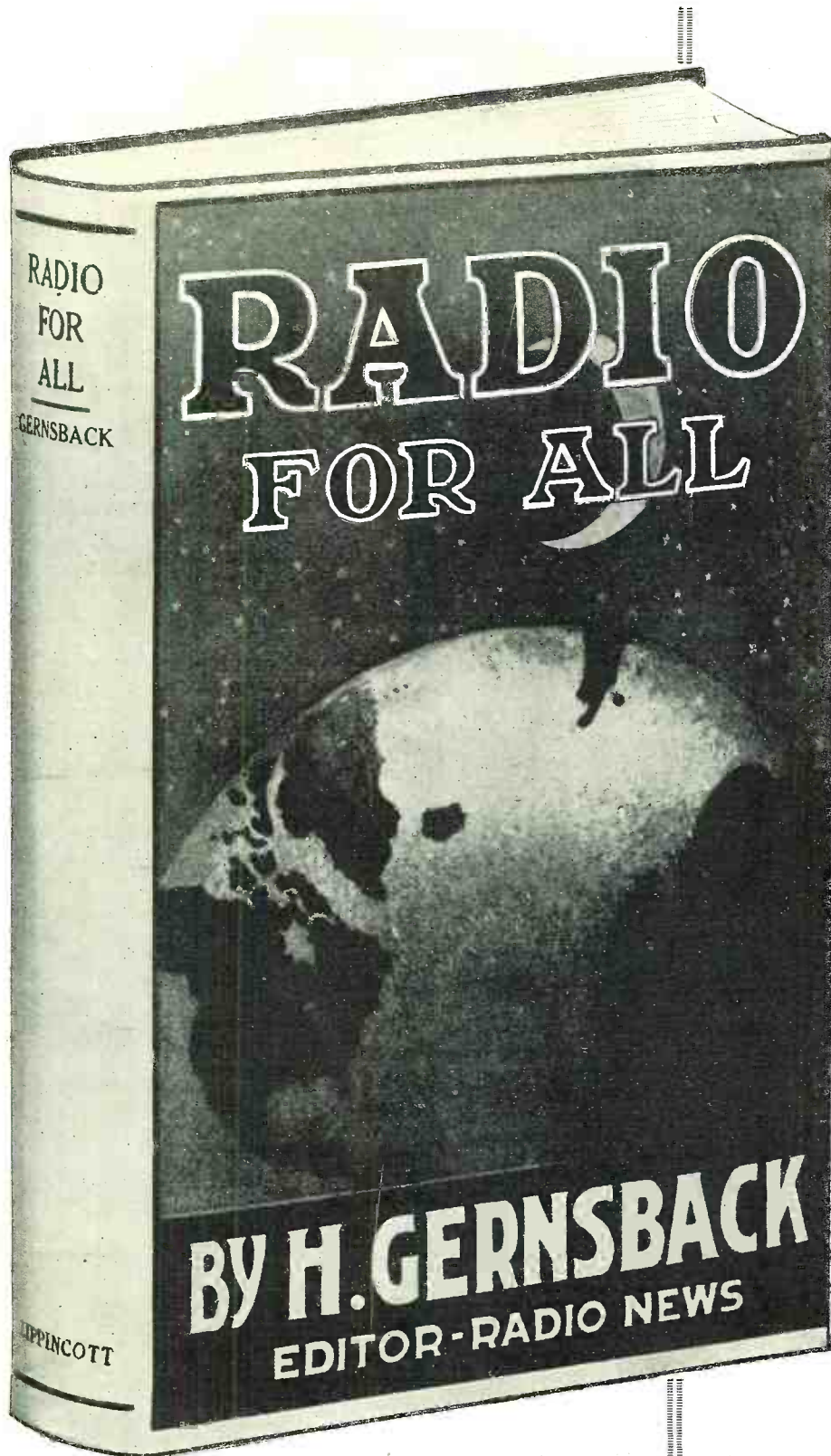

PRICE \$2.00
POSTPAID

Mail all orders with money order or cash
direct to

The EXPERIMENTER PUBLISHING CO., Inc.
53 Park Place New York City

RADIO'S

Most Complete Book of Information

By H. GERNSBACK

Editor of RADIO NEWS, SCIENCE
AND INVENTION, THE EXPERI-
MENTER, and MOTOR CAMPER
& TOURIST

What the novice in radio needs is a book in which he can get all the information necessary for him to understand radio telephony and telegraphy, to make or buy a receiving set suitable to his means, to know how to operate his set, and, after he has an understanding of the radio art, information that will enable him to advance and get the most out of his outfit. All this must ordinarily be dug out of textbooks, pamphlets and government publications, but the aim of this book is to have all the data and information that the beginner will need from the time that he takes up radio. It is a permanent, comprehensive reference book for the dred-in-the-wool dabbler in Radio.

WHAT THE BOOK IS

A combination of a radio course for the novice in radio telegraphy and telephony with a reference book for the more experienced amateur. Half a dozen books in one.

FOR THE BEGINNER

The theory of radio carefully explained with drawings.

Description of and instruction for operating instruments of receiving and sending sets, with all picture diagrams of the wiring of the apparatus.

How to make your own receiving set, costing from \$2.00 to \$50.00.

How to read diagrams; for every picture diagram there is a corresponding technical diagram using the symbols instead of drawings.

How to tune sharply and eliminate interference from other stations.

How to protect your set from lightning, and the laws regarding installation.

Explanation of time and weather signals.

FOR THE MORE EXPERIENCED AMATEUR

How to make a practical vacuum tube detector, two stage amplifier set costing less than \$50.00, that will work.

How the radio compass works.

All about underground aeriels, loop aeriels and directional aeriels.

Formulae for finding wave length; miscellaneous formulae for finding capacity of condenser and other instruments.

Tables of wire resistances, wave lengths and their corresponding frequencies, approximate wave lengths for different aeriels, tuning coil data, and much more invaluable information.

SPECIAL FEATURES

Lists of all the broadcasting stations in the United States and Canada for concerts, time signals, weather reports, press, stock market reports, etc., with their call, wave length and time of sending.

Detailed description of Washington weather signals and their translation.

Description of a modern broadcasting station and its operation.

Large map showing location of all U. S. radio telephone broadcasting stations suitable for hanging up in radio room. Collection of miscellaneous radio information for the amateur.

IN OTHER WORDS

The information that you ordinarily have to dig out of government publications, text-books, pamphlets, etc., is handily combined in this one book.

the next thought was, why not do away with the electrodes altogether and make the gas the secondary of a transformer and so do away with all electrode drop and loss? This was suggested to Mr. Westinghouse, but nothing came of it at the time, so the work was dropped.

FIRST PATENT. SILICON IRON WIRE FOR LEADING IN WIRES

In the vacuum tube experiments platinum had to be used for the wires sealed into the glass and leading the current to the electrodes. This was expensive even then. What could be used in place of it? Evidently something having the same approximate coefficient of expansion as glass and which would "wet" the melted glass, i.e., have if possible a negative capillary coefficient with respect to melted glass. Iron has a low coefficient of expansion, and glass is mainly oxide of silicon so wire made from the silicon iron alloys which had been obtained for the magnetic work suggested itself and proved satisfactory. Other alloys were tested and my first two patents applied for, with the permission of Mr. Westinghouse. *I. e.*, U. S. 452,494, Feb. 18, 1891, covering alloys of silicon with iron, nickel, cobalt, etc., and U. S. 453,742, Feb. 18, 1891, covering the method of keeping the joint clean by sealing in vacuum, driving off occluded gases by passing current through the wires, so that iron or nickel alloys could be used without addition of silicon, the oxide formed being forced to combine with, and dissolve in, the glass. Nothing was done with this at the time, but it saved Westinghouse the loss of the contract for lighting the Columbia Exposition at Chicago in 1893, and the method is apparently coming into use again.

VACUUM-BOILED OXY-CELLULOSE CONDENSERS

The condensers used for the A.C. motor experiments, though of the purest cellulose and paraffine and boiled in vacuum, heated badly, i.e., had high dielectric hysteresis. On the electrostatic doublet theory this must be due to short-conducting paths in the material, of perhaps only molecular dimensions. Cross and Bevan, and I think some others, had found that a molecule of water could be split off from cellulose by prolonged heating at a certain temperature. Possibly this water molecule was what formed the conducting path, and caused the high hysteresis. So the paper was heated in high melting point for so many hours, until the water molecule had come off, and then boiled in vacuum. It worked; the hysteresis was reduced to a small percentage of the previous loss and could no longer be measured.

PURELY SCIENTIFIC WORK

Passing over other experimental work on circuit-breakers, projectors, etc., the purely scientific work had not been entirely neglected. The money allowed me for Pullman fares on my trips was (with the knowledge of the company) used for buying scientific books, with, I believe, no loss to the efficient carrying out of the company's work. Also there was a remarkably fine public library in Newark, much ahead of the times. Alternating current theory and the papers of Hertz were thoroughly worked over. A paper on the electrostatic doublet theory of cohesion was read before a little local society, the Newark Electrical Society, in 1890, and a copy was sent to the Philosophical Magazine for publication. But it was too new. One of the editors said that it could not be correct because it did not obey Maxwell's fifth power law, overlooking the fact that I had pointed out that it did. Another objected that electrical charges could only exist on the surface of conductors, and so could not account for the cohesion of the metals. Fitzgerald, an extremely kind man and a mathematical genius, was more en-

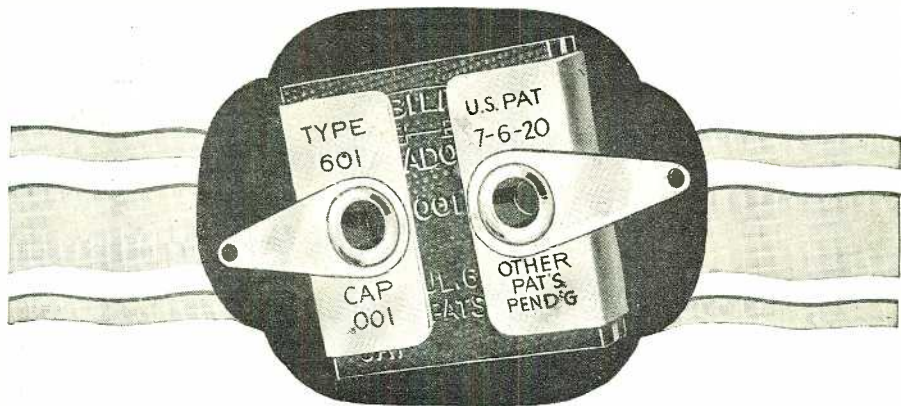

Dubilier Micadons

-Standard Fixed Radio Condensers

Nearly all of the leading manufacturers of radio sets have adopted the Micadon as their standard.

A layman might be fooled. Not so these manufacturers. They need fixed condensers with *accurately matched* and permanent capacities, and they know which are the best.

Send 10c for 32-page booklet,

"Applications of Dubilier Condensers in Radio Circuits."

Address Dept. F-2.

Dubilier

CONDENSER AND RADIO CORPORATION

4377 Bronx Boulevard, New York City

"—more than double the life of other batteries I have used."
E. E. Avery, Lynn, Mass.

Radio **DIAMOND** "B"

BATTERIES

DIAMOND ELECTRIC SPECIALTIES CORP.

103 South Orange Avenue, Newark, N. J.
Dealers, Jobbers—Write for Proposition

GEM TUBE
A Guaranteed Radio Tube Within Reach of All

Every tube guaranteed. A tube for a dollar of \$3 value. A trial order will convince you as it has thousands of others. Send your orders at once.

Orders sent C.O.D. parcel post.

Type.....401A	\$1.00
Type.....400	
Type.....499	
Type.....499A	

1 EACH
(with standard base)
Dealers, Write for Discounts

GEM TUBE CO.
Dept. N. 200 B'way, N. Y. City
220 So. State St., Chicago, Ill.
Lafayette Bldg., Detroit, Mich.

Insure your copy reaching you each month. Subscribe to Radio News—\$2.50 a year
Experimenter Publishing Co., 53 Park Place, N. Y. C.

Developed for Those Who Demand the Best

Apex Vernier Dials

are constructed on exhaustively tested and truly scientific principles and are engineered to meet the precise requirements of experts—consequently they more than meet the expectations of the average radio user. They bring in distant stations with alacrity and positiveness seldom encountered and provide control and accuracy essential to full radio enjoyment. They impart a degree of elegance that creates a marked improvement in the appearance of any set. Clockwise or counter clockwise.

Royal Brass Finish, 4 in. \$2.00; 3 1/4 in. \$1.65
Satin Silver Finish, 4 in. 2.50; 3 1/4 in. 1.90
DeLuxe Gold (24K) 4 in. 3.00; 3 1/4 in. 2.50

Apex Rheostat Dials

are little brothers to Apex Vernier Dials. Accurate, handsome—a necessity to satisfactory operation, beauty of appearance.

Royal Brass Finish \$.75
Satin Silver Finish85
DeLuxe Gold (24K) 1.00

If your dealer is unable to supply you, order direct from us.

APEX ELECTRIC MFG. CO.

1410 W. 59th St., Dept. 1006 : Chicago

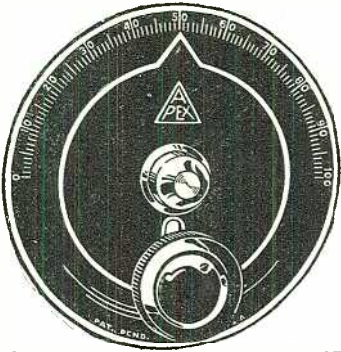

The TOWN CRIER
Radio's Most Beautiful Speaker

You will be delighted with the gorgeous colors . . . the handsome, stippled finish, and the novel design of the Town Crier—the Speaker with the voice that thrills. Ask your dealer to show you a Town Crier Speaker. Write today for beautifully illustrated circular describing the Golden Polychrome and Green Polychrome models.

List Price \$17.50
West of the Rockies \$18.50

GALE RADIO LABS.

2509 Irving Park Blvd. CHICAGO

THE LATEST

parts and sets are always featured in our Salespeaker. If you are a live-wire dealer, write for your copy, now.

HUDSON-ROSS—116 S. Wells St.
Chicago

Insure your copy reaching you each month. Subscribe to RADIO NEWS—\$2.50 a year. Experimenter Publishing Co., 53 Park Pl., N. Y. C.

couraging, and later wrote that if true it would account for Michelson and Morley's results on light and ether drag. (Still later he forwarded one of the papers to the Royal Society for publication, but could not get it in.) So the paper was not published till 1891, and then much abbreviated.

The theory was rounded up, meantime, the tensile strength of some metals which had never been measured was predicted, e.g., of cadmium, which was later confirmed almost exactly by Thurston. Also the true nature of solution was worked out and given; which became accepted later, and also Van der Waal's equation was modified into a simple form which has also been accepted, by Sutherland and others.

STANLEY-KELLY-CHESNEY LABORATORY

Stanley owned part of the electric lighting station at Pittsfield, Mass. Chesney, who had had a thorough electrical training and was a fine designer, had worked out new types of transformers which should be (and later turned out to be) better than anything on the market. Kelly had a brilliant idea of neutralizing the inductance of A.C. motors by winding a compensating winding in grooves in the pole pieces. It was thought that the silicon iron would be of use in the transformers and A.C. motors and Chesney had found that the idle current of transformers could be neutralized commercially and the all-day losses greatly reduced if my new type of condensers was used. So I was asked to join them. Zimmermann offered me the position of chief electrician and a much higher salary if I would stay, but, perhaps wisely, perhaps unwisely, I went.

Superpower Broadcasting

(Continued from page 419)

are carried overhead and consist, for the most part, of copper tubing.

The two transmitters and the modulator units, together with the kenetron rectifying units, are housed in Building No. 1 at the experimental field.

THE TRANSMITTERS

Aside from the two main transmitters, there are several others. One is built to transmit on 90 meters, another to work at 20 and 40 meters and still another to work at 5 meters. These are all distinct from the main WGY station, which is situated in the center of the General Electric Plant in Schenectady. The 90-meter set will usually work at about 5 kilowatts, though the installation is capable of a much greater output. This station is in a building of its own and the other short-wave installations are situated in still another building. The power supply for the whole outfit comes from one source, however.

The 5-, 20- and 40-meter work is still very much of an experiment, in that there is no regular broadcasting on these bands. The work being done with them is solely for the purpose of collecting data as to the behavior of radiations at the extremely high frequencies.

The two large installations are in standard form and are permanently installed. The condensers, as can be seen, are composed of large aluminum plates, which are made up in a very novel manner: the surfaces are formed of two pieces of spun aluminum which are snapped into the holders like watch crystals. They are spaced rather far apart, even for transmitting sets. However, when it is considered that in some of the sets the voltage on the plates runs in the neighborhood of 10,000 the reason is obvious.

The water cooling system is worthy of detailed description. The plate of the tube in the case of the twenty-kilowatt tubes

22 1/2 Volt Un-Acid Everlasting Rechargeable B Storage Battery

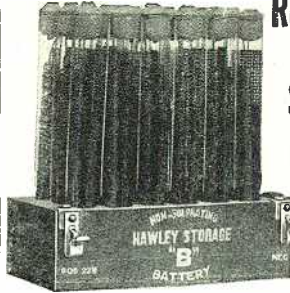

\$2.95

INCLUDES CHEMICALS

Does not lose charge standing idle. SPECIAL 2—22 1/2 (45 volts) \$5.25; 90 volts \$10.00. Any special detector or amplifying voltage easily had. Very easily charged. Nearly 3 years sold on a non-refundable 30 day trial offer with complete refund if not thoroughly satisfied. Further guaranteed 2 years. Knock-down kits at still greater savings. Complete ready to run "B" battery-charger \$2.75. Sample cell 35c. Order direct—send no money—simply pay expressman when delivered, or write for my free literature, testimonials and guarantee. My large 36 page radio goods catalogue 10c. Same day shipments. B. R. SMITH, 31 Washington Ave., Danbury, Conn.

Steinrite 1500 MILE RANGE

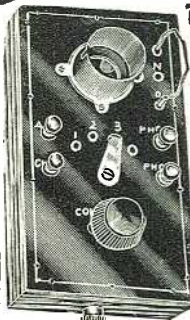

Today's Greatest 1-Tube Set

\$6 Regenerative Licensed Under Armstrong Patent 1113149

Sharp Tuning Easy to Operate FREE 10 Day Trial

Combines best radio principles of past and what is absolutely new; astonishing performance. Low expense with dry cells or storage battery—outdoor, indoor, or light socket antenna. Operates loud speaker, local or near-by stations—Coast to coast reception—greatest head phone set ever built. TRY IT AT OUR RISK

Radio value almost unbelievable; cabinet, solid mahogany, beautiful finish, special process panel size 7 1/2 x 4 x 2. Solid construction. Regenerative—a powerful set—highly selective. Money back guarantee. Any Atchison Bank guarantees our responsibility. Order today at our risk.

STEINITE LABORATORIES, Manufacturers
201 Radio Bldg., Atchison, Kan.
Write for Free Literature. Complete Line

To the
RADIO DEALER

Let us explain how you can make the sale of our publications a worth while, well paying part of your business. Write now and prepare for the Fall and Winter trade.

EXPERIMENTER PUBLISHING CO.

53 Park Place, New York City

forms the bulk of the tube. That is, the filament and grid are inside it. The leads from the elements are taken out through a glass seal at the top. Around the plate there is a metal container which carries the water circulation. The water is led to the sheath through rubber hose. A large radiator at the rear of the building keeps the water at approximately atmospheric temperature all the time.

The water lead—the hose—is coiled on large wooden drums so as to make the water column long enough to raise its resistance to a point which will prohibit leakage of current from the tube. The system may seem rather peculiar and ineffective at first sight, but practice has proven that it works very well, or at least with as good efficiency as do the other parts of the circuit.

The plate current for the various tubes is furnished by a bank of three kenotron rectifiers with inductors and condensers to smooth out the supply. Each bank is composed of four tubes, each rated at 12½ kilowatts output. If necessary, this figure can be raised. One of the photographs shows the kenotron banks. Space is provided for the installation of the fourth bank as soon as increased power demands. The supply from this unit is also arranged so that it may be thrown to any one of the sets or any combination of transmitters and modulators. All these changes are made through the insertion of plugs and jacks and the throwing of large bus switches.

TYPES OF ANTENNAE

There are several types of antennae available for use on any of the sets. At the present time a multiple tuned arrangement is being used. It consists of two sections, each of which is tuned to the emitted wave-length. Aside from this one, there are perhaps five others which may be used. Just now the engineers are carrying on extensive research in connection with horizontal and vertical doublets, that is, with an antenna system consisting of two parallel wires. A system of condensers is used to obtain resonance between the wires. It is with this type of antenna that the horizontally polarized waves are obtained. A more complete discussion of this point will be found in the article by Dr. E. F. W. Alexanderson elsewhere in this issue.

This description is the first released on the new superpower work, and represents practically the first step in the inauguration of this new phase of radio broadcasting. Our knowledge as to the behavior and efficiency of such installation is extremely hazy, but now that investigation of a wide type has been started, there will no doubt be much of interest on the subject to make its appearance within the next few months.

Parlor Magic With Your Radio Set

(Continued from page 421)

series with a loud speaker and a set. In order to have sound come from the loud speaker it is necessary that a complete, unbroken chain be established. Any number of players may join in this, but the more there are, the weaker the sounds will be. It will be noticed in this experiment that the sounds can be made to vary from very loud to weak, simply by having some one in the chain make a light contact, such as touching the skin lightly on the back of the hand. Also, it will be found that some parts of the body have higher resistance than others and consequently cut down the volume of sound. Thus, for instance, men, as a rule, providing their hands are dry, if five or six are in the chain, will practically kill all sounds from the loud speaker. This is due to the high resistance of the

Write for this Big FREE MONEY SAVING Catalog

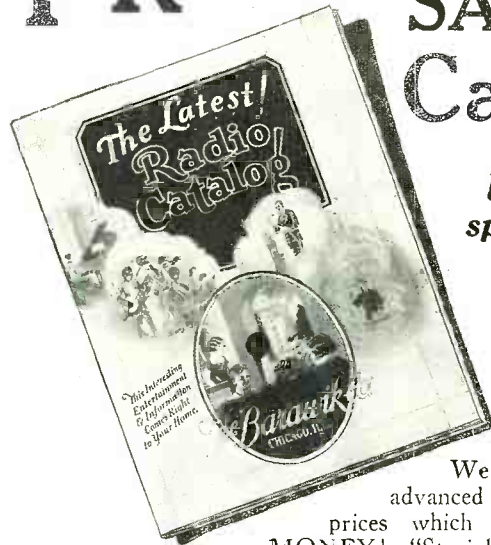

before you spend another cent for

PARTS!

We have all the new, advanced types of parts at prices which save you REAL MONEY! "Straight Line Frequency" Condensers, "Toroidal" Coils, "All-Frequency" Audio Transformers, new "Vernier" dials and all the other newest type parts. Also Kits and sets of latest improved designs. All clearly illustrated and fully described in our new, big FREE Catalog and Builder's Hook Up Guide.

Get this big Free Book today! You need it! You can't afford to be without this bona fide money saver and sure guide to success. Send for it now—at once, before you buy another part of any kind! Before you build another set! Simply send name and address and name of friend interested in Radio. *Send today!*

THE BARAWIK CO.

102-142 S. Canal St., Chicago, Ill.

One of America's Oldest Radio Institutions

Barawik Co., 104-142 So. Canal St., Chicago, Ill.
 Send me my copy of your new Radio Catalog and Builder's Guide.
 Name _____
 Address _____
 Friend _____

ELIMINATE Your STORAGE "A" BATTERY

for Reflex Radios

BLAX A. C. POLARIZER

Uses Electric Light Current—saves your recharging costs and bother. First small cost of Blax is last. Nothing to get out of order. Thousands are already giving satisfaction. Order yours TODAY.

SEND \$1. BILL or send dealer's name along with yours and will forward C. O. D.

TO THE TRADE WILL SELL YOUR SETS

BLACK BROS., Inc.
BLACK BUILDING
 Los Angeles

Potter BY-PASS CONDENSERS

- Prevent "B" voltage fluctuation
- Allow undistorted amplification
- Make possible full bass tones
- Improve reception with "B" Supply Units.

Made in 1, 1½, 2, 3 and 4 Microfarad sizes
 At Your Dealer's
POTTER MANUFACTURING COMPANY
 North Chicago, Illinois

RADIO LISTENERS' GUIDE and CALL BOOK

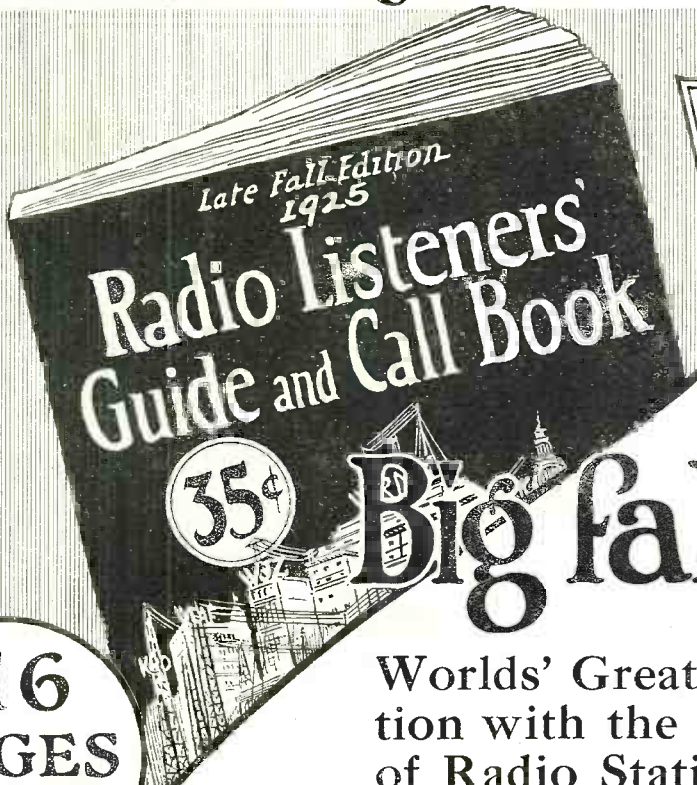

The
Radio Set Owners'
Book
of
Information

Big fall Issue

116
PAGES
OF
RADIO

Worlds' Greatest Book of Information with the Latest Complete List of Radio Stations and Call Letters

Here is the latest and greatest radio book of its kind published for the Broadcast Listener. It is a National Radio Guide Book of the United States in that it gives you, completely and comprehensively, the location of radio stations on the air. It lists all stations of the United States, both Broadcast and Amateur, giving size and location of each station, its wave-length, etc., with ample space for tabling and logging those you receive. Then just as an Automobile Guide Book tells you how to care for your car, this book explains the complete care of your radio set by explaining the fundamental operation of all principal parts. And also it gives foreign radio stations, time signals and a multitude of similar, valuable listings.

116 pages filled to the brim with valuable data.

PARTIAL LIST OF CONTENTS

- Selecting a Radio Receiving Set.
- Reaching the Shorter Wavelengths.
- How Broadcast Stations Operate.
- Locating and Eliminating Trouble in Radio Sets.
- All About Radiologs.
- The Function and Care of Vacuum Tubes.
- Loud Speakers—How to Select Them.
- Fundamental Principals of Radio.
- The Care and Operation of Storage Batteries.
- Basic and Modern Radio Circuits.
- Aerials, Loops, Ground and Lightning Arresters.
- How to Understand Radio Circuits.
- Radio Broadcast Stations of the U. S., by Call Letters.
- Radio Broadcast Stations of the U. S., by States.
- Radio Broadcast Stations of Canada.
- Special Land and Experimental Radio Stations of the U. S.
- Foreign Radio Broadcast Stations, by Countries.
- American Radio Relay League and Directory.
- Amateur Radio Stations of the U. S., by Districts.
- Foreign Amateur Radio Stations.
- Table for Making Time Transitions.
- Radio Broadcast Maps of the United States and Canada.
- Time in All Parts of the World.

35c the copy—Sold at all Newsdealers and Radio Stores

IF YOUR DEALER CANNOT SUPPLY YOU, ORDER DIRECT, USING THIS COUPON

THE CONSRAD CO.,
233 Fulton St., New York City.

Herewith find 35c for which send me Fall Edition of Radio Listeners' Guide & Call Book.

Name

Address

City

State

Sold and Distributed by

The Consrad Company, 233 Fulton St., New York

Consrad

skin of the hands. If, however, the hands are slightly moistened, the loud speaker will come on with full strength as a rule.

In the chain experiment as shown in illustrations 2 and 2A, lots of amusement will be created by the operator asking one of the girls to stick out her tongue and having the next partner touch it with the tip of her finger. The tongue, being very sensitive and moist, will naturally carry a high amount of current. If the set is of the 5-tube variety, I can vouch that the same girl will not try it twice. Although the shock is not at all serious, it is somewhat disagreeable when experienced for the first time. This particular experiment, by the way, does not work unless the polarity is right. You may have to reverse the connections at the plug in a previous experiment to find out which is the correct polarity.

The next is a most interesting experiment, as interesting as it is surprising. Even your average radio engineer, if told that you can make a perfectly good head-set with a pair of gloves will probably laugh at you. Nevertheless, the following shows how to do it. As shown in illustrations 3 and 3A, it requires two performers and one person to be entertained. The two performers must put on kid gloves (cotton or silk gloves do not work.) One pair of gloves will do; namely, a right and a left. The gloves should be put on the usual way, buttoned up, so that the palm of the hand and the stretched part of the glove become a diaphragm, which, when held with a spread hand, will be stiff.

The two performers now grasp leads or wires leading to the plug of the radio set. No loud speaker is connected in this case. The two hands with the gloves are put over the ears of the listener. Be sure that the gloves actually touch the ears. In the case of a girl, the hair must be pushed aside, as the experiment will not work well over the hair. If the station is tuned in, she will hear the selections as loud as with a good head-set. This may seem surprising, but it is simply a variation of the good old condenser telephone, invented by Professor Dolbear in 1876. In this case, the hands of the performers form the two plates of the condenser, while the gloves are the dielectric. The head of the listener becomes the third plate. The leather diaphragm vibrates under the influence of the high frequency currents, and the sounds are heard. This is a very pretty experiment and one that always arouses considerable astonishment, not only from the layman, but also from those who know something about electricity.

A clever variation of this experiment is shown in illustrations 4 and 4A. This is a duplicate of the preceding one, except that in this, no gloves are used, merely two pieces of stiff bond paper, such as used for letterheads. The two pieces of paper are pressed with the bare hands against the listener's ears, while the performers grasp the metallic ends of the wires coming from the phone plug in the two free hands, as in the glove experiment. If the choice of the paper is right, the listener will hear the sounds as loud as with a good head-set.

In both of these experiment it is assumed that the strength of the signals is good. If they are weak as for instance, those coming from a distant station, the results will be very poor. The louder the signals received, the better the results.

The reader will, of course, be able to make many variations of the experiments described herein, and with a little ingenuity a good deal of entertainment can be provided.

I have in my notebook a number of other experiments of the entertainment kind, and if you should care to see more of them, I shall be glad to hear from you. If there is enough response from our readers, I shall soon publish a second installment of Parlor Magic With Your Radio Set.



The Bridge to Amplification Without Distortion

Daven engineers were pioneers. They blazed the way for others to follow. They designed and built the first Resistance Coupled Amplifier offered the public. They found resistance coupling in an experimental stage. They perfected it.

Daven Resistance Units, Amplifier Kits and Super-Amplifiers are accepted by authorities as standard. The Daven Super-Amplifier, for use in any known set or circuit, is priced at \$15.

A NEW TUBE BY DAVEN

To meet the exacting requirements of Resistance Coupled Amplification the Daven Radio Corporation has created a new product — the DAVEN HIGH MU VACUUM TUBE, Type MU 20. It is designed for one specific purpose only — to increase the amplification of the Daven Resistance



Resistor Manual
Manufacturers of high grade sets are turning to Resistance Coupled Amplification. The authority is *The Resistor Manual*. At your dealer's 25c; or by mail, 35c.

Coupled Amplifier so as to exceed that of ordinary audio frequency coupling. The Daven High MU is a 6-volt, 1/4 ampere tube with an amplification constant of 20. The price is \$4.00. Daven Power Tube Type MU 6 is for last or output stage. Price \$5.00

DAVEN PRODUCTS ARE SOLD ONLY BY GOOD DEALERS

The Sine of Avenir
DAVEN RADIO CORPORATION
Resistor Specialists
NEWARK Reg. U.S. Pat. Off. NEW JERSEY

Use this free coupon
O-10-25
Daven Radio Corp.
158-160 Summit Street
Newark, New Jersey
Please send me the following on Resistance Coupled Amplification:
 Check one
 Resistor Manual, 25c is enclosed.
 Complete Catalog (free).
Name.....
Address.....

For Dealers: Send your letterhead or card, or this coupon and we will have our nearest distributor communicate with you.

THE BIG LITTLE THINGS OF RADIO

Just the Book You Wanted

"RADIO NEWS" AMATEURS' HANDBOOK

Volume No. 1 (Fourth Printing)

Chock full of radio constructive and instructive articles from cover to cover. Written by foremost radio authorities, in plain everyday language which everyone can understand. Sections include articles on Receiving Sets and Sundry Apparatus, Transmitters and Accessories, Radio Theory, Vacuum Tube Data, and Practical Hints for the Amateur. A book which also serves as a ready reference and should find a place in the library of every amateur. It contains 224 pages and over 375 illustrations, diagrams, and photographs, bound in a multi-colored heavy board. On sale at all leading radio stores. If your dealer cannot supply you, send a dollar bill and the book will be forwarded to you postpaid.

Price \$1.00

EXPERIMENTER PUBLISHING CO., Inc., 53 Park Pl., New York

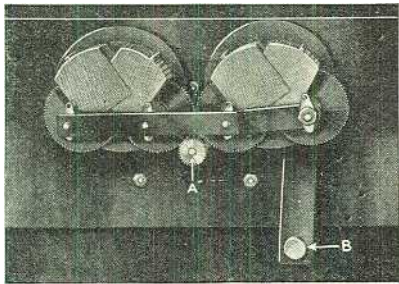

**The S-C
CAPACITY ELEMENT**

Offers an easy means of
obtaining simple tuning.

Be up-to-date!

Make your set a
single control.

This device can be easily applied to Roberts, Browning-Drakes, Superheterodynes or any set with two controls.

Furnished complete with instructions, template and Martin-Copeland vernier dial, \$15.00. Without dial, \$13.50.

4-TUBE "SUPERUNIT" with loop and S-C Capacity Element, \$55.00.

Three styles. Type A for standard base, type B for 199's, type C for UX tubes.

HANSCOM RADIO DEVICES
WOONSOCKET, R. I., U. S. A.

Does a Straight-line Frequency Condenser Exist?

(Continued from page 447)

To make things easier to comprehend, values of the inductance ratio were computed from this formula and are shown in Fig. 2. Three curves are shown, all of them applying to inductances of 100 microhenries, one curve for a coil having a capacity of 10 micro-microfarads, one for a coil of 20 and one for a coil of 30 micro-microfarads.

The horizontal axis (at the bottom) is calibrated in kilocycles, and the vertical axis (at the left) is calibrated according to the inductance ratio. Thus, a coil of 100 microhenries having a distributed capacity of 20 micro-microfarads, at a frequency of 1,000 kilocycles (300 meters), would have an inductance ratio of 1.087. (Point "a," Fig. 2.) That is, its inductance under those conditions would be 1.087 times its true inductance, an increase of 8.7 per cent.

For the purpose of exaggerating conditions, we have assumed rather large coil capacities. It is difficult to conceive of any coil of any of the types now in general use that will have as high a capacity as 15 micro-microfarads. But when we consider the effect of other apparatus in proximity to it, and the additional capacity of the connecting wires, it is probable that it may, in some cases, run as high as 20 micro-microfarads. For this reason we shall consider from now on, for the sake of argument, coils of 100 microhenries having coil capacities of 20 micro-microfarads.

Now, remember that the frequency of a circuit is given by the formula:

$$f = \frac{159.3}{\sqrt{LC}}$$

as explained above. If we consider L to change, we can easily find out the variation in the frequency that will occur as a result of this change. In Fig. 2 the limits of the broadcast frequencies have been indicated by the vertical broken lines, viz., 550 to 1350 kilocycles. Consider the 20 $\mu\mu\text{f}$ curve. The values of the inductance ratio at these limits are shown at b and c, and have the values 1.024 and 1.168.

In other words, the inductance of the coil changes in the ratio of 1.168/1.024 (or 1.142) in the frequency range 550 to 1350 kilocycles. That is, if the inductance of the coil at 550 kilocycles were 100 microhenries, its inductance at 1350 kilocycles would be 100 x 1.142, or 114.2 microhenries. Now suppose, instead of using L in the above formula, we use its new value, which is 1.142 L. The equation will then be:

$$f = \frac{159.3}{\sqrt{1.142 LC}} = 0.936 \left[\frac{159.3}{\sqrt{LC}} \right]$$

It will be noted that the form of the formula has not been changed. The part in brackets is the same as that with which we started, the only difference being that we now obtain a frequency which is 0.936 times the frequency we obtained when we assumed the inductance constant. In other words, the frequency is now only 93.6 per cent. of what it would be if the coil had no capacity. For instance, if we happen to have our radio receiver so designed as to tune to 1350 kilocycles at exactly 100 on the dial, without considering the change of inductance, it would actually tune in 1350 x 0.936 or 1263 kilocycles.

This same procedure has been followed out for various values of frequency lying within the broadcast range. A perfectly linear condenser calibration has been assumed for the sake of argument, in the solid line drawn

Motors

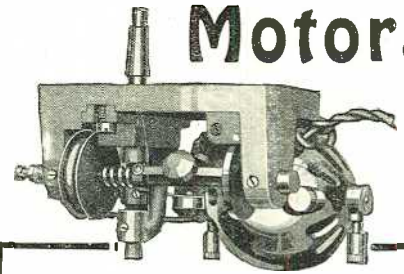

Only \$10 Each

Ideal for home-made phonographs, experimental purposes and combination PHONOGRAPH-RADIO sets.

We have a limited number of small motors which are greatly under-priced for quick clearance. You will never again equal this low price when this lot is sold.

They are universal motors, 110 volts, cycle single phase, complete with turntable, cord and socket for immediate use. 1400 R. P. M. Motor has 1" pulley with flange for 1/4" flat belt. Housed in highly polished, nickel-plated shell.

Don't lose out on this remarkable offer. Order your motor today. Tomorrow may be too late. **DO IT NOW!** Price \$10.00 f. o. b. Steger, Illinois.

Industrial Division

Steger & Sons
Piano Manufacturing Company
Dept. 60, Steger Building CHICAGO, ILLINOIS

Three "E" Straight Line Rheostat

Illustration
1/2 Size

**Perfect Control
of Filament
Temperature**

6-15-30 Ohms.



Patent
Pending

Your Rheostat must do more than merely light the filament. Perfect Reception depends on a fine, smooth dependable variation of filament temperature in the detector tube. For there is only one temperature at which efficient reception is obtained and this point is very critical.

The THREE "E" STRAIGHT LINE RHEOSTAT finds this critical point as no other can. It gives straight line variation, runs smoothly, is absolutely NOISELESS and once set "stays put!" By all means secure this precision instrument at once. Ask your Dealer or order direct, giving us his name. Price \$2.50—Postpaid.

ELECTRICAL ENGINEERS EQUIPMENT CO.
Radio Division
708 W. Madison St., Dept. 6,
Chicago, Ill.
Circulars on Request

The Aristocrat
of Rheostats



PERSONAL STATIONERY
200 SHEETS and **\$1.00**
100 ENVELOPES

Printed with your Name and Address

Clear, white bond paper, with envelopes to match. Your name and address printed in beautiful, rich blue ink, on both paper and envelopes, and sent to you postpaid for only \$1.00. (West of Mississippi river and outside of U. S. \$1.10.) If inconvenient to send the money, we will ship C. O. D. Money returned if you are not more than satisfied. Order today. Write name and address plainly.

AGENTS MAKE BIG MONEY taking orders for us today for our agent's proposition.

ELITE STATIONERY COMPANY
7056 Main Street Smethport, Pa.

Insure your copy reaching you each month. Subscribe to **RADIO NEWS**—\$2.50 a year. Experimenter Publishing Co., 53 Park Pl., N.Y.C.

**A GENUINE
SELF STARTING REMINGTON No. 10**

**CUT TO
\$38⁶⁵**



**LIKE NEW
30 DAYS FREE TRIAL**

Save more than half your cost on a machine literally like new! This is the latest Model No. 10, with the exclusive Remington "Self-starting" feature, the most popular typewriter ever built.

The best buy of the year—the biggest typewriter value ever offered. Actual cash saving, \$64 on new machine—\$20 to \$45 on rebuilt. Like new; perfect appearance and working condition. All late improvements: column selector, 2-color ribbon (automatic reverse), back spacer, variable platen release, latest style paper fingers and guide. Up to date in every way.

Standard keyboard; 81 characters. All visible. Will write on a postage stamp. Guaranteed 5 years. 30 days FREE TRIAL. Satisfaction or money refunded. Write for details. A postcard will do.

Cut Prices on All Standard Makes

LINCOLN TYPEWRITER CO., Inc.
America's Leading Independent Typewriter House
Dept. 56 298 Broadway, New York City

Insure your copy reaching you each month. Subscribe to **RADIO NEWS**—\$2.50 a year. Experimenter Publishing Co., 53 Park Pl., N.Y.C.

in Fig. 3, by assuming a frequency of 550 to be tuned in at zero on the dial, and a frequency of 1350 kilocycles at 100 on the dial. These points are shown at a and b of Fig. 3, and a straight line was drawn connecting them. This line represents a perfectly linear calibration.

The points computed as explained above, assuming the coil and associated circuit to have a total capacity of 20 micromicrofarads, were also plotted in Fig. 3, giving the broken curve. There is no doubt that this curve is a curve—it is *not* a straight line.

But the main point in this connection is that it is not very far from a straight line. The curvature is not sufficient to cause anyone any trouble in separating the many stations, which is the prime reason for the existence of the straight-line frequency condenser, anyway.

HOW CONDENSERS ARE DESIGNED

Let us go a bit further. Suppose the designer of the condenser first determined the approximate shape of the plates by the theoretical method outlined in my article in the August issue of Radio News, and then put the condenser into an oscillatory circuit. He then measured the frequency that was tuned in at every dial setting and plotted a curve. If the curve was not perfectly straight, he would grind away some of the plate, or build a new set of plates having a slightly different shape. Finally he arrived at a set of plates which gave him a perfectly linear calibration.

The coil he had been using in the measuring circuit was a good one, having low distributed capacity. The problem now is: What will happen if this condenser is used in a circuit with a coil having greater distributed capacity?

The answer is easy. The calibration curve will be *less* curved than the one we have shown in Fig. 3. The curve ab in Fig. 3 was drawn for a condenser associated with a coil which had *no* distributed capacity, and we are comparing it with the curve applying to a condenser associated with a coil of considerable capacity. Certainly there will be an improvement.

The reader must not be misled by the statements made by those who measure the capacity of a condenser at various settings and then calibrate the frequency dial-setting curve from these measurements. It is absolutely impossible to judge the straightness of the calibration curve by this method as I venture to say, the majority of the condensers will be made by the cut-and-try method, as described immediately above.

There is one other point that may prove interesting to many. Purchasers have in the past been accustomed to demand from the dealers condensers which have low minimum capacities. In the straight-line frequency type of condenser the straightness of the calibration curve will often be destroyed by cutting away the plates in the attempt to obtain a low minimum capacity. This was explained in detail in the September issue of Radio News where an experimental course obtained on a straight-line frequency condenser was prevented.

EFFECT OF CAPACITY

It has been shown above that the curve will be bent downward when the condenser is used in a circuit with a coil having appreciable capacity. It is apparent, then, that the tendency will be to straighten out the curve somewhat, thereby counteracting, to some degree, the upward curvature due to the low minimum capacity.

In conclusion I should like to say that, in spite of the fact that we are not able to have anything "perfectly perfect" in this universe of ours, the straight-line frequency condenser is about the best thing that has come



Greater selectivity, range, power, beauty and simplicity—at lower cost!

Built like—looks like—performs like a \$200 set
 *NOTICE! Enormous demand for the celebrated Miraco Ultra 5 (resulting from its many enthusiastic users so highly recommending it to their friends) has enabled us to add hosts of costly new features, latest refinements and up-to-the-minute improvements.
now only \$59.50 retail
SEND FOR SPECIAL OFFER!
The Powerful New MIRACO Ultra 5

[FIVE TUBE OUTFIT IN BEAUTIFUL MAHOGANY CASE]
 The amazing coast to coast reception (on the loud speaker) and international receiving range of the famous Miraco Ultra-5 in the hands of its multitudes of pleased users—as voluntarily reported by them to us in writing—offers proof of performance which makes claims by us superfluous. Send for plenty of this proof—and Special Offer! Remember that one of America's oldest and most reliable manufacturers of quality sets completely builds, thoroughly tests and factory guarantees each Miraco. That longer experience and immense production make possible such money-saving prices. Bear in mind that this big, beautiful, powerful and clear-toned Miraco Ultra-5 is the latest, improved model. That it has a beautifully gold-etched genuine Formica panel with large Bakelite knobs equipped with gold filled indicators for very fine tuning.
 That it is even more selective, more powerful and is capable of getting greater distances due to exclusive use of "Duo-tomers" (ultra low-loss inductance coils—the newest achievement in radio engineering). "B" battery consumption is minimized and oscillations are controlled on all wavelengths by a new patented feature, the "Counter-Balancer." Flexibly wired (to prevent broken connections). Has an adjustment for different length aerials, only two rheostats, a cut-out switch, concealed wiring and other features of costliest sets. Comes in a hand-some hand-rubbed mahogany cabinet. An instrument thoroughly tested and approved by radio's highest authorities and one which anyone can easily connect, operate and "load." Works on storage or dry batteries. Literature describes other latest improvements.

Other Miraco Long Distance Sets \$13.50 up retail
 Wonderfully improved new models in one-tube and three-tube Miraco Long Distance Sets also ready at lower prices! Powerful new Miraco R-3 at only \$27.35 (retail) operates loud speaker on distant stations. All Miraco sets work on storage or dry batteries. Approved by Radio's highest authorities. Unmatched values! Let testimony of users convince you. Write for literature and Special Offer!

All the Proof you want is waiting for You!
 Reports from their hosts of users in every state prove Miraco sets—at rock-bottom factory prices—outperform sets costing much more money. Send for latest literature, SPECIAL OFFER and plenty of additional testimony from users, leaving no doubt that "Miraco Radio Gets 'em Coast to Coast."
AGENTS, DEALERS! Write for the new Miraco proposition!

MIDWEST RADIO CORPORATION
 Builders of Sets, 404 E. Eighth St., Cincinnati, O.
 Send literature, SPECIAL OFFER and all particulars regarding Miraco Sets. () Jobber () Dealer () Agent () User
 NAME.....
 ADDRESS.....



100 AMP. RADIO BATTERY
 6 Volt Rubber Case
 TWO-YEAR Written Guarantee by THOMAS WITHERBEE
 Storage Battery Pioneer for 28 Years.
 Shipped direct from factory to you. No middlemen's profit—no delays—no grief.
Send No Money
 This is an actual 100 amp. Radio Storage Battery honestly built of purest materials by real battery builders. Solid Rubber Compartment cases—not wood (non-leakable)—will outlast the battery itself. Lead coated carrying handle. Wing binding posts.
 Will operate the average 5 tube radio set from three to four hours daily for a month to six weeks.
NO DEPOSIT or Advance Payment Required
 Simply order—and we will ship by express and you can examine battery at your express office in your heart's content. If you agree with us that it's the biggest offer ever made—pay the expressman \$9.98 plus express charges.
 If you prefer to remit with order—deduct 50c. You run no risk as we replace any defective battery during two years.
THOMAS BATTERY CORP., 511 West 50th St., New York, N.Y.

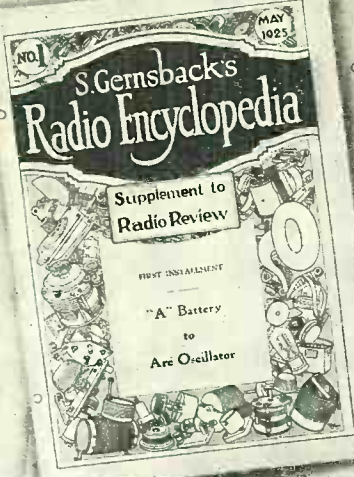

RADIO REVIEW

Reg. U.S. Pat. Off.

A Digest of the Latest Radio Hookups

Don't miss the October number, which contains many important features

The Newest Thing in Radio Literature

A complete 100 page illustrated magazine containing hookups and constructional Radio articles, gleaned from the entire radio press the world over.

Large magazine size 9 x 12 inches, printed on fine paper and profusely illustrated.

IN EVERY ISSUE A 16 PAGE SUPPLEMENT OF ONE INSTALLMENT OF S. GERNSBACK'S RADIO ENCYCLOPEDIA

This real Encyclopedia of Radio explains every word used in Radio, by means of photographs, drawings, charts or tables. (Some sample pages are shown in this advertisement). This supplement is arranged in loose-leaf form.

35c the copy on all Newsstands and Radio Stores.

Subscription price \$3.50 for 12 issues.

Published by

THE CONSRAD CO., Inc.
233 Fulton St., New York, N.Y.

THE CONSRAD CO., Inc.
233 Fulton Street, New York.
Enclosed find \$3.50 for which enter my subscription to RADIO REVIEW for 12 issues.

Name

Street

Town

State

along, as yet, in the way of helping us tune in the many concerts on the air. Despite some curvature in the calibration curves, most of them, when actually plotted in a radio receiver, will be substantially straight, and furthermore, it would require a great deal more curvature that we actually do get to cause the confusion among the short-wave stations that has existed heretofore with the use of circular plate condensers.

Radio News Laboratories

(Continued from page 461)

G & S SILK CORE DETECTOR

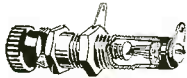

The G & S silk core detector shown in the illustration was submitted by the G & S Radio Research Laboratory, 1269 Cochran Avenue, Los Angeles, Calif. It is of the adjustable type, arranged for panel mounting. When mounted on the panel it presents a neat and inconspicuous appearance. It would be suitable for use in any radio receiver which requires a crystal detector.

AWARDED THE RADIO NEWS LABORATORIES CERTIFICATE OF MERIT NO. 889.

ERLA CIRCUOID COILS



These coils, submitted by the Electrical Research Laboratories, 2500 Cottage Grove Avenue, Chicago, Ill., are shown in the illustration. They operate satisfactorily as radio frequency amplifiers, covering the complete broadcast wave range.

AWARDED THE RADIO NEWS LABORATORIES CERTIFICATE OF MERIT NO. 888.

KEYSTONE RHEOSTAT

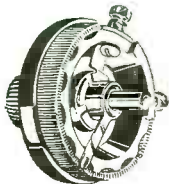

This rheostat, furnished to the RADIO NEWS LABORATORIES for test by the Keystone Radio Company, Greenville, Pa., is rigidly built and may be used satisfactorily in any kind of radio receiving circuit.

AWARDED THE RADIO NEWS LABORATORIES CERTIFICATE OF MERIT NO. 927.

ZENITH RADIO SET



The set shown in the illustration was submitted by the Zenith Radio Corporation, 332 South Michigan Avenue, Chicago, Ill. This set operates very satisfactorily over the whole broadcast range, reproducing with satisfactory sensitivity, selectivity and quality.

AWARDED THE RADIO NEWS LABORATORIES CERTIFICATE OF MERIT NO. 887.

HALOWAT RECEIVER



The Halowat Receiver, submitted by the Hallock & Watson Radio Corp., 192 Park St., Portland, Ore., is shown in the illustration. This receiver is of the five-tube type of radio frequency amplifier and will satisfactorily bring in stations on the broadcast wave-lengths. It produces a fair degree of selectivity and sensitivity and reproduces without appreciable distortion.

AWARDED THE RADIO NEWS LABORATORIES CERTIFICATE OF MERIT NO. 893.



Superior Results Guaranteed

\$9.75

Now-Plate Voltage for any Set — and You can afford it!

First Cost Economy now makes it possible for EVERYONE to obtain efficient "B" current supply right from their electric light socket. Now one of the biggest improvements in modern-day radio reception is placed within the reach of all. Think of it! A perfect, always efficient source of plate voltage for any set for \$9.75! It marks a revolutionary step forward and will be welcomed by millions of radio enthusiasts.

Maxmin
"B" Battery Eliminator

The price of this remarkable new unit is spectacular in more than one way. Besides saving you from \$15 to \$45 it is amazingly low considering the quality and superiority. You may ask "how could it be possible to build such a unit for the ridiculously low price of \$9.75?" True mechanical genius and resourcefulness alone are responsible. But the logical way to answer this question is to equip your set at once with this marvelous unit and be convinced.

ASK YOUR DEALER—OR SEND DIRECT

FARBEND Wave Trap

This company also manufactures the famous **FARBEND WAVE TRAP**—the instrument which has been widely imitated but never equaled. It is the only original and genuine.

Until nation-wide distribution is completed it is possible that your dealer hasn't stocked the MAXMIN "B" Battery Eliminator as yet. So you will not have to wait, we will make prepaid shipment direct to you upon receipt of \$9.75, or C. O. D., plus postage. Remember, *superior results are guaranteed* or your money back. Be one of the first to own and use the **FARBEND MAXMIN "B" Battery Eliminator.**

Use the **COUPON NOW!**

Ferbend Electric Company
25 East South Water Street
Chicago, Ill.

FARBEND ELECTRIC CO.
25 E. South Water St., Chicago

Send Postpaid. I am enclosing \$9.75.
 Send C. O. D., Plus few cents postage.
 Send Literature.

Name.....
Address.....
City.....
State.....

Maxmin

M&M Low Loss INSULATORS

Perfect your entire installation by insulating your antenna-ground system. Your set is not responsible for energy lost thru a poorly insulated aerial. Use **M & M Low-Loss Lead-in and Wall Insulators.**

4" Lead-in Insulators50
10" Lead-in Insulators80
20" Lead-in Insulators	\$1.50
5" Wall Insulators60

Dealers: If your jobber can not supply you write us direct, giving us your jobber's name.

The M&M Co.
CLEVELAND, OHIO.

UNCLE SAM
LOW LOSS BABY COIL
Smallest Tuning Coil in the World

Size 2 7/8 x 2 1/2 in.

This coil is so small it can be built in a cigar box.

When used with an Uncle Sam Antenna Coil, it gives a four-tube tuned radio frequency set that will break through all locals, that has unbelievable selectivity and will get coast to coast on a loud speaker.

FREE Ask your dealer or send us four cents in stamps for wiring diagrams of circuits in which these units can be used.

UNCLE SAM ELECTRIC CO.
211 East 6th St., Plainfield, N. J.



KIC-O
STORAGE BATTERY

"B" ELIMINATOR SIMPLICITY

PERMANENT ALKALINE STORAGE BATTERY RECEPTION

KIC-O MULTI-POWER UNITS operate from your lighting line and eliminate the replacing of dry cell "B" batteries—usually saving their cost in the first six to twelve months of service on Neutrodyne and Super Hetrodyne sets.

Guaranteed Two Years
MULTI-POWER UNITS (Price Complete)
90 volt ALX
\$26.50

Power — Economy — Performance

Shipped ready to use! No costly bulbs! No acid fumes! Units for 110 volt A.C., D.C., or farm plants. Write for special offer. Distributors! Everybody!

Kimley Electric Company, Inc.
2665 Main Street Buffalo, N. Y.



James Blue Bullet
FIXED CRYSTAL

Out-performs—Out-lasts—Looks better

Numerous tests have shown that James Blue Bullet will out-perform any fixed crystal for distance, volume and quality of tone. For an idea of its lasting qualities read this

\$100

James Blue Bullet has been under 180 volts on the plate steadily for a month. Of other crystals, the first burned out in 8 hours and another in 15 hours. The Blue Bullet has outlasted them all and is still going strong.

"For tone quality and volume it is superior to any crystal I've ever had, fixed or otherwise—and I've tried them all."—Kennedy, Oakland, California.

Ask your nearest dealer for a James Blue Bullet or send to us direct. Postpaid or C.O.D., \$1.00.

STAR-KING COMPANY
200 Davis Street : : San Francisco



Easy to Play
Easy to Pay

BUESCHER
True-Tone Saxophone

BENNIE KRUEGER
Director Bennie Krueger and His Orchestra. Brunswick Records.

Easiest of all instruments to play and one of the most beautiful. Three first lessons sent free give you a quick easy start—in a few weeks you can be playing popular tunes. No teacher necessary. You can take your place in a band or orchestra in ninety days, if you so desire. Most popular instrument for dance orchestras, home entertainments, church, lodge and school. A Saxophone player is always popular socially and has many opportunities to earn money. Six Days' Trial and easy payments arranged. (100)

Free Saxophone Book Shows all models and gives first lesson chart; also pictures of famous professionals and orchestras. Just send your name for a copy. Mention any other instrument in which you may be interested.

BUESCHER BAND INSTRUMENT CO.
Emerging in Band and Orchestra Instruments
973 BUESCHER BLOCK • • ELKHART, INDIANA

Radio Set Directory

(Continued from page 439)

Trade Name: Biltmore Master Reflex Model V

Circuit: Reflex
Batteries: Dry cell or storage
Antenna: Outdoor or loop
Loud Speaker: Separate
Controls: Three
List Price: \$100

Trade Name: Biltmore Master Reflex Model V-C

Circuit: Reflex
Batteries: Dry cell or storage
Antenna: Outdoor or loop
Loud Speaker: Built-in
Controls: Three
List Price: \$185

Trade Name: Biltmore Master Reflex Model VI

Circuit: Reflex with resistance amplification
Batteries: Dry cell or storage
Antenna: Outdoor or loop
Loud Speaker: Separate
Controls: Three
List Price: \$115

Trade Name: Biltmore Master Reflex Model VI-C

Circuit: Reflex with resistance amplification
Batteries: Dry cell or storage
Antenna: Outdoor or loop
Loud Speaker: Built-in
Controls: Three
List Price: \$200

Manufacturer: BLUE SEAL MFG. CO., 1406 S. Michigan Blvd. Chicago, Ill.

Trade Name: Blue Seal tuned radio frequency
Circuit: Tuned radio frequency
Batteries: Storage
Antenna: Outdoor or indoor
Loud Speaker: Separate
Controls: Three
List Price: \$135

Manufacturer: G. BOISSONNAULT CO., INC. 365 Canal Place New York City

Trade Name: White-stone
Circuit: Tuned radio frequency
Batteries: Storage
Antenna: Outdoor or indoor
Loud Speaker: Separate
Controls: Three
List Price: \$35

BRONX RADIO EQUIP. CO., 687 Courtlandt Ave., New York City

Trade Name: Breco B. S-3
Circuit: Straight
Batteries: Storage
Antenna: Outdoor
Loud Speaker: Separate
Controls: Three
List Price: \$80

Trade Name: Breco B. R. 5

Circuit: Radio frequency detector and audio frequency
Batteries: Storage
Antenna: Outdoor or loop

Loud Speaker: Separate
Controls: Three
List Price: \$100

BROWN RADIO MFG. CO. 675 Wyoming Ave., Kingston, Pa.

Trade Name: Thorbred Console B-66
Circuit: Tuned radio frequency
Batteries: Storage or dry cell
Antenna: Outdoor
Loud Speaker: Built-in
Controls: Three
List Price: \$225

Trade Name: Thorbred Model B-88
Circuit: Tuned radio frequency

Batteries: Storage or dry cell
Antenna: Outdoor
Loud Speaker: Separate
Controls: Three
List Price: \$130

Trade Name: Thorbred Model B-77
Circuit: Tuned radio frequency

Batteries: Dry cell or storage
Antenna: Outdoor
Loud Speaker: Separate
Controls: Three
List Price: \$110

Manufacturer: CHELSEA RADIO CO., 150 5th St., Chelsea, Mass.

Trade Name: Chelsea No. 122
Circuit: Armstrong Regenerative 3-circuit
Batteries: Either
Antenna: Outdoor
Loud Speaker: Separate
Controls: 1
List Price: \$25

Trade Name: Chelsea Super-5
Circuit: 2 stages tuned radio frequency detector, 2 audio amplification
Batteries: Storage
Antenna: Outdoor
Loud Speaker: Separate
Controls: Three
List Price: \$50

Trade Name: Chelsea Console No. 130
Circuit: 2 stages tuned radio frequency, detector 2 audio amplification
Batteries: Storage
Antenna: Outdoor
Loud Speaker: Built-in
Controls: Three
List Price: \$125

Trade Name: Chelsea Super-6 tuned radio frequency
Circuit: 2 tuned radio frequency, detector 3 special audio amplifier
Batteries: Storage
Antenna: Outdoor
Loud Speaker: Separate
Controls: Three
List Price: \$60

Manufacturer: CONCERT RADIO-PHONE CO. 1938 Euclid Ave., Cleveland, Ohio

Trade Name: Concert Jr. Crystal Set
Circuit: Single slider
Batteries: None
Antenna: Outdoor
Controls: One
List Price: \$3.50

FREE two unusual RADIO CATALOGS

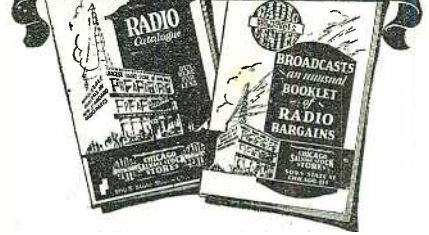

FOR "FANS"

OUR new 64-page Radio Catalog including all the best and latest Kits, Parts and Accessories for broadcast receiving sets. Lowest prices in the country.

FOR "HAMS"

NEW 32-page booklet of army and navy transmitting apparatus and miscellaneous specials for "hams" such as W. E. Choke Coils, Generators, Resistance Boxes, etc.

More than 1,000,000 fans and hams make our store their headquarters—get these books and find out why

Write for either or both



Dept. R. N. 6

509 South State Street, CHICAGO, ILL.

The Vacuum Tube Explained

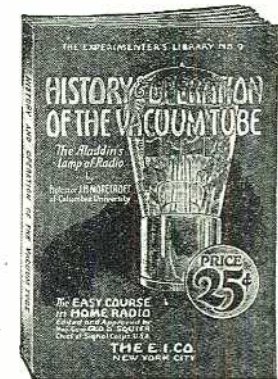

How it was invented, developed and its modern function in the radio receiver.

This book serves an interesting study of the fundamental principles, historical evolution, and practical application of the vacuum tube as used in radio apparatus of every description. Since the vacuum tube is one of the most important parts in the modern radio set, and has been largely responsible for making present-day radio entertainment possible, this book has been entirely devoted to the subject of that one particular instrument. It is written in simple everyday language with all technical terms thoroughly explained so as to make matters easily understood by everyone. 52 pages printed in legible type; 24 illustrations and diagrams; bound in two-color cover; size 5 1/2 x 7 1/2 inches.

PRICE 25c

Sold by all Reliable Radio and News Dealers

The E. I. Company
233 Fulton St., New York, N. Y.

E.I. Company

(Continued in November issue)

OPPORTUNITY AD-LETS

Follow these advertisements every month. Reliable advertisers from all over the country offer their most attractive specials in these columns.

Classified advertising rate twenty-two cents a word for each insertion. Ten per cent discount for 6 issues, 20 per cent discount for 12 issues. Name and address must be included at the above rate. Cash should accompany all classified advertisements unless placed by an accredited advertising agency. No advertisement for less than 10 words accepted.

Objectionable or misleading advertisements not accepted. Advertisements for the December issue must reach us not later than Oct. 1st.

CIRCULATION LARGER THAN THAT OF ANY OTHER RADIO PUBLICATION

EXPERIMENTER PUBLISHING CO., INC., 53 Park Place, New York, N. Y.

Agents Wanted

Agents Wanted in every city and town to sell standard radio apparatus. Attractive discounts given. If interested write us at once stating age and radio experience. Wilmington Electrical Specialty Co., Inc., 405 Delaware Ave., Wilmington, Delaware.

Big Money and fast sales. Every owner buys gold initials for his auto. You charge \$1.50; make \$1.35. Ten orders daily easy. Write for particulars and free samples. American Monogram Co., Dept. 123, East Orange, N. J.

Guaranteed Genuine Gold Leaf Letters anyone can put on store windows. Large profits, enormous demand. Free samples. Metallic Letter Co., 422 N. Clark, Chicago.

New Plan for Agents: Goods supplied on credit. Big line. Fine outfit free. No Money Needed. Write quick. Blair Laboratories, Dept. 59, Lynchburg, Va.

\$40.00 Suits for only \$23.50! Make big money taking orders from friends and neighbors. \$3.00 to \$5.00 an hour in spare time. \$75.00 to \$125.00 a week for full time. We supply handsome Svatow Outfit, large size samples and all latest styles in elegant leather case. Positively finest outfit ever furnished salesman. Write for yours at once and get started making big money right away. Address Dept. 193, James Oliver, Inc., 818 West Adams Street, Chicago.

New Wonderful Seller. Cost 10c, profit \$1.40, monogramming Autos. Experience unnecessary. Free samples. Worcester Monograms, 14131, Worcester, Mass.

Big Money—fast sales; everyone buys gold initials for their auto; sell \$1.50, profit \$1.44. Ten orders daily easy. Samples, information free. World Monogram, Dept. 27, Newark, N. J.

\$350.00 Monthly selling Radio Direct from factory. Wholesale prices. United Radio, Box 825-A, Gary, Indiana. Excellent opportunity for Radio Plan in each county as our representative. Good Pay—Pleasant Work. No investment—deposit required. Be first, immediately write for Prof. Manager, P. O. Box 121, Davenport, Iowa.

Agents—Our new Co-operative plan makes you a partner in our business and pays you profits, the same as stockholders; the most liberal plan in the United States today. \$25 to \$75 weekly easily made. B. & G. Rubber Co., Dept. 337, Pittsburgh, Pa.

Business Opportunities

Make \$100 Weekly in Spare Time. Sell what the public wants—long distance radio receiving sets. Two sales weekly pay \$100 profit. No big investment, no canvassing. Sharpe of Colorado made \$955 in one month. Representatives wanted at once. This plan is sweeping the country—write today before your county is gone. Ozarka, 813 Washington Blvd., Chicago.

Quick Sales, Big Profits, selling Little Wonder Radio Sets at \$2.00. Fully guaranteed to give wonderful results or money refunded. Great opportunity, write quick, territories limited. Send \$1.25 for sample and judge for yourself. Dept. 50, Ajax Products Co., 105 Chambers St., New York City.

Make Big Income operating a collection agency. No capital necessary. We teach you fully. Write Collection Instruction Institute, 311 Waverly, Syracuse, N. Y.

Chemistry

Learn Chemistry at home. Dr. T. O'Connor Sloane, noted educator and scientific authority, will teach you. Our home study correspondence course fits you to take a position as chemist. See our full page ad on page 539 of this issue. Chemical Institute of New York, 66 W. Broadway, New York City.

Correspondence Courses

For "Home Study Courses" (by mail), write Carnegie College, Rogers, Ohio.

Educational

Used Correspondence School courses save over half. Bargain catalogue 1000 courses free. Used courses bought. Students' Exchange, Dept. A, 47 West 42d St., New York.

Exchange

200-20,000 meter Receiver Radiotron \$23.00. Smith, 4416 Market, Philadelphia.

For Advertisers

24 Words—355 Rural Weeklies \$14.20. Admeyer, 4112-R Hartford, St. Louis.

Help Wanted

Men to build radio sets in spare time. Leon Lambert, 995-H Kaufman Bldg., Wichita, Kansas.

Detectives needed everywhere: large salaries; free particulars; write National Headquarters, 183 East 79th, New York.

Help Wanted (Continued)

All men-women 18-65, wanting to qualify for Government Positions, \$440-\$300 monthly, write Mr. Ozment, 251, St. Louis, Mo., immediately.

Detectives Needed Everywhere. Travel. Experience unnecessary. Write, George Wagner, former Government Detective, 1968 Broadway, N. Y.

Instruction

Learn Chemistry at Home. Dr. T. O'Connor Sloane, noted educator and scientific authority, will teach you. Our home study correspondence course fits you to take a position as chemist. See our full page ad on page 539 of this issue. Chemical Institute of New York, 66 W. Broadway, New York City.

Miscellaneous

Beautiful registered bull pups cheap. Bulldogs. 501 Rockwood, Dallas, Texas.

Pearls and Slugs. Pearl hunters should send their pearls and slugs by registered mail or express to Herbert H. Vertrees, Pearl buyer, Pittsfield, Ill.

Lightning Electrolyte. Charges storage batteries instantly. Make it yourself. Guaranteed formula \$5.00. Write for free circulars. Murphy, Chemist, Tujunga, Calif., Box D.

Motorcycles, Bicycles

Don't Buy a Bicycle Motor Attachment until you get our catalog and prices. Shaw Mfg. Co., Dept. 6, Gatesburg, Kansas.

Old Coins

United States 2c Bronze and Bargain Price List 10c. Arcy, Box 483, Muskegon, Okla.

Old Money Wanted

\$2 to \$500 each paid for hundreds of Old or Odd Coins. Keep all old money, it may be very valuable. Send 10¢ for New Illustrated Coin Value Book, 48¢. Guaranteed prices. Get posted. We pay Cash. Clarke Coin Company, 14 Street, LeRoy, N. Y.

Patent Attorneys

Inventors—Should write for our Free Guide Books and "Record of Invention Blank" before disclosing inventions. Send model or sketch of your invention for our Free Inspection and Instructions. Radio, Electrical, Chemical, Mechanical and Trademark experts. Terms reasonable. Victor J. Evans & Co., 922 Ninth, Washington, D. C.

Patents. Send drawing or model for examination and report as to patentability. Advice and booklet free. Highest references. Best results. Promptness assured. Watson E. Coleman, Patent Lawyer, 644 G Street, N. W., Washington, D. C.

Patents for Inventions. Long experience, highest grade work, rates reasonable, best references. Advice as to patentability. Wm. Ashler Kelly, 41 Park Row, New York.

Patent-Sense—As one of the oldest patent firms in America we give inventors, at lowest consistent charge, a service noted for results, evidenced by many well-known Patents of extraordinary value. Book, Patent-Sense, free. Lacey & Lacey, 631-F St., Washington, D. C. Estab. 1869.

Patents

Inventions Commercialized. Patented or unpatented. Write Adam Fisher Mfg. Co., 278 Bright, St. Louis, Mo.

Personal

Lonely Hearts—Exchange letters; make interesting new friends in our jolly club. Era Moore, Box 908, Jacksonville, Florida. Enclose stamp.

Lonesome—Join our club—make acquaintances everywhere. Big illustrated book with descriptions and photos, sent in plain wrapper for ten cents. Bonafide Co., Dept. 58, Kansas City, Mo.

Lonesome—Make friends everywhere through our Club. Write Eva Burchard, Box 75, Portland, Oregon, for particulars.

Radiumaet Removes Warts, Moles, Superfluous Hair, Coal, Powder and Tattoo Marks. Particulars sent free. Radiumaet Co., 1416 Cadwallader St., Philadelphia, Pa.

Printing Outfits and Supplies

Print your own cards, stationery, circulars, paper, etc. Complete outfits—\$8.85; Job Presses \$12, \$35; Rotary \$150. Print for others, big profit. All easy, rules sent. Write for catalog presses, type, paper, etc. Press Company, A-13, Meriden, Conn.

Radio

Boys! Don't Overlook This. The "Rasco" Baby Detector. Greatest detector ever brought out with inrolled base. Fully adjustable. See former advertisements in this publication, or our catalog. Detector with Galena Crystal, complete 50¢, the same detector with Radioactive Crystal, 75¢ prepaid. Send for yours today. Radio Specialty Company, 96-98 Park Place, New York City.

Attention!—50 Vacuum tube hook-ups. The greatest collection of vacuum tube circuits ever brought under two covers at such insignificant cost. These diagrams will be found in the great "Rasco" catalog, which contains raw materials and parts in a greater profusion than any other catalog. 15¢ in stamps, or coin, will bring the catalog to you. Radio Specialty Co., 96-98 Park Place, New York City.

Make Your "B" with Edison Elements. They last a lifetime. Pair 5 cents; welded, 7½ cents postpaid. Henry Chappelle, Woodburn, Ore.

Ivory Radio Panel: Grained white "Ivorylite" makes most beautiful set of all. Guaranteed satisfactory. Any size 3/16 in. thick, 3c per square inch. Sample free. Ivorylite Radio Panel Co., Dept. N, 3223 Ave. F, Port Worth, Texas.

Bargains Navy Receiving Tubes \$1.00. Storage Batteries 6 volts 80 amperes \$4.00, Edison Batteries \$3.50. 824 North Fifth, Philadelphia, Pa.

Edison Alkaline Storage "B" Battery elements. 90 volts \$5, 150 volts \$8. Instructions for assembling and charging with order. E. Parker, Putnam Street, Peabody, Mass.

Write Lambert first! Don't buy one until you've read "The Truth about Radio." Sent free. Write Leon Lambert, Wichita, Kansas.

Solid Mahogany Radio Cabinets for sale cheap. Seven by eighteen panel. Address "Factory," Ronda, N. C.

Wanted—A 500 watt Transmuting Station. Give description, service rendered, present condition and price. Box 255, Radio News.

Supersensitive Galena Crystals, pound \$1.00, prepaid. Alkemit, All-sensitive Crystals, 50c. Buskett, Joplin, Mo.

Salesmen Wanted

\$20 daily selling "World's Greatest Foot-Comfort" Shoes direct to men or boys. Quick sellers everywhere. Low prices. Just take orders, we mail shoes direct. Big cash profit and repeats. Territory protected. Best season now. Write quick, Dept. 231, Easy-Wear Shoe Co., Indianapolis, Ind.

Oil or Coal—"The Burning Question," interesting booklet, discusses high efficiency low priced residence oil burners. Copy free. Write E. L. Miller, Manufacturer Climax Burners, 53 Climax Bldg., Kansas City, Mo.

Skat Sales Agents Wanted. All or Part Time for Skat Hand Soap, Metal Polish, etc. Strictly Commission. The Skat Company, Hartford, Conn.

A Salesman wanted in every town or city within 25 miles of a broadcasting station to sell Radiogem, the complete radio receiving set that retails for \$2.50. With Radiogem there is nothing else to buy—the outfit includes the Radiogem receiving apparatus, 1,000 ohm phone, and aerial outfit. The cheapest radio outfit on the market—yet as practical as the most expensive. Big money to the right men. Send \$2.00 for sample outfit. The Radiogem Corp., 66-R West Broadway, New York City.

Scenery to Rent

Settings for Opera, Plays, Minstrels. Plush Drops. Address Amelia Grain, Philadelphia.

Song Writers

Songwriters: Let me furnish the music for your songs, guaranteeing you absolute satisfaction. Copyrights secured. Submit your scripts for estimate and free advice. Walter W. Newcomer, 1674 Broadway, New York.

Telegraphy

Telegraphy—Both Morse and Wireless taught thoroughly. Big salaries. Wonderful opportunities. Expenses low; chance to earn part. School established fifty years. Catalog free. Dodge's Institute, Cour St., Valparaiso, Ind.

Wanted to Buy

Full Value Paid for Old Gold, Jewelry, Watches, Diamonds, crowns, bridges, dental gold, silver, platinum, gold or silver ore; magnetic points, old false teeth. Packages returned if our offer is not satisfactory. United States Smelting Works (The Old Reliable) 39 So. State St., Dept. 15, Chicago, Ill.

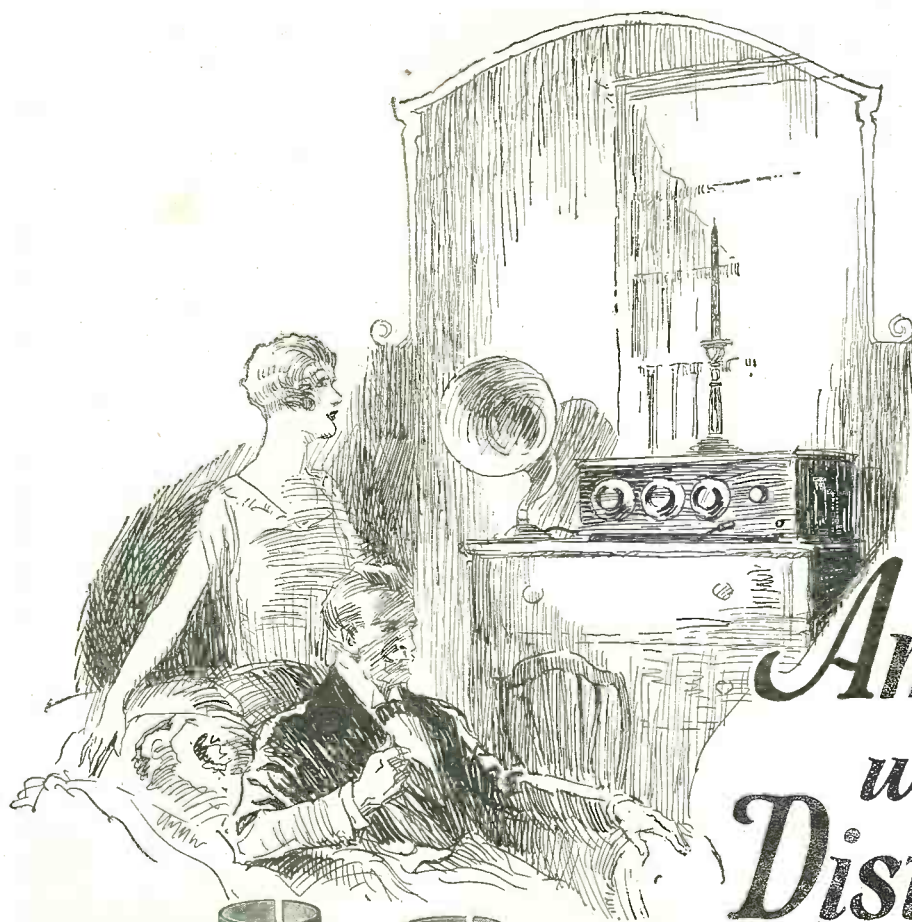

Amplifies without Distortion

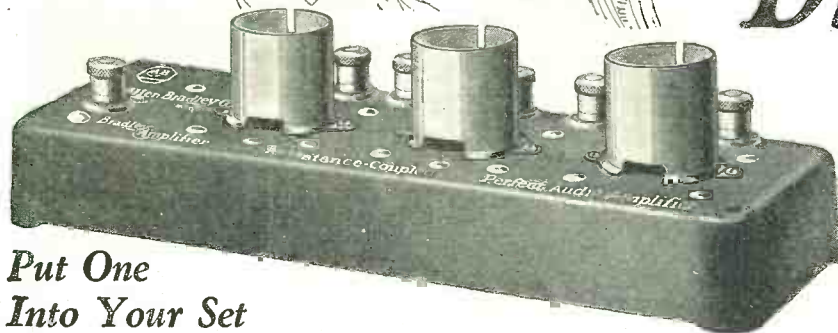

Put One Into Your Set

HAVE you been troubled with distortion, due to faulty audio-frequency transformers? If so, slip a Bradley-Amplifier into your set and experience a new thrill in radio reproduction. No special wiring is necessary, because the Bradley-Amplifier is wired, ready for instant use. Send for new booklet "Amplifies without Distortion" today! It explains, fully, the principles of audio frequency amplification and how to improve tone quality.

ALLEN-BRADLEY CO., 287 Greenfield Ave., Milwaukee, Wis.

THE latest Allen-Bradley contribution to better radio is the new Bradley-Amplifier, a marvelously compact three-tube audio amplifier of the resistance coupled type.

Aside from its faultless tone quality and perfect reproduction, the Bradley-Amplifier is amazingly small in size. All circuits, resistors, and condensers are securely soldered within the base, leaving no exposed parts.

Another outstanding feature is the use of Bradleyunits (Molded Resistors) which do not deteriorate with age nor are they affected by temperature and moisture. The Bradley-Amplifier requires no attention or adjustment.

Bradley-Amplifier

Resistance-Coupled

PERFECT AUDIO AMPLIFIER

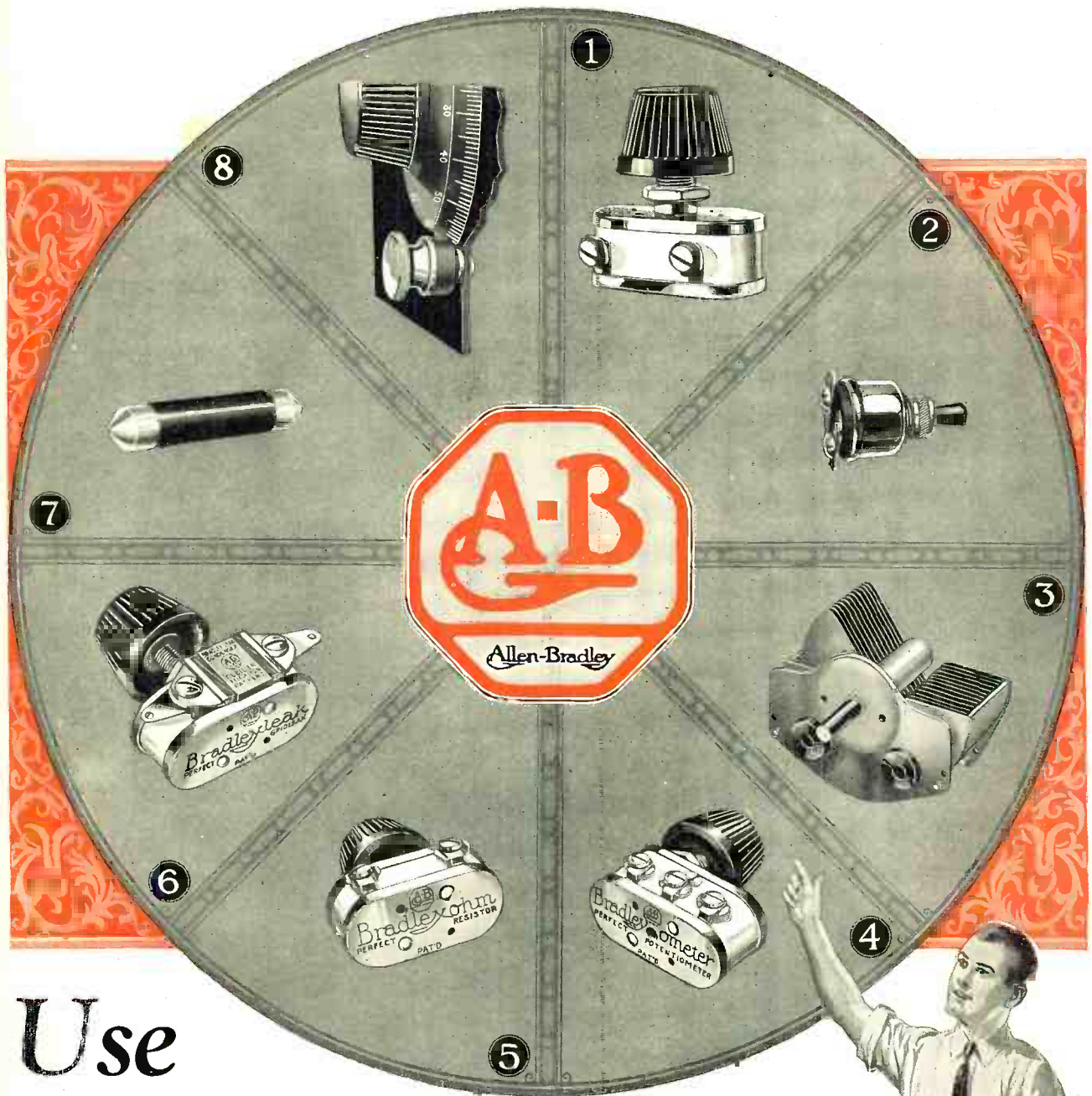

Use

Allen-Bradley Perfect Radio Devices for maximum selectivity and noiseless control

- 1—Bradleystat**—Noiseless Rheostat for ALL radio tubes.
- 2—Bradleyswitch**—Compact Switch for receiving sets.
- 3—Bradleydenser**—Low Loss Condenser for sharp tuning.
- 4—Bradleyometer**—Perfect Potentiometer for all circuits.
- 5—Bradleyohm**—Adjustable Resistor for every application.
- 6—Bradleyleak**—Adjustable Grid Leak of highest efficiency.
- 7—Bradleyunit**—Fixed Resistor for Resistance Amplifiers.
- 8—Bradleynier**—Vernier Knob, easily attached to any set.



ALLEN-BRADLEY CO.,
287 Greenfield Ave., Milwaukee, Wis.

Please send me your latest literature on the
complete Allen-Bradley line of Radio Devices.

Name

Address



It's a *genuine* UV-201-A
 only when it bears
 the name Radiotron
and the RCA mark



WD-11, WD-12, UV-199, UV-200, and
 UV-201-A are the type names of Radiotrons.
 They belong to Radiotrons only. To be sure
 you are buying the genuine, look for the name
 Radiotron and the RCA mark on the base.
 Then you are sure of quality.

Radio Corporation of America

Chicago

New York

San Francisco

Radiotron

REG. U. S. PAT. OFF.

AN RCA PRODUCT

Trolley Service restored in a jiffy!

CINCINNATI STREET RAILWAY
SPEEDS EMERGENCY WORK
WITH 2-WAY *Motorola* RADIO
and
SYLVANIA LOCK-IN TUBES

NO time lost in restoring service on the lines of the Cincinnati Street Railway Company! 2-way Motorola equipment maintains constant communication between headquarters and mobile equipment—5 tower trucks, 2 wreckers, 2 general-purpose trucks, 7 official and 5 supervisors' cars. Needed repairs are under way usually in a matter of seconds!

For a job as vital as this, Motorola has found it can depend on Sylvania Lock-In Tubes. These sturdy tubes stay firmly in place—unaffected by jolting and jarring—offer outstanding electrical advantages too. Connections are short and direct . . . there are no soldered joints, few welded ones. Getter located on top . . . leakage reduced by separating getter material from leads. See Sylvania Distributors, or write Radio Tube Division, Emporium, Pa.

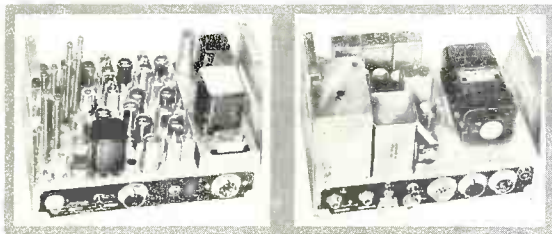

Transmitter and Receiving Unit used in Cincinnati Street Railway Company's mobile equipment, manufactured by Motorola, Inc., Chicago.

The famous Lock-In Tube's superiority makes it the ideal choice for equipment on the road, in the air, on the rails, marine radar, FM and television.



SYLVANIA ELECTRIC

MAKERS OF RADIO TUBES; CATHODE RAY TUBES; ELECTRONIC DEVICES; FLUORESCENT LAMPS, FIXTURES, WIRING DEVICES; ELECTRIC LIGHT BU



Service restoration gets under way without delay as equipment responds to dispatcher's instructions.



Headquarters can quickly direct the needed equipment to the scene of a tie-up.

Somewhat More Silent Than a TOMB!



It's Impossible to Hear a Mallory Control Operate!

Even super-sensitive meters, built for the U. S. Navy to inspect delicate electronic communication equipment, do not show an audible sound level when Mallory carbon controls are tested.

Mallory carbon controls give you totally silent operation—the tapers are smooth and accurate to assure maximum adjustment in the

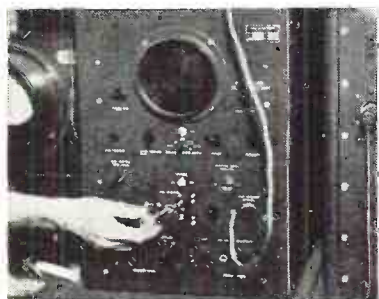

Meter used in the noise level test. Readings were taken on volume controls of all leading manufacturers. Mallory controls gave no audible sound, registered 22% below all others in inaudible sound vibrations.

proper ranges—the overall resistance values are uniform and the life of the control is the longest ever provided. This kind of quality keeps customers satisfied.

Mallory has given you so many "firsts" in the

field of radio-electronic replacement parts that you know Mallory products are the finest that can be produced! Sell them with confidence, install them with ease. The Mallory line of Volume Controls, Capacitors and Vibrators has been standardized; they are a profitable line to stock.

"Good Service for Good Business"

A business plan that will raise the earnings of radio-electronic servicemen. One important item in the plan is a unique system for following up your customers for repeat orders.

And there are ways of linking your name with the Mallory trade mark, to get the benefit of Mallory advertising. Better ask your distributor about it!



WHAT WILL MALLORY DO NEXT?

See Us at the Radio Parts Show

P. R. MALLORY & CO. Inc. **MALLORY**

CAPACITORS . . . CONTROLS . . . VIBRATORS . . .
SWITCHES . . . RESISTORS . . . RECTIFIERS . . .
VIBRAPACK* POWER SUPPLIES . . . FILTERS

*Reg. U. S. Pat. Off.

APPROVED PRECISION PRODUCTS

P. R. MALLORY & CO., Inc., INDIANAPOLIS 6, INDIANA