

CIRCULATION LARGER THAN THAT OF ANY OTHER RADIO PUBLICATION

RADIO NEWS

REG. U.S. PAT. OFF.

25 Cents

JUNE

Over 200
Illustrations

Edited by HUGO GERNSBACK

SHE WANTED
A RADIO



RADIO'S GREATEST MAGAZINE

EXPERIMENTER PUBLISHING COMPANY, NEW YORK, PUBLISHERS OF

SCIENCE and INVENTION

THE EXPERIMENTER

MOTOR CAMPER & TOURIST



Only Four Strings

a horse-hair bow, and a resonant box—yet under the hand and out of the soul of an artist what a world of ecstasy, of rare delight . . . of sadness, too, . . . comes from these simple instruments. *Only Bits of Metal*, glass encased, and an incoming antenna current delicate as a fairy footfall—yet in a Cunningham Radio Tube these combine to trap the artist's world of music and release it to eager millions. Both in the violin and in the Cunningham Tube it is quality of material, knowledge of design, and skill in manufacture which produce tones of almost uncanny purity.



SINCE 1915—
Standard for All Sets

Types C301A, C299, C300, C11, C12
In the Orange and Blue Carton

Price \$3.00 Each

Cunningham RADIO TUBES

Home Office:
182 Second Street
SAN FRANCISCO

R. J. Cunningham Inc.

CHICAGO
NEW YORK

Patent Notice: Cunningham tubes are covered by patents dated 2-18-08, 2-18-18, 12-30-13, 10-23-17, 10-23-17, and others issued and pending.

Tower



Tower Scientific Headset



Tower Meister Singer Speaker

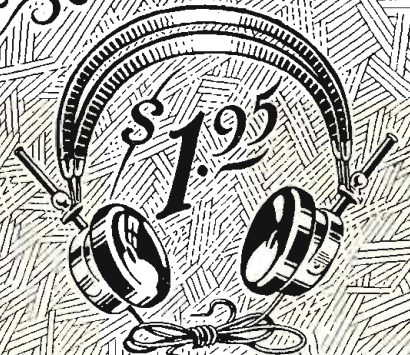

Little Spitfire Headset

The Greatest Values in Radio History

Show us a nationally advertised headset or loud speaker (with a list price not greater than ours) which is equal or better, in any respect, and we will send you a Tower Scientific Loud Speaker absolutely free.

On Sale from Coast to Coast. If your Dealer cannot supply you, order direct.

THE *Bob Morris* HOTEL Philadelphia



The first 100% Radio Equipped Hotel in the World. Tower Scientific Headsets were used exclusively



Little Spitfire Loud Speaker



Tower Scientific

THE TOWER MFG. CORPORATION
98 BROOKLINE AVE.
BOSTON MASS.

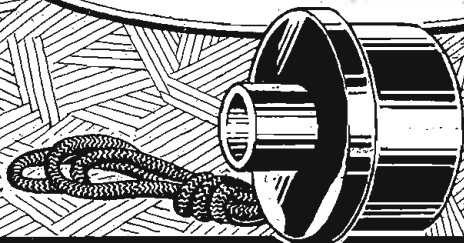

Tower's Scientific Phonograph Attachment

WORLD'S GREATEST LOUDSPEAKER VALUES

RADIO NEWS

Published by EXPERIMENTER PUBLISHING COMPANY, INC.
 Publishers of "Radio News," "Science and Invention,"
 "The Experimenter" and "Motor Camper & Tourist."
 Editorial and General Offices: 53 Park Pl., New York City
 H. GERNSBACK, President. S. GERNSBACK, Treasurer
 R. W. DEMOTT, Secretary.
 MEMBER: AUDIT BUREAU OF CIRCULATIONS

VOLUME 6

CONTENTS
JUNE, 1925

NUMBER 12

In Our Next Issue

Make Your Set Uncontrolled.

By Sidney Finkelstein.

The first of a series of comprehensive articles on the design of single-control receivers, covering all types and varieties of sets. If you would follow the latest development of radio, make your set to use only one control.

* * *

The Latest: A Vacuum-less Vacuum Tube.

By H. G. Silbersdorf.

At last, the ultra in tubes has been designed—a "vacuum tube" in the open air! A full description of the design and the story of its development is fully described by Mr. Silbersdorf.

* * *

How to Measure Gravitational Attraction with a Vacuum Tube.

By C. B. Bazzoni, Professor of Experimental Physics at the University of Pennsylvania.

Another of Mr. Bazzoni's interesting articles describing in perfectly understandable language a novel and very interesting use of the ever-prolific vacuum tube.

* * *

What Radio Manufacturers and Broadcasters Think of the 150-Meter Band for Broadcasting.

Following the article in the present issue forecasting the opening of the broadcast band of waves to 150 meters, RADIO NEWS will publish a symposium of the views of the first minds in the art.

In This Issue

- | | |
|--|--|
| Editorial
By Hugo Gernsback 2205 | The Radio Beginner—Buying a Radio Set
By A. P. Peck 2246 |
| Broadcast Stations on 150 Meters
By W. B. Arvin 2206 | Design Your Own Low Loss Coils
By Sylvan Harris 2249 |
| The Radio Micrometer
By C. B. Bazzoni 2208 | Unicontrol for Regenerative Sets
By Sander Stern 2250 |
| What Is the Bureau of Standards Doing?
By D. J. Hall 2210 | High Plate Voltage for Receiver Tubes
By D. C. Wilkerson 2251 |
| The Life and Works of Lee DeForest 2212 | Selector—A Tuner for the City
By A. A. Kubiak 2252 |
| How to Identify the Enemies of Good Reproduction
By Edgar H. Felix 2214 | Harmonizing Ideals and Practice
By Joseph Riley 2253 |
| The Inventions of Reginald A. Fessenden 2216 | The Compare Radio Typewriter
By Dr. Otto Poble 2254 |
| Broadcasting in 1912
By G. C. B. Rowe 2219 | Theory and Design of Loop Antenna
By E. E. Laufer 2256 |
| Discovering Unexplored Ultra Frequencies
By John L. Reiwartz 2220 | With the Amateurs—Keep a Laboratory
By Jay Hollander 2257 |
| Un-Crowding the Air
By William A. Bruno 2222 | 2BRB, One of the Second District's Best 2258 |
| A Midsummer Night's Scheme
By Robert Francis Smith 2233 | Radio Wrinkles 2259 |
| International Radio 2234 | Radiotics 2261 |
| History of Radio Invention
By A. H. Morse 2236 | Correspondence From Readers 2262 |
| Theories of Radio Wave Propagation
By Leon L. Adelman 2238 | Standard Hook-ups 2263 |
| The McCaa Static Eliminator
By Edward B. Patterson 2241 | New Radio Patents
By John B. Brady 2265 |
| How a Detector Detects
By Vernon C. MacNabb 2244 | Radio News Laboratories 2266 |
| | I Want to Know... 2268 |

Index to Advertisers.....2196

RADIO NEWS is published on the 10th of each preceding month. There are 12 numbers per year. Subscription price is \$2.50 a year in U. S. and possessions, Canada and foreign countries, \$3.00 a year. U. S. Coin as well as U. S. Stamps accepted (no foreign coins or stamps). Single copies, 25 cents each. A sample copy will be sent gratis on request. Checks and money orders should be drawn to order of EXPERIMENTER PUBLISHING CO., INC.

All communications and contributions to this journal should be addressed to Editor, RADIO NEWS, 53 Park Place, New York, N. Y. Unaccepted contributions cannot be returned unless full postage has been included. All accepted contributions are paid for on publication. A special rate is paid for novel experiments; good photographs accompanying them are highly desirable.

RADIO NEWS, Monthly. Entered as second-class matter at the Post Office, at New York, N. Y., with additional entry at Long Island City, N. Y., under the act of March 3, 1879. Entered on Sept. 15, 1924, at San Francisco, Calif. Title registered U. S. Patent Office. Copyright, 1923, by E. P. Co., Inc., New York. The Experimenter Publishing Co., 53 Park Place, New York. The Contents of this magazine are copyrighted and must not be reproduced without giving full credit to the publication. Copyright in Germany. Reproduction of articles in Germany is reserved for Radio, Berlin 42.

New York City
 General Advertising Dept.
 53 Park Place

Western Advertising Representatives
 Finucan & McClure
 720 Cass St., Chicago, Ill.

Pacific Coast Advertising Representatives
 A. J. Norris Hill Co.
 Hearst Bldg., San Francisco, Calif.

Kansas City Advertising Representatives
 George F. Dillon
 Republic Building, Kansas City, Mo.

RADIO NEWS is for sale at all newsstands in the United States and Canada, also at The International News Co., Ltd., Bream's Building, London, E. C. 4, England, and at Brentano's, 37 Avenue de l'Opera, Paris.

HOW TO SUBSCRIBE FOR RADIO NEWS. Send your name, address and remittance to Experimenter Publishing Co., 53 Park Place, New York. Mention the name of the magazine you are ordering. We also publish SCIENCE AND INVENTION, the EXPERIMENTER and MOTOR CAMPER & TOURIST. Write clearly. RATES AND TERMS. The subscription rate for RADIO NEWS is \$2.50 per year. (12 numbers). When remitting do so by check, money order, or registered letter if cash is enclosed. Avoid sending cash through the mail if possible. Subscriptions for less than one year are not accepted. Subscription may be made in combination with SCIENCE AND INVENTION or the EXPERIMENTER.

POSTAGE. We prepay postage in all parts of the United States, Mexico and island possessions. For foreign or Canadian subscriptions we require 50 cents in addition to the subscription price for additional postage charges.

CHANGE OF ADDRESS. Notify us as far in advance as possible. It requires several weeks to make an address change on our records. Always write clearly. ON EXPIRATION of your subscription we enclose a renewal blank in our last number to you; we stop our delivery to you on expiration.

Inherent Selectivity

THE inherent selectivity of each tuned stage in the Synchrophase is maintained even when the set is operated close to a powerful station.

The reason lies in the *Binocular Coils*—an exclusive Grebe feature. They have no external field to pick up interfering signals directly in the detector and intermediate stages. A tuning barrier is set up that prevents any but the desired station coming through.

Binocular Coils, with *S-L-F* (straight line frequency) *Condensers* and *Volume Control*, place the Synchrophase in the front rank of receivers.

Ask your dealer for a demonstration or write us for full information

A. H. Grebe & Co., Inc.

Van Wyck Boulevard, Richmond Hill, N.Y.
Western Branch: 443 So. San Pedro Street, Los Angeles, Cal.

This company owns and operates station WAHG

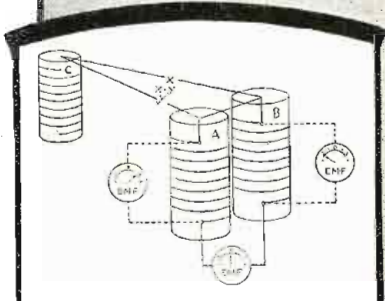

How the Binocular Coils Balance Each Other

A typical arrangement of Binocular Coils, as used in the Synchrophase receiver, is shown in the sketch.

"A" and "B" are two similar coils connected in series or parallel in such a manner that their electromagnetic fields are opposing each other.

When a source of electromagnetic field is radiated from an exterior source, such as coil "C," we can assume that an E.M.F. of +2 units value is induced in coil "A" and an E.M.F. of -2 units is induced in coil "B." Therefore, "A" and "B," being connected in the proper manner, the +2 units and the -2 units will counterbalance each other and the resulting E.M.F. across the terminals of the whole inductance will be zero.



THE GREBE SYNCHROPHASE

— TRADE MARK —



All Grebe apparatus is covered by patents granted and pending.

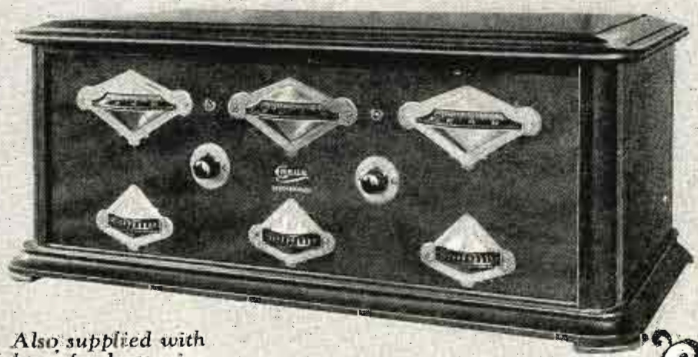

Also supplied with base for batteries

That which has inherent worth never loses its value.

Doctor M



INDEX TO ADVERTISERS

	Page		Page		Page
A					
Acme Apparatus Co.....	2275	Dey's Radio Service.....	2325		
Alden Mfg. Co.....	2314	Diamond Elec. Spec. Corp.....	2318		
All-American Radio Corp.....	2308	Dongan Electric Mfg. Co.....	2321		
Allen-Bradley Co.	2328	Don Mac Co., Inc.....	2308		
American Bosch Magneto Corp.....	2300	Dubilier Condenser & Radio Corp.	2288		
American Electric Co.....	2309	Duplex Condenser & Radio Corp.	2292		
American Hard Rubber Co.....	2272	Durkee-Thomas Products Co.....	2282		
Amplion Corporation of America, The	2314	E			
Amsco Products, Inc.....	2280-2318-2323	E. I. Co., Inc., The.....	2278-2298		
Andrews Radio Co.....	2313	E-Z Toon Radio Co.....	2284		
Armley Radio Corp.....	2319	Eagle Radio Co.....	2323		
Arrow Battery Co.....	2318	Economy Clothing Mfg. Co.....	2298		
Atlantic & Pacific Radio Corp., 2294-2300		Electric Service Supplies Co.....	2302		
Automatic Electrical Devices Co., The	2309	Electric Specialty Co.....	2296		
B					
Bakelite Corp.	2323	Elgin Radio Supply Co.....	2311		
Baldwin Pacific & Co.....	2327	Elite Stationery Co.....	2276		
Barawik Co., The.....	2297	Eric Fixture Supply Co.....	2315		
Barkleew Electric Mfg. Co.....	2320	Evans & Co., Victor J.....	2312		
Belden Mfg. Co.....	2293	Experimenters Information Service, Inc.	2309		
Biltmore Radio Co., The.....	2327	F			
Black Brothers, Inc.....	2320	Fahnestock Electric Co.....	2286		
Bluebird Tube Co.....	2306	Fansteel Products Co., Inc.....	2279		
Bodine Electric Co.....	2315	Ferbend Electric Co.....	2274		
Boice, W. B. & J. E.....	2300	Formica Insulation Co., Inc.....	2289		
Brady, John B.....	2319	Freshman Co., Inc., Chas., 2272-2280-2306			
Brandes, Inc., C.....	2325	Frost, Herbert H.....	2274		
Braunston, Inc., Chas. A.....	2284	G			
Breakers, The.....	2288	Golden-Leutz, Inc.	2317		
Bremer-Tully Mfg. Co.....	2315	Gould Storage Battery Co.....	2298		
Bristol Co., The.....	2282	Grebe & Co., Inc., A. H.....	2195		
Brown & Co., Thos.....	2319	H			
Brownlie, Roland	2308-2322	Hammarlund Mfg. Co.....	2280		
Buscher Co., C. A.....	2325	Harvard Radio Laboratories.....	2318		
C					
California Radio Minerals.....	2323	Hayden Radio & Research Co., A. C.	2286		
Cannon & Miller Co., Inc.....	2294	Heath Radio & Electric Mfg. Co.	2286		
Carter Radio Co.....	2280	Henninger Radio Mfg. Co.....	2314		
Chemical Institute of New York, Inc.	2303	Hommel & Co., Ludwig.....	2274		
Chicago Electric Devices Co.....	2306	Hudson-Ross	2278-2286-2302-2314		
Chicago Salvage Stock Store.....	2276	Hull & Co., S. W.....	2320		
Cleveland Engineering Labs. Co., The	2321	I			
Conrad Co., The, 2286-2290-2310-2322		Indian Motor Cycle Co.....	2306		
Continental Fibre Co., The.....	2272	International Correspondence Schools	2323		
Coyne Electrical School.....	2322	J			
Crescent Radio Supply Co.....	2323	Jefferson Electric Mfg. Co.....	2305		
Crosley Radio Corp., The.....	2285	Jewell Electrical Instrument Co.	2284		
Cruver Mfg. Co.....	2318	Jones Radio Mfg. Co., Inc., Jos. W.	2300		
Cunningham, Inc., E. T., Inside Front Cover		K			
D					
D X Instrument Co.....	2320	K Electric Co.....	2302		
Daven Radio Corp.....	2320	Karas Electric Co.....	2325		
Dayton Fan & Motor Co., The.....	2282	Kellogg Switchboard & Supply Co.	2276		
De Jur Products Co.....	2325	Kilbourne & Clark Mfg. Co.....	2282		
E					
L					
M					
N					
O					
P					
R					
S					
T					
U					
V					
W					
X-Y-Z					
K					
L					
M					
N					
O					
P					
R					
S					
T					
U					
V					
W					
X-Y-Z					
K					
L					
M					
N					
O					
P					
R					
S					
T					
U					
V					
W					
X-Y-Z					
K					
L					
M					
N					
O					
P					
R					
S					
T					
U					
V					
W					
X-Y-Z					
K					
L					
M					
N					
O					
P					
R					
S					
T					
U					
V					
W					
X-Y-Z					
K					
L					
M					
N					
O					
P					
R					
S					
T					
U					
V					
W					
X-Y-Z					
K					
L					
M					
N					
O					
P					
R					
S					
T					
U					
V					
W					
X-Y-Z					
K					
L					
M					
N					
O					
P					
R					
S					
T					
U					
V					
W					
X-Y-Z					
K					
L					
M					
N					
O					
P					
R					
S					
T					
U					
V					
W					
X-Y-Z					
K					
L					
M					
N					
O					
P					
R					
S					
T					
U					
V					
W					
X-Y-Z					
K					
L					
M					
N					
O					
P					
R					
S					
T					
U					
V					
W					
X-Y-Z					
K					
L					
M					
N					
O					
P					
R					
S					
T					
U					
V					
W					
X-Y-Z					
K					
L					
M					
N					
O					
P					
R					
S					
T					
U					
V					
W					
X-Y-Z					
K					
L					
M					
N					
O					
P					
R					
S					
T					
U					
V					
W					
X-Y-Z					
K					
L					
M					
N					
O					
P					
R					
S					
T					
U					
V					
W					
X-Y-Z					
K					
L					
M					
N					
O					
P					
R					
S					
T					
U					
V					
W					
X-Y-Z					
K					
L					
M					
N					
O					
P					
R					
S					
T					
U					
V					
W					
X-Y-Z					
K					
L					
M					
N					
O					
P					
R					
S					
T					
U					
V					
W					
X-Y-Z					
K					
L					
M					
N					
O					
P					
R					
S					
T					
U					
V					
W					
X-Y-Z					
K					
L					
M					
N					
O					
P					
R					
S					
T					
U					
V					
W					
X-Y-Z					
K					
L					
M					
N					
O					
P					
R					
S					
T					
U					
V					
W					
X-Y-Z					
K					
L					
M					
N					
O					
P					
R					
S					
T					
U					
V					
W					
X-Y-Z					
K					
L					
M					
N					
O					
P					
R					
S					
T					
U					
V					
W					
X-Y-Z					
K					
L					
M					
N					
O					
P					



Big Radio Book

Send For it At Once

Send For This Sensational Radio Bargain Book-FREE

Order Direct From This Page! Save About One-half!

Compare our prices with others. Only highest grade nationally known **GUARANTEED** parts. **OUR GUARANTEE PROTECTS YOU.** Money cheerfully refunded if you are not satisfied. Be sure to write your order and state prices plainly. Send post office or express money order or bank draft for total amount to insure prompt shipment. **ALL PRICES ON THIS PAGE INCLUDE SHIPPING CHARGES RIGHT TO YOUR DOOR** if you are east of the Rocky Mountains. Refer to any bank or commercial agency regarding our reliability. If your favorite circuit is shown here, order direct from this ad. No skill required to build your own radio with Randolph parts. Panels are all drilled. Instructions are simple and complete. Everything comes ready to assemble. Order direct! All shipping charges prepaid.

THIS 5-TUBE SET \$39.50

FULLY BUILT AND WIRED COMPLETE IN DARK HEAVY MAHOGANY CABINET OF BEAUTIFUL DESIGN

The Biggest 5-Tube Value on the Market

which will bring in all distant stations on the loud speaker in clear loud tones. A value of three times the price. Shipped on a guarantee of satisfaction or money back. A wonder set constructed on the new principle that requires no neutralizers and is self-balanced. Special features are low-loss coils, engraved bakelite panel, distortionless transformers and pure bakelite sockets. Wiring of the latest loose safety type. Perfect logging of stations. The set alone, shipped prepaid, is.....

\$39.50

This Set with All Accessories, Including American Bell Loud Speaker, with adjustable unit, 5 R.C.A. UV201-A Tubes, 2 45-volt "B" batteries, 1 6-volt 90 amp. hour storage battery, complete antenna equipment, including approved lightning arrester, shipped prepaid, east of the Rocky Mountains.....

\$81.30

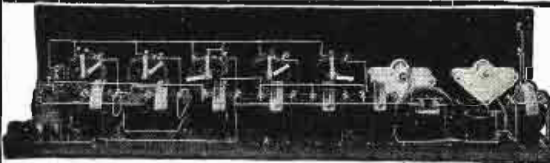

COMPLETE PARTS FOR 8-TUBE SUPER-HETERODYNE

- 2 23-Plate Duplex or Laboratory Type Low Loss Condensers
 - 3 Remler or Columbia Intermediate Frequency Transformers
 - 1 Remler or Columbia Tuned Circuit Transformer
 - 1 Special Oscillator Coupler
 - 1 Midget Condenser
 - 8 Bakelite Sockets
 - 2 Thordarson or Columbia A. F. Transformers
 - 1 Connecticut Filament Switch
 - 2 Bakelite 6-ohm Rheostats
 - 2 Bakelite 30-ohm Rheostats
 - 1 Bakelite Potentiometer, 400 ohms
 - 1 Carter Double Circuit Jack
 - 1 Dubilier 1 mfd. Condenser
 - 1 .006 Mica Condenser
 - 1 .0005 Mica Condenser and 2 megohm Grid Leak
 - 3 .0025 Mica Condensers
 - 10 Binding Posts
 - 1 .00025 Mica Condenser
 - 1 Bakelite Terminal Strip for Binding Posts
 - 1 Multicord Cable for connecting batteries
 - 1 7x30x1/4 Drilled Bakelite Panel
 - 1 Baseboard
 - 35 ft. Hook-up Wire
 - 2 4-in. Bakelite Dials
 - 2 4 1/2-volt C Batteries
- Complete wiring diagrams, base board layout, blue-prints and instructions.

\$52.75

- #### COMPLETE PARTS FOR ACME 1-Tube REFLEX \$17.45
- #### ACME 4-Tube REFLEX \$39.85

with Genuine Acme parts as specified, drilled bakelite panel and full wiring diagram.



COMPLETE PARTS FOR 5-TUBE NEUTRODYNE RECEIVING SET

Genuine Hazeltine Licensed Fada, or other Genuine Licensed Parts

- 1 7x24x1/4 Drilled Panel
- 2 Thordarson or Columbia Audio Transformers
- 3 4-in. Bakelite Dials
- 2 Precision Jacks
- 1 Bakelite Rheostat, 20-ohm
- 1 Bakelite Rheostat, 6-ohm
- 1 Bakelite Binding Post Strip
- 7 Marked Binding Posts
- 1 Grid Leak and Condenser
- 5 Bakelite Sockets
- 1 .001 Condenser
- 1 .006 Mica Condenser
- 35 feet Hook-up Wire
- 1 Kit consisting of 3 Hazeltine Licensed Neutrodyne and 2 Neutrodyne Transformers and
- 1 Baseboard
- 3 Bezels
- Complete blue-prints and working diagrams.

\$33.45

COMPLETE PARTS FOR 5-TUBE IMPROVED COCKADAY RECEIVING SET WITH RESISTANCE COUPLED AMPLIFICATION

As designed by L. M. Cockaday. Including drilled panel and wiring diagram, complete, ready to wire.

\$39.65



COMPLETE PARTS FOR 3-TUBE COCKADAY RECEIVING SET

- 1 Cockaday Coil
- 2 23-Plate Hy-Grade Cond.
- 1 Bakelite Rheostat, 6-ohm
- 2 Bakelite Rheostat, 30-ohm
- 3 Bakelite Sockets
- 1 high ratio Columbia or Thordarson Transformer
- 1 Single Circuit Jack
- 1 low ratio Columbia or Thordarson Transformer
- 2 Double Circuit Jacks
- 2 3-in. Bakelite Dials
- 1 Grid Leak and Mica Cond.
- 7 Switch Points. 2 Stops.
- 1 Bakelite Binding Post Strip
- 7 Binding Posts
- 1 7x21x1/4 In. Drilled Bakelite Panel
- 3 Bezels
- 1 Baseboard
- 1 Switch Lever
- 24-ft. Hoop-up Wire
- Complete blue-prints and wiring diagrams.
- 1-Tube Set

\$18.55

\$10.10

Easy to Build Your Own Radio Set
All complete parts for sets on this page consist of standard advertised guaranteed parts and include drilled bakelite panels and wiring diagrams for easy set construction. Everything guaranteed on money-back basis. All transportation charges paid. **Don't forget!** Only genuine guaranteed parts used. Lack of space does not permit us to itemize individual parts, but you are fully protected by our money-back guarantee. **Our Service Division is behind you.**

FREE BIG MONEY SAVING RADIO CATALOG
containing a thousand bargains of everything on radio—parts, supplies, complete parts for sets, complete sets, etc., also a mine of very latest information on all different circuits, complete list of broadcasting stations, and other valuable, up-to-the-minute radio data. Send your name and address on a card or letter. Also the names of a few friends. We will send catalog free.

Free Service Department
Our radio engineers will help you solve all your radio problems, and furnish up-to-date information on set construction, operation and improvement. This service is free to our customers.

Genuine Radio Corporation Tubes UV201-A, UV199, WD12 or WD11	\$ 2.69
Home Charger, 6-volt	12.85
Soldering Iron	.95
Solderal Tube	.19
Approved Lightning Arrester	.35
Cockaday Coils	1.59
Electing Condensers, per set	.59
Harkness Coils, per set	1.95
Hydrometer, Best Quality	.44
Battery Meters, 0 to 50 volts	.89
Baldwin Loud Speaker	19.95
Brandes Table Talker	8.45
Atlas Loud Speaker	19.95
Multiple Four Phone Plug	.89
Two Phone Plug	.24
Complete Antenna Outfit, including Lightning Arrester	2.05
Bakelite Moulded Variometer	3.25
Low Loss Condensers:	
17-plate	\$1.27
23-plate	1.42
43-plate	1.79
Bakelite Rheostats:	
6-ohm	\$0.35
30-ohm	.38
Amperite	
For all tubes	\$0.94
Bakelite Dials:	
2-inch	\$0.26
3-inch	.35
4-inch	.48
Composition Dials:	
2-inch	\$0.13
3-inch	.17
4-inch	.29
Accuratune Dials	\$3.14
Audio Transformers	
Thordarson:	
3 1/2 to 1	\$3.25
6 to 1	3.65
Acme	3.95
Columbia:	
3 1/2 to 1	\$3.79
6 to 1	3.89
American Bell:	
3 1/2 to 1	\$2.45
6 to 1	2.79
Randolph Special:	
3 1/2 to 1	\$1.89
6 to 1	2.16
Randolph Special	
Headphones	\$2.24

RANDOLPH RADIO CORPORATION
159 North Union Ave. Dept. 446 Chicago, Illinois

RADIO NEWS READERS' BUREAU

Time and Postage Saver

IN every issue of RADIO NEWS you undoubtedly see numerous articles advertised about which you would like to have further information. To sit down and write an individual letter to each of these respective concerns, regarding the article on which you desire information, would be quite a task.

As a special service to our readers, we will write the letters for you, thus saving your time and money.

Just write the names of the products about which you want information, and to avoid error the addresses of the manufacturers, on the coupon below and mail it to us.

If the advertiser requires any money or stamps to be sent to pay the mailing charges on his catalogue or descriptive literature, please be sure to enclose the correct amount with the coupon.

We will transmit to the various advertisers your request for information on their products.

This service will appear regularly every month on this same page in RADIO NEWS.

If there is any Manufacturer not advertising in this month's issue of RADIO NEWS, from whom you would like to receive literature, write his name, address and the product in the special section of the coupon below.

TEAR ALONG THIS LINE

READERS' SERVICE BUREAU,
Experimenter Publishing Co., Inc., 53 Park Place, New York, N. Y.

RN-6-25

Please advise the firms listed below that I would like to receive detailed information on their product as advertised in the issue of RADIO NEWS.

 **DO NOT USE THIS COUPON FOR TECHNICAL QUESTIONS**

NAME	ADDRESS (Street — City — State)	List here specific article on which you wish literature.	If Catalogue of complete line is wanted, check in this column
.....
.....
.....
.....
.....
.....
.....
.....

Use this space if you desire information from a manufacturer whose advertisement does not appear in this month's issue.

NAME	ADDRESS (Street — City — State)	
.....
.....
.....

Your own name here

If you are dealer check here. Address

City State

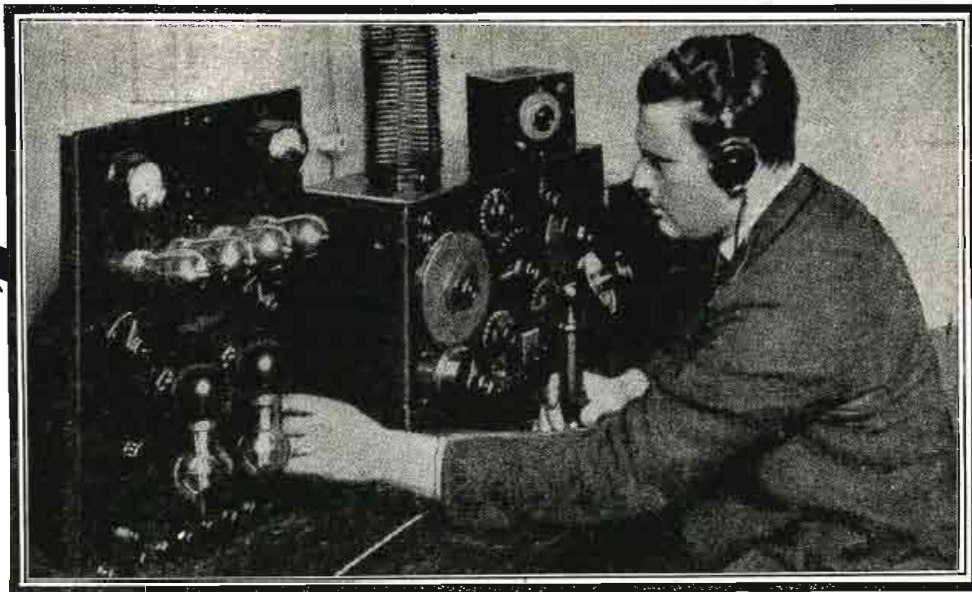

More Money For You in RADIO

There's \$50 to \$200 a Week for YOU In This High Paying Profession. Easy to Learn At Home In Spare Time

THE amazing expansion of Radio has opened up hundreds of wonderful new positions on land and sea. Big salaries, fascinating, easy work, short hours, and a wonderful future are offered to ambitious men who get into Radio now.

Take advantage of these wonderful opportunities to step into a big paying position in this great new field. You can stay at home and work up to a position paying up to \$10,000 a year, or Radio offers you an opportunity to travel and see the world, with all expenses paid, and a fine salary besides. One of our recent graduates secured a position one week after graduating, paying a salary of \$300 per month. Hundreds of others report equal success.

design Radio sets; to make new Radio improvements; to manufacture Radio Equipment and to install it; to maintain and operate great broadcasting stations and home Radio sets; to repair and sell Radio apparatus; to go into business for themselves; to operate aboard ship and at land stations.

You can easily and quickly qualify in your spare time at home through the help of the National Radio Institute, first school to teach Radio successfully by mail, established 1914. No previous experience or training needed. Prominent Radio Experts will help you in every problem, giving you personal attention.

Instruments and diagrams furnished free with the course make the study thoroughly practical at home. The same plan that has already helped hundreds of our graduates to real success and real money in Radio is open to you.

others. Read about the opportunities open now — the different kinds of work — the salaries paid. Write today for our 32-page book that tells how

America's biggest Radio correspondence school (government recognized) can teach you to become a Certified Radiotrician in your spare time. Mail the coupon or write a letter NOW.

Here's What You Get!

1. Personal individual instruction.
2. Unlimited consultation service.
3. Free employment service for life.
4. Diploma upon graduation.
5. Junior Radiotrician card given after first few lessons, enables you to get spare time Radio work. Your course with N. R. I. pays its own way.
6. Free receiving sets furnished with the course.
7. Instruments for learning are furnished free with course.
8. Special price for prompt enrollment now and for a limited time.

The most complete practical Radio Course in the world.

Easy to Learn Radio at Home

Thousands of Certified Radiotricians are wanted to

Send for FREE BOOK

No other field today offers such great opportunities as Radio. Take your choice of the many wonderful openings everywhere. Prepare now to step into the most interesting and best paid profession today. Start at once, and advance with the

From \$15 to \$80 a Week

Before I enrolled with you I was making \$15 a week on a farm. Now I earn from \$2,080 to \$1,420 a year. And the work is a hundred times easier than before. Since graduating a little over a year ago, I have earned almost \$3,000 and I believe the course will be worth at least \$100,000 to me.
(signed) Geo. A. Adams, Esmaqua, Pa.

Doubles Salary

I can very easily make double the amount of money now than before I enrolled with you. Your course has benefited me approximately \$3,000 over and above what I would have earned had I not taken it.
T. Winder, Grand Junction, Col.

Pay Increases Over \$100 a Month

I am averaging anywhere from \$75 to \$150 a month more than I was making before enrolling with you. I would not consider \$10,000 too much for the course.
(signed) A. N. Long, Greensburg, Pa.

National Radio Institute
Dept. 13HB, Washington, D. C.

National Radio Institute, Dept. 13HB,
Washington, D. C.

Without obligation send me your book, "Rich Rewards in Radio," which tells all about the opportunities in Radio. How spare time study at home will qualify me quickly as a Certified Radiotrician so I can get one of these splendid positions, and how your Employment Service helps me to secure a big pay job. (Please write plainly.)

Name..... Age.....
Street.....
City..... State.....



Somerset

1926
MODEL

\$60⁰⁰

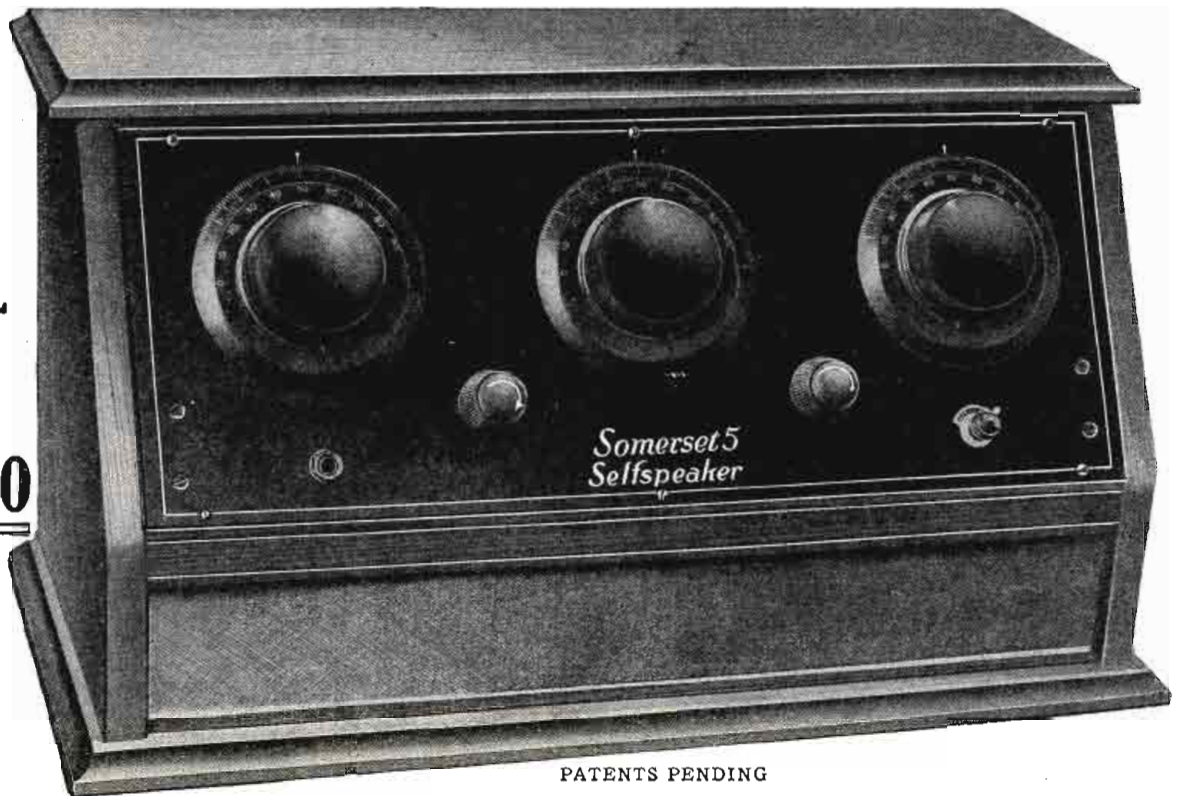

PATENTS PENDING

Somerset
Model 5
Self-
Speaker

The Ultimate in radio frequency receivers Somerset Self-Speaker

WITH SELF CONTAINED LOUDSPEAKER

There are other radio receivers as good as Somerset but they cost more. There are other radio receivers at the same price as the Somerset—but the quality is lower.

We do not claim to make the best receivers nor the cheapest receivers—for both of these are doubtful distinctions.

But we do believe we are the first to introduce a complete line of distinctively high quality, cabinet-enclosed radio receivers at prices which the average purchaser can afford.

We do believe we are pioneers in the field of honest prices for good design, good material and good workmanship—in the field of full value radio receivers.

TRUTH IN RADIO This is the Somerset policy; to give the radio buying public, so long confused and disappointed by extravagant and misleading claims, the assurance of honest value for every dollar spent.



Self Speaker

Trademark Reg. U. S. Pat. Off.



The only 5 tube Radio Frequency Receiver with self-contained loud speaker

Every now and then someone brings forth an idea of such obvious value that its merit is instantly recognized and everyone wonders why it wasn't done before. This is exactly the reception that has been accorded the SOMERSET SELF SPEAKER—the perfect Tuned Radio Frequency set.

We offer this SOMERSET SELF SPEAKER to the discriminating public, knowing full well the public's demands. This is the only five tube receiving set on the market that is sold as a complete unit including built-in loud speaker. It is the ultimate result of painstaking endeavor to offer something worth while.

Briefly, its specifications cover only standard parts and material: Bakelite Panel fully engraved, condensers of the highest quality—low-loss type—our own calibrated transformers, and only the finest sockets, binding posts, etc. The cabinet is a work of art, beautifully polished and finished in mahogany.

NOTHING cheap about this set—EXCEPT THE PRICE. Never before in the history of Radio has a 5-tube first-class set, with a built-in loud speaker sold at such a low price.

THE PERFECTLY TUNED RADIO FREQUENCY SET

On all these counts—and more—SOMERSET Radio Receivers challenge comparison, feature for feature, with any others at or near their price—bar none.

It needs no argument nor persuasion—every SOMERSET Radio Receiver speaks for itself—a piece of fine furniture enclosing an instrument of super-craftsmanship.

PERFORMANCE

THE new Somerset Self Speaker has a built-in cabinet type loud speaker of an entirely new design. Sounds roll out, not with a nasal tone, but in a clear and correct modulation. **RANGE OF SET**—With this set in New York we have brought in, in poor radio locations, stations 1500 miles away, on the loud speaker. The set tunes extremely sharp, and long-distance stations can be logged while locals are on the air.

BACKED BY THE SOMERSET GUARANTEE

We will cheerfully and promptly make good any SOMERSET SELF SPEAKER which does not fully measure up to the purchaser's expectations of quality and value. This guarantee means exactly what it says, without reservations.

EASY SELLING FEATURES

Every woman recognizes at sight the superior lines and finish of SOMERSET cabinets. They're distinctive in their rich hand rubbed mahogany finish—an artistic addition to any drawing room. The receiver is worthy of this fine setting, finest of materials and parts, superior workmanship and finish, painstaking care in the little details which mean so much in results.

NATIONAL AIRPHONE CORPORATION
18 Hudson Street, New York City

Without any obligation to me, send full details and information on the Somerset line and remarkable Dealer Service.

Name

Address

City

Prices subject to change without notice.

MAIL TODAY FOR PROFIT PAY

You wouldn't pass by money that would be yours for the picking up—don't pass up this chance to earn of profit opportunity.—Fill out and mail Coupon NOW.

NATIONAL AIRPHONE CORP

Manufacturers of Somerset Radio Receivers

18 HUDSON STREET, N. Y. CITY

Prices West of the Mississippi—add 10%

© 1925 National Airphone Corp.



Build Your Own Receiver— It's Easy The "No-Sod-er" Way!

New Method—Perfectly Simple—No Radio Knowledge Needed

No solder—No bare wires—No poor connections—No dissatisfaction.
No tools needed except a common screw-driver and common pliers.



All connections are made by the use of our flexible, insulated eyeletted connecting wire in place of bus bar or wire, and solder. And in a fraction of the time usually required when using the old fashioned way. And when the job is done it is neat and your connections are tight.

4-Tube Roberts Knock-Out \$48⁵⁶ Postpaid
Kit Y K 9215 Range 3500 Miles
The Best All-around Receiver

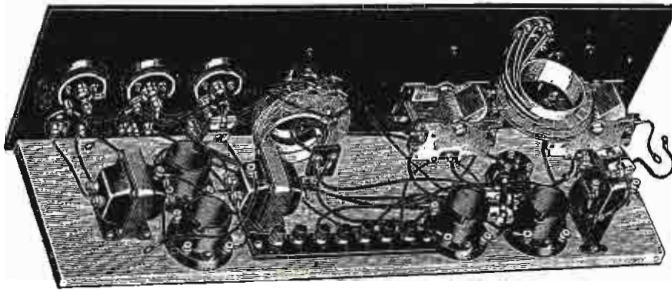

Celebrated circuit developed by Walter Van B. Roberts and Radio Broadcast Magazine, Arthur H. Lynch, Editor, says: "It is the best we have ever seen—and we have seen and operated almost every type made and used during the past 12 years. It has pulled in 46 stations on a loud speaker with 2 tubes, using an indoor antenna. Its signals have been heard through the air more than a quarter of a mile. Tube for tube, dollar for dollar, and result for result, we will stack it up against any receiver for home construction ever described by any radio publication, and gamble that it comes out a winner. It is not merely the best 4-tube receiver, but the best by a very good margin." Radio experts everywhere endorse and recommend it. Read below the kind of parts you get. Price includes large cabinet. Order it. You won't be making a mistake. Shipped on approval, no money in advance.

5-Tube 'Sickles' \$42⁹³ Postpaid
Tuned Radio Frequency Kit Y K 9216 Range 3500 Miles

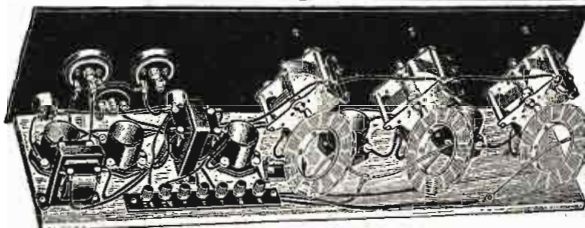

If you wish the finest 5-tube set to be had, here it is. We have produced a receiver as nearly perfect as possible with present day radio engineering principles. To do this we have adopted low loss principles throughout thus reducing all losses to the minimum. Special Features: Simple to construct and operator; highly efficient; low loss design throughout; self-neutralized; extremely sensitive over long and shorter distances; clearness; dependability; selectivity; non-reradiation. Tuned Radio Frequency is popular. You want this latest and best model. Shipped on approval, no money in advance.

MUCH FOR LITTLE

3-Tube LoLos \$30²⁵ Postpaid—Kit Y K 6996
Explorer Range 1000 Miles on Loud Speaker

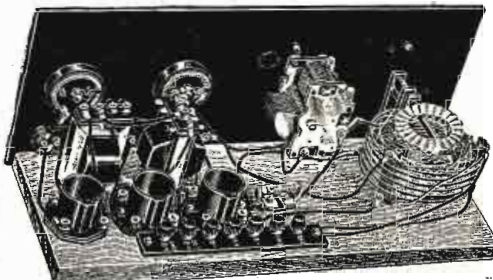

Nothing new-fangled or freaky about this wonderful new low loss receiver. Its great secret lies in the fact that nearly all losses are done away with, using energy usually wasted in other sets—hence the astonishing results in distance, volume and clearness. Special Features: Sensitivity; selectivity; clearness of reception; simplicity of construction and operation; dependability; low loss design; long distance reception; great volume. Fifteen stations were received on loud speaker

in two hours in one evening here, which are located in New York City, Philadelphia, Pittsburgh, Cleveland, Elgin and Chicago, Ill., St. Cloud, Minn., and Davenport, Iowa. Cuts right through local stations. Sure to please. Order it on approval, no money in advance.

1-Tube Single-Circuit \$11⁷⁹ Postpaid
Kit Y K 9182 Range 1500 Miles

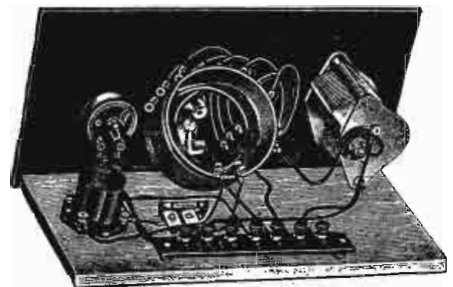

Has many advantages over other types. Just right for one who wants a set to learn with without having to invest very many dollars. Think of the low cost. Probably the most popular circuit. Simple to construct with our "No-Sod-er" connecting wires. You can do it in a half hour or so. Look at the picture. See how few wires. Simplest to operate. Receives up to 1,500 miles in favorable conditions. Sweet tone. Plenty of volume. This offer as well as all of our offers of Kits includes a nice, roomy cabinet. Order this Kit and let us become acquainted. You will be pleased. Shipped on approval, no money in advance.

Advantages of Our "No-Sod-er Method"

- No solder. Clean—not "messy."
- No expense for soldering iron or supplies. Dependable.
- Positively firm connections—none faulty as in using solder which often easily jars loose. Less resistance or loss than in using solder. Absolutely safe.
- Positively never any danger of short-circuiting as our "No-Sod-er" connectors are insulated with woven thread over rubber. Terminals are uniformly neat.
- No loss of time in making connections—unnecessary to use care in placing, since they may touch each other without short-circuiting.
- Easily handled—unbreakable. No special care needed in handling as all are insulated.
- A Kit can be wired in a fraction of the time required for wiring with bus bar and solder.
- Convenient.
- On our improved blueprints the binding posts are numbered in pairs so you may quickly and easily attach the connector properly.
- Quickly fastened. No skill or knowledge required.

The Simplest and easiest method ever devised!

"No-Sod-er"
MAKES SET-BUILDING EASY
(Trade Mark Reg. U. S. Pat. Off.)

SEE OFFERS OF 38 KITS AND ACCESSORIES ON NEXT PAGE

See the High-Grade Parts You Get!

Look at this list of well-known, high-grade, standard, dependable, satisfaction-giving parts which we use in our line of superior Kits as detailed in our catalog which will be sent to you free on request: genuine Bakelite-Dilecto panels, Sickles coil, Gen-Win low loss tuner, Hammarlund and X-Lab. variable condensers, Ampflex Grid densers, Chelton Midget condensers, genuine Bakelite dials, E-Z Tone genuine Bakelite variable dials, Thordarson transformers, genuine Bakelite rheostats, Amperte self-adjusting and Amsoe rheostats, Amsoe potentiometers and rheostats, Bell Low Loss genuine Bakelite sockets, Carter and Improved jacks, Smilcar battery switches, Bradleyleaks, Electrad grid-leaks, Bradleyleaks, Hilo and Dubilier fixed condensers, Aristocrat binding posts, "No-Sod-er" flexible insulated connecting wires, and other articles of the same high class. Please Compare Quality when Comparing Prices.

BE SURE TO SEE PAGE 2299 OF "RADIO NEWS" FOR NEW "RASCO" GOODS

WE SHIP IN 24 HOURS Satisfaction Guaranteed

ORDER DIRECT FROM THIS AD, WE SHALL PLEASE YOU
RADIO SPECIALTY CO., Kit Div. 6796, No. 25-A West Broadway, N.Y.

This Free KIT Catalog Tells Just What You Want To Know

- HOW TO ASSEMBLE YOUR OWN SET without the bus-bar-and-solder nuisance—
- HOW TO GET YOUR OWN KIT and Accessories without Charge—
- HOW TO GO INTO BUSINESS for Yourself and Make Money Building Sets for your Friends and Neighbors.

READ

- Goods Sent on Approval—
- No Money in Advance—
- Quick Shipment—
- We Pay Transportation—
- Satisfaction or Money Back

Catalog Contains Detailed Offers of the following Kits and many Parts and Accessories. All Kit Prices include large Cabinet.

RASCO KITS

Kit No.	Name	Parts	Our Price	Postpaid*	Accessories	Complete
YK0100	Rasco COCKADAY, 5-tube		\$51.66	\$38.07	\$89.73	
YK9188	Rasco FAMOUS T. R. F., 5-tube	40.89	38.07	78.96		
YK9212	Rasco KNOCKOUT REFLEX, 1-tube	21.52	12.84	34.36		
YK9214	Rasco KNOCKOUT REFLEX, 3-tube	28.86	27.75	56.61		
YK9213	Rasco ROBERTS KNOCKOUT, 2-tube	31.35	20.66	52.02		
YK9215	Rasco ROBERTS KNOCKOUT, 4-tube	48.56	35.20	83.85		
YK6996	Rasco LOLOS EXPLORER, 3-tube	30.25	27.73	57.98		
YK9189	Rasco PACIFIC RANGER CIRCUIT, 8-tube	57.13	61.11	118.24		
YK9217	Rasco PRESSLEY SUPER, 7-tube	83.75	55.08	138.83		
YK9184	Rasco REFLEX, 1-tube	19.09	17.16	36.25		
YK9185	Rasco REFLEX, 2-tube	22.54	20.66	43.20		
YK9186	Rasco REFLEX, 3-tube	26.67	27.73	54.40		
YK9187	Rasco REFLEX, 4-tube	29.23	33.36	62.59		
YK9182	Rasco SINGLE-CIRCUIT, 1-tube	11.79	10.77	22.56		
YK9183	Rasco SINGLE-CIRCUIT, 3-tube	21.65	25.55	47.20		
YK9219	Rasco THREE-CIRCUIT, 1-tube	17.69	13.93	31.62		
YK9218	Rasco THREE-CIRCUIT, 3-tube	30.49	25.55	56.04		
YK9216	Rasco SICKLES T. R. F., 5-tube	42.93	38.07	81.00		
YK4477	Rasco TROPADYNE, 6-tube	60.50	52.88	114.38		
YK9211	Rasco WORK-RITE NEUTRODYNE, 5-tube	38.95	53.37	92.32		

Other Popular Kits

Kit No.	Name	Parts	Our Price	Postpaid*	Accessories	Complete
YK9162	ACME Model A, 4-tube	\$56.87	\$50.12	\$106.99		
YK9161	ACME Model S, 5-tube	70.00	55.68	125.68		
YK9205	ERLA, 1-tube	17.31	17.60	34.91		
YK9206	ERLA, 2-tube	25.81	25.11	50.92		
YK9207	ERLA, 3-tube	34.56	32.98	67.54		
YK9208	ERLA, 4-tube	38.93	38.23	77.16		
YK9209	ERLA, 5-tube	43.31	51.75	95.06		
YK9210	ERLA, 5-tube (for loop aerial)	43.31	52.62	95.93		
YK9170	FRESHMAN MASTERPIECE, 5-tube	34.56	41.73	76.29		
YK9181	HANSCOM SUPER, 6-tube	39.37	82.28	121.65		
YK9166	HARKNESS COUNTER-FLEX, 3-tube	39.50	31.41	66.38		
YK9165	HARKNESS REFLEX, 2-tube	35.00	26.30	55.40		
YK9155	MELCO SUPREME, KD-24, 4-tube	78.75	34.56	113.31		
YK9156	MELCO SUPREME, KD-25, 5-tube	87.50	38.06	125.56		
YK9195	RASLA REFLEX, 1-tube	20.12	18.04	38.16		
YK9196	RASLA REFLEX, 2-tube	30.62	29.48	60.10		
YK9197	RASLA REFLEX, 3-tube	36.75	32.98	69.73		
YK9168	WORK-RITE DE LUXE NEUTRODYNE, 5-tube	58.18	42.61	100.79		

*We pay transportation on everything but batteries.

SQUARE DEALING

"I wish to again state my appreciation of your square dealing. My advice to fellow radio fans is to purchase from you if they want to be absolutely sure of getting the best for the least money."—Norman Smith, Eaton, Indiana.
 "The goods I purchased from you are all you say and more. I have recommended you to two of my friends who have purchased, and they are much pleased, also."—Dale Buffington, Lost Spring, Wyoming.



Book contains 36 pages 7x10 inches—packed full of the most useful and interesting matter ever put into a radio catalog.

Tells about the Marvels of Radio—How it Helps All and Brightens Every Home—Gives List of Broadcasting Stations—Specimen Programs—Show How Programs are Made Up—Answers the Questions, "What Set Shall I Buy," and How Much to Pay—Describes "No-Sod-er" Wiring System—Explains How to Get Your Own Radio Outfit Without Money—How to Save \$65.00 in Five Hours—How to Make Money by Going Into Business for Yourself and Building Sets for Others—Tells Where Orders are Awaiting You—Where and How You Can Transact Your Business—Contains Detailed Descriptions and Finest Illustrations of Large Number of Best Kits in Existence and Quotes Lowest Prices—Lists Full Line of Radio Parts and Accessories—Explains Our Fair, Easy, Liberal, Golden-Rule Plan of Doing Business. You Need It.

Send for FREE Catalog—TODAY!

RADIO SPECIALTY COMPANY

Kit Div. 6796 25-A West Broadway, New York

TEAR OFF AND MAIL THIS COUPON NOW

RADIO SPECIALTY CO., Kit Div. 6796, No. 25A West Broadway, New York. (If you desire our Kit Catalog, please write "X" in square)

Please send me your Kit Catalog No. 14 without charge or obligation
 You may ship the following goods listed on this or preceding page, subject to your guarantee of satisfaction or money back. (If you are remitting, please state amount):

Name

Address



Take It with You On Vacations

HERE'S a real Portable Radio with no apologies. This year you can camp, tour, fish or hunt, and make your vacation more complete with Radio. Bring in sport returns, concerts, music for dancing—radio entertainment in your favorite variety, to liven up dull or rainy evenings, and add immeasurably to your happiness.

The Ozarka Portable is built for long distance. The Hy-power built-in Loud Speaker makes it possible for a large gathering to enjoy the program exempt from troublesome and awkward earphones.

It is simple to operate and convenient to carry and, best of all, you can have it for home use when you return.

The Ozarka factory representative will gladly bring this Portable to your home and let you find out by tuning it yourself, just what distance, volume and tone it will deliver. Prove to your own satisfaction that the Ozarka Portable is the greatest radio value for \$75. Why not ask us for the name of the nearest Ozarka Representative, giving us the name of your county, and we'll gladly arrange for a demonstration.

\$75 Complete
with

Four No. 199 Tubes, Built-in Hy-power Loud Speaker, Four Eveready 22½ "B" Batteries, Three Eveready "A" Dry Cells, One Eveready "C" Battery, Aerial Equipment, ready to un-reel—all installed in neat fabri-koid covered case—complete weight 25 lbs.

Men Wanted for Real, Money-Mak- ing Opportunity

THE country is full of radio fans who take greatest delight in "listening in." They have been waiting for a really worth while portable radio outfit to take with them on their vacation trips—and here it is—the Ozarka Portable, newest member of the famous Ozarka Radio family.

If you can qualify, there is an opening for you in the Ozarka organization where you can make more money than you have ever made before. We are over 3100 strong, and most of our men are making \$50 to \$300 a week. Right now is a fine time to get started selling radio. There is a strong demand for Ozarka Portable, a little later on comes the powerful demand for the other Ozarka models. We allot exclusive territories. Profits start immediately. Knowledge of radio is not necessary. We supply that and the training. Our methods of demonstration insure the orders. You must be able to convince us that you are the right man for us—have good reputation and character—are industrious and ambitious. A small amount of capital is necessary. If interested, "action" is the word. Business is starting on Ozarka Portable right now. Write us today and ask for Ozarka Plan No. 100. Be sure to mention the county you live in.

OZARKA, INC., 884 Washington Blvd., Chicago, Illinois



RADIO NEWS

H. GERNSBACK, Editor and Publisher
SYLVAN HARRIS, Associate Editor

EDITORIAL AND GENERAL OFFICES, 53 PARK PLACE, NEW YORK

Vol. 6

JUNE, 1925

No. 12

NEW RADIO DEVELOPMENTS

By HUGO GERNSBACK

THE broadcast situation in this country has now reached a point where it has become necessary for the authorities in charge to do something toward alleviating a situation that threatens to become impossible. At the time this is written, there are in actual operation in this country 564 broadcast stations. There are, however, only 100 channels to accommodate all of these stations, these channels being separated by 10 kilocycles. It is like trying to run a dozen trains on a single track—not an impossibility in itself, but somewhat of a task. With the broadcast stations, the problem has been solved for the present—not in a satisfactory manner, but tentatively, at least:

First, by dividing time among some of the stations, which at once gave us 200 channels instead of the original 100.

Secondly, there are a number of stations operating on the same wave-length, but so far removed from each other that not much conflict between the stations is incurred thereby. Thus, for instance, a station in New York may be operating on the same wave-length as one in San Francisco. The difference in time alone between the two stations is of much help, and the great distance separating the stations makes for little interference, although there is, of course, some interference. By this means we have again doubled our channels, having 400 partial channels for the five hundred and sixty-five broadcast stations.

Moreover, the Department of Commerce is besieged right now with a great number of applications for more broadcast stations, while at the same time the available channels have been more than exhausted. There is no possible way of relieving the situation except by again splitting up time, which has not been done as yet to any extent. This, however, would work a severe hardship on the various stations which, having great capital investment behind them, would view such a procedure with much disfavor, and it might conceivably raise havoc with the entire industry.

To go up in the wave-length band, that is, beyond 600 meters, is not possible for many reasons, principally on account of international agreements, as most ship stations are operated on this wave band. There remains only one outlet, and that is in the lower wave band.

Until very recently the radio amateurs were in possession of the band below 200 meters. Of their own volition, however, because they found that their communication was vastly improved thereby, they have abandoned the 200-meter wave band entirely, and most amateurs are now transmitting on 80 meters and below. An entirely new channel has, therefore, been opened almost automatically, and it is now proposed that, by this fall, the broadcast wave band should include the wave-lengths from 150 to 600 meters. This additional 50 meters immediately gives us 50 entire channels which, when split up by dividing time, will give us double this number, or 100 new channels. If, again, these channels are split up by allocating the same wave-lengths for stations in the East and on the Atlantic seaboard, as well as on the Pacific coast, we shall get a total of 200 channels, thereby accommodating as many new broadcast stations, making a grand total of 800 possible stations without undue crowding.

THE reader may now wonder what good these low-wave broadcast stations will be. The objection will immediately present itself that no broadcast receiving set made at the present time will be able to tune down to 150 meters, when these new stations go on the air next fall.

The answer to this is, of course, simple. Manufacturers of broadcast receiving sets have already been apprised of this situation and know that new receivers built after this date will have to include the lower wave band. When automobiles were first manufactured they were of the one-cylinder, snorting and puffing construction. After a while, the manufacturers found out that two-, four- and six-cylinder cars worked better, so they adopted them as the auto-

mobile art progressed. Also, the puffing, evil-smelling and smoking automobile was provided with mufflers and the manufacturers soon found that they had to have them on their cars if they wanted to sell them.

Exactly so in radio today. The new fall sets, therefore, will be constructed along such lines that they will tune in the lower wave bands. That does not mean that all of the present-day outfits will have to be junked or thrown aside, for their owners will still be able to use them next fall, if they do not wish to buy new sets. They will still be able to enjoy a great variety of programs, even if they are not able to tune down to 150 meters. It is just like the man who owns a 1922 automobile, without balloon tires and without four-wheel brakes. The old car will still give him service until it wears out or until he wishes to acquire a new one. Exactly so with radio outfits. The new wave band will work no hardship on anyone—neither on the public nor on the industry. But for the man who has not acquired a radio set as yet, the 1926 outfit that tunes from 150 meters to 600 meters will be of an added interest, just as the 1926 car will be to the man who does not now own a car.

And all this is a good thing, for the simple reason that there is still a large public refraining from buying sets because it thinks great revolutions are about due in radio sets.

We believe such a view is totally unfounded, and that no great revolutions are to be made in radio sets for the next few years. In other words, if you do buy a 1925 model radio set now, that set will be an excellent one, even if it does not tune down to 150 meters. It is much better for changes of this kind to come along gradually, so that they do not cause upheaval and confusion in the trade and with the public.

The next few years will show great refinements in radio sets, rather than revolutionary changes. The radio set industry has now settled down into an orderly business, the same as the automobile industry. In both it is a matter of refinements, of improvements, rather than of revolutionary changes.

THAT part of the public which is withholding the purchase of radio sets now because of expected revolutionary changes should fully understand that there is nothing at all in this argument. 1922 sets are still doing excellent work in thousands of homes throughout the country. These sets will do good work and serve their owners for years to come, notwithstanding the fact that the 1923, 1924, 1925 and 1926 sets have been greatly improved.

So the writer repeats, as he has often mentioned, *the time to buy a radio set is now*. There is more free entertainment and better broadcasting in the air right now than at any time in the history of the art.

Furthermore, the popular impression that radio reception during the summer, on account of static, is poor, is, of course, erroneous. There is static a-plenty in the winter time, in the spring, as well as during the fall. It is also true that there are many fine summer days during which there is less static than on a wintry, snowy day. Rain or snow in the air gives rise to static, no matter what the season.

As for danger from lightning during the summer time, there is nothing in this argument either, because there is no authenticated case where lightning ever struck an antenna in this country and caused any damage. Quite the contrary. A radio outfit that is well installed with its lightning arrester becomes a protection to the building, because, in case of lightning, the latter will be carried away harmlessly to the ground, whereas if no antenna existed, great damage might be done to the building.

We repeat, therefore, there is no time like the present to acquire a radio outfit. On account of the unsettled condition in the trade, outfits can be bought more cheaply at this very minute than they probably can be for years to come. A word to the wise is sufficient.

Broadcast Stations On 150 Meters

By W. B. ARVIN

A solution to broadcast congestion is, at last, in sight. RADIO NEWS here gives the first semi-official announcement of it.

THAT the broadcast band of wave-lengths will be dropped to include 150 meters and upward is about the only solution to the present broadcast situation, in the minds of the Department of Commerce, RADIO NEWS has learned on unquestionable authority.

The effect of this announcement is all the more important when it is learned that the opening of this band is contemplated as soon as possible; in fact, Secretary Hoover will make such a suggestion for untangling the present difficulties of the art at the next radio convention, which is to be held in the early part of September.

If nothing goes awry, that is to say, if all the parties at the convention agree that this solution is the proper one—and it is the only logical course open at present—and it can be arranged commercially, the first stations in the new band will be granted about the first of October, or as soon thereafter as complete arrangements can be made.

To quote the official, who must remain nameless here for obvious reasons: "The whole question depends upon the industry itself. The tangle is so great at present that new arrangements of some kind must be made if the potential factors of the art remain the same. As long as more stations desire to go on the air, and as long as the demand for broadcasting continues, it may be taken for granted that the position will remain pretty much the same.

"Plainly, the whole question must be decided and put into final practice by the industry itself. The Department merely acts in a supervisory and regulatory manner, as a sort of arbiter for the enforcement of the rules established by the industry itself.

THE SITUATION

"The situation is this: The present channels available to broadcast stations are filled to the limit. That is, every possible channel upon which a station may transmit under the present organization is occupied. And worse—some of them are in use by more than one station! Such cases are few and geographically well separated, but with the constant increase in the sensitiveness of receiving out-

AS RADIO NEWS predicted, practically alone, for the past six months, it is now semi-officially announced from Washington that by the end of this year the broadcasting wave band will go down to 150 meters. Since it is an impossibility for the wave band to move beyond the present range of 546 meters, there remains but one thing to do, to move the wave band downward.

It is true that, until recently, radio amateurs were using wave-lengths close to 200 meters, but of late they have moved down, and most of them are now transmitting below 80 meters, so there should be no reason why the broadcasting wave-length should not come down.

As will be seen from our illustrations, this immediately opens up a vast field for a great number of new broadcasters who desire to go on the air. The Department of Commerce will advocate that all the high power stations be grouped into one section of the wave band, and all the low power stations will be grouped into another, probably the lower band.

Broadcasters will also find that transmitting on the lower waves will be vastly better than on the higher waves; because in the lower wave band the penetration is much greater for a given amount of power. Also, as we progress downward in the wave band, static, the present bane of radio, tends to diminish.

EDITOR.

fits on the market, they present a problem which must be met in the near future.

"And this is not the greatest problem. There is a constant stream of applications received in this office for the erection of new stations. What can be done about it? This

Department cannot act as judge of who shall receive licenses and who shall not. The only duty devolving upon us is to see that the prospective station will conform with the rules and regulations now in force and under which the other stations are functioning. But the applicants are clamorous; they see no reason why they may not be granted licenses. Their attitude is obvious and just. They say that if sufficient channels are not available it is the duty of the Department to rearrange matters so that they may be allowed to enjoy equal rights with others.

"So it is obvious that there must be something done about the situation. More stations wish to use the ether for broadcasting and there is no room for them under the present system of regulation. There are two alternatives for remedy. One is to open waves above the present assigned band and the other to open the area beneath that in use and set aside for broadcasting at present.

"The first is impossible on account of the international agreements which assign the waves to be used by ships at sea and for point-to-point communication and a host of other matters. The changing of these regulations would necessitate an international conference on the subject, with its attendant, inevitable complications.

"As a matter of fact, help in this quarter is quite impossible. It may not even be considered, since any change in the present arrangement would cause a remodeling of practically every station in the world. The money and work involved in such a change make it quite out of the question.

"So the only other action by which we may hope for the settlement of the situation is to open up further channels in the shorter wave bands lying below the belt at present employed by the broadcast stations. This means that the present band will probably have to be enlarged to include all frequencies between 150 and 550 meters. The addition below the present belt will include a number of channels if the present system of separation of ten kilocycles between stations is maintained.

BAND TO 150 METERS

"The Department has been considering the matter and has come to the conclusion that the band will have to be opened. It is, at present, engaged in gathering expert engineering opinion as to the technical difficulties, if any, which may be encountered in the event of such action. Also, representatives of the chief manufacturing and selling organizations are being interviewed with the idea of ascertaining what effect such a recommendation would have on the financial side of the industry and how the captains of the radio industry would accept such a proposal.

"A sort of educational campaign must be carried on so that the art, as a whole, may be able to start the necessary readjustments. Any swift change will, of course, tend to throw the whole industry into a furor and might have a decidedly deleterious effect on both the retail and stock markets. Any such change acts on the business as a bomb-shell in the heart of a city—it tends pretty much to disorganize things. Therefore, if no one is to suffer, the news must be broken easily and the new condition must not come as a *revolution*, but rather as a well-ordered and organized *evolution*.

"But even if the plan to open the range of broadcast wave-lengths to 150 meters is de-



Herbert Hoover, the supervisor of radio, listening in on a typical small receiver, in order to get the small listener's viewpoint.

clared feasible and entirely operative by the Radio Conference after it is called, the question will not then be settled by any means. For the Department, nothing could be better than a decision in favor of the new waves; it would be delighted to put them into effect by the first of October, if that were possible. But the main point is that the leaders of the industry must first give their hearty cooperation to the scheme and designate their willingness to help in bringing about the necessary changes as soon as the legal and other details have been settled.

"The great difficulty with this whole matter is that there is no actual legislative acknowledgment of it. The existing agreements and forms are entirely a matter of general consent among those concerned. Of course, the Government holds a supervisory power over all the field by virtue of its power to license and regulate.

"And this opening of new channels is by no means the least of the problems at present confronting broadcasters and the Department. According to the journals, the day of super-power broadcasting has arrived. Already we have nearly a dozen high-powered stations on the air regularly, and they are operating very near other stations of not nearly their power. And more important still, the separation between these stations is no greater than the usual ten kilocycles.

"Now the engineer at once sees the possibility of interference created under this plan. And the chances are he is right—at least in the immediate vicinity of the high-powered stations. If there is a general re-allocation of wave-lengths throughout the entire broadcast band, the logical step, of course, would be to set aside a definite band of frequencies to be used exclusively by the higher-powered stations, wherein they could be separated by a greater gap in frequency so that they would create less interference among themselves and, at the same time, be removed far enough from the other stations to keep down a great deal of the present interference. Ten kilocycles is not sufficient separation for stations of these high powers.

"As a matter of fact, it is not enough for the ordinary stations, but it is obvious that nothing can be done about it at the present time, since the whole question is one of finding more channels. A separation of more than that at present employed would tend to reduce the number of available radio routes, which is quite impossible.

"The whole question here is one of close attention on the part of the stations to their transmitting apparatus, for the purpose of keeping them on the frequency assigned by the Department. The Bureau of Standards, I understand, is working now on a device, which they hope to make available to all stations, by which they may have a constant check on the emitted wave-length and thus keep more closely to their allotted wave."

"But this is all very well," said the *RADIO NEWS* reporter, "but what about the effect that this announcement will have on the manufacturers and dealers all over the country?"

DISORGANIZATION

"That is another point which must receive careful consideration," said the official. "The chances are that the whole industry will be thrown into an uproar and that the market may become upset. The effect on the public will likewise be rather bad for everyone concerned in the art commercially. The novice, who is not well acquainted with the technical end of the game, would at once decide that the purchase of a set before the re-organization would be stupid, and so all along the line there would be fear. The consequence would be that the retail merchant would cut his stock to the minimum, fearing that ready purchasers would not be forthcoming; then, naturally, the jobber would decrease his orders for the sake of retrench-

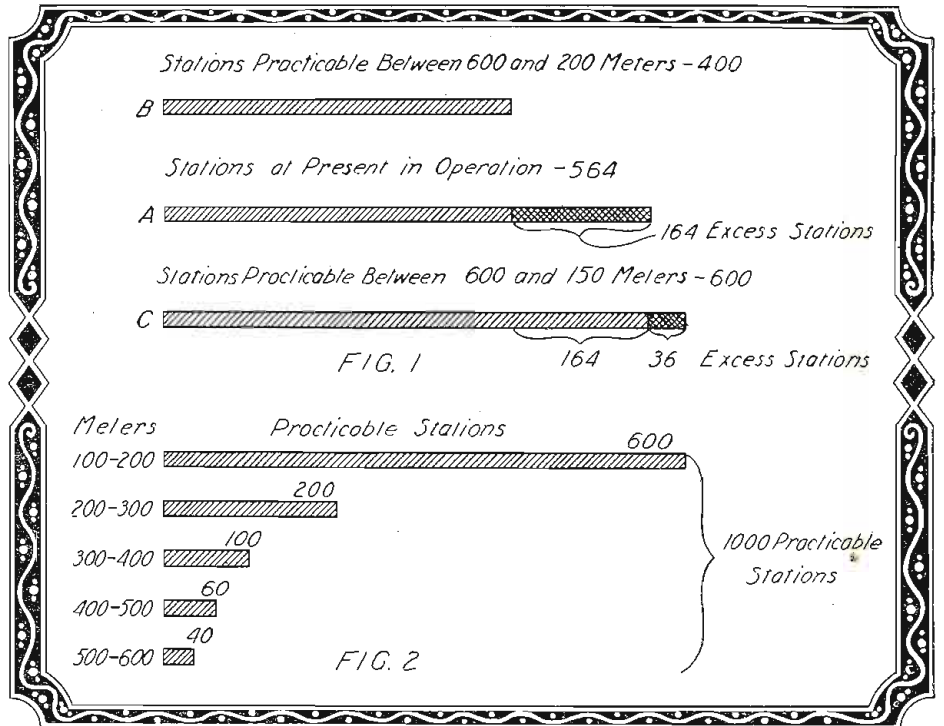

How serious the congestion of broadcast stations is in the wave band at present assigned to them can be made very apparent by a study of this diagram. The length of the band A in Fig. 1 gives a visual idea of the number of stations at present operating between 200 and 600 meters. The band marked B represents the number of stations it is practicable to operate in this range of wave-length, allowing four stations on each wave-length, located in pairs in different parts of the country, and each pair dividing its time equally. This is based on a separation of 10 kilocycles between channels, so that the number of stations practicable is four times the number of channels. There are thus 564 stations operating at present, in a range which can satisfactorily accommodate only 400. If the wave range is extended down to 150 meters, as predicted in this article, there will be 350 channels available, making provision for 600 stations. This is represented in the length of C in Fig. 1, which also shows that not only will the congestion (164 stations, indicated in A) be relieved, but there will also be room for 36 new stations. A total of 600 stations can be accommodated without crowding, if the wave range is extended down to 150 meters. The rate at which the number of stations practicable in wave bands of 100 meters changes with the position of this band in the whole broadcast range is shown clearly in Fig. 2. The increase from 200 to 400 practicable stations in going from the band 200-300 to the band 100-200 meters is striking, and illustrates forcibly the great value of the shorter wave-lengths in relieving the traffic congestion.

ment and the manufacturer would probably set his whole corps of designers and engineers to work drawing plans for new sets which will cover the whole new range.

"Business would tend to stop until the re-arrangement had been made. The Department has spoken to several representatives of the larger manufacturing corporations and they are very ticklish about the matter. All of them are agreed that something must be done, if the advancement of the art is to continue.

"Of course, in Europe, where broadcasting, in almost all cases, is given over entirely into the control of a Government-established monopoly, such a situation cannot arrive. But here, we go on an entirely different principle, we believe that competition is the life of trade and, consequently, the best method of developing any industry or art. Therefore, we cannot stifle this life-giving competition and must keep the field open for all who will to enter it. This cannot be done effectively except through the plan put forward here.

"The new stations must be allowed to come on the air as they will. If the available channels for them are not provided, some other arrangement must be made which will not give rise to all sorts of complications: otherwise, interference will become rampant and the whole thing will go to pot, thus bringing broadcasting to its own death through lack of proper supervision. Such schemes as splitting the time of stations is at best only a temporary relief and simply puts off the final accounting and, at the same time, doubles the trouble in the end. It is best to deal with the situation as soon as possible, and so keep pace with the advances that are made in the field.

TEMPORARY RELIEF

"At best, this opening of the new wave-

lengths for broadcast stations will only temporarily relieve the situation. It has been the experience of the Department that there are always more applications than there are available places to put them. It is the general notion that, as soon as the new bands are opened, there will be a deluge of applications fighting for them, even before the arrangements have been completed.

"There will probably be all sorts of conjectures about the re-allocation of the stations now in operation. This is another question concerning which the Department has as yet no complete plans. It will probably devolve on the conference to find ways and means of taking this step. There is a great deal of capital invested in station masts, etc., and many stations have made a reputation at a certain wave-length, which, obviously enough, they have no desire to change.

"Such difficulties have been ironed out before in these conferences and the chances are that an equitable arrangement will be arrived at in the one which is to be held next September.

"If a complete re-allocation is made, it will take place slowly, just as the other steps of the plan will move carefully. At the present stage of the game any great and far-reaching changes are liable to result in more harm than good.

"The cry may be raised as to what disposition will be made of the amateur when the broadcasters go down to the lower waves. A few nights listening in on the amateur transmitters will show that not much thought need be given this question, since most of them are working nearer 80 meter wave-lengths than 200. This problem has almost automatically settled itself before it has been reached.

"The utmost care is necessary in this (Continued on page 2312)

The Radio Micrometer

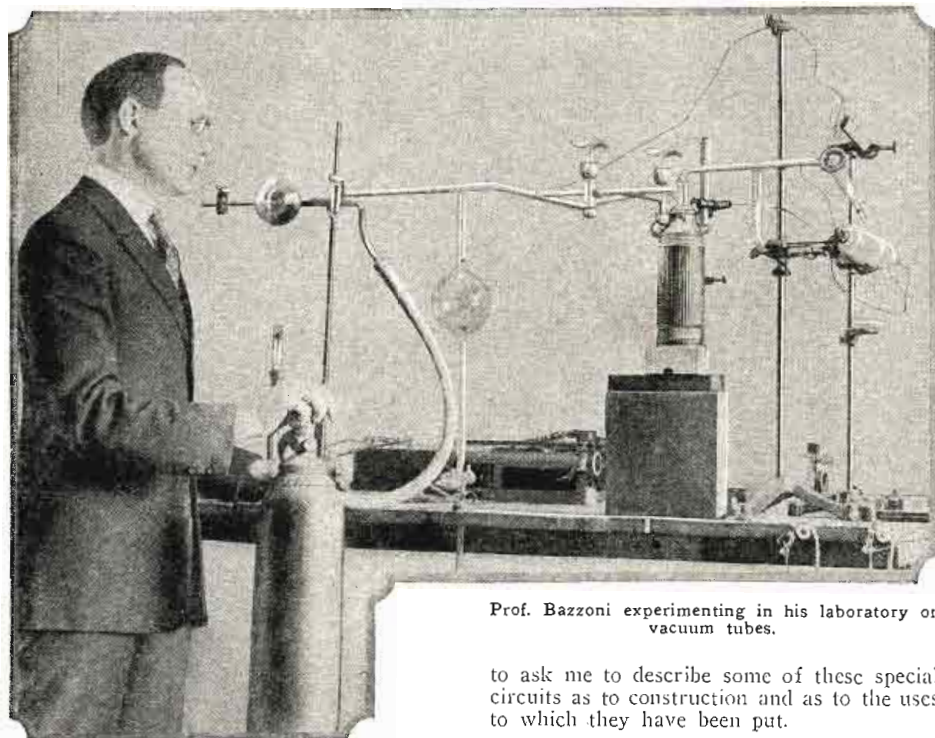

Prof. Bazzoni experimenting in his laboratory on vacuum tubes.

By C. B. BAZZONI*

EVERY radio fan has had reason now and then to marvel at the extreme sensitiveness of the three-electrode tube; sometimes with approbation when the minute energy flowing across his antenna, perhaps only a few inches square, is converted into the impressive notes of a loud speaker and sometimes with disgust when apparently unavoidable small variations in his circuit conditions render themselves apparent through energetic squeals and howls. In this second connection it must frequently have occurred to users that, since the oscillations causing these squeals and howls are developed by capacity and inductance variations so minute as to be otherwise imperceptible, circuits might be designed which would make use of these noises to detect or measure the tiny changes in capacity or inductance which cause them.

Such circuits have actually been devised by physicists working in university laboratories, here and abroad, and measuring devices have thus been developed showing almost unimaginable sensitiveness. We can, for example, by these methods detect a movement of a condenser plate through a distance not greater than the diameter of an atom, say one-half of a hundred millionth of an inch. These circuits are now in daily use in laboratories, having been applied to dozens of different purposes.

As used by physicists, such outfits frequently involve hundreds of dollars worth of special apparatus, yet the amateur who will follow the directions below can construct such circuits out of his ordinary radio supplies and get them to perform with nearly as great precision as do the laboratory workers. Since the average radio amateur has a genuine interest in the scientific possibilities of three-electrode tubes and enjoys nothing better than to experiment with them in novel connections, the Editor of RADIO NEWS has thought it worth while

to ask me to describe some of these special circuits as to construction and as to the uses to which they have been put.

CAPACITY CHANGE

In this article I shall restrict myself to the description of circuits in which use is made of minute changes in capacity. All of the important outfits developed for this purpose up to the present time may be classified into two groups, the "Heterodyne Beat Ultra-micrometers" and the "Zero Shunt Ultra-micrometers." The introduction of the first type of instrument, in 1921, is generally associated with the name of Professor Whiddington of the University of Leeds, England, although the scheme was first described (1919) by Hyslop and Carman of the University of Illinois, this country. The second type was introduced by J. J. Dowling, of the University of Dublin, Ireland, in 1921.

DESCRIPTION

Both types of ultra-micrometer depend on the use of the three-electrode tube as an oscillation generator. Fig. 1 shows a form of oscillating tube circuit such as might be used at a sending station if an antenna and ground were substituted for the condenser C. The electron stream in the circuit LC has a natural period of oscillation which can readily be calculated. When the filament switch is closed, an electrical jar is given the whole network which starts a minute surge in LC just as a blow will start a tuning fork into sounding. This rhythmic flow in L reacts on L_1 , producing in it a similar

rhythmic alteration in potential which is transmitted to the grid. The grid reacting on the plate current in exact step with the natural frequency builds up the tiny original surge in L to a value where the energy dissipated by heat and in radiation exactly balances that fed into the circuit. When this point is reached, as it is practically in a very short time, the circuit will continue to oscillate steadily for an indefinite period. If the resistance of the circuit is low, say not over 10 ohms, alternating current with effective values of from 0.5 to 1.0 ampere can thus be generated with ordinary radio tubes. The essential requirement for maintaining the oscillation is that the coupling of L and L_1 and the circuit arrangements generally must be such that the voltage induced on the grid shall vary the plate current over an amplitude sufficient to supply the coupling circuit with at least enough power to maintain this voltage on the grid. In practice such relations are easily attained. It is generally only too easy to start oscillations and too hard to stop them.

AUDIBLE FREQUENCY

If C and L are large enough to give a

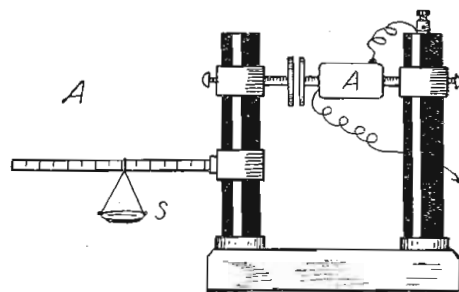

Another view of the "electrical thermometer."

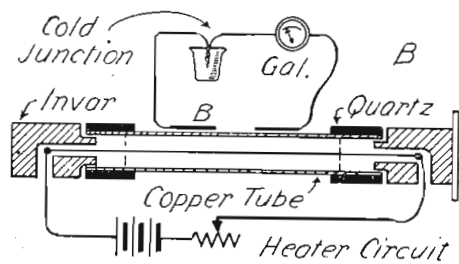
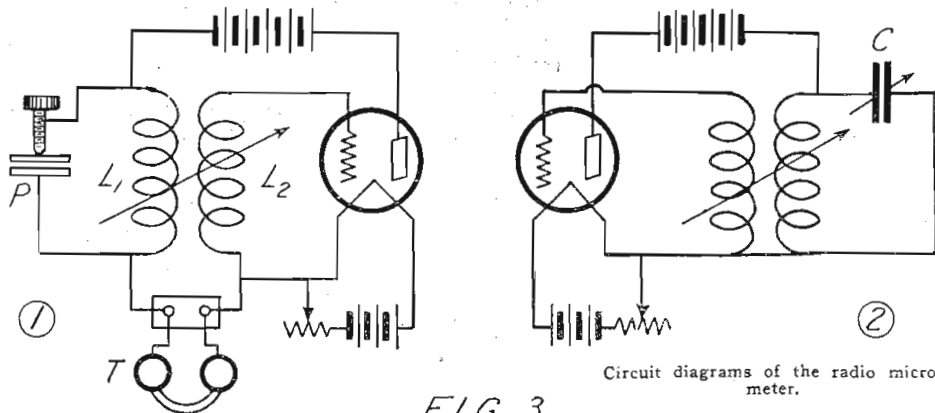

FIG. 5

The construction of the expansion element of the electrical thermometer. It consists of a heating element which heats the copper tubing.



Circuit diagrams of the radio micrometer.

FIG. 3

*Professor of Experimental Physics, University of Pennsylvania.

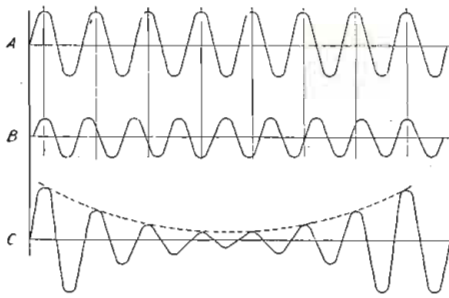

Fig. 2. A and B are two waves of different frequencies and the resulting wave is shown at C.

frequency in the audible range, say between 50 and 3,000 per second, a telephone inserted in the LC loop will give out a sound, generally a loud sound, which evidences the oscillations. This requires, however, a capacity at C of from 0.1 to 1.0 microfarad which is larger than the amateur ordinarily has available. With regular radio coils and condensers the frequency will run about 1,000,000 per second and must be demonstrated in a hot-wire or other high frequency ammeter. There is also another way in which these oscillations so far above the limit of audibility can be rendered perceptible. Suppose that we have two circuits like that in Fig. 1 side by side. Oscillations in one will produce oscillations of the same frequency in the other by inductive coupling, even though the circuits are several feet apart. If both sets are tuned to give the same frequency, say 1,000,000 per second, the current in LC will merely be somewhat reinforced due to the interaction of the two circuits, but if one circuit gives 1,000,000 per second and the other circuit 1,000,200, then the two surges acting at the same time will interfere and produce an alternate increase and decrease of net intensity 200 times each second giving a *beat* note of 200 cycles frequency in the phones. When this principle, originally introduced by Fessenden, is used in radio circuits it is referred to as heterodyning. How this beat or heterodyne note is produced will be rendered evident by a little study of Fig. 2. Line A represents

eight waves due to Circuit No. 1 produced in the same time interval as the nine waves of Circuit No. 2 shown on Line B. When these waves act simultaneously in a circuit they will reinforce when in step and subtract from each other when out of step, producing a net disturbance like that shown on Line C. The telephones will respond to the rise and fall of intensity here shown giving a beat note the number of pulses of which in the time intervals represented will equal the difference in the number of waves given by the two sources in the same interval. The high frequency surges of about 1,000,000 per second which make up the resultant disturbance are bypassed by the distributed capacity of the telephone cords. The inductive resistance of the phone coils is extremely high for these high frequencies but the low period net surge passes through readily since the coil resistance is much less for the low frequencies.

The principles above outlined are applied directly in the "Heterodyne Beat Ultramicrometer." As used by Whiddington this arrangement consisted of two oscillatory circuits set up near each other and adjusted to oscillate with frequencies, respectively, of 1,000,000 and 1,000,500 approximately. An audible beat note of about 500 frequency was thus produced in the circuits. The general layout is shown in Fig. 3.

Circuit No. 1 (Fig. 3) contains a special condenser made of two circular plates of steel about 1/4-inch thick and about three square inches in area. The lower plate is rigidly supported while the upper one can be moved up or down by a slow motion micrometer screw. These plates must be rigid with reference to each other at any one setting and must be placed on a firm table free from vibrations. The coils, L_1 and L_2 , may be an ordinary variometer or they may be a pair of special coils perhaps four inches in diameter or 150 turns each of No. 28 double silk covered or enameled copper wire. It is useful to make the coupling of these coils variable by fixing them in a frame so that they can be moved axially, something like the old style loose coupler. At T, ordinary telephones may be used, but it is better to insert here two stages of audio frequency amplification leading into a loud speaker.

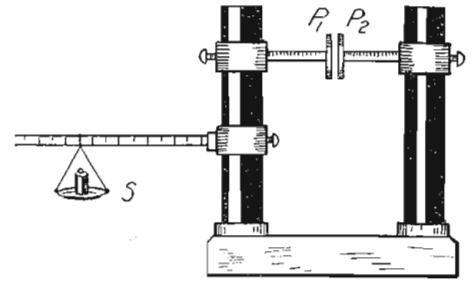

FIG. 4

An "electrical thermometer" capable of measuring changes of 1/16,000 of a Centigrade degree.

MEASUREMENT

Circuit No. 2 contains a similar pair of coils and a variable sector air condenser with a range from 100 to 1,200 micro-microfarads—a 43-plate condenser with micrometer attachment is best. After Circuit No. 1 is set up and oscillating, Circuit No. 2 is tuned by variation of C until a suitable beat note is produced from the loud speaker. A good pitch for this note is that of the first C above the middle C on a piano. If both circuits are properly shielded in metal-lined earthed boxes and if the batteries belonging to them, both "A" batteries and "B" batteries, are of large capacity and in a proper state of charge, say about one-quarter discharged, then the frequencies delivered will hold steady to one part in 100,000 for several hours. Under such conditions the heterodyne note will hold a steady pitch excepting when some change is made in the circuits deliberately. Such a change may be produced by screwing the top plate of P up or down by means of a long wood or hard rubber rod passing through a hole in the shielding.

Changes in the capacity of the condenser P due to small movements of the screw can be measured in the following way: The pitch of the beat note is adjusted by ear to a certain value such as that of a tuning fork or of a piano key. The desired change is then made in P. This will alter the pitch of the beat note. The reading of C (Circuit No. 2) is now taken and then altered (Continued on page 2321)

This drawing shows plainly the assembly of apparatus used by Dr. Bazzoni in measuring millionths of an inch. Note the oscillators and the loud speaker used to generate the audible beat notes.

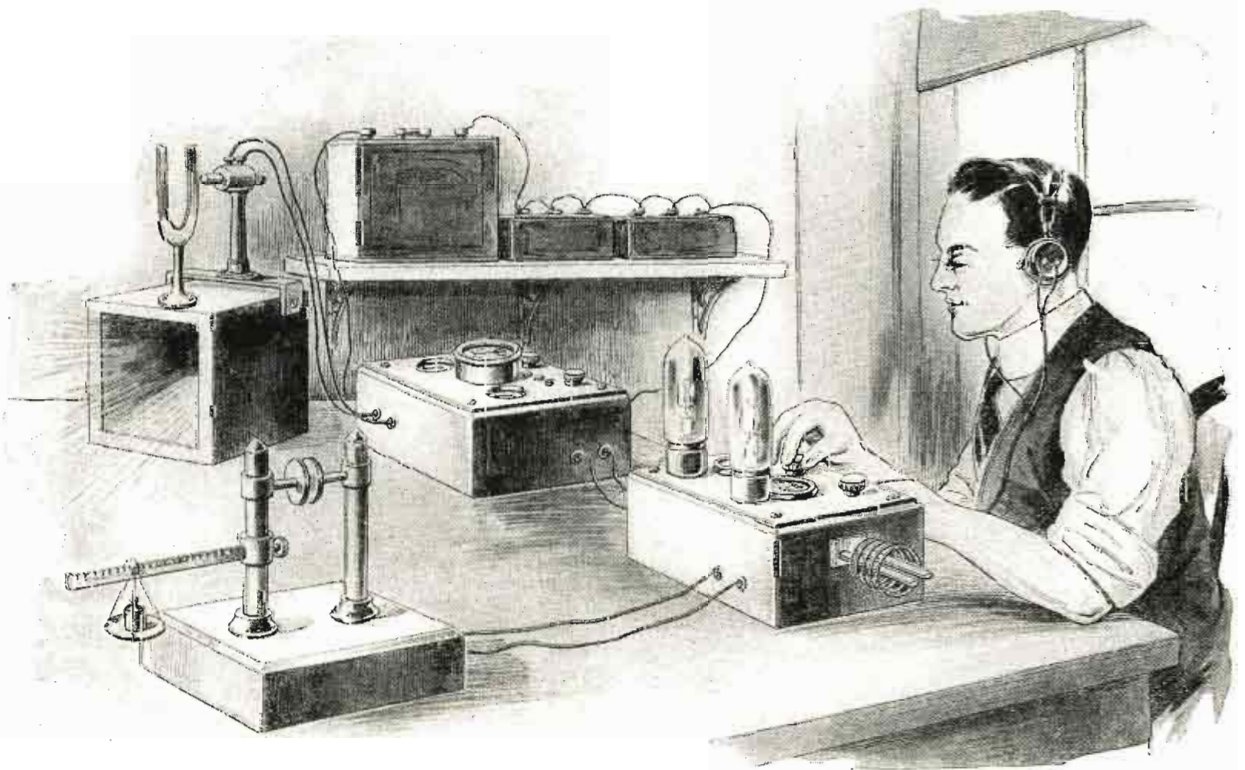

What Is the Bureau of Standards Doing?

By D. J. HALL

The United States Bureau of Standards is in the forefront of American experimenters. This article tells of the Bureau's latest work.



Dr. J. H. Dellinger, Chief of the Radio Division of the United States Bureau of Standards.

THE United States Bureau of Standards probably does more for radio and receives less praise for it than any other agency at present devoting its time to the advancement of the art.

Its latest advance in the field has been a long and concerted effort to arrive at some definite plan whereby the strength of the field created by a transmitting station may be more closely and accurately studied and at the same time more information gathered concerning the actual conditions under which radio waves are propagated through the ether—a subject upon which we are very ignorant at present.

Being accustomed to such investigations, the Radio Division of the Bureau started in the most scientific way. The first point was to design the necessary apparatus or adaptation of present means to the measurement and calculation of the factors entering into the field strength of stations at given points. This done, the next step was to make the necessary observations.

About two years ago the Radio Division decided upon the investigation and began to make its plans. The scheme was to select some two hundred or more experimenters already in the radio field and ask them to co-operate in the work. Accordingly, a program was arranged and a form issued upon which the observers might enter the results of their reception.

OBSERVATIONS

So that all the work might be along one line and every observer follow the same points of investigation, a number of forms were arranged so that the observers could follow the notations set down in it. By this method the Bureau was enabled to collect an immense amount of data covering two solid years and taking the operation of certain stations under all atmospheric and electric conditions. This was just the beginning of the task however, since all the information so collected had to be annotated and precipitated into usable form.

At the present time, the Austin-Cohen formula for the radiation from a transmitter is in common use, but it is empirical and does not give results in practice with an accuracy greater than thirty or forty percent. It is this formula, together with others which have been developed from purely theoretical considerations, that the Bureau is seeking to check and, if possible, to modify to such an extent that it may be depended upon by the designer of a station to cover certain distance under given conditions.

Dr. Austin of the Bureau is still at work checking the formula and is constantly taking observations on several wave-lengths under a number of different conditions, hoping to clear up the seeming deficiency in the present form of the law.

The forms used by the observers contained such information as a complete and detailed description of the set used, the location of the antenna system, as well as its specifications, the location of the station with regard to the surrounding terrain and absorbing objects which might have some effect upon the received signals, notations as to the meteorological conditions at the time of reception, the amount of static and its regularity and intensity, the fading quality of the station, the average strength of the signal over an extended period and the minute-to-minute strength of the signals, as well as the signal static radio.

These forms were arranged so that they could be tabulated in machines such as were used in connection with the census. After this material is all tabulated and put into a form in which some observations may be drawn from it, the Bureau will make known the findings and possibly come forward with some subsidiary laws regarding the behavior of waves as they pass through the atmosphere.

But this first examination is cursory. At the conclusion of the observations noted before, the Bureau immediately set about

working out a plan for greater accuracy in a similar set of observations to be made by more expert scientists and experimenters.

For this work the technicians of the Bureau were asked to design some sort of apparatus by which the actual field strength in millivolts and milliamperes may be measured.

THE INSTRUMENT

It is simple in the extreme, consisting of nothing more than a receiving set of ordinary design, coupled to an amplifier, and an indicating device, usually of the galvanometer type. The difference is that the measuring set is built of parts which have been carefully tested and calibrated with regard to the current passing through them. The amplification stages are built to certain specifications to give a definite and known amplification from input to output. This allows the measuring process to be a matter of plain arithmetic.

The final output of the set is led from the amplifier to a galvanometer. By the side of this instrument and fixed to the same base is a paper roll which passes its paper over a marking stylus. This stylus is connected to a bar and pointer which rides directly over the needle of the meter. The operator has only to operate the handle of the connecting rod and to keep the pointer of the stylus over the needle of the meter in order to have a running record of the exact intensity of the incoming signal all during the test. These rolls with the records may then be sent to some central point at the close of the test and the results worked into form as before. The Bureau has a regular staff working on the organization of this data.

The first tests made with this device were those during the late solar eclipse. The results of this observation were given in an article which appeared in the April issue of *RADIO NEWS*. This observation was made in New York City. At the same time there were a number of other experimenters also making notes. These notes were later sent to the Bureau and an investigation is now under way with engineers and scientists there to tabulate the results. The whole affair was carried on with the co-operation of the Bureau and to a certain extent under its plans.

TESTS AT WGY

This was the beginning. At the conclusion of the eclipse, Dr. Austin began laying further plans for checking the field strength of various stations under special atmospheric conditions and during certain periods of the day. At the present time he has some twenty observers checking the power received from station WGY at Schenectady during the sunset period. These observations will be made for a number of weeks, so that all possible conditions will be noted.

Since these are rather complicated and demand the work of a more or less trained observer, the assistance in this case is being rendered by various experimenters over the country who have had some training in the subject. In many cases, they are college and university trained radio amateurs who are famous for their original work in the radio field.

At the Bureau, Dr. Austin has been keeping daily records of the strength of reception from several of the high-powered European

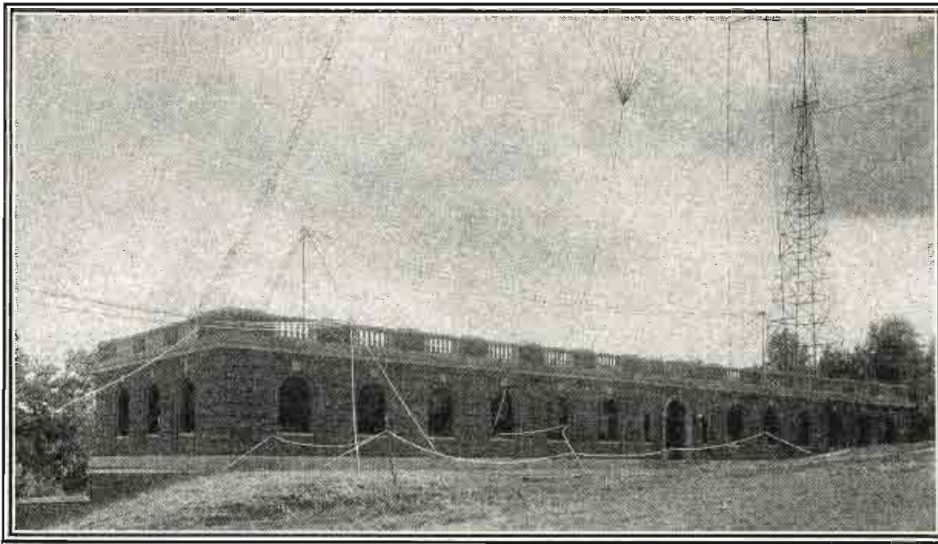

An exterior view of the building housing the Radio Division. Note the number and diversity of antennae.

stations for a period of more than two years. This work is supplemented, from time to time, by similar work with various stations in the United States, so that the whole band of frequencies from the broadcast band to the long wave trans-Atlantic stations is covered.

SUNSET

If the present observations being made to cover the sunset period prove to be of any value, the Bureau has a plan to continue the work to cover various periods of the day, hoping to discover some facts not now known concerning the nature of the ether.

Already, these investigations have thoroughly established the fact that the power of a transmitting station using the ordinary antenna system does not decrease in direct proportion to the distance of the receiver from the transmitter. This point has been held for some time but has never become generally known or accepted. However, the records of observance of the Bureau establish it without doubt. It is also pretty well established that the attenuation of the field strength bears some complicated relation to the transmitter frequency. But as yet, no definite verification of the theoretical laws governing this has been obtained.

But this work on field intensity is not the sum total of the efforts of the Bureau in the radio line at the present. Of course, everyone is acquainted with their work in calibrating the various wavemeters of the laboratories throughout the country and their regular routine work in standardization. And it is in connection with this phase of their work that one of their greatest problems has arisen. Under the present arrangements in the broadcast field, with stations working on a separation of only ten kilocycles, it is utterly impossible to keep down interference, unless all stations stay exactly on their allotted waves all the time they are sending signals into the ether.

The first plan of the Bureau to keep them where they belong, so to speak, was the establishment of the standard frequency transmissions whereby the stations could check their wavemeters and so check their own signals. In order to make some standard available at all times the Bureau established a separate transmitting station which emits a carrier wave of extreme accuracy.

Following this, they started the plan of designating to certain stations a standard frequency, if it managed to keep a good percentage in the matter of true location of carrier wave. The competition so created tended to better the conditions existing to a great extent.

But there was still a great amount of in-

terference and still is. After an investigation of some months, members of the Bureau decided that the chief trouble was with the stations themselves, being the result of having no method whereby the operator had some visible sign of the frequency of his carrier before him constantly while the station was in operation.

STANDARD WAVEMETER

No sooner was the need made known, than the Bureau set about designing the very necessary piece of apparatus. There were several special points which had to be taken into consideration in the design. It was settled immediately that the device would have to be some sort of wavemeter. But this settled, the special type which should be employed and the method of its functioning was another question.

And too, the thing had to be arranged so that its tuning would be so sharp that it could be installed on the panel with the remainder of the transmitting apparatus and yet of such type and components that it would peak exactly upon the wave of the station and show the slightest deviation from normal.

The design of the instrument is shown in an accompanying illustration. The instruments going into its manufacture have to be of the best. The visible portion of the specifications was met by passing the output of the coil and condenser combination into a galvanometer which could be so adjusted as to show the least deviation in the current passed. Since it is actuated entirely by in-

duction and since the current passed is sufficient to operate the meter only when the wave of the transmitter is exactly that to which the wavemeter is tuned, the meter begins to swing as soon as the carrier wave begins to swing.

Another modification is suggested and recommended: A contact point should be put on the face of the meter and then attached to the biggest bell that can be found in the station. A battery added to the circuit will help to call the operator's attention to the deviation when it occurs. Several of the largest stations in the United States are equipped with this device and find it exceptionally handy in keeping their reputation clear.

NEW CONTROL SYSTEM

And it is at this point that research in another field is being carried on. Dr. Hund has a whole laboratory full of quartz crystals which he is trying, in every conceivable form, in the hope of arriving at some definite and practicable method of controlling the frequency of radio stations to within a few cycles. He has already made and put into workable form a system of control with the aid of these crystals which can be used as a transfer standard. He has worked it into the form of a wavemeter which can be shipped from point to point in the country and still be depended upon to produce one standard frequency and one alone.

At the present time he is working on the theoretical end of the problem with his eye always out for the practical. He hopes to find ways and means of working the crystal into the transmitter so that all the stations in the country may install them and then forget all about the problem of interference which may be created by the station's "playing hookey" from its allotted wave channel.

These are just some of the things which the Bureau is doing. And some of the less important ones at that. But they are those which have to bear directly upon the radio fortunes of the ordinary broadcast listener.

All the work of the Bureau is not devoted to research and the clearing up of interference by any means. Probably the most far-reaching of their efforts are those devoted to the entirely theoretical end of the art. And here the Bureau is doing a work that no other organization in the country has attempted.

The Bureau is a part of the Government and therefore does not always receive the praise that it so richly deserves. But it sets tasks for itself and works doggedly, in the face of all sorts of difficulties, and usually comes out at the end with the results which were set for the goal.

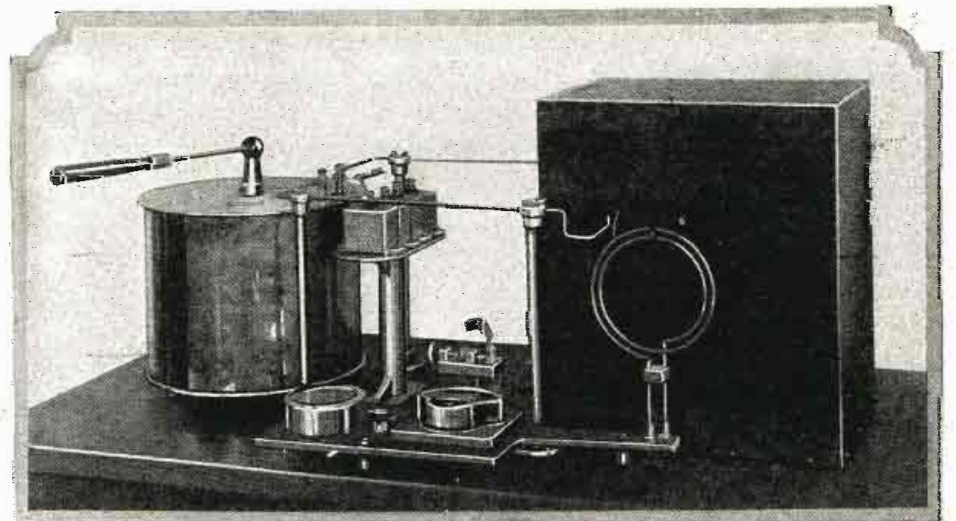

A standard wavemeter which sets the frequencies upon which the stations under United States jurisdiction operate. This instrument is accurate to a thousandth of one percent.



The Life and Work of Lee DeForest



CENTRAL ON THE FLAGSHIP. LIEUT. WEAVER, OF ADMIRAL EVANS'S STAFF, WHO WILL BE THE "HELLO" MAN ON THE CONNECTICUT.

A newspaper illustration from a Sunday supplement, showing the popular furore credited by the DeForest wireless telephone.

PART IX

FOLLOWING the dissolution of the old DeForest Wireless Telephone and Telegraph Co., due to some of the fiscal actions of its president, Mr. White, DeForest, feeling again the old tug of too little money and too much work, did not lose heart, but with a healthy determination and a resolve to watch more carefully the operations on the purely business end, started out anew to follow the same old road to success. Since he had seen the top, this depression was even worse than the early privations he had suffered. Before, it was simply struggling toward a wished-for goal. Now it was an attempt to recoup.

However, he had been injured to defeat, so the shock was not nearly so great as one would think. DeForest, finding himself without connections, simply went back to his laboratory in the Parker Building just off Madison Square in New York, and began a long, intensive period of work on his newly developed radio or wireless telephone. Already, tests had shown the absolute feasibility of DeForest's system, so he was confident that the only step needed was the commercial adaptation of the apparatus.

All during the time he was making these investigations, there were at least three wireless amateurs who were interested in the work. The Parker Building, in which DeForest had his laboratory, was situated at Eighteenth Street and Madison Avenue. Just a couple of blocks away in the Metropolitan Building, Miller Reese Hutchinson — then working on his Klaxon horn — was busily engaged in work of his own. His chief diversion, however, was to listen in on the activities of the ether with a small radio set. Then just a block further on, in one of the rooms high in the Madison Square Garden Tower, was Peter Cooper Hewitt, also equipped with a wireless set.

Hutchinson was so interested in the work DeForest was doing that, on several occasions, he helped by keeping watch at his receiver while DeForest carried out tests on some new piece of apparatus. On these occasions he and DeForest would hold long conversations over the wire line which connected their two offices, arranging a system of signals for reporting the results of the test. Then passers-by on the street below would be astounded to see a man leaning far out one of the upper windows of the Metropolitan Life Insurance Building, busily waving, as if he were slightly cracked, what appeared to be a dirty towel. Those same passers-by would, no doubt, be astounded to learn that those signals probably had more to do with the operation of the present-day radiophone than any other one act in the history of the art, for it was as a result of these tests that DeForest continued his work, finally bringing his wireless telephone to such a state of development that it could be made commercially successful.

It was a half an hour after one of these signals that the telephone hanging on the wall at the other end of the DeForest laboratory rang violently. DeForest dropped the piece of note paper he was holding in his hand, but failed to turn out the arc or stop the phonograph, which was grinding a record onto the air. He rushed to the phone and picked up the receiver.

"This is Cooper Hewitt, in the Madison Square Tower," said the voice at the other end of the wire. "Listen."

And as DeForest listened there was something strangely familiar about the music which the telephone receiver reproduced. He instinctively turned toward the phonograph connected with the arc transmitter. The music in the telephone stopped and a gr-r-r-r followed it. He saw the arm of the phonograph swinging into the center of the disc at the same time and knew that his music, being broadcast, had been picked up by Mr.

Hewitt and sent back to him over the local telephone line!

In the early spring of 1907, many of the Sunday papers carried weird tales of three brothers who, in the basement of a building just across from the Metropolitan Opera House, were creating synthetic music. By purely mechanical means, they could create a more perfect violin tone than a genuine of Stradivarius. By the simple expedient of shifting a few switches, they could make the same piece of apparatus produce the low, rumbling note of a kettle-drum in F sharp. Many musicians came to look over the set and wonder at it. They knew that they could produce beautiful tones with a seasoned old instrument but for the life of them they could not understand how a bunch of wires and a series of whirring dynamos and an awful collection of gears of iron and steel could be made to do the same thing. They went away sadly, shaking their heads.

The Cahill brothers, inventors and perfectors of the machine, were anxious to find a commercial outlet for their synthetic music. They held long conference with the officials of the New York Telephone Company and made all sorts of offers for the use of their established lines as carriers for their music. In fine, they wanted to broadcast. The Telephone Company, however, could see little, if any, gain to themselves in allowing this new-fangled idea to be installed on their lines. The engineers warily shook their heads, they were visioning the results which would be wrought if the kilowatts which could be of the "Telharmonium" — that's what the



The first portable wireless set, with the good old Army mule as portage power.

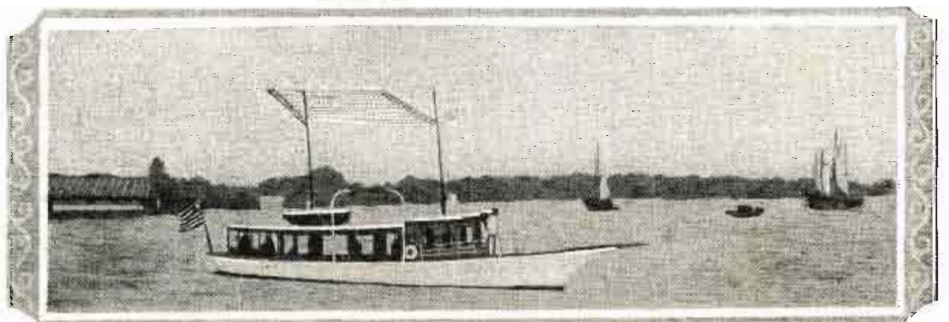

The "Thelma," first private yacht to be equipped with wireless. It reported the results of a famous yacht race.

40 Non-Technical Radio Articles

every month for the beginner, the layman and those who like radio from the non-technical side.

SCIENCE & INVENTION, which can be bought at any newsstand, contains the largest and most interesting section of radio articles of any non-radio magazine in existence.

Plenty of "How To Make It" radio articles and plenty of simplified hook-ups for the layman and experimenter. The radio section of SCIENCE & INVENTION is so good that many RADIO NEWS readers buy it solely for this feature.

List of Radio Articles Appearing in the June Issue of "Science and Invention"

Latest Radio News in Pictures.

College Radio.

Radio Television.

Super Radio System,

By Dr. Alfred Gradenwitz.

Glass Cabinet Radio Set,

By Dr. Ernest Bade.

Radio Frequency Transformers from

Honeycomb Coils.

By Herbert E. Hayden.

A Home-Made 100-Volt Storage "B" Bat-

tery.

A Paper Cone Loud Speaker.

A Page for the Novice—Part 5. Audio-

Frequency Amplifiers.

Radio Oracle.

Cahills called their machine—were allowed to pass over the lines accustomed to only a fraction of an ampere at 24 volts. They could see the induced currents from this heavy charge spreading all over the lines, burning out ringing coils and generally disrupting their work of years. Consequently, the brothers abandon this plan.

They next went to Albany to see if the State Legislature could not be prevailed upon to grant them a franchise for running cables under the street. The telephone company was again present and took the trouble to point out that their franchise was exclusive and that they would see that no other cables were run under the streets near theirs.

DeForest heard of the machine and at once saw the adaptability to his newly perfected wireless telephone. No cables would have to be run under the streets. Accordingly DeForest took himself up to the room across from the Metropolitan. There he found a system of generators producing audio frequency alternating current. By special methods of wiring and the interposition of filters in the line, all harmonics of the various frequencies could be produced, thus simulating the particular instruments. The heart of the machine was composed of a number of armatures attached to a single rotating shaft and all running in front of their field pieces. By altering the speed and changing the filter system, all the notes could be produced. The music was as near perfect

as possible, since the generators produced perfect sine waves.

DeForest saw the advantages of broadcasting this music, for the powerful current generated did away with the necessity of the microphone.

Until this time, all modulation was done with the microphone in the antenna or ground circuit of the transmitter. This made necessary a microphone designed to carry extremely heavy currents. The types available were continually jamming and choking. The output of the wireless telephone was limited, to a certain extent, by the capacity of the microphone. With the Cahill machine none would be necessary, so at one stroke this bugbear would be circumvented.

He held consultation with the inventors of the machine and their financial backers. They wanted to see a test of his set in operation. He agreed and brought up one of his transmitters for installation. He connected it up, erected an antenna atop the building and placed a companion receiver in the *Times* Building at Times Square. They began the tests with the Cahill brothers listening in at the *Times* station. The music came over with perfect clarity. It was time to talk business.

After the successful test he argued with the inventors of the Telharmonium, he showed them how wireless was the only solution to their problem, how the cost of installation was smaller for the radio system than the wire system, he showed them how it was the only logical course.

But the financial backers—and the brothers themselves—lacked the imagination and the

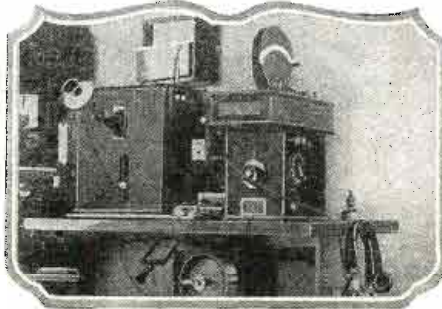

A close-up of the wireless telephone installed on the "Virginia," flagship of the fleet.

courage to attempt this very new system. It remained for one of the large corporations to do the first broadcasting some years later.

But the short transmission of music from the Telharmonium over four blocks of space to the tower of the *Times* building remains the first actual broadcasting incorporating the present connotation of the word ever successfully carried out.

DeForest swallowed his disappointment at not being able to convince the men of the practicability of his wireless telephone. He had run counter to sufficient disappointment to give him a lot of practice in taking it. He

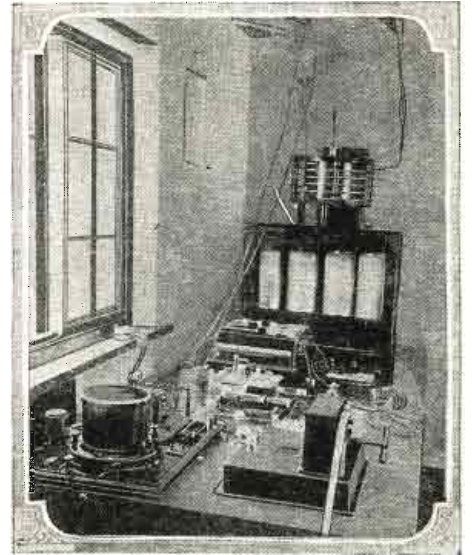

A typical commercial wireless station of the time of the present article.

was not particularly down-hearted. He returned to his laboratory to continue the investigation and perfection of his device. It was during one of these tests in which he was putting a part of an old speech and some phonograph music on the air, that one George Davis, chief electrician of the Brooklyn Navy Yard, was called in by one of his operators at the wireless station to listen to the speech and music coming in through the ear-phones. The operator was of the opinion that he had had a little too much beer at the corner and wished to have himself reassured. Davis came in, donned a pair of phones and began to think that maybe he was reaching his dotage a little early.

But the thing was a fact—four or five of the operators attested to it. His hearing could not be deceiving him. Then he remembered DeForest. DeForest, he thought, was the only man in town who could be doing such an unheard-of thing. Going on this hunch, he went to the telephone and called DeForest's studio.

"Am I drunk or crazy, or are you sending out some talk and music over that wireless of yours?" he asked, as soon as DeForest took down the receiver. DeForest laughed and told him that he had a wireless telephone working and asked him how he liked it.

Davis, immediately seeing the possibilities of the thing, sat down and wrote a report of the whole incident, together with a description of the apparatus used, to the Navy Department at Washington. . . . This same Davis is now signing his name as vice president of the Radio Corporation of America.

A couple of weeks later, the morning's mail brought DeForest a letter franked from the Navy Department. Within, the letter asked the newly formed Wireless Telephone Company—which DeForest had formed with the aid of a former salesman of the old DeForest Wireless Telephone and Telegraph Company—if it could install two of its telephones on the *U. S. S. Virginia* and *Connecticut* in view of giving the apparatus a test under actual operating conditions. Of course DeForest jumped at the chance.

The stipulations of the trial were that the apparatus was to be simple and steady in operation and that it should cover a range of ten miles. DeForest immediately put the whole force of the laboratory on the job of constructing the two test sets. They worked with all passion since it was an opportunity for all of them to make a great deal of money and fame for themselves.

In due time the sets were installed and the test made in the New York Harbor. The

(Continued on page 2325)

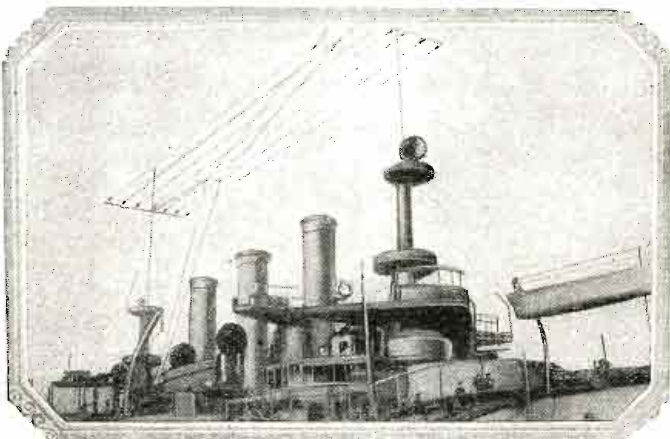

Note that the wireless telephone antenna installed on the Evans fleet was slung just under the main transmitter antenna. The result to the phone receiver of the power set operation may easily be imagined.

How to Identify the Enemies of Good Reproduction

By EDGAR H. FELIX

An interesting article about the origin of some of the noises we hear in our receiving sets.

DOES your radio receiver reproduce the mellowness of the 'cello, the sweetness of the violin, the power of the organ, and lightness of the soprano and the clarity of the flute? Does the voice of every speaker sound so realistic through your loud speaker that you would recognize him instantly if you met him? Does such realistic reproduction come to you unaccompanied by extraneous sounds and interfering noises?

There is no lack of information on *how* to cure distortion and interference, and it is not my purpose to discuss that subject here. But I hope, after you have read this article, that you will be able to *identify* exactly what causes the infidelity of reproduction which you experience.

as the sole audience. On the stage, a man is playing a piano and another a violin. The sound of the instruments comes to you echoed and re-echoed. The alcove entrance-way in back of you echoes a certain pitch strongly so that when that particular pitch is played, you hear it louder than any other. No other sound comes to your ear except the weak and distorted music from the two instruments on the stage. This is an example of the first case—distortion of the music itself.

Now, imagine yourself sitting in a noisy restaurant. There is much conversation at your own table and a loud clatter of dishes in all directions practically drowns out the orchestra. You hear enough of its rendition to be certain that it is playing well, but

than modulation which can be pointed to with an accusing finger! Nevertheless, in spite of this formidable array of conversions and processes, each can be performed perfectly, and truly marvelous fidelity of reproduction is possible by good broadcasting. First, let us narrow down our search to one of the three parts of the table.

First, the transmitter is to blame if the distorting quality is heard only when tuning to one particular station. Make certain of this by listening critically to several stations of like volume. If unfaithful reproduction or a certain characteristic of unfaithful reproduction is heard when listening to a single program only, confine your study to the possible causes of distortion in the first phase of a program's rendition—that is, its transmission.

Second, if the ether medium is to blame, all stations will be affected in a similar manner. The greater the distance you are receiving, the louder will be the interfering noises. Most, but not all, distortion contributed by the ether medium is present on all wave-lengths, whether you are tuned to

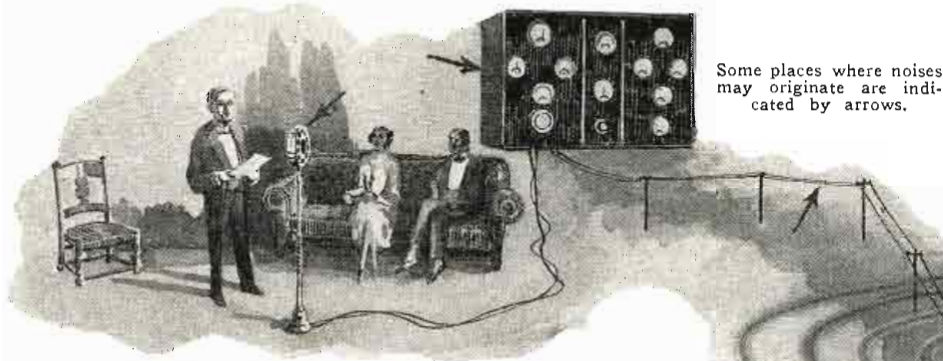

CUT YOUR DISTORTION HUNT IN TWO

In order to make your distortion trouble hunt as easy as possible, narrow down your search by a process of elimination to a few possible causes. First, distinguish between two kinds of disturbance:

- (1) Actual distortion of the music or program itself, which changes its tonal characteristics, and
- (2) Superimposed noises, which, added to a faithful reproduction, cause it to sound unmusical.

To make the distinction between these two more clear to you, imagine yourself sitting in the second balcony of a huge auditorium

the superimposed din makes it impossible to enjoy. This is an example of the second class of unmusical reproduction.

In the following tabulation all the phases through which a program must pass before you hear it are listed in logical order and the conditions which must be observed during each step if there is to be no distortion and no interfering noise, are cited.

Indeed, a manifold and complex process! Obviously, there are many factors other

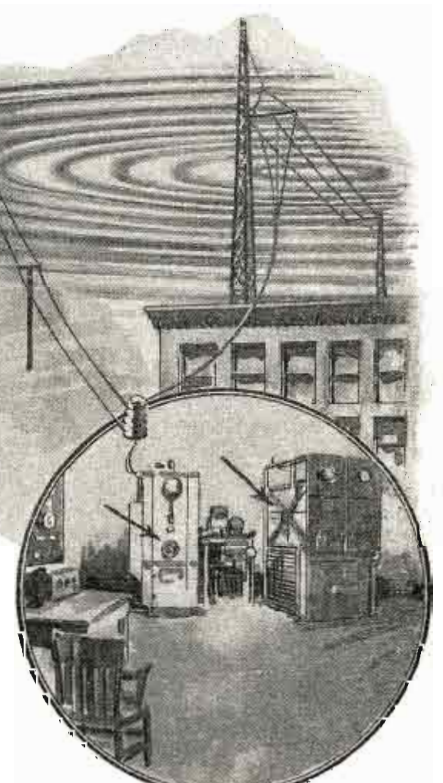

I—TRANSMISSION			
Step	Physical Form	Conditions Necessary To:	
		Good Musical Quality	Absence of Extraneous Sound
1. Rendition.	Sound wave.	Good voice or instrumental quality, timbre. Good balance of components in orchestra or singers. Absence of reverberation in room.	Absence of noise in background such as people talking, walking "or eating."
2. Pick-up by microphone.	Conversion from sound wave to audio frequency electric current.	Artists must be placed in proper relation to it. Room should not reflex echo appreciably.	Noiseless microphone properly mounted.
3. Amplified for wire transmission.	Audio frequency current.	No overloading, under or over amplifying.	Quiet amplifier.
4. Transmission by wire line to radio station.	Audio frequency current.	Well balanced line with good a. f. characteristics.	Quiet line free from parasites such as induction, etc.
5. Amplified to high power.	Audio frequency current.	Distortion-free amplifier.	Unvarying plate potential and grid wires.
6. Modulation.	Process of combining audio frequency current with radio frequency.	No over-modulation.	Unvarying plate potential and grid wires.

a station or not. If that annoying hum, squeal or click is heard all over the dials, the chances are that the ether medium is contributing some unwanted radiation to your reception.

Third, your receiving set itself may be at fault, either on account of the design of one of its components or on account of its operation. However, such a fault is always apparent with signals of equal volume no matter to what station you tune. By tuning to several stations you can distinguish it from distortion contributed by a particular transmitter, because receiving set distortion is heard when tuning to any loud station. Unlike distortion contributed dur-

ing a program's radiation through the ether, the degree of distortion does not vary with the distance being received but only with the volume.

As we have seen, faulty transmission identifies itself by being a characteristic of a single program from a certain station. Poor quality may manifest itself either as unfaithful reproduction or faithful reproduction accompanied by extraneous sounds.

NATURALNESS, TEST OF GOOD REPRODUCTION

The test of unfaithful reproduction is lack of naturalness. In what respects does the reproduction differ from the real thing? First, a particular instrument or voice of a group may be poorly transmitted; second, a particular pitch may be exaggerated or flattened; or third, music of a particular volume—usually very loud or very soft—may be unfaithfully reproduced, while all other degrees of volume may be satisfactory. These are the three types of distortion to musical programs which directly affect reproduction. Now for their identification.

POOR BALANCE IN STUDIO EASILY DETECTED

As a radio listener, you can test the balance (as the placement of artists is called) by direct observation. Piano accompaniment to a singer should be subdued and the singer's voice should predominate. Often this is neglected and the singer's voice is drowned out by the piano.

Placement of orchestras is more difficult than that of a singer and his piano accompaniment.

WHEN ONE NOTE IS LOUDER THAN THE REST

Sometimes you hear an orchestra or singer which sounds excellent until a certain note

II—RADIATION			
7. Radiation.	Liberated as ether wave from antenna system.	No reflected waves.	No radiations from receivers, transmitters, or electric apparatus, static, etc.
III—RECEPTION			
8. Received.	Converted from ether wave to modulated radio frequency current and amplified (with sets having r. f. tubes).	No chopping off of peaks. Regeneration, but no oscillation.	Tight connections and unvarying plate potential source, good tubes, etc.
9. Detected.	Separation of audio frequency component from radio frequency.	No self oscillation.	Proper value of grid leak and plate potential and filament circuit.
10. Amplified.	Audio frequency current.	Distortion free transformers.	Good connections. No magnetic coupling battery trouble.
11. Converted to sound.	Passed through phone unit.	Properly adjusted diaphragm.	Tight diaphragm.
12. Radiated as sound wave.	Through loud speaker.	Good form of horn.	No echo or reverberation in room.

announcer comes in, these interfering noises are easily identified.

Sometimes a steady hissing noise is heard. This is caused by a noisy microphone. It is a sort of muffled hiss and is easily detected when music ceases.

WIRE LINE NOISES

Many programs outside the studio are seriously marred by noises induced upon the telephone or telegraph line by neighboring wires.

The steady humming noise, particularly loud when no program is going on, and persisting after the microphone is shut off,

be received with serious and consistent distortion. Such cases have mystified engineers and various explanations have been given. It has been found in some cases, by experimentation with loop receivers, that the signals from that station in areas so affected, seem to come from two directions. With a non-directional receiver, signals from both directions are picked up. If these are slightly out of phase, there will be a distorting affect. Fortunately, such instances are few and far between.

The squeal and whistle of the regenerative receiver, the enemy to progress in radio, is too familiar to require description. Fre-

Where a few of the noises in receivers originate near our homes.

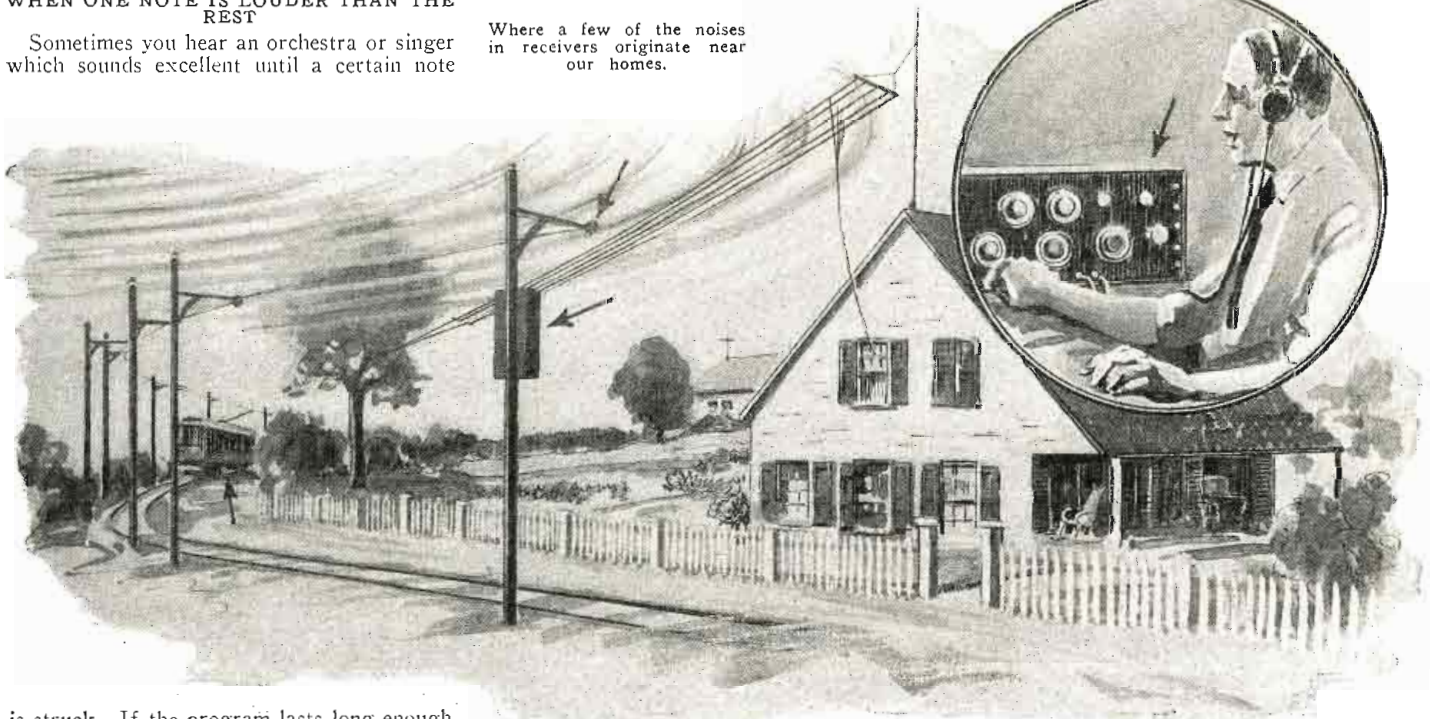

is struck. If the program lasts long enough, you can learn that pitch and strike it on the piano. Be certain that this is a characteristic of that particular program and not of all music which you hear with your set. If a particular pitch always sounds flattened, no matter what station you are listening to, look to your own receiver for the cause. But, if it is localized to a particular program, several faults in transmission may be to blame.

EXTRANEIOUS SOUNDS CONTRIBUTED BY THE TRANSMITTER

Now let us consider the extraneous sounds which may be introduced in the transmitting process. First, there is actual noise at the transmitting point, such as people talking or walking within range of the microphone. When the orchestra stops and before the

is usually due to the hum of the generator supplying the plate potential of the transmitter.

ENEMIES TO QUALITY IN THE ETHER

Assuming a program picked up and radiated with good quality and without addition of extraneous sounds, death-dealing blows to good quality may be given it during its journey through the ether, particularly by neighboring receiving sets. A regenerative receiver operated just below the oscillating point within a short distance of your receiving set gives a fuzzy quality which slight detuning may remedy.

Occasionally a particular broadcast station, well-known for its good quality of transmission, may in a certain limited area

quently, Super-heterodyne receivers are used with an antenna, having an oscillator coupled directly to the antenna circuit. The user may be enjoying a distant program with good quality of reception, and at the same time excluding everyone within a hundred square miles from a certain wave-length.

RADIATING POWER SYSTEMS

Sometimes we hear a bombardment of clicks all over the scale of wave-lengths, lasting from a few seconds to several minutes with gradually diminishing intensity. Such noises are usually accounted for by the sparks of an electric overhead system, supplying power to trolley cars or electric railways. Sand on the tracks which breaks the

(Continued on page 2318)

The Inventions of Reginald A. Fessenden

PART VI.

ONE advantage a small college has is that its best men personally teach the students; in a large university they are occupied with raising funds and executive details. The situation is somewhat as if we elected as President of the United States a man who had given evidence of his ability to deal successfully with certain nationally and internationally important problems; and then expected him to go out and raise the money for running the government by personal solicitation. It is perhaps fortunate that we no longer transact in kind or the modern college president might be asked to collect the necessary coals and vegetables.

For the administrative branch, i. e., the trustees, to elect a financial manager would, of course, not work, for this would inevitably result in one of those "nasty efficient little men who make everything work as if oiled and get everything fundamentally and incurably wrong" working into the position and becoming the de facto president. The college president should be allowed to appoint a secretary of the university treasury as a member of his personal cabinet, and be held responsible for results only.

WORK AT BISHOP'S COLLEGE

The staff of Bishop's College was exceptionally strong in the early 80's. The president, Lobley, had taken a first class in Classics at Cambridge and was a good mathematician. One of the other professors, an Oxford man, was even better, and the men in charge of French and Hebrew were fine scholars. Another good thing was that we were not worked too hard and had time to think. It is a physiological fact that one does not permanently remember a thing until about fifteen minutes after it has happened, i. e., if one is made insensible by an accident the record of the preceding quarter hour is generally lost, the connecting brain filaments which should have been growing together during that interval have not taken their places and the actions of that interval have not become a permanent part of the personality. This must be reckoned with in education. A. L. Smith, late Master of Balliol, once told me that Jowett, who trained so many great men—Asquith, Curzon, Lansdown, Morier, Swinburne, Lang, Steevens, Anthony Hope (Havkins), Milner—used to say, "Six hours' work a day gets the best out of a man." We did not average four, we could generally work in a half hour's tennis on the courts, between the river and the college, during the summer months in the morning and most of the afternoons were free. Three hours' classics and mathematics and an occasional hour of history or some lighter subject made the routine, and though in my own case the teaching work added something; on the other hand I did not have to prepare, for the honors entrance requirement at Trinity was nearly equivalent to the usual pass degree. The easy work gave a better chance to get the real beauty of the books we read. What was for many years a mortifying recollection is connected with a play of Euripides. We were supposed to read on till Lobley told us to stop. In the middle of my turn, along with the feeling that I was getting it into pretty good English, I found with disgust that the tears were beginning to come. Lobley would not give me the word to stop though I gave him a number of chances, which made me madder yet, so I had to read on to the end. I must have

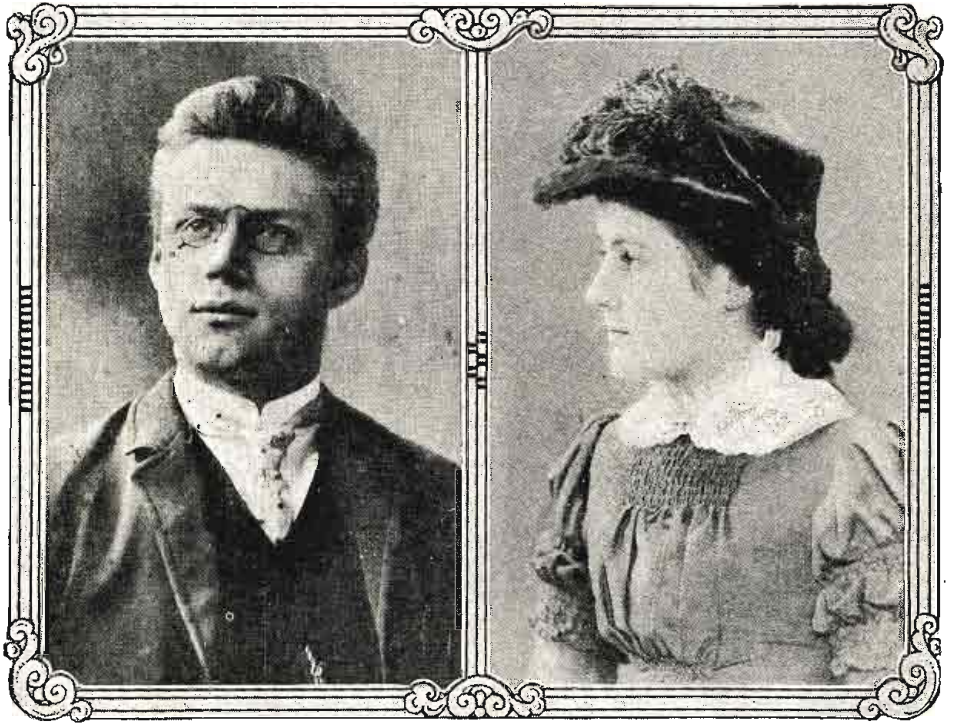

Portraits of Prof. Fessenden and Miss Helen Trott at the time they became engaged. Prof. Fessenden at this time was Principal of the Whitney Institute, Bermuda, and Miss Trott had just returned from her studies in Europe.

been a funny sight, with the tears streaming down and furious with shame, but no one laughed, for they knew I would have licked them good. While writing this I have looked up the old play for the first time since then. Most of it seemed rather poor stuff, but when I came to that part again I had to admit that Euripides was capable at times of making what Stevenson called "a brutal assault on the feelings."

There was no regular training for the boat or for cricket or tennis or boxing. We did these things when we felt like it, or snow-shoed or tobogganed or shot in the woods, or canoed the upper river. There were no secret societies with their nasty little politics and we were too far away from Sherbrook for any social affairs. So we were bored with not having enough to do and took on extra work. I took the regular work in Hebrew as an extra and worked up some Arabic on the side and enough Sanskrit to read a part of the Mahabharata, all of which, curiously enough, came in useful long after. Also, in an effort to overcome an earlier prejudice which came from reading Hamilton's works, I went conscientiously three times through Kant's Critique without any increase of respect for the subject.

NOTE.—The objection to secret societies is not on personal grounds, as I am a member of one myself. It is based partly on:

(a) What seems to me the much better social system of the English universities, where the main social groupings are by colleges or by activities.

(b) The historical origin of secret societies. The dominant race has always, as we know from history, been characterized by openness. Herodotus gives the Scythian king's answer to Darius, "In return for thy calling thyself my lord, I say to thee, 'Go weep,'" and comments, "This is what we mean by the Scythian mode of speech." And

so with the Laconians and the Franks. The secret society can definitely be said to have originated with the negro and servile races, and spread later to the negroid races of the Mediterranean and to Asia. It is not an institution of white or dominant races, and appears to be characteristic of what is termed today "the inferiority complex," possibly being in some way palliative.

(c) The kind of politics developed in such societies is effective enough in a small way, and has been developed to its highest point by the Mediterranean races. But it is useless and a hindrance when applied to larger affairs. Many pathetic incidents have been told recently of a man who might, and should, with his opportunities, have been a great statesman. But to me the most pathetic is an interview which appeared nearly ten years ago in which he replied to a question, that he thought his great forte was not history, or teaching, but affairs. His reticent methods pitifully failed when applied against opponents irritated and perhaps mistaken, but who knew the larger, more simple and more effective politics.

THE COLLEGE LIBRARY

One reason was that we had a real homely library. It made one want to use it. After dinner, an hour's preparation for next day and a half hour's boxing, one came down to the old place, lined round on the top shelves with fine work of the early printers, and lower down with the more modern works, pulled out what books one wanted one's self, lit one's pipe and lying off in a comfortable chair with feet on one of the library tables, read till twelve. Then to the College kitchen to make a Welsh rabbit and drink coffee or occasionally a glass of beer. And so to bed.

FIRST IMPULSE TO SCIENTIFIC WORK

Lobley thought I should go to England on the chance of getting a scholarship and later a fellowship, and my father wished

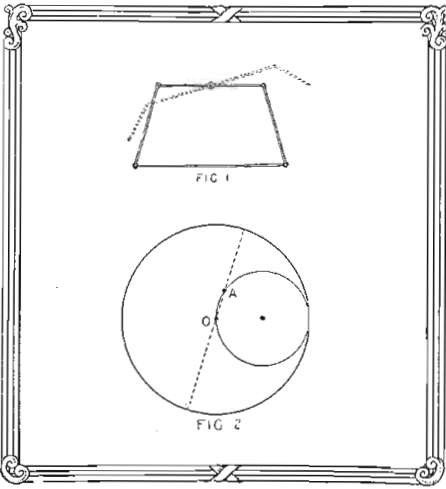

As a substitute for a straight line motion in which the four-bar linkage (Fig. 1) was employed, Prof. Fessenden while yet a student at college invented the mechanism represented in Fig. 2. As a small circle moves along the circumference of the large one, the point A describes a straight line.

this. But on the library table was a weekly scientific publication, *Nature*, which became more and more interesting and led me to the more practical *Scientific American*, some experiments with electric batteries and my first, very minor, invention. An article appeared in the latter paper on a sort of tractor for tropical countries which progressed by the lifting, moving forward and setting down again of its supports. A four bar link motion was used for this, the center point of one bar giving very closely the required straight line motion during a portion of the revolution of the bars as shown in Fig. 1.

The editorial comment was that a true straight line motion could not be produced except by using another straight line in some fashion. I built a little wooden model utilizing the well-known elementary theorem that if a circle rolls round inside on the circumference of another circle of twice its diameter, every point on the circumference of the smaller circle will describe a straight line, as shown in Fig. 2. And to apply this to the particular problem a form of link motion was incorporated. No reply was received to my communication, but many years after it was interesting to read of the difficulty Watt ran up against owing to the crank motion being covered by the patent of another inventor, and how he had overcome it by inventing his "wheel and planet" motion, based on the same principle. It gives one an idea how rapidly mechanics had advanced to think that the crank motion could be patented in 1780.

BERMUDA

The salary was not enough to pay my way, the education of my younger brothers had to be provided for, I had done substantially all the work necessary for a degree and was restless with the feeling that there were fields more constructive than investigation of the Greek particles. An offer of the principal-

Mr. J. Scott Pearman, a Bermudian friend of Prof. Fessenden, the moving spirit of the Whitney Institute and of Bermuda's botanical development.



ship of the Whitney Institute in Bermuda was at once accepted. Two incidents of the journey are vivid. A smallpox epidemic was at its height when I stopped for a few days in Montreal. There was great mortality amongst the French *habitants*, who would not be vaccinated, for many of the French priests were then not so well educated as now, and I saw a butcher with his axe and a priest beside him standing off the health officers. The other was the Hudson River as the train ran along it close to the water's edge in the early summer morning.

The Whitney Institute had been founded by some wealthy Bermudians but the moving element was another Bermudian, Mr. J. Scott Pearman, who became my best friend, and who is still adding to the Institute. The work was harder than at Bishop's College and School, for I found it possible to handle all the classes myself, so the title of principal was rather an empty one. The students were of all ages, but this appealed, for it has always seemed to me that the training of students during their first years was, if anything, even more important than during their final. Looking back I think I can congratulate myself on the results, though my methods did not always fit in with the ideas of the school inspector of the island, a conscientious but not very liberally educated product of the Board schools.

SOCIAL LIFE. ENGAGEMENT

The social life more than made up for the hard work. Most of the Bermudians of that time were planters. Quite a good many of the younger people had been educated in England and abroad. Coming direct from Bishop's College, life in Bermuda appeared to me to be what Alfred Henry Lewis has called "one continuous round of flour doin's and chicken fixin's" with all the picnics, fishing trips, dances, amateur theatricals, dinners and swimming parties. Up to that time I was rather bashful and had had very little to do with girls. So it was about the right time and the right place for me to fall in love, which I very promptly did with Miss Helen Trott, a niece of my friend Pearman and the daughter of one of the old island planters, and who had just finished her school days in England and on the continent. One could miss out a great deal of one's life and still be very happy remembering those drives back, after a dance, along the shores of Harrington Sound and the moonlight, the semi-tropical air and the smell of the jasmine flowers.

Holidays and vacations were mostly taken up with small boat sailing, and as there are innumerable small islands, channels and bays, there was always the fascination of exploring. The Bermuda dingy is very fast and has been rigged for several hundred years with a triangular mainsail whose advantages have become more generally known during the past ten years and which has been christened for advertising purposes, much to the

disgust of the Bermudian yachtsmen, with the name of a well-known wireless promoter. The swimming was ideal, the water so clear that the fishermen used to nip scallops in water thirty feet deep and pleasant all the year round, and on very hot afternoons I often drifted about in the sounds with the currents in a way they taught me there. You pull the brim of your hat over your eyes, interlock your fingers behind the back of your neck, relax and go to sleep while the tides carry you about till you are awakened by a string of big, cold, blue jellyfish sliding along your side or your heels dragging on some sandy shoal. And the caves were fascinating, so many never explored, at that time, but it does not do to leave a lighted candle tied at the end of a long tarred rope ladder when climbing back up it, or to set off too many Roman candles in a new cave without first inspecting the possibilities of ventilation.

VISITORS FROM OUTSIDE

Bermuda had not at that time become a tourist objective, but every now and then one would meet interesting people who had come there to rest. The Evanses, Dr. Evans who had aided the Empress Eugenie to escape, and his wife, stayed at Frascati for a year. It was a breath of the court of the Empire, they were so simple, so courteous, of the *grande maniere* but so unassuming that one only felt the exquisiteness of it. I should like to tell some of the things they told me. Another was an invalided American missionary from Turkey whom I learned to like very much and who went to the trouble of grounding me in Aramaic. A New York lawyer, interested in the Henry George movement, was my companion on many tramps, my opponent in many discussions on economic questions, and so persuasive over his pipe in the evenings that his absence must have been a real loss to the movement.

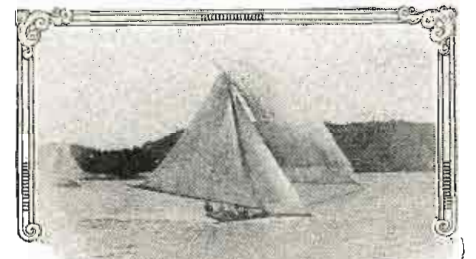

The century old triangular "Bermuda rig" on a racing dingey.

NEW YORK

Those two years were very happy ones, but I was engaged to be married and at that time there were not many business opportunities in Bermuda. So, in 1886, I went to New York with some letters of introduction from my New York friend to Henry George, recommending me for a position on his paper, and to some newspaper men on other papers. This was the year when Henry George was running for Mayor of New York. He was very busy but he saw me, glanced over some things I had written, and a few days later I was offered a job to write articles covering a certain minor field of the work. But he had recommended me to read some of the back numbers of the paper and I had done so, and that imperative and apparently ineradicable instinct for handling things quantitatively, getting the actual figures, which has so often been embarrassing, led me to look up the rise in value since purchase of several large real estate holdings, the Astors and others, and to compare them with the com-

pound interest on the original payment, the idea being that here would be a conclusive and overpowering proof of the Land Tax theory. But the mortifying figures could not be twisted legitimately so as to come out the expected, and if I was to accept the position, the necessary way. It was realized that this must have been noted by others and that there must be counter arguments, but to me it was conclusive and Henry George had been so kind that I could not face him again, feeling this, so the truthful, if ambiguous, answer went back that I had attempted the line he had indicated, but felt that one more familiar with the movement was needed.

VISIT TO EDISON

The real reason for going to New York had been to get a job with Edison. The newspaper work was to make living expenses while I was getting some practical knowledge of electricity in-odd hours. A few days going round with my letters of introduction to other editors made me realize what a fluke the Henry George offer had been, so I decided I might as well learn my practical electricity under Edison as anywhere else. At the New York office they told me he was spending most of his time at the Lamp Works at Harrison, N. J. Arrived there, my card went in with the slip of paper given me, to state my business on, and the slip came back endorsed "Am very busy. What do you know about electricity?"



View of a planter's home in Bermuda. "Rockinmore", that of Mrs. Fessenden's father, Thaddeus Trott, Esq.

This was a facer. I was a pretty fair mathematician and knew something about electrical theory and if I had had sense enough to say that would probably have been engaged. But the idea that mathematics was of value in electrical work had hardly been born. Edison himself was perhaps the first to realize it when he engaged Hopkinson to improve the design of his dynamos. In desperation at last I wrote, "Do not know anything about electricity, but can learn pretty quick." The "old man" must have been in a bad humor that day, for back came the slip, "Have enough men now who do not know anything about electricity," and back went I to New York. A few years after that, looking through some papers, I ran across the slip and handed it to him. He grinned and said, "Things must have been going pretty badly that day." And that was the fact, for he was normally the most considerate of men and I was told that just then they were having some extremely difficult situations to handle in connection with the incandescent lamps. Howell had been brought in to help solve them, the same Howell who was recently awarded the Edison medal, which he should have had long ago, and he succeeded, but it was a precarious as well as a laborious result.

NEWSPAPER WORK IN NEW YORK

Money was running short and I had no job or prospect of one. But getting a job,

it may possibly comfort some young man to know, is mainly a question of mathematical probabilities. No matter how far away the target is or how badly you aim, if you shoot a sufficient number of times you will hit the target just so often. It is substantially the same problem as advertising is. So the sooner one shoots that number of shots or applies for that number of openings, the sooner he hits the target or gets the job. In other words, get out and hustle; if you try for ten positions a day you will be placed in just one-tenth the time that it would take if you try for one position a day. In a little while I had placed some special articles, and was going round once a week to the office of the Edison Machine Works, which was then laying down the electric light mains in the district between 14th street and 52nd street. Also I was acting as assistant editor to a paper called *Social Science* which had been started at the time of the Henry George campaign. Weaverson was the editor, a very good man, from the west somewhere. One piece of work I remember was editing Ling's autobiography, in a fair and sympathetic way I hope and think.

Some of the experiences were interesting. I met Jay Gould, Pulitzer, Whitelaw Reid, in connection with the newspaper work, and a good many others through my acquaintance with a Canadian, Captain Williams, then head of the detective force. Amongst other incidents I remember dining with him and some very well-known and successful speculator—I think it was Fiske—and asking him if he had any fixed rule for speculating. He told me he had only one, and that was "Take your losses," which he explained meant that when a stock began to go down, one should sell out at once and not go on putting up margins. Gould and Pulitzer I remember most on account of their hair, Gould's heard so jet black it must have been dyed, and Pulitzer's fiery red. Both were very pleasant to me, but I imagine might have been otherwise on occasion.

Whitelaw Reid I remember mostly because he turned me down very hard on what I considered then, and still do, a good proposition. He had liked several of my special articles of a popular and topical scientific kind, so one day I suggested running a regular section. He said, "So, Mr. Fessenden, you propose a daily section of the paper devoted to scientific news and you believe that this can be made attractive to readers." I said I did. He just looked at me and then turned to his desk. In 1910, on handing him some letters of introduction (he was

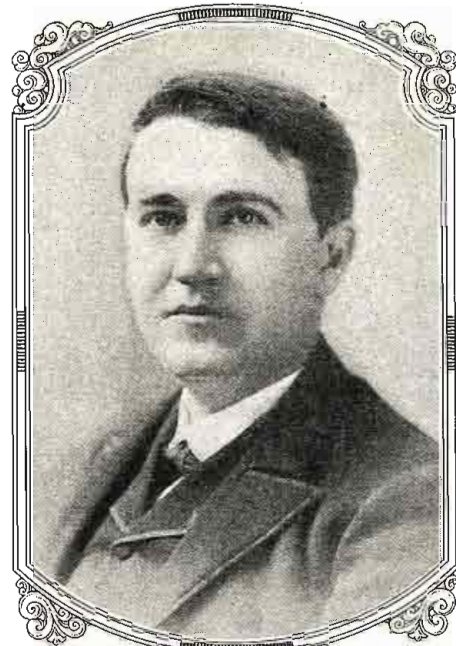

A portrait of Edison as Prof. Fessenden knew him in the late eighties.

then ambassador in London), I introduced myself as a *Tribune* man he had fired, which put us on good terms at once. But it was really an exaggeration, as I had never been on the regular staff. Later in that year (in 1910) I had the satisfaction of getting hold of some extremely important political news some months before he did (as will be told later) and telling him he had made a mistake in not keeping me on the *Tribune*.

Another interesting thing was the origin of the Shakespeare-Bacon controversy. The office of *Social Science* was in the same building as that of the *North American Review*, and Thorndyke Rice and Weaverson were good friends. Rice was appointed somewhere—to Russia, I think—and asked Weaverson to help on the *North American* during Rice's absence. One day a *North American* man brought down an article he had received from someone up in Canada, claiming to have discovered a cryptogram in an inscription in the church at Stratford-on-Avon, and asked whether it should be published. We looked it over and Weaverson finally decided the man was probably wrong, but that it was interesting enough to print. The article will be found in the *North American* somewhere about the end of 1886.

LAYING DOWN ELECTRIC MAINS IN NEW YORK

At last one day Mr. Kreusi, the head of the Edison Machine Works, located at Schenectady but having the contract for laying the mains, told me I seemed pretty persever-

(Continued on page 2274)

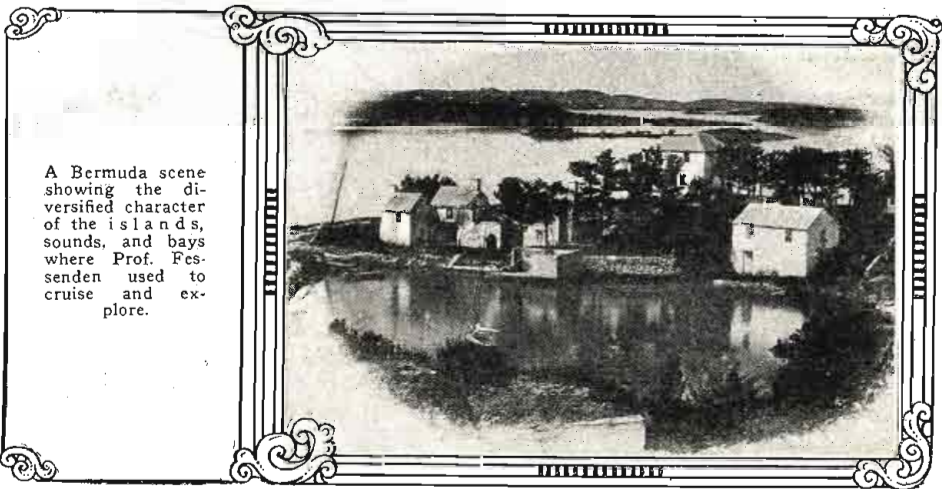

A Bermuda scene showing the diversified character of the islands, sounds, and bays where Prof. Fessenden used to cruise and explore.

Broadcasting in 1912

By G. C. B. ROWE

Very little is known now of the first commercial broadcast venture in the United States. This article chronicles its history. It was over telephone lines.



IN the age of science in which we are living people take the wonders that surround them as a matter of course and are wont to say: "How the world is progressing!" True enough, but it should be remembered that there is an old saying—"There is nothing new under the sun." How about the music, bed-time stories, news items and all the other programs that can be listened to without leaving the home, may be asked. Nothing new, is answered, nothing new, someone tried that a quarter of a century ago in Europe and thirteen years ago in Newark, N. J.

he wished to hear the latest happenings reported by the newspapers, or some snappy cabaret music, he put on his headset (even as you and I) and there was the program he wanted. Hardly seems possible, does it? But here is the tale.

In the early part of 1912 there were several gentlemen of New York traveling in Austria-Hungary and while they were in Budapest they were surprised to learn that they could listen to concerts or lectures without leaving their rooms. Being progressive Americans, they investigated this system of broadcasting programs and ascertained that it was not patented in the United States. They decided that such a system would be an excellent one to introduce at home, so they persuaded the Austrian engineers to tell them how it was accomplished.

These traveling gentlemen being of Wall Street, naturally attacked the new venture in the Street's usual manner. They formed the New Jersey Telephone Herald Company. In the charter it was stated that the company was formed to provide subscribers with entertainment by using telephone lines. Among the gentlemen who were heading the venture were Percy R. Pyne, 2d, H. B. Hollins and Charles E. Danforth.

It was decided to install the system in Newark, N. J., with the idea that if it was successful in that city, it should be introduced in New York. Wires were leased from the telephone company and the work of installation was started early in the Spring of 1912 and regular programs were being broadcast by July.

These programs started at nine o'clock in the morning and continued without interruption until 11 p. m. As has been mentioned above the same sort of programs that are broadcast today were sent out over the wires in 1912. Every fifteen minutes during the sessions of the Stock Exchange, quotations were given, supplied by ticker service from the Stock Exchange in New York. News items were read as soon as they were reported to the papers. There were fashion talks, sport talks, and bed-time stories for the



John P. Rainbault, who was the general manager of the first broadcast company.

children. The musical portion of the programs were under the guidance of Frank Clegg, who had his own orchestra at the studio and several times a week, in the evening, dance music was broadcast from one of the cabarets. Then, as now, managers of the theatres had the problem confronting them of whether they should broadcast their productions, because several plays in the local theatres were put on "on the wire."

However, the apparatus supplied by the Austrian engineers was not adaptable to American telephone engineering practice and the reception of the music and talks was not as clear as it should have been. The use of twisted pair in the distribution resulted in a

(Continued on page 2309)

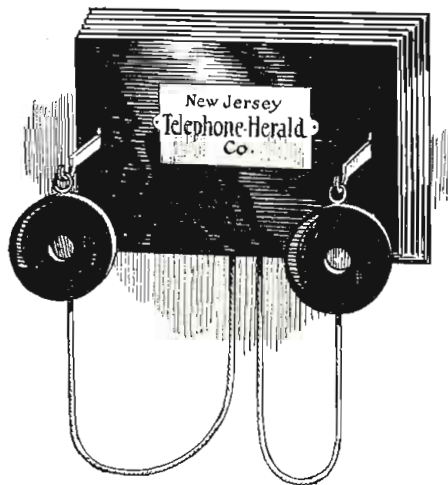

The subscriber's home installation was little more than a pair of receivers, as may be seen from the above sketch.

"What?" we can almost hear gasped, "could people hear the same sort of programs we hear today without stirring from their firesides?"

The answer is in the affirmative. If a person in Newark in the fall of 1912 wanted to learn how his pet stock was behaving or if

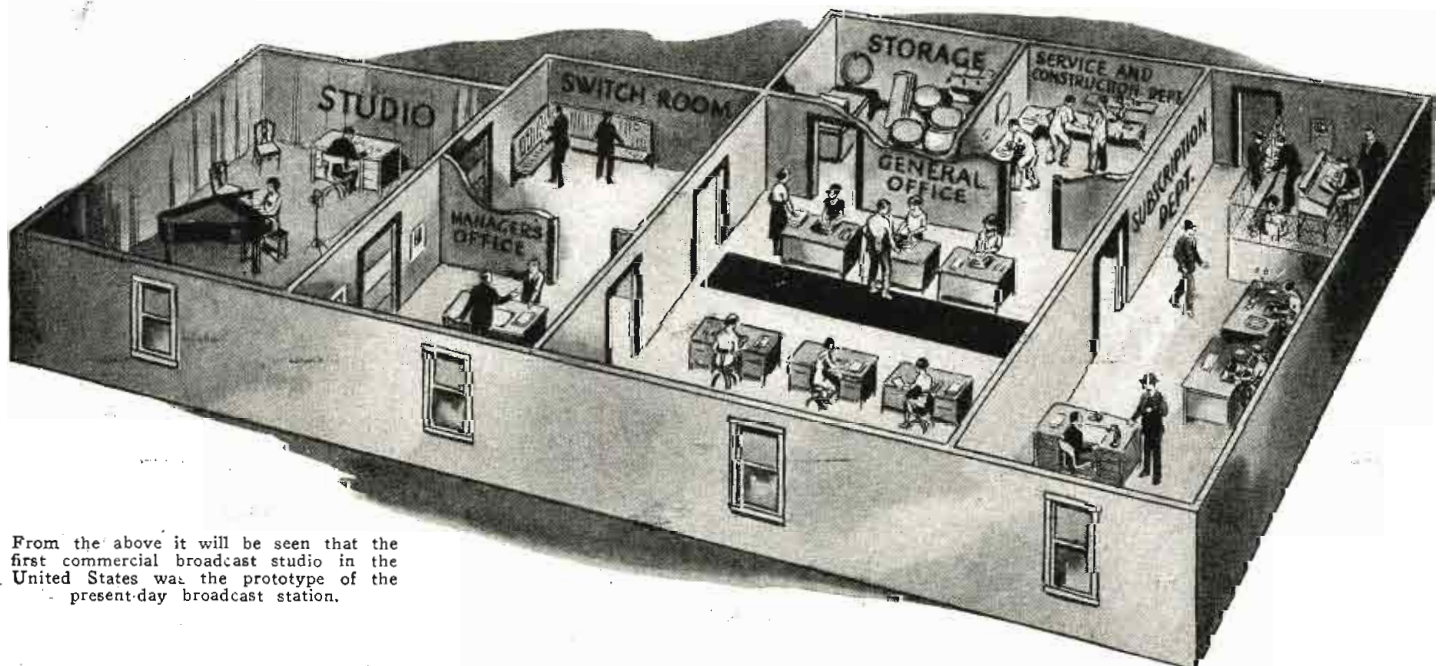

From the above it will be seen that the first commercial broadcast studio in the United States was the prototype of the present-day broadcast station.

Discovering Unexplored

By JOHN L. REINARTZ

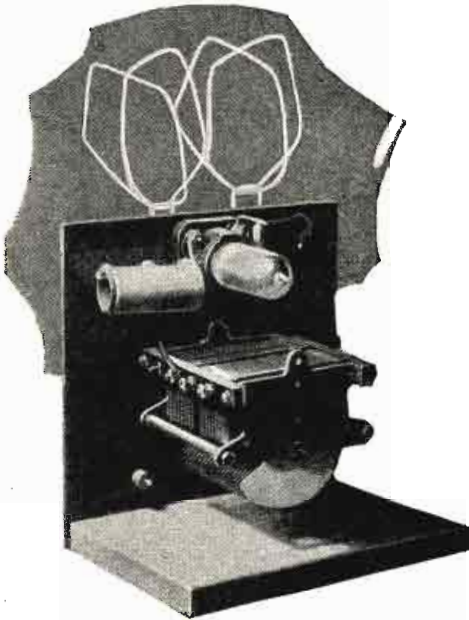

A view of the working arrangement of Mr. Reinartz 5-meter receiver.

THE strangest things imaginable happen when we begin to work a radio transmitter at the ultra frequencies that lie below the two-meter wave-length band. The experiments herein delineated were begun only a short time ago and there are still many points in the collected data which are, so far, unexplained and many others for which only the merest guesses are at hand.

What strange characteristics and phenomena will we find when we finally reach and are able to control the frequencies which lie below 150,000 kilocycles (two meters) up to the frequencies of light? That is the question which will probably be asked when the peculiar effects, which are gained by making a half-kilowatt tube oscillate and generate frequencies somewhere in this band, are told.

To start at the beginning: Along with my work on 40 and 20 meters, I have been constantly pushing downward in the wave-length band, seeking greater and greater frequencies. The huge increase in range for the same power input, gained with the use of the shorter waves, leads the experimenter who is after efficiency constantly in this direction.

EXPERIMENTING ON 2 METERS

Some weeks ago, after making my regular transmitter, shown in an accompanying photograph, work down to five meters, I decided to ascertain how high in frequency it was possible to make the tube oscillate. Accordingly, the clips of the oscillation transformer were moved closer and closer to the inside ends of the plate and grid coil and the tuning condensers were moved until the circuit was brought into resonance. The frequency was constantly checked as the clips were moved. That is, the record was kept until the lower limit of my wavemeter, which is slightly greater than two meters, was reached.

When the antenna circuit was connected to the tube and absorbed the power generated by it, the action of the set was regular in every way. The parts functioned as they should, and everything went off as usual.

But when the antenna and counterpoise were disconnected and removed from the tube, things began to happen which were most peculiar in nature and which, to date, I have not been able satisfactorily to explain.

Refer to Fig. 1, which shows a diagram of the half-kilowatt tube which was used in the experiments. This tube is the standard Radio Corporation product, being manufactured by the General Electric Company. It is rather old, has seen a great deal of service and is of old design.

About the only point of difference in the form of this tube and those now being manufactured by the company under the same designation is the location and shape of the grid lead, which runs from the element of the tube to the lug at the base which serves to make the outside connection.

The grid connection in question is formed from a small wire of some metal which is used in the regular tube construction. It leads directly from the supporting collar to a larger piece of wire which is carried through the wall of the tube to the base. But it is wound pig-tail fashion. *This seems to be of the utmost importance in the results obtained—therefore, the detailed description of the difference.*

PURPLE CORONA FORMED

When the tube was set into operation as described, without antenna or ground, as soon as the plate voltage was applied—in this case 3,000—the first point noticed was a dark blue-purple halo, or corona, which formed itself at both the narrow sides of the plate, as shown in the sketch. It was not like

comparison which may be drawn is that of a spot of very dim blue-purple light seen through a very fine cloth or ground glass screen, with the edges of the spot diffused rather than brought to sharp focus. This was evident on both the small sides of the plate and has persisted in its original form since the first time it was noticed.

The second curious effect was found at the approximate center of the large side of the plate. Here, as shown in the diagram, another somewhat similar occurrence took

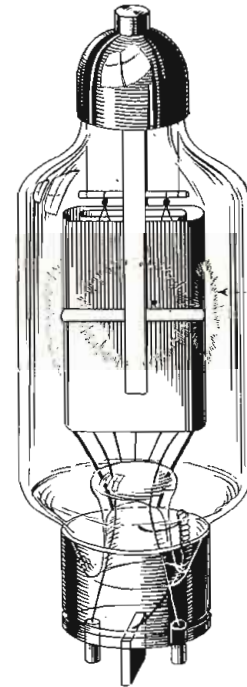

Fig. 1. The effect of ultra frequencies on the plate of a 500-watt transmitting tube is shown above. Note the small spot on the plate and the corona glow.

WE present an exclusive article on some very astounding discoveries just made by Mr. Reinartz. While it may be said that nothing astonishes us anymore, when it comes to the wonders of radio, still we were not prepared for the latest wonder.

In experimenting with tremendous frequencies, Mr. Reinartz has observed some as yet unexplained phenomena whereby it seems possible now to actually look through cold solid metal plates with the naked eye.

While it is possible to look through metal plates by means of X-rays, it is necessary to use an intermediary, platinum-barium-cyanide screen. No screen, however, is needed with the Reinartz discovery.

What this discovery may mean in the future can only be dimly imagined now.—EDITOR.

ordinary brush discharge, in that it seemed a bit more thin and was slightly away from the surface of the plates, there being possibly a sixteenth of an inch between them. The exact nature of the phenomenon cannot be described accurately. The nearest com-



Fig. 2. The ultra high frequencies do all sorts of peculiar things in passing through a tungar bulb, as may be seen above.

place. At first, the spot of light covered a diameter about the size of a five-cent piece and was entirely covered with the glow. The characteristics of this light were very similar to the other, except as to the color, which was more of a pink-purple. It seemed, in other words, to be more of a blue-purple, similar to the first, with a slight tinge of red which was not entirely merged with the other.

From time to time, as the tube was used again and again for observation of the phenomenon, the spot gradually grew in diameter until at present it is about the size of a silver dollar. With the increase in diameter of the spot, the intensity of the glow became less and less at the center—grading off to total blackness in the center and stopping abruptly at the circumference.

VISIBILITY ESTABLISHED

But the most important of all was the visibility established through the plate. This was noticed at the same time the other points were, and has given more concern as to explanation than have they. When the tube was put into operation and the light produced at the center and edge of the plate, simultaneously a spot occurred in the center of the plate in Fig. 1. It seemed at first to be an incandescent point on the surface of the plate, but investigation proved shortly that such was not the case. In spite of the light that showed on the surface and at the edges of the plate, it remained perfectly cold all during the demonstration.

Examination of the spot proved to admit of only one explanation, i.e., that there was a hole through the plate which made the filament, inside, visible! A revolving mirror

Ultra Frequencies

IXAM, IQP.

or various shutter movements before the spot served only to prove this point further. It could be nothing but a hole through the plate made by the emanations from the filament, or some other cause yet to be determined.

One theory which would serve well as an explanation of the formation of the hole is that some parasitic frequency is generated in the tube, when it is operating in the manner described, which has a new and unknown property. It might be rationalized by saying that the emission—whatever its nature—pushes the molecules of the plate metal into some sort of line, thus forming the hole and allowing the passage of the emission. A sort of parting of the Red Sea.

It is possible that the stream of vibrations from the filament simply crowds the molecules out to one side, in order to make room for their own escape.

NOT A REAL HOLE

Of course, a thorough examination of the plate proves that there is not a real hole in it at other times than when the tube is operating in this strange manner. At five meters, working with or without an antenna, none of the phenomena noted above occur.

A test was made for X-rays with the aid of a dentist's film, and proved the absence

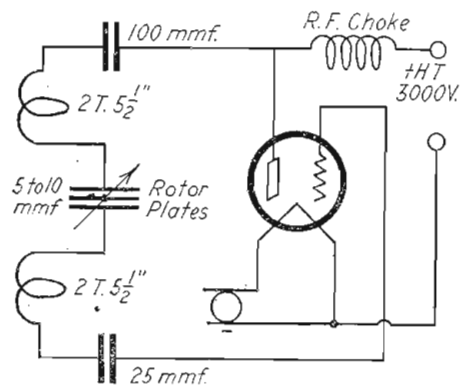

A hook-up with values used by Mr. Reinartz in his 5-meter transmitter.



The arrow shows the position at which the Tungar bulb is placed in the antenna circuit of the 2-meter transmitter.

of this ray. A number of other tests of the same type were made but brought negligible results.

The low wave work led to a number of other experiments which proved exceedingly interesting, if not particularly enlightening. Among the most important of these was the behavior of a Tungar charger bulb when placed in the high frequency circuit. Refer to Fig. 2.

There occurred a number of phenomena in this investigation which are extremely similar to the ordinary Geissler tube discharge, but at the same time have characteristics which cannot be explained by the known laws. The foremost of these is the heading effect shown in Fig. 2a. If the finger is placed on the glass of the bulb, a line of current makes its way from the anode or cathode, as the case may be, to the tip of the finger. If it is gradually moved farther and farther from the elements of the tube so that the high frequency current must travel over a constantly lengthening path, the stream will gradually form itself into a number of globules or small spheres until, just

before the cessation of current to the fingertip, each of these little balls will be entirely disassociated from the next, while the current is still traveling. The passage of the current is, of course, in the usual form seen in the Crookes tubes.

If heavy output is employed, numbers of bright spots, like small stars, will make their appearance at points along the elements of the rectifier bulb. What the reason is for such formations is not known. Possibly, it may rest in some inherent characteristic of the metal employed in the elements, or it might logically be the result of some electrical cause. The exact determination of the cause is yet to be made.

One of the most interesting demonstrations, which might well be used in teaching beginners, is the passage of the current along the wires of the elements. It actually *does* pass along the outer surface of them, with the very smallest amount of penetration possible. As a matter of fact, in many instances the current takes the form of a sort of rope, twining itself around the wires and so passing through the tube.

If the tube is held in the hand, the current jumps from the elements to the point of the flesh touching the glass, forming a sort of spot, as if making a condenser plate for itself. If the tube is suspended from the top—near the input terminal—the current will have a tendency to spread out, after the fashion of lightning.

This is the latest branch of the investigation and has, as yet, scarcely been begun—if the results which may be arrived at are considered.

Though it may mean anything or nothing, a test may be made with the same rectifier tube around the field of the oscillation transformer of a set working on five meters, which may result in some astounding revelations regarding the location of the maxima and minima in field strength.

To get back again to figures and something that is definitely and surely known, The transmission work on twenty and forty meters has shown the most peculiar characteristics regarding the distances over which the bands will work. The range for the forty-meter transmitter begins at the station at noon and with 100 watts input will cover between 2,000 and 2,500 miles. Then the local range changes until at midnight, the signals cannot be heard closer than 2,000 miles but beyond that point may be heard up to 2,300 or 4,000 miles. With the twenty-meter set, the signals may never be heard closer than 700 or 800 miles and at midnight may not be heard closer than 3,000 or 4,000 miles while the range at 100 watts extends to 7,500 miles. The twenty-meter band is almost worthless for the usual so-called local transmission at any time, day or night. Of course, up to thirty or forty miles, shock excitation, so to speak, will enable the signals to be read with ease, but further than that, the audibility of the signal depends upon

Fig. 2a. This sketch shows how the ultra high frequency current forms itself into a chain of beads when its path is made very long.

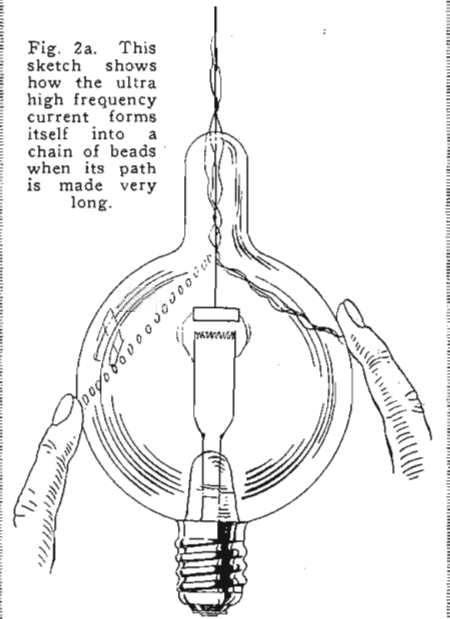

Tungar Bulb

the curve. The observations were made after a thorough check of work done over a period of almost a year. All these tests were carried on with the half-kilowatt transmitter using 100 watts input. All conditions were covered and the rule which may be deduced from the curves may be taken as empirical.

A peculiar thing is noted as to the field intensity. The portion resembling a halved torpedo at the end of the coil shows this characteristic. Practice will show that any increase in the power input will be expended three-quarters in increasing the range of audibility in the direction away from the transmitter, and the other quarter in increasing the range behind the curve or toward the station. This is a point which is important in designing a transmitter to work at these frequencies and to connect with a given point.

It is to be contemplated that the coming year will find more and more work being done in this quarter and the laws governing radio's actions in the new field more thoroughly known. Let's all work for it!

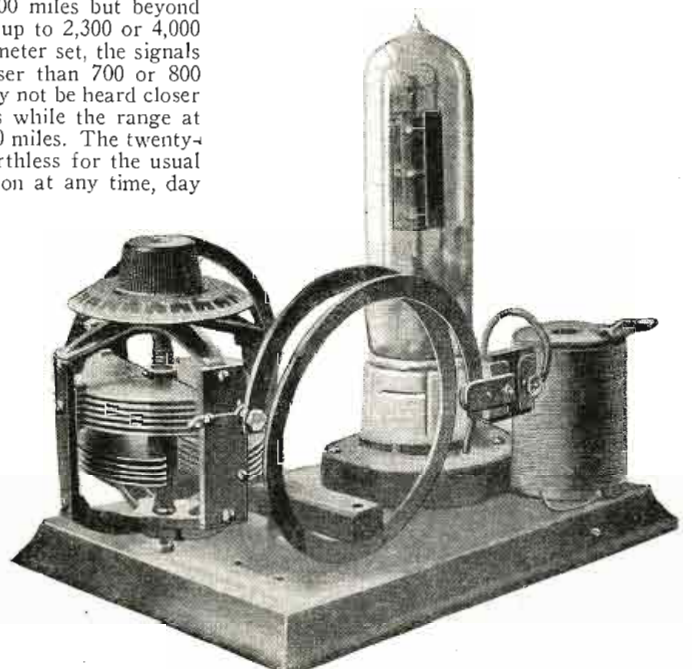

The lay-out of Mr. Reinartz's 5-meter transmitter which radiates into a 7-foot copper rod.

Un-Crowding the Air

By WILLIAM A. BRUNO, A.I.E.E.



Can your set be tuned down, at present, to 150 meters? If it cannot, try this system of switching.



ONE are the days when the radio set that would reach up as high as 550 meters and go down as low as 250 meters was considered good enough to give us all the "canned" or "uncanned" music that was traveling through the uncrowded ether.

Now, with almost seven hundred stations spread over the United States, the various frequencies are using their elbows very freely in the congested air, and are very rapidly approaching the condition so common in the well-known subways of New York City.

Nowadays, every citizen of these great United States seems to want a little portion of the air. The great corporation, the daily newspaper, the university, the hotel, the theatre, each believes that the little electrons in the upper air are not doing their full duty, unless the ether is engaged in carrying their particular message.

Broadcast stations have made great advances in power, clarity and exactness of

The difficulties of tuning the low wave-lengths will then be more pronounced than ever, so that it will be even more desirable to separate the wave range into two portions, one portion covering the range of say, 150 to 300 meters, and the other portion covering the range of 280 to 550 meters.

EUROPEAN SITUATION

The radio fan in Europe finds himself up against the same problem, but on a larger scale. Over there, the broadcasters ramble all over the ether, anywhere from 200 meters up to 1200; and trying to chase them all with any one size coil and condenser is like fishing for trout and for whale with the same tackle. A common stunt for getting around this difficulty is to build up a bank of various sizes of fixed condensers with a switching arrangement for connecting various numbers of them into the circuit.

This is a handy way of gathering in all the wave-lengths, but anyone familiar with radio theory will appreciate the lack of efficiency in such arrangements.

The sets to be described in this article have been built with these ideas in mind. The wave range is cut into two parts by means of using double section condensers, so that only one part of the condenser may be used for the short wave-lengths and the two parts connected in parallel for the longer wave-lengths. This connection is made in one case by means of a special arrangement on the dials which can be duplicated very easily and

at little cost by the experimenter. In the other case, the switching is accomplished by means of a double throw switch, which may be any of several types. When the switch is thrown one way, the two parts of the con-

A New Advance In Radio

By HUGO GERNSBACH

IT has long been known, not only to the radio fraternity, but to manufacturers of radio outfits as well, that a great many worth-while radio programs are broadcast daily on wave-lengths below 300 meters. Up to the present time, the average radio fan has not been able to pay much attention to such stations, mainly for the reason that the lower wave stations are all crowded together between a few points of the lower section of the dial. In most cases, on trying to get such stations, it will be found that it is almost impossible to separate them.

Broadcasting, however, is face to face with a situation that needs immediate and drastic rearrangement. We have close to 600 stations which are all crowded into the 150 existing channels. It is like trying to put a quart into a pint measure—manifestly an impossibility.

It has always been the writer's contention that the present method of building our sets is wrong, mainly for the reason that we use only one-half of the dial. If we could use the entire dial, it would mean that the stations would be spread out 50 percent more than they are now, and that we would have less trouble in separating them.

We would be very much surprised if all the new sets that are coming out this fall should not have incorporated in them a device of this kind.

Now that the broadcast wave-length is going down to even 150 meters, manufacturers must of necessity take some such means to give the public outfits, that can take in not only the low but the higher wave bands.

denser are connected in series, when thrown the other way, they are connected in parallel.

Early in the present radio season, a new type of variable condenser was placed on the market. It differs from the other condensers in some of its electrical characteristics. It consists, as the illustration shows, of two sets of stator plates electrically separated, meshing with a set of rotor plates similar to other condensers.

FACTS AND DATA

Assume that we have an inductance which will tune as high as 600 meters with .0005

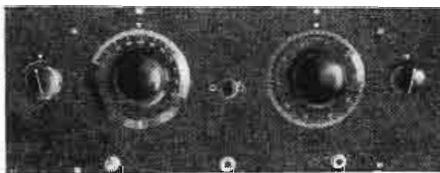

Front view of the three-tube set, interior of which is shown below.

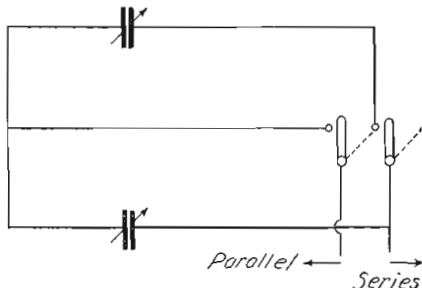

How a series-parallel switch functions is here shown diagrammatically.

wave-length, in the last few years. Corresponding advances have been made in the design of receiving sets to meet present conditions. However, in order to allow more stations to amuse us, the separating bands must of necessity be narrow, with the result that few receivers today enable the owner to receive from any desired station, but compel him to listen to the one that actually forces its way through the others.

Under these conditions, the average broadcast listener is developing an unconscious dislike for the stations below 300 meters, due to the fact that these stations are all crowded close together at the lower end of the dials and cannot readily be separated. Even radio has its limitations, and it is unfair to ask a .0005 mfd. condenser to tune in company with its coil, the entire list of stations all the way from 220 to 600 meters.

On account of this congestion of broadcast stations near the lower end of the condenser, and considering the fact that there are not many more bands available in the range between 200 and 600 meters, it seems more than likely that broadcasting wave-lengths will be dropped considerably in the near future. There is a possibility that the next half year may see concerts broadcast as low as 150 meters, or less.

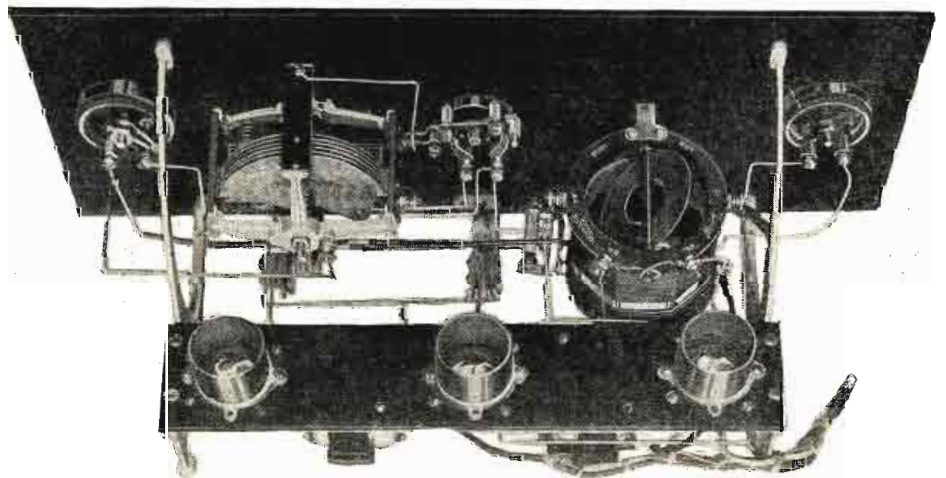

A three-tube receiving set which can be tuned from 150 to 600 meters by using the method described in this article.

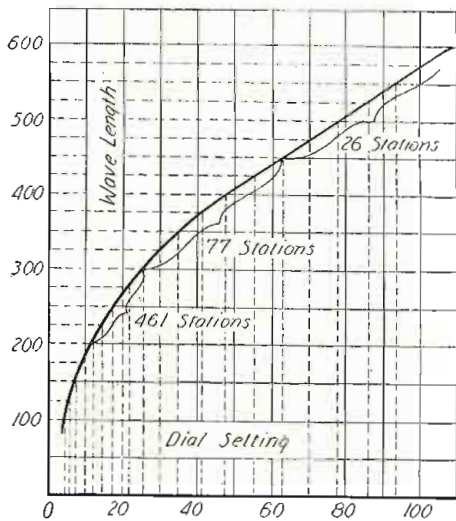

This graph shows how the stations are crowded on the lower wave-lengths and the places that they are logged on a dial. This is the case in the majority of receivers today.

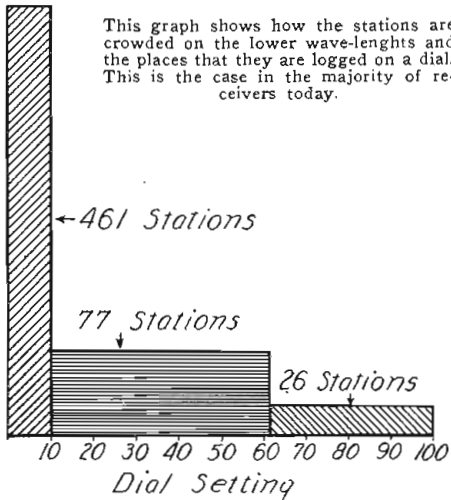

mid. condenser. If we connect it to only one section of this type of variable condenser having a capacity of .00025, the maximum wave-length obtainable will be 400 meters. If we connect the two sections of the condenser in series, disregarding the rotor connection altogether, the maximum capacity obtainable will be .000125, giving a maximum wave-length of 325 meters, with the result that all the stations received from 0 to 25, on an ordinary .0005 condenser dial with 100 markings, will be spread over the full scale of the dial.

The advantages of an arrangement of this sort are obvious. The logging of stations having short wave-lengths becomes much simpler because all stations separated by one degree on the condenser will be found four degrees apart when the condenser is connected as in Fig. 1.

This method of wave-length change is applicable to all circuits known to the radio art today.

The popular three-circuit tuner becomes

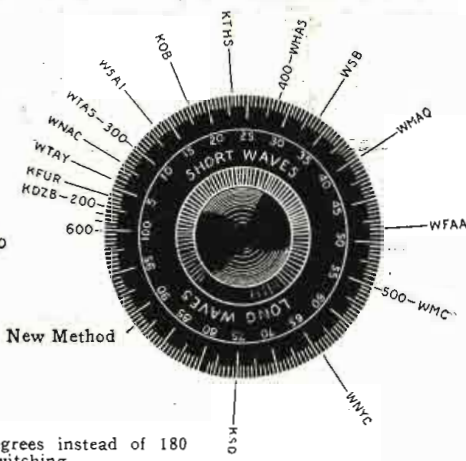
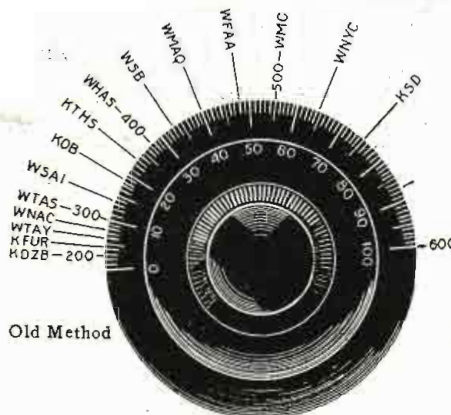

How the stations can be spread through 360 degrees instead of 180 degrees by using this method of switching.

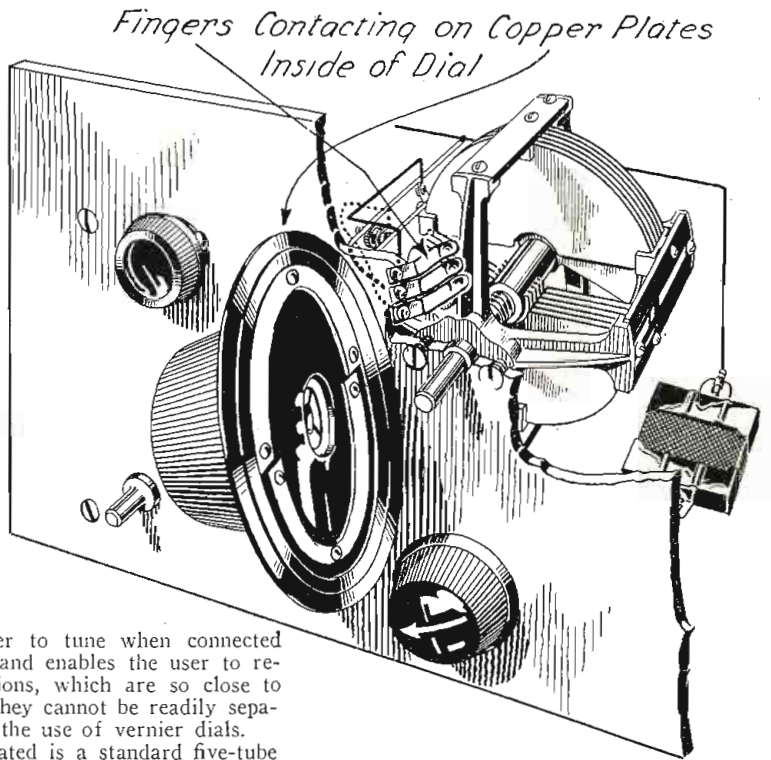

Showing the contact fingers fastened on the panel and the metal contacts fastened on the rear of the dials.

very much easier to tune when connected in this fashion, and enables the user to receive many stations, which are so close to each other that they cannot be readily separated, even with the use of vernier dials.

The set illustrated is a standard five-tube set, consisting of two stages of radio frequency amplification, detector and two stages of audio amplification employing an automatic switching arrangement to enable the connections of the halves of the condenser to be changed as outlined above.

While the switching may be accomplished with three ordinary filament switches, or better yet with three series-parallel switches, we obtained very good results with the automatic switch shown in Fig. 1.

One section of the condenser is permanently connected with the coil. The other section is connected to one of the springs on the face of the panel underneath the dial. The other spring is connected to the other section of the condenser or to the same side of the coil. The two springs are made from two socket contacts which are easily obtainable.

Care must be taken to mount the semi-circular contact plates under the numbered part of each of the dials, and each one in exactly the same place on its dial. The contacts must be tested to see that they make a perfect unbroken contact and that the break and make of the contacts occur at the same time in the three dials.

Instead of only one pointer at the top of each dial, mount one above and one below directly opposite each other. Place each dial with the number section toward its right and mark the upper pointer, "long wave-length" or lower frequency, if you want to be up to date. When you revolve the dial counter clock-wise, the contact will be closed,

and it will read the lower wave-length on the upper portion of the panel. When all the plates have meshed, and the dial reads 100, the switch will automatically break, and the maximum wave-length reached by the set will be automatically reduced. If you continue to revolve the dials, it will then read the lower wave-lengths on the lower pointer which should be marked accordingly.

There is another method of performing this automatic switching arrangement which

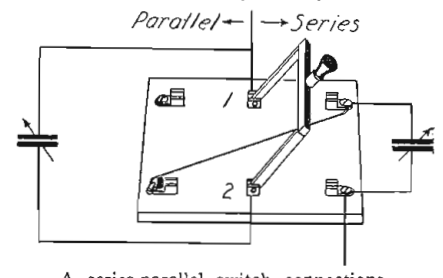

A series-parallel switch connections.

will be found much better, in actual practice, from the point of handling the condensers and dials.

The automatic arrangement described above has the disadvantage of making the wave-length discontinuous as the dial is rotated. It is shown schematically in Fig. 2. The disadvantage of this method of separating the wave-lengths is seen in the curves showing how the dial logs (Fig. 3). As one-half of the condenser is thrown into the circuit, the wave-length gradually increases, but when the plates are all the way in, and the other half of the condenser is thrown into circuit, the wave-length jumps instantly to 600 meters. As the condenser is rotated further, the wave-length decreases. The idea is illustrated in the curve-ABGD.

To make the curve continuous and to enable us to use the dial always in the same direction, the method shown in Fig. 3 can be used. This gives the curve ABD' and throws a fixed condenser in parallel with the first half of the condenser, when the first half of the dial has been covered. The capacity of this fixed condenser should be slightly less than the capacity of one-half the variable condenser to allow for overlap of wave-length. It will be necessary to have both sets of stator plates on the same side of the condenser frame.

With this arrangement and using a well-

designed set, all locals were easily cut off, and the DX stations, spread over the entire dial, came in clearly and distinctly, one after the other.

In the other set described in this article, the wave range change-over is accomplished by a series-parallel switch. This switch will

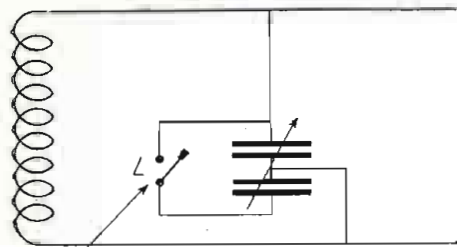

Filament Switch used here

How to use one or two sections of the condenser by employing a filament switch.

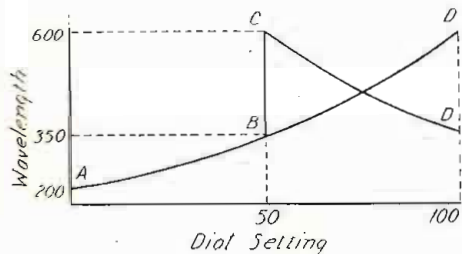

Fig. 3 shows how a continuous curve may be obtained with this method.

be seen in a photograph mounted at the middle of the panel. The arrangement here shown is a simple three-circuit tuner. It is a very simple matter for anyone owning a three-circuit tuner to make this simple change. He will be more than repaid for his efforts by the ease with which he will be able to separate the short wave station from one another.

A large number of new stations have taken the air. Generally, they have been allotted a wave of a little over 200 meters, and are sending out wonderful programs. We have found that the quality of entertainment is not proportional to the wavelength by any means, and we owe it to ourselves to tune in on the stations below 300 meters.

If you have a good set at present, you need not build another. A matter of a few

hours will enable you to take full advantage of all the entertainment now being put on the air, and will, in a way, repay the many stations which are devoting their energy, their talent, and their financial resources unselfishly to your benefit.

There are other methods of accomplishing the change of wave-length range; for instance, by change of inductance. This may be done by connecting various tapped points to the fingers running under the dial, instead of connecting the condenser thereto.

This method, however, is not the most practical or convenient, although it may be satisfactorily used. The difficulty lies in the fact that the ratio of inductance to capacity in the tuned circuit may not have the best value, for when the inductance is tapped, there is likelihood of too little inductance and too much capacity being used.

The electron tube used with all tuned circuits nowadays is essentially a voltage-operated device, and as a consequence it is desirable always to impress upon the grid of the tube the greatest voltage possible. For this reason it is desirable to use as high inductance as possible, providing the resistance is not increased too much, as the inductive voltage across the ends of the coil is proportional to the inductance of the coil.

These objections cannot be raised when the capacity switching method is used, since it can be employed with the ordinary values of coil inductance already in use.

It is to be understood, of course, that the methods shown here are for the adaptation of present apparatus to this new idea. It is hoped that manufacturers will find this idea worthy of incorporation in their new sets, since in view of variations which are bound to arise in the design of radio sets for use on the shorter waves it will be almost impossible to tune sets in the future unless some such scheme as that shown here is employed.

EXPERIMENTING

If the ordinary set builder cares to experiment with his own condensers for the purpose of attaining better results with some specially constructed bit of apparatus, the result of these experiments will undoubtedly be gratifying as well as commercially valuable.

The main point in this article is the idea incorporated. It seems strange that we can, often for years, go on using a certain kind of apparatus, built upon certain engineering principles, continually overlooking an obvious

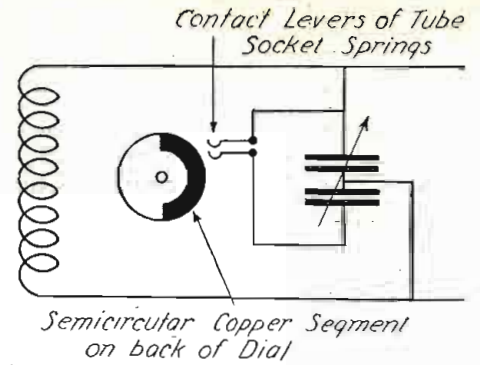

Semicircular Copper Segment on back of Dial

Schematic diagram of the contacts and segments on a dial.

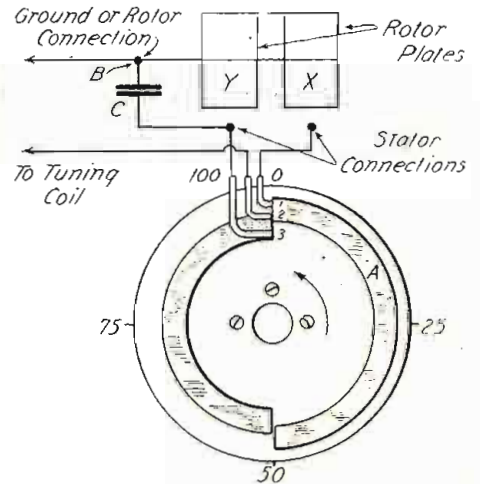

How the contacts are made in the circuit.

improvement in some detail of the constructional design, which would reduce the trouble of operation 50 percent.

However, if you do not own a radio set at the present and are intent on making instead of purchasing one, you will find later on that it was a step forward, and not a stretch of the imagination, to have incorporated the ideas presented in this article.

For the beginner, it would perhaps be better if he used the simpler method of employing a small battery switch with which he can throw from long to short waves. When this is connected properly, as shown in one of the accompanying diagrams on this page, it is a simple expedient to change from long to short waves by using the two sections of the variable condenser in parallel, or cutting one section out and employing but one.

It is recommended that the experimenter make a simple three-circuit regenerative set for the first set he attempts to construct, following the outlines as set forth in the above paragraphs.

Several sets built along the lines described in this article have been built and were tested in the Radio News Laboratories. It is very interesting and encouraging to notice how easy it is to separate the many stations now employing the short wave-lengths to broadcast their programs.

There is practically no interference, even when there are local stations on the air. The great separation between the various wave-lengths practically overcomes all trouble from interference, and the operation of the set becomes a pleasure rather than a problem like finding the proverbial pin in the haystack.

It will more than repay the experimenter to make the changes in his old set that are described here. The alteration does not involve a great deal of work, and does not even entail the purchase of additional apparatus, excepting, perhaps, the condensers, if he does not happen to own the type that is built in two equal sections.

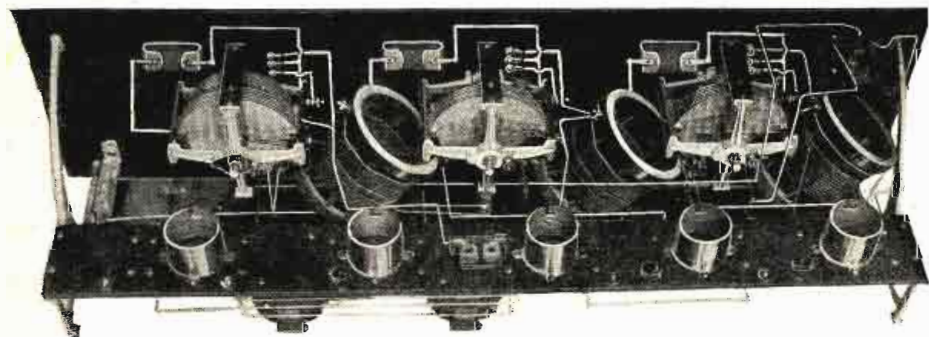

Rear and front views of the five-tube receiving set. To the right is shown how the circular strips are fastened onto the rear of the dials and the contact fingers on the panel.



The Month's Advances In Radio



FORD USES RADIO FOR INTERPLANT COMMUNICATION. Two interior views of the radio station at Henry Ford's plant at Dearborn, Mich. In each of the stations are electric typewriters which transmit messages to reproducing typewriters in the various departments. © United.

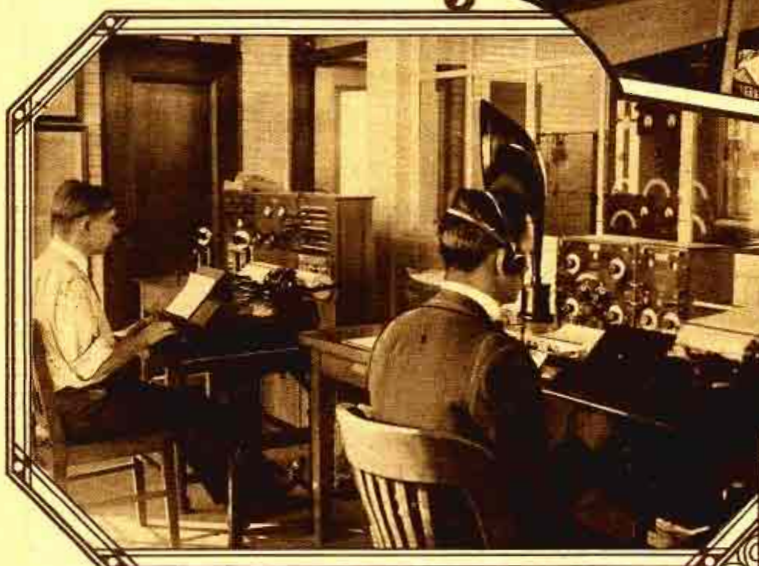

ANTENNA TOWERS AT DEARBORN, MICH. Right: Henry Ford saves many thousands of dollars every year by the use of the radio system between his six plants and four lake ships. © United.

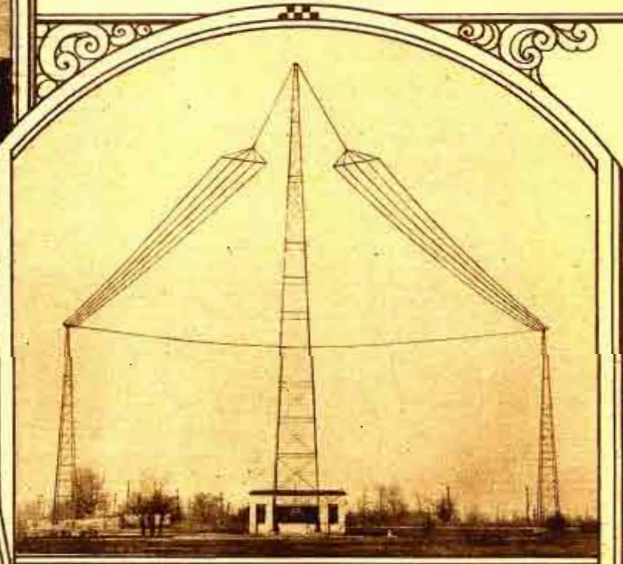

FOLDING LOOP ANTENNA. Below: A loop antenna that should appeal to the user of a portable receiver, because it folds up like an umbrella into a fairly small space for carrying. As it is made of bakelite its electrical properties are excellent. © Kadel & Herbert.



© Underwood & Underwood.

LESLIE GOULD'S "DIAL-LESS" RADIO INVENTION

Leslie Gould, amateur radio fan of Bridgeport, Conn., recently completed construction of a new radio set for which are claimed some unusual features with regard to the task of "tuning in" stations, long regarded as an irksome detail to the inexperienced radio set owner. Gould's new invention tunes automatically, being controlled entirely by a small switch on the end of a flexible cord from the set. The switch is held in the operator's hand.

The device is simple and consists merely of a small electric motor which provides motion through a belt arrangement to vary the leaves of an air condenser and variable spider-web inductances simultaneously. The motor power is also linked with a small six-volt flashlight which travels from left

(Continued on page 2272)

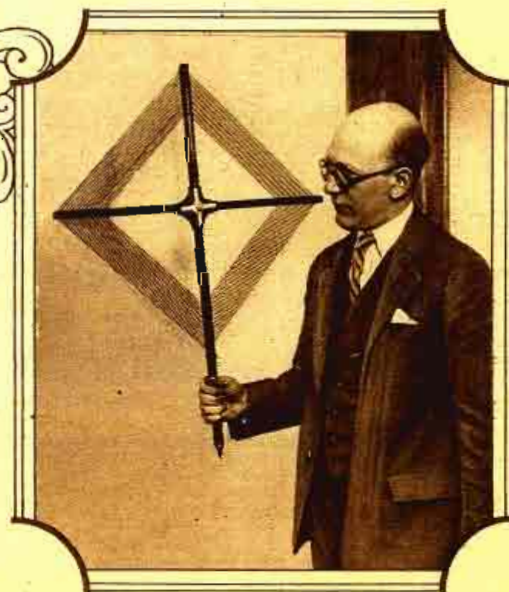

New Radio Developments

ENGLAND AND BRAZIL LINKED. Right: Gerald Marcuse, British representative of the International Amateur Radio Union, talked from his home at Caterham with the Rice Expedition at Boa Vista, Brazil, which is 7,000 miles away from England. © Kadel & Herbert.

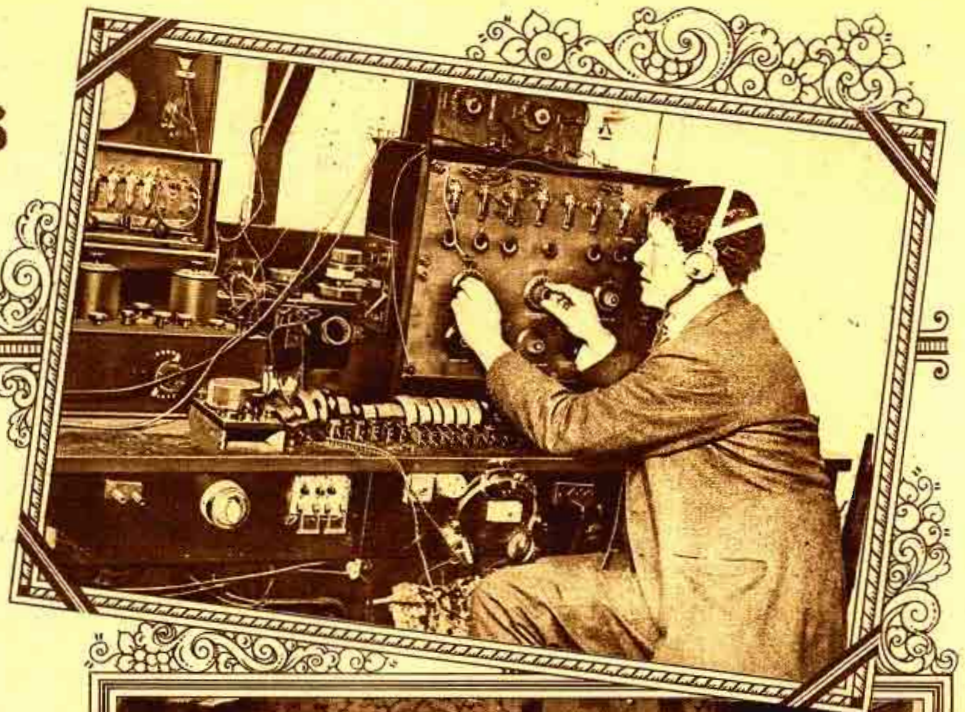

MEET RADIO ROSE. Miss Louise Henry, an inventor of New York, designed Radio Rose. The doll has a complete three tube receiver built in it and there is a loud speaker cleverly concealed in the chest. Radio Rose will receive music from any station within a liberal radius and sings or lectures while she is taken for a walk. © Underwood & Underwood

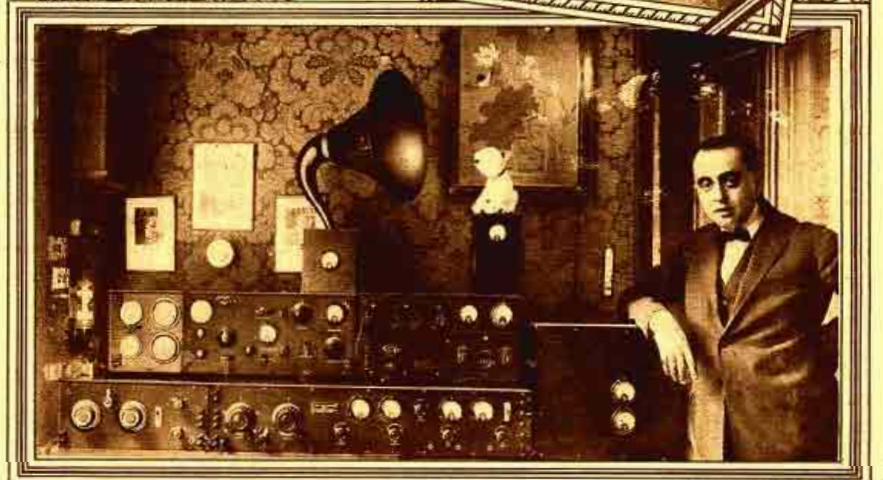

NOTED GERMAN EXPERIMENTER, Dr. Max M. Hausdorff, of Berlin, with a few of the recording and receiving instruments which he has constructed to receive American broadcasts.

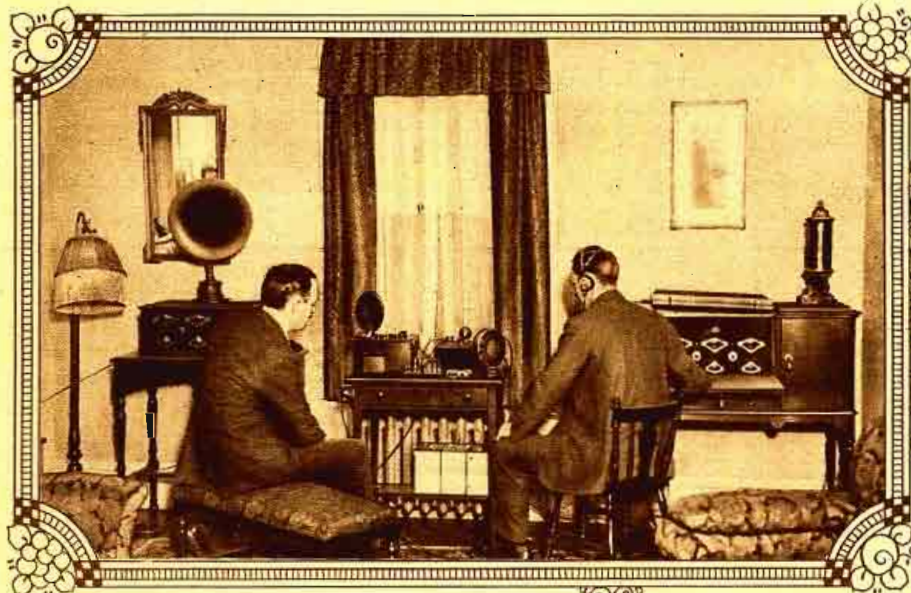

COAST-TO-COAST TENNIS RADIO WITH MISSISSIPPI RIVER AS THE NET. Recently a station on the Pacific Coast broadcast a program which was picked up by Mr. Riggin and Mr. Grebe of Station WAHG and retransmitted through that station. © P. & A. Photos.

RADIO CLOCK THAT CALLS YOU AT ANY TIME. Instead of the old-time alarm clock, the sleepy radio fan may be awakened at a certain time by this new combination of clock and radio receiver. Photo courtesy Pinto Speaking Clock Co., Inc.



Station WRNY RADIO NEWS

RADIO NEWS takes pleasure in announcing the opening of its new broadcast station sometime during May. Aside from incorporating the best in technical design and construction, the policy of the station will be radically different from any now in operation. Really new features of program will be employed which will broaden the interest and increase the appeal of the station. It will truly be something new.

Following the principles of the owners and operators, it will venture into new fields, and it is the opinion of those cognizant of the facts that the plans which are to be carried out will make WRNY a real innovation in the field of broadcasting.

The first important change in regular broadcasting practice is the wave-length on which the station will operate. It will be the first high-powered station to go on the air at a wave-length below 300 meters. It has been the contention of the editor of RADIO NEWS that the near future will find the broadcasting waves constantly lower—a prophesy fully borne out by the announcement carried in the present issue of this magazine—and going upon this assumption, it was decided that it would be proper for the station of RADIO NEWS to be the first in opening this new region to high-powered stations.

This has been done in spite of the fact that a high percentage of the present day receiving sets do not operate efficiently—on the waves in the neighborhood of 275 meters. But one station must be the first. The owners of the station are confident that the necessary changes in design of receivers will follow the reallocation of broadcasters.

The second innovation will be in the program content. Not only will the usual run of entertainment be offered, but a unique news and scientific service will be offered which will be entirely different from anything done before.

Half of the station's time will be given over to the broadcasting of the usual type of entertainment and the other half will be used in the dissemination of scientific and radio knowledge. And an important feature might be stressed here: The news and features will be entirely new. There has been some attempt heretofore along the same line, but it has met with little or no success, since the matter broadcast was old or copied from some already published periodical. WRNY will give only such news and features as have never before been published.

The station, for instance, will answer radio questions over the air. It will also broadcast radio hook-ups over the air by a new method on which a patent is now pending. In other words, if a new hook-up makes its appearance, it can be given to thousands of radio listeners within a few hours after it has been brought out.

(Continued on page 2320)



THE HOME OF WRNY.
The Roosevelt Hotel at 45th St. and Madison Ave. in New York City.

MAP OF NEW YORK DISTRICT. Here are shown broadcast stations in the metropolitan district.

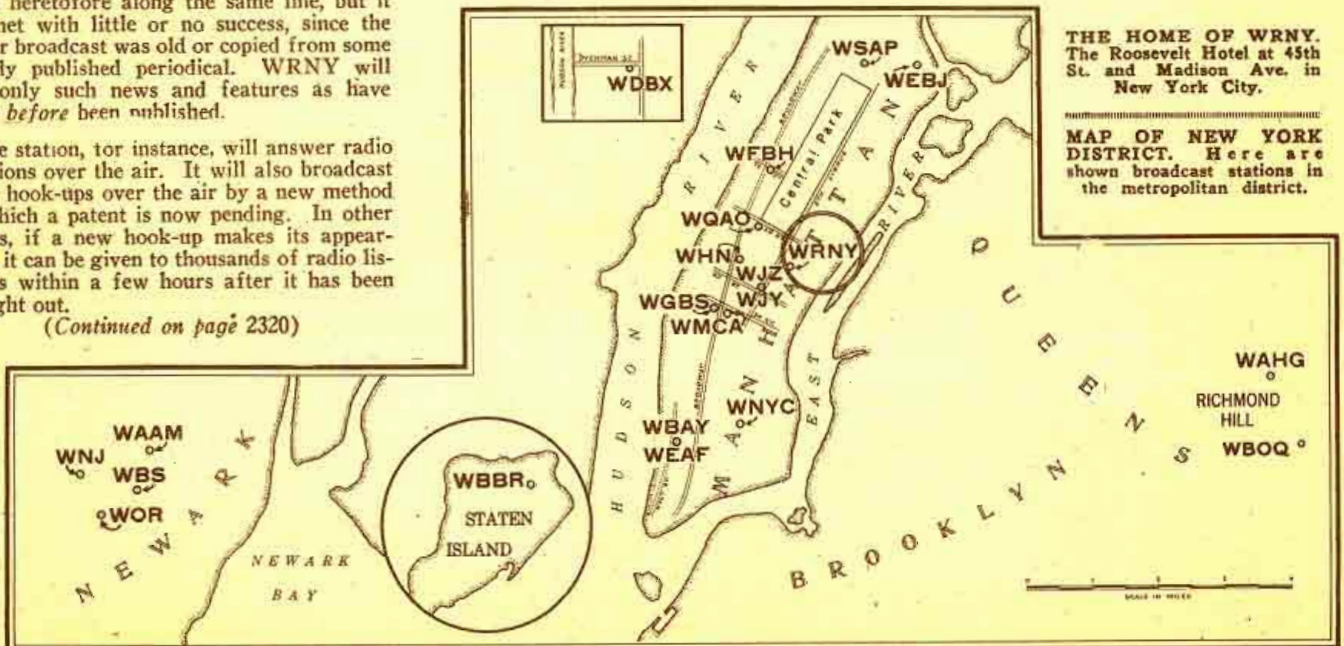

MADE IN U.S.A.

RADIO EXPERIMENTS IN THE CRATER OF MT. VESUVIUS. An expedition headed by Prof. Ricotti of Milano made the hazardous trip to determine the quality of reception at various points within the crater. When the loop antenna was placed very near the eruptive cone, where the fumes were strong, the results were poor. At a point about 300 feet from the cone reception was improved, but erratic. These tests were performed at 4000 feet above sea level. Photos by International Newsreel.

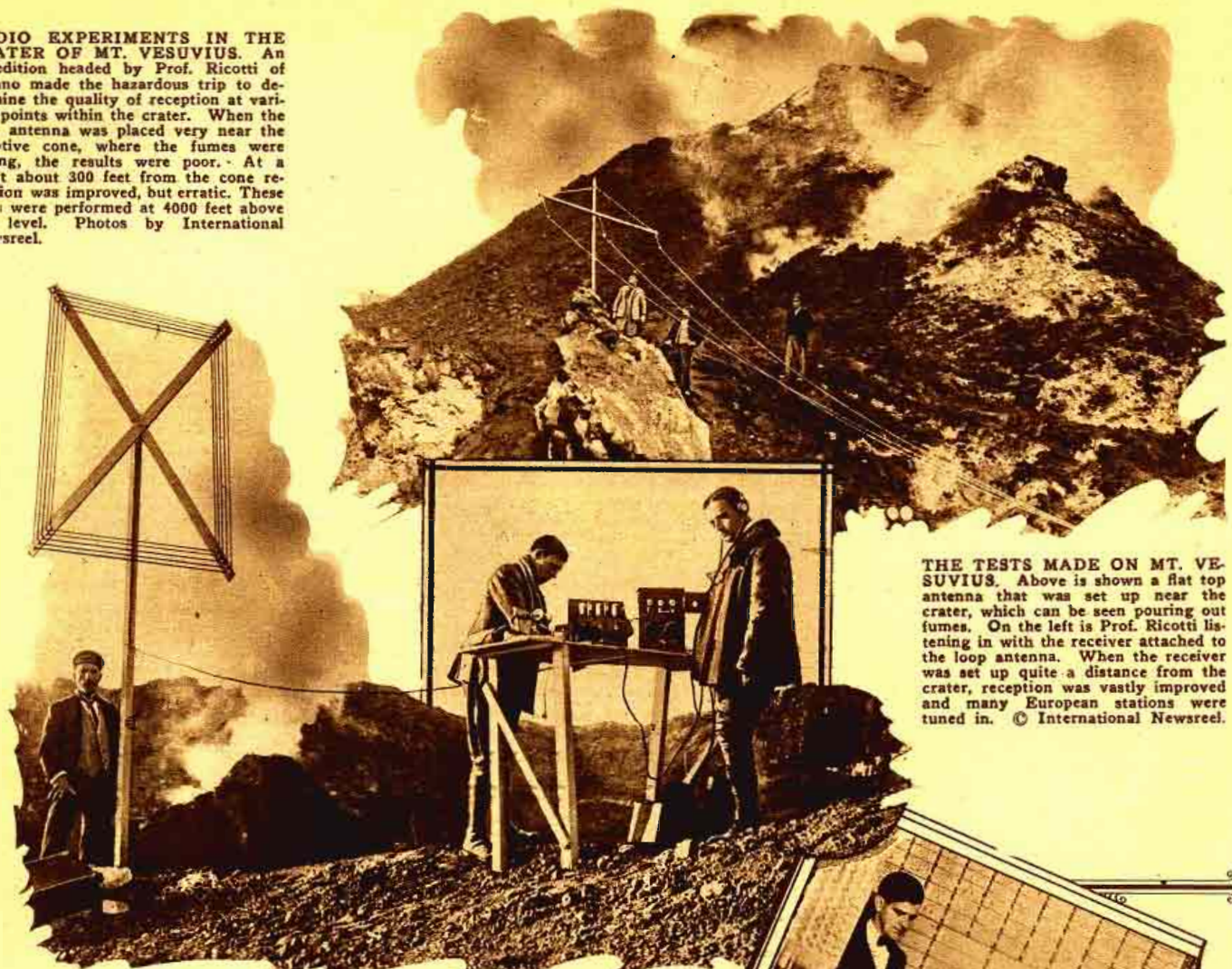

THE TESTS MADE ON MT. VESUVIUS. Above is shown a flat top antenna that was set up near the crater, which can be seen pouring out fumes. On the left is Prof. Ricotti listening in with the receiver attached to the loop antenna. When the receiver was set up quite a distance from the crater, reception was vastly improved and many European stations were tuned in. © International Newsreel.

RADIO WAVES PENETRATE STEEL WALLS. Right: Subterranean reception in Chicago vault.



TIN BUCKETS USED AS ANTENNA. This Englishman of Sheffield uses two buckets for an antenna to pick up London and Manchester. He reports excellent reception with this unique receiver. © Underwood & Underwood.



A RADIO HOME. Right: Mr. F. W. Dunmore of the Bureau of Standards has so wired his home that radio concerts may be heard in any part of the house. He can also run an extension line to his neighbors' homes and provide them with the best of entertainment. © Harris & Ewing.

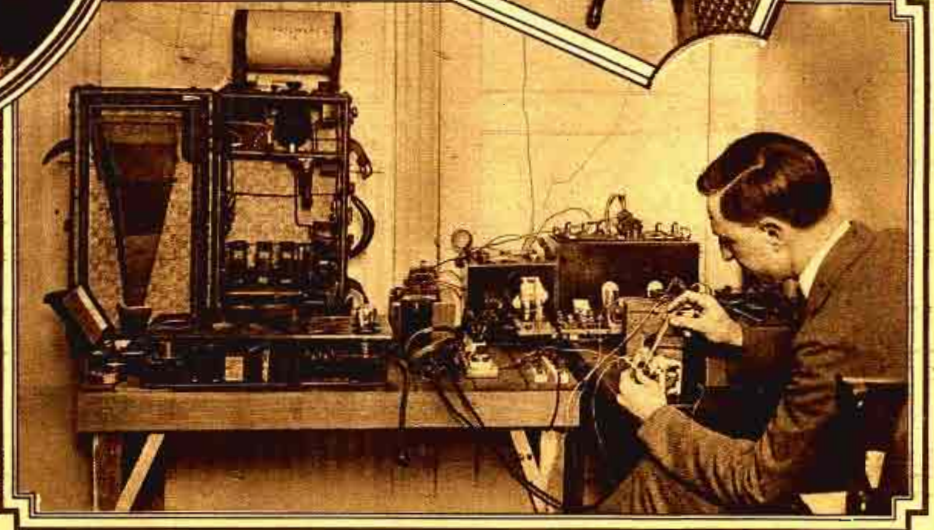

RADIO BRINGS BACK HEARING OF DEAF CHILDREN. Right: In Pittsburgh, Pa., at the DePaul Institute experiments are being performed with radio, teaching children that have been deaf from birth to hear. Remarkable results have been achieved; some of the children are hearing for the first time in their lives. By United.

OWN YOUR OWN MINE AND OVERCOME STATIC. Below: Just to prove that radio waves travel through iron ore and other things found in a mine, a radio receiver was set up in an iron mine near Birmingham, Ala. Excellent reception was reported from many stations with no noticeable static. © P & A Photos.



SETTLES CLAIMS FOR RADIO PATENTS. Below: Prof. Marius Latour, the noted French electro-physicist, whose inventions have found such general use in the manufacture of radio apparatus in this country that millions of dollars in royalties are due him. © Keystone View Co.



HEADS U. S. DELEGATION TO FIRST WORLD RADIO CONGRESS. Hiram P. Maxim, Pres. of the A.R.R.L., who headed the American amateurs at Paris at the first congress. © Underwood & Underwood.



ARMY SIGNAL CORPS SET ATTRACTS AT NEW YORK RADIO SHOW. Right: A radio set of the newest design was shown at the Hotel Pennsylvania recently by the Signal Corps. © P & A Photos.

GIANT LOUD SPEAKER. Right: At Idora Park in Oakland, Cal., music is supplied by radio and the loud speaker at one end of the swimming pool. The band that was formerly employed in the park has been deposed in favor of radio. © Underwood & Underwood.

AT STATION WMCA. Below: When this station recently went on the air many notables were present. © Foto Topics, Inc.

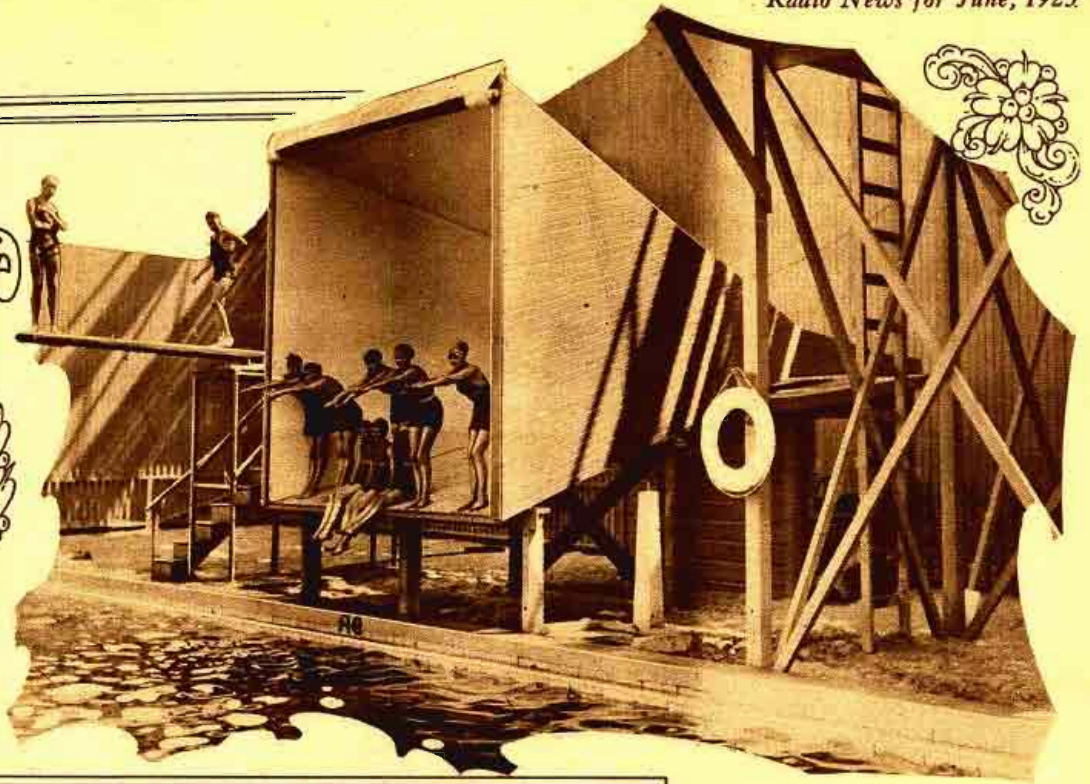

LOUD SPEAKER FOR SCHOOL ROOM. Below: Students of the Brooklyn Technical High School have constructed an 8½ foot loud speaker for use in the school's assembly room. Radio plays an important part of the school's daily schedule and great interest is manifested in the programs. © Kadel & Herbert.



SETS STANDARD OF RADIO WAVE-LENGTHS. Left: Dr. J. H. Dellinger of the Bureau of Standards in Washington is shown beside the instruments used to set the standard wave-lengths. All broadcast stations in the country have to be adjusted to these standard waves. © Underwood & Underwood.



HER BELL RINGS FAR AND WIDE. At Station WAHG, Harriet Dover, 10 years old, broadcast a railroad story and used the engine bell to give atmosphere. She was heard as far west as Arizona. © P. & A Photos.

LONDON'S RADIO TAXICAB. F. C. Fleche, a London taxi driver and radio fan, tunes in a concert for his fares while traveling. No extra charge is made either. © Keystone View Co.

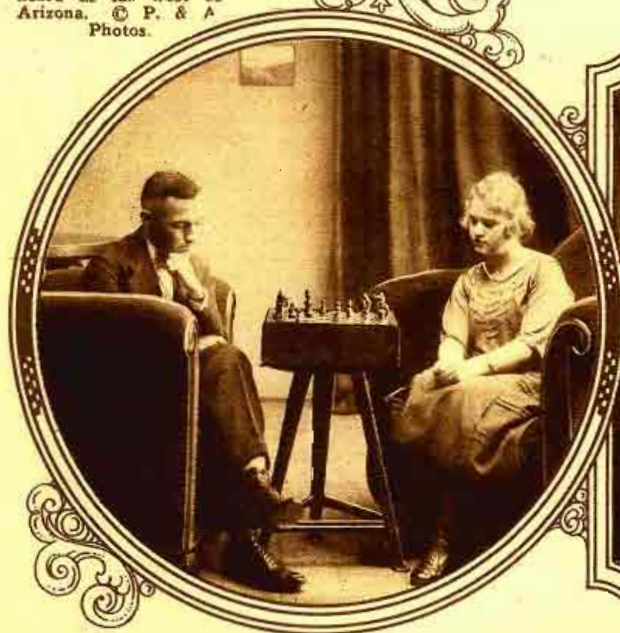
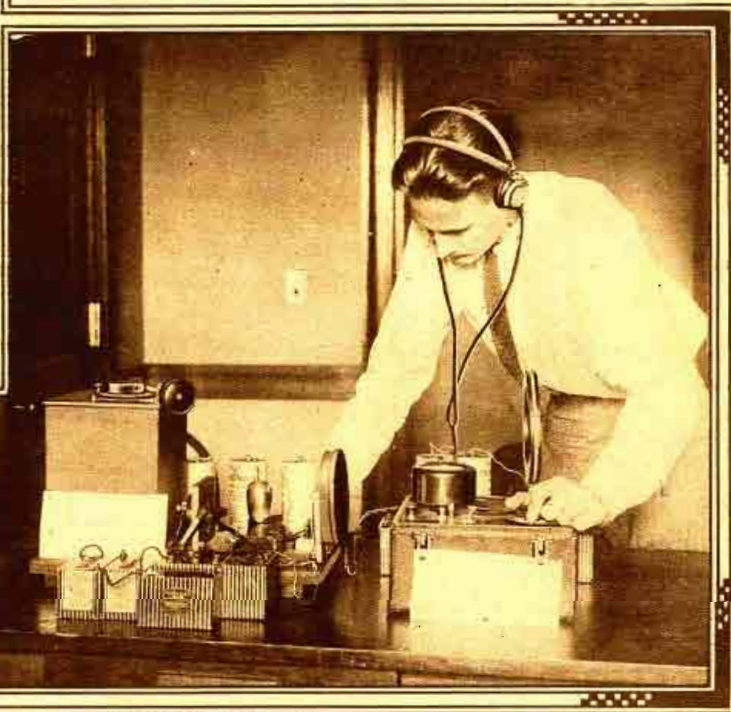

CHESS BOARD AS A BROADCAST RECEIVER. Dr. Leo Jacobsohn, who introduced radio in medical science, designed the chess board radio receiver. On the left is shown the radio set being used as a chessboard and the illustration on the right shows the radio set opened up and operating.

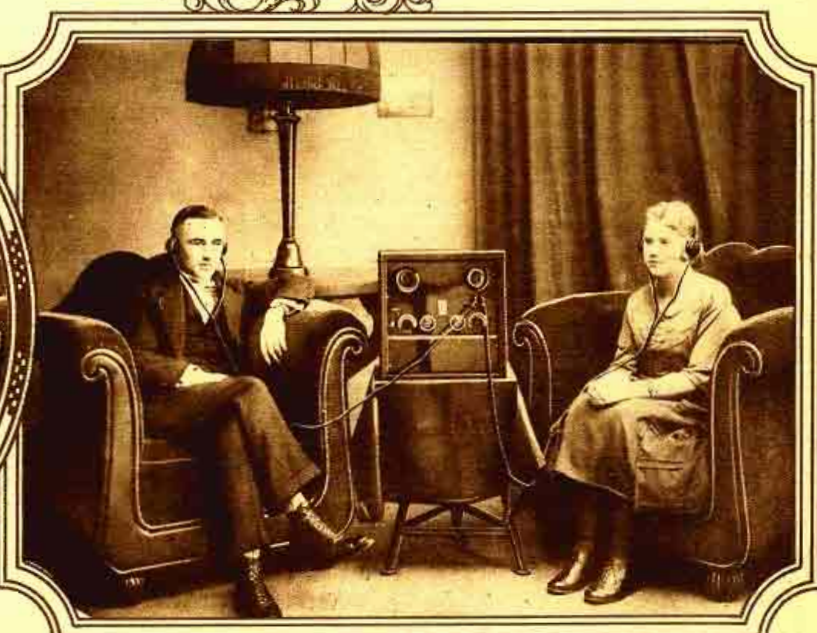

NEW METHOD OF RADIO TELEPHONY. Center: Mr. D. V. L. Fellow in London is shown working on his experimental apparatus with which he hopes to perfect a new method of secret radio telephony. It is possible, he says, to convey messages which are rendered unintelligible at the transmitting end and corrected at the particular receiver designed to take that message.



WHAT SHALL I DO WITH SUCH A RADIO FAN? Mrs. Bones asks this question when she comes downstairs at 3 A. M. to tell friend husband to get to his kennel. She does look disgusted, we admit.

"THIS IS STATION M U T BROADCASTING—". Below: This is an exclusive photograph of the popular announcer of the station mentioned above. It is rumored that all the female broadcasters are in love with this "handsome dog." © By Harry W. Frees.



RADIO PERFUME CONTAINER. Left: The miniature container for perfumery should appeal to radio fans of the gentler sex. The loud speaker and the round vacuum tube are glass containers.



RADIO CANDY BOXES. Below: These two candy boxes especially appeal to the young radio fans, mainly because these sets look "just like Father's".

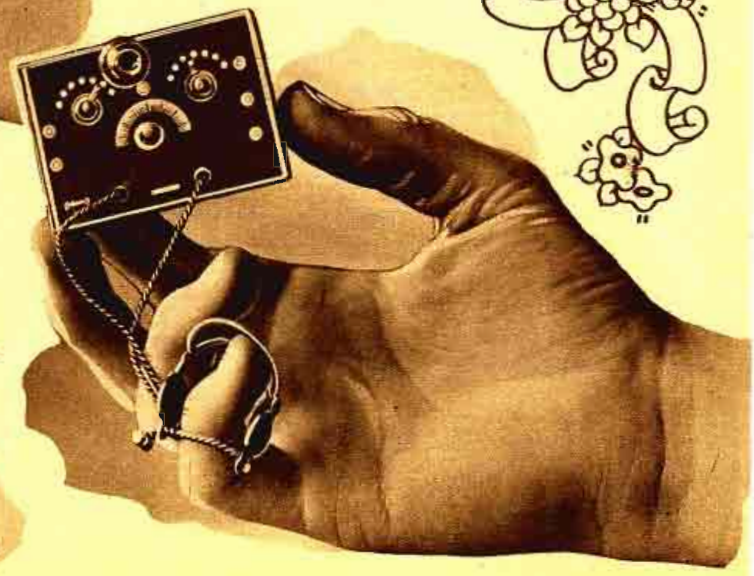

A Midsummer Night's Scheme

By ROBERT FRANCIS SMITH



"The radio square dance at the master's ball resulted in a human Superheterodyne and a Neutrodyne."

"WELL, Joe, what're the wild waves saying?" croons my little kitchen-kleanser, playfully heaving a pebble into the briny.

"Wait a minute till I gets their length," I says. "Ah, yes. 'You are now listening to Station PDQ, broadcasting from Davy Jones' Locker. The next selection will be, 'It Ain't Gonna Rain No More,' a request number by Noah."

"Cute, ain't you?" smiles Doris, who is Mrs. Joe Hammerstein when we ain't trouping in the twice daily. "I suppose the next'll be 'Hot Lips,' by Cleopatra?"

I shakes my head. "Wrong," I states. "The next number will be an oration by Horatius at Brooklyn Bridge."

"You means Steve Brodie," corrects my bathing beauty. "That guy Horatius never got further north than the Bronx."

"Such a wife!" I laments. "Doris, I'm surprised! Horatius was the bozo that stood on a railway trestle and nicked up a gang of stray Wops with a wash-boiler lid and a stiletto."

"Don't be kindergarten," snaps my little broadcaster. "What's all the shooting for? Somebody find a spark coil next door to Marc Antony's eight-tube Heterodyne?"

"Just for that I oughtn't tell you," I declares. "However, I'll be big-hearted about it. Jerry's gonna give a big blowout, but he can't decide how to frame it. At the last notice it was to be a Grecian ball."

When you mentions a party in the presence of one of the wrecker sex it's just like waving a red flag in front of a bull, or a fifty-dollar bill before the hungry eyes of a crystal set owner with the DX's. Doris sits up pronto.

"Ball!" she echoes. "Why wasn't I told?" I explains. "Well, you see, Jerry ain't much on this social game, being a bachelor by instinct, and having no women folks about. But every so often he's gotta put on a shindig, to sorta fill in the season's calendar. As they says in Kentucky, *noblesse oblige*."

"As they says in Pell Street, *me sarrer*," comes back Doris. "A Grecian ball, eh?"

I nods. "That's the idea at present. If you can design any better layout, offer it. The Master's plumb despairing of getting the right connections."

"Why, you poor things, it's simple!" exclaims Doris. "Why not give a radio ball, and have each guest come dolled up as some instrument?"

There's moments when I don't begrudge the loss of my rib, and now's one of them. "My dear," I smiles, "sometimes I'm almost certain you got brains, in spite of appearances."

My wild woman is prone to agree with me. "If you'd ever had any you'd know that I have," she cracks, sweet, quick and crisp. "Now be a good boy and run up and get Jerry. Oh, I just love framing parties!"

"Not only parties," I mumbles.

Doris looks up. "What d'ya mean?"

"Also pictures, m'dear," I replies, and heel-and-toes over the hill to the rich-house.

It's a nice spring day, and everything's happy, including The Master. This last is used in public solely by Jarvis, an English butler furnished complete F. O. B. Boston. The Master's mailing handle is Gerard Lawson. In person, he's tall, slender, dark-haired, as rich as angel-food cake and as serious as an operation for heart trouble. We're old friends; he greets me cordial.

"Hello, Joe," he says. "What's new?"

"We're saved," I says. "Doris scared up a grand idea for the ball and wants you to come on down and let her elaborate on it."

On the way back I explains things to Jerry and he's tickled. "Why, Joe, that's clever!" he exclaims. "And so simple! Why couldn't we have thought of it?"

"Parties ain't in our line, I guess," I says. "We get along better amongst condensers and vario-couplers than between dances and sit-outs."

At the house Doris has everything mapped out. Jerry's very pleased, so much so in fact that I'm afraid he'll get married to some low-loss bundle of ferrils before his admiration for feminine efficiency wears off. How-

(Continued on page 2312)

ARE you interested in motoring, touring or camping? If you are, do not fail to read the May issue of

MOTOR CAMPER AND TOURIST

Here is a magazine that tells you things in connection with your car—things that you never even suspected.

Are you just running around the country or are you getting the full benefit of your car? MOTOR CAMPER & TOURIST shows you the way. On all newsstands.

CONTENTS FOR MAY ISSUE

- Touring Off Ill Health. Vivian H. Whitmore.
- Building A Camp Trailer. Richard P. Cole.
- Weren't You Afraid? Alice Crowell Hoffman.
- For Your Stomach's Sake. Ruth Aughilltree.
- Camp-Siting. Robert L. Thayer.
- Moving Picture of a Week-End. Harry Irving Shumway.
- Radio In Camp. W. R. McClelland.

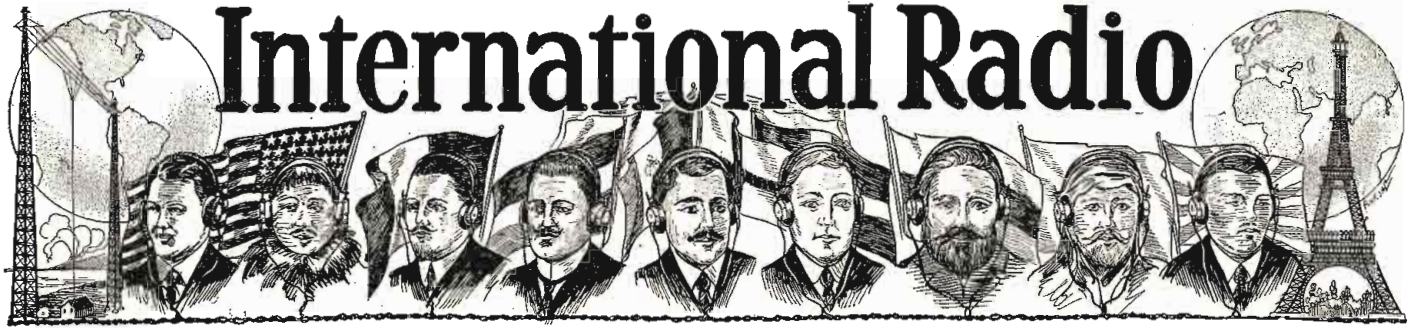

CANADA

Canadians Get U. S. Broadcasters' Best

The Prince Albert Radio Club, of Saskatchewan, Canada, reports that the United States broadcasters come in better than the Canadian stations to the East of them.

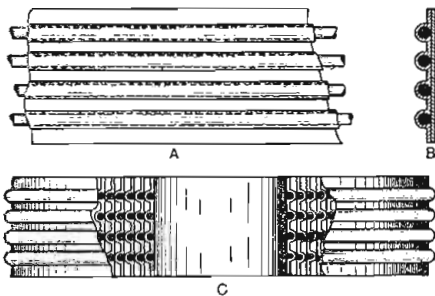

For the experimenter who likes to make his own coils, the tape shown in the accompanying sketch is invaluable. The wire is arranged parallel to the edges of the paper tape, which covers the wires as shown at A and B. When a coil is wound, the inside ends of the wire are fastened together and the tape wound on a form. As many turns as are necessary are put on and then the wire is fastened in order that there may be a continuous winding. This is an English product.

The five stations reported as most easily picked up are WCCO, Minneapolis; KOA, Denver; WEBH, Chicago; WOC, Davenport, and WDA, Kansas City. Montreal, Toronto and Ottawa stations fail to register clearly, possibly because of the great mineral belt in northern Ontario.

Pass Radio Collection Plate

The joke about the man who preferred listening to church services by radio because there was no collection plate will have to be discarded. The operator on one of the Canadian National Railways trains one Sunday tuned in a church service in Saskatoon, before the train arrived at the town. The passengers liked the service so well that a collection was taken up and sent to the pastor of the church when the train arrived at the station.



FRANCE

Death by Radio

The most fearful and awe-inspiring weapon ever invented has just been tested at Istres, near Marseilles. It is a pilotless airplane, which is controlled entirely by radio, and can be made to fly over enemy territory and drop bombs. A fleet of such planes, armed with cylinders of poison-gas, conjure up a vision of wholesale destruction that is terrible to imagine.

The equilibrium of this weird weapon is maintained by a gyroscope, but its maneuvering and control are in the hands of radio operators in the control aerodrome. After

the plane passes out of sight, it sends out signals which disclose its position and allow its course to be corrected. According to a preliminary report from France, every problem of the pilotless plane has been solved.

Development of Radio Interest

Reports from the various parts of France reveal the fact that development in the use of receiving sets is not uniform throughout the Republic. In the neighborhood of Calais, American sets of the lower price type meet with much favor and are in general use, while in the vicinity of Nancy radio sets are practically unknown. In Nice reception is reputed to be very poor and there are only two sets in use, these being employed for publicity purposes. Around La Rochelle considerable interest is manifested in radio, and it is estimated that there are about four hundred sets in operation, most of them being of French manufacture.

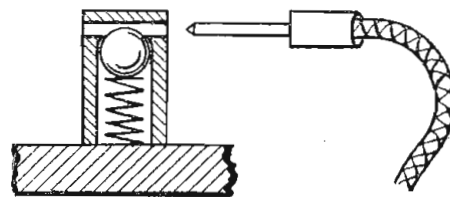

Recently there was patented in England a terminal of which the cross-section is shown above. The spring tends to keep the small ball pressed against the top of its groove. When the phone tip is inserted in its slot, contact is insured by the constant upward pressure of the ball.

Strange Antennae

The French Navy Bureau of Research has been experimenting with a jet of sea water, projected into the air, as a radio antenna. The water was drawn from the sea and shot vertically upward by means of the ship's pumps, the column of water being connected to the ship's radio apparatus and used in lieu of a regular antenna. Signals were transmitted over eight miles with the use of this curious antenna. Of course, this liquid antenna was more inefficient than the usual type, but the experiments were made to ascertain if a device of this kind could be used in case the regular antenna was shot away.

Another strange antenna, which was recently patented for use on airplanes, employs the stream of exhaust gas from the engine. This gas, on account of its very

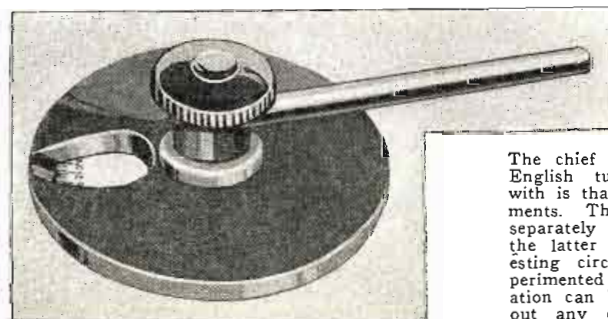

The feature of the new type English dial shown below is that the scale is protected by a small glass window and therefore remains clean.

The chief advantage of the English tube shown herewith is that it has two filaments. These may be used separately or together; in the latter case, very interesting circuits may be experimented with, as regeneration can be obtained without any extra accessories.

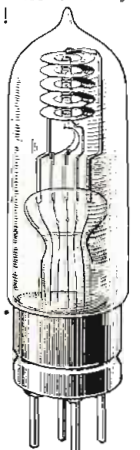

ENGLAND

Hard to Beat

Station 2LO in London is to be congratulated on some of the artists that have broadcast through their "mike": John Barrymore and members of his company in excerpts from "Hamlet"; Tetrzini, Lamond and the other "Evening Standard" stars; "Pilgrim's Progress," relayed from Covent Garden; and a recital by Ignace Paderewski. And it is said that some listeners are unsatisfied!

Amplified Heat

It is reported that Dr. C. H. Desch, Dean of the Faculty of Metallurgy at the University of Sheffield, has employed electron tubes to melt masses of steel. A 2,000-volt direct current is passed into large tubes, which convert it into alternating current of high frequency. This current is passed through the metal, which is melted by the heat thus generated.

Controversy Over New Radio Bill

There is in Parliament for debate a bill that affects the English radio fan to a great extent. In the bill there is proposed a penalty to be inflicted upon those who listen in without a license. There is also a great discussion about the "right of search." At present, engineers of the Post Office Department have issued orders to telephone maintenance men to inquire into cases of alleged failure to procure licenses, and these men feel that it is out of their sphere to do this sort of work.

Moreover, some leading scientists are questioning the wording of the new bill. They say if the bill is passed it will be a crime to light a candle or to wear glasses without a license. In one case, etheric waves are transmitted (as "light and radiant heat"), while a pair of glasses are, scientifically speaking, a receiving apparatus!



SWITZERLAND

Esperanto Association Plans Station

The International Esperanto Association has decided to build its own broadcast station at Geneva. The total cost—about \$20,000—has been almost entirely subscribed by members of the association.



GERMANY

New Telefunken Experiments

A new principle, which is the basis of a modulation system rendering transmission practically exempt from distortion, is being used in experiments in the Telefunken Laboratory in Berlin. The wavelength that is being used is 290 meters and the power 100 watts.

Radio Popular in Germany

The radio listener in Germany has to pay 50c per month, which is collected by the Postal Ministry. The total receipts for the year 1924 amounted to over \$1,300,000, which gives some idea of the popularity of radio along the Rhine.

AUSTRIA

Rhythm and Rum

The streets of the gay city of Vienna wear a deserted and lonely aspect as the result of the radio craze that has swept over the city. Listening in has replaced the long talks over a glass of beer, and families stay home to eat their meals to the tune of broadcast concerts. According to one restaurateur, the wife of a former customer has asked him to try to entice her husband back to his "stamm tisch" (reserved table), so that she can have a quiet evening once more. Please notice the apparent triumph of rhythm over rum.

Radio Saves Viennese Shopkeepers

Small shopkeepers in Vienna, who have been on the verge of bankruptcy during the lean years following the war, have been saved from ruin by the advent of

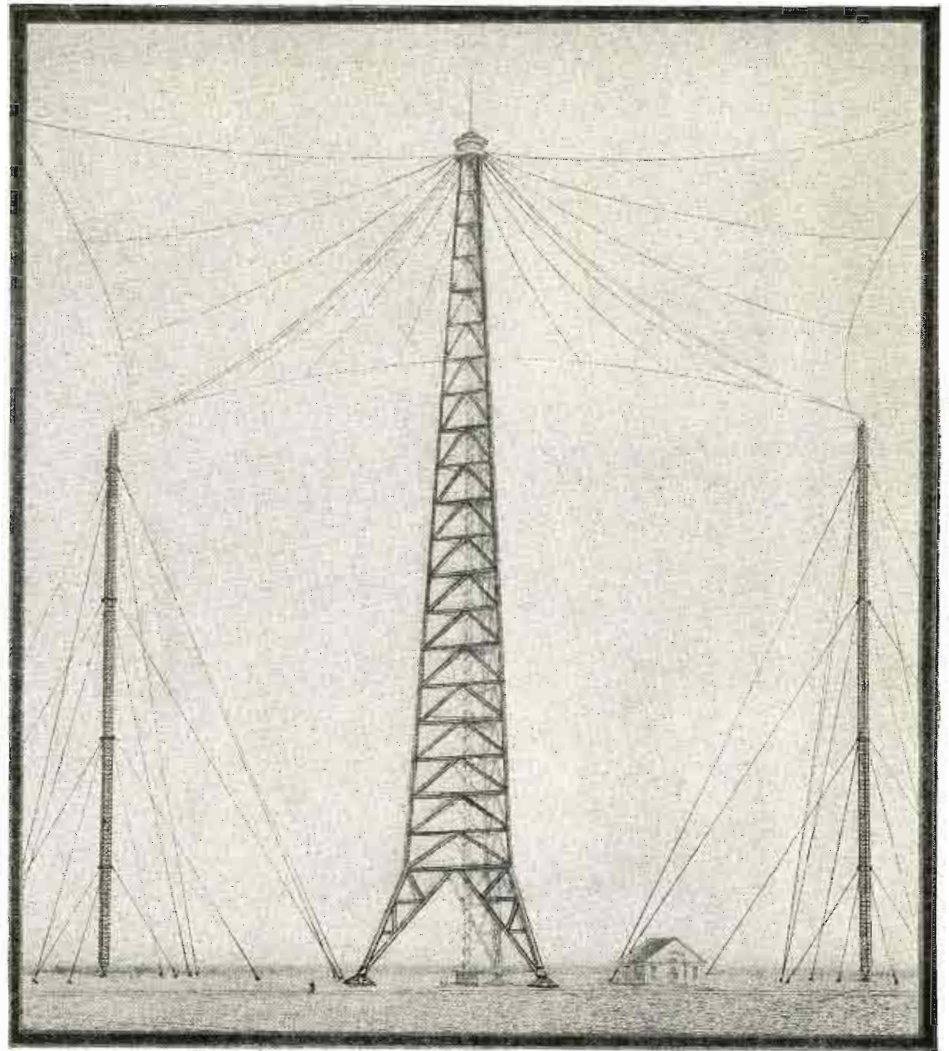

How the antenna system of the new broadcast station at Koenigswisterhausen, Germany, will appear when completed. The central mast is 850 feet high and the other towers 700 feet. This antenna system is the second highest in Europe, being exceeded only by the Eiffel Tower in Paris. Note the size of the man at the base of the tower.

radio. Nearly every shop has installed a radio department. Clothing stores, book stores, butcher shops, candy stores and many others display parts and sets. The wax models in the woman's shops are fitted with head-sets over their faultless coiffures. Plumbers urge the delight of baths taken to the accompaniment of music; in fact,

every trade is trying to get a share in the profits of the radio craze.

Many of the proprietors of restaurants and the larger hotels in Vienna have found it profitable to advertise that music is furnished by radio. This not only attracts patrons but also cuts out the expense of an orchestra or band.

Esperanto Lessons

(Prepared Especially for RADIO NEWS by James Denson Soyars, Esperanto Writer and Editor, President New York Esperanto Harmonio Club.)

LESSON 9

(Correction: In the 3rd lesson, which appeared in the March issue of RADIO NEWS, in treating the compound past tense of the verb, by error of omission it was stated: *Se mi estus tie, vi estus vidinta min*, while it should read: *Se mi estus ESTINA tie, vi estus vidinta min*, If I had been there, you would have seen me.)

PECULIAR FORMS IN COMMON USE

In every language there are peculiar expressions which are not correctly idioms, because they have equivalent forms in most other languages. We find such in Esperanto. Adverbial expressions in Esperanto are rich in their derivative forms. Where needful, one can make an adverb of the root of every word, grammatical termination or affix. This facility enables the Esperantist to express in a word

what often takes two or three words and even more to express in other languages. *Tiamaniere*, in such a manner; *matene*, in the morning; *vespere*, in the evening.

More or less. *Pli aŭ malpli*, often just: *Pli-malpli*.

The more * * * the more. *Ju pli * * * des pli*.

Example: The more I know him, the better I like him, *Ju pli mi konas lin, des pli bone mi estimas lin*.

The more * * the less: *Ju pli * * * des malpli*.

Example: The more I know him, the less I like him. *Ju pli mi konas lin, des malpli mi estimas lin*.

Ajn: Ie ajn, any place, anywhere; *kia ajn*, whatever sort of, what kind of, *Iu ajn*, any one.

Efektive, vere: Really, truly, in fact: Did he really, in fact, say that? *Ĉu li*

efektive diris tion? Really, do you believe that? *Vere, ĉu vi kredas tion?*

*Dekstre * * * maldekstre*, right, left: At our right hand stood the house, at our left the field, *Je nia dekstro staris la domo, je nia maldekstro la kampo*, or, *Dekstra de ni staris la domo, maldekstre lam kampo*.

Jus: He just arrived a moment ago, *Li ĵus alvenis antaŭ momento*.

Guŝtra: He arrived just at the right moment, *Li alvenis en la ĝusta momento*. It is an opportune moment to speak, *Estas ĝusta momento paroli*.

Let us go; let's see: *Ni iru, ni vidu*. Thus this much used expression is rendered by the imperative form.

Must and ought: We must go (necessity), *Ni devas iri*; We ought to go (moral

(Continued on page 2319)

History of Radio Inventions

By A. H. MORSE

A.M.I.E.E., Member I.R.E. New York*

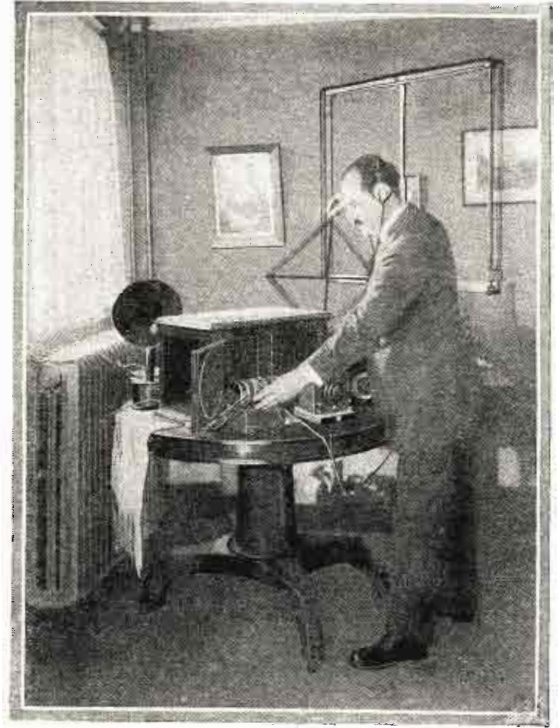

E. F. W. Alexanderson, the inventor of the high frequency alternator.

1897. Marconi filed (in March) the complete specification of his invention of 1896. The specification is largely taken up with particulars of modifications in the coherer and other details, but the part which is of chief interest is that which refers to the use of an elevated aerial, earthed at one end. In this connection, the specification says: "The larger the plates of the receiver and transmitter, and the higher from the earth the plates are suspended, the greater is the distance at which it is possible to communicate at parity of other conditions." This does not quite conform to the provisional specification filed in 1896—nine months previously; and, no doubt, it indicates the results of experiments which had been made in the interim. Further on, the specification reads: "Balloons can also be used instead of plates or poles, provided they carry up a plate or are themselves made conductive by being covered with tinfoil. As the height to which they may be sent is great, the distance at which communication is possible becomes greatly multiplied. Kites may also be successfully employed if made conductive by means of tinfoil." The actual use of an aerial, elevated at one end and earthed at the other—an earthed vertical oscillator—marked the beginning of great progress in

verified with case and certainty." The complete specification was filed on February 1, 1898. This invention was regarded as of such outstanding merit that, in 1911, when the British patent thereon was due to expire, it was (in part and conditionally) extended for a period of seven years—a unique distinction in the history of the art. Upon its extension, the patent was acquired by the Marconi Company, which fact was undoubtedly conducive to a more general recognition of its merits. For instance, in 1916, Fleming says: "Sir Oliver Lodge stated clearly, in a fundamental patent applied for in 1897, the right conditions for conducting syntonic radio telegraphy and for isolating stations, and the necessity for the employment of trains of feebly damped waves." Whereas, in 1907, he said: "The full scientific explanation of these principles, covering what is called syntonic telegraphy or the tuning of electrical circuits, was fully given long before the date of Sir Oliver Lodge's 1897 British patent. For example, they were fully set out in two papers published in 1895 in Germany by Oberbeck and by Bjerknes." Further, in the same early statement, Fleming tells us that apparatus which he had made in accordance with Lodge's specification failed to work, "while that made in accordance with Marconi's worked perfectly." The apparatus referred to was being demonstrated in Germany in 1900 before the officials of the German Patent Office by Professor Fleming on behalf of the Marconi Company. If Fleming's citations were relevant to Lodge's invention of 1897, they must have been even more so to Marconi's of 1900; moreover, they give a greater significance to the earlier inventions of Braun.

in a strong magnetic field. (Br. Pat. 9,712/98.) (Fig. 7.)

1899. S. G. Brown obtained a patent on a method of directional transmission and reception. The method involved the use of two aerials, a function of a wave-length apart, which aerials might be looped together. The specification also disclosed the use of a rotary interrupter, whereby a musical note would be obtained. (Br. Pat. 14,449/99.)

Ferdinand Braun obtained patents on a transmitter designed to radiate longer waves than those radiated by the Righi or usual type of oscillator. To this end he proposed a closed oscillatory circuit, containing Leyden jars and induction coils, inductively coupled to a radiating circuit. This use of coupled circuits in the transmitter constituted a very important advance, but Braun did not specifically claim it, or he could have held the whole art to ransom. (Ferdinand Braun, who shared the Nobel Prize with Marconi in 1909, died in Brooklyn in 1918.) (See Br. Pat. 1,862/99; German

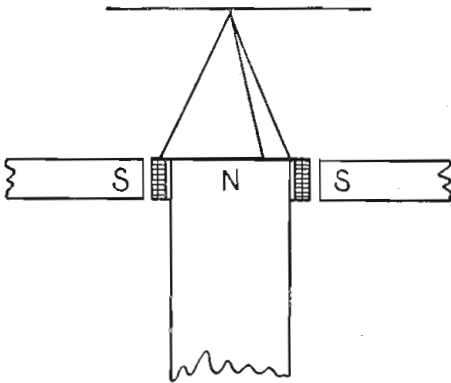

Fig. 7. Diagram of loud speaker invented by Lodge in 1898.

the art. (Br. Pat. 12,039/96; U. S. Pats. 586,193, and re-issue 11,913.)

In May, Professor Oliver Lodge filed an application for a patent on "Improvements in Syntonized Telegraphy without Line Wires," the main feature of which was the provision of means whereby the frequency of the transmitter and receiver could "be

In the same reference, Professor W. H. Eccles has said: "During the years between 1896 and 1910, Marconi, aided by Lodge's invention of the tuning coil, carried wireless telegraphy substantially to its present (1922) form," while Professor G. W. O. Howe has said of this invention that "it shows a remarkably clear insight into the problem of tuning and selectivity. It constitutes a great advance on Marconi's patent of the previous year."

As instancing the basic nature of the invention, it may be mentioned that the British Admiralty have recently been condemned by Lord Moulton, as Arbitrator, to pay compensation in the nature of royalty to the patentee thereof, on the basis of user throughout the whole period of the life of the patent—21 years. This patent, therefore, has the further distinction of being the earliest relating to radio, to be disinterestedly declared to be of a basic nature. (Br. Pat. 11,575/97; U. S. Pat. 609,154.)

1898. In the complete specification of the invention last referred to, Lodge pointed out that it was not necessary to have a spark gap in the aerial circuit. He also disclosed for the first time, a receiver inductively coupled to the aerial circuit.

In the same year, Lodge invented a loud speaker, using the now well-known device of a coil connected to a diaphragm and floating

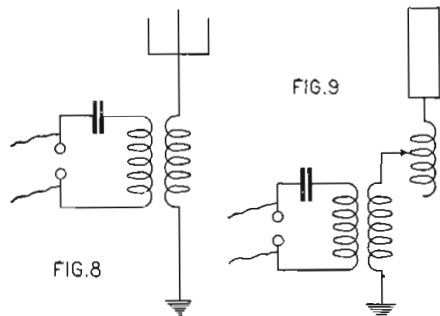

Two transmitting circuits that were among the first of the kind patented.

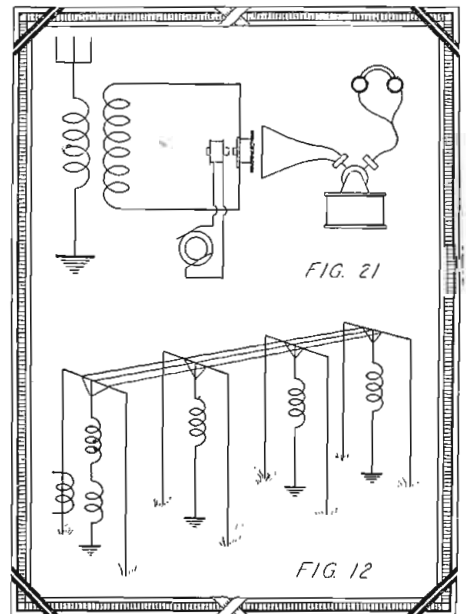

Fig. 12. Antenna designed by Marconi. Fig. 21. The Fessenden method of automatic recording.

*Late Supt. Dom. DeForest Wireless Telegraph Co. and United Wireless Telegraph Co.; Engineer, Marconi's Wireless Telegraph Co.; Wireless Adviser, Indo-European Telegraph Co.; Managing Director, Marconi Wireless Telegraph Company of Canada.

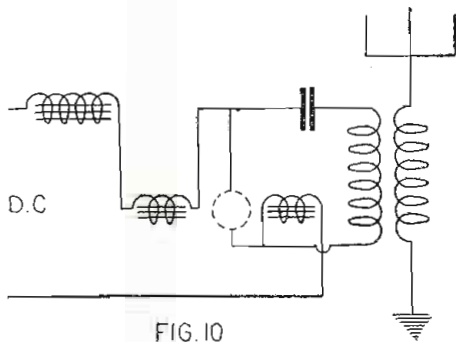
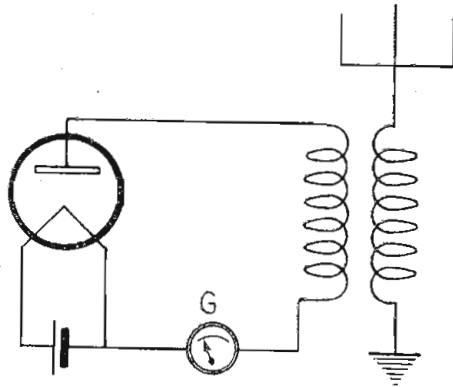

Diagram of generator with magnetic blowout.



One of the first steps in the evolution of the triode tube, the diode.

111,578/98; also Br. Pat. 22,020/99.) (Fig. 8.)
 1900. In April, Guglielmo Marconi applied for a patent on an invention which comprised practically all that was in the 1897 invention of Lodge and the later inventions of Braun, and a little more. At the transmitter, he employed separate oscillating and radiating circuits, coupled to each other, and at the receiver, separate absorbing and oscillating circuits similarly coupled; all circuits were tuned to the same frequency or harmonics of that frequency, and (inferentially) sufficiently loosely coupled to enable them to oscillate in resonance. This patent was made the basis of several successful infringement suits, and when it was strengthened by the acquisition of Lodge's 1897 patent it gave the Marconi Company for a time almost a monopoly of syntonic wireless telegraphy in England and America. (Br. Pat. 7,777/00; U. S. 763,772.)

William Du Bois Duddell, of London, applied for a patent on a static method of generating alternating currents from a direct-current supply, which method followed very closely upon the lines of that of Elisha Thomson of 1892. Duddell suggested electrodes of carbon, but he proposed no magnetic blow-out. He stated that his invention could be used for producing oscillations of high frequency and constant amplitude, which could "be used with advantage in wireless telegraphy," especially where it was "required to tune the transmitter to syntony." Duddell's invention (Br. Pat. 21,629/00) became the basis of the Poulsen arc, and also of an interesting transmitter evolved by Von Lepel.

1902. G. Marconi invented an improved form of magnetic detector (Br. Pat. 10,245/02). This detector constituted a great advance on the coherer, and it had a wide application until the advent of the Fleming Valve (Diode), the Crystal and Electrolytic Detectors.

R. A. Fessenden was awarded a patent covering broadly the voice modulation of

"practically" continuous waves. (U. S. Pat. 70,647; Br. Pat. 17,706/02.)

1903. Valdemar Poulsen, of Copenhagen, successfully applied for a patent upon a generator, as disclosed by Duddell in 1900, plus the magnetic blow-out proposed by Thomson in 1892, and a hydrogenous vapor in which to immerse the arc. (Br. Pat. 15,599/03; U. S. Pat. 789,449.) Reference will be made later to this invention, which was not commercialized for some years. (Fig. 10.)

R. A. Fessenden invented the method of telegraphing by changing the frequency of the transmitted wave. (Br. Pat. 28,290/03.)

1904. On January 1, Dr. A. Wehnelt obtained a German patent (No. 157,845) on a two-electrode vacuum tube rectifier of alternating currents. The filament or cathode of Wehnelt's device was coated with oxide, similar to those incorporated in the inventions of Von Lieben in 1911, and Franklin in 1913.

On November 16, Professor J. A. Fleming, of London, applied for a patent on the use, in connection with radio, of a vacuum valve or diode very similar to that described by Edison in 1883. According to his specification, Fleming had "discovered that if two conductors are enclosed in a vessel in which a good vacuum is made, one being heated to a high temperature, the space between the hot and cold conductors possesses a unilateral electric conductivity." While it is true that Edison was making use of the limited rather than the unilateral conductivity of the gaseous path, there is evidence both in the preamble and the claims of his specification that he was aware of the asymmetry of the conductivity; moreover, the property had been publicly discussed long before 1904 by Fleming and others, including Elster and Geitel.

As disclosed by Fleming's specification, the diode was not a very satisfactory detector. Its importance lay in the fact that it was one step in the evolution of the triode rather than in its own utility. The patents on the diode became the property of the Marconi Company, and after the specification of the British patent had been amended by disclaimer an unsuccessful attempt was made to secure an extension. (Br. Pat. 25,850/04; U. S. Pat. 803,684.) (Fig. 11.)

1905. R. A. Fessenden, of America, applied for a patent on a "beat" or "interference" method of detecting continuous and other Hertzian waves. The invention provided a method, rather than an instrumentality, and there being few, if any, continuous wave stations then in commercial oper-

ation, little use was made of it for some time. Nevertheless, the invention was undoubtedly one of the most meritorious in the history of radio, and it now has a very wide application. (U. S. Pats. 1,050,441 and 1,050,728, granted in 1913, Br. Pat. 6,203/07, see U. S. Pat. 1,141,717 to Lee and Hogan in 1915, Br. Pat. 24,458/13.)

G. Marconi applied for a patent on an inverted "L" aerial. The directional property of this aerial, which, according to the specification, was equally pronounced in transmitting and receiving, has been acclaimed by Fleming and many others. (This, by the way, is not to be confused with the "Marconi Beam.") The specification states, "This receiver may be used with great advantage to determine the direction of a transmitter, say, for instance, on a ship at sea," and explains that if "such an antenna be swivelled about its detector end in a horizontal plane, and signals be received with the antenna in a certain position, the operator will know that the transmitting station is in the line of the antenna; in other words, that its tail end is pointing directly away from the transmitting station."

As to the directivity of this type of aerial for transmission purposes, there seems to be a great conflict of opinion; and despite what has been said to the contrary, it appears that when such an aerial is high enough to be an efficient transmitter, its directivity is negligible, except perhaps when the ratio of distance to wave-length is very small.

Such a directive aerial as Marconi claimed (Continued on page 2278)

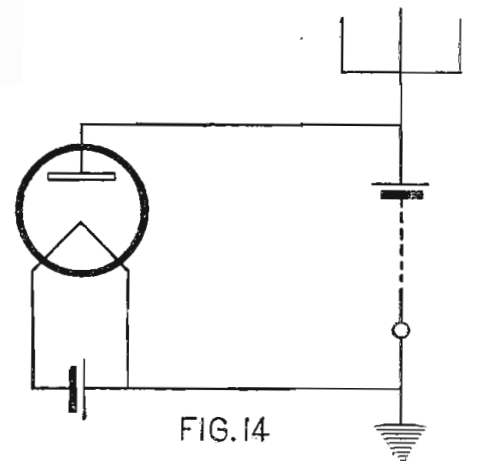

The "B" battery applied to a diode tube, patented by DeForest.

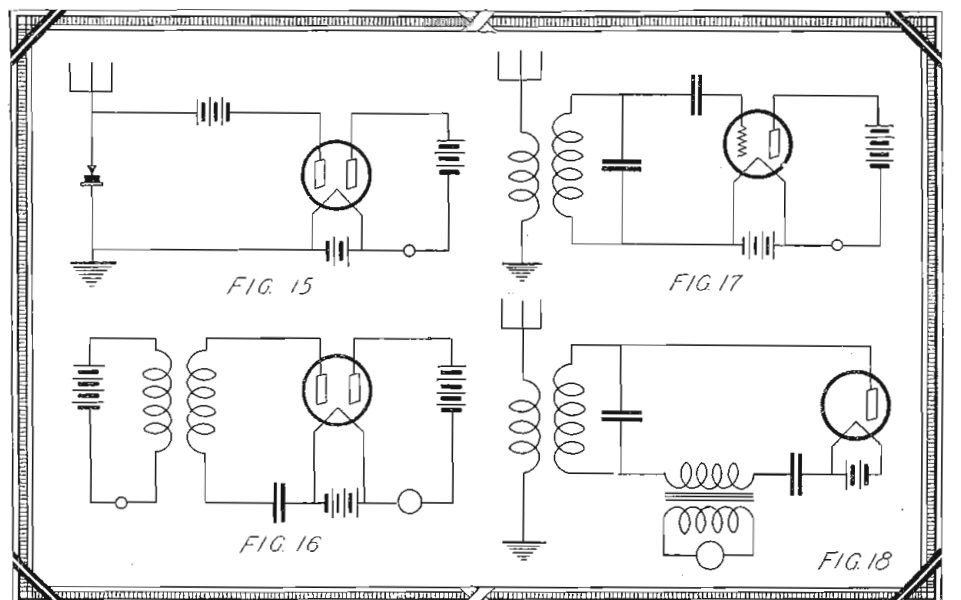

Figs. 15, 16 and 17 show diagrams in the development of the DeForest electron tube patents. Fig. 18 shows a Marconi patent for an induction coil as a step-down transformer in the plate circuit.

Theories of Radio Wave Propagation

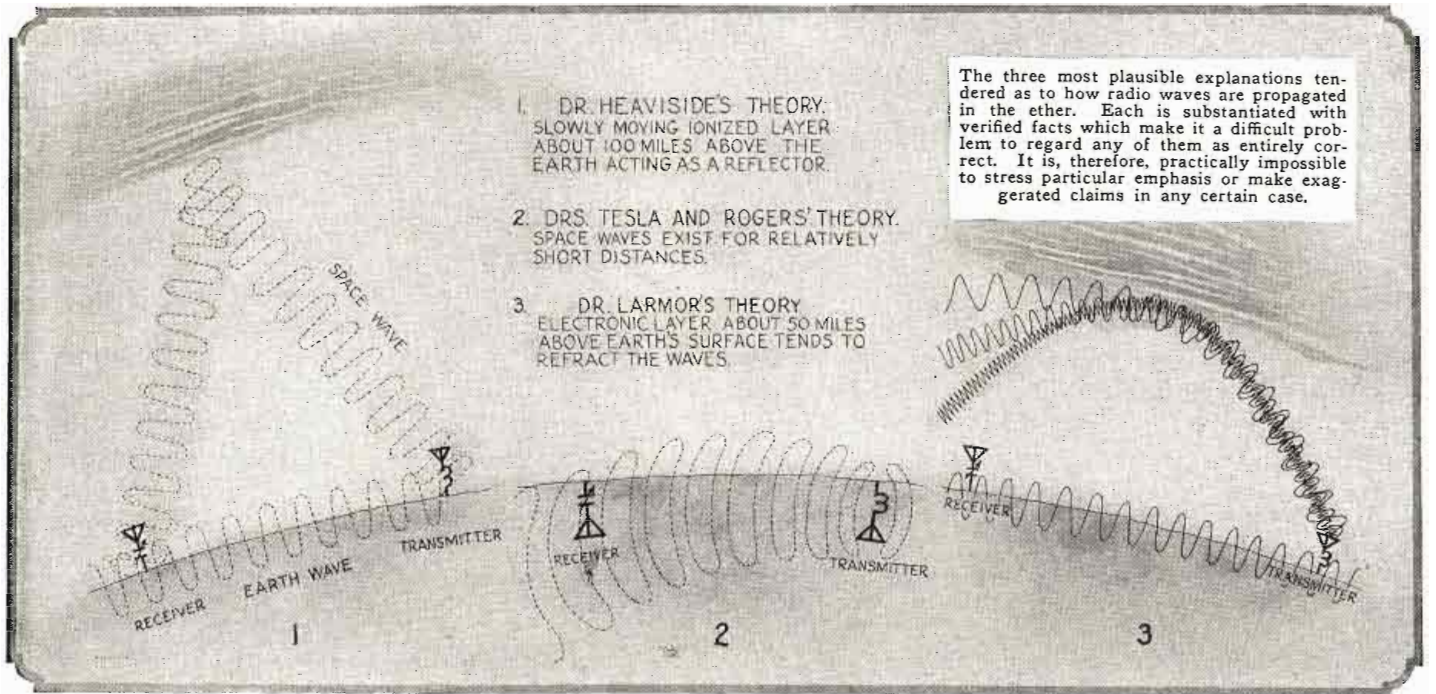

IN the latter part of the nineteenth century, a distinguished German scientist, Heinrich Hertz, announced that he had made a great discovery. He had been able to create waves in the ether, the presence of which was generally conceded to be certain. The manifestation of tiny sparks between two metallic points in close proximity, comprising part of a receiving system which was near an oscillator, assured Hertz that he had created waves in the ether.

Adhering to Maxwell's theory concerning the nature of light, Hertz began the construction of suitable apparatus and proceeded to carry on research in reflecting, refracting and polarizing the waves. Hertz called them electric waves at first, but later on termed them electromagnetic radiations, as Maxwell had at first conjectured.

However, the very wonderful experiments made by Hertz brought no appreciable measure of recognition at the time and only recently has he received the proper recognition. Incidentally, it may be stated that the short waves which are now so popular are not new, for most of Hertz's work was done on wave-lengths of only a few centimeters.

Others quickly followed Hertz and there were soon a number of experimenters who began to delve into the mysteries of the new discovery. Notable among these was Marconi, who, thrilled and impressed with the great scientist's work, began to wonder whether it was not possible to transmit these waves over greater distances than Hertz had attempted. Fired with imagination and disregarding the fact that Hertz did not employ ground conduction to increase the range of transmission, Marconi inaugurated the first antenna system with ground connection.

Both Hertz and Lodge had found that metallic conductors readily carried the waves, and so Marconi tried experiments over dry and moist earth and sea water, with results familiar to us all. It is now an established fact that a transmitter with a 500-mile range over land is capable of at least three times that over water, under ordinary conditions.

Some interesting and inexplicable phenomena occurred which were the cause of much speculation. For instance, much energy was absorbed when a ground connection was used, and this led directly to the introduc-

By **LEON L. ADELMAN**
Assoc. I.R.E.

THOUGH scientists are constantly investigating the subject, there is still much difference of opinion. This article is an unbiased report of the leading theories of radio waves.

tion of the counterpoise, a system of wires underneath the antenna, which replaced the ground. This addition resulted in sharper tuning and more radiated energy. However, for all practical purposes, Marconi's first system has been found to be as effective as can be desired, and one need but cast a casual glance at the roof tops along a street to notice how far this method has been employed.

Since Hertz could not cover any appreciable distances with his manner of producing waves in the ether, Marconi believed that the shortness of the waves used (a few centimeters in length) was the main cause for

the limited range of the transmitter. After a series of experiments he was able successfully to bridge the Atlantic with the famous letter "S," in the last month of 1901, using a wave-length of approximately 1800 meters.

HIGH WAVE-LENGTH

Both experiments and calculations showed the advisability of using the higher wave-lengths for distant communication. Progress went along toward the development of the longer wave. In fact, this condition so predominated that, for a very long period of time, no one ventured to go much below 600 meters and the general tendency was to use 20,000 to 30,000 meters.

With the announcement of Marconi's achievement, thousands of people from every walk in life and from every clime, eager to learn more about the new wireless, began to experiment, using their own lines of procedure, and absorbing whatever information it was possible to glean from the press. From these arose the class known as the amateurs. As is well known, the laws of 1912 restricted them to the use of no more than 200 meters and as far below as they desired. What a situation, when everyone was certain that very little or practically nothing could be done on these waves! Without completely realizing his condition, the amateur set about to do the best he could.

Hertz had noted that when the dimensions of the resonator were similar to those of the oscillator, maximum transference of energy from the one to the other was obtained. This was the first step toward what is known as tuning, and it remained for Pupin to design an effective system of tuning or changing the frequency of the electro-magnetic waves, although Marconi introduced syntonization or a condition of resonance in both receiver and transmitter. Hertz had also noticed that when the radiated waves encountered an obstruction, a region of electrical shadow was left behind, analogous to the shadow of an opaque object interposed in a beam of light, in which the signals received were very weak or nil. However, when Marconi perfected his basic invention of a grounded radiating system, he found that lines of force were set up be-

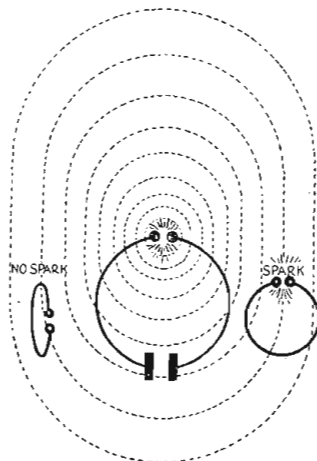

Hertz oscillator. At right angles to the plane of the oscillator, no energy was collected by the resonator. First evidence of some form of wave motion.

tween the antenna and earth which, detaching themselves, became free waves, grounded at their lower extremities, thus following the curvature of the earth. It was found also that the surface of the earth offered no appreciable hindrance to the waves and that, when an obstruction such as a hill or low mountain was reached, they passed up one side and readily glided down the other.

The conductivity of the earth has a direct bearing on the propagation of the waves. If the resistance of the ground is high, little absorption of the ground currents takes place, the earth loses its guiding influence and, as a consequence, the waves become ungrounded, act like Hertzian waves, travel in straight lines and no longer follow the curvature of the earth. Thus, it is readily seen that distant transmission is best over water.

DAY AND NIGHT

Another large factor which was very noticeable was the difference between day and night transmission. It had long been known that for a given power, greater distances can be covered at night than during the day, both over land and sea.

Someone ventured to give as a plausible explanation the answer that the moisture, collected in dew on the surface of the earth at night, increased the conductivity and the range of transmission. But this does not agree with the fact that a similar increase in the strength of the signals over water takes place at night, where the conductivity of the water is practically constant day or night. This, again, takes into consideration only the earth currents and not the space waves.

An explanation was finally found. We know that the ultra-violet rays from the sun are a powerful ionizing force. Hence, it is easily understood that it may ionize the upper atmosphere during the day and this may cause considerable absorption. But even then the answer is not wholly satisfactory since it has been calculated that ionization by the sun's rays is not great enough to produce as marked a change in the signal strength as noted. Further investigation showed the phenomenon that, on certain wave-lengths, better communication can be had between two stations during the day.

In explanation, it is only necessary to remember that Hertz was entirely successful in his attempts at reflecting the waves he created. Is it possible that this phenomenon plays a part? Let us consider and weigh the facts. Dr. Heaviside, in 1901, suggested that somewhere in the upper atmosphere there exists a well-defined stratum of ionized at-

mosphere acting as an excellent conducting surface. His deductions were based upon the known fact that, as we ascend higher into the atmosphere, the pressure diminishes and the conductivity increases. He concluded that, at an approximate elevation of 100 miles, the rarefied atmosphere, together with the increased ionization by the sun's rays, produced an exceptional conducting medium.

What happens to a traveling wave, he explained as follows: As soon as a wave leaves a radiating system, it travels upward toward the conducting layer, as well as along the surface of the earth. On striking the ionized layer, reflection takes place. The reflected wave having, of course, a greater distance to travel, arrives at the receiving station out of phase with the gliding ground wave and hence interference occurs.

The conducting layer serves as a shield and reflector returning the waves to the earth. If this is the case, interplanetary communication is out of the question. Again, Heaviside claims that this conducting layer is slowly moving and tends to carry the waves with it for a short interval of time

at sunrise and sunset, remaining constant during the day and night but, of course, being different in value during these periods.

WAVE COMPARISONS

In transmission over short distances and

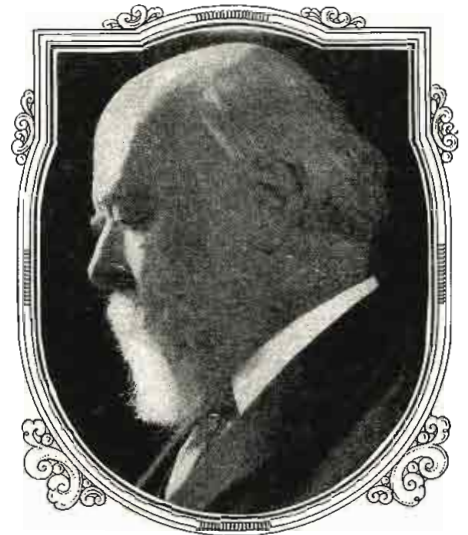

Sir Oliver Lodge, whose extensive scientific researches have won world-wide commendation. Lodge is a firm believer in the Heaviside theory.

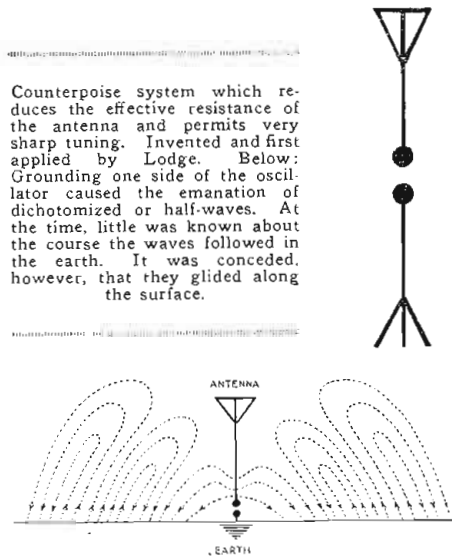

Counterpoise system which reduces the effective resistance of the antenna and permits very sharp tuning. Invented and first applied by Lodge. Below: Grounding one side of the oscillator caused the emanation of dichotomized or half-waves. At the time, little was known about the course the waves followed in the earth. It was conceded, however, that they glided along the surface.

particularly over water, the surface waves are to be counted upon as of greater importance, chiefly because the surface is a good conductor. Over long distances, however, the earth waves may be absorbed, leaving only the space wave component. Thus, for extremely long distances, the signal strength may remain constant, little or no interference taking place at the receiving station. Is it, then, permissible to concede that the degree of fading depends upon the wave-length and the distance?

This leaves the subject open to debate. If, as Meissner asserts, we need no Heaviside layer to understand this, bearing in mind that it is easy to understand that the surface waves keep to the surface, how then can one account for space waves traveling around the earth? Readily replying, Meissner declares that the difference in dielectric constants of the strata comprising the upper atmosphere, the moisture in the air and other causes, giving in effect, the phenomena of refraction and reflection, are all responsible in some measure for this condition.

Meissner's theory is but recent, and may be correct to a large extent, but before drawing any conclusions, it will be best to review the facts.

Let us begin with static: We know that this is an accumulation of static electricity which manifests itself in a wave form covering a very large range of frequencies. The strength of this manifestation varies with the period of the day and with the meteorological conditions. Close checks on the humidity and on static show that there seems to be some relation between them. Due to the constantly changing humidity in the upper regions, the fading of signals can be attributed partially to their passage from one medium to another of different density. These media consist of different percentages of water vapor kept in motion by air currents. Waves passing through them are reflected and refracted, thus causing fading.

Next comes short wave transmission. As we have seen, Meissner claims that the space waves are more predominant at the higher frequencies. Is it logical to assume, therefore, that best results should be obtained at the very short wave-lengths and at night? If so, then how can one account for the excellent results being obtained by the amateurs on some of these short waves during daylight? It has been established as a positive

before reflection takes place. This, he states, accounts for the phenomenon of fading, for with the phase relation between the space and ground components of the wave constantly changing, at no specific rate, at the receiving station, the result is that cancellation and reinforcement of the waves takes place gradually. This sounds reasonable and has been accepted by many as the probable truth, but there are, as we shall soon see, many objections to this viewpoint.

In the main, the argument seems to center about the manner in which the waves are guided around the earth, whether by the guiding conductivity of the earth's surface or by the reflection from the Heaviside layer.

TWO KINDS OF WAVES

Sommerfeld, in his theoretical investigation, found that there must be two kinds of waves, space waves which travel freely in space, and surface waves which move only along the surface of the earth. It was as a consequence of this fact that Heaviside propounded his theory. Meissner, working along the hypothesis suggested by Sommerfeld and bearing in mind that both the varieties must be in some way connected, found that the space waves are predominant in the short wave-lengths and that the ground waves are stronger in the long wave-lengths. This being the case, it can be admitted that the earth wave is affected by the conductivity of the earth which varies between day and night, and that the space wave is influenced by the degree of ionization of the atmosphere, which alters probably only

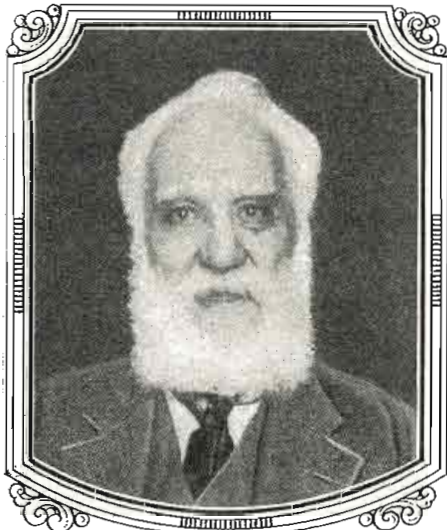

The late Prof. Alexander Graham Bell, to whom we are indebted for our telephone. Bell's conception of the telephone receiver made possible the conversion of electrical vibrations into sound.

fact that signal strength on twenty meters during the day is better than at forty meters at night.

It would be well for us to compare the electromagnetic vibrations in the ether, known as light, with those known as radio waves. Their only difference, as far as is known, is in their length. Whereas, in the space of one second, there can be from ten thousand to as many as sixty billion vibrations (corresponding to a wave-length of from thirty thousand meters to half a centimeter, the extremes of range which it has been possible to obtain to date), it is conceded that the average value of light vibrations lies in the neighborhood of six hundred trillion per second. This is ten thousand times the frequency of the shortest radio wave produced.

However, as both are vibrations in the ether, it stands to reason that they should follow the same laws and many physicists agree on this point. Unless one cares to follow Einstein, light travels in straight lines and, of course, is subject to reflection, refraction, absorption, diffusion, etc. We can state, without hesitation, the exact causes of these various phenomena. But when these actions affect radio waves, we are at loss to give a satisfactory explanation.

Sir Joseph Larmor, whose work on the electro-magnetic theory and other physical manifestations is recognized by all scientists, has shown by an elaborate analysis that the simple explanation of the Heaviside layer is not the best. He actually proves that the Heaviside layer would not act like a mirror, but that a radio wave on encountering a sufficient quantity of electrons to render the atmosphere conducting, would suffer so great a diminution that it would be damped out or absorbed in the space of a few miles. In other words, Larmor, whose theory is the latest conception, believes that reflection does not fully account for the bending of the waves. His conclusion is that refraction bends them, another seemingly logical explanation, if thoroughly supplemented with proof. His contention is as follows:

LARMOR'S THEORY

Recalling that light can be bent by refraction, such as happens when a stick plunged into water appears to be broken. Larmor agrees with Einstein that if the air were replaced by some hypothetical medium in which the velocity of a wave would increase as it reached higher levels, its path would be curved. The apparently broken stick, it must be borne in mind, is merely the path of the light through the water.

Working on this hypothesis, Larmor shows that the electrons in the upper atmosphere, some fifty miles high, would produce just such an effect, and that the fact that the curvature of this layer is the same as that of the earth explains why the rays can be bent around it.

The lower surface of this ionized layer is likely to be very uneven, having many humps and hollows, so that a wave entering the surface at a point may possibly emerge and enter the surface again, undergoing successive refractions before it emerges at an angle which will carry it to earth again.

As is well known, light is composed of different frequencies, ranging from the infrared to ultra-violet. The shorter waves, those nearer the ultra-violet band, are bent or refracted more than the longer ones, as experiments with a prism will readily show. Analogous to this, Larmor contends that the shorter radio waves are bent more than the long, consequently they lie nearer to the earth's surface. This, perhaps, may explain why short-wave transmission on low power is so successful over long distances. This theory also gives us a plausible explanation of the difficulty of East to West trans-

mission across the lines of darkness. At the boundary, between darkness and light, a rapid change is going on. The half of the earth facing the sun is ionized, while the other half is un-ionized. A radio wave cannot pass this point easily; most of the energy is reflected out into space or else absorbed by the earth. This fact also accounts for the fact that North and South transmission is always better than East and West.

Dr. Rogers, of underground antenna fame, has proved conclusively that radio waves depend on earth propagation for their conduction. It was he who was the first to incorporate the antenna system in the ground and carry on experiments in the reception of trans-oceanic stations. Satisfied that the signals emitted from them were in no way interfered with by static or atmospheric conditions, that no fading occurred and that signal intensity was greater than with the ordinary antenna system, Dr. Rogers came to believe that the space waves encountered much resistance in the atmosphere and thus died out after a relatively short distance, while the earth currents persisted and were responsible for the long range. A very important fact discovered was that there was no rise or fall in signal strength, regardless of whether it was day or night, summer or winter. In other words, the ionization due to the sun was not a factor entering into the reception.

At the time, Dr. Rogers conducted tests mainly on the longer waves, but recent investigation has led to the belief that the same conditions apply to all the wave-lengths. Amateurs in communication with the Doctor's Hyattsville laboratory report the sig-

it was he who proved the existence of the Heaviside layer.

As was mentioned in the beginning of this article, the vast army of amateurs who sprang up in every corner of the globe furnished many of the present-day radio authorities who have, in a large measure, contrib-



Senator Guglielmo Marconi, who deserves much of the credit for his inventive genius and foresight in putting radio communication on a commercial basis. Marconi's work stands out as a splendid example of persevering youth, as he was still a young man when he announced his successful experiments.

The Experimenter

has come back! If you are one of the one hundred thousand readers of the old ELECTRICAL EXPERIMENTER, you will no doubt be glad to hear that the EXPERIMENTER has come back BIGGER AND BETTER THAN EVER.

Experimental Radio

Nothing but experiments, written by the foremost radio authorities, also a monthly editorial by H. Gernsback. A fine roto-gravure section to brighten up the magazine. But best of all for you radio readers, is the big radio section of over twelve pages of some fifty radio experimental articles—and mind you, NOTHING BUT EXPERIMENTS.

LIST OF INTERESTING ARTICLES TO APPEAR IN THE JUNE ISSUE OF THE EXPERIMENTER

- Chemical Flask Motor.
By Earle R. Caley, B.Sc.
- Chemical Manipulation.
By T. O'Connor Sloane, Ph.D.
- Hydro-Electric Battery Charging Set.
By Willis L. Jones.
- Electric Chime Ringer For Clocks.
By H. Winfield Seacor.
- Getting On The Air.
By A. P. Peck, 3MO, Associate, I.R.E.

Be sure to reserve a copy from your newsdealer before the issue is sold out.

THE EXPERIMENTER will be on sale at all newsstands May 20, 1925.

nals of the short-wave set as exceptionally loud, clear and steady. There is no fading whatsoever and the intensity of the signals remains unaltered during changes in atmospheric conditions, or from day to night.

Even as far back as 1900, Fessenden began the work of finding out how the waves were propagated. Some elaborate tests were made, resulting in the confirmation of an existing ionized layer, approximately one hundred miles in height during the daytime, and three hundred miles at night. It was Fessenden who originated the gliding wave theory and

uted splendidly. Men like DeForest, Armstrong, Godley, Reinartz, Hartley, Meissner, Pickard, Heising, Colpitts, Gernsback, Mott, Maxim, Fitch and others, too numerous to mention, are from the ranks of the amateur.

The pioneers who deserve being remembered are men such as Maxwell, Hertz, Marconi, Edison, Tesla, Lodge, Thomson, Fleming, Thompson, Alexander, Bell, Dieckmann, Fessenden, Goldsmith, Pupin, Squier, Steinmetz, Massie, Stone, Weagant, Kelvin, Henry, Hughes, Branley, Dolbear, Popoff, Braun, Wein, Lieben, Reiss, Langmuir, Duddell, Poulsen, Goldschmidt, Arco, Slaby, Belin, Tosi, Latour, Faraday, Chaffee, Cabot, Cohen, Eccles, Einstein, Rogers, Joly, Crookes, Round, Wehnelt, Heaviside, Righi, Austin, Hull, Whitney, Lorentz, Majorana, Zenneck, Nakken, Nesper, Trowbridge, Muirhead, Shoemaker, Schloemilch, Von Bronk, Ferrié, Wheatstone, Kirchoff, Sommerfeld, Korn, Belin, Jenkins, etc.

It is hoped that this article has helped those who were somewhat in the dark concerning the proposed theories of wave propagation. It is, at this time, impossible to guess which of them has the majority of adherents, and it can only be said that, with the rapid strides being made, the near future will see the unveiling of the truth.

Bibliography: Principles of Electric Wave Telegraphy and Telephony—Fleming. Principles of Radio Communication—Morecroft. London Philosophical Magazine, Dec. 1924. Robinson's Manual of Radio Telegraphy and Telephony. Elements of Radio Telegraphy—Stone. Proc.—I.R.E. Marconi Year Book. Wireless Telegraphy—Stanley.

The foregoing review of the various theories propounded in explanation of the perplexing problem relating to the propagation of electromagnetic waves in the ether and how, when they are supposed to obey the same laws as light, follow the curvature of the earth, is the first article consolidating all the proved facts and assumptions ever written. It should be of great intrinsic value to all readers of RADIO NEWS.—Editor.

The McCaa Static Eliminator

By EDWARD B. PATTERSON, B.Sc., A.M.I.R.E. and
LESLIE G. BILES, A.M.I.R.E.



One of the worst forms of interference is static. Here is an easily constructed instrument which eliminates this interference.



BEFORE undertaking the explanation of the McCaa anti-static system, it is interesting to note that it is not the result of a pipe-dream. A brilliant mind, in conjunction with years of research, is responsible for the revolutionary device.

Dr. McCaa became interested in radio communication about fifteen years ago. During the last seven years he has devoted his attention to anti-static devices and about four years ago he perfected apparatus for long-wave telegraph reception.

The fundamental principles of the device are well defined and allow many different combinations. It is not the purpose of this article to discuss any of the systems except those which have a direct bearing upon the needs of the radio fan. He wants an arrangement that will enable him to receive radio signals through the worst kind of static and other strays that disturb reception.

FUNDAMENTALS

To thoroughly understand the operation of the anti-static devices it will be necessary to review some elementary electrical principles.

Even the newcomer in the radio ranks knows what a variometer is. It is an instrument with two windings connected in series, one of which usually rotates within the other. With the coils arranged as shown schematically at the top of Fig. 1, the variometer has a certain inductance. When one of the coils is reversed, the inductance is decreased.

The explanation of this action is based on the fact that the coils of the variometer in the circuit link magnetic lines of force. When the higher inductance was obtained, the magnetic lines set up by the coils were aiding one another and vice versa.

Suppose that, instead of having the two coils connected as in the variometer, that the coil "D" is connected to some circuit, and has a certain number of magnetic lines, resulting from the current flowing through its windings. We can imagine that it possesses two lines of force. Let us couple this coil "D" to another one, "A," as shown in

the lower part of Fig. 1. It is possible to set up in coil "A" bucking lines of force by a suitable system, which is called a driver or oscillator. Coil "A" can be so arranged with respect to "D," that the two lines of "D" are completely annulled by lines from the driving coil.

After the coil "D" has had its flux lines neutralized, it no longer has, in effect, what is called inductance.

The next step in the explanation is shown to the left of Fig. 2. Assume that two coils having identical properties are connected in parallel. Alternating currents flowing in the antenna system will divide equally between the two coils. On the right side of Fig. 2 the inductance of coil "D" has been increased

RADIO NEWS presents this month the first complete description of the new McCaa static eliminator.

Static eliminators have been ridiculed time and again. There are many who sincerely believe that a device of this nature cannot possibly be made. However, a full description of the device is given in the accompanying article and those desiring to build it should find no trouble in understanding its fundamental operation.

Dr. McCaa has spent considerable time and energy in perfecting his device and has conclusively shown it to do all that he claims for it. The article, which should be of vital interest to every set owner proves convincingly that a static eliminator is not outside our realm of achievement.

as indicated by the increased number of turns. Alternating current flowing in the antenna system no longer divides equally between the coils, because "D," having a larger inductance, offers more impedance to the current. The higher the inductance of "D," the smaller will be the current through it. The reverse is also true.

APPLICATION

Refer now to the heavy lines of Fig. 3 and ignore the rest of the circuit. There are two primary coils, one placed on each side of a secondary coil and coupled magnetically to it. According to the principle of the bucking fields we can so arrange "P1" and "P2" that their fields completely neutralize one another, with the result that no energy is transferred to the secondary. Such is the case with the primaries. Their lines of force are linking the secondary in opposing directions, and no energy is being transferred to the secondary.

However, if "P2" is short-circuited, the bucking action is removed and energy is transferred from the remaining primary coil, "P1," to the secondary.

The next step is to see how the three different principles outlined above may be correlated. On the right side of Fig. 2 we found that the large inductance coil "D"

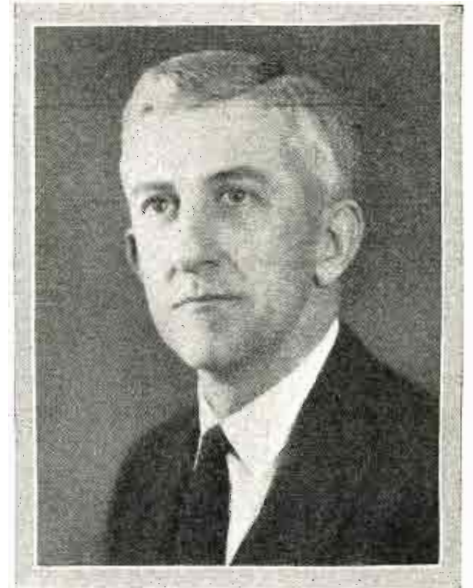

Dr. McCaa, the inventor of the static eliminator herein described.

would take comparatively little current as compared with the current taken by "P1."

Suppose that a high inductance coil, "A," is used in Fig. 3. Since its inductance is high, it will take but little current as compared with "P2." The magnetic lines of force of "P2" will not be affected to any great extent because they are dependent upon the current flowing in "P2," which has not been noticeably reduced. "P2" is small compared to "P1."

The primaries can still be made to buck, with the result that no energy is transferred to the secondary. If we had an arrangement whereby "P2" could be short-circuited at will, it would be possible to transfer energy to the secondary. This is possible because we have the information and apparatus necessary to accomplish this.

If coil "A" were to have no inductance, it would result in a short-circuit directly across "P2" and energy would be given to the secondary.

Supposing that, after closing the switch across "P2," we tune to a signal from a transmitting station. As there is no bucking action, the signal goes into the secondary and is received. Upon opening the switch there is no signal because of the bucking of the primaries.

There is a certain current flowing in coil "A" while the signal is being received. Suppose that it creates two lines of force. Referring to the first principle we found

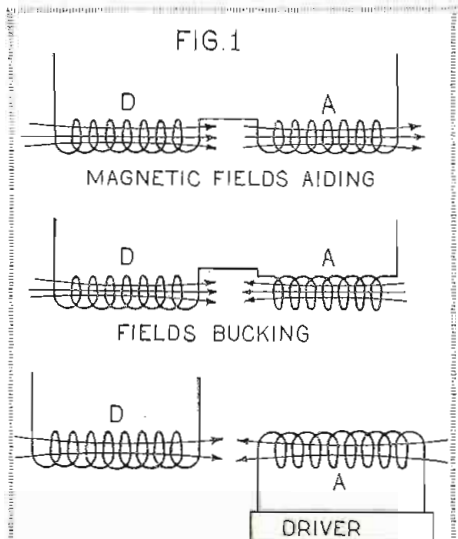
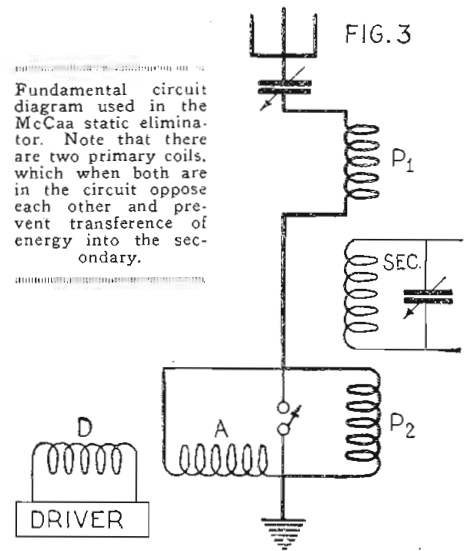
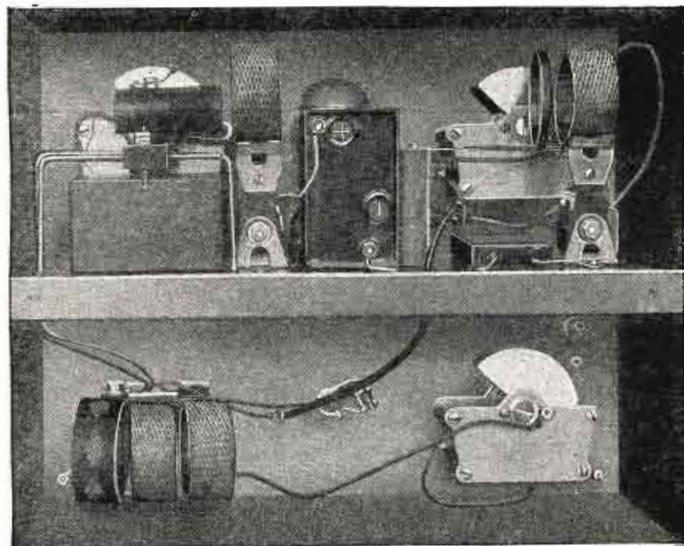

Fig. 1 shows the action of the fields of variable inductances.



Fundamental circuit diagram used in the McCaa static eliminator. Note that there are two primary coils, which when both are in the circuit oppose each other and prevent transference of energy into the secondary.



The interior of the static eliminator, showing how it is divided by the shelf. The electron tube can be seen to the rear of the "B" battery in the middle of the shelf, and the variable condensers are on each side of the tube.

The three honeycomb coils in the bottom, from right to left, represent the antenna coil, secondary coil and antenna bucking coil.

that we could make the inductance of a coil negligible by merely using a bucking force which would equalize the lines of force in the coil itself. Accordingly, we have coupled to the coil "A" another coil which can produce two lines of force to neutralize the two in "A." The final result is that the coil "A" has its inductance reduced to zero. But when its apparent inductance becomes zero, it takes all the current and, in doing so, acts as a direct short-circuit across "P2." The result is that the bucking action of "P2" is removed and the signal is allowed to pass into the secondary.

It must be borne in mind that the short-circuiting action takes place only when the two lines of coil "A" are neutralized. This is important. The driver system, or source of local oscillations, may be set for telegraph reception so that there will be a beating action. That is, it may be set sufficiently above or below the incoming signal frequency so that an audible beat is produced. For telephone work the beats are at an ultra-audible frequency. It can be understood that this driver system is readily adaptable to the Super-heterodyne. The driver serves both as the device and as the heterodyning oscillator.

MAIN CONSIDERATION

You will remember in the example given above we assumed that the desired signals created two lines of force in the coil "A." These two lines were opposed at certain chosen intervals and the signal was heard. Suppose that the static discharge causes fifty lines of force in the coil "A." Would the static be transferred to the secondary? No, because the driver was set to allow a signal producing the two lines to enter the secondary.

It is important to understand this thoroughly. The apparent inductance of "A" becomes zero and shorts "P2" only when its two lines of force are annulled. However, if static creates fifty lines of force in the coil "A," the two bucking lines set up by the driver will cause little reduction of the inductance for the static, with the result that the static does not get into the secondary, because "P2" is not shorted to the static discharge and "P2" still bucks "P1." In this way static is balanced out.

But suppose that static created only two lines of force. When such is the case the anti-static device is not needed because the static is not noticeable. There is one important point in this connection. Although the peak intensity of the static may be equal to that of the desired signal, it does not mean that the final ratio will be 1 to 1.

ANALOGY

The old experiment of placing a revolving disk in front of an air jet will serve

to illustrate this. When a disk with holes evenly spaced on its periphery is used, a musical note is produced, but a disk having holes unevenly spaced gives a noise. A comparison of the two phenomena plotted on graph paper would show that the musical note is given, when the impulses follow a regular and definite sequence.

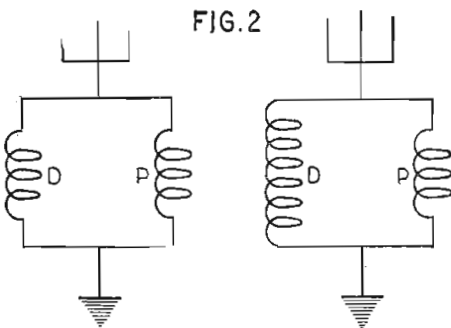

When coils in parallel have different values of inductance, there is an unequal division of current.

In the McCaa anti-static device the desired signal may be classed as musical because its impulses follow in definite sequence. The static and other disturbances, on the other hand, come in spurts and are irregular. It should be noted that static on the long waves is much more endurable than static on the shorter waves. The long wave static usually starts gradually, rises to a maximum and then slowly dies off. The static encountered on the shorter waves quickly rises to a maximum value and dies quickly.

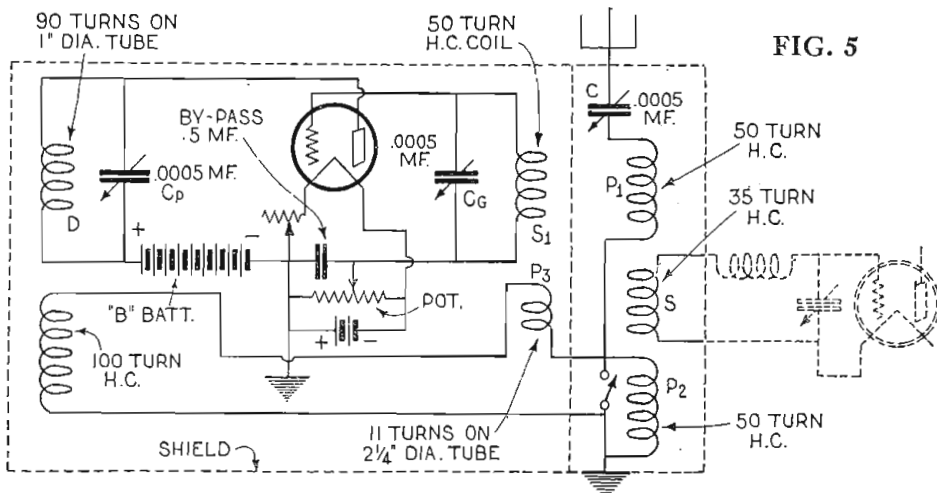

The circuit diagram of the McCaa static eliminator, showing how it is coupled to the receiving set.

OPERATION

So far we have been dealing with one of the elementary forms of the McCaa anti-static devices. The driver system, except for Super-heterodyne work and telegraph reception, is what Dr. McCaa calls the "repeater" system.

The repeater utilizes a detuning action of the primary, which was not used in the driver. The magnetic field of the repeater is synchronous, as compared to the previous driver system.

The main assumption on which the repeater system is based is that static has a predominate cyclic frequency which depends on the frequency to which the primary is tuned.

In Fig. 5 is shown the repeater circuit which is advised at the present time for those interested in broadcast reception.

A brief outline of the operation will be given. The two primary coils have the same inductance and are placed on either side of the secondary pick-up coil, which may be a coil of similar or less inductance; in the latter case, a loading coil is required in the secondary circuit in order to cover the broadcasting range with the usual variable condenser.

The primary coils are set in practically the same position as shown in the accompanying photographs. With the switch closed, the primary and secondary are tuned for some desired frequency, which we will assume to be 600 kilocycles or 500 meters. Signals and strays will be heard. The switch is then opened and the coupling of "P2" is so adjusted that it bucks the lines of "P1" with the result that neither signal nor static is heard. We have detuned the primary from the frequency we desired by admitting "P2" into the primary circuit.

It will be noted that this is different from the previous driver system where the primary was hardly detuned at all, because "P2" was chosen to have but small inductance as compared to the rest of the circuit.

The repeater tube is now set into operation, the repeater being tuned to 500 meters. (See Fig. 4.) The plate circuit is also tuned. In coil "P3" there will be a magnetic field, although very weak, caused by the desired signal at 500 meters. This field links the coil "S1." Impulses are sent to the grid, are amplified and cause a magnetic field of a certain number of lines in coil "D."

The coil "A," however, has a certain number of lines present, caused by the desired signal at 500 meters. Suppose that there are two lines of force in "A." Going back to the first explanation, we know that to remove "P2" from the circuit, or rather short-circuit it, it will be necessary to make the inductance of coil "A" negligible, so that

it will take all the current away from "P2." The lines of coil "A" are, therefore, annulled by the bucking lines of "D," which may be controlled by the use of the potentiometer or plate tuning.

Hence, when the desired signal at 500 meters comes through, the primary is tuned to 500 meters because the coil "P2" is, in effect, short-circuited. When the signal stops, the primary is tuned to some higher wave. The secondary, on the other hand, is still tuned to 500 meters. Even though the bucking action of the two primaries is not perfect, the fact that the secondary is tuned to 500 meters lessens the chance of receiving static.

We arbitrarily assumed the explanation that the desired signal produced two lines of force in the coil "A." Static, on the other hand, might produce fifty lines of force. However, since we are only bucking the two lines of the desired signal, the coil "P2" will not be shorted for the static because it is not setting up lines equal to that of the signal. It will be seen that the action in the repeater is practically the same in this respect as that encountered in the driver system.

The repeater has the advantage over the driver in that, when the signal stops, as in telegraph work, nothing is heard in the receiver. Because the grid circuit is tuned to 500 meters and the static is predominant at a higher wave, by virtue of "P2" being in the circuit when there is no signal, the chance of picking up static by the grid circuit of the repeater is small.

CONSTRUCTION

In constructing the repeater system the builder will note that the coil "A" is large with respect to "P2." The coil "A," therefore, draws but little current. The coil "P3" has but a few turns.

In Fig. 5 is shown the "Absolute System." The circuit looks rather complicated and, at the present stage of development, is more difficult to tune than the other system. The feature of this arrangement is that it is practically impossible for static to reach the grid of the repeater tube.

The circuit, including "C1," "W," "C2" and "V," constitutes a balancing-out system for static. With the switch closed, the antenna circuit is tuned for the signal to be received and the secondary is tuned also. The switch is opened and the antenna circuit is thereby detuned to a higher wave because "P2" is admitted. The circuit "C1," "W," "C2" is now tuned to this same new wave-length of the antenna and the static impulses will flow in "W." However, by coupling "V" to "W," the static impulses may be neutralized and, by virtue of the capacitive and inductive coupling, the point "Y" will be at zero static potential. This follows from previous explanations.

The grid circuit of the repeater is tuned for the desired signal. Passing through the tube, the impulses are amplified and sent

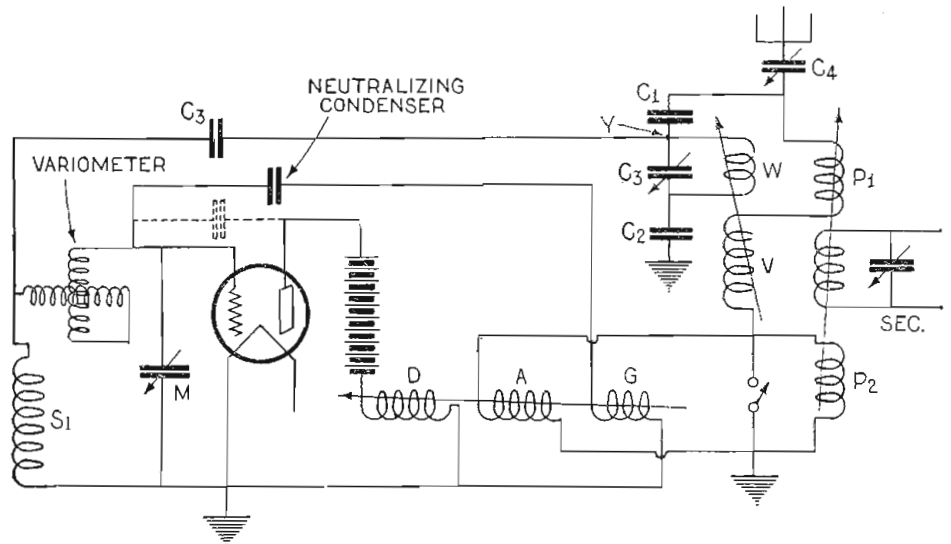

Fig. 4. Circuit diagram of the McCaa static eliminator, as it was first developed.

through coil "D," where the bucking action takes place between "D" and "A" for the desired signal, as in the previous circuits with "P2" shorted.

To eliminate the possibility of a reaction of "A" on "D," another coil "G" is added. The well-known method of neutralization is employed and the repeater tube becomes a one-way repeater only. That is, it will operate only when the grid is acted upon from the point "Y" and not when "A" is reacting on "D."

The system is called "absolute" because it is virtually impossible for static impulses to get on the grid of the repeater tube. They cannot break in at the point "Y," because the circuit is balanced against them. On the other hand, the circuit is not balanced against the incoming signal, because it is at a different frequency, and therefore the signal impulses travel over to the grid of the repeater tube. The static impulses cannot get over to the grid of the repeater, due to the coil "G," because of the neutralization of the tube capacity.

As everyone knows, it is possible with many receivers to bring in signals without an antenna, ground or loop connection. This is caused by the direct pick-up of energy by the inductances and wiring in the set. Naturally, strays will also be heard with an exposed receiver. Therefore, it follows, to secure maximum satisfaction with the McCaa anti-static device, it will be necessary to shield effectively both the anti-static unit and the receiver to which it is coupled. The anti-static unit should also be shielded from the receiver.

A box was built of cold-rolled copper $\frac{1}{8}$ -inch thick, commonly called "thirty-two ounce." The dimensions are 15 inches by 12 inches by 7 inches deep. All sides were soldered at first, with the exception of one 12-inch by 15-inch piece which was used for the back and put on after the set is complete. A copper shelf mounted on a board was placed, as shown in the photograph, six inches from the top of the box to allow clearance for the repeater tube.

A bakelite panel 12 inches by 15 inches was then placed on the front of the copper box and bolted into position.

Before proceeding further, the builder will find the following materials necessary: (Refer to Fig. 5, which is the wiring diagram to be used.)

- C, Cg, Cp—.0005 mfd. variable condensers.
- P1, P2, S1—50 turn honeycomb coils.
- A—100 turn honeycomb coil.
- P3—11 turns No. 28 D. S. C., $2\frac{1}{4}$ inches diameter (tube).
- D—90 turns No. 36 D. S. C., 1-inch diameter, (tube).

- Potentiometer and rheostat.
- By-pass condenser—.5 mid.
- Filament switch.
- Coil mountings (variable mount for P3).
- Tube socket.
- Assortment of screws, bolts, etc., and 2 hinges for the back.
- Repeater tube (preferably one having a high mu, although an ordinary amplifying tube may be satisfactory).

LAYOUT

The general layout of the instruments can be seen from the photographs. The antenna inductances, secondary (S1) and variable condenser are in the lower portion of the box. The shorting switch is also in this part and is mounted in the center. The upper section contains the repeater tube and the other inductances.

The inductive value of "S1" will depend upon the capacity of the variable condenser in the broadcast receiver.

Leads coming through the shelf should not pass close to the grid of the repeater tube. The "B" battery is in the upper part of the box with the tube.

The correct wiring for the connections to the repeater tube may be determined by changing the coupling of either "S1" with respect to "P3" or "D" with respect to "A," the repeater tube will oscillate.

It is advisable to mount the apparatus on the shelf, with flexible leads so that they can be easily connected to the other instruments.

The use of the common ground on the shield will simplify wiring somewhat. However, it is important that the variable condensers be not accidentally grounded by metal coming in contact with the copper box.

The "A" battery may be placed on the table beside the device. If the leads are long they may be enclosed in a shield of copper braid, which is then grounded with the positive "A" battery connection.

The receiver may be one employing radio frequency amplification. To reduce the number of controls, untuned radio frequency transformers may be used. Of course, sets with variable tuned transformers may also be coupled to the anti-static device. The secondary (S) is connected to the condenser, which regularly tunes the input of the first tube; the regular inductance is disconnected.

MAKING IT WORK

The actual operation is as follows: Close the switch. Tune the antenna system and the main receiver with the variable condensers to the desired signal. Open the switch and vary the coupling of "P2" so
(Continued on page 2323)

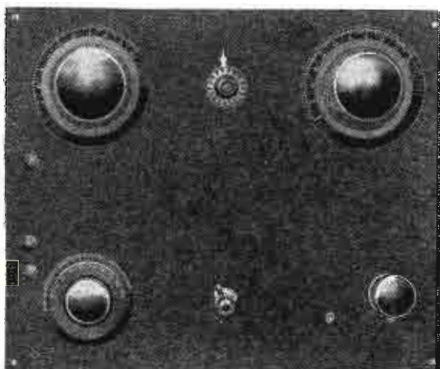

Front view of the static eliminator panel showing the three condenser dials, the coupling control and the potentiometer control. Note short-circuiting switch.

How a Detector Detects

By Vernon C. MacNabb

It is an extremely difficult matter to explain the action of the detector plainly, but Mr. MacNabb succeeds very well in this article.

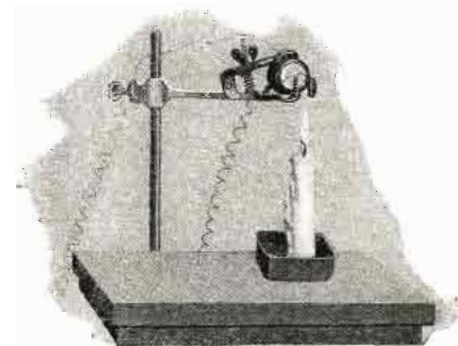

An experiment showing the principle of the electron valve. Two electrodes are placed in a candle flame.

THE detector is indeed the soul of the radio set, without which it would be mute. There have been many articles written on detectors, particularly concerning the vacuum tube used as such, that were excellent but did not cover the field thoroughly and simply.

This article will take up the radio currents at the point where they enter the set and carry them through a detector to the phones. Detection by a crystal and two methods of detection by vacuum tubes will be discussed here.

Just how an antenna picks up a radio wave is too complicated to be explained here, so we will start by saying that a wave is induced in the receiving antenna. Assuming a hook-up like that shown in Fig. 1, a circuit S is tuned to the incoming wave. This wave is made to follow around the tuned circuit. The word "tuned" may mean to a number of people simply the turning of a dial, so a brief explanation by the use of a mechanical analogy will be given.

TUNING

Take, for example, a system such as that illustrated in Fig. 2. C is a closed container with an elastic diaphragm D fastened across the middle. L is a long coil of pipe and P is a pump, both being connected to C, as illustrated. The whole system is airtight and filled with a viscous liquid, such as heavy oil. Suppose that a force F acts upon the piston (p), causing it to move up, forcing the oil to flow into chamber C at the top. The oil may take either of two courses, one to flow around through pipe L and return to the other side of the piston, the other to crowd into the space above D and cause the diaphragm to stretch downwards. It chooses to do the latter because the inertia of the long column of oil in the pipe causes it to take a long time to get started. The oil below D, which must of course be removed to allow D to stretch downwards, flows into the space left in P by the upward motion of the piston. The oil in the pipe, L, does finally get started, however, and flows around to the lower half of C, allowing D to resume its neutral position. But the law of inertia states that a body in the state of rest or motion will not change that state unless acted upon by some outside force. So just as the oil in L did not want to move when it was at rest, so it does not want to stop when it is in motion. The result is, it continues to flow and causes the diaphragm to be stretched upwards. When the oil is finally stopped by the dia-

phragm, its tension causes it to recover and so sends the oil back through L in the opposite direction.

Thus the oil would oscillate back and forth continuously if there were no losses in the system. But due to friction in the passages, this oscillation gradually dies out and the system is at rest. Suppose that, at the same instant, as the diaphragm started the oil on its return trip through L, the piston "p" was pulled downward. It would tend to help the diaphragm push the obstinate oil back through the coil. So if the piston moved in such a manner as to always help the diaphragm, the pump and oscillating oil system would be synchronized or in "tune."

IN RADIO

This is what actually happens in the radio receiver. The pump can be likened to the antenna which supplies the power and starts the system working in the first place. L is analogous to the coil of wire or inductance, and C, the condenser. The oil represents the current flowing in the circuit and F the

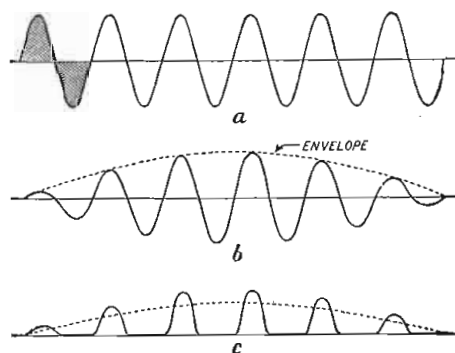

Fig. 3. The curves show resulting action of current through a radio circuit.

voltage on the antenna. The resistance of the circuit, like the resistance of the pipe, supplies the losses. If the voltage on the antenna aids the condenser in sending current around through the coil, the system is in tune.

Going back to the mechanical device, it is easy to see that when the diaphragm is distended it possesses in itself a force, which is due to the force on the piston. Thus when the condenser is charged by the antenna, it has a voltage across it. Now as the diaphragm forces the oil around through L, the diaphragm straightens out, its tension decreases, and when it is straight the tension is zero. Thus as the condenser succeeds in making current flow through the coil, its voltage falls to zero. As explained before, the diaphragm stretches in the opposite direction, therefore reversing the action. The same phenomenon occurs with the condenser and its voltage builds up in the opposite direction.

Thus we see that we have the voltage rising, falling, reversing, etc., across the condenser and the result can be plotted as a curve shown in Fig. 3a.

Let us now look for the last time at our oil system. If the piston is caused to reciprocate through a distance equal to only half the length of the cylinder, the distending and, therefore, the maximum force of the diaphragm will be less than if the piston made the entire stroke. The same idea applies to the condenser, for if the maximum force (voltage received on the antenna) changes, so will the maximum voltage across the condenser vary in some such manner as curve b, Fig. 3, which is an actual plot of a wave as sent out by a broadcast station.

The reason why a radio wave has this shape can be explained as follows: The transmitter, when no one is causing a disturbance in the microphone by speaking into it or playing a musical instrument, radiates or sends out from the antenna a pure "sine" wave, as that in Fig. 3a, and is known as the carrier wave. The frequency of this wave, i. e., the number of times that it repeats itself per second, is 1,000,000 times for a wave-length of 300 meters, which is in the range of broadcasting wave-lengths. Musical notes that we can hear range from a frequency as low as 20 cycles per second up to about 15,000 cycles per second.

When someone speaks into a microphone

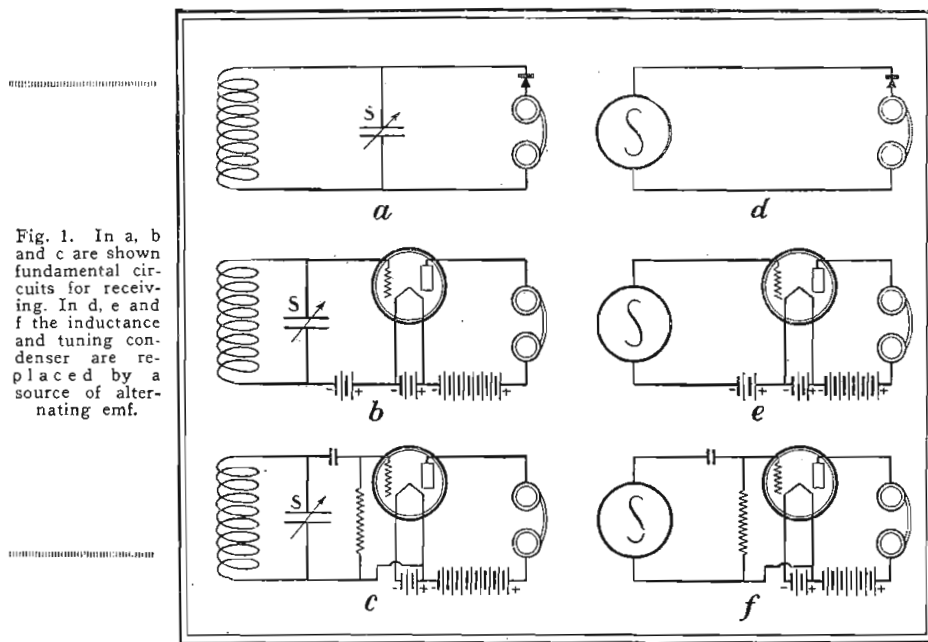

Fig. 1. In a, b and c are shown fundamental circuits for receiving. In d, e and f the inductance and tuning condenser are replaced by a source of alternating emf.

these lower frequency waves are superimposed upon the high frequency or carrier wave, and the resultant wave is their product. Due to the fact that the high frequency wave is always the same, the outline or envelope of the resultant wave is of the same general shape as the musical wave, as shown by the dotted line in Fig. 3b.

By referring to Fig. 1 it will be noted that the condenser is connected across the crystal and phones of a, and from the grid to the filament of the tube in b and c. Since we have determined the nature of the voltage across the condenser, we can replace the antenna coil and condenser by an alternating current generator, as is done in 1 d, e, f, having the required alternating voltage wave 3b. and we are ready to consider the subject of detection.

Detection is related to rectification inasmuch as it is the converting of an alternat-

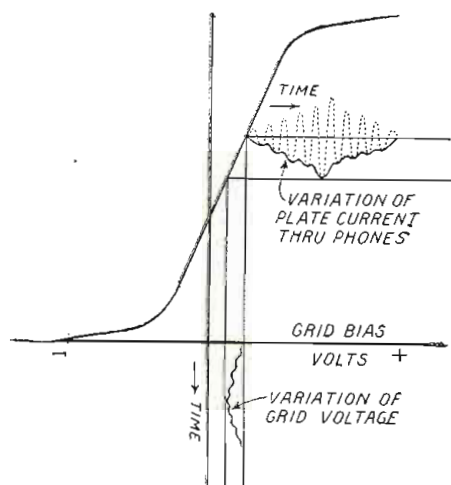

Fig. 5. Characteristic curve of vacuum tube with mechanical analogy in Fig. 6.

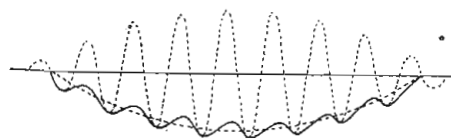

Fig. 7. Resultant curve of the variation of force on the diaphragm of a phone.

ing current or voltage whose average value is zero to a current or voltage of such a nature that the average is a finite quantity and must therefore be unidirectional, or as it is generally called, direct current or direct voltage.

What the average value of such a wave is may not be clear to everyone, but is quite simple. Referring to the two equal shaded areas of the wave of Fig. 3a, it will be noted that one is above the axis or positive and the other is below the axis or negative. Since they are equal but opposite, their average, over a complete cycle, is zero, just as a company having assets of a \$1,000 and liabilities of the same amount has nothing left. But in Fig. 3c, which we will discuss in the next paragraph, all the areas are above the axis and their average, which for each area is the area divided by the length of the base of that area, is some value which is not zero.

RECTIFICATION BY CRYSTALS

The crystal detector, used with the familiar catwhisker, has the peculiar property of offering a very high resistance to the passage of current in one direction and very little opposition to current flow in the opposite direction. The alternating current generator tries to send current first in one direction, then in the other, but it succeeds in getting current through in one direction only. This gives the effect of cutting off half of the waves, as is shown in Fig. 3c, and the average of this part that is left is direct

Fig. 2. This shows a simple mechanical analogy of the current passing through a tuned radio circuit.

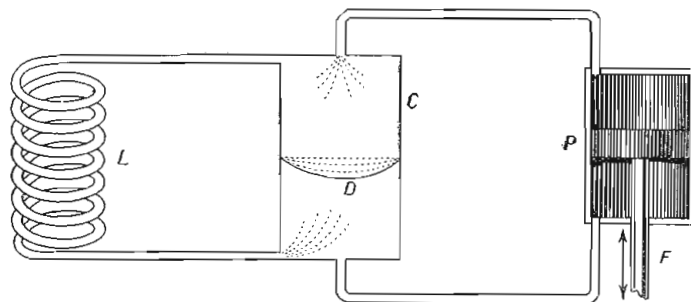

current and passes through the head-phones. The diaphragm of a telephone is comparatively sluggish and will not respond to the rapid changes of current, but does respond to the average change. The dotted line in Fig. 3c is this average change, which is the same shape as the frequencies of the musical notes impressed on the microphone at the broadcast station.

VACUUM TUBE DETECTORS

Now that we have had this little review in fundamentals, we are ready to take up the main subject of the article, namely, detection by means of the three-element vacuum tube. There are two well-known methods of detecting, known as the plate current rectification and grid current rectification. The first is much simpler than the second and the one most commonly described, whereas the second one is much harder to understand, but is the one most commonly used in sets.

Plate current rectification depends on the bend at the lower part of the well-known characteristic curve of the vacuum tube. Vertically is plotted the plate current in milliamperes and horizontally is plotted the grid voltage (Fig. 4). It can readily be seen that the bend occurs at a point where the grid voltage is several volts negative. If we wish our alternating grid voltage obtained from the generator to have its average value at this point, we must provide some way of making the grid negative with respect to the center of filament, which should be considered as a datum point. If we bring the grid return back to the negative filament, we have a negative bias on the grid equal to half the voltage drop across the filament. In the ordinary 3- and 5-volt receiving tubes this drop is generally insufficient to give the required negative bias, so an additional voltage, supplied by a "C" battery, is used, Fig. 1b. If we now take the curve of Fig. 3b and place its axis vertically at this point, we have a graphical representation of the alternating voltage impressed on the grid of the tube by the generator. If at the point where this vertical line hits the curve, a horizontal line is drawn, the curve of plate current which is dependent upon the grid voltage will be obtained. This can be done by drawing a number of horizontal and vertical lines and projecting the points from the grid voltage curve as is shown for three points as x, y and z in the figure. A curve drawn

through these points will be a rectified wave which has a finite average value, the same as the wave obtained by crystal rectification, which of course actuates the phones in the same manner. It should be noted that this is not true rectification, but is a relay action, for the plate current is supplied by the "B" batteries and is simply controlled by the alternating voltage on the grid. Another important point to be noted is the fact that no power is used in the grid circuit. This is in contrast with grid current rectification which we will take up below. On Fig. 4 there is another curve labeled grid current curve which has not yet been mentioned. The grid current is plotted vertically in microamperes and horizontally in volts, the same as the horizontal values for the other curve. The explanation for the existence of such a curve is comparatively simple and can probably be explained here briefly without interrupting the other chain of thought. It is known experimentally that a filament gives off electrons which are negative charges of electricity. These electrons carry current in the opposite direction to their own motion. Since like charges repel each other when the grid is negative, no electrons come to the grid, but any that get as far away from the filament as the grid pass through it and go to the plate. But as the grid is made positive, some of the electrons begin to come to it and, therefore, allow current to flow from the grid to the filament. But at no time does the alternating grid

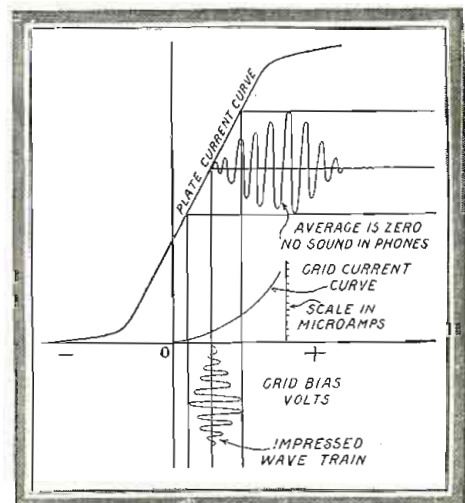

Fig. 4 above shows the characteristic curve of a vacuum tube. Fig. 6. Left. Mechanical analogy of Fig. 5.

voltage (i. e., the impressed wave train) swing far enough to the right so that any of its points lie underneath the grid current curve, or, in other words, go sufficiently positive to attract electrons. With this condition no current can flow in the grid circuit, and since power is the product of current and voltage, the power absorbed by the grid is zero.

GRID CURRENT RECTIFICATION

We will now consider the question of grid current rectification which employs the use of a grid condenser and leak resistance and

(Continued on page 2286)

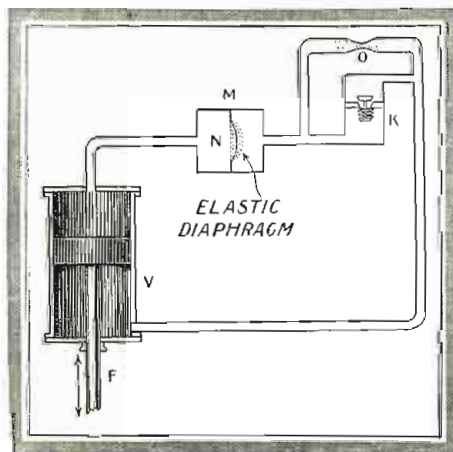



Buying A Radio Set

By A. P. PECK

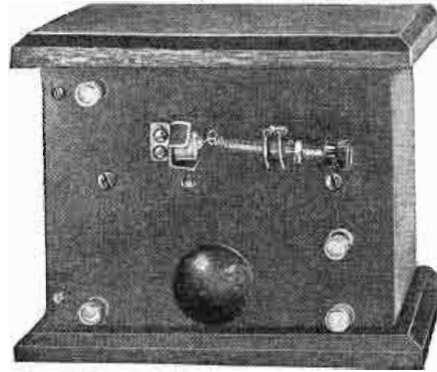
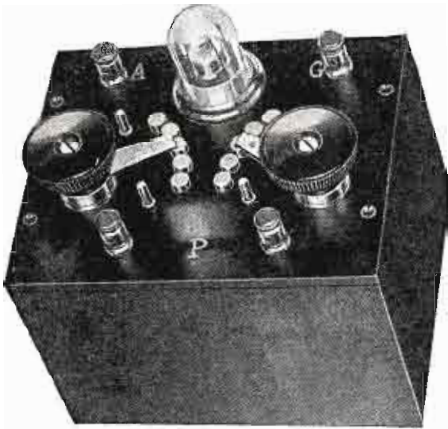

Figs. 1 and 2 above and at left illustrate standard types of crystal detector receiving sets.

or more broadcast stations within the above mentioned radius from home and will be satisfied to listen to them and not worry about distance, and at the same time are quite content to wear a pair of head-phones instead of listening to a loud speaker, a crystal detector receiving set is just the type for you. It will bring in musical concerts and the spoken voice with faithful reproduction and clarity of tone that can seldom be obtained with any other type of receiving set. Of course, the one great objection to these sets is that if the programs of your local stations are not exactly the type that you desire, you can seldom, if ever, receive from any other stations satisfactorily. Therefore, if you are a "DX" (distance) fan, and like to hunt through the ether for various broadcast stations, do not depend upon a crystal detector receiving set to supply you with such reception.

SINGLE TUBE SETS

The above described types of sets are the only ones on the market today that do not require an external set of batteries for operation. When entering into the discussion of sets employing vacuum tubes for their operation, remember that the accessory cost is greatly increased. In considering the price of all sets, you can figure that each vacuum tube will cost approximately \$3, whereas dry "B" batteries will cost about \$1.50 for each 22½-volt unit, a storage battery of the six-volt type will be around \$12 and dry cells in the neighborhood of 40 cents each.

In an article by the writer appearing in the January issue of this magazine mention was made of the fact that information on sets suitable for use by various persons in different localities and under different conditions would be supplied by the writer upon receipt of an outline of the various conditions to be fulfilled. The response to this notice was so great and from such a diversified field of readers that the writer felt it his duty to present to all of the readers of the Radio Beginner's Department concise information on various types of standard receiving sets which would enable almost anyone to select a receiver suitable to his own needs. In this article we will attempt to do just that.

IN order to cover the subject thoroughly in the short space allotted to this material, it will be necessary to select from each of the various classes of receiving sets the one which is typical of all of them as nearly as possible. Standard sets that are for sale all over the United States will be illustrated herewith and thoroughly discussed in these columns, not only as to

the volume range and selectivity, but in general as to price. In order to classify this information, the various types of sets have been separated and will be treated consecutively, beginning with very simple crystal detector sets and proceeding through the various intermediate types to the more elaborate five-tube receiving sets. Throughout this article we will leave out all technical discussions of the operation of these sets and will not touch upon the methods of installing or tuning them. Those desiring information on these two subjects should refer to the January and March, 1925, issues of RADIO NEWS in which installation and tuning were thoroughly discussed. The rules given in these articles are so general in character that they will apply to almost any types of radio set, either such as illustrated on these pages or that the reader may decide to select after consulting a competent dealer.

Let us here emphasize the fact mentioned last in the above paragraph. That is, when you go to buy your receiving set, select a dealer who carries only standard parts and is thoroughly reliable and has a good reputation. In this way you will take no chance of having inferior merchandise foisted upon you just because you do not happen to know all the ins and outs of the radio game. When in doubt or when there are no local dealers, the advertisers of RADIO NEWS can be thoroughly relied upon to supply good apparatus.

THE CRYSTAL RECEIVING SET

The first type of radio receiving set for us to consider is that known as the crystal detector type selling at a very low figure and having practically no upkeep cost. Such receivers are illustrated in Figs. 1 and 2 and cost in the neighborhood of \$5 or \$6 exclusive of aerial wiring and phones. With a good pair of phones and the necessary wire for erecting the aerial, this price will be raised to about \$12.

Receiving sets of this nature can very seldom be depended upon to give a consistent reception range of over 25 miles. Of course, reception over greater distances has been accomplished with receiving sets using crystal detectors, but only under extraordinary or even freak conditions. If you have one

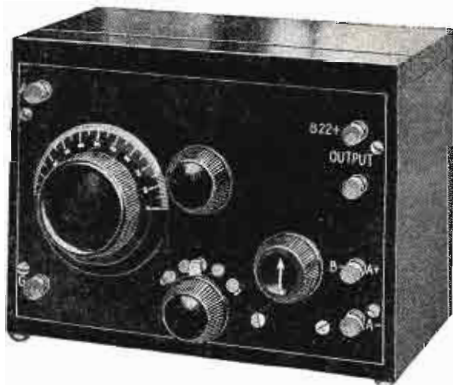

Fig. 3. An excellent type of compact single tube receiving set for use with headphones.



Fig. 10. A three tube receiving set using a reflex circuit incorporated in a handsome cabinet.

In the descriptions of sets below, the approximate prices mentioned will, unless otherwise specified, be taken to mean that that price stands for the set alone without tubes, phones, batteries or aerial equipment. With this data and the accessory prices given above, you can readily estimate the approximate cost of your completed set and you will be ready to go about the purchase of your receiver in an intelligent manner.

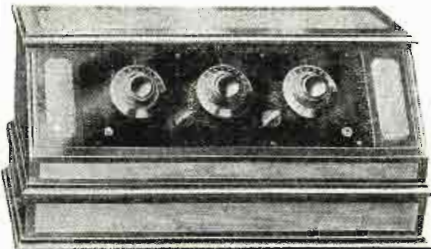

Fig. 12. Above: A five tube radio receiving set of the Neutrodyne type.



Fig. 14. Above: A novel five tube receiving set in which unconventional controls are used.

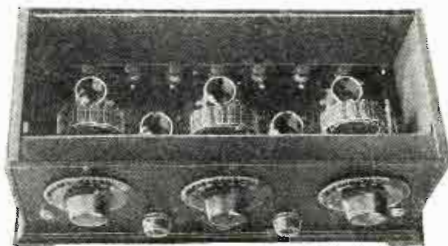

Fig. 13. Above: A five tube tuned radio frequency receiver which is not equipped with neutralizing condensers.

The single tube set illustrated in Fig. 3 is one of the simplest obtainable and comparatively low in price. It costs about \$15 less accessories. A set of this nature has to be employed with head-phones, as it is almost impossible ever to operate a loud speaker with a single vacuum tube receiving set, unless you are very close to a broadcast station. Under ordinary conditions, a set of the type illustrated can be depended upon to receive signals from broadcast stations within a radius of 500 miles. However, at the extreme range the signals will be very low in audibility and not much enjoyment will be obtained from the reception other than the usual thrill accompanying "DX" work. Local stations within a radius of 100 miles will come in with very good volume. Of course, all of the above statements and those of a like nature in the following paragraphs, must be taken to mean that this work can be done if certain accessories and equipment are provided. A good antenna is an absolute necessity, and if you are at all in doubt as to the type to use, consult the writer's article appearing in the June, 1924, issue of RADIO NEWS.

Here let us clear up a matter that seems to bother a good many embryonic radio fans. The question often arises as to whether or not dry cell tubes can be used with a set which the manufacturers equip with standard tube sockets. The answer is, "Yes." Tubes are interchangeable in practically every known circuit, the only controlling factor being the voltage of the "A" bat-

tery, which must be changed to suit the type of tube employed and the socket into which the tube fits. If the UV-199 or C-299 type of tube is employed, a special socket may be used. The same holds true for the WD-11 tube. If the set you purchase is equipped with standard sockets and you desire to economize on space by employing dry cells for the "A" battery and you wish to use either of the two types of tubes specifically mentioned above, adapters can be purchased from any reliable radio dealer, which will enable you to use these tubes with special bases in the standard sockets without making any change whatever in the wiring. These statements also hold good for every type of vacuum tube receiving set described in these columns.

Of course, there are many other types of single tube radio receiving sets on the market, but if you purchase one of standard manufacture, you can be quite sure that it will give you excellent results. The above lines give you an idea as to just what can be expected of a standard set.

PORTABLE SETS

Undoubtedly during your vacation this year you will want to take a radio receiving set with you. One type which can be depended upon to give satisfactory results is illustrated in Fig. 4. This is a very compact one-tube receiving set inclosed in a solidly constructed wooden box within which all the accessories are contained. This box can be carried in the car or with your baggage and the set will not be the least damaged in transportation. You can connect it to any aerial and ground wherever you happen to stop and receive excellent signals, employing a pair of head-phones for reproduction. A set of this nature sells in the neighborhood of \$16, less accessories, and is an excellent buy for anyone who desires a small compact receiving set that can be used in any location. You can use this set in your home and without any very great trouble can close the box, snap the lock shut and take it with you wherever your business or desires may guide you.

AMPLIFIERS

Many persons who, when they first start in radio reception, purchase a single tube receiving set, soon desire to have a set which will provide them with sufficient volume to satisfactorily operate a loud speaker and

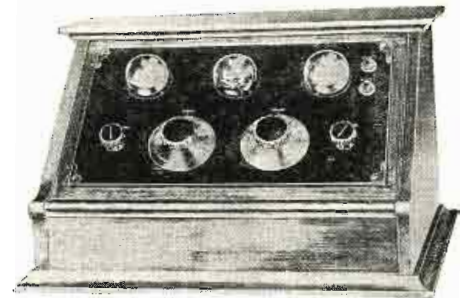

Fig. 9. Above: A standard three tube regenerative receiving set encased in a decorative cabinet.



Fig. 11. Above: A three tube reflex receiver which gives good volume when receiving from broadcasting stations within a radius of 1000 miles.

so do away with the sometimes annoying use of head-phones. At best, the latter are uncomfortable and particularly in warm weather are they undesirable for lengthy reception. An amplifier employing two vacuum tubes, such as illustrated in Fig. 5, may be attached to any ordinary type of single tube receiving set and with the addition of a couple of "B" batteries to those already used on the original set, you can produce very good volume for the operation of a loud speaker. An amplifier of this type is quite reasonable and may be purchased for about \$18, less tubes and batteries.

Besides the advantage of additional volume in reception, an amplifier will enable you to increase your reception range quite a little. Very often with your single tube receiving set you will hear stations very faintly, and it will be impossible to bring them up to sufficient volume to understand and recognize. When an amplifier is added, these stations are often brought in loudly enough to recognize them and your "DX" list will grow considerably after the installation of such an addition.

TWO TUBE SETS

The next receiver selected for presentation is a neat, compact little two-tube receiving set designed to give loud speaker reception on local stations within a radius of a few



Fig. 4. A portable receiver for the traveler or tourist which with an outside aerial gives excellent results.

miles. When head-phones are used, this range is increased one hundred fold or more and a great many stations can usually be tuned in. The set selected is illustrated in Fig. 6. This is extremely simple in operation as only one tuning control is used, and even the veriest tyro can easily obtain results with it. This set the manufacturer puts out completely equipped with tubes, batteries and phones at around \$35. To those who purchase a set of this nature the manufacturers also offer a balanced amplifier operating with two additional vacuum tubes. This is illustrated in Fig. 7. The two tubes in the amplifier are not used in an ordinary amplifying circuit, but constitute what is known as a push-pull amplifier. Such a device not only gives a great increase in volume, but at the same time preserves the clarity and quality of the received music or voice so that the current passed to the loud speaker can operate it at its greatest efficiency. Not only can this amplifier be used with the set illustrated in Fig. 6, but it can also be added to any one- or two-tube receiving set with excellent results. This amplifier retails at about \$30 complete with tubes and batteries.

There is one more two-tube receiving set on our list which is quite unique in construction and which must not be missed. This is illustrated in Fig. 8. A cabinet is provided, the right side of which is occupied by a standard phonograph. The left side, as illustrated, contains a complete two-tube receiving set and space is provided inside the cabinet for "A" and "B" batteries. With a set of this nature and a phonograph loud speaker adapter, the unit will be absolutely self-contained. The circuit of the receiving set incorporated in this duplex unit is what is known as a reflex circuit wherein two tubes are made to do the work of twice that number. Circuits of this type have been found to be quite satisfactory in operation when they are correctly designed and the set illustrated will give very good results. It is entirely portable and the combination of a phonograph and a radio receiving set makes an excellent one for use either in the home or in camp on a vacation trip. When broadcasting calls on the company, recourse may be had to the phonograph which is equipped with a record album for holding extra numbers. A receiving set of this nature, without the accessories, sells for around \$55.

THREE TUBE SETS

All of the above mentioned crystal, single tube and two-tube receiving sets, except under the conditions mentioned, cannot be relied upon to give loud speaker reception. Some of them cannot do this under any conditions and, therefore, the broadcast listener who desires to be able to sit back in his easy chair and listen to various broadcast stations will want something better and some type of set which will allow him to do just this. Of course the one- and two-tube sets mentioned above, when used with one of the amplifiers illustrated, will do this work, but then there is the inconvenience of having two separate units. Therefore, we will discuss from here on types of receiving sets which without any additional apparatus with the exception of the usual accessories will allow reception from many broadcast stations and reproduction on the loud speaker. When you go to purchase your set, it is a very good idea to decide upon the type of loud speaker that you wish at that time. Have the speaker tested in conjunction with the receiving set you are contemplating the purchase of and you will then be able to hear exactly the results that may be expected of the combination.

The first three-tube set that we will consider is illustrated in Fig. 9. This is what is known as a standard type of set employing a detector and two stages of audio frequency amplification and in the cabinet illustrated, without accessories, it sells for about \$75. With a set of this nature and an outside aerial you may expect to obtain excellent results with a minimum number of tubes and a consequent low consumption of battery current. In this particular set, jacks are provided so that the plug on the end of your loud speaker cord may be removed from the second stage jack and a pair of phones plugged in on the first stage when you want to go in for distance reception or do not want to disturb the rest of the family with the volume delivered from the second stage. A set of this type is suitable for use in any family, as it is extremely simple in tuning and will give satisfactory results even when used by one who knows nothing of radio.

The next three-tube set that we will consider is a very fancy type and is illustrated in Fig. 10. Here a cabinet similar to that inclosing the ordinary phonograph is used and the radio set is incorporated in the top as shown. A concealed loud speaker horn



Fig. 8. A combination radio receiving set and phonograph built in the same cabinet.

is placed within the cabinet and when the set is in operation, the broadcast music or speech emanates from the opening in the front of the cabinet. The particular set illustrated herewith is what is known as a reflexed Neurodyne, and while it only uses three tubes, it gives the full equivalent of a four-tube set because of the circuit used. Here also jacks are provided so that phones may be plugged in when desired. A set of this nature gives a very decorative effect to the home and in no way detracts from the existing furnishings. It lists at about \$150 without accessories.

The set illustrated in Fig. 11 is another one employing only three tubes, yet because of its reflex circuit it gives wonderful results, considering the price and upkeep cost. This set lists at \$60, less accessories. The writer has personally used a set of this type and has achieved some wonderful results with it. Local stations came in with so much volume that in most cases it was necessary to cut down the filament current. On stations within a radius of 1,000 miles it was found possible to operate a loud speaker with sufficient volume to be heard all over an average-size house. The tone of reproduction was practically perfect and nothing more could be desired of any three-tube set than was obtained from this one.

(Continued on page 2296)

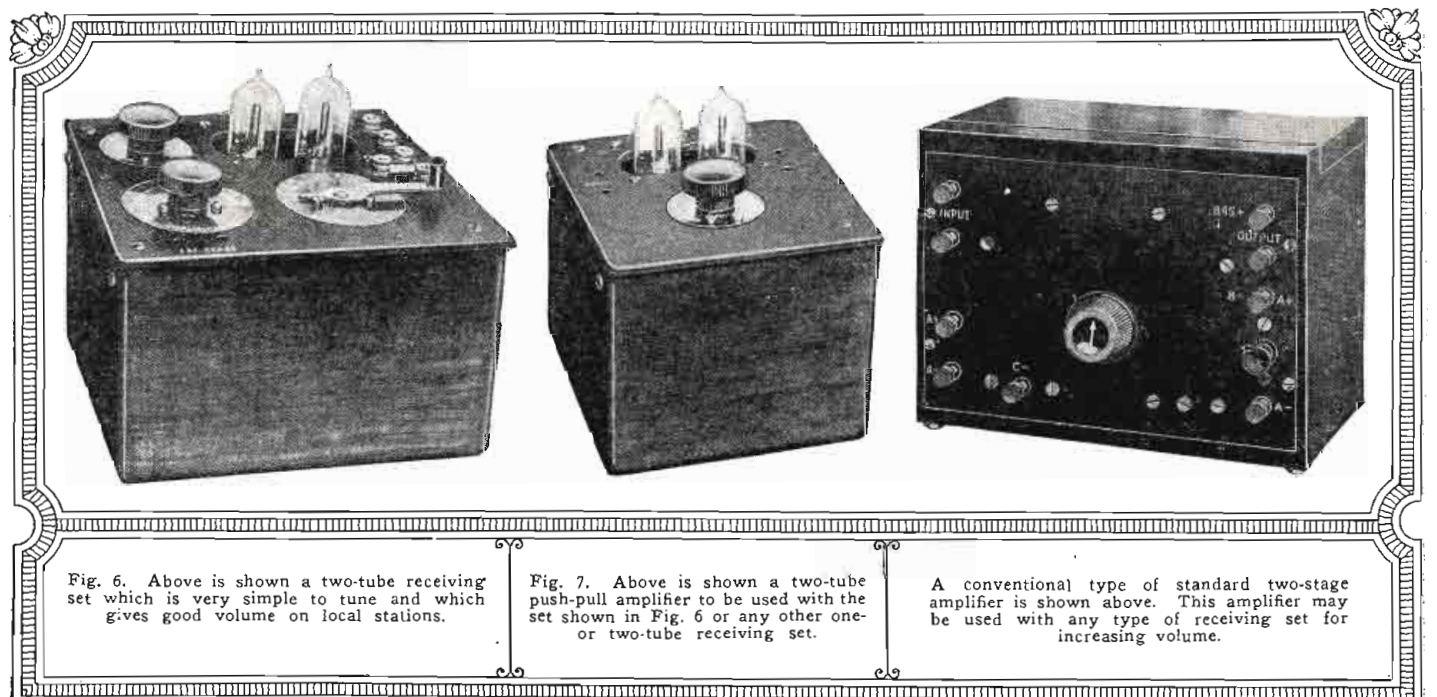

Fig. 6. Above is shown a two-tube receiving set which is very simple to tune and which gives good volume on local stations.

Fig. 7. Above is shown a two-tube push-pull amplifier to be used with the set shown in Fig. 6 or any other one- or two-tube receiving set.

A conventional type of standard two-stage amplifier is shown above. This amplifier may be used with any type of receiving set for increasing volume.

Design Your Own Low Loss Coils

By Sylvan Harris

Design your own low loss inductances! And be sure it is the best and is low loss! Mr. Harris tells how to select the proper type and how to design the proper size.



ALTHOUGH the mechanical construction of radio inductance coils is simplicity itself, the electrical design is not quite so elementary. The reason for this is that there has been no set of rules developed which enable us to calculate by simple means the various quantities involved. For instance, it is easy to calculate the inductance of a coil by any of the formulae in common use quite accurately—after the coil has been built. It is not as easy, however, to build the coil so that it will have a certain inductance which we may require. This is generally done by a cut-and-try method. A coil is built (that is, on paper) and its inductance is calculated. If this value is not near the one we want, the dimensions are changed and the inductance calculated again. This is done again and again until the proper value and coil is obtained.

To eliminate all this work, the writer has deduced the curves shown in this article. With the aid of these curves, it is possible to obtain the complete design of a tuned circuit in two or three minutes without going into higher mathematics, and without having to trouble one's self with the building of measurable models.

The first part of the problem does not necessarily have to do with the coil design. It has to do, however, with obtaining the value of inductance required in the coil. The relation between the inductance, capacity and wave-length of a tuned circuit is well known, viz.:

$$\lambda = 1884 \sqrt{LC}$$

in which λ is the wave-length in meters, L is the inductance in microhenries, and C is the capacity in microfarads. The manipulation of this formula offers considerable difficulty to many of our experimenters, but this difficulty is entirely removed by the curves in Fig. 1. These curves have been calculated from formula No. 1 and show the various combinations of inductance and capacity that may be used to cover any wave range.

AN EXAMPLE

As an example of the use of this chart,

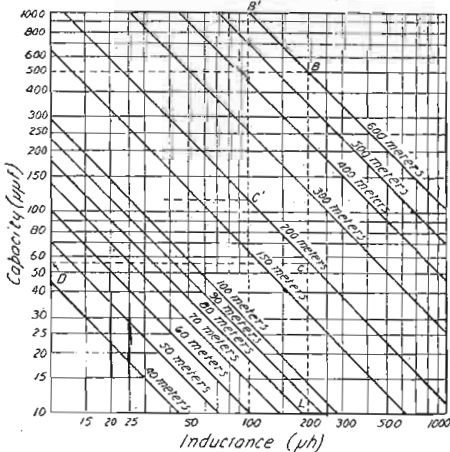
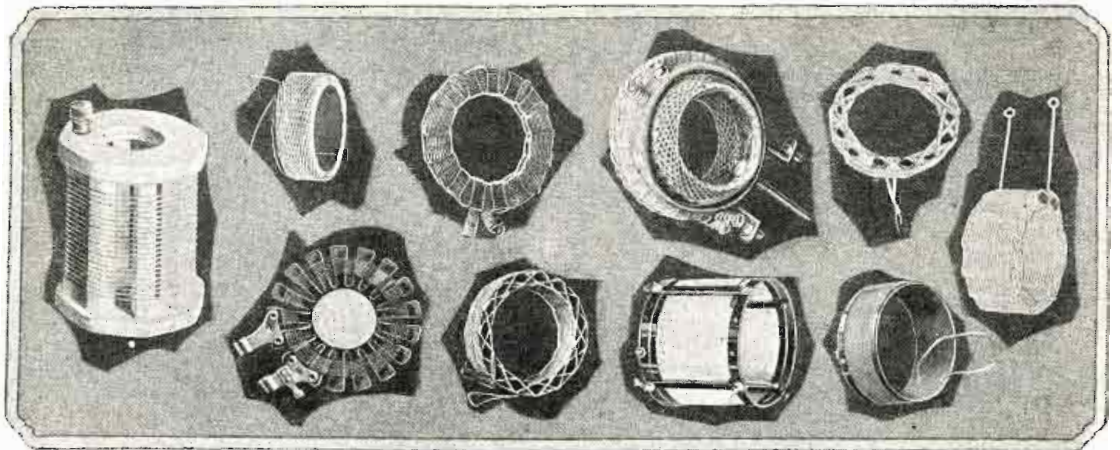

FIG. 1

This diagram will solve your coil and condenser troubles without calculation.



Some of the types of coils in ordinary use in radio receivers.

let us take the following problem. Suppose we are going to construct a tuning circuit of the usual type consisting of an untuned primary, secondary coil and a variable condenser whose maximum capacity is .0005 microfarad. The wave range of this tuning circuit is to be from 200 to 600 meters.

At the point A in the vertical scale, representing the maximum capacity of the condenser, draw the horizontal line AB until it intersects the 600 meter line. At the intersection B, draw the vertical line BL. This immediately gives the value of inductance required, which in this case is 200 microhenries. At the same time the point C, which is the intersection of BL with the 200 meter line, gives the minimum capacity required in the condenser. Drawing horizontally from C, the line CD, the value of D is the minimum capacity, in this case .000057 mfd., which is the same as 57 micro-microfarads. The next step in the problem is simply to build the coil so that it will have an inductance of 200 microhenries. How to do this will be shown later.

Many other things can be done with this chart. For instance, if we do not know what particular size condenser is to be used in the tuning circuit, we may simply slide the line BC up or down between the 200 and 600 meter lines. Suppose we slide it to the position B'C'. This shows that the range can be covered using a 100 microhenry coil with a condenser whose maximum is .001 mfd. and whose minimum is .000115 mfd.

The reverse of the problem is also possible with the chart; suppose we have a coil whose inductance is 200 microhenries and we want to find out what size condenser must be used with it to cover a wave range of 200 to 600 meters. Simply start at L in the figure and the intersection of the vertical line drawn from L, as B and C, will give the required maximum and minimum capacities of the condenser. These methods are used no matter what wave range is required and the chart will be of great assistance to those who are designing receivers to work on the short wave-lengths.

SELECTING A COIL

The next part of the problem, as has been intimated above, is to build a coil so that it will have the inductance required. The most generally used formula for this purpose is Nagaoka's, given in Circular 74 of the U. S. Bureau of Standards, formula 153, page 252. This formula involves a considerable amount of work as has been explained before, and

for this reason the writer has reduced the amount of work required to next to nothing by means of the curves shown in Figs. 2, 3, 4 and 5.

To illustrate the use of these curves, suppose that we have found in the first part of the problem that we require a coil of 200 microhenries inductance. Suppose also that we decide to wind our coil on a three inch tube, without spacing, and with No. 18 D.C.C. wire. Fig. 3 is the chart to be used in this case for it applies to three inch coils. Entering this chart at the point A on the vertical axis, which represents 200 microhenries, draw a horizontal line to the curve for the No. 18 wire. This is the point B. Dropping a vertical line from B, the point C shows that 60 turns of wire are required on the coil.

The same procedure is followed no matter what size wire or what diameter coil is to be used. The various charts have been computed for diameters of 2 3/8 inches, 3 inches and 4 inches, and for wire sizes ranging from 12 to 24. They apply only to closely wound coils of D.C.C. wire with the exception of Fig. 4, which applies to double-spaced coils.

These curves can obviously be used in the reverse manner; thus, suppose we have a coil three inches in diameter, No. 18 wire wound

(Continued on page 2292)

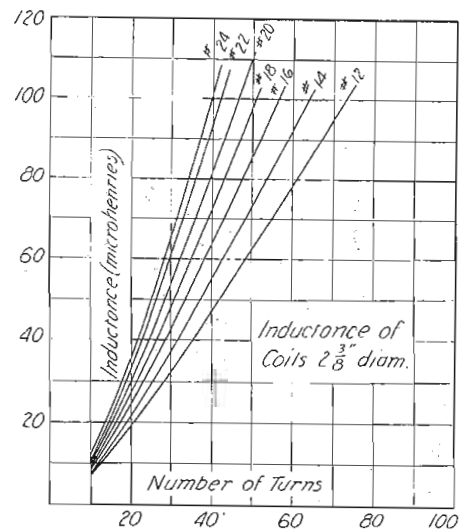

FIG. 2

Inductance of single-layer coils, 2 3/8 inches in diameter.

Unicontrol for Regenerative Sets

By SANDER STERN

Application of the unicontrol principle to the regenerative set is usually followed by failure. However, the system here detailed works with a good degree of success.

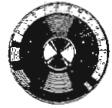

IN order that the enthusiast who builds this set may have as little difficulty as possible in its construction, adjustment and operation, a brief description of the action of a three-circuit tuner and the development of the single dial control will be presented.

In Fig. 1 is shown a three-circuit tuner diagram. The coil A, which is connected in series with the antenna and ground, transfers its energy to the coil B, which is the secondary shunted by a variable condenser. This condenser is used for tuning the second-



Front view of single control receiver, showing vernier dial used for tuning.

dary circuit. The rectification of the high frequency radio current is brought about through the asymmetrical flow of current in the plate-filament circuit. The grid of the tube impresses the modulated radio frequency signals upon the space current, which is direct current. This modulated direct current passes first through E, which by magnetic induction passes some of it back into B. Thus this process of feed-back produces a further amplification. However, this feed-back reaches a limit when too much energy is returned to B, for then B, D and E act as an oscillator. That is, E and B become the exciting field of the generator D with the phones as its load. However, when E is properly adjusted, the amplified signals heard in the phones are clear and undistorted.

When an attempt was made to combine the controls of E and B, it was found that the coupling control of E had a more or less vague relation with the condenser con-

THE trend of design in radio receivers for the last year has been toward single control. It has been applied more or less successfully to almost every type of receiver on the market except the regenerative, the most efficient of the lot.

RADIO NEWS presents here-with something of a novelty in this direction. The receiver described in this article employs a gearing system between the grid and the plate circuit in such a way that the receiver is kept practically on the point of oscillation with the same movement of the dial that tunes the set. Trouble heretofore has always been encountered in making the regenerative set single controlled, on account of the fact that the amount of feed-back necessary depends on the frequency of the station received. This point has been cared for in the present design by selecting a gear ratio and set constants of such a nature as to adjust for the necessary changes in feed-back automatically; in other words, the theoretical ratio has been made mechanical.

If the constants given in the description are followed closely, and the other notations carefully followed, the set will work very well and no particular erraticism should be encountered in its operation. Some adjustments may be necessary after the apparatus has been put together, but if the set is made to operate at its highest efficiency for one frequency setting, the same condition will hold practically throughout the wave-length range. —Editor.

trol of B, since B is tuned when E is not. Furthermore, the intensity of a signal produced by a nearby station caused a setting for the feed-back coupling different from

that necessary for a distant station of the same wave-length.

After experimenting with several different types of regenerative circuits, it was found that the circuit shown in Fig. 2 overcame these objections. Here the feed-back coil is permanently coupled to G, so the feed-back will always be the same at the same wave-length, since the tuning condenser and the regeneration control condenser are geared together. Another factor that enters is the tendency of regenerative sets to oscillate at the lower wave-lengths.

CONSTRUCTION

The logical procedure for the construction of the single dial regenerative receiver is opposite to the usual procedure familiar to the radio constructor. Instead of mounting all possible parts on the front panel, the builder should mount them on the baseboard, in order to simplify the supporting parts and the gear train shown in Fig. 3. This layout requires less time for construction, wiring and testing the set. It is obvious that this method of giving each instrument its own common base is preferable to crowding them on a panel.

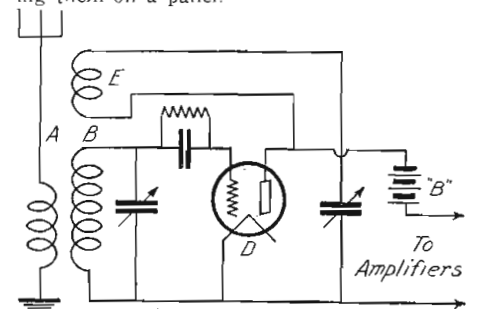

FIG. 1
The three-circuit tuner diagram, showing detector tube.

ASSEMBLY

Each piece of apparatus is then fastened in place, as shown in Fig. 4 and wired according to Fig. 5. This is done with the exception of the two variable condensers, which must be of the same make and value to prevent unequal relations of capacities. These condensers are not permanently mounted, but are only temporarily connected, as shown by Fig. 5. Little need be said about the mounting and wiring of the audio part of this set, except to repeat the usual caution of making all grid and grid return leads as short as possible. Run the plate and "B" battery wires in such a fashion that no strain is applied to the soldered ends; otherwise, disagreeable crackling microphonic noises will be experienced. On the shaft of each condenser there is fastened a 100-division dial for determining the relation between the tuning and regeneration control condensers. With the set connected to the antenna and ground, the usual procedure is followed in tuning for stations; the wave-length condenser is brought to its proper setting or resonance, and the control condenser adjusted to a position just below the oscillating point. These positions of the wave-length and control dials are noted in order to determine the relation between the two for the proper gear ratio. For example, the tuning dial for a certain station is at 70 and the control at 40. This is noted and then another station is tuned in. This new station, we will say, appears at 60 on the wave-length dial and 39 on the control dial,

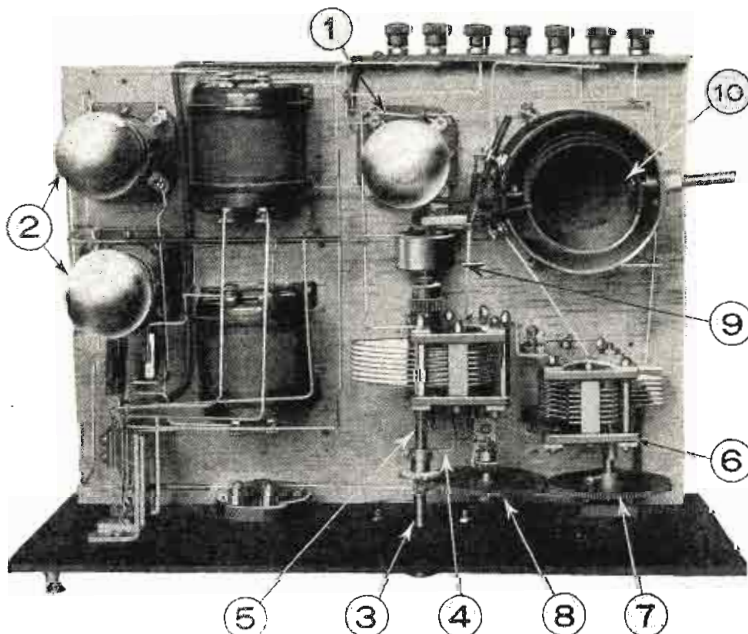
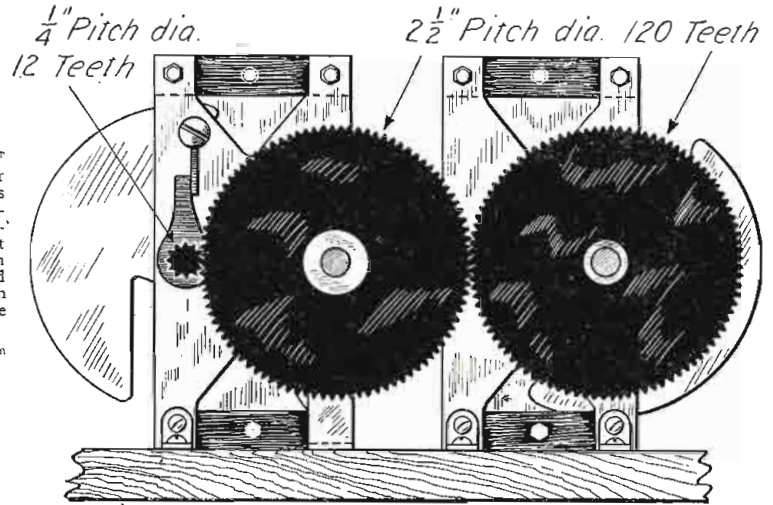

Fig. 4. Arrangement of apparatus on baseboard and panel. 1 is the detector tube; 2, the amplifiers; 3, the control shaft; 4, the condenser stop; 5, the condenser shaft; 6, the feed-back condenser; 7, the gear wheel; 8, the idler gear; 9, the variable grid leak; 10, the fixed tickler coil.

showing that for a wave-length change of 10 divisions on the tuning dial, there is a one-division change on the control dial. Obviously a 10 to 1 gear ratio becomes necessary. This relation should be proved for a number of different stations. Should this relation change at the lower wave-lengths, for reasons previously explained, the variable grid leak is adjusted until the relation becomes the same throughout the scale.

With the condensers used, this ratio was found to be 10 to 1. Therefore, three small fibre-toothed gears were obtained, two of 2½ inches diameter, and one of ¼ inch diameter. The idler gear, which is 2½ inches in diameter, is mounted at the proper height, so that its center is in line with the centers of the two condenser shafts. The tuning condenser is brought into its proper place and fastened to the base, so that its ¼-inch gear will be surely meshed with the idler. The same is done to the plate tuning condenser and its 2½-inch gear. The set is then tuned once more to some station and the control condenser adjusted to a point below the oscillatory condition, after which the gear on its shaft is permanently fastened. Tune in on the shortest wave that it

Fig. 3. The gear train that varies the two condensers. These condensers are first adjusted as shown in the text and the gears then tightened to the shafts.



is desired to receive and then loosen the set screw on the regeneration control condenser. Set the tickler coil at 5 degrees with the coil and move the condenser plates in until

the set just starts to oscillate. Then tighten the set screw.

The panel is now added to the base. It will be found that the usual length of the tuning condenser shaft will be too short to project beyond the panel. Therefore a rod of similar size and proper length should be soldered or screwed on to it. Finally connect up the filament switch and filament rheostat and the set is finished.

Since no new devices or additions have been made to the regenerative circuit of this set, the constructor will find that, when this set is properly adjusted, it should duplicate the performance of similar regenerative sets without producing howls and squeals. Also the tuning will be sharper and quicker, since the set is always adjusted below the critical oscillating point, and no time is wasted in the adjustment of the control dial. Thus, in New York City, where this set received its first test, during a period when five locals were on the air, each of these were tuned out in two divisions of the dial.

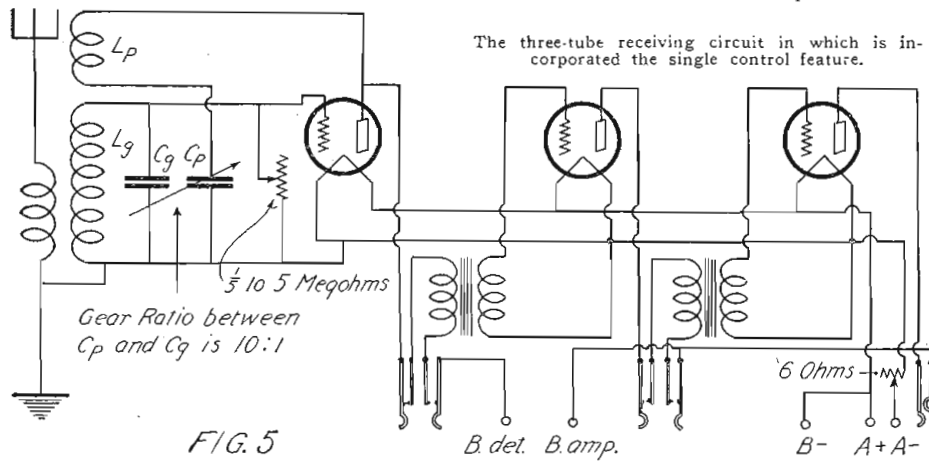

The three-tube receiving circuit in which is incorporated the single control feature.

FIG. 5

High Plate Voltage for Receiver Tubes

By D. C. WILKERSON

STRAYING off the beaten path sometimes gets one a pair of barked shins, a scalp full of cockle-burrs and, now and then, a hide full of poison ivy. Pioneering in the radio field does not always give such disastrous results, and newly-disclosed phenomena often reward the intrepid experimenter who dares to ignore the customary and usual—and tries out a new wrinkle.

Recently the writer became the possessor of about 700 volts of "B" battery, and the possession thereof inspired some random thoughts on experimentation.

I wanted to know just what would happen when some real "hard" 201A type tubes tried to handle voltages above 150 in their plate circuits. Now a "hard" tube is simply one which has a more nearly perfect vacuum or a higher degree of exhaustion than others.

In the particular set with which the writer was working, there were connections for varying the "C" battery which biased the audio amplifier stages, and connections for varying the "B" battery on the set.

My first stunt was to bias the grid of the amplifier (audio) stages, with 22½ husky volts. Nothing happened except that the reception was horribly distorted. Now I raised the "B" battery voltage by steps of 22½ until I had more than 250 volts on the plate circuit of the audio amplifier.

The reception was perfect but inordinately loud. None of the transformers seemed to lose their "smoke," a fact at which I marveled, for I had imagined that the heavy voltage would blow out a winding. I reduced the brilliance of the filaments until I had the contact arm of the rheostat on the last notch next to extinction. At this point the reception was absolutely marvelous for clarity and perfection of tone relationship. The queer part of it all was that operating ordinarily, with the customary 67½ volts on the plate and 4½ "C" battery, the set was not very good.

I was astonished at the way the set stood the high plate voltages and the high biasing voltages, and at the extremely low operating point rheostat setting for the filaments. The filaments showed a very low, dull red, and I have an idea that the driving off of the thorium skin from the filaments, under this method of handling, will not be so rapid.

Whether it would be better to buy new tubes to take the places of those which have been exhausted by burning filaments too brightly or to purchase extra "B" and "C" batteries this writer is not prepared to state.

There is a real virgin field here for experiment. One trouble, of course, will be the protection of the windings of the audio transformers. It is suggested that the ex-

perimenter bridge a small fixed condenser across the primaries of each audio transformer (like .00025 mfd.) to take out any flash or kick-back in the primaries, which will carry a pretty heavy flow of current.

Another difficulty will be to obtain tubes which will stand these high voltages. Most tubes will begin to ionize at about 135 volts. Of course, as soon as a tube shows the gassy blue glow of ionization, it is useless for this experiment.

With one set of tubes this writer ran the plate voltages as high as 400 volts before ionization. Many of the so-called independent tubes are quite well exhausted and will stand these voltages as well as any other type.

One would do well to go slow in increasing the voltages above 150 volts on the radio frequency tubes. Too great a flow of current in the input circuit of a detector is not to be desired, since a great deal of distortion which is blamed on audio frequency circuits originates in the grid circuit of the detector.

Nothing can be gained by sitting still like the little rock on the hill, and the wide-awake experimenter who is digging out some new facts is in a fair way to produce some worth-while adjunct to the fast-growing radio art, which may not only make him rich, but also be of incalculable value to the progress of radio in general.

SELECTOR—A Tuner for the City

By A. A. KUBIAC

In the more congested radio areas this tuning unit will probably be found to be the most efficient that can be installed in the ordinary set.

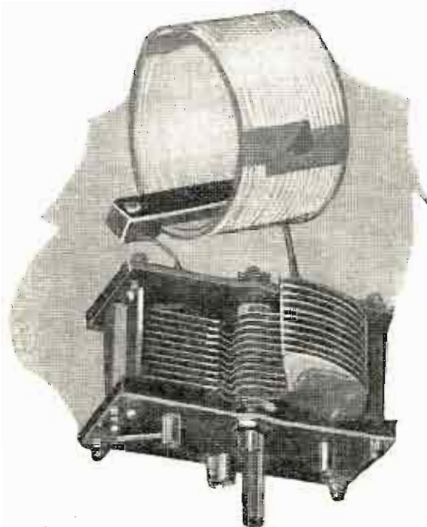

The elements of a wave trap. Both coil and condenser should have the lowest resistance possible.

MANY of our most popular "new inventions" in radio receivers are not new and startling discoveries, but merely modern adaptations of old well-founded theories; theories set down by the pioneers of the radio art. These pathfinders have indeed blazed the trail so well that the fundamental principles, and many of the circuits, are still as useful now in solving our problems as they were in the early days of radio.

THE PROBLEM

Let us apply the above philosophy to our present-day difficulties. Take for instance the ever increasing problem of eliminating interference, especially as it exists in the vicinity of New York and other large cities. Imagine trying to use a single circuit receiver to tune in a concert from WOC on 484 meters, with WEAJ only a mile away hammering in on 492 meters, and WJZ on 455 meters, with a half-hundred ships and shore stations operating so close that they scatter "forced oscillations" through all wave-lengths.

A wave trap is very effective in eliminating interference caused by one nearby station, but then how are we going to suppress the interference from a dozen other stations? We are going to go back about ten years and see how it was done in those days.

REJECTOR CIRCUIT

The use of the "rejector" and "acceptor" combination for the elimination of extremely

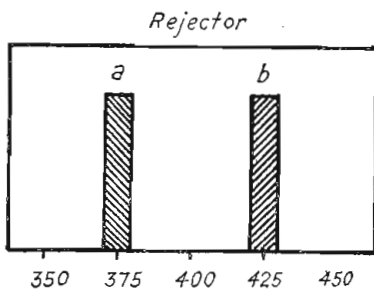
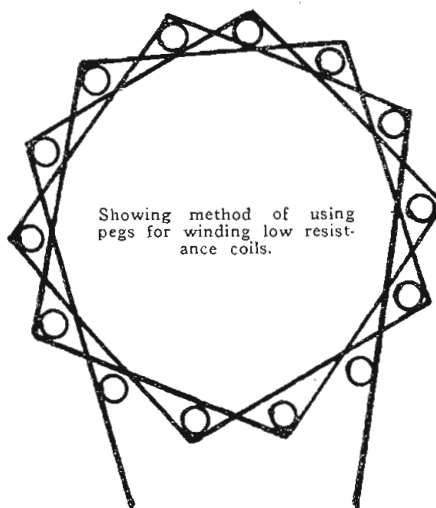

FIG. 1

The shaded portion, a, represents the part tuned out by the wave trap and b is another interfering wave.

severe interference, though not generally known to the public, is not new. In fact, such systems were used by the British during the war, and aboard our own battleships, even to the present time, with complete satisfaction.

The superiority of the "rejector system" over the "wave trap" in eliminating interference, not only on one narrow wave-length band, but on all wave-lengths, can readily be understood by referring to Figs. 1 and 2. Consider the base line Fig. 1 as the scale of wave-lengths embracing the broadcast stations. If we desire to receive a special concert from a distant station on a wave-length of 400 meters, we will encounter interference from a local station transmitting on 375 meters. This interference can be cut out by tuning the wave trap, connected in the conventional manner as shown in Fig. 3, to the interfering wave on 375 meters. The action of the wave trap in this case is to cut out the signals within a narrow band, as represented by the shaded portion (a), Fig. 1, from passing through to the receiver. This method works out fine when there exists



Showing method of using pegs for winding low resistance coils.

only one source of local interference. However, if we have another on 425 meters as indicated by the shaded portion (b), the problem becomes much more complicated. It is not practical to employ two wave traps, for if they do not possess exceptionally low losses, it is very difficult to preventing cutting out the desired signal also, while attempting to cut out the interference. Even if this condition did not exist, the use of two wave traps would add two more controls to the receiver, while the use of a "rejector" circuit adds but one. Furthermore, even with its single control, the "rejector" is superior to two wave traps as you will see with reference to Fig. 2. Note the opposite characteristics of the two circuits. Here, as in Fig. 1, the shaded portion represents the area covered by the wave-lengths that are prevented, by the action of the rejector, from passing into the receiver. In other words all waves are rejected excepting that to which the circuit is tuned, and this is passed on to the "acceptor" circuit of the receiver.

HOW THE CIRCUIT WORKS

In order to understand the function of wave traps, rejector circuits, and acceptor circuits as they are applied here in suppress-

ing interference, it will be necessary to compare the resonance phenomena in a series circuit with the phenomena of parallel resonance. To avoid confusion in the various terms used in this article we will associate the word "rejector" with the "parallel resonant circuit"; and the word "acceptor" with the "series resonant circuit," which is correct as you will see later.

A parallel circuit consists of an inductance and a capacity in parallel as shown at (a), Fig. 5, with the source of alternating potential applied at the points marked (X). This circuit will have a resonant point at some wave-length determined by the values of inductance and capacity in the circuit, one or the other of which should be made variable so that this circuit can be tuned to resonance with the externally applied current, which in this case is the current in the antenna caused by the incoming radio signal. The parallel resonant circuit acts like a very high impedance in the main circuit preventing the flow of current at the one frequency, to which it is tuned but it offers no impedance to currents of other than the resonant frequency. This condition is fully met when the parallel circuit contains zero resistance, therefore, it is important that circuits of this kind be carefully designed to reduce the losses to the smallest possible extent. The greater the losses in the parallel circuit, the greater will be the tendency for current at the resonant frequency to flow in the main circuit, thereby defeating the purpose for which the rejector circuit is used.

The series circuit shown at (b), Fig. 5, consists of a coil and a condenser in series, with the source of alternating potential applied at the points marked X. The action of this circuit at resonance is directly opposite to that of the parallel circuit. The impedance introduced into the main circuit by the parallel circuit at the resonant frequency is very great, while the impedance due to the series combination is negligible.

COMBINING THE CIRCUITS

It is easily seen that if it is desired to have a current of a certain frequency in a circuit, but to exclude currents of all other frequencies, it is only necessary to combine the series circuit and the parallel circuit into one as shown at Fig. 4. The inductance L_1 and the capacity C_1 constitute the parallel or rejector circuit, while the inductance L_2 and the capacity C_2 make up the series or acceptor circuit. The inductance L_2 is the coupling coil to the receiver. The operation of this combination is a little difficult as the tuning is rather sharp; however, once the adjustment is made it will remain fixed for

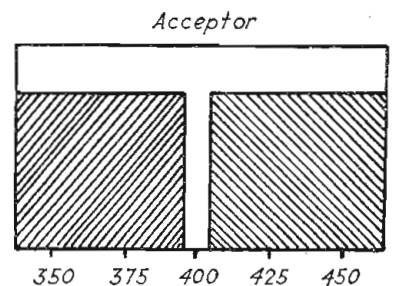

FIG. 2

With the "rejector" the unshaded portion is the only wave that gets through to the receiver.

a given wave-length, and a calibration curve can be made to aid in tuning.

In the case mentioned in the previous paragraphs where we desire to tune in a distant station on 400 meters, but have local interference both on 375 meters and on 425 meters, it is not necessary to tune the rejector circuit to the interfering waves, for the acceptor circuit eliminates all signals except that to which it is tuned, as illustrated by the shaded portion in Fig. 2. Consequently, if the rejector is tuned to the desired signal on 400 meters (750 kilocycles), it rejects the current at this frequency due to the high impedance that it introduces into the circuit as mentioned before, but acts as a low resistance path to earth for currents of all other frequencies caused by interfering stations. Now you will remember that the series circuit behaves exactly the opposite,

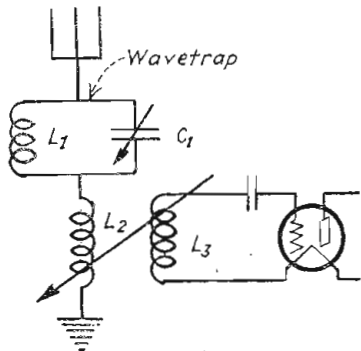

FIG. 3

Note the location of parallel and series resonant circuits.

so that if we tune this circuit to 400 meters (750 kilocycles) it offers a high impedance to interfering frequencies, but negligible impedance at the resonant frequency, therefore it accepts the current that was rejected by the parallel circuit and transfers it to the receiver through the inductance L_3 . The operation, then, is simply that of tuning the rejector and the acceptor both to the frequency of the desired signal.

If both the acceptor and rejector circuits are calibrated, and if they are geared together, the number of controls is reduced and the operation is simplified to a large degree. Again, if straight-line frequency condensers are used, accurate dial settings can be made and the result is an instrument which will serve for many purposes.

WAVE TRAP

There are several wave traps on the market that have sufficiently low losses to give good results when used as a rejector. All wave traps are essentially "parallel circuits."

The only difference between a trap circuit and a rejector circuit, as you can see by comparing Fig. 3 and Fig. 4, is the manner in which the parallel circuit is used with relation to the receiver. The point that determines whether a parallel circuit will function satisfactorily as a rejector is its resistance. It must have very low resistance, not only ohmic resistance, but also that caused by nearby metallic objects, and by dielectric losses, in both the coil and condenser. A circuit which has the plates of the condenser mounted in the magnetic field of the coil will not work, nor will it work if the coil has too great distributed capacity caused by heavy shellac or dope on its winding.

In order to insure having a circuit that

LIST OF PARTS

- 1 6"x9"x1/8" Bakelite Panel
- 1 6"x6"x9" Cabinet
- 1 .001 Variable Condenser
- 1 .001 Mica Fixed Condenser
- 1 .002 Mica Fixed Condenser
- 1 1 1/2" Switch Lever
- 3 Contact Points and 2 Stops
- 4 Binding Posts
- 25 feet No. 14 D.C.C. Wire
- 2 feet Bus Wire

will produce satisfactory results it is best that you construct it yourself according to the following specifications, which you will notice adhere to high capacity and low inductance in the circuit, but in a manner which lends itself more readily to the use of standard apparatus.

Draw a 3 inch circle on a pine board and arrange 14 pegs equally spaced about this circle (ten penny nails will do). Wind 20 turns of number 14 D.C.C. magnet wire around these pegs as shown in Fig. 7, binding each turn in several places with shoemaker's thread as it is wound on. After the 20 turns are wound on and securely tied, the pegs can be removed, leaving the coil self supporting. Do not impregnate the coil with shellac or varnish.

A back view of the panel showing the arrangement of the apparatus is shown at Fig. 8. The panel is of bakelite and the size, 6x9 inches, affords ample room for spacing of the parts. The four binding posts are connected as shown with bus wire. Do not allow the wiring to hug the panel, but bend it up so that it is an inch from the panel. The basket-wound coil is mounted so that it is two inches from the panel by using the lead wires as legs, and aside from a small fibre bracket (not shown) this is

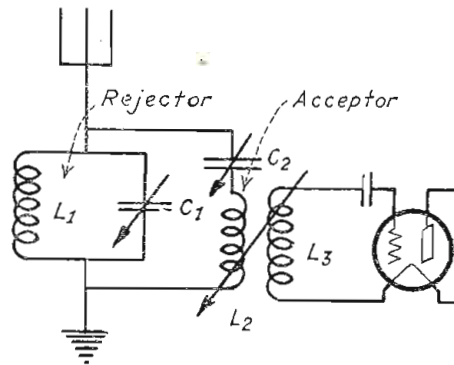

FIG. 4

The hook-up of the acceptor-rejector set with detector tube.

all the mounting used. The fixed condenser has two capacities, one of .001 mfd. and the other of .002 mfd. and the manner of connecting to the three-point switch is clearly shown. Use a good grade mica condenser here. The variable condenser is connected directly to the bus wire as shown. It is advisable to mount the panel in a cabinet.

If the receiver is of the loose-coupled type employing a primary series condenser, or even if it is the popular series circuit re-

Rejector Acceptor

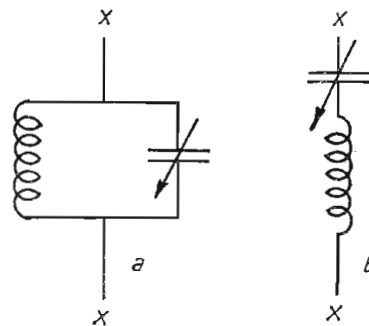

FIG. 5

The two primary circuits which form the heart of the acceptor-rejector system.

ceiver with a series tuning condenser, the parallel circuit can be connected directly to the antenna and ground terminals of the receiver, in which position it will function as a rejector, and the receiver as the acceptor. If the receiver does not employ a series circuit for tuning, it will be necessary to construct such a circuit and couple it to the receiver as shown at Fig. 4.

In operating the rejector, be careful to avoid coupling between the rejector and the receiver.

Harmonizing Ideals and Practice

By JOSEPH RILEY

Efficiency of operation is a very important thing in engineering practice and is something that engineers are always striving for. The efficiency of operation of an electric motor for driving cars or machine tools is of especial importance to the owner of the plant or car-line that employs the motor, because it is upon the efficiency of the apparatus that the size of the plant's expense account depends.

The total cost in all cases involves not only the operating expenses, but also the original investment, upon which interest and depreciation charges are made. Furthermore, the size of the original investment has a definite bearing upon the replacements that are necessary from time to time, as the various parts become worn through long or strenuous service.

In other words, efficiency is the main ob-

jective in engineering design and practice, and it is just as necessary that high efficiency be obtained in radio design and practice, as well as in power and traction engineering. It is interesting to note, however, that although power engineers have been thoroughly familiar with the idea of efficiency and have carried it in mind in all their work, they have never found it necessary to become extravagant, and go into all kinds of ecstasies and ravings about it.

What is the reason for this difference in attitude between two kinds of engineers? One might be tempted to think that 90 per cent. of the "radio engineers" had never heard of the ideas of efficiency before they began to study radio. It seems to the writer that it is about time they came down to earth and began to realize that there must be, as in all other mundane things, a happy

medium between the ideal and the real.

It is no more possible to build a coil or condenser having no losses than it is possible to build a perpetual motion machine! Moreover, it is not always in the interest of economy or convenience to reduce losses to even as low values as we often are able to attain. For instance, there is considerable doubt in the minds of many engineers as to whether much is gained by trying to design very low resistance apparatus for use in regenerative receivers. There are also many who think that even reasonable decreases in the losses in radio frequency amplifiers will not result in any appreciable improvement in operation.

As another example, let us consider a large rectangle of solid wire, such as a very large single turn loop antenna. The re-

(Continued on page 2276)

The Compare Radio Typewriter

By Dr. Otto Pohle

Radio typewriters have been known for quite some time. There are several types of them, but this new system is without doubt the best secretive one created. It is most interesting to note that the alphabet may be combined in 100,000,000 different ways.

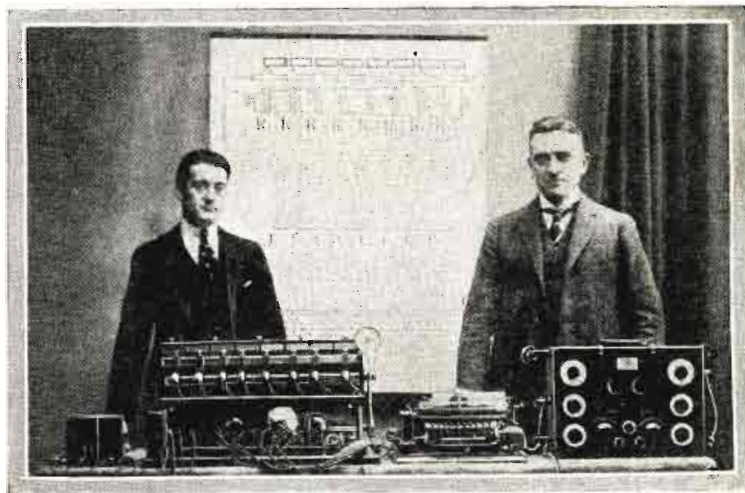

Fig. 4. The inventors of this complicated system, with a phone transmitter on the right, the keyboard next to it, the tone generators and selector commutator, which represents a complete transmitter. Much detail work was necessitated in the perfection of the apparatus, though the principle is easy to understand.

rendered active as soon as these tone-pairs are received, whereby the typing is directly effected.

The tone frequencies are generated and radiated from the transmitter as follows: A small alternator, in the form of a round, rotatable disc, is positioned by means of a spring to a motor-driven conical cylinder. This motor may be movable lengthwise of the cylinder, thereby varying the number of its revolutions and altering its frequency. The tone so generated is made audible through the loud speaker by means of an amplifier. A tone of different pitch will be produced, according to the position of the generator in relation to the cylinder.

As will be seen in Fig. 1, eight such generators, R_1 to R_8 , are placed lengthwise of the conical cylinder, which, according to their positions on the cylinder, produce eight different predetermined tones, transmitting these by suitable switch mechanisms over the transformer Tr .

By combining these eight tones in two, 28 pairs will be obtained, which correspond to the letters of the alphabet. The winding terminals of these eight generators are connected in parallel at one end, and lead over the primary winding of the transformer Tr to the keys K , which are connected in series and carry the letters of the alphabet; the other ends lead over the commutators, C_1 to C_8 —subsequently described in detail—reaching the contact rails, B_1 to B_8 , resting upon the single contacts $C\frac{1}{2}$, $C\frac{2}{2}$, etc.

The keys are so positioned that when any one of them is depressed, it will execute a rapid alternating contact; that is to say, it will make contact with the neighboring pair

GERMANY, as well as other countries, has been familiar with various telephonic typing systems, operated by wireless, using the Morse, or any other code. Messages so transmitted are in cipher and attain thereby a certain degree of secrecy. But such messages are rather difficult to send, are picked up and deciphered by listening-in stations with comparative ease, and must be decoded after reception.

The system which I am about to describe makes use of wireless telephony to transmit typewritten messages without necessitating the use of a cipher. This system was invented by an English engineer, Compare. He worked in London for several years, developing his apparatus, but for the past two years has worked jointly with us in the

laboratory of the firm of Dr. Erich F. Huth, Berlin. We disclosed this invention for the first time at a meeting for scientific research at Innsbruck, in September, 1924, where it aroused general interest.

The basic principle is as follows: Instead of speaking into a telephonic transmitter, a typewriter key—one letter—is depressed. Two frequencies are thereby transmitted; that is to say, two tones, which, however, may be of inaudible frequency if desired. These tones are of different pitch and are transmitted in rapid succession. The combination of the two tones corresponds, therefore, to one letter of the alphabet. At the receiving station, two switch mechanisms are

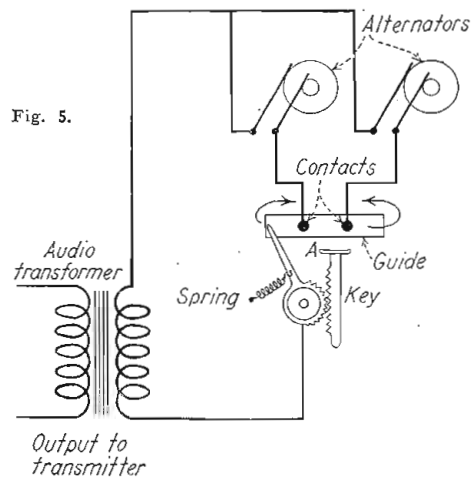

Fig. 5. Left: Principle of the transmitter. This diagram shows how two distinct tones are sent in quick succession. The frequency of the generators is readily varied by changing their position on the pulley. Fig. 1. Right: The wiring of the keyboard and tone generator. Refer to text for complete description of the various components and how they function. See also Fig. 3, which shows introduction of selector device.

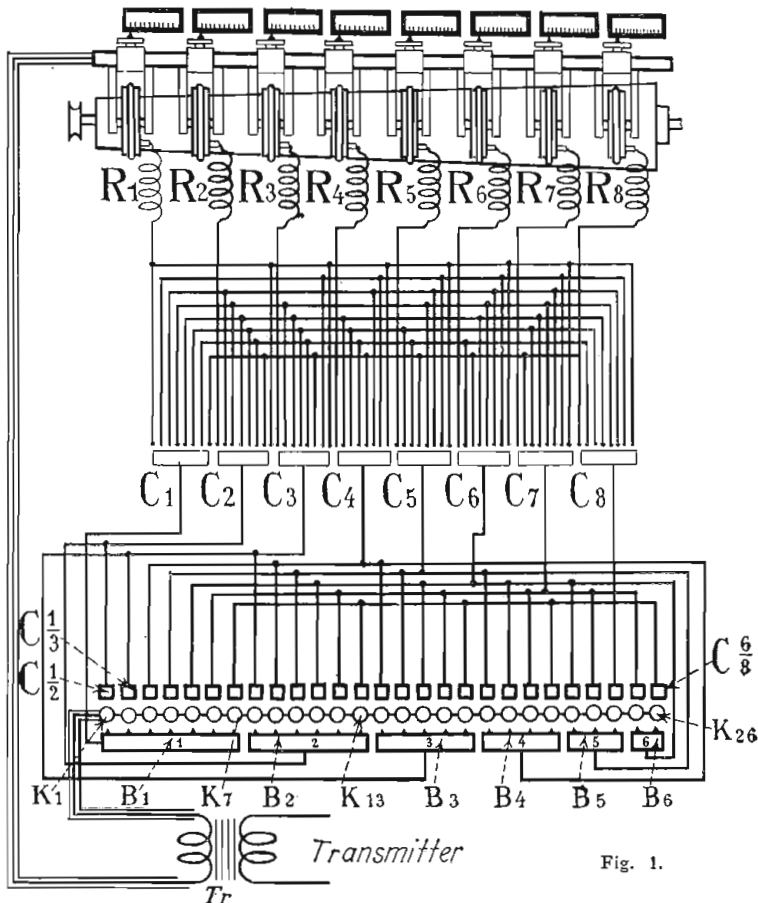

Fig. 1.

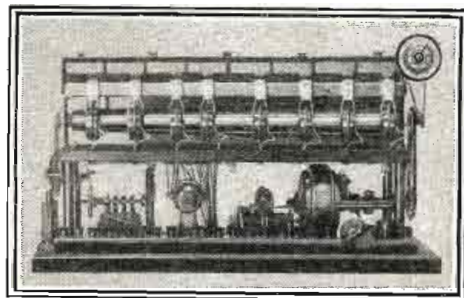

Fig. 9.

Fig. 9 shows photo of tone generators, of which there are eight, driven by a long cone pulley. Note synchronous motor, tachometer, frequency scale indicators and selectors.

of contacts; thereupon it breaks this contact, establishing contact with the other contact of the pair, finally breaking this contact also and returning to idle position. For example, if the key A is depressed, it will strike the first contact of B₁; breaking this, it will contact with C_{1/2} and thereupon will return to its idle position. I shall subsequently describe the means which permits the execution of this rapid alternating contact of A and B₁ and with C_{1/2}. As a result of the contact of A with B₁, a circuit is closed through B₁, C₁, R₁ and Tr. In this way, generator R₁ will transmit its tone to the transmitter upon the transformer. Upon subsequent contact of A with C_{1/2}, a circuit from A through C_{1/2}, C₂, R₂, Tr will be closed, whereby the tone R₂ will be transmitted. Thus it will be seen that as each key is depressed, two tones will be produced which are predetermined, but which may be differentiated by varying the speed of the generator, and which will be radiated from the transmission antenna in rapid succession.

Fig. 2 is an illustration of the receiving apparatus. Instead of receiving the single letters, that is to say, the single combinations of two tones, by means of a head-set or a loud speaker, eight resonance instruments, O₁ to O₈, may be connected in parallel and may be positioned to the receiver, or amplifying transformer. These resonance instruments may consist of a spring reed of a definite natural frequency, together with an electromagnet. There may be an electromagnet for each instrument, or all resonance instruments may have a common electromagnet.

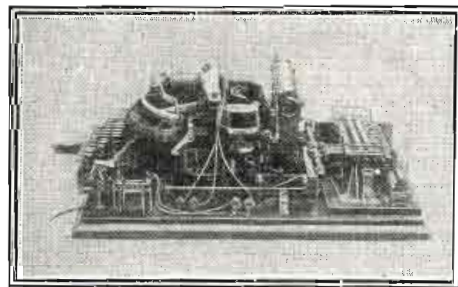
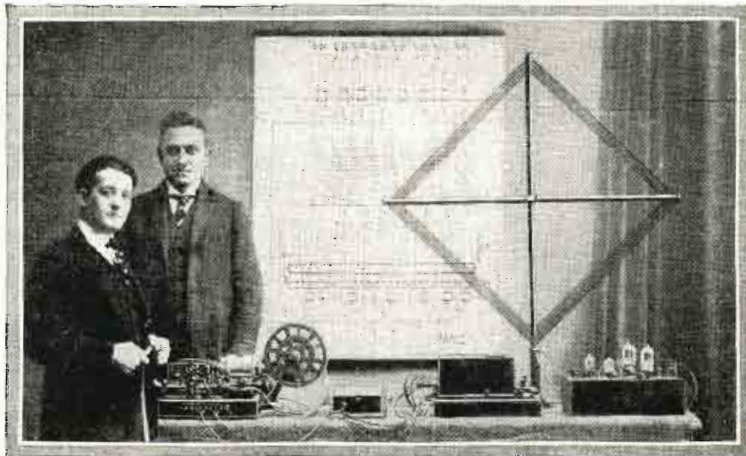

Fig. 2 is a plan view of the receiving apparatus.

When the tones R₁, R₂, etc., are transmitted and reach the receiving antenna, all eight resonance magnets are excited, but only that reed will vibrate, whose own frequency is in resonance with the tone received. The vibration of the reed will simultaneously affect the closing of a contact, O₁, V₁, or C₂, V₂, etc. C₁ to C₈ are com-

Fig. 10. The complete receiving set used by the inventors. A loop antenna serves very well. The characters are directly typed on a moving tape. Absolute secrecy is certain when using this system. An outstanding feature is that no operator is necessary.



mutators as in Fig. 1. F1/1 to F1/6 are adjustable rods with a row of fingers F. Each of these six rods has an electromagnet M, which, in turn, is provided with a spring reed. Upon excitation of one of these electromagnets M, the appropriate rod with its fingers is moved toward the rotating cylinder D. Moreover, the reed M will rest upon the iron core, thereby closing a carrier circuit of the electromagnet M₁, so that upon cessation of the first excitation, excitation will continue and the rod will remain pressed against the cylinder.

The cylinder D carries contact pins Qa, Qb, Qc, etc., the number of which corresponds to the keys K of Fig. 1, that is to say, to the letters of the alphabet. These pins are so positioned upon the cylinder that each pin will make contact with a corresponding finger F upon rotation of the cylinder, as the movable rods are pressed against the cylinder.

Insofar as the printing mechanism is concerned, which consists of a paper printing roll, a type wheel and the pressure magnet which is connected with the cylinder D, we have indicated only the magnet at P.

Upon depression of the key A (Fig. 1), the following occurs: Reception of the tone R₁ causes a vibration of the resonator O₁, thereby establishing a contact with V₁. The circuit leading from the battery through O₁, V₁, C₁ and M₁ is closed, and F1/1 is urged towards the cylinder D. The action of the spring-contact m₁, simultaneously closes the circuit leading from the battery through M₁, contact m₁ at P and back to the battery. As a result of this action, the rod F1/1 with its fingers F, continues to bear against the cylinder D, even though cessation of the tone R₁ will cause contact O₁, V₁, to open. Reception of the tone R₂ will cause O₂ to vibrate and contact with V₂, thereby establishing a circuit from the battery through O₂, V₂, C₂, the first finger F of the rod F1/1, contact pin Qa, cylinder D, pressure magnet P and back to the battery. As F makes contact with Qa, the pressure point P is immediately set in action, thereby breaking the carrier circuit of the electromagnet M₁ over m₁. The rod F1/1 springs back from the cylinder D and the apparatus is again in neutral position. Thus, it will be

(Continued on page 2306)

Fig. 6. Left: Side view of typewriter, showing the transformer and selector commutator. This machine resembles very much the ordinary typewriter, but is very much more complicated in construction.

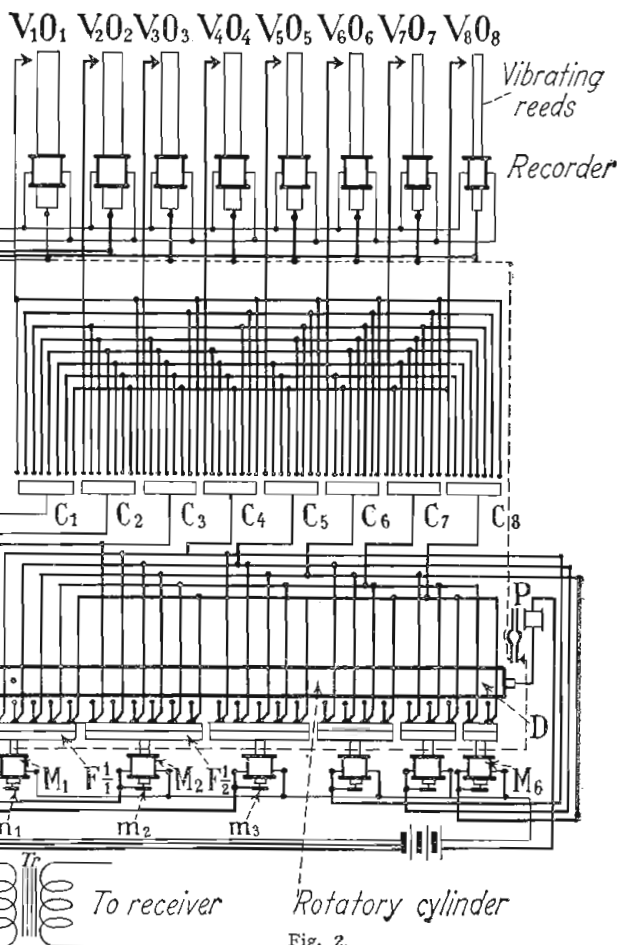
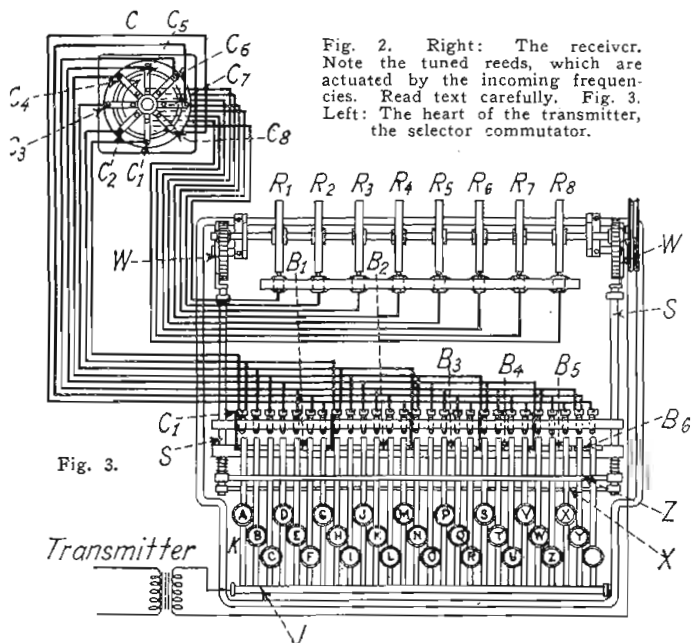

Fig. 2.

Fig. 2. Right: The receiver. Note the tuned reeds, which are actuated by the incoming frequencies. Read text carefully. Fig. 3. Left: The heart of the transmitter, the selector commutator.



Theory and Design of Loop Antennae

By E. E. LAUFER

An interesting discourse on the efficiency of loop antennae, giving facts and figures that are helpful and will guide the purchaser of a radio set employing this type of pick-up device.

IN many a group of radio fans, one of those present has been heard to boast of his ability to tune in and listen to a broadcast station hundreds, and at times thousands, of miles distant "on a loop." His statement, if not questioned for truthfulness, is very favorably commented upon and his aid requested to enable someone else to duplicate his results. It seems to be the ambition of many of the strong addicts of the radio "bug" to successfully utilize a loop for reception. Time and time again persons

sults that will perhaps compare to an outside antenna connected to a less sensitive set, say one with radio frequency amplification.

A common type of loop consists of six to eight turns of ordinary insulated wire wound on a wooden frame four or five feet on a side and the turns spaced one-quarter inch apart. Such an antenna cannot possibly pick up as much energy as a long elevated antenna and for this reason tremendous amplification is employed to build up the minute current to approximate in final results that of using the other antenna.

Perhaps the best method of explaining the theory of the loop would be to picture two vertical wires of the same length entirely insulated and placed 200 meters apart, as shown in Fig. 1. A radio wave approaching at right angles to the wires will first cut one wire and then the other. A 400-meter wave will induce an emf. or current flow just 180 degrees out of phase with that set up in the first, for the crest of the wave will cut one wire one 750,000th of a second before it will cut the other. The 400-meter wave would require one and a half millionths of a second to travel the distance of 200 meters between the wires, or one-half the time required for the wave to pass a given point. Assuming the two vertical wires then connected at the top, and the lower ends connected to a receiving device, the voltage thus produced will actuate the tube and it can be detected in the usual manner. The horizontal wires, therefore, add

The turns of such a coil antenna have of course distributed capacity and this combined with its inductance gives the coil a fundamental wave-length of its own. Fundamental wave-length is the wave at which the coil will radiate or respond best, without the addition of any capacity and inductance other than that of the coil itself. A very good point to remember is that when a loop is used for directional purposes it should not be used to receive waves shorter than about two or three times the fundamental wave of said loop. For ordinary reception the loop may be designed to be used at or near its fundamental wave.

To receive broadcast waves a loop of small inductance or few turns should be used. It is of course desirable to make the received energy as great as possible. It has been found that the amount of induced energy depends upon the number of turns and the area. The received current varies directly as the number of turns, directly as the area, inversely as the resistance and inversely as the wave-length being received. Experience has shown that it is best to use fewer turns embracing a larger area for the shorter waves.

Square or rectangular form coils are generally used, because of the ease of construction and convenience, although flat spirals may be used. With flat spirals only a few turns should be used, for the inner turns become rapidly less useful as the area decreases. Ordinary No. 20 or No. 22 insulated solid wire is just about as good as anything and is easy to work with. The spacing of the turns on the coil depends entirely on the allowable capacity of the coil. For the ordinary broadcast range of wave-lengths, spacings of one-half to one inch are common. One-quarter inch spacing and often less is used in cases where more turns are used with a smaller area.

The capacity of any given coil increases with the number of turns, at first rapidly and then more slowly. With the wires close together the capacity is at a maximum and becomes rapidly less as the wires are separated. Although a large area of coil with a corresponding smaller number of turns is desirable, space limitations and portability necessitate a reduction in area. This makes for an increase in number of turns and a decrease in spacing to produce an increase
(Continued on page 2302)

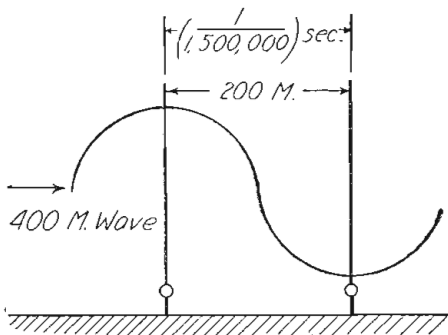

FIG. 1

This diagram shows how a 400-meter wave strikes two wires of a theoretical loop. Note 180-degree phase displacement and time difference between half a wave-length at this frequency.

with but the barest knowledge of radio are sold on the idea of a loop receiver, on no other point than that it seems to do the impossible. A good deal of the popularity for the multi-tube receiver is due to the ability of the owner to use a loop or coil antenna to advantage.

Just what is the difference between a regular antenna and a loop antenna and in what way is the loop an advantage? It must be acknowledged at the start that as an antenna, or radio wave pick-up device, its efficiency is usually about 1 to 10 percent of that of the average elevated type. This drawback is mitigated to a large extent by the addition of convenient and easily constructed amplifiers, which result in features of compactness and portability. Another advantage is the marked directional characteristics of the loop antenna which in many cases can be used to minimize interference.

In simple language the theory underlying the design and action of such a loop or coil antenna is as follows: In the first place the ordinary antenna, whether indoor or outdoor, acts primarily as a condenser. The earth or ground connection constitutes one plate and the wire or wires of the antenna the other plate. On the other hand, the loop must be considered as practically nothing but an inductance, consisting usually of one or more turns of wire in spiral or box form.

Experimenters have perhaps noted in many cases the ability to pick up local and sometimes distant stations with antenna or ground entirely disconnected. The coils and wiring of the receiving set in this case act similarly to a coil antenna or loop. The actual design of an efficient loop necessitates a careful interpretation of the theories upon which its action is based. To dispel a fanciful illusion of a good many people, a loop can in no way, when substituted for the regular outdoor or indoor antenna, equal the regular antenna for signal strength on nearby or distant stations. With a very sensitive radio frequency set a loop will give very good re-

nothing to the effective current induced in the coil. In direct contrast a wave approaching vertically or perpendicularly to the plane of the coil will strike both wires at the same instant and no phase difference or induced voltage will be had and, therefore, no action of the detecting device will result. The above explanation will of course hold for a wave other than being in length just twice the distance between the vertical wires. Any given wave-length will cause a maximum instantaneous voltage difference across the lower ends of the two wires for a wave approaching in the direction of the plane of the wires, and no change will occur for a wave approaching perpendicularly to this direction. It is obvious then that if such a coil is mounted on a frame and caused to be rotated about a vertical axis, the coil can be easily adjusted for maximum and minimum signal intensity for any given wave, thus resulting in directional characteristics and interference minimization as stated previously.

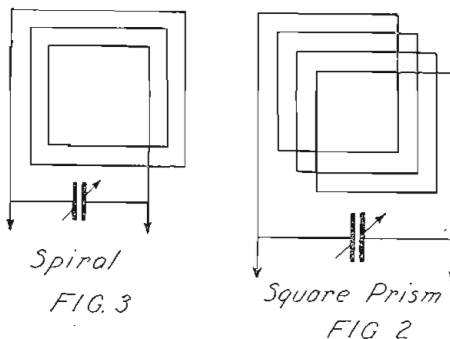

The two types of loops in common use. Both the spiral and solenoid, the latter of which is the best, can be connected with similar value capacities.

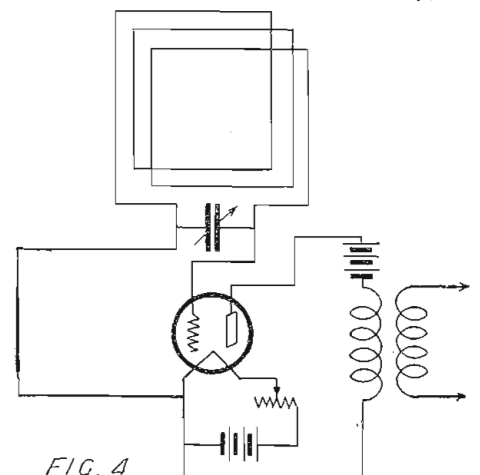

FIG. 4

The connections for a simple loop circuit. In effect, the loop replaces the tuning inductance generally used with an antenna and ground installation.



Keep A Laboratory

By JAY HOLLANDER

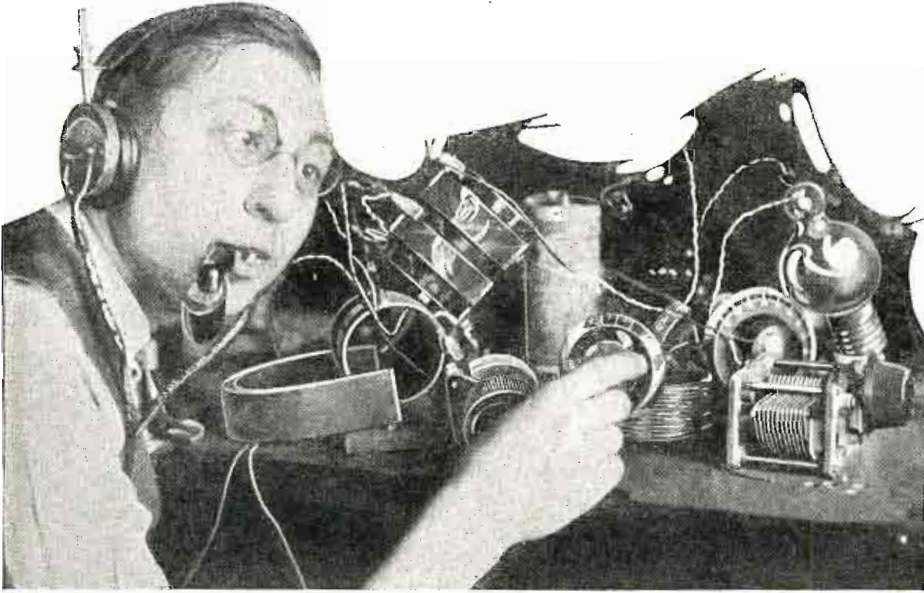

"—he seemed to find more damphool ideas to try than any hombre we have known in the present existence."

THE other night I asked a friend to test with me. He said that if the wife did not have tickets to something or other and that if the baby hadn't busted the transmitter he would be glad to. A telephone message scuttled the fact that for the evening, at least, there would be no local QRM, so he asked for the dope.

I was working on a one wave receiver, built to operate dead on one frequency, hoping maybe to dope out something that a commercial friend would be able to use. He was in the manufacturing business and had found out that he must get some sort of a product having a great advertising value. He had a lot of customers in a town in the middle west who desired service of one station only and did not want the trouble of tuning and all that, and asked me to dope out something for him. I had selected 175 as the wave because it was handy and one which fitted the apparatus at hand better than anything else. So I gave the lay to the friend.

"Sorry, O. M.," he said, "I have been working on 80 for the last six months and I don't think it would be possible for me to raise the wave to help you out. My transmitter is a peach; every part of it is made to fit and there are no extras."

"But," I replied, "you don't QRM me, you are only a short distance from the shack. As a matter of fact, a couple of 201s would do the stuff very nicely. Throw up something, I'll help you. I've got to get this job done; I promised it to the fellow for the end of the week and I want to test it before I give it to him. Come on, I'll help you build it. Only a couple of hours will be required."

"That's all right, but I haven't the junk to do it with."

"Come on, let's go see."

We went around the corner to his shack to look over the stuff. There were two large packing cases filled with his mistakes of the past in the form of junked transmitters, parts of receivers, old filters, transformers with a couple of sick looking windings—in a word, a lot of fairly good instruments in bad shape. In the pile there was enough junk to build three or four complete

outfits which could be made to work on anything from a trans-Atlantic, down to the five meter band. But the point was that the only thing workable or available in the shop was the transmitter and receiver which were in nightly use.

Now for the moral. How in the name of common sense could a dentist pull a tooth with only one pair of forceps, or a medico cut off a good leg with only a pair of tweezers? As the Governor of North Carolina said when he wanted a drink, "It can't be done."

And he was right.

Why should experimenters of long standing never learn that a transformer may be down but that it is never out until the core is used to reline the kitchen stove and the feet are used to insulate the clothes line? The soul of many a good transformer has seen at least seven reincarnations in the shop of the writer and as for other stuff—well, he has one old time O. T. which has done good service on at least seven lay-outs.

This all is by way of introduction. That is, the point is that the real experimenter is the fellow who always has about seven ideas hanging about the back of his head which are like cooties in their persistence.

Now logically, how in the name of all that's holy can the idea get any attention without disrupting the station unless there are the necessary parts about, to carry it out?

Here's what is meant. Why not start a laboratory which is in workable condition all the time and ready at a moment's notice? With the usual station, the power supply units are always ready and can be shifted at a moment's notice. Why not take all the old apparatus when it is discarded for something better on the regular station and arrange it in something of unit order so that

(Continued on page 2298)

Many progressive amateurs are vying with the broadcast stations in erecting impressive looking masts from which dangle awe-inspiring antennae. The one on the right is a bit more safe to climb than the proverbial skyscraper usually made of a couple of thousand sections of rotten 2 by 2! The station is the largest Ham ad in Jamaica, West Indies.

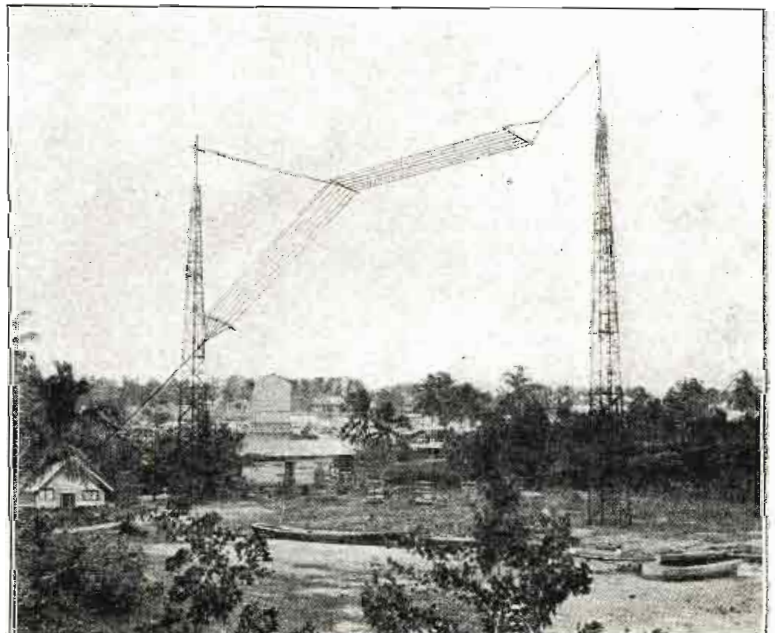

2BRB, One of the Second District's Best

MANY of our readers will remember an editorial by Mr. Hugo Gernsback in which he stated that the amateur would be able to accomplish 'round the world transmission using only a few dry batteries and inexpensive equipment. At the time, this statement was heartily ridiculed. Many believed that it could never come about.

With constant reports coming in today of some amateur or other actually working a foreign station with a five-watt tube, the truth stares us, literally, in the face. The short waves and their constant development have opened the field for the fulfillment of the prophesy.

Station 2BRB, owned and operated by Mr. Edward M. Glaser, one of the foremost amateurs of the Second District, has been one of the successful pioneer stations, which has been heard in every corner of the world.

Mr. Glaser, who lives in the heart of Brooklyn, is nineteen years old and has achieved one of the highest honors that the Hudson Division is able to give. The Executive Radio Council of the Second District has appointed him as Division Manager. The signals of 2BRB have been heard in South America, Europe,

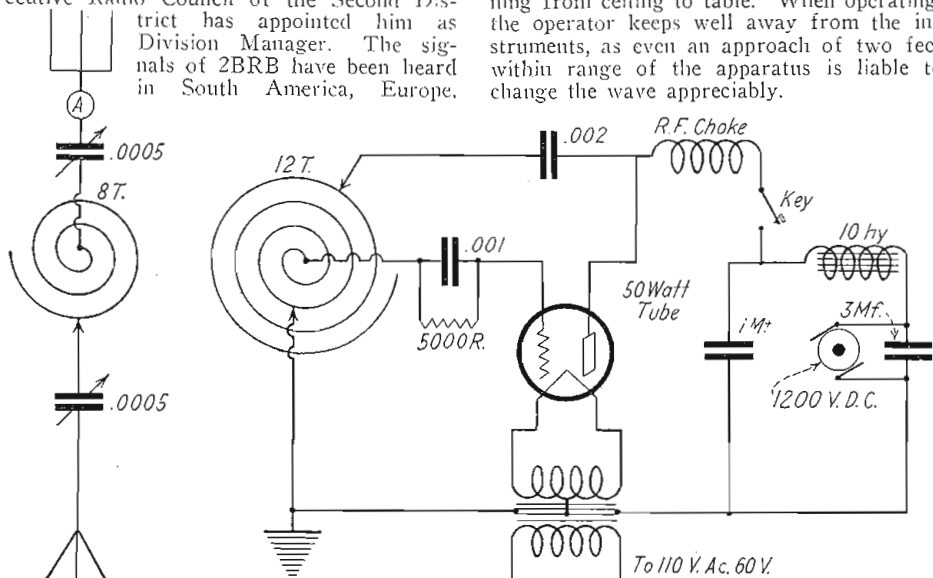

The short wave set at 2BRB which has worked wonders in pulling in far distant stations all over the world. It has a range of from 35 to 100 meters and employs the Reinartz circuit. The loosely coupled primary coil is not shown.

and in the air by strong cords fastened to insulators. Even the condensers, the meters, the tube (no, not the motor-generator), and the connecting wires are all ignominiously "mounted" by the use of taut strings running from ceiling to table. When operating, the operator keeps well away from the instruments, as even an approach of two feet within range of the apparatus is liable to change the wave appreciably.

There is a large staff of operators on hand, and it might be interesting to learn that Mr. Glaser's sister, Estelle, is on the list as an assistant operator and is capable of standing a "watch" along with the best of them.

As president of the City College of New York Radio Club, Mr. Glaser is kept very busy in handling the key and teaching others the hows and whys of radio communication.

Here's the dope, fellows: 2BRB's tuner for the short waves is bound to interest you.

And it's Hartley again. Or should we say Reinartz? The primary winding is wound in the regulation low loss style and consists of five turns of No. 16 D.C.C. wire. One end of this coil, which is four inches in diameter, terminates in an antenna 60 feet long, while the other end goes to ground.

Curiously, the primary coil is fixed in relation to the secondary at a distance of six inches. But with this extremely loose coupling, the sigs. pound in. The secondary coil is also four inches in diameter and contains 17 turns of No. 12 D.C.C. A variable condenser with an exceptionally fine vernier

(Continued on page 2302)

Africa, Asia and Australia. Even far-off New Zealand has reported hearing 2BRB's signals clearly so that it was possible to actually effect communication and handle traffic. This DX work has been carried on consistently for the past several months, some of it in daylight and some of it very early in the morning. And to witness the inside of Mr. Glaser's shack would be all that is necessary to convince one that it really is an amateur installation. Instead of wall paper, cards from practically every country in the world decorate the walls. By reference to the photo, it can readily be seen that Great Britain, France, Argentina, New Zealand, Australia, and Holland are some of the countries represented.

2BRB is now operating steadily on 40 meters. A heavy copper wire 30 feet long, supported vertically, forms the antenna, while a similar length of wire suspended horizontally functions as the counterpoise. Each leg of the system is carefully brought to resonance by series variable condensers.

The transmitter consists of a 50-watt tube which is supplied with 1,200 volts D.C. The tube is operated on A.C. for its filament supply and the set is keyed directly in the plate circuit by means of a relay. The Hartley circuit is used after several other types were experimented with. It will be noted in the diagram that pancake inductances are incorporated. These inductances are suspended

Above: The circuit used by 2BRB in his successful transmissions around the globe. It is operated at 40 meters and works consistently. Below: A corner of Mr. Glaser's shack showing a few of the many hundreds of foreign cards arranged in the well-known wall-paper method. Right: Eddie, as he is known to the hams in the metropolitan area.

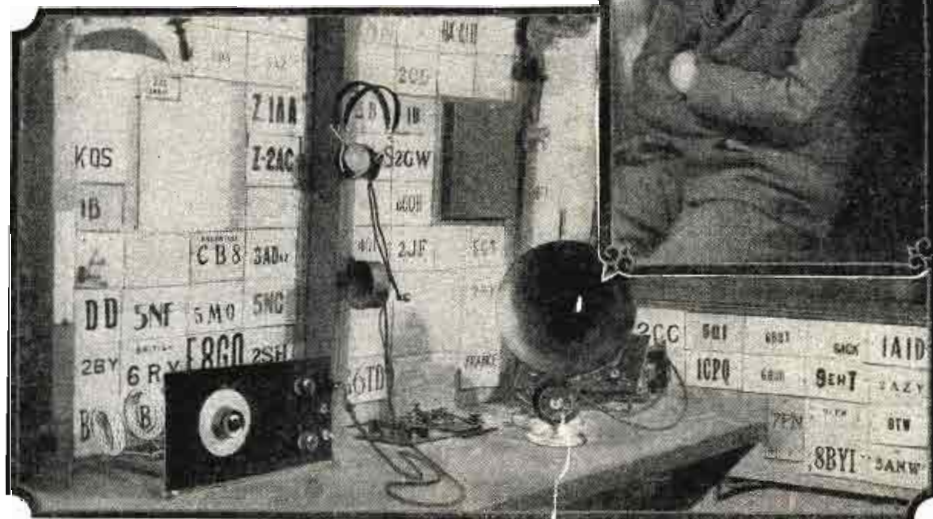
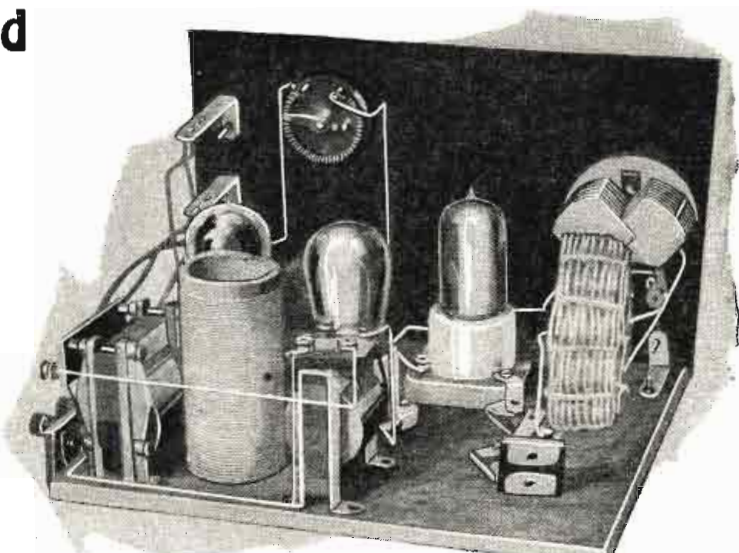

Radio Wrinkles

STORAGE BATTERY BINDING POSTS

One of the greatest troubles confronting a radio fan is obtaining good connection to the storage battery. Here is a simple solution of the problem. There are two methods

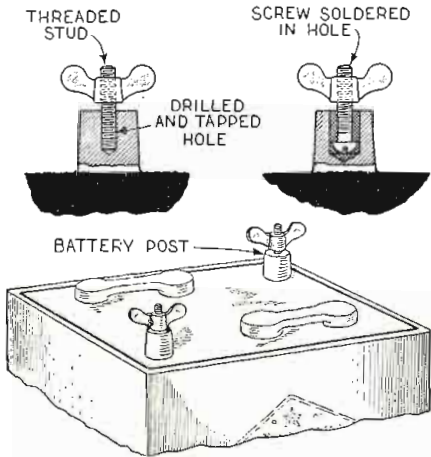

Two methods of getting good connections to storage batteries.

shown in the diagram and they are about equally efficient. Obtain $\frac{1}{8}$ or $\frac{1}{4}$ inch bolts and wing nuts to fit. In Fig. 1 the head is removed from the bolt and the battery terminal is drilled and tapped to fit the bolt, which is then screwed tightly in the hole. In Fig. 2 a hole $\frac{1}{16}$ -inch larger than the head of the bolt is drilled in the terminal and the bolt placed in it as shown. This bolt is held in position by pouring solder around it and holding it upright until the solder has hardened.

Contributed by C. A. Champion.

QUICK CHANGE COILS

For the fan who wishes to use different coils to cover different wave bands, or for experimenting with different styles of coils, the following method of mounting will be found very convenient.

About $\frac{3}{4}$ of an inch from each end of a small strip of panel—say $\frac{1}{2}$ inch by 4 inches—mount one of the little "Sockettes" such as are sold in sets of four for mounting tubes. This is for coils with a single winding, but if the coil consists of two windings, mount two of the sockets at each end of the panel strip. This panel may then be mounted with small brackets or in any man-

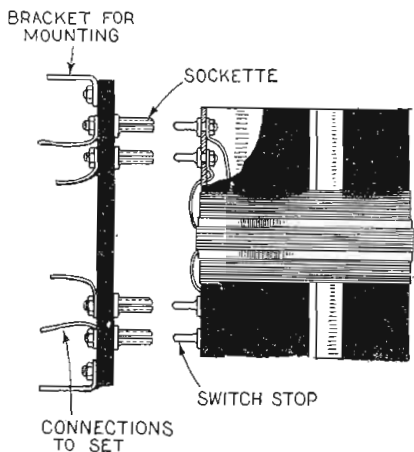

Fig. 1. Quick change method of connecting two windings on the same tube in a circuit.

ner desired, and at any convenient place in the set—on the baseboard, panel, or back of a variable condenser. Consider the sockets the terminals of your coil, and make the proper connections to instruments or binding posts. These connections may be soldered if desired.

For coils which are wound on either cardboard or composition tubes, an ordinary switch stop is mounted at each end of the tube for the single winding, or two at each end for the double winding, and the ends of coils connected directly to these stops. Care must be taken to space the stops exactly the right distance to correspond with the sockets as shown in Fig. 1. Also be careful to see that when the stops are inserted in the sockets the proper connections will be made. It is well to follow a set rule in making these connections. For example, let the two outside sockets and stops always be the terminals of the secondary winding, the right

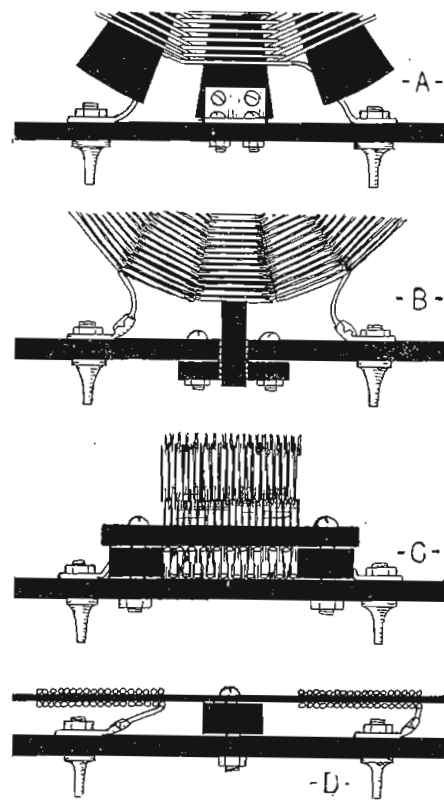

Fig. 2. How to mount four different types of coils for quick change.

to connect to the stator plates of the variable condenser and the left to the rotor, while the two inside stops will be the primary connections, right to aerial and left to ground. If the same rule is always followed, no changes will be necessary, once the connections are made.

For other styles of coils, use another strip of panel for mounting the switch stops, and attach the coil to this panel by any method desired. A, Fig. 2, shows a spider-web coil mounted with a small angle piece of brass or copper. B is one of the self-supporting flat coils, which has a small rod of wood or composition thrust into one of the openings and this rod is then inserted in a hole drilled in the panel strip, and of such a size that the rod will fit snugly. A small additional strip of the panel material used in the illustration will make it more substantial. C represents one of the basket or diamond weave coils, which is attached by means of an additional strip of the panel material, and two small

squares of the same, while D shows another method of mounting a spider-web parallel with the panel strip. Honeycomb coils may be tied on with a piece of thread or twine.

When once mounted in this way the coils in a set may be changed with practically as much ease as you plug your phones or loud speaker into a jack—simply by inserting the switch stops in the sockets. It is well to occasionally spring the four sections of the socket together, so as to be sure that they make a good contact with the stops and support the coil firmly.

Contributed by M. S. Palmer.

DUST PROOF SLIDE TUNING COIL

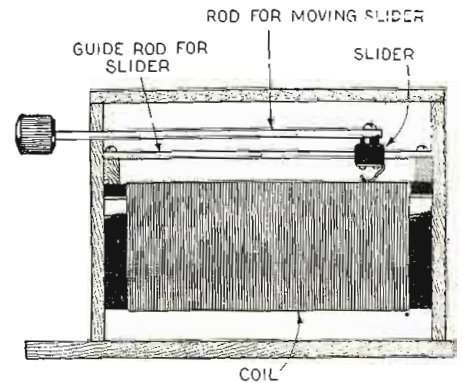

How to make your slide tuner dust-proof and improve reception.

One of the drawbacks to a slide tuning coil generally used in crystal sets is that there is no provision made for keeping the dust from collecting on the coil. This not only detracts from the looks of the set, but also decreases the electrical efficiency of the receiver. An easy method of overcoming these disadvantages is to inclose the coil in a cabinet just the size of the coil. In one end there is a hole provided for a rod for operating the slider. This rod is fastened, either by soldering or bolting, to the slider of the coil and is of sufficient length so that it may be pushed the entire length of the slide bar. The details may be seen in the accompanying self-explanatory sketch.

Contributed by E. R. Carpenter.

UNIT CONTROL FOR MULTI-TUBE SET

A very easily constructed unit control for multi-tube sets may be made of a piece of string, as shown in the accompanying diagram. A great many dials have at the base

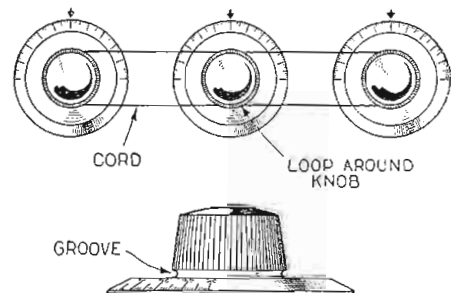

Only one hand is needed to tune a set using a string as shown above.

of the knob a small groove or cut, in which the string may be placed. If a set with three controls is to be equipped with this device, loop the string around the center knob in the groove and then around the other two knobs, making a 180 degree contact with each knob. The string is tied with sufficient tension so that when one knob is turned, the others will rotate also. For delicate adjustment, the center dial is held while the other dial is adjusted to suit. Of course, this system will work satisfactorily only when the tuning of the receiver is more or less broad. The dials will also have to be adjusted so that they have approximately the same readings.

Contributed by Jos. A. Baehr.

A METER READING DIAL

In the majority of cases in which sets can be logged, there are used more or less complicated systems for recording the dial readings and the corresponding wave-lengths. This can be simplified to a great extent by the use of the simple device herein described, in which the wave-lengths are read directly on the dial.

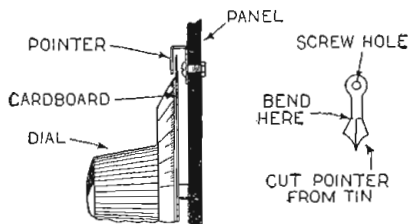
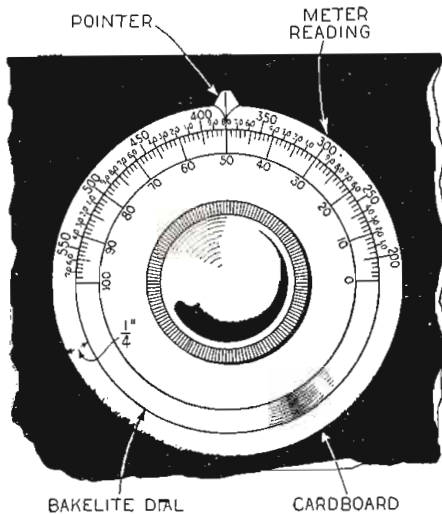

A dial and pointer that will improve the looks and operation of any set.

A circular disc, cut from either a good grade of stiff white cardboard or a piece of celluloid is prepared as follows: Place the material to be cut on a table and place on it the dial to which it is to be attached. Mark off on the material where the first and last divisions of the dial come and draw a line around the circumference of the dial. Between these two points, which are approximately 180 degrees apart, draw a concentric circle with a radius 1/4 inch larger than the other. This is then marked off, as shown in the accompanying illustration, with numbers indicating the wave-lengths. This disc is then pasted to the back of the dial in such a position that its circumference is 1/4 inch from the edge of the dial. The device should be a time-saver as the dials may be set directly in wave-length readings.

A pointer for this dial may easily be made of thin tin, as shown in the sketches in Fig. 2. This is fastened to the panel by means of a small bolt, after being bent as indicated in Fig. 2.

Contributed by Carl Schmuelling.

METHOD OF EQUALIZING CAPACITIES

In the majority of intermediate frequency transformers in Super-Heterodyne receivers it is necessary to put a condenser across the secondary in order that all the transformers

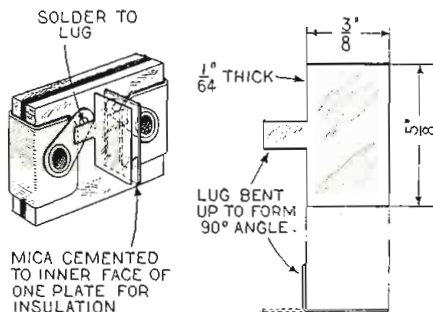

An auxiliary condenser useful for equalizing capacities.

may be operating on exactly the same wave-length. No matter how well the secondaries of the transformers are matched when wired up in the circuit, the connections may again unbalance them. The small plates that are shown in the accompanying sketch act as a small condenser in parallel with the fixed condenser and may be adjusted so that the capacity of the larger condenser may be increased an infinitesimal amount. The small plates are cut from No. 20 brass or copper sheet and are soldered or riveted on the lugs which are provided on most of these small fixed condensers. A strip of thin mica is fastened to one plate with shellac for insulation. The capacity of this vernier condenser may be varied by pushing the plates nearer together or farther apart.

Contributed by R. E. McAdams.

HOME-MADE CAT-WHISKER AND HOLDER

A simple constructed cat-whisker for crystal detector may be made as follows:

In the middle of a two-inch length of bus bar make a shallow notch with a three-cornered file. Around one end of the bus bar wind several turns of string and cover it with sealing wax for an insulated handle. A spring is wound on a 1/4-inch rod 1/2-inch long, the ends being looped at right angles to the spring, as shown in the accompanying sketch. One of these loops is soldered to the notch in the bus bar, the other being soldered to the top of a switch stop.

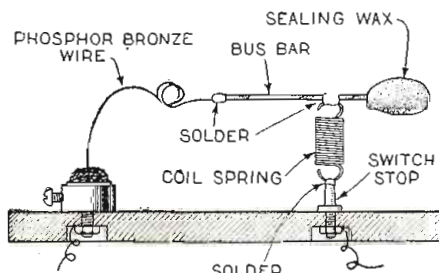

An emergency cat-whisker, easy of construction.

whisker is made of No. 26 wire coiled as shown in order to obtain the desired spring. One end of this is soldered to the bus bar, the other end being filed to as sharp a point as possible for contact with the crystal.

The knob of sealing wax is easily made by dipping the end of the bus bar wound with string into a small pot of melted sealing wax and then immersing it in cold water. This is repeated until a knob of desired size is obtained. This device may be mounted on a small bakelite or hard rubber base and with a crystal cup and two binding posts will form a very efficient crystal detector.

Contributed by C. L. Fender.

EMERGENCY CRYSTAL DETECTOR

Have you ever been listening in to a good concert and in the middle of an interesting number broken the cat-whisker of the detector? Here is an emergency detector which will serve excellently.

Two razor blades (Gillette are preferable as holes are already drilled in them) are mounted on a block of wood which is about 3/8 or 1/2 inch wide, with clips and wood screws, as shown in the accompany illustration. This block of wood is mounted on a base and the connections to the circuit are made to the clips. For a crystal a piece of

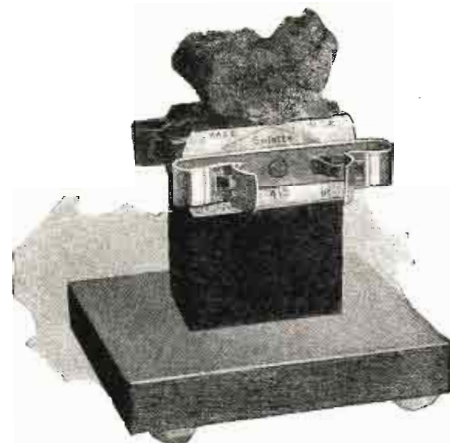

When your detector is out of commission, here is one easy to construct.

coke, carborundum or pyrites will serve very well. The crystal is moved about until sensitive spots are found, when balanced as shown on the edges of the razor blades.

Contributed by R. B. Wailes.

A BATTERY CONNECTOR

In building a set it is usually a problem how and where to connect the batteries in as simple a manner as possible. In the accompanying sketches is shown a method for doing this that should appeal to every set constructor.

Two pieces of hard rubber or bakelite 5 x 3/8 x 1/8 inches and a piece 2 x 6 x 1/8 inches are prepared. The two pieces of bakelite are then hollowed out with a rat-tail file and drilled as shown in Fig. 1. Five cord tips such as used on headphone cords are placed between the rubber strips in the

(Continued on page 2309)

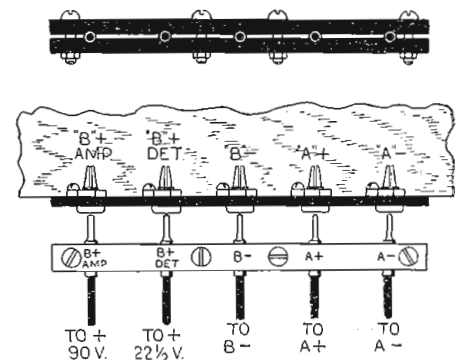
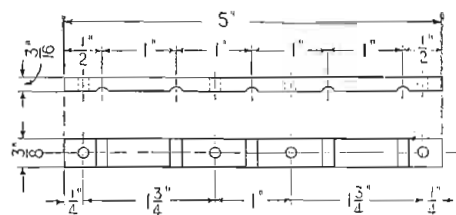

A battery connector that will save many minutes of sorting and connecting wires.

Radiotics

TUBES FOR THE CARELESS



In the February issue of the *Mansfield Daily News*, of Mansfield, Ohio, there is an advertisement by the Buchan Auto Supply Co. of "RADIO IRON TUBES". Although we are pretty careful when we handle tubes, sometimes one does slip to the ground, and then—Well, here is the tube for the experimenter who is nervous.

Contributed by R. R. Sigler.

VIBRATION PROOF

The *Cleveland News*, of Cleveland, Ohio, advises in the Feb. 20 issue the use of a "WOOL BASEBOARD" to mount a set on. Perhaps the jumps and gambols of the lambs are communicated in some way to their wool and these springs take up some of the shocks to which radio sets are subject.



Contributed by J. C. Erney.

SUPERFINE WIRE

The *Evening Bulletin*, of Philadelphia, Pa., on Feb. 7, 1925, in describing the construction of a set, advised the use of "No. 260 D.C.C. WIRE" with which to wind a coil. However, there are given no directions as to where the wire may be found, and doubtless manufacturers would be glad to know how to make it. This wire must be finer than the proverbial frog's hair.

Contributed by James P. Heywood.

FOUR CYLINDERS OR STRINGS?

The *Toronto Star*, of Toronto, Canada, describes in its Feb. 11 issue a beautiful broadcast of a composition by "CHRYSLER". We knew that ear was a dandy, but we did not know that it was so versatile! However, we cannot afford to dodge when the stars roll in overland.

Contributed by D. R. Patterson.



A COMMUNITY SUPPLY

The *Crosley Radio Weekly* of March 16 prints a statement that "A storage battery gives its best service, particularly on MULTITUDE SETS." Now, boys, get together and get one of these batteries and hattery troubles of the neighborhood will be ended.

Contributed by L. H. Jenks.

THE FEMALE OF THE SPECIES AGAIN

The March, 1925, issue of *The Experimenter Magazine* states in part "If you contemplate installing a HIGH-POWDERED set." When you get down to the bottom of things you will have to admit that radio sets are sort of like the touchy sex, skittish, temperamental and—Oh, well, you know as well as we do.

Contributed by B. M. Farrell.



WHY NOT USE ANCHORS?

From the Philadelphia, Pa., *Public Ledger* of Feb. 21 comes the following: "The consistent range of 1,000 miles with speaker volume is rather great, due to the fact that the LOCATIONS VARY." So that is why it is so hard to tune in some stations! We should advise directors to see that their stations are fastened down securely, as any movement will knock the loggings of dials galley-west.

Contributed by John McMurray.



A STATION WE WANT TO MISS



for the annual cleaning, anyway.

Contributed by M. Davis.

SIMILAR PARTS ARE NEEDED

The *Washington Herald Broadcast*, of Washington, D. C., on Feb. 28, 1925, states that "A very SENSIBLE crystal detector is necessary." That has been our quest for—lo, these many moons, and the crystals so far discovered have been those from which the saying "dumbbell" sprang. It would be great to have a crystal speak up, telling you where its sensitive spots were.

Contributed by S. W. Wolfinger.



SOME INSULATION!

In the Feb. 16 issue of the *Crosley Radio Weekly* there is an article about transformers and, in telling about the insulation used, it is stated that "the paraffin paper is ONE AND FIVE-SIXTEENTHS INCHES THICK." There must be high voltage floating around in those sets if there is need of insulation as thick as that.

Contributed by W. H. Johnson.



If you happen to see any humorous misprints in the press, we will be glad to have you clip them out and send to us. No RADIOTIC will be accepted unless the printed original giving the name of the newspaper or magazine is submitted. We will pay \$1.00 for each RADIOTIC accepted and printed here. A few humorous lines from each correspondent should accompany each RADIOTIC. The most humorous ones will be printed. Address all RADIOTICS to

Editor RADIOTIC DEPARTMENT,
c/o Radio News.

LOOSE MOMENTS

The *Herald and Examiner*, of Chicago, Ill., in its radio magazine of March 1 describes several pieces of apparatus, among them a loose coupler. It says: "Loose coupling will make a receiver much more SEDUCTIVE than a tight coupling." If this continues, the censors will treat the radio sets as they have the movies and the theatres.

Contributed by H. Mortimer.



INTERFERENCE CREATORS

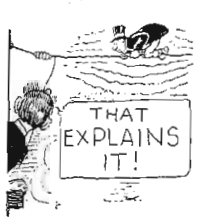

In the *Daily Standard*, of Watertown, N. Y., on Feb. 21 there appeared an article dealing with interference. Among other things that created this trouble in radio sets were listed: "Flashing signs, elevator motors and CONTRACTORS." This has been kept a secret up to now and this Department takes great pleasure in presenting it to the radio public. If you, hereafter, have any bad interference, look around carefully for any wild contractors that are interfering with anything.

Contributed by J. W. Bogard.

THE OLD GO-GETTER



is "a set what am."

Contributed by A. J. Loecke.

WAS THE SOUP COLD?

On March 2 the *Seattle Times*, Seattle, Wash., ran an announcement as follows: "12:30 to 1:30 p. m. Kiwanis Club LUNCHEON BROADCAST BY REMOTE CONTROL FROM THE OLYMPIC HOTEL." Did they provide the guests with rubber hats, coats and boots to withstand the reception of hot viands? Low bridge, brother, here comes the soup!

Contributed by H. F. Mason.



HOW ARE THE BRAKES?



In the Rico advertisement of the April issue of *Radio News* it is announced that their "coils are SELF-STARTING." We don't think so much of that idea, for suppose one of the coils should start perking in the middle of the night. We doubt if friend wife would stand for a thing like that around the house.

Contributed by Alex. MacKechnie.

AN EXPENSIVE ANTENNA

The *Chronicle and News* of Allentown, Pa., on March 14 told about the construction of an antenna as follows: "Hold the cross sticks in place with CREWS." There is a job that we will never go after. Of course, some fellows like that sort of uplift work, but we will be glad to let them do it.

Contributed by C. S. Missmer.

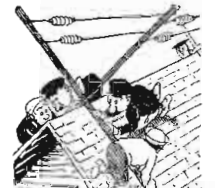

TREATS 'EM ROUGH!



This from the *Daily Post* of Baltimore, Md., on March 6: "It is necessary to have a FIGHTING arrester." It is a good idea to have a capable cop on the watch to throw out any hard-boiled squeals that persist in breaking up musical selections.

Contributed by D. K. Roberts, Jr.

NEW TYPE MACHINE SCREWS

In the *Cincinnati Times-Star*, Cincinnati, Ohio, of Dec. 27, 1924, we find mention made of a new type of machine screw, as follows: "Before countersinking any of the holes for the FAT-HEAD mounting screws—" We think that this is the wrong thing to call screws—before the experimenter has even started to build the set. If the author of the article thinks that about the set, what will the poor constructor call the apparatus?

Contributed by Jos. Fettig.



FOR AUTO OR RADIO?



In the Philadelphia, Pa., *Evening Public Ledger* of Jan. 31 there is an advertisement for a "4-TUBE Roberts KNOCK UNIT." This is perhaps one of the new-fangled gadgets that appear on the market every so often, that do a little of everything from running an automobile to bringing in the best of the DX.

Contributed by Mrs. M. D. Lechner.

Correspondence From Readers

REGENERATIVE NEUTRODYNE

Editor, RADIO NEWS:

In RADIO NEWS for September, 1924, on pages 316 and 317, Mr. A. L. Groves gives diagrams and descriptions of a Neutrodyne circuit with regeneration in the plate circuit of the detector tube.

Well, the more I looked at it the better I liked it, so decided to try it before giving up the Neutrodyne, as at that time I was experimenting with diagrams of a couple of commercial circuits which were, in my estimation, no good, regardless of the claims which were made for them.

I got the best material I could buy, using a formica panel, 7x42½ inches, as I decided to use three stages of audio frequency amplification, which would require six tubes. I will not go into the list of material I used, only to say that I put in good audio transformers, three straight stages of them, and I got real volume. It was impossible to use the third stage for home reception (only on extremely distant stations) for it would drive one out of the house.

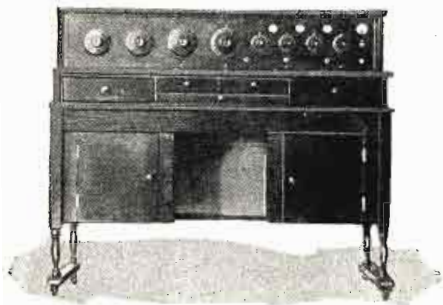

The cabinet containing the regenerative neutrodyne receiver described in the accompanying letter.

I did not hurry the job of building, but took my time and studied my wiring, to do the very best job I could. Of course this was not my first attempt at building a set, for I had wired a good many and studied them a lot, but I wanted a real job of this one, for I had a hunch that it was going to be a masterpiece. Finally I had it completed. No factory ever put out a nicer job of placing the instruments and wiring than I had done.

I looked it over thoroughly to see that I had made no mistakes and then hooked it up. It was about 2:30 o'clock on a stormy afternoon and I started to twist the dials. Every radio fan knows how I felt at that moment, and then I tuned in WCX, Detroit. A guy said it so darn loud that I thought he had burst my ear-drums, as I was using phones at the time.

Well, brother, from that time on I have had a real radio set. She is everything anybody could ask of an outfit; for volume it is unsurpassed, for selectivity and distance it ranks among the best, having so far heard 90 stations on it.

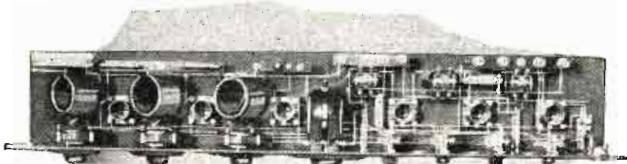

The layout of the regenerative neutrodyne receiver, employing six tubes and having three stages of audio frequency amplification.

FROM A CANADIAN FAN

Editor, RADIO NEWS:

In a recent issue of your highly interesting magazine I read an article pertaining to the seeming coldness and indifference of Canadian radio fans, and their laxness in sending letters and messages of appreciation to the various broadcast stations throughout the United States.

I was tempted to send you a line or so at the time of reading the article, but after due consideration decided that perhaps I was hardly justified in doing so, as my entry into the ranks of the radio fans had only been a month or so previous.

However, it is now some time since, and while it is the farthest thought from my mind that I am competent to speak for the thousands of Canadian fans, perhaps a suggestion or so "broadcast" through your periodical may have the desired effect.

My personal experience has been mainly that the broadcast stations do not reply to letters, and here is how it appeals to me as a new devotee of this wonderful science.

My set is just about the average (home-made two-tube) and scarcely an evening goes by without my sitting at my desk with the phones on to an early hour (sometimes two and three o'clock). I make it a point never to sit down without pencil and paper and record most everything that comes across—in some instances write to the station about the program while it is coming in. Since my set started to work, I think, without exaggeration, I have written almost a hundred letters, out of which only six have been answered and these from WDAF (three times have I written this station and three times has a reply been received. The "old chief" is surely on to his job!), WBAP, WHO, WIP and WCAP.

Of course, it is to be understood that the stations must receive thousands of letters, etc., but when a letter comes to them marked, "This is the first time I have pulled you in and I would appreciate it greatly if you would reply confirming my reception," it seems to me it would be good policy for future conditions for the station to send just a postal or some acknowledgment. It is very disappointing to pick up and hang on to, say KFKX or WFAA or WSB through possibly very adverse conditions, write them immediately after their signing off, irrespective of the time, and then not get a reply!

There is no earthly need for the station to reply after once having confirmed the fan's reception, for I take it that we are quite satisfied when once we have the "proof," but I certainly think it should not be too much trouble for the station to meet us fans in this request. They would gain. I feel sure, for if I am any criterion, once a station has been courteous enough to do this for me, they could bank on hearing from me many times again.

Of course, now that the "Stamp" system is in effect, perhaps trouble or disappointment of this nature will be eliminated, but even at that we all haven't albums, and until

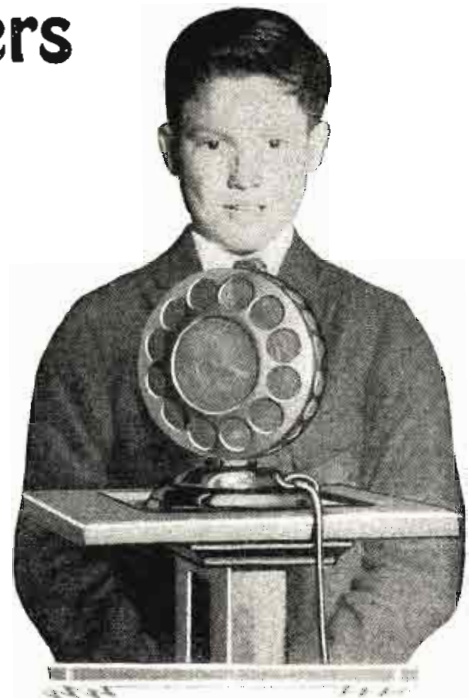

Robert Holman, of Chicago, giving a talk on birds and their habits through station WLS. © P. and A.

we get them, a postal such as I received from the previously mentioned stations is very acceptable and indeed welcome.

Could the stations not meet us in this request? If they will, then come on—Canadian fans, let's show our appreciation, for if we cannot conveniently telegraph or telephone, we can surely send a line or two by mail.

This letter has far exceeded my original intent of length, my apologies for having taken up so much of your time; but if it does help in any way to clear up this little misunderstanding, then I am sure I do not regret the time spent in writing, and I hope you will not regret the time spent in reading it.

By the way, just one thing more, and this touches on an already much discussed subject. We cannot write if we do not know where to send our letters. Just a courteous admonition to the announcers of the stations to be sure and make their letters distinct. Sometimes it is very hard to make out the call letters, although the program itself may be coming in perfectly.

CHAS. W. SUMMERS,
Montreal, Quebec, Canada.

CHILDREN BROADCAST

Editor, RADIO NEWS:

There is a system being tried here in Chicago that should prove of great interest to your readers. Under the guidance of Supt. of Schools Tobin, radio is being used as a medium to develop poise and the ability to speak in public in children. Children broadcast through station WLS speeches on birds, food for animals, health talks and the like. There is also group singing, at which the children are unusually proficient. Out here in Chicago we consider this use one of the best to which radio can be put. I notice that my own child seems to have more self-confidence than formerly.

Perhaps other cities will care to give this system a trial and give our future citizens one of the greatest necessities of life—self-reliance.

ANDREW J. TOUSLEY,
La Grange, Ill.

STANDARD HOOK-UPS

EVERY month we present here standard hook-ups which the Editors have tried out and which are known to give excellent results. This leaf has perforation marks on the left-hand margin and can be cut from the magazine and kept for further reference. These sheets can also be procured from us at the cost of 5c to pay for mailing charges. RADIO NEWS has also prepared a handsome heavy cardboard binder into which these sheets may be fastened. This binder will be sent to any address, prepaid on receipt of 20c. In time there will be enough sheets to make a good-sized volume containing all important hook-ups. Every year an alphabetical index will be published enumerating and classifying the various hook-ups.

Handy Reference Data for the Experimenter

Circuit No. 99. The circuit numbered 99 is one to delight the heart of the experimenter. It requires six tubes, but every stage of amplification is coupled to the preceding one in a different manner. The experimenter may vary these coupling placements in any way he wishes.

The constants are as follows: One is a standard two-coil type of coupling with an untuned, fixed coupling, primary. Primary "P" may consist of about 10 turns of No. 24 D.C.C. wire wound at the end of secondary "S." This secondary consists of about 50 turns of the same size wire wound on a three-inch tube, but spaced about 1/4 to 1/2 inch from the primary.

Unit two is a standard radio frequency transformer. It will probably be best to use a high-grade iron core radio frequency transformer, as shown, rather than an air core one.

Unit three incorporates resistance coupling with a plate resistor, "R," variable between 25,000 and 250,000 ohms. The working value of this resistance will be close to 100,000 ohms.

Unit four shows how a variometer is used for the tuned impedance type of coupling.

Unit five shows a choke coil type of coupling known as the "T. A. T." system. The natural period, or wave-length, of this coil is outside of the operating range of the set and functions mainly as an inductive resistance. It comprises about 250 turns of No. 30 D.C.C. wire wound on a 2 1/2-inch tube.

Unit six employs tuned impedance, but instead of using a variometer, as in unit four, a coil is shown tuned by a variable con-

denser. This coil may consist of about 50 turns of No. 24 D.C.C. wire on a three-inch tube. Regeneration in the last, or detector, tube is obtained by placing a rotor in variable inductive relation to this coil, as shown. Thus, a standard two-coil variocoupler with variable tickler coil may be used.

Condensers "C" are blocking condensers used to prevent the plate current being applied to the grids of the tubes. They may be of about .0005 mfd. capacity. The detector condenser, C1, is of .00025 mfd. capacity. Variable condensers C2 are of .0005 mfd. capacity, C3 is about .001 mfd., C4 about .05 mfd.

Resistances R1 are one megohm grid leak

The potentiometer has a resistance of 200 to 400 ohms.

From a study of this circuit it is seen that regeneration in the first tube is blocked from the third tube by the resistance coupling of unit three. Regeneration in the detector tube is blocked from the preceding tubes by the semi-aperiodic coupling afforded by the choke coil of unit five.

an amount necessary to obtain the desired period of oscillation.

It might be well to recall that in the case of the Hartley oscillator, the coupling between the input circuit (grid), and the output circuit (radio frequency), was obtained by inductive coupling. As noted above, the double adjustment is somewhat of a slight disadvantage when using the Colpitts oscillator in practice. The capacity C2 has the high potential applied to it and in order not to affect the oscillatory circuit LC2C3, a radio

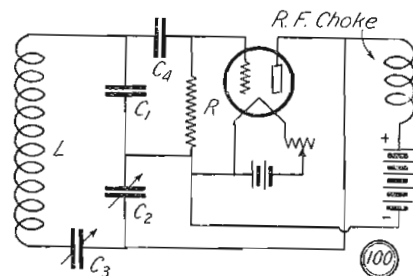

The Colpitts oscillator is shown above. As will be noticed, the "B" battery is not in the oscillatory circuit and the interposition of the R.F. choke keeps the radio frequency currents from leaking off.

THE COLPITTS OSCILLATOR

Circuit No. 100. Another efficient form of oscillator other than the Hartley described last month, is the Colpitts circuit. In this circuit, the coupling between input and output is capacitive and can be varied by changing the value of the capacity C2. In effecting this change, the oscillatory period of the circuit LC2C3 is changed, and it thus becomes necessary to change the capacity C3

frequency choke coil must be interposed between the plate supply, as is shown. C4 is a grid condenser while R is a grid leak. Due to the multiplicity of condensers, it is best to check the frequency with a standard wavemeter, because the matter of calculating the frequency would resolve itself into a rather difficult job.

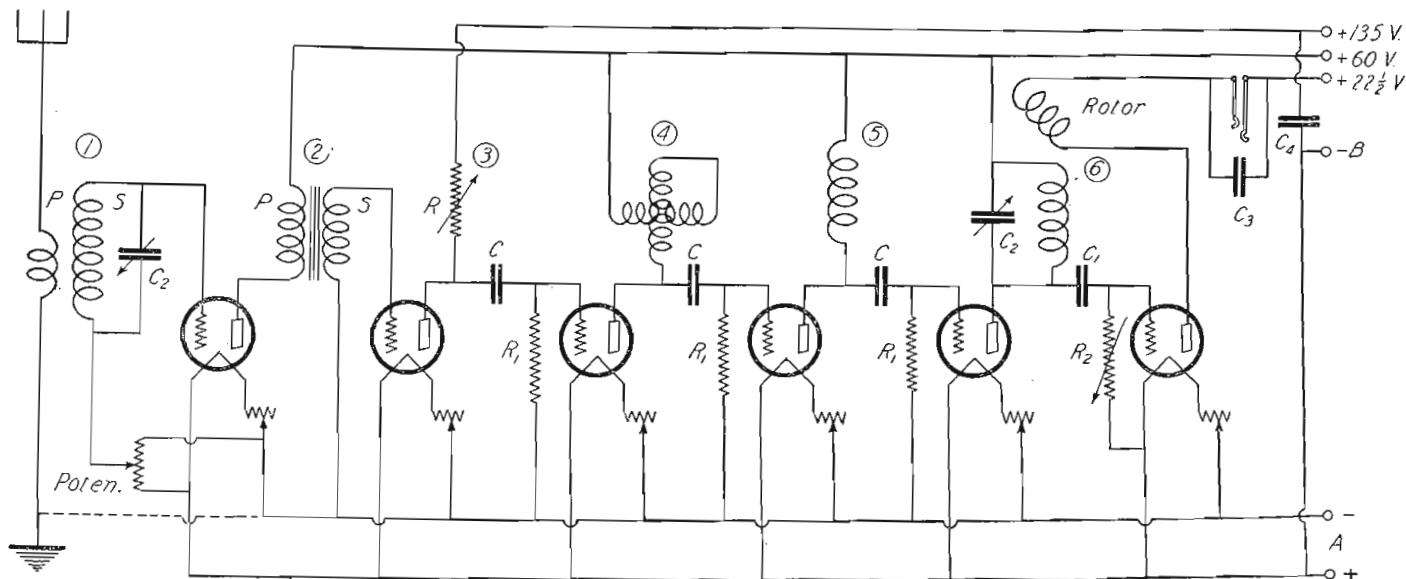

A curious circuit. Five stages of radio frequency amplification and detector employing regeneration comprise this circuit which really works. Tuned transformer, untuned transformer, resistance, impedance, choke and another form of tuned impedance coupling are used in the successive stages.

THE HEISING CIRCUIT

Circuit No. 101. One of the simplest oscillators is that devised by Heising. The circuit has a number of desirable features, which are evident upon reference to the dia-

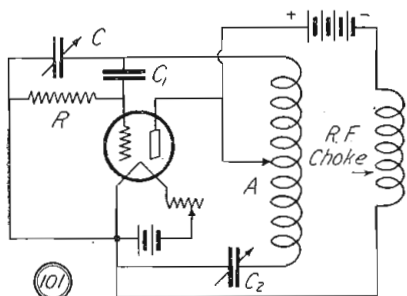

Heising's oscillator is depicted above. The condensers C and C₂ tune the grid and plate circuits respectively. Heising is famed for his method of modulation.

gram. By changing the position of the clip A, it is possible to vary the coupling between input and output. This form of oscillator has found wide application and is being used by many amateurs and experimenters. Here again, as in the Colpitts oscillator, the capacity grid leak resistance method of obtaining the required negative potential on the grid of the tube, is used.

There are different modifications of oscillators, but all are adaptations of the circuits described.

THE RASLA REFLEX

Circuit No. 102. So much has been said about the popularity, low cost, and faithful reproduction of the reflex circuit, that many people are beginning to realize its importance and are turning toward it. However, as there are so many reflex circuits, it is often confusing to the layman as to just what circuit he should use. The Rasla reflex circuit, as shown in the accompanying diagram, is one of the simplest and most efficient receivers of this type it is possible to build.

By reference to the diagram, it will be noted that the antenna system is untuned, of a semi-aperiodic nature. The secondary is tuned by .00035 mfd. condenser of the low loss type, but as will be noted, only a part of the secondary coil is included in the grid circuit. A small balancing condenser tends to obviate the undesirable creation of oscillations, and also serves somewhat as a volume control. Analyzing the circuit, we see that it consists of one stage of tuned radio frequency amplification, crystal detector, a reflexed stage of audio frequency and two stages of straight audio frequency amplification.

The radio frequency transformer is one that is designed so that its impedance matches

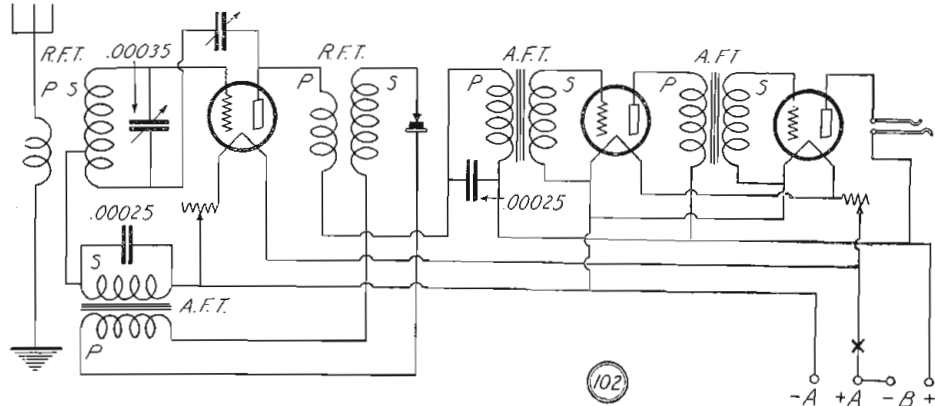

An efficient reflex circuit. It consists of one stage of tuned radio frequency amplification, crystal detector, reflexed audio amplifier and two stages of additional audio frequency amplification. This circuit can be successfully operated with a loop antenna, if the loop is directly connected to the tuning condenser. It can also be employed successfully in a portable set, if dry cell tubes are used.

that of the fixed detector, thus giving maximum transfer of energy and efficient coupling. A .00025 mfd. fixed condenser is shunted across the secondary of the audio transformer which is used for reflexing. A 30 ohm rheostat is necessary for the careful adjustment of the detector tube, while a 6 ohm rheostat will handle the audio frequency amplifier tubes very nicely.

If dry cell tubes are used, the set can be made very compact and by careful design will fulfill a valuable use as a portable outfit.

R.F. AND REGENERATION

Circuit No. 103. It is a safe bet that one out of every five receivers now on the market is a regenerative set employing three or more tubes. The owners of such a set experience interference which often cannot be eliminated readily and many of them resort to a wave trap as a remedy.

By the addition of one tube more, it becomes possible to increase greatly the range and selectivity of the set. The extra tube is used in the capacity of a radio frequency amplifier, which, through the use of a small variable condenser known as a neutralizing condenser, affords protection against radiation and serves as an aid to distance-getting.

The antenna is connected to a six-turn primary winding on a form 3 1/2 inches in diameter. This winding is placed in the center and above a secondary consisting of

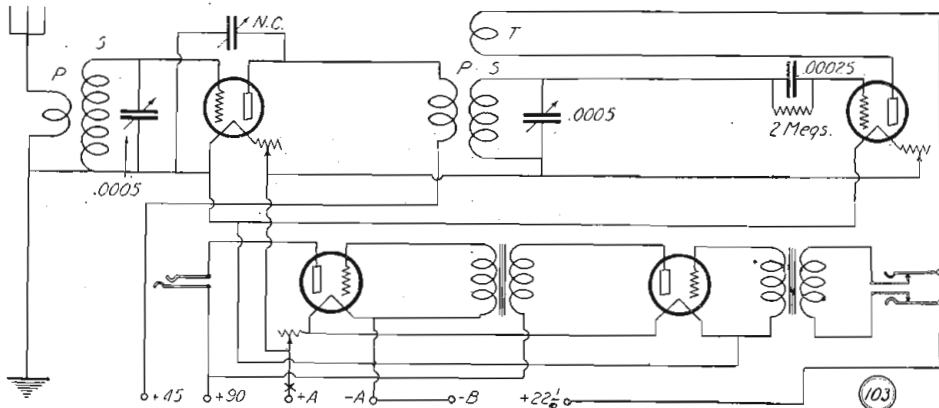

Combining tuned neutralized radio frequency amplification with regeneration and two stages of audio amplification gives a splendid hook-up. Neutroformers are employed, the second one being augmented with a rotor upon which is wound the tickler coil. This circuit is considered to be very selective.

60 turns of No. 22 D.C.C. the same size wire being used for the primary. A .0005 mfd. variable condenser is shunted around the secondary and will be found to give excellent selectivity. The regenerative qualities of the three-circuit tuner will still more enhance the receptive ability of the receiver as a whole.

Whether two stages of transformer-coupled audio, three stages of resistance-coupled or one stage of push-pull amplifica-

tion are used, the circuit will give unexcelled results when properly wired.

For the beginner who desires to build the tuner himself, the following information may be helpful: The primary consists of twelve turns of No. 12 D.C.C. wire on a tube three inches in diameter. The secondary can be wound on the same tube about one-half inch away and consists of 55 turns of No. 16 D.C.C. The tickler coil is wound with No. 22 D.C.C. on a similar size diameter tube and contains 35 turns. It should be mounted in close inductive relation to the secondary and should be variable in coupling to it.

A word about the auxiliary equipment. The antenna should be a single wire about 100 feet long and well insulated. The ground connection should go to a cold water pipe and a good clamp employed which will insure a permanent connection.

The best tubes are the storage battery type operating on 6 volts. These will give the best results, though if dry cell tubes are desired, the volume will be somewhat less. Loud speaker reception on stations over 1,000 miles away, even with the smaller tubes, is an absolute fact, and if the proper care is exercised in wiring, greater distances can be covered.

The small neutralizing condenser will have to be adjusted occasionally and should have a value of 15 mmfd. maximum capacity. Neutralization will keep the set from causing howling and squealing, and if proper hand-

ling of the regeneration is kept in mind, excellent results can be expected.

EXPERIMENTAL CIRCUITS

The field of experimenting in radio is very large. One fundamental circuit can be used in many variations which will still further resolve themselves into others of more or less complexity. Thus, radio frequency amplification can take place in forms of tuned and untuned circuits, both of which may be neutralized, may be effected by means of resistance, impedance and choke coupling, up to several stages of amplification.

The same applies to audio frequency amplification in the measure that several types of coupling may be employed: resistance, choke, transformer and push-pull. The detector tube can be regenerative, non-regenerative, superdynamer or heterodyner. These different methods are adaptable to other variable factors, so that the number of combinations possible becomes indeed great.

The general tendency in circuit design is the use of no more than three stages of radio frequency amplification, though most commercial receivers incorporate two steps. Again, two stages of transformer coupled audio frequency amplification are used to a greater extent than other types.

Experiment! There is a vast field for improvement in circuit design.



New Radio Patents

By JOHN B. BRADY*

(Patent No. 1,521,777, D. J. McCaa. Filed July 10, 1923, issued January 6, 1925. Assigned to the Electric Apparatus Co., Parkersburg, Pa., a corporation of Pennsylvania.)

RADIO SYSTEM having a circuit arrangement for eliminating interference or other disturbances. The frequency of the energy which it is desired should be excluded or reduced in effect and represented by oscillations set up by static, atmospheric or other natural electricity, is caused to differ from the frequency of the energy which it is desired shall be received, and the undesired oscillations are neutralized by an

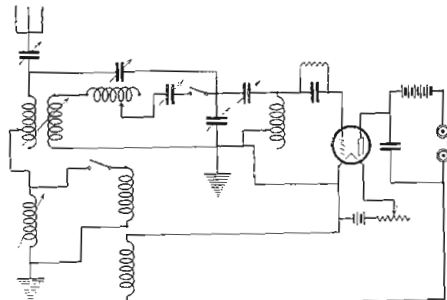

opposing and substantially equal potential caused by the received undesired oscillations, leaving the desired oscillations to effect the desired signals with substantially no disturbance by the undesired oscillations. When the undesired radio frequency oscillations are artificially produced as by transmitters emitting oscillations of frequency differing from the desired oscillations, their disturbing effects are similarly eliminated or reduced. The desired oscillations, preferably first amplified, are utilized to change the reactance of a circuit or path in which both the desired and undesired signals are received to materially increase the ratio of amplification of the undesired oscillations to the amplitude of the desired oscillations.

(Patent No. 1,522,221, E. F. W. Alexanderson. Filed November 20, 1914; issued January 6, 1925. Assigned to General Electric Company, a corporation of New York.)

METHOD OF AND MEANS FOR CONTROLLING ALTERNATING CURRENTS in transmitting systems for radio telephony wherein large amounts of energy may be controlled by

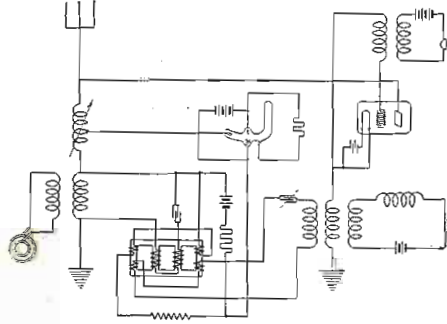

the small current variations produced by sound waves in an ordinary telephone transmitter, in such a way that the sound waves may be faithfully reproduced in suitable receiving apparatus at a distant point. The patent describes the Alexanderson magnetic amplifier.

(Patent No. 1,523,051, G. W. Carpenter and W. L. Carlson. Filed June 13, 1924; issued January 13, 1925.)

TELEPHONE HEADSET for use with sensitive multi-stage electron tube amplifiers wherein the conductors leading to the telephone headset are shielded by a tubular webbing of a metallic tinsel and textile threads. The forming of the shield with textile threads and metallic tinsel provides an extremely flexible conductive covering for the telephone cords and permits the headset to be conveniently used in connection with the amplifier.

(Patent No. 1,525,110, F. K. Vreeland. Filed August 6, 1919; issued February 3, 1925.)

AUDIO FREQUENCY SELECTIVE SIG-

NALING SYSTEM wherein the circuit connected with the detector system includes a baffle circuit and an intensity selective or other energy dissipating means which operates directly on the audio frequency currents to exclude those currents not desired from the observing circuit. The patent sets for the differences in character between the stray impulses which are very abrupt and transitory and signaling impulses which are sustained.

(Patent No. 1,522,807, L. Cohen. Filed January 15, 1922; issued January 13, 1925.)

ELECTRICAL SIGNALING receiving apparatus for reducing the interference arising from static disturbances. A wave-coil is employed in the receiving system. A portion of the wave-coil is enclosed in an adjustable metal tube which is electrically connected to a point on the wave-coil and grounded through a tuned circuit. The receiving apparatus is also connected in a circuit which is adjustably connected with the wave-coil. Points along the wave-coil are selected for a condition of maximum reception.

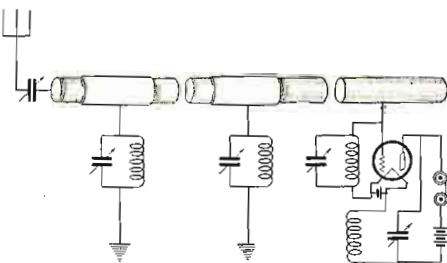

(Patent No. 1,525,177, R. B. Goldschmidt and R. Brailard. Filed May 24, 1920; issued February 3, 1925.)

DIRECT READING RADIO-TELEGRAPHIC COMPASS in which a loop collector is rotated about a vertical axis in order to receive maxima and minima signal intensity. The loop frame carries a cylindrical drum on which is mounted a

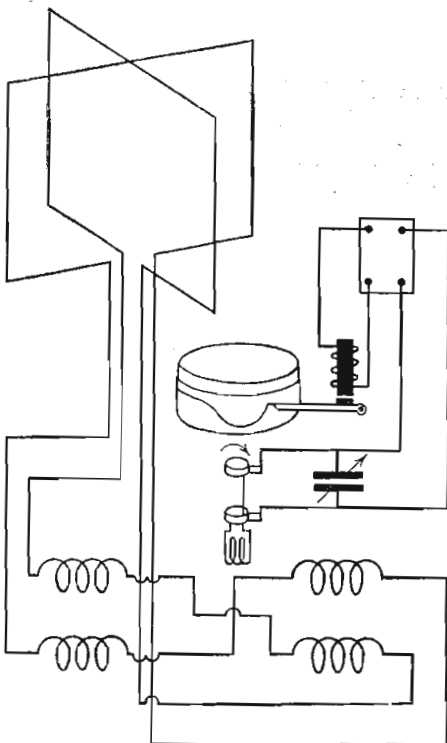
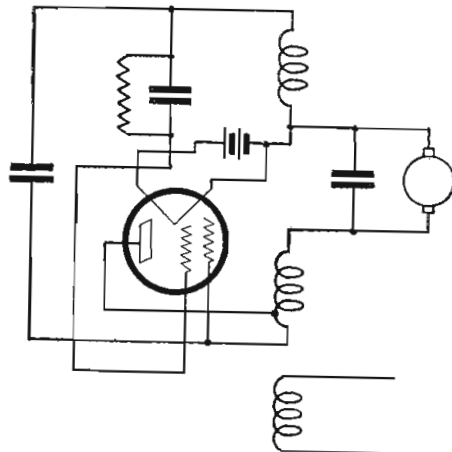
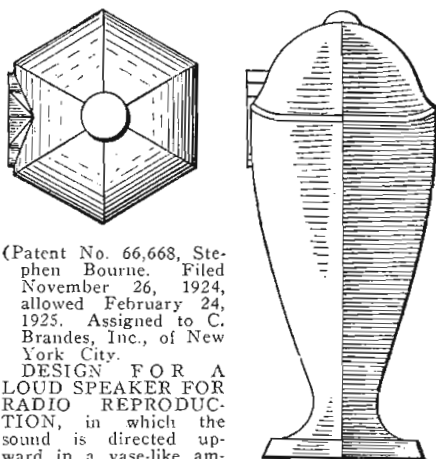

chart against which an inscribing pencil may be moved automatically to inscribe a curve characteristic of the received signals. In this manner the characteristics of the signals are made both visible and audible.



(Patent No. 1,525,827, D. C. Prince. Filed December 14, 1923; issued February 10, 1925. Assigned to General Electric Company, New York.)

PRODUCTION OF ALTERNATING CURRENTS by a pair of electron tubes operating in a push-pull circuit 180 degrees out of phase. A pair of three electrode electron tubes are connected to the anodes of each of the tubes and an intermediate point connected to a source of direct current through an inductance. A second inductive winding is provided which is inductively related to the first winding and has its terminals connected to the control electrodes of the tubes. An intermediate point of this last mentioned inductive winding is connected to the cathodes through a second inductance. The inductances are coupled to each other for the production of alternating currents by the tube system.



(Patent No. 66,668, Stephen Bourne. Filed November 26, 1924, allowed February 24, 1925. Assigned to C. Brandes, Inc., of New York City.)

DESIGN FOR A LOUD SPEAKER FOR RADIO REPRODUCTION, in which the sound is directed upward in a vase-like amplifying horn and outward to the listener-in.

(Patent No. 1,522,136, D. G. McCaa. Filed July 29, 1924, issued January 6, 1925. Assigned to The Electric Apparatus Co., Parkersburg, a corporation of Pennsylvania.)

RECEIVING SYSTEM having means for eliminating or reducing the effects of electrical disturbances in the reception of signals. The desired signal and the disturbing effects are divided between reactive paths, one of which is employed for effecting the translation of the desired signals, and with another of which is associated means for impressing thereon a part of the energy of the desired signals previously amplified, to cause a change of reactance, and thereby withholding from the signal-transferring path the effects of the undesired oscillations to greater degree than the effects of the signal-representing or desired oscillations.

*Patent Attorney, Owsy Building, Washington, D. C.



**APPROVED
RADIO NEWS
LABORATORIES
1922**

RADIO NEWS LABORATORIES



RADIO manufacturers are invited to send to RADIO NEWS LABORATORIES, samples of their products for test. It does not matter whether or not they advertise in RADIO NEWS, the RADIO NEWS LABORATORIES being an independent organization, with the improvement of radio apparatus as its aim. If, after being tested, the instruments submitted prove to be built according to modern radio engineering practice, they will each be awarded a certificate of merit, and a "write-up" such as those given below will appear in this department of RADIO NEWS. If the apparatus does not pass the Laboratory tests, it will be returned to the manufacturers with suggestions for improvements. No "write-ups" sent by manufacturers are published on these pages, and only apparatus which has been tested by the Laboratories and found to be of good mechanical and electrical construction is described. Inasmuch as the service of the RADIO NEWS LABORATORIES is free to all manufacturers whether they are advertisers or not, it is necessary that all goods to be tested be forwarded prepaid, otherwise they cannot be accepted by the Laboratories. Apparatus ready for the market or already on the market will be tested for manufacturers, as heretofore, free of charge. Apparatus in process of development will be tested at a charge of \$2.00 per hour required to do the work. The Laboratories shall be glad to furnish readers with technical information available on all material listed here on receipt of a stamped envelope. The Laboratories can furnish resistances of the various instruments, amplification curves of transformers, losses in condensers, etc., and other technical information. Address all communications and all parcels to RADIO NEWS LABORATORIES, 53 Park Place, New York City.

Apparatus Awarded Certificates

HADDAWAY RESISTANCE COUPLING UNIT

A resistance coupling unit was furnished us for test by Haddaway, Inc. This consists of two resistors, one to be used as an interstage coupler, the other to be used as a grid leak. Both are mounted on the same base together with a by-pass condenser.

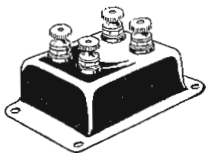

It operated very satisfactorily in the resistance coupled amplifier, the measured resistances being 45,000 and 350,000 ohms respectively on the particular unit submitted. The capacity of the by-pass condenser was .0035 mfd.

AWARDED THE RADIO NEWS LABORATORIES CERTIFICATE OF MERIT NO. 744.

THE LITTLE WONDER ADJUSTABLE CIRCLE CUTTER

This tool is of special use to those who are handling insulating material in large quantities. It is to be fastened in the chuck of a drill-press

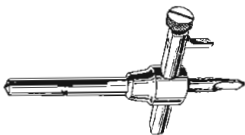

and can be adjusted to cut out holes of any diameter in insulating material. This is manufactured by the Poeppel Novelty Works.

AWARDED THE RADIO NEWS LABORATORIES CERTIFICATE OF MERIT NO. 745.

AUTOMATIC PLANE

This very convenient adjunct to the wood working shop turning out



radio cabinets and other wood work enabling edges and surfaces to be planed accurately and rapidly, is manufactured by William B. & John E. Boice. The cutter rotates at the speed of 6000 r.p.m. A spring flap covers the cutting blades where they are not covered by the piece being planed.

AWARDED THE RADIO NEWS LABORATORIES CERTIFICATE OF MERIT NO. 746.

GEM RADIO FUSE

These fuses, furnished by the Chicago Fuse Manufacturing Company, are installed in a glass tube, as illustrated in the diagram, which is supported by a special radio fuse base. Radio News Laboratories measurements indicated that they burnt out instantaneously, under a current of approximately 180 milliamperes. The approximate resistance is 10 ohms. They are to be inserted in the negative lead of the "B" battery circuit, thereby preventing a burnout of any of the tubes. The fuse element is visible so that



if the set is rendered inactive by the blowing of the fuse, it can be discovered immediately.

AWARDED THE RADIO NEWS LABORATORIES CERTIFICATE OF MERIT NO. 748.

RAY-DIO "B" STORAGE BATTERIES

These batteries, submitted by the Jordan Battery Company, come in lots of 12 cells as illustrated, giving a total voltage of about 28 volts when totally charged. They operate quietly and satisfactorily as sources of plate voltage for radio receivers.



AWARDED THE RADIO NEWS LABORATORIES CERTIFICATE OF MERIT NO. 747.

CUTLER-HAMMER RADIOLOC

This is a small lock designed for panel mounting which will enable one to shut off the set in such a manner that no one will be able to light the tubes, or otherwise operate it, without having a key to the lock. The lock is connected in the battery lines and operates in the capacity of a switch which is controlled by the key. It occupies about the same

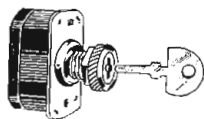

room on a panel as a filament switch and is very neat in appearance.

AWARDED THE RADIO NEWS LABORATORIES CERTIFICATE OF MERIT NO. 749.

UNIVERSAL RADIO MAST FITTINGS

These fittings, submitted by the

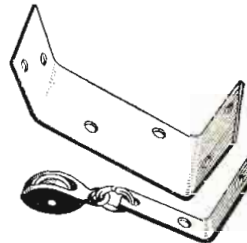

Universal Mast Company, are of great convenience to the radio builder in erecting the mast or poles to carry his antenna. They are shaped for adjustment to the pole and to the roof, chimney or wall, with holes already built for the screws or bolts, or for use with wooden poles only.

AWARDED THE RADIO NEWS LABORATORIES CERTIFICATE OF MERIT NO. 750.

RAJAH RADIO SOLDERLESS SNAP TERMINALS

The terminals furnished by the Rajah Auto Supply Company, are

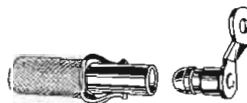

very handy to the average radio fan. One particular use of these terminals, as illustrating their use, is in securing the ground connection to steam radiators. The screw and the radiator valve handle is removed and is put back through the hole in the ground strip. The ground connection can be made instantly at will. The principle of operating these terminals is exactly opposed to that of the ordinary phone tip and receptacle.

AWARDED THE RADIO NEWS LABORATORIES CERTIFICATE OF MERIT NO. 751.

DAVEN SUPER AMPLIFIER

Submitted by the Daven Radio Corporation, for test in the RADIO

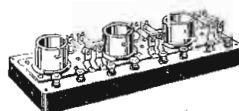

NEWS LABORATORIES. Consists of a complete assembly of apparatus required in an audio frequency amplifier outfit, employing resistance coupling.

Provision is made for three tubes and mounting six Daven resistances, three used as coupling units, and three as grid leaks. Using suitable values for the resistances and for the by-pass capacities which are connected thereto, very fine reproduction and sufficient volume for all purposes was obtained.

AWARDED THE RADIO NEWS LABORATORIES CERTIFICATE OF MERIT NO. 757.

KINGS JACK

The jack shown in the illustration, submitted to the RADIO NEWS LABORATORIES for test, was sent in by the Kings Manufacturing Company, Inc. It is ruggedly built and its perform-

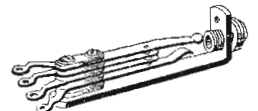

ance in circuits was completely satisfactory.

AWARDED THE RADIO NEWS LABORATORIES CERTIFICATE OF MERIT NO. 756.

X-L VARIO DENSER

Submitted to the RADIO NEWS LABORATORIES for test by the X-L Radio Laboratories. They are to be used as variable grid condensers or as neutralizing condensers. Consist of one fixed plate and another spring plate separated by a sheet of mica. The distance between the plates is varied by means of a screw passing through the top and pressing on the spring plate. The condenser sub-

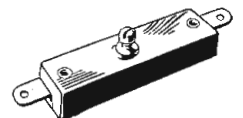

mitted for test showed a maximum of 31 micromicrofarads and a minimum of 7.

AWARDED THE RADIO NEWS LABORATORIES CERTIFICATE OF MERIT NO. 752.

BOARD'S BEARINGS

Submitted by Edward Board, as shown in the illustration. The de-

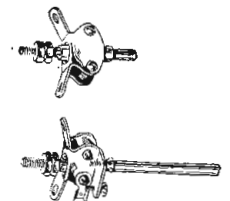

sign of these bearings is, in general, satisfactory and they operate well in variocouplers and variometers.

three circuit tuners or other coils requiring a rotor.

AWARDED THE RADIO NEWS LABORATORIES CERTIFICATE OF MERIT NO. 753.

BELDEN BATTERY CORD

This cord, submitted by the Belden Manufacturing Company, is a complete assembly under one braid



of all the connections for the "A" and "B" batteries to the set. Separate wires are identified by colored markers. Over all, the length is six feet, the wires having the ends trimmed and tips soldered.

AWARDED THE RADIO NEWS LABORATORIES CERTIFICATE OF MERIT NO. 754.

COLYTT ADJUSTABLE GRID LEAK

This adjustable grid leak, sent in by the Colytt Laboratories, is de-

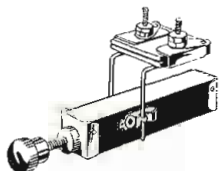

signed for panel mounting. It has a resistance range varying from two to five megohms, allowing accurate adjustment with all tubes. It operates very satisfactorily in the circuit and appears to maintain its calibration over a considerable period of time and under various conditions. It is designed for single hole mounting and presents a neat and inconspicuous appearance on the panel.

AWARDED THE RADIO NEWS LABORATORIES CERTIFICATE OF MERIT NO. 755.

UNION PHONE TIP SOCKET

Submitted by the Union Radio Company to the RADIO NEWS LABOR-

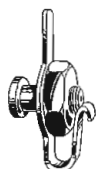

ATORIES for test is a receptacle into which the tips of the phone cord can be plugged directly without the use of extra plugs and jacks. It has a special spring feature which insures good contact.

AWARDED THE RADIO NEWS LABORATORIES CERTIFICATE OF MERIT NO. 769.

KELLOGG VARIABLE CONDENSER

This variable condenser furnished for test to the RADIO NEWS LABORATORIES by the Kellogg Switchboard & Supply Co. is of the straight line

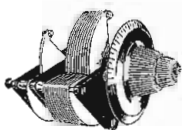

type with vernier plates attached. It has a maximum capacity of .000917 and a minimum capacity of .000024 microfarads. It is well constructed and is exceedingly strong and rigid.

AWARDED THE RADIO NEWS LABORATORIES CERTIFICATE OF MERIT NO. 762.

DURAD TUBE PROTECTOR

This tube protector, manufactured by the Duraplate Company, consists of a piece which holds a small re-

movable cartridge or wad. This wad is made in such a way that it has fastened to it on one piece a disc of paper or cardboard which has on it a thin stripe of fusible metal.



This piece has a low melting point and will burn out with small currents, satisfactorily protecting any type of tube now on the market. The wad is easily replaced and the replacement costs but little. It is connected in the "B" minus lead, thereby protecting all the tubes at the same time.

AWARDED THE RADIO NEWS LABORATORIES CERTIFICATE OF MERIT NO. 763.

KELLOGG VARIABLE CONDENSER

This condenser, submitted to us by the Kellogg Switchboard & Supply Co., has a maximum capacity of .000494 and a minimum capacity of .000012 microfarads. The condenser is very sturdily built, as pictured in the illustration and has attached to it a unique vernier attachment which permits accuracy of the condenser plates and dial. There is a very small amount of metallic material used in the construction of the plates, which are soldered together at several points on special strips

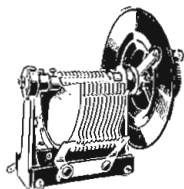

provided for the purpose. The general construction of this condenser is of the low loss type.

AWARDED THE RADIO NEWS LABORATORIES CERTIFICATE OF MERIT NO. 761.

AKRADYNE

Submitted for test to the RADIO NEWS LABORATORIES by the Sunbeam Radio Corp. This set contains two stages of tuned radio frequency amplification, detector, and two audio. It operates very satisfactorily over the complete broadcast wave range. The selectivity and quality of reproduction is very good. Operates with 201-A or 301-A tubes on the usual voltages.



AWARDED THE RADIO NEWS LABORATORIES CERTIFICATE OF MERIT NO. 758.

ELECTRIC SOLDERING IRON

Submitted to the RADIO NEWS LABORATORIES for test, by the Adroit



Tool Company, Inc. Very satisfactory for laboratory use and possesses a good feature of having a removable copper tip, thereby permitting the use of tips of various sizes and shapes.

AWARDED THE RADIO NEWS LABORATORIES CERTIFICATE OF MERIT NO. 771.

BALDWIN SUPER-HETERODYNE KIT

The Baldwin, Pacific & Co. have recently introduced a kit of Super-Heterodyne parts which comprises four intermediate frequency transformers, an oscillator and antenna coupler. The intermediate trans-

formers are designed for maximum efficiency at 45,000 cycles. Three of them are of the iron core type while the fourth or output transformer is a filter coupler of the air core type.

AWARDED THE RADIO NEWS LABORATORIES CERTIFICATE OF MERIT NO. 666.

UNION VERNIER ATTACHMENT

Submitted to the RADIO NEWS LABORATORIES by the Union Radio Co. for test. This is a very convenient instrument for the radio set

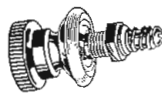

which requires fine tuning attachments. It can be attached to any panel or any dial.

AWARDED THE RADIO NEWS LABORATORIES CERTIFICATE OF MERIT NO. 770.

RICHARDSON

Submitted for test to the RADIO NEWS LABORATORIES by the Richardson Radio, Inc. This set contains

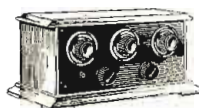

two stages of tuned radio frequency amplification, detector, and two of audio. It operates very satisfactorily over the complete broadcast wave range. The selectivity and quality of reproduction are very good. Operates with 201-A or 301-A tubes on the usual voltages.

AWARDED THE RADIO NEWS LABORATORIES CERTIFICATE OF MERIT NO. 759.

FRANCE MULTI-DUTY SUPER CHARGER

This charger, put out by the France Manufacturing Company, is designed to charge both "A" and



"B" batteries. The charging rate is 5 to 7 amperes on an "A" battery. For charging "B" batteries, the provision is made for the insertion of an incandescent lamp into the charging circuit, so as to regulate the current flow.

AWARDED THE RADIO NEWS LABORATORIES CERTIFICATE OF MERIT NO. 773.

SILVA SOLDER AND FLUX

Submitted by the Silva Products



Company. For use in all kinds of radio work requiring soldered joints. Works satisfactorily and quickly.

AWARDED THE RADIO NEWS LABORATORIES CERTIFICATE OF MERIT NO. 760.

HEMCO TUBE SOCKETS

This socket, manufactured by George Richards & Co., was submitted to the RADIO NEWS LABORATORIES for test. It is built in the usual manner, excepting that there are several admirable features connected with it. These are: First, multiple spring contacts which furnish low resistance contacts to the prongs of the tubes; and second, the nuts which hold the bolts are sunk into the molded material of the

socket base. This latter feature is a good one, for it eliminates a great deal of annoyance, which often occurs from loosening of these nuts.

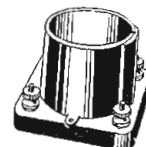

AWARDED THE RADIO NEWS LABORATORIES CERTIFICATE OF MERIT NO. 766.

RADIO SHOCK ABSORBER

This shock absorber, manufactured by the Green Rubber Company, was submitted to the RADIO NEWS LABORATORIES for test. It eliminates vibration in the set and microphonic noises. It is made of



hard rubber with sponge rubber cushion.

AWARDED THE RADIO NEWS LABORATORIES CERTIFICATE OF MERIT NO. 767.

EFFARSEE PORTABLE ANTENNA

This antenna, made by the Fishwick Radio Co., is an outfit something similar to a window shade



without a roller, in which a number of parallel wires have been interwoven. Operates satisfactorily for ordinary radio reception.

AWARDED THE RADIO NEWS LABORATORIES CERTIFICATE OF MERIT NO. 776.

HEMCO LOOP ANTENNA

This is a collapsible antenna submitted to the RADIO NEWS LABORATORIES for test by George Richards

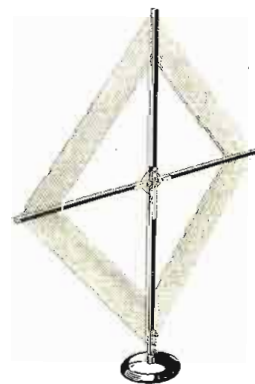

& Co. It is made of flexible wire so that it can be folded up without kinking. It is excellent for portable outfits.

AWARDED THE RADIO NEWS LABORATORIES CERTIFICATE OF MERIT NO. 768.

ALLEN SOLDERING PASTE

This soldering paste, submitted to us by the L. B. Allen Company,



Inc., is very satisfactory for use in wiring radio receivers and transmitters.

AWARDED THE RADIO NEWS LABORATORIES CERTIFICATE OF MERIT NO. 764.

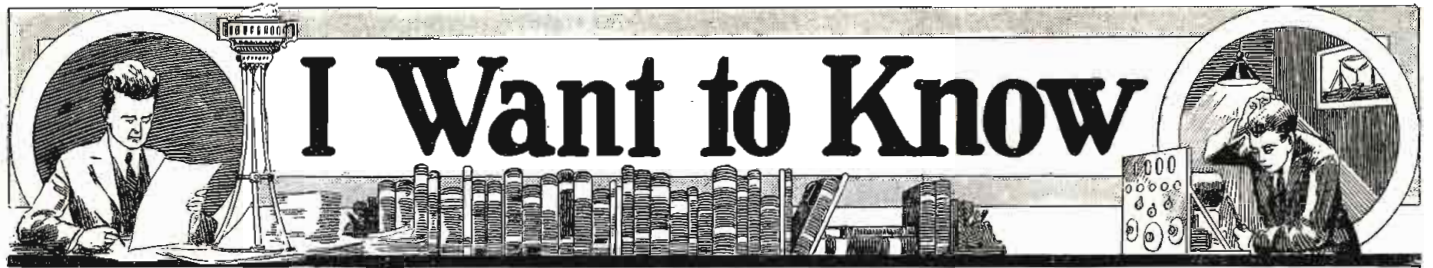

THIS Department is conducted for the benefit of our Radio Experimenter. We shall be glad to answer here questions for the benefit of all, but we can publish only such matter as is of sufficient interest to all.

1. This Department cannot answer more than three questions for each correspondent.
 2. Only one side of the sheet should be written upon; all matter should be typewritten or else written in ink. No attention paid to penciled matter.
 3. Sketches, diagrams, etc., must be on separate sheets. This Department does not answer questions by mail free of charge.
 4. Our Editors will be glad to answer any letter, at the rate of 25c for each question. If, however, questions entail considerable research work, intricate calculations, patent research, etc., a special charge will be made. Before we answer such questions, correspondents will be informed as to the price charge.
- You will do the Editor a personal favor if you will make your letter as brief as possible

PICTURE DIAGRAMS

(2116) Mr. P. Cherubini, Rahway, N. J., asks:
Q. 1. Please show a picture diagram of an efficient receiver using only a crystal detector.

A. 1. We are showing three circuits in these columns using a crystal detector but three different methods of tuning.

Fig. 2116-A uses a standard variometer, "L". C-1 denotes a variable condenser of .0005 to .001 mfd. which may be used to increase signal strength and reduce interference between stations. C-3 may be about .002 to .005 mfd. capacity.

Fig. 2116-B shows an inductance "L" of about 50 turns of No. 20 D.C.C. wire wound on a three-inch tube and shunted by a variable condenser "C-2" of about .0005 mfd. capacity. The aerial variable condenser described above is shown as C-1. If desired the audio frequency amplifier shown, in reply to question No. 3, below, may be used.

Fig. 2116-C shows a standard variocoupler as the tuning coil. The aerial tuning condenser may be in series with the aerial as at "X", or may be connected in parallel to the primary "P" as indicated by the dotted lines. This primary may consist of about 40 turns of No. 20 D.C.C. wire wound on a three-inch tube. One-quarter inch

away from this coil, and on the same tube, are wound 50 turns of the same size wire. This is the secondary "S". If desired, about 60 turns of No. 30 S.C.C. wire may be wound on a 2 1/4-inch rotor turning inside of the three-inch tube containing winding "S", the rotor winding constituting the primary.

Q. 2. Are the flat lead-ins placed between window sash and sill as efficient as the usual type requiring that a hole be drilled?

A. 2. During dry weather the flat lead-in is ordinarily quite satisfactory, but during damp weather the old style through-wall lead-ins of bakelite, Pyrex, hard rubber, or glazed porcelain are the best.

Q. 3. Please show a picture diagram of a one stage audio frequency amplifier that may be added to any set. I would prefer the use of General Radio No. 285 audio frequency transformers.

A. 3. This circuit is being shown in these columns.

If desired, individual batteries may be used for this amplifier unit. The primary connects into any set in place of the headphones. If a dry cell tube is used, dry cell "A", "B" and "C" batteries may be used, resulting in a portable unit. If a storage battery tube is used, the amplifier may be used as the first, second or even third stage of amplification, the dry cell tube not being very good where the volume handled is very great, as in the latter instance.

Any good make of audio frequency transformer may be used. If it is desired to use this amplifier as the second stage in a Super-Heterodyne or the third stage in any type of receiver it will be necessary to use very good materials and exceptional care in the construction of the unit.

The values of the condensers shown will depend upon the set and the amplifier. If the number 285 audio frequency transformer is used, resistance "R", of two to five megohms will probably be needed. This often eliminates a high pitched whistle sometimes present. When other audio frequency transformers are used it may be necessary to use as low a resistance as 50,000 ohms. Therefore, a Bradleyleak may be used across the secondary of a No. 285 transformer and a Bradleyleak of 25,000 to 250,000 ohms range when using other makes of transformers.

Distortion usually results when using a larger capacity than .00025 mfd. across the primary of a number 285 transformer but for most audio fre-

quency transformers capacity C-1 may be about .001 mfd., C-2 may be .006 to .05 or .06 microfarad and C-3 may be .002 to .005 mfd. capacity.

When using a "B" battery of about 90 volts, the "C" battery may be about 4 1/2 volts, although other voltages should be tried.

If the audio frequency transformer has a metal case insulated from both primary and secondary it is good practice to ground this. This is accomplished in effect, by connecting it to "A" minus.

MISCELLANEOUS

(2117) Mr. Edwin Thompson, Okmulgee, Okla., asks:

Q. 1. Is there any advantage in reversing loud speaker and headphone connections to the set?

A. 1. It is advisable to try reversing these connections when receiving a fairly weak signal as the volume is often increased considerably.

Q. 2. Why are some loud speakers made better by reversing the connections to the set?

A. 2. Practically every loud speaker and pair of headphones has strong permanent magnets. A heavy "B" battery current in the windings tends to assist these magnets when "poled," or connected one way, and tends to not only neutralize the magnetic field of these permanent magnets but to demagnetize these magnets as well, destroying the efficiency of the instrument.

Many loud speakers and headphones are marked to indicate which wire connects to the positive "B" battery connection. This wire is usually marked with a red thread called a "tracer."

Q. 3. Has a circuit been shown in RADIO NEWS, using a "Multi-Range" coupler?

A. 3. Yes. See the "I-Want-to-Know" department of the March, 1923, issue of this magazine.

GAROD NEUTRODYNE

(2118) Mr. Clarence Selley, Benkelman, Neb., asks:

Q. 1. Please show the Garod Neutrodyne circuit, but using one stage of audio frequency amplification instead of two stages.

A. 1. We are showing this circuit in these columns.

All the neutroformers use 3-inch tubes for the secondaries. The primaries, on tubes 2 3/4 inches in diameter, fit just inside the filament end of the secondaries. Neutroformer N-1 has a primary of seven and one-half turns of No. 24 D.C.C. wire, the same wire being used throughout.

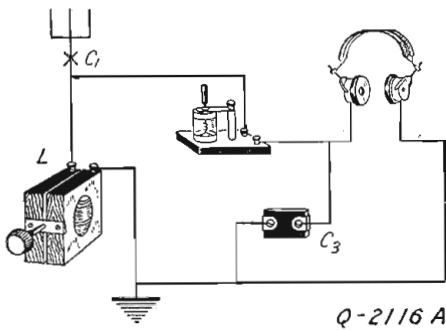

Q-2116 A

A complete radio set is shown. Anyone can make this receiver at slight expense. The few parts may be made or purchased.

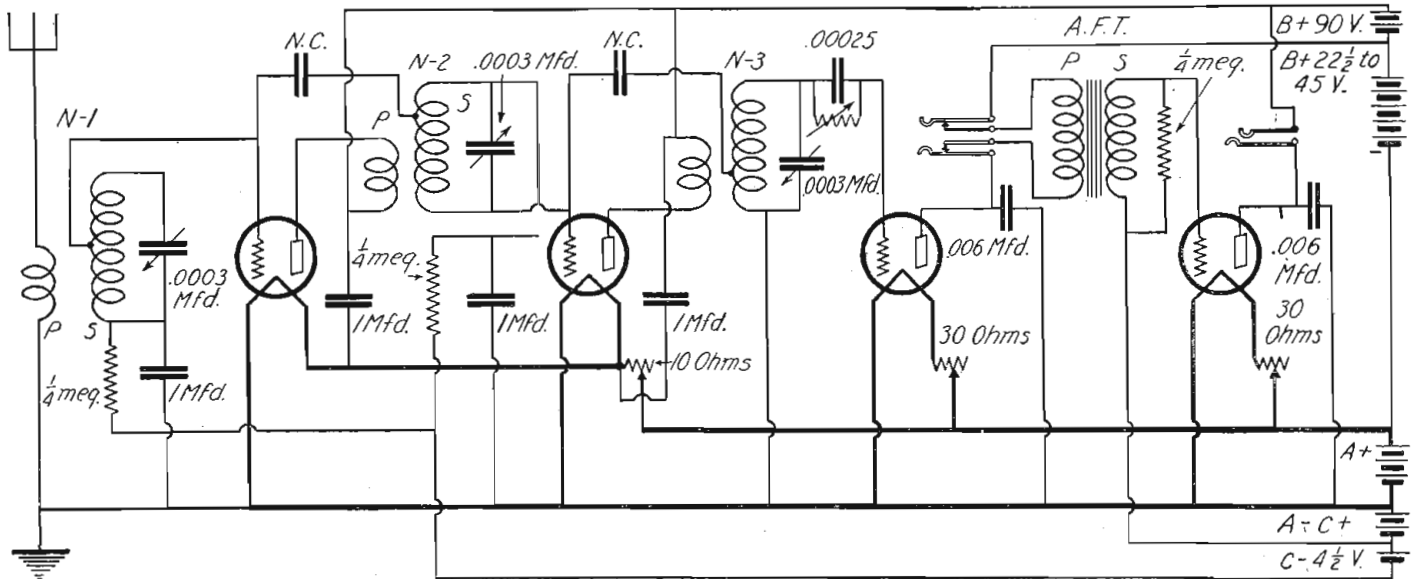

Q-2118

The Garod Neutrodyne. A study of this circuit shows it to be one difficult to surpass, where a prime requisite is tone quality. But also, it is extremely sensitive. Although reception may be excellent at the detector, a very careful audio frequency amplifier design must be employed to retain this quality. Note resistances in the radio frequency amplifier grid return leads.

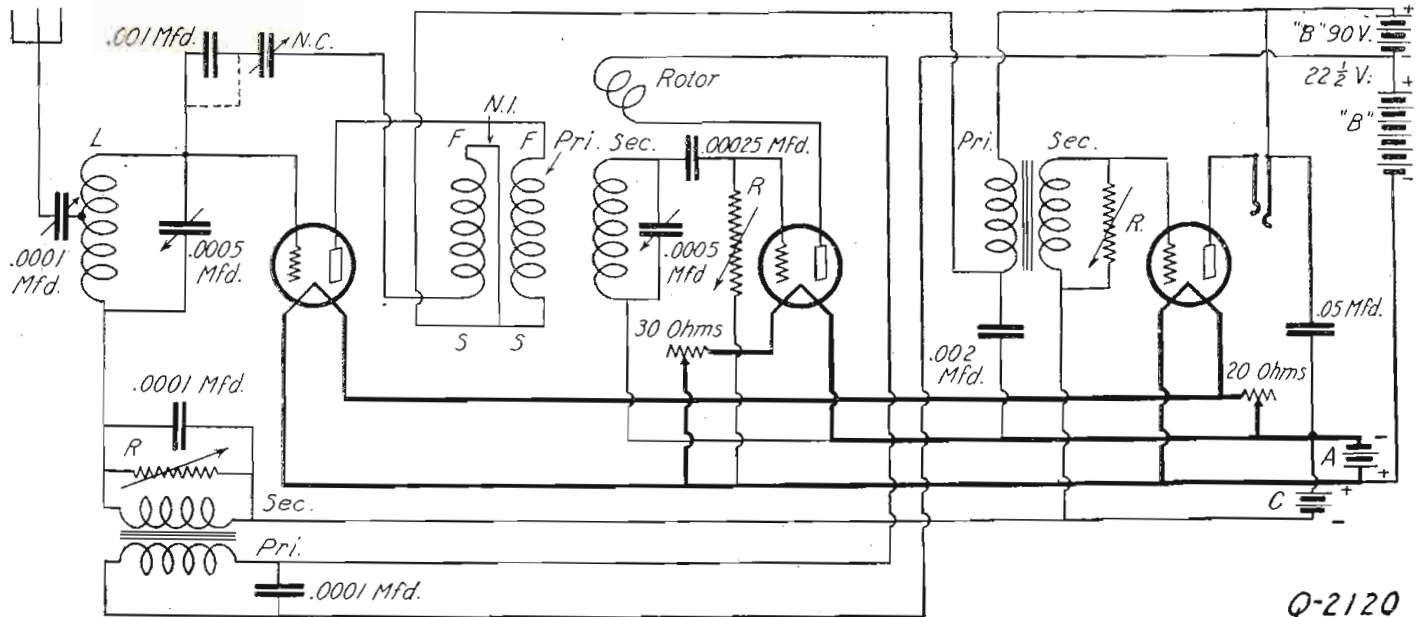

Q-2120

Roberts' non-oscillating reflex. One of the latest reflex circuits. Careful construction will result in an excellent receiver. It is advisable to experiment somewhat with this circuit as slight changes, particularly in coil relations, effect the reproduction quality.

The secondary comprises 70 turns. Neutroformers N-2 and N-3 each have four one-half turn primaries and 65 turn secondaries. These two neutroformers are tapped 22 turns from the filament end of the secondary. Neutroformer N-1 is tapped in the center. They must be placed at the usual non-inductive coupling angle. All coils are wound in the same direction.

It will be noted that the connections to both the primary and secondary of neutroformer N-2 are reversed.

A variable detector grid leak may be used. Standard neutralizing condensers may be used. While the point of neutralization is quite sharply defined, it is not difficult to find.

Although Stromberg-Carlson 4.3:1 ratio audio frequency transformers are used, any other good make of transformer may be used.

This set is extremely selective, sensitive and clear reproducing. Signals are also very strong. "B" battery consumption is unusually low. All this is explained by the high negative "C" potential, the detector grid return to "A" negative, the one-quarter megohm resistances, correctly placed and proportioned condensers, and carefully designed neutroformers. Of course, the audio frequency amplifier must be well designed in order to maintain the high quality signals of the detector circuit.

Q. 2. Does the long thin line or the short thick line denote the positive binding post of a cell or battery?

A. 2. The long thin line denotes the positive connection. In some diagrams, this is shown erroneously reversed, the short line denoting the positive connection.

Q. 3. Does it make any difference whether the "A" battery connects to the switch arm, or the resistance wire, of a rheostat?

A. 3. It makes no practical difference whether the rheostat is connected one way or the other. Also, polarity markings on the tube sockets may be disregarded, if it will not be confusing to you.

ROBERTS "KNOCK-OUT" REFLEX SET

(2120) Mr. Rodney Ware, Jr., Wadsworth, Ohio, asks:

Q. 1. Please show and describe the Roberts circuit using a "C" battery and one of the forms of neutralization. Are any changes required when using the No. 285 General Radio audio frequency transformers?

A. 1. We are showing this circuit in these columns. In addition to the variable detector leak "R", which may be a Bradley leak, one more leak of the same range will be required across each of the secondaries of the audio frequency transformers when using the No. 285 transformer mentioned above. The fixed condenser values indicated cannot be considered as exact. It may be necessary to use larger or smaller values than those shown. This is particularly true of the .002 mfd. fixed condenser. Also, the .0001 mfd. fixed condensers shown in shunt (parallel) to the primary and secondary of the audio frequency transformer in the grid circuit of the first tube should be varied in value to determine the best capacity.

If the small neutralizing condenser "N.C." should accidentally short circuit, it would cause the total "B" potential to be applied to the tube filaments, thus burning out all the tubes. To prevent this, we are showing a "stunt" in the form of a large fixed condenser which may be of about .001 mfd. capacity. This has practically no effect on the functioning of the neutralizing condenser and it serves as an added protection to the tubes. If this fixed condenser is not available, the circuit is indicated by the dotted line.

The aerial inductance "L" may consist of about 55 turns of No. 20 D.C.C. wire, tapped in the center and wound on a three-inch tube or on a spiderweb form.

Once adjusted, the aerial condenser need not be changed unless the aerial is changed.

The most difficult parts of the set are the windings comprising unit N-1. This unit is now being manufactured with spiderweb coils. There are two

ways of making this four-part unit. One is to wind the coils in cylindrical shape and the other is to wind the wire on spiderweb forms. S and F denote the start and finish of a two-wire coil made by winding two wires, side by side, at one time. The wire used should not be larger than No. 26 D.C.C. It is advisable to have one wire colored so that there will be no mistakes when making connections. It has been found that the radio frequency tube may be neutralized much easier if these two wires are first twisted. Twenty turns of this twisted wire are wound on a spiderweb form or a three-inch tube. This leaves four connecting ends, two at the start ("S" and "S") and two at the finish ("F" and "F"). The finish of one coil ("F") and the start of the other coil ("S") are connected together. On a second spiderweb form, placed about one-half inch from the first, are wound about 45 turns of No. 22 D.C.C. wire. If the three-inch tube is being used, the same number of turns may be wound, starting one-quarter inch from the starting end of the 20-turn coil. At the finishing end of the 20-turn coil is placed the rotating tickler ("rotor"). This may be of about 22 turns. If spiderweb forms are being used, the tickler may be of about the same number of turns placed on one of these forms and variably coupled to the secondary.

The variable condenser rotor plates are indicated by the arrowheads.

Use from 90 to 125 volts "B" battery and a "C" potential of 4 to 6 volts.

This circuit is sensitive, selective and very loud. The quality of reproduction depends greatly upon the inductive relations of the various coils, as will be evidenced by a little experimentation with the circuit. Aerial length seems to have very little effect on this receiver, in the matter of selectivity.

The quality of reproduction will be improved somewhat by connecting the detector variable grid leak to "A" minus instead of to "A" plus, although the sensitivity is not then quite as great.

The aerial coil must not be in inductive relation to the balance of the coils in the set.

WIRING DATA

(2119) Mr. A. S. Marriott, Toronto, Ont., Canada, asks:

Q. 1. Is there any disadvantage in using spaghetti on all wires? Does spaghetti tubing absorb moisture?

A. 1. This insulation should be used only when there is danger of one wire touching another. Air is the best dielectric. When replaced by something else, dielectric absorption losses are greater. Also, parallel wires carrying currents of two different potentials act as two plates of a condenser. With air as a dielectric the condenser effect is a minimum. In some sets this condenser effect may make the receiver inoperative.

Q. 2. Which is best to use, No. 14 enameled wire, No. 18 annunciator (bell) wire or, round or square bus wire?

A. 2. Either the enameled wire or the bus wire. We do not believe there is any difference worth considering, in the use of square or round bus wire, unless one is wiring a set to operate on short waves, such as 50 meters or less. The annunciator wire has the disadvantage of causing considerable condenser effect due to the paraffined cotton thread used as a covering.

Q. 3. Where can I secure information on the re-broadcasting systems in use?

A. 3. Mr. Frank Conrad presented a paper on this subject before the Institute of Radio Engineers. The December, 1924, issue of the "Proceedings" of this organization contains a reprint.

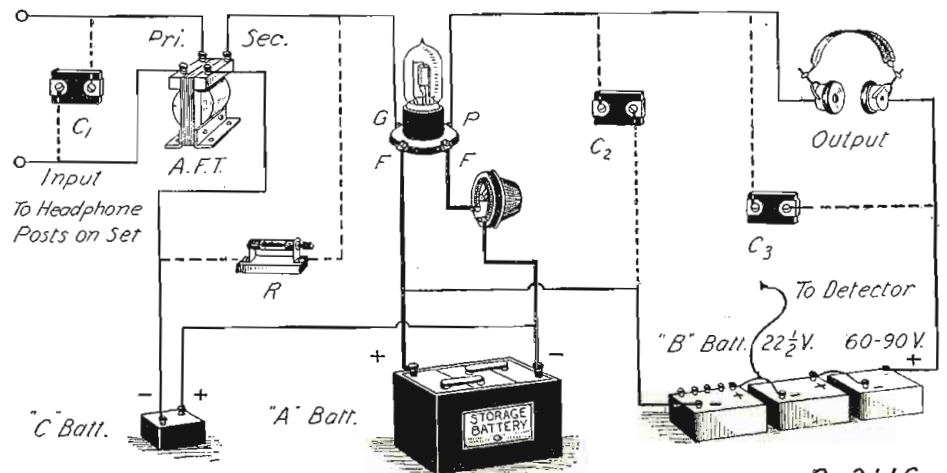

Q-2116

Picture diagram of a standard audio frequency amplifier, showing tone quality controls in dotted lines. Connect "B" minus to "A" minus if the balance of set is so connected. A separate current supply may be used for this unit.

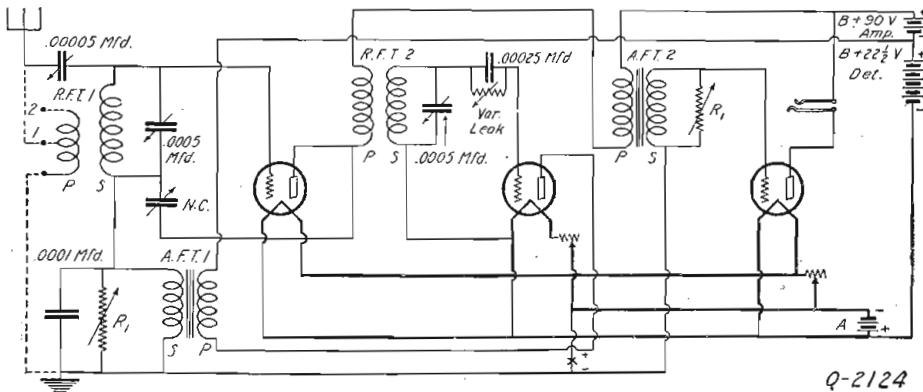

The new Harkness reflex circuit, neutralized. This set will be found extremely selective if apparatus of good quality is used. Any type of tube may be used if sockets and rheostats are changed accordingly.

If the secondary coil can be arranged to have a variable inductive relation to the double-wire plate coil, the coupling point for best operation may be easily found.

See the May, 1925, issue of RADIO NEWS containing these constructional details of the Roberts set.

Q. 2. Although the tubes in my set seem to operate well in other sets they do not seem to function in the present receiver. According to hydrometer test the "A" battery is fully charged. The tubes do not light up very brightly. In lieu of other wire, I have been using a two-conductor phone cord "A" battery lead. Can you offer any possible reasons for my results?

A. 2. The inoperation of your receiver is probably due to the phone cord you are using as an "A" battery connection. Use No. 18 wire, or larger, for your "A" battery leads. The phone cord is made with what is called "tinsel cord" and has a very high resistance.

Q. 3. When employing fixed radio frequency transformers in a set having two stages of radio

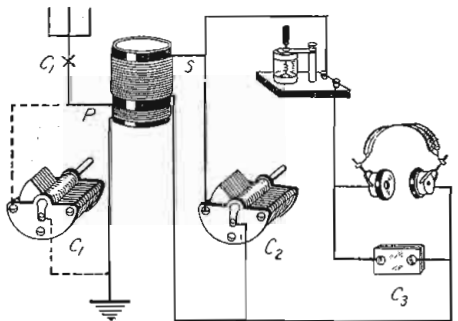

A very simple crystal set. The inductance coil shown may be a standard two-coil variocoupler either tapped or untapped.

frequency amplification, will it make any difference if low internal capacity tubes (such as the UV-199 or the C-399) and low capacity sockets are substituted for the regular storage battery type of tube?

A. 3. Yes. If a potentiometer is being used, its moving arm may now be advanced much further toward "A" negative. If a potentiometer is not being used, it may be of advantage to connect a very small capacity, such as that of a neutrodon, from the grid to the plate of one or more radio frequency tubes. Also, try connecting such a condenser from the plate of the detector to the grid or plate of the first radio frequency tube. In this instance it may be advisable to use the small type of neutralizing condenser that can be controlled from the panel.

IMPROVING THE AUDIO UNIT

(2121) Mr. Dale Kelly, Pelham Manor, N. Y., asks:

Q. 1. I have a very efficient modified Reinartz set but have no success with the one stage audio frequency amplifier I have added to it. The signal strength is exactly the same as with the detector alone. Am using UV-199 tubes, 67 volts "B" potential and a 3:1 ratio audio frequency transformer. What can I do to get increased signal strength?

A. 1. Remove batteries before making any tests not requiring the "A" and "B" potentials.

You may have a poor amplifier tube; test your amplifier tube in another set. The lead from the tube grid to the audio frequency transformer secondary is called the grid lead; the remaining secondary connection post connects to the "A" battery and the connecting wire is called the grid return lead. This grid return lead may be connected, in your receiver, to "A" plus. This will give the effect you mention. The grid return lead should be connected to "A" minus. If a "C" battery is used the grid return lead should connect to "C" minus (negative).

Try removing the fixed condenser you now have connected across the primary of your audio frequency transformer.

If convenient, try another audio frequency transformer. The one you now have may be open-circuited, short-circuited or grounded. To test for an open circuit, connect either post of a dry cell to one cord tip of a pair of head-phones. There now remains one cord tip and one dry cell post unconnected. It may be advisable to remove the set wires from the primary and secondary. Connecting the free phone tip to one end of the primary and the free dry cell tip to the other end should result in a click of considerable strength. This shows the primary circuit is not broken. It may be short-circuited but this requires a different test, and is not a usual fault with defective transformers. This test for open circuit may now be applied to the secondary. Occasionally, some transformers will give a click, even though there is a break in the winding, but this click is so slight that it is not easily heard.

To test for a ground, remove all wires from the transformer and connect one free end of the test set to either primary connection, and the remaining end to either secondary connection. If a strong click is heard, the windings are connected, which should not be the case. If a very slight click is heard it may be regarded as the natural charge and discharge click of the condenser formed by these two windings. This does not denote a fault. Either the primary or secondary may be grounded to the metal casing of the transformer and this is readily tested by touching the casing with one free end of the test set, and first one, then the other winding, with the remaining test set end. Only an extremely slight click should be heard. Use a detector plate circuit R. F. choke.

To test for a short circuit it is necessary to connect the transformer into the set. If, now, the two primary binding posts are tightly pressed with the fingers, the signal strength should be considerably reduced. The result should be similar when testing the secondary in this manner. If there is no noticeable difference then there must be a leakage having a resistance of the value developed by the pressure of your fingers, or even less. Such a resistance usually takes the form of partly conducting binding post panels. A fibre strip for these binding posts is often the cause of trouble, although good fibre is satisfactory for the purpose mentioned above.

A jack partly shorted by soldering flux will give you the same result.

Be sure the tube prongs are making good connection to the socket springs.

The jack springs may be making poor contact.

Q. 2. May dry "B" batteries be connected in series with storage "B" batteries?

A. 2. Yes. It is not advisable unless a high resistance voltmeter is used for checking battery voltages. The potential of a 32-volt or 110-volt D. C. lighting current may be increased by connecting a "B" battery in series, where the drain is

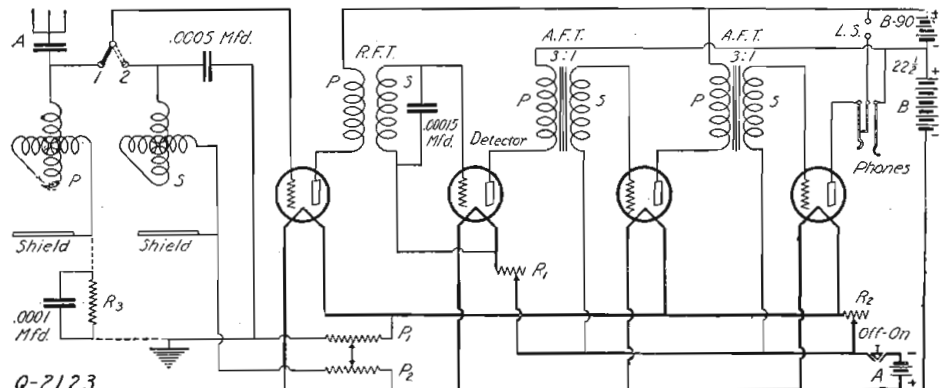

The Amrad "Inductrole." Variometers are employed in an efficient manner. The receiver is so designed that grid current leakage through the set is just sufficient to prevent the first tube from "blocking." The commercial receiver reproduces with excellent fidelity.

slight, as when supplying plate current for a receiving set.

Q. 3. Why is a one-wire aerial better than a two-, three- or four-wire aerial?

A. 3. For transmission, the four wire aerial is better. For reception, there is very little difference in the result and the one-wire aerial is cheaper and easier to install and maintain.

AMRAD "INDUCTROLE" CIRCUIT

(2123) Mr. E. E. Hollman, St. Louis, Mo., asks:

Q. 1. Please show the schematic circuits of the Amrad "Inductrole" and "Cabinette" sets shown in the Radio Set Directory appearing in the March, 1925, issue of Radio News.

A. 1. We are showing a circuit, in these columns, used in both receivers.

Resistances P-1 and P-2 may be potentiometers of about 200 ohms resistance. R-1 may be a 30-ohm rheostat, if a UV-201A or C-301A tube is used as the detector. R-2 may be of about 10 ohms resistance.

The condenser, "A", is of such a capacity as to enable the variometers "P" and "S", to cover the broadcast range, when a given aerial is used. This capacity is to be determined by test and then need not be changed unless the aerial system is changed.

The set is most selective when the switch arm is on point two. The coupling of the aerial circuit to the grid circuit is then only by induction.

A fixed radio frequency transformer is used. The amplifier voltage may be between 60 and 90 volts.

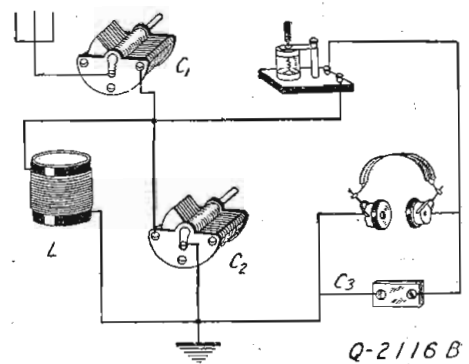

A two-dial crystal set. Winding the single coil inductance should present no difficulties to the experimenter. Sharp tuning is not a feature.

For broad tuning, the switch arm connects to point one. When so connected the second variometer, "S", has little effect upon the first variometer, but it has been found advisable to vary the rotor of the second variometer as, at a midway position, reception is improved.

Q. 2. What is the need for insulators in mast guy wires?

A. 2. The need for guy wire insulators is greatest when the aerial is being used for transmission. The guy wires absorb a certain amount of energy radiated from the aerial, and this absorption is quite considerable when the guy wires approach resonance with the aerial circuit. Breaking the guy wires up into short lengths greatly reduces this absorption.

Q. 3. What are the symptoms of too much grid leak resistance and insufficient grid leak resistance?

A. 3. Too much grid leak resistance insulates the grid from the filament and the result is a slow or fast clicking sound. Received signals are broken up a few, or sometimes several thousand, times a second.

Insufficient grid leak resistance results in reduced signal strength. If the resistance is too low the tube will not work.

For weak signals, the grid leak resistance must be higher than when strong signals are being received. If the grid leads will not be too long there-

(Continued on page 2272)

EVEREADY HOUR
EVERY TUESDAY AT 9 P. M.
Eastern Standard Time

For real radio enjoyment, tune in the "Eveready Group." Broadcast through stations—

WEAF	New York	WEAR	Cleveland
WJAR	Providence	WSAI	Cincinnati
WEEL	Boston	WWJ	Detroit
WFI	Philadelphia	WCCO	Minneapolis
WGR	Buffalo	WOC	St. Paul
WCAE	Pittsburgh		Davenport

*The proven
 Dry Cell for all
 Radio Dry Cell
 Tubes*

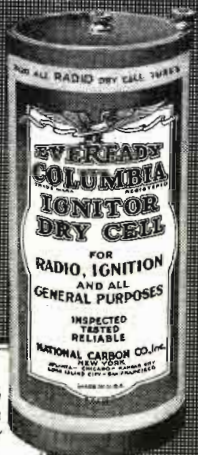

Eveready Columbia Ignitor "A" Battery for all radio dry cell tubes 1½ volts

No. 766
 22½-volt
 Large
 Horizontal
 Price \$2.00



No. 772
 45-volt
 Large
 Vertical
 Price \$3.75



No. 764
 22½-volt
 Medium
 Vertical
 "B"
 Battery
 Price \$1.75

Evereadys have long-lasting power

THE long-lasting power of Evereadys more than justifies their price. It is false economy to buy batteries that may be cheaper in first cost, but which are much shorter lived. Considering price and size, Evereadys are the most economical batteries there are, and in addition they are most satisfactory. Buy Eveready "B" Batteries. To light the filaments of all radio dry cell tubes, use the famous Eveready Columbia Ignitor.

Manufactured and guaranteed by
NATIONAL CARBON COMPANY, Inc.
 New York San Francisco
 Canadian National Carbon Co., Limited, Toronto, Ontario

EVEREADY Radio Batteries

- they last longer

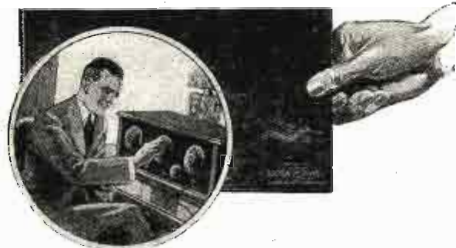

Why set manufacturers should use Radion Panels

Appearance. Radion Panels have a high-polished, satin-like finish that enhances the attractiveness of any set. They come in two colors, standard black and Mahoganite; the Mahoganite panels with their beautiful coloring and graining give an effect that is especially distinctive. Radion takes engraving beautifully.

Efficiency. Built to order exclusively for radio purposes, Radion meets the most exacting tests for high insulating qualities. Surface leakage and dielectric absorption have been proved to be exceptionally low. This is an aid in getting distance and volume.

Convenience. Another feature that recommends Radion Panels to the manufacturer is the ease with which they can be cut, sawed and drilled. Edges are smooth and even; holes are trim and clean-cut. Radion does not chip or peel as do other panel materials.

We invite manufacturers' inquiries

We are always glad to co-operate with manufacturers in meeting their requirements. We invite them to send us samples or specifications of panels and other insulated parts of radio instruments or radio sets. Radion is used on the leading makes of condensers.

AMERICAN HARD RUBBER COMPANY
Dept. A6, 11 Mercer Street, New York City

RADION

The Supreme Insulation
PANELS



Dials, Sockets, Binding Post Panels, etc.

I Want To Know

(Continued from page 2270)

by, it is almost always of advantage to use a variable grid leak arranged to be controlled from the panel.

LATEST HARKNESS REFLEX CIRCUIT

(2124) Mr. Stanley R. Hart, Philadelphia, Pa., asks:

Q. 1. Please show the latest Harkness reflex circuit.

A. 1. The latest Harkness reflex is being shown in these columns.

Radio frequency transformers R.F.T.2 may be made by winding about 50 turns of No. 24 D.C.C. wire on a three inch tube. One end of this secondary coil connects to the grid. The other end connects to "A" plus. About one-quarter inch from this end of the secondary is wound the primary, which may consist of about 15 turns of the same size wire.

In the earlier Harkness receivers the tuned radio frequency transformer marked R.F.T.1 consisted of two coils which we have designated "P" and "S." In the newer circuit it has been found possible to eliminate the 15 turn primary, the aerial being connected directly to the grid end of the 50 turn secondary (wound with No. 24 D.C.C. wire on a three inch tube), through a very small variable condenser instead of to the 10 turn tap or the end of the primary. The capacity of this condenser is higher than the maximum capacity of the average condenser of the "neutrodon" type. It is of such small size that changes in its capacity change the wave-length very little, but an excellent control of selectivity is afforded by its use. This method of inducing antenna current to the control grid of an amplifier tube will probably come into more general use.

The neutralizing condenser marked N.C. may be of the usual "neutrodon" type.

Resistances R-1, which may be variable grid leaks, will probably be required if the General Radio No. 285 audio frequency transformers are used. The .0001 mfd. fixed by-pass condenser may not be required with these transformers if the metal shell is connected to "A" minus.

Before the neutralizing condenser is adjusted a loud howl should be heard when both tuning condensers tune their respective circuits to the same wave-length.

The variable condenser rotor plates are indicated by the arrowheads.

If a three to six and one-half volt "C" battery is placed at "X," it will be possible to use as high as 135 volts in the amplifier "B" battery.

Q. 2. Why are the amateurs permitted to send "CQ" in code a dozen or more times, at a wave-length of 80 meters, when the Government has requested that these letters be sent only a few times?

A. 2. This regulation was intended to apply to spark transmission, not C.W. (continuous wave) transmission with inductively coupled antenna systems. Due to the extremely sharp tuning at such short wave-lengths, it is necessary that the receiving set be adjusted very slowly. For this reason the amateurs have been permitted to repeat this general call many times before signing the letters assigned to the sending station. This gives the receiver a chance to properly tune in the calling station, an operation requiring much more time on the short wave-lengths than at the longer wave-lengths or when the continuous waves are interrupted. Such interrupted or modulated signals are more readily tuned in, but this type of transmission is not permitted on the wave-length band you refer to.

Gould's Dial-Less Radio Invention

(Continued from page 2225)

to right and back again in the rear of a ground glass set in a large rubber panel.

To operate the set, it is necessary only for a person to take up the handle switch, press a lever in it and a circle of light the size of a ten-cent piece appears on the ground glass dial and starts traveling across the dial. The motion at the same time changing the inductances and capacities inside the cabinet so that stations come in consecutively on the glass, as the small light travels across it, as in turning dials in the regulation radio set.

When the station desired is reached on the glass, the operator releases the switch and permanently marks on the ground glass the setting for the station. An aid to this is the pilot light in back of the writing. The

LOOK HERE FOR THE RED STRIPE

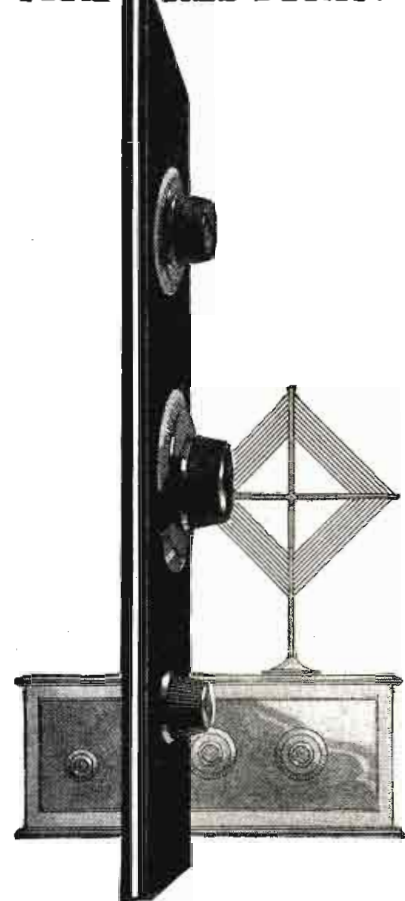

Used by the United States Navy and Signal Corps for over nine years. Dilecto is the strongest, safest radio panel that can be made. Look for the identifying "Red Stripe" that sets apart Dilecto from its imitators.

THE CONTINENTAL FIBRE CO.
FACTORY: NEWARK, DELAWARE

Service on Dilecto, also Contex, Conite, and Vulcanized Fibre, from:

NEW YORK 250 Park Ave., CHICAGO Wrigley Bldg. PITTSBURGH Farmers Bank Bldg.	SAN FRANCISCO 75 Fremont St. SEATTLE 1041 6th Ave. So. LOS ANGELES 307 So. Hill St.
--	--

Offices and Agents Throughout the World

Dilecto

(distinguished by its red stripe)

Fits Grid Leak any mounting

FRESHMAN PLUNGER
TYPE VARIABLE GRID LEAK
was designed especially for the non-technical set owner who can replace in an instant the fixed grid leak with this new, efficient cartridge type Variable Grid Leak without requiring the change of a single wire.

At your dealer or by mail post-paid. Write for free catalogue.



65c

240 W. 40th St.
New York

Insure your copy reaching you each month. Subscribe to RADIO NEWS—\$2.50 a year. Experimenter Publishing Co., 53 Park Pl., N.Y.C.

Music Master
Resonant Wood
Insures
Natural
Tone
Quality



Connect Music Master in place of headphones. No batteries. No adjustments.

Music Master Makes any good set BETTER

Music Master transforms mere radio reproduction into artistic re-creation. Mere assertion? No! Plain fact—because:

THE piano's sound board, the violin and 'cello, and Music Master's amplifying bell are all of wood—because wood produces *natural* tones.

Heavy cast aluminum eliminates over-vibration, develops sound without distortion and imparts a *unique* tonal brilliance.

This balance of resonant wood and non-resonant metal preserves, reproduces and re-creates the natural qualities of instrument and voice—and makes

Music Master the Supreme Musical Instrument of Radio, for which there IS no substitute.

Buy Music Master and be safe—buy Music Master and improve your set—buy Music Master and exchange mere radio receiving for the artistic enjoyment of radio re-creation.

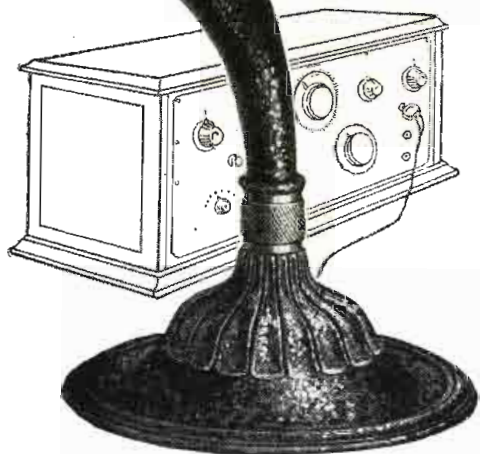

Model VI, 14" Wood Bell \$30

Model VII, 21" Wood Bell \$35



Model VIII, Mahogany Cabinet with full-floating Wood Bell \$35



Model V, Metal Cabinet, Mahogany Finish, Wood Bell \$18

Prices of all models slightly higher in Canada.

Music Master Corporation

Makers and Distributors of High-Grade Radio Apparatus
Tenth and Cherry Streets

Chicago PHILADELPHIA Pittsburgh
Canadian Factory: Kitchener, Ontario

Music Master

RADIO REPRODUCER

FROST RADIO

Parts of Quality

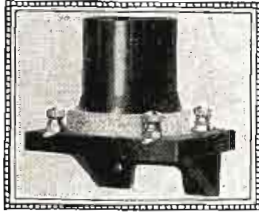

FROST-RADIO

No. 618 BAKELITE Shock Absorber Single Socket.....\$1.25

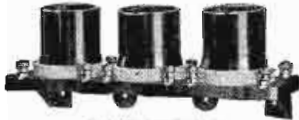

FROST-RADIO

No. 619 BAKELITE Shock Absorber Gang Socket.....\$3.25

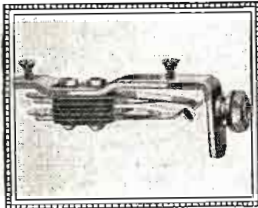

FROST-RADIO

PAN-TAB Jacks, in all types for every circuit.....70c to \$1.00



FROST-RADIO

No. 608 Push-Pull Battery Switch, BAKELITE Knob.....30c



FROST-RADIO

No. 20-P. Musette Phonograph Attachment, complete.....\$5.50



For FREE 48-Page Catalog of all FROST-RADIO Products, address Dept. 10F506.

HERBERT H. FROST, Inc.
314 W. Superior Street CHICAGO
NEW YORK CITY CLEVELAND
KANSAS CITY LOS ANGELES
Export Office: 314 W. Superior Street, Chicago

motor provides such slow motion that it actually is in itself a vernier action, nothing else being required to clear up reception. When the light has traveled entirely across the dial, the operator simply reverses the double pole switch and the glass action of the pilot light is reversed.

In appearance the set is extremely neat, as there are no outside connections beyond a snap switch to light the vacuum tubes and furnish plate voltage. In place of the usual dials and rheostat knobs is the front glass, which is graduated with spaced marks giving a pleasing effect. The control switch resembles a button hanging switch for an overhead fixture except that it comes out of the front panel of the radio set.

The Inventions of Reginald A. Fessenden

(Continued from page 2218)

ing and that he thought he would have to give me a job as assistant tester. Practically this meant scraping the conductors sticking out of the ends of the iron pipes of the mains and feeders while the tester put the galvanometer on them for grounds, or located grounds which had developed in mains already laid. It was harder work than it sounds, but I had got a start and was putting in my lunch hour in working at electrical theory and analytical mechanics, which we had not had at college. Acting on the principle that one should always leave one's chief free to go away at any time with the knowledge that his work will be taken good care of during his absence, I managed to simplify operations and lay out the work so that our section was always ahead of schedule. So my chief got his promotion to chief tester and I succeeded him. Then he went to Schenectady and I became chief tester and before the end of the year inspecting engineer for the third section of the work. They were putting down the telephone conduits in the same trenches. Crimmins, a well known New York contractor and a fine man, was in charge of that work. There were about 3,000 men employed, and occasionally at first and more often later it fell to me to take charge of a portion of the telephone conduit work as well, which gave useful experience in handling men. The sum of my experience in this line, obtained then and later, is that the one thing which the men working under one appreciate above all else, and substantially the only thing, is that the "boss" is not influenced by prejudice or favor and that under all circumstances they will have a "square deal." One of my foremen was Captain Duncan, the famous athlete and wrestler. Later I was to train for a time at the place of and under his more famous rival, Muldoon, "the Iron Man."

The only exciting part of the work was getting up defective mains without permits. Once the street was closed it was a heavy fine to open without a permit, which was hard to get, took much time and generally a money payment. It was a matter of high strategy to open a street, replace half a dozen lengths of main and get the street into innocent looking shape again between police patrols.

INTERIOR CONDUIT

Much of the laying was on Madison avenue and Fifth avenue, which were then the fashionable residence districts, and many, perhaps most, of the residents walked to or back from their offices and would stop and chat about the new lighting system; a number of acquaintances were made in this way. To many the mention of this may seem trivial, but in fact it later was often of use. Young men should, while always tak-

HOW ABOUT YOUR JOBBER ?



Does he wholesale exclusively?

Does he refer all customers' inquiries to his dealers?

Does he carry reputable apparatus that is nationally advertised and in demand?

Does he carry ample stock to insure prompt delivery?

Does he sell all his stock to dealers—even when material is scarce?

HOMMEL DOES !

Write today for Hommel's Encyclopedia of Radio Apparatus 266-S. It's free and will help you.

WHOLESALE **LUDWIG HOMMEL & CO** EXCLUSIVELY
928 PENN AVENUE PITTSBURGH, PA.



The Traffic Cop of the Air

Make your set selective—separate the interfering station by simply putting the Traffic Cop on guard. The Ferbend Wave Trap will tune out interfering local stations, no matter how troublesome. Never reduces, but nearly always increases volume.

Designed and manufactured complete by us after years of careful experimenting. It is not to be confused with imitations, hastily assembled from ordinary parts. The price is \$8.50. Shipment is made Parcel Post C.O.D. plus postage, or postpaid on receipt of price. Order today.

Send for FREE booklet
FERBEND ELECTRIC CO.
25 E. So. Water St., Chicago, Ill.



Poughkeepsie N. Y. Gentlemen: The Wave Trap ordered from you some time ago is all that you claim for it and then some. It not only keeps out the other station that is causing the interference, but it also seems to act as a clarifier of the incoming station. (Signed) W. E. Wittse.

Keep your Radio set Clean !

You must have a NODUST to keep your set working its best! Each stroke of a NODUST forces a blast of compressed air into all the hard-to-get-at places and cleans out every speck of dust and dirt in a jiffy.

If your dealer has not received his NODUSTS yet, we will send you one on receipt of one dollar. Satisfaction guaranteed.

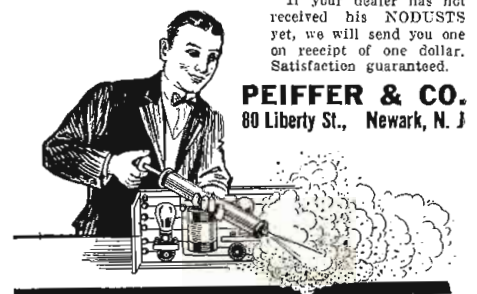

PEIFFER & CO.
80 Liberty St., Newark, N. J.

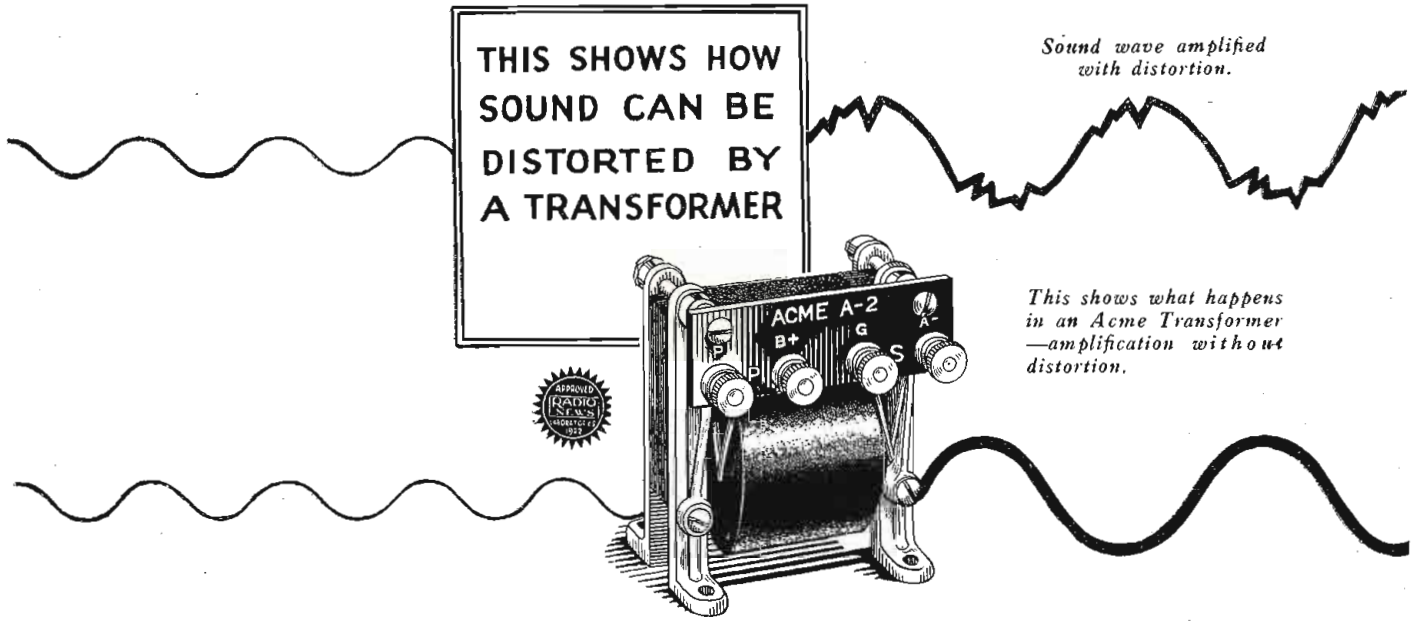

With ACME transformers you get Amplification *without distortion*

WHEN you put a lot of time and money into a radio set you want to be sure that it will give the best results. You want to know that you can bring in the distant stations loud and clear, so that a roomful of your friends can enjoy it. You want amplification, but above all you want Amplification without Distortion. To do this, use amplifying transformers that increase the sound without spoiling the quality.

The Acme A-2 Audio Frequency Amplifying Transformer is the result of five years of research by Acme Engineers. Whether you have a neutrodyne, superheterodyne, regenerative or Reflex, the Acme A-2

Audio Transformer will make your set better.

If you are not getting loud, clear, undistorted radio, change to Acme Transformers and note the difference.

Each Acme Transformer is tested in our factory and bears a guarantee tag; there are no Acme "seconds." Use Acme Transformers in the set you build. Insist on them in the set you buy. One of the big reasons why the Acmeflex Kitset gives such excellent results is that it uses Acme Transformers.

Send the coupon today for our 40-page book, "Amplification without Distortion," which shows how to get the best results out of your set through proper amplification and also contains a number of valuable wiring diagrams that will help you build a set. Enclose 10c. with coupon.

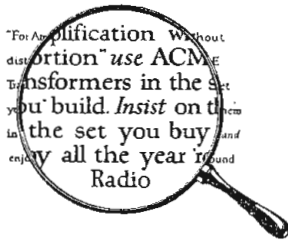

"For Amplification without distortion" use ACME Transformers in the set you build. Insist on them in the set you buy and enjoy all the year round Radio

The transformer is the magnifying glass of radio

Acme Transformers are sold by all radio dealers.

ACME APPARATUS COMPANY
Transformer and Radio Engineers and Manufacturers
Dept. K4, Cambridge, Mass.

ACME

~ for amplification

ACME APPARATUS CO.,
Dept. K4, Cambridge, Mass.
Gentlemen: I am enclosing 10 cents. (U. S. coin or stamps), please send me a copy of your book, "Amplification Without Distortion," which please send to:

Name

Street

City..... State.....



Registration applied for

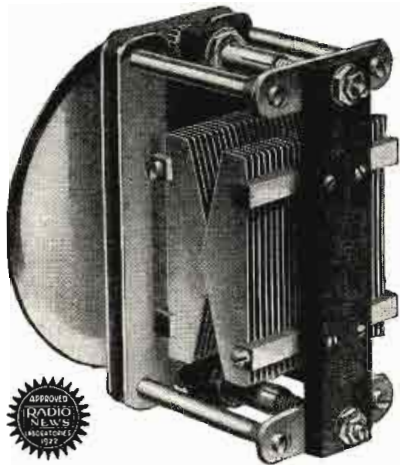

APPROVED
RADIO
NEWS
MAGAZINE'S
TEST
Pat. Pending



Eliminates Body Capacity

SPECIAL design eliminates body capacity effects for all time. The frame forms a shield about the plates, so efficient that Wade condensers may be used in the most sensitive circuits. This design is exclusively a Wade development and so vital in tuning efficiency that it's destined to change the entire phase of condenser construction.



Simplifies Close Tuning

UNIQUE design of plates and their angular operation assures straight line wave length—spreads all stations evenly over the dial. Any station can be quickly located, once a given station of known wave length is recorded. Special 360° dial, supplied with all Wade condensers, spreads the scale and gives more tuning range between stations.



SQUARE LAW
CONDENSER UNIT

All sizes, complete with 4-inch vernier dial, for:

- Short wave .000125 mfd.\$7.50
 - Tuned Radio Frequency, .00025 mfd. 7.75
 - Super-Heterodynes .0005 mfd. 8.00
 - Oscillator, Wavemeters, etc. .001 mfd. 8.50
- At your dealers, otherwise send purchase price and you will be supplied postpaid.

Wade Manufacturing Company, Inc.
1819-A Broadway New York City



ing particular care not to obtrude themselves, make as many acquaintances as possible. If it comes to doing business later, even if the man has forgotten your name or never knew it, if he remembers your face he will not be on the defensive as he would be to a stranger. And the older the acquaintanceship the stronger apparently is the effect. I have often met men whose attitude to strangers suggested that, for protective mimicry, they had assumed the winter plumage of a cake of ice, but who thawed out in the most astonishing way on being reminded, casually, of some trivial incident of a score of years before.

It was meeting Mr. J. P. Morgan in this way that led to what may perhaps be called my second invention. He, and some others in this section, had private lighting plants, and it was my unwarranted use, when testing the mains, to send an assistant to shut down any private plants which might be running nearby, as they threw out the galvanometer readings. Mr. Morgan happened to be the one on this occasion whose light had been shut off while he was reading and he had come out to see me about it, in a not entirely amiable temper. I explained that I would be through in a very short time and he asked if I would come in and advise him about insulating his house circuits as he was having considerable trouble and no one seemed able to tell him what to do. He and a charming young lady whom he introduced as his daughter showed me all over the house and explained that they had had their wiring renewed a number of times, necessitating re-plastering each time, and had had several small fires, and could I not tell them how to fix things permanently. They had been using heavy rubber covered wire embedded directly in the plaster, as was the practice at that time. I suggested using galvanized pipe, lined with waterproofed paper tubing, and drawing the rubber covered wire into that. Some objections suggested themselves, but were solved satisfactorily, sketches were made and dimensioned, and before long this system of interior conduits was installed. In after years Mr. Morgan helped me very materially in several matters I wished to put through.

APPOINTMENT TO EDISON LABORATORY

The day before Christmas, 1886, I was able to report, to the great satisfaction of the Edison Machine Co., who had feared considerable and expensive delay, that my section was complete, tested and ready to connect. They told me they would like me to come to Schenectady with them, but that, knowing my wish to work under Mr. Edison, they would send me to his laboratory as one of his assistants to carry out some experiments on dynamo development which he was making for them. I could have either position. It is not necessary to say which I chose.

Harmonizing Ideals and Practice

(Continued from page 2251)

sistance of this loop can be made as low as we please, by simply increasing the wire size indefinitely. There is a point, however, beyond which it does not pay to increase the wire size. The resistance drops rather rapidly as we approach No. 8 wire, but as we increase the size beyond this, it decreases very slowly. At the same time the mechanical difficulties involved in supporting the heavier wire increase as well as the expense involved.

IDEALIZATION

These ideas should be borne in mind by

This NEW Super-Horn

Brings Magic Clearness to Radio

The new Kellogg *Symphony* Reproducer is a new-type horn recently developed by our experts—based on the magnetic diaphragm principle. It brings to radio a marvelous tone-quality, a beauty you have never heard before. Attaches to any set and can be adjusted for the particular "volume" requirements of the set.

At all radio dealers. Ask for it by name. See it, hear it—compare!

Kellogg Switchboard & Supply Co.
Chicago, Illinois
KELLOGG
Symphony
Reproducer



With Every Kellogg Radio Part, Use is the Test.

THE LARGEST RADIO STORES IN AMERICA

Hook-ups!
All the latest and best hits in our new **RADIO CATALOG**

FREE

JUST OUT! Our new 1925, ninety-six page Catalog including all the best and latest Kits, Parts and Accessories. Also our new 32 page bargain section — Write for your **FREE** copy today!

SAVE MONEY! We buy up manufacturers' jobber, and dealer surplus and bankrupt stocks—but only brand new fully guaranteed, nationally advertised apparatus. Our enormous buying power permits us to pay spot cash and get rock-bottom prices—even way below manufacturer's costs.

RADIO CHICAGO SALVAGE STOCK STORES

509 So. State St., CHICAGO, ILL., Dept. R.N.6

PERSONAL STATIONERY 200 SHEETS and 100 ENVELOPES \$1.00

Printed with your Name and Address

Clear, white bond paper, with envelopes to match. Your name and address printed in beautiful, rich blue ink on both paper and envelopes, and sent to you postpaid for only \$1.00. (West of Mississippi river and outside of U. S. \$1.10.) If inconvenient to send the money, we will ship C. O. D. Money returned if you are not more than satisfied. Order today. Write name and address plainly.

AGENTS MAKE BIG MONEY taking orders for us today for our agent's proposition.

ELITE STATIONERY COMPANY
7056 Main Street Smethport, Pa.

Thorola

THE
SPEAKING
LIKENESS

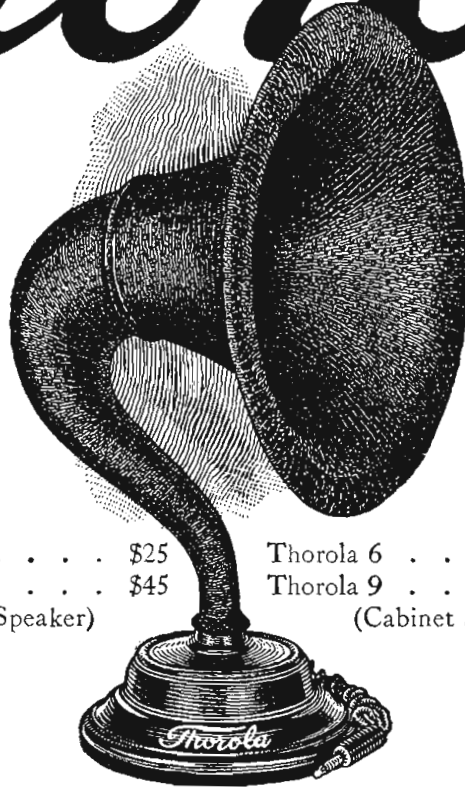

Thorola 4 \$25
Thorophone \$45
(Powerplus Speaker)

Thorola 6 \$15
Thorola 9 \$40
(Cabinet Speaker)

In No Other Speaker

No other speaker has a reproducing unit which lends itself so readily to scientific precision in manufacture. The greater size of the Thorola unit permits closer adherence to acoustic laws, just as a concert grand is truer in tone than a toy piano.

No other speaker duplicates the Thorola Controlled Mica Diaphragm, which first brought radio the most highly perfected method of musical reproduction.

No other speaker has the Separix, which enables Thorola to separate each note distinctly from every other note, preserving intact all the shadings and overtones which make the difference between music and noise; which create natural voice. And Thorola has the horn of

Thorite, a compound developed only in Thorola laboratories to overcome the natural resonance and consequent interference experienced with horn materials made by Nature. Thorite is most scientific—and most beautiful.

Then there is the exclusive Thorola Synchronizer. It virtually “tunes” each Thorola with each particular receiver, putting this loud speaker in perfect balance in the circuit. No other way assures perfect harmony.

It takes every one of these great advancements; it takes all the facilities and knowledge of America’s pioneers in the loud speaker art to give Thorola its superiority.

The difference is decisive. Thorola today is the accepted sign that radio is being heard at its best.

The Thorola 10-day Refund Warranty is a guarantee to every user that Thorola will fulfill every claim. No external battery. Plug in same as head phones.

REICHMANN COMPANY, 1725-39 W. 74th Street, CHICAGO



Get this handy radio guide to the construction of standard practical receivers

The radio constructor who wants to be safe and sure in the building of his radio receiver, whether it be a crystal set or some super circuit, should have this E. I. Company book at his side. This book contains a varied selection of the most practicable radio hookups in use today. Each hook-up is described in detail starting from the general characteristics of the set and then giving wiring diagram and all further information that is necessary to the final completion of the receiving set.

This book, like all E. I. Company books, is thoroughly practical and modern in every respect. It is written in plain language so that every one can understand it and all wiring diagrams are made as simple as possible.



SOLD AT ALL NEWSSTANDS AND RADIO STORES

Book No. 2 How To Make Practical Radio Receiving Sets, size 5 1/4 x 7 3/4 inches, 64 pages. Profusely illustrated, bound in stiff cardboard two-color printed cover.

You can obtain one of these books at your local Radio Dealer or by writing direct and enclosing 25c to

E.I. Company

Sole Distributors

CONSRAD COMPANY, Inc.
233 Fulton St., New York, N.Y.

all, regardless of whether they are dyed-in-the-wool radio bugs or not; as a matter of fact, all phases of life should be guided by them. There are many things that manufacturers would like to do, which many times they cannot do, because of things which are not in their control. For instance, it is ridiculous to hope that a condenser manufacturer could guarantee the spacing between his plates to be within two-thousandths of an inch, whereas the metal plates which he buys elsewhere may vary in thickness more than this. He could have the plates made more accurately if he wanted to have them specially made, but it would make a decided increase in his costs and a consequent increase in the retail prices.

The moral of it all is, be reasonable. Extremes are rarely good, and it is in the happy medium that we find most satisfaction. Do not expect the world for your money, and before condemning anything, first be sure that you are acquainted with all the facts and circumstances connected with the matter.

A History of Radio Patents

(Continued from page 2237)

this to be would be invaluable for long distance point-to-point stations, like those proposed for the British Imperial Chain. However, the 1922 report of the Wireless Telegraphy Commission recommended for these stations aerials of a symmetrical type.

T. L. Eckersley tells us that the directive effect of an "L" aerial "is very small" and is almost entirely destroyed when the earth screen is used, while Professor Fleming states that theory points to the fact that "any bent oscillator, however arranged, has no asymmetry of radiation for very large distances." However, in *The Times Engineering Supplement* of March, 1919 (some years later), Fleming tells us that such a directional aerial "is now generally employed in long distance high-power stations which are intended to communicate with a corresponding distant power station," and that it radiates most strongly in its own plane and away from its open end.

Marconi further points out in his specification that, while aerials of this type are preferably earthed only at one end, "they may be connected to earth at their tail ends or at other points, and inductances and condensers may be inserted in these earth connections." (Fig. 12.) This, as has been pointed out by Mr. E. H. Shaughnessy, of the British Post Office, constitutes a pretty full disclosure of the multiply-tuned aerial, which was later patented to Alexander (Br. Pats. 130,064, 142,610; U. S. Pat. 1,360,167/8), but according to C. S. Franklin when "correctly adjusted as regards phase" such an aerial radiates most strongly in a direction at right angles to its length, which is not in accord with the Marconi claims.

In the circumstances, one is not disposed to quarrel with Professor Howe's statement that the action of this Marconi "directional" aerial is very complex (Br. Pat. 14,788/05. See also Br. Pats. 3,127/06 and 20,230/09.)

A British patent was awarded to W. P. Thompson, as agent for a German firm, on a flat-top aerial with duplicate counterpoise. (Br. Pat. 14,221/05.) (Fig. 13.)

Professor Max Wien, of Germany, invented the quenched gap discharger (what was practically a quenched gap was patented to T. B. Kinraide, of Boston, in 1898),

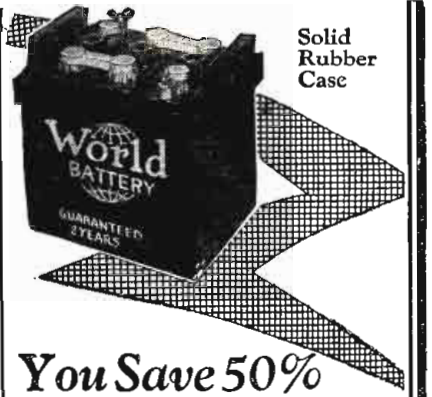

You Save 50%

World 6-Volt Storage Batteries are famous for their guaranteed quality and service. Backed by years of Successful Manufacture and Thousands of Satisfied Users. You save 50% and get a

2-Year Guarantee Bond In Writing

World Battery owners "tell their friends." That's our best proof of performance. Send your order in today.

RADIO BATTERIES
6-Volt, 100-Amperes . . . \$12.55
6-Volt, 120-Amperes . . . 14.25
6-Volt, 140-Amperes . . . 15.00

AUTO BATTERIES
6-Volt, 11-Plate . . . \$12.25
6-Volt, 13-Plate . . . 14.25
12-Volt, 7-Plate . . . 17.00

SEND NO MONEY

Just state battery wanted and we will ship day order is received, by Express C. O. D., subject to your examination on arrival.

Extra Offer: 5% discount for cash in full with order. Buy now and get a guaranteed battery at 60% saving to you.

WORLD BATTERY COMPANY
1219 S. Wabash Ave., Dept. 10 Chicago, Ill.

Solid Rubber Case
Approved and Listed as Standard by Leading Authorities including Radio News Laboratories, Popular Science Institute of Standards, Popular Radio Laboratories, Radio Broadcast Laboratories and Lefax, Inc.

Solid Rubber Container
Now Standard equipment on all World Storage Batteries. No more leakage or breakage of jars or rotting of box.

World

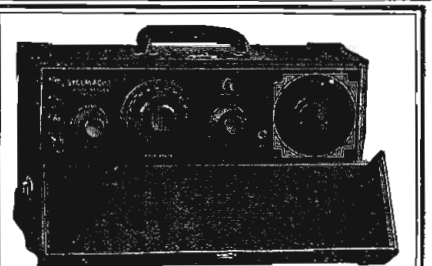

The Famous Truly Portable TELMACO P-1 Receiver

Four Tubes Do the Work of 7
Coast-to-coast reception. Aerial, loud speaker, and batteries self-contained. Carry from room to room—take it anywhere. Size 8" x 10" x 18". Total weight only 26 lbs. Complete with tubes and batteries, \$125.00 \$143.50. Receiver only

P-1 Kit Saves You Money!
In response to a popular demand we now offer the Telmaco P-1 Receiver in kit form. This contains all parts, as built by us, including case, drilled and engraved panel, and illustrated instructions. \$80.00 Complete kit

Ask your dealer or write us. Descriptive folder free.
Radio Division:
Telephone Maintenance Co.
20 So. Wells St. Dept. B, Chicago, Ill.

TELMACO
Quality Radio Exclusively Established 1918



Marshall-stat Price \$1.50
THE IDEAL RADIO RHEOSTAT
Mfgd. by Marshall Electric Co., 3235 Locust Boul., St. Louis, Mo.

SUPER-HETERODYNE
Ultradyné—Haynes Griffin—Remler
Dealers: Send for Discounts
HUDSON-ROSS
123 W. Madison St. Chicago

Balkite Battery Charger.
Charges 6-volt "A" storage
batteries.

Price \$19.50
West of Rockies, \$20
In Canada, \$27.50

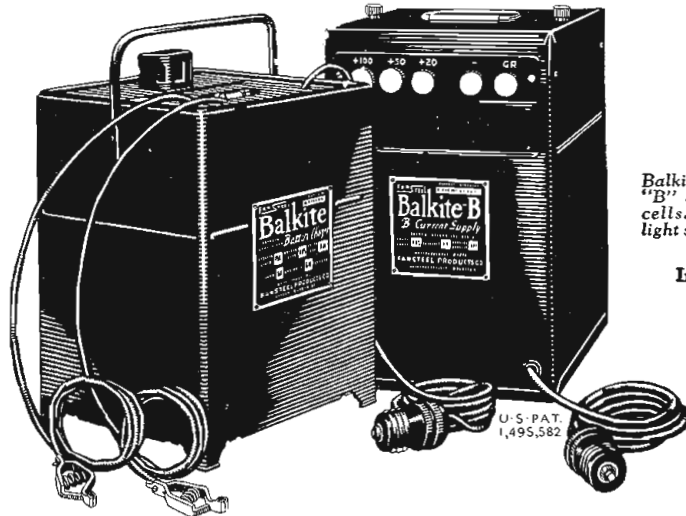

Balkite "B"—replaces
"B" batteries and dry
cells. Operates from
light socket.

Price \$55
In Canada, \$75

U.S. PAT.
1,495,582

Balkite Radio Power Units

*give your set greater clarity,
distance and volume*

Your radio set will perform consistently only if your power supply is unfailing. Balkite Radio Power Units provide a convenient power supply that furnishes a constant, uniform voltage to both "A" and "B" circuits. The Balkite Charger keeps your "A" storage battery charged and operating at full efficiency. Balkite "B" replaces both "B" storage batteries and dry cells, and supplies plate current from the light socket.

The Balkite Battery Charger

and Balkite "B" are based on the same principle. Both are entirely noiseless in operation, have no moving parts or bulbs, have nothing to adjust, break or get out of order. They do not create disturbances in either your set or your neighbor's, require practically no attention, and can be put in operation at any time by merely connecting to the light socket. Their current consumption is very low. Both are guaranteed to give satisfaction.

Sold by leading radio dealers everywhere

FANSTEEL
Balkite *Radio*
Power Units

BALKITE BATTERY CHARGER.— BALKITE "B" PLATE CURRENT SUPPLY

Manufactured by FANSTEEL PRODUCTS COMPANY, Inc., North Chicago, Ill.

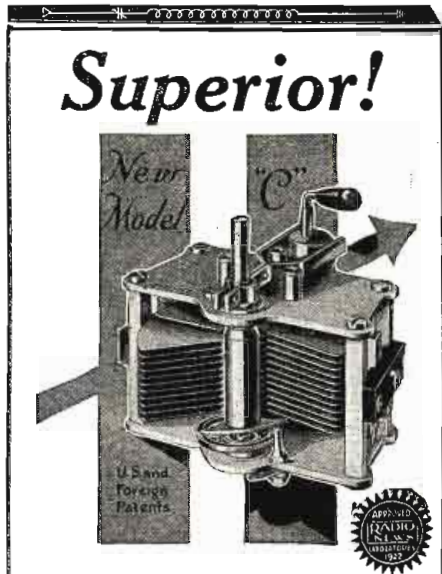

Superior!

HAMMARLUND superiority from the standpoint of the user is expressed in *Performance*. To the manufacturer it means even more. It extends back to perfection in basic design and materials.

For example, the soldered brass plates in Hammarlund Condensers have a high copper content, giving them greater conductivity and reduced series resistance. This means increased audibility on distant signals. They are of Patent Level Brass, specially stretched for flatness and rigidity.

This is just one of the nine points of superiority in Hammarlund Condensers you should investigate. All Capacities; Plain and Vernier.

Sold by the Better Radio Dealers.

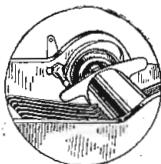

Write for Interesting Descriptive Folder.

Hammarlund Mfg. Co.
424-438 W. 33rd St., New York

For Better Radio
Hammarlund
PRECISION
CONDENSER

Copyright March 17, 1925.

M & M



Jobbers and Dealers, write for our special proposition, including attractive display board illustrated above for attaching samples. Furnished gratis to dealers.

5" Wall Insulator . . . \$.60
4" Lead in Insulator50
10" Lead in Insulator80
20" Lead in Insulator for thick walls1.50
Send for our big catalog of auto supplies and radio parts, sets and supplies.

The M. & M. Co., 500 Prospect Avenue Cleveland, Ohio

(U. S. Pat. 623,316/98; Br. Pat. 5,518/99) (Br. Pat. 5,455/05) which used to replace the rotary discharger of Tesla. (Max Wien received the Nobel Prize for Physics in 1911.)

1906. H. H. C. Dunwoody, of Washington, D. C., invented the carborundum detector and secured a broad patent covering the use, as a detector, of a non-metallic crystalline material. This detector is still very popular and deserves to be even more so, as it is by far the most simple and reliable for local broadcast receivers. Prior to the advent of the triode, the only serious competitor of carborundum in commercial use was the electrolytic detector, and the former was in far greater favor. Even today, carborundum is often used in conjunction with vacuum tubes, and it is very effective for short distance reception, even when used without a battery. (U. S. Pat. 837,616; Br. Pat. 5,332/07.)

G. W. Pickard, of Amesbury, Mass., invented the silicon detector and an efficient way of mounting all crystals. Silicon has one advantage over carborundum in that it is used without a battery, but it is less stable than carborundum. (U. S. Pats. 836,531, 877,451 and 13,798 (re-issue 1914); Br. Pat. 18,842/07.) The U. S. re-issue (expired) referred to above was especially important because it covered the practice of embedding a rectifying member in a readily fusible metal.

Lee DeForest applied for a patent on the use of a "B" battery in connection with a diode, according to Fig. 14. (Br. Pat. 5,258, March 3, 1906; U. S. Pat. 824,637.)

In the following October, DeForest applied in America for another patent on a triode "for amplifying Feeble Electrical Currents." Figs. 15 and 16 are taken from the specification of this invention, and represent a received signal amplifier and an input telephone amplifier respectively. (U. S. Pat. 841,387.) According to the specification of this invention, in which, by the way, is made the first proposal to use a metal filament, DeForest assumed that it functioned by reason of the relative movement of the electrodes under the influence of the currents to be magnified. In the course of legal proceedings in 1916, the American Marconi Company admitted infringement of this patent.

In this year Ferdinand Braun disclosed how a heart-shaped polar radiation diagram could be obtained by a combination of aerials.

1907. Lee DeForest invented the triode detector (Fig. 17) (U. S. Pat. 879,532; Br. Pat. 1,427/08), which, like its thermionic predecessors, created little interest and had little bearing on the art for several years. Ultimately, however, as is well known, the application and development of the triode revolutionized radio and created a new technique. It rendered many other promising inventions more or less abortive, and caused many thousands of dollars in apparatus to be consigned to the discard. On the other hand, it provided an instrumentality for putting into practical effect other inventions of importance, such as, for instance, Fessenden's "interference" receiver.

In 1911 or 1912, when there became due the first renewal fee on the British DeForest triode patent, that fee was not forthcoming, and the patent lapsed. However, as proprietors of the diode patent, granted to Fleming, the British Marconi Company had control of the situation in the United Kingdom until 1918, and they would have continued their control had they not been unsuccessful in their attempt to secure the extension of Fleming's patent.

In 1916 the American Marconi Company admitted infringement of this patent (U. S. 879,532 to DeForest) also; nevertheless, there has been much controversy—even in

ANTENELLA

No Aerial or Antenna Needed

The Complete Efficient and Economical Aerial



Why pay \$10 Only \$1.25

or more to have an aerial spoil the appearance of your home? Antenna eliminates all unsightly wiring, lightning arresters, etc., and precludes the possibility of dangerous grounding on a power line. It also stops "canary bird" re-radiation from nearby oscillating sets interfering.

ANTENELLA is not only a real distance getter, but also overcomes troublesome static.

At your Dealer, otherwise send purchase price and you will be supplied postpaid.

Chas. Freshman Co. Inc.
Radio Receivers and Parts
FRESHMAN BUILDING
240-248 WEST 40TH ST - NEW YORK, N.Y.

At your dealer \$1.25

WALBERT MFG. CO., CHICAGO

CARTER "IMP" BATTERY SWITCH

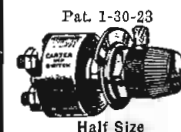

Pat. 1-30-23

Half Size
65c

Note the single hole mounting, the enclosed compact construction, quiet operation, the "On and Off" name plate, pointer and knob. You'll not find its equal.

Any dealer can show you why.

In Canada—Carter Radio Co., Limited, Toronto, Canada

Carter Radio Co.
207 S. STATE STREET
CHICAGO

INSIST UPON
AMSCO
RHEOSTATS
FOR ALL TYPES OF TUBES

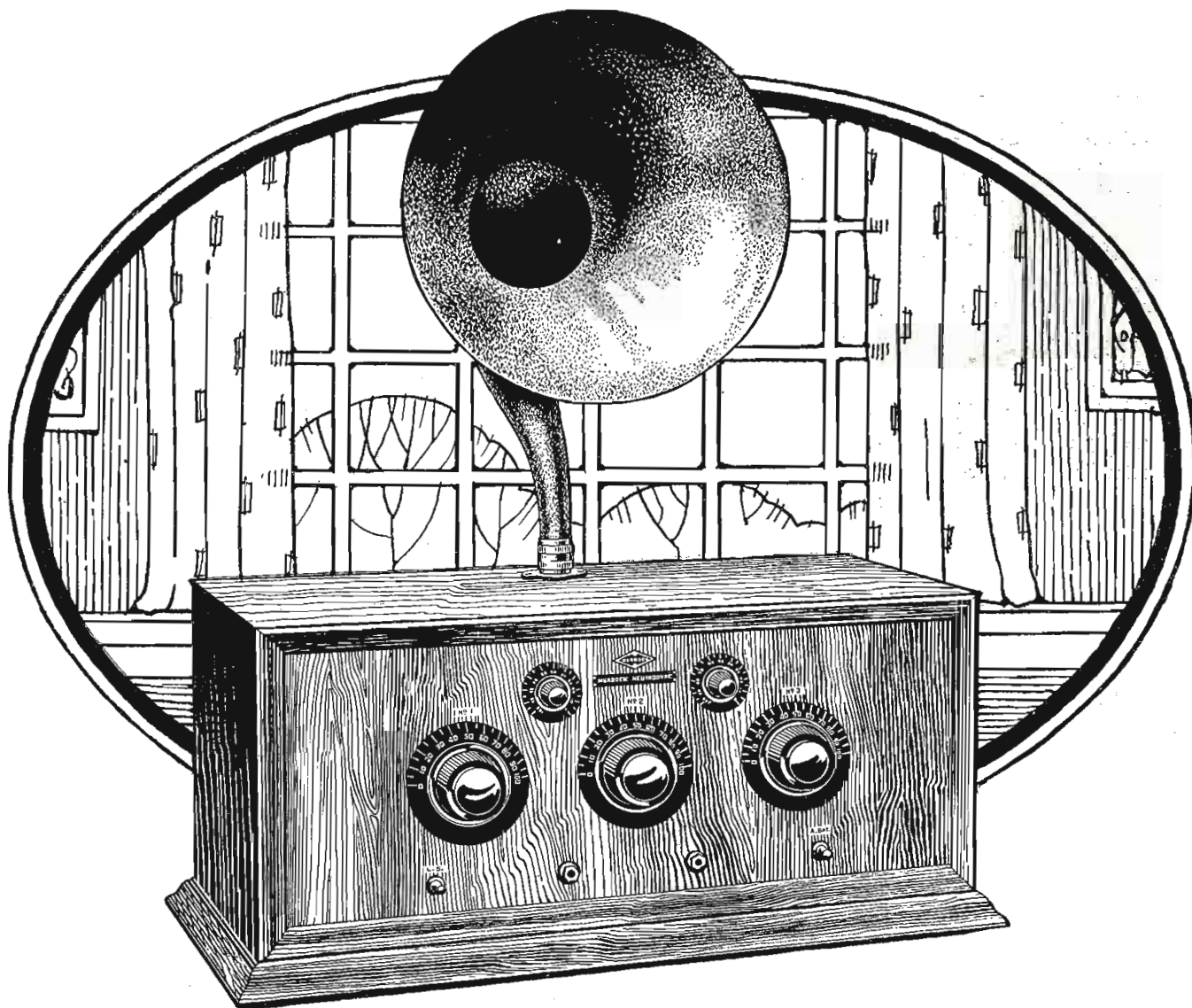

Hear the Murdock Neutrodyne

\$100
with built-in
Loudspeaker

\$92.50
without

SEE the beauty of its cabinet. Hear its pure, sweet tone. Notice how easy it is to operate. Compare these things with any other hundred dollars' worth in radio. It is the Murdock Five Tube Neutrodyne. There is space in the cabinet for the "B" Batteries. The only accessories necessary are batteries and tubes. A "Murdock" set is backed by twenty years of successful experience in making radio apparatus.

WM. J. MURDOCK COMPANY
Dept. A4, Washington Ave., Chelsea, Mass.

Branch Offices: New York, Washington, Chicago,
Los Angeles, San Francisco, Seattle



MURDOCK RADIO PRODUCTS

Standard since 1904

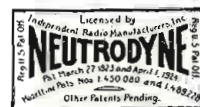

"Last night we heard the sweetest voice!"

Few boast of having heard a powerful voice. Radio has grown up. It is now something to listen to, not to marvel at. We are now in the cycle of TONE!

The other day a man said he was just realizing that he had a hundred dollars' worth of set and a dollar's worth of horn! His next move is to balance up his set with a good speaker.

The BRISTOL has all the volume you will ever want, but its fine point is TONE. It is good to listen to. The notes come in in tune. You receive a wealth of music from which the cream of tone has not been skimmed.

BRISTOL AUDIOPHONE LOUD SPEAKER

For \$20, \$25 or \$30 you can get a Bristol Speaker, and there are others for less. Ask your dealer to send one out to the house. And let us send you folder No. 3022-S; it tells why the Bristol is the horn of tone.

THE BRISTOL COMPANY
Waterbury, Conn.



Day-Fan RADIO

A Year Ahead

The set with the air telephone directory
The Dayton Fan & Motor Company
DAYTON, OHIO

DUOTRON \$12

Floating Battery Charger

Durkee-Thomas Products Co.
1228 Folsom Street--San Francisco
115 West 16th Street--Los Angeles

Insure your copy reaching you each month. Subscribe to RADIO NEWS—\$2.50 a year. Experimenter Publishing Co., 53 Park Pl., N.Y.C.

some text-books—relating to the value of DeForest's contributions to the evolution of the triode. It has been said that he did not understand the theory of his invention why or how it functioned as it did. There may be some evidence to support this contention, but what does it signify? With the exception of the specifications of inventions of men like Lodge, Pupin, Elihu Thomson and Duddell, there are few, not of a purely mechanical order, that do not indicate some such lack of understanding. One prefers not to direct attention to examples, but they abound in connection with any new art.

It may be pertinent here to quote a few expert and disinterested opinions on the merit of DeForest's invention. W. R. Cooper, when editor of *The Electrician*, London, said: "In the field of radiotelegraphy Professor Fleming's valve receiver introduced an important principle. An extension of work in this direction by Dr. DeForest led to the audio receiver, and thence to the audion amplifier. The latter bids fair to play an important part in telephony, and has already rendered it possible to transmit speech across the Atlantic by radio-telephony."

Professor Howe says: "No single invention has done more to revolutionize radiotelegraphy than that of the audion. Little did Dr. DeForest imagine, when he placed a control electrode first on the outside of the bulb of a Fleming valve and then inside the bulb as a grid between the anode and cathode, that he was making the most important step in the whole history of radiotelegraphy, but such was the case no one can now have the slightest doubt." This is taken from the Marconi Year Book for 1921, in which are biographical notes of both Fleming and DeForest. Of the former we read that he was responsible for "a pioneer invention of unusual utility, and one that has enormously aided the development of wireless telegraphy," with which we agree; but no invention is credited to the latter—which is hardly fair.

After making some less flattering comments on the inventions of DeForest, Professor J. H. Morecroft, of New York, writing in the *Radio Broadcast* of August, 1922, says: "It is to be pointed out, however, that little as DeForest contributed to an explanation of his device, the thing which he actually did, namely the insertion of the third electrode into a Fleming valve, was a most wonderful contribution to the radio art. As a matter of fact, in the opinion of the writer, this was the most important single step in the whole development of radio communication." Let us give DeForest credit for this wonderful achievement.

With regard to Professor Morecroft's last statement quoted above, it appears that there has been some reciprocity. Moreover, in fairness to DeForest, it should not be overlooked that he also originated the metal filament, the essential "B" battery, and the use of a condenser in series with the grid for detection. The simple grid-leak is also credited to DeForest. See U. S. Pat. 1,377,405; Br. Pat. 100,358. The commercial importance of the invention may be judged from the fact that, according to a report of the U. S. Federal Trade Commission, the Radio Corporation of America received orders for 2,931,262 tubes in the first nine months of 1923.

It is timely and relevant here to note that on January 12, 1907, G. Marconi filed an application for a patent on the use of a ten-inch induction coil as a step-down transformer in the plate circuit of a carbon filament Fleming valve—still without a "B" battery. (Br. Pat. 887/07.) (Fig. 18.) This Fleming characterized as "one of the best long distance receivers for electric waves yet devised." If the reader will refer to the specification of DeForest's British

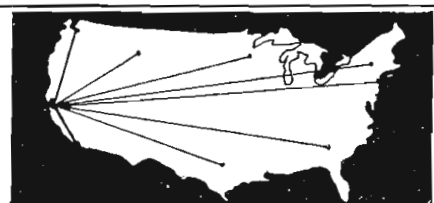

ON ONE TUBE

BIG FREE BOOKLET tells the story. California users of CROSS COUNTRY CIRCUIT hear Atlantic Coast, Canada, Mexico, Cuba and Hawaii. Our new plan makes this set easiest and cheapest to build. One hour puts in operation. One tuning control. No soldering. Any Novice can do it. BOOKLET FREE or complete instructions 25¢

WHAT USERS SAY

EAST—Am more than pleased with the parts ordered from you. The first night I hooked it up and received Omaha. Since then Minneapolis and Los Angeles. It works better without amplification than most sets with two stages. —Donals, S. C.
WEST—I am sending you a list of some of the stations heard on one tube: WSB, WGY, KDKA every night. PWX, WWJ, WTAM, WLW every night. CFAC, CHCB. Not long ago I purchased another set of parts from you and first night got WGR, Buffalo, and KDKA. —Ione, Calif.
NORTH—Received coils OK today. If I have same results with these that I had with last will be wanting more. I am 1,500 miles from nearest station and have picked 56 to date. Chicago, Havana, Mobile, New Orleans and TWO IN ENGLAND. —Lunenburg, Canada.
Vesco Radio Co. BOX RN-117 OAKLAND, CALIF.

U.S. TOOL

TRADE MARK

TYPE 6

The micrometer dial, a unique feature which forms an integral part of Type 6 U. S. Tool Condensers, affords a smoothness and slow turning accuracy that imparts to the entire rotor all the efficiency of a vernier. Performs perfectly in any circuit, under any conditions.

FACTORY GUARANTEE

Write for Literature or Inquire at Your Dealer's

U.S. Tool Company, Inc.
AMPERE, N.J.

"AIR ROAMER"

A McCall Compensated Circuit set, simple to operate, extremely selective, giving true tones, rugged and economical. Write for details.

KILBOURNE & CLARK MFG. CO.
Seattle, Washington

BRANCHES: Portland, Ore.; Los Angeles; San Francisco. Distributors: Pacific Electric Co., Sydney, Australia.

Reflectone

THE MICROMETER LOUD SPEAKER WITH THE GIGANT VOICE

Registered
Only 5 Inches High—\$8.00

RICE & HOCHSTER
134 Washington Place New York City

Prest-O-Lite

RADIO CHART

Voltage of Tubes	No. of Tubes	Type of Tubes (see foot-note)	Total Rated Amperes Drain	Recommended Prest-O-Lite "A" Batteries		
				Order by Following Types	Days between Charges	
5-Volt Tubes C-300 and UV-200 are interchangeable C-301A, DV-2 and UV-201A are interchangeable	1	UV-200	1	69 WHR or 67 WHR	22 16	
	2	UV-201A	1/2	67 WHR	33	
	2	1 UV-200 1 UV-201A	1 1/4	611 WHR or 69 WHR	22 17	
	3	UV-201A	3/4	69 WHR or 67 WHR	29 22	
	3	1 UV-200 2 UV-201A	1 1/2	611 RHR or 69 WHR	21 14	
	4	UV-201A	1	69 WHR or 67 WHR	22 16	
	4	1 UV-200 3 UV-201A	1 3/4	613 RHR or 611 WHR	22 15	
	5	UV-201A	1 1/4	611 WHR or 69 WHR	22 17	
	5	1 UV-200 4 UV-201A	2	613 RHR or 611 WHR	19 13	
	6	UV-201A	1 1/2	611 RHR or 69 WHR	21 14	
	8	UV-201A	2	69 KPR or 67 KPR	21 15	
	For sets using current at a rate higher than 2 amperes.			2 1/4	69 KRL or 67 KPR	22 13
				2 1/2	69 KRL or 69 KPR	19 16

Copyright, 1925 The Prest-O-Lite Co., Inc.

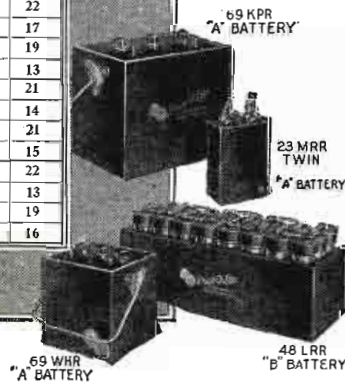

Write today for this free booklet

Whether you have a one-tube set or most advanced multi-tube outfit, you'll find a fund of interesting information in our booklet, "How to fit a storage battery to your set—and how to charge it."

This booklet gives you the complete Prest-O-Lite Radio Chart—technically accurate recommendations covering both "A" and "B" storage batteries for every type of set.

In addition, there is much vitally important data on battery care and upkeep—information that any radio fan will find of real value in keeping his set at its maximum efficiency. Write for your copy right now.

How to fit storage batteries to your set

IT PAYS to buy wisely—to select batteries that bring out the best in your set and are of the right capacity to give fine reception at recharging intervals best suited to your convenience.

The new Prest-O-Lite Radio Chart tells you how to select such batteries. The part of the master chart shown here covers "A" Batteries for 5-volt tube sets. Use either of the two sizes recommended for your set, depending on the days of service you wish between rechargings (based on the average use of your set of three hours a day). You will find the larger capacity battery more desirable unless facilities are provided for frequent and easy re-

charging. For "B" Batteries, and "A" Batteries for peanut tubes, see the complete chart at your dealer's.

Special structure plates, high porosity separators and scientific internal construction make Prest-O-Lite Batteries dependable sources of the even, unvarying current absolutely necessary for volume, clarity and distance.

Prest-O-Lite Batteries are made to give long, faithful service. They're easy to recharge—and offer you truly remarkable savings. Though standard in every respect, they are priced as low as \$4.75 and up. See them at your dealer's—or write for "How to fit a storage battery to your set—and how to charge it."

THE PREST-O-LITE CO., INC., INDIANAPOLIS, IND.
New York San Francisco
In Canada: Prest-O-Lite Company of Canada, Ltd., Toronto, Ont.

Prest-O-Lite



Miller RADIO HORNS

35 Different Styles

The Miller line of Radio Horns includes a large variety of styles and sizes designed especially for the many different types of instruments.

These designs have all been worked out scientifically. In proportion and acoustic qualities, Miller Horns have met the exacting requirements of the largest radio manufacturers in the country. They have proved to be far superior to wood and other horns because, while being inert and non-absorbing, they are unaffected by atmospheric conditions—and will not warp, crack, swell up, dry out or rattle. Being moulded, there is no possibility of a slight variation in size or shape—as is often the case with wood horns.

We manufacture a large proportion of the radio horns made in the United States. Due to our extensive resources and experiences we are able to produce any quantity—and make deliveries on short notice. Write us today for full information and prices.

The Miller Rubber Co.
Akron of N. Y. Ohio

"Read'em" Binding Posts



SHORT ANT





LONG ANT

18 Styles Engraved at Your Dealer's or Sent Post-paid 15c Each

THE MARSHALL-GERKEN CO.

The Utmost in Quality and Appearance at the Lowest Price.

Toledo, Ohio

Insure your copy reaching you each month. Subscribe to RADIO NEWS — \$2.50 a year. Experimenter Publishing Co., 53 Park Pl., N.Y.C.

Patent 5,258/06, he will read that, "The present application, therefore, does not cover broadly the employment of these ionized media as detectors, but it has been found by the present inventor that in order to obtain satisfactory working it is necessary that there shall be included in the circuit of the ionized medium a local E.M.F. . . ." which Marconi's invention lacked.

Ettore Bellini and Alessandro Tosi evolved a very simple and effective system of directional radio, which was of immense use to Britain and her allies during the Great War. H. J. Round, who was very largely responsible for its successful application, says of it: "The Bellini-Tosi idea was so complete that one might say that all the work after the original conception consisted in carrying out correctly the idea and in the improvement of the receiving apparatus. The sensitiveness of the crystal, although greater than either the magnetic or electrolytic detectors, still limited the ranges of reception very greatly on directional aeriels." This is also an interesting commentary on the state of the detector art in 1912-14.

Some credit is due to A. Artom, of Italy, for the development of the underlying principle of the direction-finder, as may be gathered from the reference to the specifications of his numerous patented inventions in connection therewith.

The original Bellini-Tosi invention (Br. Pat. 21,299/07; U. S. Pats. 943,960 and 945,440) did not comprehend a "sense" quality, which was not disclosed until the following year by the same inventors. (Br. Pat. 4,801/09.)

(J. N. Maskelyne was the first to propose a triangular aerial for directional transmission, but his aerial circuit contained a spark gap and the secondary of an induction coil. See Br. Pat. 7,983/00.)

Dr. A. Muirhead proposed some refinements in the use of the aerial counterpoise, or earth screen, in place of an "earth" connection. (Br. Pat. 11,271/07.) (Fig. 20.) The earth screen has come into considerable use in recent years, but its theory was well developed over a decade ago, particularly by Zenneck. British Patent 23,090/04 to J. S. Stone is also relevant.

R. A. Fessenden proposed the dictaphone method of automatic recording. This method has been very much used in Trans-Atlantic wireless telegraphy, and is only now being superseded. (Br. Pat. 20,005/08.) (Fig. 21.)

(Note.—It was proposed by C. L. Chisholm in 1908 to use a dictaphone as a line telephone recorder, the scriber being attached to the telephone diaphragm. See specification of Br. Pat. 9,800/08.)

(To be continued)

STATEMENT

Of the Ownership, Management, Circulation, Etc., Required by the Act of Congress of August 24, 1912, of Radio News, published monthly at New York, N. Y., for April 1, 1925. State of New York } ss. County of New York }

Before me, a notary public in and for the State and county aforesaid, personally appeared Hugo Gernsback, who, having been duly sworn according to law, deposes and says that he is the Editor of Radio News, and that the following is, to the best of his knowledge and belief, a true statement of the ownership, management (and if a daily paper, the circulation), etc., of the aforesaid publication for the date shown in the above caption, required by the Act of August 24, 1912, embodied in Section 411, Postal Laws and Regulations, printed on the reverse of this form, to wit:

1. That the names and addresses of the publisher, editor, managing editor and business managers are: Publisher, The Experimenter Publishing Co., Inc., 53 Park Place, New York, N. Y.; Editor, Hugo Gernsback, 53 Park Place, New York, N. Y.; Managing Editor, Sylvan Harris, 53 Park Place, New York, N. Y.; Business Manager, R. W. DeMott, 53 Park Place, New York, N. Y.

2. That the owner is: (If the publication is owned by an individual his name and address, or if owned by more than one individual the name and address of each should be given below; if the publication is owned by a corporation the

YAXLEY

APPROVED RADIO PRODUCTS

One Phone Plug



Cut is 2/3 size

Polished Bakelite Handle

Universally acknowledged as the handsomest, most readily handled plug made, and at the price an extraordinary value. Heavy bronze springs grip cord tips full length. Phones instantly connected without use of tools. Cords cannot be disconnected until handle is removed. All bakelite insulation prevents metal deposit and consequent leakage. Rigid brackets prevent tips becoming short circuited. Fits any jack. The short length handle makes this plug particularly desirable for compact portable sets.

50c Each

At All Radio Dealers

YAXLEY MFG. CO.

Dept. N., 217 N. Desplains St., Chicago



RUN-DOWN BATTERIES



No. 84

cause more radio grief than all other troubles combined.

Use a Jewell "B" Battery Voltmeter No. 84. A real instrument.

\$2.75 from Any Dealer

Jewell Electrical Instrument Co.
1650 Walnut St., Chicago

E-Z-TOON

(EASY TUNE)

Radio Dials

The Key to Simplified Tuning

Replace your old dials with E-Z-TOON and marvel at the simplicity of tuning—a fine smooth 80 to one Vernier adjustment. 8 in. dial, Black, \$2. Mahogany, \$2.50; 4 in. Black, \$2.25; Mahog, \$2.45. 2 in. non-Vernier dials, Black, 40c. Mahog, 46c. If your dealer cannot supply, write us.

E-Z-TOON Radio Co.
3234 W. Washington St., Indianapolis, Indiana.

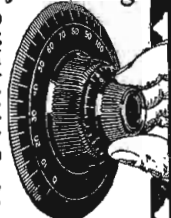

Build a 7 Tube Super Heterodyne. Use BRANSTON'S Super Transformer Kit No. R-199, \$35, and Accessory Kit No. R-199-1 (Partially Assembled), \$50. Send 25c for Sup. Het., Rad. Freq. and Honeycomb Coil circuits and catalog. Chas. A. Branston, Inc., Dept. 817, Main St., Buffalo, N. Y.

What the Trirdyn gets where it's hotter than Summer!

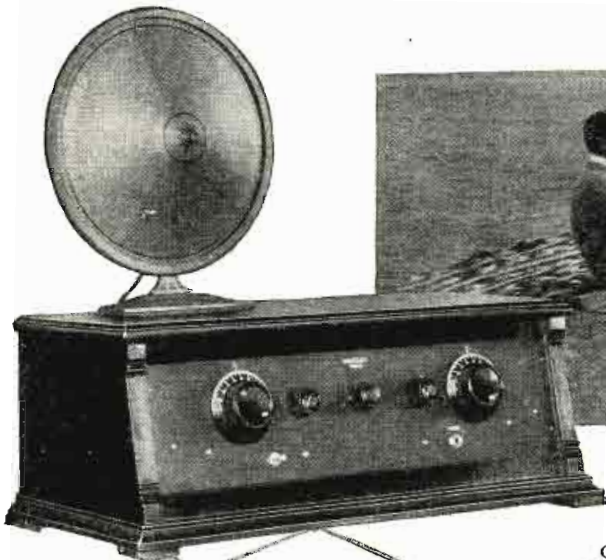

Crosley Trirdyn—on the Sahara Desert at mid-day —brings in Radio-Paris on the loud-speaker!

only at mid-day, but in February—in Northern Africa and far hotter than any American summer.

The picture above, a post card snap shot sent from Tunis to Mr. Crosley, by D.F. Keith of Toronto, Ont., tells this story on the other side:—

Tunis, North Africa, March 3, 1925

Dear Mr. Crosley:

Fishing here is rotten but radio is fine. On the Sahara, using three tubes on the Trirdyn circuit, reception from Paris came through on the loud-speaker. Along the south coast of the Mediterranean, using this set, six or eight high power European stations came in with good volume by day-light and all of them after dark. Can usually get a few American after 1 a.m. Can you fish with us this year?

Cordially,
(Signed) D. F. Keith

Further details on the margins of the picture:—

Sahara Desert, 250 miles south of Algiers, February, 1925. Receiving noon-day concert from "Radio-Paris", Paris, using aerial and counterpoise.

Who said summer in America is a poor time for radio—if the receiver is a Crosley Trirdyn?

Every radio fan—actual and aspiring—is invited to think this over and then act.

On the Trirdyn is the beautiful new Crosley Musicone, radio's most startling development. The Musicone's abilities and its beauty are so superior that we expect it to replace half a million loud-speakers this year. \$17.50.

The Crosley Radio Corporation, 622 Sassafras St., Cincinnati
Powel Crosley, Jr., President

CROSLEY RADIO

Better ~ Costs Less

\$65⁰⁰
Accessories Extra

Crosley Trirdyn Special

Three tubes better the results of five or six

A highly efficient, non-radiating combination of tuned radio frequency, Armstrong regeneration and reflexed amplification.

New cabinet, sloping panel
Battery self-contained
Exclusive Crosley 3-tube circuit



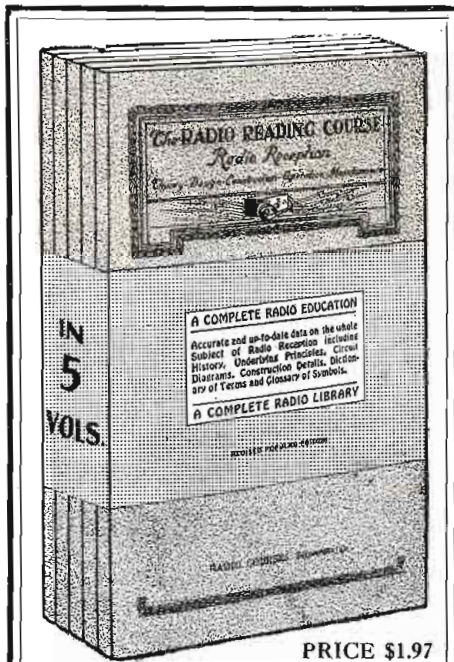

PRICE \$1.97

A RADIO EDUCATION

IN 5 VOLUMES

Theory, Design, Construction, Operation and Maintenance
LEARN AT HOME

These five component parts of a complete Radio Instruction Course are outlined in five volumes that contain not merely the essentials as so many books do, but more, they contain all that any modern up-to-the-minute textbook on any subject would cover. They are in themselves a COMPLETE radio education teaching every possible portion of Radio science.

Size of each book 6 by 9 inches, handsomely bound and illustrated with charts, diagrams, descriptions of equipment, etc.

SEND NO MONEY for these books. Just forward your name and address. We send you the books at once. On receipt of same you pay the postman \$1.97 plus a few cents postage and then they are yours.

Distributed by

The Conrad Co.

233 Fulton St. New York, N. Y.

Radio Instruction

Practical training for Radio Operators, Radio Mechanics, and Radio Dealers.

Send for 36 page booklet "Radio for Ambitious Men"

Resident and Home Study Courses.

Y. M. C. A. RADIO INSTITUTE
158 East 86th St., New York City

HUDSON-ROSS

Wholesale radio only.
One of the first and still in the lead.
Write for discounts.

123 W. Madison St. Chicago

name of the corporation and the names and addresses of the stockholders owning or holding one per cent. or more of the total amount of stock should be given.) The Experimenter Publishing Co., Inc., 53 Park Place, New York, N. Y.; Hugo Gernsback, 53 Park Place, New York, N. Y.; Sidney Gernsback, 53 Park Place, New York, N. Y.; R. W. DeMott, 53 Park Place, New York, N. Y.; H. W. Secor, 53 Park Place, New York, N. Y.; Dr. T. O'Conor Sloane, 53 Park Place, New York, N. Y.; Mrs. Catherine Major, 53 Park Place, New York, N. Y.; and M. M. Finucan, 720 Cass St., Chicago, Ill.

3. That the known bondholders, mortgages and other security holders owning or holding one per cent. or more of total amount of bonds, mortgages or other securities are: None.

4. That the two paragraphs next above, giving the names of the owners, stockholders and security holders, if any, contain not only the list of stockholders and security holders as they appear upon the books of the company but also, in cases where the stockholder or security holder appears upon the books of the company as trustee or in any other fiduciary relation, the name of the person or corporation for whom such trustee is acting, is given; also that the said two paragraphs contain statements embracing affiant's full knowledge and belief as to the circumstances and conditions under which stockholders and security holders who do not appear upon the books of the company as trustees, hold stock and securities in a capacity other than that of a bona fide owner; and this affiant has no reason to believe that any other person, association, or corporation has any interest direct or indirect in the said stock, bonds, or other securities than as so stated by him.

5. That the average number of copies of each issue of this publication sold or distributed, through the mails, or otherwise, to paid subscribers during the six months preceding the date shown above is (This information is required from daily publications only.)

H. GERNSBACK,
Editor.

Sworn to and subscribed before me this 23d day of March, 1925.

(Seal) JOSEPH H. KRAUS,
Notary Public, Queens County Register's No. 2951; New York County Register's No. 5291; New York County Clerk's No. 379. (My commission expires March 30, 1925.)

How a Detector Detects

(Continued from page 2245)

is the system generally employed in receiving sets. It will be noticed in Fig. 1c that the "C" battery is missing, a condenser and leak are in the grid circuit and the return connection, instead of being connected to the negative filament, is now connected to the positive. This puts a positive bias of half the filament voltage on the grid of the tube, which is generally sufficient for this system of detection. If we place the axis of our alternating voltage at the point of this bias (Fig. 5), and continue it up to the plate current curve, it will be observed that at this point the plate current curve is a straight line, and if the alternating voltage be replotted horizontally, as was done in Fig. 4, it would be the same above as below its axis and its average value would be zero and give no sound in the phones.

But if we look at the grid current curve we will notice that at the point where the axis of our alternating voltage intersects it, current is able to flow. So with these facts in mind we will go to a mechanical analogy to explain the phenomenon of grid current rectification.

ANALOGY

In our previous discussions we have assumed an alternating current generator connected between the grid and filament tending to send current first one way, then the other. So in our analogy we can assume our generator replaced by a pump which tends to send oil first one way, then the other. Connected in the circuit with the pump (Fig. 6) is a container M having a diaphragm N stretched across it, and a check valve K. Connected around this valve is a pipe having a constriction at O. The pump is our generator, the valve K is analogous to the space between grid and filament, for it allows oil to flow only one way, as does the grid with currents. (From previous expla-

A Pleasant Surprise Awaits the User of the A.C.H. Sharp Tuner Dials

WORM DRIVE

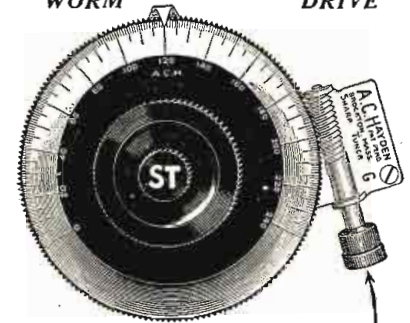

Why the A.C.H. is different

3 in. DIAL → A.C.H. → 156-TO-1

4 in. DIAL → A.C.H. → 215-TO-1

Money Back Guarantee

Price 3-inch size... \$2.50 Price 4-inch size... \$5.00
Regular fitting 5/16 shaft 3/4 and 3/16, 5c each extra

- EXTRA ADVANTAGE OF THE A.C.H.**
1. Can be attached or removed from any instrument.
 2. Rough tuning same as any dial.
 3. Movement so fine that the eye cannot detect but the ear can.
 4. Automatically locks instrument so no jar can disturb it.
 5. Dial grounded reducing the body capacity to a minimum.
 6. Special dial 2 graduations where ordinarily one.

Mail Orders Sent Prepaid in U. S. A.
A. C. HAYDEN RADIO & RESEARCH CO.
25 E. Battle St., BROCKTON, MASS., U. S. A.

PATENTS

To the Man with an Idea

I offer a comprehensive, experienced, efficient service for his prompt, legal protection and the development of his proposition. Send sketch, or model and description, for advice as to cost, search through prior United States patents, etc. Preliminary advice gladly furnished without charge. My experience and familiarity with various arts frequently enable me to accurately advise clients as to probable patentability before they go to any expense. *Booklet of valuable information and form for properly disclosing your idea free on request. Write today.*

RICHARD B. OWEN
PATENT LAWYER

2 Owen Building, Washington, D. C.
2276A Woolworth Bldg., N. Y. City

FAHNESTOCK CLIPS

The Perfect Radio Connectors—Are Used



Reg. U.S. Patent Office

FAHNESTOCK ELECTRIC COMPANY
Long Island City

By manufacturers of standard sets and parts and makers of wet Battery and exclusive on Eveready Dry Batteries. Their Sure Patented Grip is recognized universally by enthusiastic users.

HEATH CONDENSERS

For Real Radio Reception

Write for Literature

HEATH RADIO & ELECTRIC MFG. CO.,
206 First St., Newark, N. J.

ZENITH

TRADE MARK REG.

RADIO

→ LONG DISTANCE ←
TRADE MARK REG.



*Super-Zenith IX—
the ideal radio set
for the fine home,
built-in loud-
speaker; batteries
concealed and out
of the way.*

Only the Best is "Good Enough" —

The difference between a radio set that "works"—even one that "works well"—and **Zenith**, is the difference between always longing for "something better" and the supreme pleasure of owning the best that money can buy.

True, Zenith costs a bit more, but evening after evening, month after month, **year in and year out**, you will thank your lucky stars that you paid that trifling difference and made sure of the best in radio results.

—Tuning, for instance, so simple that with two dials only you can bring in every important station on the air clearly and in ample volume. Powerful locals may be on full blast, yet you tune straight through at will, get distant stations.

—**More stations in a given length of time than with any other make.** Direct comparisons invited.

The proof that Zenith is the set you want is yours for the asking. Only selected dealers who are prepared to **give service** handle Zenith. Ask your nearest Zenith dealer for a demonstration.

ZENITH - Costs More - But Does More
LONG DISTANCE RADIO

ZENITH RADIO CORPORATION

332 South Michigan Avenue, Chicago

ZENITH—the exclusive choice of MacMillan for his North Polar Expedition

The complete Zenith line ranges in price from \$100 to \$475.

With either Zenith 3R or Zenith 4R, satisfactory reception over distances of 2,000 to 3,000 miles is readily accomplished, using any ordinary loud speaker. Models 3R and 4R licensed under Armstrong U. S. Pat. No. 1,113,149. They are NON-RADIATING.

Zenith 4R - - \$100
Zenith 3R - - \$175

The new Super-Zenith is a six-tube set with a new, unique, and really different patented circuit, controlled exclusively by the Zenith Radio Corporation. It is NOT regenerative.

SUPER-ZENITH VII—Six tubes—2 stages tuned frequency amplification—detector and 3 stages audio frequency amplification. Installed in a beautifully finished cabinet of solid mahogany—44½ inches long, 16½ inches wide, 10½ inches high. Compartments at either end for dry batteries. Price (exclusive of tubes and batteries) **\$240**

SUPER-ZENITH VIII—Same as VII except—console type. Price (exclusive of tubes and batteries) **\$260**

SUPER-ZENITH IX—Console model with additional compartments containing built-in Zenith loud speaker and generous storage battery space. Price (exclusive of tubes and batteries) **\$355**

SUPER-ZENITH X—Contains built-in, patented, Super-Zenith Duo-Loud Speakers (harmonically synchronized twin speakers and horns), designed to reproduce both high and low pitch tones otherwise impossible with single-unit speakers. Price (exclusive of tubes and batteries) **\$475**

All Prices F. O. B. Factory.

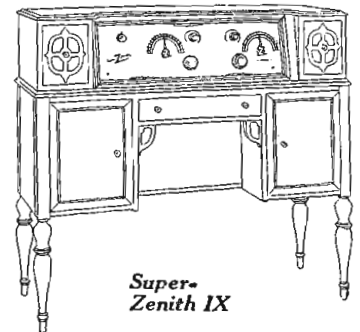

ZENITH RADIO CORPORATION
Dept. 6-B

332 S. Michigan Ave., Chicago, Ill.

Gentlemen: Please send me illustrated literature about Zenith radio.

Name

Address

Only specialists can make good fixed condensers

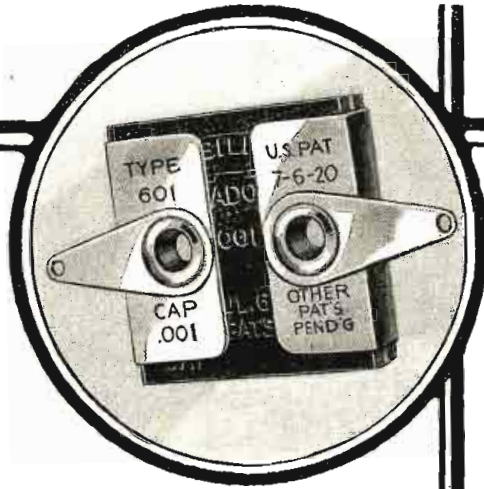

THE small fixed condensers in your radio set are there to help you get clear reception. If these little condensers are not made *most accurately* the quality of reception you get—even though your set may be excellent in all other respects—will be greatly impaired.

You will find that nearly all sets made—in fact over 90% of them—are equipped with Dubilier Micadons. This is the name by which all Dubilier fixed condensers are known.

Be sure your set—whether you buy it or build it—is equipped with Micadons. They are made by *specialists*.

Dubilier

CONDENSER AND RADIO CORPORATION

ON THE OCEAN FRONT

CAPACITY 1000

The Breakers

Atlantic City, N. J.

American or European Plan

Sea Water in All Baths

ORCHESTRA

AFTERNOON TEAS

CABINET BATHS

DANCING

GOLF PRIVILEGES

FIRE-PROOF GARAGE

DOUBLE ROOM AND BATH FOR TWO, AMERICAN PLAN \$95.00 PER WEEK

JOEL HILLMAN, President

Insure your copy reaching you each month. Subscribe to Radio News—\$2.50 a year.
 Experimenter Publishing Co., 53 Park Place, N. Y. C.

nation it should be clear that current can flow from grid to filament, but not from filament to grid.) The diaphragm N takes the place of the grid condenser and the constriction O corresponds to the grid leak.

There is an alternating force which tends to move the piston of the pump up and down. Referring to Fig. 3b we have an alternating wave of voltage which we can take as an alternating wave of force acting on the piston. As this force starts up from zero it forces the piston up. This displacement of liquid causes the diaphragm N to stretch and that in turn forces oil through valve K around to the space left below the piston by its upward motion. If the force were removed from the piston, the system would not remain in this state because the stretched diaphragm tends to force the piston down. However, this could not happen unless some oil was removed from below the piston. This *can* occur because oil is able to leak through the constriction at O, but this is a slow process and very little leaks through compared with the amount moved by the piston, so the downward motion of the piston is slight.

We left the piston in an up position to discuss the effect of the leak, so referring again to curve 3b we notice that the force starts to decrease to zero, then reverses and becomes negative. This reversed force tries to pull the piston down, which would necessarily force oil down on top of valve K. But valve K does not open in this direction, so the only oil that can flow is the small amount that gets through the constriction at O, and, therefore, the piston can move down only a very small distance. When the force on the piston again reverses and pushes up, the piston can move up a little farther because this next force is slightly larger than the first upward force and the diaphragm is stretched farther. It might be well to call to mind that as the diaphragm stretches it exerts a back pressure on the piston and stretches just enough so that its force equals the force on the piston. This continued upward motion of the piston and the greater stretching of the diaphragm goes on as each successive upward force increases, until the peak values of force reach a maximum and start to decrease. Here is where the leak through O plays its important part. It will be remembered that oil was continually leaking, tending to relieve the pressure on the diaphragm, but could not take care of the rapid increases in pressure caused by the pump. But now since each successive upward force gets less and less and therefore is continually less than the force caused by the stretched diaphragm, the leak gives the diaphragm a chance to assume a neutral position and to force the piston back to its original central position or starting point. We have now passed through a wave train and are back to the same condition as we started from and are ready for another wave train. Remembering that the force of the diaphragm is opposed to that of the piston, if we plot the variation of force on the diaphragm we will get a curve below the axis like that of Fig. 7. The ripple is due to the leak through O allowing the force to decrease a little before the diaphragm received its next push from the piston.

APPLICATION OF ANALOGY

Now to apply this mechanical analogy to the electric circuit. Remember what the different parts correspond to as explained above. The generator tries to send current around through the circuit from grid to filament and succeeds because current can flow from grid to filament, just as the valve K allowed oil to flow. This flow of current charges the grid condenser just as the flow of oil stretched the diaphragm. This charge induced on the condenser made the side toward the grid become negative and, there-

What Last Season PROVED TO Radio Manufacturers!

It proved that there is mighty little market for cheap looking radio equipment.

It proved that good material and workmanship are every day more essential to secure the confidence of the dealer — and build real business.

Service trouble ate up what little profit the dealer made on many really cheap sets — and he will sell no more of them!

The season proved that cheap substitutes for Formica panels are one of the most costly things a manufacturer can use.

Such expedients create a sales resistance that is far more costly in the end than good panels are in the beginning. That's why so many manufacturers who tried them are giving them up. Last year was the biggest Formica ever had in radio.

This year the volume will be done on sets that have Formica *base panels* — as well as Formica front panels, with their wonderful finish and permanent beauty!

Formica is one of the most lasting and unchanging materials in the world.

THE FORMICA INSULATION COMPANY
4618 Spring Grove Ave., Cincinnati, Ohio

Sales Offices

50 Church Street.....	New York, N. Y.	289 Victoria St.....	Toronto, Ontario, Canada
9 South Clinton St.....	Chicago, Ill.	1026 Second Avenue.....	Minneapolis, Minn.
516 Caxton Bldg.....	Cleveland, Ohio	725 Bulletin Bldg.....	Philadelphia, Pa.
1142 Granite Bldg.....	Rochester, N. Y.	708 Title Building.....	Baltimore, Md.
422 First Avenue.....	Pittsburg, Pa.	585 Mission Street.....	San Francisco, Cal.
6 Beacon Street.....	Boston, Mass.	419 Ohio Building.....	Toledo, Ohio
55 Calle Obispo.....	Habana, Cuba	309 Plymouth Bldg.....	New Haven, Conn.
		Whitney Central Bldg.....	New Orleans, La.

Write for Booklet "What Formica Is"

- | | |
|---|--|
| <p>1 Formica is used by 125 leading makers — and has for years been used by more makers than all other materials.</p> <p>2 Formica will last forever.</p> <p>3 Formica, in appearance, is the finest of all panel materials and always remains so.</p> <p>4 Formica's electrical qualities of every kind far exceed any possible requirement.</p> | <p>5 Formica has high mechanical strength and will not break in use.</p> <p>6 Formica will not sag from heat or cold flow under pressure. It retains its dimensions. Everything you fasten to it stays tight and precisely where you put it.</p> <p>7 Formica panels are sold in neat craft paper envelopes which assure you that you are getting the genuine.</p> <p>8 Formica is one of the most widely approved materials in radio.</p> |
|---|--|



FORMICA
Made from Anhydrous Bakelite Resins
SHEETS TUBES RODS

Hear the Formica program every Tuesday evening from 9 to 10 Central Standard Time over WLW.

Only 85 Motors

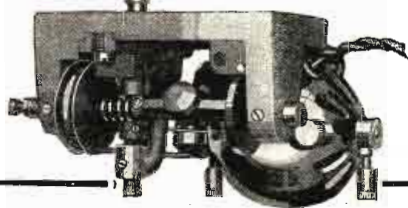

Left at \$10 Each

Ideal for home-made phonographs, experimental purposes and combination PHONOGRAPH-RADIO sets.

We have 85 small motors which are greatly under-priced for quick clearance. You will never again equal this low price, when this lot is sold.

They are universal motors, 110 volts, 60 cycle single phase, complete with turntable, cord and socket for immediate use. 1400 R. P. M. Motor has 1" pulley with flange for 3/4" flat belt. Housed in highly polished, nickel-plated shell.

Don't lose out on this remarkable offer. Order your motor today. Tomorrow may be too late. DO IT NOW! Price \$10.00 f. o. b. Steger, Illinois.

Industrial Division

Steger & Sons
Piano Manufacturing Company

Dept. 60, Steger Building CHICAGO, ILLINOIS

Insure your copy reaching you each month. Subscribe to RADIO NEWS — \$2.50 a year. Experimenter Publishing Co., 53 Park Pl., N.Y.C.

fore, the grid itself is made negative. Another way of looking at this action is by considering the electrons. Electrons, which are negative, come to the grid and are isolated there because of the grid condenser and, therefore make the grid potential become negative. When the current tries to reverse it finds itself blocked by the space from the filament to grid just as the valve K blocked the oil. Thus as the voltage trying to send the current around gets larger and larger, the grid becomes more and more negative until it reaches a maximum just as the diaphragm reached a maximum distension and therefore force. Of course, during this time the grid leak, corresponding to the constriction at O, has allowed some of the charge to leak off, but not much compared to what was being supplied at each impulse. But now, as the successive voltage impulses decrease, this grid leak allows the charge to leak off because the voltage that tends to charge the grid condenser is less than the voltage of the condenser itself. The reader will find a sentence similar to this as regards the diaphragm and pump. So at the end of the wave train the grid voltage is back to its starting point ready for the next wave train. If the voltage of the grid during the wave-train is plotted it will be identical with the wave of Fig. 7 except that it now is voltage on the grid instead of force on the diaphragm.

If we now place this variation in grid voltage in a position to notice its effect on the plate current, as is done in Fig. 8, it will be seen that it produces a similar variation in plate current, which falls to a certain value and then rises again to its original value. There is then a change in plate current and since a change of plate current in one direction causes a sound in the phones, they respond to this average change, which is of the same nature as the sounds which

strike the microphone in the broadcast station. This, then, is the oft-mentioned but obscurely spoken of phenomenon of grid current rectification using a grid condenser and leak.

Notice that in this form of rectification the grid circuit has current flowing in it which was induced by a voltage, and therefore power (the product of current and voltage) was used in the grid circuit. It will be remembered that no power was used in the grid circuit in plate current rectification. Another striking difference between these two methods of rectification is the fact that plate current rectification produces its effect on the phones by an increase in the plate current, whereas grid current rectification produces its effect by a decrease of plate current. The system using grid current rectification actually rectifies the current flowing in the grid because the grid allows current to flow in one direction only. This system also is by far the more sensitive, because the effect of the little individual waves of the wave train are accumulative and additive in their effect on the plate current, therefore producing a larger change in the plate current than does straight plate current rectification.

In conclusion, it is the sincere hope of the writer that this article in its elementary form of explanation has made itself clear to the uninitiated but interested reader, and that it has not been too simple to clear up a few points of obscurity in the mind of the man who had a general idea of rectification with the vacuum tube.

SO HE WOULD!

Enthusiastic Son: "Dad, I got Honolulu on my short wave set! What would I get if I had the Super-Het?"

Grouchy Father: "I would get a larger bill from your dealer each month."

Radio's finest and most complete Call Book



A NEW SERVICE

Conrad has developed a special service for every user of the new "Radio Listeners' Guide and Call Book" that will enable you to keep all changes in stations and any new stations that are put into operation.

It consists of special supplement sheets issued every month that contain this information.

Every purchaser of the "Radio Listeners' Guide and Call Book" can use this service at the low cost of only 50c—which covers all bulletins issued during the six months period between publication of the "Call Book."

A radio book that is absolutely essential to the full enjoyment of every radio Receiving Set

Here is a radio book of special value to everybody who owns or operates a radio receiver or transmitter.

It gives you a short instruction on radio set operation compiled by the best radio writers. Then it lists 95 full pages of broadcast and amateur radio stations from every corner of the world. The broadcast stations of the United States are listed on convenient sheets so that you can keep a log record on these pages of every station you receive.

There is also many pages of special stations, complete maps of broadcast stations for every country on the globe and complete list of U. S. stations broadcasting market reports.

Altogether you have an instant reference book for local or worldwide radio stations that is up-to-the-minute.

Size of this book is 9 by 12 inches, the large magazine size. Contains 114 pages, illustrated and bound in beautiful 2-color cover.

Published & Distributed by

The Conrad Co., Inc., 233 Fulton St., New York City

35¢

SOLD ON ALL NEWSSTANDS AND RADIO STORES

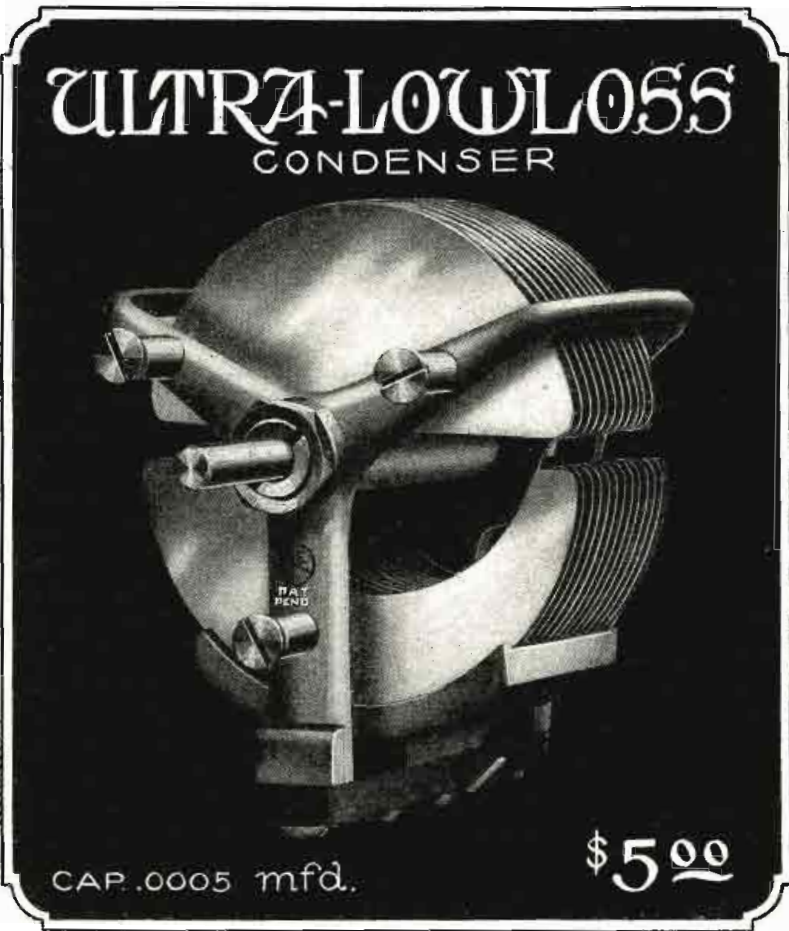

As positive as Big Ben

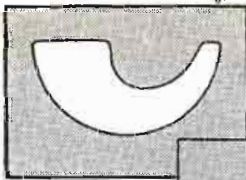

Cutlass Stator Plate exclusively an Ultra-Lowloss feature

A guarantee of satisfaction and Lacault design

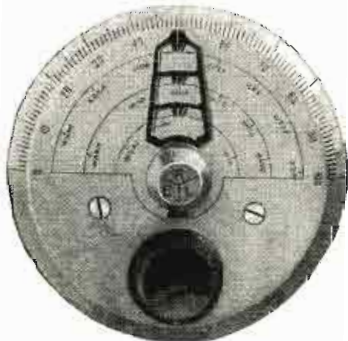
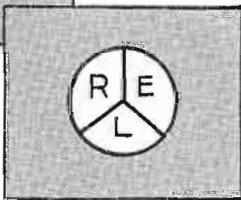

ULTRA-VERNIER TUNING CONTROL

Simplifies radio tuning. Penell-record a station on the dial—thereafter, simply turn the finder to your pencil mark to get that station instantly. Easy—quick to mount. Eliminates fumbling, guessing. Furnished clockwise or anti-clockwise in gold or silver finish. Gear ratio 20 to 1.
Silver \$2.50 Gold \$3.50

SET Big Ben at seven and at seven o'clock you're bound to get the alarm.

Just so, the Ultra-Lowloss condenser can be set at any wave-length—the corresponding station will come in clear and sharp. You know instantly where to turn, once a station of known wavelength is located. Makes tuning easy—direct—positive. Special Cutlass Stator Plates spread wave-lengths evenly over a 100 degree scale dial so that each degree represents approximately $3\frac{1}{2}$ meters.

Ultra-Lowloss condensers are designed by R. E. Lacault, originator of the famous Ultradyne Receivers, and built upon scientific principles which overcome losses usually experienced in other condensers.

At your dealer's, otherwise send purchase price and you will be supplied postpaid.

Design of lowloss coils furnished free with each condenser for amateur and broadcast wavelengths showing which will function most efficiently with the condenser.

To Manufacturers Who Wish to Improve Their Sets

Mr. Lacault will gladly consult with any manufacturer regarding the application of this condenser to his circuit for obtaining best possible efficiency.

ULTRA-LOWLOSS CONDENSER

PHENIX RADIO CORPORATION, 114 East 25th St. New York City

DUPLEX CONDENSERS

DUPLEX STANDARD



"None other so good." Conforms to Bureau of Standards specifications for lowest losses and best electrical characteristics. Skeleton metal end-plates and automatic take-up for bearing wear are among its features. Absolute satisfaction guaranteed!

DUPLEX JUNIOR



Lacks some of the costly refinements of DUPLEX Standard, but is "the best value for the price." Die cast rotor, milled stator posts, and other features usually found only in highest-priced condensers. Electrical and mechanical perfection guaranteed.

In Matched Sets For Uniform Dial Settings

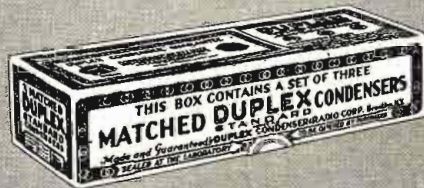

This most recent **DUPLEX** achievement—**DUPLEX Standard** condensers, specially tested, matched and guaranteed to have identical capacity curves, packed in sealed kits of three—has been enthusiastically welcomed everywhere by radio set builders, both professional and amateur. It is the *only* kit that affords uniform dial settings for Neutrodyne and all other tuned radio frequency circuits. There is only *one* number to log—not three—when you use a **DUPLEX Matched KIT**.

Instructive literature sent on request

DUPLEX CONDENSER & RADIO CORP.

52 Flatbush Ave. Extension, Brooklyn, N.Y.

Design Your Own Low Loss Coils

(Continued from page 2249)

with 60 turns. Starting at the point C from Fig. 3, go up to B and then over to A and the inductance is immediately found. The whole proposition, therefore, is an exceedingly simple one requiring absolutely no mathematics and only a few minutes of time. At the same time it saves a lot of time,

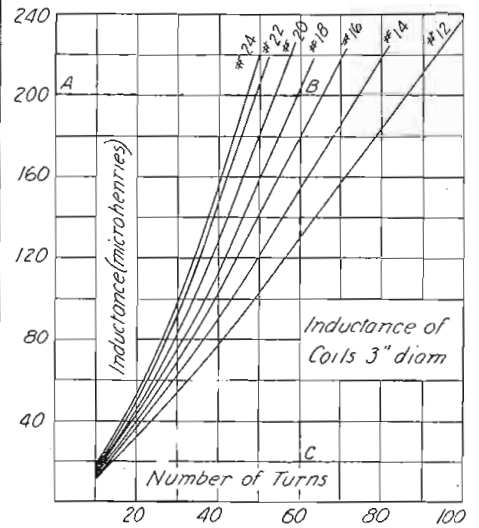

FIG. 3

Inductance of single-layer coils, 3 inches in diameter.

trouble and expense in building coils that do not cover the desired range and have to be scrapped. It will be found that by this method the number of turns of wire can be estimated to within one or two of the total.

SINGLE LAYER COILS

There is one thing that must not be forgotten in all this, namely, the method explained here applies only to a single coil of wire isolated in space and connected to a variable condenser. The moment another coil is brought into the vicinity, the condi-

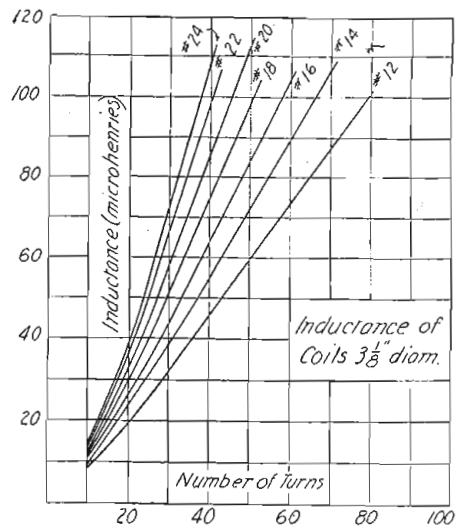

FIG. 4

Inductance of single-layer coils, 3 1/8 inches in diameter.

tions change. For instance, if the coil we have designed by the above method is to be used with an untuned primary coupled to it, it will be necessary to use one or two more turns on our secondary coil than the number we obtained from the charts. This also

True Tonal Quality

The Stromberg-Carlson No. 2-A Loud Speaker and No. 3-A Head Set have *Powerful Magnets and Layer Wound and Layer Insulated Coils*, a type of construction that ensures true tonal quality and continuous reliable operation under the highest plate voltages.

Ask your dealer

Stromberg-Carlson Telephone Mfg. Co.
1060 University Avenue
Rochester, N.Y.

No. 3-A
Head Set
\$5.50

Stromberg-Carlson

Insure your copy reaching you each month. Subscribe to Radio News—\$2.50 a year. Experimenter Publishing Co., 53 Park Place, N. Y. C.



Increase your summer range with an enameled aerial

WHEN summer comes, it will be harder to get the distant stations that entertained you during the winter months. The loud signals that came pounding in during cold, winter nights will be greatly weakened during the summer heat, and if you are using an inefficient aerial, the signals may not be audible.

Now is the time to take down your old corroded bare copper aerial and replace it with a Beldenamel stranded aerial. The smoke, grime, and corrosion on your bare copper aerial seriously interferes with the free flow of impulses to your set. A Beldenamel aerial is covered with a weatherproof, baked-enamel coating that protects the wire from corrosion and greatly increases its efficiency and range.

Try a Beldenamel aerial. It makes a world of difference.

Specify
Belden

Magnet wire, battery cords, loop antenna wire, terminals, rosin-core solder, litz wire, hook-up wire, and a dozen other items. Send for booklet.

**Send for this
Free Booklet!**



Belden
Manufacturing Company
2314A South Western Avenue
CHICAGO, ILLINOIS

Belden Manufacturing Company
2314A South Western Ave., Chicago, Ill.

Please send me your booklet—Helpful Hints for Radio Fans.

Name _____

Address _____



CANNON-BALL \$3.50

YOU want to hear voices that sound clear and natural, and music pure in tone and quality. For over eight years, Cannon and Miller have been producing quality headsets, used and approved by thousands of radio enthusiasts. Why not treat your ears to real radio reception with a Camco Cannon-Ball Headset at \$3.50, or a Camco Grand at \$4.75. Compare them at your dealer's. Choose the one you like best. Folder, "Radio As You Like It," gladly mailed on request.

CANNON & MILLER CO., Inc., SPRINGWATER, N.Y.

BUY DIRECT FROM THE MANUFACTURER

All Parts Complete to Build
THE FAMOUS 5-TUBE A. & P. STANDARD NEUTRODYNE



\$32.50

(Cabinet to fit panel 7"x24" \$4.95 extra)

THE NON-RADIATING, NON-SQUEALING, NON-HOWLING SET THAT HEARD ALL EUROPE DURING RECENT INTERNATIONAL TESTS. COMPLETE WIRING DIAGRAM AND DRAWING FOR PLACING OF PARTS FURNISHED WITHOUT EXTRA CHARGE. TUNES TO HIGH AND LOW WAVE LENGTHS AND STATIONS CAN BE FOUND REGULARLY ON SAME DIAL READINGS. ALL PARTS MADE IN OUR FACTORY ACCORDING TO NEUTRODYNE SPECIFICATIONS. FULLY GUARANTEED. THE PARTS ARE AS FOLLOWS:

- | | |
|--|---|
| 3 Variable Condensers, highest grade, capacity, .000375 | 3 Mica Fixed Condensers (capacities .006, .001, .00025) |
| 3 Neutro-Coils, silk wire wound on genuine bakelite tubing | 1 Tubular Grid Leak |
| 6 Mounting Brackets | Grid Leak Mountings. Bakelite binding post strip. |
| 2 Neutralizing Condensers (set of parts with glass Dielectric) | 7 Binding Posts |
| 5 Bakelite Sockets | 10 Lengths Bus Bar |
| 1 20 Ohm Rheostat (Bakelite) | 2 Lengths Spaggetti |
| 1 6 Ohm Rheostat (Bakelite) | 1 Panel, neatly engraved and drilled for mounting of all parts at correct angles, including jacks |
| 2 Shielded Audio Transformers | Blue Print (large, with complete and simple Diagrams) |
| 3 4-inch "Vernigrip" dials | 1 Copper sheet (for shielding) |
| 3 Improved Zero Capacity Jacks | 1 Print for placing parts |
| | 1 Specially-treated base board |

Mr. R. H. Crane of the North Dakota State Highway Commission writes: "I am getting coast to coast loud speaker reception on your set on an inside aerial 18 feet long."
Mr. Patrick Walsh, of Far Reckaway, L. I., writes: "Got a reply from station 24-A, Mexico City, that your set made a record for this station."

MAIL ORDERS GIVEN PROMPT ATTENTION
ATLANTIC & PACIFIC RADIO CORPORATION, 223 W. 34th St., New York City

holds true when a tickler coil is used with it. If the coupling between the various coils is loose, however, there will not be much change in the inductance of the secondary, so that for loose coupling this method will give rather accurate results. The same procedure applies to the coupling devices to be used in impedance or tuned transformer coupled amplifiers.

Although the object of this article is to furnish the unmathematical experimenter with an easy method of designing his tuned circuits rather than guessing them, it will not be amiss to make a few remarks concerning the low loss requirements.

Everyone is aware of the need for low loss circuits. Considerable has been said by the writer in the January, February and March issues of RADIO NEWS concerning the losses in coils and condensers and concerning the proper design of these. It would be well if the reader would look back over these issues and refresh his memory on the

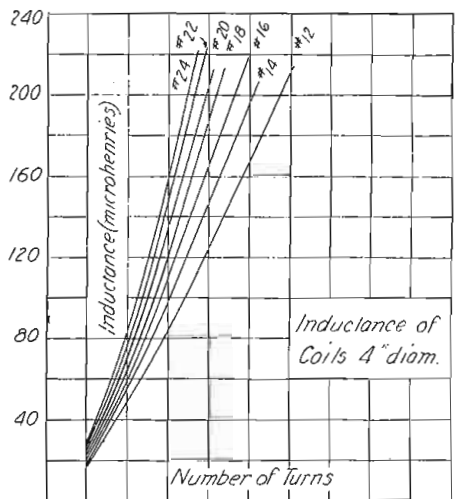

FIG 5

Inductance of single-layer coils, 4 inches in diameter.

subject. He must remember that all is not low loss that is advertised as such. A tuning coil is not necessarily low loss simply because it may be wound "on air." Many "low loss" coils which are on the market are wound with exceedingly fine wire so that the resistance of these coils is relatively high, even though the insulating material has been cut to a minimum.

The single layer coil wound in a cylindrical shape is the most efficient coil for a given size wire. Any departure from the simple cylindrical shape will result in a lowering of the efficiency of the coil. One might think of this in the same way as we think of the geometrical proposition which tells us that to enclose the greatest area within a given perimeter, the perimeter must have a circular shape.

When the coil departs from the circular shape, more wire is required to obtain a given inductance; hence the resistance will be higher. This is the reason why basket wound coils have slightly higher resistance than cylindrical coils. Pancake coils also have lower efficiency since the turns near the center, having but small diameter, contribute little to the inductance of the coil. Considerably more wire is, therefore, required to obtain a given inductance in this form of coil.

LOW LOSS

As the writer has said in previous articles, multi-layer coils are out of the question when considering low loss circuits. This is

LEARN THE CODE AT HOME

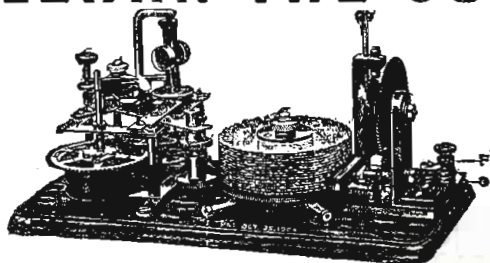

WITH THE OMNIGRAPH

THE OMNIGRAPH Automatic Transmitter will teach you both the Wireless and Morse Codes—right in your own home—quickly, easily and inexpensively. Connected with Buzzer, Buzzer and Phone or to Sounder, it will send you unlimited messages, at any speed, from 5 to 50 words a minute.

THE OMNIGRAPH is not an experiment. For more than 15 years, it has been sold all over the world with a money back guarantee. The OMNIGRAPH is used by several Depts. of the U.S. Govt.—in fact, the Dept. of Commerce uses the OMNIGRAPH to test all applicants applying for a Radio license. The OMNIGRAPH has been successfully adopted by the leading Universities, Colleges and Radio Schools.

Send for FREE Catalog describing three models.
THE OMNIGRAPH MFG. CO., 15 HUDSON STREET, NEW YORK CITY
If you own a Radio Phone set and don't know the code—you are missing most of the fun



The Simplest Practical Radio Set Made

\$2.50

A Complete Radio Receiver including Radiogem, Phone and Aerial

The Complete Outfit Consists of Three Parts

(One)

The RADIOGEM

The simplest radio outfit made—yet as practical as the most expensive. A crystal receiving set that you can operate and enjoy even though you know absolutely nothing about radio. You receive the RADIOGEM unassembled, together with a clearly written instruction book, which shows you how to quickly and easily construct the set, using only your hands and a scissors. The outfit comprises all the necessary wire, contact points, detector mineral, tube on which to wind the coil, etc., etc. The instruction book explains simply and completely the principles of radio and its graphic illustrations make the assembling of the RADIOGEM real fun.

(Two)

The GEMPHONE

An adjustable, 1,000-ohm phone complete with 3-ft. cord—the first inexpensive adjustable receiver made. The Gemphone is of standard type and made of the very best grade of materials throughout. The case is made of turned wood, an exclusive feature with the "GEMPHONE." This is responsible for its exceptionally rich, and mellow tone. Like RADIOGEM, the GEMPHONE is sold unassembled. Our Instruction pamphlet shows how to assemble it in two minutes, using only a screw driver.

(Three)

The AERIAL OUTFIT

Consisting of 100 ft. of standard copper aerial wire and two porcelain insulators.

- Complete Radiogem Outfits - \$2.50
- The Radiogem, only - 1.00
- The Gemphone, only - 1.00
- Aerial Outfit, only - .50

RAGEMCO

Radio Headquarters for the Finest and BEST Radio Tools

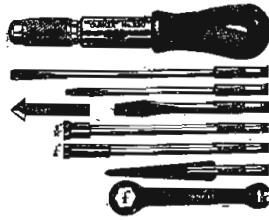

RADIO TOOLSET

This is the handiest set of tools ever made for Radio Work by the makers of the famous "YANKEE" Tools. It contains the following: 1 Ratchet Screw-driver, 6 1/2 in. long holding all attachments; 1 Blade, 5 1/2 x 3-16; 1 Blade, 3 1/2 x 1/4; 1 Blade 2 1/2 x 1/4; 1 Countersink; 2 Socket Wrenches for all small nuts; 1 Reamer to enlarge holes in panel from 1/8 x 1/2; 1 Wrench, one end 3-16" square or hex for jack, other 1/2" hex., etc.
PRICE per set—No. 701.....\$3.00

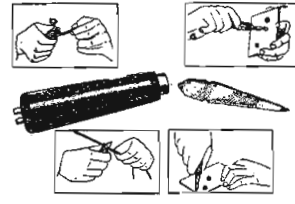

RADIO HANDI-TOOL

Bends Bus Bar or wire strips and scrapes wire, bores and reams holes, etc. Tool consists of 4 in. black japanned handle, to which is attached wire bending device, with nicked ferrule and 3 in. long two sided reamer.
PRICE—No. 702.....50c



HAND DRILL

The hardwood handle is hollow to store drills. Iron frame, nickel-plated parts, ball bearing three jawed chuck holding and centering accurately round shank drills from 6 to 16. Length of drill, 12 inches.
PRICE—No. 303.....\$2.25



TOOL CHEST

Set consists of "LOCK-GRIP" master handle, 5" long, black Rubberoid finish with steel chuck, nickel plated, buffed and with the following 9 tools: Saw, bradawl, large screwdriver, file, scratch awl, gimlet, reamer, chisel, small screwdriver. Each tool of fine steel, drop forged, tempered, hardened, and nicely finished. Set comes in leatheroid box with tray.
PRICE—No. 703.....\$1.85



WIREBENDING TOOL

For making eyes, loops, bends, and offsets on Bus Bar wire. With this device any Radio Constructor can wire his set to compare favorably with any factory made set. Easier to use and more accurate than pliers. Full directions in box. Made of heavy steel, blued and finished.
PRICE—No. 203.....\$1.00

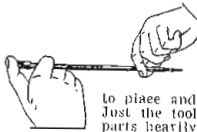

SCREW STARTER and DRIVER

Holds any screw by its slot with a firm grip, makes it easy to place and start screws in difficult places. Just the tool for the Radio Constructor. All parts heavily nicked and polished.
PRICE—No. 304.....\$1.00



CIRCLE CUTTER

Especially designed for the Radio Constructor. Made of the finest material and equipped with the highest grade high steel cutting bits. It does three things at once. It drills its own pilot, cuts out plug and puts bead or scroll around the hole in one operation. Cuts holes 1/8 to 4 in. in diam.
PRICE—No. 402.....\$3.00
411. Same tool but smaller and not fitted with bead or scroll in one operation.
PRICE—No. 401.....\$2.00

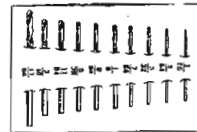

RADIO DRILL SET

Composed of 10 straight shank twist drills, fitting all hand and breast drills. The selection of these drills has been especially made for Radio Constructors and consists of the following sizes: 1-16, 5-64, 3-32, 7-64, 1/8, 9-64, 5-32, 11-64, 3-16, 17-64. Drills are mounted on white Holland Linen with sizes clearly marked.
PRICE—No. 305.....\$1.25



HAND DRILL

Especially designed for Radio Work by the makers of the famous "Yankee" Tools. A beautiful balanced, small, powerful drill with 4 to 1 ratio of gears for speed. Special chuck 9-32" capacity, to take largest drill, mostly furnished with drill or tool sets. Length over all, 9 1/2 in. Weight 1 1/2 lbs.
PRICE—No. 302.....\$2.75



ELECTRIC SOLDERING IRON

A perfect tool for Radio Work. Operates either on 110-volt A.C. or D.C. The heat element is of Nichrome, which prevents overheating and assures the desired even temperature. Size of Iron, 10 1/2 in. long. A 1-ft. cord and plug is furnished.
PRICE—No. 800.....\$2.00



Three-in-One Nut Wrench. Consists of handle with hollow stem 6 inches in length and three interchangeable sockets fitting popular sizes of nuts. The hexagon sockets grip the nut solidly.
PRICE per set—No. 301.....65c



Combination Plier, Wire Cutter, Wire Former and Wrench. Drop forged, slender but exceptionally strong, 6 in. long.
PRICE—No. 202.....75c

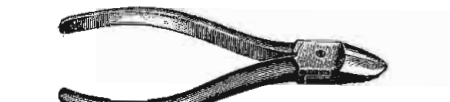

Side Cutting Nipper, Lap Joint. For cutting all kinds of wire. Jaws hardened and oil tempered. Natural steel finish with polished jaws. Length 6 inches.
PRICE—No. 201.....75c

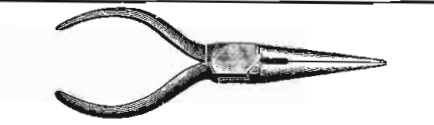

Long Sharp Nose, Side Cutting Pliers. Just the pliers for the radio constructor. Bends and cuts all kinds of soft wire. Nose 1 1/2 inches long, black body, polished jaws. Length 5 1/2 inches.
PRICE—No. 200.....75c

Order all tools by order number. All goods are shipped free of transportation charges to all parts of the United States and possessions the same day as the order is received.

MONEY REFUND GUARANTEE

If you are not satisfied money will be refunded on return of goods.

The RADIOGEM CORP., 66-R W. Broadway, New York

Silver-Marshall RADIO EQUIPMENT

110 South Wabash Avenue

::

CHICAGO

Authorized Plans for the Silver Super

Prepared under Supervision of
McMurdo Silver
A. I. R. E.

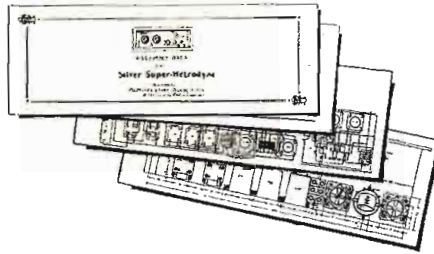

Full-size working blueprints and the most complete instruction data ever offered to the set-builder can now be obtained for the Silver Super, as described by its designer in Radio Broadcast and elsewhere. With these plans and a few simple tools the merest beginner in radio can now build this "Electrical Masterpiece" and obtain results heretofore restricted only to the more experienced builders. The plans include a baseboard layout, pictorial wiring diagram, large clear photographs of built-up models, and a point-to-point wiring plan that leaves no opportunity for error.

Put Laboratory Equipment In Your Old Super

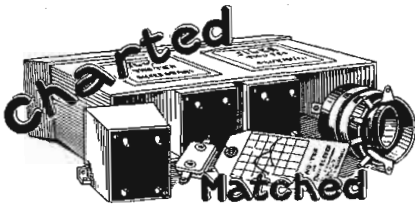

With a set of S-M Two-ten (interstage) and Two-Eleven (filter) Transformers, and a Silver Oscillator Coupler the amplification of your old super can be increased from 1½ to 2½ times, and its overall efficiency vastly improved. Each transformer supplied with its characteristic curve on a tag. Set of Matched and Charted Transformers and Oscillator in a carton.

PRICE\$26.50

Send for the "Why" of Silver Circuits

No 6 of a series of 10
"FILTER FACTS"
Follow them thru monthly

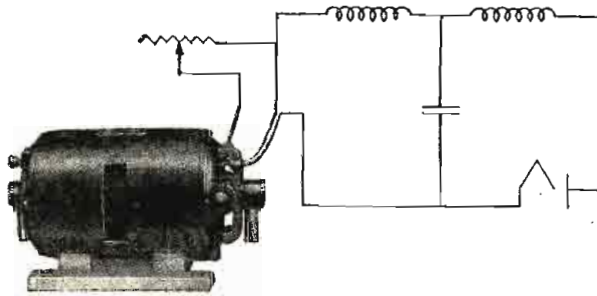

Here we have the so called "T" type of filter. It is essentially No. 5 B with an inductance placed in series with the plate. It would at first thought seem that the addition of this inductance would further reduce the voltage across the plate. It does reduce this voltage. It also increases the frequency of the cut off point. This, as already explained, is not desirable with a motor generator set. We would have had "more for our money" had the two inductances been put in series and used as in No. 5 B. It not only would lower the voltage across the condenser but would also lower the cut off frequency. This would make a more effective reduction in the moving contact disturbances than the arrangement as a "T" type.

ELECTRIC SPECIALTY COMPANY

TRADE "ESCO" MARK

211 South Street

Stamford, Conn., U. S. A.

With an "ESCO" motor generator you will need a globe for your records.

principally due to the fact that the skin-effect is very roughly proportional to the square of the number of turns per inch of coil length and by using many layers, this is increased very rapidly. Thus, a two-layer coil will have at least four times the resistance of a coil having the same inductance, same size and spacing of wire. More than this, the coil capacity also adds to the effective resistance of the coil.

The subject of losses and condensers was considered in great detail in the writer's article in the March issue of RADIO NEWS, so that it will be omitted here. It will be sufficient to note that the resistance of nearly all the condensers on the market, both variable and fixed, is very small compared with the losses in the coils. To obtain truly low loss circuits, therefore, it will be necessary for the experimenter to confine most of his attention to the coil design. The greatest efficiency can be obtained in coils if they are wound with a single layer of No. 16 wire. If the turns are spaced, larger wire may be used with a corresponding reduction in resistance, but the gain obtained by using the larger wire is small. Considerable gain results, however, from the spacing of the turns. The most economical diameter of coil to use is about three inches. A slight gain in efficiency may be had by using larger diameters, but the gain is not worth the trouble and the space occupied by the coil.

The main thing to be remembered by the experimenter is that most of the losses in coils lie in the wire itself, just as the greatest part of the losses in a condenser lies in the plates themselves. Small increases in efficiency may be gained by reducing the amount of metal in the vicinity of the coil or condenser and also dielectric material, but these are refinements to be considered as secondary to the proper choice of wire size, spacing, diameter, thickness of plates, etc.

The Radio Beginner

(Continued from page 2248)

FIVE TUBE SETS

In reading this symposium you may be inclined to think at this point that the writer has omitted one class of set, namely, four-tube sets. This, however, is intentional as there are few standard four-tube sets on the market that can be considered. Usually the next type of set to be considered after a three-tube reflex is a standard five-tube set. First, we will consider the Neutrodyne type such as illustrated in Fig. 12. This set employs a two-stage neutralized radio frequency circuit which feature tends to reduce squealing to a minimum and produce clear distortionless results. Two stages of audio frequency amplification builds up the volume. With this and the remainder of the sets to be discussed, three main tuning controls are used which are usually so balanced against each other that the settings for a certain station are very nearly the same on all three dials. The set in Fig. 12 is of a well-known standard make and retails for around \$125 without accessories. There are a good many other types of Neutrodynes on the market today, any one of them being capable of giving excellent results. The average set of this nature sells in the neighborhood of the figure mentioned above.

Other five-tube sets have appeared on the market since the advent of the Neutrodyne, which type, by the way, did more toward popularizing five-tube receiving sets than any other factor. One of the most popular five-tube sets which is not neutralized is illustrated in Fig. 13. Here a special form

AMERICA'S PIONEER RADIO DISTRIBUTORS

Offer You a Radio Service Unequaled

250,000 customers from every part of the world have purchased their Radio needs from us

SEND FOR THIS FREE CATALOG

Contains all the newest parts, sets and kits at prices that save you money

This page shows only a few of the many hundred bargains we offer. **THIS GUARANTEE PROTECTS YOU.** Examine the goods we ship you. They must suit you in every respect. If you are not satisfied with your purchase return the goods at once and we will refund the price you paid.

VACUUM TUBES
Standard Brands—Cunningham, Radiotron. Every one guaranteed new and perfect and in original carton. We will ship brand in stock unless you specify otherwise.

U105 Detector, UV200, C300. Each.....\$2.69
U112 Amplifier, UV201A, C301A. Each.....2.69
U118 5-Watt Transmitter, 7.70
U107 WVD11, C11. Each.....2.69
U101 WVD12, C12. Each.....2.69
U102 UV199, C299. Each.....2.69

ADAPTERS
To use dry cell tubes in standard base sockets simply insert one of these adapters in the socket.

U104 For 359 or 299 tubes.....40c
U109 For WVD11 or C11 tubes.....40c

BAKELITE SOCKET
U140 Standard base.....30c
U141 UV199 base.....30c
U136 C11.....39c
Moulded of genuine red brown bakelite. Binding post connections. Strong contacts. Real values.

METAL TUBE SOCKET
U134 Each.....25c
Nickel plated brass tube set in best grade mounting base. Plainly marked binding posts. An excellent value.

STANDARD TUBE SOCKET
U150 Single Gang.....\$76
U153 Three Gang.....2.25
Bakelite base. Polished nickel tube. Highest quality socket on the market. Best insulating bakelite contact. Marked terminals. For base or panel mounting.

SUPERIOR RHEOSTATS
U147 6 ohm. Each.....62c
U148 20 ohm. Each.....70c
U149 50 ohm. Each.....70c
One of the finest rheostats we have ever seen at a price that makes it the best value obtainable anywhere. Genuine bakelite base. Beautifully shaped black bakelite knob with white arrow. Single hole mounting. A rheostat you will be proud to have in your set.

U156 400 ohm Potentiometer. Matches above rheostats. Each.....89c

FILAMENT CONTROL RHEOSTATS
U132 6 ohm. Each.....34c
U129 20 ohm. Each.....36c
U131 50 ohm. Each.....38c
U135 6 ohm Vernier.....78c
Best grade. Will give real service. Durable and lasting. High heat resisting base, diam. 2 1/4 in. Tapered polished black knob, 1 1/2 in. diam.

Potentiometers. Match above rheostats. Same high grade construction.
U151 200 ohm. Ea. 52c U152 400 ohm. Ea. 59c

RADIO "BAKELITE" PANELS
We supply genuine Bakelite, Condensite, Celcon or Formica, all of which have practically identical properties. Machines well without chipping. Won't warp. Waterproof. One side has attractive natural polished black finish which can be sanded and oiled. Other side mahogany finish. Either side may be used as front. Postage 10c each extra.

Panel Size Inches	3/16" thick		1/4" thick	
	Art. No.	Price	Art. No.	Price
6x7	U450	\$5.55	U460	\$8.99
6x10 1/2	U451	.86	U461	1.10
7x10			U455	1.28
7x12			U456	1.64
7x14	U453	1.38	U468	1.73
7x18	U453	1.78	U463	2.27
7x21	U457	2.05	U467	2.65
7x24	U459	2.42	U469	2.87
7x26			U462	3.25
9x14			U404	2.35
12x11			U465	2.97
12x21			U466	4.25
			U474	3.15
			U475	3.98
			U476	5.70

COMPOSITION DIALS
Handsome dials moulded in one piece of polished composition. 2 inch size has 270° scale marked 0 to 100 finely engraved in contrasting white enamel. 3 and 4 inch size have 180° scale marked 0 to 100

Black		Mahogany	
No.	Price	No.	Price
U921	16c	U926	19c
U922	16c	U927	19c
U923	22c	U928	28c
U924	22c	U929	28c
U925	29c	U930	34c

The Very Latest

Radio Book

Free

This Book Full of Radio Bargains.

Shows Big Savings on parts, sets and accessories.

Our prices are lowest on highest quality standard goods.

Send for your copy today

ALL ORDERS SHIPPED SAME DAY RECEIVED

STANDARD BRAND LOUD SPEAKERS AND UNITS

- U618 Brandes Table Talker.....\$8.45
- U616 Atlas Loudspeaker.....21.95
- U620 Baldwin Loud Speaker.....19.50
- U603 Magnavox M4 Loudspeaker.....21.00
- U612 Magnavox R3 Loudspeaker.....31.75
- U614 Magnavox M1 Loudspeaker.....26.50
- U757 Morrison Adjustable Unit.....4.35
- U755 Genuine Baldwin Type C unit.....4.85
- U608 Atlas Unit. Each.....10.80

STANDARD BRAND HEADSETS

- U754 Baldwin Type C.....\$9.80
- U764 Frost, 2000 ohm.....3.50
- U766 Frost, 3000 ohm.....3.35
- U751 Muddock 50, 2000 ohm.....3.25
- U752 Muddock 50, 3000 ohm.....3.60
- U768 Brandes Superior, 2000 ohm.....4.85
- U769 Brandes Navy, 2000 ohm.....6.85

DUBILIER MICADON TYPE 601

- U502 .0001, 29c U507 .0025, 33c
- U503 .00025, 29c U508 .003, 40c
- U504 .0005, 29c U509 .004, 40c
- U505 .001, 33c U510 .005, 48c
- U506 .002, 33c U511 .006, 60c

DUBILIER MICADON 601G

Same style condenser as above with mounting for tubular grid leak. No grid leak included.
U581 .0025, Ea. 38c
U582 .0005, Ea. 38c

ANTENNA INSULATORS

- U263 Ribbed Porcelain insulator, 2 1/2 in. long. Ea. .66
- Dozen.....55c
- U265 Ribbed Porcelain insulator—5 inches long. Ea. .15c

STRANDED ANTENNA WIRE

Cabled of fine copper strands. Very flexible. High tensile strength. Best for aerials.
U248 100 ft. coil 56c U249 500 ft. coil \$2.60

SUPERIOR RADIO SWITCH

U283 Each.....29c
A switch fully equal to any on the market at a price about half what is usually asked for a switch of anywhere near equal quality.

SUPERIOR RADII JACKS

Finest grade jacks. Improved design. Best materials. Phosphor bronze springs. Silver contact points. Nickel finish. Mount on panels 1/2 to 3/8 in.
U390 Open circuit. Each.....32c
U391 Closed circuit. Each.....39c
U392 Two circuit. Each.....49c
U393 Single circuit filament control. 46c
U394 Two circuit filament control.....59c

You take no risk in dealing with us. We are one of the oldest and most reliable radio supply houses. For reference to our reliability we refer you to Radio News. Our guarantee protects you. Let us serve you and save money for you. All orders shipped same day received.

ORDER DIRECT FROM THIS PAGE. You will find many items you will need on this page. Send your order in for them at once. Prices quoted on this page are transportation charges prepaid in U. S. A. east of the Rocky Mountains except where otherwise stated.
Dealers send for our wholesale catalog.

PANEL MOUNTING VARIABLE CONDENSERS

These are especially high grade condensers and we guarantee them to be mechanically and electrically perfect. Fine polished end plates of heavy bakelite. Shafts 1/4 inch diameter. Sturdy, heavy aluminum alloy plates perfectly spaced to insure smooth, even reliable capacity. Dial and knob on vernier type. No dial on plain type. Our low prices save you money.

No. Plates	Max. Cap.	Plain Type	Vernier Type
3		U815 \$.79	
5		U816 .89	
11	.00025	U814 1.00	U825 \$1.85
17	.00035	U817 1.29	
23	.0005	U813 .50	U824 2.25
43	.001	U812 1.45	U826 2.46

GROUNDING ROTOR LOW LOSS VARIABLE CONDENSERS

U797 .0003\$2.75
U798 .00053.25
U799 .0013.95
The most efficient type condenser in the low loss category. Grounded rotor, straight wave line. Made of the best grade materials throughout. Heavy aluminum plates. Well insulated.

STANDARD BRAND VARIABLE CONDENSERS

- U810 Acme .0005 Vernier.....\$5.65
- U784 Coto .00025 Vernier.....3.95
- U785 Coto .0005 Vernier.....4.25
- U786 Coto .001 Vernier.....4.95
- U787 Cardwell .00025.....3.95
- U788 Cardwell .0005.....4.35
- U789 Cardwell .0005.....4.60
- U790 Cardwell .001.....5.55
- U791 Marco .00025.....3.95
- U792 Marco .0005.....4.45
- U793 Marco .0005.....4.95
- U794 Marco .001.....5.85
- U795 Flewelling .00025 Vernier.....4.50
- U796 Flewelling .0005 Vernier.....4.95

OUR SPECIAL A. F. TRANSFORMER

U549 3 to 1 ratio.....\$2.25
U550 5 to 1 ratio.....2.45
In quality of tone and volume of sound, the things a transformer is built for, we guarantee it to equal or surpass any other transformer. Neat in appearance. Carefully made. Fully mounted with plainly marked binding post connections. Wonderful results on one, two or three steps without distortion or howling. A quality item in every respect.

OTHER STANDARD BRAND AUDIO FREQUENCY TRANSFORMERS

- Fresh, Clean Stock in Original Containers.
- U587 Thordarson Ratio 3 1/2 to 1.....\$3.30
- U588 Thordarson Ratio 6 to 1.....3.70
- U589 Thordarson Ratio 2 to 1.....3.95
- U590 Thordarson Push Pull. Pair.....11.20
- U531 All American 10 to 1. Each.....4.25
- U532 All American 5 to 1. Each.....4.25
- U533 All American 3 to 1. Each.....4.05
- U534 All American Push Pull. Pair.....10.80
- U535 Rawland Lerie.....6.10
- U553 Acme.....3.95
- U597 Erla 6 to 1.....4.05
- U598 Erla 3 1/2 to 1.....3.60
- U591 Modern 10 to 1. Each.....4.50
- U592 Modern Push Pull. Pair.....9.90
- U555 Federal No. 226. Each.....4.45
- U556 Federal No. 65. Each.....6.35
- U712 Radio Corp. Each.....5.70



\$47.50

5 Tube Bargain

The greatest radio value ever offered

A five-tube radio frequency set that brings in the distant stations on the loud speaker. All the volume you could want with the finest tone quality, clear and sweet. Careful designing with big quantity production make our low price possible. Only the finest quality materials used throughout. New style efficient low loss condensers and transformers. Bakelite panel size 7x18 in. Handsome mahogany finish cabinet. Neat convenient dials. We can recommend this set for either city or country use. Will not radiate and will bring in stations from coast to coast. No set approaches this for value. Equals many sets selling at double and triple our price. Try it for ten days. If you are not satisfied return it and we will refund your money.

U867 Set, only.....\$47.50
U868 Set complete with five 201A tubes, 90 volts B battery, 100 ampere storage battery, one T613 Special Speaker, and complete antenna equipment. Nothing extra to buy. Price.....\$88.00

The Barawik Co.

102 So. Canal St. Chicago, Ill.

STANDARD BRAND RADIO FREQUENCY TRANSFORMERS

- U562 Dubilier Duratron.....\$3.45
- U565 Acme R2.....3.95
- U568 Acme R3.....3.95
- U569 Acme R4.....3.95
- U568 Erla Reflex No. 1.....4.45
- U579 Erla Reflex No. 2.....4.45

RESISTANCE COUPLED AMPLIFICATION

U570 1st Stage Unit \$2.30
U571 2nd Stage Unit 2.30
U572 3rd Stage Unit 2.49
Amplifies without distortion. Replaces audio frequency transformers using same circuit. Each unit consists of a mounting with condenser, grid leak and resistance of proper value for best results.

How To Locate Troubles In Your Radio Set

Locating troubles in your radio set, especially the super radio sets that are being built today, presents quite a problem. There are several troubles common to radio receiving sets, such as, incorrect wiring, or wiring that is short circuited, poor connections, wrong battery leads, etc.

The E. I. Company Book No. 12 tells you how to locate these troubles. It shows you how to test the batteries to see if the leads are correct, how to check the circuits of the receiver, and such explanations as will enable you to rectify practically any trouble.

This book contains sixty-four pages of information of this kind. It is one radio book that you should have on hand at all times. It may save you the price of five or six tubes, it may save you the price of a set of batteries, or it may mean the difference between good reception and poor reception.

This book is profusely illustrated with pictures, charts, and diagrams. It is written in plain English so that you can fully understand every word of it, bound with extra heavy card-board cover, printed in two colors, size 5 x 8 in.

PREPARE FOR ANY EMERGENCY BY OBTAINING A COPY OF THIS BOOK TODAY.

Postage Paid

PRICE
25¢

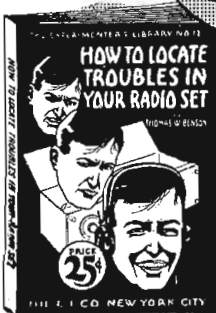

BOOK
No. 12
How to
Locate
Troubles
In Your
Radio
Receiver

E.I. Company

SOLD BY ALL RADIO AND
NEWS DEALERS

Sole Distributors

The Consrad Company, Inc.
233 Fulton Street New York, N. Y.

of winding is employed to reduce squealing and noises in the set to a minimum. Sets of this nature have given excellent results throughout the entire country and several used in the Eastern states have reported reception of Pacific coast stations under good conditions. A set of this type can now be purchased for \$60 or less, without accessories and for \$100 one can expect to purchase this set complete with all accessories and ready to operate.

The last type of radio receiving set that we will consider is one of unusual design and is illustrated in Fig. 14. Here the usual dials have been done away with or rather placed in an unusual position so that the edges project through slots in the panel. Coarse tuning may be obtained by revolving the dials themselves whereas a vernier effect is obtained by the use of the small dials directly below the large ones. A special form of winding used in the coils of this set is said to be of such value that the set is very stable in operation and produces wonderful volume for the number of tubes used.

From the above paragraphs and the illustrations accompanying them, the reader should be able to obtain a very good idea of the various types of receiving sets and the prices that are asked for them. He can then think over various conditions that the set he desires must fulfill, consult his budget and proceed more intelligently with the selection of a radio receiving set for his use.

With the Amateurs

(Continued from page 2257)

if someone asks for a short test on five meters there will be a tube, a socket, and all the necessary equipment at hand to do the job in ten minutes, if necessary.

There is no doubt about the fact that the assembly of a new set becomes boring after the first ten minutes. It's a good bit like shaving, the first time it hands a real thrill and after that the interest in it is in inverse proportion to the number of times the operation is repeated.

Well, after looking about the friend's shop which we were speaking of in the first part of this little msg., we took him back over to the shack, on the way spinning a little philosophy generally about the sacredness of the amateur experimenter and his generally high place in the world of art and affairs, ending it with a few well-chosen words about his duty to humanity and ways and means of fulfilling his duty thereto.

We ended the little talk by taking him to a sort of storeroom adjacent to the shack where on four well-ordered shelves there were bits of apparatus covering the necessity at hand. We pulled down the necessary parts, all ready for operation, put them in his unwilling arms, stuck two tubes in his side pocket and a bunch of connection wires equipped with the handiest little clips ever seen. We put these last in a tobacco pouch which felt like a flask when it was in his hip pocket, just for the sake of making him feel at home.

Thus loaded, we sent him on his way home with a strict injunction to do his stuff after dinner.

He did, and the test went off beautifully.

For exactly seven weeks thereafter we received a call almost daily from him asking for something or other. He got it every time, until we got tired of the regular visits to the improvised stock room. We decided to look into the matter and so took one afternoon off to investigate. When we got there we found the boy deep in the midst of something or other, it didn't matter much

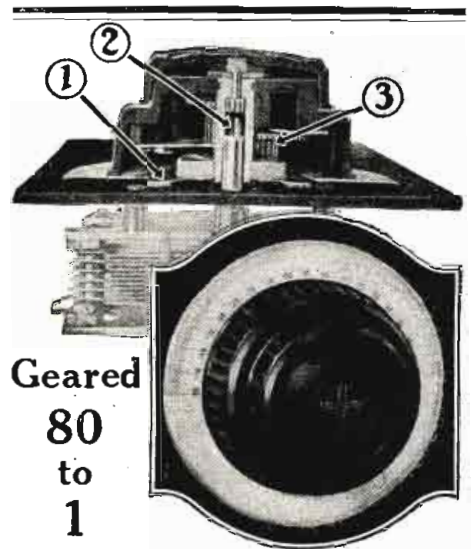

Geared
80
to
1

Close Tuning Features

(1) Friction Clutch—the heart of Accuratune Controls. Automatically locks gear train for coarse adjustment and throws train into operation for fine adjustment.

(2) Long center bushing gives maximum shaft-bearing surface and prevents all wobble.

(3) New Gear Mesh assures perfect alignment of the new brass gear train.

At your dealers, otherwise send price (\$3.50) and you will be supplied postpaid. Write for descriptive folder.

European Branch Office: Gaston E. Marbaix,
27 Anning St., London, E.C.2

Mydar Radio Company, 9-F Campbell St., Newark, N. J.

ACCURATUNE
REGISTERED PATENT 80101 U.S. PAT. OFF.
MICROMETER CONTROLS



FOR GREATER DISTANCE, VOLUME
AND CLARITY USE

X-L VARIO DENSERS

Endorsed and Used by the Foremost Radio Engineers of the Country

MODEL N—Capacity range 1.8 to 20 micro-microfarads, for balance in Roberts two tube, Brown-Draze, McMurdo Silver's Knockout, Neurodyne and tuned radio frequency circuits. Price \$1.00

MODEL G—Two capacity ranges, .00016 to .00055 and .0003 to .0015 Microfarads, for the Cockaday circuit, filter and intermediate frequency tuning in super-heterodyne and positive grid bias in all sets. Price \$1.50

X-L RADIO LABORATORIES

2426 Lincoln Ave. CHICAGO
If your dealer cannot supply you write direct



SMASH COMPETITION

Make \$25.00 every day selling Economy Suits for \$12.50. SUPERCLOTH, new discovery genuine suitings, wears longer, looks better. Beautiful patterns, Snappy Styles. Sell on sight. Big commissions paid daily. Write for BIG SELLING OUTFIT FREE.

ECONOMY CLOTHING MFG. CO.
Dept. RT-19, 2035 Charleston St., Chicago

Operate your radio from your lamp socket with a
Gould UNIPower Battery
for complete information address
GOULD STORAGE BATTERY CO.
250 Park Avenue New York

Insure your copy reaching you each month. Subscribe to RADIO NEWS — \$2.50 a year. Experimenter Publishing Co., 53 Park Pl., N.Y.C.

TROPADYNE SUPERADIO OUTFIT

THIS Superadio 6 Tube Set brings in Station KFKX (Hastings, Nebraska), 1200 miles, in New York City, clearly on a loud speaker, using only the small loop which comes with the outfit.

The outfit advertised here is complete, as listed below, everything needed is included, down to the last screw. The charts, blueprints, directions and photos furnished are so complete and explicit that anyone can build this set and have it working within a few hours. There is nothing additional to buy except the necessary batteries and tubes. Price includes mahoganite cabinet and folding loop aerial.

You can pay \$150 or more for an outfit, or \$200 or more for a set, but you cannot possibly buy a better set than this one.

READ THIS

Utmost sharpness—Cuts thru locals bringing in long distant stations as if they were locals.

Ease of Tuning—Only two dials.

Tuned Intermediate Transformers; the only real BALANCED set of its kind made. Once transformers are tuned they need not be touched again.

Your Money Refunded if this set does not satisfy you in all respects—if after 5 days' fair trial you do not proclaim the TROPADYNE the best radio set you ever listened to.



No. V4477

A GREAT ADVANCE IN RADIO SET BUILDING

By using our new NO-SOD-ER connectors, any one, by means of a screw driver and a pair of pliers, can put this set together. No bus bar, no heat, no flame, no solder, no soldering iron (only an expert can solder right), no fuss, no trouble. By means of our insulated, double eyeletted, flexible connectors, perfect connections are made, not only mechanically, but electrically as well. Short circuits impossible. Read all about this new advance on page 2202, June issue of RADIO NEWS.

Note These Important Features:

DISTANCE, VOLUME AND TONE QUALITY equal to any 8 tube set sold anywhere at any price.

LOOP RECEPTION—Outside aerial not required with this set—the complete collapsible loop is included in outfit.

PERMANENT LOGGING OF STATIONS—Follow chart furnished; there are only two tuning controls and you will always find the same station at the same spots on the dials. Our log chart shows you at what point to find any station.

MICROMETER VERNIER DIALS giving you the full advantage of the exceptionally sharp tuning.

OUTFIT IS ABSOLUTELY COMPLETE—Drilled panel, Mahoganite Cabinet and everything else needed, except tubes and batteries.

ECONOMY and SIMPLICITY—This is not a reflex, yet six tubes do the work for which other sets require eight to ten.

REAR VIEW OF TROPADYNE

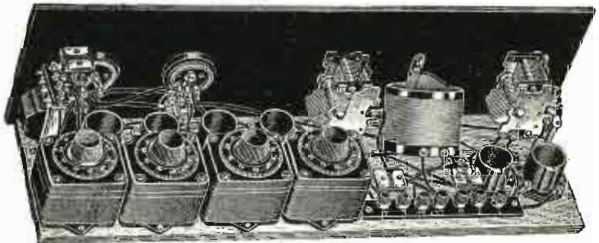

Set uses 201A or UV-199 Tubes.

WE SHIP IN 24 HOURS

The Editor of Radio News

In the August 1924 issue, said this about the Tropadyne: "Here is a remarkable receiver which we warmly recommend to our readers. It has several new and unusual features. In the first place only 6 tubes are used giving as much volume as the average 8 tube Heterodyne. The selectivity of this set is unusual. Unequalities of the intermediate transformers have now been done away with by tuning each transformer. After the transformer has been tuned, it can be left this way, no further tuning being necessary."

"This system makes for maximum sharpness and maximum volume. Another outstanding point of superiority of the Tropadyne circuit is that it practically does not radiate, thereby not interfering with other nearby receiving stations. A saving of two tubes as well as an increase of selectivity is obtained with this new circuit."

Complete List of Parts:

- Cabinet, Mahogany Finish, 7x21x8, \$5.20. Panel, Drilled and Engraved, Bakelite, 7x21, \$3.75. Baseboard, 6½x23½, 50c. Tropadyne Kit, \$10.00. Loop Aerial, \$3.75. Variable Condensers, Low Loss, .0005 Hammarlund, 2 at \$3.00, \$10.00. Vernier dials, 4-in., E-Z Tone, 2 at \$2.25, \$4.50. Transformer, Audio Frequency, Thordarson, \$4.50. Rheostat, 6-ohm, Bakelite, 65c. Potentiometer, 400-ohm, Bakelite, 85c. Sockets, Low Loss, Bakelite, Bell, 6 at 45c, \$2.70. Jack, Double Circuit, Improved, 70c. Jack, Single Circuit, Improved, 60c. Grid-Leak and Mounting, ½-megohm, Eletrad, 85c. Fixed Condenser, .005, Hilo, 75c. Fixed Condensers, .0005, Hilo, 2 at 35c, 70c. Binding Posts, Moulded, Aristocrat, 7 at 7c, 49c. Binding Post Strip, 25c. "No-Sod-er" Connecting Wires, Set, \$2.25. Necessary Hardware (screws, angles, etc.), outfit, 25c. Blueprints, with Instruction Sheet, \$1.00. Total, regular price.....\$72.99
- OUR PRICE\$60.50

RADIO SPECIALTY COMPANY,

98 PARK PLACE, NEW YORK

New "Rasco" Catalog NO. 12
CONTAINS 75 VACUUM TUBE HOOK-UPS,
300 ILLUSTRATIONS, 500 ARTICLES.
NOW 100 PAGES

All Armstrong Circuits are explained clearly, all values having been given, leaving out nothing to puzzle you.
Just to name a few of the Vacuum Tube circuits: The V.T. as a detector and one-step amplifier; one-step radio frequency amplifier and detector; three stage audio frequency amplifier; short wave regenerative circuits; 4-stage radio frequency amplifiers; radio and audio frequency amplifier; inductively coupled amplifier; all Reflex Circuits.

FREE
A POSTAL CARD BRINGS IT

SEE OUR 2-PAGE AD ON PAGES 2202 and 2203 RADIO NEWS

R.N.6 SEND NO MONEY
RADIO SPECIALTY CO., 98 Park Place, New York, N. Y.
Please send at once one complete TROPADYNE SUPERADIO Outfit as advertised in June "Radio News." I will pay postman or expressman \$60.50 upon arrival.

NAME

STREET or R.F.D.

CITY STATE

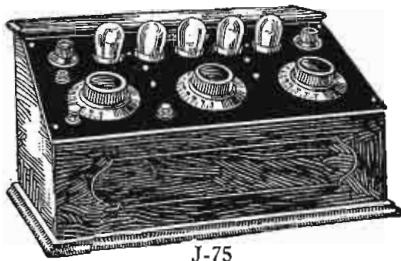

J-75

You may well be proud of your

JOS. W. JONES
RADIO
TRADE MARK

Standardized,
Precision-Made
Receiving
Set

*Rich, Sweet Tone!
Luxurious Volume!
Bona Fide Selectivity!
A Beautiful Cabinet!*

—and distance Well, you'll be certain it is a local station till you hear the announcer give its name!

Best of all, it's standardized—built of the famous Jones Precision Parts—which means utter dependability; no embarrassing moments of "indisposition" when guests are to be entertained.

The price will first surprise and then delight you!

Jos. W. Jones' Radio Dealers invite you to come and

GET THE PROOF!
Hear a Demonstration

JOS. W. JONES
RADIO MFG. CO., Inc.

40-46 West 25th Street
New York City

Buy Now Pay Later **It's Easy to Build Things**

Do ripping, mitring, grooving, tenoning, rabbeting and other operations with speed and accuracy on the

BOICE-CRANE JUNIOR SAW

Build radio cabinets, furniture, toys, novelties, etc., with this compact, practical machine. All metal construction. Attaches to light socket. Sold with or without motor and base. A quality

machine at low price.

Write for complete information on Boice-Crane Bench Saws, Jointers, Band Saws and Motors.

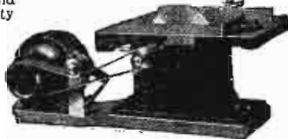

W. B. & J. E. Boice, Dept. 806-A, Toledo, O.

WAIT FOR ANNOUNCEMENT OF BOSCH RADIO APPARATUS

American Bosch Magneto Corporation
Main Office and Works: Springfield, Mass.
Branches: New York, Chicago, Detroit, San Francisco

what. The point was that he had found, through the use of my storage room and the ease with which apparatus was forthcoming, that he could have a lot of fun just fooling around with ideas which he had had some time before, but balked every time he looked into those two scrap piles for the junk to do them with.

Too much is generally more than the camel's back will support. Ergo, we told him that we were extremely thankful for the excess flattery in imitation, but that we had used up a couple of weeks' salary in shoe leather getting the stuff for him out of the stock. Attention was called, so something had to be done.

Over his left shoulder, while sitting at the operating table, there was plainly visible the door of a closet. Upon investigation, this proved to be filled with more junk of the same order as that so uselessly stowed away in the goods boxes.

We not only called, but also raised. Here was the necessary room, and the sides of the goods boxes aforementioned could be forced into service as the most excellent shelves.

A hammer and a few nails transformed the closet into something respectable in the ideas of one who thinks that orderliness is next to godliness in matters terrestrial.

The next point was to sort and store the stuff. This was a bit more of a job. But time cured it as in most other cases.

Then our own apparatus was returned to its place and he had his own stuff well ordered for the fray.

After that we swore at him roundly some dozens of times for, once started, he seemed to find more damphool ideas to try than any hombra we have known in the present existence. And like all good friends, he always troubled himself to try them on his friends. Night after night we did the obsequies over foolish notion after foolish notion.

Not all of them died at birth. To the contrary, some of them grew to a healthy age and waxed strong in the service of their master. But the point is again that once started, and with the terrible resistance of disorganization out of the way, a clear path, maybe not of roses but at least not of hot asphalt, made him into one of the most expert and continual experimenters we have seen in some time.

All this is by way of showing the gang how a lot of fun can be had when they feel the urge to work and can't do anything but CQ. If you haven't something actual to get off the traffic hook or are not carrying out a test of one sort or another, why not spend a little time in good old engineering. You will be surprised at yourself, once you give yourself a chance.

Try putting a few instruments before you on a table—not the operating table, for the love of mud—but on the laboratory work table.

Look 'em over carefully and see if there is not a defect or two in their structure which you could remedy if given a chance. The troubles will be found, and in plenty. The next step is to try and do it.

And here is where you get in deep. The cogitation will not only show inefficiencies in design, but will also give birth to a lot of radio and electrical ideas which you didn't dream existed in your fertile brain previously.

All invention—or most of it—is simply a matter of association of ideas. The way to obtain the said association is to give the old brain a chance. When it is filled with a lot of miscellaneous junk, which is of no great importance, the process under discussion has little if any chance to mature. Therefore, give it a chance.

Not only give it a trial, but force it to take the jump. Make it do a Steve Brody. And once started—parallel the case of the

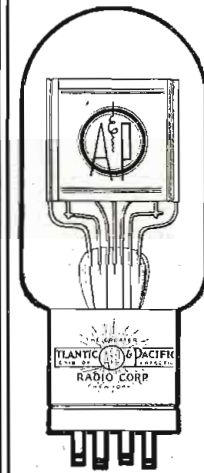

The Famous and Old Reliable ATLANTIC & PACIFIC RADIO & AUDIO FREQUENCY

TUBE

USED AS DETECTOR OR AMPLIFIER

Scientifically Constructed

NOISELESS—TIPLESS—LONG LIFE—

Ask any user, he will tell of its years of merits. The greatest tube known for DX reception. Enormous volume without distortion. Low battery consumption—uses 1/4 ampere, 5 or 6 volts.

Price \$3.00

Mail Orders Given Prompt Attention ALL TUBES FULLY GUARANTEED

FREE Our Research Department desires statistics regarding results obtained by long and constant users of A. & P. Tubes. For complete and satisfactory information and statements from bona fide users of our tubes for four years or longer we will furnish Free of Charge 5 NEW TYPE A. & P. TUBES.

ATLANTIC & PACIFIC RADIO CORPORATION

223 West 34th Street, New York City
THE PIONEER OF RADIO.

The HEART of the Circuit is AMPERITE
The "Self-Adjusting" Rheostat

As the heart controls the flow of blood through the body, so AMPERITE, the self-adjusting rheostat, controls the flow of current through the tubes—automatically—never allowing too much to injure the tubes, and always permitting true tone qualities with proper volume. No hand rheostats. No guessing. Simplifies wiring. Improves operation. Used in over 50 leading sets and circuits. \$1.10 every where.

RADIALL COMPANY

Dept. R.N.-11, 50 Franklin Street, New York City

Write for FREE Hook-ups



WRITE FOR OUR CATALOGUE RADIO PARTS-KITS-SETS
We Guarantee to Save You Money
The RADIO SHACK
55 Vesey Street, Dept. F 23
NEW YORK CITY

The Marvelous 5 Tube Radio Frequency Set



RICO-DYNE

An assurance of perfect performance, faithful tone production and \$100 radio receiver value all for

\$60.

*Mahogany Cabinet
The Set with a Punch*

AUTO BALANCED 5 TUBE RADIO FREQUENCY

The combination of "RICO" CELLUWELD Low Loss Coils and Variable Condensers is made mechanically perfect. The Coils are welded firmly to the support of the rotor plates, a new principle. (Patents Pending.)

Selective and non-oscillating, the "RICO" "AUTO-BALANCED" TUNED RADIO FREQUENCY SET accomplished by carefully setting the neutralizing angle of the Coils at the factory; remains permanent due to the CELLUWELD process.

The Complete Ricodyne Kit contains everything. The set you can build in 3 hours. Price Complete\$38.75

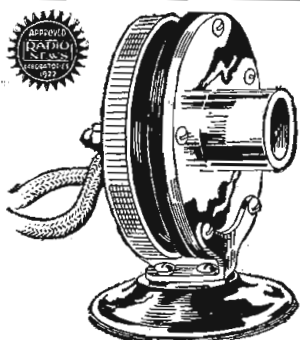

ADJUSTABLE

MAKE FULL USE OF YOUR PHONOGRAPH MELOTONE—"None Better"

Adjustable phonograph unit
makes your phonograph
a perfect loud-speaker

\$7.50

THE MELOTONE HAS ALL THE QUALITIES OF THE \$10 TO \$12 UNITS



THE NATION'S FAVORITE HEADSET RICO PHONES—The Headset of Real Value

There is more quality, real honest-to-goodness quality packed into RICO PHONES than you'll find in any headset at twice its price! Compare and see.

\$2.95

Manufacturers of the famous "RICO" straight line condensers, at \$1.75 each. The "Tropadyne" circuit is supplied free with every tuned "Tropaformer" that we manufacture for all long wave transmission. "Tropaformers" \$6.75 each. Dealers—write or wire for wonderful proposition.

RADIO INDUSTRIES CORPORATION,
131 DUANE ST., NEW YORK CITY.

Gentlemen: I am enclosing \$..... for the items checked below. Kindly ship at once.

.....RICO-DYNE SET, \$60.

.....MELOTONE UNIT, \$7.50.

.....RICO PHONES, \$2.95.

My Dealer's name is.....

NAME

ADDRESS

CITY



New Radio Pleasures -at a "touch of the switch"

It's just as easy as turning on an electric light. "At a touch of the switch" your batteries are recharged and maintained at maximum efficiency year after year. 96 volt wet "B" batteries, 6 volt wet "A" battery and recharger *all-in-one* compact and attractive cabinet. Neat, tidy and convenient for everything is in its proper place. The costly replacements and the "fading" results of dry batteries automatically eliminated. You're *money ahead* by having an All-in-One Radio Power Cabinet. It costs only \$85.00 COMPLETE.



De Luxe Model

Tudor period in Walnut or Mahogany finish. A handsome piece of furniture for any home. Write for literature with prices, specifications and detailed information.

DEALERS and JOBBERS

—this is one of the quickest selling and most profitable radio units you can stock. Write for particulars of our attractive proposition.

Universal Products Co.
Oshkosh, Wis.]



SEND FOR YOUR FREE COPY

TESTED HOOK-UPS SUBMITTED BY USERS OF OUR



WONDERFUL
TRANSMITTER

BUTTON FOR LOUD
SPEAKERS

Price \$1.00
POSTPAID
with instructions

AMPLIFICATION
AND EXPERIMENTS

K. ELECTRIC CO.

2 RECTOR STREET NEW YORK

gent aforementioned, the gent of the test, that is— notions and ideas will tumble over themselves for attention. And here is where the great work is done. The ideas themselves, in sweet virgin form, may mean anything or nothing. But the real good of the whole process comes from the intelligent observance of the various factors which present themselves during the trials.

Most of the ideas will be damphool; that is granted before the thing is begun—but—the results need not all be in the same class.

If the first tests prove of no value and nothing has been actually learned, the track may be relegated to oblivion—if you haven't a hunch as to its quality and ultimate goodness.

Parentetically speaking—play the hunches; very often they pay and pay well. Edison played them a lot of the time and now he could have five country homes and a fleet of yachts if he wanted to.

But the chances are, to go back where we left off, that the results will seldom be so nil as hinted at. There will usually be something of value in the works and past experience has taught the Ham never to overlook anything that might be profitable.

Start a lab.; it may save you borrowing five every time the income tax falls due!

2-B R B. One of the Second District's Best

(Continued from page 2258)

control is used and serves its purpose very well. A 250-turn winding of No. 28 D.C.C. constitutes an efficient radio frequency choke coil for the plate circuit of the detector. It may be noted that the detector tube is a VT-1 which uses a .0003 grid condenser and a 5-megohm leak. Two stages of audio frequency amplification are used, but generally one stage is sufficient for all practical purposes, the signals coming in loudly and clearly. One tuning dial facilitates the following of a swinging signal and affords a ready means of coming back to a station previously logged.

All in all it can readily be seen that the perfection of the station does not lie in the neatness or symmetry of the lay-out. The main factor was the choosing of apparatus the constants of which gave best results when connected in the circuits.

Fundamental Theory and Design of Loop Antenna

(Continued from page 2256)

in inductance and capacity. With a coil 8 feet on a side the separation between turns should be at least .35 inch, for one 4 feet .2 inch and for a 2-foot coil 1/8 inch. It will be seen from Fig. 3 that for a certain length of wire properly spaced the fundamental wave-length is approximately the same with different size frames.

Measurements have shown that with a coil 5 feet square with spacing of turns 1/2 inch and using a tuning condenser, as shown in Fig. 4, with a maximum capacity of .00065 mfd., wave-length range has changed with number of turns as follows: Four turns gave a range of 200 to 400 meters; eight turns 350 to 700 meters and 16 turns 500 to 1,000 meters. The same coil with a condenser of maximum capacity of .0014 mfd.

Let us
send
you this
booklet



FREE—

There must be some *very good reasons* why over FORTY of the leading set manufacturers use Pacent Radio Essentials in their sets! These reasons are explained in our Pacent booklet entitled "FOR GOOD RECEPTION." It contains a complete description of the entire Pacent line, and will "put you wise" to a few radio facts that will improve your set-building. ABSOLUTELY FREE. Write to

PACENT ELECTRIC CO., Inc.
91 Seventh Ave., New York City

Washington Detroit Philadelphia
Minneapolis Buffalo Jacksonville
San Francisco Boston Birmingham
St. Louis Chicago

Canadian Licensees:
R. H. White Radio Co., Hamilton, Ont.

DONT IMPROVISE — PACENTIZE



Alternating Current on the "A" Circuit of your Reflex Radio

The Lasco "AC" Attachment

REPLACES the bothersome, acid-spilling storage batteries or costly dry batteries. No objectionable hum, volume and clarity same as battery. Current consumed, 3 watts per hour. For "A" tubes only. Will not become inefficient with use. Life indefinite. Can be installed by anyone. For Two-Tube REFLEX only. Complete with reducing transformer LASCO "AC" Attachment and complete instructions for installing and operating.

Postpaid any place in U. S. on receipt of \$6.00

Manufactured by
LOS ANGELES SALES CO., Inc.
1211 W. 6th St. Los Angeles, Calif.

KEYSTONE ARRESTERS

PROTECT AGAINST LIGHTNING
\$1.50 COMPLETE AT ALL DEALERS

PROFIT BY YOUR METEOROLOGICAL OBSERVATIONS

The editor of TYCOS-Rochester, a little meteorological journal published by Taylor Instrument Companies, Rochester, N. Y., seeks to review manuscripts based on observations of atmospheric phenomena, its effect on radio reception, with a view to publication in above magazine. Prevailing space rates paid promptly on acceptance. All material reviewed promptly. Correspondence invited. Addressed to the personal attention of F. M. Herriek, Editor Tycos-Rochester, Taylor Instrument Companies, Rochester, N. Y.

5000
RADIO DEALERS
buy from

HUDSON-ROSS
123 W. Madison St. Chicago
Send for dealers discount.

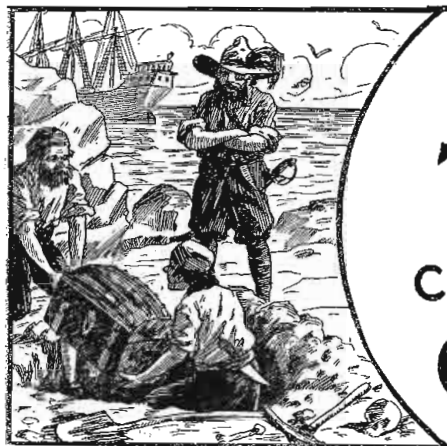

BURIED TREASURE

can still be found in

CHEMISTRY



Good Chemists Command High Salaries

and you can make yourself independent for life by unearthing one of chemistry's yet undiscovered secrets.

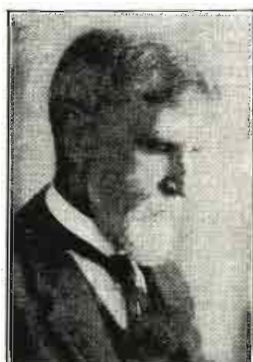

T. O'CONNOR SLOANE.
A.B., A.M., LL.D., Ph.D.
Noted Instructor, Lecturer and Author. Formerly Treasurer American Chemical Society and a practical chemist with many well known achievements to his credit. Not only has Dr. Sloane taught chemistry for years but he was for many years, engaged in commercial chemistry work.

Do you remember how the tales of pirate gold used to fire your imagination and make you want to sail the uncharted seas in search of treasure and adventure? And then you would regret that such things were no longer done. But that is a mistake. They *are* done—today and everyday—not on desert islands, but in the chemical laboratories throughout your own country. Quietly, systematically, the chemist works. His work is difficult, but more adventurous than the blood-curdling deeds of the Spanish Main. Instead of meeting an early and violent death on some forgotten shore, he gathers wealth and honor through his invaluable contributions to humanity. Alfred Nobel, the Swedish chemist who invented dynamite, made so many millions that the income alone from his bequests provides five \$40,000 prizes every year for the advancement of science and peace. C. M. Hall, the chemist who discovered how to manufacture aluminum made millions through this discovery. F. G. Cottrell, who devised a valuable process for recovering the waste from flue gases, James Gayley, who showed how to save enormous losses in steel manufacture, L. H. Baekeland, who invented Bakelite—these are only a few of the men to whom fortunes have come through their chemical achievements.

What Some of Our Students Say of This Course:

I have not written since I received the big set. I can still say that it far exceeded my anticipations. Since I have been studying with your school I have been appointed chemist for the Scranton Coal Co. testing all the coal and ash by proximate analysis. The lessons are helping me wonderfully, and the interesting way in which they are written makes me wait patiently for each lesson.—**MORLAIS COUZBENS.**

I wish to express my appreciation of your prompt reply to my letter and to the recommendation to the General Electric Co. I intend to start the student engineering course at the works. This is somewhat along electrical lines, but the fact that I had a recommendation from a reliable school no doubt had considerable influence in helping me to secure the job.—**H. VAN BENTHUYSEN.**

So far I've been more than pleased with your course and am still doing nicely. I hope to be your honor graduate this year.—**J. M. NORKUS, JR.**

I find your course excellent and your instruction, truthfully, the clearest and best assembled I have ever taken, and yours is the fifth one I've studied.—**JAMES J. KELLY.**

From the time I was having Chemistry it has never been thus explained to me as it is now. I am recommending you highly to my friends, and urging them to become members of such an organization.—**CHARLES BENJAMIN.**

I shall always recommend your school to my friends and let them know how simple your lessons are.—**C. J. ANDAHL.**

I am more than pleased. You dig right in from the start. I am going to get somewhere with this course. I am so glad that I found you.—**A. A. CAMERON.**

I use your lessons constantly as I find it more thorough than most text books I can secure.—**WM. H. TIBBS.**

Thanking you for your lessons, which I find not only clear and concise, but wonderfully interesting. I am—**ROBT. H. TRAYLOR.**

I received employment in the Consolidated Gas Co. I appreciate very much the good service of the school when a recommendation was asked for.—**JOS. DECKER.**



Experimental Equipment Furnished to Every Student

We give to every student without additional charge this chemical equipment, including forty-nine pieces of laboratory apparatus and supplies, and forty different chemicals and reagents. These comprise the apparatus and chemicals used for the experimental work of the course. The fitted heavy wooden box serves not only as a case for the outfit but also as a useful laboratory accessory for performing countless experiments.

Now Is the Time to Study Chemistry

Not only are there boundless opportunities for amassing wealth in Chemistry, but the profession affords congenial employment at good salaries to hundreds of thousands who merely follow out its present applications. These applications are innumerable, touching intimately every business and every product in the world. The work of the chemist can hardly be called work at all. It is the keenest and most enjoyable kind of pleasure. The days in a chemical laboratory are filled with thrilling and delightful experimentation, with the alluring prospect of a discovery that may spell Fortune always at hand to spur your enthusiasm.

You Can Learn at Home

To qualify for this remarkable calling requires elaborate specialized training. Formerly it was necessary to attend a university for several years to acquire that training, but thanks to our highly perfected and thorough system of instruction, you can now stay at home, keep your position, and let us educate you in Chemistry during your spare time. Even with only common schooling you can take our course and equip yourself for immediate practical work in a chemical laboratory. Dr. Sloane gives every one of his students the same careful, personal supervision that made him celebrated throughout his long career as a college professor. Your instruction from the very beginning is made interesting and practical, and we supply you with apparatus and chemicals for performing the fascinating analyses and experimental work that plays such a large part in our method of teaching, and you are awarded the Institute's official diploma after you have satisfactorily completed the course.

Easy Monthly Payments

You don't have to have even the small price of the course to start. You can pay for it in small monthly amounts—so small that you won't feel them. The cost of our course is very low, and includes everything, even the chemistry outfit—there are no extras to buy with our course. Our plan of monthly payments places a chemical education within the reach of everyone. Write us and let us explain our plan in full—give us the opportunity of showing you how you can qualify for a highly trained technical position without even giving up your present employment.

Special 30 Day Offer

Besides furnishing the student with his Experimental Equipment, we are making an additional special offer for a short while only. You owe it to yourself to find out about it. Write today for full information and free book "Opportunities for Chemists." Send the coupon right now while it is fresh in your mind. Or just write your name and address on a postal and mail it to us. But whatever you do, act today before this offer is withdrawn.

DON'T WAIT—MAIL COUPON NOW!

CHEMICAL INSTITUTE OF NEW YORK
Home Extension Division 6
86-R—West Broadway
New York City

Please send me, at once, without any obligation on my part, your free Book "Opportunities for Chemists," and full particulars about the Experimental Equipment given to every student. Also please tell me about your plan of payment and your special 30 day offer.

CHEMICAL INSTITUTE OF NEW YORK, Inc.

HOME EXTENSION DIVISION 6

86-R—WEST BROADWAY

NEW YORK CITY

NAME

ADDRESS

CITY.....
B.N., June '25

STATE.....

OUR NATIONAL PARKS

MAY 1925 25 CENTS

MOTOR CAMPER & TOURIST

Motor Camper & Tourist
gives a complete
Motor Guide to "Uncle Sam's" Vacation-Land

Thirty pages of data, descriptions, photos and routes to our gigantic system of National Parks

The National Park system of the United States has no equal in any country of the world. Beautiful roads wind for hundreds of miles through great forests, across smooth valleys, over majestic mountains and along cool sparkling streams.

MOTOR CAMPER & TOURIST in the May issue, now on all newsstands, describes this complete park system for the tourist, showing the best roads, the principal points of interest and all details of practical use for the motorist. It is a complete, illustrated National Park guide.

ASK YOUR DEALER TO LET YOU SEE A COPY OF MOTOR CAMPER & TOURIST TODAY.

GERMOTT PUBLISHING CO., Owners
 Licensed Publishers: The Experimenter Pub. Co., Inc., 53 Park Place, N.Y.

gave the following ranges: Four turns 380 to 650 meters; eight turns 400 to 950 meters; and 16 turns 675 to 2,300 meters. The minimum condenser capacity in case approximated .00004 mfd. A coil 4 feet square with four turns spaced 1 inch will give a range of 190 to 525 meters when using a condenser with maximum capacity of .0015 mfd.

Fig. 5 gives a table which will prove interesting and very useful in determining and designing coil antennae to cover various ranges of wave-length. The table is based on a four-foot coil wound with No. 20 double cotton-covered wire with turns spaced one-half inch apart. Above 24 turns, or in loops useful for receiving trans-Atlantic stations, the winding is sectioned and is wound with 2, 3, 5 or 10 conductors in each group of 24 as stated, the entire winding, therefore, consisting of 24 groups of turns connected in series, the wire composing each group being continuous.

The distance which coil antennae respond to is of course limited, if reception is desired from small power stations or with relatively weak amplification at the receiving end.

Loop antennae, as described above, when used in conjunction with a seven- or eight-tube Super-heterodyne, have been used successfully to pick up stations with good audibility at distances of 2,000 to 3,000 miles.

Proper design of loops is just as necessary, or even more so, than proper design of receiving apparatus connected to it. The above facts may enable those interested in this extremely fascinating phase of radio to obtain a greater degree of success.

No. turns	Condenser Capacity MMF					
	.00005	.0001	.0005	.001	.002	.003
1		65	128	178	250	310
3	130	155	290	400	550	675
6	230	280	500	710	1000	1200
12	430	490	920	1250	1700	2050
24	760	880	1600	2100	3000	3600
48	1550	1775	3150	4300	6000	7000
72	2200	2650	4800	6400	8800	11000
120	3930	4500	7900	10000	14700	17700
240	7600	9000	15650	20500	27200	32900

Length of side, ft.	No. of turns	Spacing of wires	Inductance		Fundamental λ-meters
			micro-henries	Capacity mfd.	
8	3	1/2	96	75	160
6	4	3/4	124	66	170
4	6	7/8	154	55	174
3	8	7/8	193	49	183

WHY SOS WAS SELECTED FOR THE DISTRESS SIGNAL

The question has often been asked if the call letters SOS have ever been designated to any station. Research reveals that even before the old distress call CQD (come quick, danger!) was abolished, the call SOS had never been assigned. SOS, it may be said, has no meaning in words, the characters in the International code being three dots, three dashes and three dots . . . — — — . . . , these being easily distinguished through any kind of interference.

MAYBE IT'S A "HUDSON TUBE"

First Radio Fan: "That new amplifying tube I just bought has no 'kick' to it at all."
 Second Radio Fan: "Ha, ha! No wonder, it's a 'bootleg' tube."

Contributed by Harry J. Walters.

Correction Notice

We regret to announce that an unfortunate error was made in the February issue of RADIO NEWS, in which an article entitled "Radio in the Vienna Fire Department" was published under the name of Mr. Oscar C. Zilisch, when it should have been published under the name of Mr. Richard Neumann.

Keep radio tubes like NEW!

JEFFERSON TUBE REJUVENATOR
doubles and trebles tube life

\$7.50
 \$10 in Canada

For Home Use



OWNERS of radio sets long have hoped for such a device as this—a "tube rejuvenator" for home use to keep radio tubes at full efficiency and greatly increase their length of life.

Weak tubes mar radio reception just as much as weak batteries. Keep your radio tubes like new with the Jefferson Tube Rejuvenator! Get from your radio the one thing you paid for—satisfactory reception at all times.

Improves Summer Reception

You cannot expect satisfactory warm-weather reception with "run-down" tubes. During spring and summer you will appreciate the Jefferson Tube Rejuvenator most of all. Get yours now.

All radio tubes deteriorate with use; the Jefferson Tube Rejuvenator "brings them back" in 10 minutes! Attach it to a convenient electric light socket. Used once a month, it adds months, even years, to the life of every tube. Takes large or small tubes—201-A, 301-A, UV-199, C-299.

At its small cost of \$7.50 the Jefferson Tube Rejuvenator soon pays for itself many times over in its saving of tubes and batteries. It's wasteful to be without one; it's economy to own one. Sold by leading dealers in radio supplies, and fully guaranteed. See it today.

If your dealer can't supply you, send \$7.50 to

JEFFERSON ELECTRIC MANUFACTURING CO.
 501 South Green Street, Chicago, Illinois

Makers of famous Jefferson Radio, Bell Ringing and Toy Transformers; Jefferson Spark Coils for Automobile, Stationary and Marine Engines; Jefferson Oil Burner Ignition Coils and Transformers.





No. 22—About 1-3 actual size.

60 Ohms per volt!

The correct resistance for a radio battery measuring instrument—no more because it is not necessary. But it must not be less, otherwise there is danger of draining your battery. Nagel Voltmeters and Voltammeters offer the radio fan a pocket type measuring instrument built to the highest standard—safe to use by touch contact or under continuous service. They're fairly priced, too. Ask your dealer or write The W. G. Nagel Electric Co., Hamilton Street, Toledo, Ohio.



NAGEL

Manufacturers of
**DRY CELL TESTERS • AMMETERS
 HIGH-RESISTANCE VOLTMETERS
 and VOLTAMMETERS • BAKELITE
 HOT MOULDED INSULATIONS**

Best for Reflex

and Crystal Sets
FRESHMAN

Double Adjustable
 Crystal Detector

No more searching for the sensitive spot.
 —Merely turn the knob as you would a dial.

For base or panel mounting, complete with Freshman Super-Crystal

At your dealer's, otherwise send purchase price and you will be supplied postpaid.

CHAS. FRESHMAN CO., Inc.
 240 West 40th St., New York

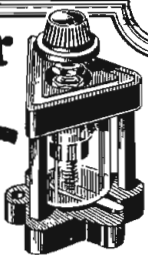

\$1.50

The Compare Radio Typewriter

(Continued from page 2255)

seen that printing will take place as the result of two rapidly succeeding actions of the coupling mechanism.

The commutator switches C_1 to C_8 (Figs. 1 and 2) establish connections with the individual generators, R_1 to R_8 , or with the resonators O_1 to O_8 . These connections may be varied by means of the commutator, so that C_1 , for example, may be connected with R_3 , C_2 with R_3 , etc., or, C_1 with O_2 , C_2 with O_3 , etc. It will be seen that in this apparatus, the commutators C_1 to C_8 are united in one single commutator C , as may be seen in Fig. 3.

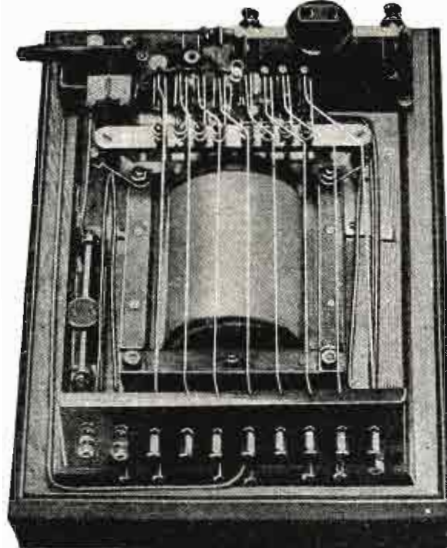
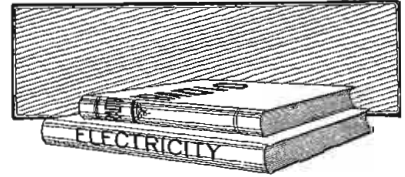

Fig. 11. Top view of the tuned reed resonator, showing the large electromagnet which operates the reeds.

Although this illustration shows a former design, we have retained the commutator for our present apparatus, on the transmission as well as on the receiving end. The construction is as follows: The single leads C_1 to C_8 terminate at the eight commutator arms, which are fastened to a shaft and are rotatable in the direction of the arrow. Each arm, C_1 to C_8 , will contact with a lead from the generators R_1 to R_8 , or else from the resonators O_1 to O_8 . In the drawing, Fig. 3, the arms C_1 to C_8 are resting upon their corresponding contacts R_1 to R_8 . As the commutator C rotates one step further, C_1 will be connected with R_2 , C_2 with R_3 , etc. In this instance, as the key A is depressed, a tone R_2 and R_3 will be transmitted. If the commutator has the same position at the receiving end, that is to say, if C_1 contacts with O_2 , C_2 with O_3 , etc., the same letter is printed, although transmitted by a different combination of two tones, namely, R_2 and R_3 , or O_2 and O_3 . By using this commutator C , each letter may be transmitted by eight different combinations of two tones, thereby increasing the degree of secrecy.

Before describing the various parts of this apparatus in detail, I wish to make a few general remarks. By combining the eight frequencies R_1 to R_8 in twos, twenty-eight different pairs will be obtained, only twenty-six of which are required for the alphabet. Now, each generator R_1 to R_8 may assume ten different positions along the conical cylinder, that is to say, each will generate ten different tones. The apparatus illustrated in Fig. 1 would, according to the position of its generators R_1 to R_8 , bear the number 1, 2, to 10, as each generator R_1 to R_8 is positioned at No. 1 of its scale. The apparatus shown in Fig. 4 indicates the No.



Knowledge of

Radio is not required to obtain perfect results with the

LIBERTY Sealed Five



Manufactured by

LIBERTY TRANSFORMER CO., Inc.
 123 N. Sangamon St., Chicago, Ill.

Tour Your State for Less Than Carfare!

Think of it—you can now motor 1000 miles for \$3.33. New Indian Prince—the Personal Motor—goes 90 to 100 miles on a gallon. Operates at 1-3c per mile. Light — Safe — Easy to handle. You learn to ride it in 5 minutes. Costs less than any other first-class machine. Write today for illustrated folder telling all about this Indian Prince—the Personal Motor — and how easily you can buy it.



Indian Motorcycle Co.

Dept. 26 Springfield, Mass.

BLUEBIRD RADIO TUBES

Distinctly New and Efficient

A quality tube at a moderate price, made possible by our direct sales plan. "Bluebird" is sensitive and powerful — produces clear volume.

WITH BAKELITE BASE

Type 400—5 Volts, 1 Ampere

Detector Tube.

Type 401A—5 Volts, .25 Ampere

Amplifier and Detector.

Type 499—3-4 Volts, .06 Ampere

Amplifier and Detector.

Type 499A— $\frac{3}{4}$ Volt, .06 Ampere

With Standard Base.

Type 412— $\frac{1}{2}$ Volts, .25 Ampere

Platinum Filament. \$2.00

Amplifier and Detector.

All Standard Types—

Type 402, 5 Watt Transmitter \$3

ALL TUBES GUARANTEED

to work in Radio Frequency.

Especially adapted for Neutrodyne, Reflex and Super-Heterodyne Sets. When ordering mention type.

BLUEBIRD TUBE CO. Dept. B

200 Broadway New York City



Shipped Parcel Post C. O. D.

TUBES REPAIRED

Burned Out Filament or Broken Bulb—Send Us the Tube.

All Work Done in Our Own Laboratory

We are not agents but own and operate a fully equipped tube factory manned by experienced tube experts. Our work is, therefore, superior and you are certain of satisfaction. We guarantee to return genuine element to you. New glass bulb put on in every instance, insuring correct vacuum and proper "hardness" for the type of tube. Tubes returned parcel post C.O.D. Send yours in today.

\$150

CHICAGO ELECTRIC DEVICES COMPANY
 Established 1920. 70 E. 22nd St., Dept. 23, Chicago

90,069,009, that is to say, R_1 is positioned at No. 9 of its scale, R_2 , at No. 0, etc. With such a position of the eight generators, the alphabet will be combined by entirely different tones as shown in Fig. 1, and it will be seen that, by using various positions of the individual generators R_1 to R_8 , along the different scales, 100,000,000 different groups of eight tones each will be obtained. In other words, the alphabet may be combined in 100,000,000 different ways! Each message will be secret and not another of the 99,999,999 receiving stations will be able to pick up the message destined to one particular station. This secrecy may be still further increased by making use of the commutator switch C, as I have previously stated in describing this switch. By means of this commutator C, the combination may be changed daily or hourly. The eight tones R_1 to R_8 at each transmitting and receiving station will deliver the same message by using eight different combinations of the alphabet. Although such a degree of secrecy is sufficient for the majority of uses, it may be still further increased in special cases, for instance, for military purposes. Although the combinations might be varied hourly, a message could still be picked up by using an oscillograph. In order to prevent such an occurrence, an auxiliary instrument is used, whereby these combinations may be altered irregularly, and if desired, automatically, both at the transmitting and at the receiving end. The message cannot possibly be deciphered and the greatest degree of secrecy is thus insured.

I shall enumerate further advantages of this apparatus and other possible uses of it, after I have described the photograph (Fig. 4) which is an illustration of the entire transmission apparatus.

At the right of this photograph will be seen the usual small telephonic transmitter, next the typewriter and finally the apparatus for the generation of the eight tones. The commutator switch C will be seen in the lower portion of this apparatus. Entirely to the left, below the hood, will be found a relay which functions to maintain a constant, automatic rotary action of the motor and the cylinder. The speed regulator is positioned on the right above the cylinder.

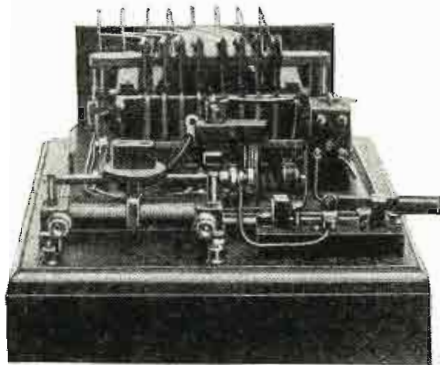

Fig. 12. Front view of the reed recorder. This device uses eight steel reeds having different periods of vibration, the incoming impulses causing them to close various circuits.

On the right side will be seen the transformer Tr, which transmits the single tones to the transmitter. Over the keyboard is found a curved contact rail and below this, a rim with its single contact pins, the number of which corresponds to the letters of the alphabet, that is to say, to the number of keys. The contact rail may be pressed downwardly by means of an electromagnet.

In Fig. 1 the keys themselves lie between the contact rods B_1 to B_8 and the contacts $C\frac{1}{2}$, $C\frac{2}{3}$, etc., thereby directly performing the short alternating contact. In this apparatus, the keyboard K is elongated by means of a rod provided with the individual contact springs, as shown in Fig. 6.

SHAMROCK HARKNESS TWO TUBE REFLEX KIT

SHAMROCK GUIDE BOOK

This signature —
Kenneth Harkness
makes it genuine.

Price for kit complete \$35

The Shamrock-Harkness combines the best features of the most powerful present day circuits at the lowest possible cost! No wonder its popularity is sweeping the country!

5-Tube Volume and Distance — Reflex Clarity!

Men who really know Radio marvel at the results they get on the Shamrock-Harkness Two-Tube Reflex. Stations within a radius of 1000 miles click in loud and clear as a bell regularly. Two tubes in this special Reflex set do the work of five!

cost of a complete set. Be sure to get the Shamrock-Harkness Kit containing only the genuine licensed Shamrock-Harkness parts, backed by our unconditional guarantee.

Also ask to see the improved Shamrock-Harkness Three-Tube Counterflex **\$39.50**
The wonder set

Build your own set with the Shamrock-Harkness Kit at half the

SHAMROCK FOR SELECTIVE TUNING

The set for the masses as well as the classes

Mail

SHAMROCK MFG. CO., Dept. 38-E, Market St., Newark, N. J.

I enclose 10 cents (U. S. stamps or coin) for copy of "Shamrock Radio Builders' Guide Book" containing diagrams and complete illustrations for building 10 sets at prices ranging from \$15 to \$50.

Name
Address

100 Volt Storage "B" Battery for \$10.00!



Everybody can now enjoy the benefits of Storage "B" Batteries—more power, quieter reception, greater economy. Rubber case prevents leakage or shorting. Easy to recharge. Will last for years with ordinary care.

SERVICE Rechargeable "B" Batteries
—in all-rubber cases
100 VOLTS **\$10.00** 50 VOLT—\$5.50
125 VOLT—\$12.50

Service "A" Batteries
Indestructible rubber case. Two year guarantee.
6 volt, 80-100 amp. hr. **\$14.00**
6 volt, 100-120 amp. hr. **\$16.00**

SERVICE BATTERY CO.
704 East 102nd Street Cleveland, Ohio

SERVICE Double-Duty CHARGER

Charges 6-volt "A" or Auto Batteries or up to 125 volts of "B" Battery IN SERIES. Noiseless in operation. Extremely economical. The height of convenience.

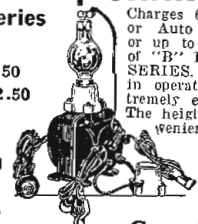

Complete with Bulb \$14.50

Prices in Canada

50 VOLT **\$7.75** 100 VOLT **\$14.50** 125 VOLT **\$17.00**
SERVICE BATTERY CO. of Canada, 137 Roncesvalles Ave. Toronto, Ontario

Always Pioneering

RADIO is a new field—in proof of real performance. Weston is an old name—in electrical measuring experience. Pioneering since the real beginning of the electrical measurement art, Weston has developed several radio instruments, tested them, proved them, and found them practical, popular and of great usefulness.

Accuracy in Radio work or pleasure is insured by their use. Write for Circular "J"—Weston Radio Instruments.

Weston Radio Plug—a 75 cent plug that was the original automatic device for changing instantly from head-set to loudspeaker. Fits standard jacks. No tools needed. Standard equipment on nationally advertised loudspeakers.

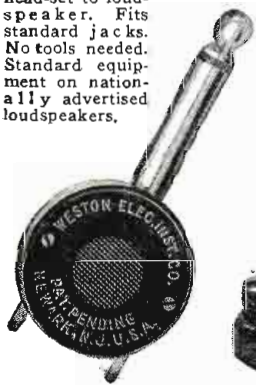

Weston Table Voltmeter—Ranges 0-7.5 to 0-150 Volts. Price \$13.50. Compact, yet of remarkable Weston accuracy. Handsome Bakelite case. Rugged and durable, of the greatest value in testing "A" and "B" Batteries using insignificant current to operate.

WESTON ELECTRICAL INSTRUMENT CORPORATION
173 Weston Avenue
Newark, N. J.



DEALERS

Sharp Discounts On Standard Quality Parts

Every dealer should have our big bargain catalog showing hundreds of standard radio parts, kits and knock-down sets. Same day shipments. Write for free catalog now on your letterhead.

FREE CATALOG

WESTERN RADIO
138 W. LAKE ST. Dept. 3-6 CHICAGO

DON MAC CO., INC.,
29 SOUTH DES PLAINES STREET
CHICAGO ILLINOIS

The contact springs K are connected with the corresponding contact pins of the rim and may perform an alternating contact with B₁ to B₆ and then with C₁/₂, C₃/₃, etc., by means of a reciprocal electromagnet. The alternating contact is released electrically and mechanically. The mechanical means consists of the tone-generating mechanism, which is illustrated in Fig. 9.

Eight small generators are adjustable longitudinally in their scale. This portion of the apparatus consists of a motor, an automatic rheostat, the commutator C and three small gear wheels belonging to the alternating contact mechanism, which may be coupled with the conical cylinder. These wheels may be seen at the lower left.

The following takes place as a key is depressed. Should the key A be depressed, the circuit below the keyboard is closed, whereby the alternator-contact mechanism with its three gear wheels is set active. The contact pin corresponding to A is simultaneously released and assumes a position below the contact rail. One of the three gear wheels immediately closes the circuit of the electromagnet of the contact rail, whereupon the latter bears down upon the contact pin A and connects it with the corresponding contact spring K. By means of the other two gear wheels, the mutual electromagnets of the contact spring rod K will receive current in rapid succession, whereupon the contact spring K corresponding to A will make contact alternately with B₁ and C₁/₂, thereby transmitting two different tones in succession into the transmitter.

Fig. 10 illustrates the entire receiving apparatus.

To the right is the receiver, a little more to the left is the resonance magnet. In this case only one electromagnet for the eight frequency reeds is used. Between the resonance apparatus and the typewriter are found eight intermediate relays, placed in the low box, which transmit the resonance contacts to the typing machine.

Figs. 11 and 12 show the resonance apparatus per se. Fig. 11 is a top, and Fig. 12 a front view. In these figures the eight reeds with their magnets and contacts are plainly visible.

The apparatus herein described has many advantages over other systems previously used. The entire apparatus may be connected without any difficulty to the usual telephonic transmitter and is very simple in construction and very easy to operate. The message is written by the typewriter in clear text and requires no ciphering or deciphering. The receiving station needs no operator, as it functions automatically. The fact that the message cannot possibly be picked up, even when audible frequencies are used, insures the maximum degree of secrecy. Finally, no synchronism is needed during the entire process.

This system may be used for diplomatic, military or any other type of secret service. It may be used in trade and in technical undertakings. It may be used in telephony and in radio-telegraphy. If used in connection with financial and press reports, it will eliminate the use of a cipher. It will be seen that messages need not be transmitted at stated times in cipher. Should the recipient at the receiving station be absent, the message will be received, typed in clear text, but transmitted with the greatest degree of secrecy.

IT MAY COME TO THIS

CRAWFORD: What! You paid \$50 for a little crystal set like this?

CRAWSHAW: Yes. The salesman told me it was quite an antique, you know.

Contributed by Moe H. Friedman.

For Reliability

There is an ALL-AMERICAN Transformer for every radio need—Audio and Radio Frequency—Power Amplifying (Push-Pull)—Intermediate Frequency.



All-Amax Receivers

The famous ALL-AMERICAN long-distance sets completely mounted, with full photographic instructions for wiring.

Your Favorite Radio Store Has Them!

ALL-AMERICAN RADIO CORP.

E. N. Rauland, President

2646 Coyne Street, Chicago

Largest Selling Transformers in the World

BROWNIE CRYSTAL

Guaranteed the Best **\$1.00**

"REFLEX SPECIAL" QUICK CONTACT RECTIFIER

Withstands Heavy Plate Voltage. The Acme Apparatus Co. says "prevent distortion and howling by using a BROWNIE CRYSTAL in REFLEX SETS."

Order From Your Dealer or Direct
ROLAND BROWNIE & CO.
22 Saunders Street Medford, Mass.

3 TUBE LOUD SPEAKING

only \$29.50

GUARANTEED

LONG DISTANCE RADIO

Users everywhere report Miraco Tuned Radio Frequency sets get programs coast to coast; outperform sets 3 times as costly. Send for proof they are radio's most amazing values. One tube guaranteed, completely assembled long distance outfit, only \$14.35. Three tube (above), \$29.50. Five tube \$75

SEND POSTAL TODAY for latest bulletin and special offer. It will interest you.

MIDWEST RADIO CORP'N
Pioneer Builders of Sets
404-R E. 8th St., Cincinnati, Ohio

AGENTS DEALERS Our proposition's a winner. Write.

MIRACO RADIO GETS 'EM COAST TO COAST

FORMICA RADIO PANELS TUBES AND RODS

WRITE TODAY for your copy of our new catalog listing and pricing 3384 different sizes and kinds of Formica Radio Panels, 126 different sizes of Formica Tubes, and 21 different sizes of Formica Rods.

DRILLING—ENGRAVING
Lowest prices consistent with good work

STARRETT MFG. CO.
520 S. Green St. Chicago, Ill.

JUST OUT—NEW

Catalogue on Hetro Magnetic Daylight Distance Receivers

SIDBENEL RADIO MFG., CO.
29 W. Mt. Eden Ave., New York, N. Y.

Radio Wrinkles

(Continued from page 2260)

grooves, as shown in Fig. 2 and fastened together by bolts. Drill five holes in the remaining piece of bakelite to correspond with the phone tips in the pieces just prepared. These holes are of such a size that they will accommodate cord tipped jacks and these are now fastened to the strip. This strip is mounted on the baseboard and the connections from the instruments of the set are made as indicated in the sketches. The external battery connections are fastened to the tips with flexible wire and the assembly of the connector will be as in Fig. 3. This device permits instantaneous connection of the batteries to the set which is a very desirable feature.

Contributed by D. M. Clayton.

Broadcasting in 1912

(Continued from page 2219)

capacity effect that had not been encountered in the installation in Budapest. The directors of the company then called in Mr. John P. Rainbault, a telephone engineer of New York and the present Eastern representative of the Fansteel Products Co., who revised the entire system according to American engineering principles. In a short time, due to his efforts, the people of Newark were able to enjoy the first broadcasting that had ever been attempted in this country. Mr. Rainbault was retained by the company as their general manager, which position covered everything from arranging the programs and seeing that they were transmitted properly, to getting new subscribers.

The central offices, the studio, and the switch rooms were located in the Essex Building in Newark. Performers in that studio of 1912 would be surprised if they should walk into a present day studio of a broadcast station, because they were just the same in nearly every detail. The walls of the room were hung with heavy drapery to eliminate any echos, there was a piano in its usual place, and then the most necessary of all, the "mike." It was in the latter instrument that the old-timer would notice the only difference, as the microphone then used was of the Erickson type. The operation of the station was also the same. Announcers, who were called "stentors," told the audience what the next numbers were to be, just as their contemporaries do today.

The layout of the apparatus and lines were in accordance with the best engineering principles of the day. The signals were picked up by the Erickson microphone and went to the switch room. Here they were connected through a switchboard to sub-distributing centers in the Branch Brook, Waverly and Market districts. The necessary apparatus of the broadcast company was placed in a building adjacent to the district exchanges, where the monitors of the system checked up on the different circuits to see that they were in proper operating condition. The lines that were leased from the telephone company were used only from the switch room to the three districts and from the district exchanges to the different sections. Each section was a city block and all the headsets in a section or block were in series with the line from the district exchange, these circuits being all carefully balanced. Inside the houses that were equipped with the service there was a small moulded insulation block with two hooks on which were

The New
NAVY MODEL
C-10 SUPER-HETERODYNE



Only 2 Main Tuning Adjustments for 10 Tubes
Panel Size Only 28 3/16" x 8"

A POWERFUL 10 TUBE BROADCAST RECEIVER

having a range and degree of selectivity far in advance of any receiver.

Total Amplification 1,500,000 Times
Wave Length Range 50 to 600 Meters

This new design by Charles R. Leutz represents final superiority over any receiver now being manufactured or even contemplated for broadcast reception.

Descriptive Literature Mailed on Request

A Patent Suit between the Westinghouse Electric & Manufacturing Co. and Radio Corporation of America vs. Experimenters Information Service, Inc., is now in progress. Regardless of the outcome, our Blue Print designs of the Models C-7 and C-10 will still be sold.

Experimenters Information Service, Inc.

476 Broadway

New York City, N. Y.

Designers of the Highest Class Radio Apparatus in the World.

Experimenters Information Service, Inc.
476 Broadway, New York, N. Y.

Please forward literature on the New Navy Model C-10. No charge.

Name

Address.....City.....State.....

GOLD SEAL HOMCHARGER

The World's Most Popular Battery Charger
Write for Booklet
THE AUTOMATIC ELECTRICAL DEVICES CO.
121 West Third Street Cincinnati, Ohio

Authorized Cockaday Coil - \$5.50
Precision Autodyne Coupler - \$3.50

PRECISION COIL CO., Inc.
209 CENTRE ST., NEW YORK CITY
Specialists in the manufacture of all types of radio coils

The "LINCOLN"

Enclosed Fixed Adjustable Detector
Kills your Reflex Troubles

New List Price \$1.50

Manufactured by LINCOLN MFG. CO., Dept. E. I. Los Angeles, Cal.

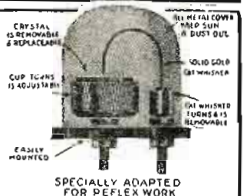

Burns

PERFECT REPRODUCER
Tone loud and pleasing. Handsome material and design.

Black—\$22.50 Shell—\$25.00
AMERICAN ELECTRIC CO.
State and 64th Sts. Chicago



Insure your copy reaching you each month. Subscribe to Radio News—\$2.50 a year
Experimenter Publishing Co., 53 Park Place, N. Y. C.

The Great Hookup Magazine!



RADIO REVIEW

Reg. U.S. Pat. Off.

A Digest of the Latest Radio Hookups

IN EACH ISSUE AN INSTALLMENT OF
ILLUSTRATED
Radio Encyclopedia

The newest thing in radio publishing—A complete 100 page illustrated magazine containing hookups and constructional articles of every kind and description, gleaned from the entire radio press the world over.

No longer do you have to seek here or there for this or that hookup—Just refer to your file of the RADIO REVIEW. All the modern, useful circuits will be accumulated in this magazine and every hookup will be described in a constructional manner so as to aid the reader in the building of a complete receiver or transmitter.

RADIO REVIEW is absolutely impartial as it is published entirely in the interest of the reader. It is of the large magazine size, 9 by 12 inches, printed on fine magazine paper and profusely illustrated. It contains 100 pages of reading matter.

35¢

In Every Issue is a Supplement of One Installment of S. Gernsback's Radio Encyclopedia

In every issue of RADIO REVIEW there will be a 16 page supplement of S. Gernsback's Radio Encyclopedia. This real encyclopedia of radio explains every word used in radio fully by means of photographs, drawings, charts or tables. The supplement is arranged in a convenient loose-leaf form so that it can be kept apart until you have accumulated all the installments.

For Sale At All
 Newsstands
 and
 Radio Stores

Published by

The Consrad Co., Inc., 233 Fulton St., New York, N. Y.

THE CONSRAD CO.,
 233 Fulton Street, New York.

Enclosed find \$3.50, for which enter my subscription to RADIO REVIEW for 12 issues.

Name..... Town.....

Street..... State.....

RADIO REVIEW—Greatest Hookup Magazine

hung the head-phones. However, there was no switch to turn off the music and so whenever the phones were placed on the ears between the hours of nine and eleven something was heard.

The price of this service was \$1.50 a month and the first two or three months the subscription department was swamped with orders for installations. Within the first three months about 5,000 subscribers were on the books of the New Jersey Telephone Herald Co. However, as with everything else, people soon tired of their new toy, mainly because loud speaker reception was not available, although the signals that were received were very clear and of excellent head-phone volume. New subscriptions continued to come in, yet there were a large number of subscriptions canceled. The management of the company realized where the difficulty lay and Mr. Rainbault and his chief engineer, Mr. J. L. Spence, worked on the perfection of a mechanical amplifier. However, they realized that the results obtained were far from satisfactory, so in December of the same year it was decided not to fight any longer against such odds.

It is an interesting fact to note that if there had been the vacuum tube as we have it today, this scheme would have worked satisfactorily in every way.

PROBLEMS

There were many problems then that are interesting to review. One of the large department stores of Newark wanted the New Jersey Telephone Herald Co. to read a résumé of their advertisements daily to the subscribers, but the directors of the company refused to comply with their requests as they feared that it would cheapen the broadcasting. The mechanical amplifiers used were nothing more than a mere diaphragm with a rod attached to its center, which energized another diaphragm. Naturally an amplifier of this type was far from being satisfactory, as the distortion present in the amplified signals was considerable. Mr. Rainbault and Mr. Spence, did considerable research work on these repeaters, but the company closed their business before any satisfactory results were obtained.

As has been mentioned above, if there had been some means of amplifying the signals that were sent out over the lines, the company would doubtless have been successful. However, there occurred the family argument that is recurring today in the homes where there are receivers using crystals for detectors—who gets the phones? Even though the reception of the signals was clear, yet the people in general could not be educated up to the idea. Advertising in Newark's papers had increased the subscription list to over the five thousand mark, yet the public refused this initial trial of broadcast entertainment. There had been an outlay of over \$200,000 and so the New Jersey Telephone Herald Co. was closed and the head-sets removed from the homes of Newark.

This was a scheme that has proved to be one of the most popular types of entertainment that has ever been devised, but to be so popular it needed the vacuum tube of the present day to amplify the received music so that entire families could listen in at the same time. This Newark venture of 1912 was just another one of those things that are devised a few years ahead of their time, in this case not more than five or six.

OH MY!

Irate Captain—What! You admit striking the wireless operator?

Passenger—Yes, sir. I gave him a radiogram to send and he started to read it.

—Contributed by Jack Bront.

Be A Radio Expert



Pleasant Home Study

During the next few months you can, by devoting a few hours each week in pleasant home study, qualify yourself to get into the biggest paying field of all time. My practical, understandable course of instruction enables you to be a Master of the Air. Every problem in radio becomes an open book to you. *Be a Master of the Air and you will be a master of your future.*

\$3,000 to \$10,000 a Year as Radio Expert

15,000 ships, hundreds and hundreds of Radio stations, with new ones springing up every day, are all keenly competing for the services of the radio-trained man. So enormous is the call for the radio expert that the man who knows his business in this field is in a position to command the size of his salary. On land or sea, in Government or private service, there are boundless fine paying opportunities for the man who understands radio problems and how to solve them.

RADIO ^{where} Knowledge is Power —and Power is Cash

I show you how to construct, install, operate, repair and sell radio equipment. Instead of being a spectator in this big game with big stakes, you become an active player. I qualify you to handle every branch of radio. There is nothing theoretical or practical that is not presented to you in complete, concise form. You are standing face to face with the greatest money-making chance ever presented to you. Will you turn your back on it or will you decide now, once for all, that you will get your share of the millions being divided among radio-trained men? Right in your own neighborhood you can make easy profits. Neighbors and friends will gladly give orders for sets, and pay for advice on radio problems.



A. G. MOHAUPT, B.A., M.S.
Head of the Radio Association of America. Graduate Electrical Engineer, University of Wisconsin. Former Radio Instructor for U. S. Government. Author of "Practice and Theory of Modern Radio."
I give my personal attention to every student taking my course. Your individual problems and questions are answered by myself. I work with you at every stage of the course, guiding you, directing you to your goal to be a Radio Engineer in the big pay class. My course prepares you to successfully pass Gov't examination for Operator's License.

FREE 1000 Mile Radio Outfit

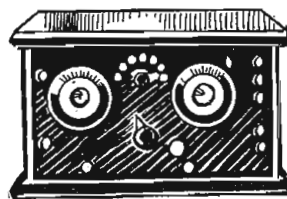

This set, when completed, has a range of over a thousand miles. I give it free with my course. I give you practical training by having you work on this set. The knowledge you gain is not mere book knowledge, but is usable, practical experience. When you have finished my course, you can sell this set at a price that will more than pay the cost of the course.

QUICK PRACTICAL TRAINING

Everything in my course is clearly and simply stated so that you can easily understand every point I bring out. No previous experience or education is required. I give you fundamental and practical training in every angle of radio. There is no time to lose. Now is the best time to pass the other fellow by. Mail coupon today and get full information on my course, also details of the thousand mile set that I give free.

A. G. MOHAUPT, Radio Engineer
RADIO ASSOCIATION OF AMERICA
4513 Ravenswood Ave., Dept. 156, Chicago, Ill.

MAIL COUPON

A. G. MOHAUPT, Radio Engineer,
Radio Association of America,
4513 Ravenswood Ave., Dept. 156, Chicago.
Please send me details of your Home Study Course—also your Free "Radio Facts" and information on how I can get a FREE 1,000 mile Radio Set.
Name
Address
City State

WRITE FOR OUR CATALOGUE
RADIO PARTS-KITS-SETS
We Guarantee to Save You Money
The RADIO SHACK
55 Vesey Street, Dept. F 23
NEW YORK CITY

Radiofeet *Cushion your Set!*
Stop tube vibration! Prevent set from marring furniture! Used under set or tube shelf. Made of pure wool felt.
Set of 4 Radiofeet, including attaching screws or washers sent postpaid anywhere in the United States or Canada for \$1.00. Do not send stamps. Specify dark red (mahogany) or brown (oak) color.
NEODYNE ASSOCIATES
(U. S. Reg. Pend.)
3121 Bencason Building
165 BROADWAY, NEW YORK

KNOW INSTANTLY CORRECT TIME THE WORLD OVER
at any hour, day or night, with
"FIND-ME-QUICK" WORLD'S TIME INDICATOR
Durable, useful gift for old and young. Indispensable for every DX Radio Fan.
Practical Vest-Pocket Size, 25c Postpaid
\$2 Per Doz., C.O.D.; Quantities Liberal Discount.
RADIO CHART BUREAU Fresno, California

FREE Send your name and address with a stamp for the complete working drawings of the famous
ELGIN SUPER-REINARTZ
This is the set that has heard the many European stations—the set of unequalled selectivity and clarity.
ELGIN RADIO SUPPLY CO.
Dept. C, 207 E. Chicago St. Elgin, Ill.



STORAGE "B" BATTERIES
KIMLEY

"B" ELIMINATOR SIMPLICITY
PERMANENT ALKALINE STORAGE BATTERY RECEPTION

KIC-O MULTI-POWER UNITS operate from your lighting line and eliminate the replacing of dry cell "B" batteries... usually saving their cost in the first six to twelve months of service on Neutrodyne and Super Heterodyne sets.

Its RECHARGER is attached to back.

We have a 100 volt Multi-Power Unit Complete at

\$32.50

To receive simply throw switch down. To recharge throw switch up—disconnect no wires—no fuss—no worry. Leave it plugged into any 110 volt lamp socket.

PRICES
Multi-Power Units
(No Recharger required)

130 volt Type P.U.	\$43.50
100 volt Type P.U.	35.00
100 volt Type C.U.	32.50

BATTERIES
P.Z. indicates panel type with switches.
C.Z. is plain type without switches.

Voltage	Type P.Z.	Type C.Z.
150	\$36.00	\$33.00
100	27.50	24.50
70	21.50	18.50
45	16.00	14.50
22½	7.50

CHARGERS

Type K-1 Single Unmounted	\$1.50
Type K-2 Single Mounted	3.50
Type K-3 Multi-Polar Mounted	5.00
KIC-O Special Charger Chemicals (One Cell)	.50

Dealers! Everybody! Write for complete details.

Kimley Electric Company, Inc.
2665 Main Street Buffalo, N. Y.



THOUSANDS

of customers have been pleased with our goods. We have been making Radio Furniture for 3 years.

Send for Free Catalogue

The Southern Toy Company
Dept. N. HICKORY, N. C.

LAW STUDY AT HOME

Become a lawyer. Legally trained men win the highest positions and biggest success in business and public life. Be independent. Greater opportunities now than ever before. Big corporations are headed by men with legal training. Earn \$5,000 to \$10,000 Annually.

We guide you step by step. You can train at home during spare time. Degree of LL. B. conferred. LaSalle students practicing law in every state. We furnish all text material, including fourteen-volume Law Library. Low cost, easy terms. Get our valuable 108-page "Law Guide" and "Evidence" books free. Send for them NOW.

LaSalle Extension University, Dept. 6409-L Chicago
The World's Largest Business Training Institution

Broadcast Stations on 150 Meters
(Continued from page 2207)

whole matter. It will have to be handled with gloves, so to speak. Every step must be carefully considered and very cautiously and thoughtfully worked out, before it is finally incorporated in our radio code. The steps we take now may make or break the whole future of the art.

"This is indeed ticklish business, and I do not know but what I have made a grave mistake in telling you of these plans before they are entirely official. However, now that you have it, I may as well add that these plans are the chief consideration of the Department at this time and the only suggestions which they are considering for submittal to the conference for the solution of the broadcast situation."

Midsummer's Night Scheme
(Continued from page 2233)

ever, The Master comes through all right. "Why, that's wonderful, Doris, simply wonderful!" he elates. "Each guest coming as a radio instrument! What'll you be, Joe?"

"Me?" I asks. "I'll be a vacuum tube, I guess."

"Bravo!" grins Doris. "You won't need any costume."

I turns to the lady of the house. "And you'll be a loud speaker without no adornments, either," I retorts, weak. "That makes us even."

"I think I'll be an aerial mast," smiles Jerry, glancing at himself in the mirror. It's as near as he can come to humor, so we laughs.

Well, the date is set for ten days ahead, and during that time we're as busy as an armless radio fiend with the seven-year itch. Jerry's mansion is all that—and a lot more. His big ballroom is a fine place to decorate. When we're through, the ceiling is strung with wires, all sizes and shapes of aerials being represented. Then there's a mammoth radio receiver—Doris calls it a Pure-food Won't-you-dine—wherefrom issues choice drinks and sandwiches at the twist of a dial. Besides these, there's novelties galore—cakes, candies and ice cream molded in the shapes of various radio apparatus; a miniature broadcast station of the Punch and Judy order where marionettes go through the process of disturbing the ether; a system of identification wherein each guest is given a call letter, to which he's supposed to answer instead of the name his parents chose. And more too humorous to mention.

It's late afternoon of the day of the blow-out, and I've been busy at home all day and haven't been over to Jerry's. And when, about four o'clock, I hop-skips up to the seat of activities, I senses that something ain't right. And I ain't in error.

The object of my journey is seated on the steps leading up to the second story of his de-luxe garage. This upper story is The Master's laboratory, serving as a meeting place for all the forces of man, nature and the devil. Generally, Jerry can control them; occasionally he can't, and it seems now is occasionally. I yells to him, and he looks up.

"Oh, hello, Joe," he says, sorta abstract. "How's things?"

X-L Three Way Radio



"IT TUNES 'EM OUT"

- (1) An ideal crystal receiver.
- (2) A perfect wave trap.
- (3) A powerful super amplifier.

As a crystal receiver the X-L THREE WAY is unequalled for selectivity, volume and simplicity of control. As a wave trap the X-L THREE WAY will eliminate interference between local and distant stations. As a super-amplifier the X-L THREE WAY when used with any super-heterodyne will greatly increase volume on distant stations.

Price \$8.75
POSTAGE PREPAID
Ask Your Dealer or Write us Direct.
Manufactured by
X-L RADIO COMPANY
1623 So. Vermont Los Angeles, Cal.

325 CORD

RADIO Storage "B" Battery
Lasts Indefinitely—Pays for Itself

32 Cells
24 Volts

Economy and performance unheard of before. Recharged at a negligible cost. Approved and listed as Standard by leading Radio Authorities, including Pop. Radio Laboratories, Pop. Sci. Inst., Standards, Radio News Lab., Lefax, Inc., and other important institutions. Equipped with Solid Rubber Case, an insurance against acid and leakage. Extra heavy glass jars. Heavy, rugged plates. Order yours today!

SEND NO MONEY Just state number of batteries wanted and we will ship day order in received. Extra Offer: 4 butt-ries in series (96 volts), \$12.76. Pay expressman after examining batteries. 5 per cent discount for cash with order. Mail your order now!

WORLD BATTERY COMPANY
1219 So. Wabash Ave., Dept. 75, Chicago, Ill.
Makers of the Famous World Radio "A" Storage Battery
Prices: 6-volt, 100 Amp. \$12.95; 150 Amp. \$14.25; 140 Amp. \$15.00.
All equipped with Solid Rubber Cases.

World FOR RADIO
STORAGE BATTERIES
KOKA - WEA - WGN - WJS - RHJ - KGO - KFAF - WJY - KOP

At your dealer **\$1.00**



WALBERT
made it first

NOW

You can put your radio set in that convenient out-of-the-way corner without straining your eyes while tuning—

LIGHT UP
your panel with the

WALBERT PANELITE
WALBERT MFG. CO., CHICAGO

PATENTS WRITE for our Four Guide Books and "REC-ORD OF INVENTION BLANK" before disclosing inventions. Send model or sketch and description of your invention for our INSPECTION and INSTRUCTIONS FREE. TERMS REASONABLE. Electrical and Radio Cases a specialty.

VICTOR J. EVANS & CO.
919 NINTH ST., WASHINGTON, D. C.

"O. K. for me," I replies. "What's eating you?"

Jerry don't answer, but his left hand sorta casually rubs up and down over a little nickel star on his vest. That explains a bit.

"Oh, something more to detect?" I asks. "Can I get in on this, too?"

Suddenly The Master stands up. "Yes, Joe, I believe you can," he says. "Come on up."

We enters the laboratory, wherein is displayed samples of about every known device that has wires attached to it. Jerry motions for me to be seated; I squats on a packing box while The Master slowly sits down on a big storage battery.

"Spill it," I requests. "Who's done something now?"

"This is serious, Joe," says Jerry. "An attempt at murder."

"Oh," I says, quieting down. "Anyone you know?"

The Master nods. "A particular friend of mine," he says. "You've met him, I'm sure—Elliot Sanford."

"Elliott Sanford!" I repeats. "Why, I know him well!"

"Then you will be more than interested in his case. Last night, about midnight, Mr. Sanford, Doctor Maxwell and myself were concluding a rather late argument on the Einstein theory. As we were about to leave, Mr. Sanford sat down to listen in on his radio. Naturally, the doctor and I waited a moment out of curiosity's sake. Suddenly, without warning, Mr. Sanford's face paled; he clutched his headset, tore it from his ears, and threw it to the floor. Then he turned to us, gasping for breath. 'My God, they've got me!' he cried, and fell to the floor, unconscious."

"Dead?" I asks.

"No," says The Master. "The rest of the family having retired, the doctor thought it unwise to waken them in view of the peculiar circumstances surrounding the case. It was obvious that Mr. Sanford had received some shock; I immediately picked up the headset, but it was broken, and there was no other. Consequently I was unable to ascertain the source of the message."

"Rather odd, wasn't it?" I remarks. "Had he mentioned ever having heard anything menacing before?"

Jerry shakes his head. "He hadn't, but that brings out another point. Mr. Sanford was not an ordinary radio fan, although no one but myself knew it. Mr. Sanford's set was built—to order—by myself; it was wired without means for altering the wave-length, and the one length which could be utilized was that of a station in San Francisco. It was plain that Mr. Sanford wished to hear only this one station."

"Only Frisco?" I inquires. "Was he a Californian?"

"Mr. Sanford came to Brightmere-on-the-Deep about fifteen years ago. I knew him when I was but a boy. A jovial man, fond of children, and devoted to literature. He was incessantly reading it, seemed to me. No one ever inquired into his past, although he is a Westerner, as evidenced by his accent. He has a large number of relatives, which might seem to throw light on the subject. But I cannot question any of them without hampering the situation. You see, the doctor and I decided that until Mr. Sanford regained consciousness it would be better not to inform the family of his condition. As I have said, Mr. Sanford was wont to lock himself in his study and remain for hours, reading. This his family believe him to be doing; they know nothing of what occurred last night."

"I see," I says, low. "Whatcha gonna do now?"

"Doctor Maxwell and an assistant have been with Mr. Sanford since last evening, although their presence is not known to the

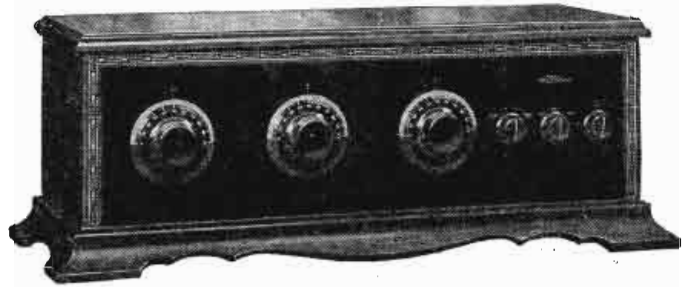

The Receiver of the Year

The year has brought forth one outstanding radio receiver—the Deresnadyne. It is the most advanced and talked about on the market.

The Deresnadyne is remarkable first of all for its purity of tone and fidelity of reproduction. And tone is what counts after you've owned a set a while. It is not merely a plaything for the fan but a musical instrument of the greatest and most lasting utility.

The Deresnadyne is remarkable for its selectivity. In this re-

spect it has no superior. Local or outside stations—it brings them in without interference.

It is remarkable for its distance. In one evening one owner got Calgary, Havana, Springfield, Mass., and Los Angeles.

Above all the Deresnadyne is remarkable because it does not sacrifice tone to power or vice versa. It combines them. It is not a Neutrodyne. It is not a Heterodyne. It is new in principle as well as results. Buy it at your dealer's.

De Luxe Model

\$165

without accessories

Also the new Portable Deresnadyne. 5 tubes.

Complete with loud speaker and loop. At your dealer's.

Andrews Deresnadyne Radio Receiving Set

DÈ-RÈS-NÀ-DÏNE · PATENTS PENDING

Manufactured by ANDREWS RADIO COMPANY, 327 S. La Salle St., Chicago



I PAY YOU TO TRY MY NEW INVENTION

My new patented device which saves from 25 to 50% of gasoline is now ready for car owners. I want agents and will send sample on free trial. If it does not amaze and please you, I will pay you for trying it. Write for full particulars today. J. A. Stransky, 114 Yale St., Pukwana, So. Dak.

\$100 EVERY WEEK

and we will prove it. Sell TripleWear suits for only \$14.85. Just out. Startling values. Big assortment of genuine suitings in beautiful patterns. Snappy styles. Real tailored to measure. Cannot duplicate for \$30. Biggest commissions paid in advance. Start at once. Write or wire for free selling out.

TRIPLEWEAR CORPORATION
Dept. J219, 2014 Wabansia Ave., Chicago

\$3 DOWN AFTER TEN DAYS TRIAL FOR THIS LONG WEARING ALL BEARING L.C. SMITH

NO RED TAPE—NO DELAY

Test this wonderful typewriter in your home or office 10 days. Send No Money. If you are not satisfied it is the best buy you ever made, your express agent will refund your \$3 deposit.

LOWEST PRICES ever made on the world famous L. C. Smith—full size—all late style operating conveniences—absolutely highest quality rebuilt—5 Year Guarantee. Small Monthly Payments.

FREE: Course of Instruction, Tools, Waterproof Cover, all free to you now. Send today for New Special Offer and Booklet of valuable typewriter information.

Smith Typewriter Sales Corp.
237-360 E. Grand Av., Chicago

THE ANDREWS PADDLEWHEEL COIL

A low-loss inductance. Improves tone quality and increases signal strength and selectivity.

Price, with bracket \$3.00

RADIO UNITS, INC.
1300 First Ave., Maywood, Ill.

Alfred Graham & Co.,
London, England,
Patentees



AMPLION

The World's Standard
Loud Speaker

LEADS IN SALES THE
WORLD OVER. HEAR IT!

THIRTY years have perfected and made The Amplion the finest loud speaker. This is to urge you to hear it—in comparison. Not only is The Amplion the most sensitive of loud speakers. In its reproduction of speech as well as vocal and instrumental music, it is also unrivaled for clarity and natural tone. Literature and dealer's name on request.

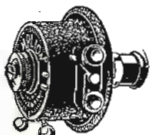

Phonograph Units
in two sizes

THE AMPLION CORPORATION
OF AMERICA

Executive Offices: Suite W
280 Madison Avenue, New York

DEMONSTRATORS WANTED
For 5-Tube
Neutrodyne Set

RADIO

Live young man in every town and neighborhood, to own, operate and take orders for the licensed, standardized, synchronized "De Luxe 5-Tube Coast-to-Coast Neutrodyne" made famous in "The Radio Digest." Complete assembly retails only \$34.49. Thousands sold. Furnished you at discount. Liberal financial arrangements. Write us all about yourself. Ask for plan. Also illustrated description of set. Be First! THE RADIO SHACK, America's Largest Radio Dealers Dept. F231, 55 Vesey Street, New York City



Na-ald DeLuxe Sockets are the only ones with these three exclusive features—lowest loss, lowest capacity and positive side-scraping contact. Send for booklet and laboratory test. Alden Manufacturing Company, Dept. K7, Springfield, Mass.

HENNINGER AERO-COILS Give More Volume and Sharper Tuning



The true low-loss inductance. 95% air dielectric! Dopeless, air spaced windings! Pri. 6 1/2 turns. Sec. 60 turns. Greatly improves tuned R.F. or any set using a tuning inductance. More volume; better selectivity. At your dealer's or direct. \$3.50 each. \$10.50 for three.

Henninger Radio Mfg. Company
1772 Wilson Ave. Dept. 33 Chicago

HUDSON-ROSS

Sells only nationally advertised radio apparatus.

Send for discounts.

123 W. Madison St. Chicago

family. At four today Doctor Maxwell will, if Mr. Sanford has not regained consciousness, leave by a window, and re-enter the front door, giving the impression of having just called. The doctor will be admitted to the study, later to emerge with the information that he and Mr. Sanford have just begun one of their arguments and are not to be disturbed. This is a common occurrence; dinner will be served, and nothing thought of it. I shall shortly go over to the Sanford's residence, on a purely trumped-up charge, to see Doctor Maxwell. You will accompany me."

"Sure," I says. "What on?"

"Foot," says Jerry absently, and I ain't got the courage to laugh.

Over at the Sanford's we're admitted by Miss Sanford, who laughingly warns us of the penalty of interrupting the two old cronies. We goes to the study, being permitted to enter only after we're identified. As soon as we're alone with the doctor and his assistant, The Master speaks up.

"How is he?"

"Still unconscious," replies the doctor. "I'm afraid it may be fatal."

Jerry examines the radio set. "There are no concealed wires of any kind," he states. "Joe, you wait until I've examined the aerial lead-in."

I sits down and picks up a book. Pretty soon Jerry returns. He looks at me. "Reading, Joe?" he inquires, in his absent way.

"A nifty detective yarn," I says. "Sorta appropriate, ain't it?"

"I'm afraid I'll have to make you be the host at the party tonight," says The Master. "Unless Mr. Sanford comes to, I'll have to remain. Besides, it will be necessary for me to listen in on the radio."

This don't sound so good. "Me manage a party?" I repeats. "Aw, have a heart, Jerry—I couldn't do it!"

"Certainly you can," assure The Master. "If I can get away, though, I'll try to be there and assist you at the beginning."

I give in. "All right, I'll do my best. But if the thing's a flop, don't blame me."

I wasn't raised amongst the four hundred, but then again I didn't see the light of day on the Bowery; when circumstances demand I can put on the Ritz with the best of them. I'm a bit uneasy while we're driving up to Jerry's, but my fears are joyously dispelled. There's The Master, all costumed up, waiting for us. As soon as I can I pulls him aside.

"Well, did Mr. Sanford wake up?" I asks. Jerry shakes his head. "Not yet, and I'm afraid he won't. However, his family are as yet unaware of his condition, and they'll all be here."

I'm not quite hep. "Sure they will, but what of it?" I asks.

"Wait and see," cautions The Master. "In the meantime, be prepared for anything."

"Aye, aye, sir," I salutes. "But don't make me pull any acrobatics in this UV-199."

Soon the guests begin coming and I'm busy explaining the why and wherefore of things. Besides being in costume, all of the folks are heavily masked, so's you really can't tell who's who, unless you knows their voices or smells their breaths. From the beginning, I can see where the act is due to be a wow, and it is. A good time is being had by everyone.

But I can't savvy Jerry. He's quite the life of the gathering, in his own peculiar way, and seems to be paying no attention to anything except the festivities. Frankly, I'm puzzled, but keeps my mouth shut and my lamps lit.

Before we realizes it, midnight is at hand. Then The Master steps up on a platform and halts the crowd.

"Ladies and gentlemen," he says, "we will next take part in the novelty of the evening—the radio square dance. I have made ar-

Better Reception

For only \$12

You pay from \$75 to \$500 for a radio set. You can add 35% to 100% to the value of that investment by paying only \$12 for—

The Super-Booster

It greatly increases distance and volume, sharpens selectivity and doubles the life of batteries and tubes. Approved by Radio News Laboratories. Effective with any of these sets—

All models of Radiolas, including Brunswick Radiolas; Atwater-Kent, De Forest, Eved-Eisemann, Ware Neutrodyne, Gillilan Neutrodyne, Angelus and Echophone. Mailed C. O. D. or on receipt of money order for \$12. Postage prepaid anywhere in U. S.

DEALERS—Easy to demonstrate, easy to sell! Write us for terms.



SUPER-BOOSTER
DISTRIBUTING CO.

Successors to Young & Rovig
2528 W. Seventh St., Los Angeles

Sterling

VOLTMETER

No. 36



An ideal combination voltmeter for the radio set owner. It has two scales, one 0-10 volts for "A" battery testing, and one 0-50 volts for "B" battery testing. This meter has two spurs at the bottom of the case, one for the 10 and the other for the 50 volt connection. 0-50 volt scale, 2 1/2 volt divisions; 0-10 volt scale, 1/2 volt divisions. Price\$3.50

Not too little resistance to overdrain the battery. Not too much resistance to give meaningless high readings.

THE STERLING MFG. CO.
2831-53 Prospect Ave. Dept. H Cleveland, O.

To the RADIO DEALER

Let us explain how you can make the sale of our publications a worth while, well paying part of your business. Write now and prepare for the Fall and Winter trade.

EXPERIMENTER
PUBLISHING CO.

53 Park Place, New York City

rangements for the music to be received by radio; Joe, will you please assist in lining up the instruments?"

The idea is to hook up the guests so's to form a complete set on each side. When I'm through we has an eight-tube Super-Het on one side and a seven-tube Neutrodyne on the other, with a lot of spare parts sandwiched in between. Then the music comes.

It seems The Master has wired a certain radio station to transmit music for a square dance at this hour. Sure enough, it comes in, and signs San Francisco.

Immediately I gives a start, and looks at Jerry. He's the picture of sweet, unmitigated innocence, directing one of the instruments. Then I looks up and down the hall. Nothing's wrong.

We're half-way through the dance when suddenly the music dies out. Jerry, who's been at the set all the while, makes a few adjustments, apologizes for the delay, and the music goes on. Soon the dance is ended.

"The next number on the program will be the grand unmasking," calls Jerry. "Stations, reveal your identities."

There's a flurry as masks are taken off. The Master quickly searches up and down the rows. Then he smiles.

"Refreshments are in order," he calls, almost gayly. "Tune in on the most popular radio set in town."

The guests, laughing and joking, form a line up to the big panel. Then Jerry takes a sneak downstairs. Before I can get away from a coupla sweet variometers, The Master's back up again, beaming with joy. I seems to be a pretty popular guy; these flapper grid leaks and debutante variable condensers keeps me tagged. I makes another attempt to break loose and get across the hall to Jerry. But I can't. It's "Oh, Mr. Hammerstein, won't you dance with me?" and "Oh, you naughty mans, won't ums take me onna stage, peease?" and more to match. This idea of being a sheik with the girls is all right, but there's times when plenty is too much. Before I can reach Jerry a butler's called him downstairs again. This time I camps near the door and nails my man when he comes back.

"Lissen here, big boy," I demands, "how, who, when and where?"

"Solved, Joe!" he whispers, excited. "Solved!"

"Zasso?" I cracks. "Continue."

Jerry sees that the crowd is busy playing cafeteria, so he and me goes down to the library. Then The Master begins, slow and easy.

"Well, the would-be murderer has confessed," he states, slow, teasing-like.

"Go on—make it snappy!"

"Joe, do you recall the title of the book you started to read over in Mr. Sanford's library?"

I puzzles a moment. "The title? No. But it was a humdinger mystery tale. What's that got to do with it?"

Jerry smiles. "A lot. I discovered that fully three-quarters of Mr. Sanford's books were of this nature. He was a veritable fend for detective stories, evidently caring little for anything else."

"Yes?"

"Having read so much similar literature, his mind quite naturally began to travel along those channels. He was probably a living detective-hero; always hearing sounds, and finding clues, and seeing blood-stained hands appear from beneath floors. You know—the usual rot."

"Mr. Sanford musta been sorta nutty, wasn't he?" I asks.

"Oh, no," hastens The Master. "He came to about 11:30 and explained all to Doctor Maxwell. It seems he had been receiving these warning messages for several weeks, and his nervous condition, accentuated by the

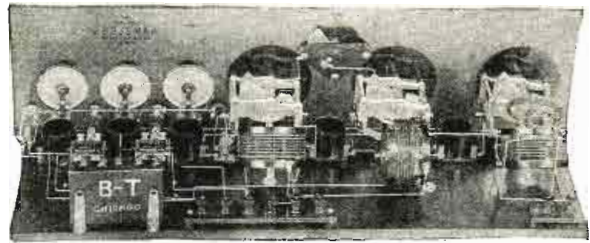

A Set You Can Rely Upon

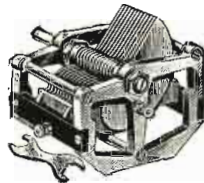

B-T Condensers have been proved in a recent laboratory test at Armour Institute of Technology to have lower resistance than their "Laboratory Standard." Their use is an added help in securing success in any worth while circuit.

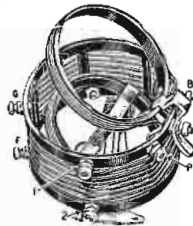

The B-T is the real 3-Circuit Tuner for use in one to four tube sets. It is of low-loss construction with series-bank windings to minimize distributed capacity.

Says Allen MacChesney, Radio Operator of Station WCAE, Pittsburgh: "With B-T Tuner and two steps of audio, using UV199 tubes, I have picked up Pacific Coast stations on the horn loud enough for dancing every night in the week."

"Have had as many as four west coast stations a night, most of this with KDKA on the air 1 1/2 miles away. "In my position I am often asked which is the best tuner and you can be sure from now on I shall talk nothing but B-T."



BREMER-TULLY MFG. Co.

532 S. Canal Street, Chicago

PATENTS

C. L. PARKER
Formerly Member
Examining Corps,
U. S. Patent Office.
PATENT - LAWYER
McGill Bldg., Wash., D. C.

Patents, Trade Marks, Copyrights, Patent Litigation
Handbook for Inventors: "Protecting, Exploiting
and Selling Inventions," sent upon request.



"Lighting Fixtures"

READY TO HANG
(Direct from Manufacturer)
Completely wired including glassware.
Send for Catalogue No. 26.
(Just off the Press)
Special Proposition to Dealers
ERIE FIXTURE SUPPLY CO.
STATION R ERIE, PA.

Valley Battery Chargers



The Charger With
Ten Points of Superiority

Mfgd. by Valley Electric Co.,
St. Louis, Mo. Sold by
Radio Dealers Everywhere.

BODINE BASKET-WEAVE LOOP AERIAL

Gives winter reception with no reduction in
distance. Folding Loop. Ask your dealer.
BODINE ELECTRIC CO.
2250 West Ohio Street Chicago, Ill.

Insure your copy reaching you each month. Subscribe to Radio News—\$2.50 a year.
Experimenter Publishing Co., 53 Park Place, N. Y. C.

How to make the New paper disc loud-speaker

Here is a real worth while loud-speaker that every experimenter can build at very little cost. The essential parts consist merely of a large, pleated, stiff, paper diaphragm, actuated by an ordinary headphone, or loud-speaker unit. It is equal to the average loud-speaker in volume, and superior to all horn typed loud-speakers in tone quality. All the overtones in harmonics are reproduced without distortion, and the lower notes of the musical scale where so many other loud-speakers fail, sound especially well.

It is an ideal loud-speaker and can be made very artistic in

appearance. A very complete description of this loud-speaker is given in the May issue of THE EXPERIMENTER. Included in this description are illustrations as to just how to proceed the building of a complete speaker.

This is only one of the radio features of THE EXPERIMENTER for May. Those who want to keep in touch with the experimental activity of radio, should read THE EXPERIMENTER. In every issue there are twelve complete pages of radio, together with many pages of intensely interesting experimental work of electricity and chemistry, as well.

ASK YOUR NEWSDEALER TO LET YOU SEE A COPY OF THE EXPERIMENTER TODAY

Sold on all Newsstands 25c the copy

12
Pages of
EXPERIMENTAL
RADIO

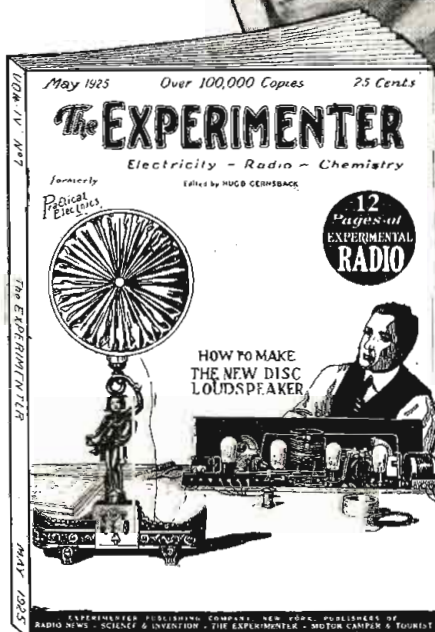

THE GERMOTT PUBLISHING CO., Owners

Licensed Publishers, The Experimenter Publishing Co., Inc., 53 Park Place, New York

type of literature he read, caused him to collapse."

"But why all this monkey business at the party?"

"I'm coming to that," smiles Jerry. "Years ago, in San Francisco, Mr. Sanford became involuntarily mixed up in a shady business deal, which, through certain California state laws, would have subjected him to extreme notoriety and a possible prison sentence had he remained there. Although a native son and ardent lover of his city, he fled rather than be found out. The only way he could keep in touch with his city was by radio. This explains his desire to listen to Frisco only."

"Point number one," I says. "Who's the murderer?"

"The person guilty of sending these messages knew of Mr. Sanford's past, and with much subtlety combined this knowledge with that of Mr. Sanford's literary tastes and radio habits. The motive, of course, being to kill."

"Sure," I agrees. "Who's the murderer?"

Jerry continues to ignore me. "Money being the object, I knew that some relative must be the guilty party. A large number of Mr. Sanford's kinsmen reside locally, having followed him from the West. Being assured of their presence at the ball, I took a chance and ran a wire from Mr. Sanford's set to my eight-tube outfit in the ballroom. I listened in very carefully, keeping San Francisco closely tuned, and the moment I heard an increase in the static, I purposely shut off the speaker. I then heard a deep voice say, 'Elliot Sanford, your time has come!' I knew one of the Sanford clan must be missing from the party. At the unmasking I quickly scanned all the faces. One Sanford was not present."

"And that was—"

"Willard, Mr. Sanford's favorite nephew."

I'm surprised. "Willard Sanford?" I echoes. "Why, I know him well. He owes me fifty bucks on a game of stud."

"Precisely," laughs The Master. "He owed others much more."

"But go on—how did he do it?"

"Willard lived in an apartment in the same block with the Sanford residence. In fact, from his window he could see into the library. I called the police, and they found him using his radio, red-handed. At first he tried to lie, but finally broke down and confessed."

"Just how could he scare Mr. Sanford without anyone else's hearing?"

The Master laughs. "He had a very weak transmitter, tuned closely to the wave used by the Frisco station. This, and a directed aerial, did the business. Willard would listen in, and when San Francisco would be silent a moment he would utter his warning. Naturally, Mr. Sanford believed it to be coming from the coast."

I sits back, relieved. "Clever, at that," I admits. "Will they jail Willard?"

"They should, but they can't," says Jerry. "He has committed no offense punishable by the law, although if they could get him on one charge, they might be able to include others."

"Sure they can," I puts in. "Was his transmitter licensed?"

The Master jumps to his feet. "By George, I never thought of that! Of course, it wasn't!"

"Any good lawyer can elaborate that into a case of anything from manslaughter to arson," I says. "Will you have him arrested?"

Jerry shakes his head. "That lies with Mr. Sanford. Personally, I don't think he will, preferring to avoid notoriety."

We sits in silence for a few moments. Then I speaks.

"Say, Jerry, we gotta party going on upstairs."

Important Notice

Patent Litigation Pending

Westinghouse Elec. & Mfg. Co.

and

Radio Corporation of America

Plaintiffs

vs.

Golden-Leutz, Inc. et al

Defendants

**Will not stop the sale of the
Pliodyne "6", Super-Pliodyne "9"
or Plio-"6" Receivers**

**Sales will continue as before
on these receivers**

GOLDEN-LEUTZ, Inc.

C. R. LEUTZ, *President*

476 Broadway, New York, N. Y.

ROICE RADIO TUBES

The Royalty of Radio Tubes
A powerful and durable tube that will greatly improve reception, increase range and volume with a maximum of clearness.

Our direct sales plan enables you to buy "Roices" at the lowest possible price.

Type 00 5 Volts, 1 Ampere
Detector Tube.

Type 01A 5 Volts, .25 Ampere
Amplifier and Detector.

Type 99 3/4 Volts, .06 Ampere
Amplifier and Detector.

Type 99A 3/4 Volts, .06 Ampere
With Standard Base Amplifier and Detector.

Type 012 1 1/2 Volts, .25 Ampere
Platinum Filament.
Amplifier and Detector. **\$2.00**

ALL TYPES **\$2.00**

Type 02, 5 Watt Transmitter **\$3**

EVERY TUBE GUARANTEED

to work in Radio Frequency. Especially adapted for

Neutrodyne, Reflex and Super-Heterodyne Sets.

When Ordering Mention Type

ROICE TUBE CO., 21 Norwood St., Dept. N, Newark, N.J.



Shipped Parcel Post C. O. D.

At your dealer **50c**

LOCK Your Set!
with this compact—noiseless—shock-proof and easily installed BATTERY SWITCH.

WALBERT LOCK SWITCH
WALBERT MFG. CO., CHICAGO

ARROW BATTERY SLASHES Prices TO CONSUMERS

Prices Smashed!
Quality Not Sacrificed

Here is real battery quality, guaranteed to you, at prices that will astound the entire battery-buying public. Order direct from factory. Put the Dealer's Profit in your own pocket. You actually save much more than half, and so that you can be convinced of true quality and performance, we give a **Written Two-Year Guarantee**

Here is your protection! No need to take a chance. Our battery is right—and the price is the lowest ever made. Convince yourself. Read the prices!

Special 2-Volt Radio Storage Battery, \$3.75
Special 4-Volt Radio Storage Battery, 6.00
6-Volt, 50 Amp. Radio Storage Battery, 7.00
6-Volt, 80 Amp. Radio Storage Battery, 8.00
6-Volt, 100 Amp. Radio Storage Battery, 9.50
6-Volt, 120 Amp. Radio Storage Battery, 11.50
6-Volt, 140 Amp. Radio Storage Battery, 13.00

We ask for no deposit. Simply send name and address and style wanted. Battery will be shipped the day we receive your order Express C. O. D., subject to your examination on arrival. Our guarantee accompanies each battery. We allow 6% discount for cash in full with order. You cannot lose! Act quick. Send your order today—NOW.

Arrow Battery Co.
 1215 South Wabash Ave.
 Dept. 6 Chicago, Ill.

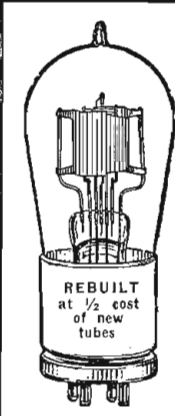

SAVE HALF THE COST OF NEW TUBES

BY HAVING YOUR OLD BURNED OUT AND BROKEN TUBES REBUILT

Guaranteed equal to new. Send us your tubes by parcel post. We return them parcel post, C. O. D. and try to maintain 24 hour service.

HARVARD RADIO LABORATORIES
 200 Old Colony Avenue
 South Boston, Mass.

One point explains Diamond's growing popularity—longer life.

Radio **DIAMOND** "B"

BATTERIES

DIAMOND ELECTRIC SPECIALTIES CORP.

103 South Orange Avenue, Newark, N. J.
 Dealers, Jobbers—Write for Proposition

INSIST UPON
AMSCO
 POTENTIOMETERS

Most Dependable Made

Wire-Nuts for joining

radio antenna and lead-in wires in one minute without solder, tape or tools. Many other uses. A million perfect joints have already been made with these new Wire-Nuts. Listed by Underwriters' Laboratories. Booklet free. Ask your dealer for Wire-Nuts. We will send 3 Wire-Nuts post paid on receipt of 25c. N. YORK COMPANY, 8 W. 40 St., New York

"Yes, of course."
 "And we'd better go on up, if we want to save the show. Unless you watches them close, those instruments are liable to hook up in some dark corner."
 "That's all right," he says. "They won't hear anything."
 And he's serious about it, too!

How to Identify the Enemies of Good Reproduction

(Continued from page 2215)

contact with the rails often magnifies troubles from this source.

If you have the experience of enjoying a distant program and having it suddenly taken away from you completely, you must look for a nearby regenerative receiver or a super-heterodyne operated from an aerial. Sometimes their influence extends for ten miles in every direction. In a metropolitan area this means that they may ruin reception for tens and even hundreds of thousands of listeners.

Those familiar with the code sometimes note clicks unaccompanied by the familiar spark note or the high-pitched whistle of the continuous wave signal which is heard when the receiver is made to oscillate. These are key clicks from a continuous wave transmitter properly operated in its assigned wave band, but with the key so hooked up as to radiate the spark which occurs when the contact is made and broken.

ANALYZING THE RECEIVER

Having negotiated safely the transmitting process and the journey through the ether, quality of reproduction is still subject to many pitfalls in the receiving set. A characteristic of all distortion caused by the receiving set is that no matter what station you tune to, so long as the volume is approximately the same, the particular kind of distortion noted occurs.

Nine-tenths of all distortion due to receiver design is attributable to the audio-frequency transformers, phone unit or horn. This part of the receiver is readily isolated by listening on the detector tube with headphones. It is advisable to apply this check before proceeding further.

Very sharply tuned receivers, particularly home-made Super-heterodyne receivers, may cause distortion because they tune too sharply. A modulated carrier wave occupies a fractional band of a wave-length and the receiver must be equally sensitive throughout this band. It is a characteristic of receivers which tune too sharply, to distort local signals considerably, while distant signals, even if amplified to full loud speaker volume, are heard with clarity and purity.

Another more frequent cause of distortion is improper manipulation of a regenerative receiver. Regeneration carried too close to the oscillating point invariably results in distortion and serious radiation. A receiver so tuned not only results in unpleasant and unmusical reception, but also spoils all possibility of getting good reproduction on the wave-length to which such a receiver is tuned for an area of several square blocks.

TRANSFORMERS, PHONE UNIT OR HORN

Assuming an undistorted detector signal, next test the audio-frequency amplifiers. Disconnect the ground, plug in the phones in the last stage of the amplifier, bringing the signal up to the maximum volume that the ear will withstand and that will not cause the phones to clatter. A ringing tone or a flat tone is unnecessary as well as unmusical. If the transformer is responsible, you will hear the same flat tone on the headphones as you do through the loud speaker.

OHIO MOTOR GENERATOR CHARGER



No More Weak Batteries

Why lose an evening's entertainment because of run-down batteries? An Ohio Motor Generator charges in one-third the usual time at 3 to 20 amperes, 6 to 10 volts.

It's a real motor generator with no expensive bulbs to break—no chemicals to renew—no contacts to burn or fuse. It has sufficient capacity to charge several batteries in parallel.

Merely hook it to a light socket—Fully automatic—Needs no watching while charging—Cannot charge in the wrong direction—Regularly equipped with 110 volt, 60 cycle A. C. Motor, 6 to 10 volt Generator. Equipped for other service if desired. Lasts a life time.

SATISFACTION GUARANTEED OR MONEY BACK

In writing for details and special prices, state service current and if Charger is to be used for "A" batteries only or both "A" and "B" Batteries.

THE OHIO ELECTRIC & CONTROLLER CO.
 5907 Maurice Avenue Cleveland, Ohio

For Summer Radio use the

PROUDFOOT LOW LOSS CONDENSER



You can't waste radio energy in summer. Every little bit counts. And only with an efficient set will you get satisfactory reception at this season.

The Proudfoot One Knob Vernier Condenser is a low loss unit built for exacting service in high grade sets. It is made in four sizes and favorably priced—

Number of Plates	M. F. C.	With Vernier Dial and Knob	Without Vernier Dial and Knob
13	.00025	\$3.75	\$3.25
17	.00035	4.40	3.90
25	.0005	4.50	4.00
43	.001	5.75	5.25

Get one at your dealer's or write us. Detailed circular on request.

CRUVER MANUFACTURING CO.
 2456 W. Jackson Blvd. Chicago, Ill.

ABSOLUTELY FREE Thousands of RADIO BARGAINS

Interesting Radio Information. Complete list of Broadcasters with space to log station. All hook-ups. How to operate sets. Write today.

STANDARD RADIO CORP.
 227 WEST MADISON ST. CHICAGO

The SATURN Perfect Jack and Automatic Plug. Your order filled by mail promptly. Every article absolutely guaranteed. The SATURN Mfg. & Sales Co., Inc. 48 Beekman St. New York, N. Y. Dept. R. N. Write for Literature

LOW LOSS TUN-A-FAR

THE NEW RADIO SENSATION GETS WONDERFUL DISTANCE. Marvelous Selectivity, Beautiful Tone and Tremendous Volume. **B-ELIMINATOR KIT** Price \$20.00

FREE Diagram for One Knob Hook-up with Each Coil. A. H. WAAGE 6 Beado St., New York, N. Y.

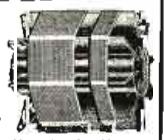

UNITED ELECTRIC STORES CO. Wholesale Radio Equipment
 East Pittsburgh, Pa. Next door to KDKA
Same Day Shipments

The output of your audio-frequency amplifier may be sweet and musical and still the output of the horn may be badly distorted. Most loud speakers have an adjustable diaphragm. The closer to the magnets the diaphragm is set, the more sensitive it becomes. Also, the more likely it is to chatter when a strong signal is impressed upon it. Overcome this either by reducing volume to a degree which the phone unit will withstand or else increase the separation between the diaphragm and the magnet. A poorly adjusted diaphragm betrays itself by a tinny metallic reproduction.

A throaty effect in reproduction, particularly noticeable in speech, is usually caused by a poorly designed loud speaker. This is aptly described as the "hot potato effect" by loud speaker designers.

POSITION OF HORN MAY INCREASE ECHO

The position of a loud speaker in the room often has a significant effect upon reproduction. If placed too near an undraped wall, reverberation is accentuated. Oftentimes this source of distortion can be remedied by a slight change in the position of the horn. Try facing the opening of the horn toward a heavy drapery and see if a richer quality is imparted to the music.

CONCLUSION

Extensive as the search for good quality may appear, radio broadcasting has actually attained such a high degree of musical fidelity that no listener should be satisfied with anything less than a faithfulness of reproduction equal to that heard with a phonograph. Since most of the contributing elements to distortion can be quickly localized to one of the three principal factors—transmitting system, the ether medium or the receiver—and further localized by determination as to whether it is an extraneous sound contributed to the music or whether the music itself is distorted—the actual search for the difficulty is made relatively simple.

Esperanto Lessons

(Continued from page 2235)

obligation). Decas ke ni iru. (Familiarize yourself with this distinction between *Devi* and *Deci*.)

Nek * * * nek, neither * * * nor: Neither he nor I saw you, *Nek li nek mi vidis vin*.

Aŭ * * * aŭ, either * * * or, Either you will come with me, or I won't go, *Aŭ vi venos kun mi, aŭ mi ne iros*.

Kaj * * * kaj, both * * * and: Both you and I can go, *Kaj vi kaj mi povas iri*.

Ja, In fact, indeed: He indeed is thankful, *Li ja estas dankema*. "Ja" is used to emphasize: I certainly do wish he were here, *Mija volas ke li estu tie ĉi*.

Jen; Behold, here in this place; *Jene*: As follows. *Jen estas via ĉapelo*, Here is your hat. *Li parolis jene*. He spoke as follows:

Tiom kiom: As many as, as much as. Example: *Li faris tiom kiom vi*, He did as much as you. The sugar weighs as much as the butter, *La sukero pezas tiom kiom la butero*.

Tro, too, too much; troe, in excess: *Dek dolaroj tro*, Ten dollars too much.

Vole: By will. *Kontraŭvole*, against the will, against one's will; *Memvole*, voluntarily, *Senvole*, involuntarily. *Volonte*, readily, willingly.

(To be continued)

BUILD YOUR PORTABLE in a KARRYADIO CASE

TRADE MARK

The ideal portable receiver case with pivoting loop and collapsible horn—takes standard panel

PRICE \$15⁰⁰

Specifications:

18 3/8 x 14 3/4 x 5 1/4 inches—covered in a good black leatherette—equipped with "easy grip" handle—just the size of a small week-end case.

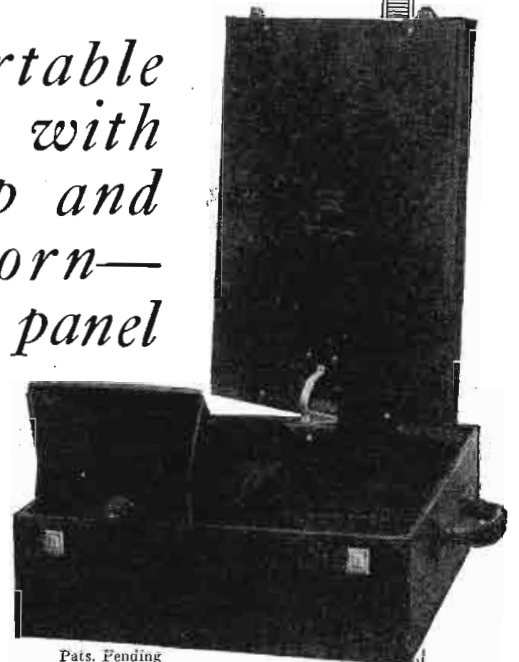

Pats. Pending

Now you can buy a case for your portable Radio without the worry about installing a suitable loop and a permanent horn that will fit. The Karryadio, a specially designed radio case, solves your problem at low cost.

The cover contains a low loss loop and is so designed that it can be turned in any direction—to pick up the different stations. This pivoting feature of the lid permits the finest adjustment without moving the case.

The Karryadio case also contains a collapsible horn. When closed the horn occupies a space only an inch thick, and can rest on top of the batteries or the set. When snapped open, it measures six inches square, giving wonderful volume and tone.

AT YOUR DEALER OR MAIL COUPON DIRECT



This Armley receiver is designed to fit the Karryadio case for those who want a factory built set. Dimensions are 7 1/2 wide x 18 long x 5 inches high. This powerful 6 tube set using dry cell tubes has 2 stages tuned radio frequency amplification—detector and 3 stages audio frequency amplification, thus producing the volume required in portables. It is a good distance getter—very efficient on a loop and is equipped with an aerial and ground connection. Price \$60.00 less tubes.

ARMLEY RADIO CORPORATION
68-70 Fleet Street, Jersey City, N. J.

ARMLEY RADIO CORPORATION,
68-70 Fleet St., Jersey City, N. J.
Gentlemen:—I am enclosing \$15 for which send me postpaid one "Karryadio case" with the pivoting loop cover and collapsible horn as described above.

Name

Address City-State

Your dealer's name

Address

Special Library of Information
on
RADIO PATENTS
and
TRADE MARKS

JOHN B. BRADY

Patent Lawyer

Ouray Building Washington, D. C.

Cable address: **RADIOPAT** Telephone: **Main 4806**

BUILDING A SET?

You must have rheostats of correct ohmage. Insist on the genuine

KLOSNER RHEOSTATS

Made by pioneer makers of the remter. FREE.—Send for valuable Rheostat Chart and information on the care and operation of vacuum tubes. Mention dealer's name.

KLOSNER RADIO CORPORATION
1024 East 178th St. Rheostat Specialists, N. Y. C.

A NEW SERVICE

The **BROWN TUBE REVIVER** rejuvenates worn down tubes in 10 1/2 minutes. An opportunity for you to immediately establish a profitable and substantial business, full or part time. This new absolutely guaranteed instrument priced at \$25.00 complete.

The first cost is the last cost. **BE THE FIRST IN YOUR NEIGHBORHOOD.** Send NOW for particulars.

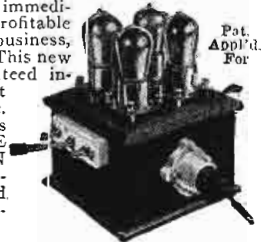

Write to nearest point.
St. Louis Radio Tube Lab., 3572 Olive St., St. Louis, Mo.
THOS. BROWN CO.
513-517 Orange St. Newark, N. J., U.S.A.

HEAD SETS LOUD TALKERS
PHONO ATTACHMENTS

TRIMM

RADIO MFG. CO., Dept. 66
24-30 S. Clinton St. Chicago, Ill.



**The DAVEN
RESISTANCE COUPLED
AMPLIFIER KIT**

The aim of Radio is distortionless reproduction. The

**DAVEN RESISTANCE
COUPLED AMPLIFIER**

hits the mark. Three or four stage kits bring its perfection to those who "build their own." Daven Amplifier Kits sold everywhere.

Obtain from your Dealer the "RESISTOR MANUAL," our complete handbook on Resistance Coupled Amplification. Price 25c. Post-paid 35c.

DAVEN RADIO CORP.
"Resistor Specialists"
Newark, New Jersey

**BUY THE
FILKO LIGHTNING
ARRESTER
SCIENTIFICALLY CORRECT**
with the **100% Guarantee**

Warranted to protect your radio from lightning, with a guarantee to pay you \$100 or to repair your set, should it be damaged by lightning through any fault of the arrester. Listed as **STANDARD** in re-examination service of the National Board of Fire Underwriters.

If your dealer has none, send his name with remittance direct to
DX INSTRUMENT CO.
Dept. RN625 Harrisburg, Pa.

\$1.50
\$2 IN CANADA

**ELIMINATE
Your STORAGE "A"
BATTERY**
for Reflex Radios

BLAX A.C. POLARIZER

Uses electric light current—saves your recharging costs and bother. First small cost of Blax is last. Nothing to get out of order. Thousands already giving satisfaction. \$1.00 bill or M. O. or send dealer's name and we will forward C.O.D.

DEALERS AND SET MAKERS—WIRE FOR PROPOSITION—

BLACK BROS. Inc.
500 BLACK BLDG.
LOS ANGELES.

**WRITE FOR OUR CATALOGUE
RADIO PARTS—KITS—SETS**
We Guarantee To Save You Money

The RADIO SHACK
55 Vesey Street, Dept. F 23
NEW YORK CITY

Four Phone Plugs and Posts
Lightning Arresters and Switches of Merit
Write for bulletins
THE BARKELEW ELECTRIC MFG. CO.
Middletown, Ohio, U. S. A.

Insure your copy reaching you each month. Subscribe to **RADIO NEWS**—\$2.50 a year. Experimenter Publishing Co., 53 Park Pl., N.Y.C.

**WRNY—Radio News
New York**

(Continued from page 2227)

Station WRNY will also do a good deal of remote control work,—all scientific gatherings, all scientific lectures of importance, thus being broadcast.

The station will also make a bid for new musical manuscripts, and the publishers of RADIO NEWS will publish successful musical selections, which will then later be broadcast. RADIO NEWS already did this very thing, having published four pieces of radio music last year, through a \$500 radio prize contest.

RADIO NEWS feels itself in an enviable position in regard to its ability to offer the radio listener the best in this new "magazine of the air" feature.

The new station, with its broadcasting equipment and main studios, will be located on the 18th floor of New York's latest and most up-to-date hotel, The Roosevelt, at 45th Street and Madison Avenue, New York City. The call letters WRNY (signifying Radio News, New York, or Roosevelt, New York) have been reserved for the station by the Department of Commerce at Washington.

The Roosevelt Hotel is ideally located for a powerful broadcast station. It is in the very center of things, accessible readily to the theatrical district, and easily reached from all parts of the city.

The hotel in which the installation is made has seen the advantages which may be taken from the radio station. Aside from the regular system of wiring which enables the picking-up of programs from any part of the hotel, there is installed a public address system in all of the meeting rooms, dining salons and ball-rooms, through which the program being rendered may be made available to guests.

The transmitting equipment, which is all of Western Electric standard make, of the very latest type, has already been delivered and the installation of the equipment will be completed very shortly. The order for the 125-foot towers has also been placed, and it is probable that all the equipment will be in place before the towers are up. WRNY is also equipped with the latest type of Harmonic Suppressor.

It is the desire of the management of the station that the programs be well balanced and clearly modulated, and every consideration, regardless of expense, will be given to this detail.

Mr. Hugo Gernsback, editor of RADIO NEWS, is a firm believer in short wavelengths, and he believes that it is only a matter of time when all broadcasting will be conducted below 100 meters. Broadcasting at such wave-lengths is far more penetrating, carrying over much greater distances. Also, in the lower wave regions there is considerably less static. Moreover, in this waveband, there is less interference on account of the rapid rise of the frequencies. Therefore, it is planned that the new station will go on the air on a wave below 275 meters.

Some minor changes have been made in the interest of clarity of background and the suppression of side bands. There is a floating battery system, which will also help to reduce the extraneous amplifier noises and a harmonic suppressor with the aid of which it is hoped to reduce this particular brand of interference.

At the present time, both the high-tension plate voltage and the filament current are supplied by machine through proper filter. However, there are tentative plans to change the power supply over to storage batteries when the proper design can be obtained. The whole power and amplifier unit is in duplicate with an emergency switching arrangement so

MIRACLE

**SUPER-POWERFUL AND SELECTIVE
CRYSTAL SET**

SOLD UNDER 10-DAY TRIAL. Gives you choice of stations without interference, clear and loud, winter or summer. Good material; handsome cabinet; engraved panel; good workmanship. No tubes or batteries. Always dependable.

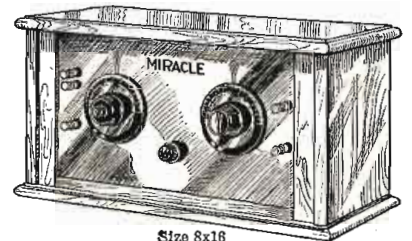

Size 8x18

**YOU BUY DIRECT FROM
MFR. AND ORIGINATOR**

"Miracle" sold under 10-Day Trial. If not satisfactory, return and your \$12.75 will be refunded.

FACTORY PRICES

\$12.75 for set. \$18.50 complete with Brandes phones and aerial outfit. Shipped by Express Collect.

UNCLE AL'S RADIO SHOP

2017 27th Avenue, Oakland, Calif.

SILVERTRON

an honest to goodness tube

**TODAY
AT A NEW LOW PRICE**

\$2.25



**The fastest selling guaranteed tube
BETTER THAN EVER
LONG LIFE
CLEAR RECEPTION**

The Silver Tube with the Golden Voice.

Type 102A 5 volts operates as either Detector or Amplifier on 1/2 amp. filament consumption. The Ideal Tubes for Neutrodyne and Super-Heterodyne Type 112—1 1/2 volts, Ampl. and Detec. Amp. 1/4. Type 112—1 1/2 volts, Detector only. Amp. 1-5. Type 399—3-4 volts, Detector and Ampl. Amp. .06

Sent C. O. D. or Parcel Post Prepaid, carefully packed to any address on receipt of \$2.25

DEALERS & JOBBERS—WRITE FOR DISCOUNT

NEW YORK RADIO COMPANY
71 West Broadway New York City

YOU CAN MAKE A CRYSTAL SET

That will receive greater distances if you buy my plans. No tubes or batteries. Copyrighted plans \$1.00 or furnished FREE with complete parts for building set, including my special coil and panel correctly drilled for only \$5.00. Satisfaction guaranteed. Satisfied customers everywhere. Particulars free.

E. A. SHARP, JR.

549 Sharp Bldg. 7050-52 N. Clark St. Chicago, Ill.

**HERCULES
AERIAL MAST**



20 Ft. Mast \$10
40 Ft. Mast \$25
60 Ft. Mast \$45

All steel construction complete with guy wires and masthead pulley. We pay the freight.
S. W. HULL & CO., Dept. A7
2048 E. 79th St., Cleveland, O.

Write for literature and **FREE** Blueprint

**Spaulding
-BAKELITE
RADIO PANELS**
SPAULDING FIBRE COMPANY INC.
TONAWANDA, N.Y.

Insure your copy reaching you each month. Subscribe to **RADIO NEWS**—\$2.50 a year. Experimenter Publishing Co., 53 Park Pl., N.Y.C.

that a continuous program will be assured. In event of a mishap to any part of the apparatus, there will be only a few seconds' interruption, it is thought that such a change can be made without the listener's being aware of it.

Mr. Gilson V. Willetts is engineer and manager of the station. Mr. Willetts has had a wide radio experience, formerly as Director of Station WOS at Jefferson City, and as Operator and Announcer and Technician at Station WOC, Davenport, Iowa. The balance of the staff will consist of men of known and tried experience in the broadcast world.

A further announcement will be made in our next issue.

The Radio Micrometer

(Continued from page 2209)

until the beat note as tested against the piano is the same as at the beginning. The change in the reading of C, which must be calibrated in micro-microfarads, will give the alteration in capacity of P.

The minimum change in capacity which can be detected in this way evidently depends on the ability of the ear to distinguish a change in pitch of the beat note from that of the standard fork or piano string. The ears of some persons of musical training are extremely sensitive in this respect, but many other persons are correspondingly insensitive especially when a little fatigued. To avoid this difficulty as far as possible, Whiddington set up a third oscillating circuit with large inductances and capacities to give an audible note in a second loud speaker. This audible note was adjusted in unison with the beat note. Changes of the heterodyne note of one vibration per second or less were now readily perceptible to anyone, since beating of the beat note was thus produced, beating as low as one in two seconds being readily counted. It is evident that this third circuit, although not absolutely necessary, will improve the delicacy and precision of measurements very considerably.

For regular micrometric work, that is, for measuring small displacements, the condenser P is altered to the form shown in Fig. 4. The two plates are supported on substantial metal rods about 3/4-inch in diameter. These plates can be strained apart more or less by putting greater or less weight in the pan S. To begin with, a heavy load of several pounds is put in the pan and the movement of P backward is measured with a screw gauge. Since elastic displacements are known to be very regularly proportional to applied load, once the large displacement produced by a heavy weight is known, the smaller displacement which would be produced by a smaller weight can readily be calculated by simple proportion. When this special condenser was inserted in Circuit No. 1, it was found that the smallest load in the pan which would produce consistent changes in the beat note was one thousandth of a gram (1/30,000 of an ounce) at a distance of five inches out from the vertical post. This load gave two beats per second against the standard note corresponding to a change of two in the frequency of the heterodyne note.

Calculation from the measured shaft in P under the heavy calibrating load showed that one thousandth of a gram at five inches would shift the plate one hundred millionths of a centimeter or four thousand millionths of an inch (0.000,000,0043 inch) which is very nearly the diameter of a single atom of hydrogen or other gas. This figure represents the smallest change in distance which could be measured with that particular outfit. In order to read displacements directly from the apparatus, the scale of condenser C must be calibrated for a series of known displacements in P produced by known

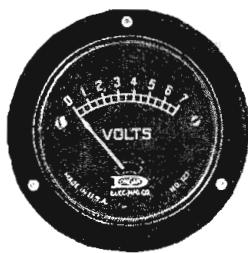

TYPE P

Black Enamel Finish. 3 holes in Flange for Panel Mounting. 2 ins. diameter.

List Prices
0-7 volts \$1.25 0-50 volts \$1.25
0-100 volts \$1.50



TYPE N

Handsome Nickel Rim with Black Bezel Clamp Style Mounting.

List Prices
0-7 volts \$1.75 0-50 volts \$1.75
0-100 volts \$2.00

DONGAN

VOLTMETERS

NECESSARY FOR EFFICIENT RADIO RECEPTION

Set Manufacturers and Fans now realize that efficient radio performance depends on correct tube and "B" battery voltage. Only in that way can you enjoy good radio all the time.

Dongan Voltmeters will keep an accurate check on your set operation. Accuracy over the entire range of scale, definite readings that can be relied upon feature Dongan Voltmeters—designed and manufactured by a company who has specialized for 15 years in the production of high-grade electrical instruments.

Dongan High-Resistance Voltmeters possess sufficient ohms per volt to insure efficient operation and are ruggedly built to give years of service.

Manufacturers Prices quoted on request.

Four Types for all purposes. Capacities from 0-7 to 0-100 volts.

DONGAN QUALITY AUDIO TRANSFORMERS
are built in ratios, 2-1, 3 1/2-1, 6-1

DONGAN ELECTRIC MANUFACTURING CO.
2983 Franklin St., Detroit, Mich.
Transformers of Merit for 15 Years



MORE THAN MATCHED
A Guaranteed Precision
of 1/3 of 1%

Complete Kit of
Six Coils

VICTOREEN SUPER KIT

The Super Heterodyne transformer which contains a condenser adjusted and sealed at the factory. Descriptive literature on request.

Kit of 6 coils, cardboard box.....\$38.50
In wooden box.....\$37.00
Complete set of 4 blue prints..... 1.00

VICTOREEN RADIO, Inc., 6536 Carnegie Ave., Cleveland, Ohio



7 TUBES GIVE THE RESULTS OF 10

NEW MODEL C-7 SUPER-HETERODYNE

THE SET THAT MADE RADIO FAMOUS

The greatest set known for long distance, volume and quality of reception.

The Model C-7 is the result of many years' work by the best known radio engineers, and is made up of the highest quality apparatus available. It is the most sensitive and most selective broadcast receiver that can be built.

We distribute only the original E. I. S. parts and make immediate shipment from stock.

"Modern Radio Reception," by C. R. Leutz, 325 pages, 200 illustrations, \$3.00 postpaid.

C-7 Blueprints showing all data, details and circuits, \$1.00 postpaid.

Write for catalog and price list.

8 South Austin Blvd. **RADIO PARTS CO.—Laboratories** OAK PARK, ILL



TWO SIZES

No. 4524—4 1/2 amp. hr.—24 volt
No. 4548—4 1/2 amp. hr.—48 volt

STORAD

RELIABLE BATTERIES

We stake our reputation as Storage Battery and Radio Engineers on these batteries because they are built to give reliable service on modern multivibe sets. You can solve your "B" circuit power problem with Storads. Ask your dealer or write direct for information.

Distributors' territory is still available.

The Cleveland Engineering Laboratories Co., 2120 Superior Viaduct, N. W., Cleveland, Ohio

One Radio Book Everyone Reads

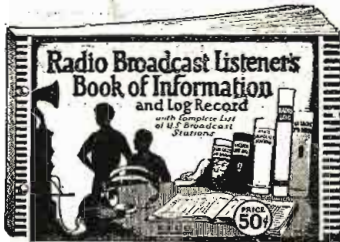

The Radio Broadcast Listener's Book of Information and Log Record

is not only a complete, practical book of those essential Radio facts that everyone who owns a radio should know, but it is also a handy log record for those who want to keep a record of the stations they receive. The book is enclosed in a handsome two-color cover, bound in Loose-leaf fashion, so that new pages can be inserted if necessary. It contains 80 pages, each one containing information more valuable than the last.

The following is a brief summary of the information contained in this book:

Information for the Broadcast Listener:

- Vacuum Tube Table:
- Meter Wave Lengths:
- Radio Batteries:
- Wireless Code Chart:
- Station Log Chart:

Complete list of Broadcast Stations of the United States, giving Power, wave length, and Time of Operation each day of the week. Log Sheets for tabulating the dial settings of the stations you receive on your radio. Size of Book, 6 in. by 9 in., with handsome 2-color cover.

Postage **PRICE 50¢** Paid

Published by

The E. I. COMPANY

Sole Distributors

The Consrad Co.

233 Fulton Street
New York, N. Y.

weights. In Whiddington's outfit it was found that, over a considerable range, one degree on the dial corresponded to a movement of the plate of $1/332,800$ of an inch. By reading to one-tenth of a degree one could thus work to about *one three-millionth of an inch*. A more precise and sensitive condenser would naturally enable one to read still closer values.

These simple and inexpensive circuit arrangements enable one, as we have seen, to measure relative movements of two metal plates of one ten-millionth or one one hundred-millionth of an inch or better—a delicacy of measurement beyond the reach of any other electrical or mechanical device. It might at this point very naturally be asked what is the use of measuring such minute movements, movements so small as to be imperceptible except in this particular period of apparatus. This question is answered by noting certain of the uses to which the ultramicroscope circuit has been put in laboratories of physics.

THERMOMETERS

The special condenser of Fig. 4 can be altered so as to form an "electrical thermometer" capable of measuring temperature changes of $1/16,000$ of a degree Centigrade. Since ordinary mercury thermometers can be read only with difficulty of $1/10$ of a degree, the electrical thermometer represents an advance in temperature measurement in the limited field in which it can be applied. Fig. 5A shows an over-all view of the device, the expansion element in its non-conducting jacket being supported at A. Fig. 5B shows the construction of the expansion element which consists essentially of a thin copper tube, four inches long, suitably supported and provided with an internal wire for heating. A constantan wire soldered on at B forms a thermocouple with the copper tube so that, for a preliminary calibration, the temperature of the tube can be determined from the reading of the galvanometer G. In use, the circuits are put into oscillation and the beat note adjusted to the standard pitch. The tube is then heated by passing current through the internal wire until the galvanometer current from the thermocouple shows that the temperature of the copper tube has increased exactly one degree Centigrade. The resultant expansion of the tube brings the plates closer together and the pitch of the beat note consequently changes. Weights are then put in the pan P until the note is restored to its former pitch as shown by the development of the same number of beats per second with the standard note as before. The amount of movement can be calculated from the weight in the pan as explained above and the amount of expansion of the copper tube is thus determined. In one test the expansion was found to be $68/10,000$ of an inch for a rise of one degree Centigrade. The smallest length change which this particular arrangement was capable of measuring was, as shown by other experiments, $0.000,000,0043$ of an inch whence we see that the device is capable of detecting a temperature alteration of 0.000063 of a degree Centigrade or about $1/16,000$ degree C.

Another application is to a device for detecting the failure of metal specimens in the testing machines used in metallurgical work to classify different lots of metal. In prior practice highly polished blocks were, in certain of these tests, subjected to stress in the machines and failure detected through marring of the surface observed optically. In the new electrical method a polished steel block, four-tenths of an inch square, is laid on the polished test piece with an insulating slip of mica, perhaps two mils thick, between. A plate condenser is thus formed which is introduced into the heterodyne circuits as shown at P, Fig. 6. When the test specimen deforms under the stress, it will



KORACH TUNED LOOP

Tuning Feature
Directional
Can Be Logged
Collapsible

The Loop COCKADAY used on his famous 8-Tube Super Reflex to bring in 2LO, London; 2BD, Aberdeen, Scotland; 5NO, Newcastle, Eng.; 2PY, Plymouth, Eng.; ESP, Paris, France; PTT, Madrid, Spain; WKA2, Porto Rico and other over-seas stations. Approved and recommended for the COCKADAY Superheterodyne and all other sets designed for loop reception. Exclusive features give you selectivity and distance unheard of before with loop aerials. If your Dealer cannot supply you, order direct from us. Price \$16.50. Send \$2.00 as good faith deposit with your order, balance C. O. D. Express. Satisfaction guaranteed.

Korach Radio Co.

309 So. LaSalle Street
Dept. 7, Chicago, Ill.

Full Particulars on Request.

DEALERS AND JOBBERS: Write at once for attractive proposition.

BROWNLIE VERNIER DETECTOR

Patent Pending

FOR REFLEX or CRYSTAL SETS

Best
Reflex
Crystal
Detector

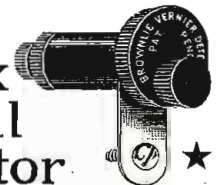

Says
the Acme Apparatus Co.

For Panel or Base Mounting
including Crystal. Guaranteed \$2.00

No longer does the whisker scratch the crystal, or is the sensitiveness killed by heavy spring pressure—the Vernier Regulator takes care of that. It will surprise you to know how sensitive Crystal Detectors are when correctly made.

At your dealers otherwise send purchase price and you will be supplied postpaid.
ROLAND BROWNLIE & COMPANY
20-24 Saunders St., Medford, Mass.

Learn Electricity in Short Time in the Great Shops of COYNE

EARN \$60 TO \$200 A WEEK

Get in the Big Pay Field. Be an ELECTRICAL EXPERT. Coyne training practical—simple. You do actual work on huge outlay of electrical apparatus. NEW, ENLARGED COURSE. Education, experience not needed. Free courses in radio and Auto Electricity. Earn while you learn. Free Railroad Fare to Chicago. Write quick for full details. Send for my big Free Catalog now.

COYNE ELECTRICAL SCHOOL, Dept. 594-A
1300-1310 W. Harrison St., Chicago, Illinois

YOUNG MEN—TURN YOUR SPARE HOURS INTO MONEY!

Earn big profits, prizes, and awards selling RADIO NEWS, SCIENCE & INVENTION, THE EXPERIMENTER, and MOTOR CAMPER & TOURIST in your neighborhood. We train you as our salesmen and pay you liberally for your time. Write at once and we will help you get started.

M. BRIDWELL.

THE EXPERIMENTER PUBLISHING CO.
53 Park Place New York, N. Y.

RICHARDSON 5 Power

A five-tube, tuned radio frequency set equalized on all wave lengths to give great power, distance and volume. Consider its performance, its appearance and its price. No wonder it is making radio history wherever it is demonstrated.



\$65

At Better Radio Stores Everywhere

RICHARDSON RADIO, Inc.

128 University Place, New York City

IT IS NOW DIFFICULT TO GET LONG DISTANCE

BUT H. J. H., Cincinnati, Ohio, "Received A-1 CRYSTAL May 8. On May 9 received following stations clearly: KDKA, WGN, WOS, WRK, WWJ, WOC, WBZ, WTAM, WGY. On May 10 heard WFAA, Dallas, Texas, 850 miles, on Crystal set."

A-1 THE WONDER CRYSTAL

For Reflex or Crystal Set Sent Postpaid by Insured Mail 50c each Dealers Write for Discounts.

California Radio Minerals

Harry Grant, Jr.
904 Oak Grove Ave.
Burlingame, California

A Laboratory Product



CRESCENT LAVITE RESISTANCES

for Distortionless Amplification

12,000, 48,000, 50,000, 100,000 Ohms. List \$1.50 each. Special Sizes to Order \$2.50 each. Dealers write for discounts. When Better Resistances are made they will be Crescents.

Crescent Radio Supply Co., 1-5 Liberty St., Jamaica, N. Y.

RADIO TUBE EXCHANGE

We Repair all Stand. Makes of Tubes \$1.50 U.V. 202 Repaired, \$3.00 All Tubes Guaranteed to Do the Work Radio Tube Exchange, 200 Broadway, N. Y. All Mail Orders Given Prompt Attention Orders Sent Parcel Post C. O. D.



The MOZART GRAND CO.

Manufacturing fine

Radio Reproducing Apparatus

at 235-49 Elizabeth Avenue, NEWARK, N. J., U. S. A.

INSIST UPON



PATENTS

DON'T LOSE YOUR RIGHTS Before disclosing your invention to anyone send for free blank form "EVIDENCE OF CONCEPTION" to be signed and witnessed. LANCASTER & ALLWINE Reg. Pat. Atty. in U. S. and Canada 270 Gurray Bldg., Washington, D. C. Originators of the form "Evidence of Conception"

buckle or wrinkle, lifting the mica, decreasing the capacity at P and thus altering the beat note. Since the amount of deformation necessary to produce this change is less than one-millionth of an inch, an extremely delicate indication of the beginning of failure is thus afforded.

In concluding this description of heterodyne ultramicroimeters, a few words of advice to amateurs who may attempt to reproduce these interesting circuits are in order. In the first place, careful shielding of the whole circuit and of its parts is essential. This is best accomplished by inclosing the circuits in small boxes lined with tinfoil or tin—the sheathing being earthed. Secondly, the outfit must be set up in a place free from jars or vibrations, preferably in a cellar. The slamming of a distant door or a foot-fall on another floor may be sufficient to throw the set out of adjustment if attention is not paid to this point. Thirdly, small variations in circuit arrangements may be necessary to meet the characteristics of different tubes. Steady oscillations can only be maintained when there is a suitable negative bias on the grid. With some tubes a heavy resistance in the grid circuit will give this bias, in other cases a small grid battery may produce a better result. Lastly, trouble in these circuits during operation is, in a large majority of cases, directly traceable to unsteadiness of the storage batteries. The filament batteries in particular must be of large capacity and in prime condition in order to get usable steadiness. Slow drifting of the pitch of the beat note is, on the other hand, usually due to fatigue of the plate batteries.

We have so far said nothing about the "zero-shunt ultra-micrometer" referred to at the beginning of this article. This device is simpler than the heterodyne micrometer and is, furthermore, of a recording type. That is, measurements are made by reading an instrument visually—certainly a less fatiguing and less nervous procedure than that of matching beat notes. The description of the "zero-shunt ultra-micrometer" will be reserved for a future article.

The McCaa Static Eliminator

(Continued from page 2243)

that the signal is not heard. This may necessitate a slight change in the coupling of "P1" to obtain the desired balance. However, once "P1" is set, it will need no further attention.

Light the filament of the repeater tube. Tune the grid circuit with the condenser (Cg), at the same time tuning with the plate condenser (Cp). An adjustment of the potentiometer may be necessary, as well as a change of the filament rheostat. Be sure that the couplings between "D" and "A" and "S1" and "P3" are correct. You will note that the construction of coil "D" makes it possible for lines of force from it to act on the larger coil "A" without having "A" react to any great extent on "D." This feature is very important.

It is, of course, understood that this procedure is necessary only in setting up the anti-static device at the start. Once the proper coupling values have been found, the only variable will be "P3."

After the preliminary adjustments have been made, the desired signal will be heard. Different stations may be tuned in by a slight adjustment of the tuning condensers and either the potentiometer or the filament rheostat. The dial settings can be logged for future reference.

There are a number of refinements that can be made on the model shown in the

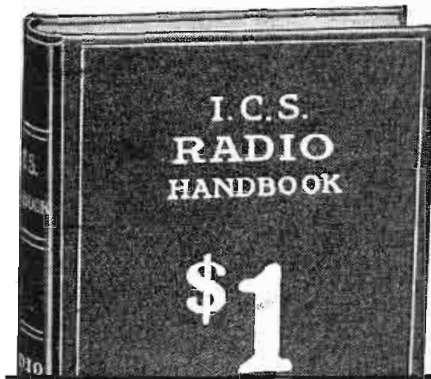

Do you understand Super-Regeneration?

This unique book shows the way to work out practical circuits 514 PAGES—100,000 SOLD—ONLY \$1

Compiled by HARRY F. DART, E.E. Formerly with the Western Electric Co., and U. S. Army Instructor of Radio Technically edited by F. H. DOANE

SUPER-REGENERATION! Do you know that big money will be made by the first one to design a practical Super-Regenerative set? This marvelous circuit can be made to do with two tubes as much as a six or eight tube super-heterodyne. But it's not yet commercialized. It's where the super-heterodyne was until recently. Why don't you find out how to make Super-Regeneration practical? See pages 377 to 383, I. C. S. Radio Handbook, for details of the circuit and how to attack its problems.

This I. C. S. Radio Handbook explains electricity, electrical terms and formulas, antennas, batteries, motors and generators, vacuum tubes, transmitting and receiving principles and practice, radio and audio frequency amplification, condensers, battery chargers, filters, codes, license rules. Many other features.

Just mail the coupon with a dollar bill and your name and address, and we will send you this 514-page I. C. S. Radio Handbook by return mail. Note the other good books listed below and the low prices.

INTERNATIONAL CORRESPONDENCE SCHOOLS

Box 8283-E, Scranton, Penna. I enclose \$....., for which send me, post-paid, the Handbooks marked X, at \$1 each. It is understood that if I am not entirely satisfied I may return them within five days and you will refund my money.

- RADIO HANDBOOK, 514 PAGES, \$1
- Automobile Handbook, 354 pages - - - \$1
- Electrical Handbook, 414 pages - - - \$1
- Chemistry Handbook, 348 pages - - - \$1
- Pharmacy Handbook, 324 pages - - - \$1
- Traffic Man's Handbook, 386 pages - - - \$1
- Building Trades Handbook, 409 pages - - - \$1
- Machine Shop Handbook, 335 pages - - - \$1
- Salesman's Handbook, 352 pages - - - \$1
- Advertising Handbook, 445 pages - - - \$1
- Bookkeeper's Handbook, 302 pages - - - \$1
- Civil Engineer's Handbook, 411 pages - - - \$1
- Steam Engineer's Handbook, 208 pages - - - \$1

Name..... Address.....

BAKELITE SOCKETS

aid clear reception. Write for Booklet 24



BAKELITE CORPORATION 247 Park Avenue, New York, N. Y. Chicago Office: 636 West 22nd St.

The EAGLET Neutrodyne

3 TUBES DRY CELL OPERATED \$75

Write for Literature



Insure your copy reaching you each month. Subscribe to RADIO NEWS — \$2.50 a year. Experimenter Publishing Co., 53 Park Pl., N. Y. C.

Some remarkable scenes of monstrous animals and wild mountainous country that were filmed in the studio lot.

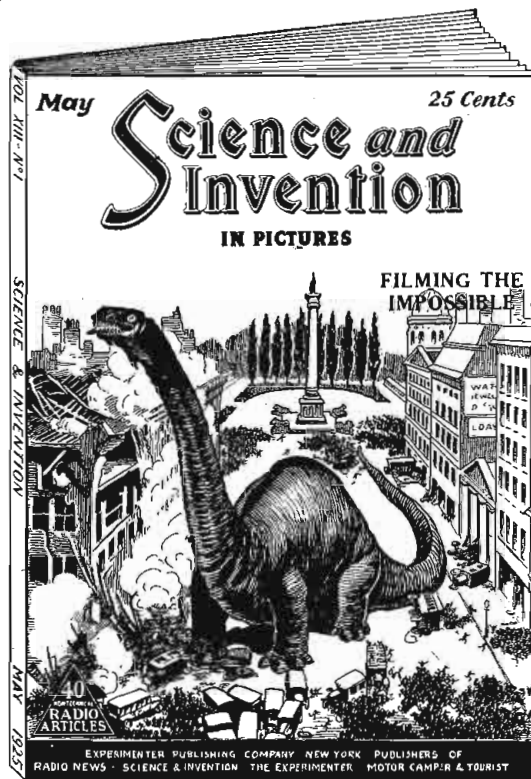

THE LOST WORLD

The May issue of *Science and Invention* presents a very complete and detailed explanation of some of the "mysteries" of the new film play entitled "The Lost World." This picture is full of surprises and is one of the best examples of trick photography in the modern cinema.

and interesting features of *Science and Invention* for May. Every page is filled with pictures, drawings and diagrams of the latest events that are transpiring throughout the world. Every page is worth reading.

ASK YOUR NEWSDEALER TO LET YOU SEE A COPY TODAY
SOLD ON ALL NEWSSTANDS

Published by

The Experimenter Pub. Co., Inc., 53 Park Pl., New York, N.Y.

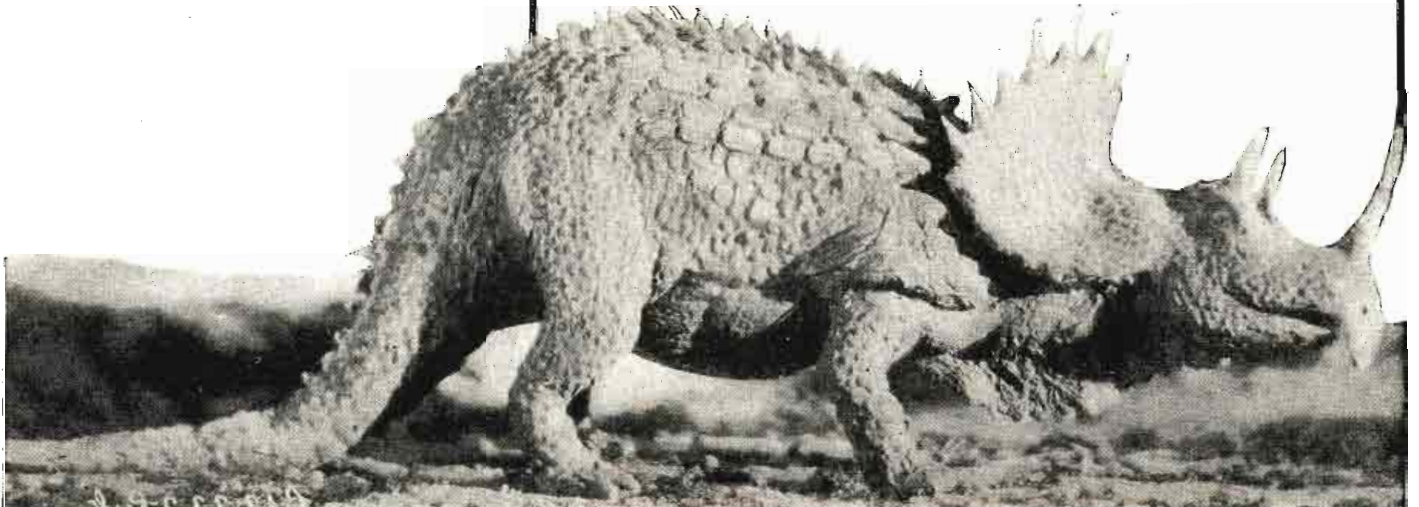



Genuine Bakelite Throughout

Note below how the contact slider and shaft are made in one piece. Permanently set at the factory, this insures perfect contact throughout the entire resistance range. The one hole makes DeJur the easiest rheostat to mount and when mounted, it sets fixed and rigid. No screws to get loose and no back panel fussing. Compare the DeJur. You will readily recognize its superiority.

At dealers everywhere
Write for Latest Catalog
Patents Appl'd for

DE JUR PRODUCTS Co.,
Lafayette & Broome Sts.
New York

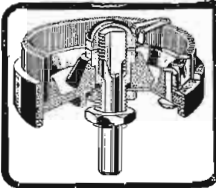

photographs, which will simplify operation. However, the main purpose of this article is to show how a successful McCaa anti-static device can be built and operated.

Dr. McCaa does not recommend that his static-preventor be used directly before a regenerative detector. In passing, it is interesting to note that the device does not affect the normal sensitivity of the receiver to which it is coupled. This can be proved to your own satisfaction by opening and closing the switch.

The anti-static device is not a cure-all for a poor receiver. Noises caused by poor connections and run-down batteries will not be reduced. Radio fans who have never been able to construct a receiver that would work properly are not advised to build the anti-static device.

The unit may be used with a number of different receivers, but care must be taken that there be no feed-back from the receiver into the device.

If the anti-static unit is constructed properly and shielded carefully, excellent results may be expected and secured from it.

The Life and Works of Lee DeForest

(Continued from page 2213)

vessels steamed out and the phones were put into operation. They not only worked the required ten miles, but kept up reliable communication at slightly more than twenty-one miles!

Commander Cleland Davis was the guiding spirit of the whole test and he was so pleased with the final results that he asked the DeForest Company to make the necessary arrangements to install their sets on all the battle ships, as well as on auxiliary craft of "Bob" Evans' fleet, which was shortly to start its justly famous trip around the world. The time allowed before the sailing of the vessels was not nearly sufficient for the assemblage of the various sets and their proper installation.

Following the only course he saw possible, DeForest with his staff began for the nth time a rush job. They sent out all the necessary orders for equipment, laid their plans and then started the work. They remained at the bench as long as possible, stopping only the smallest time possible to grab a hasty sandwich and then when they could work no longer, laid down on a convenient shop-bench or packing box to take a few hours' sleep.

Finally the sets were all arranged and packed for shipment to the auxiliary craft, which was anchored off Norfolk, Va. Then the work began in dead earnest. There was exactly forty-eight hours intervening between the arrival of the men and apparatus and the date of departure of the fleet. Needless to say, the men stayed at their tasks the whole time and did not leave the boats until they had completely finished the job. The last of the installers left the last cruiser just as she was clearing Hampton Roads. One of the crew stayed with the fleet until it reached Southern Equatorial waters. He was breaking in the Navy's operators.

This was in June, 1907. The first intelligible speech transmitted by radio was spoken across DeForest's laboratory on January 7 of the same year.

With the fleet sailing away, each of their bridges equipped with a DeForest radio phone, and each of their commanding officers in communication with all the other officers of the fleet through this little device, matters were again looking up for DeForest. The present might be dark, but there was always the light of his ambition and the undying confidence in himself, which he had proven were his two most valued allies.

He had established another mile-stone in wireless.

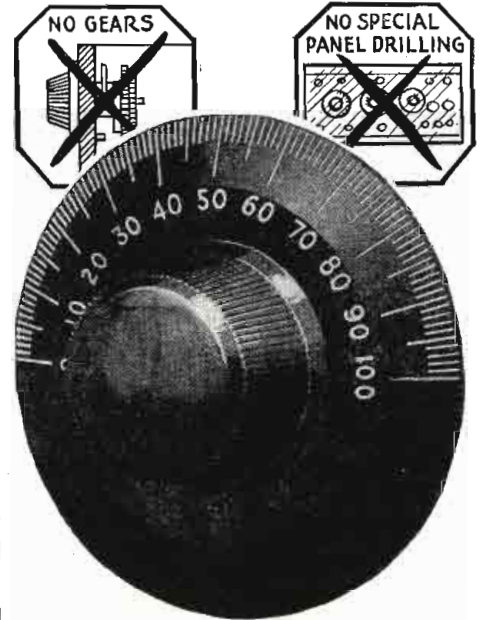

No Gears—No Special Drilling Yet finer tuning

The VISCO dial operates on an entirely new principle by which a most critical tuning movement is obtained without the use of back gearing of any kind.

This operating principle is known as the "viscous drag" which has the property of offering only a slight resistance to a slow movement of the dial but a steadily increasing resistance to a faster movement. Thus the ideal radio tuning dial is obtained.

The VISCO dial is made of extremely high grade Bakelite yet it costs only a little more than the ordinary dial.

To install the VISCO dial it is only necessary to remove the old dial and put on the new. No special extra drilling, no cutting of the shaft. Diameters of dial 3 1/4 inches, fits 3/4 inch shaft.

PRICE POSTPAID \$1.00

The Monosmith Brothers Company
Spencer, Ohio

VISCO DIAL
For Finer Tuning

PATENTS

If you have an invention and desire to secure a patent, send for our Evidence of Invention Blank and free guide book, "HOW TO GET YOUR PATENT." Tells our Terms, Methods, etc. Send model or sketch and description of your invention for INSPECTION and INSTRUCTIONS.

No Charge for the Above Information

RANDOLPH & CO., Dept. 459 Washington, D. C.

TUBES REPAIRED

Only middle west tube service station
8 hour service. No extra charge for broken glass.
WD-11, WD-12, C-11, C-12, UV-201, C-301, UV-201-A, C-301-A, UV-199, C-299, all styles DeForest, UV-200, C-309
\$1.75
Discounts in quantities of six or more. May be had in assorted styles. We pay the postage.
Write for bulletin of other products.
DEY'S RADIO SERVICE
Dept. 15, 5947 Superior St. Chicago, Ill.

Insure your copy reaching you each month. Subscribe to RADIO NEWS—\$2.50 a year. Experimenter Publishing Co., 53 Park Pl., N.Y.C.

DEALERS Stand By!
Each month BUSCHER at Kansas City broadcasts lower prices on Standard Nationally Advertised **RADIO Equipment**. You lose money if you fail to "tune in." Your name on our mailing list will pave the way for bigger profits. Write today.
C. A. BUSCHER CO.
1225 Locust St. Kansas City, Mo.

WRITE FOR OUR CATALOGUE RADIO PARTS-KITS-SETS
We Guarantee to Save You Money
The RADIO SHACK
55 Vesey Street, Dept. F 23
NEW YORK CITY

NEW RADIO TUBES
Meter Tested **\$2.00** Matched Guaranteed
ALL TYPES
Specify type when ordering. We ship Parcel Post C. O. D.
OHIO RADIO SALES
723-H Rose Bldg. CLEVELAND, OHIO

\$100 Per Week
easily made in your spare time selling one of the best and fastest selling radio sets on the market today—no experience necessary. No manufacturing; you sell a complete outfit. Send me a card and I will send you complete information.
AL REED, Salesmanager
88 West Broadway New York

MARVELOUS NEW AUDIO TRANSFORMER
adds a musical quality to any set far beyond anything you ever heard before. Karas Harmonik amplifies low, middle and high tones to the same big volume, eliminating distortion. Brings out vital harmonics and overtones of music. Price \$7.00.
Write Karas Electric Co., Dent. A-594, 4040 N. Rockwell St., Chicago.

Brandes
The name to know in Radio

OPPORTUNITY AD-LETS

Follow these advertisements every month. Reliable advertisers from all over the country offer their most attractive specials in these columns.

Classified advertising rate twenty-two cents a word for each insertion. Ten per cent discount for 6 issues, 20 per cent discount for 12 issues. Name and address must be included at the above rate. Cash should accompany all classified advertisements unless placed by an accredited advertising agency. No advertisement for less than 10 words accepted.

Objectionable or misleading advertisements not accepted. Advertisements for the August issue must reach us not later than June 1st.

CIRCULATION LARGER THAN THAT OF ANY OTHER RADIO PUBLICATION

EXPERIMENTER PUBLISHING CO., INC., 53 Park Place, New York, N. Y.

Agents Wanted

Agents Wanted in every city and town to sell standard radio apparatus. Attractive discounts given. If interested write us at once stating age and radio experience. Wilmington Electrical Specialty Co., Inc., 405 Delaware Ave., Wilmington, Delaware.

Agents—Write for Free Samples. Sell Madison "Better-Made" Shirts for large manufacturer direct to wearer. No capital or experience required. Many earn \$100 weekly and bonus. Madison Mfgs., 501 Broadway, New York.

Big Money and fast sales. Every owner buys gold initials for his auto. You charge \$1.50; make \$1.35. Ten orders daily easy. Write for particulars and free samples. American Monogram Co., Dept. 133, East Orange, N. J.

Guaranteed Genuine Gold Leaf Letters anyone can put on store windows. Large profits, enormous demand. Free samples. Metallic Letter Co., 422 N. Clark, Chicago.

Can You Sell? All-wool, union made, tailored-to-measure suits for \$19.75. Universal Tailors, 899 Bedford Street, Boston.

Agents—Signs for stores and offices. Entirely new, \$50 week easily made. World Signs, 1166 W. Washington, Chicago.

Big money and fast sales, every owner buys gold initials for his auto. You charge \$1.50 make \$1.44 profit. 10 orders daily easy. Samples and information free. World Monogram Co., Dept. 27, Newark, N. J.

Agents Wanted Full or Part Time to Sell on liberal commission new Thermostatic Automatic Carburetor control Attachment for Ford cars. Increases mileage 100%. No miles to drill. Attached in 2 minutes. Does automatically exactly what Ford Manual instructs driver to do by hand. Cadillac now using Thermostatic Carburetor Control under Blanche license. Write at once, A. C. Blanche & Co., Dept. 827H, 602 W. Lake St., Chicago.

Agents—250 per cent profit selling latest novelty sign. Storekeepers buy 1/2 to 2 Doz. Free sample. Nat. Curds Co., 124 H. W. 18th St., New York.

Want to Make Money? Easy selling new invention. Write quick for territory. Have own business. Konkle, 192 Market St., Newark, N. J.

Agents—Our new Household Cleaning Device washes and dries windows, sweeps, cleans walls, scrubs, mops. Costs less than brooms. Over half profit. Write Harper Brush Works, 160 3rd St., Fairfield, Iowa.

Cheapest Mop-Scrubber made. 100 per cent profit. Eastway Co., 465 St. Paul, Balto., Md.

Earn \$10 daily silvering mirrors, plating, refinishing metalware, headlights, chandeliers, bedsteads. Outfits furnished. Bolanger-Deeie Laboratories, 1133 Broadway, New York.

Agents—Write for "Your Opportunity." Men making \$100 weekly selling the famous Walton Duplex Shirts—two shirts for the price of one. No experience necessary. Rapid promotion. Walton Duplex Co., 707 Brooks Bldg., Chicago.

Easy Money Applying gold initials, monograms on automobiles. Anyone can do it. Simply transferred from paper; takes 5 minutes. Make \$1.50, cost 5c. Samples free. Talco, 325C Harrison, Boston, Mass.

Business Opportunities

Make \$100 Weekly in Spare Time. Sell what the public wants—long distance radio receiving sets. Two sales weekly pays \$100 profit. No big investment, no canvassing. Sharpe of Colorado made \$955 in one month. Representatives wanted at once. This plan is sweeping the country—write today before your county is gone. Ozarka, 813 Washington Blvd., Chicago.

Advertise, hundred magazines, three issues, 10c word. Pennell Company, Covington, Kentucky.

Free Booklet, How to Become Successful in Real Estate. Macdonald Cooperative Realty, San Diego, California.

Chemistry

Learn Chemistry at home. Dr. T. O'Connor Sloane, noted educator and scientific authority will teach you. Our home study correspondence course fits you to take a position as chemist. See our full page ad on page 2303 of this issue. Chemical Institute of New York, 66 W. Broadway, New York City.

Educational

Used Correspondence School courses save over half. Bargain catalogues 1000 courses free. Used courses bought. Students' Exchange, Dept. A, 47 West 43d St., New York.

Educational (Continued)

Correspondence Courses. All Schools. Lowest prices. Terms. Catalog free. Mention subject. Economy Educator Service, 440-F Sansone, San Francisco.

Esperanto

Esperanto. Easiest and most successful method for studying the Esperanto Language ever published. Booklet of sample pages illustrated by 145 illustrations sent on request. Benson School of Esperanto, Inc., 20 Mercer St., Newark, N. J.

For Advertisers

24 Words—355 Rural Weeklies \$14.20. Admeyer, 4112-R Hartford, St. Louis.

For Inventors

New Ideas Wanted. Well known Radio Manufacturer whose products are nationally advertised and sold everywhere wants new Radio device to sell. Will pay outright or royalty for idea or invention which is really new and saleable. Address: Mr. R. B. Devine, Room 1101, 116 West 32nd St., New York, N. Y.

For Sale

Typewriter—Cost \$100, will sell for \$35. Carnegie College, Rogers, Ohio.

For Sale—Why bother with dry cells? Build an everlasting "Hawley" storage "B" Battery of the nickel-iron type. No frying or hissing, clearer reception and greater volume. Put up in both knock-down units and assembled types. Requires no soldering or former experience to put together. Knock-down units contain all the parts to build the following sizes: 90 volts \$8.95; 100 volts \$9.95; 120 volts \$11.60; 135 volts \$12.75; 150 volts \$13.90; 200 volts \$17.50. Sold on a 2 year guarantee with 30 day trial offer with return of your money without any ifs or ands. Sample cell 35c prepaid. 3 page illustrated folder of instructions containing simple means of putting together, making charger and charging. Complete manufactured charger \$2.75. Order direct or write for my literature, guarantee and testimonials. Same day shipments. Address B. R. Smith, 31 Washington Ave., Danbury, Conn.

Health

Free—Stop using tobacco. We will give free information how to conquer habit easily and permanently. Results guaranteed. Anti-Tobacco League, Box M, Omaha, Neb.

Help Wanted

Detectives Needed Everywhere. Travel. Experience unnecessary. Write George Wagner, former Government Detective, 1968 Broadway, N. Y.

Earn \$25 weekly, spare time, writing for newspapers, magazines. Experience unnecessary. Copyright book free. Press Syndicate, 972, St. Louis, Mo.

Men to build radio sets in spare time. Leon Lambert, 595-H Kaufman Bldg., Wichita, Kansas.

Detectives needed everywhere; large salaries; free particulars; write National Headquarters, 188 East 79th, New York.

Home Study Courses

Correspondence Courses bought and sold. Hanfling, R-799 Broadway, New York.

Hotels and Resorts

White Mountains, Mt. Crescent House, Randolph Hill, New Hampshire. H. H. Boothman, Prop. Altitude 1800 feet. Booklet on request.

Insects Wanted

Why not spend Spring, Summer and Fall gathering butterflies, insects? I buy hundreds of kinds for collections. Some worth \$1 to \$7 each. Simple outdoor work with my instructions, pictures, price-list. Send 10 cents (not stamps) for my Illustrated Prospectus before sending butterflies. Mr. Snelair, Dealer in Insects, Box 1424, Dept. 40, San Diego, California.

Instruction

Learn Chemistry at Home. Dr. T. O'Connor Sloane, noted educator and scientific authority, will teach you. Our home study correspondence course fits you to take a position as chemist. See our full page ad on page 2303 of this issue. Chemical Institute of New York, 66 W. Broadway, New York City.

Learn code in one hour. Method new \$1.50 postpaid. H. Anderson, Box 593, Great Falls, Mont.

Miscellaneous

Beautiful registered bull pups cheap. Bulldogs, 501 Rockwood, Dallas, Texas.

Free Katalog Klan Jewelry. Sample Kluxer pocketpiece with big moneymaking plan 10c. Morris, Box 1174-RN, Omaha, Nebr.

For Your Ford—Automatic Re-Atomizer prevents foul plugs, carbon formation reduced. More mileage, saves gas and oil. Puts new life in your car. Sent prepaid only \$1.00. Specialty Mfg. Co., Hatfield, Mass.

Motorcycles, Bicycles

Don't Buy a Bicycle Motor Attachment until you get our catalog and prices. Shaw Mfg. Co., Dept. 6, Galesburg, Kansas.

Old Coins

United States 3c Nickel and bargain Price List 10c. M. Arey, Box 483, Muskogee, Oklahoma.

Old Money Wanted

\$2 to \$500 each paid for hundreds of Old or Odd Coins. Keep all old money, it may be very valuable. Send 10c for New Illustrated Coin Value Book, 4x6. Guaranteed prices. Get posted. We pay Cash. Clarke Coin Company, 14 Street, LeRoy, N. Y.

Patent Attorneys

Inventors—Should write for our Free Guide Books and "Record of Invention Blank" before disclosing inventions. Send model or sketch of your invention for our Free Inspection and Instructions. Radio, Electrical, Chemical, Mechanical and Trademark experts. Terms reasonable. Victor J. Evans & Co., 922 Ninth, Washington, D. C.

Patents. Send drawing or model for examination and report as to patentability. Advice and booklet free. Highest references. Best results. Promptness assured. Watson E. Coleman, Patent Lawyer, 644 G Street, N. W., Washington, D. C.

Patents—Send for form "Evidence of Conception" to be signed and witnessed. Form, fee schedule, information free. Lauerster and Allwine, Registered Patent Attorneys in United States and Canada, 260 Ouray Bldg., Washington, D. C.

Patents for Inventions. Long experience, highest grade work, rates reasonable, best references. Advice as to patentability. Wm. Astley Kellys, 41 Park Row, New York.

Patent-Sense—As one of the oldest patent firms in America we give inventors, at lowest consistent charge, a service noted for results, evidenced by many well-known Patents of extraordinary value. Book, Patent-Sense, free. Lacey & Lacey, 631 F St., Washington, D. C. Estab. 1869.

Patents

Inventions Commercialized. Patented or unpatented. Write Adam Fisher Mfg. Co., 278 Enright, St. Louis, Mo.

Unpatented Ideas Can Be Sold. I tell you how and help you make the sale. Free particulars (Copyrighted). Write W. T. Greene, 804 Jenifer Building, Washington, D. C.

Personal

Lonely Hearts—Exchange letters; make interesting new friends in our jolly club. Eva Moore, Box 908, Jacksonville, Florida. Enclose stamp.

Lonely—Join Our Club. Make friends everywhere. Particulars free. Write Mrs. Matthews, Box 26, Oakland, Calif.

Exchange Cheery Letters with new friends. Write Betty Lee, Inc., Box 820 City Hall Station, New York City. Stamp appreciated.

Personal (Continued)

Baldness Cured. Falling Hair stopped. New Hair promoted pronto. Recent Formula \$3.00. The Formulary, Denver, Colorado.

Lonesome—Join our club—make acquaintances everywhere. Big illustrated book with descriptions and photos, sent in plain wrapper for ten cents. Bonafide Co., Dept. 58, Kansas City, Mo.

Printing

We print Stationery, Booklets, Catalogs, Circulars, Samples. Commercial Press, Batavia, Ohio.

Printing Outfits and Supplies

Print your own cards, stationery, circulars, paper, etc. Complete outfits \$8.85; Job Presses \$12, \$25; Rotary \$150. Print for others, big profit. All easy, rules sent. Write for catalog presses, type, paper, etc. Press Company, A-13, Meriden, Conn.

Radio

Boys! Don't Overlook This. The "Rasco" Baby Detector. Greatest detector ever brought out with molded base. Fully adjustable. See former advertisements in this publication, or our catalog. Detector with Calena Crystal, complete 50c, the same detector with Radiocite Crystal, 75c prepaid. Send for yours today. Radio Specialty Company, 96-98 Park Place, New York City.

Ivory Radio Panel: Grained white "Ivorylite" makes most beautiful set of all. Guaranteed satisfactory. Any size 3-16" thick sent prepaid 3c per square inch. Sample free. E. P. Halton, Dept. N, 614 Main St., Fort Worth, Texas.

Attention!—50 Vacuum tube hook-ups. The greatest collection of vacuum tube circuits ever brought under two covers at such insignificant cost. These diagrams will be found in the great "Rasco" catalog, which contains raw materials and parts in a greater profusion than any other catalog. 15c in stamps, or coin, will bring the catalog to you. Radio Specialty Co., 96-98 Park Place, New York City.

Free Tested Crystals—Send no money, just two cent stamp for postage. Pitts Novelty Sales, 561 W. Washington St., Chicago.

Edison Elements 5c per pair. Co-operative Merchandise Co., Chelsea, Mass.

2650 Miles Distance with one tube. Any Native understands our simplified instructions. Big free booklet tells the story. Vesco Radio Co., Box 1177N, Oakland, Calif.

Build Radio Sets for friends, spare time. Very profitable. We'll supply apparatus and expert advice. Write us. The Langbein-Kaufman Radio Co. (Dept. W), 511 Chapel St., New Haven, Conn.

Super Radio Ore direct from own mine, in bulk or cut crystals. Special cold mountings. Samples Free. Chapman Radio Co., Phelan Bldg., San Francisco, Calif.

If Your Neut's Gone Back on you—Rebuild it to this Kladag Neut to Coast Circuit, using same old panel, almost same parts but no Nightmare of Neutralization. Twenty-two feet of gold sheathed wire, with only extra part and simple, complete instructions—\$5.00, prepaid anywhere. Nothing more to buy. Over a thousand "converted" Neuts are daily bringing in clean, resonant volume from Coast to Coast. Details 10c. 48 page meaty catalog of Parts Only—10c. Kladag Radio Laboratories, Kent, Ohio.

Tested Radio Galena, 50c pound bulk. Buskett, Joplin, Mo.

Experimental Electricity Course in 20 lessons. By S. Gernsback and H. W. Secor, E.E. A course of the theory and practice of Electricity for the Experimentor. Every phase of experimental electricity is treated comprehensively in plain English. New experiments are described and explained and nearly every application of Electricity in modern life is given. 160 pages—100 illustrations. Flexible cloth cover, 75c. postpaid. Stiff cloth cover, \$1.25, postpaid. Experimenter Publishing Co., Book Dept., 53 Park Place, New York City.

The How and Why of Radio Apparatus, by H. W. Secor, E.E. This newest book on radio matters fulfills a distinct gap in wireless literature in that, while the treatment is made as understandable and as free from mathematics as possible, it at the same time incorporates a wealth of technique and instruction for the Radio Amateur—the Radio Operator—the Installation and Designing Expert—as well as teachers and students of the subject in general. A very broad field has been covered by the author, at the same time giving a great deal of information not found in other text books. If you are engaged in any branch of the Radio or allied arts at all you will surely need this latest contribution to radio literature, which is destined to be found on every radio man's book shelf before long. A glance at the following list of chapters gives but a very scant idea of the extensive and useful radio knowledge provided in its text: The Induction Coil; The Alternating Current Transformer; Radio Transmitting Condensers; The Spark Gaps; Radio-Transmitting Inductances; Radio Receiving Tuners; Radio Receiving Condensers; Detectors; Telephone Receivers; Radio Amplifiers; Construction of a Direct Reading Wavemeter and Decimeter; Antenna Construction; The Calculation and Measurement of Inductances; Appendix containing very useful tables, covering all subjects treated in this very unusual book. This newest of Radio Works, cloth bound in vellum 4s Luxe, Gold Stamped and Hand Sewed, has 160 pages. Size of book 8x9 inches. The How and Why of Radio Apparatus. Postpaid, \$1.75. Experimenter Publishing Co., Book Dept., 53 Park Place, New York City.

Boys—Big Money Every Month!

WE WANT LIVE BOYS IN EVERY TOWN TO ACT AS SALES AGENTS FOR RADIO NEWS, SCIENCE AND INVENTION, THE EXPERIMENTER, AND MOTOR CAMPER & TOURIST. GENEROUS PAY—EASY WORK. WRITE TODAY! M. BRIDWELL, EXPERIMENTER PUBLISHING COMPANY, 53 PARK PLACE, NEW YORK CITY.

Radio (Continued)

BOYS WANTED!

EARN REGULAR MONEY. SEND US YOUR NAME AND ADDRESS AND WE WILL SHOW YOU HOW TO EARN GENEROUS PROFITS AND PRIMUMS AS SALESMAN FOR RADIO NEWS, SCIENCE & INVENTION, THE EXPERIMENTER, AND MOTOR CAMPER & TOURIST. WRITE TODAY! M. BRIDWELL, EXPERIMENTER PUBLISHING COMPANY, 53 PARK PLACE, NEW YORK, N. Y.

Salesmen Wanted

A Salesman wanted in every town or city within 25 miles of a broadcasting station to sell Radiogen, the complete radio receiving set that retails for \$2.50. With Radiogen there is nothing else to buy—the outfit includes the Radiogen receiving apparatus, 1,000 ohm phone, and aerial outfit. The cheapest radio outfit on the market—yet as practical as the most expensive. Big money to the right men. Send \$2.00 for sample outfit. The Radiogen Corp., 65-11 West Broadway, New York City.

Lightning Strange battery compound. Charges discharged batteries instantly. Eliminates old method entirely. Gallon free to agents. Lightning Co., St. Paul, Minn.

Scenery to Rent

Settings for Opera, Plays, Minstrels. Plush Drops. Address Amelia Grain, Philadelphia.

Song Writers

Songwriters: Let me furnish the music for your songs, guaranteeing you absolute satisfaction. Copyrights secured. Submit your scripts for estimate and free advice. Walter W. Newcomer, 1671 Broadway, New York.

Telegraphy

Telegraphy—Both Morse and Wireless taught thoroughly. Big salaries. Wonderful opportunities. Expenses low; chance to earn part. School established fifty years. Catalog free. Dodge's Institute, Cour St., Valparaiso, Ind.

Wanted to Buy

Full Value Paid for Old Gold, Jewelry, Watches, Diamonds, crowns, bridges, dental gold, silver, platinum, gold or silver ore; magnets points, old false teeth. Packages returned if our offer is not satisfactory. United States Smelting Works (The Old Reliable) 120 So. State St., Dept. 10, Chicago, Ill.

Circuit patents on radio. Manufacturer has factory facilities and will make very satisfactory arrangement with right party. Box 236, RADIO NEWS.

For Rent

For Rent—Store or Department. 100% Richmond, Virginia, 100%. For a live radio firm will rent a department or store. Each situated in the heart of the best retail shopping center, surrounded by our leading department stores and women's specialty shops and chain stores. Long lease, reasonable rent. Immediate possession. On one of the heaviest traffic bearing blocks in the city. For full particulars write. Gordon E. Strause, Broad at Seventh, Richmond, Virginia.

Super-Heterodyne Introductory Offer \$1.00

Send for this wonderful book including simplified wiring diagrams, panel templates, layouts and hook-up prints. Regular price \$2.50. A few copies only at \$1.00. Sent post paid.

Baldwin Pacific & Company
434 Pacific Building
San Francisco, California

3 Brings you a Genuine UNDERWOOD TYPEWRITER

10 DAYS FREE TRIAL Your \$3.00 unconditionally returned if at end of 10 days you are not satisfied with this late model UNDERWOOD typewriter rebuilt by the famous Shipman Ward process.
GREAT PRICE SAVING Direct to you from the largest typewriter factory in the world by our money saving methods.
EASY MONTHLY PAYMENTS So small that you will not notice it while you enjoy the use of this wonderful machine.
FREE BOOK OF FACTS Explaining Shipman Ward's wonderful system of rebuilding typewriters and also valuable information about the typewriter industry both instructive and entertaining.



Act Today! Mail Coupon 5 Year Guarantee
Shipman Ward Mfg. Company
4195 Shipman Building
Montrose & Ravenswood Aves., Chicago
Name.....
St. and No.....
City..... State.....

Insure your copy reaching you each month. Subscribe to RADIO NEWS—\$2.50 a year. Experimenter Publishing Co., 53 Park Pl., N.Y.C.

BILTMORE Master Reflex Receivers

5 TUBE

Reduced to \$100.00

(WERE \$125.00)

DEALERS: Ask us about our plan which will enable you to make summer profits equal your best winter profits!

The Biltmore Radio Company

Dept. N :: :: Boston 30, Mass.

The Allen-Bradley Line of Perfect Radio Devices

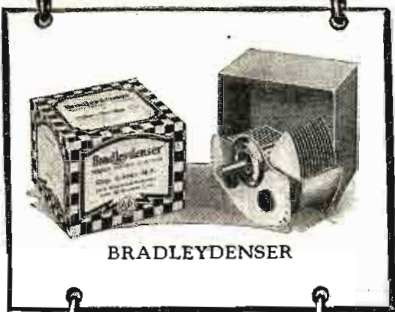

BRADLEYDENSER



BRADLEYSTAT



BRADLEYLEAK



BRADLEYOHM



BRADLEYOMETER

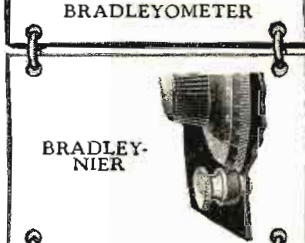

BRADLEY-NIER



BRADLEYSWITCH

A distinctive series of radio units for set builders who seek superlative results

EVERY amateur yearns for perfection in his radio receiver. Better quality, greater volume, and closer selectivity are the requirements of discriminating radio enthusiasts, and the circuits which meet these requirements are inevitable favorites.

The experienced set builder has learned the value of fine radio parts, and he knows the important part they play in getting maximum results from a selective circuit. Hence, it is not strange that the Allen-Bradley line has gained increasing popularity with the introduction of the super-selective hook-ups. In fact, for stepless, noiseless, perfect control, Allen-Bradley Radio Devices have no peers. Your set will be a better set if you use them. Let us send you an illustrated folder about the Allen-Bradley line.

Allen-Bradley Co.

Electric Controlling Apparatus
287 Greenfield Ave., Milwaukee, Wis.



Manufacturers of graphite disc rheostats for over twenty years

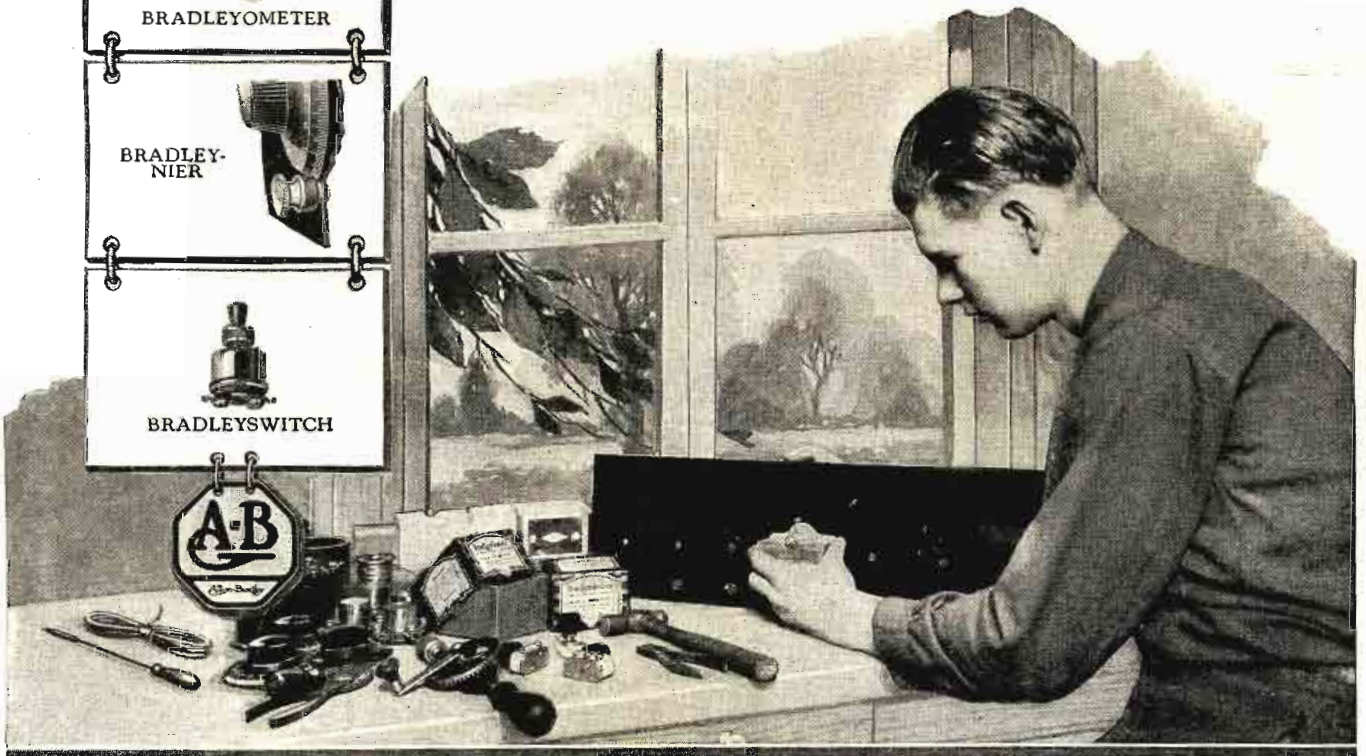

Build your Own Tropadyne!

Cockaday!

Neutrodyne!

Harkness!

Ultradyne!

Super-Heterodyne!

Autoplex!

USE THIS BLANK TO ORDER

Just clip out this coupon, check the patterns or books you want and mail it to us with full remittance.

The Consrad Co., Inc.,
233 Fulton St., New York, N. Y.

Gentlemen: I have checked below the patterns and books I desire. Enclosed find \$....., the full price. Kindly send me the items checked postpaid.

Consrad Patterns—50c each

-No. 2. How to Make a Two-Stage Amplifier.
-No. 4. How to Make a Reinartz Receiver.
-No. 5. How to Make a Reflex Receiver.
-No. 6. How to Make a Cockaday Receiver.
-No. 7. How to Make a Neutrodyne Receiver.
-No. 8. How to Make the Autoplex Receiver.
-No. 9. How to Make the S. T. 100 Receiver.
-No. 10. How to Make the Ultradyne Receiver.
-No. 11. How to Make a Five Tube Cockaday Receiver.
-No. 12. How to Make a Portable Receiver.
-No. 13. How to Make a Harkness Receiver.
-No. 14. How to Make The Original Genuine Super-Heterodyne. List \$1.00.
-No. 15. How to Make a Low Loss Receiver.
-No. 16. How to Make a Tropadyne Superadio.
-A. Radio Map of the U. S. on Cloth.
-B. 20 Radio Diagrams and Hook-ups. New Edition.
-C. All About Aerials and Their Construction.
-D. Radio Amateurs Practical Design Data.

Radio Books—25c each

-No. 1. Tips for the Radio Constructor.
-No. 2. How to Make Practical Radio Receivers.
-No. 3. Radio Questions Answered.
-No. 4. Radio Frequency Amplification.
-No. 5. Loud Talkers and How to Build Them.
-No. 6. How to Tune Your Radio Set.
-No. 7. One Hundred Radio Hook-ups. New Edition.
-No. 8. All About Radio Parts.
-No. 9. History and Operations of Vacuum Tubes.
-No. 10. The Neutrodyne and All About It.
-No. 11. How Radio is Received.
-No. 12. How to Locate Troubles in Your Radio Set.
-No. 13. Reflex Radio Receivers.
-No. 14. The Super-Heterodyne Theory and Construction.

Special Books

-Radio News Amateurs Handibook.....\$1.00
-Radio Log Book50
-Wireless Course in 20 Lessons.—Leather Binding 2.00
-The Radio Instructor 1.00
-The Radio Listeners Guide & Call Book..... .35
-The Radio Review, 12 issues \$3.50; single copy .35

Name

Address

City State

Low-Loss
Reflex!
S.T.
100
Portable!

Consrad
Books
and
Patterns
Are
Sold at
All News-
stands
and Radio
Stores

You have all the fun at half the cost and a pattern that's as easy to follow as a ladies' dress pattern

Everything Is Measured and Drawn Full Size

The CONSRAD COMPANY, Inc.
233 Fulton Street New York, N. Y.

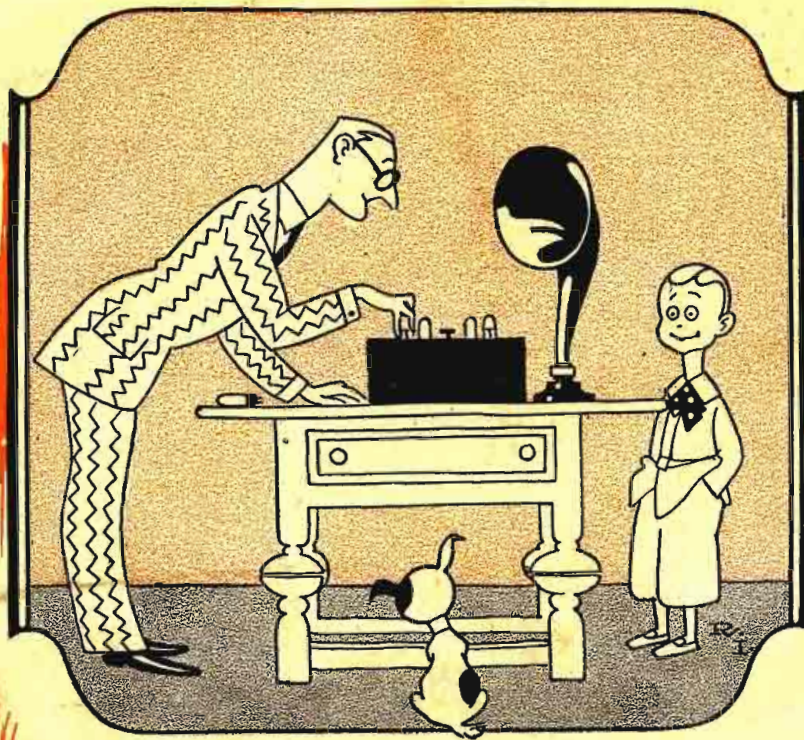

Put in the best!

To get the best out of a set—put the best into it. In some parts of the circuit, quality is more important than in others. It is *most* important in the tubes. They should be genuine RADIOTRONS.

The volume—the clearness—the quietness and the economy of operation—these depend on many things—but first of all upon the Radiotrons.

No matter what the job of the tube in the set, there's a Radiotron to fit it. You will always find it makes a difference if you demand a Radiotron—ask for it by name—and look on the tube for the word Radiotron and the RCA mark.

\$3

WD-11
WD-12
UV-199
UV-200
UV-201-a

Radiotrons with these model numbers are only genuine when they bear the name Radiotron and the RCA mark.

Radio Corporation of America
Sales Offices: Suite No. 26

233 Broadway, New York 10 So. La Salle St., Chicago, Ill.
28 Geary St., San Francisco, Cal.

Radiotron

REG. U.S. PAT. OFF.

PRODUCED ONLY BY RCA

