

OVER 253,000 COPIES OF THIS ISSUE PRINTED AND DISTRIBUTED

RADIO NEWS

REG. U.S. PAT. OFF.

25 Cents
February

1924

Over 200 Illustrations

Edited by H. GERNSBACK



THE 100% WIRELESS MAGAZINE

CIRCULATION LARGER THAN ANY OTHER RADIO PUBLICATION



**CUNNINGHAM
RADIO TUBES**

C-301A—5 Volts 1-4
Ampere filament. \$6.50
C-290—3 Volts .06 amp.
Dry Battery Det. &
Amp. \$6.50
C-300—5 Volts Gas Con-
tent Detector. . . . \$5.00
C-11—1.1 Volts .25 amp.
Dry Battery Det. and
Amp. Special Base \$6.50
C-12—Similar to C-11
with standard base
..... \$6.50

**PATENT
NOTICE**

Cunningham tubes are covered by patents dated 11-7-05, 1-15-07, 2-18-08, and others issued and pending. Licensed for amateur, experimental and entertainment use in radio communication. Any other use will be an infringement.

Type C-301A gives greater Power Amplification with only 1/4 Amp. Filament Current.

Cunningham

RADIO TUBES
For Every Make of Receiving Set

THROUGHOUT the entire country today Cunningham Radio Tubes are recognized as the ideal tube for use in all makes of Radio Receiving Sets.

The famous Cunningham C-301A Amplifier shown above is a high vacuum tube designed for use as an amplifier and detector containing a new Tungsten Filament, the characteristics of which are long life, low power consumption, low operating temperature and greater power amplification than any previous amplifier tube. This tube has a standard four prong base, and the glass bulb has the same dimensions as

C-300 and C-301. The filament current is only one-fourth of the filament current of the previous type of Amplifier tube and it is, therefore, possible to use four of these tubes in a set without exhausting the storage battery any faster than when using only one of the previous types of tubes.

The care and operation of each model of Receiving Tube is fully explained in our new 40 page "Radio Tube Data Book." Copies may be obtained by sending ten cents in stamps to our San Francisco office.

A. J. Cunningham Inc.



Home Office:
182 Second Street
San Francisco

154 West Lake Street
Chicago

30 Church Street
New York



THE AMERICAN RADIO RELAY LEAGUE
 HARTFORD, CONN. RADIO STATION _____
RADIOGRAM
 FROM: _____ TO: _____
 DATE: _____ TIME: _____
 AS THIS MESSAGE IS SENT COMPLETELY WITHOUT THE USE OF ANY
 TELEVISION OR RADIO EQUIPMENT OF THE UNITED STATES, IT IS
 TRANSMITTED THROUGH THE AIR AND IS NOT SUBJECT TO THE
 REGULATIONS OF THE FEDERAL GOVERNMENT.

ZENITH

Licensed under
 Armstrong
 U. S. Patent
 No. 1,113,149

AT THE NORTH POLE



Model 4R—The new Zenith 4R "Long-Distance" Receiver-Amplifier comprises a complete three-circuit regenerative receiver of the feed-back type. It employs the Zenith regenerative circuit in combination with an *audion detector* and *three-stage* audio-frequency amplifier, all in one cabinet.

Because of the unique Zenith "selector," unusual selectivity is accomplished without complication of adjustment.

The Zenith 4R may be connected directly to any loud-speaker *without* the use of other amplification for full phonograph volume, and reception may be satisfactorily accomplished over distances **\$85** of more than 2,000 miles



Model 3R—The new Zenith 3R "Long-Distance" Receiver-Amplifier combines a specially designed distortionless three-stage amplifier with the super-efficient Zenith three-circuit regenerative tuner.

Fine vernier adjustments—in connection with the unique Zenith aperiodic or non-resonant "selector" primary circuit—make possible extreme selectivity.

2,000 to 3,000 Miles with Any Loud-Speaker

The new Zenith 3R has broken all records, even those set by its famous predecessors of the Zenith line. Satisfactory reception over distances of 2,000 to 3,000 miles, and over, is readily accomplished in full volume, using any *ordinary loud-speaker*. No special skill is required.

The Zenith is the only set built which is capable of being used with all present-day tubes as well as with any tubes that may be brought out in the future. The Model 3R is compact, graceful in line, and built in a highly finished mahogany cabinet **\$160**

Inside the Arctic Circle, nine degrees from the North Pole, a little 89-foot schooner is frozen fast in the ice of Smith Sound. Aboard this schooner a group of brave men are enduring, as best they can, the desperate cold of the Arctic—cold that often drops to 60 degrees below zero. Human atoms in a boundless field of ice!

Cold is hard to endure, but far more terrible is the Arctic solitude—unbelievably oppressive. Radio, at length, has broken this spell forever!

Concerts from Honolulu!

Daily, by means of powerful sending and receiving apparatus, the crew of the "Bowdoin" are in communication with relatives and friends in the far-off States. Daily they listen to concerts as far away as Chicago, Dallas, and Honolulu!

When the sanity, the very lives of one's shipmates may depend upon contact with the outside world, none but the *best* is good enough.

Dr. MacMillan's Choice—the Zenith

Out of all the radio sets on the market, Dr. MacMillan selected the Zenith exclusively—because of its flawless construction, its unusual selectivity, its dependability and its tremendous *reach*.

Already his operator, on board the "Bowdoin" in *Northern Greenland*, has tuned in several hundred stations. You along the Atlantic who brag a little when you tune in Catalina Island—what would you say if you tuned in *Hawaii from the Arctic Circle*?

The set that Dr. MacMillan has is a standard Zenith receiving set. And you can do all that MacMillan does, and more, with either of the two new models shown at the right. Their moderate price brings them easily within your reach. Write today for full particulars.

**Zenith
 Radio Corporation**
 McCormick Building
 CHICAGO

ZENITH RADIO CORPORATION,
 328 South Michigan Avenue, Chicago, Illinois

Gentlemen:—
 Please send me illustrated literature on Zenith Radio.

Name _____
 Address _____

RADIO NEWS

Published by EXPERIMENTER PUBLISHING COMPANY, INC.
 Publishers of "Radio News," "Science and Invention" and "Practical Electrician."
 Publication Office: Jamaica, N. Y. Editorial and General Offices: 53 Park Place, N. Y. City
 H. GERNSBACK, President S. GERNSBACK, Treasurer R. W. DEMOTT, Secretary

MEMBER: AUDIT BUREAU OF CIRCULATIONS

VOL. 5 CONTENTS FOR FEBRUARY NO. 8 1924

	Page		Page
Editorial By H. Gernsback	1047	The Radio News Laboratories	1072
The First European Radio-Telephone Service, By Dr. Alfred Gradewitz	1048	Announcement of Standard Frequency Trans- mission	1073
Popular Radio Coming in Austria, By Armstrong Perry	1049	Radio Reception in the Grand Canyon, By S. R. Winters	1074
The Star Antenna of Eilvese, By Dr. Albert Neuburger	1050	With the Amateurs	1076
Getting the Right Radio Wave, By John V. L. Hogan	1051	Calls Heard	1077
Engineering Trans-Atlantic Radio Telephony	1052	Remote Control of a High Power Radio Station, By Charles Speaker	1078
Results of Our \$300 Radio Music Contest	1055	Transient Phenomena in Audio Frequency Transformers By Allen D. Cardwell	1079
A New Invention for Selective Reception, By John Scott-Taggart	1056	The Theory, Construction and Use of an Induct- ance Capacity Bridge By Palmer H. Craig	1080
The Ultradyne Receiver By Robert E. Lacault	1058	The Balanced Feed-Back Power Amplifier, By Clyde J. Fitch	1082
Radio Novelties	1061	Summarizing the Autoplex, By M. L. Muhleman	1083
Radio Events in Pictures	1062	A Quick Shift Oscillation Transformer, By P. N. Maynard	1084
Seek Cause for Fading of Radio Signals	1064	Use of Headphones and Loud Speakers, By Louis Frank	1085
Planting the Radio Compass Atop the World, By S. R. Winters	1065	C. W. and Radiophone Transmitters, Part V By I. R. Felder	1086
Melting Metal Without Fire in a Radio Furn- ace By S. R. Winters	1066	Correspondence from Readers	1087
Navy Ship Sends and Receives Simultaneously	1067	Radio News Laboratories	1088
The London Radio Show	1068	Radio Trade Notes By L. A. Nixon	1089
Radio Enters Building Specifications	1068	Awards of the \$50 Radio Wrinkle Contest	1090
Radio Broadcasting Proving Great Aid to Music Industry By Edward T. Jones	1069	New Radio Patents	1092
The Warning By S. P. Wright	1070	I Want to Know	1093
Radioizing the Country School, By Hal G. Borland	1071		
		Index to Advertisers	1032

General Advertising Dept., 53 Park Place, New York City. Western Advertising Representatives, Fineman & McClure, 720 Cass Street, Chicago, Ill. Kansas City Representative, Geo. F. Dillon, Republic Bldg., Kansas City Mo. Pacific Coast Advertising Representatives, A. J. Norris Hill Co., Hearst Bldg., San Francisco, Cal.

RADIO NEWS is published on the 10th of each preceding month. There are 12 numbers per year. Subscription price is \$2.50 a year in U. S. and Possessions, Canada and foreign countries, \$3.00 a year. U. S. coin as well as U. S. Stamps accepted (no foreign coins or stamps). Single copies, 25 cents each. A sample copy will be sent gratis on request. Checks and money orders should be drawn to order of EXPERIMENTER PUBLISHING CO., INC.

All communications and contributions to this journal should be addressed to Editor, RADIO NEWS, 53 Park Place, New York, N. Y. Unaccepted contributions cannot be returned unless full postage has been included. All accepted contributions are paid for on publication. A special rate is paid for novel experiments; good photographs accompanying them are highly desirable.

RADIO NEWS, Monthly. Entered as second-class matter at the Post Office, at Jamaica, N. Y., under the act of March 3, 1879. Title registered U. S. Patent Office. Copyright, 1923, by E. P. Co., Inc., New York. The Experimenter Publishing Co., 53 Park Place, N. Y. The contents of this magazine are copyrighted and must not be reproduced without giving full credit to the publication. Copyright in Germany. Publication and reproduction of articles in Germany is reserved for Radio, Berlin 42, Germany.

RADIO NEWS is for sale at all newsstands in the United States and Canada; also at The International News Co., Ltd., Bream's Building, London E. C. 4, England and at Brentano's 37 Avenue de l'Opera, Paris.

HOW TO SUBSCRIBE FOR RADIO NEWS. Send your name address and remittance to Experimenter Publishing Co., 53 Park Place, New York. Mention the name of the magazine you are ordering. We also publish SCIENCE AND INVENTION and PRACTICAL ELECTRICIAN. Write early.

RATES AND TERMS. The subscription rate for RADIO NEWS is \$2.50 per year, (12 numbers). When remitting do so by check, money order, or registered letter if cash is enclosed. Avoid sending cash through the mail if possible. Subscriptions for less than one year are not accepted. Subscription may be made in combination with SCIENCE AND INVENTION or PRACTICAL ELECTRICIAN with considerable saving.

POSTAGE. We prepay postage in all parts of the United States, Mexico and island possessions. For foreign or Canadian subscriptions we require 50 cents in addition to the subscription price for additional postage charges.

CHANGE OF ADDRESS. Notify us as far in advance as possible. It requires several weeks to make an address change on our records. Always write clearly, giving your old address as well as your new.

ON EXPIRATION of your subscription we enclose a renewal blank in our last number to you; we stop our delivery to you on expiration.



"The coming of a friend from a far-off land - is this not true joy?" Confucius -

Your friends of radio come to you each night through
The **GREBE**

Broadcast
Receiver.

Doctor M.

THE GREBE CR-12 Broadcast Receiver is a highly efficient Radio Instrument employing both Regeneration and Tuned Radio Frequency Amplification with only two tuning adjustments.

A Dial graduated in wavelengths enables you to locate the program you desire instantly.

Compartments are provided for all necessary batteries in the attractively finished walnut cabinet.

Requiring no cumbersome storage battery nor unsightly wires, this Instrument will grace your library or living room.

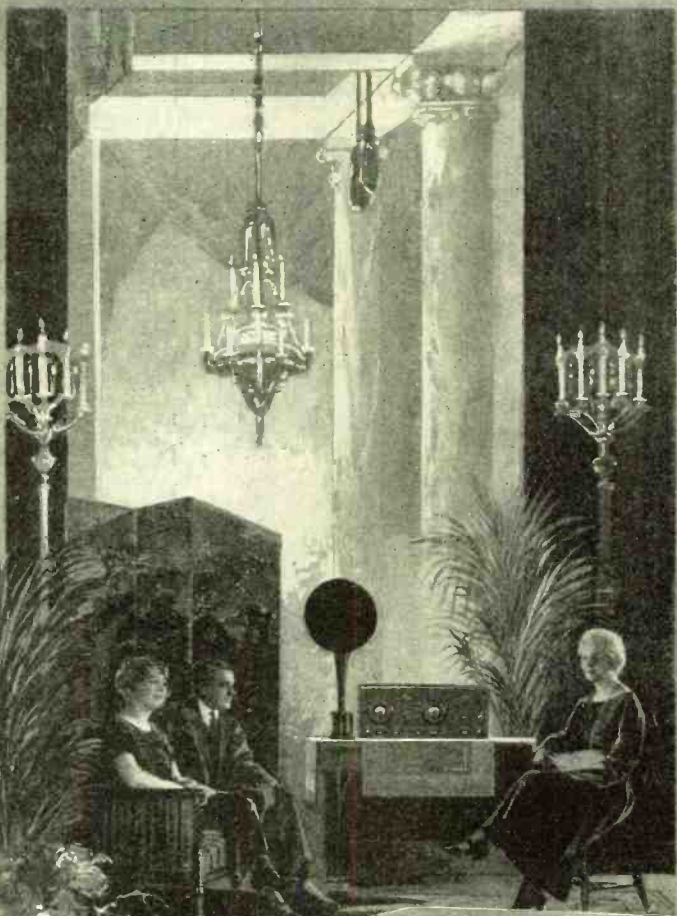

Write for "GREBE Radio in the Well-appointed Home"



A. H. GREBE & COMPANY, Inc.
Richmond Hill, N.Y.

Western Branch, 451 East 3rd St., Los Angeles, Cal.

Licensed Under
Act of Congress U. S.
Pat. No. 1,113,149



Type CR-12

Index to Advertisers

Name	A	Page
Ackerman Brothers Company, Inc.		1150
Acme Apparatus Company		1097
Adams-Morgan Company		1121
Actina Variable Condenser Company		1156
Aitken Radio Company		1174
Allen Mfg. Company		1167
Allen-Bradley Company	1046	1204
Alter & Company, Harry		1185
American Art Mache Company		1166
American Hard Rubber Company		1159
American Radio Mfg. Company		1122
American Specialty Company, The		1142
American Transformer Company		1130
Amsterdam Service Exchange		1112
Andrae & Sons Company, Julius		1154
Andrea Inc., F. A. D.		1109
Anthony, Earle C.		1170
Atlantic & Pacific Radio Co.		1195
Atwater Kent Mfg. Company		1131
Automatic Electrical Devices Co., The		1118
Autorey Company, The		1166
Ayres Battery Corporation		1175
B		
Bakelite Corporation		1122
Barwik Company, The		1043-1044-1045
Bates & Company		1168
Bel Canto Corporation		1191
Bleadon-Dun Company		1144
Bogue, B. N.		1174
Boice, W. & J.		1188
Buonton Rubber Mfg. Company		1174
Box 233		1106
Boyd's City Dispatch		1182
Brach Mfg. Company, L. S.		1095
Brandes, Inc., C.		1033
Branston, Inc., Chas. A.		1190
Bremner-Tully Mfg. Company		1104
Bristol Company, The		1148
Brockway Laboratories Company		1148
Brown Company, Thomas		1182
Brownlie, Roland		1156
Bunnell & Company, J. H.		1197
C		
Cannon & Miller Sales Corporation		1180
Carson, C. E.		1171
Carter Radio Company	1138	1140
Central Radio Laboratories		1167
Chaslyn Company, The		1184
Chemical Institute of New York, Inc.		1157
Chicago Salvage Stock Store		1149
Clapp-Eastham Company		1124
Clearstone Radio Company, The		1152
Connecticut Tel. & Electric Company		1130
Consolidated Instrument Company of America		1110
Consrad Company, Inc., The		1200
Continental Fibre Company, The		1174
Continental Radio & Electric Corp.		1134
Copper Clad Steel Company		1172
Coto-Coil Company		1161
Coyne Electrical School		1188
Crosley Mfg. Company		1037
Cunningham, Inc., E. T.		1136
Inside Front Cover		
Cutler-Hammer Mfg. Company, The	1111	1126
Cut Rate Radio Company		1185
D		
Dalton, Wittier, True Company		1182
Dayton Fan & Motor Company		1125
Delta Electric Company		1140
Dey's Radio Service		1174
Diamond Electric Specialties Corp.		1136
Diamond State Fibre Company		1129
Dictograph Products Corporation		1119
Dodge's Institute		1180

Name	Page
Dodge Radio Shortkut	1192
Dongan Electric Mfg. Company	1170
Dubilier Condenser & Radio Corporation	1191
Wm. B. Duck Company, The	1169
Durkee-Thomas Products Company	1184
E	
E. I. Company, The	1201
Eagle Radio Company	1181
Eisemann Magneto Company	1112
Ekko Company, The	1170
Electrad, Inc.	1102
Electrical Research Laboratories	1123
Electric Service Supplies Company	1184
Electric Specialty Company	1138
Electric Storage Battery Co., The	1105
Electro Importing Co.	1186
Elgin Radio Supply Company	1154
Evans & Company, Victor J.	1194
Experimenters Information Service	1099-1135
F	
Fahnestock Electric Company	1194
Fansteel Products Company, Inc.	1187
Ferbend Electric Company	1120
Fischer & Company, G. H.	1182
Ford Mica Company, Inc.	1174
Formica Insulation Company, The	1103
France Mfg. Company, The	1166
Freshman Company, Inc., Chas.	1098
Frost, Inc., Herbert H.	1195
Furness Bermuda Line	1203
G	
General Instrument Company	1192
Geiffill Bros., Inc.	1145
Globe Electric Company	1102
Goodell-Pratt Company	1180
Gould Storage Battery Company	1132
Great Lakes Radio Company	1147
Grebe & Company, Inc., A. H.	1031
H	
H. & H. Radio Company	1148
Hammerland Mfg. Company	1176
Hanes-Zener Company	1106
Harvard Radio Laboratories	1176
Hayden Radio & Research Co., A. C.	1190
Hearst's International Magazine	1120
Heath Radio & Electric Mfg. Company	1182
Holtzer-Cabot Electric Company, The	1108
Hommel & Company, Ludwig	1197
Hygrade Electrical Novelty Company	1112
I	
International Correspondence Schools	1176
J	
Jackson & Co., E. O.	1177
Jackson Radio Company	1192
Jones, Howard B.	1193
K	
K Electric Company	1172
Kellogg Switchboard & Supply Company	1141
Kennedy Company, The Colin B.	1136
Kensington Radio Supply Company	1150
Keystone Products Company, The	1192
Kilbourne & Clark Mfg. Company	1165
Killoch Company, David	1180
Kimley Electric Company, Inc.	1176
Klaus Radio & Electric Company	1168
L	
Lambert, Leon	1184
Lancaster & Allwine	1194
LeFax, Inc.	1132
Leich Electric Company	1180
Liggett & Myers Tobacco Company	1198

Name	M	Page
The M. & M. Company		1160
Magnavox Company, The		1133
Marko Storage Battery Company		1158
Marshall-Gerken Company, The		1126
Marvel Radio Specialty Company		1193
Mecky Company, The A.		1150
Midwest Radio Company, Inside Back Cover		
Michigan Radio Corp.		1185
Mitchell Company, R.		1132
Modell's		1155
Montgomery Ward & Company		1128
Montrose Mfg. Company		1152
Morrison Laboratories, Inc.		1180
Multiple Electric Products Co., Inc.		1101
MuRad Laboratories, Inc.		1175
Murdock Company, Wm. J.		1203
Music Master Corp.		1115
Myers Co., Ltd., E. B.		1162
N		
Nassau Radio Company, Inc.		1136
National Airphone Corporation		1116-1117
National Carbon Company, 1038-1039		
National Chelsea Radio Corporation		1110
National Industries, Inc.		1175
National Radio Institute	1034	1035
Newman-Stern Company, The		1100
New York Coil Company		1172
N. Y. Institute of Photography		1138
O		
O. & T. Electric Corporation		1140
Omnigraph Mfg. Company, The		1144
O'Neil Mfg. Company		1189
Owen, Richard B.		1194
Ozarka, Inc.		1176
Ozment, C. J.		1194
P		
Pacent Electric Company, Inc.		1170
Panelyte Company, The		1158
Parker, C. L.		1194
Pathe Phonograph & Radio Corporation		1106
Personal Service Purchasing Bureau		1164
Pequot Specialty Company		1150
Pignolet Instrument Company		1180
Pioneer Radio Corporation		1177
Post Electric Company		1172
Precision Equipment Company, The		1036
Press Company, The		1188
Press Guild, Inc., The		1096
Progressive Specialty Company		1098
Progress Press		1168
Pyramid Products Company		1162
R		
Radiall Company		1191
Radio Corporation of America, Back Cover		
Radio Equipment Company		1142
Radiogem Corporation, The		1169
Radio Guild, Inc., The		1164
Radio Industries Corporation, 1040-1041		
Radio Institute of America		1100
Radio Instruments Co.		1181
Radio Mfg. Company, The		1190
Radio Parts Mfg. Co.		1166
Radio Products Mfg. Company		1156
Radio Rabat Company, The		1188
Radio Research Laboratories		1104
Radio Specialty Company		1151
Radio Stores Corporation		1127
Radio Tube Exchange		1166
Radio Tube Laboratories		1193
Radio Units, Inc.		1163
Randel Wireless Co.	1170	1178
Randolph & Company		1194
Rauland Mfg. Company		1143
Reliable Parts Mfg. Company, The		1152

Name	Page
Remler Radio Mfg. Company	1114
Riggs Mfg. Company, The	1178
Rivero & Company	1174
Rose Radio Supply	1132
Rosendal & Company	1154
Royal Mfg. Company	1178
Rusonite Products Corporation	1177
S	
Sahara Dry Battery Company	1114
Samson Electric Company	1179
Saturn Mfg. & Sales Co., The	1188
Schindler, Charles	1168
Scientific Electric Works, The	1198
Scott, Walter	1187
Sears, Roebuck & Company	1146
Service Battery Company	1192
Shamrock Mfg. Company	1144
Shelton Elec. Co.	1187
Sherman Radio Distributing	1188
Shipman-Ward Mfg. Company	1203
Sidbeiel Radio Equipment Mfg. Company	1128
Signal Electric Mfg. Company	1107
Simon & Skidmore Mfg. Company	1178
Sinclair, Mr.	1194
Southern Radio Corp. of Texas	1134
Southern Toy Company, The	1194
Specialty Service Company	1120
Springfield Wire & Tinsel Company	1162
Standard Radio Company	1168
Standard Radio Corp.	1153
Steinmetz Wireless Mfg. Company	1195
Sterling Mfg. Company, The	1146
Stevens & Company	1188
Stransky, J. A.	1188
Stromberg-Carson Telephone Mfg. Co.	1102-1104
T	
Telephone Maintenance Company	1152
Times Square Auto Supply Co., Inc.	1171
Tresco, Inc.	1122
Trimm Radio Mfg. Company	1138
Trinity Radio Corporation	1134
Tri State Radio Sales Co.	1187
Tuska Company, The C. D.	1139
Twitchell's Radio House	1168-1190
U	
U. S. Mfg. & Dist. Company	1174
U. S. Tool Company, Inc.	1178
United Electric Stores Company	1130
United Mfg. & Distributing Company	1183
Unity Mfg. Company	1142
Universal Chiropractors' Ass'n	1199
V	
V-De-Co Radio Mfg. Company	1104
Valley Electric Company	1100
Veritas, M.	1188
Vesco Radio Shop	1154-1197
W	
Walbert Mfg. Co., The	1140
Walker Company, Inc., G. E.	1164
Walwart Electric Mfg. Company	1156
Webster Radio Shop	1184
West Angus Show Card Service, Ltd.	1164
Western Coil & Electrical Company	1098
Western Radio Corporation	1166
Westinghouse Union Battery Company	1113
Weston Electrical Instrument Company	1130
Willard Storage Battery Company	1137
Wilmington Fibre Specialty Company	1152
Wireless Mfg. Co., The	1136
Wood Products Company, Inc.	1160
WorkRite Mfg. Company, The	1171
Workman Radio Service	1190
World Battery Company	1172
XYZ	
Y. M. C. A. Radio Schools	1098
Zenith Radio Corporation	1029

Brandes



GRANDMA'S Happy now! Her busy fingers and tired eyes enjoy their well-earned rest. She's busy without working. Time doesn't drag. Long hours are lightened by the world of entertainment and fun brought to her by radio. A new interest fills her life!

C. BRANDES, Inc. NEW YORK

Matched Tone
TRADE MARK REG. U.S. PAT. OFF.
 Radio Headsets

© C. Brandes, Inc., 1924

"Cash In" On These Amazing

You readers of Radio News—you who are interested in Radio, and also interested in unusual money-making opportunities—let me send you, without the slightest cost or obligation, my new, interesting Free Book, "Rich Rewards in Radio"—a book which contains positive proof of the astounding opportunities in this great new industry and tells exactly how you can get your share of big money from it.

The pictures on this page give only the smallest indication of the scope of Radio today. Mail the coupon on the next page for my Free Book which gives full facts on Radio and what it can mean to you.

Earn \$75 to Over \$200 a week

You're interested in Radio — why not turn your interest into profit? Why not make big money in work you enjoy? No field today is growing so rapidly. No business offers such a rare variety of opportunities. Radio is a new, billion dollar industry in which thousands have already made far more money than they ever dreamed possible.

Radio can take you out of the rut of bare existence—into an enviable field of high salaried specialists. It can offer you unlimited opportunities for honor, wealth, power and satisfaction. It means a future filled with boundless promise!

Recognized Radio Experts In Urgent Demand

Readers of Radio News know in part the story of how Radio has jumped forward with leaps and bounds. You know there are broadcasting stations all over the country—that radio is used on every ship—that it is used by newspapers, government departments, business houses, banks, railroads, factories and stores. Every day, some new use for Radio is announced. And this wonderful expansion of Radio has opened up hundreds of splendid positions on land and sea—positions which you can qualify for within a few months!

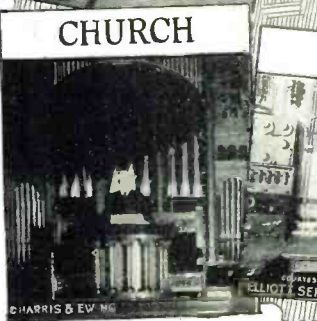
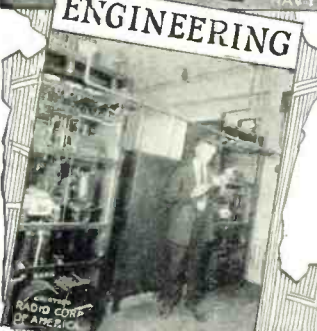
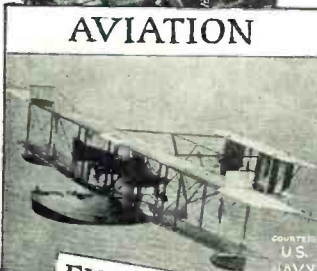
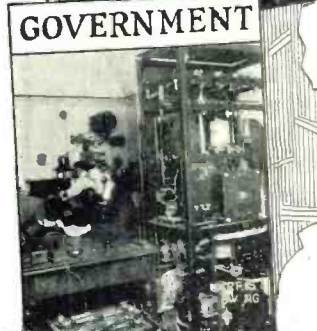
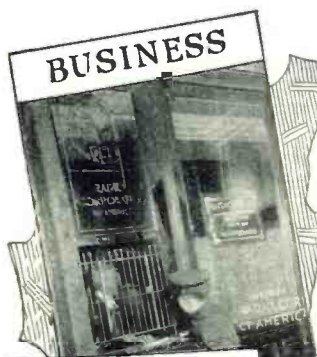

New Opportunities in RADIO!

There's big money in this wonderful new field for you. No matter what you are doing—no matter what experience you've had, you can step in and get your share of the astonishing rewards of Radio. Big salaries, fascinating, easy work, short hours, and a wonderful future—no other field of endeavor can offer anything to compare with what Radio can mean to the men who get into this work now.

Make Radio your career. Become a radio expert now!

Get a U. S. Government First Class Radio License

Remember that the best positions in Radio go to those who have advanced radio training. Radio operators on ocean and land stations—broadcasting operators—radio engineers, installation and maintenance experts, radio inspectors, executives—all specialized radio positions call for trained men. And the U. S. Government First Class Radio License is the world-wide accepted proof of first class radio training. Get this license. You can make big money with it.

Easy Now to Learn At Home

No previous training in electricity or radio is necessary. During your spare time at home, within an amazingly short time, you can get your National Radio Institute diploma, which is government recognized and accepted as part credit on your government license. For greater speed in qualifying for this license and to make the training more practical, four splendid instruments are given FREE with the course.

Send for FREE BOOK

You have nothing to lose—and everything to gain. No matter what your plans for the future are—mail the coupon now for this new Free Book which tells all about the wonderful opportunities in Radio. Let it point the way to success and happiness for you. Don't delay. Mail the coupon now. National Radio Institute, Dept. 13AB, Washington, D. C.



E. R. Haas, Director, NATIONAL RADIO INSTITUTE (Founded 1914)

I Can Qualify You as a Radio Expert in a Few Months

If you want to earn far more money than you are earning now—if you want to be your own boss—if you want a profitable business of your own—if you want to travel the world over—if you want a field of endeavor where the opportunities are unlimited—Make RADIO your profession.

Hundreds of my students write enthusiastically of my training—and tell how it has helped them. Merle Wetzel now is making three times what he did before taking my training. Emmett Welch started at \$300 a month after graduating. Scores of others tell similar stories. Send for my Free Book which tells of the great opening in Radio, what my students are doing—what you can do. No obligation. Mail the coupon now.



Mr. E. R. Haas, Director
National Radio Institute,
Dept. 13AB, Washington, D. C.

Without any obligation on my part, please send me a FREE copy of your book, "Rich Rewards in Radio." Also tell me how your Free Employment Service will help me secure a position, and send me details of your special short time offer. (Please write plainly.)

Name
Address
City State

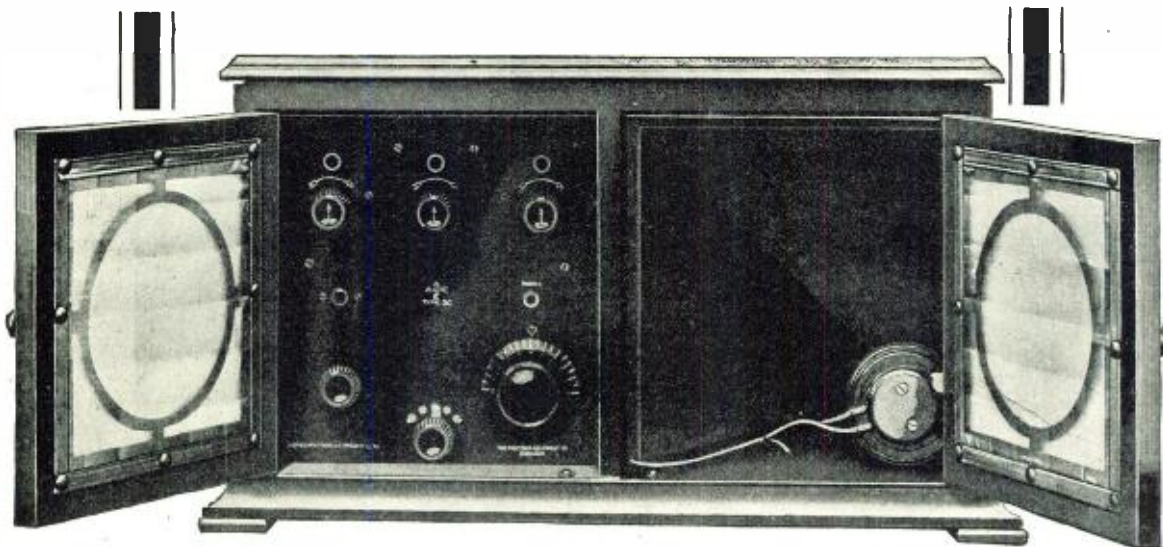

Enjoy It All
—From Everywhere
 with the
ACE TYPE 3C CONSOLETTTE

Radio is the ideal entertainment for the home. You can sit right at your own fireside and enjoy the World's best musical and vocal selections.

It doesn't matter where you live—Tampa or Portland—it's all the same with the Ace Type 3C Consolette. If you don't care for the Programme in San Francisco, the turn of a dial wafts you and your family as tho by magic to New York, Detroit, Wichita—all in the flash of a second.

This set is built into a beautiful solid mahogany, wax-finished cabinet. It consists of a regenerative tuner, detector and two stages of amplification, with built-in loud speaker. The tuning circuit is licensed under the Armstrong U. S. Patent No. 1,113,149, and due to the particular method of winding Crosley coils, it is exceptionally selective.

It has sufficient room inside the cabinet for dry batteries, making a complete self-contained long-range receiving outfit. Phone jack for tuning with head phones; Crosley multistat; filament switch; Crosley moulded condenser; beautifully engraved Formica panel. Uses all kinds of tubes. An exceptionally splendid set at a remarkable price—\$125.00, without tubes or batteries.

Other Ace sets are the Ace Type V, which sells for \$20.00, and the Ace Type 3B at \$50.00. Ask your dealer to demonstrate the Ace Radio Sets to you.

THE PRECISION EQUIPMENT COMPANY

POWEL CROSLY, JR., President
 222 Vandalia Avenue CINCINNATI, OHIO

The COURT JESTER of TODAY

*"No wit to flatter left of all his store,
No fool to laugh at, which he valued more."
—Pope*

SINCE the earliest days, laughter and gaiety have been the most sought after things in life. In ancient times stately rulers unbent, courtly knights forgot seriousness; beautiful ladies became more alluring as the clever quips and merry pranks of the court jester brought a sparkle to their eyes and drove dull care away. But they were limited to the clownish antics and slap stick comedy of the jester.

Moderns have unlimited sources of amusement. Every broadcasting station has its Jester; its humorous stories; amusing songs and clever comedies. Each night the air is filled with merriment.

With a Crosley Model X-J radio receiver, amusement may be brought clearly and distinctly to your fireside. Sitting comfortably in an easy chair you forget dull care. The magic wand of the radio sends worry scurrying.

The very moderate prices of all Crosley instruments bring radio within the reach of all. No matter which Crosley Model you may select you can be assured of the maximum results at the lowest cost.

Let a Crosley Radio Receiver bring fun, laughter and good humor into your home.



CROSLEY
Better - Cost Less
Radio Products

See the Crosley Line at Good Dealers Everywhere

Write for Free Catalog. This fully describes the Crosley line of Radio receivers which range in price from the Model VI, a 2 tube set at \$30, to the graceful Consolette Model X-L at \$140. It also shows the complete line of Crosley parts.

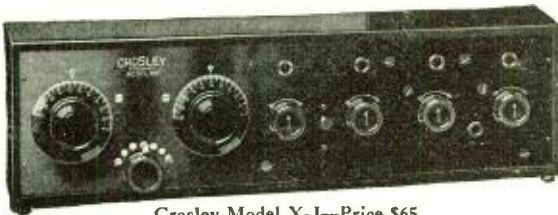

Crosley Model X-J—Price \$65

For tuning out local interference and bringing in distant stations this receiver is unexcelled. It is a 4 tube set combining one stage of tuned radio frequency amplification, detector and two stages of audio frequency amplification.

Nowhere can a better set be purchased at any price

Cost of necessary accessories \$40.00 and up.

CROSLEY MANUFACTURING COMPANY
Powel Crosley Jr., President
222 Alfred Street Cincinnati, Ohio

CROSLEY \$ **65**
Model X-J

*The Broadcasting Station WLW is maintained by the
CROSLEY MANUFACTURING COMPANY*

MAIL THIS COUPON TODAY

Crosley Manufacturing Co.,
222 Alfred St., Cincinnati, Ohio.

Gentlemen: Please mail me free of charge your complete catalog of Crosley instruments and parts together with booklet entitled "The Simplicity of Radio".

Name

Address



Eveready "Three" 4½ volts, three distinct uses. At all reliable radio dealers.

This "C" Battery a wonder-worker



The loud speaker is a new delight when the Eveready "Three" is used as a "C" battery in the amplifier automatically controlling the purity of reproduction of speech and music.

For Automatic Amplifier Control

YOU can make the loud speaker re-sound with a new roundness and naturalness of tone. You can save money by adding months to the life of your "B" Batteries. These things you can do by using the new Eveready $4\frac{1}{2}$ volt "Three" as a "C" Battery.

You already have an "A" Battery for the filament and a "B" Battery for the plate. A "C" Battery is connected to the third element of your vacuum tube, the grid, affording an automatic control that is marvelous in action on audio frequency amplifiers. Especially extraordinary with 90 volts of "B" Battery and two stages of amplification.

As a "C" battery the Eveready "Three" prevents distortion and excessive flow of current from the "B" battery, lengthening its life. It is a wonder-worker that saves its small cost many times over. Connect it in your audio frequency amplifier and

note the difference. Full directions on the label and in "How to Get the Most Out of Your 'B' Battery," a booklet on "B" and "C" batteries, sent free on request.

This triple-use battery can also be used as an "A" Battery in portable sets. Light and full of pep. Its third use is as a "B" Battery booster. Five of them in series make a $22\frac{1}{2}$ volt "B" Battery.

Use Eveready "Three" the most universal dry battery ever made for radio, available for the grid, filament or plate circuit. A tested product of the world's leading electro-chemical battery laboratory.

If you have any battery problem, Radio Battery Information Headquarters will solve it for you. Write G. C. Furness, Manager, Radio Division, National Carbon Company, Inc., 122 Thompson Ave., Long Island City, New York.

NATIONAL CARBON COMPANY, Inc., New York and San Francisco

Headquarters for Radio Battery Information

CANADIAN NATIONAL CARBON CO., Limited. *Factory and Offices: Toronto, Ontario*

EVEREADY

Radio Batteries

- they last longer

RICO GUARANTEED PRODUCTS

ALL "Rico" goods are guaranteed unqualifiedly by us. "RICO" goods are standard today and are used all over the country. Ask any of your friends about "RICO" goods and "RICO" workmanship. A trial of any of our items will convince you. There is a dealer somewhere near you who stocks "RICO" goods and who will be glad to show and demonstrate to you the latest additions to our line. Whenever you want good goods at the lowest price, think of "RICO."



No. 250 Melotone Tuned (Adjustable) Loud-speaker, complete\$6.00



No. 700 "Rico" Single Fonehorn, complete (without loud-speaker unit)\$2.50



No. 701 "Rico" Double Fonehorn, complete (without phones)\$3.00



- No. 6 2000 ohms (standard non-adjustable)\$3.50
- No. 7 3000 ohms (standard non-adjustable)\$4.00
- No. 20 "Rico" De Luxe Tuned (adjustable) 2000 ohms.....\$4.50
- No. 30 "Rico" De Luxe Tuned (adjustable) 3000 ohms.....\$5.50
- No. 40 "Rico" De Luxe Tuned (adjustable) 4000 ohms.....\$7.00

SEND NO MONEY

Radio Industries Corp., R. N. 2
131 Duane St., New York City.

Gentlemen:—Please send me by Parcel Post....

"Rico" for which I will pay
the postman the amount of

Name

Street

City State

"Rico" Tuned (adjustable) Melotone Loud-Speaker
The highest grade, lowest priced and most popular loud-speaker on the market today. This speaker is equipped with "Rico" tuned (adjustable) loud-speaker phone unit. Comes fully equipped with black fibre horn and five foot cord. This low priced speaker compares well with the most expensive ones. Length of horn 11½", total height 9".
No. 250 Melotone Loud-Speaker\$6.00

SINGLE FONEHORN
NEW! Here is the appliance you have been waiting for. 11½" fibre horn, mounted on a heavy cast base stand. The stand also has one of our single phonodapters. Will take any loud talking phone unit. At a small expense you can now have a loud-talker. It not only looks good, but gives surprising results due to the fibre horn. All metal work, with the exception of the base, is nickel plated and polished. Not a toy, but a massive piece of apparatus that looks good, works well, and is marked at a very low price. Horn swivels in any direction independent of base and phone.
No. 700 Single Fonehorn.....\$2.50

DOUBLE FONEHORN
This article is constructed similarly to our No. 700 single Fonehorn. The double Fonehorn is made to take any standard head set and thereby the appliance becomes a real loud-speaker unit. Acoustically worked out to perfection, this appliance will give excellent results. It is equipped with 11½" full fibre horn. All metal parts nickel plated and highly polished. Heavy cast base in dull black finish. This appliance has two of our phonodapters which will take any make head set. An article that looks good with any expensive set. Horn swivels in any direction independent of base and phone.
No. 701 Double Fonehorn.....\$3.00

"Rico" Head Sets
These head sets are the original ones using the center pole pull on diaphragm principle. Well known for their sensitivity, loudness and absolutely tuned quality. Now made with superior tungsten steel magnets, better head band, a heavier and better quality cord, sherdized diaphragm, and a number of minor improvements. The highest priced phones are made with tuned (adjustable) diaphragms.

FONEKUSHIONS
The latest radio wrinkle. How many times have you had a headache from wearing tight head receivers? How many times when you are listening for DX have you not been able to hear clearly due to outside noises in the room? Fonekushions do away with all this. Made of sponge rubber. They not only make wearing your receivers a pleasure but they positively exclude all noises and make reception a pleasure. Made of black sponge rubber that will last for years. Can be washed with soap and water. Smooth outside surface. Light as a feather. Once worn, always worn.
No. 500 "Rico" Fonekushions, set of two.....\$5.50



SPONGE RUBBER
No. 500 Fonekushions, set of two \$5.50

"Rico" Tuned (adjustable) Loud-Speaker Phone
This is our famous (adjustable) loud-speaker phone unit. This phone gives amazing results as a loud-talker on one and two stages of amplification. You must hear this phone to appreciate it. This unit has a rubber gasket underneath diaphragm which makes phone fully adjustable. Can be adjusted for loud or weak sounds simply by slightly loosening or tightening cap.
No. 25 Loud-Speaker Phone with 5 ft. cord\$3.50



No. 25 "Rico" Loud-speaker Phone with 5 ft. cord....\$3.50

"Rico" Single Phonodapter
This Phonodapter fits Victrola, Columbia and Sonora phonographs. Entire adapter is made of pure rubber with a brass tube insert. Adapter will stretch over any make of phone. Note construction! No echoes due to special lip. Comes complete with brass tube insert which makes it fit any phonograph.
No. 131 "Rico" Phonodapter\$5.50



No. 131 "Rico" Single Phonodapter\$5.50

"Rico" Double Phonodapter
This handsome instrument is made of a single casting, nickel plated and highly polished. There are three generous soft rubber bushings. The Phonodapter fits all phonographs and takes any standard double head set, thereby making your phonograph a loud-talker. Made in just the right proportion to fit your head set.
No. 132 Double Phonodapter\$7.50



No. 132 "Rico" Double Phonodapter\$7.50



FREE!!
All Tuned "RICO" Phones now furnished free with two Fonekushions. Now! The most comfortable phones in America.

Dealers and Jobbers
Write or Wire for Territory that is Still Open for Proposition

RADIO INDUSTRIES CORPORATION
131 Duane Street, New York City
Cable Address: Ricotrade, New York

Get This Big Radio Book!

224 Pages. 375 Illustrations.

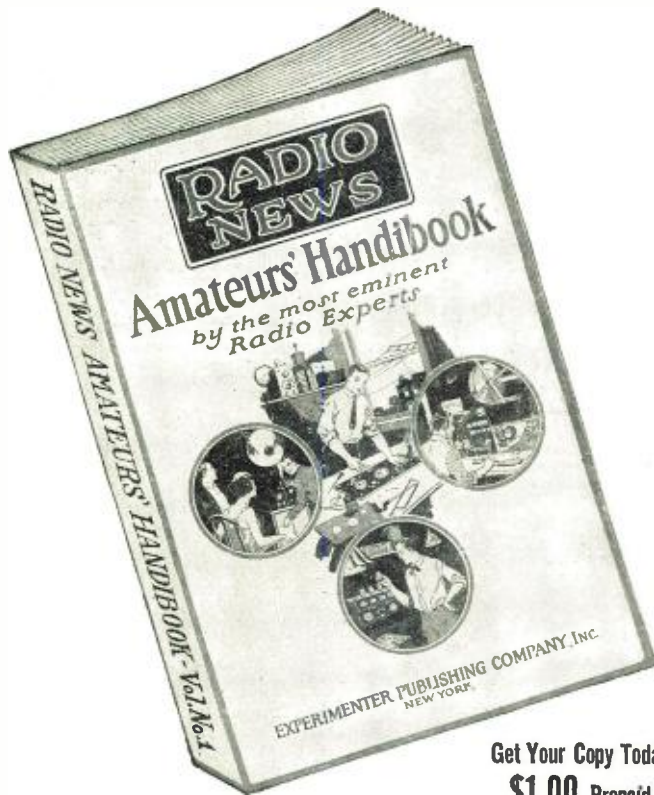

Amateurs' Handbook

Volume No. 1

Tells how to build various types of receivers, transmitters, and sundry apparatus. Every description is extensively treated and illustrated with sketches, diagrams, and photos. A separate portion of the book is especially devoted to the operation, characteristics, and adaption of vacuum tubes. Another portion takes in radio theory, dealing with the antenna, regeneration, super-regeneration, radio frequency amplification, damping, impedance, high frequency resistance, etc., etc. A good part also gives numerous hints for construction of apparatus and general radio kinks.

All in all, the edition is just cram full of the sort of material which delights the heart of the radio fan. It should find a permanent place on the bookshelf of every amateur.

Bound in multi-colored heavy board.
Size 6 x 9 inches.

Get Your Copy Today
\$1.00 Prepaid

Some of the articles included in the Radio News Amateurs' Handbook are:

A Typical Amateur Receiver, A Radio Flivver, A Universal Receiver, A Radio Frequency Receiver, A Multi-Range Regenerating Receiver, A Reinartz Set, A 3-Tube Reflex Receiver, A 1-Tube Super-Regenerative Receiver, A Honeycomb Coil Receiver, A Compact Super-Regenerative Set, An Efficient Receiving Set, A Super-Sensitive Receiver, An Armstrong Super-Regenerative Receiver, A well designed Super-Regenerative Receiver, How to Make a Portable Receiver, a Practical Receiver, A Detector-Amplifier Unit, Modern Hook-ups for the Amateur, Dual Amplification Circuits, A Simple Reflex Circuit, An Efficient Amateur Receiving Circuit, A Long Distance Hook-Up, A Receiver Using Rectified A.C. Supply, How to Make D-Shaped Variometers, Regenerative Tuners to B.F. Amplifiers, Head Sets, Reducing Interference With Single Circuit Sets, Broadcast Receiving and Receivers, Hints on Loud Speaker Unit Operation, Amateur Reception on Honeycomb Coils, A Portable Wavemeter, A Wavemeter for Short Wave-Lengths, An Aerial Cleaner, The Construction of a Loop Aerial, Wiring the Radio Set, The Construction of a 10-Watt Transmitter, A 5-Watt Telephone and Modulated C.W. Set, A Spark Coil C.W. Set, A Vacuum Tube Transmitter Operating on a 6 Volt Storage Battery, A C.W. Measurement Set, Construction of an Electrolytic Rectifier, A High

Frequency Buzzer, Construction of a Modulation Transformer, Two Practical Radiophone Circuits, Loading Coil Design, Meters for C.W. Sets, A Dial Indicator, Regeneration and Super-Regeneration, Radio Frequency Amplification, Damping, Matching Impedances, High Frequency Resistance, Different Types of Coupling, Principles of the Antenna System, The Relation of the Antenna to Detection Efficiency, Theory of Crystal Detector Operation, Condensers, Monographic Charts for Measuring Capacity, Inductance and Wave-Length, Fundamental Operation of Vacuum Tubes, Operating Characteristics of Vacuum Tubes, Practical Points on Amplifier Operation, Vacuum Tube Facts, Basket-Wound Coils, Winding G-R Solid Wire Coils, An Arc Buzzer Practice Set, A Storage Battery for 1½ Volt Vacuum Tubes, Amplifier Trouble, Notes on Crystal Detectors, Practical Pancake Coils, A Sensitive Detector, Simple Mounting for Variocoupler Secondaries, A Method of Mounting Coils, A Practical Method for Writing Code, Form Wound Coils, Cores for Transformers, An Inexpensive Amplifying Transformer, A Silver Dial, Duo-Vertical Coil Winding, How to Solder Connections, Connecting Phones, How to Wind Duo-Lateral Coils, A Spider-Web Coil Mounting, A Carbon Disc Rheostat, A Device to Eliminate Dial Scratch.

On sale at all leading radio stores. If your dealer cannot supply you, pin a dollar bill to this coupon with your name and address and book will be forwarded to you postpaid.

Experimenter Publishing Co.,
53 Park Place, New York City, N. Y.

Gentlemen:
Kindly send me, prepaid, a copy of the RADIO NEWS AMATEURS' HANDBOOK. I enclose one dollar in payment of the same.

Name

Address

Experimenter Publishing Co., Inc.,
53 Park Place, New York City.

BUILD YOUR SET BETTER-AT LOWER COST

SUPERIOR 180° VARIOCOUPLER
L521 Each.....\$1.98
A wonderful value. Produces excellent results. Green silk windings on black fibre tubes. Rigid mounting support for table or panel mounting. Precision tuned for fine tuning. 1/2 inch shaft. Range 200 to 600 meters.
L522 Variometer—same style. Each..\$98

SUPERIOR VARIOCOUPLER
L523 Each.....\$1.15
A handsome instrument of superior design and construction. Major tube and rotor ball of moulded red brown bakelite. Large size green silk windings insure highest efficiency. Table or panel mounting. 1/2 inch shaft. Superior results in circuits for 180 to 450 meters. Tapped primary for finest tuning.
L526 Special shunt circuit type...\$3.60

SUPER MOULDED VARIOMETER
L412 Each.....\$2.60
Polished black moulded rotor and stator forms. Maximum inductance with greatest efficiency and minimum distributed capacity. A high grade instrument that will get the best results.
Wave length 180 to 600 meters.

EXCEL MOULDED VARIOMETER
L524 Each.....\$4.45
A wonderful value at our price. Properly designed and constructed. Polished black bakelite rotor and stator forms. Large size green silk wire insures highest efficiency. 1/2 inch shaft. Noiseless electrical connection. Table or panel mounting. Split stator winding with binding post connections.

SUPERIOR VARIOMETER
L525 Each.....\$3.68
Forms moulded of red brown bakelite. A neat and compact instrument. Green silk windings calculated for highest efficiency. 1/2 inch shaft. Noiseless electrical connections. Table or panel mounting. Produces superior results in any type circuit 180 to 600 meters.

RADIO INDUCTANCE COILS
Carefully made for looking coils. Highest efficiency. Low distributed capacity effect, low resistance—high self inductance. Very firm impregnation. Is a K 0 given in meters with variable condenser. Mounted coils have standard plug mountings. Art. Not Art. Prices Turned Range No. Mtd. No. Mtd.
25 120-250 L301 \$0.32 L320 \$0.75
35 175-450 L302 .37 L322 .90
50 250-750 L303 .43 L323 .96
75 300-910 L304 .48 L324 1.02
100 500-1150 L305 .52 L325 1.07
150 600-2000 L306 .57 L326 1.11
200 900-2500 L307 .66 L327 1.20
250 1200-3500 L308 .72 L328 1.29
300 1500-5000 L309 .76 L329 1.30
400 2000-7000 L310 .91 L330 1.51
600 4000-10000 L312 1.20 L332 1.72
750 5000-12000 L313 1.36 L333 1.87
1000 7500-17000 L314 1.54 L334 2.18
1250 9750-19500 L315 1.86 L335 2.35
1500 11500-26500 L316 2.10 L336 2.50

INDUCTANCE COIL MOUNTINGS
L340-3 Coil. Each.....\$3.35
L341-2 Coil. Each.....2.67
Sturdy, rigid durable construction. Made of polished black bakelite.

BACK OF PANEL MOUNTING
Mounts back of panel, with knobs or dials on front of panel. Helps make a neat efficient set. \$4.45

COIL MOUNTING PLUGS
Moulded of genuine bakelite. L344 Plug for mounting "honeycomb" inductance coils. L345 Stationary plug to fasten mounted coil stationary to panel.
L346 Movable plug to fasten mounted coil to panel so it can be rotated. 89c
L343 Fibre strip to hold coils for mounting. Two foot piece.....15c

SPIDER WEB COILS
L290-25 turn 39c L292-50 turn 47c
L291-35 turn 42c L293-75 turn 54c
L294-100 turn. Each.....68c
A new popular type of highest efficiency. Lowest distributed capacity and lowest high frequency resistance. Firm green silk windings with fibre mounting strips.

YOU SAVE MONEY WHEN YOU BUY FROM US
We Pay Transportation Charges East of the Rockies
THE PRICES QUOTED DELIVER THE GOODS TO YOUR DOOR
FAST SERVICE—TRY US AND BE CONVINCED
THIS GUARANTEE PROTECTS YOU—Examine the goods we ship you. They must suit you in every respect. If you are not satisfied with your purchase return the goods at once and we will refund the price you paid.

OUR SPECIAL VARIOMETER AND VARIOCOUPLER
Build into your set reliable instruments. You can depend on this variometer and variocoupler to give you the best results in any circuit working from 180 to 650 meters. In design and construction they are the best. Only the highest grade materials are used. The prices quoted save you 30 to 40 per cent. Why pay more?

L418 Variocoupler. Each.....\$2.45
The most efficient type of coupler, insures better tuning and louder signals. Primary and secondary wound on natural uncolored genuine bakelite tubes. Handsome green silk windings. Primary tapped for fine tuning. Can be panel or table mounted. 3/16 inch shaft.

SOLID BARE COPPER WIRE
Solid bare copper wire for aeriads, leads or wiring instruments.
Solid Bare Copper Wire, size 14.
L240 100 ft. coil 48c L242 500 ft. coil \$3.25
Solid Bare Copper Wire, Size 12.
L244 100 ft. coil 67c L245 500 ft. coil \$3.05

STRANDED ANTENNA WIRE
Cabled of fine copper strands. Very flexible. High tensile strength. Best for aeriads. L248 100 ft. coil 58c L249 500 ft. coil \$2.75

MAGNET WIRE
Insulated copper wire. Best quality even drawn wire, one piece to a spool. Prices quoted are for 8 oz. spools unless otherwise stated. Note, our prices are prebaid.

Double Cotton Covered	Enameled Insulation	Green Silk Covered
Number L990	Number L992	Number L991
Gauge Price	Gauge Price	Gauge Price
20.....48c	20.....45c	20.....30.75
22.....48c	22.....45c	22.....30
24.....80c	24.....50c	24.....1.05
26.....85c	26.....55c	26.....1.15
28.....85c	28.....55c	28.....1.15
30.....95c	30.....65c	30.....1.30
32.....1.15	32.....85c	32.....1.30

ANTENNA INSULATORS
L260 Size 1x2 1/2. Composition, metal eyes. \$1.7c
L263 Ribbed Porcelain Insulator, 2 1/2 in. long. Ea. 6c
L265 Ribbed Porcelain Insulator—5 inches long. Each.....15c

LEAD-IN INSULATORS
L270 For 4 inch walls or less.....42c
L271 For 9 inch walls or less.....69c
The only practical lead-in insulator for aerial wires. Small, neat, effective, durable. Fits 3/8 inch hole. Securely locked by two adjustable nuts.

OUTDOOR LIGHTNING ARRESTER
L980 Price.....\$1.55
Protect your instruments with this lightning arrester. Weatherproof porcelain case. Air gap type. Permanent. Durable. Underwriters approved. Lists for \$1.10.

JEWELL LIGHTNING ARRESTER
L981 Each.....85c
A dependable protector, always on guard. Small and compact. Weatherproof porcelain case. Easily fastened and connected. Underwriters approved. Lists for \$1.10.

PANEL MOUNTING VARIABLE CONDENSERS
These are especially high grade condensers and we guarantee them to be mechanically and electrically perfect. Fine polished and plated of heavy bakelite. Shafts 1/2 inch diameter. Sturdy, heavy aluminum alloy plates perfectly spaced to insure smooth, even, reliable capacity. Our low prices save you money. These condensers are of the very best make and are not to be compared with many inferior, cheap condensers offered. We guarantee them to please you or your money back. The vernier style has one separately controlled plate which permits of the finest tuning. These values are unapproached by others.

REGULAR STYLE	VERNIER STYLE
L815-3 plate.....58c	L825-14 plate .0025 mfd.....\$2.45
L814-11 plate .00225 mfd.....97c	L824-26 plate .0005 mfd.....2.76
L813-31 plate .0005 mfd.....1.27	L826-48 plate .001 mfd.....2.95
L812-45 plate .001 mfd.....1.47	

OUR SPECIAL AUDIO FREQUENCY AMPLIFYING TRANSFORMERS
L550 Each.....\$2.25
In quality of tone and volume of sound, no other things a transformer is built for we guarantee it to equal or surpass any other transformer. Neat in appearance. Carefully made. Fully mounted with plainly marked binding post connections. Wonderful results on one, two or three steps without distortion or howling. A quality item in every respect.

NATIONAL SHIELDED TRANSFORMER
L551 3 1/2 to 1 Ratio \$2.48
L552 6 to 1 Ratio...2.68
Note that our price is prepaid. The same high grade style of transformer as above enclosed in a metal case which completely shields it from any outside magnetic influences. Free from howling and local disturbances.

OTHER STANDARD BRANDS AUDIO FREQUENCY TRANSFORMERS
Fresh, clean stock in original containers.
L232 THORARSON Ratio 3 1/2 to 1 \$3.30
L233 THORARSON Ratio 6 to 1...3.70
L553 Acme. Each.....4.21
L554 Oto. Each.....4.45
L555 Federal. Each.....4.45
L712 Radio Corp. Each.....5.70
L234 All American 10 to 1 Shielded 3.80
L236 All American 5 to 1 Shielded 3.60
L235 All American 3 to 1 Shielded 3.60

TRICOIL RADIO FREQUENCY AMPLIFYING TRANSFORMER
L550 For 201A or 301A Tubes.....\$1.58
L561 For 190 or 11 or 12 Tubes.....1.58
This transformer will produce wonderful results in any type of regular or reflex radio frequency circuit. Perfect for one, two or three stages. Compact, convenient form, easily mounted. Range 175 to 600 meters.

OTHER STANDARD BRANDS RADIO FREQUENCY TRANSFORMERS
L568 Our special—as good as any of them.....\$.48
L502 Dubilier. Each.....4.45
L563 Oto. Each.....4.45
L565 Acme. First stage. Each.....4.45
L566 Acme. Second stage. Each.....4.45
L567 Acme. Third stage. Each.....4.45
L714 Radio Corp. Each.....5.85
L995 All American. Each.....3.95
L575 Eria. First stage. Each.....3.45
L576 Eria. Second stage. Each.....3.45
L577 Eria. Third stage. Each.....3.45
L578 Eria. Reflex No. 1, 2 or 3. Each 4.35

LONG NOSE PLIERS
L970 Price..95c
The handiest pliers for radio work. Made of fine hardened steel. Length, 5 in.

DIAGONAL JAW NIPPERS
L972 Price.....95c
For fine electrical work, made of hardened steel. Length, 5 inches.

FOUR-IN-ONE SCREW DRIVER
L974 Each.....55c
Especially suitable for radio work. Will handle any size screw. Smaller drivers nest inside larger one. Are held in place with screw cap. Made of steel, nickel finished.

TINOL L989 Per tube...19c
A combined solder and flux in handy form. Put a little on the connection heat with a match, torch electrically and mechanically perfect joint.

AUTOMATIC BLOW TORCH
L543 Each.....\$1.19
Burns denatured alcohol. Automatically generates pointed flame in a few seconds. Easy to solder joints in hard places. Lights with a match. Burns 20 minutes on one filling. 5 1/2 inches high. 3/4 inch diameter cylinders. Works fine with Tinol listed above.

SUPER BLOW TORCH
L544 Each.....39c
Burns denatured alcohol. Vest pocket size. Blowing on tube produces a hot pointed flame. Lights with a match. Works fast. Burns 10 minutes on one filling. Easy to solder joints in hard places. 3 in. high. 3/8 in. cylinder. Long rubber tube. Produces fine joints with Tinol listed above.

THE BARAWIK CO. Chicago's Original Radio Supply House Bearer of Initiators **102 South Canal St., Chicago, Ill.**

WITH BARAWIK QUALITY RADIO GOODS

VACUUM TUBES
Standard Brands—Cunningham, Radiotron. Every one guaranteed new and perfect. We will ship brand in stock unless you specify otherwise.

L105 Detector UV200 C300 Each \$4.10
L112 Amplifier, UV201A C301A Each 3.45
L118 5-Watt Transmitter..... 7.70
L107 WD11 (11). Each..... 5.42
L101 WD12 C12. Each..... 5.42
L102 UV199 C209. Each..... 3.42
L104 UV199 Adapter fits 199 tube to standard socket 39
L108 WD11 Socket. Each..... 31
L109 WD11 Adapter. Each..... 45

BAKELITE TUBE SOCKET
L140 Standard base .39c
L141 UV199 base 39c
Moulded of genuine red brown bakelite. Binding post connections. For table or panel mounting. Neat and strong.

199 SOCKET
L145 Each 49c
Moulded of high insulating material. Sponge rubber base prevents ringing in tube. Flat metal binding post connections. Neat and compact.

STANDARD TUBE SOCKET
L150 Each 59c
Bakelite base. Polished nickel tube. Highest quality socket. Binding post. Best insulation. Positive contact. Marked terminals. For base or panel mounting.

FILAMENT CONTROL RHEOSTATS
L132 6 ohm. Each..... 39c
L129 20 ohm. Each..... 40c
L130 30 ohm. Each..... 44c
L135 6 ohm Vernier..... 95c
Best grade. Will give real service. Durable and lasting. High heat resisting base. diam. 2 1/4 in. Tapered polished black knob 1 1/4 diam. Potentiometers. Match above rheostats. Same high grade construction.
L151 200 ohm. Each..... 50c
L152 400 ohm. Each..... 55c

OTHER STANDARD BRAND RHEOSTATS AND POTENTIOMETERS
L207 Filkostat. Each..... \$1.90
L208 Bradleystat. Each..... 1.74
L209 Bradleystat 200 ohm. Each..... 1.89
L210 Bradleystat 400 ohm. Each..... 2.89
L211 Howard 6 ohm Plain Rheo. Ea. 85
L212 Howard 6 ohm Ver. Rheo. Ea. 1.25
L213 Howard 25 ohm Plain Rheo. Ea. 85
L214 Howard 25 ohm Ver. Rheo. Ea. 1.25
L215 Howard 40 ohm Plain Rheo. Ea. 85
L216 Howard 40 ohm Ver. Rheo. Ea. 1.25
L217 Howard 200 ohm Potentiometers. Each..... 1.25
L218 Howard 400 ohm Potentiometers. Each..... 1.69
L219 Klosser 6 ohm Vernier. Each..... 1.19
L221 Klosser 20 ohm Vernier. Each..... 1.55
L222 Amperite with mounting..... 95

SUPERIOR RHEOSTATS
L153 6 ohm. Each..... 69c
L154 20 ohm. Each..... 75c
L155 30 ohm. Each..... 85c
The finest rheostat. Smooth, even action. Best design, best workmanship. Supplied with attractive dial and knob. A rheostat for high grade sets.
Potentiometers to match above rheostats with dial and knob.
L156 30 ohm..... 89c

QUICK ACTING RHEOSTAT
L124 6 ohm. Each..... 79c
L125 15 ohm. Each..... 88c
L126 30 ohm. Each..... 99c
Vernier adjustment at every degree of resistance. Pushing knob in turns off the filament.

COMPOSITION DIALS
L921 Diam. 2 in. for 3-16 in. shaft. Ea. 16c
L922 Diam. 2 in. for 1/4 in. shaft. Ea. 16c
L923 Diam. 3 in. for 3-16 in. shaft. Ea. 22c
L924 Diam. 3 in. for 1/4 in. shaft. Ea. 22c
Handsome dials moulded in one piece of polished black composition. 2 inch size has 270° scale marked 0 to 100 finely engraved in contrasting white enamel. 3 inch size has 180° scale marked 0 to 100.

BAKELITE DIALS
L931—2 in. Diam. for 3-16 in. shaft. Each..... 35c
L932—2 in. Diam. for 1/4 in. shaft. Each..... 35c
L933—3 in. Diam. for 3-16 in. shaft. Each..... 39c
L934—3 in. Diam. for 1/4 in. shaft. Each..... 39c
L935—4 in. Diam. for 1/4 in. shaft. Ea. 48c
Moulded in one piece of genuine bakelite in polished black finish. Finely engraved scale in contrasting white enamel. Sure grip knob that fits the fingers. Higher grade dials for food sets. Match perfectly.

VERNIER DIAL ADJUSTER
L941 Each..... 19c
Easily installed at edge of dial. Gives finest vernier adjustment of condenser or inductance. A great value. Polished black knob.

WE PAY TRANSPORTATION CHARGES EAST OF THE ROCKIES PRESERVE THESE PAGES—ORDER FROM THEM AND SAVE MONEY

THE PRICES QUOTED DELIVER THE GOODS TO YOUR DOOR
OUR GUARANTEE PROTECTS YOU—We handle only the best goods, carefully tested and checked by expert radio engineers. You are assured of getting guaranteed apparatus that will give superior results. And while our goods are best, our prices are lowest. Our goods equal or surpass the claims we make for them. We do not attempt to deceive or mislead. Our reputation for fair dealing is our most valued asset.

HOW TO ORDER—Write your order plainly, state Article Number, Description and Price of items wanted. Send Postoffice or Express Money Order Certified Check or Bank Draft for Total of Order. Prompt Shipment is assured when these directions are followed.

ENCLOSED DETECTOR
One of the finest crystal detectors on the market, supersensitive galena crystal enclosed in heat glass shield. Quick, positive adjustment. Brass parts polished nickel finish.
L730 Each..... 89c

GALENA DETECTOR
Easy fine adjustment. Crystal mounted in cup. Moulded base and nickel plated nickel finish. An unequalled.
L732 Each..... 59c

DETECTOR CRYSTALS
L736 Galena, Arlington tested, piece 19c
L738 Silicon, Arlington tested, piece 19c
L742 Tested, Galena, mounted, piece 9c
L737 Tested, Silicon, per piece..... 9c
L739 Genuine million point crystal. Ea. 29c

STANDARD BRAND FIXED CRYSTAL DETECTORS
The latest development in Crystal Detectors. Give better results and more reliable than old style. Used in Retex circuits.
L743 Greenal Detector, Each..... \$1.48
L743 B Metal Detector, Each..... 2.18
L744 B Metal Crystal, Each..... 1.28
L741 Gold Grain Detector, Each..... 89
L745 Yellow Tip Detector, Each..... 1.79
L746 Du-Tec Crystal, Each..... 27

SUPERIOR VARIABLE GRID RESISTANCE
L167 Each..... 80c
L168 With .00025 Condenser..... 99c
Eliminates hissing, clarifies signals. Capacity smoothly varied from 0 to 6 megohms by half turn of knob. Easily mounted on any panel.

TUBULAR GRID LEAKS AND CONDENSERS
Very convenient. Permit of quick change of leaks or condensers of varying capacity. Condensers leak mounted. Leaks and condensers have same appearance. Each part priced separately.
L849 Grid Leak, Each..... 15c
Resistances—1/2, 1, 1 1/2, 2, 3, 5, 7, and 10 megohms. Specify which size is wanted.
L831 Grid and Plate Condensers. Ea. 39c
Capacities .00025, .0001, .00025, .0005 mfd. Specify which size is wanted.

STANDARD BRAND VARIABLE GRID LEAKS
L177 Freshman base mounting type with .00025 Condenser..... 79c
L172 Durham Variable Grid Leak with Mounting..... 89c
L173 C.R.L. Variable Grid Leak..... \$1.19
L175 C.R.L. Variable Grid Leak with grid condenser..... \$1.48

FRESHMAN MICA CONDENSERS
L512 .00025 mfd. 26c
L513 .0005 mfd. 26c
L514 .001 mfd. 31c
L515 .002 mfd. 31c
L516 .006 mfd. 60c
L517 .01 mfd. 60c

DLBILIER MICADON TYPE 601
L502 .0001..... 28c
L503 .00025..... 28c
L504 .0005..... 28c
L505 .001..... 32c
L506 .002..... 32c
L507 .0025..... 32c
L508 .004..... 40c
L509 .001..... 40c
L510 .001..... 40c
L511 .001..... 60c

BARAWIK QUALITY HEADSETS
L770 Per Set, 2000 ohms..... \$2.98
These headsets have proven on rigid tests to be one of the very best on the market. The tone quality is excellent with an unusual volume. Skilled workmen make them from only the best selected materials. The receiver cases are fine polished brass with polished black car pieces. Fabric covered head band comfortably and quickly fitted to the head. Supplied with 5-foot cord. These sets were designed to sell for much higher prices than we ask, and at our price are a wonderful bargain. We guarantee that you will be pleased with them and agree that they are the best value by far yet offered. If they don't suit you we will cheerfully return your money.

STANDARD BRAND HEADSETS
L754 Baldwin Type (1) with 2000 ohm 33.30
L755 Baldwin Type (2) with 2000 ohm 33.35
L758 Western Electric \$9.50
L759 Federal..... \$5.50
L751 Murdock 56, 2000 ohm..... \$3.25
L752 Murdock 56, 3000 ohm..... \$3.90
L753 Dictograph Aristocrat..... \$6.90

SUPERIOR RADIO JACKS
Finest grade jacks. Improved design. Brass materials. Phosphor bronze springs. Silver contact points. Nickel finish. Mount on panel 1/2 to 3/4 in.
L390 Open circuit. Each..... 39c
L391 Closed circuit. Each..... 45c
L392 Two circuit. Each..... 54c
L393 Single circuit filament control..... 52c
L394 Two circuit filament control..... 69c

STANDARD JACKS AND PLUG
L387 Open circuit. Each..... 27c
L388 Two circuit jack. Each..... 35c
L396 Plug—takes two sets of phones. 35c
Well made, durable, smooth working, nickel finished frame. Well insulated.

SUPERIOR RADIO PLUGS
L395 With 4 set screws for fastening cord. Each..... 35c
L397 Two-way—takes two pair any style cords. Lists for \$1.00. Each..... 59c
Highest grade plugs. Fit any standard jacks. Polished round barrels.

SWITCH CONTACT POINTS
Brass polished nickel finish. All have 1 in. long, size 6-32 screws and two nuts. All prices the same.
Dozen 15c
Hundred \$1.00
Order by Article Number.
L360 Head, 3-16" diam. 1-1/2" high
L362 Head, 3-16" diam. 1-1/2" high
L363 Head, 3-16" diam. 1-1/2" high
Solder Lugs to FH Contact Points
L365 Dozen 8c Hundred 30c

SWITCH LEVER STOP
Brass polished nickel finish.
L386 Dozen 18c Hundred \$1.05

SWITCH LEVERS
Very neat polished black composition knob. Exposed metal parts polished nickel finish. Fitted with panel latching and two set nuts. A high grade
L281 1 1/2" Radius. Each 14c

INDUCTANCE SWITCH
L85 Price including knob and dial. \$1.27
Mounts switch points and contact lever. One hole needed to mount. 15 switch points, any number of which may be used.

BINDING POSTS
Brass polished nickel finish. Washer and 6-32 in. screw extending 3/4 in.
L370 Large size—barrel and knob 3/4" long. Dozen..... 70c
L372 Small size—barrel and knob 3/4" long. Dozen..... 70c
L374 Large size with composition knob Dozen..... 45c
L376 Large size with hole for phone tin of wire. Dozen..... 80c
L378 Small size with hole for phone tin of wire. Dozen..... 35c

SUPERIOR INDUCTANCE SWITCH
L288 Each..... 85c
Quickly and securely mounted by drilling one hole. On knob and pointer show in front of panel. Connections can be soldered before fastening switch making assembly much easier.

PLATE CIRCUIT "B" BATTERIES
You can make real savings on these batteries. We guarantee them to equal any on the market regardless of price. Expect long life. Don't throw away your money in cheaper inferior useless batteries.
L180 Signal 'C' type, small size, 15 cells, 22 1/2 volts. Each..... \$1.10
L182 Large size, 5 taps 10 1/2, 18, 19 1/2, 21 and 23 volts. Each..... \$1.45
L184 Variable Large Navy size, 16 1/2 volt inches 5 taps, giving range from 16 1/2 to 22 1/2 volts in 1 1/2 volt steps. Each \$1.95
L188 Combination Tapped 45 volts, 30 cell, 13x13 battery. Tapped to give 45, 22 1/2, 21, 19 1/2, 18 and 16 1/2 volts. Handles both detector and amplifier tubes. Ea. \$3.28

"B" BATTERY METER

L189 Each..... 90c
Reads 0 to 50 volts. Accurately tells you the exact condition of your B Battery. Converter switch size. Polished nickel case with wire lead.

STORAGE "A" BATTERY

A high grade battery. Guaranteed for three years. Made of best new materials. Full capacity. The best battery buy on the market. Try one of these batteries on your set for 10 days. If at the end of that time you are not fully satisfied with the battery return it and we will refund the Purchase Price.
L194 6 volt, 40-80 ampere size. Ea. \$ 9.90
L196 6 volt, 80-120 ampere size. Ea. \$13.25

HOMECARGER BATTERY CHARGING RECTIFIER

Charge your battery at home overnight for a few cents. Simply connect to any 110 volt 60 cycle light socket, turn on current and rectifier does the rest automatically. Will work for years without attention. Simple construction. Give a tapering charge which batteries should have. You can make it pay a profit charging your friends' batteries. Long connecting cords with pair of battery clips.
L261 For 6 volt battery..... \$12.95
L263 For 12 volt battery..... 12.95

HYDROMETER

L190 Each..... 48c
Accurately tells you the condition of your storage battery. Helps you keep your battery in better condition.

BATTERY CLIPS

L198 Two for..... 28c
Clip onto storage battery terminals, lead coated. Make positive non-corrosive contact at all times.

WIRE CONNECTING CLIPS

L199 Per dozen..... 30c
Small connecting clips for quickly fastening leads on to binding posts, etc. Handy and useful. Every radiolist should have at least a dozen.

MELOTONE LOUD SPEAKER

L611 Price \$4.85
One of the best popular priced speakers. Talks loud and clear. Compares favorably with more expensive makes. Fibre horn. Heavy metal base. Five foot cord. Nickel plated goose neck. 6 1/2 in. bell. Size over all 14 1/2 in.

STANDARD BRAND LOUD SPEAKERS AND UNITS

L610 Murdock Loudspeaker..... \$4.38
L613 Barawik with Baldwin unit..... \$11.25
L614 Atlas Loudspeaker..... 22.50
L616 Atlas Loudspeaker..... 22.50
L612 Magnavox M3 Loudspeaker..... 32.50
L614 Magnavox R1 Loudspeaker..... 32.50
L617 Music Master Loudspeaker..... 27.00
L755 Gene Baldwin type C Unit..... 5.10
L619 Murdock Special Unit..... 2.60
L618 Brandes Table Talker..... 6.75
L620 Baldwin Loud Speaker..... 27.00
L609 Dictograph Dictostrand..... 21.50
L608 Atlas Unit. Each..... 10.75
L607 Western Electric Unit. Each..... 10.75

PHONODAPTER

L771 Each..... 39c
The Phonodapter will fit any phone. Metal tube fits any standard phonograph. Make your phonograph a radio talker. Fits Columbia, Victor, Edison Sonora phonographs. Is made entirely of pure soft rubber with brass tube insert.

THE BARAWIK CO. Chicago's Original Radio Supply House Beware of Imitators 102 South Canal St., Chicago, Ill.

IT IS EASY TO BUILD YOUR OWN RADIO SET

GUARANTEED QUALITY GOODS

at money saving prices. There are no strings tied to our prices. Order what you want—be your order large or small. You will get immediate service from the most reliable source of radio supply house. Before you consider buying elsewhere, ask your banker as to our responsibility and financial rating. You will find that we stand high in the commercial world and we have earned our standing only through fair dealing, prompt service and by offering merchandise of high quality at prices unequalled by others.

FAMNESTOCK CONNECTORS

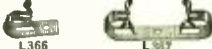

L366 Single, Dozen \$25e
L367 Double, Dozen \$39e
 Handy and convenient for connecting wires or making connections on binding posts or other brass instruments. Wires held firmly in spring grip but may be instantly removed.

UNIVERSNIER CONTROL DIAL

L918 For 3-16 inch shaft \$1.15
L919 For 1/4 inch shaft \$1.15
 Replaces ordinary knob or dial. Gives perfect vernier control on condenser, variometer, varicap, etc. Positive easy action. Looks fine. Easily installed. Especially desirable in tuning retrodynam sets.

RADIO SWITCH

L287 Each 28c
 Cuts current on and off instantly by a push of button. Very neat. Well made. Durable. Saves tubes and batteries.

BEZELS

L399 Diameter 1 1/2 inch, Each 15c
L400 Diameter 1 1/4 inch, Each 15c
 Polished nickel finish. Finest quality. Fit any thickness panel. Greatly improve appearance of panel.

CABINETS

Fine looking cabinets solidly built. Elegant dark mahogany finish. You will be proud of your set mounted in one of these cabinets.
 Hinged top. Front rabbeted to take panels. Panels not included. Prices are transportation paid. Note that our prices are prepaid.

Panel Size	Inside Dimensions High Wide Deep	Art. No.	Price Each
6x7	5 1/2" 6 1/2" 7"	L420	\$1.95
6x10 1/2	5 1/2" 9 1/2" 7"	L421	2.45
7x10	6 1/2" 9 1/2" 7"	L421	2.60
7x12	6 1/2" 11 1/2" 7"	L424	3.05
7x14	6 1/2" 13 1/2" 7"	L423	3.20
7x16	6 1/2" 15 1/2" 7"	L426	3.45
7x21	6 1/2" 20 1/2" 7"	L425	3.85
7x24	6 1/2" 23 1/2" 7"	L429	4.35
7x26	6 1/2" 25 1/2" 7"	L431	5.50
8x14	6 1/2" 13 1/2" 10"	L430	4.00
8x14 1/2	11 1/2" 13 1/2" 10"	L430	4.00
8x21 1/2	11 1/2" 20 1/2" 10"	L432	5.05

RADIO "BAKELITE" PANELS

Notice our very low prices on this fine quality material. Others ask as much for hard rubber panels which are worth much less. We supply genuine Bakelite, Condensite, Cellon or Formica, all of which are materials with practically identical mechanical, chemical and electrical properties. Machines well without chipping. Won't warp. Waterproof. Highest mechanical and dielectric strength. Attractive natural polished black finish which can be sanded and oiled. Note that our prices are prepaid.

Panel Size	1/4" thick	3-16" thick	1/2" thick
Art. No.	Price	Art. No.	Price
6x7	L450 \$0.55	L460 \$0.65	L470 \$1.15
6x10 1/2	L451 .86	L461 1.10	L471 1.73
7x14	L458 1.38	L468 1.73	L478 2.76
7x18	L453 1.78	L463 2.27	L473 3.56
7x21	L457 2.05	L467 2.65	L477 5.10
7x24	L459 2.42	L469 2.97	
7x26	L464 2.85	L472 3.25	L474 3.56
8x14	L454 1.05	L465 2.97	L475 4.78
8x21 1/2	L456 3.62	L466 4.25	L476 7.13

RUBBER COMPOUND PANELS

Made of a special compound having a rubber base. Equal in appearance and in all essential points to any other class of panels. Fine smooth polished finish. Can be drilled or cut without chipping. Guaranteed not to warp and to be a perfect insulator for radio use. Smooth, clean edges. Thickness 3/16 inch. Size given is in inches.
L481 7x10 \$.88
L482 7x12 1.05
L483 7x14 1.22
L484 7x18 \$1.60
L483 7x21 1.85
L483 7x21 1.22
L486 7x21 2.10

PANELYTE RADIO PANELS

A new practical radio panel. High dielectric strength, rigid and durable. Easy to drill, tap or refinish. Black in color, polished on one side, matte grain on other side. 3-16 inch thick.
L487 7x10 \$1.28
L488 7x1284c
L489 7x1496c
L490 7x18 \$1.28
L491 7x21 1.44
L492 7x21 1.68

Over 30,000 Barawik Radio Sets are Operated All Over the World

All of these sets were built with Barawik Standard Radio Parts mostly by persons without any previous radio experience. These home made sets equal in results the best factory made sets—many are even superior and at a cost only a fraction of the cost of the factory made sets. You can easily equal these results by following directions given in the numerous magazine articles on radio. Also directly below you will find listed Blue Prints, Instruction Books and books. With the help of these anyone can successfully make a Radio Set.

RADIO BOOKS

That every Home Builder and Amateur needs. Written in plain simple language everyone can understand.
L631 100 Radio Hookups, Each 25c
 Shows hookups from the simple crystal set to the more elaborate and latest tube circuits. Numerous types of Reflex super-regenerative, super-Heterodyne, Neurodynam, Reinartz, Flewelling, Bishop, etc.
L632 How to Tune Your Radio Set, Each 25c
L633 How to Build Loud Talkers, Each 25c
L634 How to Make Radio-Phone Receiver Sets, Each 25c
L635 How to Make Radio Frequency Amplifiers, Each 25c

SPIDER WEB COIL FOR REINARTZ CIRCUIT

L296 Each \$1.15
 Lists for \$2.50. A very unusual bargain. Made of green silk covered wire, spider web wound to produce greatest efficiency and lowest losses. 21 taps so arranged that crossing is avoided. Two fibre strips and wooden rod permit various styles of mounting. With this coil a high grade set can be built at a low cost. Directions included.

ULTRA AUDION COIL

L297 Each \$5e
 Spider web wound of green silk covered wire. Four taps. Produces wonderful results. Fibre strips and wooden rod for mounting included. Directions furnished.

COCKADAY COILS

L298 Per Set \$1.95
 Compelte set coils for Cockaday circuit. Properly calculated and made to give best results on this new wonder circuit.

NEUTRODYNE TRANSFORMERS

L571 Each \$1.75. Per set of three, \$4.95
 An air core transformer for use in neurodynam method of reception. Can also be used for tuned radio frequency. Also furnished complete with condenser across secondary. Proper design for results and efficiency. Green silk windings on bakelite tubes with adjustable mounting brackets to fit most any condenser.

NEUTRALIZING CONDENSERS

L572 Per set of two \$4.0c
 Simple, inexpensive, effective Precision type. Micrometer adjustment is attainable. Easily mounted in circuit.

STANDARD NEUTRODYNE PARTS

L851 WorkRite Neurodynam (combined transformer and condenser), Each \$4.78

L852 WorkRite Neurodynam Kit \$14.95
L853 WorkRite Neurodynam Kit \$3.20

AMSCO COMBENASTING CONDENSER

L854 AmSCO Combenastng Condenser, Each \$2.89
 A 3 electrode condenser for balancing the grid charge on amplifying tubes. Stops all local oscillations without detuning amplifier. Shielded against hand capacity. Complete with 2 inch dial. Provides perfect and rapid control of tube.

L853 WorkRite Neurodynam, Each \$4.3e
 A very accurate and easily adjusted condenser for neutralizing tubes.

L855 Fada Neurodynam Parts \$25.00
 A combination package of three neurodynamers and two neurodynam with instruction book.

L856 Fada Parts for 4 tube set, complete \$64.00
L857 Fada Parts for 5 tube set, complete \$65.60

Contains all necessary parts including drilled panel, careful instructions, sockets, dials, condensers, transformers, bus bar wire and fine mahogany finish cabinet.

ANTENNA LEAD-IN

L259 Each 25c
 Solves a long standing problem. With it you can bring in the antenna wire without drilling a hole for an insulator. Place on window sill and window can be closed down tight and locked as before. Takes but a minute to install. Perfectly insulated. Can be bent into any shape. Made of copper strip properly insulated. Neat and durable.
 We offer our agents 20 percent discount on nearly all standard goods not listed on these pages. Send us Your order—we give you the right price.

PRINTS OF POPULAR CIRCUITS

These prints give a full-size panel layout, schematic hookup, hook-up showing parts wired and explanatory notes. With them as a guide anyone can build a set that will operate perfectly and bring in the long distance stations.
L621 One Tube Reflex and Amplifier, Each 10c
L622 Single Circuit Tuner, Each 10c
L623 Reinartz Tuner using Spider Web Coil, Each 10c
L624 Radio and Audio Frequency Amplifier, Each 10c
L625 Short Wave Regenerative Set, using two Variocouplers, Each 10c
L626 Honeycomb Coil Circuit and Amplifier, Each 10c

Complete Sets of Parts for Popular Circuits

Only high grade parts are used in these sets and each part is guaranteed to be Perfect. Each one of these circuits has been tried and successfully operated under many different conditions. The detailed instructions and diagrams supplied with each set make it easy for any one without previous experience to build an outfit that will give most satisfactory results.

HAZELTINE NEUTRODYNE 5 TUBE CIRCUIT

L858 Complete set parts \$39.50
 Essential parts licensed under Hazelitine patents. A set that will give really wonderful results. Only the highest grade parts are used. The following items are included:
 1—7x24x16 Formica Panel.
 2—Rheostats with dials.
 3—4 inch Bakelite dials.
 4—Bakelite sockets.
 5—Composition top binding posts.
 6—0005 Bakelite end variable condensers.
 7—7x24 high grade cabinet.
 8—Base board for mounting.
 9—Neutralizing Condensers.
 10—Variable grid leak and condenser.
 11—Baravik audio transformer.
 12—Base board for mounting.
 30 ft. tinned bus bar wire.
 Instructions for assembling and wiring.

ERLA SINGLE TUBE REFLEX CIRCUIT

L859 Complete set parts \$18.95
 The following parts are included:
 1—Erla Reflex No. 1 Transformer.
 2—Audio Transformer.
 3—Varicoupler silk windings on bakelite tube.
 4—0005 Bakelite end Variable Condenser.
 5—Bakelite standard base sockets.
 6—002 Mica condenser.
 7—00025 Mica condenser.
 8—Fixed detector.
 9—High grade rheostat.
 10—7x12 Bakelite panel.
 8—Binding posts with composition tops.
 11—dozen switch points and 4 stops.
 12—Switch levers.
 13—7x14 1/2 Bakelite panel.

AUTOPLEX CIRCUIT

L860 Complete set parts \$13.25
 A single tube circuit that brings in signals loud enough for a table talker. The following parts are included:
 1—Wood form Variometers silk windings.
 2—7x12 Bakelite panel.
 3—2 inch polished black dials.
 4—1250 turn honeycomb coil.
 5—Bakelite socket with standard base.
 6—6 ohm rheostat.
 8—Composition top binding posts.
 9—Name plate wire.
 10 feet bus bar wire.
 1—Autoplex pattern.
 1—Fine 7x12 cabinet mahogany finish.

COCKADAY CIRCUIT

The following parts are included:
L861 Complete set parts \$13.35
 1—Set Cockaday coils.
 2—2 inch polished black bakelite dials.
 1—Bakelite socket for standard base.
 1—Freshman grid leak and condenser.
 1—Double Rheostat.
 8—Composition top binding posts.
 2—High grade switch levers.
 3—Yerxk Rheostat.
 1—7x14 1/2 Formica panel.
 3—0005 bakelite end variable condensers.
 1—Base board for convenient assembling.
 10 feet tinned bus bar wire.
 Diagram and instructions.
L823 Cabinet extra \$3.20

MIGNON VERNIER VARIABLE CONDENSERS

L827 .0002 M.F. Each \$2.30
L828 .0005 M.F. Each 2.90
L829 .001 M.F. Each 2.75
 Highest grade instruments. Accurate rating. Extremely low dielectric losses. Independent friction vernier control insures perfect positive adjustment. 3/4 inch shaft. No dial included.

"CONSOLIDATED" RADIO PLAN PACKETS

Designed and laid out by the foremost radio engineers. With their help you can build an outfit that will give the finest results. Every packet contains complete instruction for the construction and tells what tools and parts are needed. Detailed directions for drilling, mounting and wiring, also how to handle set after it is built. Thousands of sets have been built from these plans and are in perfect operation. Folder giving detailed description of each packet sent on request. For more complete description of these packets see the Consolidated Co. advertisement in this magazine.
 Price per packet 42c

Order item wanted by article number.
L640 How to make a Neurodynam Receiver.
L641 How to make a Reinartz Receiver.
L642 How to make a Regenerative Receiver.
L643 How to make a Cockaday Receiver.
L644 How to make a Reflex Receiver.
L645 How to make Detector and Amplifier Units.
L646 All about aerials and their construction.
L647 Twenty Radio Diagrams of Latest Hook-up Posts with perfect operation.
L648 14 Radio Formulas and Diagrams.
L649 How to make an Autoplex Receiver.

FLEWELLING CIRCUIT

L864 Complete set of parts \$12.39
 The following parts are included:
 1—7x12 Bakelite panel.
 1—0005 Bakelite end variable condenser.
 2—006 Mica condenser.
 1—2 coil honeycomb mount.
 1—Variable grid leak and condenser.
 1—50 turn honeycomb coil.
 1—75 turn honeycomb coil.
 1—coil mounts with straps.
 2—3 inch polished black dial.
 1—Bakelite socket for standard base.
 1—Vernier 6 ohm rheostat.
 8—Binding posts with composition top.
 1—Base board for assembling.
 Instructions for assembling and wiring.

REINARTZ CIRCUIT

L862 Complete set parts \$10.75
 The following parts are included:
 1—7x18x16 Bakelite end variable condenser.
 1—Bakelite socket standard base.
 1—Vernier Rheostat.
 1—0005 Bakelite end variable condenser.
 2—3 inch polished black dials.
 3—Switch levers.
 1—Green silk insulated coil.
 1—Freshman variable grid leak with condenser.
 1—dozen insulated top binding posts.
 30 ft. tinned bus bar wire.
 Instructions for assembling and wiring.
L426 Fine 7x18 Cabinet mahogany finish. Extra \$3.45

REINARTZ CIRCUIT

Note—The above amplifier. Set can be supplied with 2 additional condensers, 2 audio transformers, 2 additional rheostats and size and include amplifier.
L863 Complete with two stage amplifier.
L425 Fine 7x21 Cabinet mahogany finish. Extra \$4.65

ULTRA AUDION CIRCUIT

L865 Complete set parts \$8.95
 The following parts are included:
 1—Spider web coil with taps.
 1—0005 Bakelite end variable condenser.
 1—7x12x16 Bakelite panel.
 1—Bakelite socket for standard base.
 1—Variometer with silk windings.
 1—Vernier 6 ohm Rheostat.
 1—Fixed grid leak with condenser.
 8—Binding posts with composition tops.
 1—Base board.
 10 feet nickelled bus bar wire.
 Diagrams and instructions.
L424 Fine 7x12 cabinet mahogany finish. Extra \$5.05

The ultra audion circuit gives fine results with two stages of amplification added.

Set as above with 7x18 panel and 2 audio transformers, 2 additional bakelite sockets and 2 additional rheostats.
L866 Complete \$15.95
L426 Fine 7x18 cabinet mahogany finish. Extra \$3.45

LIGHT SOCKET ANTENNA

L251 Each \$970
 Screws into any light socket. Replaces the regular cut door antenna. Very satisfactory for nearby stations and under favorable conditions will bring in distant stations. Easy to install. No danger. Gives clear reception with little static interference. Ideal for people in apartment buildings.

RADIO SOLDER SET

L538 Complete \$3e
 Handy for soldering radio connections or for general small repair jobs. Consists of soldering copper with handle, sal ammoniac, soldering salts, solder and sand paper.

THE BARAWIK CO. Chicago's Original Radio Supply House Beware of Imitators **102 South Canal St., Chicago, Ill.**

Radio Broadcast Contest reveals Bradleystat supremacy for Long Distance Reception



RADIO Broadcast recently conducted a prize contest, open to all radio enthusiasts, for the purpose of interesting amateurs in long-distance reception. Ninety contestants were entered, and the names of all, including prize winners, were published in several issues of Radio Broadcast, after the contest closed.

How the remarkable Bradleystat records were discovered!

AFTER the names were published, a letter was written by the Allen-Bradley Co. to each contestant to ascertain what filament rheostat was used in each radio set. Seventy-two reports were received, and after they were tabulated, the most amazing discoveries were made about Bradleystat performance and Bradleystat popularity.

The Bradleystat captured first place in all leading events!

The superiority of the Bradleystat was proved, conclusively, by these facts:

1. The First Prize Winner used the Bradleystat in his set.
2. The greatest mileage record of 305,420 miles, total, was made by a Bradleystat user.
3. The Bradleystat was the most popular rheostat in the entire contest.
4. More Bradleystats were used than the next four types of rheostats, combined, see diagram.
5. No carbon or metallic powder rheostat was reported in competition with the Bradleystat in this record-breaking contest.

Your radio set needs a Bradleystat. Try one tonight!



\$1.85

IN CANADA

\$2.50

PARCEL POST
10¢ EXTRA



Bradleystat Leads by Big Margin



Analysis of Returns

Each line represents a different type of rheostat used in the contest. The numbers indicate how many of each were used. Note the overwhelming popularity of the Bradleystat, first on the list.

Allen-Bradley Co.

Electric Controlling Apparatus

287 Greenfield Avenue



MILWAUKEE, Wisconsin

THE ALLEN-BRADLEY CO. HAS BUILT GRAPHITE DISC RHEOSTATS FOR OVER 20 YEARS

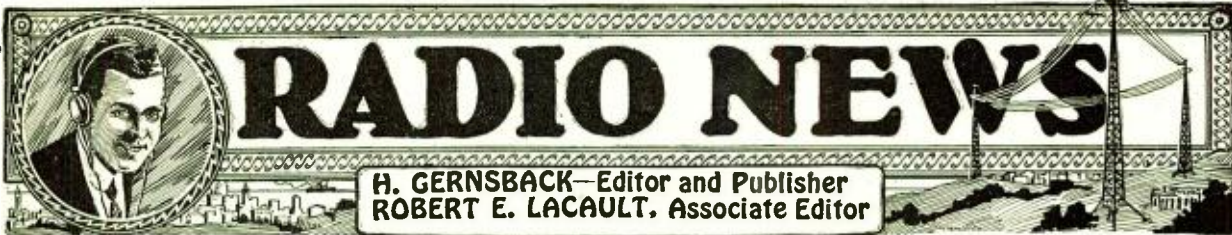

H. GERNSBACK—Editor and Publisher
ROBERT E. LACAULT, Associate Editor

EDITORIAL AND GENERAL OFFICES, 53 PARK PLACE, NEW YORK

Vol. 5

FEBRUARY, 1924

No. 8

The Hook-Up Fever

By H. GERNSBACK

WE are now in the midst of one of those peculiar outcroppings of radio which is unique in the art. We refer to the hook-up craze, which once more has taken not only this country, but perhaps the entire world, by storm. Not that the hook-up craze is new—it existed when the radio art was still young. The writer remembers that, away back in 1909 and 1910, in his first radio magazine, *Modern Electrics*, there can be found evidences of a hook-up craze. At that time the vacuum tube was unknown to the general public, and few amateurs and experimenters had ever heard of it. It was still in the laboratory stage; indeed, as the pioneer of the vacuum tube, Dr. Lee DeForest, was still experimenting with it. But we had the coherer, the crystal detector and the electrolytic detector. We had condensers, variable and fixed. We had tuning coils and loose couplers. These started the first hook-up fever. Every radio amateur, even though endowed with but a little originality, had his own pet hook-up.

For those good souls who do not know what we are talking about, let us enlighten them by saying that by a hook-up in radio is meant the wiring that connects the various instruments together. These hook-ups, which really are electrical circuits, follow some well defined laws. In many cases, however, they are no more than mere custom.

Taking an aerial, ground, a crystal detector, a pair of phones and a tuning coil, it is obvious that many combinations of connecting these instruments together are possible. All of them have been tried out. In the end, there may be five or six hook-ups that have been evolved from experiments and which are found to work efficiently. These then become known as standard hook-ups.

But as the art progresses and radio instruments multiply, it will be seen immediately that the combinations of hook-ups that are possible, with even a limited number of radio instruments, become enormous. At the present time, among standard radio instruments may be found vacuum tubes, which themselves fall into two groups—detector and amplifier tubes. Then we have various transformers such as Radio Frequency and Audio Frequency, the Radio Frequency standing for distance, the Audio Frequency for loudness of the signals received. Then we have phones or loud-talkers; condensers, fixed and variable; rheostats and potentiometers; grid leaks and high resistances; variocouplers and variometers; concentrated inductances such as honeycomb or spider-web coils; and the end is not yet. Taking just these few instruments which we mention, it becomes obvious that several million combinations of hook-ups are possible. It is like taking a stack of cards and trying to figure out all the combinations that are possible while a game is being played. These combinations run into the millions.

In our present day hook-up boom, we might say that we have only scratched the surface. Evidently, all the radio experimenters know this, for they are sitting up through many nights at a stretch, trying out new combinations. Every once in a while some ingenious amateur or research man comes across a hook-up that was not known before and if it be strictly original, not only fame, but fortune, awaits the tireless worker. Armstrong is an instance of this with his regenerative circuit, which is one of the best hook-ups, even

today, and which has not only brought him fame, but \$1,000,000 in cold cash as well.

No wonder then that the whole radio world has gone hook-up mad! Every possible, and impossible, combination has been tried. What does it matter if vacuum tubes are blown out, if the birth of a sacred new hook-up is at stake? Anything and everything is tried and frequently so-called "freak" hook-ups are evolved. The "freak" hook-up, by the way, is one that works well, but does not work along orthodox lines and is, therefore, sneered at by the radio experts—so-called.

Indeed when it comes right down to the finer workings of a hook-up there are few people who really know what happens within the circuits. The action of the vacuum tube is so involved that there are but few persons living today who have a correct inside knowledge of the mysterious "glass bottle." But why go so far as that? There is probably no man alive today who knows exactly what happens in a crystal detector.

In the meanwhile, the expert and "inexpert" merrily continue with the hook-up race and every day presents new surprises. One can hardly open a radio magazine, or newspaper containing a radio section, in which a new hook-up is not discussed. To show the trend of the times and how rapidly the hook-ups change, we mention just a few of the more prominent hook-ups. When broadcasting became stylish, there was, first of all, the Armstrong regenerative circuit, which has its many adherents and quite a number of those who do not uphold it. This is particularly true of the single circuit hook-up, which, while excellent, sends out waves into the ether to the great annoyance of other broadcast listeners when tuned by inexperienced persons. Then we had the Reinartz, the super-regenerative, the Reflexes, then the Neutrodyne. Of recent date the Autoplex, and the latest and perhaps the most popular, the Super-Heterodyne circuits came to the fore. These latter are perhaps the most sensitive, so far evolved, because with their use tremendous ranges can be covered, never dreamt of, even a year ago.

While, of course, the hook-up craze is harmless, as well as an exciting sport, which really is most interesting because it sharpens our wits, it presents also the poor sides of the game. We refer to the unscrupulous radio dealers who advertise their own "hook-ups" under some fancy jaw-breaking name. Indeed, there is hardly a radio store today that has not its own pet hook-up. Many of these are unquestionably good, but some irresponsible dealers are getting up hook-ups for the express purpose of moving surplus parts with which they are overstocked. They proceed to evolve a hook-up that contains half a dozen parts which are really not required, are unnecessary, and burden the ultimate victim with a lot of junk which he will promptly discard as soon as he finds out the swindle. The consumer should beware of such fancy hook-ups and he should keep in mind that if the particular hook-up were really good, the radio magazines and newspapers would be glad to publish it. Of course, there are stores that advertise hook-ups under special names, but they are really only well known ones with minor changes, and as long as the customer knows what the particular hook-up is, and knows that the brand of merchandise sold him is good, there can be no great harm in this custom.

The First European Radio-Telephone Service

By DR. ALFRED GRADENWITZ
Berlin Correspondent of Radio News

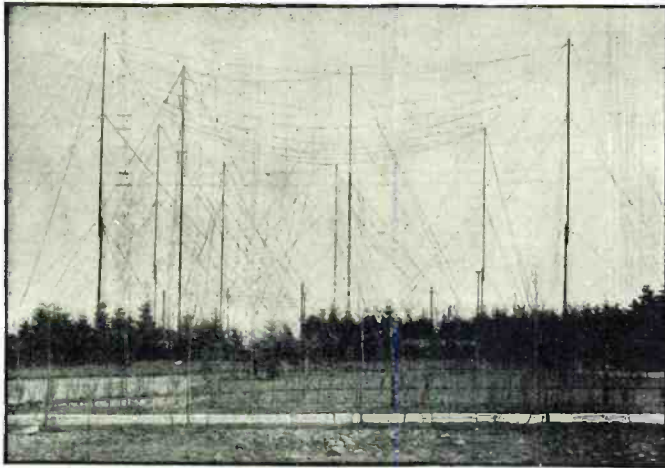

Fig. 1. The Elaborate Transmitting Antenna at the Copenhagen Station.

In the case of the Copenhagen-Bornholm service, a radio telephone station newly erected at Lyngby is used at the Copenhagen end. Figs. 1 and 2 show the antenna masts and the Lorenz-Poulsen transmitter. A loop aerial on a mast 30 feet high is used for receiving. A receiving station has been installed in the Isle southeast of Copenhagen where the distributor has been put into operation.

At the Bornholm end, there is likewise provided a Lorenz-Poulsen transmitter installed at the Hammeren Radio Station while the receiver has been put up near Ronne harbor on the western coast of the island.

In connection with tests made previous

A DUPLEX radio telephone service connecting the Danish capital with the far distant rocky island of Bornholm, which so far has been without any telephone or telegraph connection with the rest of the country, has just been inaugurated. While the most striking feature of this service is a combination of radio with wired telephones, the telephone subscriber at either end does not require any special apparatus or installations, but uses his ordinary telephone. He rings up the telephone exchange and is connected by wire- less from the State Telephone with the subscriber on the Isle of Bornholm.

The peculiar difficulties that had to be overcome were mainly due to the low intensity of the currents set up by talking into the microphone. On the other hand, in order to be carried with sufficient acoustic intensity through the telephone line on the island to the subscriber the weak received impulses had to be reinforced. This is achieved by means of up-to-date vacuum tubes.

The main problem to be solved in transferring the electric waves to the telephone line and vice versa is giving duplex service, i. e., simultaneous transmitting and receiving without any mutual interference. The proper distribution of the transmitting and receiving currents is effected by means of a "distributor" built on the Wheatstone bridge principle.

Fig. 3. The 30-ft. Loop Aerial Used for Receiving the Radio Telephone at the Bornholm End of the Circuit. The Small Building Houses All the Relay Apparatus Which Permits Continuous Duplex Operation. This System is Similar to the One Now in Operation Between the Coast of California and Catalina Island.

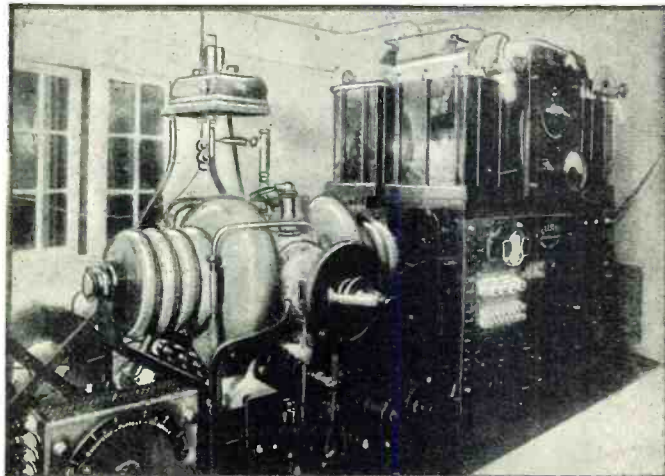
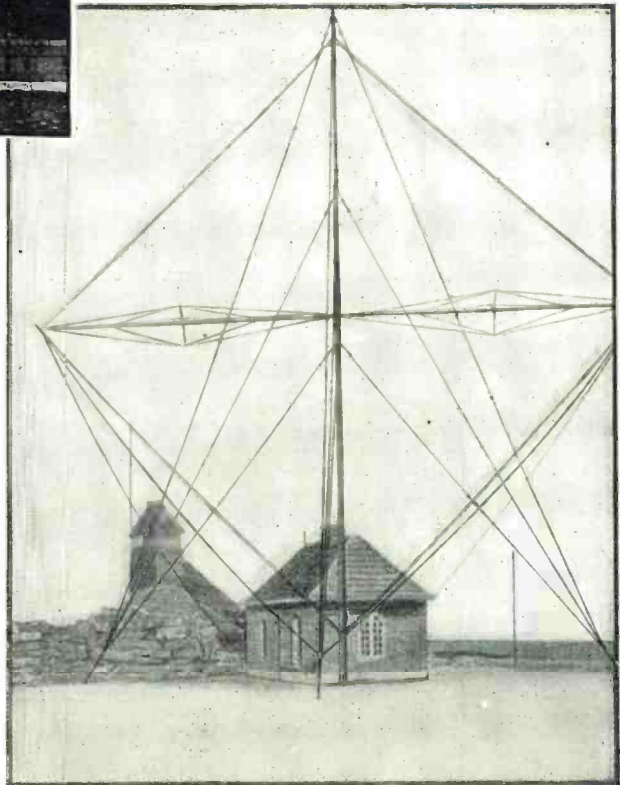

Fig. 2. The Lorenz-Poulsen Arc Transmitter at the Bornholm Plant.

to the opening of the new service the apparatus was worked between Copenhagen and Berlin. These tests gave excellent results and were favorably discussed in the daily press, and tests with the American steamer "United States" in which the ship's captain maintained a telephone connection with a subscriber to the Copenhagen telephone system, caused a sensation.

Every subscriber to the Copenhagen telephone system will henceforth be in a position to speak with any Bornholm telephone subscriber.

This is the first regular radio telephone service in Europe. It has been installed by the C. Lorenz firm of Berlin and was inaugurated in the presence of the King of Denmark.

The first radio telephone circuit in the world was established between the coast of California and Santa Catalina Island. This is being used with great success. The telephone centrals at both ends are connected to the duplex radio systems and two way conversation is carried on.

Popular Radio Coming In Austria

By ARMSTRONG PERRY



At the present time the use of radio transmitters and receivers is prohibited in Austria, but there are several individuals over there who take an unusual interest in broadcasting and reception. Through their efforts, Austria will no doubt break into radio mania in the near future—like the rest of the world.



THE radio amateur is hard to find in Austria because, if found, he usually gets "pinched." The government, nominally social-democratic, is neither when it comes to radio. Everything is so unsettled and uncertain in the dismembered country that they even have two sets of policemen in Vienna, one to watch the other.

But if the radio amateurs have learned to play one party against the other in such a way as to give radio a chance, they are keeping still about it. A millionaire, a baroness and a professor all told me that they knew where there were private stations in operation. But they were not giving out names or addresses.

The Austrian who wants to play with radio without being in danger of going to jail must become a government official, attend a government school, or join the Army. There is no Navy radio, for Austria's only seacoast was handed over by the treaty of Versailles to Italy. Among other things, she lost all but three of her radio stations, as a result of the war.

The United States is using one of the remaining radio stations, the one at Laarburg, near Vienna. Early in June this was handling government traffic via Constantinople and Paris. The chief operator's name was, of course, Sweeney. At about the same time it was reported that the Marconi Company had bought the Laarburg station and would put on a program of broadcasting. Since the government prohibits private radio receivers, it seemed obvious that the Marconi Company must be planning either to broadcast for the benefit of listeners in Switzerland, Belgium, England, France and Holland, who would have to be DX fiends if they picked up the broadcasts at such distances, or else to change the government.

At the Marconi headquarters in London they were entirely willing to give the public the whole truth, which was that at the pres-

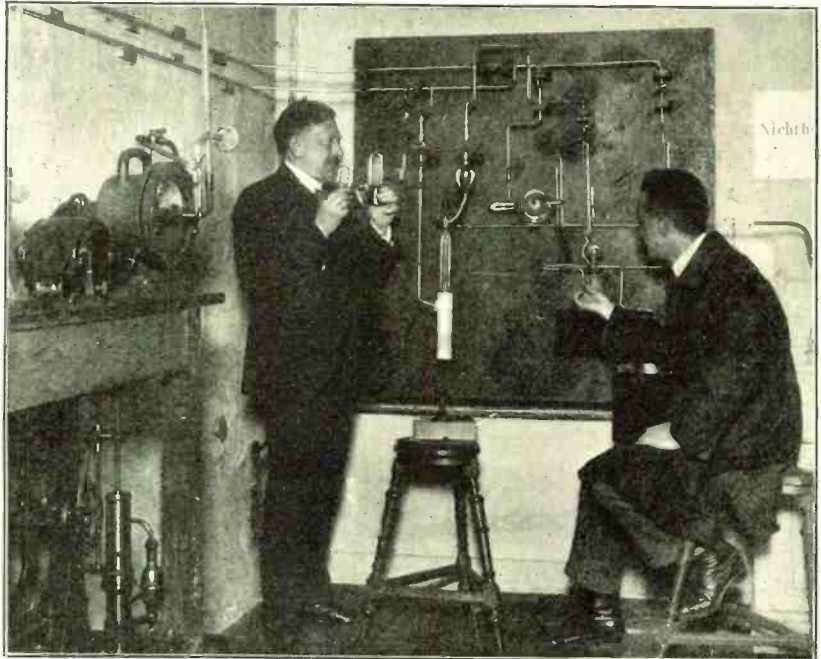

Dr. Max Reithoffer (Left), Austria's Outstanding Radio Expert, and I. E. Wolf, Who Assists Him at the Technical Institute in Vienna. The Tube in the Doctor's Right Hand is a Detector and Sells for Fifty Cents in Austria!

ent stage of negotiations there was nothing to say. Later they announced that they had secured the monopoly of international radio communication in Austria.

The real center of radio interest, both amateur and otherwise, in Vienna, is evidently *Das Elektrotechnische Institut der K.*

Technischen Hochschule in Vienna. I went there and was most cordially received by Dr. Max Reithoffer, Professor der Elektrotechnik, and by his assistant, Ingenieur Emil Wolf.

Dr. Reithoffer spoke German, Mr. Wolf French, and I English, so we had not the slightest difficulty in understanding that when the eight-foot loop was turned toward Berlin it brought in the stock market reports more distinctly. At times, while we were testing out the six-stage amplifier (yes, four of radio and two of audio) and discussing the prices of tubes and phones and other things we worked ourselves up into a sort of feast of pentecost, in which, though each spoke in his own tongue, all understood. At other times, when I wanted to be sure of my ground, I accepted the services of the interpreter furnished me by J. F. Ziegler, the biggest meat packer and best sport in Austria.

DOUBT AS TO WHEN AUSTRIA WILL HAVE BROADCASTING

Neither Dr. Reithoffer nor Mr. Wolf could tell when or how the broadcasting of concerts, lectures and other programs such as we have in America would begin in Austria. There had been some broadcasting, experimentally, they said, looking around guardedly at their own transmitting outfit. "Did any government official hear?" I asked.

"No, they never listen," was the reply. About one thing they were perfectly sure: When the broadcasting era does arrive, as of course it must, the Electrotechnical Institute will be in the forefront of the movement. Dr. Reithoffer is at the head of it and he is fully awake to the benefits that the country

(Continued on page 1126)

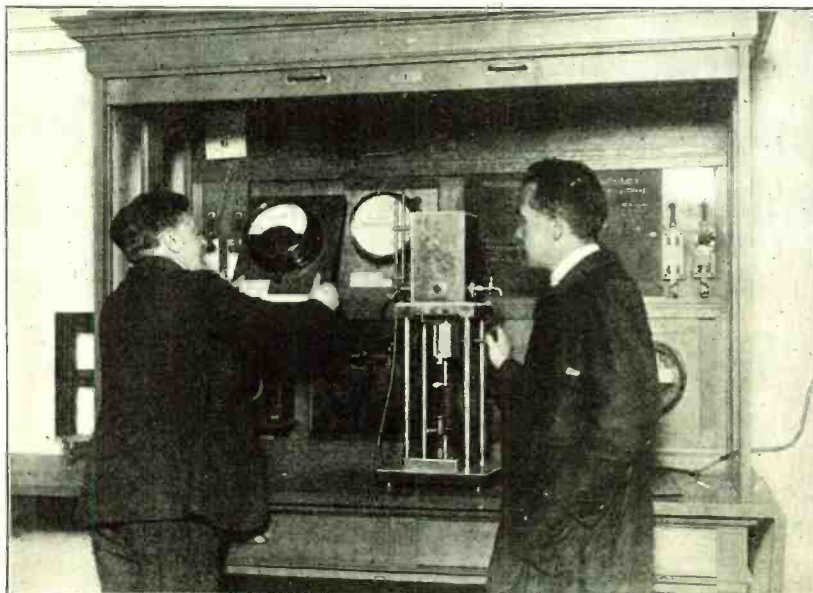

Dr. Max Reithoffer, and I. E. Wolf, His Assistant, Operating a Poulsen Arc at the Government Radio Institute.

The Star Antenna of Eilvese

By DR. ALBERT NEUBURGER

A very interesting description of the transmitting station at Eilvese, Germany, which at the present time handles most of the commercial traffic for the United States.

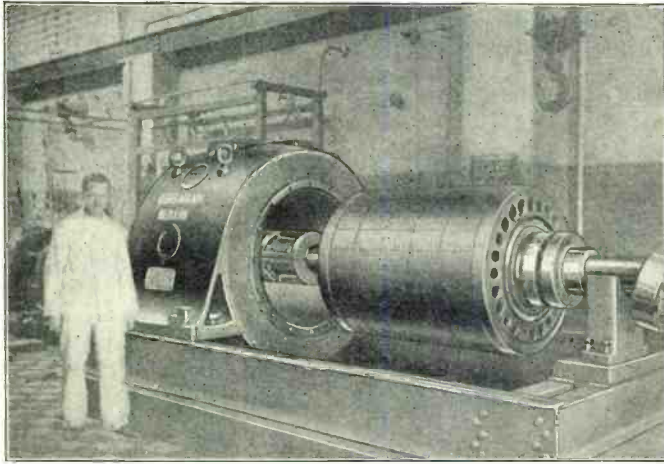

A Disassembled Goldschmidt High Frequency Alternator Showing the Construction of the Rotor. Note the Size of the Machine Compared to the Man.

power plant. This current is delivered at a potential of 4,000 volts and runs a three-phase motor which turns the two 440-volt, 1,000-ampere and 220-volt, 440-ampere continuous current generators. The 220-volt generator serves as an exciter for the high frequency machines while the 440-volt generator provides current for turning the two 165 and 184-K.W. motors which are always directly coupled with one of the two Goldschmidt high frequency alternators. These machines run at 3,000 r.p.m.

An automatic speed regulator equalizes the variations in both alternators within 2 per cent. The American stations which work with Eilvese are delighted by the improvements in transmission which have been gained by this automatic regulation of speed.

At present, Eilvese is the only German station communicating directly with the United States. The receiving station is situated at Geltow, near Potsdam. If there should be disturbances at Geltow, or if its installation should be overloaded, Eilvese would instantly take up the receiving service with America.

ADDITIONAL RADIO ROUTES

High-power radio stations are in process of construction in the Netherlands, Sweden, Poland and Italy, and when completed direct radio service will be established from New York to commercial centers of those countries.

Austria, Spain, Denmark, Portugal and Russia are each engaged in surveys for the establishment of high power, radio stations for inter-continental work, and all of these additional circuits should be in operation by the summer of 1925.

In the Far East an American company is proceeding with the erection of a radio station in China, designed to communicate with the stations of the Radio Corporation of America in Hawaii and California. Another American company plans a radio circuit between the countries of the Orient and Alaska and Seattle. A high-power station of the Dutch Government is now in operation at Malabar, Java, communicating with the United States naval radio station at Cavite, but this East Indian station will probably establish a circuit direct to the United States or via Hawaii.

THE curious star shown in the accompanying figure might easily be taken for the photograph of a "radiolaria," a kind of animalcule living in water which, as is well known, sometimes has the construction of a star. This star, however, has nothing to do with water and is no living thing. It is a model of the great antenna of Eilvese, one of the two great German radio stations which maintain service with the United States.

Eilvese lies on an island of sand amidst the great fens of the Luneburgmoors, very much out of the way of regular traffic. But its situation is a very good one for the purposes of the radio service, as its distance from Berlin, Hamburg and Bremen and from the great industrial cities of the Rhine is nearly the same. From all sides telegrams can easily be given to Eilvese by cable and telegraph. Not all the cables which are to serve Eilvese are completed as yet. The connections with the great "Transradio" station in Berlin are not complete yet, so present messages are routed through the city of Hagen, north of Eilvese, while Berlin is situated to the southeast. Notwithstanding these difficulties, Eilvese is now sending one-half of all the telegrams transmitted from Germany and other parts of Europe to the United States.

The antenna has, as shown by the star, the form of a double cone umbrella. The main mast has a height of 825 feet and is surrounded by six smaller masts, each of which is 390 feet high, and stand a distance of 1,500 feet from the main mast. The antenna itself is composed of an umbrella and a second cone or ring arranged around it. Both antennae are isolated from each other and each has its own connection with the station. The idea of this arrangement is to gain duplex operation on different wave-lengths. The umbrella antenna works on a wave of 9,700 meters and the ring antenna on a wave of 14,600 meters. In the first case the antenna current is 180 amperes and in the second case 250 amperes. It is possible to switch both antennae together and use all available high frequency energy. With this arrange-

ment the antenna current is 450 amperes at a wave-length of 14,600 meters. Current is supplied from a nearby water

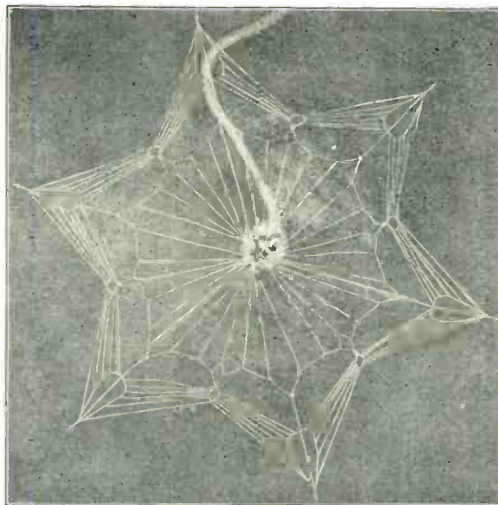

Bird's-Eye View of the Star Antenna at Eilvese. The Transmitting Station Can Be Seen in the Direct Center.

Interior View of the Power Plant at the Eilvese Station, Showing the Goldschmidt High-Frequency Alternators.

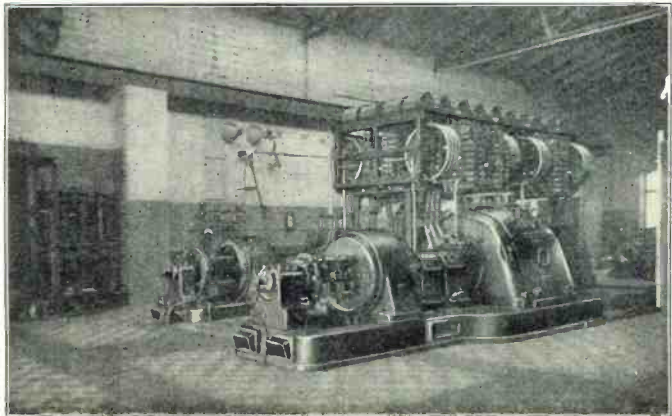

Getting the Right Radio Wave

By JOHN V. L. HOGAN*

CONSULTING ENGINEER; PAST PRESIDENT AND FELLOW, INSTITUTE OF RADIO ENGINEERS; MEMBER, AMERICAN INSTITUTE OF ELECTRICAL ENGINEERS.



One of the great problems of the Radio listener is understanding the principles upon which selectivity is based. In this article, which was delivered by the author through station WEAJ of the American Telephone and Telegraph Co., the frequencies of radio waves are compared to those of the piano cords and this analogy makes the subject easier to understand.

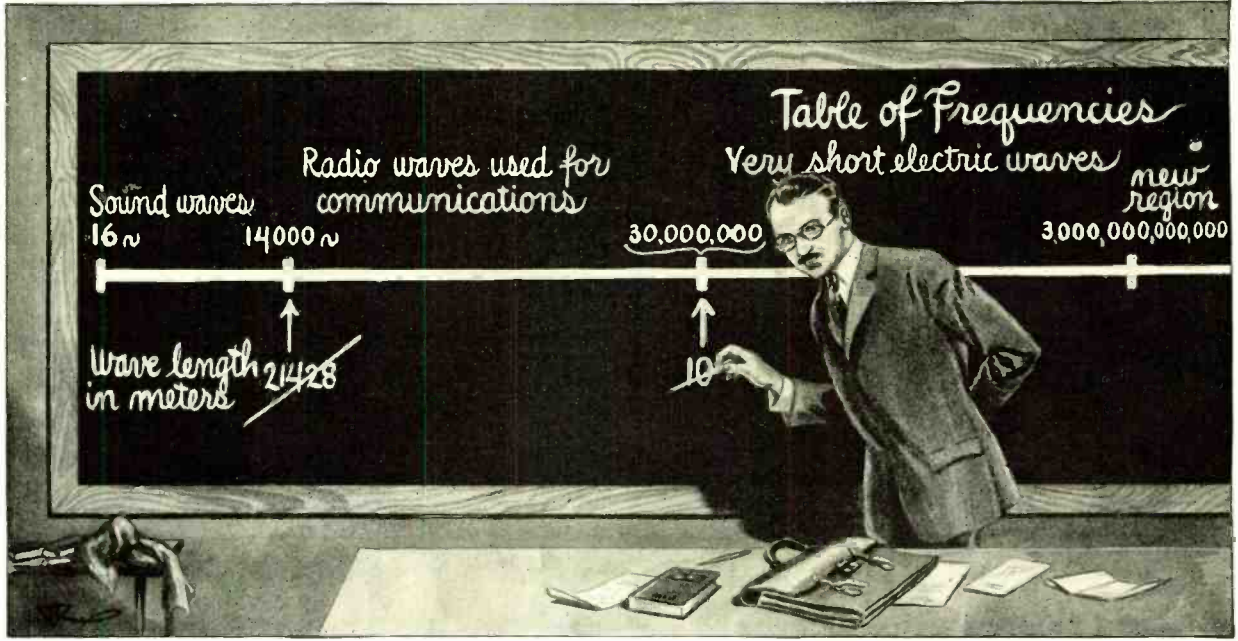

The Measurement of Waves in Meters Has Only Been Applied to Radio Waves. The Logical Measurement or Designation Should Be in Cycles, or the Frequency of the Current Which Has Always Been Used in the Commercial Electrical Field. In the Future, Radio Waves Are to be Designated by Their Frequency, Not Their Wave-Length in Meters.

THE broadcasting radio wave frequencies run from 550 kilocycles to 1,350 kilocycles, in steps of 10 kilocycles, so giving us about 80 different waves that are 10 kilocycles apart. The frequencies of the corresponding piano keys run from about 550 cycles to about 1,350 cycles per second, but there are only 17 piano keys in this range. Of course, the musical notes have frequencies that are only one-thousandth as great as those of the radio stations that we are discussing, and so the sound frequencies are measured by the number of cycles or vibrations per second, whereas the radio frequencies are measured in kilocycles or thousands of vibrations per second. Since the relative frequencies are the same, the piano is useful to give us some idea of the rather limited range of frequencies into which 80 different broadcasting waves must be crowded.

The same plan may be used to illustrate the relative position of the broadcasting waves in the full scale of frequencies that includes all the different kinds of radio services.

Useful radio frequencies extend from a low value of about 15 kilocycles all the way up to 5,000 kilocycles, or higher. The lowest note on the piano, 27 cycles, is musically in the same position on the sound scale as the great trans-Atlantic radio station WRT, at Bound Brook, N. J., is on the radio scale. This station sends out waves of about 27-kilocycle frequency. The second C, as one goes up the scale, has a frequency of 64 cycles; a wave of about 64 kilocycles is used by the long distance overland radio station KWT at Palo Alto, Cal. A sharp, immediately above, is of about 113 cycles, which corresponds to the NAA or Arlington station's time signal wave of 113 kilocycles.

*Author of "The Outline of Radio".

The common ship wave of 500 kilocycles might be represented by the C above middle C, and the class "B" broadcasting range, from 550 to 1,000 kilocycles, by the notes from C sharp to the next B. The 833 kilocycles used by class "C" broadcasters would lie near the middle of this group, relatively about at A sharp. The low-powered broadcasters extend up to 1,350 kilocycles, or proportionately to the third F above middle C on the piano. Then come amateurs and experimental workers from 1,500 kilocycles (the next G on the scale) on up the keyboard.

THE RADIO "SCALE"

Thus radio waves cover a scale of their own with frequencies 1,000 times as high as the note frequencies of the piano. This scale is about eight octaves long. Broadcasting stations use a little over one octave of it. The wave-frequency of any radio station is definitely characteristic of the station just as the frequency or pitch is characteristic of a musical note.

Of course, we cannot hear the radio waves directly as simple sounds because their frequencies are too high. Moreover, radio waves are electro-magnetic vibrations which cannot affect our ears directly, whereas sound waves are mechanical vibrations and can affect our ears directly. But we can use the inaudible radio waves to carry sounds, and I will tell later more about how that is done.

The comparison that we have just made between radio frequencies and piano frequencies is useful in more ways than one. For instance, let us think about the problem of selecting a single frequency from all the others. Of course, our ears can recognize the difference in sound between any two adjacent notes on the piano keyboard. When

the two notes are played with equal loudness the only difference between them is one of pitch or frequency. Since we can easily tell the sounds apart, it is evident that our ears are to some extent able to discriminate between sounds of different frequency. This ability is called a sense of pitch, and some people have a good deal better pitch-sense than others.

Now let us consider another kind of ear, a sort of electrical ear; that is to say, a radio receiving set. We can imagine that any radio receiver listens to and "hears" radio waves much as we listen to sound waves. Radio waves of different frequencies would then seem of different pitches to any radio receiver, just as sounds of different frequencies have different pitches to our ears.

Radio receivers are something like human ears in other ways, too. For one thing, they vary widely in what might be called their "sense of pitch." Some unfortunate people can't tell one musical note from another of different frequency; their sense of pitch is defective. Some radio receiving sets, unfortunately, can't distinguish one radio wave from another of different frequency. Their "sense of pitch," or, in radio terms, their selectivity, is defective. On the other hand, many musically trained people can easily distinguish between notes that are much less than a half tone apart in frequency. So, too, any well constructed radio receiving set can distinguish between radio waves that are only a few kilocycles apart in frequency.

SELECTIVITY DESIRABLE

Distinguishing between radio waves is not all that a radio receiving set ought to do, however. We want our receivers not only to show some difference in the effects produced by waves of different frequencies, but

(Continued on page 1148)

Engineering Trans-Atlantic Radio Telephony



For about a year, tests have been carried on between New York and London to ascertain the practicability of Trans-Atlantic Radio Telephony. So far they have proved successful and we may expect some day to talk from our Homes or offices to friends abroad with the same ease that we can now speak over the telephone to persons in another city.

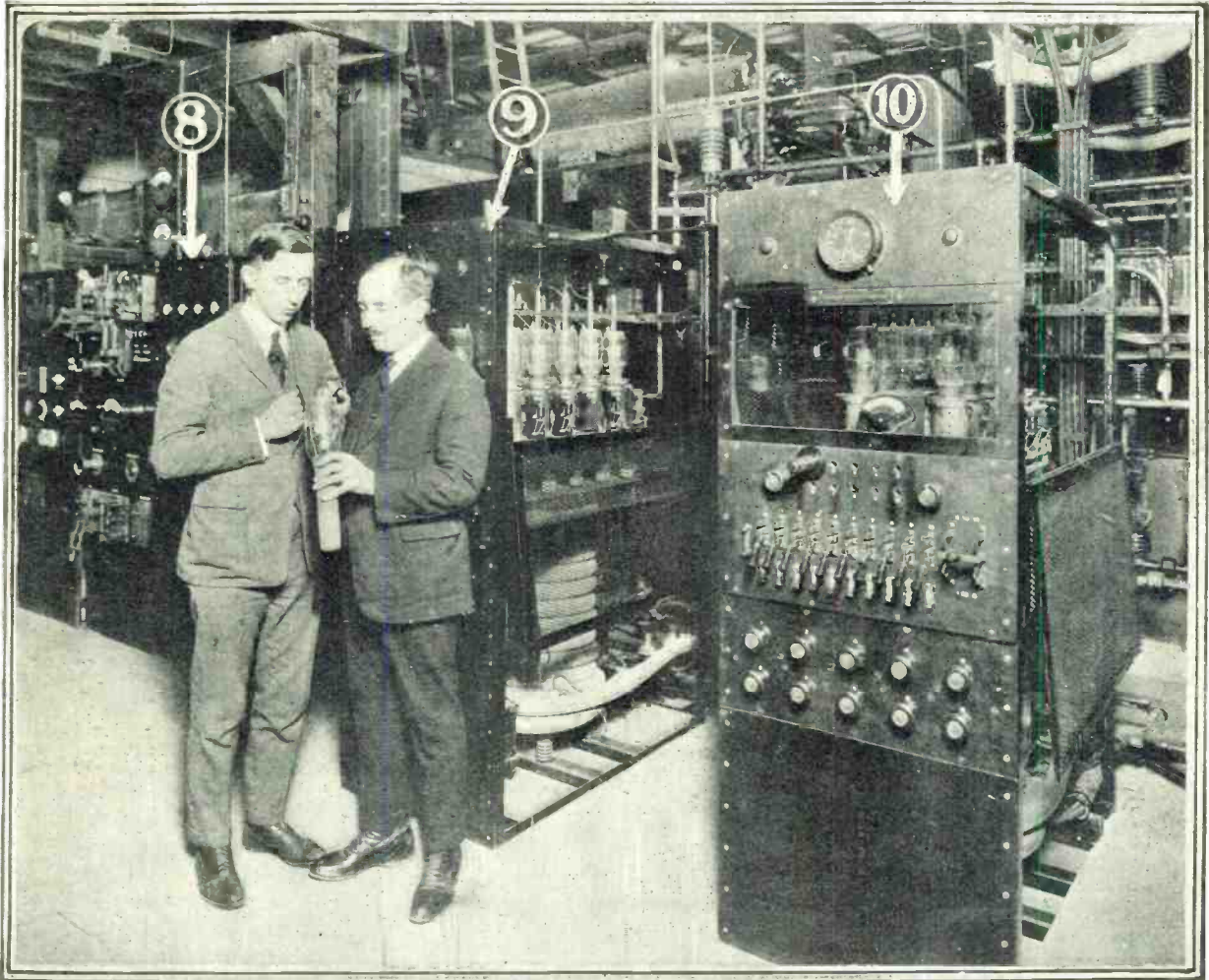

The Powerful Amplifiers Installed at the Long Island Station and Used in the Tests with England. 20-K.W. Water-Cooled Vacuum Tubes Are Employed in the Power Amplifiers, Delivering 150 K.W. of Energy. Fig. 8 is the 15-K.W. Amplifier; 9 is the 150-K.W. Amplifier; and 10 is the Rectifier Producing the High Tension D.C. for the Plates.

THE idea of being able to talk to friends in Europe or on a steamship in the Atlantic from any telephone in America is certainly fascinating. Such a service, based upon developments in radio telephony, is possible, and tentative plans are being investigated by the telephone interests of America and Europe. In order that such a service be comparable with the high standards set by the long distance telephone lines on land, every effort is being made to solve the many problems involved.

It was eight years ago that the human voice was first carried across the Atlantic, and it was nearly a year ago when officials of the American Telephone and Telegraph Company talked from New York, continuously, throughout a period of three hours, to an assembly of prominent people in London. The first transmission of the human voice across the Atlantic, like that of last January, was accomplished by engineers of the American Telephone and Telegraph Com-

pany and the Western Electric Company. Using the antenna of the Naval Radio station at Arlington, Virginia, they sent out short messages which were heard not only at Paris but also 5000 miles to the westward in Honolulu. These experiments were of great significance for, in addition to proving the possibility of trans-Atlantic telephony, they showed that the vacuum tube can be used both to develop high power at high frequencies and to control hundreds of horsepower by the infinitesimal power of the voice.

The American telephone wire system already ties every city and hamlet of the country together and has been extended to Canada and Mexico and the Islands of Cuba and Catalina. The next great step will be a radio link connecting the wired telephones of this country with those of Europe. The importance of such an extension to the diplomatic service and business of this country can hardly be overestimated, for it will enable the quick exchange of ideas and a sat-

isfactory solution of problems which now require days. When the President of the United States can talk from his desk in Washington directly to representatives of foreign governments in Europe, much will have been done toward everlasting peace.

Such a project presents problems which, in many respects, are similar to these the engineers have already encountered in wire communication. However, they differ in one respect; transmission by radio varies enormously from time to time whereas transmission by wires is very constant.

In order that communication may be successfully carried on over great distances under all conditions, a knowledge of the transmitting characteristics of the ether—as to its variations from hour to hour, day to day—must be gathered and charted. With this information, the engineer can proceed to design his speech channels, determining the band of frequencies allotted to each channel and the power necessary for successful com-

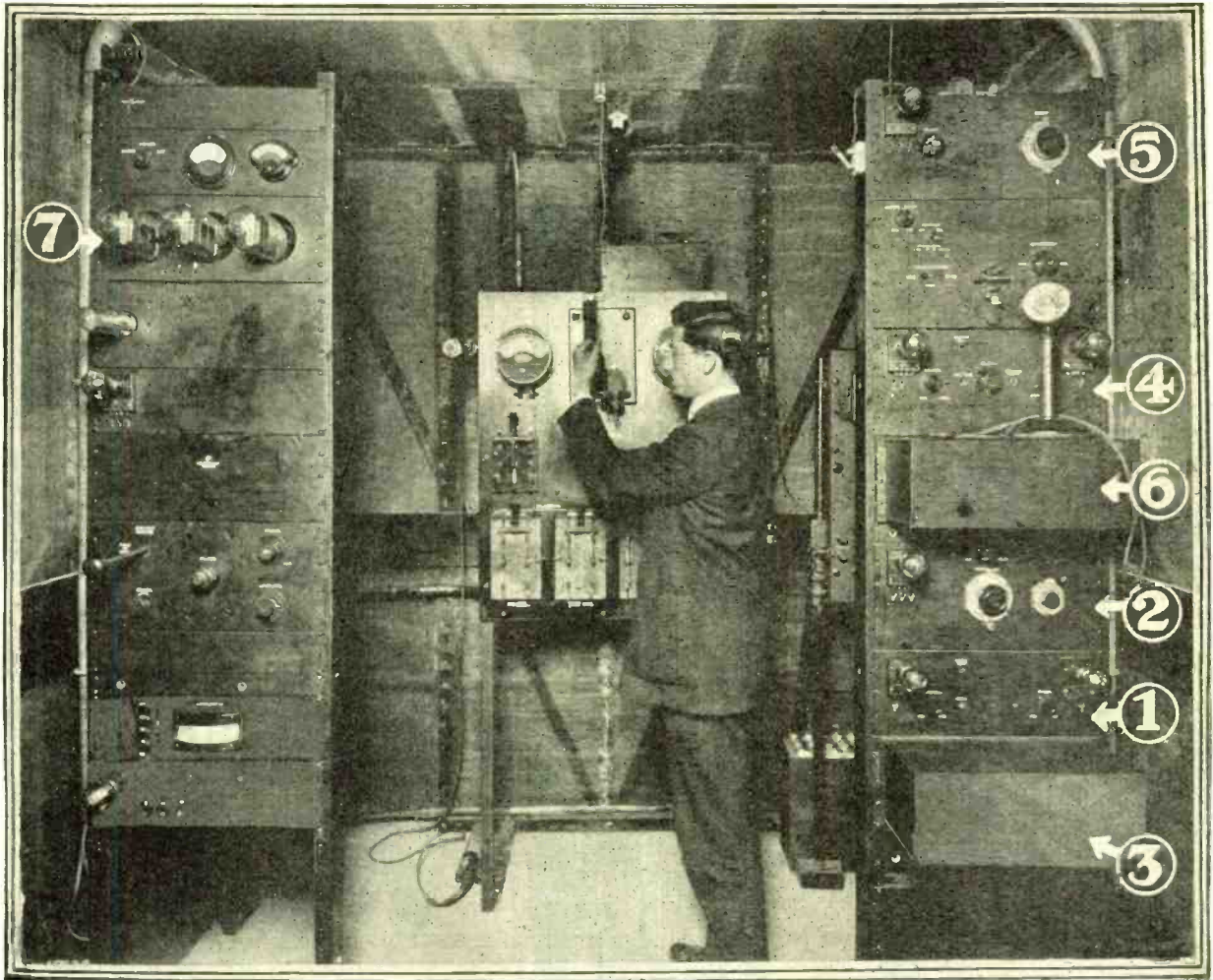

The Apparatus Through Which the Voice Passes Before Reaching the Power Amplifiers. In the System Employed, Only One Side Band is Transmitted Which Results in Obtaining Three Times the Range Which Would Otherwise Be Obtainable Should the Carrier Wave and Other Side Band Be Transmitted. The Diagram on Page 1054 Shows How the Instruments Pictured Above Are Connected. Above, 1 is the First Modulator; 2 the Oscillator; 3 the Filter; 4 is the Second Modulator; 5 the Second Oscillator; and 6 the Second Filter. 7 is the 750-Watt Amplifier. Since No Carrier Wave is Employed, Local Oscillations, Acting as Such, Are Produced Near the Receiver, Which Then Functions in the Usual Way. A Loop Aerial is Generally Employed with a Radio Frequency Amplifier at the London Station.

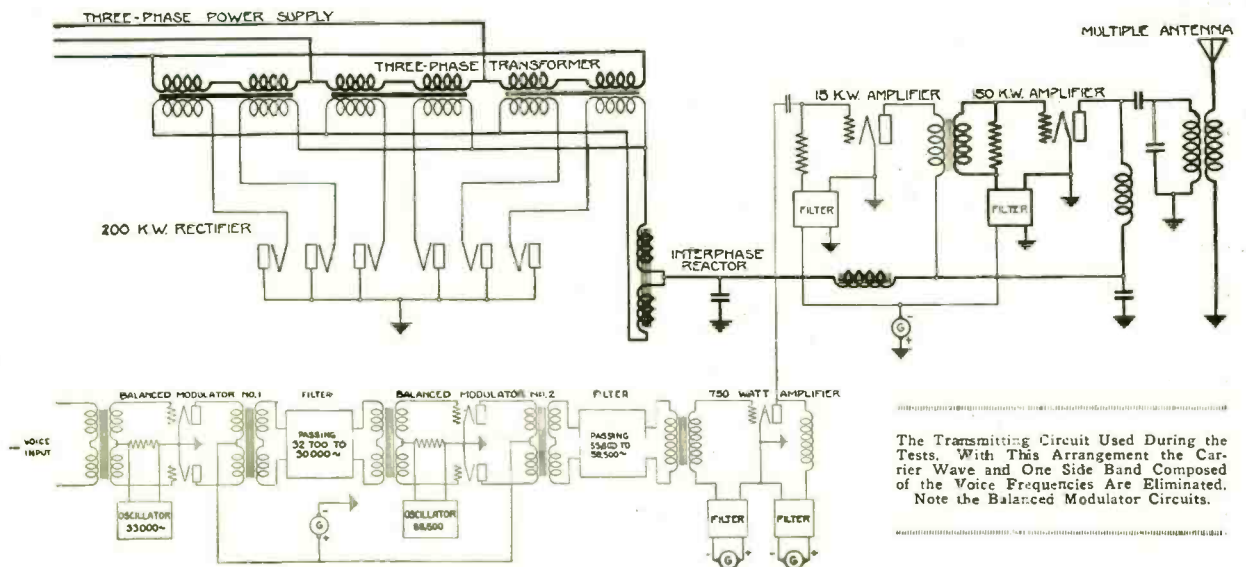

The Transmitting Circuit Used During the Tests. With This Arrangement the Carrier Wave and One Side Band Composed of the Voice Frequencies Are Eliminated. Note the Balanced Modulator Circuits.

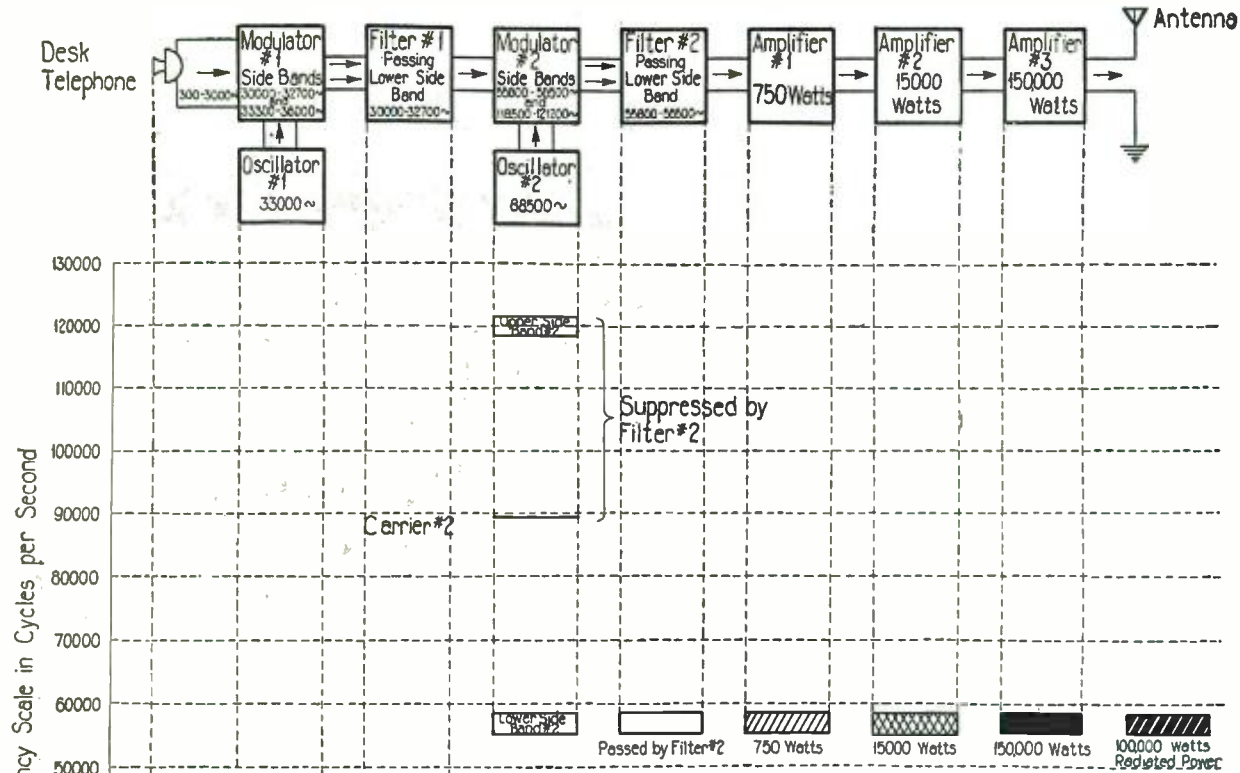

This Chart Shows How the Single Side Band System Operates. The Speech Frequency Bands Are Taken as Being from About 200 to 2000 Cycles. As May Be Seen, the Filters Eliminate the Carrier-Waves and the Upper Bands.

munication. Some of this work has already been done.

The measurements of the vagaries of the ether already obtained are very interesting and should prove valuable to the radio amateur. In making these determinations, signals were transmitted from Rocky Point, Long Island, to London, England. A measuring set of special design in London enabled the amplitude of the received signals to be measured. Measurements of the interference and noise due to static and other causes were also made and the ratio between the two quantities taken. This was done for each hour of the day and the results of corresponding hours averaged for each month. This ratio of the strength of signal to the strength of noise for the first eight months of 1923 is plotted in Fig. 1.

Along the vertical axis is plotted the ratio of the signal strength to noise. This ratio is a direct measure of the understandability of spoken words. Along the horizontal axis is the time of day, both as reckoned in America and in London. The hatched areas designate the hours when it is dark only at one station. The blackened area represents the hours when it is dark at both stations.

It will be observed that reception in winter is best just before daybreak in England, while in summer it follows daybreak by a few hours. It will further be observed that a period of poor reception occurs just before

two modulators, two filters and three amplifiers. A rectifier is shown in the upper left corner which provides the plate voltage necessary for the amplifiers. The simplified form of this circuit shown in Fig. 3 indicates more clearly how this set functions.

The telephone speech currents from the transmitter give rise to a band of frequencies ranging from 300 cycles to 3000 cycles. These are combined by modulator 1 with a carrier current of 33,000 cycles from oscillator 1 to form what is known as side bands. One of these contains frequencies higher than the carrier and is known as the upper side band while the other contains lower frequencies and is known as the lower side band. One third of the energy is divided about equally between these two bands and the rest, or two-thirds, remains in a carrier. This current is next sent through filter No. 1 which allows the power of the lower side band to pass but excludes most of that contained in the carrier and the upper side band. It then passes to modulator No. 2 where it is combined with current having a frequency of 88,500 cycles from oscillator 2. This again gives rise to two side bands and a carrier. These are sent through filter 2. This time the side bands are sufficiently separated that the filter can effect a very complete isolation of this new lower side band. Having now prepared a band of frequencies extending from 55,800 cycles to

58,500 cycles it is next amplified by three steps to a final power somewhat less than 150 k.w. and sent out onto the antenna.

In the ordinary methods, used in radio broadcasting for instance, both side bands and the carrier are put out onto the ether. Such a scheme, at best, is only one-third as efficient and occupies a space in the range of wave lengths about twice as wide as when the carrier and one side band are eliminated. This economy of both wave-length range and power is very important. Where previously only four speech channels were possible in a certain band of wave-lengths now seven channels can be accommodated. It is as if the loads which were previously hauled on low broad gauged trucks were loaded onto narrow trucks. Such a change would obviously increase the capacity of any street.

In the usual method of transmission where both the carrier and side bands are transmitted, detection at the receiving station is readily accomplished by permitting all of the components to pass through the detector. In case the carrier and one side band have been eliminated at the transmitting end, a local current must be supplied at the receiving end having a frequency corresponding to the original carrier. This, of course, can be done efficiently, for the power required in reception is very small.

The one-way telephone circuit described above was used in the Rocky Point-London demonstration several months ago.

Commercial trans-Atlantic telephony will involve two-way transmission and the principles described above are being adapted to this type of service. However, it should be borne in mind that after our knowledge of the variability of ether transmission is adequate and after all of the technical problems have been solved, the actual introduction of trans-oceanic service must await the solution of many commercial problems.

(Continued on page 1156)

Results of Our \$300 Radio Music Contest

The Prize Winners

RADIO JAZZ entry No. 25, composition by Lindsay McPhail, lyrics by Jack Nelson, 4501 Lake Park Avenue, Chicago, Illinois, prize \$150.00.

RADIO MARCH, entry No. 43, composition by Bert Green, 53 Yale Street, Springfield, Mass., prize \$150.00.

The two compositions are now being published and in addition to the prize money, the composers are entitled to 10% royalties on sales of all sheet music copies; also on piano rolls and phonograph records, should these be made.

IN our September issue we offered \$300 in prizes in gold for two musical compositions. For the benefit of those who have not read the prize announcement, we give herewith an abstract from our September issue:

There does not exist today two pieces of music which we have in mind, namely, a good "Radio Jazz" and a good "Radio March." To be sure, we have all sorts of marches and all sorts of jazes, but what we wish particularly are two pieces of music that are especially adapted to be broadcast by radio. If you are musically inclined, you will at once grasp what we mean. *The pieces should have peculiar radio characteristics.* For instance, in radio we have radio code. We are all familiar with the code signals going thuswise: dah-de-de-dah Then everyone is acquainted with the radio squeal, the little birdlike flute-noises that we hear when the other fellow is trying to tune in. These two and a number of other sounds are characteristic of radio and should be taken as a basis or theme for the new radio compositions.

What we want, therefore, are two pieces of music, as mentioned before: one a composition which will be known as the "Radio March," the other one as "Radio Jazz." For each one of these compositions, we will pay to the successful composer \$150.00 outright. In addition to this, a 10 per cent commission on the sale of the sheet music, roll music and record music will be paid by us to the composers, on all sales made.

Through the RADIO NEWS organization, the two pieces, by arrangement with the broadcast stations throughout the country, will be popularized on a scale never before attempted with any musical composition. At the beginning the sheet music will not be sold in music stores at all, and can be had only by application to the broadcast stations and to this office. *All advertising will be done by radio.* At the end of six months, and at the end of the first year, the results of the experiment will be published by RADIO NEWS.

It should be understood, and it can be readily realized, that the nature of the contest is such that there can be only one prize for each composition; there are no second or third prizes.

All in all, the contest was a huge success. Hundreds upon hundreds of compositions came pouring in to us from all parts of this country, and foreign countries as well. We received all sorts of compositions, but the great majority of them, the judges found to



A Photograph Taken in the Studio of Station WJZ During the Broadcasting of the Music Entered in the Prize Contest. Left to Right: H. Gernsback. Standing Beside Him is Mr. Peter Weisenkeller, Bandmaster of the 16th U. S. Infantry Band. Kneeling: Nat. Sanders, Ada Rubens and Rose Shelby. Sitting—Extreme Right: Milton J. Cross, Announcer "AJN." Standing Behind Him is First Lieut. George T. Wyche of the 16th U. S. Infantry. Background: Members of the 16th U. S. Infantry Band. On the Table Can Be Seen the Radio Spark and Radio Oscillator Used by Mr. Gernsback at This Occasion to Produce Weird Musical Sounds.

be of little value. Those that did not pass muster had borrowed themes or had otherwise very little merit.

Of course, many amateurs tried their hand at music writing, with results that were none too good. Out of the hundreds submitted, there were found to be at least twelve com-

positions that were not only meritorious but ranked well with some of the best popular music that we have today. Of these, six pieces certainly were excellent and were pronounced so by the majority of the judges. Of the two prize winning pieces finally selected, the judges were almost unanimous. On the Radio March there was not one dissenting vote between the six judges. On the Radio Jazz there were dissenting votes, but *Radio Jazz* No. 25, by Lindsay McPhail, won by a majority. Composition No. 31, "Music In the Air," by Jack Nelson, was the next on the list. These three pieces have already been ordered published and they will be available by the time this issue is in your hands. Arrangements have been made with a great many broadcasting stations all over the country to broadcast these pieces, and from what we have heard of the compositions, we have no doubt that within the next few months everybody will be singing or whistling one or all of these compositions.

In order to test out the idea on the public, it was decided to play six of the best compositions over the radio and for this test Station WJZ was selected. On the evening of November 24, 1923, the selections were played with the assistance of the 16th U. S. Infantry Band, between the hours of 10 and 11 o'clock. By advertising in newspapers and by previous broadcast announcements from station WJZ, the public was asked to vote for the pieces they liked best. The results of the popular vote were practically the same as those of the judges. The number of votes received on the Monday after the broadcast performance was astonishing. At this time of writing, 4,269 votes have been received, and they are still coming from all parts of the country. The public took a most lively interest in the performance, which was novel in many respects, as this was the first time the public had been asked to vote its preference as to a musical composition. Before the selections were played, Mr. H. Gernsback, Editor, who was in charge of the entertainment, spoke over the radio as follows:

"As you listen in tonight you are about to enjoy—I hope—a new feature, one that to

(Continued on page 1150)

THE JUDGES OF THE CONTEST

Hugo Riesenfeld—Musical director and famous conductor of the Rialto, Rivoli and Criterion Theatres, New York.

Ted Lewis, of the well-known Ted Lewis Band and the Ted Lewis Frolics. The Jazz Master.

Vincent Lopez—Leader of the Pennsylvania Hotel Orchestras.

Leo B. Riggs—Musical director of the Hotel Astor Orchestra, New York City.

Milton J. Cross—"Announcer AJN" of "Broadcast Central, WJZ," New York, member of Institute of Musical Arts, and member of Paulist Choristers.

H. Gernsback, Editor.

Hardman Piano used for this contest.

positions that were not only meritorious but ranked well with some of the best popular music that we have today. Of these, six pieces certainly were excellent and were pronounced so by the majority of the judges.

Of the two prize winning pieces finally selected, the judges were almost unanimous. On the Radio March there was not one dissenting vote between the six judges. On

A New Invention for Selective Reception

By JOHN SCOTT-TAGGART, F. Inst. P.



This new development arrives at a time when a selective form of receiver capable of eliminating interference is a necessity. With this system it will become possible to operate transmitters on waves with a difference of but a few meters of each other. The method outlined in this article is ingenious to say the least.

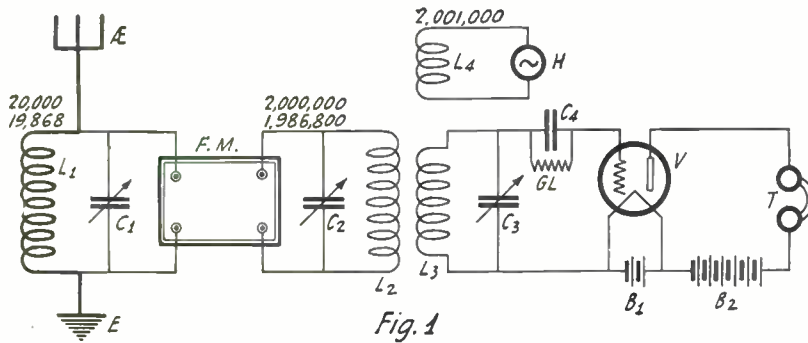

Fig. 1
Circuit Employed for Reducing Interference by the Multiplication of the Frequencies of Incoming Signals.

A STAGE in the history of radio telegraphy has been reached when those engaged in communication work view with grave concern the future prospects of the art. Atmospheric interference remains an important problem and the ether is becoming congested.

The ether is rapidly becoming filled with signals of all wave-lengths, from 50 meters to 20,000 meters. Even at the present time, not a little difficulty is being experienced in separating desired signals from those of stations working on adjacent wave-lengths.

The syntonisation of wireless receiving apparatus has progressed considerably since the remarkable early work of Lodge and Marconi. The introduction of high-frequency tuned amplifiers has enabled a very high degree of selectivity to be obtained. The use of reaction has also contributed, in no small measure, to the success of modern selective receiving apparatus. Note-frequency tuning has also been elaborated and used for commercial long-distance communication.

The greatest achievement, however, in selective reception is unquestionably the method of continuous wave reception known as the "heterodyne" system, invented by Fessenden. By this beat method of receiving continuous waves, not only is greater selectivity achieved, but a pure, musical signal is obtained which lends itself to selective reception on tuned low-frequency circuits.

In spite, however, of 27 years of research work and commercial experience, even those with the most intimate knowledge of modern developments regard the future with a certain amount of apprehension. E. F. W. Alexanderson, the Chief Engineer of the Radio Corporation of America, a month or two ago made the following remarks:

"It can now be readily seen that since the ability to receive distinct signals depends on the separation of different frequencies, there is a definite limit to the number of 'channels' of communication between stations that can be set up.

"If the wave-lengths between 11,000 and 22,000 meters are divided into 2 per cent bands, there are 35 'channels'; if into 1 per cent bands, there are 70 'channels.' Except to such an extent as directional reception will permit, the number of one-way channels open for such long distance communication is limited to the number of these bands.

"The congestion of the ether is, therefore, not a mere matter of looking into the future,

but a real present-day problem. The necessity for traffic regulation, at least enough to prevent reckless driving, so to speak, is just as apparent as the undesirability of hide-bound regulations until such time as the limit of possible improvements in technique have been more definitely determined.

"Such is the present situation in the long distance radio ether. The congestion is due to the necessity for the use of the longer waves for long-distance work and the fact that all high-power stations are broadcast stations; much improvement is possible in existing practice, but radically new methods of operation must also be considered."

Having pointed out the immediate need for new methods of selective reception, a few remarks regarding present-day methods will not be out of place.

PRESENT-DAY METHODS

When receiving continuous waves, it is usual to take advantage of two, and often three, methods of selective reception. In the first place, the signals are more or less selectively received by means of high-frequency tuned circuits, vacuum tube amplification being used for the purpose. Heterodyne reception is employed to convert the radio-frequency currents into musical notes which will operate telephone receivers or other indicating apparatus. Instead of applying the audio-frequency signals directly to the telephone receivers, or like apparatus, audio frequency tuning is often resorted to. In view of the musical notes received by the heterodyne method of reception, the advan-

tages of both high- and low-frequency syntonisation are obtainable. No mention has been made of directive aerial systems, but these are commonly employed in long-distance communication.

That Fessenden's invention has its limitations is disputed by none. Heterodyne reception, remarkable as it is for the selective reception of short wave-lengths, is of comparatively little value for the reception of the waves commonly used for long-distance communication. Nevertheless, the beat method of reception, even for long wave-lengths, is a sensitive one, and also provides a pure musical note, or, rather, low-frequency currents of regular wave-form.

The very important fact however, remains, that the full advantages of heterodyne reception are not realized on the longer wave-lengths. This, of course, is very unfortunate, as long-distance communication is carried out usually on wave-lengths between 10,000 and just over 20,000 meters. These waves have been found to be most suitable for communication over long distances.

The comparative failure of the heterodyne system on commercial wave-lengths used for trans-oceanic communication has left us dependent, very largely, on methods of eliminating signals which involve resonance phenomena which were applied to selective reception 26 years ago.

The two great landmarks in the history of selective wireless reception are the utilization of resonance phenomena and the reception of continuous waves by means of the production of beats. The time has now come when these trusted methods are no longer sufficient. Today governments are becoming more and more reluctant to issue new wave-lengths for radio communication. The ether is already overcrowded and the allocation of any new wave-lengths only makes matters worse. There is, with modern apparatus, a limit to the extent to which wave-length channels may be adjacent to each other. A certain number of kilocycles have to separate the frequencies of two different stations if they are not to interfere with each other. This means that on the longer wave-lengths there has to be a greater difference in wave-length between the different stations and only a relatively small number of high-power stations can communicate on the band of wave-lengths between 10,000 and 20,000 meters. In other words, on the longer wave-lengths, unless existing methods are altered, it will only be possible to have a

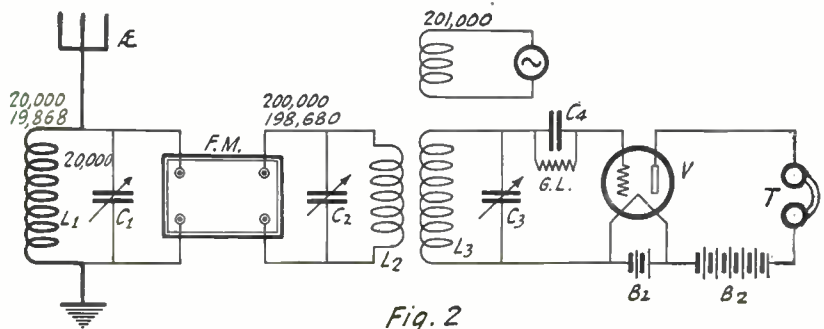

Fig. 2
The Effect of a Frequency Multiplication of 100 Times is to Further Increase the Selectivity of the Circuits.

certain number of transmitting stations, and this number will soon be completed.

We cannot increase the wave-length used indefinitely, owing to innumerable factors, and even if we could, the problem of selective reception would become worse and worse, owing to the necessity of separating out the wave-lengths of the stations farther and farther apart.

A NEW INVENTION

Having outlined the shortcomings of present-day apparatus, I propose to give a very brief outline of an invention which I patented in May, 1920, but which is publicly described today for the first time.

The principle is of such a basic character that its application may affect the whole trend of methods of selective reception.

The invention involves the increasing, at the receiving station, of the frequency difference between desired and undesired currents. This method of solving the problem of selectivity and atmospheric elimination has never yet been attempted or suggested. The frequencies have remained the same, and the methods which have been adopted have been calculated to separate the desired from the undesired frequencies without attempting to change the actual frequency of either.

According to part of my invention, the frequency of the incoming currents is increased, with the result that the frequency

quency difference, therefore, is only 132 cycles.

If now, instead of receiving these signals in the ordinary way as, for example, by the heterodyne method, we multiply the frequencies of both signals by 10, we will increase the frequency of the signals, due to the 15,000-meter station to 200,000 cycles, this corresponding to a wave-length of 1,500 meters. The 15,100-meter interfering signals will produce interfering oscillations having a frequency of 198,680 cycles.

It will be readily appreciated that the difference between the new desired and undesired currents is now ten times as great, and equals 1,320 cycles. Where before we had to differentiate between signals having a difference in frequency of only 132, we now have the considerably easier task of separating out signals having a difference

aerial circuit, which contains the inductance L_1 and variable condenser C_1 , we have two sets of oscillations. One set has a frequency of 20,000, corresponding to the wave-length 15,000 meters of the desired signals, and the other currents have a frequency of 19,868, corresponding to the interfering signals of 15,100 meters. The circuit is tuned, of course, to the frequency of 20,000, corresponding to the desired signals but nevertheless, this method of selective reception is grotesquely ineffective when the frequency difference is so small. The next stage in the process is to apply the two sets of currents to a frequency multiplier which is shown, for the sake of convenience, as a box FM. This frequency multiplier may take many forms, and might be a series of frequency doubling devices, such as valves, or it might be an apparatus for producing harmonics, a selected harmonic being then treated as the fundamental for reception purposes. The output currents from FM pass through the oscillation circuit L_2, C_2 , and even here resonance tuning may not be effective. Loose coupling between L_2 and L_3 will, however, if the primary and secondary circuits are tuned to the new 200,000-frequency signals—which are really derived from the original 20,000-frequency signals by a multiplication of 10, cause the 198,680-frequency currents, due to the interfering signal which originally had a frequency of only 19,868, to be less effective.

Oscillations are now induced into the circuit L_3, C_3 from the heterodyne H, which may be, for example, a valve oscillator. This heterodyne induces local oscillations having a frequency of 201,000. The result of inducing currents of this frequency into the circuits L_2, C_2 will be the production of two sets of beats. The 201,000-frequency oscillations will beat with the desired 200,000-frequency oscillations producing beats of 1,000 frequency, and these beats will be rectified and detected by the tube V, in the output circuit of which are the telephone receivers T. The 1,000-frequency beats will of course, produce a musical note in the telephones T having a frequency of 1,000, which is a very convenient frequency for the reception of continuous wave signals. The 201,000-frequency oscillations induced by the local heterodyne, will also produce beats
(Continued on page 1120)

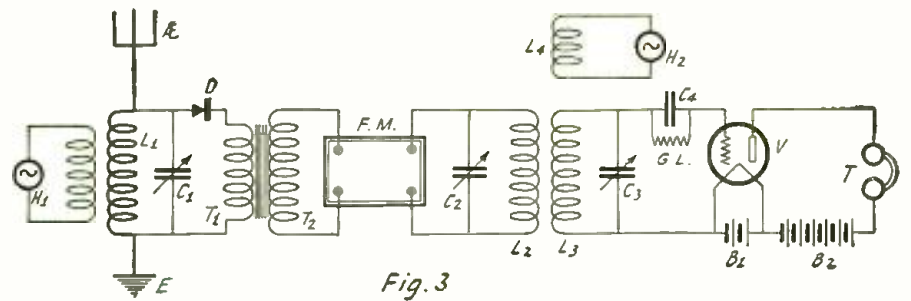

Fig. 3
Circuit Employed for the Multiplication of Low Frequency Currents.

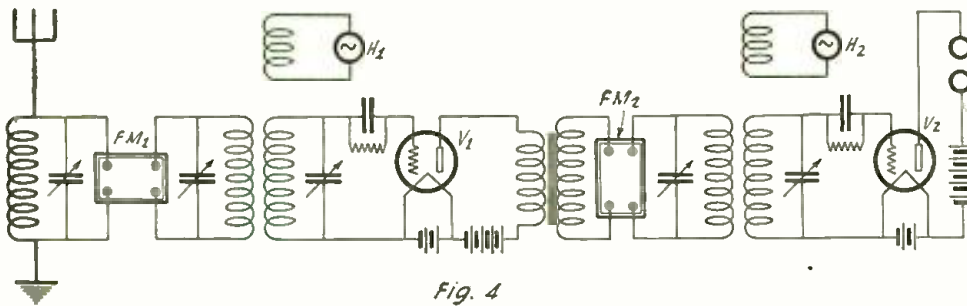

Fig. 4
System for the Multiplication of Both the High and the Low Frequency Currents.

difference between currents of different frequencies is increased.

An example will explain more readily what is meant. Let us assume that two stations are working on wave-lengths of 15,000 meters and 15,100 meters. The wave-length difference, in this case, amounts to 100 meters, a very narrow margin and one which, under ordinary circumstances, would lead to the 15,100-meter signals jamming the 15,000-meter signals. If now we apply both sets of incoming currents to a frequency multiplier giving a multiplication of, say, 10 times, currents will be delivered to the receiver proper by both sets of incoming currents. The 15,000-meter desired signals will set up oscillations corresponding to a wave-length of only 1,500 meters, while the 15,100-meter signals will be resolved into signals corresponding to a wave-length of 1,510 meters. There will now be 10 meters difference between the two signals, but 10 meters difference on a wave-length of about 1,500 meters is ten times more valuable than a difference of 100 meters at a wave-length of 15,000 meters.

The number of cycles difference is the controlling factor in considering selective reception without interference. The example of the 15,000-meter signals being jammed by the 15,100-meter signals may be understood more clearly if we deal in cycles of frequency instead of meters. The 15,000-meter desired signal will set up oscillations having a frequency of 300,000,000 divided by 15,000, which equals 20,000. The 15,100-meter signals will correspond to oscillations having a frequency of 19,868. The fre-

quency of as much as 1,320 cycles. Put crudely, it is ten times as easy to separate out the two stations.

The new currents of multiplied frequency may be applied to selective high-frequency receiving circuits and the heterodyne method of reception may be employed.

FREQUENCY MULTIPLICATION AND THE USE OF BEATS

It needs very little imagination for a student of these matters to appreciate the remarkable selectivity which is obtainable by a combination of frequency multiplication and heterodyne reception. A theoretical circuit is illustrated in Fig. 1.

In this figure, it is assumed that in the

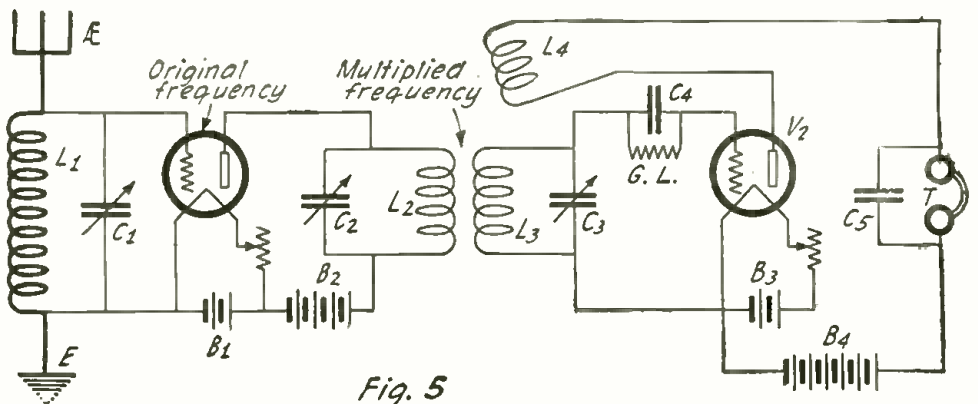

Fig. 5
The Application of Frequency Multiplication to a Standard Form of Circuit.

The Ultradyne Receiver

By ROBERT E. LACAULT, A.M.I.R.E.



The receiver described in this article is a modified super-heterodyne. The improvement made is of such a nature that the sensitiveness is increased and a minimum of controls employed making the set easier to tune. The name "Ultradyne" is merely employed to differentiate this super-heterodyne receiver from those employing the standard circuit. Complete data for the construction of such a receiver is given in the article.

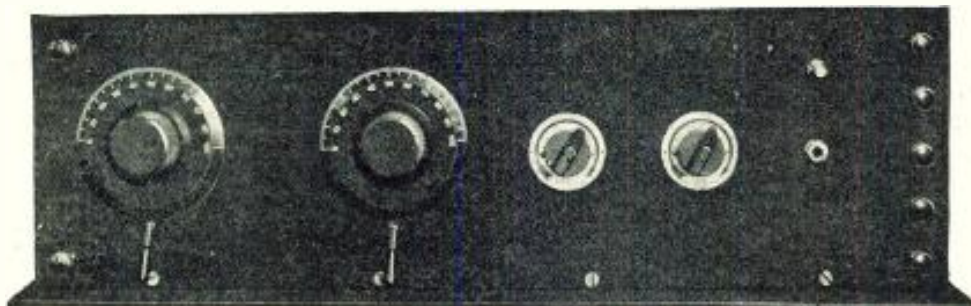
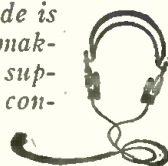

Front View of Complete Receiver. The Number of Controls Has Been Reduced to a Minimum. Which Makes the Tuning Easier.

THE super-heterodyne receiver is coming more into use among the amateurs and broadcast listeners on account of its numerous advantages, and it is our intention to describe in this article the construction of a super-heterodyne functioning under a new principle. This improved receiver, which has proved superior to the usual type is the result of a long series of experiments carried out by the author. The principle of operation of this receiving system has already been explained in many text books and radio magazines, but we shall describe it again in a few words for the benefit of those who do not have such reference at hand.

Everyone who has operated an ordinary regenerative receiver has noticed that when a broadcast station is being received a whistle is heard in the telephones when regeneration is increased beyond a certain limit. This is caused by the receiver itself, which oscillates and produces, by interference with the carrier wave of the transmitting station,

a beat note of an audible frequency. How beats are produced was very clearly explained by Prof. W. P. Powers in an article which appeared on page 535 of the November, 1923, issue of this magazine. A beat note has a frequency equal to the difference between the two frequencies which produce it. For instance, if a carrier wave of 1,000 kilocycles is received, a beat note of 1,000 cycles will be heard in the receivers if an alternating current of 999 kilocycles, or 1,001 kilocycles is made to interfere with it. In the super-heterodyne receiver, this principle is employed, but instead of producing beat notes at an audible frequency, beats of a super-audible frequency, such as 50 or 100 kilocycles are used. By means of a variable condenser the oscillator circuit may be tuned so that such a beat note is produced for any incoming signal. Therefore, no matter what the incoming signal frequency is, the signal which is amplified and detected is always of the same frequency. This is a great advantage because it is easier to design

a radio frequency amplifier to function on one frequency only, than one which amplifies in the same proportion a broad band of frequencies.

In most short wave radio frequency amplifiers using untuned transformers, the amplification varies for each frequency. It is generally found that greater amplification is obtained at two points, while comparatively smaller amplification is had over the remainder of the frequency range covered by the transformer. If tuned radio frequency transformers are employed, the tuning becomes very complicated, owing to the numerous controls, and it is difficult to tune in a station unless the entire amplifier is calibrated. The radio frequency amplifier used in the super-heterodyne receiver is designed to amplify at maximum intensity at one frequency only, thus increasing the selectivity, since only signal frequencies which are interfered with by means of the oscillator can pass through the amplifier.

THE MODULATION SYSTEM

In the ordinary type of super-heterodyne, the first tube employed as a frequency changer is connected as a detector with a grid condenser and grid leak. This detector rectifies the incoming signal after it has been heterodyned and the variation caused in the plate circuit amplified through a long wave radio frequency amplifier. In the system to be described a new principle is made use of. This system, which has been called the modulation system, causes the incoming signal to modulate the oscillations produced locally in the same way that the speech modulates the output of the oscillator tubes in a radio telephone transmitter. This system, which is a departure from the conven-

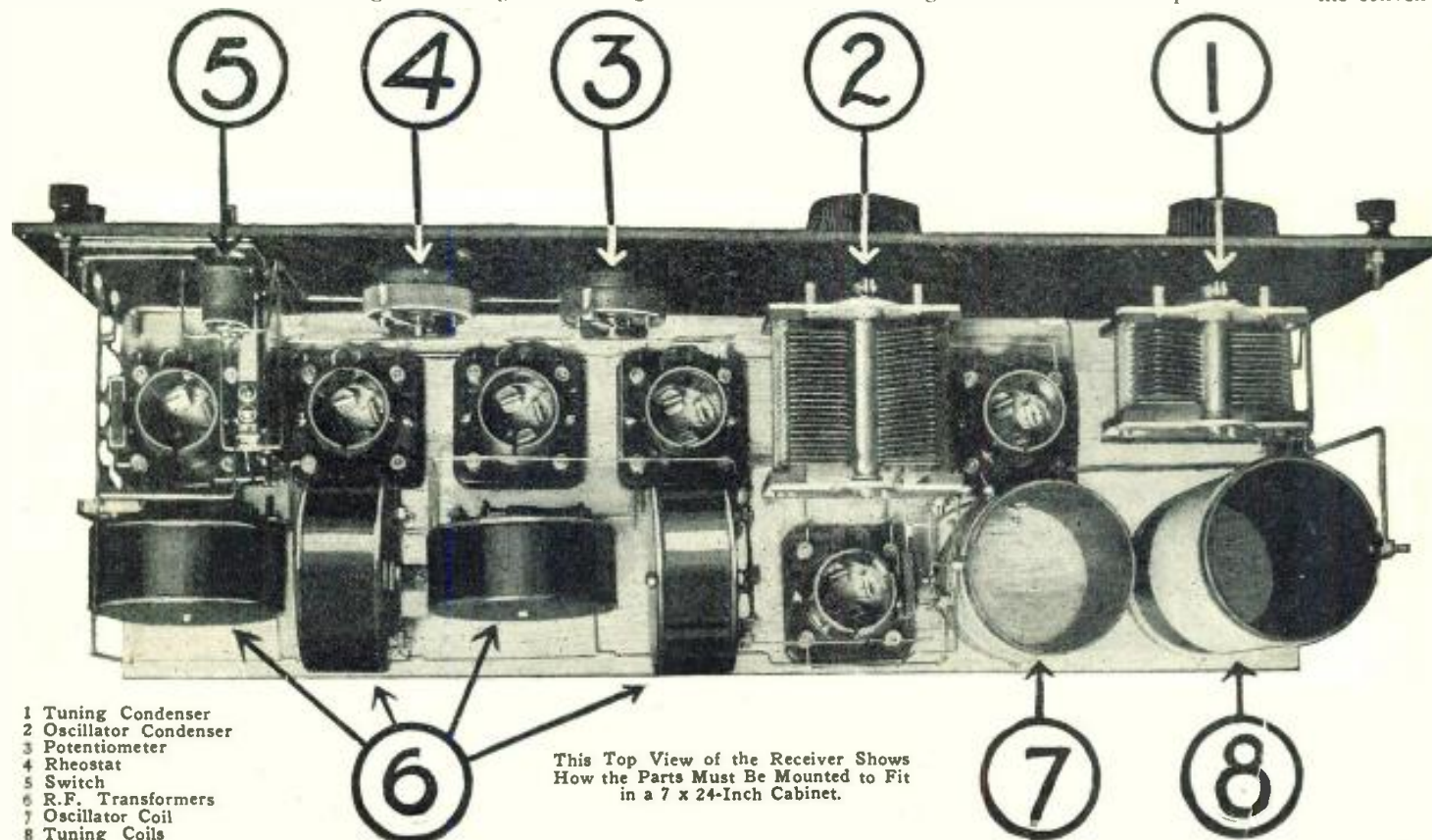

- 1 Tuning Condenser
- 2 Oscillator Condenser
- 3 Potentiometer
- 4 Rheostat
- 5 Switch
- 6 R.F. Transformers
- 7 Oscillator Coil
- 8 Tuning Coils

This Top View of the Receiver Shows How the Parts Must Be Mounted to Fit in a 7 x 24-Inch Cabinet.

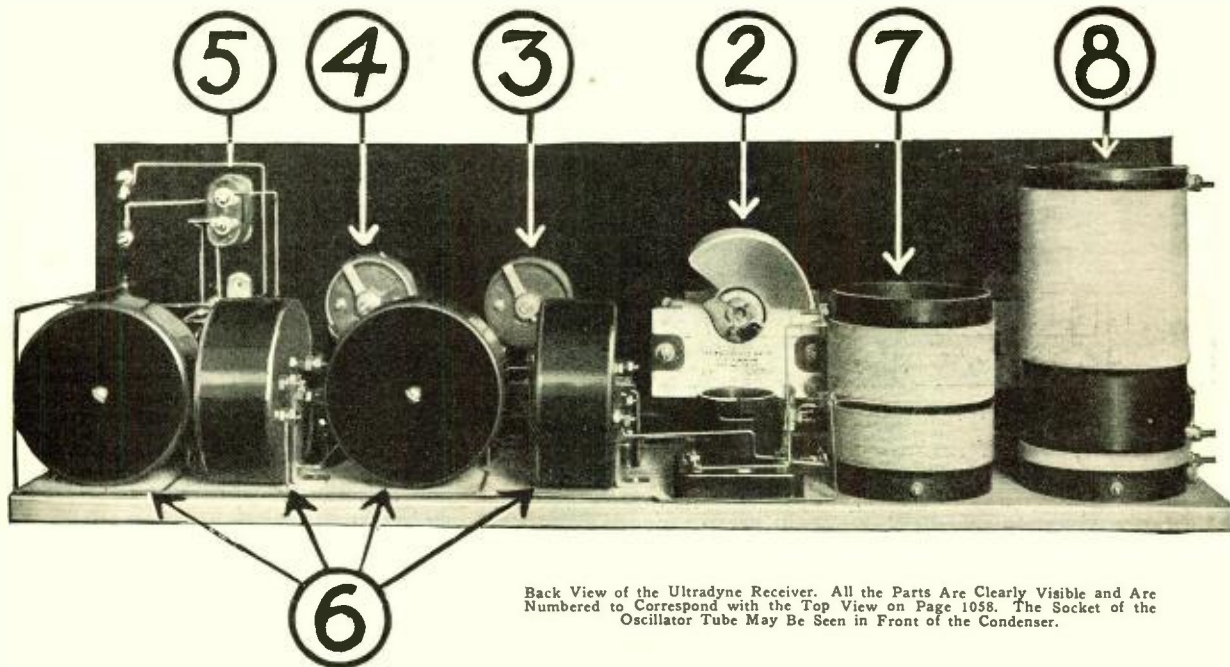

Back View of the Ultradyne Receiver. All the Parts Are Clearly Visible and Are Numbered to Correspond with the Top View on Page 1058. The Socket of the Oscillator Tube May Be Seen in Front of the Condenser.

tional detector arrangement, is not only more simple, but produces a greater signal strength, which is more noticeable on weak signals.

Fig. 1 shows the principle of operation of the circuit. The first tube, which is called the modulator, is connected across the oscillating circuit of the oscillator. The plate filament space acting as a resistance, the value of which is varied by the incoming signals impressed upon the grid. In this arrangement no "B" battery is necessary, for the plate of the modulator tube is supplied by high frequency current from the oscillating circuit. To receive continuous waves, this arrangement is very efficient, and it has been applied very successfully to the super-heterodyne receiver described in this article.

To give an idea of the sensitiveness of this receiving arrangement we would mention the results obtained with it in New York City, the set being installed on the fourth floor of an apartment house situated in a good location. Using only the secondary coil composed of 72 turns of wire wound on a tube 3 inches in diameter, stations in Cincinnati, Detroit, Atlanta, Chicago and other cities are heard practically every night with good audibility. No audio frequency amplification is used, and no loop, aerial or ground are connected to the receiver. With one or two stages of audio frequency the loud speaker may be operated and, of course, the music and speech are audible throughout the apartment.

Fig. 2 is a complete diagram of connections of the receiver, while Figs. 3, 4 and 5 are three views of the apparatus completed. The entire outfit may be mounted in a cabinet 7x24 inches, and is composed of the following parts:

- 1 panel 7x24 in.
- 1 cabinet 7x24x7 in. deep
- 1 .001 M.F. variable condenser with vernier
- 1 .0005 M.F. variable condenser with or without vernier
- 1 potentiometer
- 1 6-ohm rheostat
- 1 double circuit jack
- 1 battery switch
- 7 binding posts
- 6 sockets
- 4 radio frequency transformers
- 1 .00025 M.F. grid condenser

- 1 .001 M.F. fixed condenser
- 1 grid leak with mountings
- 1 .00025 M.F. fixed condenser
- 1 .005 M.F. fixed condenser
- 1 piece of bakelite, hard rubber or formica tubing 3 in. in diameter and 6 in. long.
- 1 piece of the same tubing 3 3/4 in. long
- Bus bar for connections, screws, baseboard 7x23, wire, etc.

The constructional details of the tuning inductance and of the oscillator coil are given in Fig. 6. L1, which is the untuned primary, consists of eight turns of No. 20 D.C.C. wire wound 1/2 inch from the end of the tubing. L2, which constitutes the secondary, is wound with 72 turns of the same wire and 1 1/2 inches away from the primary on the same tubing. The oscillator coil is composed of two sections wound in the same direction as shown in Fig. 6. The first section, L3, connected between the grid and filament of the tube, is composed of 24 turns of No. 20 D.C.C. wire, while the second section, L4, connected between the plates and "B" battery, is wound with 32 turns of the same wire. These coils should be carefully wound and given a light coat of special varnish, which may be obtained from firms manufacturing insulating materials. If no such varnish is obtainable, a light coat of varnish made of acetone, in which celluloid is dissolved, will do very nicely. No shellac should be used on the coils.

It is advisable to fasten the ends of the wire, in each coil, to small screws with nuts fixed on the tubing, as this permits a good connection to be made between the connecting wires and the inductance. The coils may be fastened to the baseboard supporting them by means of small brackets made of brass

strips bent at right-angles as shown in Fig. 7C. The ends of the wire in each coil should be soldered to the screws fastened to the tubing in order to insure perfect contact. Once the set is wired, a drop of solder should also be applied to the joint of the bus bar wire and the screw.

The radio frequency transformers may be of any suitable type designed for long wave reception. Those used in the receiver illustrated in Figs. 4 and 5 are of a special design and may be easily constructed of hard wood or insulating material, such as hard rubber or bakelite. Fig. 7 shows how these transformers are constructed. They may be turned out of a solid piece, or made up of discs of the proper thickness and diameter. The end disc, which is of larger diameter than the others, supports four screws or binding posts, to which are fastened the ends of the primary and secondary windings, and a bracket made of a strip of brass fastened under the screw holding the unit, permits its mounting on the base board. The primary should be wound first and should consist of 500 turns of No. 28 double silk covered wire in the center slot, which is 1/4 inch wide. The secondary is wound in two sections with No. 30 double silk covered wire; 550 turns should be wound in each slot on each side of the primary. The two sections may be wound without breaking the wire by passing it over the primary from one section to the other. To maintain the ends of the wires in place, a drop of sealing wax may be applied on the last turn of both windings. Once the transformers are wound, the screws used as binding posts are fixed on the large disc and the ends of the wire are soldered to them.

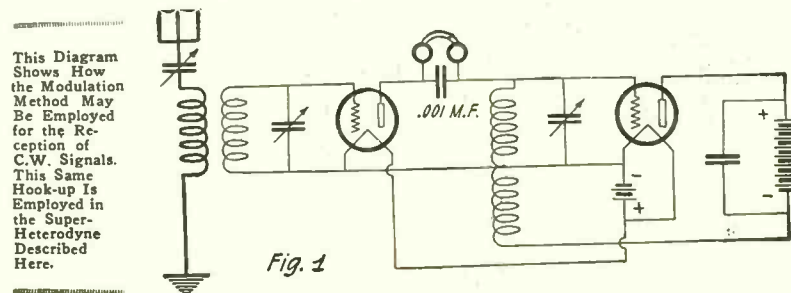

This Diagram Shows How the Modulation Method May Be Employed for the Reception of C.W. Signals. This Same Hook-up Is Employed in the Super-Heterodyne Described Here.

Fig. 1

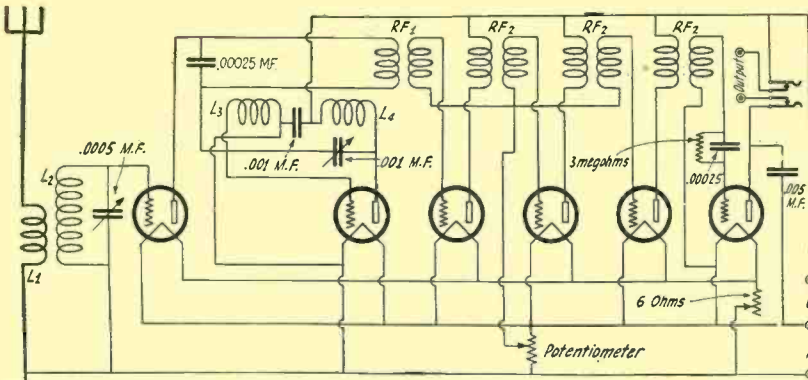

The Complete Diagram of Connections for the Ultradyne. A Double Circuit Jack or a D.P.D.T. Switch May Be Used to Connect the Modulator Tube to the Tuning Circuit or Loop. If It Is Desired to Use One.

The beginning of the primary and secondary windings should go to the positive pole of the "B" battery and center arm of the potentiometer, respectively, while the outside ends of the windings are connected to the plate and grid of the amplifying tubes. In order to reduce the action of one transformer upon the other, they should be mounted so that their axis are at right-angles to each other, as shown in the photographs. It should be noted that the primary of the first transformer is wound with only 300 turns, so that its natural frequency is brought up to the same as that of the other transformers when the .00025 M.F. by-pass condenser is connected across it.

The two photographs, Figs. 4 and 5, clearly show the arrangement of the parts on the baseboard supporting the outfit. In order to simplify the wiring of the receiver, it would be advisable to proceed as follows: After the various pieces of apparatus mounted on the panel are fixed, all the wires which are against the panel may be placed and soldered. The sockets, inductances and transformers are then wired separately and the panel fixed to the base. The only connections which remain to be made are those joining the condensers, rheostat, potentiometer and binding posts.

Before mounting the various parts on the panel and baseboard, it is a good precaution to screw tightly all the screws and bolts of the sockets, rheostats and other apparatus, which are very difficult to reach with tools, once they are fixed on the panel or board. We strongly recommend that any amateur attempting to build such a receiver use instruments of good quality, as this is an important factor in the results obtained with a super-heterodyne receiver of this type. The connections should be made with bus bar wire bent at right-angles, or else with No. 16 copper wire, which is cheaper and very efficient for connections.

If a loop aerial is used, the tuning inductance composed of L1 and L2 is not necessary, since the loop is connected across the first condenser in place of the inductance L2. However, it is preferable to use a short antenna, as the signal strength is greatly increased with this type of collector. If no antenna can be installed outdoors, a single wire stretched around a room at a distance of about a foot from the walls and ceiling by means of insulators will be preferable to a loop. The ground connection may be taken on the radiator system, the water pipe, or any other grounded metal-work. If none is available, a counterpoise may be made with a length of lamp cord wound spiral-fashion under the carpet, or rug.

The tuning of the super-heterodyne receiver is extremely simple, and in a short time anyone should be able to bring in dis-

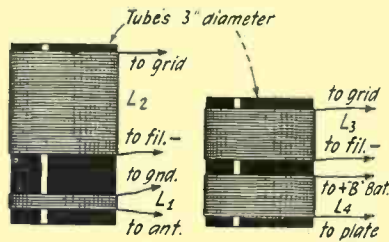

Fig. 6

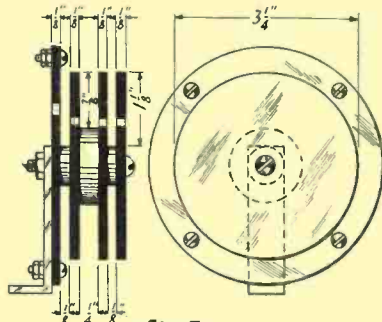
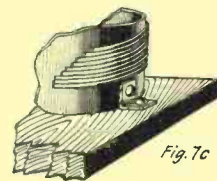

Fig. 7



Constructional Details of the Coils and Radio Frequency Transformers.

tant stations, provided the tuning and oscillator condensers are turned very slowly. As the tuning is very sharp, a vernier is necessary on the oscillator condenser, but it may be dispensed with on the tuning condenser,

which is not so critical in adjustment. The receiver may be calibrated if the same loop or tuning circuit is used at all times, and if desired a silver dial may be employed on the tuning condenser, thus permitting the inscription of the station call letters to be put directly on it. To tune the receiver, the tuning condenser should be moved two degrees at a time, and the oscillator condenser turned over the whole scale range for each setting of the tuning condenser. Some station should be heard at one place or another along the scale; if whistles are heard, the potentiometer controlling the radio frequency amplifier should be turned until the whistles stop. The station may then be brought in loudly and clearly. The potentiometer may then be adjusted at the most critical point where amplification is maximum, and need not be readjusted unless very weak signals are tuned in. The rheostat acts as a vernier for the potentiometer and sometimes may prove quite useful in bringing to good audibility a distant station. It will be found that signals are heard at two different adjustments of the oscillator condenser. It is therefore best to try the setting which gives loudest signals. After a few hours spent in operating this receiver, it will be quite easy to tune in stations, for at a certain point a slight rushing noise is heard, indicating that a carrier wave is tuned in. From 45 to 90 volts of "B" battery may be used on this receiver. If an audio frequency amplifier is added to operate the loud speaker, it is advisable to use a separate "B" battery on the audio frequency tubes, although the same filament battery may be used. It is recommended to use 201-A or 301-A tubes for the modulator and radio frequency amplifier. A different tube may be used as a detector, although very good results may be obtained with one of the above mentioned tubes, if the proper grid leak resistance is used. For the oscillator we would recommend a 216-A, or E tube (VT-2), although any other tube which operates well as an oscillator may be employed. It is a good idea to try the tubes in different positions, for very often some tubes function better in some stages than in others.

In the next article, which will appear in the March issue of this magazine, the construction of a two-stage audio frequency amplifier to be used with this receiver will be described. Of course, any amplifier is suitable, but this one was designed to match the Ultradyne receiver. We shall also endeavor to answer in the next article any questions which may be asked by amateurs building this receiver, which to date is undoubtedly one of the most sensitive it is possible to build at a reasonable cost.

WLAG TO BE CENTRAL CALIBRATING STATION FOR BUREAU OF STANDARDS

Ray A. Sweet, Chief Engineer of Station WLAG, the Twin City (Minneapolis and St. Paul) Radio Central, operated by the Cutting & Washington Radio Corp., has

(Continued on page 1183)

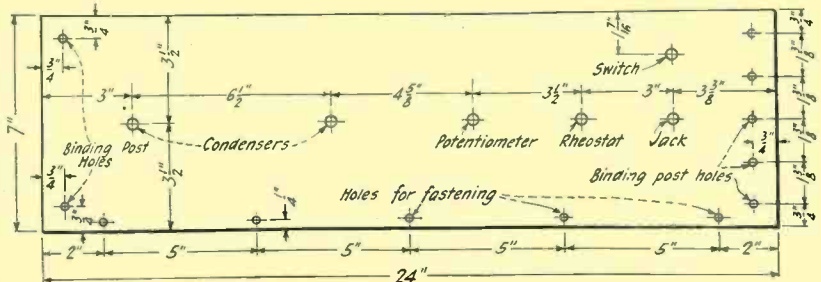

Panel Layout for the Six-Tube Super-Heterodyne Receiver. A Separate Audio Frequency Amplifier Should Be Used, or May Be Built in by Using a Larger Panel.

Radio Novelties



1



2



3



4

1. At a Recent Fair Held at Leipzig, Germany, the Visitors Were Entertained with Concerts from Local Broadcast Stations Picked Up by a Novel Form of Portable Radio Receiving Set. The Outfit Was Strapped on the Back of One of the Officials at the Fair Who Walked from Place to Place with a Curious Crowd Following Him. © Kadel and Herbert.

2. To Satisfy the Girls, Who Insist Upon Radio Novelties, Merchants Are Racking Their Brains for Innovations that Will Appeal to the Fair Sex. Miss Gilbert Appeared at the Philadelphia Radio Show with a Parasol Loop Aerial That Attracted

Considerable Attention. Like Other Loops, it is Directional and Has the Added Advantage of Closing Up With the Parasol. © Keystone View Co.

3. Using Five Different Aerials and Four Separate Receiving Sets, A. L. Bennett of New York City, Enjoys the Novel Pleasure of Receiving from 30 to 50 DX Stations Nightly. The Long Set at the Top of the Cabinet is an Eight-Tube Super-Heterodyne and the One to the Right of it is a De Forest Reflex Receiver. Beneath is a Westinghouse R. C. Receiver and Two-Stage Amplifier and a De Forest Honeycomb Receiving Set. Mr. Bennett has His Station Fully Equipped with Control Panels, Se-

lective Switching System for the Aerials, Battery Chargers, etc. © Foto Topick.
4. We Have With Us the Phusiform Circuit, Which the Inventor Tells Us Means "Natural Force" in Greek. The Three Square Boxes, with the Dials Shown on the Side of the Set, Contain the Phusiforms Which Are in Reality Tuned Radio Frequency Transformers. But Are So Designed as to Eliminate Oscillation Without the Use of Neutralizing Condensers. Bob Kalmus, Who Designed This Receiving Set, is Shown Using a Water Hydrant as a System for Picking Up the Waves from Local Broadcast Stations. © Kadel and Herbert.

Radio Events In Pictures

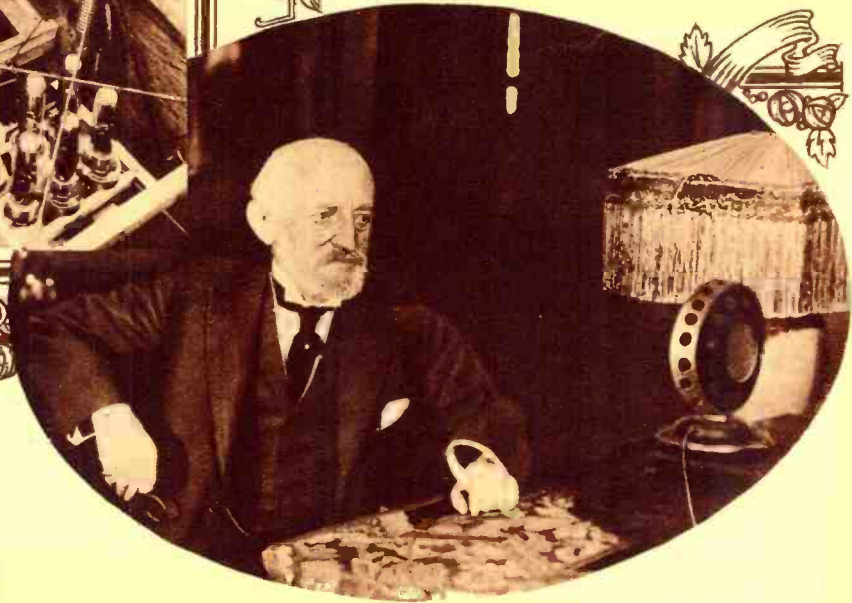
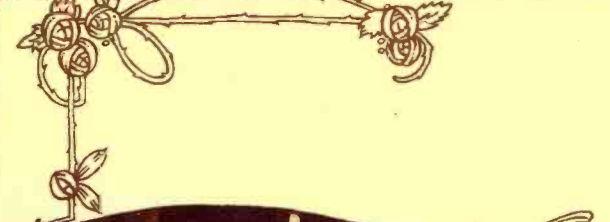
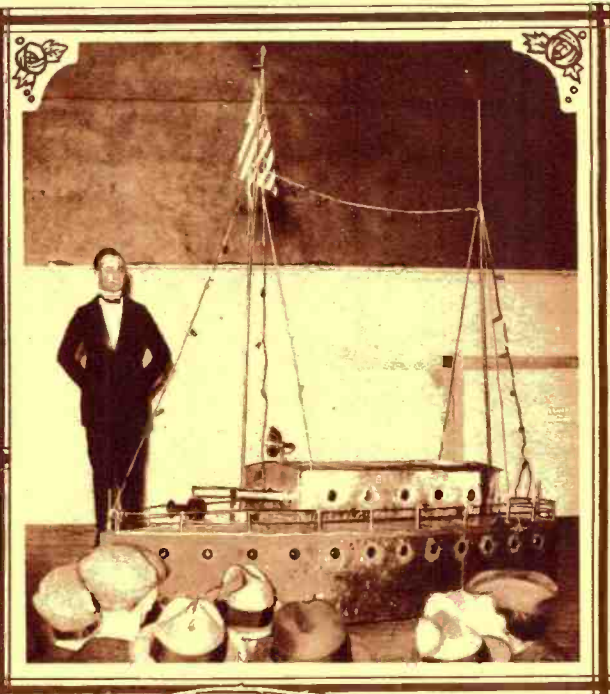
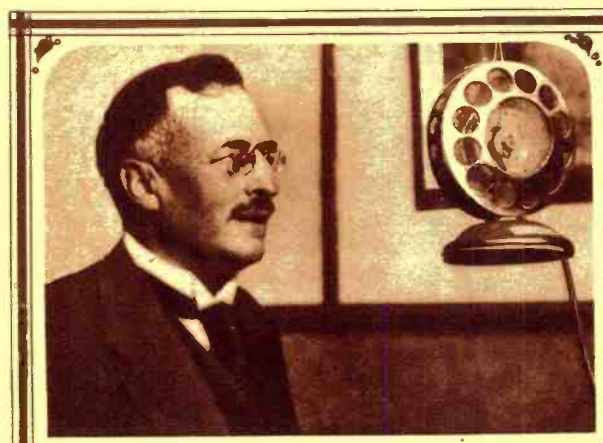

When Doctor Sven Hedin, World-Famous Swedish Explorer and Writer, Shown Here Speaking at the Studio of KHJ, The Times, Los Angeles, California, Recently Thrilled Radio Listeners with an Account of His Hazardous Exploration of the Tibetan Desert, He Was Equally Thrilled with This. His First Experience in a Broadcast Studio.

The Upper Right Photo Shows Mr. Francill, Known as the "Radio Wizard," with a Model Ship Equipped with Radio Control, Explaining the Wonderful Achievements Which May Be Accomplished with This Equipment. This Boat Was on Exhibition at the Radio Show in Chicago, Where Thousands of Fans Were Daily in Attendance. © P. and A. Photos.

The Photo Above Shows the Cockpit of a United States Mail Plane, and Its Radio Equipment. The Receiver and Transmitter, with Control Apparatus, Are Just Visible Inside the Body of the Plane. At the Back Are the Vacuum Tubes. Ordinarily Covered and Out of Sight When Flying. © Kadel and Herbert.

Oscar S. Straus, Member of the Permanent Court

of Arbitration at the Hague. Former Ambassador to Turkey, and Member of President Roosevelt's Cabinet, is Here Shown Broadcasting His Message on "A Constructive Program for Peace." Through Station WDAR, Philadelphia, Pa., Where the 6th Annual Convention of the American Council for International Friendship Was Held. © Keystone View Co.

Radio Pictorial

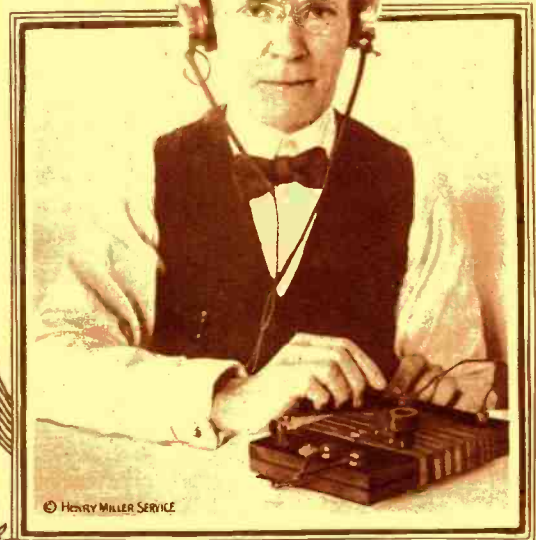

© HENRY MILLER SERVICE

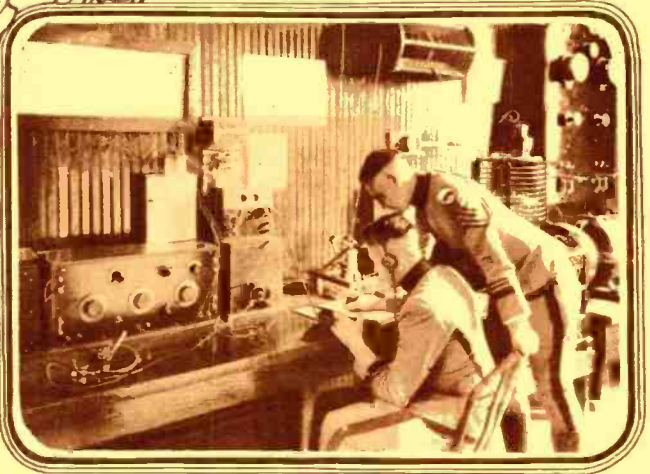
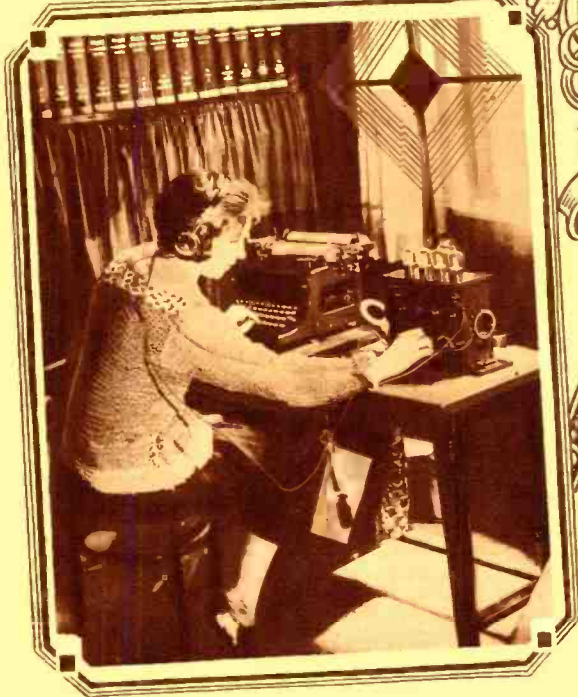

The Photograph at the Top of the Page Shows Cheer Leader T. J. Kauffold of Stevens Institute of Technology, Announcing the Returns of the Yale-Princeton Football Game, at New Haven, to the Crowd Watching the Game Between Stevens Institute and Swathmore College, Castle Terrace, Hoboken, New Jersey. Two of the Students Are Receiving the Returns of the Yale-Princeton Game on a Radio Receiving Set. ©Fotograms, N. Y.

Mr. John T. Buckley of the United States Bureau of Standards Has Designed a Crystal Receiving Set That Is Both Cheap in Construction and Efficient in Operation. This Set Is Composed of Two Small Boards, Upon Which Are Wound the Primary and Secondary Coils of the Receiving Transformer. A Fixed Telephone Condenser Is Compressed Between the Two Boards. It Is Said That These Sets Can Be Sold in Quantities for Approximately 60 cents. © Fotograms, N. Y.

Many Typists Have Improved Their Speed at the Keyboard by Having Some One Read Passages to Them From a Good Book, But an Ideal Friend Cannot Always Be Found. The Radio Receiving Set Proves To Be More Than a Friend in This Case and the Young Lady Above Is in the Act of Tuning in Some Jazz or Whatever May Appeal to Her Most, Before She Commences Her Daily Grind. © Keystone View Co.

The Culver Military Academy Has One of the Best Equipped Radio Stations in the South for the Purpose of Instruction in Radio Telephony and Telegraphy. Two of the Students Are Shown Copying a Message From a Telegraph Station With Which They Are Communicating. The Receiving Set Can Be Seen to the Extreme Left of the Photograph and the Large Spark Transmitter and Motor Generator to the Right. © Gilliams Service, N. Y.

JUDGE UPHOLDS BOYS IN FIGHT FOR AERIAL

Judge Yeatman of Cincinnati has just established a precedent and once more proved himself to be a friend of human souls that long for healthy pleasures and struggle for the establishment of their individual rights.

Two boys, Masters Robert Branigen and Edward Avery, wanted to install a radio

receiving set in the latter's home. The landlord objected. In fact, he told them he wouldn't stand for it. About this time along came a good friend to all boys. Rev. William P. C. O'Conner, their pastor, who said that the best thing to do was to take the case right down to court.

When the case came up before Judge Yeatman, what do you think he said? Why, just this: "Radio is one of the most beau-

tiful influences a boy can have!" Guess that was telling the landlord something, wasn't it? Certainly it was! Now Robert and Edward may tune in without any fear of having the aerial torn down by an irate landlord who has forgotten all about the joys of his own boyhood days when he had to amuse himself with things far less interesting and beautiful than radio.—Abstract from New York World.

New Radio Features



Henry Farkouh, Builder of a Portable Set that Really Can Be "Ported." The Set Has Sufficient Power to Operate a Loud Speaker. Outfits of This Type Are Often Employed on the Stage in Conjunction with Mental Telepathy Acts. The Performer on the Stage Usually Wears a Small Earphone Underneath Some Form of Head-dress. A Radio Transmitter Beneath the Stage Operated by an Accomplice Does the Trick. © The Gilliams Service, N. Y.

Have You Ever Thought of Employing a Revolving Book-case as a Frame for a Loop Aerial? The Photo to the Right Shows a Complete Radio Outfit with an Aerial of This Type.



Photo Shows Capt. John J. Brangan Giving Instructions on Care and Operation of Radio Sets to Police Reserve Officers of New York City at Their Headquarters. A Complete Long and Short Wave Regenerative Radio Receiver Is Being Used for This Purpose. © Kadz & Herbert.



SEEK CAUSE FOR FADING OF RADIO SIGNALS

WHEN radio was first used for long distance communication it was noticed that signals were not transmitted as far during the day as during the night time. It has also been observed that at night, radio signals on the higher radio frequencies or shorter wave-lengths vary greatly in intensity from minute to minute. Persons who receive broadcast concerts from distant stations have occasion to notice this variation in intensity of received signals

since loud signals may be received from a given distant station at one moment only to disappear entirely for a few minutes and then recover their original intensity.

This and related phenomena have been recorded from time to time and various hypotheses have been brought forward in an attempt to explain them. The phenomena are dependent upon a large number of variable quantities such as the weather conditions, the nature of the country over which transmission occurs, the surroundings of the

(Continued on page 1158)

Planting the Radio Compass Atop the World

By S. R. WINTERS

WHEN the ZR-1, titanic airship of the United States Navy, goes aloft she has facilities for taking compass bearings with quite the same readiness as seagoing vessels have in determining their courses. It is the first radio compass installation on a lighter-than-air craft. Moreover, apparatus for the transmission and reception of radio communications are available for the exchange of intelligence between this immense dirigible and other craft navigating the air, with ships at sea, or with radio stations on land.

A radio compass of particular design is installed forward in the dirigible's control car. It was recently subjected to tests by the Radio Division of the Bureau of Engineering, Navy Department, at Lakehurst, N. J., and found to operate very satisfactorily. This radio compass is spherical in shape and is composed of two sets of coils—a wheel within a wheel, figuratively speaking. The entire framework and the windings are operative when bearings are being determined on long wave-lengths. However, in the reception of radio signals on short

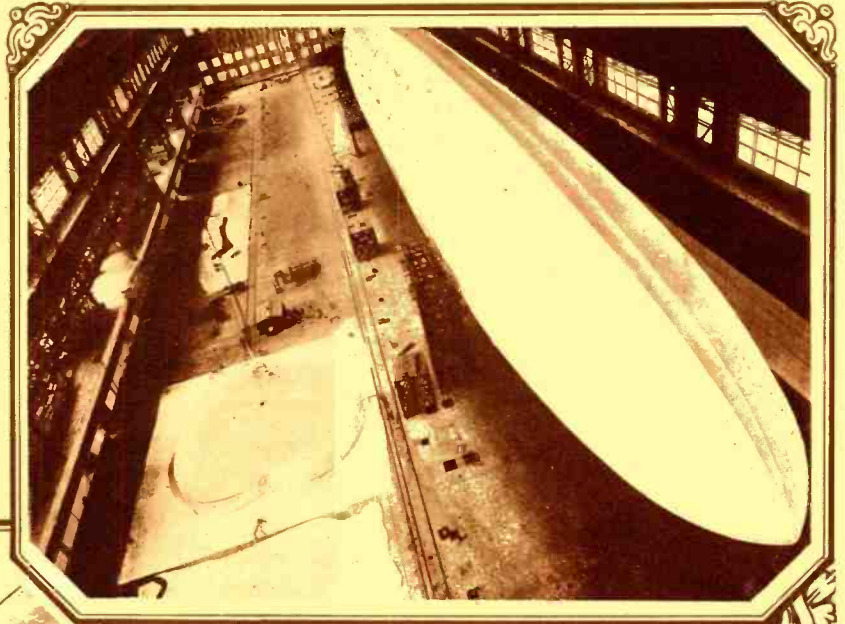

A Photograph of the U. S. S. Shenandoah in Its Hangar. This Dirigible is Completely Equipped with Radio Apparatus. © Kadel & Herbert.



A Photograph Taken of the Shenandoah's Control Car While Flying Over the New England States. The Aerial Can Be Seen Dropping From the Gondola. The Photo to the Right Shows One of the Cabins in Construction. © Kadel & Herbert.

Notable among these outposts of communication are three radio stations in Iceland. Among the other wireless communicating points in the extreme north are those maintained by the Radio Division of the United States Navy Department and the Signal Corps of the War Department in Alaska; several in northern Russia; Spitzbergen on the 78th parallel; and Mijgbugton, 73 degrees North, on the coast of Greenland. These outposts of civilization would afford wireless signals by which the ZR-1 could obtain cross-bearings and thereby chart its northward bound course. Even if these

(Continued on page 1173)

wave-lengths, only one of the two inter-linking coils may be functioning, an effect not dissimilar to the use of the variometer in radio receiving sets. The radio compass, capable of taking bearings on the wide range of wave-lengths from 500 to 30,000 meters, is shown in one of the photographs.

If the ZR-1 makes an expedition within the region of the North Pole, which trip is problematical, of course, the radio compass would be the principal means of guiding the great boat. There are several wireless stations from which radio signals could be received all during a flight over the north polar regions from which, by the use of the radio compass, this huge dirigible could plot its position.

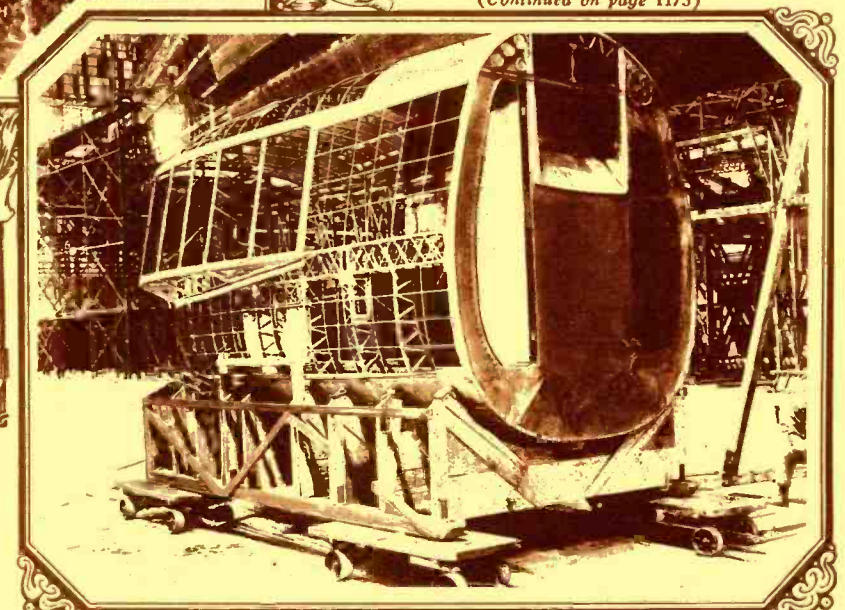

Melting Metal Without Fire In A Radio Furnace

By S. R. WINTERS

The high frequency furnace described in this article is the invention of Dr. E. F. Northrup, and permits the melting of metals by eddy currents induced in the material to be melted. It is similar to a Radio transmitter of the spark type, and might be used as such.

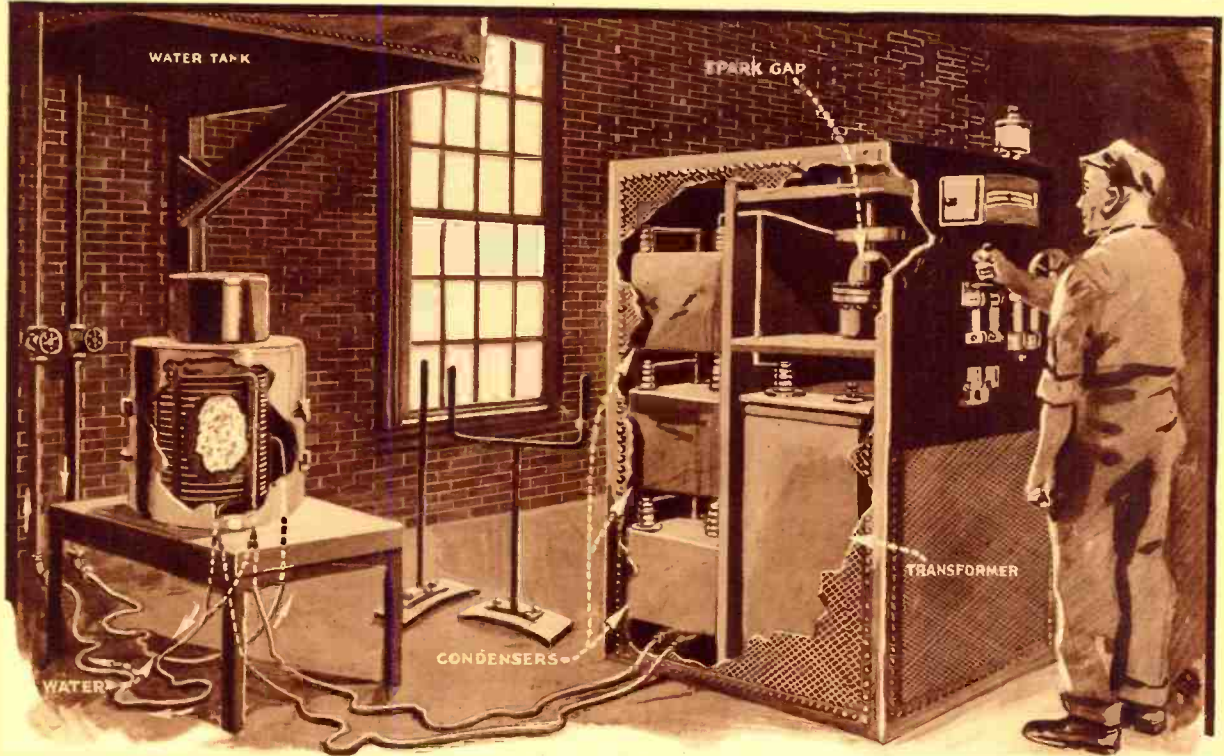

This Picture Showing the Complete Radio Furnace Illustrates How Metals and Alloys Are Melted in the Furnace. The High Tension Producing Apparatus Are Housed in the Cage, Behind the Switchboard, and the Solenoid, in the Center of which is the Crucible, is Mounted on the Small Table. The Two Units Are Connected by Means of Flexible Leads. In This Picture the Sides of the Apparatus Are Broken to Show the Inside Arrangements.

A RADIO furnace, operating without fire, which will melt platinum in a container that can be handled with the bare hands, is the latest development in high frequencies. By applying the eddy-current principle and using the currents to form heat, E. F. Northrup has designed a furnace which bids fair to take a large place in the manufacture of light bulbs and vacuum tubes.

The plan of the furnace is simple: A crucible is surrounded with a heat insulating material. At the outside of the insulator is wound about 50 turns of heavy copper tubing. A 15,000-cycle current flows through the tube, setting up powerful eddy currents in the mineral or metal in the crucible. The tube which conducts the current is cooled by a stream of water passing through it.

In preliminary tests made by the Bureau of Standards and the manufacturers it was found that the furnace developed about 65 per cent efficiency.

One of the greatest advantages of the furnace is its swiftness of operation. A melt of platinum put into the crucible at room temperature can be brought to the melting point in less than twenty minutes, according to tests made. When working on iron and nickel the work is much faster, since the hysteresis of the iron to the magnetic field of the coil increases the heat.

One of the greatest factors making for the advantageous operation of the furnace is the fact that the nature of the currents induced into the metal being heated causes it to be constantly stirred.

No little argument has arisen among the technical men as to the results the operation of the furnace will have as QRM. It has been said that the frequencies used in its operation will find their way into the radio field and further increase the already great amount of interference. However, one of the furnaces is installed in the center of Manhattan Island and is kept in almost constant operation, and to date, according to the manufacturers, there has been no complaint whatever.

They state that in case interference should develop it would be a small matter to eliminate it by simply putting metal shields around the furnace and the high frequency generator.

The Bureau of Standards of the United States Department of Commerce maintains the services of three of these high-frequency induction steel furnaces, two of 20-kilowatt and one of 10-Kilowatt capacity. One of these units is reserved for investigations relative to heat and temperature measurements, while the other two are operated by the Metallurgical Division of the Bureau of Standards. In the production of pure platinum this type of furnace is peculiarly fitted.

Only recently the General Electric Company, the Western Electric Company and the Westinghouse Electric and Manufacturing Company have been issued licenses to manufacture high-frequency apparatus for heating the interior parts of electron tubes while gases are being dispelled. Gases in these metal parts are said to be more readily driven off by this induction method than by

applying heat to the tubes during evacuation, by conduction and radiation from filaments heated by the passage of current.

By means of the new furnace, energy ordinarily represented as heat losses in many electric furnaces is converted to a useful purpose.

The converter, which transforms the 60-cycle commercial electric current into high frequencies ranging from 10,000 to 20,000 cycles per second, takes the form of a metal cage. On its face is a switchboard, containing a wheel for controlling the electric power and an indicating wattmeter. The three essential units of this converter are enclosed in this cage, namely, twelve condensers, a transformer and a discharge gap. The latter has two electrodes which are raised and lowered over a surface of mercury held in a metal container. A hand wheel on the face of the switchboard is manipulated for the raising and lowering of the electrodes. The power delivered by this converter may be varied from zero to 20 kilowatts by changing the distance of these electrodes above the surface of the mercury. The transformer steps the line voltage up to 6,600 volts in the absence of danger, since the high-tension parts are enclosed in the metal cage, which is grounded.

The furnace proper is a box made of asbestos board. This receptacle contains the inductor coil, the electrical insulation, the small amount of heat-insulating material required, and the crucible in which is deposited the mineral or alloy to be melted. The com-

(Continued on page 1175)

Navy Ship Sends and Receives Simultaneously

THE battleship *Colorado* has just accomplished what radio engineers said was impossible a few years ago.

Her radio personnel has succeeded in receiving messages on five different wave-lengths while her transmitter was sending despatches across the continent on another wave-length.

This was accomplished by means of a special high-power tube transmitter and the use of special aerials for the receiving sets. Naturally the transmitter is an exceptional one. It emits a pure wave free from harmonics and mush. The receivers were most carefully designed as to selectivity. The difficulty of receiving several messages at a time on a ship, especially if a single aerial is used, is to keep from interfering with the other receiving sets tuned to various waves. This is difficult with ordinary apparatus (if possible at all) due to the fact that in tuning up and down the scale the other sets are interfered with and messages interrupted.

The Radio Officers of the S.S. *Leviathan* from Left to Right: A. N. Pickerill, Chief Radio Officer. A. C. Tamburino, 1st Ass't. R. J. Green, 2nd Ass't. H. F. Bollandok, 3rd Ass't. E. E. Engelder, 4th Ass't. C. R. Underhill, 5th Ass't. Right: The Cage Antenna System on the U. S. S. Wyoming, One of the Recently Completed First Line Battleships.

© Kadel & Herbert.

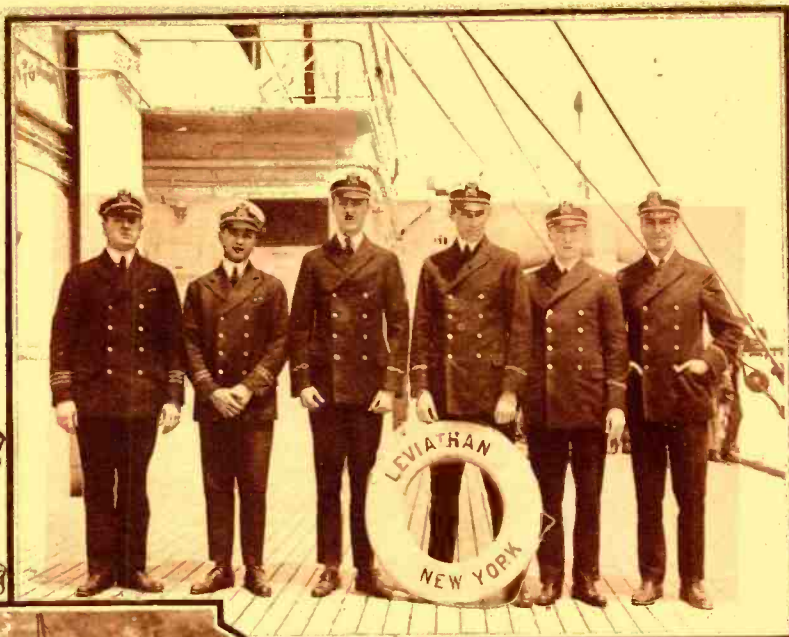

Capt. H. C. Fish, Staff Commander of the S.S. *Leviathan* Working the New Type Radio Compass Which Was Installed on Board During the Ship's Last Stay in New York. This Radio Compass Lessens the Danger of Collisions in Fogs. © Kadel & Herbert. Below: Pretty Soft Some 100 Feet In the Air and Repair the Aerial of the U. S. S. Maryland, Flagship of the Atlantic Fleet. She is Under Repair at Brooklyn Navy Yard Preparatory to Her Cruise to Southern Waters for War Maneuvers. © P. & A. Photos.

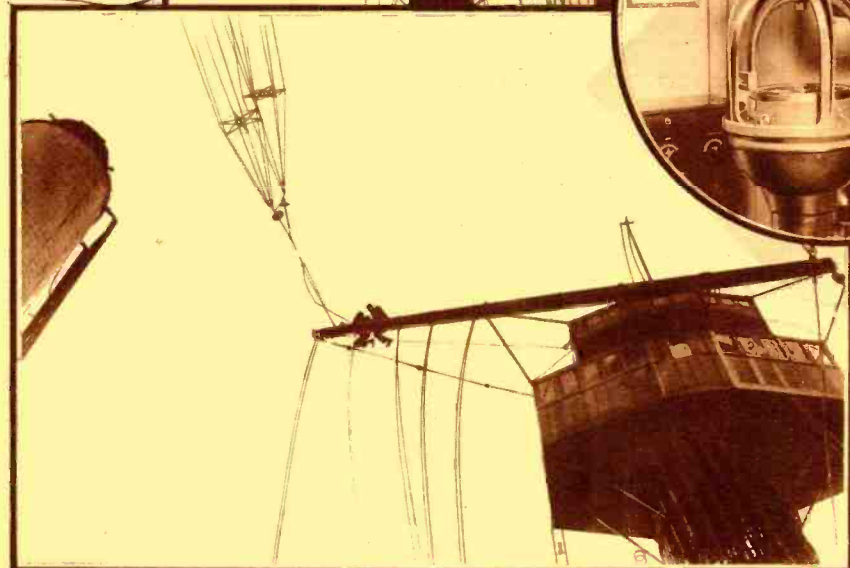
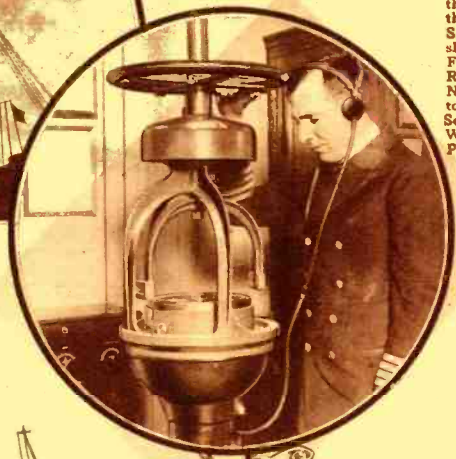

This system of sending and receiving was effectively tried out by the *Colorado* while lying off the Virginia Capes recently. She transmitted messages to San Diego and San Francisco on a wave of 1,430 meters and at

the same time copied five stations on 600, 1,300, 2,300, 4,300 and 4,600 meters during both day and night watches. The transmitting antenna with a 45-ampere input approximately, was only a few feet from the re-

ceiving antenna, a vertical affair of three or four strands suspended from a yard arm. This antenna picked up the messages for the five receiving sets—in itself a surprising (Continued on page 1174)

The London Radio Show



The Apparatus Illustrated Above Were Exhibited at the Second Radio Show Recently Held in London, England. These Are Only a Few of the Large Display. But Are Typical of the Style Now in Vogue in Europe. The Upper Pictures Show a Honeycomb Coil Tuner with Detector and Amplifier in Two Separate Units and a Portable Receiver Housed in a Suitcase. The Latter Requires Only a Very Short Aerial, as Do Some of the Most Recent American Portable Outfits. In the Large Photograph Are Shown Several Receivers Using Tuned Radio Frequency Amplifiers and "Plug In" Types of Transformers. In the Lower Right-Hand Corner Is a Complete Receiver Composed of Tuner, One Stage of Tuned Radio Frequency Amplification, Detector and Two-Stage Audio Frequency Amplifier and Power Amplifier in Separate Units. On the Left Is a Variable Condenser with Vernier, Manufactured by a French Firm. Note the Long Handle Controlling the Vernier. The Receiver Shown in the Right Center Picture Is Also of French Make and Has Proved Quite Efficient in Recent Tests. It Embodies Radio and Audio Frequency Amplification. Photos © Keystone, and by courtesy of Messrs. Burndy, Ltd., London, and Etablissements G. M. R., Paris.

RADIO ENTERS BUILDING SPECIFICATIONS

RADIO is fast becoming indispensable as a household service, not unlike permanent features such as light, power and heat. Radio receiving sets are now considered by architects as fixtures, and the details of wiring, battery space and antenna installation are being written into specifications.

One of the first radio homes—that is, with

facilities for radio built into the house—is that of Mr. L. E. Whittemore, Secretary of the Governmental Inter-Department Radio Advisory Committee. Before construction was begun, Mr. Whittemore explained his radio requirements to the architect, who included in the plans all radio facilities required by this engineer and enthusiast.

A non-metallic conduit pierces the study wall for a lead-in wire; another goes below

to a special space in the cellar reserved for the batteries, while a third is for the ground lead. Another piece of conduit pipe will carry leads from the set to a floor or wall socket in the living room, where a loud-speaker may be installed if desired.

Besides fixtures for erecting an aerial on the house-top, the owner plans to install two single, vertical loops in the north and west wall spaces of his study, the wires terminating in special sockets for an antenna plug.

When Broadcasting Was In Flower



Back in the Days of Yore When Broadcasting Was in Flower the Polar Station Oogi-oogi Sending on a Temperature of 3 Below Zero, Put on Some Marvelous Programs. The African Station WUF-WUF on 103 in the Shade Was No Mean Station Either. Their Jazz a la Cannibal Was Fit for the Ears of a Deal King. Both of These Stations Had Excellent Transmitters, Employing "Brute Force" Modulation. As Good as They Were, it is Sad to State that Neither Had Enthusiastic Audiences, the Reason Being of Course Because There Were No Receiving Sets.

Radio Broadcasting Proving Great Aid To Music Industry

By EDWARD T. JONES

WHEN Radio Broadcasting first began, no one knew just what effect it would have on the music industry. We all knew that it was a permanent thing, insofar as the American people were concerned and that it was spreading like wild-fire in every direction at a tremendous rate of speed. The beginning of very few industries were marked with such a period of enthusiasm, publicity and enormous volume of actual sales.

Interest at that time was so great that it is quite probable the music industry suffered an appreciable loss in sale of instruments as well as records, sheet and roll music. However, any fair minded music dealer will tell you (today) that his business is steadily increasing and that instead of being opposed to the broadcasting of music by radio he is ready to support it because it increases his sales materially.

It is said that the broadcasting of music by radio is an advertising and selling campaign for the music people by the radio people on such a large scale that it would not be possible for any corps of music concerns to duplicate it.

There is a phonograph in our home in addition to one of the best radio outfits we were able to get. We certainly could not do without either of them. Each instrument means a lot to the family and I am positive that the loss of either would prove very disagreeable.

We have learned to rely to a certain extent on the radio installation for selecting

radio broadcasting is doing more for the music industry than any one man, or body of men, ever endeavored to accomplish.

As the Quackenbush Company of Paterson, N. J., puts it, "The Radio Fan gets what he gets when he is getting it. The phonograph fan gets what he wants when he wants it." There is quite a difference and that difference makes it possible for both industries to enjoy a healthy existence.

Everyone is cognizant of the marked difference which exists between the radio set and the phonograph. When preparing one's self for an afternoon musical concert, which is to be intercepted by the use of a radio receiver, you haven't the slightest idea as

to what kind of music you are going to have the pleasure of listening to. It may be classical, jazz or popular music. No matter what kind of a musical program you finally tune in, there is no way of pre-determining the selections which constitute the evening's program. Therefore, it is true—that you have to get what you get when you're getting it.

Quite the contrary with the phonograph)
(Continued on page 1128)

TO OWNERS OF PHONOGRAPH AND RADIO RECEIVING SETS

- 1—Which instrument is of most value to you insofar as entertainment is concerned?
- 2—Which instrument do you prefer? Why?
- 3—Has Radio prompted you to purchase records?
- 4—What difference do you think exists between the two as amusement devices?
- 5—Do you believe radio helps or hurts the music business?

our records. The selections played by one of the artists at one of the powerful broadcasting stations may not be new ones, but they appeal to us and we must have them—therefore, our trip to the music dealer the next day in search of the selections we chose the night before. DOES THIS INCREASE THE MUSIC DEALERS' BUSINESS????? Who could deny this pertinent fact?????

Every indication points to the fact that

The Warning

By S. P. WRIGHT

Many things happen at sea that cannot be explained. The Captain had told him not to laugh at sailors' superstitions. Nor did he when the warning came. Read this gripping tale of the sea and its mystery.

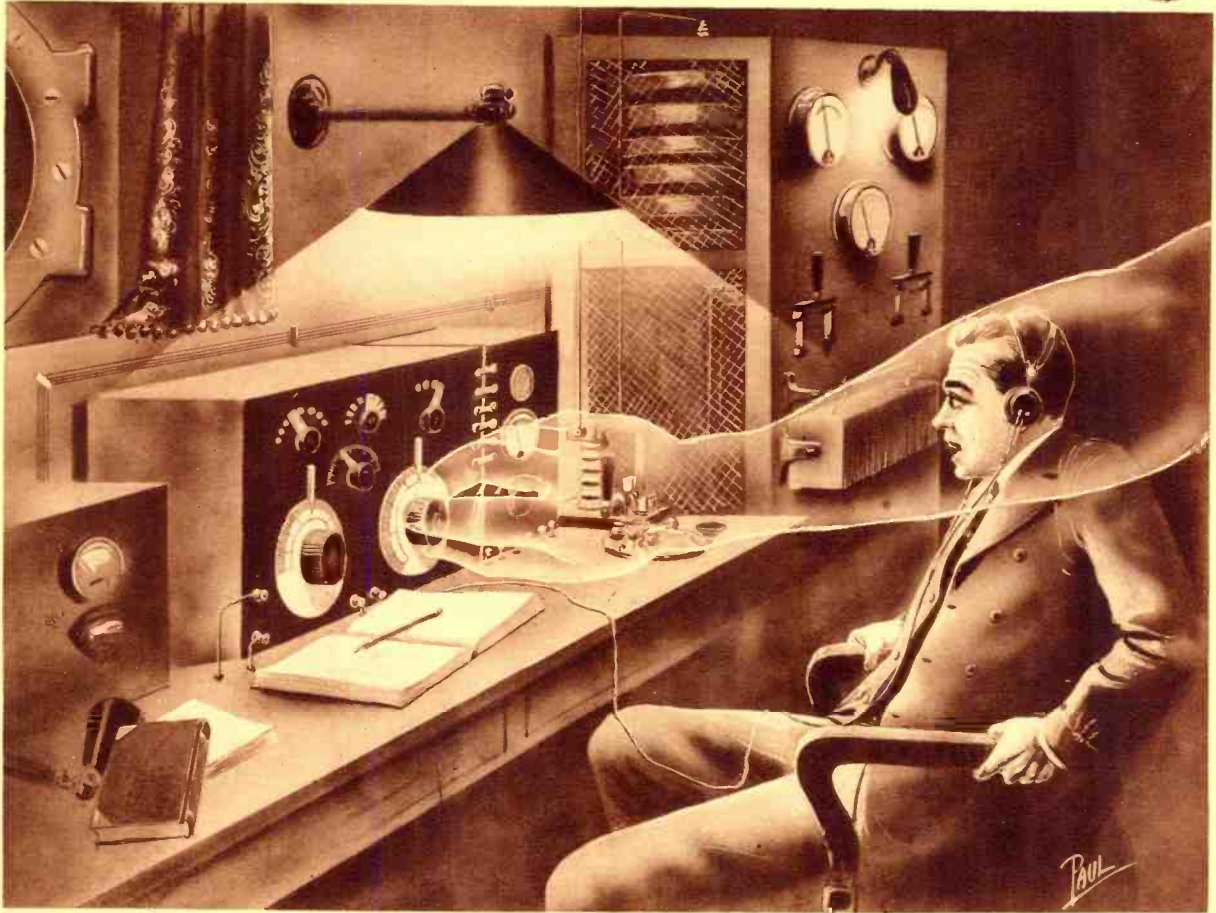

The Tuning Dial of My Set Was Turning; Slowly, Carefully, Smoothly. Turning to a Higher Wave; Turning as Though the Hand of an Experienced Operator Grasped the Knob, Exploring the Ether for a Signal. Up the Scale, a Slight Pause, and Down a Bit It Turned While I Stared, with Hammering Pulses.

LOTS of things happen at sea, Sparks, that can't be accounted for; I don't admit to any more superstitions than the average sailorman, but I will say that I've heard of things—yes, and seen them!—that couldn't be explained by books!

I'm not quite sure how we got into the discussion, the four of us, but somehow the talk had shifted to sailors' superstitions, and, having scarcely shaken the dust of a small Ohio town from my feet, I had attempted to make light of them. Captain Harrison, as you have seen, promptly gave me their true value.

Nelson, the mate, nodded in his deliberate Scandinavian way, and Farrington, the second mate, cast a disapproving glance at me.

"Sparks may be a good radio man, Captain," said he, "but he's got a lot to learn about salt water. Living on the ocean may make a man a bit different, a little closer to nature, so to speak, or perhaps there's a special Providence for mariners: be that as it may. Do you remember the case of the *Eastern Queen*, and the warning her master had the night before she piled up off the coast of China? Do you recall what Mc-Masters, chief engineer of the old *Glengarry*

said before he died from exposure, after 11 days at sea in an open boat?"

Captain Harrison's gulf-water blue eyes had a far-away look in them as he replied:

"We don't have to go so far away or so far back as all that," said the "old man" quietly. "You haven't forgotten our last Sparks, have you?"

I knew by the looks that came over the faces of the other officers that the story was a tragic one. I said nothing, and waited for the Captain to continue.

"Robert Foster was the way he signed the ship's articles, and he had been Sparks of this old tanker for three years or more; one of the best operators I ever had. Perhaps you knew him?"

I shook my head in silence. Harrison went on with the story.

"He came into breakfast one morning looking rather downcast, which was unusual for him, and naturally, we asked him what was on his mind.

"I had a funny dream last night he told us, and went on to say that he had had what he called a 'warning.' Just exactly what his 'funny dream' was none of us ever did learn.

"That same day one of the halyards sup-

porting the aerial parted and Sparks insisted upon fixing it himself, as he always did. 'A sea-going operator should never have to call on a deckhand' was the way he put it.

"Well, to cut the yarn short, Sparks lost his hold, somehow, and crashed to the deck. He was still alive when we picked him up, and for a while we thought he would live. As luck would have it we were just a few hours from Key West at the time, and regardless of orders, we put on every ounce of steam and made for port so as to get proper medical attention for him."

Captain Harrison drew a deep breath, and seemed for a moment to forget the rest of us; it was very evident that he had been very much attached to the unfortunate operator.

"When he heard that we had changed our course, in spite of his suffering, he begged us to go on and not bother with him. We might as well have done so, for less than half an hour later—he died."

There was a suspicious brightness in the Captain's eyes as he finished the story.

"We buried him at sea, as he requested when he knew he was slipping his moorings for the Last Cruise.

(Continued on page 1169)

Radioizing the Country School

By HAL G. BORLAND

Radioizing the country school is a new born idea and has met with great success in the West. Through the use of radio receiving sets, the country school children have access to the latest news of the day, the best music and various educational features that heretofore only the city children have had. Radio is certain to play an important part in the educational system of the future. It will cultivate more in the country school children than daily lessons.

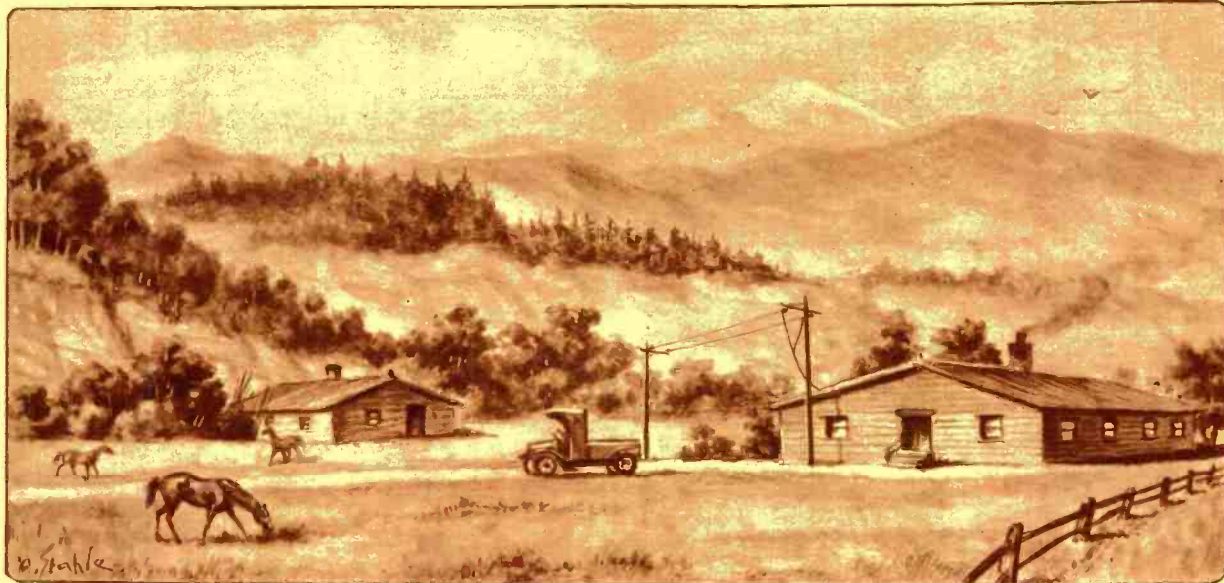

Situated in Remote Localities Where People Speak of "The Outside World" the Country School Cannot Give to the Children the Same Broadening Education the City Children Receive. But with Radio Receiving Sets the Gap is Bridged, the Country Child is Able to Enjoy Music, Lectures, Talks by Celebrities on Any Number of Interesting Subjects. The Influence is Obvious.

NEW England had her steam-heated log school houses, and the Mississippi Valley instituted motorized transportation to centralized rural schools, but it remained for Colorado, that romantic land of gold miners, cowpunchers and sheep ranches, to bring out the combination of radio telephony and sod school houses.

Out where old Pike's Peak each evening casts her cool shadow-mantle over the El Paso county plains there is a group of ranchmen and old-time pioneers who regard their rural schools as a part of their homes. And it is these men with their far-sighted sympathy, who have made the latest step forward in the methods of rural pedagogy. They have installed in several schools of El Paso county and the surrounding territory radio telephone receiving sets capable of receiving messages and concerts broadcast from stations in Denver, Kansas City and even as far away as San Francisco.

With this school year is being conducted a severe test of the practicability of radio in the rural school. And thus far it has come out a strong winner. Though a new movement, it is not limited to one struggling trial; throughout an entire district on the plains east of Colorado Springs the country schools are this year being "radioized."

One may now drive for miles without seeing a cultivated field, then, perhaps just after passing a large herd of range cattle, drive to the door of a sod school house of unimposing appearance and hear the voice of a Chicago opera star or the advice of a Los Angeles horticultural expert. For more than a year the ranchmen of this territory have been using radio apparatus to get market and weather

reports which are sent out from Denver and Kansas City; and through the efforts of these "fans" the receiving sets were installed in the schools.

Katherine L. Craig, State Superintendent of Public Instruction for Colorado, was approached by the ranchmen school directors last spring relative to the innovation. The rural folks wanted to know if the state superintendent would object to their installing the apparatus in their schools. They wanted to know what sort of official reaction there was to be to their "new fangled" idea.

"Excellent!" was the Superintendent's verdict. "It's the best idea I've heard of for a long time."

"Then you really think it would be all right if we went ahead and installed the receiving sets in the schools of our district?" inquired the leader of the delegation.

"I think it would be so much all right," answered the Superintendent, "that I am going to suggest the same thing to every school board in the state. It is one of the best ideas I've had presented in years. Go ahead and get your instruments and make use of them. I'll back you up, and I'll watch your progress with the deepest interest."

They went ahead as they had planned. A radio telephone receiving set was first bought and installed at the biggest school in their district—a centralized school with an attendance of more than 50. It was tried out and found to work successfully. Messages were received from the broadcasting stations not only in Denver but in Kansas City and even as far away as the West Coast.

Then other sets were purchased and installed in the smaller schools of the

territory. They also were found to be satisfactory. Then things were left for the summer, and everything was all settled until school opened up this fall, about the middle of September. Some of them are holding short terms—some seven months and some eight months—but all are making extensive use of the radio.

A few days after school started at the big centralized school I was talking with Andy McComb, head of the school board and one of the old-time ranchmen of that territory—a man who holds several thousand acres of choice grazing land and who ships many cars of choice feeders to the Denver markets every year.

"Everything is sittin' pretty," he grinned. "Couldn't ask for anything better. All the kids are enthusiastic over the prospects for this year, we've got a good bunch of teachers, and the 'kid-wagons'—motioning to a group of busses which gather up the youngsters every morning and take them home from school every night—are all running on schedule."

"How's the new apparatus working?" I was anxious to get Andy's opinion of the new radio outfit.

"What part of it do you mean?" He was beaming with pride. "You know we put in several new things this summer—the new heating system, the new ranges in the domestic science rooms, and the new radio outfit."

"The radio."
"Great!" Andy was thoroughly enthusiastic. "The first day we opened school they had a big concert in the afternoon, the whole thing broadcast from the Denver stations. And every day since then they've been getting stuff from all"

(Continued on page 1132)

The Radio News

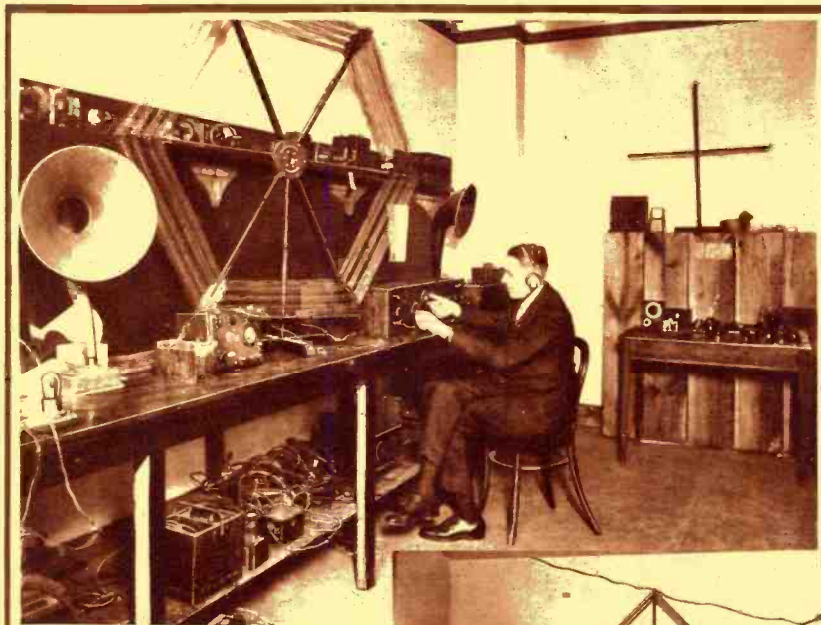

Radio News Laboratories Have Been in Existence for Two Years and Were Formed for the Sole Purpose of Testing Manufactured Radio Apparatus and Carrying on Experiments with New Circuits and Receivers. The Results of the Tests Given Apparatus Are Published Each Month in this Magazine in Order That the Radio Public May Know the Merits of All Instruments Which Are Found to be Satisfactory. The Reader Can Obtain Only a Partial Idea from These Photographs as to the Great Amount of Research Work Being Carried on Continually in the Laboratories. The Photo to the Left Shows One of the Laboratory Engineers Testing a New Type of Receiving Set.

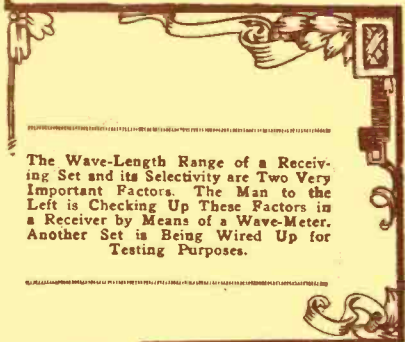

The Wave-Length Range of a Receiving Set and its Selectivity are Two Very Important Factors. The Man to the Left is Checking Up These Factors in a Receiver by Means of a Wave-Meter. Another Set is Being Wired Up for Testing Purposes.

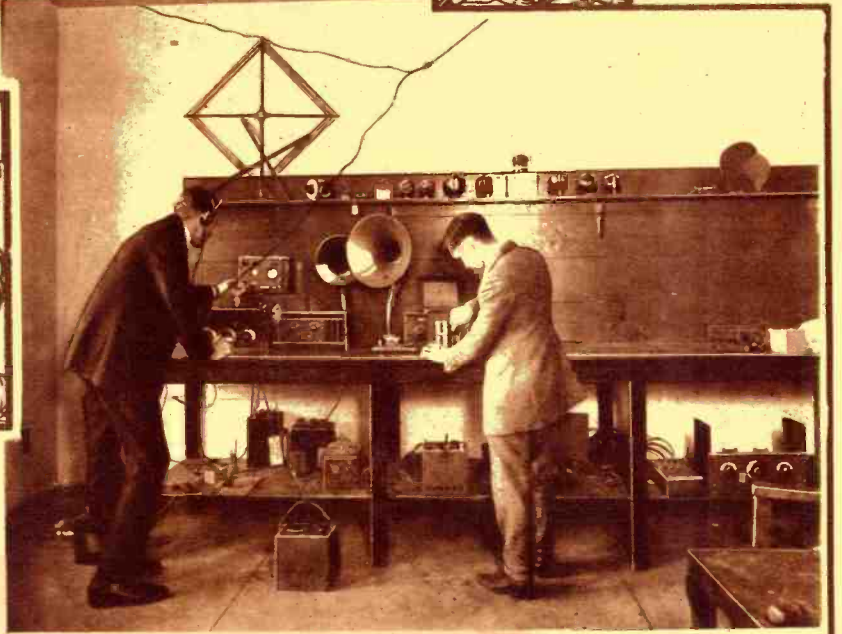

The Laboratory "Capacity Bridge" Which Accurately Measures the Capacity of Condensers ranging from a Fraction of a Micro-Micro-Farad Upwards.



Laboratories



Before an Instrument is Placed in an Experimental Set it is Thoroughly Tested. The Photo Above Shows Two of the Men Testing and Assembling the Parts of a New Type of Receiver.

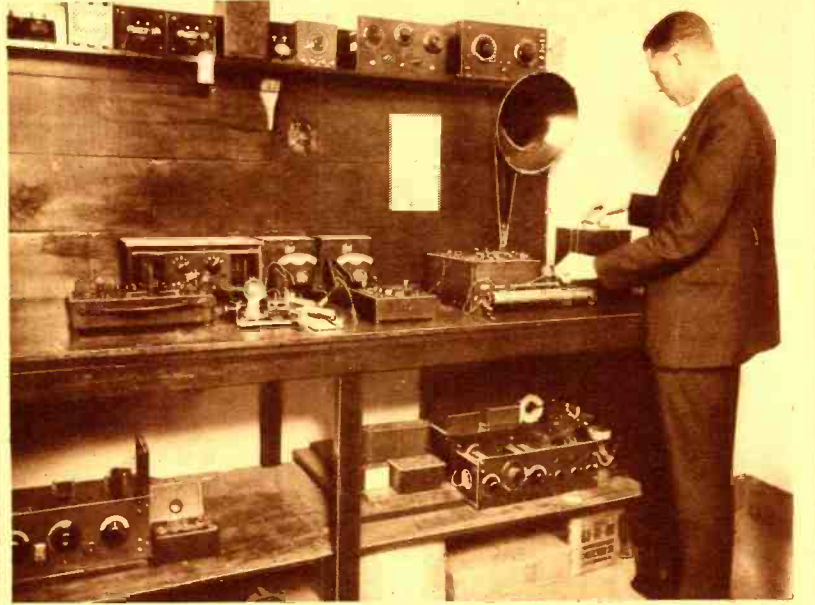

Above: A Part of the High Frequency Apparatus Employed Determining the Breakdown Voltage of Various Forms of Insulation. Left: One of the Engineers Testing Loudspeakers and Transformers with an Audio Frequency Oscillator and Peak Voltmeter.

Announcement of Standard Frequency Transmissions

THE Bureau of Standards is transmitting special signals of standard frequency about twice a month. The signals can be heard and utilized in general east of the Mississippi River.

These special signals of standard frequency are of use to testing laboratories, transmitting station operators, and others, in checking wavemeters and adjusting transmitting and receiving apparatus. Their accuracy is better than three-tenths of one per cent. Information on how to use the signals was given in the February, 1923, issue of the Radio Service Bulletin. More detailed information is given in Bureau of Standards Letter Circular No. 92, which may be obtained, on application, from the Bureau of Standards, Washington, D. C.

All transmissions are by unmodulated continuous-wave telegraphy. A complete frequency transmission includes a "general call," a "standard frequency signal," and "announcements." The "general call" is given at the beginning of the eight-minute period and continues for about two minutes. This includes a statement of the frequency. The "standard frequency signal" is a series of very long dashes with the call letters WWV intervening. This signal continues for about four minutes. The "announcements" are on the same frequency as the "standard frequency signal" just transmitted, and contain a statement of the measured frequency. An announcement of the next frequency to be transmitted is then given. There is then a four-minute interval

while the transmitting set is adjusted for the next frequency.

The schedule is as follows:

Eastern Standard Time	Schedule of Frequencies in Kilocycles (Approximate Wave-Lengths in Meters in parentheses)		
	Jan. 21	Feb. 5	Feb. 20
11:00 to 11:05 P. M.	500 (600)	1300 (231)	150 (2000)
11:12 to 11:20 P. M.	600 (500)	1400 (214)	205 (1463)
11:24 to 11:32 P. M.	700 (428)	1500 (200)	260 (1153)
11:36 to 11:44 P. M.	833 (360)	1600 (187)	315 (952)
11:48 to 11:56 P. M.	900 (333)	1700 (176)	370 (810)
12:00 to 12:08 A. M.	1000 (300)	1800 (167)	435 (689)
12:12 to 12:20 A. M.	1200 (250)	1900 (158)	500 (600)
12:24 to 12:32 A. M.	1400 (214)	2000 (150)	570 (526)

President Coolidge Addressing the 68th Congress

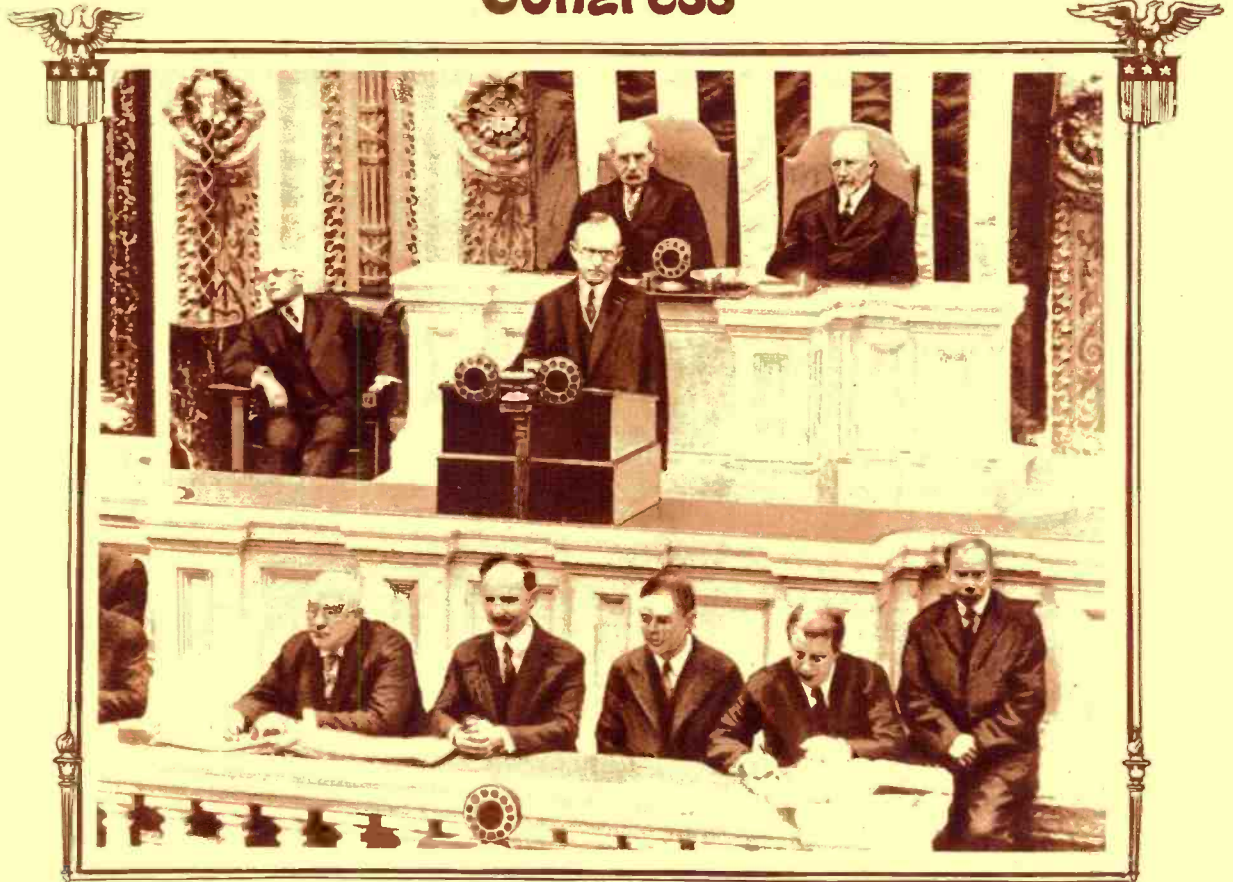

At the Clerk's Desk in the House of Representatives, President Calvin Coolidge Made His First Address to the 68th Congress. This Was the First Time in the History of Radio Broadcasting that a President's Address to Congress Was Transmitted Through the Ether Direct to the Homes and Offices of Thousands Upon Thousands of Citizens. The Microphones that Picked Up President Coolidge's Voice and Transmitted It to the Broadcast Stations Are Clearly Shown in the Photograph. © Wide World Photos.

Radio Reception in the Grand Canyon

By S. R. WINTERS

A CANARY bird chirping in a room in Los Angeles is heard in the depths of a canyon 400 miles distant. On August 10, a group of persons hemmed in by sheer walls of 2,000 feet of rock paid silent tribute to the late President Harding as his body was being lowered into the grave. The results of the first two games of the World's Series were listened to amid the roar of rushing waters in a gorge 20 miles from the nearest railroad. The same listeners on another occasion received the contents of their own telegram confirming their safety after a report had gained circulation that they had been killed by rapid and swelling currents dashing their boats against rocks.

If we were living in a period of the "Arabian Nights" instead of the twentieth century when scientific accomplishments encompass and even exceed the greatest flights of imagination one would be prone to attribute the events set forth in the preceding paragraph as dreams. In reality, however, this account is faithful to facts, and it is a tale of how radio, for the first time, invaded the roughest waters of 300 miles of the Grand Canyon of the Colorado River. This vehicle of communication was utilized

on a surveying expedition recently completed by an exploring crew of the Geological Survey, United States Department of Interior. It was the crew's only means of keeping in touch with civilization while on a two and one-half months' expedition down the river distinguished for its dangerous rapids.

The stringing of antenna wires across the roof of a house or placing a loop aerial in the corner of a room is, indeed, a tame undertaking compared with the thrill of planting a mast in a river bed and stretching a wire for nearly a hundred feet beside a rough-hewn mass of rock. A photograph illustrating this article portrays more graphically the picturesque arrangement than any text could hope to do. This antenna could be used for one evening, when it would be uprooted and transplanted to another point as the exploring party proceeded along its course.

The thrill of planting an antenna on soil heretofore not traversed or surveyed was great in itself. However, the experience of clamping head telephones on your ears, adjusting the dials of the receiving set in resonance with the ethereal world of concert and speech, while closeted in the depths of a

canyon, must be an unforgettable sensation. For instance, at Vasey's Paradise the exploring party filled their canteens, explored a large cave, made survey of a possible dam site, and camped on the limestone ledges at the head of another rapids. Here radio messages were received from KHJ, at Los Angeles, Cal., though not without static interference.

"The outstanding event received by radio telephone on this memorable trip," to quote an interview the writer had with Herman Stabler, a hydraulic engineer of the Geological Survey, "was the announcement of the death of President Harding. Camp was made at the head of Soap Creek rapids, about eleven miles from Lee's Ferry, when the party learned of the death of the President, three-quarters of an hour after it occurred. This was probably before the majority of the people of the United States had heard the sad news. By the same means of communication, the crew remained idle on August 10, as a tribute of respect to the memory of the dead President." Mark Twain, who upon one occasion had been reported dead, denied the story by declaring the report was slightly exaggerated. Similarly, this crew of explorers not only cor-

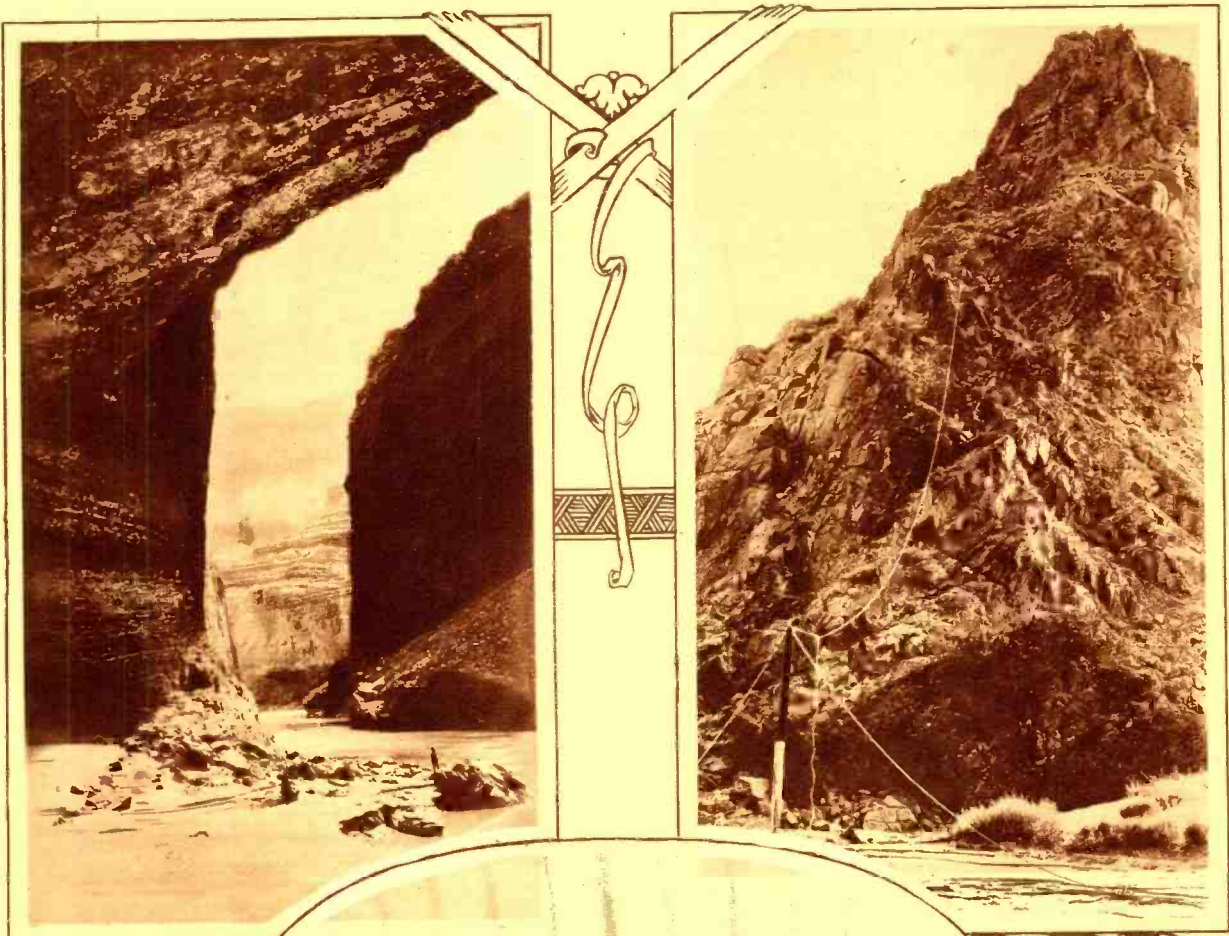

A Number of Views of the Grand Canyon. Despite the Fact That There Is Considerable Cre in These Formations, the Party Were Able to Receive Broadcast Programs at the Very Bottom of the Canyon.

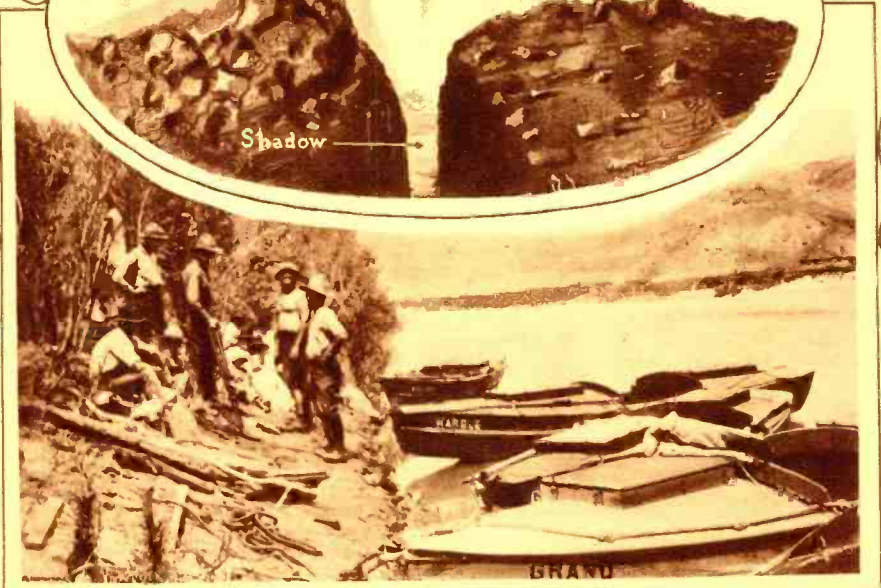

The Camping Party and Their Boats. The "Grand" Had a Water-Tight Compartment in Which the Camera and Radio Were Stowed to Protect Them While Going Through the Rapids.

rected reports that they had been lost in a flood, but they had the supreme satisfaction of acknowledging, by radio, a telegram dispatched to Washington reporting their safe arrival at Diamond Creek.

The boats had just been overhauled and the radio telephone outfit repaired and installed at this point when KHJ, broadcast station operated by the Los Angeles Times, broadcast the telegram announcing

the safety of the party at Diamond Creek. On September 8, within the depths of the canyon, the party, camping at the mouth of Tapeats Creek, heard by radio of the dis-

(Continued on page 1169)



Oberlin College Radio 8YAE



Station 8YAE is Well Laid Out and Lends a Pleasing Appearance to the Eye. The C.W. Set is Only a 10-Watter, But Has a 2-Amp. Kick that Jars Phones on the West Coast. There Are Two Receiving Sets; One a Single Circuit Regenerative, Covering 150 to 400 Meters; and the Other, a B.C. Receiver with Power Amplifier. Note the G.R. Wave-Meter to the Extreme Left of Table.

THE antenna system at 8YAE consists of a six-wire flat top 55' high and 75' long, swung between two of the college buildings. At the end of a 20' fan lead-in, a heavy stranded cable leads to the set which is located in one of the Physics Laboratory rooms on the third floor. The counterpoise covers an area of over 2,000 square feet directly beneath the antenna. It contains eight strands on 23' spreaders, and is 100' long. At a height of 15' above the ground, the CP is the same distance below the transmitter as the antenna is above it, bringing the center of oscillation within the set. The pipes of the city water system and the college heating plant are used as earth connection.

The C.W. transmitter employs two 5-watt tubes in a Colpitts circuit. The plates are supplied with 500 volts from an Acme 200-

watt transformer, and a chemical rectifier of 12 jars. Ordinary jelly glasses are used as containers for the electrolyte, a saturated solution of Borax. The plates are 6"x1/2" lead and aluminum strips, bolted together and supported in the solution by a wooden crosspiece. The height may be varied so that any surface may be immersed. A filter system consisting of two 2-mfd. condensers and a 15 h. choke renders the note very pleasing and easy to copy according to all reports on the signals. The regular operating wave-length is 220 meters with an antenna current of 1.8 to 2.0 amperes. Some experiments on the lower waves brought good results as low as 180 meters. The plate milliammeter usually reads about 105, and the filaments are burned at a constant voltage of 7.8 A.C. supplied from the tertiary of the power transformer.

Low-Power C. W. Records In Australia

REMARKABLE records in low-power C.W. transmission have been made by Mr. Maclurcan, of Strathfield, New South Wales, Australia. Mr. Maclurcan conducted a series of tests with Mr. Hull, a Melbourne amateur, and starting with a power of a little more than seven watts, gradually reduced his power until he was transmitting on as low a power as .078 watt. The signals throughout were clearly received, and Mr. Hull signaled to Mr. Maclurcan asking him to reduce still further. On the following night Mr. Maclurcan again carried out tests with Mr. Hull, and succeeded in transmitting messages which were quite readable in Melbourne, although commercial stations were working, on a power of .044 watt.

Later on he again reduced the power, this time to .012 watt, and although some of the signals were received in Melbourne, atmospheric disturbances resulted in others not being readable. Mr. Maclurcan's measuring instruments were read by a separate observer, and later were checked by Mr. E. Joseph, an expert, and were found to be correct to within one per cent.

In view of the success met with during the Melbourne tests, Mr. Maclurcan resolved to carry out further low-power transmission work, this time over longer distances, and commenced a series of tests with Mr. Bell, of Waihemo, Shag Valley, New Zealand.

Commencing with a power of 7 watt, he gradually reduced to .04 watt, then to .01 watt, and finally to .0037 watt. Mr. Bell

The receiving equipment includes two complete sets, one for use on amateur wave-lengths, and the other for the reception of broadcast programs. On the left of the antenna switch is the single circuit receiver used exclusively for relay work. It is a home-made set employing the circuit used in the Grebe CR-5 with one stage of audio frequency amplification. The latter is found amply sufficient for all DX work, even when using the small indoor receiving aerial for working through heavy QRN. It covers the wave-lengths from 150 to 400 meters.

On the table to the right of the transmitter is the broadcast receiver. This set was built up in the laboratory and is used in connection with the weekly radio concerts given for students in the Physics lecture hall. Either a three-circuit regenerative or a non-regenerative unit may be used with this set. Two stages of radio frequency and one of audio are provided. The last unit on the right is a power amplifier and loud speaker. With this outfit, musical programs have been heard with remarkable clearness several hundred feet from the loud speaker.

Radio 8YAE has been in active operation since the first of the year. A staff of four operators has kept the traffic total well up each month. In addition to this, the DX records made by the 10-watt transmitter are worthy of mention. Of some interest also is the manner in which these records are recorded in graphic form.

A large map of the United States was mounted on a sheet of Beaver Board, and a quantity of colored map pins secured to show the location of stations worked, heard, and reporting. In the course of the last season the pins have pretty well covered the map from one coast to the other and from Canada to the Gulf. Reliable communication has been established with every district in the United States and Canada, the best working records being with 6XAD in Avalon, California, and 7SC in Aberdeen, Washington. On many occasions, the signals of 8YAE have been reported QSA at various points on the Pacific Coast.

C. W. THATCHER (GX), Chief Operator,
263 Elm St., Oberlin, Ohio.

replied that the signals were strong and steady throughout, even on the lowest power. In this case also the readings at Mr. Maclurcan's station were made by neutral observers.

CORRECTION

In reference to the diagram of Fig. 4 in the article, "A Well Designed Short Wave Receiver," appearing in the January issue, the ground connection should be eliminated. With its use it is not possible to get below 180 meters. Furthermore, the latter portion of the caption of Fig. 2 should read, "It is to be noted that the H.F. resistance of the solid wire increases very rapidly with a decrease of wave-length."

Hamitorial

WHAT IS DX?

A few nights ago we were listening in, hoping to pick up something worth while. The twos came roaring in, the threes were fair and the eights and nines pushed against the diaphragms in fine fashion. While feeling around we struck a five, two sevens and a number of fours. "DX", said we to the gang in the corner repairing a 220 to 550 boiler.

"Yea," said they, "who did ya get?"

"A five, two sevens and some fours," we answered.

"How come DX?" piped up one. "You ought to get flocks of sixes with that layout of yours;"—from all of which the question arises, when is DX and when isn't it?

Did you ever stop to think this over? What do we mean by DX. Everything over 1,000 miles, no matter whether the receiver used is a one-lunger or a Super-Heterodyne, or anything we may personally think is long distance? The "Calls heard" column means nothing to us unless we know what kind of a receiver was used and the power of the stations logged. Where is the line to be drawn? Since physical characteristics of a location have much to do with reception, it is impossible to set ranges for one-lungers or Super-Heterodynes, or any other kind of a receiver, even into the loop. Won't some of you Hams relieve our minds? Don't tell us though, that anything over 1,000 miles or 1,500 miles is DX, because if you do, we will install a super-heterodyne dingbatoflex and make it local stuff! In conclusion we ask, where does DX start?

SINCE WHEN?

We had occasion to ask three Hams the other day what kind of receivers they had. One said, "A single circuit regenerative," which we found was of the feed-back variety. Another said, "A two-circuit regenerative" which we were informed had a single coil shunted by a V.C. and a variometer in the plate circuit. The third Ham said, "A three-circuit regenerative"; you know, two variometers and a vario-coupler. Now we ask you, since when? Ham No. 1 has a single circuit set. Ham No. 2 takes out the tickler coil and sticks in a variometer, and lo and behold, it becomes a two-circuit set! Ham No. 3 uses a primary and secondary and a plate variometer, so he has a three-circuit set. What we want to know is, why the tickler coil is disregarded. The plate circuit is controlled by the tickler coil, just as in case No. 2 and No. 3 the plate

circuit is controlled by the variometer. So far as we're concerned, Ham No. 1 has a two-circuit tuner. Try and make us think different. Of course, if we are speaking of the number of knobs and dials, that's a different matter. If Ham No. 1 wants a single-circuit tuner he's got to take the tickler coil out. What say?

WATCH YOURSELF!

There are some empty ump thousand broadcast listeners in the United States at the present time, and the majority of this gang can be termed radio bugs, meaning they are nuts about radio. They aren't happy unless they can experiment

John L. Reinartz and His Balanced C.W. Transmitter with Which He Worked French 8AB for Two Hours Straight, on the Evening of November 27. 8AB Uses the Same Circuit and Both He and Reinartz Have Been Working on a Wave of 100 Meters. The Balanced C.W. Circuit Was Described in the Last Issue of Radio News.
© Foto Topics



with all the new circuits and if they can't hear KHJ or WJZ, depending upon whether they are on the west or east coast, they can at least say they do. This is perfectly all right, as a good radio man shouldn't let golfers and fishermen put anything over on him when it comes to stories. When it comes to radio bugs, though, you can't beat a dyed-in-the-wool Ham. If some one in the morning tells him that Litz doesn't compare with No. 14 D.C.C., he argues about it the rest of the day. He is more nuts about it than the average BCL. He eats, sleeps and talks radio. He is off—completely spooify. We know a young Ham who radiates radio. One night he was heard to say in his prayers: "Dear Lord, this is Sammy sending, please QSY to 150 meters, there is QRM on 200."

The moral is: Lay off once in a while or you'll go batty. Don't be a Boiled Owl more than two nights a week. See the girl once in a while (and for the OW's, take a shot at a romantic movie) and ease up on that portion of your brain that has to work overtime on radio matters.

Calls Heard

This space is set aside each month for the listing of amateur calls heard. We invite you to send us a list of the stations you have heard, typewritten if possible, or at least sufficiently readable to prevent mistakes. Print the calls on a separate sheet of paper, using but one side. These should be arranged alphabetically for each district. To distinguish the stations that have been worked, they should be put in parenthesis, and, according to the rules now in use, the C.W. stations should be mentioned in a separate list. The lists should reach us by the first of the month for publication in the following issue.

LEONARD STROBEL, AKRON, OHIO

1AF, 1AS1, 1BES, 1BGC, 1BOM, 1CMP, 1CRW, 1DD, 1DE, 1FB, 1GL, 1IL, 1MC, 1RR, 1YB, 1YK, 2ABG, 2ADB, 2AFS, 2AGC, 2AGX, 2AU, 2BDO, 2REM, 2BQH, 2BTX, 2BUM, 2BY, 2BYF, 2BZV, 2CKN, 2CXD, 2CXL, 2FH, 2GK, 2HH, 2SU, 2TR, 2UU, 2VA, 2X1, 3AFS, 3BBV, 3BDO, 3BFC, 3BGT, 3BMN, 3BOF, 3BOP, 3BVN, 3BWT, 3CBL, 3CFV, 3CHG, 3CJM, 3HK, 3JG, 3JJ, 3ME, 3NF, 3OO, 3TR, 3UU, 3WA, 3WB, 3XA, 3ZO, 4AY, 4BE, 4DM, 4DN, 4EB, 4EO, 4FA, 4FG, 4FT, 4GL, 4GT, 4GW, 4GZ, 4JH, 4JU, 4KC, 4KU, 4MB, 4OA, 4OM, 4OF, 4CU, 4ZA, 5ABD, 5ABY, 5AEO, 5AFS, 5AGJ, 5AIJ, 5AIR, 5AIU, 5AMF, 5AMH, 5AMS, 5AN, 5BM, 5BN, 5CT, 5DA, 5EK, 5ER, 5FR, 5FV, 5GI, 5GJ, 5GN, 5GM, 5IIL, 5HT, 5IA, 5IF, 5IN, 5JN, 5KS, 5LR, 5ME, 5MI, 5MK, 5MO, 5NJ, 5NK, 5OV, 5PH, 5OI, 5RD, 5SK, 5SL, 5UK, 5UP, 5WO, 5XA, 5ZAS, 5ZAV, 5ZH, 5ZZ, 6ANB, 6ASK, 6ASU, 6AVV, 6AWT, 6BCL, 6BIC, 6BUA, 6CGW, 6TM, 6ZAH, 6ZAS, 6ZV, 6ZZ, 7BF, 9AAS, 9AAT, 9AAW, 9ACQ, 9AFU, 9ACN, 9AHY, 9AIC, 9AIM, 9AJE, 9AJV, 9AKI, 9AMH, 9AMO, 9AMU, 9AN, 9AOU, 9APE, 9AUS, 9AU, 9AWF, 9AWM, 9AWS, 9AXX, 9BAB, 9BAZ, 9BRG, 9BES, 9BEZ, 9BFI, 9BFP, 9BG, 9BHN, 9BIS, 9BJQ, 9BKC, 9BKH, 9BKO, 9BLG, 9BMU, 9BQG, 9BRK, 9BSH, 9BSV, 9BUO, 9BVN, 9BZI, 9BZY, 9CAK, 9CAQ, 9CCH, 9CCS, 9CCW, 9CCZ, 9CDO, 9CEE, 9CFS, 9CHD, 9CPG, 9CPX, 9CRX, 9CTE, 9CTR, 9CUD, 9CVS, 9CWC, 9CFV, 9CVQ,

(Continued on page 1158)

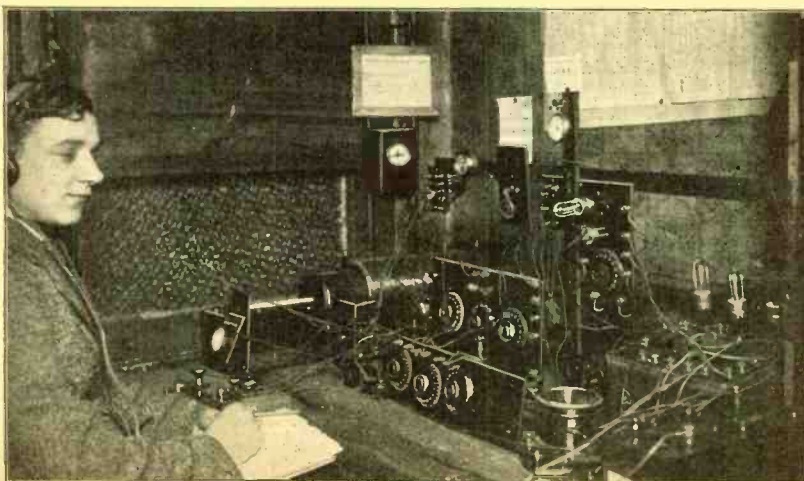

Mr. Florsham and His Station 2UV, London, England. A 10-Watt C.W. and Phone Set Employing the 1DH Circuit is Doing Service. 2 UV Says He is Going to Jack Up His Power for the Trans-Atlantics. American Hams are QSA at His Station.

Remote Control of a High Power Radio Station*

By CHARLES SPEAKER, R.E., Navy Department

Describing the system on trial at the radio station, Arlington, Va. A similar arrangement might be used by the amateur whose transmitter is located at a distance from the receiver.

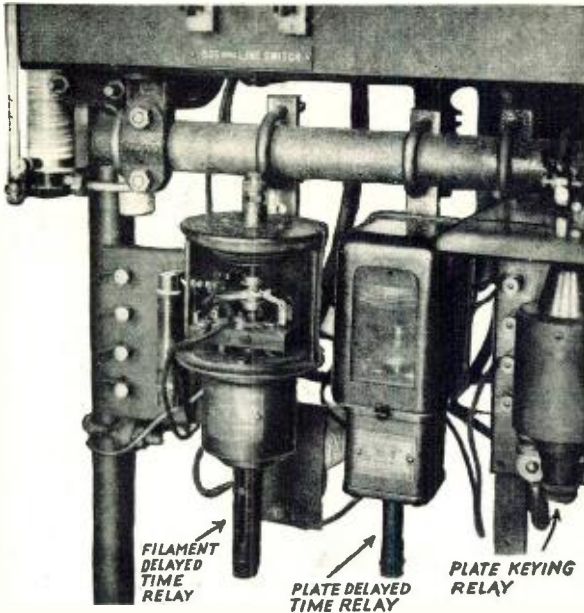

Fig. 1. Photograph of the Remote Control System Employed at the Naval Station at Arlington, Va. The Keying Circuits Are Situated at Washington, D. C. A Press of One of the Transmitting Keys Automatically Starts the Motor Generator and Lights the Filaments of the Tubes. A Release of the Key for More Than Fifteen Seconds Automatically Closes Down the Transmitter.

stopping of the transmitting apparatus arise. It has been the practice to provide an "order wire" between the message center and the transmitting station over which the keying operator can tell the operator on watch at the station when to start the motor-generators or light the filaments of the transmitting tubes. The use of such an order wire means that there must be the closest co-operation between keying operator and station operator if no time is to be lost in handling the traffic. The order wire is at best a troublesome arrangement.

In the case of the Arlington alternating current tube transmitter which is now handling the 2650-meter broadcast formerly done by the Fessenden spark, it was decided to make the transmitter completely remote-controlled from the message center, doing away with the order wire. The requirements for such complete automatic remote control may be summarized as follows:

(a) Automatic means must be provided for starting and stopping the motor-generator when the keying operator wishes to begin or has finished sending messages.

(b) Automatic means must be provided for lighting and extinguishing the filaments of the vacuum tubes prior to starting and at the close of operation.

(c) Means must be provided for preventing the application of plate voltage to the tubes until the filaments have come up to full brilliancy. Otherwise the tubes may be damaged.

(d) Means must be provided for remote "keying" of the transmitter, that is, starting and stopping the antenna current as the operator makes dots and dashes.

REMOTE CONTROL SYSTEM AS USED AT ARLINGTON

The above requirements have been met in the case of the new Arlington alternating-current tube transmitter by the use of so-called delayed time limit relays which are shown in the close-up view of the left front corner of the transmitter, Fig. 1. Power station men will recognize these relays as a modified form of the protective inverse time limit relays which are provided at generating station switchboards to protect the machines

(Continued on page 1179)

AS most of the readers of RADIO NEWS probably know, it is not customary for the keying operator of a large radio shore station to be located at the transmitting station itself. He is usually at some "message-center," miles away, and keys the transmitter over a telegraph line. For example, the high power Naval arc at Annapolis is controlled over a wire from Washington, D. C., a distance of about forty miles. Likewise the high power Alexander alternator station of the Radio Corporation of America at Rocky Point, Long Island, is controlled from the Radio Corporation message center at 64 Broad St., New York City.

The receiving apparatus over which the keying operator receives answers to his messages is usually located at the message center. At Arlington the message center is located in the Army and Navy building, Washington, D. C. There are two of these, one is used by the Army and the other by the Navy. Both services handle outgoing traffic through the Arlington station. The Army Arlington traffic is sent out with call letters WXY and the Navy uses the old N.A. call.

SIMPLEX AND DUPLEX OPERATION

Of course, the apparatus at the message center may be so arranged that the keying operator receives answers to the messages by listening in on the receiver at the close of each message. This method of handling traffic is called simplex operation. Often, however, the keying operator does nothing but transmit leaving the receiving to be done by another operator seated beside the keying operator. This method is called duplex operation.

It will be at once evident that the duplex

method of operation results in greatly increased speed of handling traffic. When the keying operator does not have to wait for an answer to his messages he can send to many stations within a given traffic period. The duplex system results in systematic traffic in such a way that it can be handled on a schedule basis. It eliminates a good deal of the useless calling in "raising" a station to which the usual non-scheduled simplex method is subject. A very important advantage is that full use is made of the transmitting machinery during a traffic period for it does not have to run idle while the keying operator listens, as in simplex.

THE ORDER WIRE

When the keying operator is located at the distant message center, certain important problems connected with the starting and

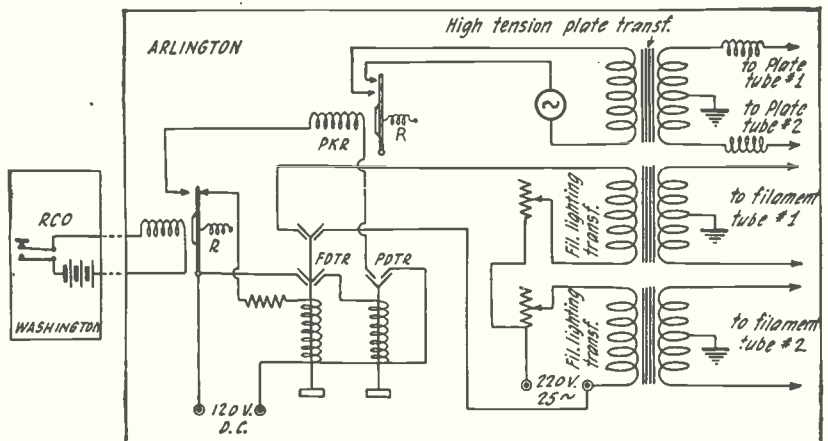

Fig. 2. Complete Circuit Diagram of the Remote Control System. Closing the Key Circuit Operates the First Relay Which in Turn Closes the Circuits to the Delayed Time and Plate Keying Relays.

*Released by permission of the Director of Naval Intelligence.

Transient Phenomena In Audio Frequency Transformers

By ALLEN D. CARDWELL



We are pleased to have the opportunity of publishing this article on audio frequency transformers. Mr. Cardwell has revealed the important considerations in transformer design and points out the limitations of those on the market at the present time. You are sure to find this an interesting discourse.

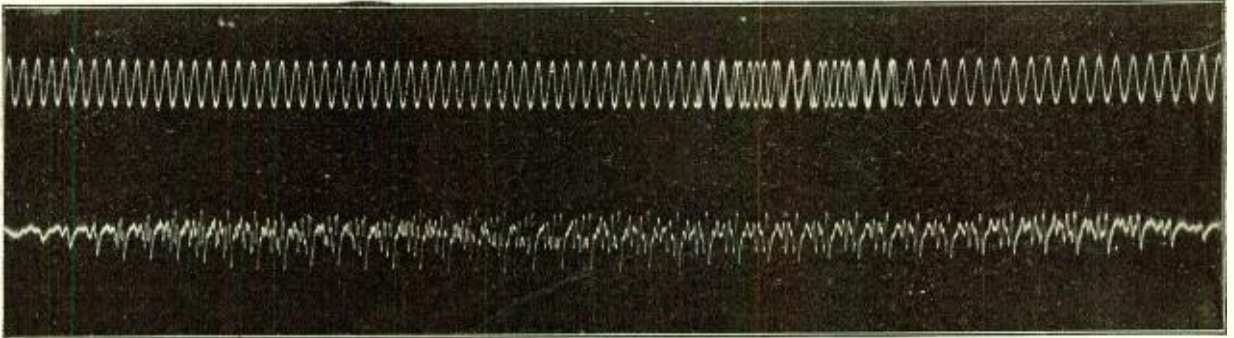

Very Few People Have a Conception of What the Engineer Has to Contend with in the Design of Audio Frequency Amplifying Transformers. The Above Oscillogram Will Serve to Illustrate. At the Top is Shown a Pure Sine Wave or Alternating Current and Directly Below, a Similar Wave After Having Been Modulated by Ever-Changing Voice Frequencies. In Order to Amplify This Complicated Wave Without Distortion, the Transformer Must Be So Designed as to Amplify Equally All Frequencies Encompassed by Speech and Music and to Immediately Respond to Their Rapid Variations.

SO much has been written and published in the radio press upon the subject of audio frequency amplifying systems that it might be deemed presumptuous to come forward at this hour with unorthodox ideas as to the basic principles underlying the problems involved. It does seem, however, that some very important considerations have been left untouched by practically every savant upon the subject—and upon these points, it is my hope to suggest some hypotheses which may prove interesting, if not scientifically conclusive.

In audio frequency amplification, we are generally dependent upon vacuum tubes coupled by transformers. Thus we have essentially a progressive set of relays intended to control higher and higher voltage and current variations so that on the output side, the original signal strength may be increased some 300 or 3,000 times—enough to operate loud-speaking devices.

An audio transformer is partly a voltage amplifier and partly a loading device of such constants as to utilize the tube at maximum efficiency. In this respect, we begin to deal immediately with such well-known factors as tube impedance, turn ratios, mutual conductance, etc. So we have an ocean of technical verbosity in which to swim in any direction for an interminable period of time without reaching any particular island of fact in practical results.

It is from this theoretical conception of the duties of an audio transformer that we have been led to believe that the amplification factor of a transformer at different frequencies begins to tell the efficiency of the device—a questionable assumption. In telephone parlance, when we express the "miles of cable amplification" of a transformer at different frequencies we have derived a curve of the particular instrument and from this we can note its efficiency—at least this is the popular practice.

As a general rule, the "curve" of the transformer is dependent upon the "average" efficiency of the transformer at different frequencies which in audio considerations vary between 50 and 5,000 cycles.

The significant fact proved in practise, although not accepted by present-day engineers, is that such curves mean very little because we are dealing with constantly changing minute variations and not "voice envelopes," which are the assumed frequencies in the sense in which these measurements are generally made.

An audio transformer depends not upon its steady alternating voltage as represented by the voice envelope, but upon its instantaneous reluctance at all phases of a highly complex impressed voltage.

The static characteristic of a transformer when tested in a laboratory, may be as symmetrical as you please, but it has no practical value in estimating audio frequency effects.

The sound of "O" for example impressed upon an ideal diaphragm and transferred in voltage variation upon the grid of a tube, will have a characteristic envelope due to the timbre and pitch of the speaker's voice. If this voice envelope is analyzed when it is impressed upon the transmitting diaphragm, and when it is emitted from the receiving telephone it will be evident that quite a little has happened to it.

TRANSMITTERS ARE STILL IMPERFECT

First, the transmitting devices in practical use are not perfect, otherwise there would be less criticism of the modulation effected by hundreds of broadcast stations. We have mechanical inertia effects, echo and blast effects, resonant effects, damping effects—a dozen or so factors due to the character and shape of the material used to pick up the sound and to transmute it into electrical values to the grid of the first tube or tubes.

At the other end, we have the same difficulties operating upon our telephone receivers only in a more acute form, because all the distorting effects of the microphone, tube and telephone coils, are now affecting another diaphragm which is also subject to inertia, resonance, damping and hysteresis.

These defects we find very common in commercial telephone systems in spite of years of the most intensive engineering research and an enormous investment devoted to overcoming line problems such as cross-talk, voltage drops, inductance and capacity effects, microphone and receiver sensitivity. While there is considerable distortion on wire telephone systems it is not necessarily objectionable because we do not commonly use the telephone for esthetic purposes such as listening to concerts, coloratura sopranos or dramatic readers. The line telephone is utilitarian—it is for the communication of spoken words, and as long as the speaker is understood we accept it as satisfactory.

Obviously, we are dealing with no very simple problem. Audio currents can become even more difficult to analyze than those of radio frequency. The telephone engineers

have put in years of patient and exhaustive toil upon the subject and most of them will admit that they still have a few problems left to work upon. It is, therefore, a proper caution to the average radio student to advise that he be not too confident of his knowledge on the audio side of his receiver. For example, the characteristic of the vacuum tube may introduce abnormal variations of part of the signal intensity where the impressed voltage passes the straight portion of the characteristics.

We seldom can draw a true curve of a single tone or sound which is pure or which repeats itself on every cycle without variation. It will, if the sound is continued the proper fraction of the second, go through a series of repeating patterns, but seldom does this help us, because, for practical purposes, we are dealing with sounds as we use them in music, singing or speaking.

Fourier showed that any complex wave form could be reduced to fundamental wave forms. In natural speech or music these wave forms are not simple sine form waves, but are made up of many component higher frequencies. Otherwise one person would speak about the same as another and one violin would be about as good as another, whereas, they are individually recognizable by their endless variation.

If, instead of using a telephone receiver to transmit the message via the auditory nerves, we would use an oscillograph or a needle scratching these voice variations on a smoked glass cylinder, we would have rather difficult work in deciphering the speech because the transient variations are only intelligible when scrambled together.

Furthermore, no two ears hear the same sounds in the same way. Some are more responsive to certain frequencies than to other frequencies.

However, let us forget all these obstacles and let us consider simply the characteristic action of an audio transformer as an electrical device.

In a general way we understand that if we vary the voltage on the primary winding of a transformer, the secondary voltage will be more greatly varied if it contains a larger number of turns, the inductance of which is part of the field of the primary. Any text book on radio will give you this general basis and it seems obvious at first glance that if the turn ratio were run up far enough, we could produce almost any degree of signal increase we desired.

(Continued on page 1114)

The Theory, Construction and Use of an Inductance-Capacity Bridge

By PALMER H. CRAIG



Although the theory, construction and use of inductance-capacity bridges have been taken up numerous times in the past, none have managed to put the subject before the scientific experimenter and amateur in so concise a manner as Mr. Craig has succeeded in doing in this article.

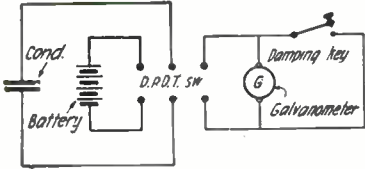

Fig. 1

The Arrangement for a Simple Method of Measuring Capacity.

ALTHOUGH the terms "inductance" and "capacity" are two of the most common in radio, and although practically every text book or magazine article dealing with radio gives critical values for the inductances or capacities in question, nevertheless there is a particular dearth of practical data in regard to the actual measurement of these most important quantities. The object of this paper is to give practical information on the theory, construction and use of an instrument which will measure these values with a very high degree of accuracy.

The design of the inductance-capacity bridge described in this paper is such that the number of parts is cut to the minimum for the benefit of the amateur who has little money to spend, the main parts of the instrument being used for the measurements of both inductance and capacity, and the whole being combined in one instrument instead of the usual two separate instruments.

THEORY

Probably the simplest method of measuring capacity is by means of the ballistic galvanometer as seen in Fig. 1. When a capacity C is charged to a potential V, the condenser contains a quantity of electricity Q, where $Q = CV$. Q is expressed in coulombs if C is in farads and V in volts. If this quantity of electricity is suddenly discharged through a ballistic galvanometer, the resulting deflection will be proportional to Q, so that $Q = kD$, where D is the deflection of the galvanometer, and k is the galvanometer con-

stant, i.e., the number of coulombs required to produce a deflection of one centimeter. In order to determine k, connect a condenser of known capacity to a cell of known voltage, and after the condenser has charged for a second, discharge it by means of the D.P.D.T. switch into a galvanometer. Reverse the terminals of the battery and repeat. Use the mean of these two deflections to calculate k. Now with a cell of known voltage and a condenser of unknown capacity we can calculate C by means of the above equations.

The ballistic galvanometer method just described is, however, not sufficiently accurate for radio purposes and will give only a rough approximation to the true value of capacitance. The method is, nevertheless, of great help as a first step toward the actual value to be determined by the more accurate method to be de-

latter two comprising a ratio arm so that the unknown inductances may be measured far beyond the normal range of the standard known inductances. The operation of this bridge is as follows: (cf. Laboratory Manual by L. M. Alexander, Page 25). A balance is first obtained on D.C. (one 2-volt storage cell being used as a source of D.C.) by adjustment of r_1 and r_2 . R_1 and R_2 are set at approximately the correct value before adjustment of r_1 and r_2 is begun. When the bridge is balanced on D.C. we have

$$r_1 i_1 = r_2 i_2$$

A.C., from a microphone hummer or buzzer, is then thrown on, and the variable self-inductance L_1 is adjusted until a minimum sound is heard in the telephone receivers. Since the resistances have not been changed, the D.C. relations hold for resistance, and the only change is the inductive drop caused by the A.C. For a balance this drop across arm 1 must equal that across arm 2 and is:

$$e = 2\pi f L_1 i_1$$

where f is the frequency of the A.C. source. The drop due to the inductance in arms 1 and 2 will be

$$E_1 = 2\pi f L_1 i_1$$

$$E_2 = 2\pi f L_2 i_2$$

Since the drops must be equal for a balance

$$L_1 i_1 = L_2 i_2$$

Since there is no inductance in R_1 and R_2 , $r_1 i_1 = r_2 i_2$

Dividing one equation by the other, the bridge relation is

$$\frac{L_1}{L_2} = \frac{R_1}{R_2}$$

Thus, knowing the ratio between R_1 and R_2 , and L_1 being known, we can calculate L_2 immediately.

Fig. 3 is a simplified form of Fig. 2. In this arrangement switches 1 and 2 (which in practice should be combined in one D.P.D.T. switch) switch the source of supply from D.C. to A.C., and at the same time switch the method of detection from galvanometer to phones. R_1 and R_2 are the ratio arms and L_x and L_s are respectively the unknown and known inductances. Switch 3 throws the D.C. balancing resistance, r , into either the L_x arm or the L_s arm. This arrangement provides a very reliable method for the measurement of inductance, and is the type employed in this paper. The author has, however, combined with this instrument a method of measuring capacity

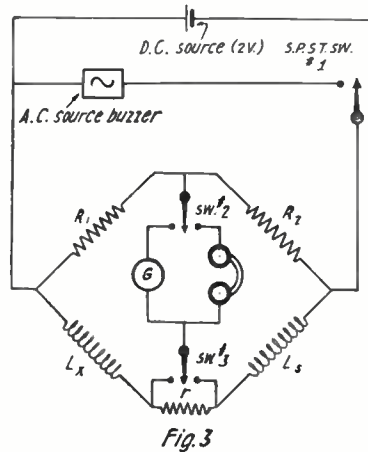

Fig. 3

A Simplified Arrangement for Measuring Inductance with the Use of a Wheatstone Bridge.

scribed later, because it is often extremely difficult to guess even a rough approximation to the true value, and in the Wheatstone bridge method set forth in this article it is very helpful to know roughly the approximate limits between which the correct value of the condensers lies, especially in the case of condensers of large capacity where approximation by the Wheatstone bridge method is rather tedious owing to the relatively large dielectric loss resistance of large condensers having dielectric other than air.

The fundamental principles of the Wheatstone bridge for the measurement of resistance are probably familiar to every advanced amateur or, if not, may be found in any college textbook on elementary physics, such as "A Text Book of Physics," by W. Watson; "College Physics," by Kimball, or "A Text Book of Physics" by Duff. An adaptation of the Wheatstone bridge for the measurement of inductances is given in Fig. 2. In this diagram L_1 and L_2 are the known and unknown inductances respectively, r_1 , r_2 , R_1 , R_2 are non-inductive resistances, the

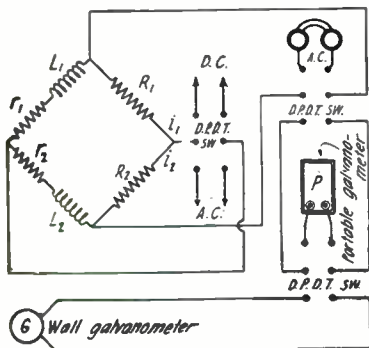

Fig. 2

The Wheatstone Bridge Method for Measuring Inductance.

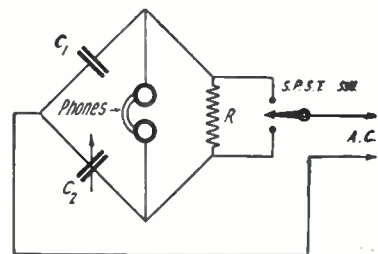

Fig. 4

An Adaptation of the Wheatstone Bridge for the Measurement of Capacity.

which follows similar lines. Fig. 4 gives the simplified capacity bridge hook-up which is here employed. Fig. 4 is again an adaptation of the Wheatstone Bridge principle, wherein the unknown condenser, C_x , is balanced with the variable condenser, C_s . When a minimum sound is heard in the phones the balanced condition has been reached. A variable known resistance R is so arranged that it can be thrown into either arm for a ratio balance. This enables us to determine capacities far beyond the range of the known condenser; thus with the proper ratio, capacities many times that of the standard condenser can be read, or on the other hand, capacities much smaller than the lowest appreciable reading on the standard can be had by simply adjusting the value of the resistance and throwing it into the desired arm.

CONSTRUCTION

Fig. 3 for the measurement of inductance, and Fig. 4 for the measurement of capacity are combined in Fig. 5, which gives the internal wiring of the complete inductance-capacity bridge. Fig. 6 gives the external panel layout of the instrument. The apparatus comprises a standard inductance consisting of a variometer which has been calibrated accurately, a calibrated condenser, a set of inductance ratio arm resistances of known value, and switches. The calibration of the variometer, condenser, and resistances will be done by the Bureau of Standards for a small fee, or any well equipped college physics laboratory should be able to do it. Sometimes the makers of the better class of instruments can furnish a calibration curve of the particular instrument which you buy. It is well to buy the finest variometer and condenser obtain-

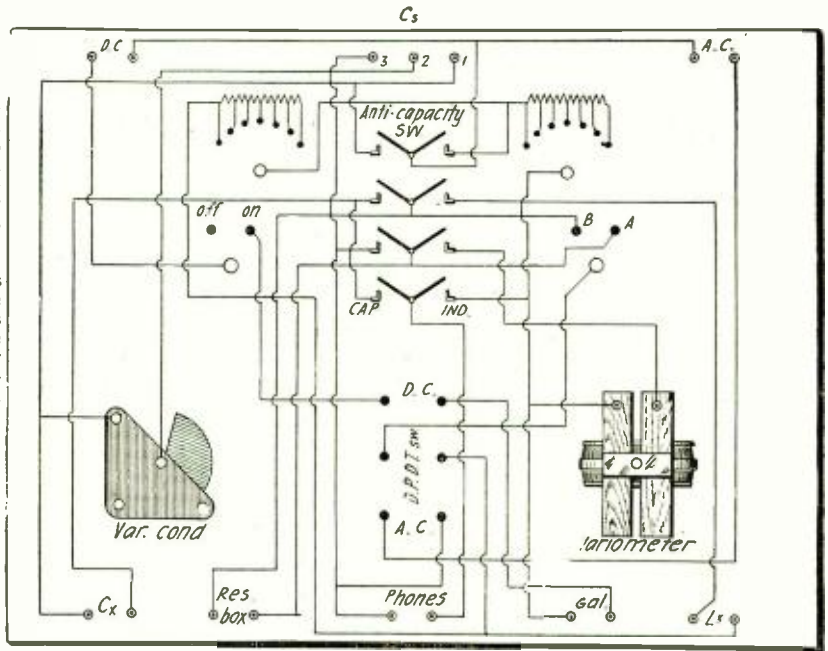

Fig. 5

Complete Schematic Diagram of the Inductance-Capacity Bridge Which is a Combination of the Circuits of Figs. 3 and 4.

should have a maximum resistance of 10,000 ohms. This resistance is used as a ratio arm when capacities are being measured, and as a D.C. balancing resistance when inductances are being measured.

The inductance ratio arms in the upper center of Fig. 6 can be made by the amateur in exactly the same way as the ratio arm resistance described above. Both of these inductance ratio arm resistances should be as near non-inductive as possible. They should be varied in steps of 1, 10, 100, and 1,000 ohms. These resistances are used only for the measurement of inductance.

The upper right-hand small switch in Fig. 6 throws the D.C. supply on or off. The direct current should be obtained from two dry cells or a single storage cell and is used only for the D.C. balance on inductive measurements.

The miniature double pole double throw switch in the lower center of Fig. 6 is used to change the electrical supply from D.C. to A.C. in inductive measurements. When capacitances are being measured this switch is always on "A.C."

The A.C. supply may consist of an ordinary radio test buzzer having a high note, or a microphone hummer may be used for better results. It is desirable that the A.C. supply have as near a pure sine wave as possible, and harmonics should be avoided in order to facilitate finding the minimum point when testing.

THE INSTRUMENT IN USE

To measure capacitance, connect the test buzzer or other source of A.C. to the posts marked "AC." Connect the unknown capacity to posts marked "Cx" (see Fig. 6), and connect phones and resistance box to their respective binding posts. The three posts marked C_s are for the purpose of shunting the standard variable condenser by a fixed standard condenser or putting such an auxiliary condenser in series with the standard. In the first case connect the auxiliary condenser to posts marked 1 and 2. In the second case to posts 2 and 3. At all times

except when the auxiliary condenser is in series, the posts 2 and 3 should be bridged externally. Ordinarily the auxiliary condenser is not necessary (and posts 2 and 3 are bridged), but this condenser is employed only when working at the extreme points of the scale, i.e. when measuring very high or very low capacities. When the auxiliary condenser is used its value should be calculated with that of the standard for the determination of the unknown. If shunted, add the capacity of the auxiliary variable; if put in series, use the formula

$$\frac{1}{C_1} = \frac{1}{C_2} + \frac{1}{C_3}$$

where C_1 is the combined capacity of the auxiliary and standard, C_2 that of the standard, and C_3 that of the auxiliary condenser.

(Continued on page 1136)

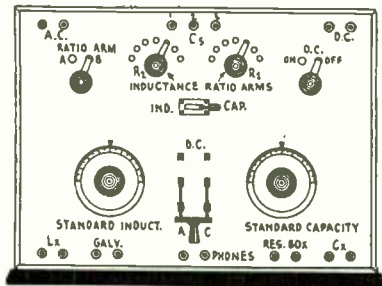
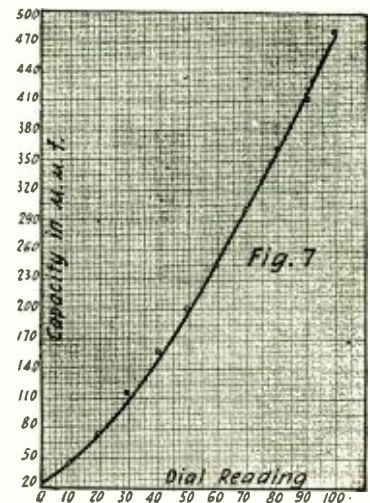

Fig. 6

Panel Layout of the Inductance-Capacity Bridge Showing the Position of Each Control.

able for this purpose, because it is essential that the constants of the instrument should not change to any great extent, otherwise the readings will be inaccurate. A master anti-capacity switch (a 4-pole double throw switch) is employed to switch the instrument from an inductance bridge to a capacity one. The small switch to the upper left in Fig. 6 is used to switch the binding posts at the lower right, marked "Res. Box") from one arm of the bridge to the other. This resistance, which should be one of known value, may be either the well known Leeds & Northrup 0-10,000-ohm type or a similar instrument. The amateur may construct such a resistance by winding accurate lengths of thin resistance wire on spools and arranging a switching system so that the resistance may be varied in steps of 1, 10, 100, and 1,000 ohms. The resistance per unit length of any wire may be obtained from the manufacturer's catalog or from the Electrical Engineers' Handbook. The instrument



Typical Calibration Curve of a 43-Plate Variable Condenser.

The Balanced Feed-Back Power Amplifier

By CLYDE J. FITCH

An interesting and comprehensive article on a new form of audio frequency amplifier which contains a number of improvements over similar types. Standard push-pull transformers are used.



SECONDARY

INSIDE LEADS & CENTER TAP
OUTSIDE LEADS

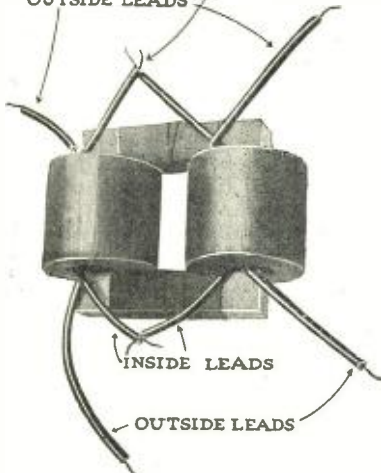

PRIMARY

An Improved Push-Pull Transformer. Two Similar Coils Mounted on One Core Form a Very Efficient Instrument, Having Center Taps in Both Primary and Secondary Circuits.

It seems to be the practice of the present day to evolve new vacuum tube circuits, the main idea being to simplify the apparatus and make one or two tubes do the work that previously required three or four. Most of the work along this line has been with regenerative and radio frequency amplifying circuits. Little has

same two tubes connected so as to give one more stage of parallel amplification. While one tube has positive feed-back and tends to howl, the other has negative feed-back and absorbs and prevents howling. The two effects exactly balance each other and allow the entire output to be fed back to the input. In consequence, this circuit is equivalent to one step of push-pull amplification and one step of straight amplification

coil connect to the grids of the tubes, as shown, so that one tube is always operated 180 degrees out of phase with the other. In other words, when the grid of one is positive, the grid of the other is negative. The primary coil of the output transformer T₂ has a center tap which connects to the "B" battery. The two ends of this coil connect to the plates of the tubes, which are also 180 degrees out of

The Standard Push-Pull Circuit. Note That Two Transformers Having Tapped Windings Are Employed.

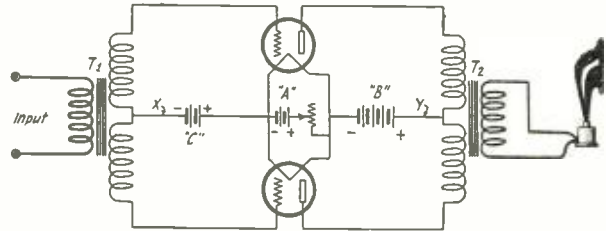

Fig. 1

with two tubes in parallel, which, of course, in the ordinary circuit would require a total of four tubes. In actual practice, however, it can be assumed to be equal to a three-stage transformer coupled amplifier, except that only two tubes and two push-pull transformers are required. Theoretically it will give four times the amplification and twice the output of a two-stage amplifier.

THE CONNECTIONS

Before describing the circuit in detail, we will first discuss the action of the standard push-pull amplifier, as shown in the diagram. (Fig. 1.) This circuit requires two push-pull transformers, which are similar to ordinary audio frequency amplifying trans-

formers. The secondary coil is connected to the loud speaker, as shown.

This circuit not only gives greater amplification than the ordinary 1-step amplifier but it amplifies with much less distortion. Amplified music and speech are exceptionally clear with this method. It is claimed that this circuit produces nine times the output of the same two tubes connected in parallel with the same amount of distortion.

The ordinary iron core audio amplifying transformer introduces much distortion, due to its great inefficiency on the notes below 1,000 cycles. In a two- or three-stage amplifier the lower notes are amplified very little, while the higher ones are enormously amplified; therefore the fewer amplifying transformers we have in a circuit the better will be the quality of the reproduced speech or music. To eliminate one of the push-pull transformers in Fig. 1, the circuit shown in Fig. 2 may be employed. We not only eliminate one transformer, but also much distortion. It will be noted that two loud speaking phones are used in this circuit, one in the plate circuit of each tube. The two phones may be clamped to one horn as shown. It may be necessary to reverse the leads to one phone for best results. A phone with a center tap on its winding could be used in place of the two phones.

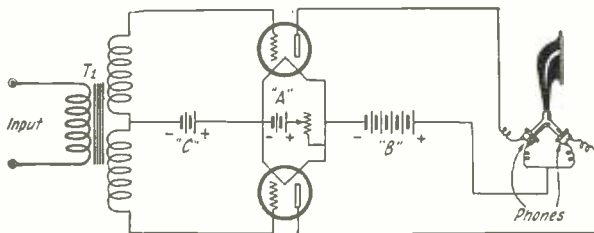

Fig. 2

In This Circuit Only One Push-Pull Transformer is Employed. The Use of a Loud Speaking Phone in the Plate Circuit of Each Tube Eliminates One Transformer.

been done with the audio frequency amplifiers. Perhaps one reason for this is that audio frequency regeneration is not considered practical—especially when the frequency is rapidly changing, as in music or speech reception—because the circuit tends to oscillate at its own natural period, setting up a loud howl. Yet in a cascade audio amplifier the last tube is usually worked to the limit of its output, while the first one does very little. This indicates that great improvements are possible.

In the following circuits a special system of regeneration is employed which can be used with radio as well as audio frequency currents, and the arrangement is such that there is no possibility of howling or oscillating, regardless of the amount of energy regenerated or fed back. This system makes use of two tubes connected so as to give one stage of push-pull amplification, the output of which is fed back to the input of the

formers except that they have tapped windings. The input, or primary coil of the first transformer T₁ is connected to the receiving set. The secondary coil of this transformer has a center tap (which should be exactly at the center) which is connected to the filaments of the two tubes through a suitable "C" battery. The two outside ends of the

BALANCED TRANSFORMERS

Referring to Fig. 1 again, if the two push-pull transformers were perfectly balanced and the voltages of the "C" and "B" batteries adjusted so as to operate the tubes on the straight portion of their characteristic curves, no current would flow through

This is a Dual Amplifier Circuit. Input No. 1 Operates the Tubes Push-Pull Fashion and Feeds Loud Talker No. 1, While Input No. 2 Operates the Tubes in Parallel and Feeds Loud Talker No. 2.

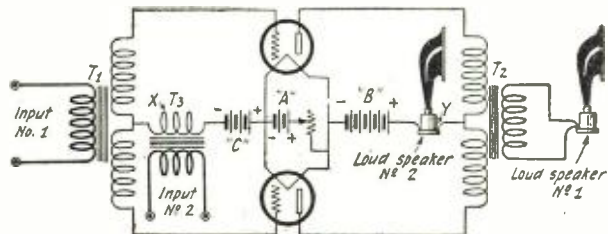

Fig. 3

the center connection marked X, and we could connect something in this lead, such as the secondary of an amplifying transformer without interfering in the least with the action of the push-pull amplifier. It is also evident that the alternating current component of the plate current will not flow through the center lead Y. In other words, the current flowing through Y is always constant, although the current flowing through each half of the primary winding of transformer T2 is fluctuating. Therefore, we can connect an instrument such as a loud speaker in the lead Y, without interfering with the action of the amplifier. In such a case no sounds would be heard in the loud speaker, provided the transformers are correctly balanced. This is a good test for push-pull transformers.

Now we have the circuit shown in Fig. 3, with an amplifying transformer connected

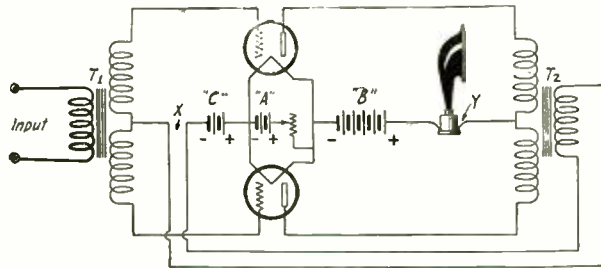

Fig. 4

The Balanced Feed-Back Circuit is Here Shown. The Tubes Are First Operated Push-Pull Fashion and Then in Parallel, Giving Two Stages of Amplification.

of transformer T3 to another receiving set tuned to WOR and hear WOR in loud speaker No. 2; WOR will not be heard in loud speaker No. 1. Therefore, we have two tubes connected in push-pull fashion

to explain the action of the following circuits. Theoretically it will work perfectly if the input currents are not too strong. If they are they will interfere with each other by operating the tubes beyond the straight portion of their characteristic curves. This circuit is very unstable and howling noises will be heard in both loud speakers unless the tubes and transformers are perfectly balanced.

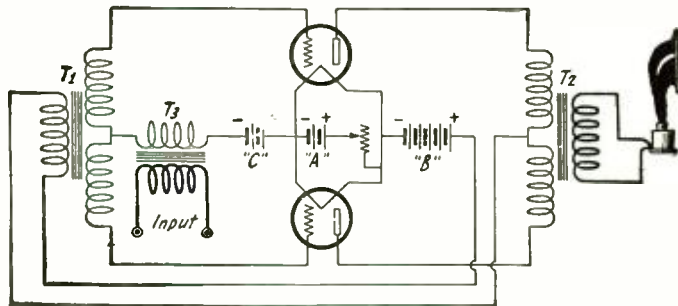

Fig. 5

Another Balanced Feed-Back Circuit. This Circuit is Not as Stable as the One Depicted in Fig. 4, and a Separate Filament Rheostat for Each Tube is Recommended.

in the X lead and a loud speaker in the Y lead. We can connect the input of the transformer T1 to a radio set tuned to WJZ and hear WJZ in loud speaker No. 1, but not in loud speaker No. 2. We can, at the same time, connect the input

that amplify one concert and at the same time they are connected in parallel and amplify another concert, each concert being heard independently in its own loud speaker.

This duplex amplifying system is not practicable, and is given here merely to ex-

plain the action of the following circuits. It will be noted that when the two tubes are operated in parallel by using transformer T3 and loud speaker No. 2 the input current divides equally through both halves of the secondary winding of T1. The inductance of one-half neutralizes that of the other half so the action is the same as if the winding were short circuited or not present. The same effect takes place in transformer T2. The plate current divides equally through both halves of the primary winding, one-half opposing the other, thus neutralizing the inductance and preventing any transfer of energy to the secondary coil and loud speaker No. 1.

Instead of amplifying two concerts separately with the same tubes and using two loud speakers, we can make the tubes amplify one concert twice, thus giving two

(Continued on page 1180)

Summarizing the Autoplex

By M. L. MUHLEMAN, A.M.I.R.E.

IN closing this series of articles on the Autoplex it was thought advisable to give the readers of RADIO NEWS a bit of information as to the results that are being obtained with this circuit and to discuss a few of the less known points relating to the characteristics of super-regenerative receivers.

Noises, decidedly foreign to a regular regenerative receiver, are quite noticeable in the process of tuning such sets. If properly handled, however, these noises—except the high pitched whistle or variation frequency—will disappear when a station is tuned in. The Autoplex is a simplified super-regenerator. It has practically the same circuit noises and requires the same careful adjustment as the more complicated sets operating on the same principle. Failure to eliminate circuit noises in either a one-tube super-regenerative receiver or Autoplex is usually due to the operator's inexperience with this type of receptor. This and the failure of the Autoplex to reach longer broadcast wave-lengths are the two major complaints against it.

These points shall be taken up in due course, but first we will interest ourselves with the following letters which were received by the author. The first is of particular interest.

Dear Sir:

Your articles in the November and December issues of RADIO NEWS have resulted in my writing this letter to you.

At Eaton, Ohio, 600 miles from New York City, I was able to get former President Woodrow Wilson's Armistice Day address,

Saturday, November 10, on a loud speaker without amplification. Call letters of the station being W.E.A.F.

Apparatus used and other data are as follows:

- 2 variometers, large type.
- One 1,500-turn inductance.

Radio Articles Appearing In February Science and Invention.

How President Coolidge Spoke to the Nation Via Radio.

Single Tube Hook-Ups, By Armstrong Perry.

Revised List of Broadcasting Call Letters.

Radio Oracle—Questions and Answers.

Hints on Loop Antenna Construction.

Prize Winners in \$200.00 Single Tube Radio Receiving Contest.

Radio Trouble Shooting—Illustrated With Photos.

Improving the Single Circuit Tuner. By Jack Kay.

UV-201A tube, 45 volts on the filament, 90 volts on the plate. No antenna. Ground to point A, same being 12 feet of lamp cord to a gas pipe with 28 feet of pipe between attachment and ground.

A loud speaker.

The volume was sufficient to fill a room 14 x 16 feet so that all present could hear and understand what was said.

This performance speaks well for the DX

ability of the Autoplex and tends to confirm the data collected by Andrews and yourself.

(Signed) Dr. H. Riley Spittler, Eaton, Ohio.

This letter is of particular interest since former President Wilson's voice did not carry well as shown by reception in the vicinity of New York City. As Dr. Spittler mentioned, this certainly tends to confirm Mr. Andrews' experiments with super-regenerators in which he found that the amplification factor in a super-regenerative circuit increased as the incoming signal energy decreased and vice-versa. Relative to this, Mr. Clyde J. Fitch of the "Radio News Laboratories" suggests that in order to receive local stations on the Autoplex with appreciable volume, it is necessary to detune the circuit so that the signal energy decreases. This allows the amplification factor of the circuit to increase. When detuning a local station, it is no doubt true that every station on a but slightly dissimilar wave is detuned as well. If true, this would account for the interference experienced while local stations are in operation. From this we might gather that an Autoplex receiver or, in fact, any form of super-regenerative set will be more efficient when operated in localities some distance from broadcasting stations. From the two following letters, we can presume this to be true.

Dear Sir:

You will no doubt be interested in learning of my experience with the Autoplex circuit.

On October 31, I happened to be visiting

(Continued on page 1181)

A Quick Shift Oscillation Transformer

By P. N. MAYNARD



The description of an oscillation transformer that, having been calibrated, can be rapidly adjusted to any number of wave-lengths.

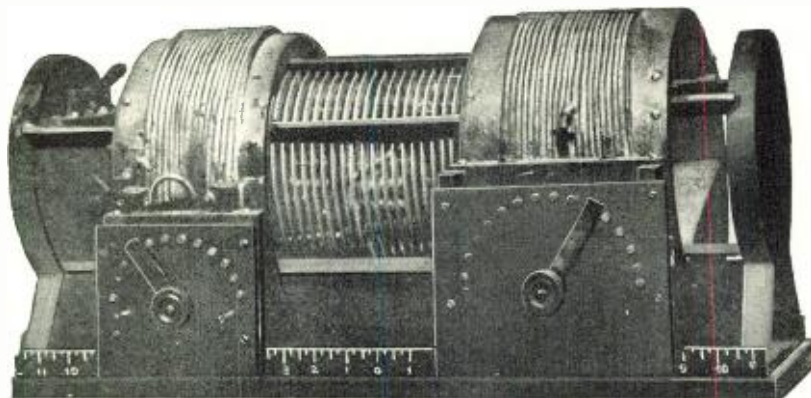

Photo of the Completed Oscillation Transformer Showing the Tapped Movable Plate and Grid Coils.

THE new regulations giving the "HAM" a band of wave-lengths from 150 to 220 meters, open up a new field to amateur communication. No doubt these new regulations are going to be the direct cause of breaking up some of our own QRM, to say nothing of the increased amount of traffic we are going to be able to clear. This improved state of affairs is going to be brought about by means of a quick and accurate wave changing outfit. QSY is destined to become one of our most common Q signals and it is hoped it will run a close second to CQ as a favorite conventional signal.

To QSY in spark work would not be so much, but for the modern C.W. hound who is busting up the ether on all the neighboring planets, it involves a little more complication, but at that it "ain't no worse." for the following effort will describe a "Hootnanny O. T." that is and will, cut the buck and then some. This Hootnanny O. T. will play a tune all up and down the line, as far as wave-lengths are concerned. The enclosed photo shows the Hootnanny O. T. as is. This has a rapid fire change of wave-lengths and can be made, on five seconds' notice, to percolate on 185, 200, 300, 360, or 600 meters. Any one of the changes can be made on short notice and the pretty part of the story is that the changes can all be made while the transmitter is HOT; in other words, all adjustments of plate, grid and antenna coils, to say nothing of coupling, can be made with the transmitter in operation.

This O. T. has been doing business at 6CCH (KUS on 360) for better than a year and was recently duplicated at 6CMR. It sure eats up this QSY stuff in a hurry. Here at KUS I can make the change from 360 meters down to 200 meters in just five seconds by the clock. This change covers a wider band of wave-lengths than the new regulations have allotted to the "Hams."

The O. T. is used in conjunction with the Meissner circuit, both at 6CCH and 6CMR. This is the same circuit that friend 6JD used on the old space annihilator of his, when he burst the ear drums of the Aussies, during the recent Australian tests. As to the transfer of energy in this Hootnanny O. T., I guess it transfers a little of that ether bust-in stuff, too, for 6CMR got through to Australia and was among those present, heard in New Zealand. For

further evidence, turn to Mix's report in September QST, reporting 6CMR off the Greenland coast, in August. (Two 50-watt bottles at 6CMR). However, I cannot say how the Hootnanny O. T. would work out on any other circuit than a Meissner, as I have not tried it, but I'll venture a guess that the modern C.W. hound, found in the A. R. R. L., is the guy who can make his Hootnanny O. T. percolate on about any old circuit.

To get the wave changing down to a system where speed and accuracy are obtained, requires some little experimenting. The set should be tuned with an accurate wavemeter and the radiation brought up to maximum on the desired wave and then the settings of every movable part of the transmitter recorded, and this record kept handy for reference. It has been found that once a setting is worked out and recorded, it can be depended on to be the same and do the same today, tomorrow and next week, provided the same exact settings are used as per the record of the previous settings.

PLATE AND GRID COILS

The tubes for the plate and grid coils could not be purchased at the time of construction, so they were made by pasting several layers of thin cardboard together, around a form $8\frac{1}{4}$ " in diameter. The form used in this case happened to be a roll of wrapping paper. The diameter of the tubes determined the distance from the windings of the plate and grid coils, to the winding of the antenna coil, which determined the coupling as well as the decrement of the emitted wave to a great extent. This diameter gives about an inch clearance between windings and the emitted wave is extremely sharp. Enough layers of cardboard were pasted on one another, until a tube $\frac{3}{8}$ " had been formed, and in this case the tube was about 20" long. This was then set aside and allowed to become thoroughly dry before attempting to remove the tube from the roll of wrapping paper. This roll was pretty well mused up before getting the tube off, but finally the tube was removed and then cut in half and smoothed down to a thickness of a quarter of an inch, on a sander. It would be very much easier and would simplify matters to a great extent to purchase bakelite tubes of the desired dimensions, as well as making a better job both mechanically and electrically, to say nothing of the trouble and grief en-

countered in constructing them. The tubes were given a thorough boiling in paraffin after being sanded down to the $\frac{1}{4}$ " thickness.

ANTENNA COIL

The antenna coil consists of a UL-1008 R. C. oscillation transformer, with the base and other supports removed. Only the copper spiral is used. The coil is supported and its shape held by three bakelite strips, $\frac{1}{4}$ " thick, $\frac{7}{8}$ " wide and 24" long. These strips also act as supports and slide rods for the plate and grid coils, which are slid back and forth, to vary the coupling. Slots were cut in these bakelite strips with a hack saw, using a blade the same thickness as that of the copper spiral; the set in the blade will allow ample space for a snug fit of the copper spiral in the bakelite strip. The wooden support that came on the original R. C. oscillation transformer was clamped in a vise along with the bakelite strip and made a perfect template, and maintained the original spacing of the turns of the copper spiral. The bakelite strips were then slipped over the copper spiral giving the coil its original uniform shape and making it rigid. The end supports are sawed out on a band or with a coping saw, from one-inch well-seasoned oak. One-quarter-inch slots were then morticed in each end support, to allow a snug fit for the bakelite strips. This arrangement completes the antenna coil, giving a coil of ample carrying capacity, as well as enough turns to cover a wide band of wave-lengths and with the strips snugly fitted to the end supports, which are fastened to the base of one-inch oak, gives a very rigid layout.

THE COIL GUIDES

The guides were made from 1" fibre and sawed to the desired shape with a coping saw (see Diagram) leaving an ample shoulder to secure them to the inside of the tubes with a 6-32 brass machine screw, placing a brass washer under the head of the machine screw.

(Continued on page 1166)

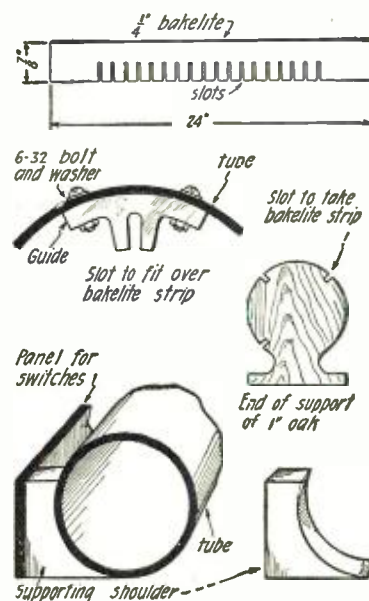

Constructional Details of the Parts Composing the Quick Shift Oscillation Transformer.

The Use of Headphones and Loud Speakers

By LOUIS FRANK

Very few people give any attention to headphones or loud speakers when really they require as much consideration as any other portion of a radio receiver. Read what Mr. Frank has to say about them.

IN the last article of this series the subject of audio frequency amplification was taken up in detail and the various methods by which the signal could be increased in volume and intensity were outlined. This signal which comes from the amplifier is either passed through headsets or loud speakers and is thus heard. It, therefore, concerns us to understand how these appliances should be used for best results.

In the first place, a brief statement should be made as to the construction of these units and their mode of operation. The headset, as is well known from the novice's experience, consists of two magnetic units, each being complete in itself, one unit for each ear. Each unit consists of a permanent magnet which has two poles on which are wound coils of wire. These coils are connected in series and the audio frequency current coming from the audio frequency amplifier flows through these windings. Spaced a few thousandths of an inch above the pole pieces of the magnets is an iron diaphragm and the complete unit is housed in some non-magnetic case, such as hard rubber or aluminum. The audio frequency currents flowing through the windings increase and decrease the strength of the permanent magnetism, depending upon the direction in which the currents flow through the windings. This variation in intensity of magnetism results in a variation in the force with which the diaphragm is attracted or repelled. Hence the diaphragm moves back and forth and gives out sounds in accordance with the variations in the audio frequency currents. The loud speaker consists generally of a single headset such as described above, which is placed at the narrow end of a horn, the effect of the horn being to increase the volume of sound. However, the output of the ordinary headset is generally too small to enable it to give a very loud sound even though it is at the end of a horn, and therefore special loud speaking phones are made which are able to handle considerable energy.

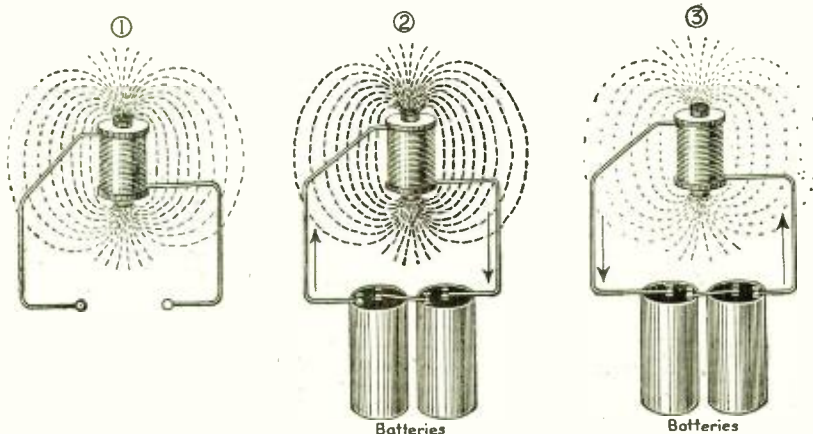

The Above Sketches Illustrate the Importance of Having Current Run Through Headphones or Loud Speakers in the Right Direction; (1) Shows the Normal Field of a Phone Magnet, (2) The Increased Field with the Application of a Current Flowing in the Right Direction and (3) The Weakened Field Due to a Current Flowing in the Wrong Direction.

THE HEADSET

This part of the radio set is generally given the least attention, the attitude being that all that is necessary to be done is to insert it in a circuit and listen. If the set is good, then the phones must necessarily give good results. However, a pair of telephones may be used correctly and incorrectly just like any other piece of equipment. Unless the headset is used properly it will be found that it begins to lose its original sensitivity and the signals become weaker and weaker. Weakening of signals may be due, of course, to run down batteries, but we will assume that these are in good shape.

positions are changed, resulting in loss of magnetism.

Now it is not necessary for a permanent magnet to be hit with a hammer for it to lose its magnetism. In such an event it loses its magnetism instantly. By continuous jarring and rough usage the magnet slowly loses some of its magnetism until finally its sensitivity is reduced so low as to be useless. This is exactly what happens to radio headsets. They are handled roughly by most novices, as can be seen by watching some of them, as they drop phones on the floor.

Every time this happens the phone magnets lose a little bit of their magnetism until finally they are so insensitive that the signals are observed to be weaker and weaker. In this state the phones are not of much use, and the best thing to do is to have them re-magnetized by the manufacturers or some reliable concern. But the novice should learn that the phones are a delicate mechanism which easily gets out of gear. He will not throw his watch on the floor, and some headsets cost more than some watches.

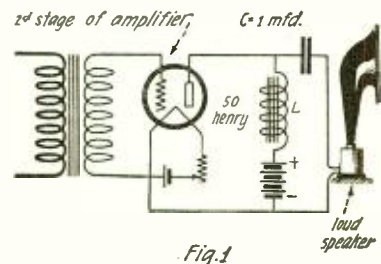

By Using a Large Iron Core Choke Coil and a Fixed Condenser the Possibility of Loud-Speaker Magnets Becoming Saturated is Done Away With.

Weak signals due to lowering of the sensitivity of phones are the result of demagnetizing the phones, and demagnetization is generally due to two causes: (1) rough handling of the phones, and (2) improperly connecting phones in plate circuits of tubes.

It is a well known fact that when a permanent magnet is hit hard blows with a hammer it loses its magnetism, in spite of the fact that it is called a permanent magnet. This is explained theoretically by the fact that in a permanent magnet the molecules are assumed to be lined up uniformly in a certain position. When the permanent magnet is hit hard, the molecules are shaken up and their

The second cause for demagnetization of headsets is due to improperly connecting the phones in the plate circuit of vacuum tubes. When phones are connected in the plate circuit of tubes a direct current flows through the magnet windings. If this plate current flows in one direction it will aid the magnetism of the permanent magnets, and thereby strengthen the magnets. If it flows in the opposite direction it will oppose the permanent magnetism of the magnets and thereby decrease the permanent magnetism. If the phones are connected in the latter way constantly it is easy to see that the opposing magnetic effect of the direct current through the windings will ultimately reduce the permanent magnetism to a point where the magnets are demagnetized and signals will be considerably weakened. In other words, care must be taken to see that the phones are connected so that the direct current through them increases the magnetism of

(Continued on page 1110)

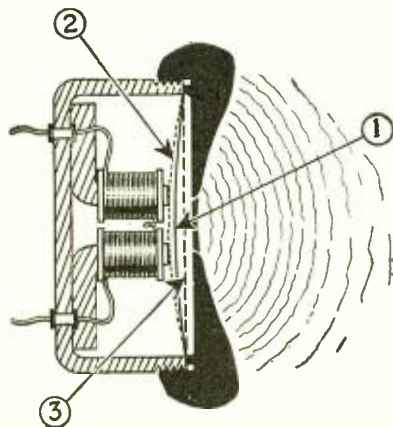

At 3 is Shown Normal Position of a Receiver Diaphragm; 1, The Extent of Pull it is Usually Put To, and 2, the Point Where Distortion Will Take Place Due to its Striking the Pole Pieces.

C.W. and Radiophone Transmitters

By L. R. FELDER

Part V.

In this article Mr. Felder takes up the subject of modulation in connection with radiophone transmitters of medium and high power and points out the usual reasons for distortion and how they can be eliminated.

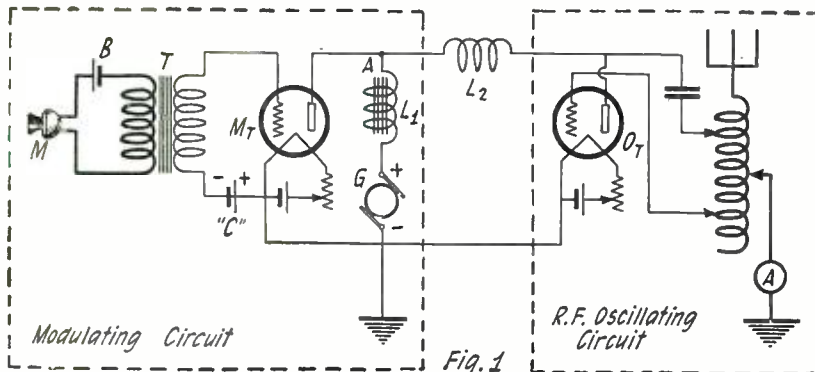

The Heising Modulation System Employs a Separate Tube as a Modulator, the Output of Which Varies the Plate Current of the Oscillator Tube.

THE radio telephone system, which will now occupy our attention, is the most popular and widely used system today for the reason that it is the most efficient, and is used in all broadcast stations of any merit. It is known as the Heising Modulation system. It is also known as the "constant current" modulation system for the reason that the current supplied by the plate circuit generator is always constant.

HEISING MODULATOR

This system requires a separate tube for the modulator. The audio frequency voltages are built up and amplified by the modulator tube and are then impressed on the radio frequency oscillations generated by the oscillating tube. The method by which this is accomplished and modulation secured is shown in detail in the following. In Fig. 1 we have represented in detail a complete radio telephone circuit employing the Heising modulator. The circuit has been separated into the R. F. oscillator circuit and the modulator circuit. The radio frequency oscillator may be any one of the recognized circuits for generating C.W. oscillations, as explained in the previous articles of this series. Ot represents the oscillator tube which acts as the generator of high frequency oscillations. The plate voltage to the oscillator is supplied by the generator G. The performance of the high frequency oscillator has been explained in other articles of this series and will, therefore, not be considered any further here.

Mt represents the modulator tube, which must be of the same power as the oscillator tube. It is desirable that both modulator and oscillator tubes have the same characteristics. The plate voltage to the modulator is supplied by the same generator, G, which supplies plate voltage to the oscillator tube. M is the microphone or telephone transmitter into which the operator talks. The primary of the telephone transformer, T, is connected in series with a battery and the microphone. As a result, when the microphone is not spoken into, a steady direct current flows, the value of which is limited by the voltage of the battery and the resistance of the microphone and transformer. This steady current through the transformer primary has no effect on the transformer secondary, hence

it has no effect on the grid circuit of the modulator. Therefore the plate current in the modulator tube remains constant.

When the microphone is spoken into, the motion of the diaphragm alters the pressure on the carbon granules and therefore the microphone resistance varies with the speech. As a result, instead of a constant

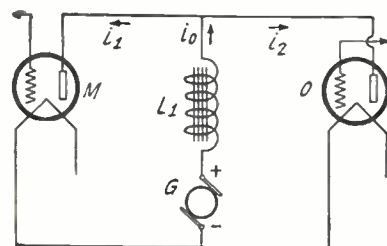

Fig. 2

The High Inductance L₁ Prevents Any Change of Current Through It, Therefore the Total Current is Always Equal to $i_1 + i_2$ irrespective of Plate Current Changes in the Tubes.

direct current flowing through the transformer primary there is a pulsating current. This pulsating current induces an alternating current in the secondary of the telephone transformer, T, which is now applied to the grid of the modulator tube. As a result of the varying speech voltage, which is now applied to the modulator grid, the resistance of the modulator tube also varies. The result of a variation in the resistance of the modulator tube is, normally, to produce a variation in the plate current. However, this does not occur to the full extent because of the presence of the audio frequency choke coil L₁.

This choke coil is in series with the plate circuits of both tubes and its reactance is very great. It is so high that it prevents any variation of the current flowing through it. As a result the speech variations on the grid of the modulator tube do not produce a plate current change, as might be expected theoretically. However, since the plate resistance of the modulator tube does change when the grid voltage on the modulator tube changes, and since the voltage of the D. C. generator is constant,

there must be some variation in the plate current.

How is this secured? Fig. 2 shows. The total plate current supplied to both modulator and oscillator tubes by the plate generator G is represented by i_0 . This current remains sensibly constant no matter what the changes in both tubes, for the effect of the high inductance L₁ is to prevent any change of current through it. This current divides into two parts, i_1 to the modulator tube and i_2 to the oscillator tube. The total is always equal to $i_1 + i_2$, no matter what value i_1 and i_2 take. Now, suppose the effect of a certain sound on the microphone is to make the alternating speech voltage applied to the modulator grid positive, and, therefore, to decrease the internal resistance of the modulator tube. It follows that the current on the modulator plate must increase. But since $i_0 = i_1 + i_2$ is always constant, the only way that i_1 , the modulator current, can increase is by i_2 , the oscillator plate current, decreasing. This is what actually occurs. The modulator tube robs the oscillator tube of some of its plate current when the resistance of the modulator is decreased. And, vice versa, it furnishes the oscillator tube plate circuit with extra current when its resistance increases. In other words, variations in the plate current of the modulator tube, resulting from speech voltage variations on the grid, take place only by producing an opposite variation in the oscillator plate current.

CHOKE COIL EFFECT

Speech variations of voltage on the grid of the modulator tube, therefore, do result in plate current variations in the modulator.

It was stated above that the effect of the choke coil, L₁, was to prevent any variation of the current through it. Actually, for this to happen, the reactance of the coil would have to be infinite. Since it is not infinite (but is very large) a very small variation in current does take place. This variation is due to the modulator tube and is an audio frequency variation which conforms to the sound striking the microphone. Since the current does vary through the choke coil, there will be produced across it a voltage drop. This drop is of audio frequency similar to the speech voltage applied to the grid of the modulator tube. However, it is very much greater, for it is amplified by the modulator tube in the same way that an audio frequency signal is amplified in an audio frequency amplifier. The ultimate result of all these reactions

(Continued on page 1175)

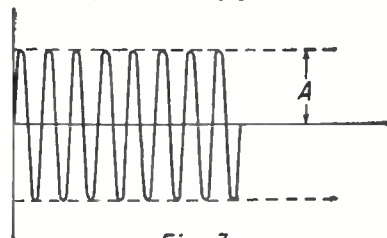

Fig. 3

Illustrating the Unmodulated R.F. Current of the Oscillator Tube.

Correspondence from Readers

VERY GOOD

Editor, RADIO NEWS:

Last week I made a set according to instructions given in the October issue of RADIO NEWS under the heading "An All-Purpose Receiver." Having all necessary parts except the fixed coupler, I purchased a 4 in. composition tube 3 in. long and wound eight turns of No. 22 D.C.C. wire on same for the primary; 1/2 in. from the primary winding I wound 46 turns No. 22 wire for the secondary. Using the following parts, I have had exceptional success: 1 home-made fixed coupler (described above), 1 23-plate vernier condenser, 1 variometer, 1 variable grid leak, 1 WD-11 tube and socket, 1 pr. 2,000-ohm phones, 1 light socket aerial.

In the past three nights I have picked up the following stations: 5AJI calling SUW, 9XN calling WNP; WOC, WOAW, WOAI, WDAP, KHJ, KJL, WVF, WJAZ, WDAO, WBAP, WFAA, WHAF, WEAY, WSB, WMAQ, WDAF, WAAD, WHAS, WMC, WOI, WOQ, WMAP.

I think the above is exceptional for a one-tube set using a light socket aerial.

THOS. R. SCOTT,
Box 458,
Brownwood, Texas.

RE MR. LAKE'S LETTER

Editor, RADIO NEWS:

I have read Mr. Lake's letter on single-circuit tuners and there are a few points upon which I cannot agree.

He has brought up Mr. Marshall's case which he uses to defend the single-circuit tuner. Mr. Marshall used a Beverage aerial (as stated in the Editor's note) which tends to change the situation quite a bit. The Beverage wire aerial is now regarded as about the most efficient antenna one could have, being exceedingly directional and offering greater signal strength than any other known type. Keeping this in mind, the other thing to be considered in Mr. Marshall's case is the fact that he had no local QRM or interference to impair his reception. With these two vital assets it is not unusual to obtain excellent results.

As for finding out the owners of single-circuit tuners and educating them—this would be extremely difficult. From where I live I can hear a receiver, which is actually two miles from me, squeal. Sometimes a receiver can be heard for three miles or more; I know of a particular case where this happened. Now, if Mr. Lake wishes to search the city within a three-mile radius of his house he is free to do so, and if the offenders were found it would take quite a little talk to convince them and then they would usually fail to better their tuning. We all know that the single-circuit tuner is a good transmitter, for its circuit is very similar to the Hartley transmitter circuit.

The single circuit tuner will, then, work very well under good conditions and when there is no local QRM, but it will also transmit just as well.

FREDERIC L. STAFFORD (1BAG),
Hartford, Conn.

EVER TRY THIS?

Editor, RADIO NEWS:

The following experience may not be new or of interest to the "hams," but it may prove so to the newer BCL's, one of which I am at present.

My neighbor's set failed to function on a certain wave-length, i.e., 2,650 meters, and in order that he might listen in, I ran a twisted pair of wires from my set to his, a distance of approximately 100 ft. He attached his phones to the wires and I at-

tached the wires to the output of my set with my phones in series.

All reception, NAA as well as broadcasting, was heard clearly and well by him.

While listening, I heard him cough. I then spoke to him through one of my head receivers and told him to reply in like manner. Spoken communication was thus established and has been maintained.

We call by the use of buzzers and telegraph keys that are thrown into and out of the circuit by D.P.D.T. switches at each end. Energy is supplied by bell-ringing transformers attached to the 110-volt lines.

J. M. GREGORY,
Morristown, N. Y.

CAN YOU HELP?

Editor, RADIO NEWS:

In reply to Mr. D. H. Kamp's letter, published in the November issue of RADIO NEWS, I think he has said a few things of worth while interest to the BCL's who want to become amateurs.

I am myself a phone hound, as he expresses it. I have learned the code fairly

\$200 In Prizes!

ONE of the most interesting prize contests that you have ever heard of is in full swing now. Big prizes will be paid for making miniature radio instruments, such as rheostats, loose couplers, variocouplers, tuning coils, variometers, telephone head sets, variable condenser, etc. The only condition is that these instruments must not be larger than three-quarters of an inch and the models must work. The prize contest includes not only radio instruments, but all electrical instruments as well. For full particulars see page 1196 of this issue.

Some of the interesting articles appearing in the February issue of "PRACTICAL ELECTRICS":

The Radiotron; A Vacuum Tube. By B. S. Havens of General Electric Company.
Simple Oscillograph. By Carter Fiske.
Electric Animals.
Tidal Electric Power. By Albert Staehle.
Voltage Finder.
Electrical Destruction of Atoms. By Professor Rogers D. Rusk.
Electric Camera Shutter. By A. Kiedis, Jr.
Carbon Contact Rheostat.
Goertz-Beck Arc Lamp.
Analogs and Others. By T. O'Connor Sloane, Ph.D.

well, on the advice of my friend 8CAE, but when I tune in an amateur or "ham" I find that I can catch only about one out of fifty of the letters. I, for one, feel the same as Mr. Kamp does. Although I suppose the amateurs had the same trouble, I feel that they could co-operate with us by sending slowly once a week or so. I am sure that those BCL's who wish to become amateurs would appreciate it very much. I would gladly write to any amateur who could help, and tell him how much I appreciated his co-operation with us. Then we, too, could install transmitters and talk to or work them.

LEO J. SUBER,
Box 332,
Deshler, Ohio.

LEARN TO TUNE YOUR SET

Editor, RADIO NEWS:

I have not been a reader of RADIO NEWS very long, but I notice that the amateurs and BCL's are trying to be on the "outs." The writer, a few years ago, spent three years as a Naval radio operator, but since that time has not devoted any time to radio in any shape or form. I purchased a good standard receiver a month ago and have joined the BCL's; also, I am glad to say, I spend from two to three hours with the amateur and commercial stations every night and per-

sonally I have never been bothered by an amateur or commercial station while listening to the broadcast stations. Some may wonder why, but it is easy to tune them out. That is the trouble with the average BCL, he does not know how to properly tune his set, home-made or some standard make. I have found that the BCL often encounters a lot of interference from his brother BCL, who has not tuned in properly or has a single circuit set which is the worst offender of all; and Mr. BCL will sit and rave about some amateur spoiling the program he is trying to hear. Let's all begin right now, and learn to tune our sets. Then learn the International Morse code, and you will be surprised how much enjoyment you will get out of the little dots and dashes that go flying through space waiting to be harnessed and put down in your log. The writer would like to become an amateur himself, but has not the time. However, I am for the amateur, broadcaster and BCL, for they all join the world in one small space and make us all brothers for a better understanding and a better world to live in. Brother BCL's, let's sit down tonight and learn our receiver and how to handle it and all our troubles will be over.

Ex-Operator, WTW.,
Larned, Kan.

YOUR CHANCE TO LEARN THE CODE

Editor, RADIO NEWS:

Mr. Kamp's letter in your November issue has interested the officers of the Commonwealth Radio Association, of Boston, Mass., sufficiently to cause them to arrange a nightly transmission of code practice for the radio enthusiasts in their locality.

Although numerous broadcast stations have given code practice, the Commonwealth Radio Association believes that those who are interested in learning to receive code will likewise desire to learn just how the amateurs talk to each other, the abbreviations used, the methods of calling, answering, etc. Considering this, the association's code practice transmission will be carried on between two stations on amateur wave-lengths just as ordinary "ham" communication is carried on, with the exception that it will be at slow speed. We believe this process of actual communication will be more interesting, entertaining and beneficial than would be a mere broadcast of code practice.

The station which will probably cover the greatest area will be 1VV, of South Boston. 1VV has done no little DX with his transmitter, and it is just possible that the code practice will benefit enthusiasts at more distant points than we anticipate.

The Commonwealth Radio Association is formed for and by both amateurs and broadcast listeners. It has already done much to benefit these enthusiasts in this locality, and appreciates letters like Mr. Kamp's which show what and how services may be rendered which will help the "fans" to really enjoy the "game."

VERNAL E. FULLER,
Chairman, Publicity Committee.
Boston, Mass.

PASADENA "HAMS" TAKE NOTE

Editor, RADIO NEWS:

Have just pulled the plug out of my receiving set in disgust, said action now being stock equipment, practically every evening, and while the mood is upon me, would certainly like to unwind a few on the subject.

(Continued on page 1100)

APPROVED RADIO NEWS LABORATORIES 1922

RADIO NEWS LABORATORIES



RADIO manufacturers are invited to send to RADIO NEWS LABORATORIES, samples of their products for test. It does not matter whether or not they advertise in RADIO NEWS, the RADIO NEWS LABORATORIES being an independent organization, with the improvement of radio apparatus as its aim. If, after being tested, the instruments submitted prove to be built according to modern radio engineering practice, they will each be awarded a certificate of merit, and a "write-up" such as those given below will appear in this department of RADIO NEWS. If the apparatus does not pass the Laboratories tests, they are returned to the manufacturers with suggestions for improving them. No "write-ups" sent by manufacturers are published on these pages, and only apparatus which has been tested by the Laboratories and found to be of good mechanical and electrical construction is described. Inasmuch as the service of the RADIO NEWS LABORATORIES is free to all manufacturers whether they are advertisers or not, it is necessary that all goods to be tested must be forwarded prepaid, otherwise they cannot be accepted by the Laboratories.

Apparatus Awarded Certificates

UNIVERSNIER

This is a vernier control dial that may be mounted on the shaft of any instruments such as condensers, variometers, etc. It has a geared type knob having a ratio of 12 to 1. Pushing the knob in gives direct rotation, which is an advantage, as rough adjustment is usually only required at the start of tuning. It is equipped with a silver-plated dial having very fine and plainly marked graduations which aid in setting the pointer when using the vernier adjustment. The dial is $\frac{3}{4}$ inches in diameter. The knob fits a $1\frac{1}{2}$ -inch



shaft. It is manufactured by the Walbert Manufacturing Co., Chicago, Ill.

Arrived in excellent packing.
AWARDED THE RADIO NEWS LABORATORIES CERTIFICATE OF MERIT NO. 307.

SCIENTIFIC PHONES

These phones are of the standard bi-polar construction and are very efficient electrically. The audibility is maximum at frequencies ranging from 600 to 3,000 cycles and is fair



beyond these limits. The impedance of the headsets at 1,000 cycles is 22,400 ohms. They are manufactured by the Scientific Electrical Works, 98 Brookline Ave., Boston, Mass.

Arrived in excellent packing.
AWARDED THE RADIO NEWS LABORATORIES CERTIFICATE OF MERIT NO. 308.

HAMMARLUND VARIABLE CONDENSERS

These condensers are of excellent mechanical and electrical construction throughout. The plates are of brass, securely soldered to the supports and in perfect alignment. A micrometer adjustment is obtained by means of the lever arm and cam arrangement that turns the shaft by a friction hold that can be adjusted with a screw. The movable element is mounted between cone bear-



ings, which may be adjusted very accurately. Only a small amount of insulating material placed so as to be fairly away from the electrostatic field is used in the construction of the condensers. They are made in 11, 17, 23, and 43 plate sizes, having maximum capacities of 259, 385, 525 and 994 M.M.F., respectively, with minimum capacities of 14, 20, 22 and 28 M.M.F. The dielectric absorption losses, which are very low, are equivalent to series resistances ranging from 30 to 59 ohms at 1,000 cycles, in the four samples submitted. They are manufactured by the Hammarlund Mfg. Co., 144 W. Eighteenth St., New York City.

Arrived in excellent packing.
AWARDED THE RADIO NEWS LABORATORIES CERTIFICATE OF MERIT NO. 301.

TRUE TONE LOUD SPEAKER

The Little Senior Tru-tone loud speaker shown in the illustration contains a Baldwin-made phone unit of special design in the wooden tone chamber in the base. The horn is of crystalline composition and very attractive; it is 24 inches high with a 10-inch bell, and has excellent



acoustic properties. Manufactured by the Sadler Manufacturing Co., 86 Fourth St., San Francisco, Cal.

Arrived in excellent packing.
AWARDED THE RADIO NEWS LABORATORIES CERTIFICATE OF MERIT NO. 309.

FIL-KO-STAT

This filament rheostat is designed to control the filament current of

practically all types of receiving tubes now on the market. It is noted for its exceptionally infinitesimal and uniform control of the current. For instance, the critical adjustment of a one-ampere tube is spread out over a range of four turns of the knob, thus enabling a micrometer adjustment to be obtained. Several samples were submitted for test by the Radio Stores Corp., 218 West Thirty-fourth St., New York City, and the resistance of each was practically the same, having an average maximum resistance of 31 ohms. The resistance



element is of a finely divided powder enclosed in a Bakelite tube, as shown in the illustration. The instrument is equipped with rugged Fahnestock clips.

Arrived in excellent packing.
AWARDED THE RADIO NEWS LABORATORIES CERTIFICATE OF MERIT NO. 302.

CIC LOUD SPEAKING PHONES

The Connecticut CIC phone is of the Bi-polar type and is similar in construction to the ordinary phone



except that it employs a non-metallic diaphragm having a circular piece of soft iron attached to its center. The air gap is adjusted by turning the phone cap, after which the gap selected may be kept by locking the phone cap with a set screw. The resistance of this phone is approximately 1,388 ohms and the impedance at 1,000 cycles, 33,000 ohms. It is furnished with a 10-foot cord. Manufactured by the Connecticut Instrument Co., Inc., Stamford, Conn.

Arrived in excellent packing.
AWARDED THE RADIO NEWS LABORATORIES CERTIFICATE OF MERIT NO. 303.

NEUFELDT & KUHNKE HEADSET

The Goldschmidt Corporation, 15 William St., New York City, submitted for test the 3,000 ohm Neufeldt & Kuhnke headset shown in the illustration. This headset is of excellent mechanical and electrical construction. It is of the bi-polar type with nickel-plated shells and large ear pieces, and has a leather

covered head band. The headset has an impedance at 1,000 cycles of approximately 17,500 ohms. The audibility is maximum from 300 to



6,000 cycles and the reproduction is very clear and faithful.

Arrived in excellent packing.
AWARDED THE RADIO NEWS LABORATORIES CERTIFICATE OF MERIT NO. 304.

DUO SPIRAL LOOP ANTENNA

This loop antenna is very light in weight and of pleasing appearance. It has 12 turns of green silk covered copper wire wound six turns on each side of the wooden supports. The leads are connected to a metal tube and a metal rod, which make contact with the contacts on the base, one of which rubs against the metal tube under pressure of a spring as the loop is rotated. When shunted by a .0005 mfd. variable condenser, a wave-length range of 260 to 575 meters is covered. This loop is manufactured by the Radio Units, Inc., Maywood, Ill.

Arrived in fair packing.



AWARDED THE RADIO NEWS LABORATORIES CERTIFICATE OF MERIT NO. 288.

ACOUSTIC WOOD HORN

The loud talker shown in the illustration is of novel design and pleasing appearance. It employs the Baldwin phone unit which is mounted in the base of the wooden horn, or sound reflector. The horn is artistic in design, highly fin-

ished, and has good acoustic properties. Excellent results were obtained with this horn. Manufactured by Edward A. Lefebvre, 277 Sixth Ave., Astoria, Long Island, N. Y.



Arrived in excellent packing. AWARDED THE RADIO NEWS LABORATORIES CERTIFICATE OF MERIT NO. 305.

TINY TURN VERNIER ATTACHMENT

A very small and effective vernier attachment that is simple to adjust is shown in the illustration. This attachment may be mounted on the panel near any control dial. Push-



ing in on the knob forces the small rubber rimmed wheel, which is geared to the knob, against the dial. Turning the knob turns the wheel which rotates the dial by its friction contact. It should be noted that the dial turns in the same direction as the vernier knob. This attachment is manufactured by Radio Units, Inc., Maywood, Ill.

Arrived in excellent packing. AWARDED THE RADIO NEWS LABORATORIES CERTIFICATE OF MERIT NO. 289.

WALNART V. T. SOCKETS

As shown in the illustration, the vacuum tube sockets manufactured by the Walnart Electric Mfg. Co., 1251-53 W. Van Buren St., Chi-



cago, Ill., are of metal, highly polished, and insulated with thick pieces of hard fibre. The spring contacts are securely fastened and always maintain positive contact with the tube prongs. Both standard sockets and sockets for the UV-199 or C-299 tubes are made.

Arrived in excellent packing. AWARDED THE RADIO NEWS LABORATORIES CERTIFICATES OF MERIT NOS. 286 AND 287.

MIDGET VARIOCOUPLER

This variocoupler, although small in size, is very efficient and of good mechanical construction. It is of the same shape and size as this company's midget variometer and the two units can be used together to form a very compact receiving set. The shaft is 1/16 inch in diameter. Connections to the rotor coil are brought out by means of flexible leads, thus avoiding noisy rub-



bing contacts. This instrument is manufactured by the Kilbourne & Clark Mfg. Co., Seattle, Wash.

Arrived in excellent packing. AWARDED THE RADIO NEWS LABORATORIES CERTIFICATE OF MERIT NO. 310.

MIDGET VARIOMETER

The midget variometer here illustrated is of similar construction to the midget variocoupler described in these columns and is manufactured by the same company, Kilbourne and Clark



Mfg. Co., Seattle, Wash. When connected in series with the secondary winding of the midget variocoupler to the grid and filament of a vacuum tube, a wave-length range of 270 to 520 meters was covered.

Arrived in excellent packing. AWARDED THE RADIO NEWS LABORATORIES CERTIFICATE OF MERIT NO. 311.

B-METAL REFLEX DETECTOR

This is a permanent crystal detector especially designed for Reflex circuits. The crystal is securely sealed in a glass container and mounted on a base as shown in the illustration. The detector was found exceptionally sensitive and gave excellent results. It is manufactured by the B-Metal Refining Co., 3134 Trumbull Ave., Detroit, Mich., and is known as "Type C Reflex Tube Detector."

Arrived in excellent packing. AWARDED THE RADIO NEWS LABORATORIES CERTIFICATE OF MERIT NO. 312.



B-METAL ADJUSTABLE DETECTOR

The B-Metal Refining Co. also manufactures the adjustable type D crystal detector. This detector, shown in the illustration, is noted for its exceptionally small size, ease of adjustment and ability to hold its adjustment. It is very sensitive, the sensitivity, of course, depending upon the crystal used.



Arrived in excellent packing. AWARDED THE RADIO NEWS LABORATORIES CERTIFICATE OF MERIT NO. 293.

B-METAL LOUD TALKING CRYSTALS

The B-Metal loud talking crystals, which are also manufactured by the B-Metal Refining Co., are furnished mounted ready to fit the standard crystal detector cup. They are very sensitive over practically the entire exposed surface.

Arrived in excellent packing. AWARDED THE RADIO NEWS LABORATORIES CERTIFICATE OF MERIT NO. 294.

MARTIN-COPELAND GRID LEAK

The small size of this variable grid leak makes it convenient for



panel mounting. As shown in the illustration, the rotating arm does not slide on the resistance element, but presses a spiral shaped spring against the resistance. A range of 70,000 ohms to 10 megohms was obtained on the sample submitted, although the advertised range is only 1/5 to 5 megohms. The control is uniform. This grid leak is manufactured by Martin Copeland Co., Providence, R. I.

Arrived in excellent packing. AWARDED THE RADIO NEWS LABORATORIES CERTIFICATE OF MERIT NO. 295.

C.R.L. VARIABLE GRID LEAK

The C.R.L. variable grid leak are noted for their uniform and stable control, and the average range



from a number of samples submitted was 1/4 to 25 megohms, although a much shorter range is claimed by the manufacturers. The illustration shows that they are of rugged mechanical construction. Contact is made with the resistance strip by pressing a spring against it, thus avoiding a rubbing contact. The resistance element is impregnated cloth. Manufactured by the Central Radio Laboratories, 303 16th Street, Milwaukee, Wis.

Arrived in excellent packing. AWARDED THE RADIO NEWS LABORATORIES CERTIFICATE OF MERIT NO. 296.

PANELYTE RADIO PANELS

The Panelyte Board Co., Enterprise Avenue, Trenton, N. J., submitted two panels of an insulating material which was found to be very excellent for use as radio panels or other insulating parts. The radio frequency phase difference angle is very low. The material is easily cut and drilled and of good finish. It does not warp and is not affected by moisture.

Arrived in excellent packing. AWARDED THE RADIO NEWS LABORATORIES CERTIFICATE OF MERIT NO. 278.

FANSTEEL BALKITE BATTERY CHARGER

The Fansteel Balkite battery charger is designed to meet the needs of those radio fans who employ six-volt storage batteries for



lighting their vacuum tubes. It comprises a step-down transformer and an electrolytic rectifier. A cord is furnished for attaching it to any 110-volt 60-cycle light socket and two other leads with clips connected to the battery being charged. The outlet consumes about 80 watts and charges a six-volt storage battery at a three-ampere rate. Manufactured by the Fansteel Products Co., Chicago, Ill.

Arrived in excellent packing. AWARDED THE RADIO NEWS LABORATORIES CERTIFICATE OF MERIT NO. 313.

Radio Trade Notes
By L. A. NIXON*

"SELL sets, sell sets," was the universal cry by writers in trade papers all summer and during the early fall. Manufacturers of sets spent a great deal of money to tell the trade that the sale of complete sets was the easiest and best way to build up a profitable volume of sales for the retail store.

During the month of November the cry changed. It was from the other end. "Give us sets!" was the appeal from practically every jobber in the trade. Manufacturers of sets tried to increase production, attempted to build up a stock to take care of holiday demand. The orders were increasing at a greater rate than the production in every factory of any importance in the trade. One

*Of the Radio Dealer

manufacturer on November 15 announced a production of more than one thousand sets a day, and on that same day a jobber in one city sent in an order for 100 sets of a certain type.

In Newark, N. J., alone, according to four of the leading jobbers there, 400 high priced radio sets were ordered by retailers in one week of six business days.

Radio manufacturing today presents a production problem that perhaps will yet bring to the fore a production man that the trade can acclaim as a leader.

Production managers in other industries have past experience to work on. Their workers do not have to be trained from the bottom up. Better still, there is no sprinkling of "experts" among the applicants for

positions who feel they can improve the product if given a few minutes to play with it. Quantity production, however, as opposed to the old style method of "personal supervision" is coming to the front rapidly. It will not be surprising in another year to see several radio factories engaged in the manufacture of sets with productions in excess of one hundred thousand sets each per year.

Organizations in the trade are coming to the front with members bound together by common interests other than fear of patent suits or desires to buy co-operatively. Retailers in several cities have perfected associations to handle National Radio Week. (Continued on page 1184)

Awards of the \$50 Radio Wrinkle Contest

First Prize

A FIVE-CENT VERNIER

By ANDREW TOU

Any number of vernier attachments have been described in various radio periodicals, but most of them are either too complicated in construction or have a mechanical drawback. The vernier attachment I am to de-

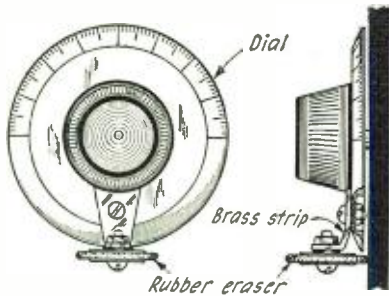

A Sidewise Movement of The Thumb on the Eraser Affords a Very Fine Adjustment of the Position of the Dial.

scribe cost me 5c and as can be seen from the illustration, is simplicity itself so far as operation is concerned. The following parts are necessary for its construction: Two small brass bolts taken from dry cells, two nuts to fit these bolts, a scrap of sheet brass and one 5c round eraser. The drawings are self explanatory. Fine adjustment is made by rolling the eraser with the thumb. This vernier does not require any hole in the panel and the knob and dial may be moved to another set without removing the attachment.

Second Prize

CELLULOID VARNISH FOR SELF-SUPPORTING COILS

By RAYMOND B. WAILES

An excellent insulating fluid which can be easily made by the radioman has for its base celluloid. Drying very quickly, more so than shellac, it combines high insulating qualities with a beautiful gloss, strong body, not masking the original color of the coil or instrument treated. The composition is made by dissolving scrap celluloid such as photograph film in acetone, which can be purchased very cheaply at the corner drug-

gist's. The photographic film should first be scraped of its gelatinous emulsion by immersion in lye water, hot water or household "ammonia." The coating is then easily removed by scraping. The cleaned cuttings of the film are then shaken in a corked bottle with the acetone, more acetone being added if the mixture becomes too thick, or more celluloid if it has a tendency to flow too easily.

Coils, such as variometer rotors, wound on forms and painted with the celluloid var-

nish will retain their shape wonderfully, allowing very close coupling between it and the stator, this not being possible if a tube or other support were used.

Prize Winners

FIRST PRIZE \$25

A Five-Cent Vernier
By Andrew Tou
R. F. D. No. 10
Columbia, Mo.

SECOND PRIZE \$15

Celluloid Varnish for Self-Supporting Coils
By Raymond B. Wailes,
3118 14th St.,
Washington, D. C.

THIRD PRIZE \$10

A Horizontally Directional Loud Speaker
By E. H. Woods,
Richmond, Nelson, N. Z.

nish will retain their shape wonderfully, allowing very close coupling between it and the stator, this not being possible if a tube or other support were used.

Third Prize

A HORIZONTALLY DIRECTIONAL LOUD SPEAKER

By E. H. WOODS

The accompanying diagram illustrates the simple construction of the home-made reproducer for various sound frequencies of broadcasting. The sound waves it will receive pass vertically through the horn. They are then reflected from the sides of the right pyramid, down and outwards, striking

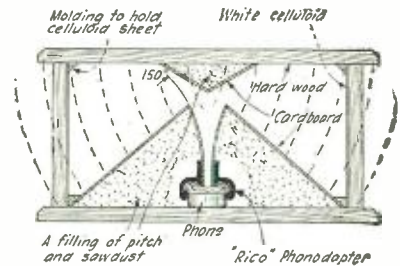

Details of the Interior Construction of the Loud Speaker.

(before setting in position) and colored paper mounted on the back to improve the appearance. As places in this celluloid sheet showed a tendency to vibrate at certain audible frequencies, small pieces of celluloid were cemented on the backs of these portions.

This reproducer which may be small in size can find a fitting place anywhere in the room. There is very little distortion of speech or music and the music is right there in the room and not at the end of a long hall. I am contemplating the building of another,



Exterior View of the Completed Loud Speaker.

having its three radiating surfaces in the form of half a hexagon, the middle surface having a clock set in its center, so that the reproducer may take the place of my clock on the mantle piece.

A NOVEL LOUD SPEAKER

The loud speaker or resonator herein described not only works well, but requires no mechanical or electrical parts to be constructed or purchased. The requisites are a banjo or headphones, the latter used with one or two stages of amplification, depending on the nearness of stations.

The banjo is turned upside down, one edge being raised slightly by placing it on a book or some such convenient object, so as to keep the tone chamber clear of the desk or table top. The phones are then laid on the skin of the banjo, inside. The instrument acts as a resonator of the sound in the phones, giving a clear, musical tone of pleasant characteristics. The tones are distinct at all frequencies, and enough volume is furnished to fill a room with music from stations 500 miles distant, using a two-step audio-frequency amplifier with a non-regenerative coupled receiver.

The writer has tried no other musical instruments as resonators. However, it seems apparent that they could be used, experimenting with various positions of the phones on



Dissolving the Cleaned Strips of Photo Film in Acetone to Make the Transparent Insulating Varnish. A Formed and Coated Variometer Rotor Can Be Seen at the Right. It is Very Rigid. Simply Flow the Varnish on Your Coils with a Brush and it Will Be Dry in Two Minutes!

the tone chamber until satisfactory results were obtained. A tambourine should work practically as well as a banjo in the capacity of a loud speaker.

Contributed by Theron W. Bean.

GETTING AROUND STATIC

There are a great many readers who are using a single circuit set, but there are very few who know the following little kink.

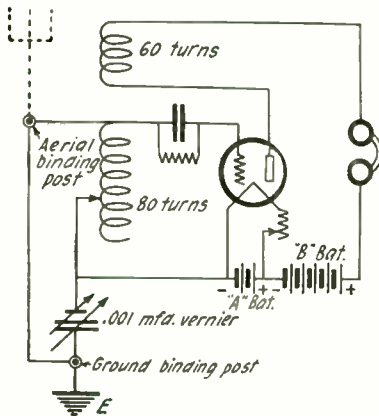

Reception Without an Aerial is Feasible and Will Cut Down Static Interference Considerably Without Depreciating Signal Strength to Any Great Extent.

Some time when the static is very bad and you wish to use your set try this: Disconnect the aerial wire from the set and run a wire from the aerial binding-post to the ground post, thus leaving the condenser across the coil. If the condenser has a vernier plate, you will experience very little difficulty in bringing in DX stations. Nearly all the static will be eliminated and you will be surprised at the number of stations you will be able to hear.

Contributed by Wilford Lakman.

UNIT PANEL RECEIVING SET

The usual amateur is not content with a receiver for any great length of time, since new circuits are appearing monthly. To change from one circuit to another, it usually requires a change in position of the apparatus of the old set and possibly the addition of more instruments. After a panel has once been drilled, it is difficult to make any such changes. The arrangement shown in the illustration has an attractive appearance and allows for the changing about of the different instruments to conform to any desired circuit and at the same time allows for the

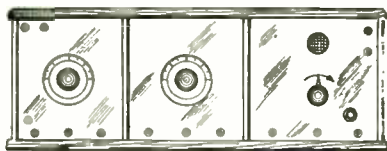

Fig. 1



Fig. 2

A Unit Panel Receiving Set in Which the Instruments Can Easily Be Interchanged.

addition of more parts without detracting from the general appearance of the entire unit. The small panels upon which the instruments are mounted may be cut from old hard rubber, storage battery cases which are easily obtainable in any garage. This can easily be accomplished with a hack saw

and the pieces can be squared up to the desired sizes and sandpapered to give them a good finish. The application of a bit of paraffin oil will give them a glossy appearance. When joining each unit together, small lengths of light brass sheeting are bent as shown in the illustration and placed between each panel. This effectively conceals the joints between each unit.

Contributed by Joe Harner, Nevada, Mo.

A DIRECTIONAL LOOP AERIAL

From time to time I have read articles on the construction of loop aerials, from those that would fit inside a suit case to those of greater dimensions, each with different lengths and sizes of wire.

Before spending the time to construct an elaborate frame for a loop I looked around for something on which to wind wire temporarily so as to prove what length and size would give best results; this was easy enough, but then I went a step further and found that which would be adjustable and also directional, as shown in the drawing.

The construction of the pegs allows them to be fastened to the door by small R. H. screws which will leave a very small mark when removed.

After trying out a loop of this kind there is no reason why it could not be constructed neatly and used permanently.

Contributed by Henry L. Edwards.

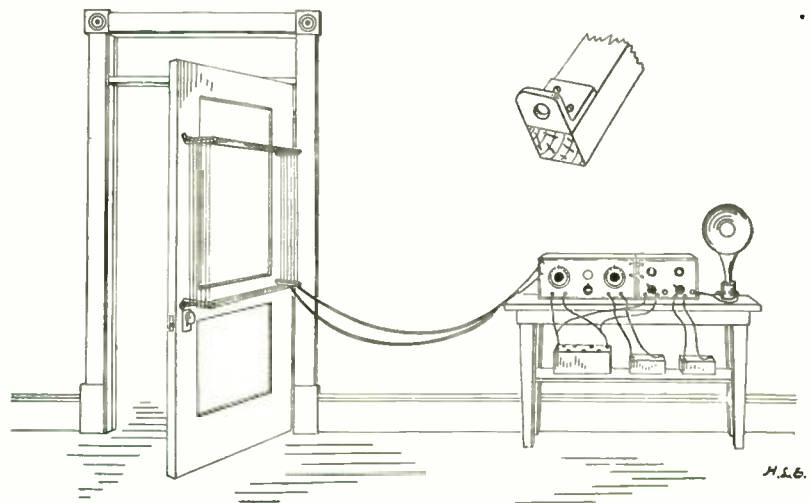

A Loop Aerial is Rather Cumbersome if Placed on the Table With the Receiving Apparatus. Why Not Mount It on the Door of Your Room, as Shown in the Illustration?

A SUBSTITUTE FOR RESISTANCE

Some experimenters, when constructing a rectifier, find considerable difficulty in finding suitable resistance to place in series with their battery that is being charged, other than a bank of lamps which is rather expensive since so many are needed. Instead of the resistance, place an ordinary plug receptacle in series with the battery terminal and the high voltage side. Then procure your mother's electric iron and taking care that it is on a holder and will do no damage when hot, connect it in the plug receptacle. This will do the same work that thirteen 50-watt lamps would do and when your mother wants her iron it is hot and ready for service.

Contributed by James V. Clark.

BUSHING DIALS

At times it is necessary to mount a dial or knob with a 1/4" hole on a 3/8" shaft. After trying several methods, the following was

found to be the most satisfactory and can be done by anyone without particular skill.

Take a length of bare No. 18 copper wire and wrap it snugly and closely around the 3/8" shaft. Remove the spring thus formed and dip it into molten solder, shaking off the surplus. When cool, a neat little bushing is complete and ready for use. Any high spots can be readily smoothed off with a file. Dials so bushed will turn true and even.

Contributed by Thomas Benson.

A RECEPTION REPORT CARD

The quality of the music and programs which are broadcast from the radiophone stations will be, in the future, influenced by

RECEIVING REPORT	
RECEIVED BY
AT	STATE
DATE	1923
FROM STATION	P. M. E. S. T.
METER WAVE LENGTH
PROGRAM
RECEIVING SET
REMARKS

the wishes of the listeners. However, to let the stations know the wishes and the dislikes of the vast audience, it is of the ut-

most importance that you transmit to them your criticisms. The best time to write a line is while you are listening to the program or immediately afterward. I would suggest that you have cards printed by the local printer or have a rubber stamp made up similar to the enclosed report card. As far as I know there are no suitable printed cards which can be obtained from the radio trade. Irrespective of whether you write a letter or just send a card, let the artists and the owners of the stations know just what your views are—for everyone likes true appreciation and appreciates true constructive criticism.

Contributed by J. E. Frisbee.

A GOOD SPRING CONTACT

I think you will find the following scheme of great benefit to all amateurs. I have always had trouble in winding variometers or variocouplers, but just how I could attach

(Continued on page 1148)



VACUUM-TUBE AMPLIFIER

(Patent No. 1,465,332. Issued to Harold De Forest Arnold, of Maplewood, New Jersey, August 21, 1923).

This invention relates to vacuum tube amplifiers, and more particularly to arrangements for supplying space current thereto.

An object of this invention is to provide means whereby a plurality of vacuum tubes to be used as repeaters or amplifiers may be supplied with space current from a single source, but in such a manner that current changes in one tube due to signals being repeated cannot be impressed upon another tube through said source.

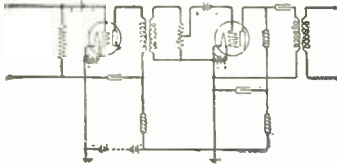

With the arrangement shown herein, a single source of space current is used to energize both tubes of a two stage amplifier, and in the branches of the circuit therefore are interposed filters of series inductance and shunt capacity to prevent alternating current from being bypassed therethrough.

METHOD OF, AND MEANS FOR, AMPLIFYING POTENTIAL VARIATIONS.

(Patent No. 1,468,116. Issued to Irving Langmuir, of Schenectady, New York, September 18, 1923).

It has been discovered that if two electrodes are enclosed in an envelope exhausted to such a degree that the passage of current between the electrodes produces substantially no gas ionization, irrespective of the voltage employed, the flow of current is dependent upon certain conditions. In case a heated cathode is used the current with constant temperature of the cathode, will, between certain limits vary as the 3/2 power of the voltage impressed on the anode. As the voltage is increased, however, a point which may be termed the "saturation" point, is finally reached at which the current becomes constant. By varying the temperature of the cathode the impressed voltage at which the current becomes constant may be varied and the value of the saturation current may be varied. Devices of this type are described and certain broad features thereof are claimed in my copending application, Serial No. 84,242, filed March 14, 1916, which is a continuation of my application Serial No. 795,610, filed October 16, 1913.

If a negative electrostatic field is set up within the envelope of an electron discharge device in which the current has not reached the saturation point, by impressing a negative potential upon a conducting grid interposed between the electrodes the flow of current will be decreased, and if the negative potential used is great enough with respect to the potential impressed on the anode the flow of current may be stopped altogether. On the other hand if a positive potential is impressed upon the grid the flow of current may be increased. In controlling the current in this way if the anode is maintained at a constant potential a small variation in the potential of the grid will cause a very large change in the current between the elec-

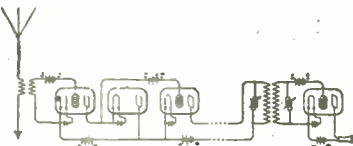

trodes. This property of such devices has been made use of by impressing upon the grid the potential of the very feeble current impulses of waves of radiant energy such as are received by the antenna of a wireless station, thereby producing a current flow between the electrodes which varies in accordance with the variations in the received current, but which is of much greater amplitude. If on the other hand, it is desired to cause a constant current to flow through the device the anode potential required to produce that current will vary in accordance with the variations in the potential of the grid. In carrying my invention

into effect I make use of this last property in such a way as to amplify the potential variations of the received waves instead of the current variations and by so doing secure a high degree of amplification. In accomplishing this result I may also make use of the current saturation effect of a second electron discharge device to prevent the current through the amplifier from exceeding a certain amount, irrespective of the voltage impressed upon the grid.

BALLAST TUBE

(Patent No. 1,470,788. Issued to Paul Thorne Weeks, of Caldwell, N. J., October 16, 1923).

In some cases, ballast tubes employing hydrogen gas have been found to be subject to more or less gradual changes in the current voltage characteristic, or the mean value of current about which the tubes should exercise their corrective effects. The direction and amount of these changes appear to be dependent on the conditions under which the tubes have been previously operated. For instance, it has been fairly definitely established that, after a ballast tube has been operated at a high temperature for some time, the current-voltage characteristic will have shifted, so that the corrective effects exerted by the resistance in the ballast tubes will not take place at the given current value but at a higher current value. Later, however, if the tube is not used for some time or is operated at a low temperature, the current-voltage characteristic will shift back to approximately the original value.

The apparent explanation of this shifting phase of the current-voltage characteristic is that the hydrogen is probably absorbed by the material composing the filament, at certain temperatures, while at other temperatures, it may be evolved. The absorption may be due to a chemical or a physical action or a combination of both. Obviously, when the absorption takes place, a corresponding change in the pressure and density



of the gas likewise occur, depending on the extent of such absorption. As pointed out previously, when the density changes but slightly, a marked change in current may take place, particularly, when the density is within the critical range; hence, when the density of the gas within the iron-hydrogen ballast tube is within this critical range and variations occur, due to changing density conditions from absorption or evolution of the gas, the temperature of the filament will vary accordingly. This results in a change in the current value at which the tube will exercise its corrective effects.

This invention concerns itself with the employment of a gas other than hydrogen which will be more reliable in maintaining the current at the requisite value and which will not be absorbed to such an appreciable extent by the material composing the filament, thus providing against any marked change taking place in the current-voltage characteristic. At the same time, the cooling effect on the filament secured, by the employment of hydrogen need not be sacrificed, as it is possible to employ a gas having this additional property.

RADIO RECEPTION

(Patent No. 1,471,165. Issued to Lester L. Jones, of New York, N. Y., October 16, 1923).

This invention aims to provide a receiving system whereby radio signals of low damping, and especially continuous waves, may be efficiently received with the exclusion of disturbances of all kinds resulting from waves or pulses of relatively high damping, or from waves differing in frequency from the signal waves.

The invention comprises a method wherein two receiving antennae or absorbing means, are utilized which are designed to receive substantially equal amounts of wave energy of high

damping or of frequency substantially different from the signal frequency, and greatly unequal amounts of signal energy of low damping, and wherein the currents produced by the energy absorbed in the two antennae are separately rectified and thereafter combined in opposition for operating the indicating means. The currents resulting from energy absorbed from waves of high damping and from waves of a frequency substantially different from the signal frequency, are thus caused to neutralize each other in the indicating circuit, while a signal current is produced in the indicating circuit by the absorbed signal wave energy of low damping and operates

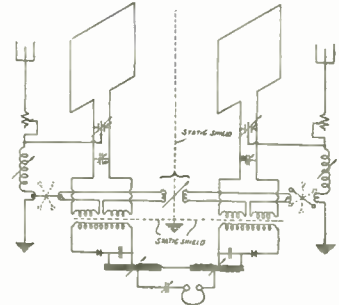

the indicating device free from disturbance. The two receiving antennae should be electrically alike, should have low and equal dampings, and should be in close proximity and electrically and magnetically decoupled one from the other. Loop antennae are best used because of the greater difficulty of decoupling open antennae. The loop antennae should both point in the same direction and should most desirably be symmetrically placed with respect to surrounding objects. For convenience in adjusting the setting of the loops, it is desirable to use loops of fairly small dimensions.

PROCESS AND APPARATUS FOR RECEIVING RADIO SIGNALS

(Patent No. 1,468,060. Issued to Roy A. Weagant, of Roselle, New Jersey, September 18, 1923).

In the investigation of static disturbances, I have discovered that antennae separated from one another by considerable distances appear to be acted upon by such disturbances substantially simultaneously, the effect being as though such disturbances were caused by electro-magnetic waves or impulses propagated perpendicularly to the surface of the earth, and almost without horizontal components. This effect, in other words, is as though these disturbances chiefly originated at a great height above the earth and had their horizontal components substantially neutralized, so that widely separate antennae, if on the same level have disturbances set up in them which occur simultaneously.

I have reached this conclusion after numerous tests which appear to admit of no other explanation, but whether or not it is a correct state-

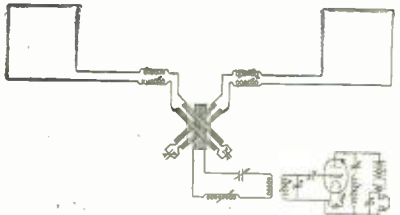

ment of the facts, I find that by proceeding on this assumption and using a directional combination of separated antennae, as hereinafter described, I am able to very largely overcome the interference with reception caused by the most objectionable forms of atmospheric disturbances.

The disturbing causes do not behave as though possessed of either definite wave length or decrement, but set up in the antennae oscillations which have the frequency and the decrement of the antennae themselves, and by suitable adjust-

(Continued on page 1118)



THIS Department is conducted for the benefit of our Radio Experimenter. We shall be glad to answer here questions for the benefit of all, but we can publish only such matter as is of sufficient interest to all.

1. This Department cannot answer more than three questions for each correspondent.
2. Only one side of the sheet should be written upon; all matter should be typewritten or else written in ink. No attention paid to penciled matter.
3. Sketches, diagrams, etc., must be on separate sheets. This Department does not answer questions by mail free of charge.
4. Our Editors will be glad to answer any letter, at the rate of 25c for each question. If, however, questions entail considerable research work, intricate calculations, patent research, etc., a special charge will be made. Before we answer such questions, correspondents will be informed as to the price charge. You will do the Editor a personal favor if you will make your letter as brief as possible.

THREE STAGE A. F. CIRCUIT

(834) Mr. R. F. Rinard, Argos, Ind., requests:
 Q. 1. Please polish a hook-up for a detector and three stages of audio frequency amplification using WD-11 tubes. A Baldwin type C unit is to be used on the third stage.
 A. 1. This hook-up will be found in these columns. A separate "B" battery is advisable for the third stage of audio frequency, as shown. If WD-11 tubes are used, three or four dry cells should be connected in parallel for the filaments.
 Q. 2. I have three All-American transformers with ratios of 10:1, 5:1 and 3:1. In what stages should these transformers be placed?
 A. 2. These transformers should be placed in first, second and third stages, as listed in this question.

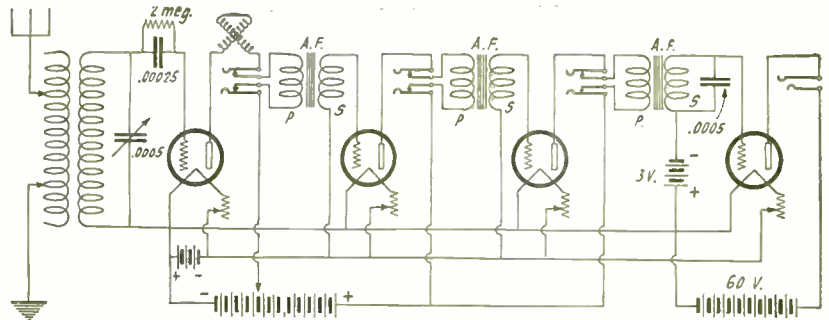

Q. 834. Plenty of Volume Will Be Had from This Three Stage Audio Frequency Amplifier. A Separate "B" Battery is Used on the Plate of the Last Amplifier Tube.

TUBE FOR AUTOPLEX CIRCUIT

(835) Mr. Robert A. Lambert, Bethlehem, Pa., asks:
 Q. 1. Will you please tell me whether a UV-199 tube can be used as satisfactorily as the UV-201A tube in the new Autoplex circuit?
 A. 1. A UV-199 tube can be used with fair success in the Autoplex circuit, but if sufficient

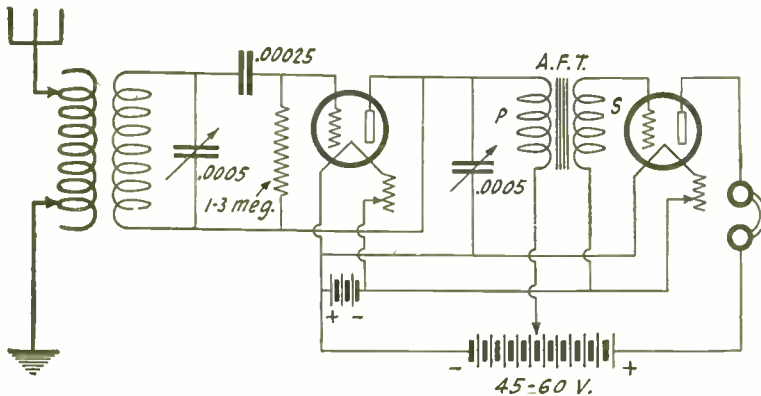

Q. 837. Good Results Will Be Had With the Well Known Ultra Audion. The .0005 mfd. Variable Condenser Connected from the Plate to the Filament of the Detector Tube Controls the Regeneration.

volume for the operation of a loud speaker is desired a UV-201A tube should be employed. As the Autoplex receiver is an amplifying circuit, a tube having a high amplification factor is necessary.

STEP-UP TRANSFORMERS

(836) Mr. E. A. Burriss, Sellers, La., wants to know:

Q. 1. What is the difference between an A. C. and a D. C. step-up transformer?
 A. 1. There is no such thing as a D. C. step-up transformer. A transformer relies upon the principle of induction for its operation, which is caused by the magnetic field of a pulsating or alternating current, expanding and collapsing in unison with the alternations, and in so doing, cutting the turns of a secondary coil, thereby inducing a voltage in direct ratio to the number of turns in this coil. As direct current has no fluctuating magnetic field, it cannot be used to operate a transformer.

ULTRA-AUDION CIRCUIT

(837) Mr. James B. Kendrick, Houston, Texas, requests:

Q. 1. Please publish an Ultra-Audion hook-up with one stage of audio frequency amplification.
 A. 1. This hook-up appears on these pages. A variocoupler is used as the tuner in this circuit. Regeneration is obtained and controlled by the variable condenser which is connected from the plate to the filament.

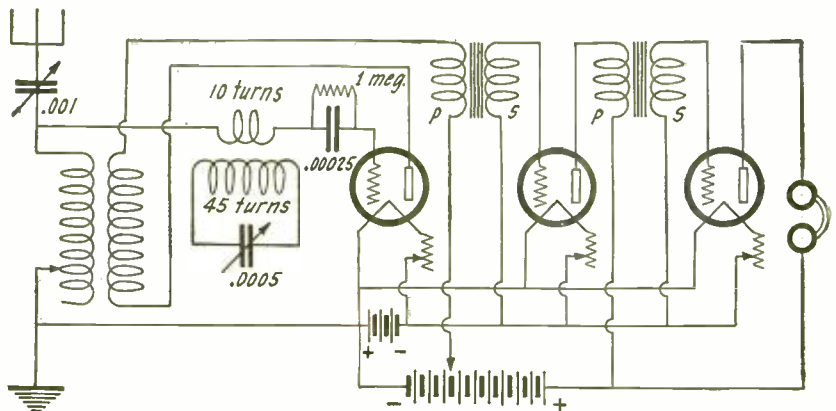

Q. 839. Great Selectivity Can Be Obtained with a Single Circuit Receiver by Using the System Shown Here. Both Coils Are Wound on the Same Tube.

"B" BATTERY CHARGING

(838) Mr. J. R. Moore, South Boston, Va., wants to know:
 Q. 1. Kindly advise me through your "I-Want-to-Know" department if there is a way or means whereby I may connect the Balkite "A" battery charger to charge a "B" battery of about 40 volts.
 A. 1. This battery charger is designed to charge a six-volt battery only and the voltage delivered from the rectifier is not high enough to charge a 45-volt "B" battery.

SELECTIVE SINGLE CIRCUIT RECEIVER

(839) Mr. A. J. Welzenback, Peoria, Ill., writes:
 Q. 1. I have a single circuit receiving set employing two stages of audio frequency with a Magnavox. I would like to know if I could possibly increase the selectivity of this set.
 A. 1. We are showing in these columns a hook-up of a single circuit receiver employing a method whereby great selectivity can be obtained. It consists of a wave trap placed in the secondary or grid circuit of the tuner. This wave trap has two coils, both wound on a 3-inch tube separated from each other by 1/4 inch.
 Q. 2. What is the average range of a receiving set of this kind? My longest distance has been about 1,000 miles.

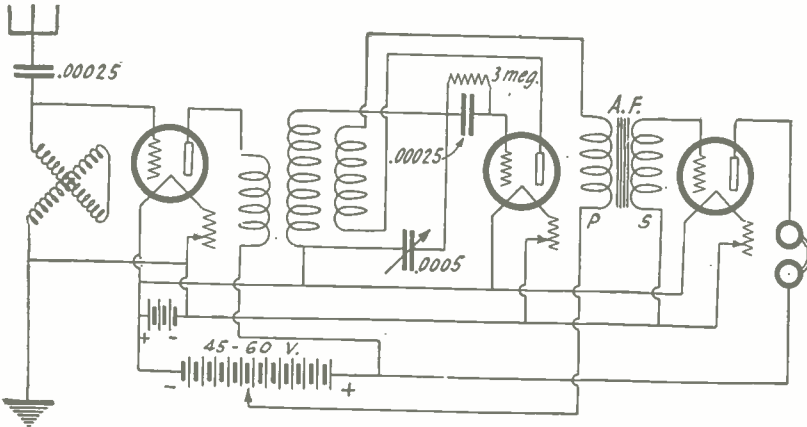

Q. 841. Regeneration Can Be Used in Conjunction with a Radio Frequency Amplifier if This Circuit is Used. Details Are Given in the Text.

A. 2. 1,000 miles is considered a good average range for a receiver of this type. If you can receive consistently stations at this distance you have nothing to complain of.

THE SODION TUBE

(840) Mr. Vincent Getty, Jr., Chicago, Ill., wants to know:

Q. 1. Does the Sodian tube excel all other makes as a detector?

A. 1. There has been very little actual work done with this tube outside of the laboratory and we cannot say at this time whether it will excel all other makes for all around work. In a demonstration it showed great promise as a rectifier of weak signals, giving as much volume without regeneration as a good detector tube does in a regenerative receiver.

Q. 2. What A. F. and R. F. transformers operate most efficiently with it?

A. 2. Any good audio frequency transformer may be used with this tube. A special radio frequency transformer must be used, if it is employed directly ahead of the tube. This tube requires very loose coupling in a transformer or a tuner for best results, this coupling being determined by experiment. Two honeycomb coils of 25 and 50 turns for the primary and secondary may be used as a tuned radio frequency transformer when using this tube. The secondary of the transformer should be shunted by a .0005-mfd. capacity variable condenser.

Q. 3. Please give specifications for the construction of a coupler especially adapted for DX work with this tube.

A. 3. If this coupler is to be used with the Sodian tube without radio frequency it may take the form of an ordinary coupler with the exception that the secondary must be much more widely separated from the primary. As stated in answer to question No. 2, this coupling must be determined by experiment.

R.F. WITH REGENERATION

(841) Mr. R. F. Jones, Atlanta, Ga., requests:

Q. 1. Please publish a hook-up using one stage of radio frequency amplification, showing how regeneration can be obtained in the detector circuit.

A. 1. This hook-up will be found herewith. An ordinary variocoupler may be used in this circuit for a tuned radio frequency transformer. Only a portion of the primary winding is used,

depending upon the diameter of the tube. If the tube is 3 1/2 in. in diameter, approximately 37 turns will be employed and these are used as the secondary of the transformer. The primary of the transformer is made by winding 12 turns of No. 20 S.C.C. wire directly over the original primary winding. These two windings may be separated by a tight-fitting cardboard tube. The secondary, or rotor, of the coupler is used in this case to obtain regeneration by connecting it in the plate circuit of the detector tube.

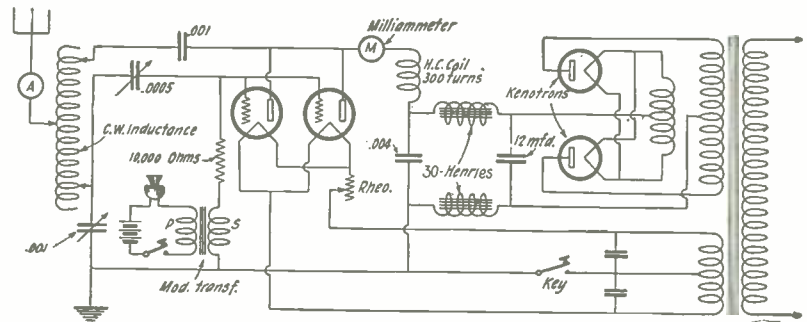

Q. 843. Here is the Circuit for a Good 10-Watt C.W. and Phone Transmitter. Kenotron Tubes Are Used to Rectify the Plate Voltage.

C.W. TRANSFORMER DESIGN

(842) Mr. C. M. Curtiss, Montreal, Canada, asks:

Q. 1. Kindly publish complete details for the construction of a 200-watt transformer similar to the Acme C.W. transformer.

A. 1. A 200-watt transformer may be constructed as follows: A core 8 x 6 x 2 in. sq. is required. The primary will consist of 414 turns of No. 14 D.C.C. wire. The secondary will consist of 4,574 turns of No. 34 D.C.C. wire tapped at the 2,287 turn. The two filament windings will consist of 38 turns of No. 14 D.C.C. wire. Each of these two windings should also have center taps at the 19th turn. This transformer will

give two secondary voltages of 550 and each filament winding will deliver 10 volts.

C.W. TRANSMITTER

(843) Mr. Willid Graves, Los Angeles, Calif., writes:

Q. 1. Please publish the hook-up given in the July issue under question No. 708, using Kenotron rectifier tubes in place of the chemical rectifier shown.

A. 1. This hook-up will be found in these columns. Two Kenotron rectifying tubes are used in place of the chemical rectifier.

Q. 2. What kind of coil is it that is numbered L-300 used in this circuit?

A. 2. This coil is a Duo-Lateral or a honeycomb coil of 300 turns.

REFLEX CIRCUITS

(844) Mr. E. Beauchamp, Riverside, Calif., wants to know:

Q. 1. In reference to the Erla hook-ups in the December RADIO NEWS, would like to know how to connect a loop aerial to each of the sets.

A. 1. A loop aerial can be used with either of these receivers by connecting it to the input of the first tube in place of the secondary of the tuner.

Q. 2. Can a Gold Grain detector be used instead of a fixed crystal detector in these circuits? A. 2. A Gold Grain detector will function very satisfactorily when used for rectification in either of these circuits.

GREBE CR-13 RECEIVER

(845) Mr. Clarence Selley, Benkelman, Neb., writes:

Q. 1. Please publish diagram of the Grebe CR-13, short wave receiver.

A. 1. This diagram appears herewith. It will be seen upon close examination that this is a single circuit receiver using a radio frequency transformer with a tuned secondary. The vario-

meter used for tuning is wound with approximately 19 turns on each half of the stator and rotor coils; the entire instrument consists of 76 turns of wire. No. 14 or No. 16 D.C.C. wire should be employed in this instrument. The coil in the plate circuit of the radio frequency tube consists of 15 turns of No. 26 S.C.C. wire wound on a tube approximately 4 1/2 inches in diameter. This winding is in inductive relation to the stator winding of the second variometer. This variometer is wound with No. 16 D.C.C. wire employing 23 turns for each half of the stator and rotor coils, giving a total of 92 turns for the complete variometer.

QUESTIONS ON THE AERIOLA SR.

(846) Mr. M. Rodgers, Ft. Wayne, Ind., requests:

Q. 1. Please publish the wiring data, size of coils, etc., of the Aeriola Sr.

A. 1. This information will be found in answer to question 636 in the "I-Want-to-Know" column of the April, 1923, issue of RADIO NEWS.

Q. 2. How high will a receiver of this kind tune?

A. 2. This receiver will tune to a wave-length of approximately 600 meters.

ELIMINATING CAPACITY EFFECTS

(847) Mr. C. A. Steiner, New York, N. Y., writes:

Q. 1. I have a circuit consisting of a variocoupler, using a variable condenser to tune the secondary and a variometer in the plate circuit for regeneration. How can I eliminate the body capacity effects which are very pronounced in this receiver?

A. 1. The regular method of eliminating body capacity effects is to shield the back of the panel with tinfoil or copper and connect this shield to the ground. We believe, however, that if your secondary variable condenser is connected in the circuit with the movable plates connected to the filament, you will not be troubled by capacity effects.

(Continued on page 1096)

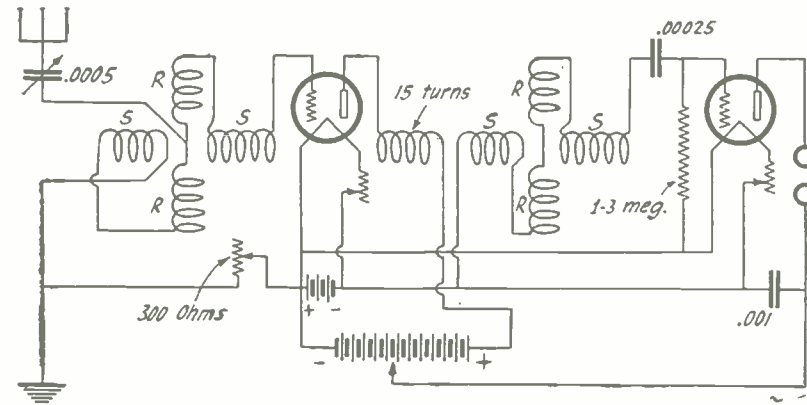

Q. 845. The Circuit Above is That Used in the Grebe CR-13 Amateur Short Wave Receiver. This Arrangement Employs Two Split Variometers.

Protection for Radio and Home



Safety Demands the BRACH VACUUM RADIO ARRESTER

The Biggest Little Thing in Radio is Insurance.

Every set should have it.

The National Board of Fire Underwriters insists upon it.

Insurance policies may be void without it.

Your choice of an arrester should be guided by the 17 years' experience of leading engineers who have installed over 3,000,000 Brach Vacuum Lightning Arresters on railroad signal, police and fire alarm circuits and over 750,000 Brach Vacuum Arresters on Radio since 1913.

Made to protect—not to Meet a Price.

Approved Indoor Type \$2 and \$2.50

Approved Outdoor Type as illustrated \$3

Sold by
Leading Radio Dealers
All Over the World

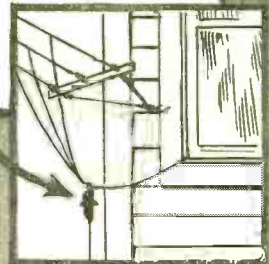

SOLDERALL

a remarkable metal in paste form—so easily applied a match will melt it—no clumsy soldering iron necessary. Results are guaranteed to equal wire or bar soldering.

SOLDERALL SELF-ACTING TORCH

greatly improved—facilitates the application of Solderall.

25c a tube

Insure Perfect Reception by Soldering All Radio Joints and Connections with Solderall.

Solderall has become almost indispensable to the radio fans and is now employed by them to make perfect their connections. Solderall's value, its easy application, its convenient form, its great economy appeals to everyone.

Sold by Radio Dealers All Over the World

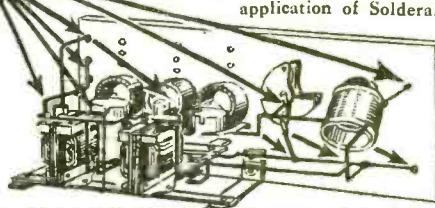

Brass Torch \$1.75

Illustration about Half Size

L.S. BRACH M'F'G. CO.

NEWARK, NEW JERSEY

YOU CAN LEARN NEWSPAPER WORK

**Experienced Editor Will Teach You
How to Become a
Reporter**

FASCINATING WORK--GOOD PAY

**Only a Few Months' Work Required
To Qualify You for a
Better Position**

Regular reporters earn from \$40 to \$125 a week. Good deskmen on a daily paper are paid from \$60 to \$100 a week. A "Star" Reporter can command his own salary. Hundreds of ambitious men and women enhance their income materially by corresponding for newspapers or writing for magazines in their spare time.

We Will Teach You at Home

We can develop your talent for writing and lead you into this well paying profession. Our Practical Course in Journalism was personally prepared by Henry J. Brockmeyer, Assistant City Editor of the New York Evening Post. Mr. Brockmeyer has trained hundreds of men and women, many of whom have, under his guidance, developed into front rank reporters or feature writers.

Mr. Brockmeyer's course will teach you what it would take years of actual newspaper work to learn. It consists of six comprehensive lessons just brimful of everything a reporter must learn. The following are only a few of the subjects covered.

Starting in Journalism. What is a Newspaper? What is News? Start and Finish of a News Story. Technical Terms. The Type Point System. Styles of Type. Proof Reading. Capitalization and Punctuation. A Late Fire Bulletin. Court Stories. Libel Laws. Copyright. Hints to Reporters. Personal Conduct. Re-Writing and Condensing Stories. Paragraphs and Short Items. Good and Bad Styles. Broadening the Vocabulary. Aids to Good Style. Special Stories. Suggestions for Stories. Rhetoric. Preparing Your Story. Don'ts for Writers. Office Organization. Syndicated Matter. Business Office. Mechanical Department. Hints for Headline Writers. The Make-Up. The Country Correspondent, etc., etc.

This Complete Course For \$10

The price for the entire course is only \$10, and entitles the student to full consulting services which are directed by Mr. Brockmeyer personally, including any questions in connection with journalistic work.

Five Days' Trial

Just pin a check, money order or ten dollar bill to the coupon below and mail. Then take five days after the course arrives to decide whether you want to keep it. If not, return it at our expense and your money will be immediately refunded.

Or Write For Free Circular "R"

THE PRESS GUILD, Inc., 66-R West Broadway N. Y.

THE PRESS GUILD, Inc.,

66-R—West Broadway, New York City

Enclosed find \$10 for which you are to ship me at once, prepaid, Henry J. Brockmeyer's complete course in Practical Journalism with the distinct understanding that if I return the course in five days my full \$10 will be refunded and no questions asked.

(Name)

(Address)

(City) (State)

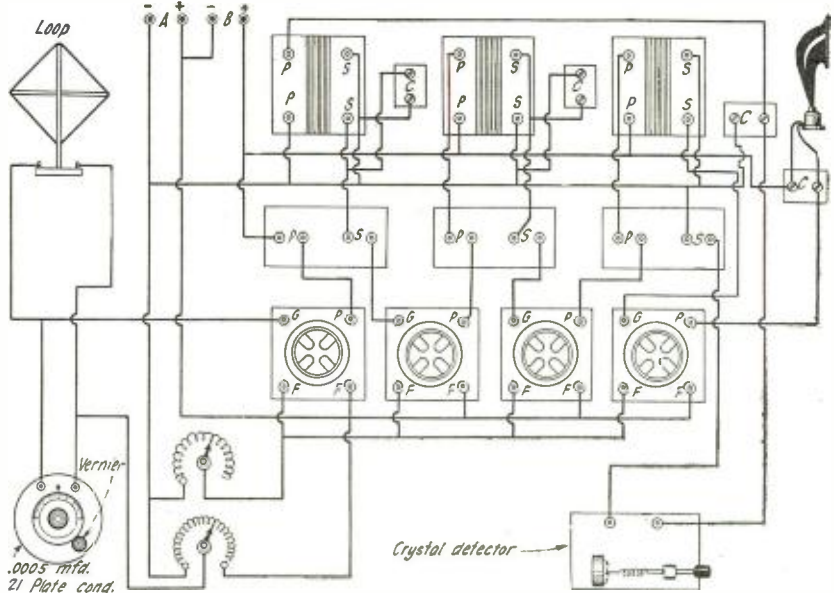

Q. 851. Circuit Diagram of the Acme Four-Tube Reflex Receiver Using Three Radio and Three Audio Frequency Transformers. Further Details Are Given in the Text.

Q. 2. What determines the number of circuits of a receiver?

A. 2. A receiver using a single coil for tuning is generally known as a single circuit set, but this may or may not have regeneration by means of the feed-back method. If a variometer is used to obtain regeneration it means that the plate circuit must be tuned, giving a two-circuit receiver. A three-circuit receiver consists of one wherein there are three circuits to tune, namely: the primary, secondary and plate circuits.

A. F. TRANSFORMER IN REFLEX

(848) Mr. H. Sheckard, Chicago, Ill., wants to know:

Q. 1. Can an audio frequency transformer with a ratio of 4 1/4 : 1 be used in place of a 6:1 ratio transformer in a three-tube reflex circuit?

A. 1. It is always advisable to use a low ratio transformer whenever possible in a reflex receiver, and for this reason better results should be obtained with the transformer of a 4 1/4 : 1 ratio.

Q. 2. What is the maximum wave-length range of the Autoplex circuit?

A. 2. If variometers of large size are used in this circuit, it should tune from 200 to about 540 meters.

PATENT ADVICE

(849) Mr. B. G. Brabec, Chicago, Ill., asks:

Q. 1. I have discovered a hook-up which seems to be better than any I have tried before, including most standard ones. Would it be worth while to obtain a patent on the hook-up?

A. 1. If your new hook-up has incorporated in it something new that has not been used before, a patent might be obtained. If, however, you are using regeneration, no patent could be had, as any circuit of this kind is already covered by the Armstrong patents. If regeneration is not used and you think the results obtained are worth

while, we would suggest that you get in touch with some reliable patent attorney.

R.F. TRANSFORMERS IN REFLEX

(850) Mr. Erwin Hollingsworth, Salina, Kansas, requests:

Q. 1. What are the ratios of the radio frequency transformers in the four-tube Reflex Receiver as described in the July issue of RADIO NEWS?

A. 1. Radio frequency transformers are designed for a particular band of wave-lengths and have no definite ratio, such as audio frequency transformers. There is now on the market a radio frequency transformer especially designed for reflex circuits which will prove very satisfactory.

Q. 2. Can a stage of radio frequency amplification with a transformer be added to a single circuit regenerative receiver?

A. 2. Radio frequency can be added to practically any standard circuit, but it would be of no advantage to use one stage with a single circuit receiver, as in this case regeneration will be sacrificed and the tuning would be very much broader.

ACME REFLEX CIRCUIT

(851) Mr. John Beresford, of Mount Vernon, N. Y. writes:

Q. 1. Kindly publish the Acme four-tube reflex circuit in connection with a loop aerial.

A. 1. The circuit you ask for will be found on this page.

Q. 2. What are the capacities of the fixed condensers connected across the audio frequency transformer secondaries and also the one across the loud speaker?

A. 2. The capacities of the fixed condensers from left to right are: .00025 mfd.; .00025 mfd.; .002 mfd. and the one across the loud speaker, .005 mfd. Use fixed condensers having mica insulation.

SEVEN STANDARD STATIONS

Seven radio stations have been named by the Bureau of Standards as maintaining sufficiently constant transmission frequencies to serve as standards for calibrating wave meters and radio receiving apparatus. Two, KDKA and WGY, are broadcasters.

The stations, located in Massachusetts, New York, New Jersey, Pennsylvania and Maryland, include one Naval station, four Radio Corporations, One General Electric

and one Westinghouse station. The Tucker station of the R. C. A. leads the seven in accuracy, deviating only 0.1 per cent in 36 tests of its assigned frequency; all the other stations are, however, not deviating on an average of over 3%, and should serve as fairly accurate measures of frequencies.

The seven stations follow with their frequencies and other data:

(Continued on page 1098)

Station	Owner	Location	Assigned frequency, kcs.	Period covered by measurements	No. of times measured	Greatest deviation	Average deviation
WQL	R.C.A.	Coram Hill, L. I., N. Y.	17.13	Aug. 24-Oct. 12	16	1.2 per cent	0.3 per cent
NSS	U.S.N.	Annapolis, Md.	17.48	Aug. 24-Oct. 12	30	0.5 per cent	0.2 per cent
WQK	R.C.A.	Rocky Point, L. I., N. Y.	18.21	Aug. 24-Oct. 12	22	0.4 per cent	0.2 per cent
WGG	R.C.A.	Tuckerton, No. 1, N. J.	18.85	Aug. 24-Oct. 12	36	0.4 per cent	0.1 per cent
WSO	R.C.A.	Marion, Mass.	25.80	Aug. 27-Oct. 12	36	0.6 per cent	0.2 per cent
WGY	G.E.	Schenectady, N. Y.	790	June to Oct. (326 meters)	34	0.5 per cent	0.2 per cent
KDKA	W.E.M.	E. Pittsburgh, Pa.	920	June to Oct.	30	0.6 per cent	0.3 per cent

NOTE: R.C.A.—Radio Corporation of America. U.S.N.—U. S. Navy. G.E.—General Electric Co. W.E.M.—Westinghouse Electric & Mfg. Co.

Make it "REFLEX" with ACME

How to get distant stations loud and clear

What "REFLEX" is

THE Reflex circuit is one which uses both vacuum tubes. It is the circuit which will give the best consistent results for the least expenditure, the least construction and tuning effort, and the least trouble. It is a circuit which will allow all the year round radio on a loop and loud speaker. When using an antenna, the only limit of reception is interference of all kinds.

What "REFLEX" will do

NO CIRCUIT or set can be stamped with a distance guarantee, but the Acme Apparatus Company has found after two years of trial and experiment that the Reflex circuit will do more than any other employing the same number of vacuum tubes. It will bring in the distant stations loud and clear, and it won't annoy your neighbor.

Covers the wave length band

THE three and four tube Reflex receivers cover the whole new wave length band with equal amplification, which allow the listener to choose most of the broadcasting stations at will.

To build a "REFLEX" set

GET the Acme Diagram and follow it closely. It took the Acme Apparatus Company two years to get it worked out properly. This diagram is being published by Radio News. It is of a four tube set, three radio and three audio frequency amplification (equivalent to six tubes).

Precautions to observe

THE APPARATUS. Use only the best apparatus for best results. Lay out the apparatus on a board first, wire it up, and try it out. When you want to put it in a cabinet, you will then know how.

The Tuning Circuit. There are two tuning circuits which may be used, one for antenna, and one for loop operation. In either case, use a low loss Acme condenser. The antenna or loop receives only a little energy from the distant station, don't waste it. For a coupler in the antenna circuit, use a well made one, and for sharper tuning, use only a few turns on the rotor in series with a loud coil.

The Amplifier. Use Acme transformers, they are the product of pioneer transformer and radio engineers and manufacturers. The amplifying transformer is the heart of the circuit, and the "Reflex" has been worked out especially for Acme transformers.

The Detector. Use a crystal detector (preferably Brownlee Galena) to prevent distortion and howls. The crystal with three stages of radio frequency amplification will stay in adjustment for days, and you are sure that all the va-



ACME A-2 Audio Frequency Transformer

cuum tubes are increasing the strength of broadcasting.

The Wiring. Keep all wires as short as possible. Use No. 14 bare wire if possible, and keep the general layout shown in diagram. If you solder, use RESIN for flux.

The Tubes. All types of vacuum tubes are suitable for this circuit, but the 201A tubes are especially recommended.

The Loud Speaker. If the circuit is followed closely, a source of undistorted power will be available for any loud speaker. For reproduction of the broadcasting use an Acme Kleerspeaker.

The Acme Engineering Service. The Acme Apparatus Company is interested in anyone using its products, and wants you to get results. If you have any difficulties, write to our Engineering Department who are at your service gladly and freely.

For more information use coupon

IF YOU want more information on Reflex and Amplification, send 10 cents for the booklet "Amplification without Distortion" containing many wiring diagrams and helpful hints on construction and operation. Use the coupon. The book will be sent at once postpaid.

THE ACME APPARATUS COMPANY
Dept 24, Cambridge, Mass.

ACME

for amplification

Acme Apparatus Company,
Dept. 24,
Cambridge, Mass., U. S. A.
Gentlemen: I enclose 10 cents (U. S. Stamps or U. S. Coin) for "Amplification without Distortion."

Name

Address

City State

*A Variable Condenser,
the plates of which
actually vary in area—
an engineering feat
never accomplished
before—giving especially
fine adjustment for
selective tuning.*

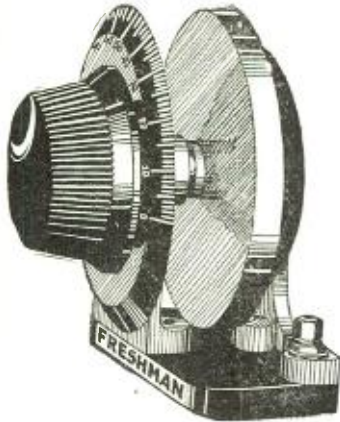

For
Transmission or Reception

The highest class Variable Condenser,

**"FRESHMAN SELECTIVE"
Mercury Variable Condenser**

Will stand more than 5,000 volts.

Plates are dust and dirt proof, thereby eliminating leakage which creates noises.

No plate vibrations—absolutely quiet. Compact and attractive in appearance.

Mercury plates give intimate contact with Mica Dielectric.

*As Near 100% Efficient
as a Variable Condenser,
Can be Made*

Do not confuse the 'Freshman Selective' Mercury Variable Condenser with any other heretofore on the market.

.0003 m. f. (equivalent to 17 plate) \$5
.0005 m. f. (equivalent to 23 plate) ALL
.001 m. f. (equivalent to 43 plate) TYPES

All Molded Parts and Dial of the Finest Bakelite

At your dealer, otherwise send purchase price and you will be supplied postpaid

Chas. Freshman Co. Inc.
Radio Condenser Products

106 Seventh Avenue New York

**Never Before Such Radio Opportunities!
Positions Assured**

Radio Companies frequently find it necessary to scour the country for licensed operators. In a number of cases ships have been held up and in a few instances vessels have had to clear port without operators. Study Radio in a recognized school. Write to-day for illustrated booklet.

Y. M. C. A. RADIO SCHOOL
158 East 86th, St., New York
"Best Radio School In The East"

Commenting on the standard frequency situation, the Bureau of Standards says: "If every radio transmitting station maintained exactly the wave frequency assigned to it, there would be available a standard frequency wave every time any station was in operation. However, at present this is the case only with certain stations, and because it is a matter of difficulty to maintain exactly the assigned frequency, and also because this is of great importance, the Bureau has been collecting some interesting data on the subject. As a result of these measurements, it is possible to give out information from time to time on stations which maintain a sufficient accuracy to be useful as frequency standards. Several stations, which use special means for maintaining constant frequency, have very nearly attained the goal of remaining within 2 kilocycles of the assigned frequency, as recommended by the Second National Radio Conference.

Transmissions from seven stations may be used in standardizing apparatus, by the methods given in Bureau of Standards Letter Circular 92, "Radio Signals of Standard Frequency, and Their Utilization."

AMATEUR ABBREVIATIONS

Radio amateurs and fans have originated and are at the present time developing a universal language of their own. It has even been intimated that some day this or a similar elaborated language may become useful to the peoples of the whole world as an abbreviated language for the written word.

Hundreds of radio fans and amateurs are now using many of the standard radio code terms and phrases in their writings, and several are successfully using the code for making notes in their daily business.

There is nothing mysterious or remarkable in the code. It is very simple and not unlike the Phillips code, which is generally used by wire telegraphers in sending press despatches. This radio code is based upon phonetic spelling, and in a long word many of the letters are deleted. For example, the word radiation in radio code is cut down to but three letters—rdn.

Following is a list of the most prominent, used by every dyed-in-the-wool radio amateur:

Code	Phrase	Code	Phrase
F.B.—	fine business	hl—	radio laugh
O.M.—	old man	ml—	my
O.W.—	old woman	onli—	only
hr—	hear or here	gv—	give
hrd—	heard	sum—	some
u—	you	dlf—	difference
wen—	when	enuf—	enough
ur—	your	culd—	could
spk—	speak	wkg—	working
gud—	good	inpt—	input
hv—	have	impt—	important
ruf—	rough	prf—	primary
pt—	point	sec—	secondary
tubd—	too bad	wy—	wave
ges—	guess	wl—	will
no—	know or no	wy—	way
vy—	very	betr—	better
cond—	condenser	gvg—	giving
freq—	frequency	TCA—	Thermo coupled
thot—	thought	amps.	
wrk—	work	CRA—	Commonwealth Radio
wrkd—	worked	Ass'n	
hwat—	how's that	cum—	come
hw—	how	thr—	there
cu—	see you	r—	re
cuagn—	see you again	ru—	are you
cul—	see you later	cld—	called
73—	best regards	cl—	call
B4—	before	clg—	calling
2nite—	tonight	rite—	write
ltr—	letter	DX—	long distance
sori—	sorry	tmrw—	tomorrow
tt—	that	fr—	for
gg—	going	crd—	card
shud—	should	rw—	now
abt—	about	pse—	please
trub—	trouble	sed—	said
wid—	with	aud—	audibility
gnd—	ground	cr—	chemical rectifier
rdn—	radiation	ant—	antenna
cntpse—	counterpose	dlvr—	deliver
bt—	by	dlvrd—	delivered



**Protect Your Tubes
GUARANTEED
Progressive Safety "B" Battery**

Guaranteed not to burn out your radio tube through crossed wires or wrong connections. The Progressive Radio Safety "B" Battery easily leads the battery field in long life and perfect action. It saves its users trouble and expense by its special protection of tube filaments against accidental crossing of wires or improper inserting of tubes.

22½ Volt-Standard Size\$3.50
45 Volt-Standard Size..... 6.00

If your dealer cannot supply you the battery will be shipped direct, C. O. D. or upon receipt of remittance.

Dealers—Write for our proposition.

Progressive Specialty Company
314 Sycamore St., Cincinnati, Ohio

**You Don't Need to
Be an Expert**



RADIODYNE

"The Voice of a Nation"

The RADIODYNE is operated by simply grounding to a water pipe or radiator and throw a few feet of wire on the floor. No outside antenna or leads necessary. You don't have to be an expert to install and operate it effectively.

For use in apartments, boats, automobiles, railroad trains, etc., the RADIODYNE is enjoyable where other types of receiving sets would not be practical.

Stations within a radius of 2000 miles can be picked up on the loud speaker; any wavelength from 200 to 700 meters. The RADIODYNE is so sensitive that it picks up Radio telephone speech and music when other types of equipment fail.

Write for illustrated folder which describes the RADIODYNE in detail. Every radio fan will be interested in this new type (antennalss) receiving set.

Western Coil & Electrical Co.
314 5th St. Racine, Wisconsin

TUNED RADIO FREQUENCY AMPLIFIER

AN ADDITION FOR YOUR PRESENT SET

TWICE THE DISTANCE TWICE THE VOLUME

USE
RADIOTRONS
UV201A
or
UV199

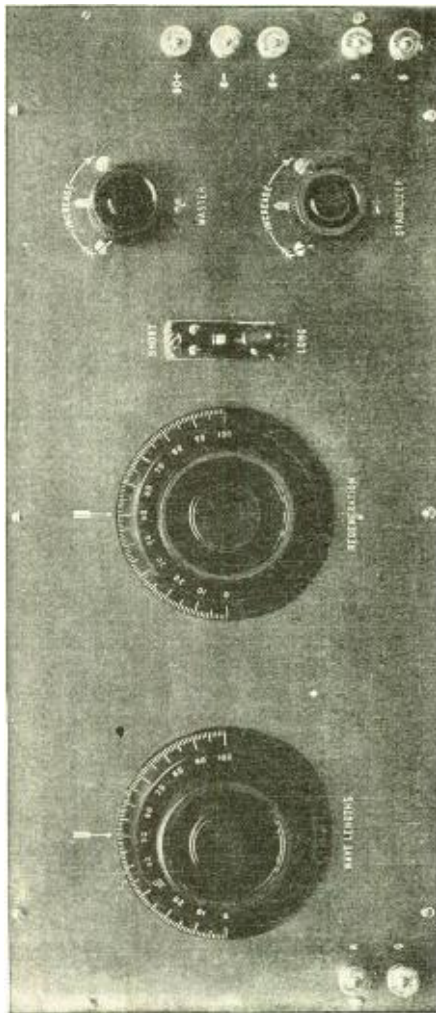

MODEL "J" TUNED RADIO FREQUENCY AMPLIFIER

Use with following
Receivers
SINGLE CIRCUIT
TWO CIRCUIT
THREE CIRCUIT
or with
MODEL "C"
SUPER-HETERODYNE

This new unit consists of two stages of tuned radio frequency amplification, and can be attached to any standard receiver, allowing at least twice the receiving range and double the volume from stations now within range. Practically uniform efficiency is obtained on all wave lengths from 160 to 625 meters. Amplification factor 14 per stage

Complete Constructional Blue Prints 3 Sheets 52"x26" \$2.00 Postpaid.

EXPERIMENTERS INFORMATION SERVICE

Designers of the Highest Class Radio Apparatus in the World

531 West 46th Street

New York City



Guglielmo Marconi, as he appears today. Signor Marconi is Honorary Chairman of the Radio Institute of America

Success for You —in RADIO

The big men in radio today started—almost all of them—as radio operators. Very many of them are graduates of the Radio Institute (or Marconi Institute, as it was formerly called).

The demand for trained radio men today is too great to fill. Beginners are needed—and positions are open all the way up the ladder to the top. Train now. Radio is swiftly growing. And the opportunities grow with it.

Study at home

You can start now—at home—from the very beginnings of electricity—with the same guidance and instruction that has built the reputation of the Radio Institute. In a few months you can be fitted for your Government operator's license—and your first job.

The Radio Institute is under the auspices of the Radio Corporation of America, which places more men in radio than any other organization in the world—and gives preference to our graduates. Your opportunity is limited only by your ability.

Advanced Radio Course

Great popular demand by the advanced student and experienced amateur has led to the opening of an **ADVANCED HOME STUDY RADIO COURSE**, specializing in C. W., I. C. W., telephone and radio measurements. Investigate!

Radio Institute of America
(Formerly Marconi Institute)
Established 1909
324 Broadway, New York City

Indicate by a cross X the course you are interested in:

Radio Institute of America,
324 Broadway, New York
Please send me full information about radio opportunities today, and your
 COMPLETE RADIO COURSE
 ADVANCED RADIO COURSE
Name.....
Address.....

Correspondence from Readers

(Continued from page 1087)

Why, oh why, is there anything in the world other than a C.W. brass pounder! The writer is one of the great army of simple ordinary garden variety of BCLs, and as such, other noises of the ether interest him not at all. Night after night, he has hunted through the directory to locate a distant station, to get its time on the air, its wavelength and power, and then after much tuning and straining of ears, finally gets a faint whisper which he hopes is the desired goal; but just about the time the call is in order, a dot and dash sound owning station 6NIX starts in to tell 4MORE that he once knew a fellow who knew of another fellow who had almost worked 3BUGS using a flea powder can for an antenna. The result can easily be imagined. The patiently sought for announcement goes a-glimmering, another long wait is quite the proper thing, and there are excellent chances of the same disastrous results. And all because two individuals would have speech with one another while the station they are murdering is entertaining thousands.

The writer experienced this trouble very early in the game, and on the advice of experts discarded his four-tube single-circuit set and invested in a three-tube Reflex outfit to be used with loop. But not being able to raise any DX stuff, and having the mistaken idea that he had as much right to use the atmosphere as anyone else, finally purchased a five-tube Neutrodyne go-getter. Being able to reach out further only-made matters worse for now there is a whole flock of "splatter-buzz" to dodge.

This bunch of grief is directed principally at the owners of spark, unfiltered C.W. and I.C.W. stations though those operating pure C.W. outfits using solid ivory condenser plates in their wavemeter instead of a good piece of hard rolled aluminum are also helping to make the air dirty. It is surprising how high some 200-meter C.W. stations can get and still imagine they are only pushing out 200 bumps at a time. But be that as it may the spark boys are the ones who win the rubber pointed ice pick. They seem to have the impression that Darwin evolved air for their special and sole benefit. The broadcast stations have millions invested for the simple purpose of giving free entertainment, knowledge and pleasure to millions, and against this deluge of progress and enlightenment, a few short-sighted ether disrupters would pit their puny strength, for, according to latest returns, there are 2,790,045 receiving sets in commission, with an estimated listening in audience of 11,160,180.

Look through any of our excellent radio magazines and 95 per cent of the reading matter and advertisements carried are made up to register on the despised and never-to-be-considered BCL. But the worm is turning; in fact, one has already turned, and the rest of his life will be spent in the occupation of trying to get some clean air . . . laboring under the policy of common sense, and the most good to the greatest number.

W. ED. EDWARDS,
285 W. Washington St.,
Pasadena, Calif.

THAT'S THE SPIRIT

Editor, RADIO NEWS:

This is my first "pop off," but not my last as long as I read RADIO NEWS. Having just got my November copy, I looked it over and noticed Mr. Kamp's letter. I think his idea of amateurs teaching code is a great one.

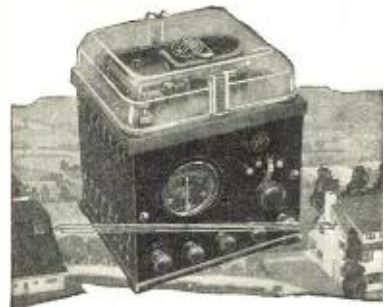

ONE CHARGER for Every Radio Battery

Longer distance and clear signals are the pleasing results which you can be sure of when both the A & B batteries of your radio set are storage batteries. No other source of power for radio equals the storage battery.

The Valley ABC Battery Charger is so simple and so easily operated that it makes storage batteries the most convenient and inexpensive source of power for radio. Enjoy radio at its best. Use storage batteries and charge them with the Valley ABC Battery Charger.

Charges 2-volt peanut tube batteries, 6-volt A Batteries, 6 and 12-volt automobile batteries, and 1 to 4 B Batteries. Bakelite panel, glass top. Harmonizes with any receiving set. At good radio shops.

VALLEY ELECTRIC CO.
3157 S. Kingshighway St. Louis, Mo.

Valley Battery Charger

**IF YOU CAN'T BUY THEM
AT YOUR DEALER'S
SEND DIRECT TO US**

"Red-Heads" are guaranteed radio phones. You run no risk when you buy them. Money back if, after 7 days' trial, you're not satisfied that they're the best receivers on the market at the price. Why not act right now and get a pair? It'll mean getting the maximum from broadcasting from the day you put them into use.

RED-HEAD RADIO RECEIVERS

These remarkable head-sets are made by The Newman-Stern Co., one of the pioneer radio manufacturing houses in America.

JUST OUT

The new 1924
Model F

\$6.50
PER PAIR
Complete

This is the standard 3,000 ohm "Red-Head." The 1924 Model F has eleven improved features. Sensitive and fine-toned; aluminum case; famous brown-red ear caps; military headband; high-grade cord.

"Red-Heads" sent prepaid on receipt of price if you are unable to get them at your dealer's.

The new 1924
"Red-Head" Jr.

\$5.00
PER PAIR
Complete

The Junior Model has most of the quality features of the standard Model F here described. The resistance is 2,000 ohms per set instead of 3,000 ohms. A remarkable value.

THE NEWMAN-STERN COMPANY
Dept. RN Newman-Stern Bldg. Cleveland

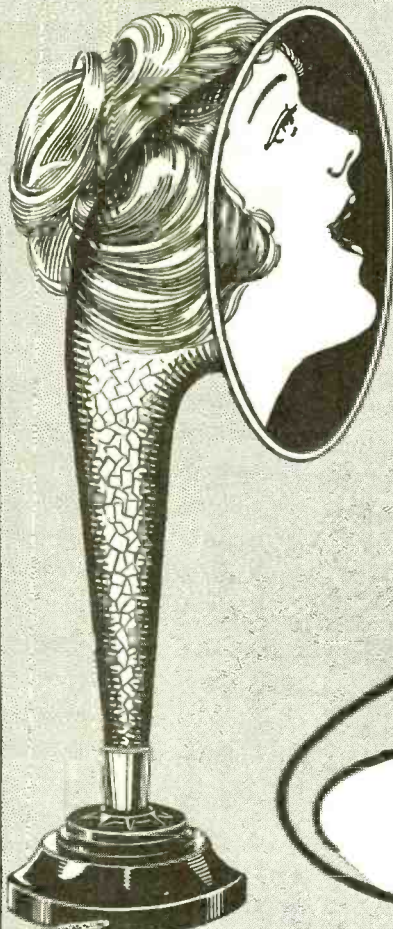

TRADE MARK

Atlas LOUD SPEAKER Natural Re-Production

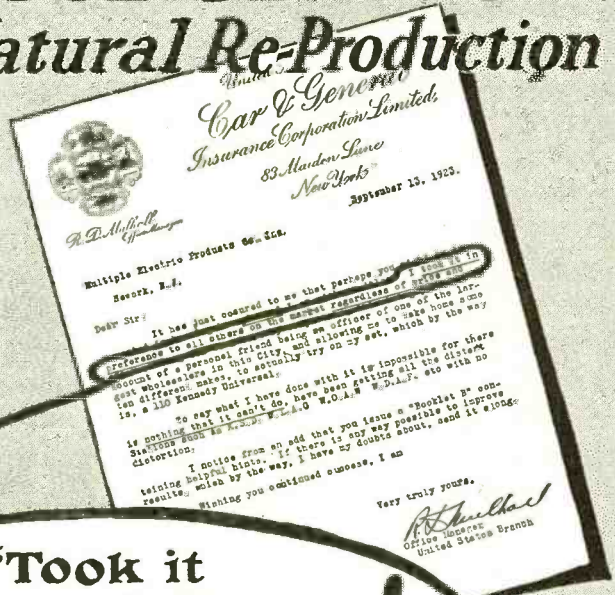

**"Took it
in preference
to all others"**

THIS letter, like scores of others sent us by enthusiastic owners of *Atlas Loud Speakers*, reveals how great is the difference between ordinary loud speakers and this *real* radio reproducer. It is the difference between *real* and artificial revival of the music broadcasted. The exclusive "double diaphragm" responds equally true over the entire range of musical cycles. There are no distortion points. This device is adjustable to your set and particular receiving conditions.



Write for Illustrated Booklet "F."
Letters from Users Requested

Make Your Own Loud Speaker with THE
ATLAS UNIT, with phonograph attachment \$13.50
(Unit without attachment \$12.50)

Sole Canadian Distributors:
The Marconi Wireless Telegraph Company of Canada, Limited, Montreal, Canada.

Hear the Atlas Loud Speaker
Ask your dealer for a demonstration. Submit it to any reasonable test. Get the proof NOW.
LIST PRICE COMPLETE \$

\$25

Multiple Electric Products Co. Inc.
ORANGE ST., RADIO DIVISION NEWARK, N. J.

ELECTRAD PRODUCTS



The NEW DIODE

Discard crystals! Use the Electrad Diode in all circuits. Overcomes former difficulties with reflex work. Gives greater volume, greater selectivity and steadies the circuit. Eliminates tedious adjustments for change of wave lengths. A perfect detector tube. Real results. Absolutely guaranteed.

\$2
Socket 50c

RADIO'S GREATEST INVENTION



Electrad Variohm

Doubles your receiving distance. Give the precision value of grid leak resistance your detector tube requires. Variohm does the work of a thousand ordinary grid leaks. Resistance variations secured are infinitely close and gradual, not by steps and jumps. Range $\frac{1}{4}$ to 10 megohms. Increases volume. Eliminates circuit noises. Enables you to get distant stations clear and distinct. Absolutely guaranteed.

75c

The LEAD-IN

Fits right under closed window. Can be bent into any shape to fit ledges. Covered with fire-proof insulating material which prevents grounding of circuits on wet window sills. Takes the place of ungainly porcelain tubes and holes in the window sash. Fitted with Fahnestock Clips. Always presents a neat appearance.



40c

All products at your dealers, otherwise send purchase price and you will be supplied postpaid.

Write for FREE Cockaday-Diode Reflex Circuit.

ELECTRAD, Inc.
428-H Broadway
New York

This will bring the amateurs and BCLs close together.

I am like Mr. Kamp, I am getting tired of so much broadcast reception; I like to listen to the amateurs. It gives me a thrill to hear an amateur sending code slowly enough for me to read it.

Another thing I would like to say is that I have yet to meet an amateur who would not help me with any radio problem. It was an amateur, back in 1913, who got me interested in wireless, and an amateur is helping me erect a transmitter now. He has given me hook-ups of his own that have helped me very much. I believe the amateur and BCL will have to co-operate before radio will be a very great success.

I hope to be in the amateur ranks very soon and will help all I can.

ROBERT B. HECKERT,
R. F. D. 7, Box 30, Independence, Kan.

WANTS TO LEARN CODE

Editor, RADIO NEWS:

After reading the "Correspondence From Readers" column, I cannot refrain from making some comment on the subject discussed.

First, I am a BCL and I want to say that if the "hams" in my town were willing to give me some "dope" on the code and special slang used, the rest of the BCLs and myself would have less to say about the interference caused by "hams," for the dit-dot would be just as fascinating as the squeal from Cuba. However, I haven't run across a "ham" as yet. As an attempt at getting together, nothing has been done on either side. I am in favor of a "get-together" to stop hard feeling.

I am using a honeycomb set and yet on 500 meters I can hear the rock crusher on the same block going full blast. I am employed now as a builder of radio sets and have had experience with all sorts of circuits. I still have to see a set that will tune sharply enough to eliminate the old fashioned rock crusher, for that is what it sounds like in the phones. I am in favor of abolishing the single circuit receiver as well as the spark transmitter. Above all, let's be fair. We all have equal rights on the air. Just because a fellow knows a bit more about the science does not mean that he should have more rights on the air.

B. LUNIN, BCL.
128 Court St., Newark, N. J.

FLORIDA'S RADIO

Editor, RADIO NEWS:

Both you and Mr. Perry probably realize by now that anyone who writes of Florida invariably starts something. May I add my little bit?

We went north for a vacation trip and found radio everywhere. In fact, we found so much of it that we decided we wanted a set ourselves. To the radio dealers we put the question "What kind of a set should we have to get WDAL, our nearest station, which is 113 miles north of us?" The dealers held up their hands in horror. "Radio in Florida!!! It cannot be done." So we tried to play golf. Some of the country clubs would let us play if we bought the course, and, having no dynamite, we couldn't get into the others at all. So we took our golf money and bought a radio set to find out for ourselves. We have "shot the whole works." A five-tube set, two stages of radio, detector, and two stages of audio frequency, loud speaker and storage "A" and "B" batteries. What could be sweeter for a dealer? We bought the parts, put them together, and they worked.

Now for the joker. No one in Daytona, Fla., can get Jacksonville. I will not enclose my correspondence with WDAL, as I don't want this wheeled to your desk on a truck. We would like a little jazz with Mah Jong



AT YOUR DEALER'S COUNTER

Buy a good Head Set.

Good Head Sets must have Powerful Magnets. Powerful magnets ensure sensitivity, great volume of sound and true tonal quality.

The power of Head Set magnets is easily tested at your dealer's counter.

Unscrew the cap on the ear piece. Place the thin circular diaphragm on the counter. Hold the ear piece above it and see how far the magnet will pick up the diaphragm.

The farther the pick up, the more powerful the magnet, and the better the Head Set.

A Stromberg-Carlson Head Set will pick up its diaphragm at least one-fourth of an inch. Will yours?

Stromberg-Carlson



Have You Found a Really Good

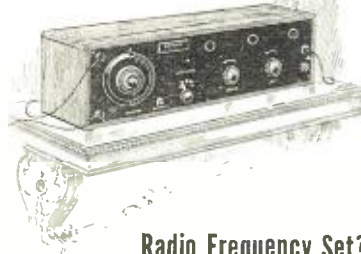

Radio Frequency Set?

—a long range set that is easy to tune—only two controls—that brings in big volume yet can be sold at a popular price of \$70.00 for a four tube set in a mahogany cabinet.

To keep posted on what's new you owe it to yourself to write for descriptive literature on the Globe No. 820.

Manufactured by

GLOBE ELECTRIC CO.
MILWAUKEE

GLOBE

RADIO



Feature Formica Panels

MU-RAD is another high quality, nationally advertised radio line, which uses Formica Insulation for Panels.

Acceptance, by the great majority of leaders in radio, is Formica's certificate of character. This acceptance is so general that Formica's position is one of real dominance in radio insulation.

Naturally amateurs, who build their own sets, and dealers, who wish to supply their customers with the best material, prefer to handle a material that is so widely preferred in the best informed circles.

Dealers: Formica's great national and trade advertising campaign this year is again the most powerful support behind the radio dealer. Quick service on sheets or panels in individual envelopes.



THE FORMICA INSULATION COMPANY

4618 Spring Grove Avenue, Cincinnati, Ohio

Sales Offices

50 Church St., New York, N. Y.
422 First Ave., Pittsburgh, Pa.
1042 Granite Bldg., Rochester, N. Y.
415 Ohio Bldg., Toledo, Ohio

1210 Arch St., Philadelphia, Pa.
1819 Lyndale Ave., S. Minneapolis, Minn.
Sheldon Bldg., San Francisco, California
Whitney Central Bldg., New Orleans

516 Caxton Bldg., Cleveland, Ohio
9 S. Clinton St., Chicago, Ill.
313 Title Bldg., Baltimore, Md.
47 King St., Toronto, Ontario

FORMICA

Made from Anhydrous Redmanol Resins
SHEETS TUBES RODS



Fits Anywhere—Smaller than a Magazine—All Enclosed

THE same range of reception for which you now require a 100 foot or longer aerial, an indoor strung aerial, or an awkward loop aerial no better than the first one invented—infinity improved upon by the *Warren Radio Loop* that fits into a coat pocket. Interference eliminated. This wonder aerial selects and tunes with remarkable ease and accuracy. All enclosed by Bakelite shields. Four compact sizes for every purpose. The best known—the best liked. Satisfaction unrestrictedly guaranteed.

Write for the name of the nearest Warren dealer and Bulletin T102.

A Type For Every Set

- Type A-737 (300-700 meters) 6 inches square—non-directional\$10.00
- Type A-7236 (175-1000 meters) 6 inches square—non-directional 12.00
- Type B-2537 (300-700 meters) 18 inches square—directional 20.00
- Type BL-2520 (200-18,000 meters) with honeycomb coil mounting, 18 inches square—directional 25.00

V-DE-CO RADIO MFG. CO.
Dept. N ASBURY PARK, N. J.

B. T. Bremer-Tully Vernier Tuner

These three instruments, The Bremer-Tully Tuner and the two Bremer-Tully twenty-three plate Vernier Condensers, hooked up in Bremer-Tully Circuit No. 2 will give a receiving set that can't be beat—for distance—selectivity—and volume. Our book on Better Tuning tells you why and shows you how. Sent on receipt of 10c or free with each tuner.

Ask your dealer—if he can't supply you write us.

BREMER-TULLY MFG. CO.
Canal and Harrison Sts.
CHICAGO

Vernier Condenser



Universal Tuner



Vernier Condenser



in the afternoon, but we cannot get it. We have to wait for dark and then we catch it. We are not DX hounds, but we thankfully take anything that comes. I get all of our stuff between 6:30 and 10:30 p. m. Contrary to the general opinion, a hotel man does get tired, even though he apparently does nothing. The following is my station list: KDKA, KYW, PWX, WBAP, WBAV, WBZ, WCAP, WCX, WDAR, WFAF, WFAA, WFI, WGM, WGR, WGY, WHAS, WHAZ, WHB, WIP, WJAR, WJAX, WJAZ, WKAG, WMAK, WMC, WOAI, WOC, WOO, WOR, WOS, WRC, WSAI, WSB, WSY, WTAM and 6KW.

So, if you will ask your friends to quit telling people, "There is no radio in Florida," we will not have to tear our set apart to show that there is no phonograph concealed. That "I know you are lying" look that you get when you tell a man he has just heard Pittsburgh on the loud speaker certainly is annoying. They drive our dealers crazy. Yes, dealers. We have three in a town of 6,000. I don't know how many sets there are in town, but I have nine friends who are hunting for the guy who lets his set oscillate all evening.

So I rise to say, "We have radio in this part of Florida."

G. P. ALLEN,
Austin Hotel, Daytona, Fla.

APPLAUSE

Editor, RADIO NEWS:

Speaking of applause cards sent to the entertainers at the various stations in appreciation of their efforts, here's mine showing

B C L Station

of
Le Roy Howard



Massachusetts

our Old Lady of the Broom enjoying a concert through my flivver set. She's still up to date after 300 years or so, too.

L. R. HOWARD,

CRYSTAL RECEPTION

Editor, RADIO NEWS:

After hearing so much about crystal sets being only for short distance, I am sending you my record. Using a galena crystal and no amplification, I've heard 29 stations, 21 over 500 miles and four over 1,000 miles. I use no special circuit only a tuning coil and an 11-plate condenser. The phones are 3,000 ohms. There is no tube set in the immediate vicinity. The nearest are three, six, seven and eight miles, respectively. The farthest station is KHJ, which is 1,200 miles. I got KHJ, WJAZ and PWX twice this season (since October 1st). I have received the following stations: WOC, Davenport, 934 miles; WBAP, Fort Worth, 240 miles; WDAF, Kansas City, 694 miles; WFAA, Dallas, 250 miles; WHB, Kansas City, 694 miles; WJAD, Waco, 172 miles; WOS, Jefferson City, 720 miles; WMC, Memphis, 624 miles; WKY, Oklahoma City, 428 miles; WOAW, Omaha, 840 miles; PWX, Ha-



Layer Wound and Layer Insulated

Stromberg-Carlson Head Set Coils are wound a layer at a time with a wrapping of tough insulating material between layers.

This high grade construction is revealed by sawing through a section of a coil taken from the

Stromberg-Carlson

HEAD SET

It's the only head set construction which will stand up under the high plate voltages now prevalent for loud speaker hook-ups.

Therefore, it's the only head set construction which ensures permanent sensitivity.

It's a construction which is an exclusive feature of Stromberg-Carlson Head Sets.

Ask Your Dealer

Stromberg-Carlson Telephone Mfg. Co.
ROCHESTER, N. Y.



THE FRANSDEN TUNER AND VARIOCOUPLER

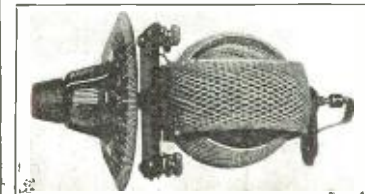

AT LAST THE PERFECT TUNER for Broadcast Reception.

The most efficient and selective tuner made. For single circuit with tickler or variocoupler with loose coupled primary and secondary circuits.

Perfect and continuous variation of the inductance of the antenna circuit without SWITCHTAPS and without a VARIABLE CONDENSER in the antenna circuit.

Complete for panel mounting, postpaid, \$7.50.
RADIO RESEARCH LABORATORIES
ATASCADERO, CALIFORNIA

SALESMEN

Largest radio publishing organization in the world, wants salesmen, either whole or side line, to sell an assortment of 20 books to the trade.

Liberal commission to hustlers.

Box 233, RADIO NEWS
New York City.

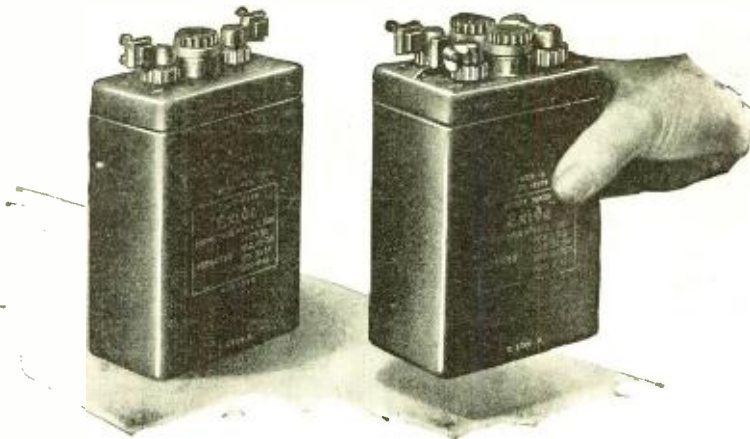

What you have been waiting for

HERE are two rugged little storage batteries designed particularly for low-voltage tubes.

Although they weigh only 5 and 6 pounds, they are of true Exide quality. Highly efficient and with ample power for long-distance receiving, these batteries will give you a type of service that you would find it hard to duplicate.

These sturdy little batteries are neat and compact. They were specially designed for WD-11 and UV-199 vacuum tubes, but can be used with any low-voltage tube. The two-volt Exide A Battery consists of a single cell. It will heat the filament of a WD-11 or other quarter-ampere tube for approximately 96 hours. The four-volt A battery, having two cells, will light the filament of a UV-199 tube for 200 hours.

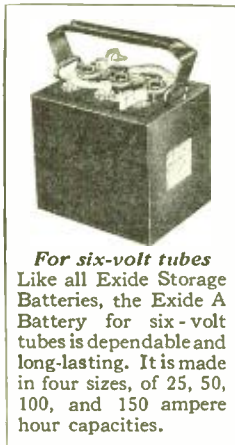

For six-volt tubes

Like all Exide Storage Batteries, the Exide A Battery for six-volt tubes is dependable and long-lasting. It is made in four sizes, of 25, 50, 100, and 150 ampere hour capacities.

With an Exide B Battery hooked up to your set, static is the only undesirable sound you will have to contend with. The Exide B Battery supplies steady, noiseless current. It permits the

Service you will appreciate

Exide Radio Batteries are carefully constructed on sound engineering principles. They give the kind of service every radio fan would like to get from his storage battery.

As you know, any variation of current in the plate circuit produces weird sounds in your phones.

niceties of adjustment that make radio receiving an unalloyed pleasure.

The Exide A Battery for six-volt tubes has extra-heavy plates, assuring constant potential and uniform current over a long period of discharge. Like all Exide Batteries, it embodies the finest materials available.

In marine and commercial wireless

On sea and on land the Exide plays an important role in the industrial life of the nation. In marine wireless, Exide Batteries provide an indispensable store of emergency current. A majority of all government and commercial wireless plants are equipped with Exides.

Exide Radio Batteries are sold by radio dealers and Exide Service Stations everywhere. Ask your dealer for booklets describing in detail the complete line of Exide Radio Batteries. Or write direct to us.



Exide B Batteries

give noiseless, full-powered service over a long period of discharge. Designed throughout to prevent electrical leakage. Capacity, 3 ampere hours.

Exide

RADIO BATTERIES

THE ELECTRIC STORAGE BATTERY COMPANY, PHILADELPHIA

Oldest and largest manufacturers in the world of storage batteries for every purpose

Service Stations Everywhere

Branches in Seventeen Cities

New 1924 Model



LOUD SPEAKER

See It Today

STEP into your dealer's store—he will gladly give you a demonstration without obligation. See this wonderful new value, placed on the market now for the first time. You will realize the outstanding superiority of the new Pathé Loud Speaker. Notice its beautiful Mahogany finish and its ability to reproduce long distance signals clearly. With the new low price it is the best buy on the market.

Mahogany Finish

Price Now

\$17⁵⁰

(West of Mississippi \$19.00)

FREE PAMPHLETS

Write now for free pamphlets on the Pathé Loud Speaker, Pathé Variometer, Pathé Variocoupler, Pathé Dials and the new Curtantenna.

Jobbers and dealers write for new special proposition

PATHÉ PHONOGRAPH & RADIO CORPORATION

20 GRAND AVE., BROOKLYN, N. Y.

Western Sales Office, 533 Wabash Ave., Chicago, Ill.

SUPER VALUES

OUR POLICY **20% OFF LIST PRICES** ON ALL STANDARD RADIO APPARATUS
SPECIAL NEW N. & K. MODEL D 4000 OHMS **\$6.50**
 Manufactured by Neufeldt & Kuhnke, Kiel, Germany

Reinartz Circuit Complete

	List Price	OUR Price
Genuine Reinartz Coil endorsed by John L. Reinartz and bearing his signature. The only genuine coil for this circuit on the market. All others are imitations	\$ 2.50	\$ 2.00
One 7x10x3-16 Radlen Panel	1.25	1.00
National Bakelite Socket	1.00	.40
Vernier Rheostat	1.50	1.00
Two 23 Plate Variable Condensers at \$5.00 each	8.00	3.00
Switch Points and Nuts	.80	.40
Six Switch Stop Points and Nuts	.40	.20
Freshman Grid Leak and Condenser	1.00	.65

Seven Binding Posts	.70	.35
25 Ft. Tinned Bus Bar	.50	.30
3 Switch Levers with Knobs	.75	.35
One Baseboard for mounting	.75	.40
One Fixed Phone Condenser	.40	.25
One Single Jack	1.00	.25
Blue Prints with complete instructions for assembly and mounting	.50	.50

Regular Price \$19.05

OUR PRICE \$11.05

All the necessary screws, nuts and miscellaneous small parts which are necessary to complete the set are included in the above prices. Any part in either of these circuits may be purchased independently at the advertised cut prices. SEND MONEY ORDER, INCLUDING POSTAGE. WRITE FOR OUR CATALOGUE D.

The Radio Mail Order House Known for Our Low Prices



3 West 29th St. New York City

Insure your copy reaching you each month. Subscribe to Radio News—\$2.50 a year. Experimenter Publishing Co., 53 Park Place, N. Y. C.

vana, Cuba, 1,080 miles; KSD, St. Louis, 790 miles; WOA, Kansas City, 694 miles; WSB, Atlanta, 792 miles; KHJ, Los Angeles, 1,200 miles; WJAZ Chicago, 1,030 miles; KYW Chicago, 1,030 miles; WSY, Birmingham, 730 miles; PYZ, Mexico City, 700 miles; WAAW, Omaha, 840 miles; WEAY, Houston, 192 miles; WNAD, Norman, Okla., 470 miles; WAAP, Wichita, 576 miles; WPA, Fort Worth, 240 miles; WGM, Atlanta, 792 miles; WOAA, Ardmore, Okla., 392 miles; KLZ, Denver, 792 miles; and WMAB, Oklahoma City, 428 miles.

Most of the stations at about 500 miles are received regularly.

GILBERT BECK,
Route 3, Box 56,
San Antonio, Texas.

THE OTHER SIDE

Editor, RADIO NEWS:

With further reference to the bootleg tube situation: In the December issue, Mr. J. W. Jackson of Brooklyn, N. Y., states that the manufacturers of legitimate tubes are encouraging bootleggers to manufacture tubes by not offering legitimate tubes to the public at \$1.50 or \$2.50.

Those people who are inclined to make use of bootleg tubes are merely encouraging the bootleggers and causing legitimate manufacturers much unnecessary trouble and expense—the cost of which will naturally be wiped off—in the sale of tubes.

By supporting bootleggers in buying their filthy wares you, and everyone else buying them, are responsible for the high price of legitimate tubes.

I believe in fair play, I also believe that the best tubes can only come from the great laboratories which have the facilities to manufacture them. Their research engineers are YEARS AND YEARS ahead of any of these fly-by-night concerns which are turning out fairly good Mazda lamps for vacuum tubes. We cannot, on the outside, realize how far ahead these great companies are, until we attempt to file a patent and have an investigation made of the files to ascertain whether our patent is worth while or not—then the truth dawns upon us.

Numerous foolish devices have been brought out by concerns that ought to know better—and tried to get by the patents of the vacuum tube. Don't fool yourself into believing that any outsider can make vacuum tubes AS GOOD, not to say BETTER, than the legitimate makers, because, while this country is fairly large, there are no other concerns as large as that one—no concerns which have the brains at work in their research laboratories—no concerns in this country which can legitimately manufacture a three-element vacuum tube.

There is no argument at all—the proof is so convincing that one must call hlack white in order to mis-state the facts.

E. T. JONES,
864 Roosevelt Place,
New Orleans, La.

CONDITIONS IN SOUTH AMERICA

Editor, RADIO NEWS:

This has been my first visit to South America in four years. In that four years commercial, naval and amateur radio has gone forward in whirlwind fashion. The pace has not been so rapid in Brazil for the unfortunate amateur. In scouting the city for a few parts required for the ship's set. I was amazed to see but one or two antennae that would have been a great credit to a twelve-year-old "radio plebe."

The tube transmitters are fast taking the place of spark in this section of the world, as well as in North America and Europe. In my line of duties with the stations equipped for continuous waves, it appeared that

AMPLION

The World's Standard Loud Speaker

A Few Practical Points About Amplion Supremacy

The Amplion requires no power amplifier — no battery. You simply attach it to regular head phone connections.

The diaphragm is made of a special alloy, found to have no equal after years of experiment with all other materials.

The electro-acoustical device is insulated entirely from the horn to eliminate distortion, ring or resonance.

Its Non-vibrating wood horn surpasses all other materials for true tone and clearness.

An Adjustable feature makes the Amplion sound true with any make of receiving set, and ensures faithful reproduction.

The Amplion mechanism is not new — it has not been hurriedly devised to meet the radio boom. Rather, it is a development, for radio purposes, of a loud speaking device used for years by leading Navies of the world.

The Amplion is manufactured by the oldest manufacturer of loud speakers in the world.

The Mahogany horn — the enameled sound conduit — the highly polished nickeled base — the reproducing mechanism — all are of the highest quality.

Ask your dealer for a demonstration.

Patentees: ALFRED GRAHAM & CO.

SIGNAL ELECTRIC MFG. COMPANY

Sole United States Distributors

Menominee, Michigan

BURND EPT OF CANADA, LTD. — Canadian Distributors — 172 King St. W., Toronto

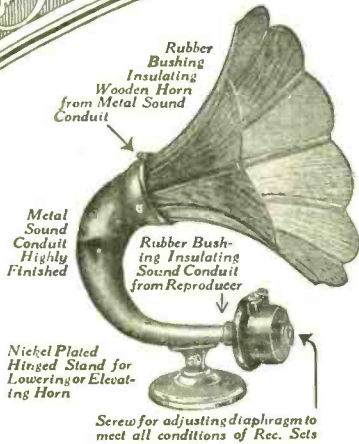

Amplion Deagon AR-19
\$40.00



Phonograph Unit AR-35
\$24.00

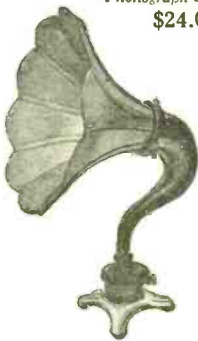

Amplion Beauty AR-13
\$46.00



Amplion Junior DeLuxe AR-45
\$26.00

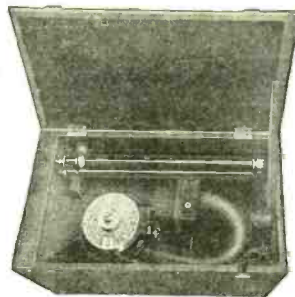

Amplion Portable AR-61
\$50.00



Amplion Junior AR-39
\$18.00

The Supremacy of The Amplion is The Supremacy of Actual Performance

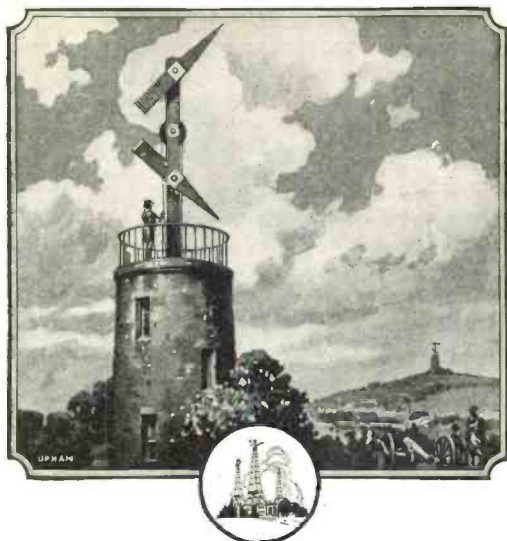

IN NAPOLEON'S DAY

IN the early part of the nineteenth century the semaphore was the quickest means of transmitting information. Great battles often hinged on the information received or sent by this method.

Today, due to sensitive instruments and electricity, messages are conveyed over vast distances with the speed of light.

Your radio set receives the faint electric waves sent through space and builds them up into relatively strong currents, but it is your head phones that transform this current into the music or spoken words that you hear.

Your set can be no better than your head phones and, as the enjoyment of broadcasting depends upon the quality of sound, you cannot be satisfied with inferior phones.

Holtzer-Cabot Phones are the perfected results of over twenty-five years' specialization in sensitive electrical instruments. With Holtzer-Cabot Head Sets you may be sure that you are getting all the enjoyment that your radio set can give.

Holtzer-Cabot Loud Speaker,	\$25.00
Holtzer-Cabot Phonograph	
Attachment,	10.00
No. 2 Universal Head Phones,	9.50
No. 4 National Head Phones,	6.00

Write for booklets "What you should know about Radio Reception" and "A better Loud Speaker."

THE HOLTZER-CABOT ELECTRIC CO.
125 Amory Street, Boston, Mass.
6161-65 South State Street, Chicago, Ill.
Department D

Holtzer-Cabot
BUSINESS ESTABLISHED 1875
HEAD-SETS

ONE THOUSAND AGENTS WANTED

WE want one thousand agents to sell subscriptions to **RADIO NEWS, SCIENCE AND INVENTION** and **PRACTICAL ELECTRICS**. We will pay a generous commission for this work and help you in every way. Our three publications are leaders in their fields, ready sellers and this is an offer well worth your while. A few spare hours a day will bring you a handsome return. Write regarding our proposition at once and be the first one to get started in your vicinity.

Experimenter Publishing Co.

HERBERT H. FOSTER, Sales Manager

53 Park Place

New York

they are not yet fully acquainted with its proper method of operation. They change from one wave to another very rapidly without the proper "QSY" and the plate supply is poor and unsteady. It is, indeed, a very hard task to master a radiogram transmitted from one of these naval or commercial stations.

The amateur, I am informed by a reliable source, is nil. For one to transmit on any wave in Brazil places himself in a wobbly chair with a serious charge hanging over him. To receive broadcast music, one must pay a rather high tax in addition to an outrageous price for the receiver. Two of the largest and well known radio and electrical manufacturers have branches here. Neither of them carry radio apparatus.

Argentina is a bird of another color. The story is directly the opposite. Amateurs are in abundance, as are broadcasting stations, but their waves! Good heavens! It is possible to tune them in from 200 to 2,000 meters! I am referring to only a few, the majority of them being on a good sharp wave between 200 and 600 meters!

It is indeed a simple task to listen, on perhaps a wave of 590 meters and enjoy several concerts at the same time! If our broadcasting regulations were in existence here, the "please repeat" would not be the familiar saying of several ships and stations within a few hundred miles of Buenos Aires. Modulation in practically every studio is perfect. It should be. They arise at 7 A. M., start a series of tests in broadcasting and continue until well after midnight.

Buenos Aires itself is a beautiful city. The amateur and broadcasting aeriels, to the American eye, corrupt the beauty. One aerial in particular, I noted. When I saw it about a mile from its location, I was amazed because it was a beauty for an amateur to own or build. We (my friends and co-operators) hurried to the spot to see more clearly. Here is how it was built. The masts were constructed of 3/8-in. angle iron, about 8 ft. at the base and extending into the air for 150 ft. Each was separated a distance of 100 ft., having a double cage with a cage lead-in to the shack between the masts. But wait! There were eight guy wires from each mast, from the top, and a little over the middle. Not one of them was less than 100 ft. in length and there was not an insulator from top to bottom! The guy wires were brought down to a steel fence that enclosed the building. A counterpoise of eight wires on steel spreaders with a few porcelain insulators, ran from mast to mast about 12 ft. above the ground. The cage lead-in entered the shack between the fourth and fifth wires of the counterpoise a few feet above the top of the small building.

In order to purchase apparatus here, one must have a very good income. The prices are approximately 200 to 250 per cent higher than in the United States. Of course, one must realize that everything is imported. I purchased two .006 and one .0002 paper condensers, a U.V.-712 transformer, 30 feet of No. 16 wire (R.C.) and two jacks. The bill was \$13 in American money. How many hams would there be in the States if prices like that prevailed?

The static is detrimental to DX reception, although a few boys from the States roll in; 5MS is the most persistent that I can recall. The list I compiled has been introduced to the "W.B." It cannot be found and I am sorry that I am unable to tell who they were. For commercial DX records and using a tube transmitter, it is "WIM." We copy him at this port, a distance of 5,375 miles. WSA is next, then WCY. The last two use spark not exceeding nine and five kilowatts respectively.

JR., KDYI (WD),
Buenos Aires, Argentina,
S. S. Western World.

(Continued on page 1140)

INSIST ON FADA NEUTRODYNE PARTS

To successfully construct Neutrodyne circuit radio receivers requires special parts called "Neutrodons" and "Neutroformers."

These two FADA parts and especially the "Neutroformer" must have very critical electrical constants. Values of inductance, high frequency resistance, coupling co-efficient, and mutual inductance are of extreme importance.

FADA engineers working for the past year in close cooperation with Professor Hazeltine have designed FADA Neutrodyne receivers and special Neutrodyne parts that function efficiently. The radio experimenter using such FADA parts and the FADA "How to Build It" book can build satisfactory home-made receivers using the Hazeltine Neutrodyne Circuit.



The FADA set of Neutrodyne parts pictured above consists of three "Neutroformers", two "Neutrodons" and a thirty-two page book—the most comprehensive information on Neutrodyne receiver construction published. The total cost only \$25.00.

The five tube Neutrodyne receiver pictured below was built using FADA parts and instruction book. Such a receiver, having two stages of tuned radio frequency amplification, vacuum tube detector, and two stages of audio frequency amplification will bring in both local and long distance broadcasting stations (from 1000 miles and over) with extremely good loud speaker volume and with a pleasing purity and clarity of reproduction.

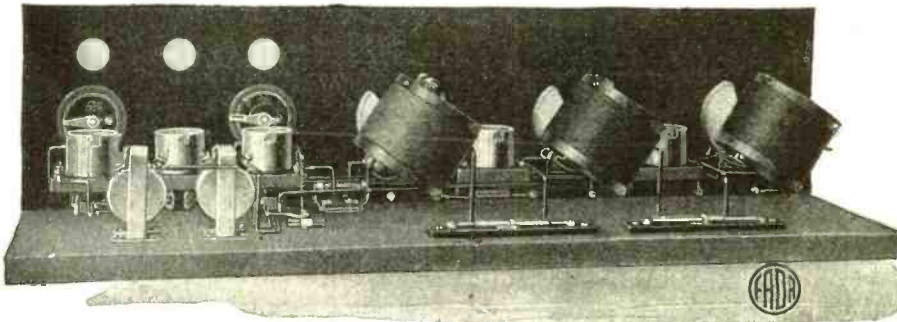

For the first time, knock-down sets of radio receiver parts have been successfully marketed. Parts for both four and five tube Neutrodyne sets are supplied complete to the last screw and including drilled and engraved panel and wooden base-board. Everything except the cabinet is supplied. This four tube set of parts (including the Neutrodyne parts) costs \$64.00 and the five tube set \$65.60.

F.A.D. ANDREA, INC.
MANUFACTURERS OF RADIO EQUIPMENT
1581-A Jerome Ave.,  NEW YORK CITY



FADA "Neutroformers" consist of a variable air condenser and a very specially designed radio frequency transformer. Calibrating the "Neutroformers" in each set of parts insures practically identical dial settings of the completed Neutrodyne receiver.



FADA "Neutrodons" are very special variable condensers having a capacity of approximately 1 to 10 micro micro farads. All high frequency losses are reduced to a low minimum in these FADA neutralizing capacitors or "Neutrodons."

Send
right
now!



for the
"How to Build it" Book

F. A. Andrea, Inc.,
1581-A, Jerome Ave.,
New York, New York.
Enclosed is 50c for a copy of "How to Build Hazeltine's Neutrodyne Receiving Set." If this book is not exactly as represented money will be refunded.

Name.....

Address.....

City..... State.....



Performance!—Read this Letter:



RECEIVER NO 102. PRICE, \$95.00
(Licensed Under Armstrong Patent 1,113,119)



Audio Frequency Transformer, No. 50

Gives maximum amplification without distortion
Ratio 3 1/2 to 1. Moisture proof.

PRICE, \$4.50



Vernier Variable Condenser, No. 10

Twenty-three plates, capacity .0005 M.F.
Built-in vernier—low resistance and losses.

PRICE, \$4.50

Write for our large Catalog No. 7 illustrating a complete line of sets and parts



Melrose, Mass., November 10, 1923.
National Chelsea Radio Corp., Boston, Mass.
Gentlemen: I know that you will be interested in the remarkable reception which I obtained with one of your Type No. 102 Regenerative Receivers.
I received the instrument Friday, November 2, and connected it in the presence of two of the Boston Edison Company's engineers. On this evening without any previous experience, I heard practically every station throughout the Middle West on a loud speaker. I am very much delighted with the performance of this receiver.
I am attaching below a list of stations which I have heard during the past six days. All of these stations were received on the loud speaker with sufficient volume to be heard all over my home with the exception of Denver. Nearly all of these were received prior to 10 p.m.
WQC Davenport, WDAI San Antonio, KLG Denver, WEN New York City, KHJ Los Angeles, WFAA Dallas, WDAK Phila., Pa., KDKA Pittsburgh, Pa., WRC Washington, D. C., WFAF New York City, WOR Newark, C'F'F Montreal, WGT Schenectady, WBZ Springfield WHAZ Troy, N. Y., WCHD Zion, Ill., WAAM Newark, N. J., WGR Buffalo, WJZ New York City, WOS Jefferson, Mo., WCAU Phila., Pa., WFI Phila., Pa., WNAC Boston, WGI Medford, WDAF Chicago, Ill., WTAM Cleveland, Ohio, WLAG Minneapolis, Minn., WFW Cincinnati, KQW Pittsburgh, WIP Phila., Pa., WCAE Pittsburgh, WWJ Detroit, KYW Chicago, WDAF Chicago, WSB Atlanta, KSD Kansas City, WHAS Louisville.
Assuring you that I am an enthusiastic booster of Chelsea Receivers I remain
Yours very truly,
A'BREY R. GOODWIN.

You can secure the same results with this wonderful Chelsea Receiver

CHELSEA PARTS

The marvelous results obtained by CHELSEA RECEIVERS are largely due to the Chelsea Parts. If you are building your own set you may be certain that the use of Chelsea Parts will give you the maximum results.

The Use of Headphones and Loud Speakers

(Continued from page 1085)

the permanent magnets. Good reliable phones are marked so that connections are properly made. Thus some phones are marked by means of coded wire, that is, the two terminals of the phones are connected to wires having different coverings. Thus one wire has a red stripe running through its cotton insulation, the other wire may have a pure black insulating covering with no stripe. In such cases the manufacturers specify that the red stripe terminal is to be connected to the positive side of the circuit.

Where no instructions at all are given, the following method should be followed to determine which wire is positive. Connect the phones in circuit and listen to signals and judge the intensity of the signals. Now connect the phones in the opposite way and again listen to signals and judge the intensity. The connection which gives loudest signals is the correct connection, for then the direct current flows through the winding in such a manner as to assist the permanent magnetism. If the above care is taken in the use of headsets, the user should have no trouble on account of reduced sensitivity of headsets.

Another precaution to observe in the use of headsets is that poor results will be obtained if headsets are used on two or more stages of amplification. Ordinarily head telephones are designed to handle a very limited amount of energy. In fact, this is the great virtue of the headset, that it will respond to absurdly small amounts of energy. When the energy put into a headset is increased to very large amounts, distortion of the signal is produced. A peculiar rattling of the diaphragm is observed and the natural period of the telephone diaphragm becomes very annoying. Every telephone diaphragm has a certain natural period which is generally in the neighborhood of about 900 or 1,000 cycles per second. The telephones, therefore, respond best to frequencies of this pitch, which accounts always for the prominence of a certain note in telephone reception. When the input into the telephones becomes very great, this resonance becomes more marked than ever, is very disagreeable and spoils reception. Also just as it is possible to overload any piece of machinery or equipment, that is, give it more to do than it is capable of doing properly, so it is also possible to overload a pair of telephones.

By applying too much energy to the headset and giving it more than it can stand, distortion becomes more marked. This almost invariably happens when listening to two or more stages of audio frequency amplification, and explains why listeners do not enjoy broadcasting when listening to the output of the second stage as much as they do when listening right after the detector or first stage. The telephones can handle the energy delivered to them by the detector or first stage without producing distortion, while they cannot do this in the second or third stage. Besides there is really no reason why anybody should listen to the output of the second stage of an audio amplifier with a headset. This signal is loud enough for phone reception in the detector and first stage, and the second stage simply produces a volume of sound which is very uncomfortable. For phone re-

The Newest Thing in Radio—The Cico Bakelite Jack

Moulded completely from bakelite—no metal in frame construction. Wires connected to Nickel Plated Brass Binding Posts —no soldering necessary. Special whitened phosphor Bronze Springs used throughout. Contact points of Sterling Silver.



- No. 30—Single circuit open \$.86
- No. 31—Single circuit closed .85
- No. 32—Double Circuit90
- No. 33—"A" Battery Switch .90

The Best Plug on the Market—The Cico 2-Way Plug

A recognized leader in its field for two years. Takes either one or two sets of headphones simultaneously. Just insert two cord tips in each slot instead of one. In the same manner, loud speaker and phones can be connected to the same plug. Fits all standard jacks. Takes all types of tips.



Price 60c



Every CICO PRODUCT is packed in a distinctive GREEN BOX and unqualifiedly guaranteed against all defects.

Consolidated Instrument Company of America, Inc.
41 East 42nd Street, New York City



This Little Box Brings Maximum Efficiency to Your Receiving Set

Since the Cutler-Hammer Engineers announced the C-H Variable Grid Leak, thousands have learned the secret of grid control. This little instrument makes it possible for the grid condenser to discharge at just the proper rate for maximum reception, and is built with watch-like precision to give perfect results. It is quickly installed in any set without additional wiring—the short link to the grid post (adjustable to any position) assures maximum efficiency and the long insulated shaft makes adjustment from the front of the panel easy and accurate.

Put one in your set today! But insist on the C-H trademark and the orange and blue carton, for the grid circuit is the most delicate in your set and only the most precise instruments can be used with safety. Here the faint electrical pulsations are brought direct from the aerial to start through the process of amplification that finally makes them powerful enough to violently vibrate a "loud speaker" diaphragm. False fluctuations induced by poorly constructed or improperly designed apparatus are magnified thousands of times. Insist on the grid leak by the "Master Builder" and be certain of success. Sold by dealers everywhere.

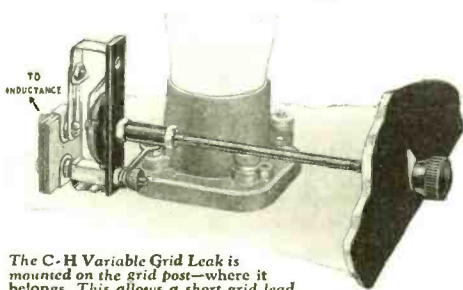

The C-H Variable Grid Leak is mounted on the grid post—where it belongs. This allows a short grid lead for maximum efficiency and the long insulated shaft to the panel prevents "body" noises.

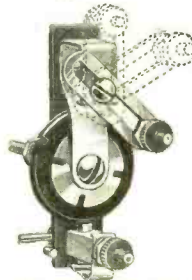

The C-H Variable Grid Leak is fully adjustable to care for any grid condenser.

THE CUTLER-HAMMER MFG. CO.

Member Radio Section
Associated Manufacturers of Electrical Supplies

MILWAUKEE, WISCONSIN

"BUILT BY THE MASTER BUILDER"



Instruments of Guaranteed Quality Assure Success in Radio



The C-H 4 Ohm Vernier Rheostat Perfect detector tube control. Also furnished without vernier for amplifier tube control.



The C-H 30 Ohm Radio Rheostat For control of the $\frac{1}{2}$ ampere, "UV201A-C301A" type receiving tubes and the "UV199-C299" type.



The C-H 125 Ohm Radio Rheostat The rheostat that makes it possible to use a 6V storage cell with the UV199 or C299 tubes.

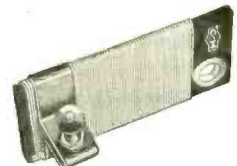

The C-H Variable Resistance Unit Attach it to your present 4 ohm rheostats to obtain the required 30 ohms for the new tubes.



The C-H Radio Potentiometer The potentiometer with the resistance unit that does not wear and cannot be displaced under constant usage.



Variable

GRID LEAK

Just plug it in— no extra resistance coil required



A combination adapter and resistance coil for UV-199 and C-299 Radiotrons. It fits any standard base socket.

A coil having 18 ohms resistance is embodied in the base.



In changing to UV-199 or C-299 tubes, it is only necessary to connect to a filament battery of proper voltage and insert this combination Resistance-Adapter.

It is unnecessary to substitute a high resistance rheostat or use an extra coil. The required resistance is obtained by using this combination Resistance-Adapter in series with a low resistance rheostat (4 to 10 ohms).



Construction Details

- (1) Contact at tube terminals is positive. Steel spring supplements tension of phosphor bronze contacts.
- (2) Design of spring and method of mounting contacts gives low distributed capacity.
- (3) First quality insulation, moulded in one piece, reduces leakage to a minimum.
- (4) Resistance element (18 ohms) is counter-sunk in a deep groove, assuring thorough protection from mechanical injury.
- (5) Projecting knurled edge simplifies insertion and removal of Adapter.
- (6) Like all other Eise-mann Products, this unit will be found to be thoroughly efficient and high grade.

Ask Your Dealer For It
Price \$1.25



EISEMANN MAGNETO CORPORATION

William N. Shaw, President

50-33RD STREET, BROOKLYN, N. Y.

A Store Covering a Thousand Acres

would probably be required to carry in stock a supply of everything made. The progressive merchant is anxious to give the best of service. While there are many articles he cannot carry in stock, he is willing to order merchandise you want—standard, frequently used products or something unique and unusual for the home, factory or office—articles for daily use or for any special occasion.

We believe he can best serve you through our organization.

AMSTERDAM SERVICE EXCHANGE
Amsterdam Ohio

"World's Purchasing Agent"

Note to dealers in radio and all other lines: You may include in your local advertising until further advised by us and providing you mail us clipping of each advertisement, the following: "We (1) will be glad to order for you through Amsterdam Service Exchange, Amsterdam, Ohio, articles not carried in stock by us (me)."

HYGRADE SPECIALS

V.T. Sockets—Federal 85c—Paragon	\$.85
Fada 85c—Signal 75c—Na-aid	.85
Phone Plugs—Federal 69c—Fibro	.85
Patent 45c—Weston 89c—Cico	.45
2 in 1 Variable Grid Control	1.75
Bradleystat (new type)	1.59
Filkostats (new type)	1.75
Ambassador 3000 Ohm Head Set	3.25
Brandes Matched Tone Head Set	4.98
Nervo 2200 Ohm Head Sets	2.49
Skindervik in Transmitter Buttons	.85
General Radio Loud Speaker Units	8.95
Merrison Loud Speaker Units	8.95
Acme R.F. Transformers Types B2, B3, B4	3.98
Audio Frequency Transformers Thordarson	3.49
Jefferson No. 41—\$3.49, Paragon	4.59
Federal No. 225W—\$4.50, Federal No. 65	5.98
No. 164A—Fada Neutrodon Condensers	1.10
No. 163A—Fada Neutroformers	6.49
No. 165A—Fada Hazeltine Parts	21.51
Marke Storage Batteries	\$8.75 up

All Orders Must Include Parcel Post Charges

Hygrade Electrical Novelty Co.,

41 WEST 125th STREET, NEW YORK, N. Y.

ception the output of the first stage of the audio frequency amplifier is sufficient.

THE LOUD SPEAKER

In fact the object of the second stage of audio frequency amplification is to enable a loud speaker to be operated so that very large volume may be secured and so that the sound may be heard throughout a room. Results obtained with loud speakers vary all over the map, of course, depending upon what type of loud speaker is used. This depends upon what kind of telephone receiver is used and what kind of horn is used. If the ordinary type of low energy telephone receiver, as for example the ordinary type of headset, the same kind of distortion and unsatisfactory results will be secured, as mentioned in the previous paragraph. The best that can happen in such a case is, that, due to the presence of the horn, the volume of sound is increased. The quality will, however, not be the best. There are now some receivers on the market which are purported to be loud speaking receivers. These are able to handle considerably more energy than the ordinary type of headset, and therefore do give fair results.

Loud speakers, like telephone receivers, have a natural period of vibration due to the diaphragm which introduces a certain amount of distortion. This particular frequency is amplified more than others with the result that the reproduced speech is somewhat unnatural. This is a defect of all instruments with diaphragms which it is very difficult to eliminate, and which constitutes one of the big problems of loud speaker design.

The horn is a very important part of the loud speaker, this part having a great influence on the quality of the reproduced speech. One of the important factors in this connection is the type of material of which the horn is made, whether metal, wood, fibre, etc. It is found that a horn also has a natural period of vibration; in fact, it may have several periods of vibration depending upon its shape. Each of these periods results in a marked resonance as a result of which certain speech or musical frequencies are emphasized more than others, and thus a distortion is produced. Thus metallic horns are frequently said to have a tinny sound, which is due to the properties of the metal horn. Wooden or fibre horns are not supposed to have this marked resonance phenomenon, and are therefore supposed to reproduce more naturally. This is probably true and accounts for the fact that the talking machines, though originally built with metal horns, are now exclusively made with wooden horns. Fibre horns are coming into use and seem to give very good results. The shape of the horn has considerable to do with the reproducing qualities of the loud speaker, but indications so far point to the ordinary bell shaped horn as the best. The subject is only in its infancy, however, and is only now being studied by those who are interested.

A number of firms market complete loud speakers including the telephone unit and the horn. In such cases it is best to buy the product of a reliable and old manufacturer who has specialized in the manufacture of telephones and loud speakers. A few such reliable concerns exist at present and the novice should have no difficulty in getting as good a product as can be turned out.

The loud speaker is generally connected directly in the output circuit of the audio frequency amplifier, exactly where the head telephones would be connected. Unless the receiving station is very close

Insure your copy reaching you each month. Subscribe to Radio News—\$2.50 a year. Experimenter Publishing Co., 53 Park Place, N. Y. C.

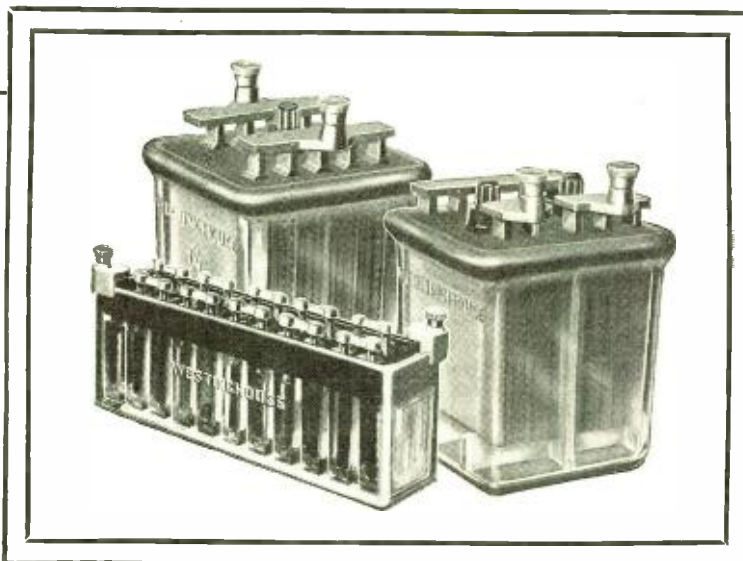

When Westinghouse places an article on the market you can depend on it for highest efficiency. Westinghouse Radio Batteries are made with the most careful consideration of every factor that enters radio broadcast transmission and reception. Built for full-powered and even-powered current delivery; for long sustained voltage; for ample capacity; for utmost quiet; for long life; for economy. Nothing but the very best is good enough in the construction or equipment of an instrument so sensitive as a radio set. Don't be satisfied with anything less than Westinghouse Radio Batteries.

Westinghouse **CRYSTAL CASE** Radio Batteries have unit-built, visible-interior glass cases. Solid glass cell partitions and plate rests. Thoroughly insulated against current leakage. They hold their charge long. Last indefinitely and can be easily recharged innumerable times. "A" Batteries in 2, 4 and 6 volt sizes. "B" Batteries in 22-volt units. Regular type 22-MG-2; quadruple capacity 22-LG-2. "C" Batteries in 6 volt units.

WESTINGHOUSE UNION BATTERY CO.

Swissvale, Pa.

WESTINGHOUSE

CRYSTAL CASE

"A" "B" and "C" BATTERIES

REMLER VARIOMETER

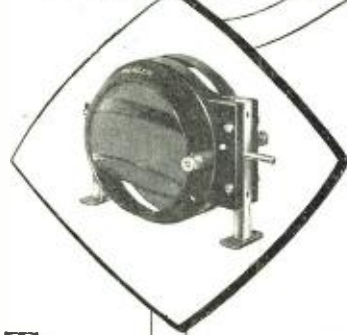

**Acknowledged
Everywhere**

**AS THE MOST EFFICIENT RADIO ITEM
ON THE MARKET.**

INTERNAL PIGTAIL CONNECTIONS
— WAVE LENGTH RANGE 180 - 570
METERS POSITIVELY GUARANTEED

**Type
500**

WITH
CLOSED
ROTOR

\$7.50

FROM the enthusiastic reports constantly received from all points of the country, this new type Remler Variometer has proved a winner in appearance and performance from the day it was placed on the market.

The perfect contact and quiet operation obtained by reason of the pigtail connection between stator and rotor is a big feature in itself, but the low minimum and high maximum wave length—the greatest ever obtained in a Variometer is a Remler accomplishment.

The wave length variation is exactly proportional to the reading of the dial scale. It will cover the entire range of amateur and broadcast wave lengths when used with any variocoupler. When used with a Remler variocoupler the wave length is guaranteed to be from 180 to at least 570 meters.

All metal parts are buffed and nicked; green silk wire is used on both stator and rotor. The general appearance and quality of the bakelite molding is the best ever built into a radio item.

If your dealer cannot supply you, send the attached coupon direct to us with certified check or Postal money order. Write for complete descriptive circular.

Remler Radio Mfg. Co.,
182 Second St.,
San Francisco

Gentlemen:—

As my dealer is unable to supply me with your new Remler Variometer I wish to place my order direct with you and am enclosing certified check or money order for \$7.50.

It is understood that if after a 10 day free trial I find that this Variometer does not conform to your statements, my money will be refunded upon return of the instrument to you in the condition it was received.

Name

Address

Remler Radio Mfg. Co.

Home Office
154 West Lake Street Chicago 182 Second Street San Francisco 30 Church Street New York City

to the transmitter it will be found necessary to employ two stages of audio frequency amplification to get good results on a loud speaker. One stage will give altogether too weak a signal to listen to comfortably. Sometimes trouble is experienced in connecting the loud speaker directly in the plate circuit of the last tube and distortion results. This is due to what is called saturation of the loud speaking telephone. When a large direct current flows through a magnet it becomes magnetized, but if the current exceeds a certain strength the magnetization of the core does not follow the current, and distortion results. The only way to overcome this is to prevent direct current from flowing through the loud speaker magnet. This may be accomplished by means of the circuit shown in Fig. 1. Here L is a large iron core choke coil having a high inductance, about 50 henries will do, and C is a 1/2 to 1 microfarad condenser. By using this connection the direct current is made to flow through the inductance L and the audio frequency voltages which are amplified are developed in this inductance. This audio frequency voltage then passes through the condenser C which has a very low reactance and through the loud speaker, which is then actuated. Thus the only current flowing through the loud speaker is the audio frequency current which is the only current which produces sound. Thus the direct current is prevented from flowing through the loud speaker, saturation of the magnetic core of the loud speaker is avoided and distortion due to this cause is eliminated.

In conclusion; if the reader will keep in mind the important points in connection with the use of headphones and loud speakers covered in this article, he will save himself considerable trouble.

Transient Phenomena in Audio Frequency Transformers

(Continued from page 1079)

But we now discover that if we increase the turn ratio we introduce distortion and one of the most commonly given reasons for this effect is that the secondary does not respond proportionately beyond certain frequencies for a given voltage variation in the primary.

One of the limiting factors in transformer amplification seems to rest in the fact that when we wind a very large number of turns of secondary upon a primary coil, the losses in the secondary become greater at higher frequencies. These losses may be represented by the swinging of a long pointer held in the hand—as the inertia or weight of the pointer will carry the end beyond the swing of the hand, or will cause vibration of the natural frequency of the pointer, or the resistance of the air will check it and various mechanical effects will react on it in such a way that the far end of the pointer does not vary exactly with the speed and direction of the hand which guides the pointer.

A beam of light reflected from a mirror held in the hand would be an example of the ideal condition which is desirable, but in the transformer the wire has resistance, and many turns wound in a small space have finite distributed capacity, and any coil will have characteristic periods due to its induction and distributed capacity, as well as other inductance and capacity in the external circuit.

Because the instantaneous voltages acting on an audio transformer do not lend them-

(Continued on page 1118)

SEND TODAY



Solid Rubber Box furnished either with strap or side handles.

6 Volts
80 Amperes

Latest, Most Effective Radio "A" Battery

SAHARA STORAGE BATTERY—IT'S DRY

Think of its advantages. There is no liquid acid to spill and ruin floors, rugs or creep up hosts and ruin clothes—ideal for portable sets. Recharges quickly—easily—and cannot be harmed either by overcharging or drawing down too far. These exclusive features are what you want. We guarantee them. It is not a gelatin battery. It's dry and "check full" of pep and life. Be the first in your town to have one of these remarkable batteries.

Order Today—Send No Money

We ship C.O.D. subject to your inspection, carrying charges to be paid by you. The price is \$25 if you order at once. Shipments made same day order is received. Remember there is no liquid—it's Dry. Orders are coming in fast. Get yours in today.

SAHARA DRY BATTERY CO.
PAWTUCKET, R. I.

Dealers: There is a big business for you if you show this battery now. Send for discounts and get exclusive right in your territory.



Music at its Best!

FULL, clear, rich, beautiful—MUSIC MASTER brings into your home the majestic tones of the pipe organ, the incomparable master instrument of the musical world.

It will enable you to hear and *feel* the majesty and grandeur of the organ as though you were in its very presence.

MUSIC MASTER gives you the *truth* of each soft strain, every arpeggio, the inspiring, kingly chords and the rich, rolling bass tones.

Why not let *everyone* hear the organ? Flood the whole room with its wonderful music—simply by connecting MUSIC MASTER to your radio set.

MUSIC MASTER is equipped with a wood amplifying bell; and wood, properly shaped as a horn,—furnished only with MUSIC MASTER,—is the one material that makes possible the perfect reproduction of the actual, living tones themselves.

Dealers Everywhere

14-inch horn (spruce or mahogany)
for the Home\$30
21-inch horn (mahogany only) for
Concerts\$35

MUSIC MASTER CORPORATION
FORMERLY GENERAL RADIO CORPORATION
Makers and Distributors of High Grade Radio Apparatus

CHICAGO

PHILADELPHIA

PITTSBURGH

S.W. Cor. 10th and Cherry Streets

Music Master

RADIO REPRODUCER

ANNOUNCING NEW

MONODYNE AMPLIFIER

\$850

Without
Tube

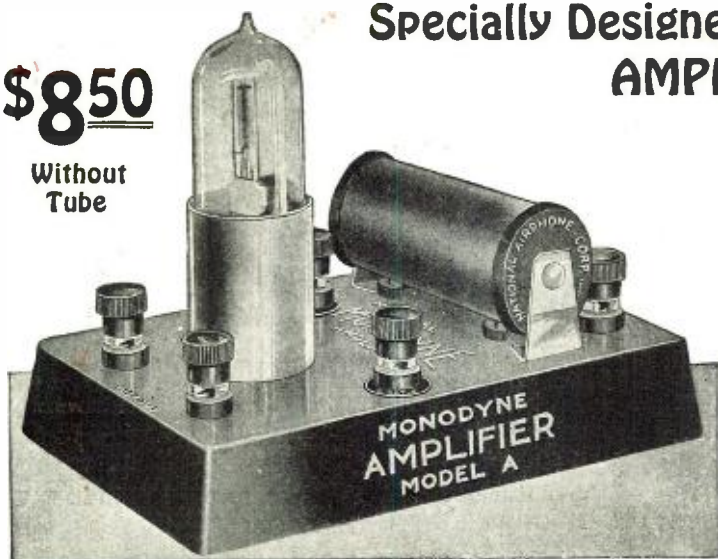

Specially Designed for
**AMPLIFICATION of
MUSIC and VOICE**

One or More Stages
Will Operate
a Loud Speaker

Worthy Companion of the
National Monodyne
"The Set that Revolutionized
Radio"

Exceptional Power. Freedom from Distortion and Howling

The NATIONAL MONODYNE AMPLIFIER is as radically different from all other Amplifiers as the Monodyne is from all other Radio Receivers. Entirely new Audio Frequency Transformer amplifies without distortion. Amplifier is compact and rugged. Construction of same size and style as the National Monodyne tube set.

The NATIONAL MONODYNE AMPLIFIER, while especially designed to match the MONODYNE receiver, can be used with any other radio outfit whose intensity it is desired to amplify. The NATIONAL MONODYNE AMPLIFIER will work with any standard tube on the market, although WD12 and UV199 Dry Battery tubes are recommended.

Dealers, Jobbers and Distributors—Send for Samples and Prices

IF YOUR DEALER CANNOT SUPPLY YOU MAIL THIS COUPON DIRECT TO US

-----SEND NO MONEY-----

NATIONAL AIRPHONE CORPORATION
18 Hudson St., New York, U. S. A.

R. N. 2

Please send me prepaid the articles crossed, for which I will pay postman upon delivery the advertised price.

- One National Monodyne
- One Audio Amplifier
- One Interference Eliminator
- One Panel Detector

NAME

STREET

CITY State.....



18 HUDSON ST.

NEW YORK

NATIONAL Apparatus of Simplicity and Perfection

The Monodyne circuit is one of the most radical advances in Radio engineering. Parts heretofore considered essential are omitted. One simple tuning control gives selectivity, equal if not superior to sets costing hundreds of dollars.

For Reflex and Crystal Sets

NATIONAL "GOLD-GRAIN" DETECTOR



\$1.00

Actual Size FOR PANEL MOUNTING

Only One Tuning Control

All Wave Lengths

NATIONAL MONODYNE TUBE SET MODEL GT-1

No Storage Batteries

\$10.00

Including Two Inductance Coils Without Tube



Uses but one dry cell tube, preferably WD-12, or any other standard dry cell tube. Local and distant broadcasting comes in clear and loud.

NATIONAL INTERFERENCE ELIMINATOR

The National Interference Eliminator can be used with any and all radio outfits no matter what make, tube or crystal sets. Will bring in stations you never heard before. Nothing else required with set as illustrated. Just connect it with two short wires to your outfit.

\$7.50



THE SINGLE TUBE

Performs the Function of 2-Tubes AS RADIO FREQUENCY AMPLIFIER AND DETECTOR

3000 Miles on the MONODYNE

On Tuesday night, Nov. 27th, between 10:12 and 10:21, I heard on your National Monodyne Single Tube Set, hooked up with two stages of amplification, London, England, broadcasting speech, piano and violin solo. I also heard Liverpool, between 10:26 and 10:30 broadcasting dance music very clear.

FRANK DONDA, 241 East 56th St. New York City.

An Absolute Necessity to Clear Reception

Eliminates broadcasting and code-signal interference Can be used to increase or shorten wave lengths

Dealers, Jobbers and Distributors—Send for Samples and Prices:

NATIONAL AIRPHONE CORPORATION
REG. U. S. PAT. OFF.

18 HUDSON ST., NEW YORK

SEND NO MONEY

NATIONAL AIRPHONE CORPORATION
18 Hudson St., New York, U. S. A.

R. N. 2

Please send me prepaid the articles crossed, for which I will pay postman upon delivery the advertised price.

- One National Monodyne
- One Audio Amplifier
- One Interference Eliminator
- One Panel Detector

NAME

STREET

CITY STATE



The hook-up that eliminates battery trouble

Some radio fans are still slaves to their batteries—lug them to service stations every time they need recharging—allow them to spoil many evenings' entertainment by running low.

Other fans—and they're quickly coming to be the vast majority—have found new economy and convenience in the GOLD SEAL HOMCHARGER, the world's best as well as its most popular rectifier. With it any radio or auto battery can be charged at home overnight—for a nickel. Simple, dependable, practically silent and absolutely safe. Beautifully finished in mahogany and gold. Approved by Underwriters. UNQUALIFIEDLY GUARANTEED. Over 150,000 now in use.

WHY PAY MORE—OR GET LESS?

Why buy a 2 or 3 ampere rectifier *without ammeter* requiring from 40 to 50 hours to charge your battery and costing twice as much to operate when, for the same price you can secure the genuine 5-ampere GOLD SEAL HOMCHARGER which

does a better job in one-third the time and at half the cost. Fitted with high-grade ammeter (eliminating guesswork) charging cable and battery clips—no extras to buy. For sale by all good dealers—\$18.50.

Insist on the GOLD SEAL

ACCEPT NO SUBSTITUTE. No other charger is just as good. INSIST on seeing our registered trade-mark, the "GOLD-SEAL," on nameplate and carton before purchasing.



RADIO FANS—ATTENTION!

FREE Ask your dealer for a free copy of the HOMCHARGER international list of broadcasting stations. Contains call letters, location, name and wave length of nearly every broadcasting station in the world.

DEALERS—JOBBER!

Prepare for the big HOMCHARGER year ahead by writing today for a copy of our elaborate merchandising plans. In it is illustrated many attractive sales helps that will enable you to get your share of this business.

The Automatic Electrical Devices Co., 118 West Third St., Cincinnati, O.

Largest Manufacturers of Vibrating Rectifiers in the World

GOLD SEAL HOMCHARGER

TO THE RADIO DEALER.

Let us explain how you can make the sale of our publications a worth while, well paying part of your business. Every one that enters your store is a prospective buyer of RADIO NEWS. RADIO NEWS will sell with little effort on your part.

You may sell our publications on a single copy basis with a fine margin of profit or on a subscription basis with a generous commission allowance.

Write now and prepare for the Fall and Winter trade.

EXPERIMENTER PUBLISHING CO.,
53 Park Place, New York.

(Continued from page 1114)

selves to analysis in ordinary form, the actual facts have been overlooked (not unsolved), and theories have been accepted because, apparently, they offer a scientific explanation which, due to our ignorance of the facts, seems to satisfy the conditions.

In making a good transformer, we are primarily concerned in preserving very minute variations as well as an average or "voice envelope." This is a highly important distinction.

Many transformers of the "flat-range amplification curve" will unquestionably give remarkable amplification for average audio variations, but they will not preserve the delicate nuances of the voice or music characteristics. These shadow effects are everything in musical quality. If we preserve them we have the genuine quality of the orchestra or singer—at least as far as the microphone and tubes can pass these to the transformer. If we do not preserve these delicate values, we blunt the points of each super-audible variation and the result is what we usually blame on the loud speaker.

Some of the audio frequencies are extremely high. If our violin, for example, is on a high note, such as upper E, its pitch frequency is 652 cycles per second, but its harmonics of super-audio frequencies may be many times this frequency and we must preserve as many harmonics in amplification as the ear is capable of originally hearing.

These frequencies are often in signal strength in relation to the dominant frequency, of the order of 1:100 or even more.

Furthermore, the harmonics are not strictly sine form. They are without regularity, but in the process of transmission and amplification the tendency is to make them sine shaped.

In conclusion we may say that many important considerations in transformer design have been slighted, because the importance of faithfully preserving the minute audio variations has been subordinated to the electrical standards based upon amplification efficiency at artificial frequencies. The remedy is to perfect the design not by the use of amplification curves, but by the study of transient conditions as they exist in normal speech or music.

New Radio Patents

(Continued from page 1092)

ments, I find it possible to cause the electromotive forces, induced in two or more antennae by the atmospheric disturbances, to set up currents therein of the same wave length, decrement, and phase, so that by opposing their effect on the detector circuit substantial neutralization may be accomplished.

The effects produced upon two such antennae by signals will, however, be out of phase with one another, except when the signal is received in a line at right angles to a plane common to the antennae. This difference of phase will be greatest when the antennae are in a common plane which also passes through the point of origin of the signals.

I have found that with such an arrangement it is possible to cause the effects produced in a plurality of antennae to be so combined in a single circuit as to neutralize or combine differentially the effects due to static and those due to signals coming in a direction at right angles to the plane of the antennae, while combining cumulatively the effects of signals arriving in the common plane of the antennae or from directions not too nearly at right angles thereto.

The difference in phase of the electromotive forces set up by received signal waves will also depend upon the distance of separation of the effective centers of the antennae measured in the direction of propagation of the waves.

In my own practice of the invention up to this time, I have found it desirable to bring leading-in wires from the antennae to a common point, preferably, but not necessarily, to the center of the antenna system.

RECEIVING SYSTEM

(Patent No. 1,462,882. Issued to Henri Chireix, of Paris, France, July 24, 1923.)

The present invention consists in the following: a vibrator system and a thermostat asso-



THAT mysterious "thing" that makes hardened criminals wide-eyed with fear—the Detective Dictograph:—
That motionless box that gives life itself to monster business organizations—the Dictograph System of Interior Telephones:—
That tiny black disc that brings tears of joy to the once hopelessly deaf—the Dictograph Acousticon:—
That faithful mouth that gives ready voice to diplomats or jazz-kings—the Dictogrand Loud Speaker:—

All do now pay homage to this most modern of Dictograph achievements—the Aristocrat Dictograph Headset!

Truly, here is a superb gift that will be an absolute necessity to the professional operator—a supreme luxury to the amateur experimenter—and an eloquent tribute to the discriminating purchaser!

Three thousand ohms. Priced at eight dollars. Net weight, 10 oz.

If your dealer has not yet stocked, write to us direct

DICTOGRAPH
PRODUCTS CORPORATION

220 W. 42d ST.

NEW YORK CITY

An Easy Way to Cut Out Interference

Add a Ferbend Wave Trap to Your Set

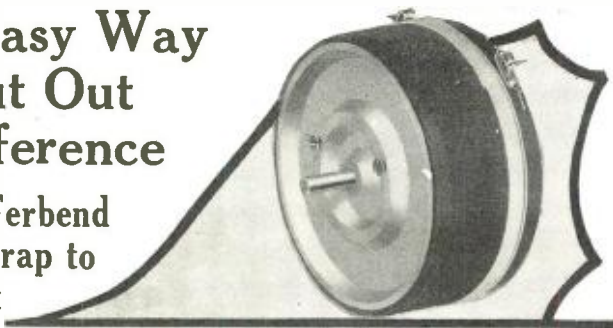

Enjoy your radio set. Get the station you want, *quickly*. Listen in on one thing at a time without annoying squawk-k-k-s or irritating whistles.

The Ferbend Wave Trap Makes Every Night Silent Night

New radio broadcasting stations are making receiving constantly more difficult. Many owners of long-distance sets are discovering powerful amplification is of little value so long as local stations are "all over the dial." Hundreds of users have solved the difficulty with the Ferbend Wave Trap—the missing link in Radio. A St. Louis user reports: "Heard Havana clearly with three St. Louis stations broadcasting. My receiver works like a new set. The 'Ferbend' is certainly a wonder!"

YOU Can Obtain These Remarkable Results

You can obtain results as satisfactory as this St. Louis user. If you don't, it doesn't cost you a penny for the "Wave Trap"

FERBEND ELECTRIC CO.
25 E. South St., Chicago

Ferbend Electric Co.,
25 E. South Water St.,
Chicago.

Send me a Ferbend Wave Trap. I will pay Postman \$6.00 (plus postage). I understand you guarantee the "Wave Trap" to tune out my local stations or my money will be refunded.

Name

Address

is sold with a positive guarantee that it will tune out your powerful local stations. Don't wait. Order now at our risk.

SEND NO MONEY

You need not send a penny. Pay Postman \$6.00 (plus postage). If you prefer, send \$6.00 with order and Wave Trap is mailed *postpaid* ready for panel mounting. Money back guarantee either way. You see you take no risk, so order TODAY.



The Original Wave Filter



The Ferbend Wave Trap can also be supplied completely mounted ready for instant use on formica panel in mahogany finished cabinet, 6 x 5 x 6, \$8.50. Get full benefit of all the distance your set will give you. Order your Ferbend TODAY.

ciated therewith for actuating a call indicating apparatus such as a bell is carried back to the circuit of the element that controls the oscillating conditions (comprising a three electrode tube arranged as a detector in accordance with the previous applications). The vibrator system is preferably arranged in a special manner by the combination of the two electro-magnetic relays. The invention will be more clearly understood by reference to the single figure of the enclosed drawing which illustrates an embodiment of the invention. As shown, the arrangement comprises a three electrode tube 1, operating by appropriate circuits as a generator for maintaining oscillations in one or the other of the oscillating circuits 2 and 3

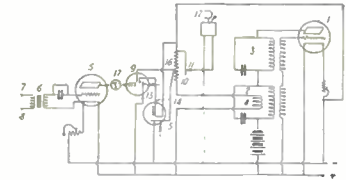

Normally, the circuit 2 is oscillating, but this oscillating condition may be destroyed and the circuit 3 set into oscillation due to the variations in the conditions of the circuit with which a coil 4 is associated, the coil being, for example, inductively connected with the circuit 2. As shown, this coil 4 is included in the plate circuit of a three electrode tube 5 arranged as a detector. This tube is actuated by the oscillations received through the coupling transformer 6, the primary terminals 7 and 8 of which are connected with the antenna of the station. In accordance with the present invention there is provided in series in the plate circuit of tube 5 the coil of relay 9 and a certain portion of an integrating device such as portion 10 of the resistance of a thermostat. The thermostat has a contact 11 through which the call indicating apparatus 12 (bell, test lamp, etc.) is placed in a circuit. When the armature 13 of relay 9 engages the contact the coil of relay 14 is connected in the battery circuit. When the armature 15 of this relay makes contact it shunts the portion 10 of the thermostat resistance and subjects the second portion 16 of the said resistance to the total potential of a common battery provided for heating the two tubes 1 and 5, for feeding the plate circuit of tube 5, for heating the thermostat, and for feeding the indicating apparatus 12. This battery is not shown in the drawing, and its positive and negative poles are connected to the similarly marked terminals of the circuits. A milliammeter 17 may be provided for regulating the circuit.

A New Invention for Selective Reception

(Continued from page 1057)

with the oscillations having a frequency of 198,680 which, it is assumed, have not been tuned out by the use of resonance phenomena. The beats, in this case, will have a frequency of 2,300.

We now have in the telephones T two sets of signals. The desired sets have a frequency of 1,000, while the undesired ones have a frequency of 2,300, and no difficulty should be experienced in reading the desired signals without material interference from the other signals. It is important to notice that the incoming signals are not, of course, simply steady streams of continuous oscillations, but consist of dots and dashes of short duration, and that during a considerable period of time, dots and dashes of the undesired signals are received during the intervals between dots and dashes of the desired signals.

HUNDREDFOLD MULTIPLICATION

A far more striking example of the possibilities of this new principle in wireless reception is when we consider the frequency multiplication to be, say, 100 times. Such conditions are illustrated in Fig. 2.

The frequency multiplier FM now increases the frequency of the desired signals to 2,000,000, corresponding to 150 meters, while the interfering signals now have their frequency raised to 1,986,800. The frequency of the local oscillations of the heterodyne are adjusted to 2,001,000. With the

RADIO FANS

Tune in on station
WEAF (New York)
every Thursday at 8.50 P. M. and listen to a story or article selected from

HEARST'S INTERNATIONAL

This is one of the most popular weekly features "on the air"

FREE

Write for Free Copy of the Latest Radio Reprint B. It contains a complete story from "Hearst's International Magazine."
Address Radio Editor, Hearst's International Magazine, 119 West 10th Street, New York City

SURE-FIRE
D-X
CRYSTAL

THE MARVEL OF ALL SYNTHETIC CRYSTALS

Extraordinarily supersensitive all over. Ideal on Helly circuits. Tested, sealed, guaranteed. Invented by N. V. Mail and Tribune.

50c. Mtd. at all dealers or sent postpaid.

Specialty Service Co., 9 Hanson Pl., Bklyn, N. Y.
Radio, Ltd., Montreal, Can. Canadian Distributors.

Insure your copy reaching you each month. Subscribe to Radio News—\$2.50 a year. Experimenter Publishing Co., 53 Park Place, N. Y. C.

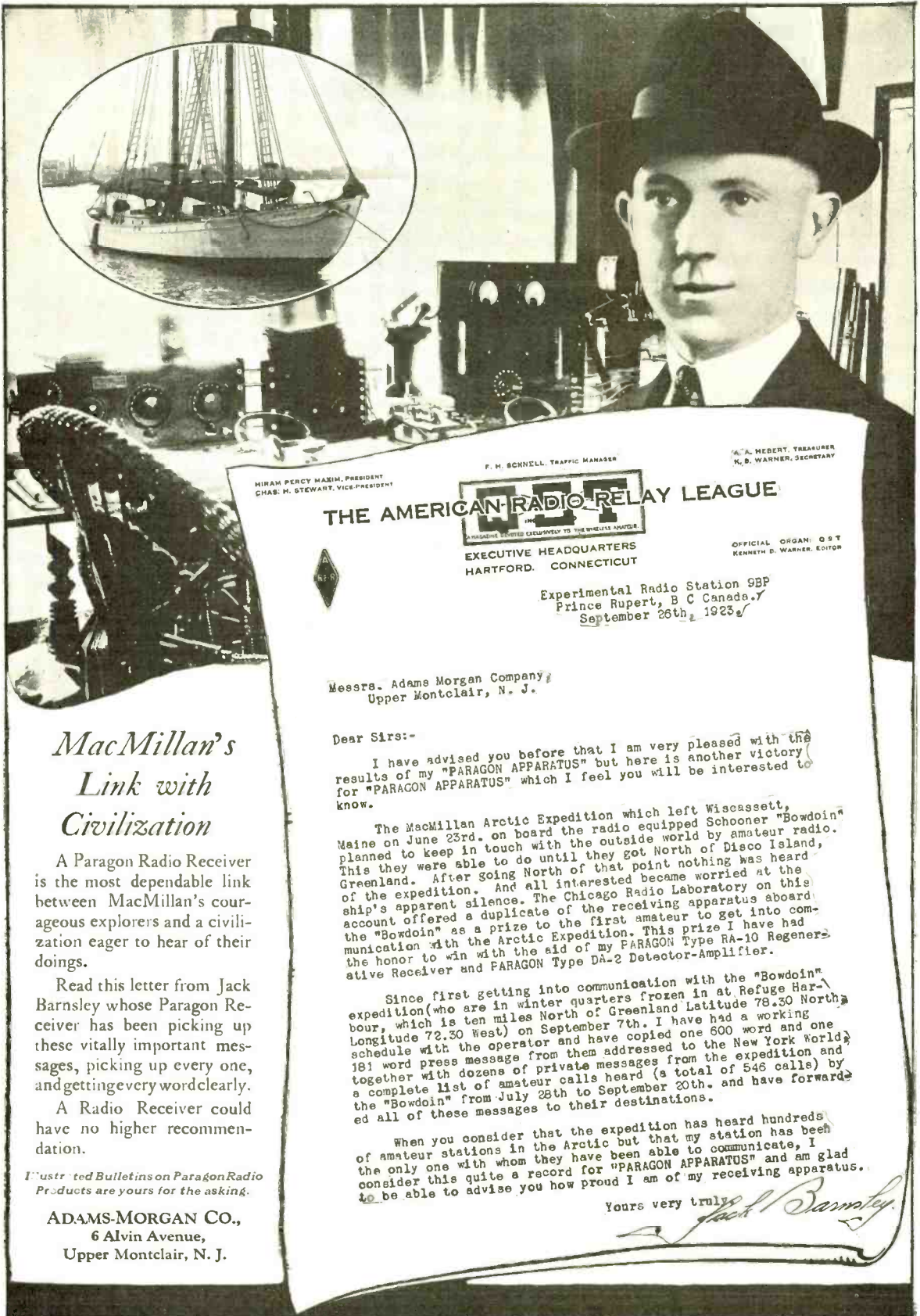

HIRAM PERCY MAXIM, PRESIDENT
CHAS. H. STEWART, VICE-PRESIDENT

F. H. SCHNELL, TRAFFIC MANAGER

W. A. MEBERT, TREASURER
H. B. WARNER, SECRETARY

THE AMERICAN RADIO RELAY LEAGUE



EXECUTIVE HEADQUARTERS
HARTFORD, CONNECTICUT

OFFICIAL ORGAN: QST
KENNETH E. WARNER, EDITOR

Experimental Radio Station 9BP
Prince Rupert, B C Canada.
September 26th, 1923

Messrs. Adams Morgan Company
Upper Montclair, N. J.

Dear Sirs:-

I have advised you before that I am very pleased with the results of my "PARAGON APPARATUS" but here is another victory for "PARAGON APPARATUS" which I feel you will be interested to know.

The MacMillan Arctic Expedition which left Wiscasset, Maine on June 23rd. on board the radio equipped Schooner "Bowdoin" planned to keep in touch with the outside world by amateur radio. This they were able to do until they got North of Disco Island, Greenland. After going North of that point nothing was heard of the expedition. And all interested became worried at the ship's apparent silence. The Chicago Radio Laboratory on board account offered a duplicate of the receiving apparatus to get into communication with the Arctic Expedition. This prize I have had the honor to win with the aid of my PARAGON Type RA-10 Regenerative Receiver and PARAGON Type DA-2 Detector-Amplifier.

Since first getting into communication with the "Bowdoin" expedition (who are in winter quarters frozen in at Refuge Harbour, which is ten miles North of Greenland Latitude 78.30 North Longitude 72.30 West) on September 7th. I have had a working schedule with the operator and have copied one 600 word and one 181 word press message from them addressed to the New York World together with dozens of private messages from the expedition and a complete list of amateur calls heard (a total of 546 calls) by the "Bowdoin" from July 28th to September 20th. and have forwarded all of these messages to their destinations.

When you consider that the expedition has heard hundreds of amateur stations in the Arctic but that my station has been the only one with whom they have been able to communicate, I consider this quite a record for "PARAGON APPARATUS" and am glad to be able to advise you how proud I am of my receiving apparatus.

Yours very truly

Jack Barnsley

*MacMillan's
Link with
Civilization*

A Paragon Radio Receiver is the most dependable link between MacMillan's courageous explorers and a civilization eager to hear of their doings.

Read this letter from Jack Barnsley whose Paragon Receiver has been picking up these vitally important messages, picking up every one, and getting very word clearly.

A Radio Receiver could have no higher recommendation.

Illustrated Bulletins on Paragon Radio Products are yours for the asking.

ADAMS-MORGAN CO.,
6 Alvin Avenue,
Upper Montclair, N. J.

BAKELITE

REG. U. S. PAT. OFF.

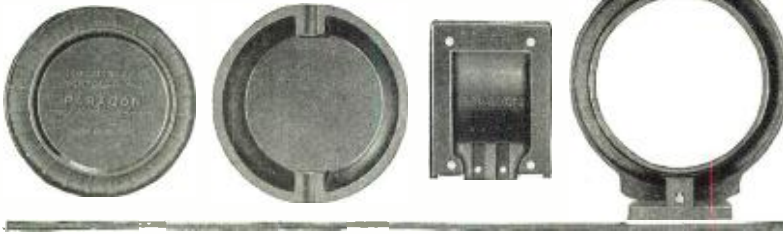

Paragon and Bakelite

The pleasure and satisfaction that the Paragon Receiver brings to the family circle is appreciably increased through the use of Bakelite.

Bakelite possesses a combination of properties not found in other materials, which makes it peculiarly suitable for this service. Its excellent electric properties provide complete insulation that remains unimpaired under all atmospheric conditions.

Because of its high temperature resistance and non-absorbent properties, Bakelite performs equally well in all climates.

Its great mechanical strength, permanent beauty of finish and color enhances the value of any Radio Equipment in which it is used.

The Adams-Morgan Company chose Bakelite because of these desirable qualities and, for the same reason, leading Radio Manufacturers have adopted Bakelite as standard insulation for the manufacture of parts and complete units.

Send us your name and address and we will mail you a copy of our Radio Booklet B.

BAKELITE CORPORATION

247 Park Avenue, New York, N. Y.
Chicago Office: 636 W. 22nd Street

BAKELITE
Condensite
REDMANOL

are the registered Trade Marks for the Phenol Resin Products manufactured under patents owned by

BAKELITE CORPORATION



desired currents of 2,000,000 frequency, the heterodyne currents will produce beats of 1,000 frequency which will produce a musical note of 1,000 in the telephone receivers. With the interfering signals, the local oscillations will produce beats having a frequency of 13,300. This frequency, to all intents and purposes, may be treated as above the audible limit, and the desired signals would, therefore, be received in the telephone receivers without any interference whatever from the undesired signals, even though in the initial aerial circuit the frequency difference amounted to only 132 cycles.

The advantages to be gained from the method outlined in this article are supplemented by resonance tuning and in practice a frequency multiplication of 100 times would not be necessary. It will readily be appreciated that even a multiplication of only 2 will double the difference in frequency between desired and undesired signals. This means that we can increase the "elbow room," as it were, for signals of any particular wavelength, and greater selectivity is thereby obtained. Alternatively, we can say that by doubling the frequency of the incoming signals we can have twice as many channels of communication in any given band of wavelengths. If, for example, we take Alexander's figure of 35 channels of communication between 11,000 and 22,000 meters, by frequency doubling we can increase this to 70. By multiplying the frequency 10 times, we could have 350 stations working between these two extreme wave-lengths. If we multiply the frequency of signals 100 times, we could have 3,500 stations working.

By the application of this invention to long-distance communication, it would therefore seem that the problem of the congestion of the ether has been solved.

While this method of reception marks a third stage in the progress of selective reception, both resonance tuning and beat reception retain all their former usefulness; in fact, heterodyne reception becomes even more important as it now becomes a really effective process in the reception of continuous waves of great length. One way of looking at the invention which is the subject of this article is to consider that the long wave signals are brought down to the lower wave-lengths where the full advantages of beat reception, as regards selectivity, are obtained. The lower the level to which we bring the incoming signals, the more selective does heterodyne reception become.

APPLICATION TO LOW FREQUENCIES

So far, the application of the method to high-frequency signals only is described. The principle, however, is just as applicable to audio frequencies as to radio frequencies. The author's experiments in this direction have fully borne out theoretical expectations, and two signals having a note frequency imperceptibly different have been entirely separated in such a way that one of the frequencies is entirely suppressed.

Such a very remarkable achievement could not be obtained, or even approached, by any other method which has hitherto been proposed. Its significance, of course, is that note tuning becomes a reality; almost the whole of the selective apparatus may be concentrated on the low-frequency side of a wireless receiver. When receiving continuous waves, even the slightest differences between two sets of continuous oscillations will produce different beat notes with a local heterodyne. These will give rise to slightly different audio frequencies which would seriously interfere with each other and entirely prevent the selective reception of a desired signal.

Where existing methods cannot differentiate between signals of slightly differing pitch, it is possible by this invention to magnify their difference to such an extent

THE MATERIAL OF A THOUSAND USES

CATALOG **E19-0 10 PAGES FREE**

EVERYTHING IN RADIO

One of the largest complete stocks in the world. 40 diagrams of latest Hookups.

DEALERS ALL OVER THE U.S.

Making big profits handling our supplies. 24-hour service. Goods shipped same day order received.

American RADIO Mfg. Co.

WHOLESALE RADIO DISTRIBUTORS
Dept. A. 6 West 14th St. Kansas City, Mo.

WOC--TRESKO

Licensed under Armstrong U. S. Patent No. 1,113,149

A long distance. 1000 mile, 600 meter range regenerative tuner for **\$12.50**

Add parcel post on 6 lbs. New circuit startling results. Cheaper than crystal set. Uses any aerial. Amplifiers to match set for your loud speakers. Circuits free—Full instructions.

TRESKO
Tri City Radio Elec. Supply Co. DAVENPORT, IOWA
BOX 148

WANTED—Back numbers of Radio News, Dec., 1921, Jan. and Feb. and April-May, 1922. Experimenter Publishing Co., 53 Park Place, New York City.

Reduce Tubes by Half With Erla Synchronizing Transformers

Vacuum Tubes
in ERLA Duo-
Reflex Circuits

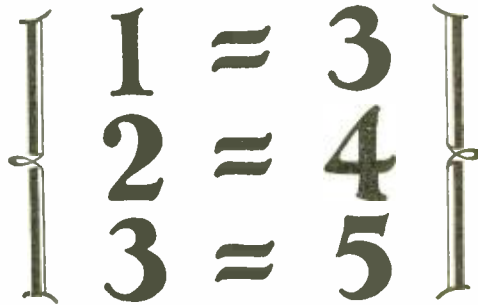

Vacuum Tubes
as Ordinarily
Employed —



Increased amplification and elimination of distortion inevitably follow installation of Erla transformers, Reflex and cascade types. \$5

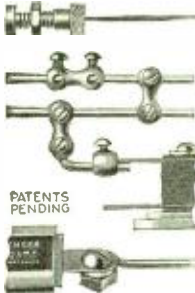

PATENTS
PENDING

Erla solderless connectors simplify enormously wiring and assembly of radio apparatus, saving time, temper and money. List, 3 to 5c ea.



Crystal troubles vanish on installing an Erla rectifier. No adjustment required. Proof against jolt and jar. Lasts indefinitely. List \$1



Look for the words "tested capacity," found exclusively on the labels of Erla fixed condensers. Made in eleven sizes, 35c to 75c ea.

Nation Wide Loud Speaker Reception With Only Three Tubes

Greater range and volume with fewer tubes than ever before are attained through Erla Duo-Reflex circuits, using Erla synchronizing radio and audio transformers.

In Erla circuits, tubes do triple duty, as simultaneous amplifiers of received radio frequency, reflexed radio frequency, and reflexed audio frequency currents. Through accurate superimposition of currents identical in phase and frequency, by means of Erla synchronizing transformers, this triple function is flawlessly performed, resulting in tremendously magnified amplification without distortion.

Even one tube provides excellent loud speaker reception over a wide range; two tubes blanket the zone ordinarily covered by four, while three tubes bring in stations on the loud speaker from coast to coast.

Other notable improvements, contributing vitally to the superiority of Duo-Reflex circuits, are the Erla fixed crystal rectifier and Erla tested capacity condensers. Combining advanced characteristics for reflex work with unduplicated uniformity, they are indispensable to complete stability and purity of reproduction.

Detailed diagrams and descriptions of Erla Duo-Reflex circuits are presented in Erla Bulletin No. 16. Ask your dealer, or write, giving your dealer's name.



Erla audio transformers add tremendously to the purity and volume of any receiving unit in which they are used. Ratios 3 1/2 and 6 to 1. \$5



Screen unsightly openings for tube ventilation with Erla bezels, made in 1" and 1 1/2" sizes, in bright nickel or dull enamel. List, 20c



Erla sockets combine maximum beauty and strength, with heavy, nickel-plated shell cast into moulded Bakelite base. Many other advantages. 75c



Erla two-way phone plugs reveal unequalled quality of materials and workmanship, assuring superior service and satisfaction. List, 75c

Electrical Research Laboratories
Dept. C. 2515 Michigan Avenue, Chicago



RADAK R4

Complete Regenerative Receiver

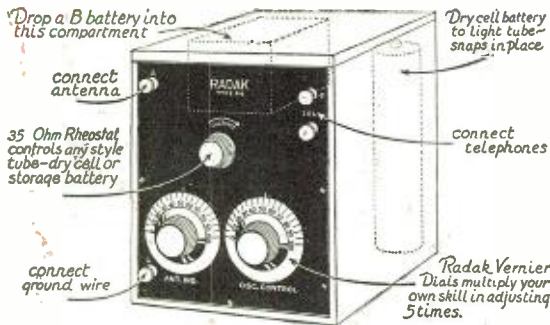

Licensed under Armstrong U. S. Patent 1,113,149

PRICE \$25.00

A newly designed and thoroughly tested circuit of superior capability, solid mahogany cabinet, genuine Formica panel, remarkable Radak Vernier dials, all batteries inside the cabinet with overall size of but 6 x 8 x 10 inches.

Where else will you find these earmarks of quality in a set selling for \$25.00? The new Radak "Governing Capacity" controls regeneration with surprising ease. Radak R4 is a self-contained set designed for use on dry cells and operating over a range of wave-lengths of 225 to 550 meters. Wherever you are, or wherever you go, you can take this set with you. Merely slip in a flashlight battery, a small "B" battery and a 3-volt vacuum tube, connect to a wire hung out the window, thrown over the limb of a tree or even laid on the roof if no antenna is available, and programs from considerable and often surprising distances may be received in a few minutes from the time you start. While easily carried to your summer home, camp, or on your vacation, the R4 is in no sense a portable or makeshift outfit, but its high quality of finish and workmanship will grace the most refined surroundings.

R4 Set complete, as illustrated and described, without accessories\$25.00

A4 RADAK 2 STAGE AMPLIFIER EXACTLY MATCHES THE ABOVE SET\$25.00

From the R4 at \$25.00 to the C64 five tube radio frequency set at \$220.00 THE BASIS OF RADAK SUPREMACY lies in the fact that Radak sets are an engineered entity not a mere assembly of parts. Complete bulletin of all models sent on request.

Manufactured by

CLAPP-EASTHAM COMPANY

107 MAIN STREET, CAMBRIDGE, MASS.

New York, N. Y.
395 Broadway

Cleveland, Ohio
Caxton Bldg.

San Francisco, Cal.
709 Mission St.

that either signal may readily be read without interference.

The original audio-frequency signals have their frequency stepped-up by means of harmonic producing, or other frequency-multiplying apparatus, to a radio frequency which should preferably be well above the audible limit. These radio-frequency currents may now be selectively received by the aid of tuned high-frequency circuits and then combined with local radio-frequency continuous oscillations. These local oscillations are produced by a heterodyne, beats being produced. All the advantages of high-frequency tuned circuits and beat reception are thereby obtained, and whereas the original difference in frequency might be only 100 (barely perceptible) the final difference in frequency might be 10,000, a frequency which would enable the interfering signals to be cut out entirely.

Fig. 3 shows a theoretical wireless receiving system in which the invention is applied to the low-frequency currents. The high-frequency signals are rectified by the crystal D producing audio-frequency currents through T₁, due to the fact that a local oscillator H₁ induces continuous oscillations into the aerial circuit of a frequency slightly different from that of the desired signals. The currents of musical frequency passing through T₁ are then applied by means of the transformer T₁ T₂ to the frequency multiplier F M, in the output circuit of which we have a circuit L₂ C₂ tuned to a multiple of the desired audio-frequency currents passing through T₁. The circuit L₂ C₂ will be a radio-frequency circuit, and the frequency of the currents in L₂ C₂ should preferably be above the audible limit. The circuit L₂ C₂ is tuned to the same frequency, and by loosely coupling L₂ to L₃ a certain amount of resonance selectivity is obtained. The principal method of obtaining the selectivity, however, is by the induction of local oscillations produced by a second heterodyne H₂ tuned to produce currents having a frequency differing by, say, 1,000 from the currents in L₂ C₂. The beats of about 1,000 frequency are now detected by the valve V and produce a musical note in T. The beats produced by the interaction of the local oscillations supplied by H₂ and the undesired signals of multiplied frequency are arranged to be above or below the audible limit so as not to interfere with the desired signals.

A COMBINED HIGH- AND LOW-FREQUENCY SELECTIVE SYSTEM

It is, of course, convenient to apply the invention to both the high- and low-frequency sides of a wireless receiver, and Fig. 4 shows a simplified arrangement illustrating the different stages in the reception of continuous waves by this system. It will be seen that the first frequency multiplier FM₁ is for the purpose of increasing the frequency of the original oscillations. The oscillations of multiplied frequency are then heterodyned by H₁ and detected by the tube V₁, producing musical low-frequency currents. The output currents from the tube V₁, which will be of musical frequency, although, of course, it is not necessary that this should actually be so, are communicated to the second frequency multiplier FM₂; the frequency is once more stepped-up so as to reach above the audible limit and the currents are selectively received by the aid of loose coupled circuits and the second heterodyne H₂, which enables a musical note to be obtained in the telephones.

THE APPARATUS EMPLOYED

It is not possible within the scope of this article to deal with the various practical circuits for achieving the desired results. The method of obtaining the multiplied frequency is not, of course, an essential part of the basic invention. Vacuum tubes, operated under special conditions, have been found

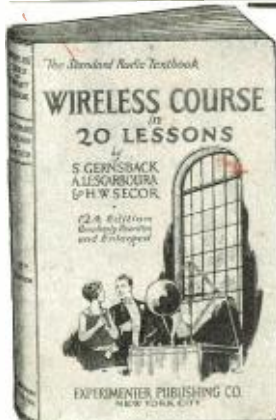

\$2.00 12th Edition \$2.00

WIRELESS COURSE IN 20 LESSONS

By S. GERNSBACK, A. LESCARBOURA and H. W. SECOR

The Standard Radio Text Book

Size 6 x 9 inches. 264 pages. 500 Illustrations. Binding de Luxe. Semi-flexible Leatherette Cover. Genuine Gold Stamped, Round Corners, Red Edges.

Experimenter Publishing Co.

53 Park Place

New York, N. Y.

Get Greater Pleasure From Your Radio Set

There's nothing so disappointing to the radio enthusiast as limited range and imperfect tones. With these DAY-FAN units you may overcome such common faults and get greater pleasure from your Radio Set.

Coast to Coast Reception

Coast to Coast reception is made possible with DAY-FAN Tuned Radio Frequency Transformers. Instantaneously adjustable to any Public Broadcasting Wave Length. The Wonder Instrument of the year. Model 5011—\$6.00



Tuned Radio Frequency Transformer

Tones Without Distortion

Music and Voice—Clear and True. DAY-FAN Audio Frequency Transformers faithfully amplify Concerts, Speeches and all broadcasted entertainment.

Model 5002—9 to 1—\$5.00

Model 5026—4½ to 1—\$5.00



Audio Transformer

For All Wave Lengths

180 to 710 Meters—the tuning range of the DAY-FAN Bank Wound Variocoupler includes all Public Broadcasting Wave Lengths. Don't limit yourself to a narrow band of entertainment. Model 5010—\$7.50.

There are many more DAY-FAN Radio Units, all just as necessary and efficient as those mentioned above. Before you complete your set, get our descriptive booklet, free. Use DAY-FAN radio parts, and be assured of getting the utmost in pleasure and satisfaction from your radio reception.

Jobbers—write for our cooperative advertising plan.



Bakelite Variocoupler

THE DAYTON FAN AND MOTOR COMPANY

Established 1889

DAYTON

OHIO



Any set is better with this switch on the panel.



—and the Same Program Will Be There When You Want It

The Tuning of Your Set Is Not Disturbed When You Have C-H Control

The Cutler-Hammer Engineers have provided a real convenience for every panel in the little radio switch which bears their famous signature of approval, the C-H trade mark. They have built it worthy of the finest sets—yet so simple to mount that any one can install it in less than five minutes.

And it can be used to serve you in many ways. In your "A" battery circuit it makes it possible to interrupt a program without loss of the station received. It protects both your tubes and batteries and indicates at all times whether the current is On or Off (with the new tubes that do not burn bright there is no other way of knowing). It is built sturdy to do well any task you may assign, and has broad, self cleaning knife-blade type contacts that give perfect connection and freedom from microphonic noises.

Have your dealer show you the genuine C-H Radio Switch. Snap the button in and out! You can tell by its action that it was built by switch specialists. Their trade mark on both the dustproof case enclosing the mechanism, and on the bright orange and blue box in which the switch is sold is your protection.

THE CUTLER-HAMMER MFG. CO.

Member Radio Section, Associated Manufacturers of Electrical Supplies
MILWAUKEE • WISCONSIN

The C-H Radio Switch can be installed on any panel in only a few minutes. Just one 7-16 inch hole is required. Large, concentric binding posts with cupped washers make wiring easy.



The C-H Engineers designed this radio switch mechanism so that the contact member floats, independent of the button. Touching it, or jarring the table does not cause noise in the phones.

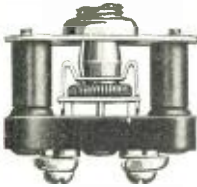

The wiping knife-blade type construction insures clean contacts for freedom from microphonic noises.

C-H

RADIO SWITCH

"Read'em"
Binding Posts



The Marshall Gerken Co. Toledo, O.

WANTED Complicated Hook-ups!

To simplify difficult hook-ups use "Read'em" Binding Posts. Tell at a glance whether it is Antennae, Ground, Fones, A or B battery, etc. Name neatly engraved for keeps on top of each post. (See illustration). The irremovable knobs save time, trouble and petty annoyances. "Read'em"s add to the appearance of any set. Don't be without them. Price 15c. each. Set of ten (as shown) \$1.50.

If your dealer can't supply you with "Read'em"s, order direct.

Look for the name "Read'em" on every post.

The Marshall Gerken Co.

Dept. A 27 N. Ontario St.
Toledo, Ohio

suitable for producing harmonics or merely for doubling the input frequency. If harmonics are used, a considerable factor of multiplication may be obtained.

Fig. 5 indicates how the invention might be applied to the reception of incoming waves. The tube V_1 is operated at, say, saturation point, so as to produce harmonics in its output circuit $L_2 C_2$, which is tuned to one of these harmonics. The tube V_2 is a self-heterodyne receiver which then receives the desired harmonic and treats it as the signal to be received.

The present paper is only intended as an outline of the new system, and at some future date it is hoped to give further technical details.

THE MINIMIZATION OF ATMOSPHERIC INTERFERENCE

The system of reception lends itself particularly to the elimination, or rather minimization, of atmospherics. While this is probably, at the present date, the most important advantage of the system, yet it is mentioned at this stage of the article because this process of atmospheric elimination is essentially one of selectivity. The application of the method of frequency multiplication to the low-frequency side of a receiving circuit will automatically cut out all, or most, of the atmospherics, owing to the fact that most atmospherics have lower frequencies than the heterodyne notes due to desired signals. Unless their frequency exactly corresponds with the heterodyne note, the process of frequency multiplication and resonance, combined with further heterodyning, will eliminate the atmospheric interference.

By the application of the method to the high-frequency side of the receiving apparatus, the effect of atmospherics may also be minimized by causing them to produce oscillations (for example, by the impact excitation of a detuned circuit) different from the incoming continuous waves. Frequency multiplication increases the divergence between the two different signals, and in any case currents of the wave-form of atmospherics will not readily produce effective harmonics.

*A reproduction of a paper read before the British Association for the advancement of science at Liverpool on September 19, 1923.

Popular Radio Coming in Austria

(Continued from page 1049)

would derive from radio. The Institute would, of course, broadcast everything it was permitted to send out so far as its resources would permit.

They took me to the large auditorium, as well equipped a college lecture hall as any in America. Electric currents of every description are wired to the desk of the professor. Behind it is a blackboard, the top at just the right height for writing. He wrote a few lines and with a slight movement of the hand raised the board. Some diagrams followed and the board was instantly adjusted for what was to come under them. When filled and raised to its full height it stretched upward 25 feet, the top being above the level of the eyes of the students on the topmost row of seats. The turn of a handle covered the blackboard with a white screen for stereopticon views or motion pictures and at the same time light-proof screens noiselessly covered the windows. Along the straight edges of the balconies I noted scales that would enable pupil or professor to see at a glance the distance from the projector to the screen or from the screen to the eye.

Window screens, motion picture screen and blackboard all disappeared and a ground glass was revealed, the same size as the huge blackboard, on which microscopic or other subjects could be projected from apparatus

WANTED—Back numbers of Radio News, Dec., 1921, Jan. and Feb., 1922. Exporter—Pamphlet Publishing Co., 53 Park Place, New York City.

The filament kontrol of infinite adjustment FIL-KO-STAT

Everywhere

In current Radio literature, the FIL-KO-STAT is being praised by foremost authorities as the supreme achievement in vacuum tube filament control.

Kenneth Harkness in his recent volume, "Radio Frequency Amplification," says the FIL-KO-STAT is indispensable. W. J. Merrit Garvey's "Experimenters' Pocket Reference" tells why he prefers FIL-KO-STAT to all other filament controls and R. P. Clarkson Radio Data Sheet Expert, in his card on Filament Control, states that only FIL-KO-STAT gives ideal results.

All these endorsements are the result of laboratory tests and actual use of the FIL-KO-STAT. Put one in your set to-day and you will be of the same opinion.

FIL-KO-STAT

- Provides scientifically correct filament control
- Assures longer tube life
- Is not a carbon powder rheostat
- Has no discs to break
- Has no wires
- No puzzling adjustments
- Ideal "off" position for all tubes adjusted at the laboratory
- Full resistance 30 ohms

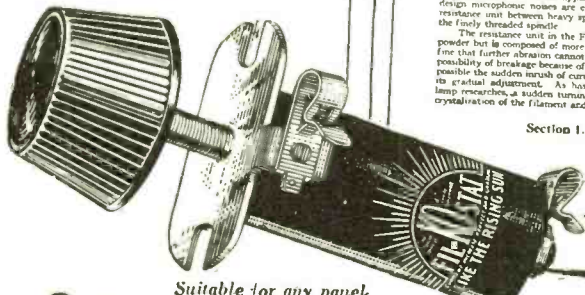

Suitable for any panel mounting without re-drilling. Equipped with Fahnestock clips. Heavy nickel plated drilled and tapped mountings for rigidly setting up FIL-KO-STAT on table or board—15 cents.

\$2 AT DEALERS EVERYWHERE
In Canada 2.75

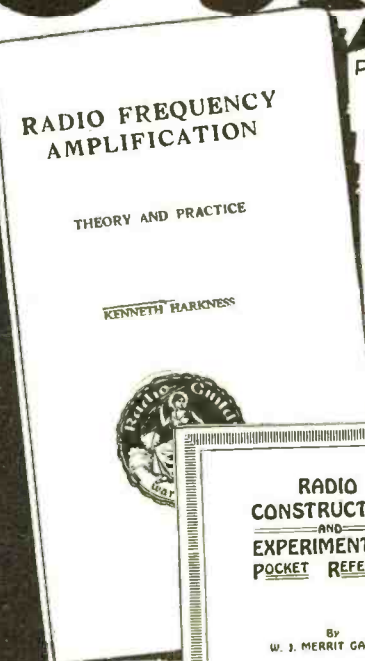

PAGE 119

"Fil-KO-Stats" provide fine regulation essential if maximum efficiency is to be obtained particularly useful tuning in weak stations. Fil-KO-Stat gives such fine control of filament temperature that it has become almost indispensable."

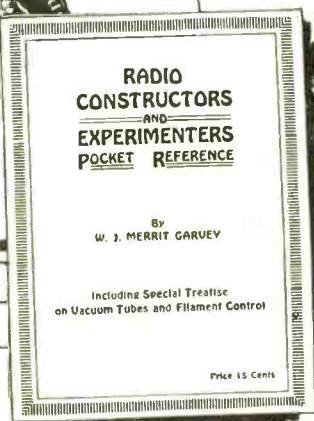

PAGE 9

"...found Fil-KO-Stat" enabled operator to make micrometer adjustments allowing infinitesimal current changes eliminating noises."

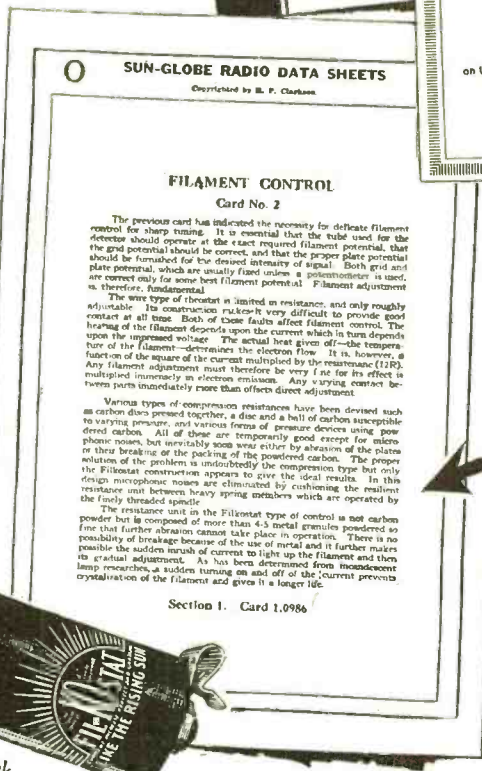

"...but only the Fil-KO-Stat construction appears to give the ideal results...microphonic noises are eliminated... makes possible sudden inrush of current and then its gradual adjustment."

MADE AND GUARANTEED BY
DX INSTRUMENT CO.
HARRISBURG, PA.

RADIO STORES CORPORATION
Sole International Distributors
Dept. R N 224 218-222 West 34th Street, New York
Chicago Minneapolis Kansas City Los Angeles



Save 1/3 on Guaranteed Radio Equipment

Write us a post card—
Address Dept. 2-R

and we will send you free this 52 page catalogue of radio sets and parts. It also contains explanation of radio terms, map and list of broadcasting stations and much radio information, including an explanation of successful hook-ups and circuits.

You will be amazed at the low prices Ward's quote. A complete tube set having a range of 500 miles and more, including tube, head set, batteries, and antenna equipment, as low as \$23.50.

This catalogue contains everything for the expert and amateur. Complete sets and every improved part for building sets, all the most up-to-date devices—at the lowest possible prices.

Headquarters for Radio

Montgomery Ward & Co. is headquarters for Radio, selling everything direct by mail without the usual "Radio-profits." Why pay higher prices? Ward quality is the best and the prices will often save you one-third. Everything sold under our Fifty Year Old Guarantee—Your Money Back if You Are Not Satisfied. Write today for your copy of this complete 52-page Radio Book.

Write to our house nearest you
Address Dept. 2-R

Chicago Kansas City St. Paul
Portland, Ore. Ft. Worth Oakland, Cal.

This Radio Catalogue FREE

Established 1872
Montgomery Ward & Co.
The Oldest Mail Order House is Today the Most Progressive

behind it. With such facilities, radio leadership can be developed as rapidly as the demand may require.

APPARATUS CHEAP IN AUSTRIA

Radio apparatus produced in Austria is so low in price that it would seem as though the people could have all they wanted of it as soon as they are permitted to use it. A good detector tube costs about fifty cents, 4,000-ohm phones about a dollar and a quarter.

Radio education is cheaper still. For six months' tuition at the Electrotechnical Institute the charge is less than two dollars. As apartment rentals in Vienna are limited by law to about seventy-five cents a month, food, clothes, books and shows are about all that a man with an average American student's income would have to worry about. He would not require much to keep on a level with the average Austrian for economy is practiced by all. The Austrian, however, has difficulty in raising money even for what seem to us small expenses. The European Student Relief has helped many of them. A competent cashier and private secretary receives 1,500,000 kronen per month, about \$22.50. It would be a crystal set on the installment plan for hers, if she had radio at all.

AUSTRIANS ARE MUSIC LOVERS

To appreciate the possibilities of radio in Austria it is necessary to remember the Austrian's appreciation of good music. Much of the stuff purveyed in America never would get across in Central Europe.

Vienna is the world's center of musical appreciation. I stood through a two-and-a-half hour concert by the Vienna Manner-choir, where the audience had about as much freedom of movement as cigars in a sealed box. There was not a cough nor a sneeze nor a shuffle during any part of any number, except once when a man fainted in the aisle and had to be carried out. Nobody noticed him except the two men who did the heavy work.

If radio can give opera to folks who have been starved for food and music, can let the populace hear Jeritza and other world-famous Austrian stars who come home when America goes to the seashore, antennae will grow like spider webs over night. The average Austrian will go without food or even without beer rather than forego the pleasure of music.

Radio Broadcasting Proving Great Aid to Music Industry

(Continued from page 1069)

if there are some particular numbers you are very fond of, it is a very easy matter to get out the records and play them to your heart's content. And, mind you, there is no repetition of selections on the radio. The selection is played but once from the broadcasting studio and you have no voice in the matter, unless you happen to live in the immediate vicinity of the station and then it is quite probable that you will not be able to get them in time to have them repeat the selection.

I was interested in obtaining the other fellow's side of the story, so I distributed 25 questionnaires (like the sample shown herewith). These were sent to individuals owning both a radio receiver and a phonograph. The results are very encouraging and, in the meantime, I learned that I was correct in my own belief that radio broadcasting is materially assisting the music industry.

This "B" Battery Will Last 5 Years

A "B" Battery Built for Radio
By Radio Experts

An Improved Re-chargeable "B" Battery Insures Noiseless Radio Circuits

The SIDBENEL Re-Chargeable "B" BATTERY is not a group of glass cells nor does it contain any war-time Edison elements. No sir, the container is made of genuine solidly constructed hard rubber; the sections are casted into the walls, making it absolutely leak-proof. Extra large twenty-five hundred mill. amp. metal plates are used giving it double the capacity of other Batteries but yet sells at the same price.

SIDBENEL STORAGE "B" BATTERIES are universally recognized as "Perfect for Radio Work." Its many SPECIAL NEW FEATURES include: One piece hard-rubber container. Separate sealed cover for each cell. Extra large plates. Hard-rubber vent-caps.



SPECIAL PATENTED PLATES ARE USED

Chemically treated so that low current can be drawn without causing the tubes to howl or squeak. (Only Battery containing this feature.) A single charge will last from four to six months, can be re-charged direct from your lamp socket, a Battery charger with attachments or lighting generator costing about one cent. A wonderful Christmas present.

Variable Type	201D Assembled	Knocked Down	Complete illustrated directions for charging from your lamp socket or from your generator and how to assemble come with each battery.
1 unit	22½ volts.....	\$ 5.00	\$ 4.00
2 units	45 volts.....	9.80	7.75
4 units	90 volts.....	18.00	14.75
5 units	115 volts.....	22.50	17.75
A. C. Rectifier.....	1.50	.85	

At your request we will send you a special printed Christmas catalogue containing greatly reduced prices on over five hundred different parts, sets, Batteries and many extraordinary Christmas suggestions. Don't buy until you see this.

Dealers requests welcome.

Sidbenel

RADIO EQUIPMENT MANUFACTURING COMPANY
25 Mt. Eden Ave., New York City



“Here’s the panel I want”

THE panel is the “front door” of your radio set. The selection of the panel is an important step. You want a good-looking panel. And you want a panel that has high dielectric strength.

Your Celoron panel comes wrapped in a dust-proof glassine envelope. Dust and grit cannot scratch it. Human hands cannot leave greasy fingerprints on it.

Because of its high dielectric strength, Celoron, a bakelite product, is approved by the U. S. Navy and the U. S. Signal Corps.

Celoron radio panels are finished in *black, oak and mahogany*. They come ready to use in these standard sizes:

1—6 x 7 x 3/8	5—7 x 18 x 3/16
2—7 x 9 x 3/8	6—7 x 21 x 3/16
3—7 x 12 x 3/8	7—7 x 24 x 3/16
4—7 x 14 x 3/16	8—12 x 18 x 3/16
	9—7 x 26 x 3/16

Other sizes are cut to order from sheet Celoron. *Ask your dealer.*

An interesting booklet for the radio set builder is “*Getting the Right Hook-Up.*” This booklet is sent *free* upon request.

To radio dealers: Send for special dealer price list showing standard assortments

Diamond State Fibre Company

BRIDGEPORT (Near Philadelphia) PENNSYLVANIA

Offices in Principal Cities

In Canada: Diamond State Fibre Company of Canada, Limited, 245 Carlaw Ave., Toronto

CONDENSITE
CELORON
 STANDARD RADIO PANEL

Great!

WESTON Instant Change PLUG



**\$1
Everywhere**

To see this plug is to admire it. To feel its lightness and ease of grip is to want it. But to change from one set of phone cables to another with it—means that you *must own it*. Interchangeable in 2 seconds. Merely press triggers to pull cables out. Shove cables in to connect. No tools, No broken fingernails, inconvenience or lost time. Operators everywhere admit its infinite superiority. Ask your dealer to let you see it or get it for you. Full information upon request.

Double Range Portable Voltmeter

Positively essential to know actual grid, filament and plate voltages. A great aid to exact tuning, prolonging the life of tubes, distinguishing B battery noises from static. Ranges 7½ and 150 volts. Weston built—insuring life-time service and satisfaction. Mounts on panel if desired. Your equipment is not complete without it. Write today for particulars.

WESTON ELECTRICAL INSTRUMENT CO., 173 Weston Avenue, Newark, N. J.
Branches in All Principal Cities

Electrical
Indicating
Instrument
Authorities
Since 1888

WESTON

STANDARD - The World Over



Improve
your set
with an
AmerTran



Send for
Circular
No. 1005

**STANDARD
of
EXCELLENCE**
for audio amplification

With all tubes—In all stages

AMERTRAN

TRADE MARK REG. U.S. PAT. OFF.

Its flat-top, distortionless amplification curve assures a pure tone rendering of the full musical scale.

It amplifies in one stage from 30 to 40 times in the flat part of the curve, depending on the tube

constant—the amplification is approximately 5 times the tube constant.

In one type only. Turn ratio 5:1. Price, \$7. Ask your Electrical Dealer; or, sent carriage charges collect.

American Transformer Company, 177 Emmet St., Newark, N. J.
Designers and builders of radio transformers for over 22 years.



**Wholesale
Radio
Equipment**

Same Day Shipments

East Pittsburgh, Pa. Next door to KDKA

UNITED ELECTRIC STORES CO.

The **Sodion** Tube

CONNECTICUT TUBE COMPANY

NEWARK, CONNECTICUT

RESULTS

Question No. 1—Phonograph most valuable, 50 per cent. Radio most valuable, 30 per cent. 50-50 basis, 20 per cent. Total 100 per cent.

Question No. 2—Prefer radio. Because of novelty and unlimited possibilities. Varied musical and educational programs. No changing of needles. No purchasing of records. 70 per cent.

Prefer phonograph. Because they can play what they want when they want it. Can repeat pieces as often as they care to. There is something in the guarantee that you can have the music when you want or need it most. Weather does not control action. 30 per cent. Total 100 per cent.

Question No. 3—Radio prompted purchase of record roll or sheet music, 90 per cent. Could not truthfully say so, or recall, 10 per cent. Total 100 per cent.

Question No. 4—The following is the sum and substance of what was said in answer to this question:

RADIO SET

Radio broadens the mind by linking one with distant points. It is a strong stimulant for the imaginative powers. You are never finished listening to it. You can choose your programs. Wonderful educational possibilities. Drives away gloom from hospitals.

The radio set is making it easier for the music dealer to sell music of all kinds. The radio concerts are educating the mass in music and there will be a continual increase in demand for music everywhere. Radio concerts will automatically create a demand for talented artists and their personal appearance anywhere will be greeted by a full house.

THE PHONOGRAPH

You can play what you want when you want it. You can play a selection as often as you desire. Weather conditions play no part in its operation.

Question No. 5—Radio helps the music business, 95 per cent. Not positive yet, 5 per cent. Total 100 per cent.

These questionnaires point clearly in favor of the music industry. Fifty per cent claim the phonograph most valuable because of the fact that it can be relied upon 100 per cent. They pointed out the fact that one could not actually guarantee a concert on the radio (at the present time) but that the reception of a good concert depended entirely on the weather conditions and that we have absolutely no control over the weather.

Even though a great majority claimed the phonograph most valuable, 70 per cent of them denoted their preference for the radio set. They enjoy the operation of the set and the tuning in of the distant stations. "There is a mystical agent hidden in the radio set" as one man puts it.

According to some big men in the musical industry (as yet opposed to radio broadcasting), the United Fruit Company ought to file claim at once for damages against the house that published the song, "Yes, We Have No Bananas." This "suggestion" about bananas will be conveyed to every nook and corner of the globe and it is quite probable that the sale of bananas will increase materially. In fact, I would not be a bit surprised to learn that some one high up in the fruit business had this song published. It sounds logical.

I do not believe it is necessary to go further into this matter to prove how materially radio broadcasting is assisting the music people, and it is gratifying to know that a great majority of them have already felt its beneficial influence in their business. The few who have not as yet been convinced, will make the important discovery before long and we will have their support as well.

ATWATER KENT

RADIO EQUIPMENT

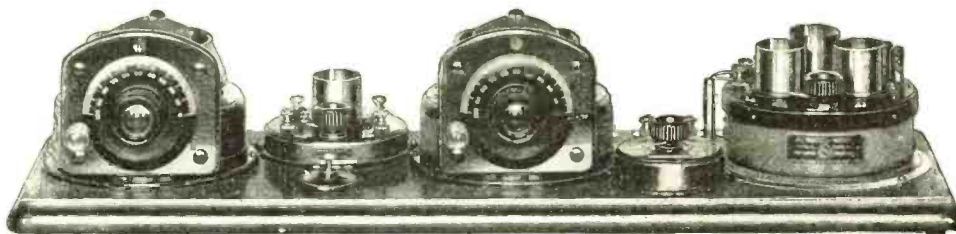

Atwater Kent Model 9 Receiving Set

Clear Reception Without Annoying Interference

THE ATWATER KENT Model 9 is an easily operated, highly efficient receiving set which gives excellent loud speaker performance on distant broadcasts. With this instrument it is easy to return to the dial settings once they have been noted.

You will find the fidelity with which the ATWATER KENT Loud Speaker reproduces tones delightfully pleasing. With it the true gift of the broadcasting artist is brought into the home. No batteries required.

ATWATER KENT Equipment embraces a variety sufficiently wide to meet the requirements of every user of radio. It includes complete sets and every instrument necessary for the assembling of sets from tuning unit to loud speaker.

If you are now working with a one-tube set, the ATWATER KENT 2-Stage Amplifier will give you the necessary volume to use a loud speaker.

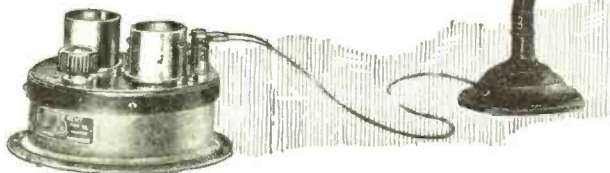

Phonograph Attachment



Literature describing the entire line of Atwater Kent Radio Sets and Parts sent on request

ATWATER KENT MANUFACTURING COMPANY, PHILADELPHIA, PA.

4943 STENTON AVENUE

q

All You Want to Know about RADIO

Here is a Radio information mine. It can't grow old nor out-of-date. It grows with new Radio discoveries. It is in loose leaf form and every purchaser is a registered owner. Every month, by mail, you get in printed, finely illustrated, punched pages every new fact concerning Radio without extra charge. You buy the book *once*.

LEFAX PERPETUAL RADIO HANDBOOK

was written by Dr. J. H. Dellinger and L. E. Whittemore, Chiefs of the Radio Laboratory, U. S. Bureau of Standards, Washington, D. C. You simply insert the pages instantly and easily in the handy pocket size, flexible bound Lefax Handbook.

It is finely, accurately illustrated. It has linen index tabs. It is clearly, cleanly printed. It gives a full list of broadcasting stations with full information about them—and new ones as they are established. Lefax is a reference and instruction book that takes all the mystery out of Radio.

Ordinary Radio guides become obsolete rapidly. Radio is developing every day. Only Lefax develops with it. The best way to keep up is to own Lefax and get the added facts every month by mail. See it, examine it, buy it from your Radio supply house, your stationer or bookseller.

Lefax, Incorporated, Publishers
147 South Ninth St., Philadelphia

Radioizing the Country School

(Continued from page 1071)

over. Market reports, lectures on cattle diseases sent out from the State Agricultural School, talks by well-known men, and all that kind of thing. Just yesterday the kids came home with the news about the trouble in Turkey; got it over the wire from some station in Denver. Next thing they'll be bringing in the President's messages.

"We get most of that stuff at home—you know I've got a set there that I use to pick up the daily reports sent out from the Denver markets. But I haven't got the time to fool away getting hooked in for these concerts. The wife's getting so she can tune in, however, and she'll soon be taking her evening concerts as nice as you please. And then my oldest boy is getting big enough to fool with the instruments and occasionally picks up something worth listening to.

"But over at school the professor knows a lot about the set and is having fine luck. He spent a couple of days before school opened getting the instruments all lined up and learning their habits. Now he knows them well enough to get about what he wants out of them."

I talked with Andy for nearly an hour, he continuing in his enthusiastic fashion and bubbling over as few of the ranchmen are prone to bubble. Most of them are staid and reserved. So is Andy, under ordinary circumstances. But I had struck a responsive chord in his make-up, and he just couldn't keep from being enthusiastic.

"They're using the apparatus in half a dozen ways. In their physics class they use it for experimenting and for demonstrating a lot of things about electricity and the like. The domestic science teacher says she is getting a lot of new recipes from the broadcasting stations. They get the standard time from the air every day. And those youngsters who live where they don't have receiving sets are given the weather reports and the market conditions whenever they want them."

The next day I saw the professor, a young chap from a Middle Western college, who is spending a few years teaching in order to get enough money to go East and study law. He was a star football man in college, and is the big, husky type to whom the Westerners' hearts soon warm up. Ward was his name, Jim Ward.

"Mr. Ward," I asked him, "what do you think of this stunt of putting radio in the school?"

"Great!" His judgment was the same as the State Superintendent's. "I've never seen a thing which took the youngsters like this, either. They are as interested in it as the parents—and in this section that's saying a lot, for the parents regard their schools as a part of their homes."

Ward was interested in radio in college, in the passing way that many are interested in it, and took the trouble to learn the intricacies of receiving the material broadcast from the stations. So when the school board asked for a principal of schools who could handle a radio receiving set Ward was all fixed to qualify for the job. He got it without argument.

"Mr. McComb probably told you how we are using the apparatus," he went on in his genial manner. "We have been

RADIO



PRODUCTS

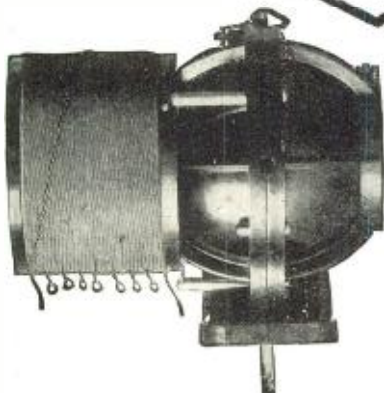

SE-AR-DE Molded RADIOMETER

Build Your Own Single Circuit Tuner

CATALOGUE No. 165

\$13.00

Range 180-3100M
" 300-3280M

R. MITCHELL & CO.

255 ATLANTIC AVENUE

BOSTON, MASS.

Operate your radio from your lamp socket with a

Gould Unipower Battery

For complete information address

GOULD STORAGE BATTERY CO.,

30 East 42nd Street

New York

SW RADIO SW

Complete Stock—Both Sets and Parts—All Makes

ROSE RADIO SUPPLY

129 Camp Street

New Orleans, La.

Send 10c for latest catalog

"New York's Grand Opera - one of the many events enjoyed by Magnavox owners"

MAGNAVOX
Radio
Reproducers and Amplifiers



MMAGNAVOX instruments are never subject to those internal interferences which, at critical moments, are so apt to mar the performance of ordinary radio reproducers.

To measure the success which Magnavox engineers have accomplished in the design and manufacture of Magnavox products, remember that they have been sold in far larger quantities than any other radio units in the world.

Magnavox Reproducers

- R2 with 18-inch curvex horn \$60.00
- R3 with 14-inch curvex horn \$35.00
- M1 with 14-inch curvex horn.
Requires no battery for the field. \$35.00

- horn and 1 stage of amplification \$59.00
- A2-R consisting of electro-dynamic Reproducer with 14-inch curvex horn and 2 stages of amplification \$85.00

Magnavox Combination Sets

- A1-R consisting of electro-dynamic Reproducer with 14-inch curvex

Magnavox Power Amplifiers

- A1-1-stage \$27.50
- AC-2-C-2-stage \$55.00
- AC-3-C-3-stage \$75.00

Magnavox Products are for sale at Registered Magnavox Dealers everywhere. Write for new 32-page Magnavox Radio Catalogue.

THE MAGNAVOX CO., Oakland, Calif.

New York Office: 370 Seventh Avenue

Perkins Electric Limited, Toronto, Montreal, Winnipeg, Canadian Distributors

2R

For every receiving set there is a /
MAGNAVOX



CONTINENTAL

"New York's Leading Radio House"

CROSLEY-XJ



New Broadcast Receiver

**Better—
Costs Less**
Crosley Products meets the demand of every Radio user both in cost and quality.

This set consists of one stage of tuned radio frequency amplification, detector, and two stages of audio frequency amplification.

This set is very similar to the well known Crosley Model X. It is equipped with new parts including the new Crosley Condensers having moulded plates, mould composition sockets, and new Miltistats in moulded cups.

A good set at a popular price means quick turnover.

2059-Q

CONTINENTAL RADIO and ELECTRIC CORPORATION
SIX and FIFTEEN WARREN STREET, NEW YORK, U. S.

THE TRINITY LOUD SPEAKER



TYPE "A1"
21" FIBER
HORN
\$25.00

TYPE "B"
(For Phonographs)
\$12.50

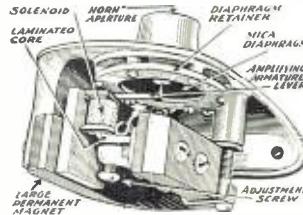

An ear phone is an ear phone no matter how fancy the horn that covers it may be, and, due to the delicate construction of an ear phone it is utterly incapable of giving true tone reproduction, especially, when relatively large currents are passed thru its coils, such as the output of a two-stage or power amplifier.

The Trinity Loud Speaker element embodies the well-proven and tested principles of the phonograph reproducer with the soundest principles of electromagnetic design best adapted for loud speaker operation. It is not an ear phone when placed on a head band and a loud speaker when covered with a horn. It is a sturdy loud-speaking element ALWAYS.

Send for Literature.

TRINITY RADIO CORPORATION

446 TREMONT STREET, BOSTON, MASS.

SOUTHERN RADIO

RADIO DISTRIBUTORS—WHOLESALE AND MAIL ORDER

GREBE—FEDERAL

THE SOUTHERN RADIO CORPORATION OF TEXAS

Successors to the Wholesale Department of ALAMO RADIO ELECTRIC CO., Inc.

San Antonio, Texas

getting about anything we want all we have to do is to tune in and find what is to be had. Everything from grand opera to market reports is at our finger tips.

"The school has a Victrola and all that; but the children are much more interested in the music we get from the air. We hook up the amplifier, and they sit there enjoying it as much as any audience at the Chicago Opera Company's offerings. No more trouble keeping up the interest in school.

When I was a kid I went to a country school in western Nebraska. We had a 'soddy' for a building, and I had to walk three miles to get there. Besides, we had only five months of school each year. So naturally I had no great interest in school. I was contented to get there an hour late, or even not to go at all.

"But now—you couldn't keep those kids away with anything short of pneumonia, and they'd come then if they could get out of the house. They will do anything for us—you know I have three other teachers under me—if we only promise them a concert or a radio lecture before we close for the day."

We went in the building to the radio room, a small ante-room which was at one time a cubby-hole for brooms and dust-rags—and there Ward gave me a treat such as I've experienced in few places. Thirty miles from a railway town, in the midst of a cattle country so sparsely settled that at night one can see less than five lights from the school house, we two sat and listened to solos and duets broadcast from the FitzSimmons Hospital in Denver, to an evening fairy story for children, to weather forecasts for the following day, and to the closing reports from the Denver and Kansas City markets.

When the program was over, and it was getting dark outside we got up from the instruments and came back to a realization of the plains and school house and the range cattle. Ward stretched himself and looked through the window at the long shadows from the mountains to the west.

"You know," he started speaking with a far-away, dreaming attitude, "sometimes I think the youngsters of this generation don't know just what they have in their hands. You and I went to a country school, walked miles to get there and after we got there sat on a broken old bench and shivered beside a cracked old stove fed with cow chips. We had a cold lunch at noon, had to be content with one teacher for a dozen youngsters scattered through eight grades, and left home at dawn and didn't get home till dark.

"Now see what they've got. The children who go to this school, for instance, while living out here on these ranches miles from town, are picked up by the busses at eight o'clock in the morning, hauled to the school house—a place heated by a furnace and equipped with the best furniture that can be bought—and again taken to their doors in the evening. They don't have to walk a mile, they can get hot lunches in the domestic science department here, the district furnishes the school books, and we have four teachers, college trained, to take care of them. They have access through this radio to the latest news of the day, the best music and everything the city children have."

I turned to leave, for the country was more or less strange and I had no desire to be wandering over the uninhabited plains after midnight.

SUPER-HETERODYNE

The World's Best Radio Receiver

BY PERFORMANCE

ADVANTAGES NO OTHER RECEIVER CAN EQUAL

- 1. UNIFORM EFFICIENCY** over the entire wavelength range of 160 to 850 meters. This means that all stations, Radio-telephone Broadcasting, Amateur and Commercial within this wavelength range, will be received with maximum intensity. This very desirable feature is not obtainable by any other practical method using Radio Frequency amplification.
- 2. SELECTIVITY** by this system, greatly exceeds that obtained in all other methods of reception. Using the Model "C" with a loop in the Suburbs of New York, WOR 15 miles distance, operating on 405 meters, can be completely eliminated, and PWX 1300 miles distance operating on 400, can be received on a loud speaker. This holds true on an average cool night. There is no telegraphic interference from 200 meter amateur stations or 600 meter ship stations.
- 3. SIMPLICITY** to change from one station to another, there are only two dials to vary. The two dials can be calibrated for all the various stations, as there is only one best position for each station.
- 4. AMPLIFICATION** is much greater than obtainable in any other standard receiver. Total is as follows: 1st the Heterodyne Amplification in the 1st Detector; 2nd, the Regenerative Amplification in the 1st Detector; 3rd the 3 stages of Tuned Regenerative Radio Frequency Amplification; working at a low advantageous frequency; 4th, the second Detector action, and 5th, the two stages of low ratio distortionless audio frequency amplification.
- 5. RECEIVING RANGE** other factors correct, the receiving range is in proportion to the effective radio frequency amplification applied. As this receiver has much greater effective radio frequency amplification than all others, the range is proportionally greater.

Complete Constructional Blue Prints Consisting of Two Sheets 50x21" and Two Sheets 27x21" Our Numbers 30141-145. \$2.00 Postpaid.

Designers of the Highest Class Radio Apparatus in the World
Experimenters Information Service 531 West 46th Street :: New York City



"THE ROLLS-ROYCE OF RECEPTION"



MODEL "C" SUPER-HETERODYNE

Wavelength Range 160 to 850 meters. Tubes, 2 Detectors, Oscillator, 3 Tuned Radio Freq. Amplifiers, 2 Audio Amplifiers.

The Super-Heterodyne is the most efficient method of short wave radio frequency amplification known. It is used extensively by the Commercial radio companies and various governments, when it is necessary to receive over extremely long distances, without interference from near-by stations.

The remarkable results are due to the Super-Heterodyne action, which is briefly as follows: the incoming signal, which may be any wave from 160 to 850, is changed thru the use of a local oscillator, to a wavelength of 10,000 meters. At this wavelength an exact duplicate of the original signal is amplified at radio frequency with the very highest efficiency possible, rectified and amplified at audio frequency.

During this change a very high degree of selectivity is secured, due to the amplifier, which is designed to pass nothing but 10,000 meters. Accordingly while there may be ten or more signals in the loop, only one will be received at a time, the one that the oscillator heterodynes thru the amplifier.



"I know the battery's all right—It's a

DIAMOND

Radio Plate

"B" Battery"

Fading, fainting batteries often lead the radio fan into a needless search for defects in his set. Diamond Batteries eliminate this uncertainty.

One worry of the radio fan banished—Diamond Radio Plate "B" Batteries stand up better, last longer, and deliver more uniform current night after night. The product of the best skill and years of experience. Our reputation is your security. Your order filled direct, if your dealer has none in stock, upon receipt of price and the dealer's name and address.

LIST PRICES

No. B-1, 22½ volts	\$3.00
5 binding posts in steps of 1½ volts,	
No. B-2, 45 volts	\$5.50
5 positive taps	
No. B-16, 45 volts	\$4.50
5 taps from 16½ to 22½ volts,	
No. B-4, 22½ volts	\$1.75
for portable sets. 5 taps,	
No. 3, Type C, 4½ volts,	3 taps. 70c.

DIAMOND ELECTRIC SPECIALTIES CORP.
 103 SO. ORANGE AVE. NEWARK, N. J.
Dealers—Jobbers, Write for Proposition.

"Better stay for supper," Ward interposed. "I live here, and the domestic science teacher told me when she left that her class left a big kettle of baked beans in the oven for me. And if you'll stay all night, for break-as: I'll offer you the best poached egg on toast you've had for a long time. We have our own light plant here, and I've got a marvelous electric toaster. How about it?"

An Inductance-Capacity Bridge

(Continued from page 1081)

Throw anti-capacity switch to "Cap" side, and throw D.P.D.T. switch to "A.C." If the condenser being measured is of smaller capacity than the standard variable one, throw the ratio arm switch to the "A" side, otherwise to the "B" side. Next adjust the resistance box until a minimum of sound is heard in the receivers; then turn the variable standard condenser until a sharp minimum is obtained. Obtain this capacity value of the standard variable condenser from the calibration curve, and if the ratio arm is at "B" multiply this capacity by the number of ohms in the resistance box at this setting. If the ratio arm is at "A" divide the capacitance of the standard by the number of ohms in the resistance box. This gives the value of the capacitance being measured.

To measure inductances, connect A.C. (buzzer), D.C. (2 or 3 volts), phones, resistance box, and a small portable galvanometer to their respective binding posts. Connect the inductance to be measured to the posts marked "L_x". (See Fig. 6). Throw anti-capacity switch to "IND" side. D.P.D.T. switch to "D.C." side, and throw upper right hand D.C. switch "ON" (Fig. 6). Adjust the resistance box, throwing ratio arm switch to "A" or "B" (to be determined by experiment) until there is no deflection of the galvanometer, showing that a direct current balance has been obtained. See "Theory" above. Now throw D.P.D.T. switch to "A.C." side leaving resistance box alone for the rest of the measurements. Adjust inductance ratio arm switches (top-center of Fig. 6) until a minimum of sound is heard in the phones. Now turn the standard inductance until a sharp minimum is heard; read this inductance value of the variometer from its calibration curve and apply the formula to be found in the "Theory" above, where L_x refers to the unknown inductance, L_s to the standard variometer, and R₁, R₂ refer to the right and left hand inductive ratio arm resistances respectively in Fig. 6. The unknown inductance is derived from this formula.

With a little practice this instrument will respond readily, and values of inductance and capacity may be read off in rapid fire order and with a very high degree of accuracy.

The tables shown herewith give a good idea of the actual measurements made with this instrument. The inductance values of a very large variometer is given with the corresponding scale readings on a 180° scale. The capacity of a 43-plate variable condenser is given against the scale readings on a scale reading of 0 to 100. The next table gives the capacity of a large standard precision condenser. This condenser was used as a standard in all of the capacity tests. The scale on this condenser read 0 to 2,500. The inductance of a vernier tuner was taken using a pancake type variometer as a



Type LT-11
\$35.00
Type LA-20
\$19.50
Without Condenser

Pat. Pend.

The Peak of Radio Perfection



Type LR-70, 3 Stages Radio, Detector.
3 Stage Audio Frequency Amplification.

The Secret is in the Patented Winding

The LOOP TUNER

TRADE MARK

and the Uni-Tune Receiver

TRADE MARK

Receiver

Eliminates Aerial and Ground with Clearer Reception. EXTREME SELECTIVITY with easy manipulation. FLEXIBILITY—4 to 7 tubes may be used at will. RANGE—DX stations on the Loud Speaker. SPECIAL WESTON VOLTMETER—Showing A and B Battery voltages. Contains all batteries for dry cell operation. Write for Circular "R."

NASSAU RADIO COMPANY, Inc.

60 Court Street Brooklyn, N. Y., U. S. A.

199 NECESSITIES

WIMCO 199 SOCKET	\$.75
WIMCO 199 C SOCKET	1.00
WIMCO 199 ADAPTER	.75

Send for free literature.
Jobbers' inquiries solicited.

THE WIRELESS MFG. CO., Canton, Ohio

MANUFACTURERS—DISTRIBUTORS

KENNEDY

The Royalty of Radio



See your dealer for demonstration of Kennedy receiving sets or write us for descriptive literature.

THE COLIN B. KENNEDY CO.

Saint Louis San Francisco



“There’s Another Station We Never Had”

Fishing for the new ones—that’s half the fun, isn’t it? And if you’ll try it with Willard Rechargeable B Batteries hooked up to your set, you’ll get a new thrill.

For when you use Willard B’s, you never need to operate with run-down batteries. You can easily keep them working always at full rated voltage, and signals you otherwise would not get, come in distinctly.

Willard Rechargeable B Batteries, too, cut out the noises produced by electrical leakage in the ordinary batteries—those frying, crackling noises that muss up the music.

They save you many dollars, because their cost is moderate and when you buy Willards, your B Battery buying is done for years.

They require recharging only occasionally—usually not more often than three or four times a year.

These are some of the reasons why eighty-one broadcasting stations have replaced other batteries with Willard B’s and why they are used by many thousands of radio fans.

Your Willard Service Station or Radio Dealer will be glad to demonstrate the superiority of Willard B Batteries. Ask him, too, for the free booklet, “Better Results from Radio”, or write direct to the Willard Storage Battery Company, Cleveland, Ohio.

Willard Rechargeable Batteries for Radio





Willard B Batteries
Willard Rechargeable B Batteries are made in 24 volt or 48 volt units, each type in two capacities, 2,500 and 4,500 m. a. h. Glass jars enable you to see the condition of your battery at all times and help prevent electrical leakage.



Willard A Batteries
Good A Batteries are as important as good B Batteries. There are several types of Willard A Batteries in a range of prices, including the Willard All-Rubber A Battery, with rubber case and Threaded-Rubber Insulation. Five sizes, 20 to 125 a. h.

For Peanut Tubes
A leak-proof, noise-free storage battery that costs little, lasts for years and has many advantages over the ordinary peanut tube battery. See your Willard Dealer, or send for descriptive literature.



Dr. Wm.D. Reynolds,
Denver, Colo.

Hyattville, Wyo.
May 30. 23.

Dear Dr:

As to results obtained with the little Electric Specialty Dynamotor, I am pleased to say I have been getting wonderful results with it, but instead of running off 6 Volt battery, have been using an 8 Volt, which gives me a high voltage of .600 Volts and, what everybody says, a Beautiful Tone, every card I get mentions that a fine note I have; I have talked one (using loop modulation) with 5SK at Fort Worth Texas, after daylight in the morning, Falconi at 5ZA Roswell New Mex. says my fone so QSA he can hear it 10 feet from bones, and work him with CW way after sun rise, which is going some; I work most all the Boys in Denver and they're all crazy about my tone. I am more than pleased with the Dynamotor, and any time I can be of service to you regarding its action just let me know.

Yours truly,

B.G. Vandlyke

TRADE "ESCO" MARK

Quality always Supreme

ELECTRIC SPECIALTY COMPANY
STAMFORD, CONN., U. S. A.

standard. The values of the main inductance, rotor, untuned primary, and loading coil are given in the table.

It is of course possible to obtain values of fixed inductances and capacities as well as variable ones. As an example, the capacity of a "Ducon" antenna plug condenser is given. This plug consists of two mica condensers, one on each side of the lighting circuit. It is seen from the table that these condensers are each about the size of an ordinary grid condenser. The capacitance of a tapped blocking condenser is also given in the next table. This table gives also the dielectric loss resistance and the tangent of the angle of phase displacement. The phase difference in radio condensers should not exceed 2 degrees, and it is seen from the table that this condenser is well within these limits. The author will explain in

Capacity and Inductance Data Obtained With Capacity-Inductance Bridge

Ind. in Millihenries	Scale Reading	Capacity of Variable Condenser	Capacity of Gen-Leeds-Northrup Variable Condenser		Capacity of Ohio 43 Plate Condenser	
			Scale Reading	Capacity in M.M.F.	Scale Reading	Capacity in M.M.F.
2.50	5	0	25.0	0	48	
4.75	10	10	48.0	200	98	
6.00	15	20	73.8	300	155	
6.90	20	30	117.0	400	213	
8.00	25	40	160.8	500	274	
9.50	30	50	201.4	600	334	
10.95	35	60	243.5	700	394	
12.00	40	70	301.0	800	454	
13.50	45	80	358.0	900	514	
14.80	50	90	414.0	1000	574	
16.00	55	100	484.0	1100	634	
17.00	60			1200	694	
18.10	65			1300	754	
19.10	70	Inductance of Bremer-Tully Vernier Tuner		1400	815	
20.20	75			1500	876	
21.10	80			1600	929	
22.08	85			1700	1002	
23.04	90	Main Inductance Tap		1800	1065	
24.00	95			1900	1128	
25.00	100			2000	1192	
26.00	105	F to S	.20 m.h.	2100	1255	Capacity of Du-bilier "Ducon" Antenna Plug
27.00	110	F to 1	.12 m.h.	2200	1318	
27.95	115	F to 2	.10 m.h.	2300	1380	
29.00	120	2 to S	.10 m.h.	2400	1441	
30.10	125			2500	1492	
31.20	130	Rotor	.12 m.h.			
32.45	135					Capacity of Du-bilier "Ducon" Antenna Plug
33.80	140	Untuned Primary	.09 m.h.			
35.10	145					
36.50	150					
38.00	155	Loading Coil	.21 m.h.	Red Dot Side = 325 M.M.F.		
39.30	160					Black Dot Side = 258 M.M.F.
40.35	165					
41.20	170					
42.02	175					
43.00	180					

Capacity Data on DeForest Blocking Condenser

Tap	Cap. in M.M.F.	Dielectric Loss Resistance	Tan $\delta \times 10^{-7}$
1	244	117 Ω	18167
2	454	105 Ω	29950
3	754	44 Ω	20844
4	1050	34 Ω	22431
5	1380	16 Ω	13872
6	1694	15 Ω	15967
7	2065	14 Ω	18681
8	2380	14 Ω	20936
9	2664	12 Ω	20085
10	2960	10 Ω	18598

Tan $\delta = 2\pi f CR$
at 1,000 cycles $2\pi f = 6283$

Phase difference varies from approximately $0^\circ 4'$ to $0^\circ 10'$

RADIO VETERANS DEMAND

\$7.65
"Professional"

TRIMM

\$5.00
"Dependable"

Head Sets



The finest instrument of its kind that money and science can produce. Molded Bakelite cases and ear caps; single bar Tunksten steel magnets; light weight; exceptional tone and volume. A \$12.00 quality for \$7.65.

\$10.00
ACOUSTICOLA
Phonograph Attachment

Positively the only headset on the market sold with a lifetime guarantee that covers every detail of materials and workmanship excepting only cords and shells which cannot be guaranteed against breakage if dropped. Absolutely no charge AT ANY TIME for repairs, replacements or for re-magnetizing. The head sets to buy: the head sets to sell.

See! Hear! the
TRIMM
LOUD
TALKERS
\$22.50

Composition Horn
ACOUSTICOLA



Standard bi-polar construction. Aluminum case. Splendid finish; beautiful appearance. Wonderful volume and clarity of tone. Compare the Trimm "DEPENDABLE" with any \$6.50 to \$8.00 headset on the market. Money back if not satisfied with any TRIMM product.

\$35.00
ACOUSTICOLA
GRAND
With Cast Aluminum Horn

All fitted with Special TRIMM jumbo size Loud Talker Unit. Write for folder. Or order samples with privilege of return after 5 days' examination and test.

Trimm Radio Mfg. Co. Dept. 64

24-30 S. Clinton St.,
CHICAGO, ILL.

CARTER
Vernier Control Rheostat
Only one knob—closest adjustment. Positive contact. Pistall connection. Write for complete catalog.

Carter Radio Co.
207 S. State St. CHICAGO

BECOME A PROFESSIONAL PHOTOGRAPHER
EARNING \$35 TO \$125 A WEEK
Three to six months' course. Motion Picture, Commercial, Portraiture. Practical instruction. Modern equipment. Ask for Catalog No. 56.

N. Y. INSTITUTE OF PHOTOGRAPHY
NEW YORK CHICAGO BROOKLYN
141 W. 38th St. 630 S. Wabash Ave. 503 State St.

detail in his next paper how to obtain this equivalent series or dielectric loss resistance, and also how to get the phase difference, the "effective" high frequency resistance, impedance of radio frequency circuits, time constant of inductances, distributed capacity, and the wave-length range covered by inductances and capacitances.

TUSKA RADIO

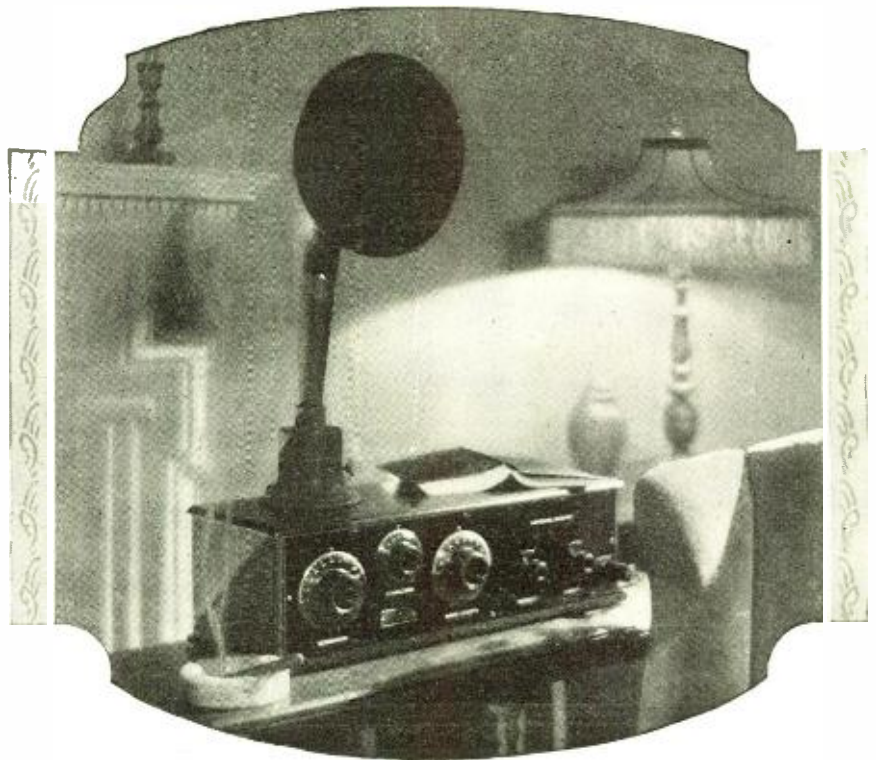

The Tuska Superdyne Radio Frequency Receiver

Radio enthusiasts who have had the opportunity to hear this new Tuska creation are amazed at its wonderful range, selectivity and volume. Uses four tubes but equals or surpasses the performance of six-tube sets. Write for special folder II-H.

Your Tuska will please you for years

Your first enthusiasm over a Tuska Radio grows stronger as time proves the wisdom of your purchase. The Tuska is graceful in appearance, but it is also sturdy, trouble-proof, simple and highly efficient. It is designed and built for years of practical use; not merely to take advantage of an eager market.

There is nothing untried or experimental about Tuska Radio. C. D. Tuska, whose finely made radio apparatus has been admired, praised and used by experts for thirteen years, personally supervises the construction of Tuska Radios. Each type of set is built with scrupulous care, in surroundings that inspire and encourage the best of workmanship.

Some Tuska sets cost as low as \$35; others are larger and more expensive. But they are all equally well built, for we expect to be as proud of years-old Tuska sets as their owners will be.



Records of distance made by Tuska users prove that Tuska Receivers will reach as far as any. It does not require an expert to tune in far away stations—you can do it.



Mr. Carl R. Beker, of Bloomingdale, N. Y., reports receiving 26 stations in three hours one evening—and his experience has been duplicated by other Tuska owners.

THE C. D. TUSKA CO., Hartford, Conn.

WALBERT MANUFACTURING COMPANY

MANUFACTURERS OF
FINE MECHANICAL TOYS, GAMES,
MUSICAL AND RADIO SPECIALTIES
925-941 WRIGHTWOOD AVE.
CHICAGO

Today

RADIO FANS
EVERYWHERE

Subject: *Efficient Tuning*

DEAR READERS:—

Many thousands of you have learned that UNIVERNIER control is the best and cheapest improvement you have added to your set. At our booth at the Chicago Radio Show, we heard from you countless expressions like this: "My set is now 100 per cent. more selective and easier to tune," "I put three UNIVERNIERS on my neutrodyne set and last night got twenty stations a vernier condenser out of date." We were even asked repeatedly how to apply a UNIVERNIER to a vernier condenser. Such comments from people who know, must have a logical foundation. Briefly, the facts are as follows:

Micrometrical control of the whole variable condenser, the variometer, the tickler, etc., is the only practical and theoretically sound method for obtaining efficient vernier control. The entire range of your set is thus under continuous vernier control, permitting reception of many signals which are passed by unknowingly with intermittent or no vernier control.

The UNIVERNIER simply takes the place of the ordinary knob without altering your set. The simple mechanism contained within the knob gives you a twelve to one ratio and also direct control at will. The pointer always indicates the true position of the instrument, because it is rigidly attached to the shaft. The UNIVERNIER has the approval of leading radio engineers, and we submit it with confidence for yours.

Yours for better reception,

THE WALBERT MANUFACTURING COMPANY.
P. S.—You will find that the UNIVERNIER certainly will dress up your panel.



Made in two sizes:
No. 188 for 3-16" shafts
No. 231 for 1-4" shafts

THE UNIVERNIER \$ 1.25

At your dealer or postpaid on receipt of above amount.
Dealers and Jobbers Write for Discounts.
THE WALBERT MANUFACTURING COMPANY
935 Wrightwood Ave., Chicago, Ill.

Clear as a Silver Bell

O-T SILVERTONE TUBES

(Registered)

In your radio set assure—

sharp, clear, mellow tones—
music with its delightful and thrilling modulations—
speeches without distortion, audible down to a whisper—
and all the other joys of Radio at their best

Three Models

O. T. 1A—2 to 4 volts,
Battery Draw .15 amps. Price, \$6.00

O. T. 9—2 to 4 volts,
Battery Draw .06 amps. Price, \$6.50

O. T. Power Tube—5 volts,
Battery Draw .25 to .35 amps. Price, \$7.50

At your dealer or direct by mail.
Write for complete literature.

Manufactured by DeForest Tel. & Tel. Co.

Exclusively for the

O. & T. Electric Corporation

1819 Broadway, New York
High class representatives wanted.

The O-T is the only genuine Silvertone Tube.
Fully guaranteed.
Beware of imitations.



Carter \$2.00
Inductance Switch

No sliding contact, 1-15 points.
Special numbered knob and dial included. Send for catalog.

Carter Radio Co.

207 S. State St. CHICAGO

DELTA GOLD STRIPE

Radio Headphones

DELTA ELECTRIC CO.
Marion, Indiana

Fig. 7 is the calibration curve of a typical 43-plate variable air condenser. The capacity in micro-microfarads is given, plotted against the scale readings on a scale which read 0 to 100. It is to be understood that a micro-microfarad (written mmf. or $\mu\mu\text{f.}$) is one-millionth of a microfarad, which in turn is one-millionth of a farad, so that a microfarad is sometimes written 1×10^{-6} farad, while a micro-microfarad is written 1×10^{-12} farad. Inductances, on the other hand, are usually expressed in millihenrys, instead of microhenrys. A millihenry is one-thousandth of a henry, and is sometimes written 1×10^{-3} henry. Thus .001 mfd. (the ordinary value of a 43-plate condenser) could be expressed $.001 \times 10^6$ farad, or 1×10^{-9} farad, while 250 micro-microfarads (the ordinary value of a grid condenser) could be expressed 250×10^{-12} farads, or by 250×10^{-6} microfarads. An inductance of .12 millihenrys could be written $.12 \times 10^{-3}$ henrys, or 12×10^{-5} henrys.

The amateur should have little difficulty in making inductance and capacity measurements similar to these tables, and by so doing will be able to design his radio instruments scientifically.

Correspondence from Readers

(Continued from page 1108)

LESS JAZZ

Editor, RADIO NEWS:

I have been a constant reader of RADIO NEWS from the beginning. Also a "Radio-phan." After reading Mr. George Niemi's letter, "Attention Announcers," I will say that I certainly agree with him. I myself have listened equally as long many times for an announcement of a station with the same results he points out.

The Chicago Board of Trade Station, WDAP, is the best station in the United States today, and should be congratulated, as they make it a point to announce their station even during the shortest intermission in the music. I travel quite a lot, and wherever I go the sentiment seems to be the same. Too much jazz and singing. There are today thousands of people who love the old-time music but turn away from the loud speaker as soon as the jazz comes in. There are thousands of good old-time songs and instrumental numbers that would be appreciated far more than this jazz. One can tune in any night and 90 per cent. of the music is jazz. Station WBAP, at Fort Worth, Texas, I believe, is the most popular station in the United States simply because they have a splendid station, and an announcer who gives the radio listeners what they want, namely, good old-time music. The state of Texas should be proud of this station. And when the rest of the broadcast stations take pattern from WBAP, radio will be much more popular as well as beneficial. Therefore, I say, give us the old-time music and less songs and jazz. Give the older people a chance to enjoy radio as well as the younger ones. I would like to hear what others have to say regarding old-time music through the columns of your splendid magazine.

H. S. STAUER.
Winnett, Mont.

INTERFERENCE A DETRIMENT

Editor, RADIO NEWS:

In the December issue there appeared an article about making the receiving set simple to operate. While this article is true, I think the first thing to be done toward the betterment of radio is to remove the

A Transformer of Real

Merit

*Amplification
of Entire
Musical
Range
Free from
Distortion*



The winding that Kellogg developed, was found to be most efficient for audio frequency transformers. Its problems involved the finding of the proper thickness of paper, the proper kind of insulated wire to provide the proper number of ampere turns, and impedance.

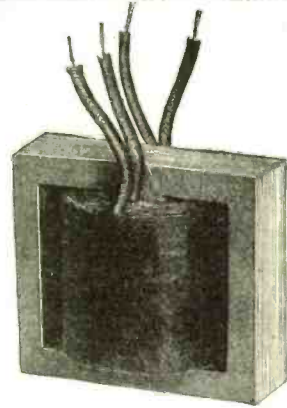

The one-piece laminations of silicon contain no punched holes, which in many other transformers causes eddy currents and losses. The one-piece lamination is exclusively a feature of the Kellogg transformer. It provides an exceptionally true electro-magnetic core.

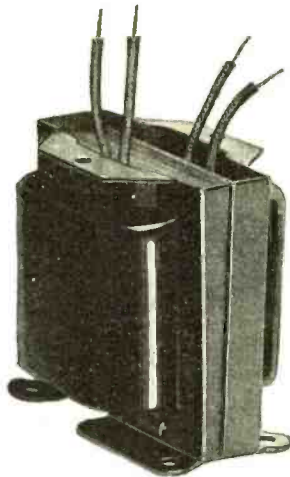

To correctly shield these transformers that they may be mounted in any position desired without losses, this brass shield was designed. It is so arranged that both sides are interchangeable, locking together at the base. They are finished in a handsome maroon enamel.



The wires extend through the Bakelite top, which affords perfect insulation, and are soldered to the terminals in plain sight, where they may be inspected. This also eliminates any possibility of breakage of transformer leads.



The finished job, of which we are mighty proud. The leads are soldered to tinned terminals, which are under nickel plated nuts over which are placed knurled nuts. Each binding post is plainly marked so that it is impossible to make incorrect connections.



Amplify the pleasure of your radio set by installing Kellogg audio frequency transformers. Second to none in volume, clarity and freedom from distortion.

No. 501—Ratio $4\frac{1}{2}$ to 1. No. 502—Ratio 3 to 1. Only \$4.50 each

Built and Guaranteed by

Kellogg Switchboard & Supply Company

1066 West Adams Street, Chicago

After All, It's Quality that Counts—

Build Your Set with High Quality Regal Parts

REGAL INDUCTANCE SWITCH No. 164

The real genuine "REGAL." A complete assembly of switch points in one unit. No more drilling holes in panels. No more chipped panels. No more messy soldering back of panels. Mounted on panel with one threaded bushing and nut.

Complete with handsome knob and dial.....\$1.50



REGAL" RHEOSTATS are known the world over for their high quality. Smooth positive contact. One thread bushing only for mounting.

Vernier 6 Ohms	\$1.25
Vernier 30 Ohms	1.25
Regular 6 Ohms	1.00
Regular 30 Ohms	1.00
Junior 6 Ohms75
Junior 30 Ohms75
Potentiometer 200 Ohms	1.50

DEALERS — JOBBERS — DISTRIBUTORS

Ask for our new Catalog No. 18 showing 30 handsome "REGAL" items.

The American Specialty Co.
115-220 HOLLAND AVE., BRIDGEPORT, CONN.



NEW "REGAL"
VERNIER
RHEOSTAT

commercial stations to a higher wave-length so there will not be any interference with broadcasting. If radio is to become as common as the telephone, the people will want sets that they can go to at any time and pick up a concert clear and distinct and listen to it until the broadcasting station signs off. It is almost impossible to listen to a station that is located over 200 or 300 miles without being interfered with. I think this is a big stone in the way of progress. The people will get disgusted with radio. It is not the amateurs who are interfering, but the commercial stations, and the sooner the people realize this and cease condemning the amateur the better off they will be. I am a BCL and I know that the amateurs are our friends, not enemies. If a person has ever tuned in a station and has had some commercial station come pounding in, he will know what I mean. At any hour in the evening one can hear these stations. I think this is unfair to the listener-in. It should be regulated, as radio is now accepted as a necessity in the home.

G. R. SCOTT,
2245 Campbell Park,
Chicago, Ill.

A CAMEL THAT WOULD WALK A MILE FOR RADIO NEWS

Editor, RADIO NEWS:

I am forwarding herewith a photograph and details of my "nutshell" wireless.

Perhaps I should say a word or two about us antipodeans and the "craze." It has caught on, and badly at that. Five years ago there was no such thing as a wireless shop in Sydney; now we have 14 dealers, besides numerous electrical houses which carry radio as a side line. The same applies to publications. A few years back one had practically to file a petition to secure a copy of a wireless journal. At that time one could

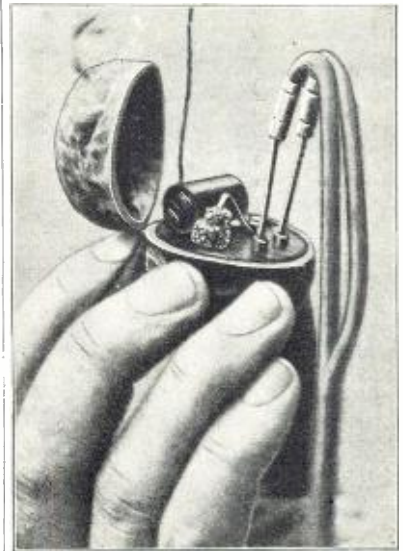

Radio in a Nutshell.

pass it on a dozen times at a profit. Now one sees RADIO NEWS at every bookstall, and in every country town.

I recall a little incident that may be of interest to your readers.

I am continually traveling, and a few months ago I was at a place called Bourke, where camel transport is a feature. One day while strolling around a transport camp, my attention was attracted by a slight commotion, in which an irate driver and a camel were the leading characters. The camel, placid as usual, was calmly chewing and surveying the man, who, holding a torn magazine in one hand, was shaking the other at

RADECO SAFETY FUSES

(Patented)

Now available for
DEALERS' SALE



Radio users have learned that *Radeco Safety Fuses* are a necessary tube protection—that their price (50 cents) is small compared with the great service they render.

The merit of the fuses, their low price and our extensive advertising have created a ready sale.

Up to now these fuses have been sold direct by mail, but the demand is so great that we want to distribute them in larger units through the trade channels. You will find *Radeco Fuses* a profitable item to add to your stock.

To assist you in handling them, we have made up attractive display boxes in colors containing an assortment of two dozen fuses.

Price per box (2 dozen fuses)
\$12.00

Subject to Regular Trade Discounts
Order Today

Radio Fans! Radeco Fuses can now be purchased at your Dealers

RADIO EQUIPMENT COMPANY
New England's Oldest Exclusive Radio House

20 STUART STREET BOSTON, MASS.

Unity Rheostats are the Best

Vernier and Non-Vernier
The Unity Vernier Rheostat

The highest type electrical instrument made for controlling resistance.

"Hear a set that uses Unity Rheostats"



Price \$1.75
6 ohms, 25 ohms, 40 ohms

The Unity Non-Vernier Rheostat

or the Cartridge Rheostat

Resistances are interchangeable without removing the bracket from the panel
Unity Potentiometer Cartridges also fit the Unity Brackets

If your dealer cannot supply you, send your check or money-order to the factory with dealer's name.

UNITY MFG. CO., 228 North Halsted St., Chicago

Dealers are offered a free Counter Display Card



6 ohms, 25 ohms, 40 ohms	Other resistances if desired
Complete Rheostats . . . \$.90	Cartridges, any resistance . . . \$.25
Potentiometers, complete, 200 or 400 ohms . . . \$ 1.45	Potentiometer cartridges only . . . \$ 1.00

More than half a million in service

Standard equipment on the better sets



ALL-AMERICAN Amplifying TRANSFORMERS

AUDIO AMPLIFICATION

—to get *all* stations clear and strong

Distant reception is largely a matter of *amplification*. Therefore, to add to the power and range of your set—easily and at trifling cost—simply improve your audio amplification.

For the best possible audio frequency amplification—*volume without distortion*—all the “old-timers” will tell you to use All-American Audio Frequency Transformers. Your dealer will advise the proper type.

You will be highly pleased with the added distance you get—and the greater clarity and strength of the voices and instruments you hear from out of the air.

Note the special offer below.

ALL THE BETTER
Dealers Recommend
THE “ALL-AMERICAN”



All-American Socket

One-piece molded bakelite—for panel or base mounting. Finest socket money can buy. Only 75c.



Power Amplifying Transformers for “Push-Pull” Circuits. (Input and Output Types.) Price each \$6.00.

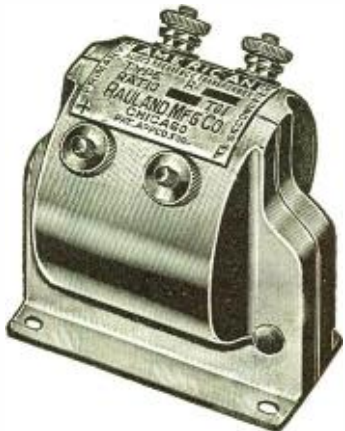

All-American Audio Frequency Transformers are available in three ratios: 3-1, 5-1, 10-1. Prices: \$4.50, \$4.75, \$4.75.

POWER AMPLIFICATION

—for *utmost* volume and pure, rich tone

The addition of the well-known “Push-Pull” form of power amplification to your audio frequency amplifier—by means of All-American Power Amplifying Transformers—develops maximum volume, with a roundness, richness, depth and purity of tone that will amaze you.

Use any good loud speaker—you’ll be more than delighted.

Exhaustive tests prove conclusively that All-American Power Amplifiers are the most efficient, most satisfactory “push-pull” transformers that have ever been made. Here again All-Americans lead the industry.

Read the special offer below.

RAULAND MFG. CO.
Pioneers in the Industry
204 North Jefferson Street, Chicago

We Will Send You the latest All-American diagram and circular, describing Power Amplification; also the famous All-American book of Tested Hook-ups—on receipt of 4c in stamps to cover mailing charges.

Read This Offer

LARGEST SELLING TRANSFORMERS IN THE WORLD

The B-D Electric Soldering Outfit

\$2.00 Retail

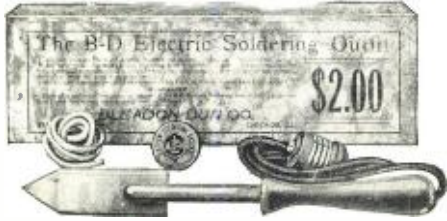

Used by Housewife

The only complete Electric Soldering outfit on the market. Handy and ideal for home, factory, and radio work. The B-D Electric Soldering Iron is made of *Copper* from accurate dies, the heating element being contained in a unit of one-piece construction. It is of special construction, the highest grade Nichrome wire being used. Outfit contains electric soldering iron, cord, plug, soldering paste and solder, all contained in strong handsome box.



For Wire Connections



For Radio

The workmanship and heating element of the B-D Electric Soldering Iron is fully guaranteed for a period of one year.

GUARANTEE

Manufacturers

BLEADON-DUN CO.

Dept. B.D.2

213 S. Peoria Street

Chicago



For Automobile

the camel. "This 'flaming cow,' (American equivalent, 'gol durned son of a gun') has chewed up me bloomie' RADIO NEWS," he cried.

True, it had done so; camels are noted for their versatile appetites, but it meant a terrible loss to the poor chap 500 miles from anywhere.

I discovered while chatting with the driver that he had a small, yet very efficient crystal set fixed in his wagon. At night he would stretch out long lengths of wire and listen in. He had served, during the great war, in the Signal Corps, and consequently he was quite at home with the dots and dashes.



A Terrible Battle Between a Camel and His Keeper Over the Possession of a Copy of Radio News!

I might mention a peculiar effect, or shall I say phenomenon, noticeable in Sydney. By way of experimentation I constructed a large loading coil and listen in occasionally on 60,000 to 100,000 meters. When on the "full coil," static is considerably eliminated, but peculiar roars punctuated by periods of silence manifest themselves. I can only conceive these sounds to be some "aurora" disturbance from the South Pole. I wonder if any of you South American readers could follow up this experiment? I hope to let you have some more news later.

FRED C. JONES, 20G.
Box 126
Sydney N. S. Wales
Australia.

A GOOD RECORD

Editor, RADIO NEWS:

Here are a few distances and comments on phone stations I heard on the way across. I don't consider any of them records, but wish I had had a real set to listen in with. Was using only one tube with a single circuit regenerative, home-made set.

Sept. 5, approximately 1,000 miles east of New York: WDAP, WJAX, KOP, WOR (at 1,000 E. WOR generator hum as loud as signals.)

Sept. 6, approximately 1,213 miles east of New York: WGY.

Sept. 7, approximately 1,475 miles east of New York: WJAX, WJAU, WGY, WDAP, WJAZ, WDAR—at 12:10 A. M. E. S. T., heard a station which I think was State Police, Harrisburg, Pa., sending police reports.

Sept. 8, approximately 1,725 miles east of New York: WDAP.

Sept. 9, approximately 1,900 miles east of New York: WDAP. Also organ recital from some New York church. Address letters Skinner Organ Co., also announced Burr McIntosh for later date.

Sept. 10, 2,090 miles east of New York: "The Voice from Way Down East," WOR, WGY (sermon most all heard), WHAZ, WEAR (doubtful).

Sept. 11, 2,300 miles east: WDAP, WGY.

Sept. 12, 2,500 miles east. WMAF. Static roaring, so I knocked off at 8:45 P. M., E. S. T.

Sept. 13, 2,770 miles east: WMAF, WGY.

Sept. 14, approximately 3,030 miles east of New York: Passed Cape St. (?) Vincent, Spain, about 6 P. M., E. S. T. WDAP had some fine dance music. Descrip-

An Absolute Guarantee
with every instrument
made them famous!

SHAMROCK
FOR SELECTIVE TUNING

180°

Vario-Coupler

List price,
\$3⁵⁰ each



DOUBLE
DUTY
PIG-TAIL

Variometer



SHAMROCK MFG. CO.
318 Market St. Newark N. J.

LEARN THE CODE AT HOME

"Just Listen—The Omnigraph will do the teaching"

with the

OMNIGRAPH

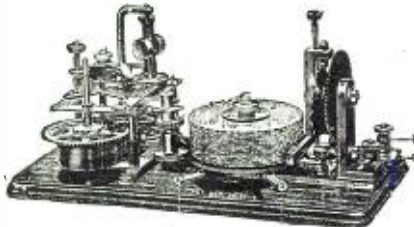

THE OMNIGRAPH Automatic Transmitter will teach you both the Wireless and Morse Codes—right in your own home—quickly, easily and inexpensively. Connected with Buzzer, Buzzer and Phone or to Sounder, it will send you unlimited messages, at any speed, from 5 to 50 words a minute.

THE OMNIGRAPH is not an experiment. For more than 15 years, it has been sold all over the world with a money back guarantee. The OMNIGRAPH is used by several Depts. of the U. S. Govt.

—in fact, the Dept. of Commerce uses the OMNIGRAPH to test all applicants applying for a Radio license. The OMNIGRAPH has been successfully adopted by the leading Universities, Colleges and Radio Schools.

Send for FREE Catalog describing three models, \$14 to \$30. DO IT TODAY.

The Omnigraph Mfg. Co., 20 Hudson St., New York City

If you own a Radio Phone set and don't know the code—you are missing most of the fun



CHICAGO

Getting distance ~ with ease!

ONLY those who have built their own sets experience that priceless thrill of personal achievement which comes surging in with the sound waves caught from afar off.

Tuning out or in at will, erasing interference in favor of the sending point sought, is always most easily accomplished by *synchronized* apparatus.

Don't build mongrel sets. Even if parts used are each of highest quality—but the products of various makers, they will hardly work together as efficiently or harmoniously as if they were the products of one reputable manufacturer. You'll find sets built up of

Gilfillan Radio Parts

perfectly synchronized. While these parts will of course do good work in conjunction with apparatus of other makers—the best results—at probably no greater expense, is obtained by using Gilfillan parts throughout.

See your dealer today and have him show you Gilfillan parts. Even on sight you'll appreciate their superiority.

If your dealer does not handle this superior line, write us for name of nearest dealer, descriptive folder and list.



LOS ANGELES

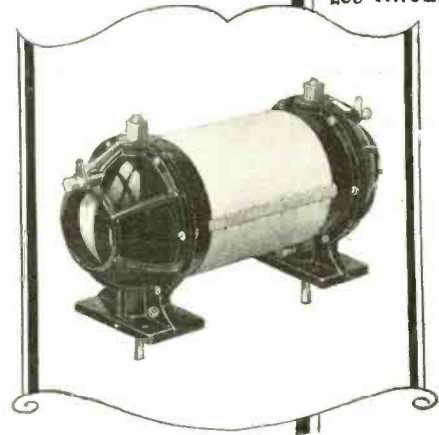

Gilfillan Tuning Unit

Another Gilfillan achievement making for increased simplicity and greater efficiency. This unit replaces two variometers and one variocoupler. Note how compact it is. Wave length range 225 to 890 meters, covering all broadcasting. High selectivity in tuning. Brown moulded bakelite. Split bronze bearings. Net weight 22 oz. Height 4 3/4". Diameter 3 3/4". Length 8 1/2".

Genuine Gilfillan Radio Parts can always be identified by this trade-mark—look for it

GILFILLAN BROS. INC.

1925 McGee St.,
Kansas City, Mo.

1815 W. 16th St.,
Los Angeles, Cal.

225 W. 57th St.,
New York, N. Y.

Licenses General Bakelite Co.



Sears, Roebuck and Co.

The World's Biggest Mail Order House

3,000 OHMS Head Set

At last—the inexpensive, efficient head set you've been looking for, and **only \$2.98!** Makes clear those distant signals. Fits your head as comfortably as your cap. Complete with six feet of good grade cord. Excellent workmanship. Order NOW! Shipping weight, 1½ lbs. Shipped from CHICAGO or PHILADELPHIA store.

\$2.98

57AB9220—...
Order Direct From This Advertisement

Save On All Radio Supplies

Our big FREE Book shows hundreds of bargains in radio supplies and complete sets. Highest quality apparatus. Satisfaction guaranteed. This new, fascinating catalog tells "How to Build an Aerial." Complete list of broadcasting stations. Many new "Hookups." Write today! Ask for Radio Catalog No. 82R98.

Mail This Coupon NOW



Sears, Roebuck and Co.
Chicago — Philadelphia

Send me FREE Radio Catalog No. 82R98.

Name _____

P. O. _____ State _____

Rural Route _____ Box No. _____

Street and No. _____

The Better Class of



Radio Equipment



Filament Rheostat
The 4 ohm type is a necessity on UV200 and UV201 tubes. Gives fine regulation and dispenses with troublesome vernier. 10 ohm type gives close regulation of current for UV-201A tubes; also for WD11 and WD12. 50 ohm for UV-201A or UV199. Also 50 ohm type. Best looking and most efficient Rheostat made. Price 75c and \$1.00.

Portable Rectifier

A type designed according to the latest specifications adopting the 5 amp. charging rate. Simplicity, ease of adjustment and tapering charge, are features. 50 and 60 cycle 6 and 12 volt \$16.00. Add \$1.00 west of Rocky Mountains.



Audio & Radio Frequency Transformers

One of the original transformers of the radio field. The Audio type gives louder signal amplification, best tone qualities, and uniform amplifications. List price \$1.00. The Radio types are limited to the range of wave lengths over which they will operate successfully. Responds to range of 200-600 meters. Gives sharp tunings. Price \$1.00.



Pocket Voltmeters

All types for testing of "A" and "B" Batteries, dry and storage. Draw just the right amount of current from battery while voltage is being read to make readings entirely accurate. New No. 45 voltmeter is used for testing the amperage of "A" Battery Cells and voltage of "B" Batteries. Price \$4.00. Other types \$1 up.



You Never Know How Good Your Radio Set Is— Until You Use Sterling Parts.

The Sterling Mfg. Company
2580 Prospect Ave. Cleveland, O.

tion of Firpo-Willard fight was clear and loud. Then later WGY came in with some fine music and next week's program. Copied most of program.

Of course, these weren't the "three feet from phones" kind of signals, but were clear and loud enough to make no mistake. They were not steady, but would fade for a few seconds at times.

Stations on waves below 400 meters are easiest to hear at sea, as some ship is always jamming you when above 400. Also music can be enjoyed when you can get practically no sound of the voice.

On the night of Sept. 17 we were about 365 miles S. E. of Genoa, Italy; I listened in a few moments before turning in. Static was crashing, but I heard a station which I think was WGY at 8:07 P. M., E. S. T., playing a flute solo. At 8:13 P. M., E. S. T., a piano solo and at 8:30 P. M., E. S. T., started on a speech.

I wonder how many commercial ops find NAA tube set N. G. Power seems to vary and at a distance, with bulb oscillating (to copy by C.W.) it's impossible to copy. Bad enough to have some of the strikers (?) practice on you, but added together they make you want to hang the phones up.

L. J. PEEK, S. S. West Elscasco.

IN A NUT-SHELL

Editor, RADIO NEWS:

It appears that Mr. W. W. Brackenridge and Mr. G. W. Lewis both need a little assistance in their discussion of single and triple circuit receiving sets.

In the December issue Mr. Lewis signs off by saying, "Yours for the abolition of the re-radiating circuit receiver." Since when, may I ask, is a double or triple circuit receiver a non-radiating receiver??? You can send very nearly as far and cause just as much trouble with a triple circuit receiver when put into a state of "oscillation" as you can with a single circuit receiver.

Furthermore, the novice is liable to get the three circuit into a state of "oscillation" more often than when using the simplified single circuit receiver.

Remember, Mr. Lewis, that the Armstrong patent covers regeneration, amplified radio frequency only and not "oscillation." That point on the tickler or plate variometer where the circuit is just about to spill over is Armstrong's property, and when properly employed, does not cause re-radiation or distortion.

Down here in New Orleans, triple, four and five circuit tuners are of no avail through the Naval station.

So, when they abolish the re-radiating receiver, your three circuit prize tuner will go with the single circuit receiver.

E. T. JONES,
864 Roosevelt Place, New Orleans, La.

A SIMPLIFIED REGENERATOR

Editor, RADIO NEWS:

In the March number of RADIO NEWS there appeared an article by H. L. Peterson entitled, "A Simplified Regenerator," in which was described a modification of the Ultra-Audion Circuit.

I would like to add, for the benefit of those who have built this set, that a 43-plate condenser shunted across the antenna circuit from aerial to ground connections will greatly sharpen the tuning and strengthen reception. A variable grid leak will also be of benefit. Using a tuning coil of 80 turns, wound upon a tube 4 inches in diameter, the whole broadcasting range may be easily tuned in, and if two stages of audio frequency amplification are added, the volume of sound received is sufficient to operate an or-

SEE OUR GUARANTEE HOOK-UPS and CATALOG FREE

REDUCED PRICES ON STANDARD QUALITY PARTS

SERVICE AND QUALITY BUILT THIS HOUSE

WE PAY TRANSPORTATION CHARGES IN THE UNITED STATES ONLY



PHONES THAT HAVE STOOD THE TEST

- E161 Frost double set 3000 \$3.35
E171 Frost double set 3000 \$4.05
E162 Frost double set 2000 \$4.05
E163 Frost double set 3000 \$4.65
E172 Frost double set 3000 \$5.19

- set 3000 mfd. \$5.19
E166 Brantley Superior double set. \$5.19
E167 Brantley Navy type double set. \$5.75
E168 Genuine Type C Baldwin Phones double set \$10.50
E169 Genuine Type C Baldwin Unit with cord \$5.15

- BALDWIN LOUD SPEAKER \$25.00
SPAGHETTI AND WIRE
E33 Per 1-ft. length \$2c
E32 Tinned Paper No. 16 Wire \$1c
E34 Wire with insulation similar to spaghetti on it. Wire is tinned for soldering. Price 10 feet \$29c

- ERLA R. F. TRANSFORMER
Specily 1st. 2nd and 3rd stage. \$3.40
ERLA REFLEX TRANSFORMER
E1650 Reflex Transformer \$4.40

- TESTED CRYSTALS
E12 Galena, per pkg. \$0.10
E13 Silicon, per pkg. \$0.10

- JACKS AND PLUGS
E133 One spring (open circuit) \$0.32
E134 Two spring (closed circuit) \$0.42
E131 Four spring (two open circuits) \$0.50
E135 Three spring (two open circuits, called "single filament control") \$0.53
E136 Five spring (two open and two closed elements, commonly called "two circuit filament control") \$0.69
E139 Plug with threaded barrel instead of set screw. Takes cord tips. \$0.45

- VARIABLE GRID LEAK
E50 Grid Leak \$13c

- GRID AND PHONE CONDENSERS
E55 Grid Condensers \$16c
E59 Phone Condenser, .001 Mfd. \$5c

- D. R. L. ADJUSTABLE GRID LEAK AND CONDENSER
E107 C. R. L. Adjustable Grid Leak and Grid Condenser. \$1.49

- FRESHMAN NICON TESTED MICA CONDENSERS
E62 .0025 mfd. \$0.27
E63 .0005 mfd. Condenser. \$0.27
E64 .001 mfd. Condenser. \$0.31
E65 .002 mfd. Condenser. \$0.31
E66 .0025 mfd. Condenser. \$0.41
E67 .005 mfd. Condenser. \$0.65
E68 .006 mfd. Condenser. \$0.65
E69 .01 mfd. Condenser. \$1.37

- FRESHMAN VARIABLE GRID LEAK AND GRID CONDENSER
E60 Freshman Variable Grid Leak and Condenser \$0.85

- AERIAL WIRE
E355 Copper 1 strand 100 ft. coil. \$0.77
E356 Single No. 11 Bare Solid Copper. Wire 100 ft. Coils \$1.40

- SWITCH POINTS AND STOPS
E130 Switch Point \$1.05
E130 Switch Point \$1.05
E150 Switch Stops \$1.40

OUR GUARANTEE YOUR PROTECTION

Your satisfaction guaranteed. If for any reason you do not feel satisfied with your purchase, you can return it and we will refund your money. We will pay return transportation charges.

- 180° VARIDCOUPLER
E1100 Coupler \$2.75

- 180° MOULDED ROTOR TYPE COUPLER
E1220 Moulded Variometer \$3.95

- VARIABLE CONDENSERS
E1423 21 plates, .0005 Mfd. without dial \$1.49
E1411 11 plates, .00025 Mfd. without dial \$1.15
E1403 3 plates, .00005 Mfd. without dial \$0.98

- VERNIER VARIABLE CONDENSERS
E1422 22 plates vernier .0005 Mfd. with dial \$2.73

- ERLA AUDIO FREQ. TRANSFORMER
E1750 Erla Audio Transformer \$1.40

- INDUCTANCE COIL MOUNTINGS
E1603 Three coil mounting. \$3.38
E1602 Two coil mounting. \$2.70
E1601 Single coil mounting. \$2.37

- INDUCTANCE COILS
E1728 25 125-250 \$0.34 \$0.78
E1728 35 175-350 .38 .81
E1727 50 240-720 .44 .97
E1728 75 390-910 .49 1.03
E1729 100 500-1,450 .53 1.08
E1730 150 600-2,600 .58 1.12
E1731 200 900-2,500 .67 1.21
E1732 250 1,200-3,500 .73 1.30
E1733 300 1,500-4,500 .77 1.31
E1734 400 2,000-5,000 .82 1.52
E1735 500 2,800-6,000 1.07 1.58
E1736 600 4,000-10,000 1.22 1.73
E1737 750 5,000-12,000 1.38 1.88
E1738 1,000 7,000-15,000 1.65 2.19
E1739 1,250 9,750-19,500 1.67 2.39
E1740 1,500 14,500-26,500 2.13 2.53

- INSULATORS
E360 Moulded insulator shown \$0.10 \$1.10
E365 Porcelain insulators .09 .95

- VARIOMETERS
E1200 Variometer \$2.65
E1205 Knocked-down Variometers \$1.85

- DIALS
E502 Dial, 3 inch, 3-16 in. shaft \$0.32
E503 Dial, 3 inch, 1/8 in. shaft \$0.35
E501 Dial, 3 inch, 1/4 in. shaft \$0.35
E504 Dial, 4 inch, 3/8 in. shaft \$0.67

- AUDIO FREQUENCY AMPLIFYING TRANSFORMERS
E1506 Shielded Transformer \$2.95

- THORADSON AUDIO FREQUENCY AMPLIFYING TRANSFORMERS
E1504-Thoradson Transformer \$3.35
E1505-Thoradson Transformer \$3.75

- "B" BATTERIES
E230 2 1/2 volt Signal Corps \$1.18
E240 2 1/2 volt large variable-5 positive taps. Size 6 1/2 x 3 1/2. \$2.25
E245 2 1/2 volt large size binding posts. Size 7 1/2 x 6 1/2. \$4.50

- INDUCTANCE SWITCH
E1095 Inductance Switch \$1.22

- MAGNET WIRE
E18 50 40 \$0.76
E20 52 \$22.90
E22 68 \$24.10
E24 78 \$26.18
E26 88 \$30.70
E28 1.02 \$32.20
E30 1.40 \$36.27

- SWITCH LEVERS
E151 1 in. Radius \$1.40
E155 1 1/2 in. Radius \$1.40

- VACUUM TUBES
E300 UV200 Detector \$4.37
E301A UV201A Amplifying \$5.83
E11 WD11 1 1/2 volt. \$5.83
E12 WD12 1 1/2 volt. \$5.83
E299 UV199 3 volt. \$5.83

- QUALITY SOCKETS
E1073 Signal Socket \$5.65
E1074 Heiden Socket \$6.00
E1075 Great Lakes Nickel \$37
E1076 Great Lakes Bakelite, base mount only \$49
WD11 Bakelite Socket \$40
299 Adapter \$43
299 Bakelite Socket \$42
299 Adapter \$39

- GREAT LAKES SUPREME RHEOSTATS AND POTENTIOMETERS
E90 G. L. Supreme Rheostats, 6 ohm \$3.99
E91 G. L. Supreme Rheostats 25 ohm \$4.22
E92 G. L. Supreme Rheostats 40 ohm \$4.45
E93 G. L. Potentiometer, 200 ohm \$5.52
E94 G. L. Potentiometer, 400 ohm \$5.56

- HOWARD RHEOSTATS
E1064 Howard 6 ohm Plain \$1.98
E1065 Howard 6 ohm Vernier \$1.35
E1066 Howard 25 ohm Plain \$1.35
E1067 Howard 25 ohm Vernier \$1.35
E1068 Howard 40 ohm Plain \$1.85
E1069 Howard 40 ohm Vernier \$1.85
E1068 Howard 200 ohm Potentiometer \$3.55
E1069 Howard 400 ohm Potentiometer \$3.55

- CUTLER-HAMMER RHEOSTATS
E1061 Cutler-Hammer Vernier \$1.35
E1062 Cutler-Hammer Plain \$1.35
E1052 C. H. 30 ohm Resistance \$2.22
E1063 C. H. 200 ohm Potentiometer \$1.35

- BINDING POSTS
E110 Large size, all nickel 7c
E112 Medium size, nickel, with holder or phone tip or size. 3c
E112 Medium size, black composition, top \$4.30c
E120 Large size, composition top. 5c 48c

- WORKITE NEUTRODYNE PAT.
E269 7x12x3/4 \$2.40
E269 7x12x3/4 \$2.70
E269 7x12x3/4 \$3.40
E228 7x18x7 \$3.75
E224 9x14x7 \$3.53
E224 9x14x7 \$3.85
E222 7x21x7 \$4.63

- CABINETS
E217 5x7x7 \$2.40
E219 7x9x7 \$2.70
E213 7x18x7 \$3.40
E228 7x18x7 \$3.75
E224 9x14x7 \$3.53
E224 9x14x7 \$3.85
E222 7x21x7 \$4.63

- PANELS
E269 9x7x3/4 \$0.58
E269 7x9x3/4 \$0.90
E269 7x12x3/4 \$1.25
E268 7x18x3-16 \$2.16
E274 9x14x3-16 \$2.80
E261 7x21x3-16 \$2.95
E262 7x24x3-16 \$3.50
E262 7x24x3-16 \$3.50

HOW TO ORDER
Order from this page. Please give number, description and price of the article you order to help us avoid mistakes. Total the amount of your order and send Post Office money order, certified check or draft with your order. Be sure to give your name and street address on both letter and envelope. Do not include money for transportation. We pay it except on storage "A" batteries. See ads of previous months for other items.

GREAT LAKES RADIO CO., 136 W. Lake St., Chicago, Ill.

Bring Your Set Up to Date!

Pick up more stations. Receive over longer distances. Tune in more easily, more quickly and more accurately. Put this newly invented condenser on your panel and enjoy the increased efficiency and exclusive advantages that come from its revolutionary construction.

THE BROCKWAY VARIABLE CONDENSER Makes Multiple-Plate Condensers Old-Fashioned

Has only two plates, of thin spring bronze, separated by mica dielectric. Plates are scientifically formed to properly control the capacity curve. (Patent Pending.) Does away with bulky multiple plates, thus eliminating high resistance and moving contacts, reducing radio frequency and dielectric losses.



PRICE \$3.50

Saves space behind panel. Beautiful bakelite dial and base, with plates between, mount entirely on front. More easily adjusted than a vernier. Two revolutions of dial (720 degrees movement) allow wide range for fine adjustment, giving easy, accurate tuning, more stations and longer distance reception.

Gives higher efficiency in Radio Frequency, Reflex, Neutrodyne and Other Critical Circuits. Improves any circuit requiring 11 to 43 plate condenser.

If your dealer hasn't the Brockway in stock, ask him to order for you. Or we will send one postpaid on receipt of price with dealer's name and address.

BROCKWAY LABORATORIES COMPANY, Toledo Factories Bldg., Toledo, Ohio

BABY AUDIOPHONE

TRADE MARK

REG. U. S. PAT. OFFICE

The New Model

big in volume—big in value—but low in price. The Baby Audiophone offers a real high grade Loud Speaker at a popular price.

The same goose neck and horn used in the Senior Audiophone help to give the big volume and good quality in the smaller size Loud Speaker. The Audiophone line is now very complete with

- Senior AudiophonePrice \$32.50
- Junior AudiophonePrice 22.50
- Baby AudiophonePrice 12.50



Bristol One Stage Power Amplifier



No "C" batteries required. It provides the additional volume necessary to bring in far distant stations on the loud speaker. Price\$25.00

Ask for Bulletin 3012-S telling about the entire Audiophone Family.

THE BRISTOL COMPANY, Waterbury, Conn.

We repair the following RADIO TUBES and Guarantee Them



WD-11	\$3.50	DV-6	3.00	UV-201A	3.50
WD-12	3.50	DV-1	3.50	C-301A	3.50
UV-200	2.75	DV-2	3.50	UV-202	4.00
UV-201	3.00	DV-6A	3.50	C-302	4.00
C-300	2.75	UV-199	3.50	Marconi	3.00
C-301	3.00	C-299	3.50	Moorhead	3.00
6 v. Plate Amplifier	3.00	6 v. Plate Detector	\$2.75		

Mail Orders solicited and promptly attended to
Dealers and Agents write for Special Discount

H. & H. RADIO CO.

P. O. BOX 22-H.

CLINTON HILL STA.

NEWARK, N. J.



A Good Spring Contact

(Continued from page 1091)

the inside winding or secondary coil so that I could turn it through 360 degrees, if necessary, was a problem. In the old arrangement I had, the wires were continually breaking. The arrangement I used is shown in the accompanying sketch, consisting of a small piece of sheet brass with a hole in the cen-

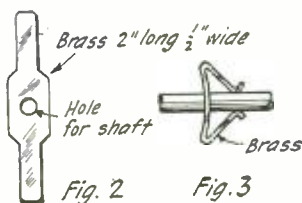
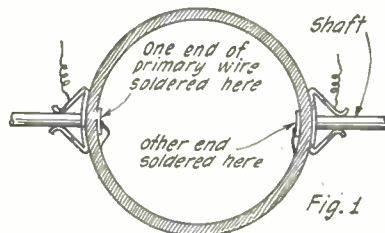

Details of the Spring Contact for Variometers and Variocouplers

dinary loud speaker satisfactorily on stations 300 miles distant. With a Magnavox reproducer and about 60 volts of "B" battery, the set is loud enough to fill a large auditorium without further stages of amplification.

W. C. LANE,
Sanford, N. C.

Getting the Right Radio Wave

(Continued from page 1051)

to be capable of selecting one particular wave frequency while at the same time excluding all others. To do this requires in the receiver a selectivity or frequency-sense far more highly developed than would be desirable in our ears. A selective radio receiving set corresponds quite closely to a human ear that can hear only one note. Such highly selective ears would be no good to any of us. We could not hear music or even satisfactory speech if we had them. We would hear nothing but the one note to which our ears were able to respond. We would, however, hear that note and hear it clearly even though the air around us were full of other sounds.

Selectivity of that kind is exactly what we want in our radio receivers. No matter how many other waves of various frequencies are flying past us through space, we want our receivers to pick out and respond to a single radio wave and that only. It must be deaf to all the other frequencies but keenly sensitive to waves of the frequency we desire to receive. When you adjust your receiver to hear WEF at 610 kilocycles frequency, you don't want to hear a sound from Philadelphia at 590 or Memphis at 600 on one side nor from Davenport at 620 kilocycles on the other side. Fortunately, it is not very hard to arrange a radio receiver so it will be quite highly selective, and the next talk of the series will deal with the way that can be done.

Insure your copy reaching you each month. Subscribe to Radio News—\$2.50 a year. Experimenter Publishing Co., 53 Park Place, N. Y. C.

Western Electric



VT-2
TUBES
CW 931
5 Watt

"E" Tubes
\$7.45

About 1/3 of these 10,000 brand new, genuine Western Electric VT-2 Tubes that we bought from the U. S. Signal Corps have been sold. Radio men know that a genuine VT-2 Tube for \$7.45 is an unusual opportunity—a real "find"! These tubes may be used for RF and AF amplification and for CW and phone transmitting. They have a higher amplification factor than any tube made! Not Navy rejects—sold only as a surplus. Characteristics: Filament 6 volts, current consumption 1 amp., plate potential 22.5-350 volts.

Automatic Electric

LONGE
\$3.65



These headsets were formerly sold by the Automatic Electric Co., makers of telephone exchanges, at \$10 each. We bought their entire stock—40,000 phones—paid spot cash and because of this buying power (unequaled elsewhere in the radio field) we are able to offer you a \$10 headset for \$3.65. 30 years of experience have produced the Automatic Headset. Coil is wound with about 6500 turns of No. 40 enamel coated copper wire. D.C. resistance 1600 ohms. Impedance at average music and voice frequency (800 cycles) 21,000 ohms. (Effective impedance rather than D.C. resistance is the big factor in a good headset.)

ERLA 1-TUBE REFLEX

CONSISTING OF	Our Price
1 Variocoupler	\$3.45
23-Plate Variable Condenser	1.45
2 Eria Sockets	1.30
1 Eria Reflex No. 1 Transformer	4.85
1 Eria A. F. Transformer	4.40
1 Eria .002 Mica Condenser	.30
1 Eria .001 Mica Condenser	.30
1 Eria .00025 Mica Condenser	.25
1 Eria Fixed Crystal Detector	1.00
1 Howard Rheostat	1.00
2 Bakelite Dials	.50
8 Binding Posts	.40
1 Dozen Switch Points and 4 Steps	.30
2 Switch Levers	.50
1 6½x14½" Formica Panel	1.37

Our Price **\$20.90**

REINARTZ DETECTOR and 2 STEP



Reg. Price	Our Price
Each	EACH
\$6.00 1 Panel 7x28x3/16 Inch	\$3.92
2.50 1 Spider Web Coll.	1.95
6.00 1 23-P. Ver. Condenser	3.45
5.00 1 11-P. Ver. Condenser	2.95
1.50 1 Howard Vernier Rheostat	1.35
1.10 2 Howard Plain Rheostat	1.00
.75 3 Firth Sockets	.35
2.00 1 Variable Grid Leak and Condenser (cartridge type)	1.40
4.75 2 Transformers (All American 10-1 and 3-1 or new type high and low ratio thordarson)	3.95

Detector Alone (Plain Condensers)

\$11.45

Reg. Price	Our Price
Each	EACH
.10 7 Binding posts	.05
.40 2 Dozen Switch Points	.20
.02 6 Switch Steps	.01
.50 3 Switch Levers	.25
1.00 2 Bakelite Dials	.25
1.00 2 Double Circuit Jacks	.50
.65 1 Single Circuit Jack	.35
1.00 1 Baseboard	.50
.75 Blue Print for Assembly	.50
.50 25 Feet Tinned Wire	.25

Detector and 2 Step **\$29.95**

509 South State Street Chicago Ill. Dept. N-6



509 South State Street Chicago Ill. Dept. N-6

What Salvage Really Means

Sometimes a manufacturer over-produces and must sacrifice his surplus stock for cash. Sometimes a dealer misjudges market conditions and must unload—again for cash. Our business is to buy—to "Salvage"—these special offers by paying spot cash for the entire surplus. That's how we bought 40,000 Automatic Electric Headsets—10,000 Western Electric VT-2 Tubes, etc. But in order to keep on taking advantage of such offers, we must make a quick turnover. That is why we offer you a \$10 Automatic Electric Headset at the unequalled price of \$3.65. That, too, is the main reason why all our offers are priced so attractively. "Salvage" to us does NOT mean something that has been used. We handle no second-handed merchandise. Every item we sell is guaranteed brand new—in fact 95% of our merchandise is in the manufacturer's own carton and carries his guarantee along with ours. "Salvage" to YOU means buying quality radio merchandise for less!

IMPORTANT!

Any individual part in any of the four outfits above may be purchased separately at the special reduced prices listed under column headed "Our Price."

COMPLETE INSTRUCTIONS

for assembling and blueprints for wiring are included with each outfit. Instructions written so everyone can understand them. No special skill or technical knowledge required—a few hours and you're ready to tune-in New York, Los Angeles—any of 'em!

PANELS DRILLED FREE

Specially drilled panels are included with each of the sets illustrated and described below. We give this free service only on panels included with complete sets.

SPECIAL!

Complete Parts for 2 STAGE AMPLIFILR

To amplify Ultra-Audion, Reinartz, Flewelling, Knocked Down Short Wave Receiver, Crystal or any receiving set so that loud speaker or phonograph can be used in place of headset.

CONSISTING OF	Reg. Price	Our Price
\$1.05 7x9 Formica Panel (Other suitable size)	\$.95
4.75 High Ratio All-American or Thordarson Transformer	3.95
4.50 Low Ratio All American or Thordarson	3.85
2.20 2 Howard Rheostats	2.00
2.00 2 Bakelite Sockets90
3.00 3 Double Patent Jacks	1.50
1.30 13 Binding Posts65
1.30 Baseboard15

\$21.00 Our Value Price **\$12.95**

COCKADAY RECEIVER

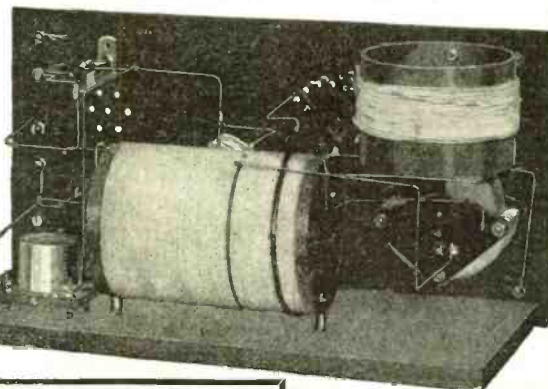

Regular Price	Our Price
\$3.00 1 Cockaday Coll	EACH \$1.95
1.00 2 Bakelite Dials	.25
1.00 1 John Firth Socket	.45
1.00 Freshman Grid Leak and Condenser	.65
1.50 1 Howard Vernier Rheostat	1.35
1.00 1 Patent Double Circuit Jack	.50
.80 8 Binding Posts	.05
.04 7 Switch Points	.02
.50 1 Switch Lever	.25
1 7x14½" Formica Panel	1.44
1 Blue Print and Wire	1.00
1 Baseboard	.25
3.30 2 23 Plate Condensers	1.45

Our Price **\$11.95**

SHORT WAVE RECEIVER

Regular Price	CONSISTING OF	Our Price
\$10.00	2 Variometers	\$3.90
5.00	1 Variocoupler	1.75
3.00	3 Bakelite Dials	.75
1.00	1 John Firth Socket	.45
1.10	1 Howard Rheostat	1.00
4.50	1 Mahogany Cabinet	2.95
2.25	1 Genuine Formica Panel	1.75
.80	8 Binding Posts	.40
.50	1 Switch Lever	.20
.40	12 Switch Points	.20
1.00	1 Freshman Grid Leak and Condenser Combined	.65
1.00	1 Complete Drawing for Assembly and Wiring	.50

\$25.89 Our Value Price **\$13.45**

1 7x21x3-16 drilled formica panel	
1 Howard rheostat	
3 4" Radion Dials	
3 John Firth Bakelite Sockets	
8 Binding Posts	
3 23 Plate Variable Condensers	
1 Wave Control Neutroformer	
2 R. F. Amplifying Neutroformers	
2 Grid Neutralizing Condensers	
1 .00025 Micon Condenser	
1 Marva Variable Grid Leak	
1 Base Board for mounting 25 feet tinned copper bus bar wire and complete instructions for assembling and wiring.	

\$28.60

4 tube set ... \$44.65
5 tube set ... \$46.25

Everything In Radio In Our New Catalog

Our new 48-page catalog lists, describes and illustrates 10 complete sets like those pictured above. It contains hundreds of bargains in parts that have not and can not be duplicated elsewhere.

Write For Your Copy TODAY!



Ackerman LOUD SPEAKER

Complete.
Ready for
Immediate
Use.

\$9.50

Delivered
Anywhere
in the
U. S. A.

**A marvelous speaker for
the price of a headset.**

Superior to many of the higher-priced amplifiers. Thousands of radio fans have welcomed this popular-priced quality speaker.

Standing 21" high, with 11" bell and made of heavy metal, eliminating vibration, together with its special loud speaking unit, this speaker reproduces voice and music far beyond expectations. Finished in plain black or brown; also special alligator grain in black and green or black crystalline.

If your local dealer is unable to supply you, send order direct to us and pay postman on delivery.

Sold on a Money-Back Guarantee

Ackerman Brothers Co., Inc.
301 West 4th St. Dept: ("R. N.") New York City



This speaker has been selected as the best value by the largest selling organization in the country.

ter of a size that will fit over the shaft of the instrument. After it has been inserted, the two ends are bent so as to make a firm contact with the shaft proper.

Contributed by James Barr.

A SIMPLE VERNIER ATTACHMENT

Here is a vernier that can be added to the variable condenser of your set very easily. Drill a hole in the panel near the condenser and mount an old switch lever (I have used a long shank binding post) after breaking

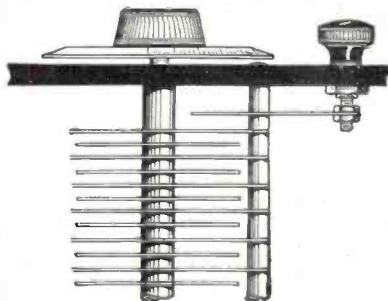

A Vernier Attachment Made of An Extra Condenser Plate Controlled by a Separate Knob.

off the blade. Cut and drill a piece of aluminum (as per the sketch) and fasten it to the switch post so the plate will slide between the panel and the stationary plate of the condenser. Fasten a lead from the switch to the rotary plates of the condenser.

Contributed by R. J. Harris.

No More Leaks!

Loose, leaky connections cause troublesome balkiness in even the best-built radio sets.

Spare yourself such annoyances from the start by making every joint absolutely fast with the *HOME Electric Soldering Iron*.

It's the handiest solderer you can use. Turn a switch and the point gets hot enough to melt solder almost instantly. The current consumed is negligible.



Lasts a life-time. Pays for itself many times in convenience and utility.

Packed in a sturdy carton, with full instructions and a supply of flux and solder.

Costs only \$3.

If your dealer does not carry the *HOME Electric Soldering Iron*, send us your order and we will ship you one by return mail, either COD., parcel post or on receipt of cash or money order.

THE A. MECKY COMPANY
1705 Allegheny Ave., Philadelphia
HOME Electric Soldering Iron

RADIO SUPPLIES AT CUT PRICES

Baldwin Phones Type D	\$4.95
Aeme Audio or Radio Transformers	8.25
Federal Audio Transformers No. 65	5.95
Audio Amplifying Transformers	3.25
Ames Audio Amplifying Transformers	2.95
22½ Volt Variable B Battery	.90
22½ Volt Variable B Battery	1.75
45 Volt Variable B Battery	2.50
22½ Volt Eveready B Battery	1.25
22½ Volt Eveready Variable B Battery	2.25
45 Volt Eveready Variable B Battery	3.95
43 Plate Var. Condensers Bakelite Ends	1.85
23 Plate Var. Condensers Bakelite Ends	1.50
3 Plate Vernier Condensers	.65
43 Plate Condensers with Vernier and Dial	3.95
23 Plate Condensers with Vernier and Dial	3.50

ALL ORDERS MUST INCLUDE POSTAGE

KENSINGTON RADIO SUPPLY CO.
4417 18th Avenue Brooklyn, N. Y.

PEQUOT SPECIALS

R.C.A. Tubes UV-201A, WD11, WD12	\$6.85
\$3.00 National 22½ V Large Var. B Battery	1.85
5.50 National 45 V Large Var. B Battery	3.65
20.00 Crosley "Ace" Complete Receiver	18.45
3.50 Work-Rite Variometer, Work-Rite Bakelite Coupler	2.95
2.75 Eastern Cockaday Coils and Hook-up	1.95
4.00 Vernier Condenser with dial, Bakelite ends	2.55
23 Plate Bakelite Condensers	1.75
5.00 Vernier Condenser with dial, Bakelite ends, 43 Plate	3.35
2.50 Plain Condenser Molded ends, 11 Plate	1.35
3.00 Plain Condenser molded ends, 23 plate	1.45
3.50 Plain Condenser molded ends, 43 Plate	1.75
4.75 All-American 5 to 1 Audio Transformer	4.15
2.00 Tri-Coil Transformer with reflex hook-up	1.85
12.00 Nathaniel Baldwin Phones	9.65
3.98 Ambassador Phones	3.75
SPECIAL—Genuine licensed Hazeltine parts with Panel layout and complete instructions for building Neutrodyne Set	15.85
All Goods Sent Post-paid on Receipt of Price. Send Money-Order, Draft or Check.	
PEQUOT SPECIALTY COMPANY Dept. N. NEW LONDON, CONNECTICUT	

Results of Our \$300 Radio Music Contest

(Continued from page 1055)

my knowledge has never before been attempted.

"Some time ago the idea was conceived to test the possibility of promoting and popularizing a given piece of music entirely by radio, instead of through the ordinary channels of advertising and promotion.

"Radio has taken a firm foothold in our daily lives—thousands—yes—hundreds of thousands of families find enjoyment every night by listening in—radio has become a permanent home fixture. These families are the great new radio public. In reaching them it would seem that our test tonight—and its future development—can hardly be anything but successful.

"This all evolves from the late united efforts of the music publishers and authors to ban the use of their copyrighted compositions for broadcasting purposes, claiming that such use is detrimental to sales. They liken this use to the use of a newspaper—good for one reading only—claiming that when hundreds of thousands of families hear this music broadcast, these families have no desire to hear those pieces again and just so many thousands of sales have been lost. The fact is, that just so many sales have been created—dependent, of course, upon the quality of the music broadcast.

"This theory—I should say, unbased theory—is so illogical that further discussion of it is unnecessary. But, for example, when you buy a player piano roll, a phonograph record or even sheet music, do you use it just once and then discard it to the rubbish heap as you would yesterday's newspaper, or do you play it again and again? So it is with broadcast music—you hear it broadcast and if the melody has pleased you, you buy that piece in one form or

Insure your copy reaching you each month. Subscribe to Radio News—\$2.50 a year. Experimenter Publishing Co., 53 Park Place, N. Y. C.

"BUILD YOUR OWN" WITH "RASCO" PARTS!

Buy from the Oldest and Original Exclusive Radio Parts House in the United States

We pay all transportation charges in U. S. ALL GOODS SENT PREPAID IN 24 HOURS

Order direct from this page.

NOTE NEW PRICES FOR THIS MONTH ONLY

Money refunded if goods do not satisfy



Jacks and Plugs Best materials. Silver contacts. Factory making Postal Telegraph jacks, makes these. F1000 Jack 4 springs \$65 F1001 Jack 3 springs .75 F1002 Jack 3 springs .80 F1003 Plug .55	Cord Tip Jack Takes place of binding posts. Cord tip thru grip by jack. Made of brass, nickel plated. Screw to attach lead wire. No soldering necessary. F1500 Cord tip jack Each .15	Phonehorn Base consists of Phonodapter into which fits a base enameled fibre horn. Size of horn 12"; bell 5 1/2". Slip Phonodapter end on a single telephone receiver. F1321 Phonehorn. Prepaid. \$1.45	Radiocite Detector Base solid black composition. Automatic crystal holder. Triple adjustments. Smallest, neatest detector made. Radiocite crystal. F1609 Detector .60 F1898 Galena detector .50	Audio Frequency Transformer No better Transformer made. Highest class materials. Impregnated coils. Silicon steel stampings used. Save 50 per cent by assembling it yourself. F1100 Ratio 1/2 to 1 \$2.00 F1150 Ratio 6/2 to 1 \$2.00	Duo-Spiderweb Coil For Rehnartz circuit, 200-600 meters. 19 taps. Size 3/4" diam.; 1 1/2" center opening. Coil is firm and will not flat apart. F2650 Spider-web Reinartz coil 219 .15 F2660 Coil for panel mount. 225-600 met. \$1.90	Melotone Loud Speaker Best popular loud speaker. Fibro horn, heavy metal base, five ft. cord. Nickel gossamer. Greatest toned (adjustable) talker. Horn length 11 1/2"; bell 6 5/8"; total height 9". F255 Melotone Speaker .90
---	--	--	---	---	--	--



75 VACUUM TUBE BOOK UPS 310 ILLUS. 516 ARTICLES 84 PAGES FREE "The Big "Rasco" catalogue. Contains all Armstrong circuits. Every up-to-date vacuum tube hookup. Greatest little book printed. Free upon receipt of postal.	Molded Variometer Highly substantial instrument. Silk windings. 1/4" shaft. Flange B when placed into AB direction makes instrument panel mounting. 180 to 650 meters. Money back if this instrument is not all that we claim for it. FS353 Variometer .33.00	Fonokushions Made of sponge rubber. Make wearing your receiver a pleasure. Positively exclude all noises and make reception a pleasure. Sponge rubber will last for years. Light as a feather. F350 Fonokushions, set of two .55	Straight Line Condenser Simplest and most practical type of condenser. F4500 "Rico" Condenser .001 mfd. 43 plate capacity \$1.75 F4230 .0005 mfd. 23 plate capacity \$1.75 F4110 .0025 mfd. 11 plate capacity \$1.75 All types no dials \$1.50	Radio Frequency Transformers Best Radio Frequency Transformer developed so far. Designed by R. E. Loewell, Associate Editor RADIO NEWS. Air core type. F2800 Transformer, size 7 1/2" x 2 1/2" \$1.50	Spaghetti Varnished flexible cambric tubing turned. No. 22 wire; 320 takes 18 to 22 wire; 21 takes 16 to 18 wire; 344 takes 22 to 23 wire. F319-320-321 Per ft. .06 F344 Flexible soft rubber tubing; 10 foot for .320	Soldering Iron Smallest and handiest made. Fits any flat iron percolator plug. Plug then becomes handle. 5" long. Complete but without plug or wire. F2200 Soldering Iron .14.45
---	--	---	--	--	--	---



Formica Panels Clearance Sale As we are discontinuing these particular sizes, this material is now offered at cost. All 3-1/2" thick. F352 9x12" each .1.75 F354 6 1/2 x 19 1/4" each 1.90 F356 6 1/4" each .1.80 F357 6 1/2" each .65	Brass Rods Sold in 6" lengths only. F8032 Rod 8-32" thread length .3.08 F6032 Rod, 6-32" thread length .4.06 F1425 Rod, plain 1/4" round, length .3.10 F3616 Rod, plain 3/8" round, length .3.06	Litz Wire Prices are Per foot. E= .005" thick. F823 E No. 25 B&S \$0.2 F890 E No. 28 B&S .01 F891 E No. 21 B&S .04 F892 E No. 20 B&S .03 100 per cent discount in 100 foot lengths.	Copper Ribbon F700 3/4" wide; F701 1/2" wide; F702 3-16" wide. All sizes per foot. \$1.75 F501 1/2" thick, 4" wide. \$1.00 F5025 Copper Foil Per foot .80 10-foot length .80	Tin Foil All our tin foils come 4" wide. Uniform product throughout. Best grade only. F850 has 1500 sq. inches per lb. F851 700 sq. inches to lb. F850 Tin foil .35 F851 Tin foil .35	Switch Knob F199 Knob, 1 1/4" dia. height 5/8"; 8-32 screw. F4451 has 8-32 to 10-52 bushing, no screw. F199 Knob .10 F4451 Knob .06	Marconi Knob Fits central hole of 5-32" and seat to hold screw, dia. 1 1/4", height 3/4". F838 Knob, each .12 Fluted Knob With 8-32" bushing. Black composition. F2055 Knob 1" high 1 1/4" diam. each .15
---	--	--	---	---	---	--



Mounted Crystal-Cup Cup has screw and adjustment nut. Fits any standard mounted crystals. Nickel plated, polished. F318 Nickel Cup .3.20 F317 Radiocite Crystal .25 Most sensitive mounted crystal. U. S. Navy using it. Each tested.	Rasco Vernier Why use a vernier condenser when a vernier attachment will do anything and everything a vernier condenser accomplishes. Cleverest vernier made. Can be used with any dial. Soft rubber ring encircles dial. Nothing to come apart. F1450 Vernier .30	Angle Bushing Angle piece used to mount panels on boards, tubes on panels etc. 1,000 uses. 5-16" wide, height 7-16". F1475 Angle piece. Each .03 Adapter Bushing Makes 3-16" dial fit 1/4" shaft. 1/2" long. F866 Bushing .04	Silver Dials Silver surface black enamel lettering. For 3/4" shaft. No set screw required. All 2 1/2" dia. F800 Plato variometer \$1.00 F801 Prim. Con.; F802 Sec. Cond.; F803 Coupler; F804 Fil. Rheo.; F805 Grid Variometer. Each style .80 Set of six .15 Shipped express collect.	Storage Batteries Guaranteed for two years. Only NEW material used. Acid proof terminals. Patent vents. F2400 Two volt, 40 amp. hours .53.90 F343 Rotor .30 F640 Six volt, 40 amp. hours 7.25 F666 Six volt, 60 amp. hours 9.50 Shipped express collect.	Vario-Rotor Made of hard wood, accurately turned. Takes any finish. Larke hole 2" diameter. Width 2". diameter 3 1/2". 2 shaft holes. F343 Rotor .30 "Rasco" Universal Bearing. Especially made to take above rotor for panel mounting. F1375 Uni. Bearing .25	Rheostats and Potentiometers High heat dielectric base. Come with tapered, knurled knob. 2 1/2" dia. Complete with pointer. F4310 6 ohm .45 F4311 30 ohm .65 F4312 Potentiometer, 20 ohms .85
--	---	--	---	---	--	--



Phone Plugs Sold from 15c. to \$1.00 everywhere. Hard rubber composition shell and patented cord tip holder. Finest workmanship throughout. F1030 Rasco Telephone Plug, each .35	Bakelite Socket Octagon shape. Post nickel binding posts, phosphor bronze contact springs. Best brown bakelite. F6510 Bakelite Socket \$40 F6400 Post Bus Bar Wire 25 Entirely of composition. Best made. Each .35	Condensers Best make, paper-impregnated condensers. Capacity guaranteed. F6500 Phone Condenser. .50 F6505 Grid Condenser. .50 .00025 .50 F6509 Grid Leak Condenser. .00025 .30	Name Plates All name plates brass with silver letters. F839 (Right or left) \$1.10 F809 Comes in 35 styles. Any denomination, each style .50 Panel Seals, 2 1/2" x 9/8" metal, silver background, black lettering. Each \$1.15 F715 Seal, Each .15	Binding Post Name Plates Dia. 3/4". These styles: Phones, Ground, Output, "A" Bat., "B" Bat., Loud Speaker, "C" Bat., Aerial, Input, "A" Bat., "B" Bat., Loop "C" Bat. F6000 Name Plates all styles, each .03	"Rasco" Posts Made of black composition. F650-51 Each .08 F202 Has nickel-plated bottom, each style .08 Dozen, each style .30 F122 Initialed Binding Posts. Six popular styles. Each .12	Cord Tips Standard Phone cord tips, nickel-plated. F315 Each .03 Separable Cord Tips No solder required. Wire goes in ferrule. Shank holds it tight. Nickel plated. F2900 Each .06
---	---	--	--	--	--	---

AUTOPLEX CIRCUIT

The famous Autoplex circuit described in RADIO NEWS has taken the country by storm. The only single tube outfit that works a loud-talker. Results guaranteed.

- 1-F714 Mahogany Cabinet. \$3.35
- 1-F7140 Diode Panel \$1.20
- 2-F5333 Molded Variometers 6.00
- 2-F3076 4" Dials 1.85
- 1-F5014 1250 turn Honeycomb coil 1.90
- 1-F6500 Vacuum Tube Socket .35

Our special price, Complete \$15.25

Complete with Melotone Loud-speaker \$20.00

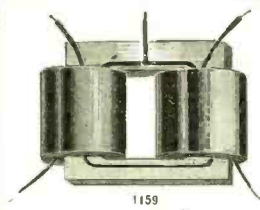

New! New!!

Push Pull Transformer for many new circuits. See any radio magazine. Made of best materials. Coils impregnated. Silicon steel laminations. Save 50 per cent by assembling yourself. Simple instructions furnished. Fully Guaranteed.

F1159 Push Pull Transformer. Ratio 6/2 to 1 .94.00

2 Stage Amplifier

- 1-F710 Mahogany Cabinet. \$2.60
- 1-F7100 Diode Panel 4.90
- 1-F1100 A.F. Transformers 4.00
- 2-F1100 Double Circuit Jacks 1.30
- 1-F1003 Rasco Plug .55
- 2-F6500 Tube Sockets .70
- 2-F4311 30 ohm Rheostats. 1.30
- 10-F6080 Post Name Plates. 30
- 10-F201 Rasco Binding Posts 1.00
- 30 Ft. F6400 Bus Bar Wire 7.50
- Blue Prints and directions. .50

Total \$13.90

RADIO SPECIALTY CO., 98 Park Place, New York City
 Factories: Brooklyn, N. Y. Elkridge, Md.

This advertisement copyright 1924 by R. S. Co., N. Y.

Telmaco Radio Guide Book

Describes the Best in Radio

Our new 64-page Catalog No. TCR contains twenty of the most popular radio circuits printed in blue. These include the Hazeltine Neutrodyne, Grimes Inverted, Colpitts, Flewelling, Reinartz, Diode Electrad, Heterodyne, Super-Regenerative and many others. Each article used in circuit is attractively pictured instead of appearing in straight schematic form. Besides containing blue prints, the best in radio is also illustrated and described. Catalog sent postpaid for Ten Cents. Each circuit worth double. Send for your copy today.



DEALERS! Our New Dealers' Catalog and Price List describes nearly all the better Standard Radio Lines. You should have it. Mailed FREE to all bonafide dealers making request on their business stationery.

Radio Division
TELMACO TELEPHONE MAINTENANCE CO.
 Quality Radio Exclusively 20 So. Wells St., Dept. B, Chicago, Ill.

A CLEARSTONE PRODUCT

That means the best in Radio—good volume, long distance and easy tuning. Each and every GOLDCREST Model is designed to give maximum results in the simplest way.

The Best 1924 Radio Value

This mahogany console model GOLDCREST Receiver is a four tube set. It is entirely self-contained, generous space having been provided for batteries and Loud Speaker. The gold-plated panel provides a shield that completely eliminates body capacity.



GOLDCREST Model 62 \$120.00

It is the ideal receiver that you have been waiting for—beautiful and serviceable, yet reasonably priced.

O and T SILVERTONE TUBES Recommended
 Dealers, Jobbers, write for information, Catalog and Discounts.

Model 20	\$40.00	Model 32	\$115.00	Model 60	\$60.00
Model 31	70.00	Model 40	75.00	Model 42	135.00
		Model 61	\$75.00		

The Clearstone Radio Company, Cincinnati, Ohio

75C will make All the Difference

Better reception—longer range—finer adjustments—clearer amplification. See your dealer for a Reliable Micro-Air Neutralizing Condenser today.

The Reliable Parts Mfg. Co.
 2819 Prospect Ave.,
 Cleveland, O.

RELIABLE

neutralizing condensers



VULCANIZED FIBRE Be sure and specify "WILMINGTON FIBRE"
 Sheets, Rods, Tubes, Washers, Etc., Specialties
 Wilmington Fibre Specialty Co. Wilmington, Del.
 Branch Offices "Everywhere"

Ask Your Dealer For a **MONTROSE VERNIER CONDENSER**
 The condenser with genuine bakelite end pieces. Has positive contact between the vernier plate and main shaft. Will get the results where others fail. Guaranteed to give entire satisfaction.
MONTROSE MANUFACTURING CO.
 1200 Bedford Ave., Brooklyn, N. Y.

another and hear it again with pleasure many times.

"In order to substantiate this latter claim, RADIO NEWS initiated a Radio Song Contest. Prizes of \$150 each were offered for the best radio march and the best radio jazz. In addition to the prize money, the successful composers will also be paid a generous royalty or commission upon the sale of their compositions. It is our idea to have the two prize winning compositions suitable for broadcasting and also characteristic of radio, with static noise, code and other effects with which radio users are familiar.

"A great many broadcast stations have expressed their willingness to co-operate with us in our plan and will later broadcast the two winning compositions that you will hear tonight.

"These two prize winning pieces will be used to test our contention, or rather, prove it. No other means but radio broadcasting will be used to introduce these songs to the public—they will be sold only through broadcast stations, in radio stores, by radio dealers, etc., so that their sales may be traced back directly to this one means of promoting them—broadcasting by radio.

"The response to our contest announcement was tremendous. Hundreds of compositions were received, not from this country alone, but from many foreign lands.

"A staff of experts, musicians and vocalists, were engaged by us to go over the entries and pass on their merits. Those that were found to have merit were passed on to the judges.

The judges of the contest were as follows: Hugo Riesenfeld—Musical director and famous conductor of the Rialto, Rivoli and Criterion Theaters, New York.

Ted Lewis of the well known Ted Lewis Band and the Ted Lewis Frolics. The Jazz Master.

Vincent Lopez—Leader of the Pennsylvania Hotel Orchestras.

Leo B. Riggs—Musical director of the Hotel Astor Orchestra, New York City.

Milton J. Cross—"Announcer AJN" of "Broadcast Central, WJZ," New York, member Institute of Musical Arts, and member of Paulist Choristers.

H. Gernsback, Editor.

"The judges were almost unanimous in their selection of the two prize winning compositions. You will hear both of these presently. I will not disclose these two numbers, which will be broadcast with four others that were given honorable mention.

"I want your opinion of the merit of these songs and request that you vote your preference and mail a card or letter to me in care of RADIO NEWS, 53 Park Place, New York.

"To all those who guess the two prize winners correctly, a copy of each of the compositions—arranged for piano—will be sent gratis. The two selections are now in print and will come off the press shortly.

"In order to familiarize the audience with the new compositions, each one will be played several times. I ask you to be good enough to write down the identification numbers of the compositions now so that you will be better able to vote your preference when all of the selections have been rendered. If you will please take your pad and pencil I will now read off the names of the compositions slowly—twice in succession—so as to be sure that you get them right.

Are you ready?

"Radio Jazz No. 25.
 "Radio Jazz No. 31.
 "Radio Jazz No. 100.
 "Radio March No. 43.
 "Radio March No. 34.
 "Radio March No. 101.

"I am introducing some new musical effects tonight which have never been heard before by radio. These instruments really

Get a Handy Binder for your RADIO NEWS. Holds and preserves six issues, each of which can be inserted or removed at will. Price 65c. Experimenter Pub. Co., Inc., Book Dept., 53 Park Place, New York.

LOWEST RADIO PRICES

SAVE MONEY—no matter what you need for your Radio Outfit you will find you can save money if you buy from the Standard Radio Corporation.

RICO TUNED RECEIVER
Nationally advertised head set. For complete description see the advertisements. 2000 ohm double head set.



PHONES
Baldwin Head Set—Type \$7.95
Baldwin Type C Unit with Cord \$4.65
Siron Head Set—P-178—2000 ohms \$3.95
Siron Head Set—P-179—3000 ohms \$4.50
Supreme Head Set—P-180 \$7.50
Murdock Head Set—P-181—2000 ohms 4.45
Murdock Head Set—P-182—2000 ohms 3.95
Amateur Head Set—P-177—2000 ohms 2.95

VARIOCOUPLER

Exceptional vario coupler 180 degree bakelite tubes, wound with green silk wire, metal parts nickel plated.
P-350 Premier Vario-coupler \$3.65
Standard vario coupler, bakelite tube, wooden rotor, brass parts.
P-325 Standard Vario-coupler \$1.95

VARIOMETERS

High grade variometer, mahogany forms, accurately wound, exceptional value.
P-85 Mahogany variometer \$1.95
Excellent moulded variometer, high dielectric can't warp, a real buy.
P-35 Moulded variometer \$3.50
Highest grade moulded variometer, wave length 130 to 600 meters, exceptional bargain.
P-165 Supreme Variometer \$4.95

VARIABLE CONDENSERS

These condensers are fully guaranteed and are of the highest grade workmanship. The vernier types are furnished with 1 1/4 dial and knob.
31P—Vernier Condenser \$2.85
23P—Vernier Condenser 2.65
14P—Vernier Condenser 2.35
41P—Plain Condenser 1.40
21P—Plain Condenser 1.10
11P—Plain Condenser 1.05
3P—Plain Condenser85
1P—Plain Condenser50

DIALS

High grade black dials, bushed for 3/8-inch shaft.
P-729 2-inch dial \$0.25
P-720 3-inch dial25
P-731 3 1/2-inch dial35
P-732 4-inch dial45

DOUBLE PHONO-DAPTER

Cast in nickel plated. Soft rubber bushings. Fits a 1/2 inch head set. 40c

MELOTONE LOUD SPEAKER



This tuned feature the same as all RICO phones. 1 1/2 inch horn, heavy metal base. Five foot cord. Nickel rosette neck. \$4.90

MAGNAVOX

The Genuine Specify which type you desire. R-3 or New M-1 which requires no battery. Our price \$28.95



HOME CHARGER

The genuine. For your Radio Set or auto battery. 110 Volts. 60 cycles. \$18.50 value \$16.65

Electric Soldering Iron

Every Radio fan and every electrician will find this the most handy article ever offered. Operates on AC or DC 110 Volts. Take advantage of this opportunity to buy one at a greatly reduced price.

EXCEPTIONAL VALUE \$1.98

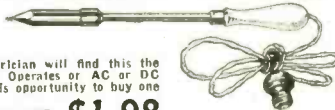

ERLA REFLEX TRANSFORMER

The genuine Eria Transformer nationally advertised, complete with pamphlet for instruction and hook-ups, is furnished in two types for first and second stage.
P-810 1st stage Eria Transformer \$4.65
P-820 2nd stage Eria Transformer 4.65
P-831 ERLA Synchronizing Transformer (3 1/2 to 1) 4.65

PHONO-DAPTER

Pure soft rubber with brass tube insert. Fits Columbia, Victor and Sonora. 40c

BINDING POSTS

Binding posts and contact points are brass nickel finished. Per doz.
P-10 Nickel plated Binding Post, Large Size \$0.40
P-20 Hard Rubber Binding Post, Large Size60
P-30 Nickel plated Contact Point, 2 Nuts15
P-40 Solder Lugs to fit Contact Points10

STORAGE BATTERIES

A high grade storage battery fully guaranteed for two years 100 ampere hour. This is an exceptional value.
P-40 100 amp. hr. storage battery \$2.95

MISCELLANEOUS

Spaghetti Tubing, per foot \$0.10
No. 14 Copper Tinned Connecting Wire, per ft.25
Solderall, per tube25
Tape, 1/2 lb. roll20
Solders, 1/4 or 2/1612
Solder Paste, per can10
Battery Clips, each10
Grievol Permanent Crystal Detector 1.65
RW Adjustable Detector 1.50
LW Battery Voltmeter 0-30 V 2.25

HONEYCOMB COILS



Honeycomb duo-lateral on coils completely mounted with plug and strap.
Number of Turns Wave Lengths Mounted Price
P-25 25 125-250 \$ 8.95
P-35 35 175-350 1.00
P-50 50 240-720 1.05
P-75 75 350-915 1.10
P-100 100 500-1450 1.20
Any of the above sizes unmounted 45c each.

HONEYCOMB COIL MOUNTING

Can be used for panel or base mounting, connecting leads furnished. Constructed of Bakelite, metal parts nickel plated.
P-140 3-coil mounting \$3.85
P-50 2-coil mounting 2.85
P-100 Single coil mounting40

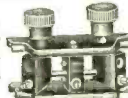

Visit either of our two big stores at any time. Our Experts will be glad to help you with your problems. This advice is absolutely FREE at any time.

FRESHMAN

The Freshman fixed condensers are carefully tested and guaranteed. They are constant capacity and accurate. Made in the following sizes.
4001 Mr Capacity Alcon \$0.30
4002 Mr Capacity Alcon30
4003 Mr Capacity Alcon30
4004 Mr Capacity Alcon35
4005 Mr Capacity Alcon35
4006 Mr Capacity Alcon40
4007 Mr Capacity Alcon40
4008 Mr Capacity Alcon50
4009 Mr Capacity Alcon50
4010 Mr Capacity Alcon60

SOCKETS

199 Socket 40c
W.D.11 Socket 40c
199 Adapter 45c
W.D.11 Adapter 45c
Composition VT Socket 25c
Porcelain VT Socket 25c
King VT Socket 75c
Special Metal Socket 50c
De Luxe Socket \$1.00



AERIAL EQUIPMENT

Stranded Antenna Wire No. 14 (7-22) per 100 ft. \$0.60
No. 14 R. C. Lead-in Wire per 50 ft.75
Porcelain Aerial Insulator each05
Composition Insulator (Like cut) each 10 Ground Wire Insulator each 10
Lightning Protector for Radio set. 1.50

RADION PANELS

High grade panels for mounting your set. Nationally advertised.
Size Bk. Mfg. Size Bk. Mfg. Each
6x7 in. \$ 7.75 7x21 in. \$2.15 \$2.60
6x10 1/4 in. .90 1.15 7x24 in. 2.40 2.95
6x14 in. 1.20 1.50 7x18 in. 5.00 5.90
6x21 in. 1.80 2.20 9x11 in. 1.80 2.20
7x9 in. .80 1.15 10x12 in. 1.70 2.10
7x10 in. 1.00 1.20 12x11 in. 2.30 2.75
7x12 in. 1.20 1.50 12x21 in. 3.40 4.15
7x14 in. 1.40 1.75 14x18 in. 3.40 4.15
7x18 in. 1.80 2.20 20x24 in. 6.80 8.25

RADIO CABINETS

Mahogany finished cabinets built sturdy adds to the appearance of any radio set, hinged top, takes panel of sizes listed below.
P-1 6x7 \$2.10
P-2 6x10 1/4 2.55
P-3 6x11 2.95
P-4 8x21 3.50
P-5 7x18 3.30
P-6 7x21 3.65
P-7 7x21 4.65

VACUUM TUBES

We carry the standard tubes in stock. Radio-ron and Cunningham and will ship which we have on hand.
P-910 UV-200 Detector Tube \$4.30
P-920 TV-201A Amplifier Tube 5.65
P-921 UV-199 Tube 5.65
P-922 WD-11 Tube 5.65
P-923 WD-12 Tube 5.65
P-924 DV-6 DeForest Tube 5.45



ALL AMERICAN TRANSFORMER

The genuine All American Shielded Transformer, latest type.
P-610 3-1 Ratio All American \$3.95
P-620 5-1 Ratio All American 4.10
P-630 10-1 Ratio All American 4.15
Federal—\$5.50 Value 4.45
Federal—\$7.00 Value 6.50
AmerTran—\$7.00 Value 6.50

B BATTERIES

High grade. Guaranteed long life. Large size 2 1/2 Volt. Regular \$3.00 sellers.
P-100 2 1/2 Volt large battery \$1.75
P-500 3 1/2 Volt large battery \$3.65
P-600 2 1/2 Volt small battery 1.10
Dry Cell Batteries 1 1/2 Volt40



RHEOSTATS

Howard Rheostat 6-25 or 40 ohms. .95c
King Rheostat 6-25 or 10 ohms. .95c
King or Howard Vernier \$1.35
SHACO Rheostat 60c
200 ohm Potentiometer \$1.35
400 ohm Potentiometer \$1.6f

FRESHMAN VARIABLE GRID LEAK

Grid Leak only \$5.35
Grid Leak and Condenser65
C.R.L. Variable Grid Leak 1.00
Fresnel Mark Grid Leak \$1.15

SWITCH LEVER

An excellent switch lever for a radio set, bushing lever with nickel plated switch arm.
P-12 Switch Lever \$0.25
P-11 Switch Lever (cheaper grade)19

Ten per cent discount on all C.O.D. orders. Otherwise remit by personal check or P.O. Money Order. We guarantee your complete satisfaction on everything purchased from us. No orders taken outside of U. S. and Possessions. DEALERS WANTED. WRITE FOR CATALOGUE.

ORDERS PROMPTLY FILLED

STANDARD RADIO CORPORATION

227-229-231 W. MADISON ST. 410-412-414 SO. WABASH Av.
TWO BIG STORES CHICAGO ILL.

SEVERAL GOOD REASONS

for the Widespread Popularity OF THE VARIABLE-VERNIER ELGIN BOOK CONDENSERS



FOUR SIZES:

- No. 4 .001 mf. \$1.75
- No. 3 .0008 mf. 1.50
- No. 2 .0005 mf. 1.25
- No. 1 .0003 mf. 1.00

Can be used in any circuit specifying rotary plate condensers, with the following advantages:

- 1st. Vernier All the Way. Three turns required from maximum to minimum capacity, instead of the customary half turn.
- 2nd. No Hand Capacity, if the plate nearest the hand is connected to the grounded, or dead side as we direct.
- 3rd. Cannot Become Shorted by metallic dust or by warping due to temperature changes.
- 4th. No Sliding Contacts to cause noise or trouble.
- 5th. Saves Space. Lies flat and requires but a fraction of an inch back of the panel.
- 6th. Rugged and Substantial. Heavy phosphor bronze bending leaf. Nothing to break or wear out.
- 7th. Reasonable Price. About one-third the cost of a vernier rotary plate.
- 8th. Straight Capacity Line. This is accomplished by giving a convex shape to the inside leaf, causing the outer one to separate from it gradually with a sort of unrolling motion.

Send a two-cent stamp for circular containing one, two, and three bulb hook-ups of the Elgin Super-Reinartz, the set which with only one bulb lighted brings in stations two thousand miles away on a loud speaker.

ELGIN RADIO SUPPLY COMPANY
207 E. Chicago Street
ELGIN, ILL.

Test this Battery any way you like!



A ROSENDAL "B" Battery is good in every way. Test it for continuous service and note its remarkable long life. Try it in intermittent service and see its great recuperative powers. There is every reason why a "Rosendal" should be a good battery. It is made of the finest materials under expert supervision and it comes to you fresh. That means

longer life—and at a price that saves you money because you buy direct from the manufacturer.

"The proof of the pudding" is in the eating. Try a "Rosendal" and if you don't like it send it back. Your money will be refunded.

Shipment prepaid at the following direct to consumer prices

	Large	Med.	Small
22½ V. Plain	\$1.66	\$1.33	\$0.93
22½ V. Variable	1.84	1.50	1.00
45 V. Plain	3.33	2.33	—
45 V. Variable	3.66	2.66	—

Ask for Circular on other radio parts

Send M. O. or order C. O. D.

ROSENDAL & CO.

Chemical and Radio Engineers

2 and 4 Stone Street New York

Reliable RADIO Goods

Results are Sure with RELIABLE Goods

And it's easy to get such goods—anything you want in radio equipment. Big, complete stock—everything guaranteed; quick service; right prices. And you're sure it's reliable when it comes from Andrae. Get our complete catalog—FREE.

Dealers

Buy reliable equipment from a house of established reputation. Send for catalog of tested and approved apparatus and our discount sheet.

JULIUS ANDRAE & SONS CO.
117 Michigan Street Milwaukee, Wis.

ANDRAE in Business Since 1882

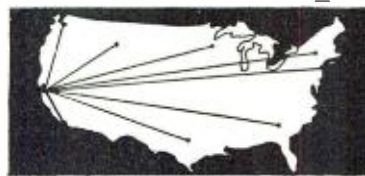

ON ONE TUBE

Broadcasting from Atlantic Coast, Mexico, Hawaii, Canada and Cuba heard in California by users of CROSS COUNTRY CIRCUIT. Range due to simplicity of set and only one tuning control. Easily and cheaply built by any novice. Dry cell tubes may be used. All instructions, blueprint panel layout, assembly photo, etc. Postpaid 25c. Stamps accepted. VESCO RADIO SHOP. Bx. RN-117. Oakland, Cal.

are not musical at all, but are radio instruments as used by us in our laboratories. They have been brought here to assist the 16th U. S. Infantry Band. These instruments give radio spark characteristics, as well as the well known radio howls, imitation of static, etc. In order to acquaint you with these different sounds, I take great pleasure in introducing to you first the radio spark. (The sounds of radio spark, produced by a large spark coil, condenser and spark gap, were then broadcast.) And now the radio oscillator—as fearful as its name implies. (The oscillator is an instrument used in Radio News Laboratories for testing frequencies of various radio apparatus. By this means, peculiar, weird, as well as shrill notes, could be produced which can be made to run the entire gamut of the scale. The sounds produced were often flute-like, often saxophone-like, but the quality was different from that produced by musical instruments.)

"And finally, before we go on, I wish to introduce to you the well known 16th U. S. Infantry Band, which, in way of passing, was the musical accompaniment for the first United States regiment to march on French soil during the late war. The same regiment was first in action—had the first casualties and captured the first German prisoners."

PROGRAM

First Number

Words and music by Alois E. Hauser, New York.

Radio March—Entry No. 101—Sung by Mr. Nat Sanders; Miss Ada Rubens at the piano.

Radio March—Entry No. 101—Played by the 16th Infantry Band; directed by Bandmaster Peter Weisenkeller.

Second Number

Words and music by Jack Nelson, Chicago, Ill.

Radio Jazz—Entry No. 31—Played by the 16th Infantry Band.

Radio Jazz—Entry No. 31—Sung by Miss Rose Shelby; Miss Ada Rubens at the piano.

Third Number

Bert Green, Springfield, Mass.

Radio March—Entry No. 43—Played by the 16th Infantry Band; directed by Bandmaster Peter Weisenkeller.

Fourth Number

Music by Lindsay McPhail, words by Jack Nelson, both of Chicago, Ill.

Radio Jazz—Entry No. 25—Played by the 16th Infantry Band.

Radio Jazz—Entry No. 25—Sung by Miss Rose Shelby; Miss Ada Rubens at the piano.

Fifth Number

Words and music by Henry H. Tobias, New York.

Radio Jazz—Entry No. 100—Sung by Nat Sanders; Miss Ada Rubens at the piano.

Radio Jazz—Entry No. 100—Played by the 16th Infantry Band; directed by Bandmaster Peter Weisenkeller.

Sixth Number

Lillian C. Tilton, Brooklyn, N. Y.

Radio March—Entry No. 34—Played by the 16th Infantry Band.

All in all, we believe the contest was a success, and the next few months will tell us whether our idea of popularizing a given piece of music solely over the radio is correct or not.

IT'S MUTUAL

Miss _____ who was playing piano selections at station _____ for the first time, desired that listeners telegraph or phone in stating how they enjoyed her offering. To be truthful, the music was terrible. Soon a telegram arrived reading as follows: "Tell Miss _____ that I don't know how to play the piano either!"

Insure your copy reaching you each month. Subscribe to Radio News—\$2.50 a year. Experimenter Publishing Co., 53 Park Place, N. Y. C.



RADIO AT NEW YORK PRICES

Via Daily Parcel Post

The Prices Quoted Below Deliver Goods to Your Door

REFERENCES:
R. G. Duns, Bradstreet, Coal & Iron National Bank, Corn Exchange Bank, N. Y. City.
No salvaged goods handled. Only standard brands in original packing, which bears ours and the manufacturers' guarantee. Due to our tremendous output we can undersell any of our competitors. Send your order in today and insure prompt delivery.

HOW TO ORDER—Write your order plainly; state number, description and price of items wanted. Send Post Office or Express Money Order, personal check or bank draft.



VACUUM TUBES

Standard brand Radio Corp. tubes. Guaranteed brand new.

- 150 Detector, U.V. 200 ea. \$4.25
- 151 Amplifier, U.V. 201A ea. \$5.75
- 152 1 1/2 volt W.D.11 ea. \$5.75
- 153 W.D.12 ea. \$5.75
- 154 U.V. 199 ea. \$5.75
- 155 U.V. 199 Adapter for U.V. 199 tube fits any socket ea. \$0.50
- 156 W.D.11 Adapter for W.D.11 tube and any standard socket ea. \$0.50

AUDIO FREQUENCY TRANSFORMERS

The following transformers are guaranteed standard makes, and will produce very efficient results

- 163 Dietzen 3 to 1 Ratio 3.95
- 164 Dietzen 5 to 1 Ratio 3.95
- 165 Dietzen 10 to 1 Ratio 3.95
- 166 Aermc Audio 3.95
- 167 American 3.95
- 168 U.V. 712 R.C.A. \$5.75
- 169 U.V. 714 R.C.A. \$5.75

LOOP AERIAL

176 Can be assembled by anyone in five minutes, a 11 wood parts, wire and binding posts included, complete \$8.95

MOULDED BAKELITE VARIOMETER or VARIOCOUPLER

179 Ea. \$4.95. List... \$7.00
A high grade instrument. Takes in the wave lengths from 250 meters to 800 meters. Table or Mounting.

FRESHMAN VARIABLE GRID LEAK AND GRID CONDENSER

Lowest filament current. Increases battery life; eliminates howling; zero to 5 megohms.

- 1102 Freshman Variable Grid Leak alone \$0.65
- 1103 Freshman Variable Grid Leak and Condenser combined \$1.85

FILAMENT CONTROLLED RHEOSTATS

Highest grade of material used. Tapered knob.

- 1104—8 ohm \$0.39
- 1105—30 ohm .49
- 1106—200 ohm Potentiometer .79
- 1107—400 ohm Potentiometer .79

WAVE TRAP

Simplifies tuning. Eliminates interfering stations, thereby improving the selectivity of your set. Selects between conflicting stations. Spectral white quantity lasts.

- 1131 Each \$4.95

HONEYCOMB COIL MOUNTINGS

- 1140 2-coil mounting \$2.85
- 1141 5-coil mounting 3.79
- 1142 Single coil mounting .40
- 1143 Receptical for single coil mounting .50

MISCELLANEOUS

- 1163 Spagetti Tubing per yd. \$0.09
- 1164 Synthetic Crystal .30
- 1165 Ground Clamps .17
- 1166 Black Rubber Binding Posts .05
- 1167 Nickel Plated Binding Posts 2 for .05
- 1168 No. 18 Annunciated Wire half pound coil .39
- 1169 6 ft. Phone Cord with tips .79
- 1170 20 ft. Extension Cord with tips 1.95
- 1171 Wall Insulators, Porcelain .05
- 1172 Tubular Porcelain lead-in insulators. 6 in. .10
- 1173 Reinartz Coil 1.45
- 1174 Cockaday Coil 2.45
- 1175 2 in. Dial and knob .25
- 1176 3 in. Dial and knob .35
- 1177 Switch Arm—tapered knob .19

BUILD YOUR OWN SET

COCKADAY CIRCUIT COMPLETE

- Consisting of
- 1 Cockaday coil and 7 pictal connections
 - 2 0005 Variable Condenser
 - 1 Socket
 - 1 Panel 7x18
 - 2 Dials, 3 in.
 - 1 Grid Leak and Condenser
 - 1 Rheostat
 - 1 Switch Lever
 - 1 Base Board
 - 12 Ft. Bus Bar
 - 7 Switch Points
 - 7 Marked Binding Posts
 - 1 Jack
- Wiring Diagram and Instructions

J-178 . . . Our Price \$12.65

DIETZEN SUPER HEAD SET

1181 2200 ohms. \$2.95
Reg. Price \$5 per pair.
Since we are wholesale distributors for this wonderful headset we pass this bargain on to you. The Tone quality is of unusual volume. These Phones can be used as a loud speaker unit. Sold with a money back guarantee if not satisfactory.

HARD RUBBER PANELS

The highest grade panel on the market. Highly polished finish; cut in the following sizes:

- 188—7x10 \$0.95
- 189—7x12 1.15
- 190—7x14 1.25
- 191—7x18 1.65
- 192—7x21 1.95
- 193—7x24 2.20

HIGH GRADE WOODEN VARIOMETERS

197 Price \$2.15
A real high grade job. An extremely low price. Package in all wave lengths.

IMPROVED OUTDOOR LIGHTNING ARRESTER

Passed by the Board of Fire Underwriters. Regularly sells for \$1.50.

- 1108 \$0.95

AMPLITONE LOUD SPEAKERS

This speaker will give efficient results when used with any pair of Head Phones; highly nickel plated; 18 inches high.

- 1117 \$3.95

STANDARD BRAND HEAD PHONES

- 1134 Brandes Superior \$5.25
- 1135 Dietzo graph 6.75
- 1136 Baldwin Type "C" Double .985
- 1137 Baldwin Type "C" Single .495
- 1138 Western Electric 10.50
- 1139 Dietzen Navy type 3000 ohms 4.95
List price 8.00

Modell's

71 Cortlandt St.
New York, N. Y.

America's Greatest Radio Mail Order House
ELEVEN NEW YORK STORES

BUILD YOUR OWN SET

REINARTZ CIRCUIT COMPLETE

- Consisting of
- 1 Reinartz Coil and 16 pictal connections
 - 2 5 in. Dials
 - 1 0005 Variable Condenser
 - 1 11-Plate Condenser
 - 1 Socket
 - 1 Fernier Rheostat
 - 3 Switch Levers
 - 1 7x14 Panel
 - 1 Base Board
 - 8 Marked Binding Posts
 - 12 Ft. Bus Bar
 - 1 Grid Condenser
 - 2 doz. Switch Points and stops
- Wiring Diagram and Instructions

J-179 . . . Our Price \$10.85

DOUBLE PHONOGRAPH ATTACHMENT

This attachment fits all phonographs; will take any headset. It converts your phonograph into a loud speaker.

- 1132 Double attachment \$0.85
- 1180 Single attachment fits any single phone unit to be used on phonograph .49

1/2 VOLT DIETZEN TUBE

Two-element Fleming valve effect; operates on one dry cell with or without "B" Battery; wiring diagram free with each tube.

- 195 Dietzen Tube \$1.00
- 196 Socket for Dietzen Tube .40

BAKELITE TUBE SOCKETS

Moulded of brown bakelite; Binding Post Connections.

- 199 Standard Type for 201A 301A, W.D.12 \$3.50
- 1100 For U.V. 199, U.V. 299 Socket .39c
- 1101 For W.D.11, C11 39c

RADIO SOLDERING IRON

Indispensible for the man who builds his own sets.

- 1109 \$2.50
- 1133 Soldering Paste Tube .25

VARIABLE AIR CONDENSERS

These condensers are made of heavy aluminum plates. High grade bakelite ends.

- 1110—21 Plate 0005 Mfd. \$4.75
- 1111—11 Plate 0025 Mfd. \$2.25
- 1112—3 Plate .0000 Mfd. \$0.95
- 1113—15 Plate .001 Mfd. 2.25

VERNIER VARIABLE CONDENSERS

Specifications the same as above

- 1114—14 Plate Vernier with knob and dial \$2.95
- 1115—26 Plate Vernier with knob and dial 3.45
- 1116—45 Plate Vernier with knob and dial 3.95

MAGNET WIRE (8 oz.)

Size	Covered Price	Green Silk Price
1144 18	\$0.43	1145 18 \$0.73
1146 20	.53	1147 20 .85
1148 22	.68	1149 22 1.00
1150 24	.78	1151 24 1.13
1152 26	.88	1153 26 1.65
1154 28	1.07	1157 28 1.95
1156 30	1.58	1157 30 2.65

WOOD CABINETS

Highest grade Mahogany finish Cabinets Hinged top. These cabinets are being sold at less than one-half regular value.

- 157 Wood Cabinet; panel size 7"x10" Each \$2.50
- 158 Wood Cabinet; panel size 7"x12" Each 2.75
- 159 Wood Cabinet; panel size 7"x14" 3.00
- 160 Wood Cabinet; panel size 7"x18" Each 3.50
- 161 Wood Cabinet; panel size 7"x21" Each 3.75
- 162 Wood Cabinet; panel size 7"x24" Each 4.00

RADIO FREQUENCY TRANSFORMERS

- 170 Tri-coil for 201A or 301A tubes \$1.95
- 171 For 199, 299 or W.D.11 and 12 tubes 1.95
- 172 Erla A11 3.75
- 173 Erla A12 3.75
- 174 Erla A13 3.75
- 175 Erla Reflex 4.65

VARIOCOUPLER

177 High Grade 180 Degree Coupler made of Bakelite tubing with green silk wire. Special \$2.45
178 Variometer same specifications 2.45

PLATE CIRCUIT "B" BATTERIES

The highest grade of battery made at prices lower than they ever were sold before.

- 180—2 1/2 Volt Small \$1.45
- 181—2 1/2 Volt Medium 1.45
- 182—2 1/2 Volt Large 1.95
- 183—4 1/2 Volt Medium 1.95
- 184—4 1/2 Volt Large 2.50
- 185—4 1/2 Volt Extra Large 3.50
- 186—360 hr. 1 1/2 Volt twin double duty "A" Battery .75

RUSONITE

CRYSTAL RECEIVER
MULTIPOINT

1160 14 K. Gold Supersensitive Rusonite Patchhiker. Permanent. Will not oxidize. Price \$25.
1161 Rusonite Reflex Crystal. Manufactured expressly for Reflex Circuits. Guaranteed. Price, mounted \$1.00

JACKS AND PLUGS

Jacks are polished nickel constructed with pure silver contacts.

- 1118 One Spring open circuit \$0.39
- 1119 Two spring closed circuit .49
- 1120 Round Plug as illustrated .49

AERIAL WIRE

- 1121 100 ft. solid copperweld wire coil \$4.49
- 1122 7 strand 100 ft. .69
- 1123 25 ft. coil. Ground Wire Rubber Covered No. 14 \$1.49
- 1124 50 ft. coil .85

INSULATORS

These are very strong strain type insulators.

- 1158 Moulded Insulator shown Ea. \$0.10
- above Doz. \$10.10

LOUD SPEAKERS

1125 Herald Loud Speaker; no extra battery required. \$23.95
Ideal instrument for the home school or church.
New \$30.00
1126 Magnatone new type \$29.95
1127 Music Master 28.50
1128 Atlas Speaker 22.50
1129 Pathe Speaker 21.95
1130 Dietzen Speaker 18.95
The above prices delivered to your door.

Robert J. Casey (Chicago Daily News) builds set of RPM Units.

"The set is a two-tube regenerative double-jointed reflex designed by the engineers of the Radio Products Mfg. Co." writes Mr. Casey in Chicago Daily News, Nov. 3rd. In Action it is a distinct surprise. Both tubes give an R.F. amplification stronger than many other circuits. Tuning sharp enough for anybody. One of the novelties of this hook-up is the standardization of parts, permitting easy change of the component elements.



"Another is the variable condenser which affords a micrometer adjustment with a variation from minimum to maximum that will do the work of any 1 to 43 plate condenser."



A unit for every receiving purpose. Mounted and Unmounted Variometers, Variocouplers, Variable Condensers, Coupled Circuit Tuners. Also Detector and Amplifying Units.

At a big saving, you can build this—or any other set—using RPM Standardized Units. Hook-ups in every package. No soldering of joints, no tools necessary. Merely connect binding posts. Each RPM Unit is complete in itself. Moulded Bakelite—very handsome. RPM units are efficient in performance, superior in quality and have absolutely no body capacity. You can pay more but you can't buy better units. At your dealers' or write us. Unconditional guarantee.

RADIO PRODUCTS MFG. CO.,
667 West 14th Street Chicago

WALNART TWINS



Variable
Grid Resistance
\$1.00
Inductance Switch
\$1.25



To get distance you must have positive contacts. The average arrangement of switch points is not satisfactory. Walnut inductance switch gives positive contacts—insuring better reception.

Different tubes require different grid resistance—Walnut Variable grid resist-

ance varying from minimum to maximum of six Megohms clears up signals and adds to the efficiency of the set.

The instruments are made of highest quality material; base is genuine condensite Celoron made under Bakelite patents.

WALNART ELECTRIC MFG. CO.

1249 W. Van Buren St.

Dept. 606 CHICAGO, ILL.



"AETNA" Condensers

High Grade Quality

"AETNA" condensers are made of the best material, hard, pure Aluminum and Condensite Celoron end plates.

WE guarantee every Condenser to prove to capacity.

Mail Orders Filled Promptly.

Variable Condenser PRICES
No. 11 Plate...\$1.30
No. 17 Plate... 1.45
No. 23 Plate... 1.60
No. 43 Plate... 1.90

AETNA VARIABLE CONDENSER CO.

Phone: Lincoln 6052, 333-43 North Ave., Chicago, Ill.

BROWNLIE CRYSTAL

FOR REFLEX OR CRYSTAL SETS

50¢

"CLEAR AS A BELL"

Guaranteed Sensitive from Edge to Edge.

Withstands Heavy Plate Voltage. The Acme Apparatus Co. says "prevent distortion and howling by using a BROWNLIE CRYSTAL IN REFLEX SETS."

Order From Your Dealer or Direct

ROLAND BROWNLIE & CO.

22 Saunders Street. Medford Mass.

Engineering Trans-Atlantic Radio Telephony

(Continued from page 1054)

The cost of communication is one factor that will require serious consideration. Trans-oceanic telephone service will be of little use to the public if the cost is prohibi-

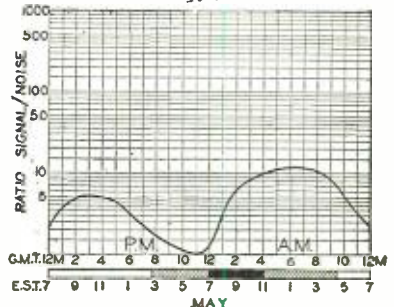
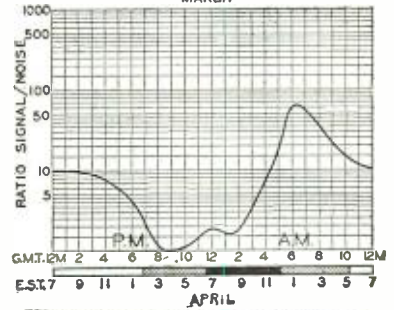
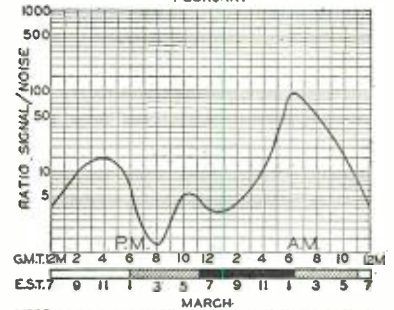
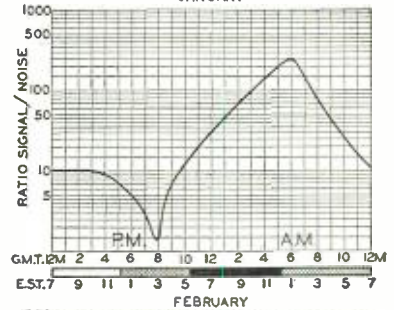
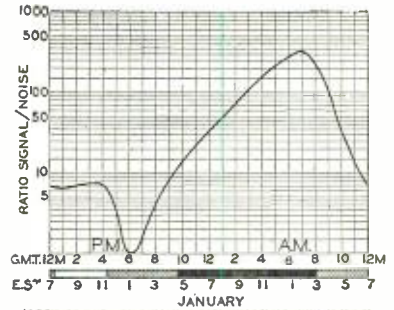

Insure your copy reaching you each month. Subscribe to Radio News—\$2.50 a year. Experimenter Publishing Co., 53 Park Place, N. Y. C.

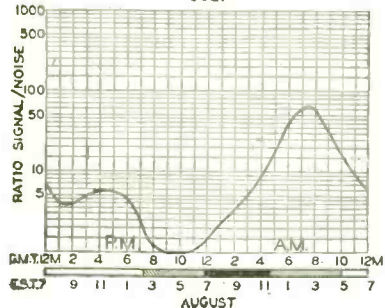
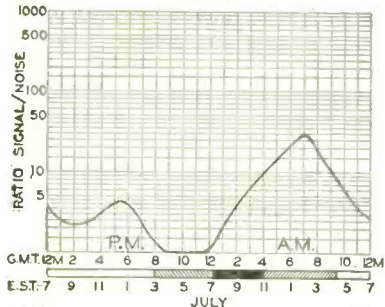
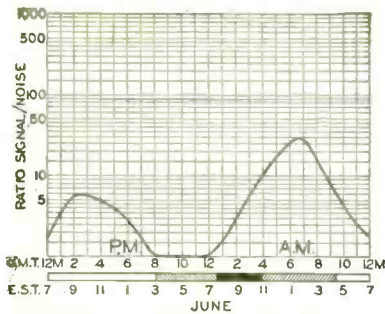

Trans-Atlantic Radio Transmission Measurements. Monthly Averages of Diurnal Variations in Signal to Noise Ratio for 1923. Transmission from Rocky Point to London on 57,000 Cycles (5,260 Meters). Measurements on Loop Reception. Curves Corrected to 300 Amperes Antenna Current.

tive to the average person. The charges cannot be much more than those at the present time for communication across the continent. To bring the cost of operation down to a low figure is a problem indeed.

KYW TO BROADCAST TWO MID-NIGHT REVUES EACH WEEK

Since the inauguration of the midnight revues which are broadcast every Friday night from Westinghouse station KYW, the invisible radio audience all over the United States has an acute case of insomnia.

There is nothing more comforting these cold evenings than to recline at ease in your most comfortable chair and listen to a program of good entertainment with nothing more to do at the end of the show than to turn off your set and "turn in for the night." However, it seems impossible to sit at ease, or even lie down when dance selections and other lively musical numbers are rendered by the professional entertainers who send out their tantalizing strains of harmony from KYW.

Mr. Wilson J. Wetherbee, director of station KYW, is responsible for the first midnight show sent out from any broadcasting station. When Mr. Wetherbee decided to put on this new feature, a preliminary announcement was broadcast asking that those of the invisible audience who desired such a novelty send in their approval via Uncle Sam's mail. Within a week, thousands of letters from all over the United States were received, and the first midnight show was sent out.

No Matter What Your Vocation

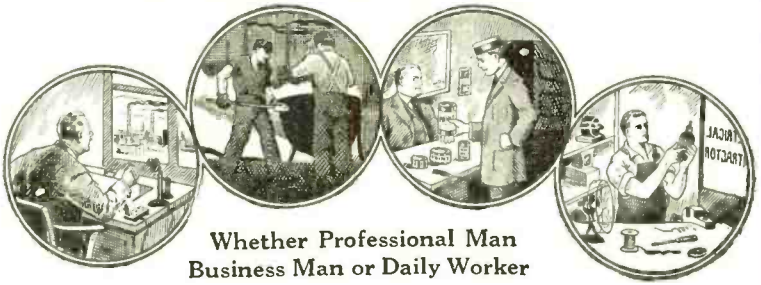

Whether Professional Man
Business Man or Daily Worker

**A Thorough Training In
CHEMISTRY
Will Help You To Get Ahead**

TO be successful today is to know Chemistry! Every line of business, every branch of industry depends upon Chemistry in some form. You may not realize it, but your own proficiency in whatever work you are doing would be increased by a knowledge of Chemistry. In many lines such knowledge is absolutely essential. In others it is a guarantee of promotion and more money.

The keen competition that exists in every commercial activity today requires that a man know all there is to know about his vocation. If you have something to sell—no matter what—Chemistry enters into its make-up. The salesman who knows the chemical composition of his article can talk about it more intelligently than the one who lacks this information, and his sales are proportionately larger. In the building trades Chemistry is of prime importance. The mason, electrician or painter who knows something about Chemistry can do better work and command more money than the one who does not. Through Chemistry a shop-keeper learns how to attract the most trade, and even in clerical positions one can capitalize his chemical skill.

Chemistry should be as much a part of your mental equipment as the ability to calculate or to write correct English. The world is paying a thousandfold more for ideas than for actual labor. The big rewards go to the man who can show how to turn out a little better product at a little lower cost. And Chemistry will give you the ideas that will save money for yourself or your firm in the very fundamentals of your business. There is nothing remarkable about this; it is going on every day. If you have not heard of it before, it is because the general public has been slow to recognize the tremendous value of chemical training. People have been content to leave Chemistry in the hands of a few trained chemists who could not possibly develop the subject to anywhere near its greatest extent.

Now we are on the eve of a great awakening. Our heritage from the World War has been an intense development of the chemical industries in the United States and a tremendous interest in all the applications of Chemistry. People are taking up the subject merely for the good it will do them in their own line of business.

It is no longer necessary to enter college in order to learn this fascinating science. Our Home Study Course trains you just as thoroughly, and with the same assurance of success, as those who took the longer way. And our methods are so simple that we can teach you no matter how little previous education you may have had. Many of our graduates now hold responsible positions or have materially increased their incomes from private enterprises as a result of taking our course. Hundreds of letters from students testifying to the benefits they have derived from our training are here for your inspection.

Remember that you do not need to study Chemistry with the idea of actually becoming a chemist, although a great many of our students are taking our course with this object in view. If you want to know more about what Chemistry will do for you, if you want to know what our home study course offers, then mail the coupon today for FREE BOOK "Opportunities for Chemists."

**Chemical Institute
of New York, Inc.**

HOME EXTENSION DIVISION 2
66-R West Broadway, New York City

**DR. T. O'CONNOR SLOANE Will
Teach You Chemistry In
Your Own Home**

The Chemical Institute of New York, of which Dr. T. O'Connor Sloane is Educational Director, was founded to fill the need of ambitious, far-sighted men who realize and recognize the splendid future Chemistry offers them, but who cannot spare either the time or the money to attend college. Dr. Sloane, a foremost authority on Chemistry, will teach you and will give you any individual help you may require. He will personally go over your papers, correct them, point out your faults, teaching you in a practical and interesting way. No special education required other than the ability to read and write English. One student has characterized our lessons as "The course that takes the mystery out of Chemistry."

**Read What One of Our Recent
Graduates Reports**

"I thought I would let you know of my success. I finished your course about two months ago and now have a fine position as chemist at the DuPont Dye Works. I am getting along fine with my work and like it very much. It was through your course alone that I have been so successful. It is wonderful and I hope you have great success with it."
(Name and Address on request).

Easy Monthly Payments

You do not have to have even the small price of the course to start. You can pay for it in small monthly payments—so small that you won't feel them. The cost is very moderate, and includes everything, even the Laboratory Equipment—there are no extras to buy with our course. Our plan of monthly payments places a chemical education within the reach of everyone.

**Laboratory Equipment Given
To Every Student Without
Additional Charge**

We give to every student without additional charge his chemical equipment, including forty-two pieces of laboratory apparatus and supplies, and seventeen different chemicals and reagents. These comprise the apparatus and chemicals used for the experimental work of the course.

Special 30-Day Offer

For a short period we are making a special offer that will be worth your while to take advantage of. Write for particulars, using the coupon below or simply a Postal card. This will not oblige you in the least. Do not wait until to-morrow. Send the coupon now while you think of it.

**Sign and Mail the Coupon for
FREE BOOK**

CHEMICAL INSTITUTE OF NEW YORK, Inc.
Home Extension Division 2,
66-R—West Broadway, New York City.

Please send me at once without any obligation on my part your Free Book "Opportunities for Chemists," and full particulars about the Laboratory Equipment furnished to every student. Also please tell me about your plan of payment and your special 30 day offer.

NAME

ADDRESS

CITY

STATE

R.N. 2-24

Each Panelyte Panel individually inspected, packed and sealed at factory.

**A HIGH QUALITY
PANEL.
LOW IN PRICE.**



Every Panel in Attractive Cardboard Container.

Radio Panels

Patents Pending

Reasons why you should use Panelyte Panels:

Excellent Dielectric Properties
High Surface Resistivity
High Volume Resistivity
Uniform in Quality

Wonderful Performance.

Beautiful Gloss Finish on one side, other side grained
Easy to Tool and Drill
Sold in 15 standard sizes or out to special size

Make your next Panel Panelyte.

Order direct from factory or from your nearest dealer.

THE PANELYTE COMPANY

TRENTON, N. J., U. S. A.



"A" MARKO BATTERY

90 and 120 AMP. HRS.

IN RUBBERLITH CASE

Ornamental As Well As Efficient

The Rubberlith case is a composition case with a high gloss giving the appearance of ebony. It is moulded in one piece, including handles and cells—no jars to break—and is practically indestructible. A worthy addition to your set.

All sizes, from 2 volt batteries up, carried in Mahogany Finish Cases.

DISTRIBUTED BY

MARKO STORAGE BATTERY CO., 210 West 54th St., New York, N. Y.
MARKO STORAGE BATTERY CO., 102 Jefferson Ave., Brooklyn, N. Y.
RADIO DISTRIBUTING CO., 8 W. Park St., Newark, N. J.
ALBANY RADIO CORPORATION, 356 Broadway, Albany, N. Y.
TRUE & BLANCHARD CO., Inc., Newport, Vt.
SCHIMMEL ELECTRIC SUPPLY CO., 526 Arch St., Philadelphia, Pa.
CONSOLIDATED WIRE & MCHY CORP., Green & Congress Sts., Chicago, Ill.

Sold by Radio Supply Stores and all Marko Service Stations

MADE BY

MARKO STORAGE BATTERY CO.

1402 ATLANTIC AVENUE, BROOKLYN N. Y.

TO THE RADIO DEALER.

Let us explain how you can make the sale of our publications a worth while, well paying part of your business. Every one that enters your store is a prospective buyer of RADIO NEWS. RADIO NEWS will sell with little effort on your part.

You may sell our publications on a single copy basis with a fine margin of profit or on a subscription basis with a generous commission allowance.

Write now and prepare for the Fall and Winter trade.

EXPERIMENTER PUBLISHING CO.,
53 Park Place, New York.

Seek Cause for Fading of Radio Signals

(Continued from page 1064)

transmitting and receiving stations, and the method of handling the receiving apparatus. Only by a statistical study in which the results obtained simultaneously at a large number of receiving stations are collected and tabulated, may reliable averages be obtained.

In an attempt to secure some worthwhile statistics of this kind, a co-operative study of radio signal fading was made by the Bureau of Standards and the American Radio Relay League during 1920 and 1921. In these tests from five to ten radio stations transmitted signals in succession on certain nights, according to prearranged schedules. The signals were received simultaneously by about 100 receiving stations whose operators were provided with forms for recording the variations in the intensity of the signals as received.

The paper gives summary tables pointing out possible relationships between weather conditions and the fading and intensity of radio signals and the prevalence of strays or atmospheric disturbances. On account of the limited number of observations and the large number of factors which influence transmission, the statistical results can be considered as only tentative.

The general result of these tests, however, substantiates the theory that the sources or causes of fading are intimately associated with the conditions at the Heaviside surface, which is a conducting surface some 60 miles above the earth. Daytime transmission is largely carried on by means of waves moving along the ground, while night transmission, especially for great distances and short waves, is by means of waves transmitted along the Heaviside surface. Waves at night are thus free from the absorption encountered in the daytime, but are subject to great variations caused by irregularities of the ionized air at or near the Heaviside surface. These variations probably account for fading.

The results of these tests are embodied in Scientific Paper No. 476 of the Bureau of Standards. Copies can be obtained from the Superintendent of Documents, Government Printing Office, Washington, D. C. The price is ten cents, cash.

Calls Heard

(Continued from page 1077)

9CVW, 9DBA, 9DCH, 9DCW, 9DES, 9DFH, 9DGE, 9DGL, 9DGW, 9DHK, 9DHU, 9DIA, 9DJM, 9DKC, 9DKV, 9DLM, 9DLY, 9DND, 9DNN, 9DPA, 9DR, 9DSV, 9DTT, 9DVK, 9DWA, 9DXK, 9DXN, 9DYY, 9DZZ, 9ECV, 9EHE, 9EHH, 9EHT, 9EKF, 9EKT, 9ELB, 9HK, 9JR, 9JY, 9KD, 9LH, 9LR, 9MC, 9OX, 9RC, 9ST, 9UR, 9US, 9UZ, 9VM, 9VZ, 9YY, 9ZG, 9ZT, 9ZV, 9ZY, all C. W.
Phones—2WA, 2XI, 5AMF, 5HL
Canadian—2BG, 2BN, 2CG, 2CN, 2IC, 2IV, 3AA, 3AS, 3BP, 3DE, 3GK, 3JT, 3IN.

R. E. GROEBE, 338 EL MORA AVE., ELIZABETH, N. J.

1ADN, 1AEZ, 1AHZ, 1AIN, 1AJA, 1AJT, 1AJX, 1AKR, 1ALI, 1AMC, 1ANB, 1AOC, 1ARW, 1ATJ, 1AUR, 1AWV, 1AWW, 1BAM, 1BDB, 1BEZ, 1BGC, 1BGN, 1BMA, 1BMF, 1BNE, 1BOM, 1BOQ, 1BSB, 1BSH, 1CAV, 1CAZ, 1CJR, 1CKN, 1CMP, 1CNP, 1CON, 1CRW, 1CWB, 1DOP, 1XAM, 1AR, 1GG, 1EZ, 1FD, 1GS, 1HW, 1HX, 1TT, 1KA, 1MQ, 1MY, 1OZ, 1RR, 1UM, 1VG, 1WI, 1XU, 1XZ, 1YK, 1ZE, 3AAO, 3ACQ, 3ACY, 3AEC, 3AFQ, 3AIC,

3AKY, 3AMW, 3ARM, 3ATS, 3AVA, 3BCJ, 3BDA, 3BDO, 3BDR, 3BEI, 3BGC, 3BGG, 3BJD, 3BKT, 3BLC, 3BML, 3BNT, 3BNU, 3BOF, 3BSB, 3BTA, 3BTL, 3BVN, 3BWT, 3CAH, 3CAN, 3CBZ, 3CFV, 3CIA, 3CIO, 3CJN, 3AS, 3AV, 3BG, 3BQ, 3BN, 3DO, 3DS, 3EH, 3FB, 3GK, 3JI, 3IV, 3JI, 3KQ, 3LD, 3ME, 3OO, 3OX, 3FZ, 3OM, 3SG, 3SU, 3TB, 3UU, 3VV, 3WF, 3ZM, 3ZO, 3ZS, 4AI, 4AV, 4BK, 4BQ, 4DB, 4DU, 4DV, 4EB, 4EL, 4EQ, 4FS, 4FT, 4HR, 4HZ, 4IU, 4JK, 4JZ, 4KC, 4KU, 4LJ, 4MB, 4ME, 4ML, 4MY, 4NA, 4OB, 4ON, 4OU, 4OF, 4RH, 4SAB, 4SABN, 4SABT, 4SABY, 4SADB, 4SADH, 4SAFS, 4SAGJ, 4SAIR, 4SAIU, 4SAMA, 4SAMH, 4SAMS, 4SAMW, 4ZAK, 4ZAS, 4AA, 4AC, 4BW, 4DA, 4EK, 4ER, 4FV, 4FX, 4GJ, 4IF, 4IL, 4KG, 4KH, 4KR, 4LR, 4MI, 4MO, 4MW, 4NN, 4OK, 4PH, 4SK, 4TF, 4U, 4UK, 4VO, 4VP, 4VW, 4WG, 4WX, 4ZA, 4ZB, 4ZG, 4ZM, 6AIR, 6AOL, 6AVV, 6BBH, 6BFG, 6BIH, 6CHU, 6FP, 6KM, 7IO, 7KS, 7SH, 7WS, 7ZD, 7ZU, 8AAF, 8AAJ, 8ABD, 8ABE, 8ACN, 8ACT, 8ADH, 8AEG, 8AFN, 8AFU, 8AGL, 8AGP, 8AHO, 8AIG, 8AII, 8AJE, 8AJH, 8AMM, 8AMR, 8AMX, 8ANB, 8ANQ, 8ARD, 8ASV, 8ATN, 8AWL, 8AWT, 8AZH, 8AZI, 8AZO, 8BAI, 8BBV, 8BCI, 8BCU, 8BDA, 8BFE, 8BFR, 8BGT, 8BIA, 8BIO, 8BIV, 8BLB, 8BLR, 8BMB, 8BMD, 8BNH, 8BNK, 8BOA, 8BOE, 8BOI, 8BRM, 8BSI, 8BTU, 8BXD, 8BXH, 8BZS, 8'BC, 8CCJ, 7CCO, 8CCR, 8CDZ, 8CED, 8CFO, 8CGB, 8CGI, 8CGO, 8CHB, 8CHP, 8CIA, 8CKN, 8CLC, 8CLI, 8CMT, 8CMU, 8CMY, 8CNL, 8COO, 8COH, 8COS, 8CRC, 8CRN, 8CRV, 8CSE, 8CSJ, 8CTE, 8CTZ, 8CUQ, 8CUV, 8CVM, 8CWK, 8CXM, 8CXN, 8CYM, 8CYT, 8CZZ, 8DAC, 8DAW, 8DBL, 8DBS, 8DCH, 8DCY, 8DCZ, 8DDC, 8DDO, 8DFV, 8DHS, 8DHV, 8DIF, 8DIG, 8DIP, 8DIS, 8DJB, 8DJD, 8DKJ, 8DJP, 8DKI, 8DKY, 8DLH, 8DYN, 8ZAF, 8BT, 8CC, 8DO, 8EL, 8EO, 8FU, 8GZ, 8HJ, 8KG, 8KO, 8LR, 8LV, 8MD, 8MT, 8NB, 8ND, 8NZ, 8OM, 8PB, 8PD, 8PL, 8QN, 8RV, 8TE, 8TR, 8TT, 8UF, 8UP, 8VV, 8WX, 8WZ, 8XE, 8YN, 8ZR, 8ZZ, 9AAU, 9ADY, 9AEM, 9AEN, 9AET, 9AGN, 9AHO, 9AHV, 9AHY, 9AIZ, 9AIM, 9AIV, 9AIX, 9AJN, 9AJV, 9ALI, 9ALY, 9AMB, 9ANU, 9AOA, 9AOU, 9APE, 9APE, 9APS, 9AQK, 9ARB, 9ARH, 9ARK, 9ARU, 9ARV, 9ASE, 9AUA, 9AUS, 9AVG, 9AVN, 9AVP, 9AWF, 9AWG, 9AWV, 9AXT, 9AYX, 9AZI, 9BAF, 9BAF, 9BAS, 9BAZ, 9BBT, 9BCB, 9BED, 9BEZ, 9BF, 9BGT, 9BIV, 9BJI, 9BJR, 9BKH, 9BLG, 9BLY, 9BMD, 9BMT, 9BNA, 9BNB, 9BQJ, 9BRI, 9BRK, 9BRT, 9BRX, 9BRY, 9RSH, 9BSP, 9BWA, 9BXO, 9BXT, 9BYC, 9BZI, 9CAA, 9CAJ, 9CBJ, 9CCS, 9CCV, 9CDB, 9CDI, 9CDO, 9CFI, 9CFK, 9CFY, 9CFZ, 9CGU, 9CHC, 9CHQ, 9CJA, 9CJC, 9CJH, 9CKH, 9CKP, 9CKW, 9CLN, 9CLO, 9CLZ, 9CMN, 9CNV, 9COL, 9CSZ, 9CTB, 9CTE, 9CTG, 9CTU, 9CUI, 9CVS, 9CWB, 9CWF, 9CWI, 9CFE, 9CYO, 9CZW, 9CCS, 9DAY, 9DBN, 9DBU, 9DCB, 9DCP, 9DCG, 9DDT, 9DDU, 9DGE, 9DGI, 9DGH, 9DHP, 9DHO, 9DHU, 9DIA, 9DIH, 9DJI, 9DKH, 9DKK, 9DKP, 9DLM, 9DNN, 9DOF, 9DON, 9DPX, 9DQU, 9DRK, 9DRO, 9DSW, 9DTH, 9DVK, 9DVK, 9DXC, 9DXJ, 9DXK, 9DXL, 9DXN, 9DYV, 9DZS, 9DZU, 9DZY, 9EAK, 9EAR, 9ECB, 9ECL, 9ECV, 9EDO, 9EEA, 9EFZ, 9EHH, 9EHI, 9EHO, (?), 9EIF, 9EIA, 9EJV, 9EIV, 9EKF, 9EKY, 9ELL, 9CR, 9EI, 9EF, 9EG, 9GS, 9HK, 9HZ, 9IR, 9JR, 9JY, 9JZ, 9KD, 9KV, 9LH, 9LA, 9MM, 9PB, 9PE, 9PF, 9PW, 9QR, 9UR, 9US, 9UZ, 9VM, 9WC, 9XI, 9YV, 9ZY

Canadian—1AR, 1DD, 1DO, 1ZL, 2AM, 2AU, 2BE, 2BG, 2BN, 2CG, 2CT, 2HG, 2HV, 2IC, 3ADN, 3ADU, 3BA, 3BM, 3BQ, 3BT, 3CO, 3CT, 3EP, 3FC, 3FO, 3GK, 3HE, 3KG, 3KP, 3LW, 3NI, 3OE, 3PG, 3OS, 3SP, 3TB, 3TF, 3WG, 3XI, 3YH, 4CL, WNP.

SAIA, LAKE CHARLES, LA. (ONE TUBE)
 C. W.—1AJX, 1ASD, 1BQD, 1BWJ, 1DD, 1FD, 1II, 2AGB, 2AGC, 2CEI, 2CXL, 2EL, 2TS, 3ABW, 3AHP, 3ATB, 3AUW, 3BGO, 3BMN, 3CDN, 3CFV, 3CO, 3HD, 3PH, 3ZO, 4AY, 4BK, 4BY, 4CL, 4EB, 4ER, 4ET, 4FA, 4FT, 4GW, 4HR, 4HZ, 4JH, 4MY, 4OB, 4OF, 4QW, 4ZA, 6AMS, 6ASX, 6AWT, 6BCL, 6BIC, 6BII, 6BSN, 6CBI, 6CBU, 6COW, 6CWE, 6PL, 6ZAH, 6ZH, 6ZO, 7IW, 7ZD, 8AZJ, 8ACN, 8AGO, 8AGP, 8AHO, 8AHZ, 8AII, 8AM, 8AMD, 8AMF, 8APT, 8APV, 8ATP, 8ATZ, 8BDM, 8BDN, 8BF, 8BNN, 8BPU, 8BRM, 8BSY, 8BYI, 8BZC, 8CAZ, 8CC, 8CDZ, 8CED, 8CEO, 8CGI, 8CLC, 8COH, 8COX, 8CRW, 8CSE, 8CVG, 8CWK, 8CVL, 8CWU, 8DAC, 8DAW, 8DCG, 8DDC, 8DDF, 8DHO, 8DQX, 8DW, 8DZS, 8GZ, 8HN, 8IG, 8JV, 8KG, 8PD, 8PX, 8QN, 8UK, 8WN, 8XE, 8ZO, 8ZZ, 9ACT, 9AEB, 9AEV, 9IC, 9AIV, 9AIP, 9AUW, 9AWF, 9AWV, 9AZ, 9BAV, 9BDS, 9BEI, 9BJI, 9BK, 9BKH, 9BKM, 9BLG, 9BQO, 9BZI, 9CVD, 9CDE, 9CDO, 9CFA, 9CHE, 9CJC, 9KP, 9COL, 9CTR, 9CYC, 9DCR, 9DFH, 9DIA, 9DKX, 9DLG, 9DND, 9DPC, 9DWA, 9DWD, 9DXN, 9DXY, 9DZI, 9EQO, 9EF, 9EHT, 9EHV, 9EIF, 9EKF, 9EKY, 9ES, 9FG, 9IW, 9LH, 9LT, 9OX, 9PB, 9PW, 9PX, 9TA, 9ZV

Spark—3BDA, 9AQE, 9LF.
 Phone—5GM, 5MA, 9AMC.
 Canadian—3NI, 3TB, 4CL, 5GO.
 All crds QSL'd. Tnx OM.

9DH, CROWN POINT, IND. (ONE TUBE)
 C. W.—1BOQ, 2BY, 2MU, 2WL, 2WR, 3BMN, 3BUN, 3AS, 3JJ, 3HK, 4BU, 4BQ, 4DB, 4EB,



18
Stock Sizes
Radion
Panels

6x7	6x10½	8x14
6x21	7x9	7x10
7x12	7x14	7x18
7x21	7x24	7x48
9x14	10x12	12x14
12x21	14x18	20x24

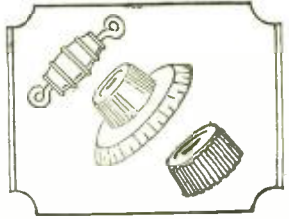

Mahoganite has the Beauty of Polished Mahogany

Mahoganite Radion Panels have a satin-like finish comparable to that which age and a skilled cabinet maker give to mahogany. Radion Dials and Knobs can also be had in Mahoganite to match.

AMERICAN HARD RUBBER COMPANY, 11 Mercer St. N. Y.

RADION

The Supreme Insulation

PANELS

Look for this stamp on every genuine Radion Panel. Beware of substitution and imitation.

THE W. P. CO. VARIOMETER

The Best Wooden Variometer Made Price for Set of Five Parts

\$1.25

All parts accurately made in our own Factory from selected first quality birch, Kiln-dried and specially moisture proof treated.

Outside diam. of Stators, $4\frac{3}{4}$ ", inside diam. $3\frac{3}{4}$ ", diam. of Rotor $3\frac{1}{2}$ ".

Set of five parts, shipped knocked down, to make this Variometer, as illustrated, consists of two Stators, one Rotor, Base and Winding Form, easily assembled.

If your dealer cannot supply you, we will send you a set of parts direct by Parcel Post for \$1.25. Prompt shipment, no delay.

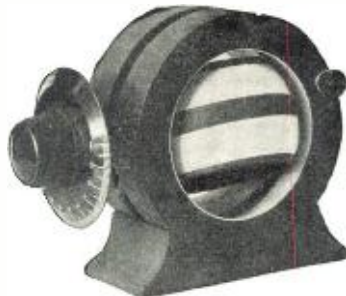

We will mail you the best wooden VARIO-COUPLER ROTOR made, upon receipt of 25 cents

Wood Products Company Incorporated

Mfrs. of Wooden Radio Specialties

Brewer :: :: :: :: Maine

4EL, 5AIP, 5AGO, 5ADS, 5AMH, 5AIU, 5BE, 5BI, 5HL, 5MO, 5OO, 5UP, 5VV, 5ZB, 8APN, 8AQO, 8BDA, 8BDU, 8BOB, 8BNH, 8CJG, 8CNW, 8CWX, 8CRC, 8DIG, 8DHO, 8AL, 8GZ, 8IJ, 8TT, 8WL, 8XE, 8XH, 8YN, 8ZZ, (9AEM), 9AGN, 9AZI, 9AUS, 9AVZ, 9AXX, 9ASE, 9ACY, 9AMI, 9AHY, (9AHE), 9AAD, 9BAY, 9BBH, 9BAP, 9BHI, 9BSP, 9BAV, 9BOH, 9BNH, 9BSM, 9CZZ, 9CKW, 9CLX, (9CXH), (9CWW), 9DKO, 9DOU, 9DCT, 9DIS, 9DOZ, (9DVK), (9DKV), 9DHK, 9BE, 9BL, 9BW, 9CW, 9EQ, 9FP, 9HK, 9IG, 9IT, 9JY, 9OX, 9ST, 9YB, 9ZT.
 Spark—9AMP, 9AAW, 9BWS, 9BOF, 9BUX, 9BTG, (9CBH), 9CIC, 9DHz, 9DIL, 9DWK, 9DWN, 9LF, 9WX, 8BDA, 8EB?
 I. C. W.—8VQ, 9AAW, (9AEM), (9CXH).
 Phone—(9AEM), 9CWL, (9DVK), 9CP.
 Canadian, C. W.—2BN, 3TB, 3ZL.
 Canadian I. C. W.—3WA.

2BZP. BROOKLYN, N. Y.

1ATS, 1ARY, 1BLN, 1BHW, 1BOQ, 1BTI, 1BWJ, 1CAB, 1CKP, 1CW, 1CYD, 1CYW, 1CZW, 1FD, 1JV, 1KY, 1PA, 1RR, 1YB, 3AIS, 3AH, 3AMJ, 3ARM, 3BES, 3BSB, 3TR, 3YR, 3AHQ, 3AJE, 3BHN, 3BF, 3BRM, 3COI, 3CRV, 3DCT, 3DIL, 3FL, 3FU, 3PL, 3PU, 3SE, 3UF, 3ZW, 3BAK, 3BBN, 3BUV, 3CCF, 3CFK, 3DAW, 3DHG, 3DLW, 3DTT, 3DSW, 3DI, 3ELD, 3ELV, 3EI, 3EX, 3MC, 3P.
 Canadian—2BN, 2CG, 2IC, 3ZL.
 Will gladly QSL all crds

LORAN BLACK, KIRTLAND, N. M.

1ARY, 3LU, 4CD, 4DX, 5AAW, 5AO, 5BY, 5DS, 5FT, 5GN, 5JC, 5LJ, 5LR, 5MA, 5NM, 5NY, 5PA, 5PS, 5OL, 5SR, 5TJ, 5ZV, 5ZADA, 6AV, 6AVV, 6CDD, 6CE, 6DR, 6DR, 6GH, 6BR, 9AI, 9AOD, 9BAK, 9BDW, 9BL, 9BY, 9RRM, 9CD, 9CFI, 9CFK, 9CLY, 9CSG, 9CVC, 9CX, 9DAW, 9DE, 9DF, 9DFH, 9DG, 9DXX, 9EL, 9IC, 9WB.
 Phone—9CVC, 9CLY, 6BOV, 5ANA, 5MA, 8BR, 5PA, 5LU.

MASONIC RADIO CLUB, CONVERSE, IND.

C.W.—1AJX, 1AMI, 1AFO, 1ASI, 1BBI, 1BHK, 1BNN, (1BOM), (1BOO), 1BWJ, 1CMP, 1CMW, 1CPN, 1CPN, 1CW, (1ER), 1FB, 1FD, 1IX, 1II, 1KI, 1MC, 1MO, 1OK, 1ON, 1RY, 1SK, 1WR, 1XM, 1XP, 1XX, 1XZ, (1YB).
 Phone—(1BBO), 1XU
 C.W.—(2AAY), 2ACY, 2AGB, 2AWF, 2BGT, 2BHK, 2BLN, 2BOH, 2BRB, (2BSC), 2BRW, (2CCD), 2CFB, 2CJR, 2CJX, 2CPO, 2CPA, 2CUI, 2CWA, 2CXY, 2AK, 2AL, 2BR, 2BY, 2CR, 2GK, 2TS, 2WR, 2XAP, 2XQ.
 Phone—(2CKA), 2IC, 2RB.
 C.W.—3ABW, (3ACO), 3ADA, 3ADB, 3AIC, 3AJD, 3AJN, 3ADP, 3ATB, 3AVN, 3BDI, 3BDO, 3BGT, 3BHL, 3BJI, 3BNU, (3BPM), 3BOL, 3CBL, 3CDN, 3CEL, 3CKL, 3AB, 3AD, 3BD, 3JW, 3LP, 3MT, 3NE, 3RD, 3UW, 3WC, 3YO.
 C.W.—4AG, 4AI, 4BD, 4EE, 4FT, 4GA, 4HE, 4HT, 4JL, 4KU, 4NA, 4NV, 4ME, 4QF.
 Phone—4HR, 4QW, 4RF
 C.W.—5ABH, 5ABN, (5ABT), 5ABY, 5ACA, 5AGJ, 5AGT, 5AHD, 5AHS, 5AHR, 5AIA, 5AIR, 5AIU, 5AIX, 5AKN, 5AMA, 5AMB, 5AMH, 5AMV, (5AMW), 5AJ, 5BM, 5BX, 5CF, 5CN, 5DN, 5DW, 5DO, (5EK), 5EJ, 5FT, 5FX, 5GA, 5IG, 5IM, 5IT, 5JC, (5HT), 5IA, 5I, 5KR, 5KM, 5KU, 5LR, 5MI, 5MN, 5MO, 5NJ, 5NN, 5NW, 5OK, 5ON, 5OV, 5PH, 5OF, 5OL, 5OO, 5SD, 5SK, 5SR, 5TJ, 5UK, 5UP, 5VF, (5VV), (5WO), 5WS, 5XA, 5XJ, 5XU, 5XAV, 5ZB, 5ZL, 5ZM, 5ZN, 5ZAV.
 Phone—5ABT, (5AMP), (5ANA), 5EA, 5EK, (5HL), 5LD, 5LJ, 5MA.
 C.W.—6AVV, 6AOL, 6AWS, 6AWT, 6BWE, 6BIC, 6CBI, 6CGW, 6CKP, 6LA, 6BM, 6ZA, 6ZW, 6XAD.
 C.W.—7ABB, 7SH, 7WM, 7ZD, 7ZU.
 C.W.—8AAJ, 8ABE, 8ABI, 8ACG, 8ADA, 8AFG, 8AFW, 8AHQ, 8AIE, 8AIG, 8AIP, 8ALN, 8AMD, 8AME, 8APN, 8APT, 8AQO, 8ARV, 8ARD, 8ARB, 8ATC, 8ATA, 8ATN, 8ATP, 8AVD, 8AVS, 8AWG, 8AZH, 8BCH, 8BCP, (8BCU), 8BDN, 8BDT, 8BFH, (8BFM), 8BGG, 8BGT, 8BHN, 8BIL, 8BJO, 8BJZ, 8BMM, (8BNH), 8BNN, 8BOJ, 8BQA, 8BQS, 8BRA, 8BXJ, 8BYM, 8BYN, 8BZN, 8CAE, 8CAV, 8CDZ, 8CDC, 8CEJ, 8CGI, 8CCJ, 8CGO, 8CHL, 8CIE, 8CIH, 8CMT, 8COA, 8CON, 8COB, (8CRC), 8CTE, 8CWX, 8CWR, 8CXI, 8CYX, (8DAC), 8DAP, 8DCG, 8DCZ, 8DDV, 8DDV, 8DGE, 8DJF, 8DJN, 8DIP, 8DKI, 8DLO, 8DPP, 8AB, 8CG, 8CT, 8DO, 8EI, (8EO), 8ER, 8FM, (8FU), 8GI, 8GT, 8IG, 8JT, 8MB, 8MM, (8VO), 8WN, 8XE, 8NH, 8YEA, 8ZC, 8ZW, 8ZY, 8NB, 8OE, 8OI, 8OM, 3PD, 8PE, 8PS, 8OD, 8QN, 8SF, 8TR, 8UF.
 Phone—(8BDA), (8DAT).
 Canadian, all C.W.—1AC, 1BE, 2BG, 2BN, 2CG, 2IC, 3AA, 3AB, 3BO, 3AM, 3JL, 3KO, 3NI, 3OH, 3OM, (3PG), 3SP, 3TF, 3UD, 3NI, 4CL, 4CN, 5CN, 5GO.
 Mani 9s. Like call book.

9ARB, 710 W. PROSPECT ST., KEWANEE, ILL.
 1HX, 1II, 1JT, 1MY, 1RV, 1AFA, 1AJX, 1ASP, 1BKQ, 1BOM, 1BOQ, 1BWJ, 1YKJ, 2BY, 2OS, 2SV, 2WB, 2WR, 2AA, 2AGB, 2ATE, 2BQC, 2BSI, 2CDB, 2CQI, 2CXL, 2XQ, 3CA, 3HH, 3HK, 3TE, 3VO, 3ADD, 3BEI,

INSULATORS

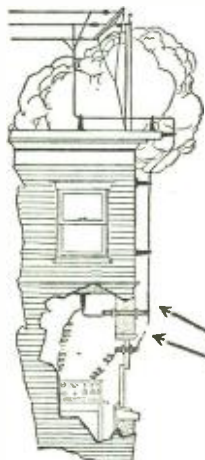

The best insulators for all lead-in wires. Made of hard rubber with brass conductors in the centers. They fit close to the window or wall and keep out wind and weather. Don't delay any longer! Make sure of the insulation of your lead-in wires by installing these insulators at once. Your dealer has them.

4-Inch Insulators ... 50c
 10-Inch Insulators ... 80c

10-inch lead-in insulator for walls and window casings.
 4-inch lead-in insulator for window frames.

JOBBERS and DEALERS WRITE OR WIRE FOR SPECIAL PROPOSITION

WALL INSULATOR

Made especially for radio work. Has steel base moulded into hard rubber column. Holds any sized wire from No. 14 to 4. Keeps wire 5 inches from wall thus meeting underwriters' requirements.



60c LIST



4-inch Window Insulator

THE M & M COMPANY

500 Prospect Avenue Cleveland, Ohio

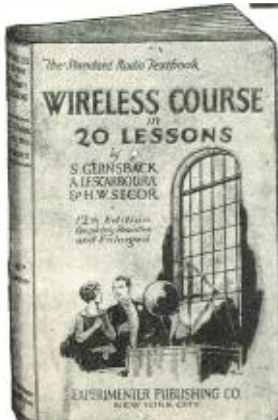

\$2.00 12th Edition \$2.00

WIRELESS COURSE IN 20 LESSONS

By S. GERNSBACK, A. LESCARBOURA and H. W. SECOR

The Standard Radio Text Book

Size 6 x 9 inches. 264 pages. 500 Illustrations. Binding de Luxe. Semi-flexible Leatherette Cover. Genuine Gold Stamped, Round Corners, Red Edges.

Experimenter Publishing Co.

53 Park Place

New York, N. Y.

3BFE, 3BTI, 3BWE, 3CEJ, 3CJN, 4AY, 4CO, 4CS, 4DB, 4EL, 4ER, 4FA, 4JK, 4JT, 4MB, 5AC, 5BW, 5CV, 5DW, 5EK, 5GL, 5GM, 5GN, 5IN, 5KI, 5KG, 5KM, 5KN, 5KR, 5LJ, 5LR, 5MI, 5MO, 5NJ, 5NR, 5PF, 5PH, 5QL, 5QW, 5TJ, 5UP, 5UR, 5VV, 5WE, 5AAT, 5ABN, 5ABY, 5ADS, 5AFS, 5AHD, 5AHR, 5AIR, 5AIU, 5AKF, 5AMA, 5ANC, 5AOM, 5XAP, 5ZA, 5ZG, 5ZU, 5ZAV, 5ZAX, 6CU, 6FP, 6LV, 6NX, 6PE, 6PL, 6AGK, 6ANI, 6AOL, 6ARB, 6AU, 6BBW, 6BCS, 6BDS, 6BEG, 6BIC, 6BII, 6BJO, 6BLM, 6BRF, 6BTT, 6BVE, 6CEK, 6CFZ, 6CGW, 6CKP, 6CMU, 6CKR, 6ZH, 6ZQ, 7AF, 7AK, 7CH, 7DC, 7OT, 7SF, 7WP, 7AFN, 7AKII, 7ZD, 7ZL, 8AL, 8DO, 9DX, 8FS, 8GZ, 8OM, 8ON, 8QN, 8RV, 8TR, 8UF, 8UP, 8VT, 8VY, 8WG, 8ADS, 8AGC, 8AGO, 8AIG, 8AII, 8AII, 8AII, 8AMX, 8ANM, 8APN, 8AQA, 8ARD, 8ARF, 8ATZ, 8BBA, 8BCI, 8BCF, 8BDA, 8BDU, 8BFM, 8BFR, 8BGE, 8BIO, 8BIV, 8BLR, 8BMB, 8BMG, 8BMV, 8BNH, 8BOI, 8BYI, 8BZC, 8BZQ, 8CCQ, 8CEI, 8CEJ, 8CES, 8CJD, 8CJP, 8CLC, 8CNW, 8CRW, 8CTN, 8CUX, 8CWU, 8CZC, 8DAA, 8DAW, 8DCG, 8DDA, 8DFH, 8DFV, 8DGG, 8DIG, 8IJP, 8DKA, 8DKI, 8DMK, 8DLE, 8DLH, 8XE, 8XH, 8YN, 8ZZ.

Canadian—2CG, 2IC, 3IV, 3TJ, 3LL, 3MV, 3NI, 3OM, 3TB, 3ANU, 3NI, 3ZL.

Printed card to any of above who QSL for same. QRK my 10-watt C.W.

EX-9BCJ PRESCOTT, ARIZ.

November 18th.
Daylight—C.W.—(2BY, 2CU, 5UW, 5OQ, 5AFQ, 5AMU, 5ZH, 6BBI, 6CEII, 6CIA, 6CJF, 7QT, 9SS, 9AIM, 9AVS, 9AYL, 9AYP, 9BRI, 9CHJ, 9CLO, 9EKY.)
Night—C.W.—(1FD, 2CQI, 3ATB, 4MH, 5CV, 5F, 5GW, 5HO, 5KG, 5UW, 5ADH, 5AIU, 6HC, 6LI, 6WT, 6AII, 6ANI, 6BBG, 6BCS, 6BPF, 6BQE, 6BWP, 6CBB, 6CDG, 6CIC, 6CIA, 6CNI, 6ZAU, 7PI, 7OT, 7TT, 7ZX, 7ACT, 8DN, 8GZ, 8BCP, 9EQ, 9GW, 9LE, 9TI, 9ZT, 9AAL, 9AFM, 9AGR, 9AIM, 9AMU, 9AVS, 9AYP, 9BDR, 9BGC, 9CBB, 9CFY, 9DBR, 9DIZ, 9DLM, 9DPI, 9EPU.)
Spark—(6GT, 9BOF, daylight).
1 C.W.—(5ZA).

November 19th.
All daylight—C.W.—(AOL, 2BY, 3CHG, 5AS, 5BX, 5EZ, 5LW, 5TD, 5UQ, 5YG, 5AAT, 5AHC, 5AII, 5AMS, 5AMU, 5NAC, 6AFO, 6ALK, 6BII, 6BJJ, 6BU, 6CGL, 6CNG, 6CNI, 8IJ, 8JJ, 8UF, 8AFN, 8AII, 8BGO, 8BVT, 8CTP, 8CZZ, 9JF, 9MC, 9OI, 9QW, 9AAU, 9AHZ, 9ALK, 9AVN, 9BDE, 9BDH, 9BGC, 9BGL, 9BII, 9BLT, 9BNH, 9BSH, 9BZG, 9BZS, 9CCJ, 9CCZ, 9CJ, 9CEH, 9CIC, 9CKW, 9CLN, 9CLQ, 9CQJ, 9DFW, 9DHP, 9DQC, 9DTT, 9DWN, 9EIJ, 9EDM, 9ELW). (Can. 3OH).

Spark—(5GF, 6AUD, 9HOF).
1 C.W.—(9BRX).
Will QSL cards on exceptional daylight DX.

6KJ, NEVADA COUNTY, CALIFORNIA.
6AOS, 6AO, 6AWT, 6AUT, 6ADN, 6ALY, 6BCL, 6BM, 6BTY, 6CGL, 6CAE, 6COL, 6CP, 6CJ, 6CNG, 6CEY, (6DC, J, QRA), 6FH, 6GR, 6GF, 6IB, 6FD, 6FY, 6AGE, 7NY, 7LN, 7VN, 7ZU, 7QJ, 7UH, 7KS, 7CY, 7MI, 8GZ, 9AAU, 9BZ, 9DII, 9CNS, 9BEL, 9IG, 9AYL, 9EKY, 9AVM, 9BNY.

Canadian—4CL, 5CN, 9BP.
Hawaiian—6CEX.
Mexican—JH.

Also American C.W. Stations—1AW, 1ANA, 1ACN, 2ACD, 2RB, 3BVA, 4KU, 5KC, 5UX.

5AMH, BIRMINGHAM, ALA.

(1APH), (1ACU), (1ARP), (1BOM), (1BOQ), (1BT), (1IV), (1VB), (1FB), (2AGB), (2BRI), (2BMR), (2BOM), (2BQB), (2BQH), (2CFB), (2CXD), (2CNI), (2RS), (JACQ), (JADV), (3BWT), (3CHG), (3UL), (3UT), (3SU), (3TJ), (3ZS), (3OM), (5AEG), (5AGI), (5AHD), (5AK), (5AKJ), (5AKN), (5AL), (5CE), (5DR), (5DW), (5FC), (5FX), (5ZG), (5GA), (5GU), (5UF), (5UT), (5LL), (5LR), (5NN), (5OV), (5PB), (5SR), (5UJ), (5BY), 6AVV, 6AWT, 6ZZ, 6ALP, 6ALV, 6BCL, 6CWW, 6XAD, 6BHG, (7LN), 7ZU, (8AAJ), (8ABE), (8ABN), (8ADA), (8ADD), (8AGO), (8AGP), (8AIB), (8AKD), (8ANP), (8ANB), (8ARK), (8ARQ), (8ASV), (8AVD), (8AVN), (8AZO), (8BCF), (8BCI), (8BF), (8BI), (8BWZ), (8BYF), (8BZB), (8CAB), (8CDO), (8CDE), (8CGL), (8CJD), (8CXL), (8CP), (8CPU), (8CRW), (8CTN), (8CVM), (8CWS), (8DCZ), (8DDJ), (8DFZ), (8DLO), (8FU), (8GZ), (8KR), (8UC), (8OM), (8PB), (8PD), (8PI), (8TR), (8TT), (8WA), (8XE), (8YM), (9AAD), (9AIC), (9AIM), (9AMS), (9APS), (9APW), (9ARC), (9ARP), (9AUS), (9AWG), (9AWO), (9AZX), (9BBR), (9BEZ), (9BMU), (9BRK), (9BRT), (9BTA), (9AAW), (9BZL), (9CCV), (9CDV), (9CDO), (9CDZ), (9CEE), (9CIU), (9CHO), (9CKP), (9CLU), (9CMC), (9CPR), (9CS), (9CTD), (9CTT), (9CYF), (9CZW), (9DA), (9DCH), (9DDY), (9DEK), (9DII), (9DKK), (9DMW), (9DND), (9DPV), (9DRM), (9DVK), (9DXL), (9DXN), (9DXU), (9DDY), (9DZS), (9HK), (9IH), (9KD), (9MM), (9MN), (9PB), (9RC), (9UC), (9UR), (9YB), (9ZT), (9ZV).

Canadian—(2CG), (3HE), 3GO, (3NI), (3ON), (4CL).



Build Your Radio Set Compact and Portable

Short leads, close spacing and Coto Compact radio parts give you a radio set of rare efficiency and individuality. A set too that you will enjoy carrying with you to the homes of friends and on jolly outing trips. Coto prices are moderate for extreme quality.



Coto Compact Air Condenser with Vernier

Just as rugged and efficient as it looks and only 2 7/8 inches square on the panel. Constructed on a metal base for rigidity. Insulated with scientific care. Stator plates are soldered to three posts for rigidity and low losses. Rotor plates soldered to shaft. Built right to serve you many years.

Type 3505 \$5 Type 3510 \$6
.0005 Mfd. .001 Mfd.



Coto Tapped Radio Frequency Transformer

Efficiently covers the whole broadcasting range because it is tapped. Single switch control for one or several stages.

Type 5000A \$7.50



New Coto Compact Moulded Variometer

Size only 3 1/4 x 1 3/4 x 3/4. In moulded bakelite. Stator is homecomb wound. Pigtail connections to rotor. Range 200 to 600 meters. Base or panel mount.

Type 8000 \$5



New Coto Compact Moulded Variocoupler

Companion piece of the Variometer. Size only 3 1/4 x 3/4 x 3/4 in. Range 200 to 600 meters. Base or panel mount. Pigtail connection to rotor.

Type 9000 \$5.50



Cotogrip Tube Socket

Has unique double positive grip of tube terminal posts. Best hard rubber insulation.

Type 7000 85c



The Original Honeycomb Wound Inductance Units

Popular low priced favorites of the amateur and experimenter. Permit the economical building of an all wave set. Sold mounted or unmounted.

Reliable Dealers Always Recommend Coto Quality

Dealers value the trade of those who insist on Coto Quality. If your dealer fails you, send us his name and we will see that you are supplied.

Coto-Coil Co.

87 Willard Ave.
Providence, R. I.

Pacific Coast Branch,
329 Union League Bldg., Los Angeles, Cal.

Northwestern Branch,
Geo. F. Darling, 705 Plymouth Bldg.,
Minneapolis, Minn.

Southeastern Branch,
C. P. Atkinson, Atlanta Trust Co. Bldg.,
Atlanta, Ga.



The Tube's the Thing!

Get Radio Reception Without Noise

MYERS RADIO VACUUM TUBES

PRACTICALLY UNBREAKABLE

Concerts, Speeches, stories—hear them without noise or tube hiss with Myers Tubes. They give much greater amplification, are perfect Detectors and Oscillators. They add 50 per cent to the efficiency of your set.

TWO TYPES. Myers Dry Battery Tube 2½ Volts—¼ Ampere Myers Universal operates on either 3 Dry Cells or storage batteries. Ready for mounting. No sockets or extra equipment needed. See that you get the New Improved Myers Tubes. You will know them by the Silver Coating. Others are not guaranteed.

\$ 5⁰⁰
Each

At Your Dealer, otherwise send purchase price and you will be supplied Postpaid.

F. B. Myers Co. Ltd.

Radio Vacuum Tubes

240 Craig Street W.,

Montreal, Canada

Unbroken Reception

WITH a crystal detector, perfect reception is possible only when there is perfect control of tension on crystal. The DE-TEC-TONE gives you this—and more. It gives you a range of volume not possible with the ordinary detector.

The secret lies in the full micrometer adjustment that stays put with each adjustment. No jar can change it. Insures finer tuning, greater distance, unbroken reception.

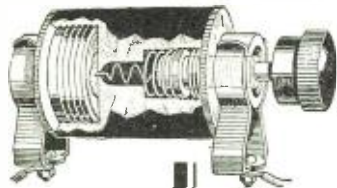

Mounts in clips like a cartridge fuse, instantly adjustable, reloadable, detachable. Unequaled for reflex circuits.

Wherever a crystal is used, DE-TEC-TONE will give better results. If your dealer hasn't it, send \$1.50 to Pyramid Products Co., 117 No. Dearborn St., Chicago, Ill.

DE-TEC-TONE

CRYSTAL DETECTOR

Increase your Range

From 15 to 100 per cent

You can, with your present equipment, by using SPRINGFIELD 16-STRAND BRAIDED ANTENNA.

Most wonderful wire for indoor loops. Its extra large surface—twice that of ordinary wire—enables you to get greater distance and clearness.

125 feet in your attic, in strands 3 feet apart, gives better results than 150 feet of ordinary wire outdoors. Write for free booklet.

At dealers—or send us \$2.50 for 100 feet.

Dealers and Jobbers—write for prices and terms.

SPRINGFIELD WIRE & TINSEL CO.
67A Taylor St., Springfield, Mass.



Springfield Braided Wire

Ordinary Antenna Wire

About ½ inch in circumference

About ¼ inch in circumference

Springfield 16 Strand Braided Antenna

5AMB, DENISON, TEXAS
All C.W.—2SC, 4AG, 4AY, 4E1, 4JH, 4JK, 5IU, (4MY), (5QF), 6GW, 7FD, (8ABE), 8AMX, 8BBW, (8BCP), (8BMP), 8BFP, 8BK, 8CIA, 8DDC, 8DAT, 8DJC, 8DJF, 8AT, 8BF, 8JE, (8JJ), 8MZ, 8PD, (8PL), 8WZ, (8ZC), 8ZE, 8ZZ, (9AAP), 9ACK, (9AFM), 9AFV, (9ANY), (9AOM), 9AON, 9AFS, 9AOU, (9BAK), 9BIS, (9BQQ), 9CCT, 9CCV, 9CGU, 9CHN, 9DCE, (9DKY), 9DC, (9MC), 9DZY.
Phone—5 AMF, (9AML), 9BSC — daylight, 9BWV.
Canadian—(4CO).

92T, MINNEAPOLIS, MINN.
(1ER), (1HX), 1LL, 1SN, 1XM, 1VV, (1YB), 1YD, 1YK, 1ADA, 1AJA, 1AQ1, 1BCU, 1BGK, 1BQ, (1CKP), (1CMP), 1CRW, 1CSU, (1XAO), 2AH, 2BK, (2GK), 2IC, 2KF, 2KI, 2P, (2RB), 2RK, 2SH, 2TS, 2WB, (2XO), 2AFP, 2AGB, 2ANA, 2AW11, 2BKQ, 2BMR, 2BRH, 2BRB, 2BRC, (2BTE), 2BNP, 2BXW, 2CFB, 2CJR, 2CKA, (2CQZ), 2CSL, (2CXD), (2CXLL), (2XAO), 3AB, 3BW, 3HG, 3HS, 3JI, 3ME, 3PZ, 3UR, 3VO, (3WF), 3XI, (3YP), (3ABN), (3ADB), 3AJD, 3ALN, 3AUV, 3AVP, 3CFV, 4CR, 4CS, 4DB, 4EB, (4FA), 4FG, 4KU, 4MB, 4QF, 5BW, (5CE), (5GA), 5GF, (5GJ), (5GM), (5HY), 5IN, 5JE, 5KC, (5KK), 5KP, 5LR, 5MI, (5MO), 5QL, 5OW, 5SK, (5TJ), (5TK), (5UR), 5WE, 5WO, (5XV), (5ZA), 5ZG, 5ZM, 5AAW, (5ABG), 5ABH, (5ADH), 5AFQ, 5AGJ, 5AGO, 5AHH, (5AHR), 5AIC, 5DAT, 5ZAS, 5ZAV, 6AK, 6AO, (6CU), 6FH, 6HP, (6KM), 6NX, (6PL), (6VE), 6ZH, 6ZW, 6ADJ, (6AHP), 6AHU, 6AJD, 6AKZ, 6ALY, (6ALV), 6ANB, 6AO1, 6AOS, (6AVV), (6AVT), 6BCC, 6BBW, 6BBW, 6BCL, 6BFG, 6BIH, 6BJQ, 6BJC, 6BJQ, (6BPZ), 6BRF, 6BLA, 6BG, 6BUR, (6BVG), 6CBP, (6CDG), 6CFZ, 6CCW, (6CKR), 6CNH, 6CWA, 6XAD, 6ZAH, (7HG), (7HW), (7IH), (7KS), 7LN, 7LR, (7OJ), 7RY, 7SC, (7SF), 7TO, 7WM, 7WP, (7WS), 7ZI, (7ABB), 7AEA, 7AEL, (7AFN), (7AGE), 7AGR.
Canadian—2BN, 2CG, (5GO), (5CN), Bowdoin—(WNP).

2CQ1, BAYONNE, N. J.
1CI, 1FD, 1GH, 1GL, 1GS, 1HO, 1IV, (1JV), (1KX), 1MO, 1MY, (1PA), 1QP, 1QV, 1RV, 1VV, 1XM, 1XZ, 1YB, 1YK, 1ZH, 1ADN, (1AEZ), (1AFA), 1AGH, 1AIW, 1AJX, 1AJA, 1AJP, (1ALJ), (1ALD), 1AMG, 1ARL, (1AOI), 1ARY, 1ASU, 1AUR, 1AWO, 1BBC, (1CAB), 1CMP, 1CAZ, 1XAK, 1BQL, 1BOP, 1BWJ, (1BOM), 1BHW, 1BOQ, 1BCG, (1BEZ), 1XAM, 1BIS, (1CKO), 1BOM, 1CRW, 1CPI, 1BZO, 3CJN, (3BSS), (3IH), 3ME, 3AB, (3AFC), 3AJD, 3TJ, 3ABW, 3CEL, 3MB, 3BDO, (3CEJ), 3AAO, 3FB, 3BWT, 3BNU, 3BTI, 3CGN, 3BVR, 3AS, 3CBZ, 3AHP, 3VO, 3YO, 3CDN, (3TR), (3CIZ), (3ALV), (3ALN), 3GY, (3MF), 3ACY, 3BVN, 3CKD, (3BCJ), 3CFV, 3CFZ, 3ZO, 3OO, (3AEN), 3AEC, 3OX, 3ADB, 3BG1, 3SH, (3ABJ), 3BDI, 3BK1, (3UD), 3SU, (3BEI), 3IW, 3CC, 3ALE, 3CHG, 3CFI, 4EB, 4EQ, 4MB, 4NV, 4AG, 4KC, (4FA), 4FT, 4IJ, 4AF, 4DB, 4QY, 4JK, 4AY, 4OA, 4HS, 4QW, 5AAG, 5HL, 5V, 5GA, 5DA, 5AGJ, (5AGO), 5LR, 5SK, 5UP, 5SP, 5PY, 5MO, 5QI, 5AHR, 6FP, 6OU, 8DAT, 8ZAE, (8FU), (8AZO), 8NE, 8ATP, 8AII, 8BRM, 8IJ, (8ZZ), 8CZ, 8OM, 8BK, 8BNH, 8FM, 8CJP, 8ASV, 8APV, 8SP, 8DAW, 8PF, 8UR, 8BIZ, 8DDO, 8BDA, (8BOA), 8CRN, 8DDI, 8CBC, (8APY), (8CSE), 8DIL, 8BCU, 8BPC, 8OE, 8ANM, 8AAJ, (8BGE), 8BIA, 8DO, 8DBL, 8PD, 8CKO, 8TR, 8BCI, 8AQO, 8AMM, 8BOI, 8ARD, 8CUQ, 8ANB, 8EO, 8AA, 8BNY, 8PL, 8BFO, 8CP, 8YX, 8AGO, 8BLR, 8BYR, 8BXH, 8COI, 8BFM, 8ABR, 8CVE, 8AAF, 8DIS, 8UZ, 8CCO, 8CC, 8AFC, (8CTP), 8CMT, 8BVG, 8DW, 8ATN, 8ALM, 8BRC, 8KH, 8AHO, (8BAY), (8CVY), 8MB, 8CFO, 8RT, 8APT, 8DKL, 8UG, 8SF, (8AWJ), 8IJ, 8BT, (8CRC), 8AVD, 8TO, 8CF, 8CDI, 8CFX, 8AFO, (8AOM), (8FL), 8LR, 8BB, 8RV, 8FI, 8CZZ, 8ZAB, 8AII, 8BYN, (8CPR), 8DCM, 8RH, 8DA, 8ATE, 9AAU, 9BA, 9BAK, 9ZY, 9VZ, 9CCS, 9IYZ, 9BWW, 9CKW, 9DJP, 9ZT, (9EHI), 9AIIY, 9EKY, 9DI, 9CTE, 9AON, 9ELV, 9VM, 9XY, 9QI, 9DRO, 9BRK, 9MC, 9ELD, 9BP, 9EBI, 9DHV, 9DWK, 9SI, 9EQ, 9DCP, 9AAD, (9CHD), 9DDN, (9DDU), (9CKP), 9AIM, 9PF, 9ARH, 9EG, 9BXL, 9DOD, 9AUS, 9BWR, 9CCZ, 9DKX, 9DKV, 9ELL, 9BED, (9DVV), 9DOU, 9CYW, 9BYE, 9CHB, 9CGW, 9DCR, 9DHR, 9BRI, 9XI, 9ARS, 9CTR, 9B1G, 9BUS, 9BZI, 9DTN.
Canadian—(1DD), 2BG, 2HV, 2BN, 2IC, 3OH, 3ZL, (3IR), 3WH, (3TB), 3OM, 3AB, 3ZS, 3TR, 3WV, 3PG, 3MV, 3JT, 3AEC, 3NF, (3OE).

9BWA, GENESEO, ILL.
All C.W.—1AJ1, 1AS1, 1BHW, 1BWJ, 1CKP, 1CMP, 1ER, 1HX, 1PA, 1YB, 2ACY, 2AWF, 2AY, 2BGI, 2BLV, 2BWR, 2BY, 2BZV, 2CDM, 2CLU, 2CPA, 2CVJ, 2RM, 2S, 2TS, 2WB, 2XQ, 3AA, 3ADB, 3AKR, 3ALI, 3AS, 3AVA, 3BDO, 3BER, 3BIJ, 3BKT, 3BML, 3BXU, 3BOF, 3BOF, 3BQZ, 3BTL, 3BWT, 3CAH, 3CBZ, 3CFV, 3CVI, 3CKJ, 3HH, 3IS, 3JX, 3ME, 3NF, 3QS, 3TE, 3YP, 3ZS, 4BK, 4CM, 4DB, 4EP, 4FA, 4FT, 4HR, 4MB, 4OA, 4ON, 4HR, 4XJ, 5ABY, 5AEZ, 5AFS, 5AGO, 5AHD, 5AHR, 5AJJ, 5AIR, 5AIU, 5AJJ, 5AMJ, 5AMH,

5BE, 5BI, 5BX, 5CN, 5CV, 5EK, 5GM, 5HT, 5HJ, 5IP, 5IX, 5KH, 5LG, 5LR, 5MA (phone), 5NI, 5NN, 5OK, 5PI, 5QJ, 5SQ, 5SG, 5TJ, 5UO, 5UP, 5UR, 5VF, 5VY, 5XA, 5ZA, 5ZB, 5ZG, 6AK, 6BCL, 6BIS, 6CGW, 6KA, 7QJ, 7ZD.
 Canadian—2BN, 3AA, 3ADN, 3BA, 3BE, 3CO, 3FC, 3HA, 3JL, 3JT, 3KJ, 3NI, 3OE, 3OH, 3SP, 3WS, 3XI, 4CN, 4CL.

FRANKLIN BOWERS, R.F.D. NO. 8, PHOENIX, ARIZ.

C.W.—1AW, 2AGB, 2CNL, 3HE, 3MB, 4CL, 4KU, 5AAW, 5AHA, 5AHR, 5AIC, 5AKU, 5AMA, 5AMW, 5AQT, 5BE, 5CV, 5GF, 5GI, 5GM, 5HQ, 5KC, 5KG, 5LG, 5LR, 5NA, 5OT, 5PH, 5QL, 5SD, 5UW, 5UY, 5XV, 5YG, 5YV, 5ZA (phone), 5ZAV, 5ZAX, 5ZB, 6's too many, 7AF, 7AGR, 7AGV, 7AIC, 7ALG, 7HW, 7IO, 7IH, 7OB, 7OT, 7PX, 7QC, 7SC, 7TO, 7XE, 7ZU, 8BU, 8DAT, 8JJ, 8PE, 8PU, 8VT, 8XE, 9AAM, 9AAP, 9AAU, 9AHZ, 9AMB, 9AMU, 9AOU, 9APS, 9AQO, 9AVM, 9BEZ, 9HJJ, 9BFB, 9BJK, 9BKH, 9BLY, 9BRI, 9BUN, 9BKX, 9BVO, 9BXQ, 9BZI, 9CAA, 9CCS, 9CCV, 9CCZ (daylight), 9CDO, 9CES (daylight), 9CHC, 9CJC, 9CJY (daylight), 9CLD (daylight), 9CLQ, 9CMK, 9CML, 9CNB, 9CNS, 9CR, 9CTE, 9CZV, 9DAY, 9DES, 9DEW, 9DCH, 9DHI, 9DHO, 9DFX, 9DRW, 9DTE, 9DXY, 9DZY, 9EER, 9EKY, 9ELV, 9EPF, 9IHH, 9MA, 9MC, 9MV, 9NR, 9PB, 9QW, 9VY (daylight), 9ZY.

B. AITCHISON, 3CIY, 202 W. CLINTON TERRACE, WASHINGTON, D. C.

C.W.—1BOQ, 1MY, 2COE, 3BA, 3HQ, 3TB, 4FO, 4OW, 5HT, 8ANB, 8BZC, 8CEO, 8CLO, 8DOX, 8DKJ, 8FAV, 8FL, 8GZ, 8TT, 8VIE, 9AFN, 9ARF, 9ASV, 9BAK, 9BBI, 9BED, 9BFF, 9BKH, 9BSO, 9CCS, 9CCZ, 9CR, 9DAY, 9DHL, 9DHR?, 9DGL, 9EHL, 9ELF, 9ELV, 9HK, 9LZ, 9RR, 9WU, 9ZT.
 Canadian, C.W.—3ADN.
 British, C.W.—2JF?

4JE, SAN JUAN, PORTO RICO

1AS1, 1AW, 1BGC, 1BHW, 1ROK, 1BOM, 1BOQ, 1BQ, 1BSK, 1BUY, 1CRW, 1ER, 1FD, 1H, 1IL, 1IV, 1MO, 1OL, 1RV, 1XAM?, 1YB, 2AFP, 2BWR, 2BZV, 2CCD?, 2CEE, 2CG, 2CHU, 2CPA, 2CNL, 2KF, 3AS, 3BSS, 3BWT, 3CHG, 3FK, 3IW, 3OB, 3UO, 4EB, 4EL, 4FT, 4GW, 4GX, 4OM, 5DA, 5IZ, 5AZY, 8BCG, 8BCO, 8BCR, 8BNH, 8BR, 8CEF, 8CED, 8DCB, 8GZ, 8PL?, 8UE, 8XE, 8XH, 8ZZ, 9AOU, 9BED, 9BKH, 9CCS, 9CH, 9CJC, 9CJR.
 Canadian—1AR.

Note: Calls marked ? unassigned. 6RA?

2BWR, BROOKLYN, N. Y.

1ER, (1GL), 1H, 1RV, 1U, 1VB, 1ZH, 1ABY, 1ACH, 1ACZ, 1ADN, 1AGK, 1ALI, 1ALJ, (1APC), 1AQL, 1ARK, 1AVE, 1BEH, 1BES, 1BGC, 1BHK, 1BNL, 1BOM, 1BOQ, 1BQM, 1BQN, 1BSJ, 1BTF, 1BYJ, (1CIT), 1CMP, 1CPL, 1CSW, 1CSV, 1CRI, 3AB, (3CS), 3HH, 3HK, 3FZ, (3QV), (3TR), (3BJ), (3BKL), 3BKT, 3BS, (3CDK), 3CHQ, 4DB, 4EB, 4EQ, 4FT, 4OA, 5HT, 5LR, 5QF, 5UK, (5AIE), 5AIR, 5AIU, 5AMH, 6QR, 6ZW, 6AAK, 6AGE, 6AVT, 6XAD, 6CHU, 7SK, 7AB, (8BF), 8DO, 8FI, 8FU, 8GG, 8HJ, (8JU), 8JY, 8MR, 8MT, 8PK, 8QB, 8QC, 8QW, 8OZ, 8KJ, (8RV), 8TR, 8UF, 8UT, 8AAF, 8ACM, 8ADK, 8AFD, 8AFK, 8AGC, 8ALF, 8AMB, 8AMS, 8APK, 8ATN, (8AYJ), 8AZO, 8BBU, 8BCI, 8DDU, 8BFH, 8BFM, 8BHF, (8BNN), 8BOB, 8BOH, 8BRC, 8BTR, 8BXT, 8BYN, 8CEJ, 8CPG, 8CHQ, (8CID), 8CMW, 8COA, 8COD, 8COM, 8CRB, (8CRC), 8DAN, 8DAT, 8DBO, 8DDJ, 8DGO, 8DJP, 8DKL, (8DKM), 8DLE, 8NAN, 8YN, 8ZW, 8ZZ, 8ZAB, 9BA, 9C, 9E, 9FI, (9I), 9OB, (9VM), 9VC?, 9VY, 9APE, 9AWF, 9AVP, 9BAK, 9BAV, 9BEH, 9BFF, 9BLG, 9BLY, 9BUN, 9BVW, 9CCS, 9CKP, 9CKV, 9CTC, 9CTD, 9CVW, (9DAY), 9DBU, 9DDU, 9DFW, 9DFX, 9DGI, 9DGM, 9DLM, 9DYY, 9DZY.
 Canadian—1AR, 2AM, 2AZ, 2CG, 3AA, 3BA, 3BQ, 3GK, 3GL, 3OJ, 3TB, 3YH, 3ZL.

8CCK, LIMA, OHIO

1ER, (1EZ), 1YB, 1AAO, 1AW, (1ADN), 1BES?, 1BWW, (1BKG), 1BGG, (1BTT), 1AFA, 2GK, 2BJO, 2BOO, (2BQH), (2BGJ), (2BJX), 2CLA, (2CCD), (2CWJ), (3GK), (3QP), (3TR), 3BDO, (3AJD), (3BU), (3ABW), (3CAH), (3BO), (3UR), (3CKJ), 4GV, 4NA, 4KU, 4ON, (4FT), (5GJ), (5MM), 5KN, (5KC), 5LR, 5MA, 5MN, 5HR, 5PR, 5NG, (5GM), (5OF), (5UK), 5OV, (5AAT), (5ABT), 5AMH, 5AMU, 5ZAS, 5ZAV, (5AIU), 6LV, 6XP, 6AVT, 6BIK, 6AUV, 6ACM, 6CDO, 6CGW, 6ARB, 6BUA, 6XAD, 7WP, 7VW, 9IG, (9APF), 9APE, (9BOF), 9BZE, (9BTT), (9CEE), (9BMU), 9CAA, 9BHQ, (9BKC), (9DAN), (9DZY), (9AVN), (9ECK), (9CLO), (9CPT), (9EAK), (9DMJ), (9DCH), (9BEP), (9BHI).

Canadian—(2CG), (3NI), 2BN, 3DP, 3PG, 3ZL, 4CI, 9CE, 9QR? my 10 watt C.W. and phone. All crds answered.

8CCK

The call 8CCK has been reassigned to K. R. Ling, 419 3rd Street, Cresson, Pa.

TINY-TURN

A New and Superior Vernier Control

TINY TURN makes possible an exactness in tuning never before attained. It has a 30 to 1 gear ratio instead of only 4 or 5 to 1 as in the ordinary vernier. No lost motion! The vernier turns in the same direction as the dial. It can be instantly disengaged, leaving dial free. TINY TURN provides a continuous vernier adjustment over the entire range of the dial. When you desire, you can pass from one station to another by a continuous rotation of the vernier knob, without touching the dial at all. TINY TURN can be INSTALLED ON ANY SET IN 3 MINUTES. Handsome nickel and black finish. Packed in individual demonstrating boards.

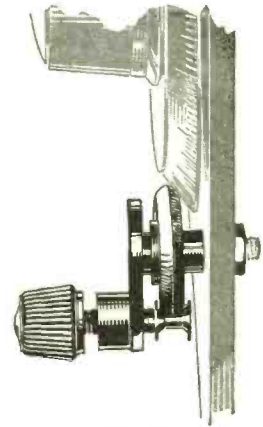

Pats. Pend.
 Side View showing friction drive against dial.
 Actual Size.

"MAKES TUNING EASY"

Enclosed please find 75 cents for another TINY TURN. It made such a great difference in my tuning condenser that I am going to put one on my tickler dial at once. It certainly "makes tuning easy" as you say and also eliminates the body capacity effect.

F. J. ARMSTRONG,
 624 Third St., Brooklyn N. Y.

Price 75c Each

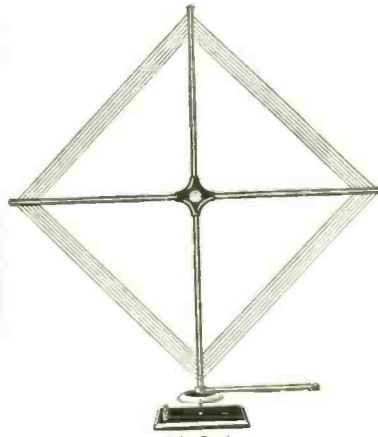

Pats. Pend.



Top view of base showing new dial with long handle.

DUO-SPIRAL

The Leading Loop Aerial With the New Dial and Handle

The DUO-SPIRAL Loop spans the continent on a loud speaker with many types of radio-frequency sets. Careful tests of all available loop aerials by leading manufacturers and radio engineers proves the superiority of the DUO-SPIRAL Loop. It is used exclusively by the largest manufacturers of radio frequency sets. It has many advantages over other forms of antenna for all radio frequency circuits, such as the Neurodyne, the Reflex, the Super-Heterodyne, the transformer coupled circuits, etc. It is trim and neat in appearance and handsomely finished. It rotates freely on its base. Adjustment is made easy by handsome dial and a long handle which eliminates body capacity effects. The green double silk covered wire is kept always taut by hidden springs. The DUO-SPIRAL Loop completely replaces roof antenna and ground and practically eliminates static.

"HIGHLY EFFICIENT—VERY SATISFACTORY"

Answering your inquiry relative to my DUO-SPIRAL loop, I am pleased to say that I consider it highly efficient and very satisfactory in every way. I use it continually in my radio work.

EDWIN A. BEANE,
 4900 N. Whipple St., Chicago, Ill.

24-inch size \$8.50
 12-inch size \$7.50

(These prices include new dial and handle).

The above products (folders on request) are sold through dealers and jobbers. If your dealer cannot supply you, write us direct.

RADIO UNITS INC. Suite 500 Webster Bldg. Chicago, - - Illinois

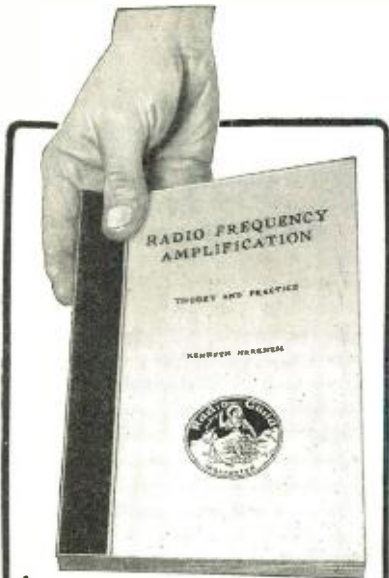

"As Interesting as a Novel"

That's how one reader describes Kenneth Harkness' famous book "Radio Frequency Amplification."

"The book is comprehensive, concise, accurate, scientific, interesting as a novel . . . I wouldn't be without it for 10 times its price" he writes.

Makes Advanced Radio Easy

This book explains to you in easy-to-grasp language the theory of radio reception from A to Z. It tells you everything you want to know about radio—answers all your questions. Kenneth Harkness wrote this book in your language, the language you use every day—the language you understand. His book fills an open gap in radio literature. He explains advanced radio—hitherto understood by mathematicians only—yet he explains it in simple, easily-understood English.

Tells how to build Sets

In this book Kenneth Harkness shows you exactly how to build 5 different types of modern radio frequency amplifying receivers. He tells you all about the astonishing new single-tube "Harkness Receiver" which operates a loudspeaker and is consistently receiving stations within a radius of 3000 miles! 175 diagrams, drawings and action photographs banish misunderstanding.

5-day Examination Offer

We are so confident you will be delighted with this book that we will send it to you for 5 days' examination and let you judge for yourself. Just fill in and mail the coupon below. When the postman arrives deposit with him only \$1.25 plus a few cents postage. Examine the book for 5 days. Read it from beginning to end. See for yourself how it expands your knowledge of radio. If you are not absolutely satisfied, send the book back and we will refund your money without question. That's fair enough, isn't it? You take no risk; you're nothing to lose and everything to gain—so mail this coupon NOW and get your copy by return.

**Send No Money
Just mail this coupon**

THE RADIO GUILD, Inc.,
256 West 34th Street,
New York, N. Y.

Send me—immediately—Kenneth Harkness' book "Radio Frequency Amplification." I will pay the postman \$1.25 plus a few cents postage with the understanding that if I am not absolutely satisfied, I may return the book within 5 days after receipt for a prompt refund of my money.

Name

Full Address

RM 3-14

6KJ

QRA-6KJ, Mr. E. Penrose, Nevada County, California.

5AMH

The call 5AMH has been assigned to L. E. Hughes, 231 Grace Street, Birmingham, Alabama.

5AIA

A mistake has been made in listing the power of 5AIA owned by Ferris L. Deitz, 719 Ryan Street, Lake Charles, La. Instead of 485 watts, as given in the Government call book, a 5-watt spark coil C.W. transmitter is used.

STATE COLLEGE RECEIVES GIFT OF RADIO PLANT

Through the efforts of Dean Goddard, the New Mexico College of Agriculture and Mechanic Arts is the recipient of the gift of a new radio station. This will include the equipment for constructing a 100-watt transmitter and the building to house it. The station will be utilized for experimental purposes and amateur relay work under the Government license of 5ND. It will be separate and entirely distinct from the present radio house and its equipment, which will then be used solely for broadcasting service under its present call letters of KOB.

A site east of the engineering department's forge shop and south of the Commercial Building has been selected. This site gives plenty of open space about the building, where a new aerial of the T-cage type can be easily erected. It is planned to support the new aerial from two 60-foot "A" frame towers, spaced 125 feet apart. A counterpoise system of 20 wires is planned. These wires will radiate from the roof of the building in all directions to steel post supports at their outer ends.

The transmitter planned is of the reversed feed-back type, using two 50-watt Radiotron tubes for oscillators. The plate current will be supplied by a Kenotron rectifier and filter system. The materials for this have already been purchased and the set will be constructed by the Radio Club members from designs furnished by Dean Goddard.

THE MILWAUKEE AMATEURS' RADIO CLUB

The technical committee of the Milwaukee Radio Amateurs' Club, Inc., is one of the busiest as well as the largest in the club. The present large investigating body is found much more practical than the old method of using one member in this capacity. Reports such as "The Relative Efficiencies of Battery Charger Rectifiers," by R. E. Lathrop, 9ATX, former Vice-President of the Waukesha Amateur Radio Club; "An Amateur's Notion of the Heaviside Layer Theory," by M. H. Doll, 9ALR, West Allis A.R.R.L. City Manager; and "The Remotely Controlled System at Station 9AAP," by M. F. Szukalski, Jr., are typical of this committee's work. Mr. Doll is chairman.

"Magnetism, and Some Original Experiments in its Manifestation," was the title of an address given before the society by Rev. John B. Kremer, S.J., A.M., Professor of Physics and Director of Station WHAD, Marquette University. Father Kremer, known as an eminent physicist, has recently become a deep student of radio communication and has evolved a new microphone for broadcasting stations. Another lecture arranged by the program committee was "Tube Transmitter Design," given by Le Roy M.E. Clausing, 9XN, Operating Engineer at Station WJAZ of the Chicago Radio Laboratory. As a program feature, a contest in defining technical radio terms was held. Great enthusiasm was aroused, the winners being C. R. Griesbacher, 9CYL, and M. H. Doll,

G. W. 5 Circuit Radio Plug

PATENT APPLIED FOR



PHONES
LOUD SPEAKER
SERIES
PARALLEL
SHUNT

Accommodates
Head Set and
Loud Speaker or
Two Head Sets —
permitting instant
choice of Five Circuits
without removing plug or
changing tips.

Price \$1.50

At Your Dealer or Direct From Us
MADE OF GENUINE BAKELITE
Jobbers Write for Quantity Discounts

Manufactured by

G. E. WALKER CO., Inc.
1926 CHESTNUT ST. ST. LOUIS, MO.

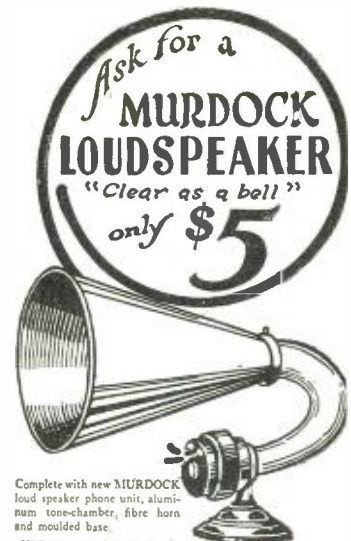

Complete with new MURDOCK
loud speaker phone unit, aluminum
tone-chamber, fibre horn
and moulded base.

NOT FOR CRYSTAL SETS

AT ALL RADIO DEALERS

Or Sent Direct if Your Dealer Cannot Supply You

W. M. J. MURDOCK COMPANY
344 Washington Ave., Chelsea, Mass.

EARN MONEY AT HOME

YOU can make \$15 to \$60 weekly in your spare time writing show cards. No canvassing or soliciting. We instruct you by our new simple Directograph System, supply you with work and pay you cash each week. Write today for full particulars and free booklet.

WEST-ANGUS SHOW CARD SERVICE LIMITED
Authorized Capital \$1,250,000.00
154 Colborne Building, Toronto, Can.

Let Radio Experts Buy for You

This Service Is Free Why hunt from store to store? Save time, trouble and money—a group of Radio Experts in New York will act as your personal representative, buy for you any standard make of radio equipment you want, from the smallest part to a complete set, either assembled or unassembled, and deliver it to you prepaid. Satisfaction guaranteed. Advice on all radio problems—free to our clients. Write for plan.

PERSONAL SERVICE PURCHASING BUREAU
505 Fifth Ave., Desk 15, New York

K & C TUNED R. F. TRANSFORMERS

These Efficient Units Gaining Remarkable Success

These Radio Frequency Transformers are the result of considerable research work by our Radio Engineers, and are remarkably flexible and efficient units. The wave length of the transformer is controlled by the position of the rotor and can be set for any given wave length between 150 and 600 meters. This range covers all broadcasting and permits of maximum efficiency of the transformer. Previous efforts along the lines of radio frequency amplification have been confined to the use of a Radio Frequency Transformer, working efficiently only at one or two wave lengths. The K & C Radio Frequency Transformer can be accurately tuned to any wave length between the limits mentioned above.



CONTINUOUSLY VARIABLE RADIO FREQUENCY AMPLIFYING TRANSFORMER

Two stage \$10.00
 Single stage 5.50
 Range 150-600 meters
 Send 25c for blueprint giving details of highly efficient Radio Audio Frequency Circuit.

SPECIFICATIONS

Insulated shaft and disc type coupling. Pig-tail connections to rotating secondaries.
 Each stage of amplification adjustable. Constructed of high grade bakelite.
 Arranged for both panel and base mounting.



KC Your Guarantee



The Essence of Simplicity

K & C NEW "SERIES AUTOMATIC" PLUG A WINNER

Costs No More than Any Standard Plug

BUT

It enables you to add any number of headsets in the circuit *instantaneously*.
 No multi-jacks or terminal blocks to fuss with.
 Just "Plug plugs" into each other.
 Any other make of standard plug can be used with the K & C "series automatic" plug.
 Moulded in pure bakelite.

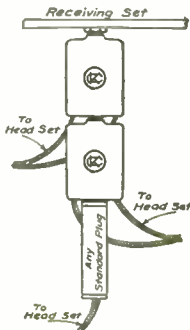

K & C "Series Automatic" Plug \$1.25 each

KILBOURNE & CLARK MANUFACTURING CO.

Head Office and Works, Seattle

Portland, 305 Larrabee Street, Phone East 6156 Los Angeles, 1103 West Tenth Street, Phone 581-002
 San Francisco, 591 Mission Street, Phone Sutter 40 New York City, 80 Washington Street

Radio Products of **K**uality & **C**haracter

40 Non-Technical Radio Articles

In the February Issue of



25 Cents a copy—On
 All Newsstands
 January 20th—
 \$2.50 per year

THE NEW
**Science and
 Invention**
 IN PICTURES

"Look for
 the
 Gold Cover"

THE New Science & Invention is a sensation—a scientific magazine without text—only illustrations and short captions. This is the first scientific magazine ever printed with pictures and captions only. Order from your dealer now, otherwise you will surely be disappointed in not getting your copy.

Experimenter Publishing Co., Inc., 53 Park Place, New York City



\$15.00 F.O.B. Cleveland

Type 6 charges 6 Volt Storage Battery from any 110 Volt, 60 Cycle lamp socket at average rate of 6 amperes, or over if battery needs it.

The Satisfactory Charger for Ten Years Past

The F-F, the first successful mechanical charger, is now the most popular. F-F features are distinctive, its construction is simple. It has been the one satisfactory charger for ten years past. It has no expensive parts to replace. Battery cannot discharge through it. And it utilizes both sides of the alternating current wave. (Efficiency). The

F-F BATTERY CHARGER

Fool-Proof and Shock-Proof

will charge a dead battery because it operates independently of battery. Copper to Carbon contactors that cannot BURN or STICK permit a desirably high charging rate.

Insist on the F-F for complete satisfaction.

Buy from your dealer. If he cannot supply you, write for literature or enclose remittance covering express or postal charges on 9 lbs.

ITS FREE—Write for Bulletin No. 32

The France Mfg. Co.
10432 Berea Road
Cleveland, Ohio

Oldest Manufacturer of the First Successful Mechanical Charger.

Dollar Radio Specials

- 3—Standard Base Sockets\$1.00
- 3—Honeycomb Coils, 35, 50, 75 turns 1.00
- 1—Rheostat and 1 Potentiometer 200 or 400 ohms 1.00
- 125 ft. Tinned Copper Wire No. 16 1.00
- 1—pr. Rubber Ear Cushions and New Radio Map... 1.00
- 150 ft. Stranded Tinned Copper Aerial Wire..... 1.00
- HOOK-UP PACKAGE: 12 ft. Spaghetti, 24 Copper Terminals 1 tube Solderall, 3 ft. Resin Core Solder, 15 ft. Tinned Copper Wire\$1.00
- AERIAL OUTFIT: 100 ft. Copper Aerial Wire, 1 Aerial Switch, 2 Insulators\$1.00

EXTRA SPECIAL

Electric Soldering Outfit (Guaranteed 1 year)....\$1.95
Write for Bargain List No. 6-N
WESTERN RADIO CORPORATION
Cedar Rapids, Iowa.

DEALERS

Send for new price list of parts & knocked down outfits.
RADIO PARTS MANUFACTURING CO.
1245 Marlboro Detroit, Mich.

9ALR, who were awarded American Radio Relay League emblems.

On weekly meeting evenings—Thursdays—at 7:15 o'clock, a code class for BCLs is held. This is held in the trustees' room of the Milwaukee Public Museum and has been quite well attended, among those wishing to learn to receive the International Morse Code are two YL's.

Under the leadership of F. W. Catel, 9DTK, a most successful membership drive has been put over. From a large group of Milwaukee County non-member amateurs a majority have been induced to join the club and the American Radio Relay League, of which this society is a local section. M. F. Szukalski, Jr., 9AAP, the society's Vice-President, has recently been appointed A.R.R.L. City Manager for Milwaukee and now heads the city's traffic work. An active campaign against spark stations has begun and attempts to mitigate the spark interference to broadcasting, as caused by commercial transmitters on ship stations, are being made, for it is this interference that is most troublesome to local radio fans.

The traffic committee solicits reports of QRM for investigation. All communications to the club should be addressed to its general office, 601 Enterprise Bldg., Milwaukee, Wis. Its officers may be interviewed at the weekly meetings, which are open to the public.

IMPROVED SET USED IN EMERGENCY ON THE "HARRY LUCKENBACH"

On a recent voyage of the steamship *Cuba* the motor generator used to operate the radio set became inoperative, and because of this defect, which the radio operators and the ship's electrician were unable to remedy, the vessel could not transmit radio signals and obtain compass bearings, which probably would have saved the vessel.

In a similar case the resourcefulness of the operators of the steamship *Harry Luckenbach* is to be commended. The operators contrived an apparatus for interrupting the direct current by taking an ordinary electric fan and providing brushes for the same, which were placed in the direct-current circuit. In this way they were able to work distances up to 1,400 miles. The blades of the fan acted as a motor and made contact with the improvised brushes, thus giving a pulsating current through the transformer. This improvised emergency set made it possible to carry on radio communication and is brought to the attention of other radio operators who may in the future have similar experiences.—(Abstract from *Radio Service Bulletin*.)

A Quick Shift Oscillation Transformer

(Continued from page 1084)

chine screw, outside of the tube. Some difficulty was encountered in getting the guides in the proper position so that the tubes would slide freely on the bakelite strips. It was found that the easiest way to accomplish this was to slide the tubes over the antenna coil and its supports and then slip the guides down the bakelite strips and secure them in position with the guides on the strips. This gave an accurate alignment and allowed the tubes to slide freely over the antenna coil.

The windings on the plate and grid coils are of rubber covered, 19-strand high-tension wire, which was purchased from an automobile supply house. The windings are placed on the tube as tight and as close together as possible, making the winding neat and smooth. The wire was then marked with a pencil, where the taps were to be

You would prefer the Philharmonic Orchestra to a noisy street band?

For the same reason you will prefer the Radiotive Loud Speaker.

Horse Shoe Magnet—Balanced Armature Corrugated Non-Metallic Diaphragm
Type E \$45—Type K \$25
Type K, with Large Horn, \$28

For Sale at all the Best Shops Carrying Radio Equipment, or write to

RADIOTIVE CORPORATION
681 Fifth Avenue, New York
Telephone Plaza 3416

You Know These HEADBANDS

Simple friction slide adjustment. Most satisfactory on the market. No thumb screws to bother with or to catch in the hair. Two yoke sizes fit any 'phones. Bands covered in Black or Khaki webbing. Prompt deliveries on any quantity.

\$500,000.00 worth of special and automatic machinery assures quantity output and guaranteed delivery for manufacturers and dealers on any radio equipment.

Submit sample of product. Write for prices.

THE AUTOYRE CO.
OAKVILLE, CONN.

Die Cast Wood MADER Clearspeakers

At last! Real speech—real music. No. 804—\$15.00. Finished in crystal black and brown. Equipped with Baldwin "C" Type Unit.

AMERICAN ART MACHE CO.,
345-59 West Austin Avenue,
CHICAGO

taken off. These tap marks were staggered, so that no two taps would fall next to one another. The winding was then taken off and the insulation carefully skinned where the pencil marks indicated that a tap was to be taken off.

Leads about 12" long, which allowed ample length to reach any one of the switch points on the face of the coil, were carefully tapped and soldered and the joint finished off by taping with rubber tape making the insulation at the tap equal to that of the rest of the wire. This wire with the taps soldered to it was then rewound on the tube and the taps fell exactly in position, as they were marked with the pencil making them stagger so that no two taps lay next to one another to eliminate any danger of insulation breaking down at the joint. The coils were then given a thorough boiling in paraffin, which, after cooling, held the windings securely in place. The number of turns on the plate and grid coils had to be determined by experiment for this particular case and cannot be vouched for, to apply to all sets, as the average set does not have to cover as wide a band of waves as is required of a limited commercial station. However, in this case there are 16 turns on the grid coil, with 12 taps taken off at single turns. From 200 to 360 meters only four points on the switch are used, which means eight turns, as the first four are not tapped, but it is necessary to cut in all 16 turns to get up on 600 meters. The plate coil in this case has 20 turns, 14 of which are taken off in single turn taps. The switch point readings are four points or eight turns for 200 meters, 10 points or 14 turns for 360 meters and all 20 turns are cut in to get up to 600 meters.

MOUNTING THE SWITCHES

The switches are mounted on the face of each of the coils by shaping two supporting shoulders out of one inch fibre so



Adapter No. 429 for 189 Tubes, 75c



De Luxe No. 400 Price 75c



Small-space No. 401 35c, 3 for \$1.00



Na-ald W.D.11 No. 411 Price 75c

It's the Contact that counts

Weak reception due to inferior contacts is banished when Na-ald sockets are placed in a set. Na-ald contacts exert a strong wiping pressure on tube prongs over a broad surface, regardless of frequent removal of bulbs or variation in the length of prongs.

You can count on Na-ald Sockets under all conditions. They are moulded of genuine Bakelite, with uniform cross-section and cure. These features prevent plate to grid losses and insure full efficiency from tubes.

Insist on Na-ald sockets, and put an end to weak reception. All good dealers carry them.

Na-ald Inside Facts, No. 499

Making a socket for U.V.199 and C299 tubes would seem comparatively simple. When we came to design the No. 499 socket, we did not find the task so easy. Compactness and sturdiness were requisites; and to be true to Na-ald standards this socket required a dependable contact. Owing to the shortness of the tube prongs, the dual-wipe contact of our De Luxe socket was impossible. In the No. 499 we avoided capacity effect and secured positive contact over the full surface of the end of the tube prongs. This again justified the phrase "It's the contact that counts."

In constructing this socket we have provided a real resilient base that actually absorbs all vibration. The socket floats in air, and all rubber with its corroding effect is kept away from the contact clips and screws. Again this foresight in design adds efficiency in service.

Send for "Why a Bakelite Socket" for further facts.



Na-ald Special Socket No. 499 for U.V. 199 and C,299 Tubes. Price 50c.



No. 3032-4, 2 Inch Dial 55c., 3 for \$1.00



No. 3783-3/16" Insert, 3784-3/4" Insert, 3785 3" Dial, Price 75c, 3" Dials, 35c, 3 for \$1.00

Alden Manufacturing Company

Largest manufacturers of radio sockets and dials in the world.
Dept. K. 52 Willow Street
SPRINGFIELD, MASS.
Cable Address, Aldence

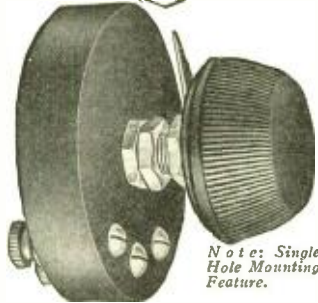

Note: Single Hole Mounting Feature.



Adjustable Grid Leak



- No. 106 (without condenser)\$1.50
- No. 107 (with .0025 mica condenser)\$1.85

By parcel post, 10c extra
Write for descriptive pamphlet.

Elimination of Inductance Increases Volume

The designers of the popular C R L Variable Grid Leak have incorporated the same patented features in the C R L NON-INDUCTIVE POTENTIOMETER which is adjustable through an infinite number of steps and which is truly non-microphonic.

Radio resistances must be non-inductive in order to allow free passage of high frequency current. Potentiometers in which the resistor is a wire winding choke back the delicate high frequency current of the received signal, and interfere with the free regenerative oscillation of your circuits.

The "C R L NON-INDUCTIVE POTENTIOMETER" has a resistance as free from inductance as it is scientifically possible to make it. A thin graphite resistor achieves this result. A perfectly non-microphonic pressure contact is made with the resistor by the patented "C R L" method. This gives noiseless adjustment through an infinite number of steps. A circular disc is mounted between the resistance strip and the pressure shoe providing a smooth surface for the shoe to ride on and preventing any wear of the resistor. No turns of fine wire to come loose and cause trouble.

- No. 110 (400 ohms)\$1.75
- No. 111 (2000 ohms)\$2.00

This instrument together with a C R L Adjustable Grid Leak, which has replaced thousands of the uncertain pencil mark types, gives you complete control over two of the most important elements in your set. You'll find them everywhere, the most popular devices of their kind.

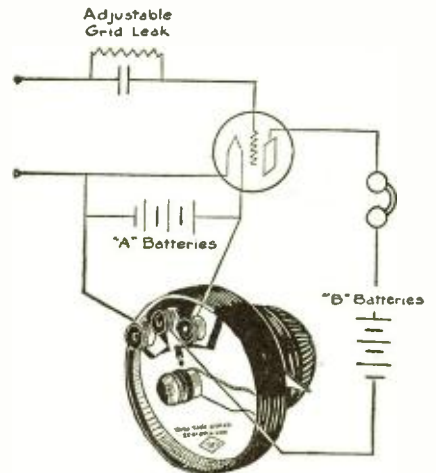

Hook-up showing positions of CRL Non-INDUCTIVE POTENTIOMETER and Adjustable Grid Leak in Tube Circuits.

CENTRAL RADIO LABORATORIES

305 16th Street,

MILWAUKEE, WISCONSIN.

SCHINDLER'S BUILD-UP Mica Condenser



50c to
75c

Schindler's "Build-Up" Condensers fill a definite need for reasonably priced condensers that may be easily increased or decreased in capacity. By the use of a "Build-Up" Mica Condenser you can change from an ordinary phone condenser to a special .006 value used in the Flewelling Circuit. By simply adding extra plates of mica and copper to the "Build-Up" base, you can obtain any definite capacity from .00025 to .006. (Each mica plate with the alternate copper plate has a capacity of about .002 Mfd.)

"Build-Up" Condensers are dilation proof. They insure high efficiency and will add satisfaction to the operation of any set. Each assembled complete in neat carton.

Mfd.	List price
.0002550c
.000550c
.00155c
.00260c
.002565c
.00570c
.00675c

Extra envelope containing 20 mica and 20 copper plates, or sufficient to build up a condenser from .00025 to .006. List price 25c. Table showing required number of plates for any capacity is furnished with each Condenser. Ask your dealer or order direct.

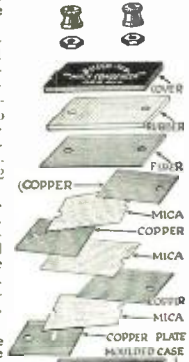

PRICES



Patent Pending

\$2
Including Hook-up Charts

SCHINDLER'S RADIO FREQUENCY TRANSFORMER

Makes signals audible on a small indoor loop aerial, that were originally too weak for detection even on the outdoor type of antenna. "Excellent results obtained," says Radio News Laboratories.

Made in two types, Type A for wave length of 150 to 500 meters. Type B for 300 to 850 meters. Price \$2 either type. If your dealer can't supply you order direct.

CHARLES SCHINDLER
Manufacturer of Radio Parts and Specialties
1401 West Delaware Avenue, Toledo, Ohio

SAVE ON RADIO

Stop paying exorbitant prices for radio apparatus. We can supply you any standard parts at greatly reduced prices.

WDJ TUBES, SPECIAL PRICE.....\$5.75
UV 201A AND C501 A TUBES.....\$3.75
BRANDES SUPERIOR PHONES.....\$4.95
22 1/2 VDLT B BATTERY.....\$1.30

You can save money on the latest and best in radio at our rock-bottom prices. Orders shipped same day received, C. O. D., under absolute money-back guarantee.

Free postage on orders accompanied by check. Write today for our Price-slashing bargain list. STANDARD RADIO CO. 1233 Walnut St., Kansas City, Mo.

Start New Year with "WHERE I GO BY RADIO"

Popular, Original and Useful Radio Record Book in which can easily be kept for reference. Where and How Stations are "Picked up," and What is Heard, is what you have long been wanting. Accurate List of Broadcasting Stations revised to November 15, 1923. Space for hundreds of records. Popular Edition, 2 Copies \$1.00; One Holiday Edition, Larger and More Attractive \$1.00, or all three for \$1.75. Order Today. This Record Book makes an ideal New Year's Gift.

Radio Department R. PROGRESS PRESS.
Union, South Carolina, U. S. A.

that the face supporting the switch contact panel is perpendicular and the back of it is cut to fit the outside curve of the tube, and then bolting them to the coils on the space not occupied by the windings. This makes a support to which the bakelite panel is bolted and a switch of the rotary type is built on this bakelite panel. (See diagram.)

The switches are made exactly as we used to make them for the old loose couplers, back in the old days in 1910, except that the spacing between the contact points is a little farther and the switch arm is heavier. The switch points are mounted in the usual way on a bakelite panel and the leads from the coils are carefully soldered to them on the back of the panel. The switch knob is necessarily of good moulded bakelite and not "Mud," as the knob is used to vary the coupling as well as the capacity and if the insulation should break down, one would find he had a whole handful of the real hot stuff, so this knob must be of the best insulation obtainable. It is soon learned that the fingers and knuckles must be kept clear of the switch arm and switch contacts during tuning or wave changing with the transmitter in operation, as the hand is right there amongst the HOT STUFF.

Variation of the antenna coil in this case is obtained by a single pole double throw switch, but where a greater number of variations are desired, it can be easily worked out by incorporating a rotary switch on one of the end blocks the same as on the plate and grid coils, with a lead running from each switch point to a different clip on the antenna coil. The position of the clips once determined by a wave-meter are not altered, but are brought out with separate leads to switch points on the end supports, using the heavy rubber covered high tension cable from clip to switch point. It then becomes an easy matter to refer to the recorded setting and with a simple twist of the wrist set the antenna coil to any desired wave. Another twist of the wrist and the grid and plate coils are in resonance and the deed is done and the wave is where it was intended to be.

Of course, all switch points must be numbered so that in recording the settings it is an easy matter to return to that setting. This saves counting the switch points as I did at first, and also tends to make the wave changes more rapid. The method for recording the coupling setting and being able to return to it in a jiffy was worked out by simply placing an engraved bakelite strip on the face of the "Hootnanny" under the shoulders supporting the rotary switches, so that this strip also helps to support the grid and plate coils and the supporting shoulders act as pointers on the scale, making it possible to tell at a glance what the coupling is, or setting to a recorded coupling.

As said before, this "Hootnanny O. T." has been kicking out results at 6CCH for the past year, and it is an easy matter to jump from 360 to 200 meters or from 360 to 600 or any other wave-length that I happen to reach out for, in a matter of just a few seconds, even while the transmitter is in operation, and this is a wider band than the amateur is ever going to be allotted, so there is no reason why this "Hootnanny O. T." cannot be incorporated in the up-to-date ham station, and so make it possible for him to QSY to any wave the law allows him, in just a very few seconds and to do that means to clear up a lot of QRM among ourselves as well as moving a lot of the traffic that has been hanging on the peg.

JUNK YOUR SET?



The new TWITCHELL AUXILIARY TUNER connected to your present set will enable you to bring in the long and short wave stations which your present set cannot get. It also positively cuts out all local stations so you may bring in distant any time without local interference. Copyrighted diagram of this tuner 50c, or with all parts \$12.00. Complete instrument in Walnut cabinet, ready to use \$20.00. Transportation prepaid.

MY HIGHLY IMPROVED REINARTZ brings in all important stations on this Continent loud, clear and without distortion. We dance to music from Atlanta and Los Angeles.

Build one of these wonderful 3 tube sets from my blueprint and specifications, Price 50c, or with a complete and perfect double-wound silverweb coil \$3.00 by mail. Picture of this set on a glass panel with every order. This copyrighted circuit is the most successful of any Reinartz modification yet produced, and is limited the most. Thousands are in use.

My W. D. 11 Circuit is the Reinartz especially designed for use with the "Pickle" tube and brings out the full value of the little tube as no other circuit can. Stations 1000 miles away come in clearly on one tube. This set is small, complete, portable. For the man who wishes the highest efficiency, this is the set to build. Price of blueprint and specifications, 50c, or with complete and perfect windings, \$2.00. Photo of set with every order. A wonderfully efficient coil of new and scientific design for the above circuits, the highest quality coil made. Coil only \$4.50 or with ether blueprint \$5.00.

Sets built from these copyrighted plans will receive all broadcasting stations operating under the new laws. Their wave length range is from 170 to 800 meters.

All goods prepaid. These instruments are easy to build, easy to operate. Everything shown as shown.

TWITCHELL'S RADIO HOME
1027 Western Avenue, Minneapolis, Minn.

KLAUS

Complete Stock of
Broadcast Receivers

Ready for shipment, KLAUS carries a complete stock of the latest and best broadcast receivers. All apparatus distributed by KLAUS is manufactured by the best manufacturers and bears the KLAUS GUARANTEE. Get our prices on amateur receiving and transmitting equipment.

KLAUS RADIO BULLETIN for Dealers—Do You Get It?

Expert advice regarding radio problems, latest information about new equipment, and hints on radio merchandising which helps dealers make more money, is in every issue of the KLAUS RADIO BULLETIN. If you are not on our mailing list of dealers receiving the bulletin, send us your name and also receive our trade discount lists.

KLAUS RADIO & ELECTRIC CO.
Authorized Distributors
Dept. 200 EUREKA, ILL.

Comfort Cushion Your Ears!

The BATES Ear Cushion takes the headaches out of headphones. Improve the hearing qualities of your set 100 percent with

The BATES EAR CUSHION

Slips over any radio phone—Instantly and easily. Cushion your ears and hear in comfort. Costs little—worth lots.

POSTPAID ANYWHERE IN U. S. for \$1.00 Per Pair

DEALERS: Write for special discounts. BATES Ear Cushions are fast sellers!

BATES & COMPANY
1516 Montana St. Chicago, Ill.

Radio Reception In the Grand Canyon

(Continued from page 1075)

trous earthquake occurring in Japan. Another bit of news, not disconcerting but pleasurable, was the report that the Washington baseball club had won a game. Bed-time stories, news events, concerts and the variety of items included in a broadcast program were received nightly in the canyon, or wherever the party happened to be, from KHJ, the station at Los Angeles. Also, all communications dispatched by the Washington office of the Geological Survey were transmitted to Los Angeles, thence to the exploring party by radio. Messages from stations located in Salt Lake City and Colorado Springs were also received.

No attempt was made to install radio equipment on the boats as they were plunged here and there at the mercy of the swift rapids. The compact radio outfit, weighing a little over 25 pounds, was enclosed in a water-tight compartment of the "Grand," one of the four boats used on the expedition. That this arrangement was necessary and useful is proven by the fact that the boat overturned, and, despite its submersion for half an hour, the cameras and radio apparatus were dry and ready for immediate use.

The official report says: "The party left Lee's Ferry August 1, and camped that night at the head of Badger Creek rapids, seven and one-half miles below Lee's Ferry. Here the radio set was tried out, and in spite of adverse prophecies, some of them widely circulated in print, to the effect that a radio set could get nothing in the depths of the canyon, KHJ, at Los Angeles, was heard plainly, although the canyon here is narrow and nearly a thousand feet deep. From this point on down the canyon the radio outfit was set up from place to place and received messages from Los Angeles, Salt Lake City, San Francisco, and on one occasion, from Colorado Springs."

The antenna used was ordinarily 100 feet high, consisting of a single wire stretched up the incline of a rock, the wire being insulated near the end, and tied to a projection by a string. The wire was grounded in water, this method giving better results than when the wire was submerged in moist soil. No extra batteries were included in the radio equipment. Two head telephone sets were used. The longest distance over which any communication was received within the canyon was that covered by the news of the death of President Harding, approximately 600 miles. Atmospheric disturbances were annoying during August owing to the severe thunderstorms, but at no time was static so intense that the messages broadcast from Los Angeles could not be read at night. Even in an environment where boats were tossed about like corks on huge waves, the radio receiving set in its water-tight compartment was unimpaired and, when installed, remained the one link between the explorers and civilization.

The Warning

(Continued from page 1070)

"I wish I could do something to repay you for all your kindness," he whispered, "but I'm signing off for good, I think. Bury me at sea—there's no one ashore who cares, anyway. My warning came true; I was sure—that's as far as he got; Sparks was dead."

An odd silence came over the little dining saloon of the *Lone Star*, each of the three officers seeming lost in thought. Suddenly

—and Now a Complete Radio Receiving Set

Consisting of

Radiogem Phone and Aerial **\$2.50**

Shipping Charges Prepaid to Any Point in the U. S.

This outfit is absolutely complete. It includes everything you need to hear the Broadcast. Programs, market reports, time signals, ship calls or land station messages. Nothing more to buy—no batteries or tubes needed—no upkeep cost of any kind.

The Complete Outfit Consists of Three Parts

(One)

The RADIOGEM

The simplest radio outfit made—yet as practical as the most expensive. A crystal receiving set that you can operate and enjoy even though you know absolutely nothing about radio. You receive the RADIOGEM unassembled, together with a clearly written instruction book which shows you how to quickly and easily construct the set, using only your hands and a scissors. The outfit comprises all the necessary wire, contact points, detector mineral, tube on which to wind the coil, etc., etc. The instruction book explains simply and completely the principles of radio and its graphic illustrations make the assembling of the RADIOGEM real fun.

(Two)

The GEMPHONE

An adjustable, 1,000-ohm phone complete with 3-ft. cord—the first inexpensive adjustable receiver made. The Gemphone is of standard type and made of the very best grade of materials throughout. The case is made of turned wood, an exclusive feature with the "GEMPHONE." This is responsible for its exceptionally rich and mellow tone. Like RADIOGEM, the GEMPHONE is sold unassembled. Our instruction pamphlet shows how to assemble it in two minutes, using only a screw driver.

(Three)

The AERIAL OUTFIT

Consisting of 100 ft. of standard copper aerial wire and two porcelain insulators.

Complete Radiogem Outfit	\$ 2.50
The Radiogem, only	1.00
The Gemphone, only	1.00
Aerial Outfit, only	.50

Order Direct or From the Following Dealers:

Akron, Ohio Federman's Dept. Store	Dallas, Texas Cullum & Boren Co.	Los Angeles, Cal. Lester's Radio Shoppe	Phillipsburg, Pa. O. Curtis
Atlanta, Ga. Cook & Foster	Dallas, Texas Texas Furniture & Store Co.	Medford, Ore. Virgins Radio Service	Poughkeepsie, N. Y. Chas. P. Raymond
Atlanta, Ga. Miller's Dollar Store	Freeport, L. I. Alexander Gold	Media, Pa. Media Elec. Co.	Providence, R. I. The Outlet Co.
Baltimore, Md. A. A. A. Co.	Hamilton, Ont., Canada Radio Supply Co.	Melbourne, Australia Marks & Abrahams, Pty. Ltd.	Pullman, Wash. Electric Supply Store
Boston, Mass. Radio Specialty Co.	Hartford, Conn. Saco Allen Co.	Newark, N. J. L. Bamberger & Co.	Saginaw, Mich. J. A. Loubert & Co.
Brooklyn, N. Y. Levy Brothers	Hawera, New Zealand H. H. Hlake	New York City, N. Y. Dixie Supply Co.	St. Louis, Mo. United Auto Supply Co.
Buffalo, N. Y. Wahler Talking Mach. Co.	Havana, Cuba Compania Radiotelefonica de Cuba	Eastern Radio Corp. Radio Specialty Co.	St. Paul, Minn. Hill District Radio Sheet Metal Co.
Chicago, Ill. Barwick Co.	M. Massena Manuel Nodar, Jr.	Harold M. Schwab F. J. Sawyer	Seattle, Wash. Parsons Elec. Shop
Chicago, Ill. Home Supply Co.	Radio Novelty Co.	Northampton, Mass. Parsons Elec. Shop	Springfield, Mass. Johnsons Book Store
Cleveland, Ohio Anderson Elec. Co.	Hoboken, N. J. C. R. Prieman Co.	Oregon City, Ore. Singer Hill Radio Service	Washington, D. C. Chas. Klaben Co.
Service Publishing Co.	Laurel Springs, N. J. Stone & Egan	Philadelphia, Pa. Jos. J. Miller	

THE RADIOGEM CORP., 66-R-West B'way, N. Y. City



DUCK'S Big 256 pp. Combined Radio Catalog and Text Book—No. 16. Mailed for 25c. in coin or money order. Not sent otherwise. Full of radio information and hook-ups. Prices extraordinarily attractive. Ever since 1909 Duck's catalogs have blazed the way with the best and most dependable radio products.

FREE Send postal for our special price list on all radio instruments in our catalog and countless new instruments and sets not in Catalog No. 16. Of special importance to those having catalog No. 16.

THE WILLIAM B. DUCK CO.

711-12 ADAMS STREET Dept. 3 TOLEDO, OHIO

ekko



Listen to radio through your phonograph

Ekko adapter connects your head phones with the tone arm of your phonograph and turns the sound box into a loud speaker. The best loud speaker you can use—utilizes the scientific design of the phonograph sound box, producing a pure mellow tone. (Not adapted to crystal sets without amplification.)

For Double Head Phones . . \$2.00

(Without Connectors)

For Single Head Phones . . . \$1.00

(Without Connectors)



Ekko fits Victor, Silvertone, Sonora and other makes without connectors. Add 20c for connector for Pathé, Columbia, Vocalion; 25c for Edison; 30c for Brunswick. Or 75c for complete set.

Ekko Connectors at above prices also available separately to attach practically all loud speaker units to your phonograph.



The ekko Clamp

For ground wire and battery terminal contacts. The Ekko Clamp bites through rust or corrosion and assures positive contact on all electrical connections. Also used to tap 2 and 4-volt current from a 6-volt battery.

Ekko Clamp 25c. Pair (for battery terminals) 50c Ekko Adapter and Ekko Clamp at your dealer's. Or order direct from us. Sent postpaid. Money back if not satisfied.

The Ekko Company

111 West Monroe Street Chicago, Ill.

the Captain shook himself from his reverie and rose. We all followed.

"No, Sparks, you don't want to laugh at sailor's superstitions," he said. "If you do, you're liable to have some experience that you won't fancy. I've known that to happen!" He spoke with a deep note of earnestness in his voice that somehow sent a cold chill down my spine. I laughed a bit nervously and glanced around for some answering mirth on the faces of the mates. I was disappointed.

There was but a tiny crescent of a moon outside, but the stars were quite brilliant, except off our starboard quarter, where a low lying cloud bank seemed to blot out their cold, remote radiance. I filled my lungs with the fresh salt air, enjoying its grateful tang, tilted back my head and inhaled great breaths of the invigorating atmosphere in an unconscious effort to clear my brain of the cobwebs of fancy with which the talk around the supper table had obscured my mental vision.

The wind had freshened considerably, and even as I watched, the blot in the west seemed to extend itself, swallowing up the stars one by one, like some great monster from the nether regions creeping up over the horizon, intent upon devouring the heavens.

The thought brought back to me the weird tales that the remarks in the dining saloon had suggested to my mind, and once more the icy finger of fear sent a cold shudder, that I could not repress, tingling down my back. Somehow, away from land and solid things the Supernatural seems more real; the vastness of the ocean, the immensity of space, make it easier to believe; one's "credo" is enlarged surprisingly by contact with the sea.

With a conscious effort and a laugh that was far from spontaneous I diverted my thoughts into other and more healthy channels and mounted hastily to the radio shack.

The radio room was small, not larger than seven by ten feet, and was illuminated by a single green-shaded light immediately over the operating table; although there was a large light set into the center of the ceiling, it was never used. It was a bare, dismal place with its cold looking instruments and the severely-framed licenses hanging on the walls.

I seated myself before the operating table,



A Vernier Condenser Grid Control

Every Detector Tube Needs a VARI-GRID

Tube characteristics are not alike. The Vari-Grid varies the capacity of the tube. Has variable grid leak. Also used as a plate condenser. 1 1/4 in. wide, one hole to drill.

If your dealer cannot supply you, order direct. \$2.25

RANDEL WIRELESS CO.

11 Central Ave., Newark, N. J. Jobbers and Dealers—Write for Discounts.

FOR SALE

Original 100 watt Broadcasting Equipment of

KFI—Los Angeles

Equipment consists of 100 watt oscillator and 100 watt modulator with 50 watt speech amplifier. Fully equipped with filter apparatus and motor generator power supply. Regularly reported from all over United States during its operation. A chance to secure a powerful broadcast equipment of the highest quality at a low figure. Write or wire

Earle C. Anthony, Inc.

Radio Division 1000 South Hope St., Los Angeles, Calif.



Pacent Plug and Jack Devices

Pacent jacks are obtainable in ten different types... 60c to \$1.00 Other plug and jack devices are the Duoplug, Duojack, Twinadapter and Multijack at \$1.00 each. The Multiadapter at \$1.50, and the deluxe Jackset at \$1.25.

Pacent Electric Co., Inc. 22 Park Place, New York

Pacent RADIO ESSENTIALS

IMPROVED! UNIVERSAL PLUG

The Pacent "Forty," already popular as an efficient and low priced plug, has now been greatly improved by a new, simplified type of connection. You need only to insert cord tips in springs, and place shells of plug together as shown in illustration.

All metal parts heavily nicked. Polarity is stamped on connection clips.

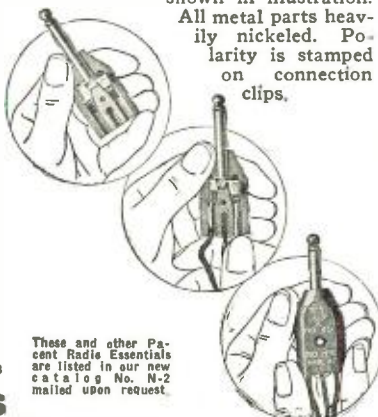

These and other Pacent Radio Essentials are listed in our new catalog No. N-2 mailed upon request.

A NEW



AUDIO TRANSFORMER

Maximum amplification without distortion. This is what the radio fan wants—it is what he gets in the TYPE M-6.

Radio Toy and Bell Ringing Transformers Catalogues sent upon request.

Dongan Electric Mfg. Company

Transformers of merit for 14 years DETROIT MICHIGAN

adjusted the receivers comfortably on my ears, and turned on the filament rheostats of the detector and two steps of audio frequency that we were blessed with.

The static was bad, just as I had expected from the storm that was brewing in the west. The diaphragms of my headset clicked and rattled with the force of the atmospheric. But I had nothing else to do so I stuck to my post, idly turning my tuning dials and picking up bits of amateur gossip on 200 meters, some broadcasting on 630 and 400, and the whole buzzing jumble of commercial traffic on 600 meters.

Tiring of this I picked up a novel I had started to read earlier in the day. With my phones still clamped to my ears I tried to interest myself in the adventures of some heart-broken Easterner who was attempting to find solace in the wide-open spaces of the Northwest. Somehow, my mind refused to attach itself to the book, and continued dwelling upon the conversation of the supper table. At last I threw the book under the operating table in disgust, and gave myself up to the weird thoughts that somehow seemed to possess me.

Outside, the wind was still rising. I could hear, even with my phones on, the whistling of the blast as it tore around the unprotected corners of the radio cabin, and could feel the thudding might of the waves as they struck the sides of the empty tanker. The rattling of the static was increasing slowly but steadily.

I started to whistle, and broke off in the middle of a note. Suddenly an overwhelming consciousness of the presence of *somebody* or *something* in the room struck me with a force that was almost physical in its intensity. I could feel eyes boring into the back of my head, hands reaching toward me. There seemed to be a dank, cold breath from the secret depths of the ocean fanning my cheek. I glanced hurriedly, nervously, involuntarily behind me into the soft black shadows. Nothing, and yet the dominating "presence" was stronger than ever in the room.

"Bill," I told myself, "you'll have to snap out of this, and snap out of it quickly! It's nothing in the world but your imagination—" Suddenly the static which had been crashing unremittingly in my receivers died down almost to silence. Instinctively I looked toward my receiver to see if a connection had broken or a bulb had burned out. Nothing was wrong; I knew that, for any experienced operator knows the sound of a "live" set. Yet the sudden cessation of the static was unaccountable on any other basis. Again, and stronger than before, I seemed to feel the "Presence" in the room, but I kept my eyes glued to the operating panel, and refused to give way to my fancy.

Suddenly my scalp tickled and I could feel my hair rising on my head. The blood drained from my face, my eyes strained in their sockets—was I dreaming or mad, or did I see—?

The tuning dial of my set was turning; slowly, carefully, smoothly, turning to a higher wave; turning as though the hand of an experienced operator grasped the knob, exploring the ether for a signal. Up the scale, a slight pause, and then down a bit it turned while I stared with hammering pulses.

The static had ceased utterly; not a sound in my receivers as the dial continued its slow, intelligent, *directed* movement. Not a sound—and then suddenly a Voice:

"—derelict dead ahead; stumps of three masts, floats just awash—" The dial, which had paused again for the brief second that it took for these words to be uttered, turned a degree or two more and stopped.

Suddenly the static started pounding in my

WORKRITE NEUTRODYNE RADIO PARTS

(LICENSED UNDER HAZELTINE PATENT NO. 1,450,080)

WorkRite Neutroformer



This instrument is made from two WorkRite Neutrodyne Radio Parts,—the WorkRite Variable Condenser and the WorkRite Neutrodyne Transformer mounted together. The Condenser is accurately made. Each part is held to within .001". The plates are properly spaced. End plates are made of hard rubber, highly polished. .0004 Mfd. capacity. The Transformer is most carefully made with just the proper spacing between the Bakelite Tubes and right number of turns

of wire. The instruments are made to work together. They may be purchased separately if desired.

WorkRite Neutrodyne Transformers, each\$2.00. Set of three\$6.00
WorkRite Neutroformer\$5.50

WorkRite Neutrodyne Kit

3 WorkRite Neutroformers
2 WorkRite Neutrodons
Panel layout and Book of Instructions.
The principal instruments of a Neutrodyne Receiving Set.

\$ 17⁵⁰

WorkRite Neutrodon



Neutralizing a Neutrodyne Receiving Set requires careful adjusting. The best instrument for neutralizing the set will be none too good. The WorkRite Neutrodon will give the most accurate adjustment. Made for mounting on panel or in the line. Price each 50c. Set of two \$1.00. USE ALL WORKRITE NEUTRODYNE PARTS to get best results from your Neutrodyne Set.

WorkRite Non Microphonic Sockets



These sockets have sponge rubber bases which eliminate ringing in the set due to jarring of the tubes. No. 199 for 1V, 199 and C299 Tubes. 75c. WorkRite No. 200 Socket for use with all regular Tubes. Price 90c.

Send for free WorkRite Neutrodyne Hookup and complete catalog of WorkRite Radio Parts

"WORKRITE RADIO PARTS WORKRITE"

The WorkRite Manufacturing Co.

1822 E. 30th Street

Cleveland, Ohio

(Branch Office, 536 Lake Shore Drive, Chicago)

RADIO

SEND FOR OUR COMPLETE MONEY SAVING CATALOG

TIMES SQ. AUTO SUPPLY CO., INC.

MAIL ORDER DEPT.

1745 BROADWAY AT 56th STREET NEW YORK, N.Y.

New Easy Way

to wind coils of any kind. Clamp "Lock-Grip"

on the Wire

Ordinary pliers won't stay clamped. "Lock-Grip" grips tight and locks—the easy way to do your winding. Tool steel, nickel plated. Sent postpaid for \$1.00 or c.o.d. An extra hand for you, Satisfaction or money back. Order today!

C. E. CARSON
Dept. 10 1001 Washington Blvd., Chicago, Ill.

WANTED—Back numbers of Radio News, Dec., 1921, Jan. and Feb., 1922. Experimenter Publishing Co., 53 Park Place, New York City.

**To Pay Less is Risky
To Pay More is Unnecessary**



New York Variable Condensers are all equipped with **GENUINE BAKELITE INSULATION**. Positive contact and of the best value obtainable.

- 11 Plate\$1.50
- 23 Plate\$2.00
- 43 Plate\$3.00



A Variable Grid Leak of quality and precision. Roller contact incomparably better.
Price\$1.50



Mica Fixed Condensers of tested and permanent capacity, ranging from .0001 to .006, 35 cents to 75 cents, of superior quality.

New York Coil Co.

338 Pearl St., New York City

Pacific Coast

1240 S. Main St., Los Angeles, Cal.

SEND FOR YOUR FREE COPY

TESTED HOOK-UPS

SUBMITTED BY USERS OF OUR



Price \$1.00
POSTPAID
with instructions

**WONDERFUL
TRANSMITTER**

**BUTTON FOR LOUD
SPEAKERS**

**AMPLIFICATION
AND EXPERIMENTS**

K. ELECTRIC CO.

15 PARK ROW

NEW YORK

receivers again, and I had a feeling of freedom from the "Presence" of which I had been so acutely conscious.

I pushed back my hair from a forehead clammy with cold sweat. My hand shook with a nervous trembling. I clenched my teeth in a vain effort to control myself.

"—derelict dead ahead; stumps of three masts, floats just awash—" The clear, cold tones rang in my mind like the words of a song, over and over again. I tried to convince myself that it was all imagination, that the lurching of the ship had moved the dial, and that what I had heard was but a fragment of some ship's radio telephone reporting a menace to navigation. I twirled the dials in a frantic effort to tune in the mysterious Voice again—in vain. Either he had signed off, or— Was I mad?

For what seemed a century I debated the matter, trying to convince myself that it was merely a coincidence, an accident—anything but what my fevered brain was shouting in its delirium. At last I could stand it no longer; I made my way to the bridge, where I knew the Captain would be taking his evening constitutional.

"Why, what's the matter, Sparks?" he queried, gazing intently into my face. "You're as white as a ghost!"

I laughed as best I could—a poor effort—and then I told him just what had happened, expecting—and hoping—that he would laugh me to scorn. When I had finished he looked out over the black, heaving sea in silence for a full minute.

"Sparks," he said at last, "I've seen a lot of funny things happen at sea. Things that landsmen would laugh at, and ridicule. They may call us superstitious if they like, but—Mr. Burleigh!" he called.

"Sir?" answered the third mate, who had the watch. "Did you call me?"

"Will you put a lookout up in the bow, and give the engine room half speed ahead?" Mr. Burleigh gave him an odd look, but turned with a brief, "Yes, sir" to execute the command.

Captain Harrison looked out over the sea again, and for several minutes, apparently, was lost in thought. Then he looked at his watch and turned back to me. "Ten five, ship's time," he said, apropos of nothing.

At exactly twelve minutes after ten the lookout sighted the dim bulk of a derelict, the stumps of three masts showing. She floated barely awash, and it was only the lookout's keen eyes, our half speed and a wheel hard down that saved us from a ramming that would probably have sunk, or at least horribly crippled our ship.

"I wonder," said Captain Harrison thoughtfully when we were proceeding at full speed once more, "I wonder . . . Do you remember what I told you about the last wish of that other Sparks, who said he would like to do something to show his gratefulness . . ." He did not complete the sentence; it was not necessary.

I thought of the dial that had turned so slowly, surely—just as a good operator tunes, and I think the captain read my thoughts in my eyes. He smiled, and an odd look swept across his rugged, weathered features.

"No Sparks, it doesn't do, always, to laugh at sailors' superstitions. Things are different, somehow, out here." He indicated the wide, barren waste of black water that was the Atlantic, with a great sweep of his arm.

I nodded, slowly, thoughtfully, and without a word made my way down from the bridge.

A RIDDLE

If Reinartz dines at the Astor Hotel, where does Neutrodyne?

By William P. McLaughlin.

World's Greatest BATTERY BARGAIN

FREE

Written 2-year Guarantee
Your Proof of Performance

Start the New Year Right

SAVE 50%

and Get a "B" Battery and Hydrometer Free

Thousands of Radio News readers will do just that through this amazing World Battery offer. They will buy the famous 2-year Guaranteed World Battery at the lowest price ever quoted and with it they will get free a hydrometer and a "B" battery.

COMPARE THESE PRICES

Special 2 Volt Storage Battery \$5.03	For U.V.199 Tubes. Same features as 2 Volt.
For W.D. 11 and W.D. 12 Tubes. Will run 200 hours on one charge.	6 Volt, 80 Amps. \$8.50
Rechargeable.	6 Volt, 80 Amps. 10.00
Special 4 Volt Storage Battery \$8.00	6 Volt 100 Amps. 12.50
	6 Volt, 120 Amps. 14.50
	6 Volt, 140 Amps. 18.00

SEND NO MONEY

You need not send a penny. Just clip this ad, and mail with your name and address. The battery you specify will be shipped to you the day your order is received. When the battery arrives, inspect it—read our 2-year guarantee before you pay one penny. Convince yourself you are protected from every angle—that the World Battery saves you 50 per cent. Get the "B" Battery and hydrometer FREE. Clip the ad, and send your order today.



World Battery Co.

1219 So. Wabash Ave.

Dept. 10 R.N.

CHICAGO, ILL.

5 per cent discount for cash in full with order.

"COPPERWELD"
THE IDEAL RADIO ANTENNA

COPPERWELD IS 50% STRONGER
than Copper. Can be strung out, stays up when other wires stretch and break and gives 100% electrical efficiency.

COPPER CLAD STEEL COMPANY
BRADDOCK P. O. WENNER, PA.
Directions for Antenna construction on reverse side of carton

The New METALECTRIC SOLDERING IRON
AN ALL-METAL QUALITY INSTRUMENT. OPERATES ON ANY CURRENT WITH THE SIMPLICITY OF A LEAD PENCIL. **\$5.50**

Cool Handle
Inter-changeable Tips.
"Worth It!"

—Accepted—
as the logical Solution to Radio Soldering Problems
"Guaranteed"
of your dealer or write
POST ELECTRIC CO. 34 E. 42nd St., New York

Planting the Radio Compass Atop the World

(Continued from page 1065)

radio stations are not equipped with compasses, the navigation officer on the dirigible can determine his bearings simply upon the reception of signals with the use of the radio compass.

SIMILAR TO A SHIP RADIO-COMPASS

The system of radio-compass direction finding of the Navy Department now in wide use for guiding vessels through fog or thick weather involves the signaling of two or more shore stations. After a ship has picked up signals from two or more transmitting stations on shore and carefully noting the exact direction from which they came with the aid of a sensitive variable loop, the vessel plots its own position by noting where the two angles obtained from the land stations cross. Similarly, on the contemplated expedition of the ZR-1 to the North Pole, when its course was in doubt, two or more of the wireless stations in Iceland, Alaska, Greenland or Russia, could be asked for signals. An Arctic explorer is responsible for the observation that the ordinary compass is sluggish in performance in the extreme north; which prompts him to offer the suggestion that radio compasses and radio instruments have the possibilities of accurately defining positions on polar expeditions. These appliances could conclusively establish the claim of an explorer that he had attained the northern pinnacle. Unlike the claim of another would-be discoverer of the North Pole, the radio compass and other radio instruments do not lend themselves to subterfuge.

THE TRANSMITTING APPARATUS

With respect to radio installation as well as gigantic proportion, the ZR-1 is the *Leviathan* of the air. Radio telegraph facilities are provided for both the transmission and reception of intelligence. Radio telephone signals may be used also. Voice communication will be serviceable in landing the dirigible since a large force is necessary on the landing field to operate the lines which haul the big ship to earth. This operation must be directed by the ship's captain. A standard Navy Department type transmitter, including recent improvements, has been installed. This apparatus, for sending of C.W. and I.C.W. signals, uses six 50-watt vacuum tubes and has an average output of 150 watts to the antenna. The operating wave-lengths are 507, 600, 800 and 975 meters.

The antenna employed on this airship is common to the type used on aircraft in general, namely, a trailing wire. In this instance, the antenna is 300 feet long and is reeled up when not in use. The transmitting equipment has been subjected to tests on the bench with a phantom type antenna having the same characteristics as the present trailing wire antenna with the following results: Fundamental wave-length, 315 meters; capacity, 300 micro-microfarads; inductance, 93 microhenries. The resistance ranges through the variable wave-lengths used from 9 to 13 ohms, affording a radiation constant of 5 amperes. A loop antenna will be used when the airship has made a landing. It will be located between the control car on which the radio instruments are installed and the two leading wing cars. This arrangement will facilitate ground communication.

SENSITIVE RECEIVING EQUIPMENT

The receiving equipment for operation on short wave-lengths is of two circuit design with six stages of amplification—three of radio-frequency, two of audio-frequency, and a detector. The six vacuum tubes are of the SE1444 type. The long distance re-

Radio Frequency Amplification WITH Ballantine Variotransformers

(Patents Pending)



Model 5, \$9.60

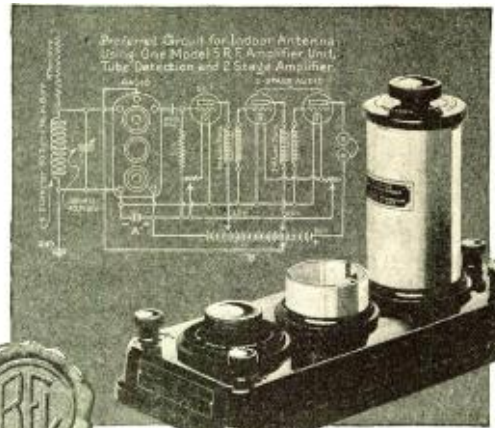

Complete Unit, \$15.00

"TURN THE KNOB"

1. Continuous variation in wave length.
2. Self-contained and shielded.
3. Control of regeneration and tuning by single knob; *no potentiometer*.
4. Fits your set—either base or panel mounting.
5. Improved tone quality.

"Radio Frequency Amplification with the Ballantine Variotransformers" — a 25-page booklet—mailed free on request.

BOONTON RUBBER MFG. CO.

Pioneers in Bakelite Moulding

524 FANNY ROAD

BOONTON, NEW JERSEY

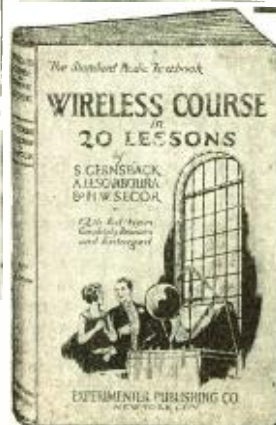

\$2.00 12th Edition \$2.00

WIRELESS COURSE IN 20 LESSONS

By S. GERNSBACK, A. LESCAUROU and H. W. SECOR

The Standard Radio Text Book

Size 6 x 9 inches. 264 pages. 500 Illustrations. Binding de Luxe. Semi-flexible Leatherette Cover. Genuine Gold Stamped, Round Corners, Red Edges.

Experimenter Publishing Co.
53 Park Place New York, N. Y.

faultless!

Bakelite - Dilecto (x x grade) is 100% perfect for radio panels. Insist on it!

bakelite dilecto!!

(A Laminated Phenolic Condensation Material)

Better than plain fibre because it resists water, solvents and acids.

Better than hard rubber because it resists heat, high-voltage, ozone and fumes, and is more durable.

Better than wood because it is tougher and harder, does not swell, warp or crack, and is non-inflammable.

Your electrical dealer will get it machined for you.

The Continental Fibre Co.,
Factory: Newark, Delaware.

Dealer Service From:

New York, 233 Broadway
Chicago, 332 S. Michigan Ave.
Pittsburgh, 301 Fifth Ave.
San Francisco, 75 Fremont St.
Seattle, 1041 Sixth Ave., S.
Los Angeles, 411 S. Main St.



SUNSET REFLEX CRYSTALS

GUARANTEED for sensitivity, clearness, volume. Superior for reflex circuit and DX Wood metal mounting assures 100% efficiency and greater distance.

50¢



Granular Galena in Bulk. Mfrs., Dealers, Jobbers: Write for Proposition.

U. S. MFG. & DIST. CO.
45 CLINTON ST. NEWARK, N. J.

TUBES REPAIRED

Only Middle West Tube Service Station.
8 Hour Service. No Extra Charge for Broken Glass.

WD-11, WD-12, C-11, C-12	\$3.00 Ea.
UV-200, C-300	2.75 Ea.
UV-201, C-301	3.00 Ea.
UV-201-A, C-301-A	3.25 Ea.
UV-198, C-299	3.25 Ea.

All Tubes GUARANTEED and Returned P.P. C.O.D.
DEV'S RADIO SERVICE
Dist. E. 235 Pine Ave. Chicago, Ill.

ceiving outfit is of recent design, capable of functioning over a range of frequencies from 500 to 30,000 meters. A universal amplifier of six stages with telephone jacks for using either radio or audio alone in one or two stages is available.

The electric energy for operating the radio instruments is derived from a gasoline driven generator and in the event of an emergency, from a storage battery. This power unit furnishes current for lighting the airship as well as the operation of the radio apparatus. In the event of a breakdown of the generator, the storage battery is of sufficient capacity to operate the radio outfit for two hours.

The radio instruments are installed forward in the control car, shown in one of the accompanying photographs. The radio call letters will be the name of the airship, "ZR-1." The comparatively great height of the antenna—300 feet—should favor long distance work.

Any apparatus liable to sparking is gas tight as a safeguard against danger from spark ignition of any hydrogen-laden atmosphere that might concentrate about it dirigible.

The Bureau of Aeronautics of the Navy, in contemplation of the expedition of the airship to the North Pole, has tentatively outlined two possible routes for the trip. One suggestion is that the ship follow a course directly north from its hangar at Lakehurst, N. J., while the other route suggested would involve flying northwesterly to Alaska, using Nome as an advance base. From the latter point, the course would be 1,766 miles, a little over a day's journey by aircraft. The R-34, airship of Great Britain, crossed the Atlantic Ocean and returned to England in 1919, traversing a distance of 7,000 miles in seven days. A German Zeppelin made a cruise of 5,500 miles in four days. The cruising radius of the ZR-1 is approximately 5,000 miles, a factor which lends probability to a Polar expedition.

Navy Ship Sends and Receives Simultaneously

(Continued from page 1067)

Two 10-K.W. water-cooled tubes were used for transmitting the trans-continental messages covering a distance of some 3,000 miles on the wave of 1,430 meters. Incidentally, a low wave for this work compared with the 17,120-meter wave ordinarily employed by Annapolis for long distance work on the 500-K.W. arc set.

Standard Naval receiving sets with amplifiers developed by the U. S. Naval Research Laboratory were used in the tests. The Naval experts call the attention of broadcasters and listeners-in who say waves assigned to stations are many times too close to each other, to the fact that this vessel transmitted on 1,430 meters and received on 1,300 meters on almost adjacent antennae. Regular radio telegraph messages were used in the tests.

LEVIATHAN'S LIFE BOATS HAVE OWN CALLS

Two of the *Leviathan's* life boats, both 10-knot motor boats, have radio transmitting and receiving sets and calls of their own. Life boat No. 67 is "WSNA" in radio talk, and No. 68 is "WSNB". The *Leviathan's* own call is "WSN," her two tenders carrying an additional letter. This is a new departure in American shipping, planned as an additional sea safety precaution. If the *Leviathan's* radio apparatus should get out of order, or she should be sunk, her two motor boats could communicate for relief to ships within about 50 miles, guiding them to the scene.

SUPERTRAN

The Audio-Frequency Transformer that gives the highest possible amplification on all wave lengths without the slightest loss of tone quality and volume



The F.M.C. SUPERTRAN can be used with any amplifying tube on the market today with excellent results.

Price \$6.00

At your dealers or by mail (postpaid on receipt of purchase price). Write for our free literature.

Ford Mica Co., Inc.
14 Christopher St. New York



Send—NOW—for a

Brownie Airphone

Thoroughly practical—absolutely reliable, complete set that sells for less than any other high-class outfit made in America. Thousands in daily use.

Clear reception within 30-mile radius. No batteries or current required—will accommodate six receivers at a time.

\$7.50 complete — postpaid. Includes 1000-ohm receiver; 1 ultra-sensitive crystal; 100 ft. copper aerial wire; 25 ft. insulated lead-in wire; 30 ft. copper grounding wire; 2 porcelain insulators; directions for installing. Save time, money and useless experimenting. The *Brownie* answers every need. Mail your order today. Extra phones \$2.00 each.

Write for Dealer Proposition

RIVERO & COMPANY

GENERAL DISTRIBUTORS

806 Merchants Exchg. Bldg., San Francisco 11001

FREE

Complete Price List

AITKEN RADIO CO.
504 Superior St., Toledo, O.

You can be quickly cured, if you

STAMMER

Send 10 cents for 288-page book on Stammering and Stuttering. "Its Cause and Cure." It tells how I cured myself after stammering 20 yrs. B. N. Bogue, 895 Bogue Bldg., 1147 N. 111 St., Indianapolis

Melting Metal Without Fire in a Radio Furnace

(Continued from page 1066)

pleted furnace is mounted on a table which is also built of heavy asbestos board. This table is 20 by 36 inches in dimensions and stands to a height of 15 inches. The leads from the high-frequency converter are permanently connected to the metal pieces beneath the cover of the table. After the furnace has been placed upon the table, contact is formed with these metal pieces by two metal feet at the base of the furnace box.

This new type of electric furnace is capable of heating with marked rapidity. A crucible filled with graphite can be subjected to a temperature of 2,500 degrees Centigrade in a period of less than twenty minutes. Yet, with this degree of heat on the inside of the furnace the temperature on the outside is not likely to exceed 100 degrees Centigrade, a condition contributing to the operator's comfort.

C.W. and Radiophone Transmitters

(Continued from page 1086)

is to produce a greatly amplified speech voltage which conforms exactly to the variations at the microphone. (The high potential point of this audio frequency voltage is at A in Fig. 1.)

The object of this audio frequency voltage is to have it modulate the radio frequency oscillations produced by the oscillator. Let us suppose for an instant that the modulator tube is disconnected from the entire system leaving only the R. F. oscillator with a constant applied plate voltage. Under such conditions the R. F. oscillations generated are constant in amplitude as shown in Fig. 3. The amplitude, A, of the oscillations is proportional to the applied plate voltage. If the effective voltage on the plate of the oscillator tube changes, the amplitude of the R. F. oscillations also changes. When the modulator is connected in circuit and the microphone is actuated by voice waves, we saw that an alternating audio frequency voltage was generated across the choke coil L₁. Thus the audio frequency voltage due to the modulator is superimposed on the D. C. plate voltage on the oscillator plate. As a result, the effective voltage on the oscillator plate will be varied by the modulating A. F. voltage. When the modulating audio voltage is positive, it is added to the plate voltage, thus increasing the effective voltage on the oscillator plate and increasing the amplitude of the R. F. oscillations. When the modulating audio voltage is negative it is subtracted from the D. C. plate voltage, thus decreasing the effective voltage on the oscillator plate and decreasing the amplitude of the R. F. oscillations. In this way the amplitude of the R. F. oscillations is made to vary directly with the modulating audio voltage, which in turn takes its form from the voice impressions received by the microphone. (Fig. 4.)

The above outlines simply and fully the real actions which take place in the Heising modulator. Let us go back to the complete circuit of Fig. 1 to ascertain the functions of the different elements and the actual values of the different constants for a practical set. The design constants for the radio frequency oscillator have been given in previous articles. Data for the microphone and telephone transformer have also been given.

Establishing a New Horizon for Radio!

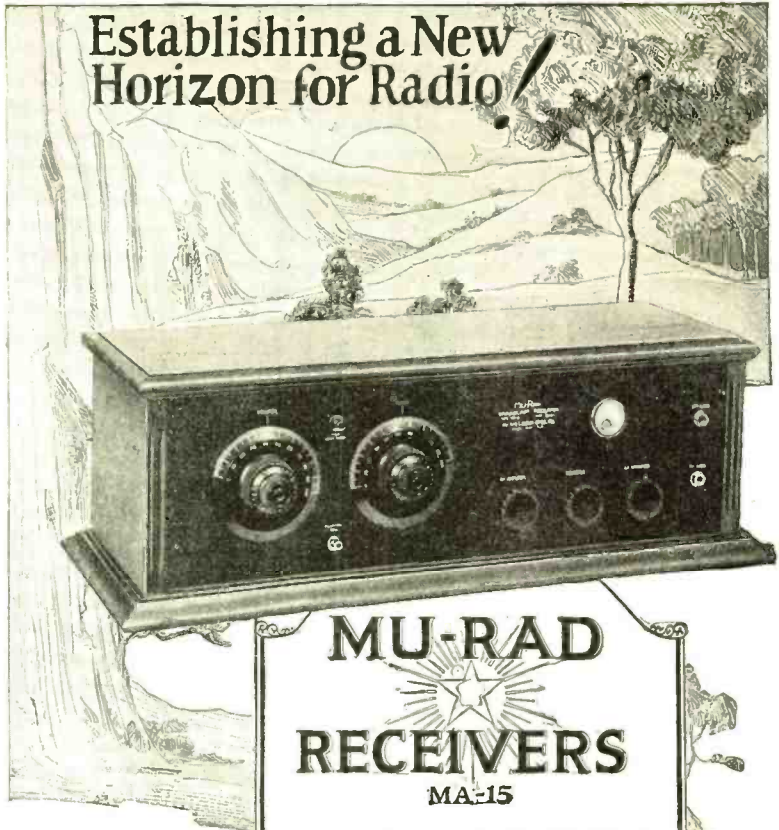

MU-RAD RECEIVERS MA-15

FROM the greater heights of this latest MU-RAD achievement, larger possibilities for radio entertainment are brought within your reach. The new MU-RAD RECEIVER MA-15, combining the famous MU-RAD simplicity of operation and selectivity, with loud speaker volume and clarity, is designed specifically for long ranges, with only a two foot loop. Well balanced appearance. Volt-meter for instant readings of "A" and "B" battery condition. Three stages of radio frequency amplification, with detector.

Guaranteed Reception—1000 Miles

MU-RAD LABORATORIES, INC.
801 FIFTH AVE. ASBURY PARK, NEW JERSEY

"3,000 mile"



RADIO "B" BATTERIES At Factory Prices

Greatest radio "B" battery on market. Full number voltage taps; Quality Guaranteed; Lowest Prices; brings in concerts Louder and Stronger; will work on any tube or loud speaker. Order by number TODAY with check, money order or pay postman C.O.D.
No. 422B 22½ volt variable, regularly \$2.25.....\$1.52
No. 422A 22½ volt variable, regularly \$3.00.....\$1.85
No. 445A 45 volt, 8 taps, regularly \$5.50.....\$3.25
AYRES BATTERY CORPORATION, Cincinnati, Ohio



New York's Leading RADIO EXPORTERS

Connections wherever Radio is Known
Exclusive Export Distributors for 25 leading American Radio Manufacturers. Wholesalers and Manufacturers abroad write for catalogs.

NATIONAL INDUSTRIES, INC.
154 NASSAU ST., NEW YORK, N. Y., U. S. A.

WANTED—Back numbers of Radio News, Dec., 1921, Jan. and Feb., March and April-May, 1922. Experimenter Publishing Co., 53 Park Place, New York City.

Every Question ANSWERED for only \$1

At last you have under one cover a Complete Radio Handbook



JUST OUT 514 PAGES

Compiled by **HARRY F. DART, B.S.E.E.**

Formerly with the Western Electric Co., and U. S. Army Instructor of Radio.

Technically Edited by **F. H. DOANE**

NO more need you turn from book to book, hoping to find what you want. It is all here, in 514 pages crammed full of every possible radio detail. Written in plain language, by engineers for laymen. Clears up the mysteries, tells you what you want to know. A complete index puts everything within your reach in a few seconds.

IT EXPLAINS: Electrical terms and circuits, antennas, batteries, generators and motors, electron (vacuum) tubes, every receiving hook-up, radio and audio frequency amplification, broadcast and commercial transmitters and receivers, super-regeneration, codes, license rules. Many other features.

Under one cover. Yes, it is all in one volume of 514 pages of clear type with hundreds of diagrams and illustrations. Takes the place of eleven or more specialized texts, each costing from two to ten times the dollar you pay for this single book. Belongs in every radio-equipped home, on every amateur's table.

Send \$1 to-day and get this 514-page I.C.S. Radio Handbook—the biggest value in radio to-day. Money back if not satisfied.

TEAR OUT HERE

INTERNATIONAL CORRESPONDENCE SCHOOLS
Box 8281-B, Scranton, Penna.

I enclose One Dollar. Please send me—post-paid—the 514-page I. C. S. Radio Handbook. It is understood that if I am not entirely satisfied I may return this book within five days and you will refund my money.

Name

Address

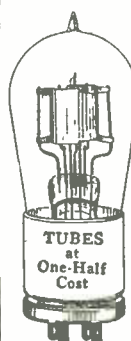

TUBES at One-Half Cost

GUARANTEED TUBE REPAIRS

W.D. 11\$3.50
W.D. 123.50
U.V. 2002.75
U.V. 2013.00
C.3002.75
C.3013.00
U.V. 201-A3.50
C.301-A3.50
D.V. 6-A3.50

All tubes positively guaranteed to be satisfactory.

Special discounts to dealers. Tubes returned P.P. C.O.D.

HARVARD RADIO LABORATORIES
200 & 204 Old Colony Ave.,
So. Boston, Mass.

(Part IV). In connection with the telephone transformer, T, it should be stated that too high a step-up ratio will produce poor speech quality. For a high step-up ratio, although it gives much higher grid voltages, results in large distributed capacity in the transformer which shunts the high speech frequencies producing distortions. A 10:1 ratio transformer will be found very good. The use of an open core transformer will avoid distortions due to saturation of

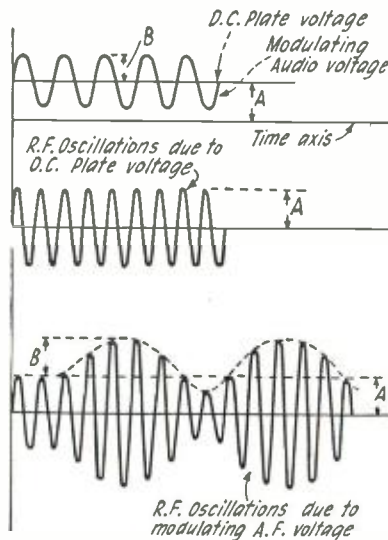

Fig. 4

Illustrating the Modulation of the R. F. Oscillations by the Modulating Audio Frequency Voltage.

the core by the direct current in the primary microphone circuit.

THE "C" BATTERY

In Fig. 1 it will be seen that a "C" battery is placed in series with the grid circuit to give the grid a negative potential. The "C" battery is always necessary in the modulator tube circuit of the Heising system if had distortion is to be avoided. The reason for this precaution will be evident from Fig. 5 which shows the grid voltage-plate current, and grid voltage-grid current characteristic curves. Suppose no negative voltage were applied to the grid. Its mean negative voltage is then zero. If an audio frequency voltage were applied to the grid of the modulator it would oscillate about the mean grid voltage point A as the operating point. The effect of this would be two-fold. First let us consider its effect on the plate voltage. Since the slope of the characteristic curve around point A is different at each point due to its varying curvature equal positive and negative voltages would produce unequal variations in plate current. Thus — 1 volt would produce say, a drop of 10 milliamperes

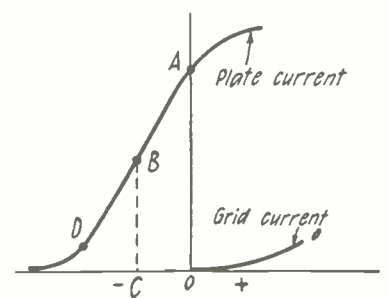

Fig. 5

By Employing a Negative Bias on the Grid, the Working Point on the Plate Current Curve is Skifted to B on Either Side of Which the Plate Current Changes Are Uniform.

New Model "B" HAMMARLUND



Patents Pending

Vernier Variable Condenser
SHARPEST TUNING — MINIMUM LOSSES
Will Increase Your Range and Volume—
Eliminates Interference

Description and test of this condenser appears in laboratory columns of this issue.

PRICES FOR PANEL MOUNTING

43 Plate .001 Mfd. . . \$7.00	17 Plate .00037 Mfd. \$5.75
23 Plate .0005 Mfd. \$6.00	13 Plate .00025 Mfd. \$5.50

3 1/2" pure Bakelite Jars \$2.75

At your dealers—otherwise send purchase price and you will be supplied postpaid. Write For New and Interesting Folder.

HAMMARLUND MFG. CO.

144-146 W. 18th St. New York City



100 Volt Panel Type

"The most popular in this vicinity—"

We wish to commend your storage "B" battery," says the Southern Radio Sales Co., Newport News, Va. Such endorsements come to us unsolicited. KIC-O Batteries always make good. Alkaline type, won't sulphate or buckle. Life unlimited. Not harmed by short-circuiting, overcharging, idleness. Panel switches give single cell variations. Recharges from any 110-volt A.C. line with small home rectifier. Charge lasts 3 to 6 months in detector circuit.

Cells	Volts	Price With plain panels
16	22	\$5.50
24	32	7.25
36	48	9.50
50	68	12.50
78	100	17.50
108	145	23.50

GUARANTEE Unmounted Rectifier \$1.00
Your money back on any Mounted Rectifier \$2.50
KIC-O Battery if not satisfied within 30 days. Write for full information on "A" and "B" Batteries.

KIMLEY ELECTRIC COMPANY, Inc.
2665 Main Street Buffalo, N. Y.

KIC-O Storage "B" Batteries

—long service, low cost

RADIO TUBE EXCHANGE

We Repair All Standard Makes of Tubes Including

W. D. 11 or W. D. 12\$3.50
U. V. 200 or C. 3003.75
U. V. 201 or C. 301\$3.00
U. V. 201A or C. 301A\$3.50
U. V. 199 or C. 299\$3.50
U. V. 202 or C. 302\$3.50
New 1 1/2 Volt Tubes\$4.00

All tubes guaranteed to do the work.

RADIO TUBE EXCHANGE

200 BROADWAY NEW YORK CITY, N. Y.
All Mail Orders Given Prompt Attention
Orders sent Parcel Post C. O. D.

RADIO WALL MAP 10c.
Up to date. Just off the Press. Shows call letters, location, wave length, and kilocycles of all radio broadcasting stations also American Relay divisions and radio districts. Complete with scale for measuring distances. Size 28x34 inches. Printed in three colors. Postpaid for a dime.
OZARKA, INC., 863 Washington Blvd., Chicago

in plate current, while + 1 volt would produce a rise of only 5 milliamperes in plate current. For true reproduction of speech equal voltage changes should produce equal plate current changes, which does not occur when we are operating with no grid bias. Furthermore when the grid voltage becomes positive there is a flow of grid current, while when the grid voltage is negative there is no flow of grid current. Thus a rectification effect is produced in the grid circuit which introduces still more distortion. The only way to eliminate this distortion is first, to operate on the straight portion of the characteristic curve so that equal grid voltage changes produce equal plate current changes, and second, to operate on such a point of characteristic that the effective grid voltage is never positive, thus avoiding the flow of grid current, and rectification. This is exactly the same principle that is used in supplying a "C" battery to audio amplifier tubes in receiving sets. Suppose we apply a negative grid potential so that the operating point is moved to point B, Fig. 5. Then it is seen that the characteristic curve is sensibly a straight line on either side of B, hence grid voltage changes will produce equal plate current changes, eliminating one of the causes for distortion. It will also be seen that if the audio frequency maximum amplitude is not greater than OC, Fig. 5, the effective grid voltage will never be positive, hence no grid current will flow and no rectification with its attendant distortion will be produced. It is possible, of course, that the audio frequency voltage at times may exceed the value of OC, thus producing grid current. By increasing the bias on the grid this effect can very easily be eliminated. There is little danger in moving the point of operation back along the line, though care should be taken that too much bias is not used. If the operating point on the characteristic curve is moved to point D, Fig. 5, all possibility of distortion due to grid current rectification is removed but it again introduces distortion due to unequal plate current changes for equal grid voltage variations. It is easily seen that the same effect is caused at point D as at point A. It is therefore essential to adjust by experiment the value of the grid bias until best results in speech quality are secured. In connecting the "C" battery it will be observed in Fig. 1 that it is connected to the filament or ground side. Never connect it to the grid as it may introduce harmful capacity effects, such as shunting high frequencies. Amateurs should make it a rule never to connect apparatus to the grid side of a tube if the connection may just as well be made on the ground side. Considerable trouble will be avoided if this simple rule is followed. The grid is the most sensitive terminal of the vacuum tube and should be disturbed as little as possible.

It is across the audio frequency choke coil, L_a , that the audio voltages are developed. Its value should be as great as possible theoretically for best results. Practically, however, it is not possible to make an infinitely large choke coil, but it is not necessary and may be harmful. If it is made too great, its distributed capacity may be so high that it will short circuit or by-pass all the higher speech frequency voltages and thus produce distortion. The reactance of the choke coil should be at least equal to the resistance of the modulator tube at all frequencies in the speech range. This means that if the internal resistance of the tube is 5,000 ohms the reactance of L_a should be 5,000 ohms at all frequencies between approximately 50 cycles and 5,000 cycles. Such a coil would therefore have to have an inductance of 20 henries. For amateur purposes this value is quite satisfactory, though if possible larger inductances (up to 40 or 50 henries) would be better. There would be no advantage gained in exceeding these upper limits.

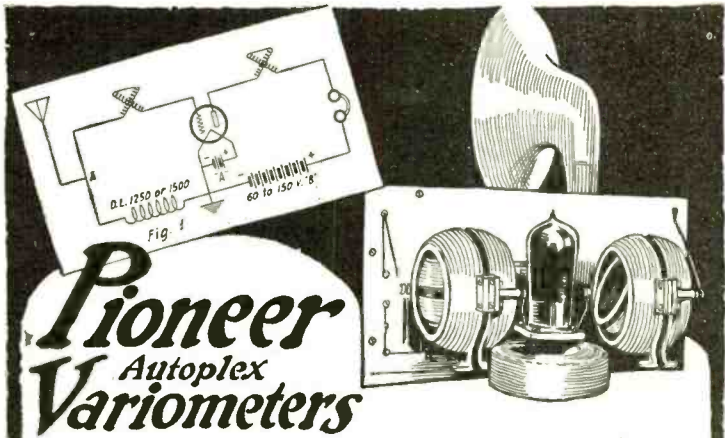

The One Tube Set that Works a Loudspeaker—

The autoplex circuit on account of its simple construction and unusual efficiency bids fair to become the most popular circuit. Here you have a simplified super regeneration with all of its increased power, but none of its difficult tuning characteristics.

Mr. Muhleman writing in "Radio News" on the Autoplex circuit issues this warning:—

"Of primary importance are the variometers. These should have a high ratio of inductance (for broadcast reception and preferably have the stator coils close to the Rotor coils. Variometers having the stator coils wound on the outside of the stator coils are poor for this work."

Pioneer Variometers have High ratio of inductance. Stator and Rotor coils close together—Stator coil wound on inside of form.

Wiring diagram and full particulars of this circuit mailed on request.

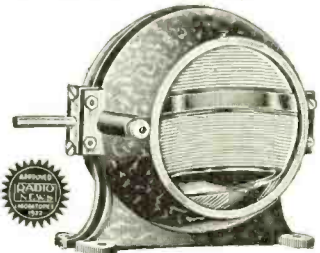

Pioneer Variometer
Price \$6.50

PIONEER  **RADIO CORPORATION**
101 Pioneer Ave. Galesburg, Illinois

RUSONITE

CRYSTAL RECTIFIER
(Patent Pending)
THE PERFECT SYNTHETIC CRYSTAL DETECTOR
SENSITIVE OVER ENTIRE SURFACE
No Hunting for "Spots." Loud and Clear.
Endorsed by Thousands of Satisfied Users.
Sensitivity Price
Guaranteed Mounted **50c**
14 K. Gold Supersensitive
RUSONITE CATWHISKER, Price **25c**
Permanent. Will not Oxidize.
RUSONITE REFLEX CRYSTAL
Manufactured Expressly for Reflex Circuits
Will Stand Up Under Heavy Plate Voltage
Guaranteed Mounted **\$1.00**
WATCH FOR OUR NEW FIXED CONDENSER
Order from your dealer or direct from
RUSONITE PRODUCTS CORP., 15 Park Row, New York

RADIO FANS

Frank D. Pearne, RADIO AUTHORITY, Says--
"The only reliable way to determine if "B" Batteries are still capable of service is by testing with a Voltmeter."

YOU NEED THIS

Indian Head **VOLTMETER** **\$1.50**
Tests B Batteries 0 to 50 Volts.
Guaranteed accurate Indian Head Ammeter at same price.
If your dealer can't supply you send money order to us. Also name of your favorite radio dealer.
Dealers and Jobbers. Send for attractive proposition, also list of other fast sellers with attractive discounts.
E. O. JACKSON & COMPANY
Dept. C 500 So. State St., Chicago, Ill.

Insure your copy reaching you each month. Subscribe to Radio News —\$2.50 a year. Experimenter Publishing Co., 53 Park Place, N. Y. C.



U. S. TOOL CONDENSERS

Plates Protected Against Oxidization

YOU can't SEE the difference between ordinary plates and the plates and spacers in U. S. Tool Condensers, but eventually ordinary plates and spacers oxidize, setting up a high resistance. Our chemists fought this deterioration of the plates with a counter-chemical treatment. Loss of efficiency prevented by Laminated Condensite-Celeron end plates. Reasons for the persistent efficiency of U. S. Tool Condensers. Unconditionally guaranteed.

Write for booklet.

U. S. TOOL COMPANY, Inc.
118 Mechanic St., Newark, N. J.



THE NEWEST SIMORE TOOL "Lightning-Change"



Radio fans will find this combination KNIFE and screwdriver a winner. A keen steel knife blade and two screwdriver blades in the handle—blades selected and produced by gravity instantly, the knife blade can never fold or turn and injure you, change blades in two seconds.

This Combination KNIFE and screwdriver will be sent you post prepaid for only \$2.25, check or money order. The only tool of its kind, ideal for radio fans, carpenters, motorists, and for household use. Order Today. Dealers are invited to write for proposition on this and other Simore tools.

\$2.25

THE SIMON & SKIDMORE MFG. CO.
Dept. 12-2 Santa Ana, Calif.

RADIO FREQUENCY CHOKE COILS

It will further be observed in Fig. 1 that there is a small inductance, L_s , connected between the plates of both modulator and oscillator tubes. This is a radio frequency choke coil whose function it is to prevent radio frequency from the oscillator tube backing into the modulator tube. It will be seen that both modulator and oscillator tubes are connected in parallel. The oscillator feeds a radio frequency circuit, and, since the modulator tube parallels the oscillator and R. F. circuit, it would also draw R. F. current from the oscillator. This is disadvantageous since it decreases the efficiency and output of the oscillator tube. To avoid this, a radio frequency choke coil is placed between modulator and oscillator tubes and the choke prevents the R. F. from backing into the modulator tube. This choke coil must be adjusted for different wave-lengths for best choking action. Single layer wound coils are best for low waves such as are employed by amateurs and the value of the coil should be between 1 and 3 millihenries, for wave-lengths between 100 and 300 meters.

Before closing this article a word should be said about the meaning and significance of degree of modulation and its bearing on the quality of radio telephonic transmission. If Fig. 4 is observed carefully it will be seen that the amplitude of the modulated wave varies from a low to a high value, below and above the value of the amplitude when no speech is transmitted. A is the amplitude of the R. F. oscillations when no speech is transmitted, which amplitude is proportional to the D. C. voltage on the plate. B is the amplitude of the audio frequency voltage which modulates the radio frequency. The larger the audio amplitude the greater is the degree of modulation. In fact the ratio of $\frac{B}{A}$

is a measure of the percentage of modulation. When B equals A the ratio of $\frac{B}{A}$

is unity and we have 100 per cent modulation. In this case the amplitude of the radio frequency oscillations varies from 0 to 2A. The advantage of a high degree of modulation is that more power is radiated. In fact the power transmitted is proportional to the product of AB, hence the larger B is, or the greater the degree of modulation, the greater will be the power transmitted.

MODULATION

It might seem, therefore, that it would be desirable to increase the percentage of modulation up to 100 per cent, or even make B greater, thereby increasing the modulation to over 100 per cent, called over-modulation. However, a careful analysis of the problem does not verify this conclusion. We are interested not only in securing maximum possible output from a radio telephone set, but also in transmitting intelligible speech. If the speech, which is transmitted, is so badly distorted that it is unintelligible, no matter how large our radiated power is, it will be useless. Quality considerations in the analysis show that if a sound having a frequency of f cycles per second is transmitted then due to the nature of our rectifying detectors, a sound having a frequency of f and $2f$ cycles per second will be received. In other words, a distortion has been introduced in the nature of a double frequency. For if we transmit a sound of f cycles we want to receive a sound of f cycles and not f and $2f$ cycles. When the number of frequencies transmitted is very great there will be a great number of double frequencies with considerable distortion. The smaller the double frequency distortion term the smaller will be the distortion.

RIGGS RECTIFIER R
\$12.50

Prepaid Anywhere in the U. S.

Money Back Guarantee
We guarantee the Type B-3 to please you. If it does not, return it and we will return your money.

THE RIGGS MFG. CO.
Eastern factory Urbana, Ohio
Western factory Everett, Wash.

GREWOL DETECTOR
Fixed Adjustment

Don't lose patience! There is a really efficient crystal detector — the GREWOL. Fixed on the most sensitive spot. Best for reflex circuits and crystal sets. Guaranteed not to burn out.

AT your dealer's or direct upon receipt of **\$2.00**

RANDEL WIRELESS COMPANY
11 Central Avenue
Newark, N. J.

COAST TO COAST ON ONE TUBE

E. MacDonald of Bangor Me., received Wenatchee, Wash., on 1 tube Royal Portable Broadcast Receiver. One dial control. Takes all wave lengths.

Complete parts, cabinet, instructions.....	\$ 7.95
Royal Portable 1 tube set assembled.....	10.00
Phones, batteries, tube, aerial, etc.....	extra 9.75
Autolox circuit complete—Tube Free.....	18.50
Cockaday — Reinartz — Ultra-Audion circuits, panel, complete parts—Tube Free with each.....	13.67
5 Tube ROYAL Neutrodyne (mounted).....	49.47
ROYALTRON tubes, guaranteed. Standard base	
1 1/2 volt detector or amp. 6 V. amp.....	3.95

Write for Catalog
ROYAL MANUFACTURING COMPANY
Dept. 25 World Building, New York City

Mathematical analysis shows that the value of the double frequency term is directly proportional to the degree of modulation. The greater the degree of modulation the greater is the distortion. Thus we see that high modulation and good quality are not consistent with one another. If you want a high degree of modulation you must sacrifice quality of transmission. On the other hand for good speech transmission you must sacrifice in degree of modulation. Good quality is the prime requisite of a radio telephone station, hence modulation should be kept within limits, 50 per cent being a good average value. The circuit given in Fig. 1 will give good quality and very low modulation generally. In order to obtain good quality with as much modulation as is consistent, it is necessary to build up the audio frequency voltages before modulation. This requires speech amplifiers. In the concluding article of this series, therefore, we will discuss the subject of speech amplifiers for radiophone transmitters, and will take up the general design of a complete radiophone system such as those employed in broadcast stations.

Remote Control of a High Power Radio Station
(Continued from page 1078)

from sudden short circuits or overloads. The plungers of these relays are opposed by the action of a small leather air bellows equipped with a small needle valve. The speed of rise of the plunger is governed by the adjustment of this valve. These relays have made it possible for the operators at the message centers in Washington to use the Arlington transmitter at any time without calling the station operators. When the message centers have finished, the transmitter automatically shuts off.

The detailed operation of these relays may be understood by reference to the wiring diagram (Fig. 2). When the remote control operator presses his hand key, RCO, the relay, R, is operated. When this relay is pulled away from its back contact, current is cut off from the filament delayed time relay, FDTR, which immediately closes its two contacts. One of these two contacts passes current to the primaries of the filament lighting transformers. The filaments light up. The second contact allows current to pass through the coil of the plate delayed time relay, PDTR, and the plunger PDTR is pulled up. This plunger does not come up immediately, being opposed by the air bellows, the needle gap being adjusted for a three-second rise. Only after the conical contact of PDTR is closed can current pass through the plate keying relay PKR and thus permitting voltage to be applied to the plates. Thus three seconds after the keying operator at the message center depresses his key he can hear the Arlington transmitter start. It is usual practice for the keying operator to wear headphones connected to a receiver tuned to the wave of his own sending stations so as to check up on his own sending.

As soon as he hears the transmitter start he can begin his message. As long as the keying operator continues sending messages, the relays FDTR and PDTR will remain in the position for sending because the relay FDTR is also provided with an air bellows and needle valve which prevents the plunger from coming up and opening the contacts for about fifteen seconds. If the remote control operator stops for more than fifteen seconds relay FDTR will open, causing PDTR to open in turn, thus shutting off the filaments and cutting off the plate supply. To start another message he must start his transmitter again by a preliminary depression of his key. Similar



Tests Prove It Best!

Below we print extracts from reports of tests made by experts under the most exacting conditions. These tests establish the indisputable superiority of the SAMSON HW-A1 Audio Frequency Transformer and place it first in efficiency from every desirable angle.

Results: Less Distributed Capacity; 40% More Amplification; No Distortion

Samson HW-A1 AUDIO FREQUENCY Transformer

EXPERTS marveled when they tested the SAMSON HW-A1 Audio Frequency Transformer. Never had they used an audio frequency transformer which gave them such remarkable results! One stage of amplification with a SAMSON proved far more satisfactory, in most cases, than two stages of some and better than three stages of other transformers. No howling.

You need the results which a SAMSON gets you. Insist on a SAMSON from your supply dealer; if he hasn't it we'll ship one, prepaid, on receipt of \$7.00. Ratio 6 to 1.

Helical Winding Does It

Here is the secret of SAMSON'S success. Note that the wire is laid in layers without paper insulation. This reduces distributed capacity to an absolute minimum, increases amplification, eliminates distortion. Helical Winding is exclusive with the SAMSON.



Made by
SAMSON ELECTRIC COMPANY
Factory: Canton, Mass.

Sales Offices: Boston, New York, Philadelphia, Pittsburgh, Chicago, Cleveland, Detroit, Indianapolis, St. Louis, Atlanta, Minneapolis, San Francisco, Los Angeles, Seattle, Portland, Montreal and Toronto.

1
"Amplification is very well maintained toward the lower end of the frequency band, in this particular improving on the performance of any other audio transformer. . . . Was agreeably surprised to find a transformer which would give such a characteristic and yet give the comparatively high amplification shown by the SAMSON."
(Name on request)

2
"Are pleased to inform you that a certificate of merit will be issued shortly. . . . As far as distortion is concerned, this instrument is much better than the average."
(Name on request)

3
"Our technical adviser states that the SAMSON HW-A1 Audio Frequency Transformer stood the highest test of any transformer ever tested in his laboratory."
(Name on request)

ONE THOUSAND AGENTS WANTED

WE want one thousand agents to sell subscriptions to RADIO NEWS, SCIENCE AND INVENTION and PRACTICAL ELECTRICS. We will pay a generous commission for this work and help you in every way. Our three publications arc leaders in their fields, ready sellers and this is an offer well worth your while. A few spare hours a day will bring you a handsome return. Write regarding our proposition at once and be the first one to get started in your vicinity.

Experimenter Publishing Co.,
HERBERT H. FOSTER, Sales Manager

53 Park Place

New York

Morrison



\$10.00 Complete

Loud Speaker

Enthusiastic

—is the only word that describes those radio critics who have chosen Morrison Loud Speaker. For them Radio has taken on new delights. Bright stars of the musical comedy stage, famous lecturers and singers—all are theirs no matter where they live—every night as long as they care to stay awake.

Real reproduction without annoying vibrations as soft or loud as you please—that describes Morrison attached to your phonograph tone arm or used with a horn.

\$10.00

That's all Morrison costs complete with 5 foot cord Nickel Plated Model

This perfect little loud speaker has no rivals. We assure you your money back if you don't like it.

Ask for descriptive two-color catalogue.

DEALERS:

Thousands of new radio fans have receiving sets—Christmas presents. Every one needs a Morrison Loud Speaker. We will show you how to merchandise Morrison. Ask us for our plan—at once.

Morrison Laboratories, Inc.

339 Jefferson Ave. East Detroit Mich

delayed time relays will start and stop the motor-generators. These latter relays must, of course, be adjusted for a longer time delay, say three or four minutes.

This complete automatic remote control system has been undergoing service test at Arlington for many months and is an unqualified success.

The Balanced Feed-Back Power Amplifier

(Continued from page 1083)

stages of amplification. This is accomplished in the circuit shown in Fig. 4. The input of transformer T1 is connected to the receiving set. The concert is amplified by the push-pull circuit and transferred to the secondary winding of transformer T2. This secondary winding is connected in the lead X in place of the transformer T3 shown in Fig. 3, and the tubes are operated in parallel to give still further amplification. The concert is reproduced in the loud speaker connected in the Y lead. A "B" battery of 120 volts and a "C" battery of 6 to 12 volts will be found approximately correct. An amplifier of this type is very stable and little difficulty should be experienced in building and operating one.

REVERSED ACTION

In Fig. 5 the action is reversed by first operating the two tubes in parallel and then push-pull fashion. The disadvantage of this circuit is that three transformers are required, which not only introduces more distortion, but makes the circuit unstable and difficult to adjust. The transformer T2 could be eliminated by using a loud talker with a center tap on its winding, but unfortunately there are none on the market today. The advantage of this circuit would be that the tubes are operated push-pull fashion on the last step and would give a minimum of distortion.

The transformer T3 is an ordinary iron core audio amplifying type, and one of low ratio is preferable. Experience with amplifying transformers shows that those having a low ratio cause less distortion than those having a high ratio. This is one reason why the quality of reproduction from push-pull amplifiers is so good. Many manufacturers simply tap the center windings of their standard transformers and make push-pull transformers of them. This cuts the ratio in two.

It is difficult to tap a transformer at the exact center of its winding, giving equal values of inductance on each side, but a well balanced push-pull transformer can be easily constructed by assembling two transformer windings, which are exactly alike, on one core. Such a transformer is shown in the reproduced photograph. This instrument gave excellent results and was made by assembling the two coils on two U-shaped cores which are butted together, the joints occurring inside of the coils. Straight steel strips pass through the center of each coil and core and hold the core together.

For the transformer T1, Fig. 4, two 6:1 ratio coils with their primaries connected in series are recommended. The two secondaries are also connected in series with a connection brought out for the center tap. It is important that the coils are placed on the core, as shown in the illustration, so that the two outside leads of the secondary coils are left free for the grid connections. The two inside leads form the center tap.

For the transformer T2, Fig. 4, the two secondaries of the 6:1 ratio coils are connected in parallel and the two primaries in series, with the two inside leads connected together forming the center tap. It may be necessary to reverse the secondary leads to



Quality Headsets

\$3.50 and \$5.00

Thousands of satisfied users of Radio Headsets made by us during the past 8 years, know their Quality. Let us tell you why we can make the following headsets at such a low price.

Cannon Ball, 2000 Ohms \$3.50
 Camco Grand, 3000 Ohms \$5.00
 Camco Loud Speaking Unit \$3.00

At your dealers or write

Cannon & Miller Sales Corp.
 47 W. Huron St., Buffalo, N. Y.
 Factory: Springwater, N. Y.

District Sales Offices
 Boston, 261 Franklin Street
 New York, 99 Chambers Street
 Chicago, 21 E. Van Buren Street
 St. Louis, 915 Olive Street.

Get this new **MURDOCK PLUG-JACK**

and you can connect four pairs of headphones to your Radio Set at one time—only \$1-



For 19 years **MURDOCK Radio Apparatus** has satisfied users the world over.

AT ALL RADIO DEALERS
 Or Sent Direct if Your Dealer Cannot Supply You.

WM. J. MURDOCK COMPANY
 344 Washington Ave., Chelsea, Mass.

KILLOCH HEAD SET
 2000 OHM \$3.25 POSTPAID IN U. S. A.
 Baldwin Head Set \$8.75 Postpaid in U. S. A.
 Send For Radio Catalogue

DAVID KILLOCH CO., 57 Murray St., N. Y. City

TELEGRAPHY

BOTH MORSE AND WIRELESS taught thoroughly. Big salaries; tremendous demand. Oldest, largest school. Endorsed by Telegraph, Railway, Wireless and Government officials. Expenses low—opportunities for large fortune. Catalogue FREE.

DODGE'S INSTITUTE, Mora Street, Valparaiso, Ind.

Write for free catalog illustrating and describing our complete line of 1500 Good Tools

GOODELL-PRATT COMPANY
 Toolsmiths
 Greenfield, Mass., U. S. A.

LEIGH ELECTRIC CO.
 Leitch Headphones, Non Tune Retainers, L-Radio Jacks and Plugs
 Write for complete Radio Bulletin 101-M.
 Genoa, Illinois.



Reduce Cost of Operating Your Radio Set

Pignolet Radio Voltmeter

is essential to satisfactory operation.

Write for booklet.

PIGNOLET INSTRUMENT CO., Inc.
 114 Liberty Street New York City

obtain best results. Usually the outside leads should connect to the grid.

Although the balanced feed-back system has not been tried out with radio frequency transformers as yet, there is no doubt that it will work, especially on the longer wave-lengths. Many modifications of the circuit may be made, such as using one stage of push-pull R.F. amplification, then using the tubes in parallel as a detector, and again as a push-pull A.F. amplifier. It may also be used in conjunction with super-heterodyne circuits.

Summarizing the Autoplex

(Continued from page 1083)

friends at Frankfort, Kansas. As they were very much interested in radio, I built a set, using this circuit and took it with me. This was my first experience with the hook-up and I was a bit doubtful as to the results I would obtain, especially after I learned that a number of people had been invited over to listen in. To my great surprise, however, the first station picked up was Chicago, Ill. It came in very clearly through the loud speaker. This was about 7:30 P. M. From that time on we enjoyed the evening immensely, listening to most everything that is broadcast by radio.

During the evening I picked up 27 stations. These were all brought in without amplification, just using the one tube and 90 volts of "B" battery. All stations were brought in over the loud speaker and heard plainly by everyone present. The loud speaker, by the way, was a small sized one. The following is a list of stations that were picked up during the evening of October 31.

WDAP, Chicago, Ill.; WJAZ, Chicago, Ill.; KYW, Chicago, Ill.; WGY, Schenectady, N. Y.; WEAU, Sioux City, Iowa; KDKA, Pittsburgh, Penn.; WHB, Kansas City, Mo.; KFI, Los Angeles, Cal.; KHI, Los Angeles, Cal.; WDAF, Kansas City, Mo.; (call not clear) St. John, Canada; WOS, Jefferson City, Mo.; WMIC, Memphis, Tenn.; WTAM, Cleveland, Ohio; WJAX, Cleveland, Ohio; KFKB, Milford, Kansas; WLAG, Minneapolis, Minn.; WFCK, Colorado Springs, Colo.; CFCN, Calgary, Canada; WOAM, Omaha, Neb.; WJAG, Norfolk, Neb.; WSAI, Cincinnati, Ohio; WSB, Atlanta, Ga. (Signed) C. C. Clancey, 532 Armstrong Avenue, Kansas City, Kansas.

Dear Sir:

I am pleased to report on the operation of the new Autoplex circuit which I built in one night.

Using two honeycomb variometers. I got 14 different stations in less than one hour's time, including KDKA, WDAP, WOAW, WLVW, and PWX.

For a single tube outfit, this circuit is a wonder in every respect.

(Signed) Dr. C. E. Crawford,

326½ West Main Street, Denison, Texas.

The above letters go to show that with the correct equipment and a good antenna or ground system, remarkable results can be obtained. It should be remembered that lumped capacity in the circuit is a detriment to its efficient operation. A lump capacity shunted across the large honeycomb coil will lower the frequency of this unit and thus increase its natural wave-length, but at the same time will increase the circuit noises considerably. If capacities of a value of approximately .00025 mfd. are connected across the variometers, the circuit will fail to oscillate at radio frequency and will thus make the receiver practically useless. The reason for this peculiarity is that the capacities provide a by-pass for the radio



**Balanced!
RADIO RECEIVER**

PERFECT radio reception, free of common difficulties, once a dark mystery—now an open book for the least adept—through the remarkable simplicity and efficiency of this "receiver without limitations."

Hitherto unattainable range, clearness and volume of reception now realized in the Eagle Neutrodyne Receiver by the perfect balance of tube capacities, as fine as that of a balance wheel. Causes of regeneration, reradiation, and body capacity entirely banished. Stations logged and always found at the same points on the dials. Operation as easy as playing a phonograph record. No skill, no knowledge of radio, no special care required. Each Eagle Neutrodyne Receiver individually tested by a neutrodyne expert. A national known reputation backs each set. Unreservedly guaranteed.

Licensed by Independent Radio Manufacturers, Inc., under Hazelton Patent No. 1,450,080. Dated March 27th, 1923, and other patents pending.

Write for Illustrated Booklet.



20 Boyden Place



*Balanced
as finely as
the Balance
Wheel of
Your Watch*

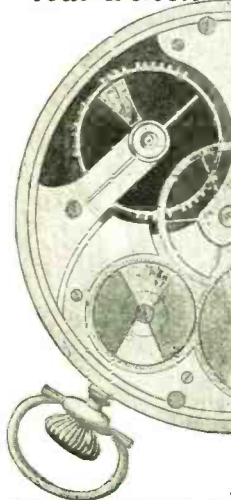

**ARE YOU GETTING
100% RESULTS
FROM YOUR
COCKADAY 4 Circuit Tuner?**

—IF NOT—HERE'S HOW—

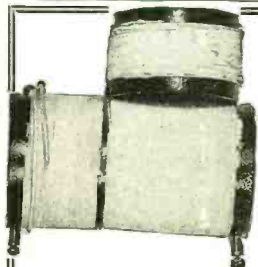

Correct hookup and correct construction coupled with the proper instruments are the only means of obtaining the wonderful results that this remarkable tuner is capable of producing. Get the original hookup and constructional data by Lawrence M. Cockaday, the inventor, together with price list on best instruments for perfect results. For a limited time only.

COCKADAY COILS A, B, C and D complete with diagrams, wound for the new high wave length Prepaid \$3.00
Special Cockaday Cam Vernier Condenser, 17 plate Prepaid 4.00

RADIO INSTRUMENTS COMPANY

17 North Wabash Avenue

Dept. 112

Chicago, Illinois

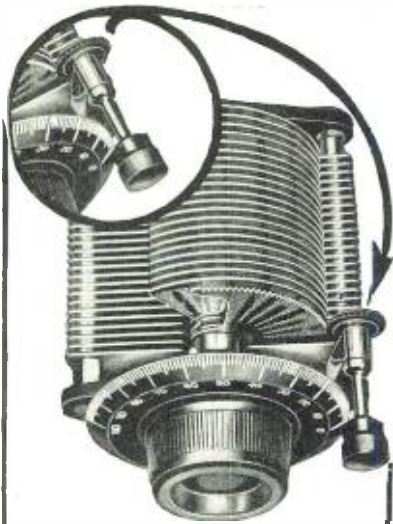

HEATH'S Radiant Condensers

When you put *Heath Radiant Condensers* behind a panel, you can forget about them. They will *always* tune as perfectly as the day you mounted them. Absolute alignment is permanent, because the plates are protected against warping and buckling by the *Heath* process of stamping and tempering. Each plate is **PERMANENTLY FLAT**.

Vernier with a Hairline Adjustment

Separate vernier adjustment—reducing gear meshed into teeth cut in rim of vernier plate. Ordinary adjustment reduced to infinite fineness. Absolutely positive adjustment—without backlash.

Write for illustrated booklet and name of the nearest Radiant Dealer.

LIST PRICES VERNIER TYPE

13 Plate including 2 1/2" dial and knob.....	\$5.00
25 Plate including 2 1/2" dial and knob.....	\$5.50
35 Plate including 2 1/2" dial and knob.....	\$6.50

Jobbers and Dealers
Write Immediately for Proposition

Heath Radio & Electric Mfg. Co.
206 First Street Newark, N. J.

Boyd's Radio Lists 19-21 Beekman St., New York City

10,293 Radio & Wireless Equipment and Supply Dealers and Jobbers, price \$50.00	
5,185 with estimated standing of \$5,000 or over, price	30.00
3,485 with estimated standing of \$50,000 or over, price	25.00
1,788 with estimated standing of \$100,000 or over, price	15.00
1,070 Radio & Wireless Apparatus Mfrs. & Assemblers, including Parts & Supply Mfrs.	7.50

The first mentioned list contains and indicates the restricted selections. Lists cover the United States, Typewritten. With street addresses. Also supplied for local territory, certain states or cities, etc. Send for General Price List giving state figures on Electrical Supply Dealers, Retail Hardware, General Stores and other handlers of Radio Equipment. Names of any class for all parts of the world. Addressing, Mailing, Typewriting, Fac-simile Letters.

frequency currents around the variometers. It is easily understood then that variometers having a high distributed capacity of their own will not be as effective in the circuit as variometers designed to have as little distributed capacity as possible.

In numerous cases, people have obtained long distance reception with the Autoplex, but have been unable to eliminate circuit noises. The following letters should be of interest in this instance.

Dear Sir:

I have constructed the Autoplex circuit described in the November issue of RADIO NEWS. After using it for several nights, I can say that with the exception of one thing it is a very efficient circuit. All stations received have come in loudly and distance seems to make no difference. I could get all of them about as well with ground alone, aerial alone or both. With a loop aerial I was able to receive some stations louder than when employing an outside aerial and ground together.

The one trouble was noise. It is a very loud sort of rushing sound that spoils the reception. I also noticed some body capacity effect. I am using two variometers, 1250 turn honeycomb coil and a UV-201A tube. The following is the list of stations that were received:

Pittsburgh, Pa.; Newark, N. J.; Davenport, Iowa; St. Louis, Mo.; Kansas City, Kansas; Louisville, Ky.; Wapaka, Wis.; Zion City, Ill.; Peoria, Ill.; Jefferson City, Mo.; Los Angeles, Cal.

(Signed) L. A. Tomlin,
222 West Market Street,
Havana, Ill.

Dear Sir:

I recently built an Autoplex receiver and although I am experiencing a bit of trouble with it, I have had some very good results. Following is a list of stations I have heard during the past week, using four feet of bell wire running from a water pipe to the antenna binding post.

WJY, WOR, WHN, KDKA, WSAI, WDAP, WGR, WMH, WJAX, WNAC, WSB, WAAN.

I am employing a 1250 honeycomb coil, UV-201A vacuum tube and a 90-volt "B" battery.

The trouble I am experiencing consists of some circuit noises; in some cases, I can hardly hear a station because of this.

(Signed) E. A. MacDonald,
602 East 36th Street,
New York City.

As mentioned in the first part of this article, failure to eliminate circuit noises is usually due to the inexperience of the operator; however, in the above cases it is, no doubt, due either to a run-down "B" battery, the characteristics of the vacuum tube used, or the physical characteristics of the antenna or ground system employed. If the vacuum tube is inclined to oscillate violently, the use of a rheostat in the filament circuit will allow for critical adjustment of the filament temperature and assist in cutting down the circuit noises. A 4 1/2- to 9-volt "C" battery in the grid circuit of the tube is also of great assistance. As explained before, a large capacity introduced across the honeycomb coil will increase circuit noises. Since a capacity exists between the receiving set and the ground and also between the collective agency, connected to the top binding post, and the ground, this represents a shunt capacity across the honeycomb coil. For this reason various aerial and ground systems should be tried, and it is usually best to employ aerials that have small surfaces.

We now come to the point of the wavelength range of the Autoplex receiver. In connection with this we publish the following letter:

Approved!



The Champ—VARIOMETER No. 53 Approved as a Record Breaker

Approved because perfectly constructed
Approved because it has a genuine mahogany stator and a kiln dried rotor
Approved because of Fahnstock spring clip connections and non-conductive adhesive
Approved because—you'll know why when you

GET ONE FOR \$3.50
20 Diagrams FREE With Each

For sale at your dealer's—otherwise send the \$3.50 directly to the manufacturer and you still be supplied postpaid.

G. H. FISCHER & CO.
123 Liberty St. New York City



LATTICE COIL Specialties

Plain Coils Variocouplers
Tapped Coils R.F. Transformers
Variometers Micro-Mike Condensers

Make that New Circuit
AUTO—MILO—or any other PLEX
TALK right Out Loud by
Using Quality Apparatus as supplied
under the ESTRU Trade Mark

Uni-Flex Parts Flexible Units Interchangeable for all Kinds of Circuits.

Write for Literature



Dept. R-11 2905 W. MADISON ST.

Vacuum Tubes Repaired

WD-11, WD-12, UV-201A, UV-199

and others for

\$3.00

Quick service. All tubes repaired by us guaranteed to work as good as new.

Send your dead tubes. We prepay parcel post to you. All you pay is \$3.00 to postman. We give 48 hour service.

THOMAS BROWN CO.

511-517 Orange Street Newark, N. J.

Dear Sir:

I have lately constructed the Autoplex receiver as described in the November issue of RADIO NEWS, and have obtained excellent results with same.

I used the hook-up shown on page 657. I received fair results with this, but I could not get a very high wave-length range. Using either a detector (22½ volts on the plate) or an amplifier (45 plate voltage) I received amateur signals very loudly, but I could not receive on a wave-length higher than that of KDKA. In an attempt to increase the wave-length of the set I hooked up a variable condenser across the phones. This did the trick and at the same time I could tune down to the short wave stations. The stations came in very loudly, but body capacity was quite noticeable in the grid variometer.

After I had learned to know the set, I tried one stage of audio frequency on it. That sure was the "berries." I received KDKA and other stations so loudly that they could be heard quite a distance from the phones. The amateurs came in as loud as the broadcasters.

Well, taking it all in all, it is a pretty good set and I would recommend it to anyone who wants an efficient broadcast or amateur wave receiver.

(Signed) Robert Waffle,
388 Park Avenue,
Fond du Lac, Wisconsin.

Mr. Waffle suggests one way of increasing the wave-length range of the Autoplex receiver. Another method which has proven to be quite satisfactory, is the use of a small vernier variable condenser connected across the grid and plate binding posts of the tube socket. This tends to increase the feed back from plate to the grid as well. If, however, the capacity is too large, the tube will cease to oscillate at radio frequency. The usual type of vernier condenser on the market will suffice for this purpose.

As to body capacity this is noticeable in any form of regenerative receiving circuit and can usually be eliminated by shielding the panel supporting the instruments or by the use of variometers in which the connections of the rotor coil are not made to the metal shaft. Even though the panel is shielded, body capacity effect is quite noticeable when employing variometers in which the shaft is a portion of the circuit as the hand of the operator and the metal shaft form the two plates of a condenser and the insulating portion of the knob the dielectric. Any change in the position of the operator's hand will naturally vary the capacity.

WLAG to be Central Calibrating Station

(Continued from page 1060)

been notified that WLAG has been selected by the U. S. Bureau of Standards as the Bureau's "Central" calibrating station.

WLAG was chosen as the result of a series of tests because of its power, central location and capability of being heard on both the Pacific and Atlantic coasts consistently. The Government started the calibrating work December 7, broadcasting standard signals all over the country so the 700 or more sending and hundreds of thousands of receiving stations may check up on their wave-lengths.

The eastern station designated by the Bureau as a calibrating station is KDKA, the Westinghouse Electric and Manufacturing Company's station at East Pittsburgh, Pa., which broadcasts to the Pacific coast with the aid of its relay station at Hastings, Neb. WLAG will pick up the Bureau of Standards signals at wave-lengths of 300 to 600 meters and as a single unit will broad-



Let Us Once and For All Time Settle This Question of Audio Amplification

Transformers, in order to give perfect audio amplification must have a characteristic curve as near to a straight line as possible.

United Audio Transformers have just such a curve as can be seen from the above chart.

A perfect audio transformer necessitates the best of core and winding design and construction.

In the United the best of core iron is used, a proper air gap is another reason for their perfect performance, and the winding construction and impedance further combine to make it the absolute best.

The winding ratio and shielding pre-

sent other items necessary to a perfect transformer.

The Good United Transformers have solved both questions in an admirable manner.

Last, but really first, a perfect audio transformer must give perfect practical results.

Recently, United Audio transformers came out FIRST in tests conducted by the University of California—conclusive proof that United is supreme.

Ask your dealers to show you these transformers, and other United efficient Radio parts. Variable Condensers, plain and Vernier, Audio and Radio Frequency Transformers, Radio Frequency Amplifier Units,

United Mfg. and Distributing Company

9701 Cottage Grove Ave., Chicago

New York Office, 50 Church St., New York, N. Y.

San Francisco Office, 709 Mission St., San Francisco, Cal.

UNITED TRANSFORMERS

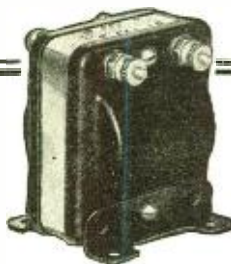

Type A-1
Ratio 5 to 1



Type A-2
Ratio 3.5 to 1

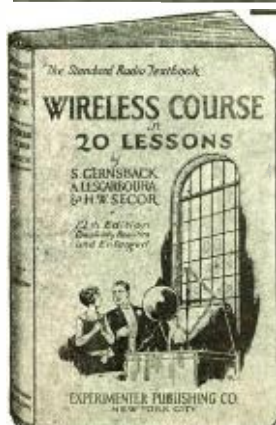

\$2.00 12th Edition \$2.00

WIRELESS COURSE IN 20 LESSONS

By S. GERNSBACK, A. LESCAUROU
and H. W. SECOR

The Standard Radio Text Book

Size 6 x 9 inches. 264 pages. 500 Illustrations. Binding de Luxe. Semi-flexible Leatherette Cover. Genuine Gold Stamped, Round Corners, Red Edges.

Experimenter Publishing Co.

53 Park Place

New York, N. Y.

DUTHO

Rechargeable Storage "B" BATTERIES

*Cost You Less
Last Longer*



\$5
6"x
2 3/4"
x 2 3/4"
Weight
2 1/4
lbs.

DUTHO 'B' Batteries eliminate all battery noise and internal action. This prevents distortion. Heavy, individual glass tubes permit visibility at all times and make surface discharge impossible. You can see when and how to "keep them up." Condensing chamber in each cell overcomes fumes and prevents spillage.

\$9 6"x2 3/4"x4 3/4"
Weight 4 1/2 lbs.



DUTHO Batteries are sold DRY CHARGED, with solution in separate container. Once filled your battery is fully charged, ready for immediate use. Ordinary care in following directions will make DUTHO 'B' Batteries last indefinitely. Thousands in use today.

DEALERS: Write for attractive proposition.

DURKEE-THOMAS PRODUCTS CO.
1228 Folsom Street
San Francisco

\$17 6"x2 3/4"x9".
Weight 8 3/4 lbs.

Chemical **\$1.95**
Rectifier

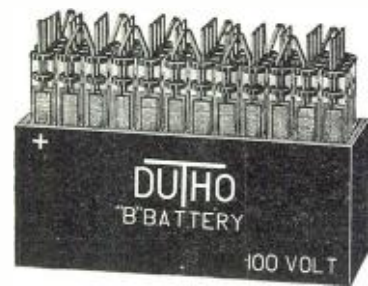

cast them to all corners of the country. Stations tuning in will be able to regulate their wave-lengths.

Government tests leading to the selection of WLAG, which broadcasts alternately from Minneapolis and St. Paul, shows that the station's wave-length, 417 meters, varies less than any of those tested. The station operates a 500-watt installation with motor generator set furnishing 1,600 volts. The entire plant is inspected daily and the wave-length is tested three times daily. WLAG has been heard at sea 450 miles west of Honolulu, in Europe, Cuba and Mexico.

Radio Trade Notes

(Continued from page 1089)

Associations of manufacturers and jobbers are reported busy on standardization work. Radio credits are slowly climbing out of the doubtful class and banks are beginning to recognize the permanency of the trade. Radio has arrived as a business and its growth can be expected to be steady and certain for many years.

The much advertised and rapid selling dry cell tube has not worked the great damage to the sale of wet cell radio batteries that was expected, if the sales records of the leading battery manufacturers of the country can be taken as a guide. A certain type of set will not work successfully or economically on the dry cell tubes, and many radio fans who originally used the dry cell tubes in their sets are changing over to the wet cell type.

The increased sale of the multi-tube set is also another factor that has aided in holding up the sale of the six-volt battery. Wet cell "B" batteries are also growing popular with many set owners. The charger business seems as steady as ever before.

All of this goes to prove that no change in radio apparatus, no matter how radical, can be expected to completely antique present apparatus. It will be a matter of several years before the demand for crystal sets will simmer down, according to experts who have gone over the business very carefully, while the six-volt tube seems as permanently established in favor as radio itself.

Fans can take this as an encouraging sign, and it is believed the little bit of history outlined above will greatly increase sales for retailers, as there still remain a great many who are "waiting until it is perfected."

While not properly a trade subject, one of the radio inspectors tells a story about a man who complained about the interference he got on his set every night. The inspector came back with a wail about his automobile. He shaved a man's fender, broke down a tree in his yard, and almost tore the door off the garage the first day he drove it.

When told that he must learn to operate a car first, the inspector turned the story around for the radio set owner.

The work of the radio inspectors of the United States in policing the air is very important to the trade, and it is hoped every reader of this article will join the movement to secure a greater appropriation for this force as the 53 employees in the field today are not sufficient to adequately perform the necessary police duties.

Statistics recently presented by one of the leading bodies in the electrical field pointed out that radio is today one of the leading lines in the electrical trade. A radio association in turn presented the argument that the electrical trade handles only a small part of the radio business. Radio as a merchandising business, is established today in

S. O. S. Battery Tester

Accurate, quick, and no figures to read. The Red, White and Green Balls tell the condition of your battery without removing tester from the acid. Float all three, charged fully. Sinks the White, charge is right. Sinks the Green, charge is lean. Sinks the Red, charge is dead.



A fellow stayed up out of bed
And scratched and scratched,
And scratched his head
He could get no D. X.
Till SINKOR SWIM put
him next
That charge in his
"A" was dead.



Shinkor Swim
The Chaslyn Bar

FIVE DOLLARS will be paid to any man or maid, who sends us in a rhyme we can use sometime in praise of SINKOR SWIM, the Battery Tester Trim.

\$1.00 Postpaid, anywhere in the world.

THE CHASLYN COMPANY
Dept. 1, 3845 Ravenswood Ave., CHICAGO

YOU DON'T NEED TUBES

to hear concerts from distant Cities.

YOUR CRYSTAL SET

will bring them in if you follow my instructions. You may already have all the parts you need and merely have it hooked up wrong. People using my plans hear Programs clearly from stations

400 TO 1000 MILES AWAY

No TUBES, Batteries or AMPLIFYING Apparatus required. My COPYRIGHTED instructions selling for \$1.00 are written so anyone can understand. They show you exactly how to fix the set. You have or make one like mine. Satisfaction Guaranteed or money refunded. Picture of my set and further particulars FREE. Write me today.

LEON LAMBERT

595 So. Volusia St.,

Wichita, Kansas

To the Radio Dealer

Let us explain how you can make the sale of our publications a worth while, well paying part of your business. Every one that enters your store is a prospective buyer of RADIO NEWS. RADIO NEWS will sell with little effort on your part.

You may sell our publications on a single copy basis with a fine margin of profit or on a subscription basis with a generous commission allowance.

Write now and prepare for the Fall and Winter trade.

Experimenter Publishing Co.,
53 Park Place New York

KEYSTONE

RADIO LIGHTNING ARRESTERS

Should be on every aerial the year 'round. Provides highly efficient lightning and static protection for the home. Fully approved by Fire Underwriters. Can be installed outdoors. Has no vacuum to lose. Install one in your aerial lead now—be safe.

This pioneer radio arrester is backed by 31 years' experience in lightning arrester design. For sale by Dealers everywhere, or sent post paid for \$2.00. Write for circular.

Electric Service Supplies Co
17 & Cambria Sts.
Philadelphia

Monadnock Bldg. Chicago
50 Church St. New York

the United States on such a firm foundation that it will take a great deal more than static next summer to cut sales down in any proportion.

All-year-round enjoyment of the radio set will be the theme of much advertising during the coming summer.

Radio's advantages are more and more being impressed upon the public with an increasing number of listeners being added daily to those who enjoy programs from broadcasters.

Radio business men are giving a great deal of serious consideration to the broadcasting situation. Committees from practically every trade body in the industry are working on plans for continuance of freedom of the air. How these plans will work out no one can say at this time, but it is felt that as soon as one broadcaster falls out in a strategic point another will come up to replace him.

Radio retailers assume a rather peculiar attitude towards broadcasting in that they often refuse support for the very broadcasters who are entertaining their customers. The general reply to requests for assistance is "when you quit we will take it up, but we don't feel like splitting the expense just now."

This seems a cold-blooded viewpoint, but the patent situation being considered, together with the fact that every radio organization today is doing a heavy business, brings this into another light. Radio broadcasting is shut down until the air is cleared, usually by some coastal Naval station. When one comes in, broadcasting is shut down until the air is cleared, usually by some coastal Naval station.

BROADCASTERS ALSO LISTEN-IN

Out of thousands who listen in on WRC, few know that WRC, as well as all broadcasters near the Coasts, also listens in constantly, not on its own "stuff," speaking informally, but for ships. As the law requires every hour of the day while the big Class B Station of the Radio Corporation in Washington is on the air, one operator is listening in on 600 meters, the ship emergency wave, for SOS calls. When one comes in, broadcasting is shut down until the air is cleared, usually by some coastal Naval station.

One Friday during the midnight show, the operator on watch at WRC heard an SOS from a ship off the coast of New York, and immediately pulled the switch, cutting off the power in the midst of a number by a local orchestra. Later, when NAA and NAO, Naval stations at New York and Charleston reported "all O.K.," WRC went on with her show. This was the third SOS call heard while the station was broadcasting, and shows the necessity of keeping a watch on the 600 meter wave. If broadcasting kept up during the transmission of distress calls, it is doubtful if the calls would get through or whether aid would be brought to the ship; the law requires, however, that coastal stations cease operation when an SOS call is heard.

CAPTAIN JACKSON HEAD OF NAVY RADIO

Captain Orton P. Jackson, U. S. N., has reported to Secretary Denby as Director of Naval Communications, taking the place recently vacated by Rear Admiral Ziegemeier, now in command at the Navy Yard, Norfolk, Va.

Commander Bingham, who has been acting director for several months, will remain as assistant director.

Captain Jackson was formerly in command of the battleship *Mississippi*.

MICHIGAN MIDGET

DETECTOR—\$27.

AMPLIFIER—\$30.



The Sensation of Radio

No matter what you pay, you can't get a receiving set that will give you any better results than the Michigan "Midget."

Distance—It has received in Grand Rapids, stations from coast to coast.

Selectivity—The smallest turn of the dial throws out or brings in stations.

Clearness—The clearness of the reception will surprise and please you.

The Cost—You could not build a set, buying the parts yourself, at anything like the price at which the Midget is sold.

- Made in these styles:
- M 10 Midget Detector\$27.00
 - M 11 Midget Amplifier\$30.00
 - M 12 Midget Detector and Amplifier in one case.....\$57.00

Ask your dealer to demonstrate this wonder to you.

Write us for illustrated folder.

MICHIGAN RADIO CORPORATION

GRAND RAPIDS, MICHIGAN

Send for DEALERS Catalog

HARRY ALTER'S "POCKETBOOK" is a monthly net price catalog of Radio, Electrical and Lighting supplies. All good dealers should have a copy—get on our mailing list now. No obligation. Use your letterhead.

HARRY ALTER & CO.
WE SELL WHOLESALE ONLY
100 DENVER BOULEVARD, CHICAGO

Why Pay More?

GENUINE R.C.A. TUBES
 W.D. 11 UV-199
 W.D. 12 \$5.95 UV-201A

ALL NEW, NO STAMPS, NO C.O.D.
 BALDWIN PHONES \$9.75
 Send for our New Price List with many other items.

Save Money By Buying From Us
CUT RATE RADIO CO.
 P. O. Box 472 Newark, N. J.

WANTED—Back numbers of Radio News, Dec., 1921, Jan. and Feb., March and April-May, 1922. Experimenter Publishing Co., 53 Park Place, New York City.

AN IMPROVEMENT IN SPEECH AMPLIFIERS

By H. A. HANKEY

In order to get distortionless amplification, two things are necessary. Firstly, the tube should be worked on the straight part of its characteristic curve; and secondly there should be no grid current. If the characteristic curve of an *K* tube is plotted it will be seen that if a low plate voltage of, say, 50 volts is used, the middle point of the straight part of the characteristic will correspond to a grid potential of some 8 volts positive, and that such a voltage causes an appreciable grid current flow. Should, however, the plate voltage be raised to 90 volts, the straight part of the characteristic is brought back approximately to the zero point of grid potential. A still further increase of voltage to 120 will move the middle point of the characteristic to the left, namely to about 3 volts negative. When this has been done, it is possible to put quite a small oscillation potential on the grid without the grid ever becoming positively charged and grid current flowing. This negative potential to the grid is of paramount importance if distortion is to be avoided. Of course it is possible to incorporate a dry cell battery in the grid of an amplifier, but this is not to be relied upon, and is incidentally inconvenient. Certainly it cannot be termed an engineering proposition.

The method of operation recommended, by which the grid potential is automatically maintained at the correct value, will be most

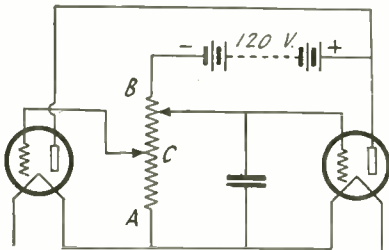

By Means of This Resistance Coupling Method, Distortion May Be Eliminated from Audio Frequency Amplifiers.

easily understood by reference to the simplified theoretical diagram above.

In the plate circuit is a resistance of *R* of 2,400 ohms, which is connected between the plate battery negative and the negative end of the filament. Taking the plate battery negative terminal as a fixed potential, there is a drop of potential right around the plate circuit from the plate battery positive, equal to the voltage of the plate battery. Thus while the end of *A* on the resistance is at the same potential as the filament negative, the other end *B* is at a potential lower than that of the filament negative. As the grid of the tube is connected to point *B* it follows that the grid is maintained at a negative potential relative to the filament negative, the amount of this negative potential being equal to the potential fall across *R* which depends on the currents flowing in the plate circuit. The grid of the first tube is connected to point *C* so that the value of the negative potential impressed on the grid is only one quarter of that on the grid of the second tube. Referring again to the characteristic curve of the receiving tube it is seen that as the plate voltage is increased, so the grid negative is increased, and this state of affairs is brought about automatically in the method described, thus each tube is worked at a point giving minimum distortion. In an actual instrument, the grids would be connected to the resistance via the secondaries of transformers and the resistance shunted by a 2 mfd. condenser.

Abstract from the "Electrician."

The FANSTEEL Balkite battery charger

PATENTS APPLIED FOR

FANSTEEL BALKITE

is a new metal developed for this charger. It acts as a valve, allowing current to flow into the battery but not out of it. It is the most efficient charger valve made, is practically indestructible, and does away with noisy, delicate vibrators and fragile bulbs.

The Gould Storage Battery Company is also marketing, under the Fansteel Balkite Patents, a complete battery and recharging unit known as the Gould Unipower, into which this charger, under the name, "The Fansteel Balkite Rectifier," has been incorporated.

The Fansteel Balkite Battery Charger will charge the ordinary 6 volt radio "A" or automobile storage battery at 3 amperes, from 110-120 AC, 60 cycle current. It comes complete and ready for use. Get it from your dealer, or use the coupon below.

Price, \$18
(\$18.50 West of the Rockies)

FANSTEEL PRODUCTS CO., Inc.
Dept. 10-A North Chicago, Illinois

Dealers and Jobbers: The Fansteel Balkite Battery Charger does away with complaints and replacement troubles. Write for literature and discounts.

Dept. FANSTEEL PRODUCTS CO., Inc., No. Chicago, Ill. Enclosed please find \$18. (\$18.50 west of the Rockies.) Send me the Fansteel Balkite Battery Charger for Radio 6 volt "A" Batteries. If I am not entirely satisfied I will return it and you will refund my money.

Name

Street

City State

\$6.50 TUBES \$5.43

GENUINE R. C. A. RADIOTRON—FIRSTS \$5.43
—In Original Packages—
UV-199 — UV-201A — WD11 — WD12

BRANDES "SUPERIOR PHONES"	\$4.86
BRANDES "TABLE TALKER"	7.98
BREMER TULLY VERNIER TUNER	3.97
3-AMP. TUNGAR TYPE BATTERY CHARGER	9.38
ERLA REFLEX OR AUDIO TRANSFORMERS	3.96
ALL AMERICAN TRANSFORMERS (All ratios)	3.82
"PACENT" NEW STYLE PHONES	3.12
COMO PUSH-PULL TRANSFORMERS (per pair)	9.87
0 to 50 POCKET VOLT-METER	1.12
"GOLD SEAL" HOMECHARGER	14.79
ACME AUDIO TRANSFORMERS	3.96
23-PLT. VERNIER CONDENSER, Knob & Dial	2.13
23-PLT. VARIABLE CONDENSER	1.17

Include Postage—Send for Complete List.

TRI-STATE RADIO SALES CO.
1806 Lafayette Ave. St. Louis, Mo.

Nath. Baldwin Phones with

SHELTONE
LOUD SPEAKER

COMPLETE \$10.00

Use your headset for two purposes. Exceptional combination value. Every pair of phones tested. Guaranteed to give results. Ideal Home loud speaker.

WALTER SCOTT
1157 E. Broad Street
Newark, N. J.

Get a Handy Binder for your RADIO NEWS. Holds and preserves six issues, each of which can be inserted or removed at will. Price 65c. Experimenter Pub. Co., Inc., Book Dept. 53 Park Place, N. Y.

New Hook-Ups Are Easy Now



To save hours of labor to get connections as solid as soldering, spin the radio nuts tight with

Stevens SPINTITE Wrenches

Hollow stem goes down over projecting screws. Hex socket secures a firm grip. Comfortable, ergonomized handle provides strong leverage and easy reach in difficult places. Approved by Radio News and Radio Broadcast—used by radio manufacturers.

Send \$1.00 for Set of 3 Radio Sizes

STEVENS & CO.
Toolsmiths since 1889
379 B'way, New York

Stevens SPEED UP Tools

Automobile Makes 27 Miles on Air

An automobile goes 27 miles on air by using an automatic device which was installed in less than 5 minutes. The automobile was only making 30 miles on a gallon of gasoline but after this remarkable invention was installed, it made better than 57. The inventor, Mr. J. A. Stransky, 599 Eleventh Street, Pukwana, South Dakota, wants agents and is willing to send a sample at his own risk. Write him today.—Adv.

LEARNING THE CODE

By L. C. BYGRADE

IT is well worth while for the possessor of a radio set to learn the code. Signals can be received at almost any time, and there is a constant interest and source of amusement in the endeavor to decipher these messages. There have been many systems devised from time to time to reduce the labor involved in learning the code. Merely to take a list of the code signals for the letters and to study it is an insufficient and uninteresting method of attacking the task.

It has often been recommended that a letter and its opposite should be learned at the same time, as for instance, N (— ·) is learned as the opposite of A (— —). This is not a good method, as there is quite enough confusion between similar letters, without deliberately associating them.

PREVIOUS METHODS

Another system is to have a sentence beginning with each letter and having long and short syllables representing the dashes and dots. Q may be given as an example, the sentence being "Queen cakes for sale," the two long, one short and one long syllables representing the sign — — · —. Some of the letters have not such good sentences, and when one is told to remember "Nury the boy" for X, and "Just all three fall" for J, it is time to look for something better. In any case the method is not satisfactory, as confusion arises, even when the sentence is remembered, regarding the division of the words into short and long syllables.

The alphabet has also been written so that each letter is formed of its sign, and in another arrangement words are used which give the clue to the signal of their initial letter. I do not think the last system has ever been published and it may be of interest to give a few examples. The initial letter does not form part of the sign, and the remaining letters are squat for a dot (such as a, c, m, o, and s) and tall for a dash (such as l, t, k, h, and d). Thus the word for B is Blare (— · · ·) D is Dhow (— · ·), H is Harem (· · · ·), F is Fists (· · · ·) and V is Viand (· · · ·).



The Saturn "Above the Ordinary" RADIO PRODUCTS

Automatic Plug

Phone cords connected, disconnected List in a moment. Pulling on cords automatically tightens grip, lever instantly releases. No taking apart or soldering. **\$1**

Perfect Jack

Easy soldering crowfoot off-set terminals with solder flux compound, nickel-plated rounded corner brass brackets, spring German silver blades and sterling silver contact points.

LIST PRICES

- No. 1 Single Circuit, Open50c.
- No. 2 Single Circuit, Closed55c.
- No. 3 Double Circuit, Closed70c.
- No. 4 Single Filament control75c.
- No. 5 Double Filament control80c.

Write for Folder

The SATURN Mfg. & Sales Co.

48 Beekman St.
New York, N. Y.

SHERMATRAN

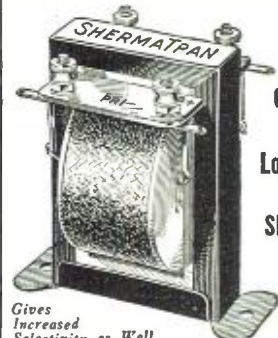

**One Stage
Operates
Loud Speaker
with a
ShermaTran**

Audio
Amplifying
Transformer
Type
AS-5

Gives Increased Selectivity as Well

As Regeneration. Maximum Amplification without Distortion. Similar Variable Audio Transformer gives a ratio from 2-1, to 15-1.

SHERMAN RADIO DISTRIBUTING CO.
112-114 TRINITY PLACE NEW YORK CITY

The RāBAT

a Rechargeable Wet 'B' Battery at Only \$3.96



A rechargeable wet "B" Radio battery built on strict storage battery principles. Yet it costs only a trifle more than an ordinary dry cell.

The Ohio Rabat at the low price of \$3.96 has 12 cells with a total of 24 volts and ample capacity. It is noiseless, fool-proof, and compactly constructed. Built on a solid rubber base. Small, but neat and efficient. All elements visible—No internal discharge—More economical—Longer life—Higher and more continuous voltage—Easily recharged at home with aid of inexpensive Rabat Rectifier. If your dealer cannot supply you send direct.

Rabat Rectifier for recharging, 75c

THE RADIO RABAT COMPANY
RUSSELL BUILDING Playhouse Square CLEVELAND, OHIO

12 CELLS The RāBAT 24 VOLTS

Build It Better—Quicker—Easier

With a JUNIOR BENCH SAW

Does your ripping, mitering, grooving, rabbeting, tenoning, sanding, grinding, and many other operations with surprising ease and accuracy. Top 10" x 12" stock. Dadoes 5/8" x 5/8". Machine built entirely of metal. Driven by 3/4 or 1 1/3 hp. motor. Portable. Attaches to any light socket. Extremely accurate.

Descriptive circular tells many things of interest to workers in wood and soft metals

W. & J. Boice, Dept. 802
1730 Norwood Ave., Toledo, Ohio

ARE YOU SELF-CONSCIOUS?

Embarrassed in company, lacking in self-control? Let me tell you how you can overcome these troubles. **M. VERITAS, 1400 Broadway, New York City**



Print Your Own

Cards, circulars, labels, book, paper. Press \$12. Complete in 1-2 months. Enter apprentice. No course free. Special limited offer for Big Free Catalog. Act NOW! Write factory for press catalog. TYPE, cards, etc. **THE PRESS CO., D-72 Meriden, Conn.**

Learn on \$200,000 equipment in great shops of Coyne. Complete in 1-2 months. Enter apprentice. No course free. Special limited offer for Big Free Catalog. Act NOW! **Coyne Electrical School Dept. 89-42**
1200-1212 W. Harrison St., Chicago, Ill.

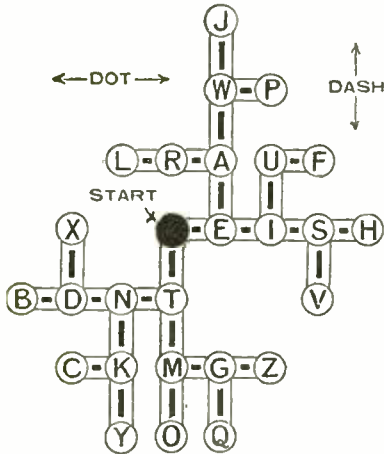

The Code May Easily Be Learned by Means of This Clever Chart.

These devices are ingenious, but they all have a common failing, especially for the wireless enthusiast, as the code is learned more from the sending than the receiving point of view. The letter is associated with the sign, instead of the sign being associated with the letter. It is more difficult to learn to receive than to send, and it is therefore better to approach the matter from the standpoint of the incoming signals.

It is always taught that one dot is E, two dots I, three dots S, and four dots are H, whilst T, M and O are a similar set for the dashes, but this is usually as far as the building up process is carried. The diagram shown herewith carries this method to a logical conclusion, and the way each letter is built up can be seen at a glance. Starting from the central black spot each move up or down indicates a dash, and each move to the right or left indicates a dot. For instance, for the signal - - - - one move down, two to the left and one up must be taken, thus arriving at X, which is the corresponding letter. By tracing incoming signals in this way it is possible to receive slowly with the aid of the diagram without knowing the code at all.

READING THE SIGNALS

To learn the code, the diagram should be carefully studied, the position of the letters and their connecting links being noted. Such

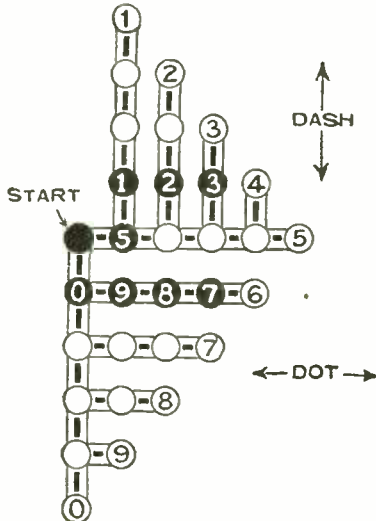

This Chart, Which is Similar to the One Shown Above, Permits Those Interested to Learn the Numerals as Sent in Continental Code.



O'NEIL AUDIPHONE

THE highest standard of music reproduction, the phonograph, now equalled by the O'NEIL AUDIPHONE. Designed and built on phonograph principles by phonograph craftsmen and radio-acoustic engineers. A radical improvement over the old ear-phone type of loud speaker. The entire voice or instrument is transmitted through the "laminated voice core." Diaphragm adjusted by exterior thumb screw. **Absolute "money-back-if-not-satisfied" guarantee on every O'Neil Audiphone.**

No extra batteries needed. Complete, with connecting cord.

\$25
Model in antique bronze
\$30

Should your dealer have none on hand, order direct, C. O. D., mentioning your dealer's name. Write for booklet.

Dealers, Jobbers, and Distributors:
Write for attractive proposition.

Note the similarity of construction between the phonograph reproducer (illustrated in the upper panel) and the reproducer of the O'Neil AUDIPHONE (below): both have a mica diaphragm set in a sound-box chamber and actuated by an elbow stylus bar—the principle of sound production is the same, resulting in perfect reproduction.

O'Neil Mfg. Co.

719 Palisade Ave., West New York, New Jersey.

One Thousand Agents Wanted

WE want one thousand agents to sell subscriptions to **RADIO NEWS, SCIENCE AND INVENTION** and **PRACTICAL ELECTRICS**. We will pay a generous commission for this work and help you in every way. Our three publications are leaders in their fields, ready sellers and this is an offer well worth your while. A few spare hours a day will bring you a handsome return. Write regarding our proposition at once and be the first one to get started in your vicinity.

EXPERIMENTER PUBLISHING CO.

HERBERT H. FORSTER, Sales Manager

53 PARK PLACE

NEW YORK

BRANSTON RADIO

**Branston
D. L.
Honey-
comb
Coils**



16 Sizes; Use the Combination that Gives the Wave Length You Desire



Study these coils and mountings carefully. Note sturdy, substantial, permanent construction and beautiful finish.

R-61 Three Coil Geared Type. Front Panel Mounting. Substantial Gears give vernier adjustment. Very neat appearance. Made of Genuine Bakelite, complete with flexible leads. **\$5.00**



R-62 Three Coil Bevel Geared Type. Back Panel Mounting. Bevel Gears provide very smooth operation and vernier adjustment. Made of Genuine Bakelite, complete with flexible leads. Arrow knob show position of coils **\$6.00**



R-73 Three Coil Bakelite Mounting. Neatest three coil mounting on the market. Made of Genuine Bakelite and complete with flexible leads. **\$4.50**

Licensed under DeForest Patents.

Send 2c Stamp for New Honeycomb's Coil Hookups



Compiled by experts and includes five good Honeycomb Cell "Hookups" and complete catalog of famous Branston Radio Apparatus. Write today. Give us name of your radio dealer. If he cannot supply you, write

CHAS. A. BRANSTON, INC.
817 Main St., Buffalo, N. Y.
In Canada—Chas. A. Branston, Ltd., Toronto

Look for this trade-mark card in your dealer's window or sales-room.

Manufacturers of Branston Violet Ray High Frequency Generators

TWO SUPERSENSITIVE CIRCUITS

(Both Copyrighted)

My Highly Improved Reinartz brings in all important stations on both coasts and Mexican border, loud, clear and without distortion. We dance to music from Atlanta received on one loud Baldwin unit. Build one of these wonderful sets from my blueprints and specifications, price 50c, or with a perfect and complete double wound spiderweb coil, \$3.00 by mail. No other windings used. Photo of my set on a glass panel with every order.

This copyrighted circuit is the most successful of any Reinartz modification yet produced, and is limited the most. Thousands are in use.

My **W. D. II Circuit** is especially designed for use with the "Pickle" tube and brings out the full value of that little tube as no other circuit can. Stations 1000 miles away come in clearly on one tube. This set is small, complete, portable. For the man who wishes the highest efficiency, this is the set to build. Price of blueprint and specifications, 50c, or with complete and perfect windings, \$3.00. Photo of set with every order. Sets built from these plans will receive all broadcasting stations operating under the new laws. Their wavelength range is from 170 to 800 meters.

AUXILIARY TUNER

This new instrument connected to your present receiving set with one wire enables you to easily bring in both the long and short wave stations which you cannot get with your present equipment. It also enables you to eliminate that local interference so you may listen to distant stations.

Copyrighted diagram and complete instructions for building and operating this instrument, 50c, or with all parts, including condenser, coils, switches, and panel, \$3.50. Complete instrument, \$15. All goods prepaid.

These instruments are easy to build, easy to operate. Everything clearly shown.

S. A. TWITCHELL

1927 Western Avenue Minneapolis, Minn.

groups as E I S H, A R L T M O, and N D B are easily remembered, and these comprise that half of the alphabet which is most used. The positions of the less used letters, such as J, P, X, Y, Q, and V must be particularly noted, as they are a little more difficult to remember. Then put the diagram aside and try to reproduce it with a pencil and a piece of paper, and you will be surprised to find that most of the letters can be placed. Compare with the original, note your mistakes and omissions, and try again. After a few times the diagram will be reproduced correctly and the code will have been learned! The numbers form a beautifully symmetrical diagram, as shown in the other figure, and are easily mastered.

In order to work up the speed of receiving (and some radio operators do get a move on) it is a great advantage if two people learn at the same time and practice sending to one another. An attempt should be made to send each individual letter fairly fast, with a good pause between each, so that the sound of each letter is learned as a whole, and when the naming of each letter can be done without effort, the pauses should be gradually reduced until high speed sending can be read. Excellent practice can also be had by using the phonograph records sold for that purpose. If a fellow learner, or the records, are not available, tune into some radio telegraph station that is sending almost continually and try to pick out a letter here and there, reducing the intervals after practice until the whole can be read.

There is usually no difficulty in getting spark signals at any time, even on a crystal, if the set can be tuned to 600 meters or so, but if a tube set is used with regeneration, a host of continuous wave stations can be received as well.

(Abstract from Popular Wireless Weekly.)

A SERIES-PARALLEL SWITCH FOR RADIO WORK

By DR. ALBERT NEUBURGER

It is often necessary to switch two elements connected in series to a parallel connection and vice versa. For an example, the antenna tuning condenser is connected in series with the antenna inductance if the receiving set is to respond to short waves, and in parallel with this coil for the reception of long waves. In variometers also, the two coils, movable one against the other, can be connected temporarily in parallel, or temporarily in series so that various wavelength ranges can be covered.

For all these purposes a series parallel switch is necessary. The remarkable feature of the throw switch constructed by Dr. Siegmund Loewe at Berlin-Friedenau and shown in the illustration is that only two contact plates are employed which necessitate only one upward and downward movement. By a clever use of the shaft as the switching device it is possible to perform series or parallel connections which heretofore have required bipolar switches.

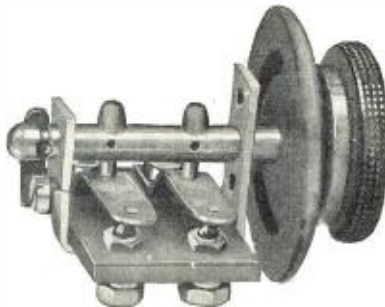

This Double Pole Double Throw Cam Switch Insures Good Contacts.

USE A C H SHARP TUNER DIALS



Why the A.C.H. is different

3 in. DIAL

156-10-1

4 in. DIAL

216-10-1

Tough tuning with dial one thousandth of an inch in either direction.

Price ACH 3" Dial complete.....\$2.50
Price ACH 4" Dial complete..... 5.00

Regular fitting 5/16" hole, 3/4" and 3/16". Bushings, 5c each extra. 10c for all.

ASK YOURSELF THIS:

Would W. S. Brooker, Alberta, Canada write and say "held Ft. Worth, Texas one hour steady, thanks to the ACH" and order another if he was not satisfied? To retain your good will you must be satisfied or money refunded. Ask for circular No. 6 on RV Loud Talker and Detector set. A wonderful set. All ready for you to put together.

A. C. HAYDEN RADIO & RESEARCH CO

Brockton, Mass., U. S. A.

Mail Orders Sent prepaid in U. S. A.

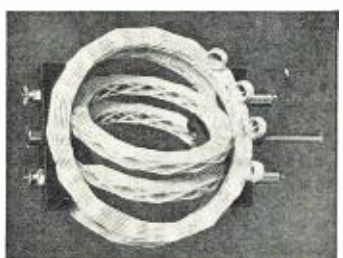

Diamond Weave Variocoupler an R-M-C Product

Seven-eighths of windings are in mid-air, thus reducing dielectric losses to a minimum. Diamond Weave construction reduces distributed capacity to a minimum.

The R. M. C. Variocoupler has a wave range of 150 to 600 meters. The Variometer is the same size and general construction as the variocoupler, and has a variance in inductance of 300 meters.

Outside diameter of primary windings is 3 1/4"; of secondary, 2 3/4"; extreme length 2 1/4". These R. M. C. products will greatly improve any circuit where a variometer or variocoupler can be used.

Variocoupler\$4.50

Variometer\$4.50

Write for catalog of other diamond weave coils, and Radio Frequency Transformer.

THE RADIO MANUFACTURING CO.
of Springfield, Massachusetts

Dept. A 97 Dwight Street

Here is your opportunity to SAVE MONEY

Write for our NET PRICE LIST of Radio Parts at lowest New York Prices. Sent FREE on request.

WORKSMAN RADIO SERVICE, Dept. N
14-16 Vesey Street New York, N. Y.

INTERFERENCE FROM SPARK STATIONS NOT PREVENTABLE AT RECEIVING END, SAYS PROFESSOR HAZELTINE

At a meeting of the Radio Club of America, held at Columbia University on November 23, a report on radio interference was submitted by a committee appointed for that purpose. This included a discussion which is of general interest to radio fans by Professor Hazeltine, of Stevens Institute of Technology, on the theory of interference. Professor Hazeltine's conclusion is that the nature of the radiation from spark stations makes it scientifically impossible to eliminate or even greatly reduce the interference which they cause, no matter what type of receiver is employed or what measures may be taken at the receiving end.

Although we are accustomed to thinking of radio waves as having a single wavelength, or a single frequency, this is not really the case. For signaling purposes, whether by telephone or telegraph, the radiating oscillation must be modulated, either by the voice or by a telegraph key, or by a tone source in addition to the key. All such modulation affects the oscillation by introducing components of other frequencies.

The simplest modulation would be that corresponding to a pure musical tone impressed on a telephone transmitter which controlled the intensity of the radiated oscillation. This gives three frequencies—the original "carrier" frequency and two "side" frequencies. For example, a 300-meter oscillator gives a carrier frequency of 1,000,000 cycles per second. If this is modulated by a pure tone having a pitch of 1,000 cycles per second, the result will be three waves having the frequencies 999,000, 1,000,000 and 1,001,000 cycles per second. The side frequencies are respectively the sum and the difference of the carrier frequency and the modulation frequency.

If the modulation is by a musical note which is not a simple tone—for example, if it is produced by a note from the violin—it will have a fundamental frequency and harmonics, which are multiple frequencies such as 1,000 for the fundamental and 2,000, 3,000, etc., for the harmonics. In this case there are two side frequencies radiated for each harmonic, such as 998,000 and 1,002,000 cycles, etc., for the second harmonic.

In radio telephone broadcasting musical notes above 5,000 cycles per second are not appreciable; so for a 1,000,000-cycle carrier wave all frequencies will be confined between 995,000 and 1,005,000 cycles per second, the extreme values being of relatively little importance.

In a spark telegraph station, on the other hand, the oscillation is produced in a series of groups and has a duration very small compared with the interval between groups. This is essentially equivalent to modulating a continuous wave by a variation in intensity which rises very rapidly to a maximum, then falls very rapidly, and is sensibly zero for a large portion of the cycle. Such a modulation curve is very rich in high harmonics. If the rate of increase of the oscillation is very high and the decrement is at the legal limit of 0.2, a wave which nominally has the frequency of 1,000,000 cycles will actually consist of waves having frequencies ranging from about 970,000 to 1,030,000 and having almost equal intensities. And in addition it will have waves having frequencies extending down to very low values and up to a few million cycles per second, with intensities which drop off only moderately rapidly.

Good radio receivers, no matter of what type, can and should be designed to receive a narrow band of frequencies. For broadcast reception this band should approach 5,000 cycles on either side of the carrier fre-

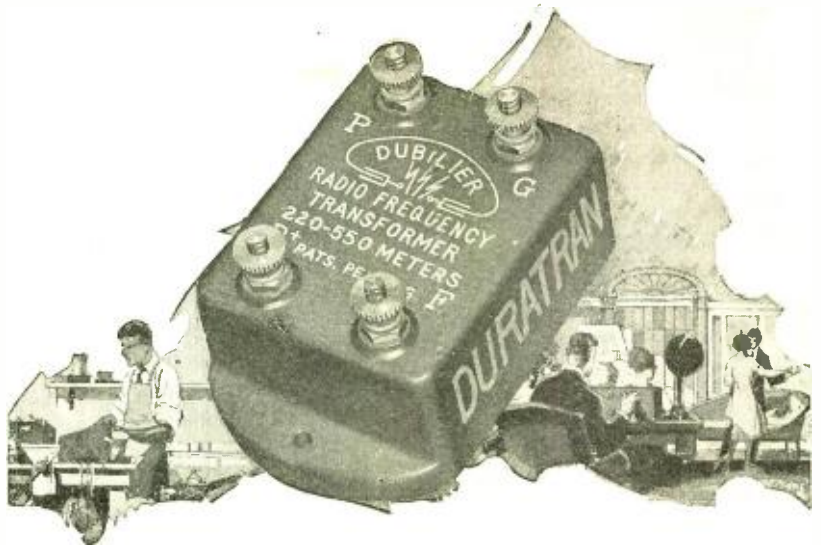

**The DUBILIER Duratran—
Radio Amplification on all Wave Lengths**

The Dubilier Duratran is the supreme radio-frequency transformer.

It amplifies powerfully and uniformly over all wave lengths now used by broadcasting stations.

Price, \$5.00. At all good dealers.

Address Dept. 22 for free booklet, which simply and accurately describes Radio Frequency amplification, with valuable hook-ups.

DUBILIER CONDENSER AND RADIO CORP.
48-50 West Fourth Street, New York City



Dubilier Micadon Fixed Condenser



Dubilier Ducon Socket Plug



Dubilier Variadon Variable Mica Condenser

**DUBILIER
DEVICES**

\$25.00 for \$10.00
FAMOUS
BEL-CANTO
LOUD SPEAKER
DIRECT FROM
FACTORY TO YOU
NO SALESMAN, NO DEALERS,
NO JOBBERS
\$10.00 SENT PREPAID
THE RADIO SENSATION OF THE YEAR
Send Money Order or pay postman \$10. C. O. D.,
delivered to your door.
GUARANTEE
We guarantee that each and every instrument is mechanically perfect and if found mechanically imperfect within one year we will replace it with a new one without charge of any kind.
BEL-CANTO MFG. CO.,
Bensel-Bonis, Inc., Dept. R. N.,
General Office and Factory
417-419-421 East 34th St., New York

USE ONLY
AMPERITE
THE SELF ADJUSTING RHEOSTAT
FOR AMPLIFYING TUBES
\$ 1.19 WITH MOUNTING
ELIMINATES
HAND RHEOSTATS
SAVES YOUR
TUBES
ASK
YOUR
DEALER
GIVES LOUDER
AND CLEARER
MUSIC
SIMPLIFIES
WIRING
GREATER
DISTANCE
A BATTERY
RADIALL CO. 320 WEST 42ND STREET
NEW YORK

How?

Can you expect good reception, no matter how expensive your set, if you haven't the right plug! Sounds strange—still the plug is the last link in perfect reception.

The ORIGINAL

COMSCO  COMSCO

AUTOMATIC BULL DOG GRIP PLUG

Licensed under Pat. Pend. Serial Nos. D3010 578540



Saves you from short circuits and battery kicks. No more burned out phones or ruined transformers. No more broken finger nails.

Simple to Operate

INSERT

By a single touch and the connecting tips of your phone cords accomplish automatically the most perfect electrical contact



RELEASE

By pressing the small knob and the tips will slide out easily without pulling the electrical contacts



For one pair phones \$1.00
For two pair phones \$1.50

For sale at your dealer. Otherwise send purchase price to us and you will be supplied.

GENERAL INSTRUMENT CORP.

123 LIBERTY ST.,
NEW YORK CITY

quency, giving, therefore, a width of the order of one per cent. This width is quite readily attained in the design of a receiver. A smaller width is suitable for C.W. telegraph reception, but it would result in some distortion in telephone reception. A greater width is useless in telephone reception, and increases interference and atmospheric disturbances.

The small width of telephone broadcast frequency bands permits the ready selection between stations, provided one of them is not too powerful. However, the very wide band of the spark telegraph waves makes it absolutely impossible for any receiving method to tune it out. The interference from such a station, as a rule, is not due to its nominal frequency, but rather to a frequency occurring in the side bands. Those who have used neutrodyne receivers, for example, have observed that a strong spark station can be tuned in almost anywhere on the dials, providing only that the three dials are set for the same frequencies. When the dials are set for different frequencies, usually the spark stations (and also atmospheric) are no longer heard. This is a direct proof that the interference is not caused by the nominal frequency of a spark station, but rather by one of its side frequencies.

It cannot be too strongly emphasized that the interference from spark stations is something which scientifically is impossible of elimination at the receiving end. It is also impossible of elimination at the transmitting end unless the rate of building up and dying out of the spark oscillation can be slowed down to correspond with the rates of amplitude variation in modulated continuous waves. Such a result, however, has not been attained by any form of spark oscillator. The solution of the problem of interference from transmitting stations, therefore, must be the substitution of continuous wave for spark transmitters. The pure continuous wave is by far the most preferable, as the modulation is at a low rate, corresponding to the keying. Modulated continuous waves, however, are not likely to be objectionable if the modulation is not abrupt in character.

HOOVER URGES GOVERNMENT RADIO POLICY AND LAWS

Reiterating his plea for radio legislation made last year, Secretary of Commerce Hoover explains the present radio situation in his annual report and urges Congress to designate someone to handle radio regulation.

"The rapid growth of radio communication make necessary an affirmative declaration by Congress of a governmental policy along whose lines radio is to be conducted, and the empowering of some agency to carry that policy into effect," the Secretary states. "This can only be done through an officer with discretionary powers and under regulations made by him to carry out the general terms of the law," he adds, commanding the matter to the attention of Congress.

Work of revising and simplifying the White Bill, which passed the House last session, is known to be under way, and Secretary Hoover believes no opposition will be found when the new bill is presented. Radio regulation is now under his direction and it is known that Mr. Hoover is greatly interested in its development.

The report states that facilities for the enforcement of the present law are wholly inadequate. There are some 25,000 stations now sending radio messages within our country or along our coasts. The law requires the inspection of all these stations, and it is known that Mr. Hoover is greatly interested in its development.

WHY PAY MORE?



RECHARGEABLE
50 Volts \$5.50
75 Volts \$7.75
100 Volts \$10.00
125 Volts \$12.50

Recharge from any 110 volt A.C. line with small home rectifier. Shipped fully charged and ready for use after adding acid. Will last for years with ordinary care.

SERVICE "A" BATTERY



6 Volt \$14.00
80-100 Amps
6 Volt \$16.00
100-120 Amps

2 YEAR GUARANTEE
INDESTRUCTIBLE
RUBBER CASE

SERVICE BATTERY CO.

704 East 102nd St., Cleveland, Ohio

RADIO BARGAINS

REAL VALUES and the best of Merchandise. OUR PRODUCTS ARE GUARANTEED. We enable you to keep the cost of the building and upkeep of your set at the lowest figures and offer you only the most scientific and reliable products.

SAVE ON RADIO

- Variocoupler—180° Bakelite tubing, green silk wire \$2.85
- Moulded Variometer, green silk wire, special 3.45
- Variocoupler—180° Jaco special 1.45
- Variometer—180° Jaco special 1.45
- Vernier Condenser, 23 plate 3.25
- Tricoil Reflex Transformer (Sencify tube used) 1.85
- United Audio Frequency Transformer, 5 to 1 ratio 3.45
- Magnavox Loud Speaker 29.75
- Head Phones, Long Distance 4.95
- 22 1/2 Volt B Battery 1.45
- Phone Plug, Special .75
- UV 199 Sockets .09
- Electric Soldering Iron 2.45
- Rheostat 6, 20 or 40 ohm special .48
- Potentiometer, 2000 or 4000 ohm .59

We offer this extraordinary opportunity to buy your radio supplies at unheard of prices. Take immediate advantage by ordering TODAY. Send money order cash or check.

JACKSON RADIO COMPANY

Dept. 23, 639 W. North Ave., Chicago, Ill.
For other bargains, write for our RADIO BULLETIN

ATOMITE FOR **CRYSTAL POWER VOLUME**

LOUD EVERYWHERE. A SIZABLE CHUNK—SENSITIVE ALL OVER. ATTRACTIVELY MOUNTED.

PRICE 50c POSTPAID

NION PRICE \$1.00 POSTPAID

FIXED DETECTORS—ARE LOUD AND CLEAR.

NICKEL PLATED Especially Adapted for REFLEX DURABLE
PAT. APPLIED FOR

THE KEYSTONE PRODUCTS CO.
168 Gardena Avenue, ROYAL OAK, MICHIGAN

Code Instructions That Instruct Only \$2.00. Students now licensed mastered Code 15 Minutes. Ten word speed 3 Hours. Information free. Dodge Radio Shortcut. Dept. N. Mamaroneck, N. Y.

TO THE RADIO DEALER

Let us explain how you can make the sale of our publications a worth while, well paying part of your business. Every one that enters your store is a prospective buyer of RADIO NEWS. RADIO NEWS will sell with little effort on your part.

You may sell our publications on a single copy basis with a fine margin of profit or on a subscription basis with a generous commission allowance.

Write now and prepare for the Fall and Winter trade.

EXPERIMENTER PUBLISHING CO.,

53 Park Place, New York

quency. To inspect these 25,000 stations the department now has a total of 29 men, all that can be employed within the limits of the appropriation. Obviously, under such conditions effective inspection is impossible.

"To perform satisfactorily the constantly increasing duties in this branch of the service, it is essential that a larger appropriation be provided," Mr. Hoover points out. "Such work as the inspection of ship stations for the safety of life, the inspection of broadcast stations to prevent interference, and the inspection of amateur stations to prevent interference with the broadcast listeners and with commercial and ship stations, are some of the important duties which should not be neglected."

In order to secure the most successful and extended use of radio in the future, legislative action along lines recommended to Congress last year is essential, the report continues. It is becoming more difficult each year to apply the existing law of 1912 to services which not only did not exist, but were not contemplated at the time the law was formulated. For the purpose of considering what should be done from an administrative point of view to lessen the amount of interference in radio broadcasting, the Secretary called a second radio conference which met in Washington on March 20 last. As far as practicable, the recommendations offered by the conferees have been put into effect with encouraging results. Much interference has been eliminated through these improvements.

Of the many services performed by radio, unquestionably the Marine Service is the most valuable, since it is employed as a life-saving device to summon aid in the event of an accident at sea. The radio inspectors of the Department of Commerce are required to give first consideration to the inspection of radio installations on American and foreign vessels clearing from our ports. During the fiscal year 1923 there were 11,298 such clearances and 6,936 inspections, as compared with 10,240 clearances and 6,071 inspections in 1922. The number of inspections should be increased, it is shown, but to do this, additional men are needed at ports not now covered.

PERMANENCY IN BROADCASTING SEEN

Radio broadcasting continues to hold the interest of the public in this country and is to a limited extent gaining recognition in other countries. The United States had 573 broadcasting stations on June 30, as compared with 382 a year ago. In foreign countries there are but 61, Canada having 30 of these.

The permanency of this means of disseminating news, entertainment and instruction seems assured, according to officials. It is not reasonable to expect a continuation of the rapid growth of broadcasting stations. Improved apparatus, greater care in providing high-class programs and closer supervision by the radio inspection service to minimize the interference should, however, guarantee a continued growth in the audience.

There is no abatement in amateur activity, according to the Secretary's report. The number of licensed amateur transmitting stations increased from 15,504 in 1922 to 16,370 on June 30, 1923. Serious effort is being made by the amateurs to improve their apparatus so as to reduce interference and increase the efficiency of their stations. Annually these experimenters conduct trans-Atlantic tests with European amateurs. The last test was in December, 1922, when 315 were successful in getting their signals across to Great Britain, France and Switzerland.

"Few realize the importance of our amateur auxiliary communication system which can be put into immediate operation and temporarily provide a means for dispatching trains, giving flood warnings, and trans-

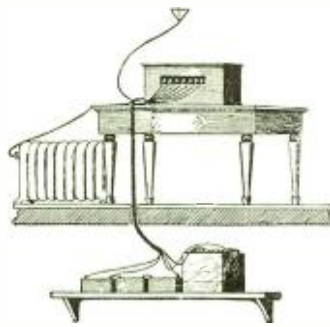

(Pat. Applied For)

batteries, etc., connected to the cable and plug. Thus several sets can be tested one right after the other and instant connection made.

Dealers can connect several Binding Post Sockets to various models and use one set of batteries, etc. A simple quick connection can be made and the prospect given demonstration of several sets, without disconnecting and reconnecting batteries, etc., to the Binding Posts of each set.



(Pat. Applied For)

In house use, batteries can be placed in cellar and small hole drilled through floor for cable—the length and size of wire is designed so no efficiency in current is lost.

Plug and socket are so constructed they will not fit except in proper positions.

Manufacturers will find this a big selling help. This plug and socket (panel mounting) has been adopted as standard equipment by several leading set manufacturers.

PRICES

Panel Mounting Type	\$4.00
(Templet for drilling panel furnished)	
Binding Post Type	5.00
Extra Binding Post Ends for set, each	1.80
Extra Panel Mountings, each80

Write for illustrated folder.

Condenser Cleaner

From your dealer10c.
Postpaid from us12c



(Pat. Applied For)

It gets between the plates and cleans, without bending the plates. 24 on a card.

Fiddle Stick

From your dealer10c.
Postpaid from us12c.



(Pat. Applied For)

The vernier tuning that eliminates body capacity. 24 on a card.

HOWARD B. JONES

612 So. Canal St., Chicago

MARVEL SPECIALS!

NEUTRODYNE PARTS Genuine, 5 Tube.....	\$50.15
\$30.00 MUSIC MASTER Loud Speaker	24.50
\$18.50 Homecharger Gold Seal, A.C. current.....	14.95
\$7.00 Pioneer Bakelite Moulded Variocouplers.....	4.95
\$6.50 Pioneer Bakelite Moulded Variometers.....	4.85
\$1.75 22½ Volt B Batteries, small.....	.75
\$3.00 22½ Volt B Batteries, large.....	1.45
\$4.75 45 Volt B Batteries, medium.....	2.00
\$5.50 45 Volt B Batteries, large.....	2.90
\$5.00 ACME AUDIO & RADIO Free. Trans.....	3.95
W. D. 12 and U. V. 199 Transformers, high ratio.....	3.25
\$2.00 Tri-Coil R. F. Reflex Trans. state tube used.....	1.75
\$6.00 Brandes Superior Phones	5.25
AMSCO VERNIER CONDENSERS	
13 plate—\$2.65 23 plate—\$3.50; 43 plate.....	4.00
Merchandise guaranteed by manufacturers. Remittances Must include Postage. Send for our Free Monthly Price List.	
DEPT. R. N. 5	

MARVEL RADIO SPECIALTY CO.
132 Nassau St., New York City

WE REPAIR SAME AS NEW



W. D. 11 or W. D. 12.....	\$3.50
U. V. 200 or C. 300	\$3.25
U. V. 201 or C. 301	\$3.35
U. V. 201a or C. 301a	\$3.50
U. V. 199 or C. 299.....	\$3.60
U. V. 202 or C. 302.....	\$4.00

and give you a WRITTEN GUARANTEE
Mail us a burnt-out tube—order any type repaired tube.
Rebuilt Tubes For Sale.
Orders Sent Parcel Post C.O.D.

Radio Tube Laboratories
3570 Olive St., St. Louis, Mo.

WANTED—Back numbers of Radio News, Dec., 1921, Jan. and Feb., 1922. Experimenter Publishing Co., 53 Park Place, New York City.



DESIGNED ESPECIALLY FOR RADIO RECEIVING

We are Manufacturers of Fine Furniture and we sell direct to you with only a small factory profit.

A handsome hardwood hand-rubbed mahogany or golden oak finished Radio Table. Size of top 20x34 inches x 31 inches high.

Conceals A and B batteries. Small drawer holds tools and accessories.

PRICE, FREIGHT PAID, East of Mississippi River \$18.00
 FREIGHT PAID to Rocky Mt. States 20.00
 FREIGHT PAID to Pacific States 22.50

Cash with order. We have prepared a large stock and can ship tables and cabinets immediately.

CABINET PRICES REDUCED!

Hardwood, hand-rubbed mahogany finish. Hinged top.

Panel Size	Depth	Price
6 x 7 in.	7 in.	\$2.25
6 x 10 1/2 in.	7 in.	2.50
6 x 14 in.	7 in.	3.00
6 x 21 in.	10 in.	3.75
7 x 18 in.	10 in.	3.60
9 x 14 in.	10 in.	3.50
12 x 14 in.	10 in.	4.00

POSTPAID, East of Mississippi River.

POSTPAID to Rocky Mt. states, add 25 cents.

POSTPAID to Pacific states, add 50 cents.

Cash with order.

Send for Free Catalogue of Radio Furniture

THE SOUTHERN TOY CO.
 HICKORY, NORTH CAROLINA

mitting emergency messages to and from sections temporarily deprived of wire facilities," it is stated.

Radio communication is assuming a place of the first importance in the electrical field, and naturally a large part of the time of the Bureau of Standards, Electrical Division, has been devoted to radio subjects. The Bureau is endeavoring to aid in the commercial standardization of radio equipment, a progressive step of great importance. Progress has been made in the development of precise frequency measurements and other investigations connected with the reduction of interference. The work on vacuum tubes and insulating materials will have a most important industrial application. Estimates of expenses for radio work at the Bureau next year call for \$81,040, an increase of \$15,000 over the 1924 appropriations.

SMOKE CONSUMERS CAUSE INTERFERENCE

Radio fans have complained about practically every kind of interference, but lately a new form of electrical emissions making local radio reception difficult has been called to the attention of the radio officials of the Department of Commerce. Complaints against plants using the Cottrell electrical smoke precipitation system have come from fans in Pennsylvania, Arizona and Montana.

Several letters received state that the factories using this high-frequency method of consuming and purifying smoke cause electrical disturbances which interfere with regular radio messages and broadcasting within a radius of about 20 miles. A very noticeable hum is sent out into the atmosphere by the precipitation. There is no law against interference from this sort of inadvertent transmission, and the Department of Commerce has merely called the attention of the offending plants to the disturbance they were creating.

Steps taken by a company to prevent the hum in their Arizona plant have been satisfactory, it is said, and other plant owners have expressed a willingness to clear the air for the radio fans. A method of grounding or shielding the electric equipment is understood to be under investigation.

Literally the plants using this form of smoke consumer are benefiting all their territory, since they are clearing the air of injurious and poisonous gases, soot and other objectionable matter, even if they do create a slight electric discharge similar to the hum of a motor generator.

RADIO JUMPS MOUNTAIN

Radio is being used successfully in India to send messages over a mountain 15,000 feet in height. Previously, considerable difficulty was found in wire communication due to heavy snowdrifts and storms which severed the lines. This achievement has been effected between the cities of Srinagar and Jammu, in Kashmir. Other installations have been effected or are planned in Bhopal, Gwalior, Hyderabad and Rejkot, by Marconi engineers, Trade Commissioner Spofford reports to the United States Government from Calcutta.

OPERATORS WANTED

There are 420 vacancies in the Navy Radio Service, according to a recent survey of the enlisted personnel handling wireless work. The numbers of men on duty are as follows: Radio gunners, 12; chief radio men, 485; first class, 397; second class, 506, and third class, 1,074. The vacancies all occur in the three upper grades; there are 48 vacancies in chiefs rating; 539 in first class; and 379 in the second class. This leaves a surplus in the third class of 546 men, many of whom will be promoted, it is understood.

PERFECT CONNECTIONS

are always sure with **Fahnestock Patent Wire Terminal**

Grips like a Vise.
 Eliminates Vibrations
 Easily Attached. No Soldering.
 Best of All for RADIO OUTFITS



No. 46

Made in All Sizes and Shapes
 At Your Dealer's

Fahnestock Electric Co., Long Island City, N. Y.

Dealers can obtain Fahnestock Products from following distributors:

- BOSTON
Wetmore-Savage Co.
- F. D. Pitts Co.
- DETROIT
Detroit Electric Co.
- CHICAGO
Barawik Co.
- MILWAUKEE
Julius Andrae & Sons Co.
- PHILADELPHIA
H. C. Roberts Elec. Supply Co.
- PITTSBURGH
Ludwick, Hommel Co.
- WESTERN DISTRIBUTORS
Marshall & Co., Los Angeles, Cal.

PATENTS

To the Man with an Idea

I offer a comprehensive, experienced, efficient service for his prompt, legal protection and the development of his proposition. Send sketch, or model and description, for advice as to cost, search through prior United States patents, etc. Preliminary advice gladly furnished without charge. My experience and familiarity with various arts frequently enable me to accurately advise clients as to probable patentability before they go to any expense.

Booklet of valuable information and form for properly disclosing your idea free on request.

Write today.

RICHARD B. OWEN
 PATENT LAWYER

2 Owen Building, Washington, D. C.
 2276A Woolworth Bldg., New York City

PATENTS. WRITE FOR List of Patent Buyers, Three Guide Books and RECORD OF INVENTION BLANK before disclosing inventions. Send model or sketch and description of your invention for Examination and Instructions. Electrical cases a specialty. Highest references, reasonable terms, prompt attention.

No charge for the above information

VICTOR J. EVANS & CO.
 919 NINTH ST. WASHINGTON, D. C.

PATENTS C. L. PARKER
 Formerly Member
 Examining Corps,
 U. S. Patent Office.
 PATENT LAWYER
 McGill Bldg., Wash., D. C.

Patents, Trade Marks, Copyrights, Patent Litigation
 Handbook for Inventors, "Protecting, Exploiting and Selling Inventions," sent upon request.

PATENTS

If you have an invention and desire to secure a patent, send for our Free Guide Book, HOW TO GET YOUR PATENT. Tells our Terms, Methods, etc. Send model or sketch and description for our opinion of its patentable nature.

RANDOLPH & CO.
 Dept. 459 Washington, D. C.

PATENTS
 DON'T LOSE YOUR RIGHTS
 Before disclosing your invention to anyone, send for blank form "EVIDENCE OF CONCEPTION" to be signed and witnessed. Form and information concerning patents free.
LANCASTER & ALLWINE
 270 Ouray Bldg., Washington, D. C.
 Originators of the form "Evidence of Conception"

Patent
 Wonderful, new device, guides your hand; corrects your writing in few days. Big improvement in three hours. No failures. Complete outline FREE.
 Write C. J. Ozment, Dept. 32 St. Louis, Mo.

WHY NOT spend Spring Summer and Fall gathering butterflies, insects? I buy hundreds for kinds for collections. Some worth \$1 to \$7ea. Simple outdoor work with my instructions, Pictures, price-list. Send 10c (not stamps) for my illustrated Prospectus before sending butterfly. Mr. Sinclair, Dealer in Insects, Dept. 37, Ocean Pk. Calif.

FIVE NEW BROADCASTERS GO ON AIR

The following five class "A" broadcasting stations were licensed by the Department of Commerce recently.

Call	Station	Frequency Kcys	Wave-Length Meters	Power Watts
KFLX	George Roy Clough, Galveston, Texas	1250	240	10
WABS	Essex Mfg. Co., Newark, N. J.	1230	244	50
KFLY	Fargo Radio Supply Co., Fargo, N. Dak.	1300	231	20
WABQ	Haverford College Radio Club, Haverford, Pa.	1150	261	50
WABR	Scott High School, N. W. B. Foley, Toledo, Ohio	1110	270	50
WLAQ	Arthur S. Schilling, Kalamazoo, Mich.	1060	283	10

SOME RADIO DEVELOPMENTS IN 1923

By JOHN LISTON

Important improvements in vacuum tubes for radio purposes marked developments in 1923. These were mostly in the direction of increased efficiency of operation and a general betterment of electrical characteristics.

It is also interesting to note that during the year there was started in regular production a new tube of the highest power so far standardized, and also the smallest tube requiring the least power expenditure in the filament that has so far been made available to the public for radio receiving sets.

The smallest standard receiving tubes, UV-199 and C-299, operate with an expenditure of only .18 watt for the filament, which is of a new type and insures high electron emission, silent operation and long life.

The development of the new filament made possible the remodeling of the Radiotron UV-.01, C-301, the previous standard receiving tubes, so that it only required one-quarter the former amount of filament power. At the same time the characteristics of the tubes were changed so that they became better detectors and amplifiers.

A new highly efficient 50-watt transmitting tube, UV-203-A, C-303-A, was developed and put into production. This tube also incorporated the new filament which enabled the filament energy required to be cut to one-half its former value for this size of tube and at the same time the characteristics were greatly improved. The operating life was also increased several fold by the change to the new filament.

A new tube of 250 watts, UV-204-A, C-304-A, output also employed the new filament which decreased the power consumption to about one-quarter of its former value and also improved the life.

A transmitting tube of 20-kw. output operates from a direct current source of 12,000 to 15,000 volts. In this tube, UV-207, C-307, the anode is also the container and the tube is designed to operate with the anode container immersed in running water so as to dissipate the heat developed in the interior of the tube. Several of these equipments were placed in service and more than a dozen other sets are being installed or are under construction.

Many important improvements were made in the design and production of radio apparatus, the advances being especially notable in broadcast receivers. The public's interest in broadcasting continued unabated and the demand for apparatus was so insistent that a considerable number of new styles were standardized.

The sectional units which were formerly standardized were combined in various



Genuine Bakelite

No. 611 50c
C-299 UV-199

The world's finest adapter of course is FROST-RADIO

THE radio world was waiting for this new 199-299 adapter in *Genuine Maroon Moulded Bakelite* at the low price of 50c. From the moment it was placed on the market it became the nation's choice for quality, service and value. Made in one piece of moulded bakelite. Has nickel plated brass contact prongs, nickel silver contact springs. Knurled edge makes it a joy to use.



FROST FONES
\$4.00
\$5.00
\$6.00

No. 140 **2-FONE** Plug 60c

ANOTHER tremendously popular **FROST-RADIO** item is this new No. 140 2-Fone Plug at 60c. Accommodates two pair of fone cord tips—holds them tight—never lets go. Finely made—beautifully finished.



Ask Your Neighborhood Dealer

HERBERT H. FROST, Inc.
154 WEST LAKE STREET, CHICAGO, ILLINOIS.

550 Gates Bldg., Kansas City
30 Church Street, New York

LOUD SPEAKING CRYSTAL SET AT LAST

You can add a loud speaker to any crystal set by using the STEINMETZ Amplifier. Guaranteed to operate on any kind of crystal set regardless of what type it is, or we will refund your money. By using your crystal set with this amplifier music is brought in as clear as a bell and can be heard all over the room. Amplifier uses dry cell tube.

Write for our complete catalog and also information on a highly efficient detector and two-stage amplifier at \$22.50

STEINMETZ WIRELESS MFG. CO.,
Manufacturers and Engineers
5705 PENN AVENUE PITTSBURGH, PA.

NEUTRODYNE

5 Tube Knock-Down NEUTRODYNE SET

with blue print, drilled and engraved panel. Every part needed to build a 5 Tube Neutrodyne Set is included. We guarantee these parts to be of the best quality that money can buy, irrespective of price.

Enclose postage with order. **\$25.95**

ATLANTIC & PACIFIC RADIO CO.,
131 West 37th St., New York City.

Insure your copy reaching you each month. Subscribe to Radio News—\$2.50 a year. Experimenter Publishing Co., 53 Park Place, N. Y. C.

\$200 Miniature Electric Prize Contest

THIS prize contest conducted by PRACTICAL ELECTRICS magazine, promises to be one of the most interesting that has been staged in recent years.

Here at last is something worth while. Not only can you win an attractive prize, but you will derive a tremendous amount of personal satisfaction from this contest. The illustration on this page shows the smallest electrical motor that has been built. Its dimensions are as follows: 11/64" high; 19/64" long. It weighs 5.5 grains.

This little motor is along the lines of our new contest except that we will not be quite so hard on the participants. We require miniature electric models, the largest dimensions of which must not be more than 3/4". Any electrical appliance, any electrical apparatus, any radio instrument that will be reproduced in a working condition in miniature, is eligible for entry in this contest.

World's Smallest Electric Motor

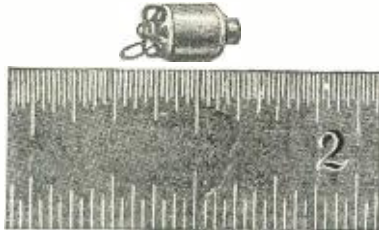

Total weight slightly above 5 grains. The tiny armature, .09" in diameter, has 4 Bala pieces and is wound with No. 40 silk copper wire. Silver brushes are used. The over-all dimensions of the motor measure 19/64" long and 11/64" high. When connected to a small flash light battery, the motor runs at a very high speed.

The judges will welcome miniature models of the following: Electric bells, switches, all kinds of electric heating appliances, electric generators, telephones, microphones, telephone desk stands, telegraph instruments, any and all radio apparatus, static machines, electric lamps, batteries, rheostats, measuring instruments, fans, transformers, in fact any electrical apparatus or electrical appliance. *One of the rules of the contest is that the miniature models must work.* Dummies cannot be entered in this contest. The builders of these miniature models will come in for a goodly share of publicity as many newspapers and periodicals will feature these models.



Full particulars, for entering the miniature models in this contest, closing date, rules and restrictions, etc., will be found in full in the January issue of PRACTICAL ELECTRICS.

\$200 IN GOLD	
First Prize	\$75
Second Prize	50
Third Prize	20
Fourth Prize	20
Fifth Prize	10
Sixth Prize	10
Seventh Prize	5
Eighth Prize	5
Ninth Prize	5

The Electrical Magazine for Everybody Now Greatly Enlarged



One-third More Text and Reading Matter than Heretofore

This Magazine is Edited by **H. GERNSBACK**
Also Editor of
Radio News
and
Science & Invention

100 Articles
Over 100 Illustrations
For Sale At All News Stands
25c. the Copy
\$2.50 a Year
Canada and Foreign
\$3.00 a Year

SEND FOR
FREE
SAMPLE COPY TODAY
See Coupon Below for
SPECIAL OFFER

PRACTICAL ELECTRICS is probably the most novel magazine of its kind ever conceived. It is personally edited by H. Gernsback, editor of SCIENCE & INVENTION and RADIO NEWS. Mr. Gernsback, who founded the old "Modern Electrics" as well as the "Electrical Experimenter," knows thoroughly what his readers want and have wanted for many years. PRACTICAL ELECTRICS, the 100% electrical magazine eclipses the best that was in "Modern Electrics" and "Electrical Experimenter."

Electricity covers such a tremendous field that the man who does not keep abreast with it does himself a great injustice. PRACTICAL ELECTRICS covers that field from every angle. It is written in plain every-day language that all can understand. It portrays the entire electrical development of the month faithfully in non technical language. It caters to everyone interested in electricity, be he a layman, an experimenter, an electrician or an engineer—each will find in this magazine a department for himself and plenty more.

The February issue now on the news-stands contains 64 pages, over 100 different articles and over 150 illustrations, with an artistic cover in three colors. Professor T. O'Connor Sloane, Ph.D., is associate editor of the magazine.

INTERESTING ARTICLES IN FEBRUARY "PRACTICAL ELECTRICS"

- The Radiotron: A Vacuum Tube By B. S. Havens of General Electric Company
- Simple Oscillograph By Carter Fiske
- Electric Animals
- Tidal Electric Power By Albert Staehle
- Voltage Finder
- Electrical Destruction of Atoms
- Electric Camera Shutter By Professor Rogers D. Rusk
- Carbon Contact Relay By A. Kiedis, Jr.
- Gratz-Beck Arc Lamp
- Analgesics and Others By T. O'Connor Sloane, Ph.D.

PRIZES

This magazine offers a number of prizes, as follows: Our \$200 Prize Contest for Junior Electricians and Electrical Experimenters includes as its elements simplicity, as great a degree of novelty as possible, and practicability. A new contest offering \$200 in prizes for best miniature working models of electrical apparatus. Also a new prize contest giving four prizes amounting to \$27.50 for the best account of an odd electrical experience. \$3.00 for the best article on Elec-Tricks, the new department. \$2.00 for the best "short-circuit," the semi-humorous department. In addition to this, the magazine pays high prices for all electrical experiments, electrical articles, etc. See current issue for full details.

This issue also contains articles by some of the greatest electrical writers, workers and students. The magazine will prove a revelation to any one interested in electricity.

Every issue besides its many other features contains the following departments:

- "New Things Electric"
 - "Experimental Electrics"
 - "Electrical Digest"
 - "Junior Electrician"
 - "Elec-Tricks"
 - "Motor Electrics"
 - "Short Circuits"
 - "How and Why" (Questions and Answers.)
- Make all checks payable to: "Practical Electrics Co."

SPECIAL OFFER

gentlemen: Although your regular price is \$2.50 per year, you will accept my subscription at \$2.00 per year (Canada and foreign \$2.50). I enclose the money herewith and I have written my name and address in margin below.

groups so as to meet different requirements. One of these units, a detector amplifier, was used in conjunction with the tuning unit, and suitable means were devised for combining the two to form a receiver suitable for use with outside antenna. The set is very simple in operation, having a single-tuned circuit, and is provided with regeneration when operated with a tube detector. A crystal detector is a part of the receiver for giving head telephone reception on nearby broadcasting stations when desired. These sets were adapted for the dry battery radiotrons, thereby entirely eliminating the necessity of storage batteries.

Another set was made by combining the same detector amplifier unit with a three-stage radio frequency amplifier unit to make a set suitable for use with loop aerial. This set is very simple in operation, there being but one tuning control, the variable condenser in parallel with the tuning loop.

New component parts were added to the line of standardized parts already available for use by amateurs and those desirous of constructing their own sets. The principal additions included sockets and rheostats for the new low filament current radiotrons as well as adapters for using these tubes in the sockets originally supplied in many sets.

A loud speaker was developed for use as an addition to sets not already equipped with one. It is very sensitive and reproduces signals with clear quality, and a single adjustment is provided for the diaphragm, which gives good operating efficiency over a considerable range of signal intensities.

Early in the year, the requirements for receivers took on a new aspect. Portable and self-contained receivers had become possible, due to the new tube developments, and these suddenly were widely demanded. The receiver designed to meet this need utilizes a single-circuit regenerative system with a detector and an audio amplifier tube, functioning well over the broadcast range. The method of control is exceptionally simple. The telephones and plug are carried in the front cover, while the batteries are in the rear. Having a complete weight of but 18 pounds, the set is made easily portable by the addition of a leather carrying handle.

The small crystal receiver previously standardized was also adapted to meet the changing demand. It is now housed in a wood case, and is fitted with a carrying handle for portability, the telephone being carried in a compartment in the rear cover.

Perhaps the best example of the adaptation of the new radiotrons to a complete receiver is to be found in the self-contained cabinet receiver which utilizes a single-circuit tuning system with regeneration and has a detector and two audio frequency stages. The batteries are supported inside the cabinet, and the loud speaker is built into it. The tuning controls, two in number, are easily accessible.

COMMERCIAL APPARATUS

Developments in the line of commercial receivers included the standardization of those used in the trans-Atlantic and trans-Pacific stations of the Radio Corporation of America. The layout of these communication channels consists of three separate divisions: First, the transmitting station usually located at some advantageous position near the coast for sending the communications across the sea; second, a receiving station, also advantageously located for reception from across the sea, but usually removed from the transmitter; and third, the operating division, usually located in the heart of the business or financial center to which the communication service is to be rendered. The operating division may frequently be

Keep your Customers satisfied



by aligning yourself with a dependable radio jobber

Progressive Radio Dealers in all parts of the country realize the importance of handling strictly high grade radio materials and apparatus. This organization wholesales exclusively,—they represent only the leading radio equipment manufacturers,—their products are guaranteed,—they are, therefore, a dependable source of supply, and the type of jobber you should tie up with for your requirements.

Hommel's Encyclopedia of Radio Apparatus 236-S Gives Complete Details.

Write for your copy.

LUDWIG HOMMEL & CO
530-534 FERNANDO ST. — PITTSBURGH, PENNA.

TELEGRAPH INSTRUMENTS
DANDY MORSE LEARNER'S OUTFIT

One dry cell is all that is required to operate this instrument. Made by the best Telegraph Instrument Makers in the World. Other types carried in stock. Send stamp for Telegraph Manual No. 43R. Instrument only...\$5.00 With dry battery...\$5.50 Special Price to Dealers. J. H. BUNNELL & Co., 32 Park Place, N. Y.

Simplified Reinartz

Improved circuit using Dile banked inductance eliminates 4 controls. No switches, taps or soldering. EASIEST and CHEAPEST to build. Greater distance and volume by removing switch tap losses. Pile banked windings give extra sharp tuning and low distributed capacity. One control tunes 200 to 600 meters. Complete instructions, hookup, panel layout, etc. 25c. stamps accepted. TYPE "R" INDUCTANCE Vesco banked, with all circuit instructions, \$2.50 postpaid.

Vesco Radio Shop
Bx RN-117 OAKLAND, CALIF.

Insure your copy reaching you each month. Subscribe to Radio News—\$2.50 a year. Experimenter Publishing Co., 53 Park Place, N. Y.



**“What a whale
of a difference
just a few cents
make”**

*All the difference
between just an ordinary
cigarette and the most skillful
blend in cigarette history.*

FATIMA
— a mild cigarette

WEIGHS ONLY 8 OZ

The Scientific

A \$200,000.00 COMPANY stands squarely back of the guarantee on every Scientific headset

SEND NO MONEY!

20,000 TURNS EQUIVALENT TO 3,000 OHMS

Order TODAY by Postcard and Pay Postman on arrival

\$2.95

POST-PAID

LOUD SPEAKER UNIT \$1.95

THE PHONE IT TOOK A SOLID YEAR TO DESIGN

We Guarantee The Scientific Headset to be the greatest value on the market. Try it for five days. If not satisfactory send it back and your money will be refunded immediately. Circular on request. Dealers wanted.

THE SCIENTIFIC ELECTRIC WORKS
98 Brookline Ave. DEPT. H. BOSTON, MASS.

separated by 100 to 200 miles from either of the two other divisions, but it directly controls through suitable remote-control relays the operation of these two divisions. Thus, communication is directly carried on from the desired point, without transcription by the other divisions.

The equipment in the receiving stations consists of eight separate large units, not including the relays necessary for transposing the signals on the land wires.

It is interesting to note that both the stations which took part in bringing the news of the recent Japanese disaster in September, 1923, to the world, were equipped with the above standard receiving equipment. On the Japanese side, the operating division of station J.A.A. was located in Tokyo, while the transmitting division was in Haranomachi, some 155 miles away, and the receiving division 187 miles away at Tomioka. On the American side, a similar situation existed. Station KET has its operating division in San Francisco, its transmitting station at Bolinas, about 50 miles away, and its receiving station at Marshall, 44 miles away.

Station J.A.A. usually works through the Radio Corporation station at Koko Head, Honolulu, but in this emergency communication was carried on directly across the water. The personnel of both stations worked incessantly at fever heat, while Japan told of her terrible calamity and needs. With all other communication systems out of order, radio stood as the only means by which the call for assistance could be brought to mankind.

EXPERIMENTAL WORK

For the purpose of securing a high voltage direct current supply for the operation of radio vacuum tube transmitters, and for experimental work, there was developed and built for the U. S. Navy Department a kenotron rectifier, rated at 30 kw. at 15,000 volts direct current. It contains 12 kenotrons so constructed that so-called 3-phase full wave rectification is obtained.

The rectifier has associated with it the necessary controls whereby the output can be adjusted from full output to a small fraction thereof. The filter system is associated with the rectifier, which smooths out the remaining ripple in the rectified alternating current to less than one-tenth of 1 per cent. This rectifier is now installed in the Navy Department Laboratories at Bellevue, near Washington, D. C.

AIRPLANE APPARATUS

In connection with the air mail service of the U. S. Post Office Department, there was designed an aircraft transmitter and receiver for use on the mail planes. The transmitter of this equipment puts approximately 200 watts into a trailing wire antenna. The power for the operation of the set is obtained from storage batteries which are kept charged by the engine of the plane. These batteries operate a high voltage dynamotor, which supplies high voltage direct current power for the operation of the transmitter.

The set consists of three major units, the transmitter, receiver and control box, together with a number of auxiliaries. The equipment was designed so that it can be advantageously installed in the fuselage of the plane, and so that maximum accessibility is given to the operator. The planes which will utilize the sets are built to carry the pilot only, and it was necessary to develop and design this equipment so that it can readily be operated by the pilot without interfering with the navigation of the plane.

What Do Chiropractors Mean

by Innate Intelligence ?

THE temperature of a normal human body is approximately 98.6 degrees. You may sit in a room the temperature of which is 80 degrees, or go out of doors when the thermometer registers zero and your temperature, if you are in health, will not vary a single degree, because, resident in your body is an intelligence that generates, distributes and regulates the heat of the body, and instantly adapts it to the change in temperature.

If you start in June to take a plunge in the lake every morning and continue it every day until December, this same power resident in the body will intelligently adapt the body to the seasonal change in temperature.

This innate power gave the polar bear his long hair, that he might live in the land of eternal ice, and the gentle deer his speed, that he might escape his less swift foe. It is this power that in the struggle for existence gave wings to the birds and cunning to the fox, spots to the leopard and strength to the lion. It is this power that elongated the neck of the giraffe so that he could reach the high-hanging foods and for obvious reasons webbed the feet of the duck and goose. This inborn power adapted the stomach of the carnivora to a meat diet, the stomach of the herbivora to a vegetable diet, and the stomach of man to both.

maintains its vigor and then slowly lets the house in which we live decay. During all the circling three-score years and ten it coordinates the physical functions, heals the body's wounds, mends its breaks, adapts it to the change of season, occupation and pursuit and performs the miracle of changing common food into living, breathing, sensate bone and flesh.

It laughs at all our efforts to locate it or to imitate its work and yet some people, because they cannot find it, weigh it or measure it, question its existence and say "Vital force is a chemical phenomenon."

Call it what you will, it's there—a rose by any other name is just as sweet.

This "power within" Chiropractors call Innate Intelligence and all their philosophy, science and art is built upon this fundamental fact. They teach that "Innate Intelligence" functions through the brain and nervous system, and that disease is but the abnormal expression of one or more of the nine primary physical functions. Any pressure of a harder tissue (bone) upon the soft nervous tissue, impairs the conductivity (function or work) of that tissue and results in disease. All that is necessary for a complete restoration to health, is that the impinging tissue be adjusted to normal position, which permits the nerve again to function normally.

Scientists call the modus operandi of the "power within" the law of adaptation. Among the professions engaged in getting the sick well, chiropractors alone recognize the existence of the thing itself, and the law of its expression, through the nervous system.

That is the reason Chiropractic succeeds where other methods fail.



DEFINITION
The practice of Chiropractic consists of the palpation and adjustment, with the hands, of the movable segments of the spinal column to normal position for the purpose of releasing the prisoned impulse.

The **LAST WORD**

FROM ANY COMPETENT CHIROPRACTOR

ASK FOR IT

BEING THE TRUTH ABOUT CHIROPRACTIC

Write for information regarding Chiropractors or Schools to the

Universal Chiropractors' Association
Davenport, Iowa, U. S. A.

Get the Consrad Cloth Radio Map of the U. S.



The Consrad Radio Map is different from all other maps in that it is printed on CLOTH and with proper care will last a lifetime.

The Map measures 17x22" and contains a special distance computing gauge of our own design which enables one to find any broad-casting station at a moment's glance.

A measuring rule is also furnished to help find the distance from any point in the United States to the station which is being received.

The broad-casting stations are contained on a separate sheet which can be fastened to the map by ordinary paper fasteners. The list is up to date and contains the new wave lengths.

The map is furnished in two colors and with the sheet of broad-casting stations, is enclosed in a two color heavy manilla envelope 9½x12".

Consrad Pattern No. 9. How to Make the ST100 Receiver

The S. T. 100 receiver employing a circuit devised by John Scott-Taggart of London, has proven to be one of the most efficient sets of reflex variety for broad-casting reception.

While only two tubes, a crystal detector are used, the energy amplified of incoming signals is powerful enough to operate any type of loud speaker without additional amplification.

The quality of reception will astonish those who are familiar with the performance of other circuits.



Another important feature is that the set tunes sharply, which is one of the utmost requisites of an ideal receiver.

The packet consists of blue prints for drilling the panel, wiring the apparatus, and a four-page instruction pamphlet giving complete details as to the parts required, tools needed, and even how to tune.

All these are contained in a two color heavy manilla envelope, 9½x12".

50c.

\$1.25 Here is Your Chance to Learn All You Can About RADIO The \$10.00 "Radio Reading Course" Special at \$1.25

All the technical details and a thorough explanation of radio reception, written in easily understood, non-technical language by a foremost radio engineer and inventor. The five Lecture books with over 100 graphic drawings give you the knowledge to intelligently buy, design, build, operate and maintain radio receiving apparatus. Tells you how to locate and correct troubles, how to make your

apparatus more efficient and gives you a thorough knowledge of radio science. This set of five handsome Lecture books are a complete radio library. To own them is like having a trained engineer or instructor at your side, answering questions, pointing the way. No matter what your interest in radio, take advantage of this attractive special offer and be the owner of this fine set of books.

This set can be gotten at your dealers or direct from us on receipt of \$1.25. If you prefer we will send it C.O.D. and you can pay the postman on receipt.



The Consrad "Making Your Own" series consists of plans for the construction of the most popular radio circuits and are gotten up so that anyone can construct a receiving set as easily as a woman can sew the simplest dress. Blue prints are furnished for drilling the panels and wiring the parts and a four-page pamphlet contains complete instruction even as to tuning. Each pattern is contained in a two colored heavy manilla envelope 9½x12" and sells at **50c.**



The Titles in this Series:

- No.1 How to Make a Short Wave Regenerative Receiver.....50c
- 2 How to Make Detector and Amplifier Units.....50c
- 3 How to Make a Radiophone Crystal Set.....50c
- 4 How to Make a Reinartz Receiver.....50c
- 5 How to Make a Reflex Receiver.....50c
- 6 How to Make a Cockaday Receiver.....50c
- 7 How to Make a Neutrodyne Receiver.....50c
- 8 How to Make an Autoplex Receiver.....50c
- Packet B 29 Radiophone Diagrams with Supplements.....50c
- C 14 Radio Formulae and Diagrams.....50c
- D All About Aerials and Their Construction.....50c

On Sale at All Reliable Radio Dealers or Direct from us.

THE CONSRAD CO. Publishers and Sales Agents 233 Fulton St., N. Y. C.



Two New E. I. Books for the Radio Fan

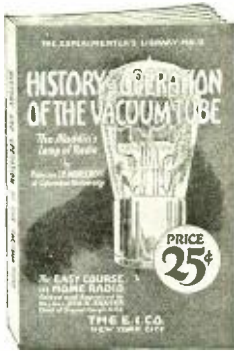

History and Operation of the Vacuum Tube

By PROF. J. H. MORECROFT

Associate Professor of Electrical Engineering, Columbia University

Edited and Approved by

MAJOR GENERAL GEO. O. SQUIER, Chief of the Signal Corps, U. S. A.

This book serves an interesting study of the fundamental principles, historical evolution, and practical application of the vacuum tube as used in radio apparatus of every description. Since the vacuum tube is one of the most important parts in the modern radio set, and has been largely responsible for making present-day radio entertainment possible, this book has been entirely devoted to the subject of that one particular instrument. It is written in simple everyday language with all technical terms thoroughly explained so as to make matters easily understood by everyone.

The book contains chapters on the phenomena of vacuum tubes in general; the operation of vacuum tubes as detectors and amplifiers; and the junction of the vacuum tube used in various transmitting and receiving circuits, etc., etc.

52 pages printed in legible type; 24 illustrations and diagrams; bound in two-color cover; size 5½ x 7½ inches; Price, 25c.

All About Radio Parts

By THOMAS W. BENSON

This book gives an extensive description of the various parts used in all types of receivers, especially explaining the features of certain apparatus and circuits. It also describes why the different parts are used and how they operate. There has been nothing overlooked.

To begin with, the book tells how radio waves are collected by means of an aerial, giving details of construction of different types and their advantages. Then detection is explained and various types of crystal and vacuum tube detectors described. Amplification, including regeneration, radio and audio frequency, is simply told.

This very instructive book will prove to be of great value in the hands of anyone interested in radio as it is very explicit and thorough.

Contains 52 pages, 36 illustrations and diagrams; bound in a two-color cover—size 5½ x 7½ inches. Price, 25c.

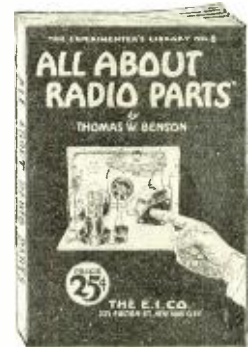

Other Books in the "Experimenters' Library"



No. 2—How to Make a Radiophone Receiving Set 25c

No. 3—Radio Questions Answered 25c

No. 4—Radio Frequency Amplifiers 25c

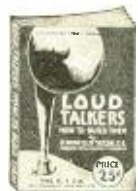

No. 5—Loud Talkers and How to Build Them 25c



No. 6—How to Tune Your Radio Set 25c

No. 7—100 Radio Hook-Ups 25c

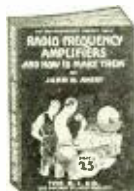

The "Experimenters' Library" is being increased at the rate of at least one new title each month. Every book is written by an authority and in language easily understood by everybody.

On Sale by All Reliable Radio Dealers

The E. I. Company (The Conrad Co., Selling Agents) 233 Fulton St., N. Y. C.

OPPORTUNITY AD-LETS

Follow these advertisements every month. Reliable advertisers from all over the country offer their most attractive specials in these columns.

Classified advertising rate fifteen cents a word for each insertion. Ten per cent discount for 6 issues. 20 per cent discount for 12 issues. Name and address must be included at the above rate. Cash should accompany all classified advertisements unless placed by an accredited advertising agency. No advertisement for less than 10 words accepted.

Objectionable or misleading advertisements not accepted. Advertisements for the April issue must not reach us later than February 1st.

THE Net Paid CIRCULATION OF RADIO NEWS IS OVER 200,000
 EXPERIMENTER PUBLISHING CO., INC., 53 Park Place, New York, N. Y.

Agents Wanted

Agents Wanted in every city and town to sell standard radio apparatus. Attractive discounts given. If interested, write to the Editor, Radio News, 53 Park Place, New York, N. Y.

General Agents—Service Men! Genuine Gold Letters for store windows easily applied. 20 percent cash commission on all orders from local agents appointed by you anywhere. 50 percent discount on your own orders. Free samples. Metallic Letter Co., 122 N. Clark St., Chicago.

Big Money and fast sales. Every owner buys gold initials for his auto. You charge \$1.50; make \$1.55. Ten orders daily easy. Write for particulars and free samples. American Monogram Co., Dept. 133, East Orange, N. J.

We want Salesmen and Agents, either whole or side line, to sell our low priced radio books to the trade. Excellent proposition for live wires. The E. I. Company, Publishers, 253 Fulton Street, New York City.

You can make \$75.00 to \$100.00 a week selling our big line of 150 articles, used constantly in every home. Write us, we will send you our handsome \$15.00 Sample Case Outfit on trust. Federal Pure Food Co., Dept. T, Chicago.

Rug Salesmen—Get next to the biggest seller of the year. Complete Rug Sales Kit at \$25.00. Write for details. Rug Sales Kit, complete Rug Catalog, Free. Malsley-Payne Mfg. Co., 101-N Hanover St., Boston, Mass.

New wonderful sell. Over 100 percent profit on every sale of Harper's Ten-Use Set. Needed in every home. Washes and dries windows, sweeps, scrubs, mops, etc. Greatest year-round seller. Write Harper Brush Works, 160 2nd St., Fairfield, Iowa.

Two-in-One-Line. Something New for Tailoring or Reincoat agents. Great for men who have been waiting to break into this profitable business. Tailor made-to-measure suits or overcoats at \$23.50. Raincoats \$23.85. A money maker from start to finish. Big rebater. Satisfied customers guaranteed. Real sales help. Offer will soon be withdrawn. Agency equipments are limited. Get in line for one of our \$300.00 a week jobs. Elliott Bradley, Inc., 1028 W. VanBuren, Dept. A20, Chicago.

If you can Sell—You can make from \$75 to \$150 a week taking orders for our guaranteed all-wool tailored-to-measure suits at all one amazing low price. Tailoring experience not necessary. We teach you and supply you with finest selling outfit. We do all the designing. You just write orders and get your pay cash with order. When you write, state experience and give references. Address Dept. 761, Goodwear Chicago, Inc., 814 W. Adams Street, Chicago.

Start your own business as sole agent, selling 100 famous home products. All or spare time. Dr. Blair Laboratories, Dept. 511 Lynchburg, Va.

American Made Toys

Manufacturers on Large Scale, also homeworkers, wanted to manufacture Metal Toys and Novelties. Millions needed of Barking Dogs, Wax Tail Pups, Wild Animals, Automobiles, Indians, Cowboys, Baseball Players, Cannons, Toy Soldiers, Croving Roosters, Statues of Liberty, Miniature castings of Capitol, Bathing Girl, Souvenirs and others. Unlimited possibilities. Guaranteed casting forms finished manufacturers at cost price from \$5.00 up, with complete outfit. No experience or tools necessary. Thousands made complete per hour. We buy goods all year and pay high prices for finished goods. Cash on delivery. Contract orders placed with manufacturers. Catalog and information free. Correspondence invited only if you mean business. Metal Cast Products Co., 1896 Boston Road, New York.

Automobiles

Automobile owners, garagemen, mechanics, send for free copy of America's popular motor magazine. Contains helpful, money-saving articles on repairing, overhauling, ignition, carburetors, batteries, etc. Automobile Digest, 528 Butler Bldg., Cincinnati.

Build It Yourself—A real Automobile that any handy man or boy can build. A low priced, speedy cycle car. Power supplied by famous 2 1/2 H.P. Shaw Motor. Send stamp today for Descriptive Circulars and send 25c for Complete Book of Easy-to-Follow Plans. Shaw Mfg. Co., Dept. B.N.1 Galesburg, Kansas.

Books

Hypnotism—25 easy lessons, complete methods, guaranteed \$1.00. Mind-reading (any distance) 50c postpaid. The Collins Co., 32 Liberty Street, Hastings, Brooklyn, N. Y.

Chemistry

Learn Chemistry at Home—Dr. T. O'Connor Sloane, noted educator and scientific authority, will teach you. Our home study correspondence course fits you to take a position as chemist. See our ad on page 1157 of this issue. Chemical Institute of New York, 68 West Broadway, New York City.

Correspondence Course

Used correspondence courses of all schools said rental and enhanced. New 1924 catalogue free. (Courses bought). Lee Mountain, Pisgah, Alabama.

Business Opportunities

Make Big Money Out of Radio. Thousands of People want to buy a good Radio instrument. They have read that cast instruments have been made and they are ready to buy now if you show them the best. It is one thing to make a good radio instrument for your own amusement, but why not cash in now on your experience? Let us send you full particulars of the Ozarka Plan which shows you how to "Make \$120 weekly" selling long distance Radio sets. The season is on right now. Let us tell you how to combine the clear signal of the crystal detector with the distance of the vacuum tube. Write today and don't fail to give the name of your county. Ozarka Incorporated, 813 Washington Blvd., Chicago.

For \$5 we'll write three catchy classified advertisements that will simply have to bring you business. We'll name rates of most profitable magazines, how to use them, etc. Martinek Company, 45 Humphrey Street, Corona, N. Y.

Free Booklet describes four methods of making money. \$50 starts you. Dept. X, Paul Kaye, 119 Broadway, N. Y.

Exchange

For Sale. Aerialia Senior two stage amplifier, including two tubes. New condition \$35. R. A. Workman, Woodward, Okla.

200-20,000 Meter Receiver including Radiotron \$35.00. Two stage Amplifier \$22.00. Smith, 4116 Market, Philadelphia.

For Sale: 1 Aerialia Sr., \$25; 1 Radiola R. C. \$65; 1 Crosley Model Y; \$14; 1 Ace Regenerative \$25. C. Benjamin, Clyde, N. Y.

\$110.00 Edison Chrome nickel 6 volt 150 ampere hour storage A batteries at \$29.85. A wonderful battery at an equally wonderful price. 6 volt 300 ampere hour at \$37.90. Edison chrome nickel B storage battery plates at 4c per pair. Parts for making rechargeable B storage battery from Edison B Plates 100 volts at \$8.95, 150 volts \$12.95. Consists of plates (Edison) glass vials special wire, perforated separator, chemical electrolyte and simple instructions for assembling and making charger. B. R. Smith, 31 Washington Ave., Danbury, Conn.

For Sale. Grebe CR No. 9 with RORH attachment complete to run for \$140.00. Howard B. Cogswell, Hammondsport, N. Y.

Help Wanted

We want Salesmen and Agents, either whole or side line, to sell our low priced radio books to the trade. Excellent proposition for live wires. The E. I. Company, Publishers, 253 Fulton Street, New York City.

Earn \$25 Weekly, spare time, writing for newspapers magazines. Experience unnecessary; details free. Press Syndicate, 5665 St. Louis, Mo.

Detectives Needed Everywhere. Work home or travel. Experience unnecessary. Write, American Detective System, 1908 Broadway, New York.

All Men, Women, Boys, Girls, 17 to 65 willing to accept Government Positions \$171-\$250 traveling or stationary write Mr. Orment, 231, St. Louis, Mo., immediately.

Get Posted—Good prices paid for butterflies, insects. See Sinclair display advertisement, page 1194.

Improved Made Toys

Wanted—Manufacturers and Homeworkers to manufacture Metal Toys and Novelties. Wonderful opportunity. Millions needed. In Whistling Birds, Wild Animals, Wax Tail Pups, Croving Roosters, Automobiles, Baseball Players, Statue of Liberty, Indians, Toy Soldiers, Barking Dogs, and 50 others. No experience or tools necessary. Guaranteed casting forms with complete outfit, at cost. From \$3.50 up. We buy goods all year. Cash on delivery. Fisher prices for finished goods. Contract orders placed. Send for catalog and information free. The Improved Metal Casting Co., 342 East 145 St., New York.

Insects Wanted

Get posted—Good prices paid for butterflies, insects. See Sinclair display advertisement, page 1194.

Instruction

Learn Chemistry at Home—Dr. T. O'Connor Sloane, noted educator and scientific authority, will teach you. Our home study correspondence course fits you to take a position as chemist. See our ad on page 1157 of this issue. Chemical Institute of New York, 68 West Broadway, New York City.

Indian Goods

Hunting Bows, relics, minerals. Geology, stamps, butterflies. Thousand Indian articles. Catalogue 10c. Indian-Craft-A-Co., 366 Connecticut, Buffalo, N. Y.

Languages

World-Romie System. Maerkey to All Languages. Primers, 23 languages, \$1.91 each language: English, French, German, Italian, Portuguese, Spanish. Pronunciation-Tables, 102 languages, 90c each language. Languages Publishing Company, 8 West 40th Street, New York.

Mail Order Novelties

40 Mailorder Magazines and Papers 25c. Hansen Company, Eleven, Brookings, S. Dak.

Miscellaneous

Get posted—Good prices paid for butterflies, insects. See Sinclair display advertisement, page 1194.

Why Use String? Perfect Little Gummed Tape Machine, simplest, cleanest, most compact rapid, unique, practical; no equal for any business. Postpaid with 12 rolls 1 inch tape, only \$5. Quicksal, 13M, Mass.

Gasoline Lamps and Lanterns. Catalog free. Little Wonder Light Co., Terre Haute, Ind.

Attention Radio Inventors. Have you any new ideas for improving Radio Tubes or have you any patents for them? If you have, communicate with me at once as I am very much interested in this particular line. Have full equipment to experiment with as well as the necessary capital and am in a position to spend a great deal of time in bringing out any plans I may receive. If ideas are carried out to please you, satisfactory arrangements can be made for the manufacture of them. Just get in touch with me and let me experiment for you. Box 150, RADIO NEWS.

Motion Picture Business

Motion picture machines, films stereopticons. National Equipment Company, Duluth, Minn.

Motorcycles—Bicycles

Don't buy a Bicycle Motor Attachment until you get our catalog and prices. Shaw Mfg. Co., Dept. 6, Galesburg, Kansas.

News Correspondents

Earn \$25 Weekly Spare Time writing for newspapers, magazines. Experience unnecessary; details free. Press Syndicate, 566 St. Louis, Mo.

Patent Attorneys

Patents. Send drawing or model for examination and report as to patentability. Advice and booklet free. Highest references. Best results. Promptness assured. Watson E. Coleman, Patent Lawyer, 821 F Street, Washington, D. C.

H. F. Lowenstein, Registered Patent Attorney, Radio Expert. 825 McLauchlin Building, Washington, D. C.

Patents—Send for form "Evidence of Conception" to be signed and witnessed. Form, fee schedule, information free. Lancaster & Allwine, 209 Huray Bldg., Washington, D. C.

Patents—Inventors should write for Free Guide Books and Record of Invention Blank before disclosing invention. Send model or sketch of your invention for our Free opinion of its patentable nature. Radio, Electrical, Chemical, Mechanical and Trade-Mark experts. Victor J. Evans & Co., 922 Ninth, Washington, D. C.

M. P. Laughlin, Patents Engineer-Attorney, 48 East 41 Street, New York.

Patents

Inventions Commercialized, Patented or unPatented. Write Adam Fisher Mfg. Co., 378 St. Louis, Mo.

Radio Equipment

Genuine Edison Elements (new) for making "B" Batteries, obtained from U. S. Government. A positive and negative element—6c. Glass tube—2c. all other parts at reasonable prices. Postage, etc., 50c extra per order. Free instructions. Todd Electric Company, 109 West 23rd St., New York.

Personal

50 "Funny" Jazzy Parodies on Latest Songs. Yes! We Have No Bananas Today, etc. 25c. R. N. Collins Co., 197 Fulton Street, Brooklyn, N. Y.

Correspondence club—Many wealthy members everywhere Fascinating particulars free. Smith, Box 1167 Denver, Colo.

British Girls desire American Correspondents. Proposition 10c. Neclaire, 16, Cambridge St., London, S. W. England.

Lonely Hearts—Exchange letters; make interesting new friends in our jolly club. Eva Moore, Box 908, Jacksonville, Florida. Enclose stamp.

Exchange Chery Letters with new friends. Write Betty Lee, Inc., 4251 Broadway, New York City. Stamp appreciated.

Lonesome—Join our club—make acquaintances everywhere. It's illustrated book with descriptions and photos, sent in plain wrapper for ten cents. Ionafide Co. Dept. 58, Kansas City, Mo.

Printing

Mail Order Radio Catalogues 21 page with cuts. Your Name. Prices \$10.00 per 100, sample 2c. Stewart's 3121 Cherokee, St. Louis, Mo.

Salesmen Wanted

Lightning strange battery compound. Charges discharged batteries instantly. Eliminates old method entirely. Gallon free to agents. Lightning Co., St. Paul, Minn.

Scenery to Rent

Settings for Opera, Plays, Minstrels. Plush Drops. Address Anella Grain, Philadelphia.

Song Poems Wanted

Poems Wanted—Sell your song-poems for cash. Submit Mas. at once, or write New Era Music Co., 152, St. Louis, Mo.

Song Writers

A \$500.00 Cash Prize is offered for the best second verse written for the song "Remember." Those wishing to compete may receive a free copy with rules by addressing Equitable Music Corporation, 150 State Theatre, N. Y.

Stammering

St-St-t-t-tering and Stammering cured at home. Instructive booklet free. Walter McDowell, 121 Potomac Bank Bldg., Washington, D. C.

Stamps and Coins

Danzig Free—Nice Set Danzig Stamps with Biggest catalogue issued. 2c postage. Midland Stamp Co., Station E11, Toronto, Canada.

Stamps—50 varieties. Brazil, Peru, Cuba, etc., 10c. 50 different C. S. 2c, 1,000 boxes. 10c. 1,000 mixed. 40c. Post free. C. Stekman, 5926 Cote Brillante, St. Louis, Missouri.

California gold. Quarter size 27c; half-dollar size 32c. In outline and catalogue 10c. Norman Shultz, Colorado Springs, Colo.

Telegraphy

Telegraphy—Both Morse and Wireless taught thoroughly and quickly. Premiums, demand, 142 salaries. Wonderful opportunities. Expenses low; chance to earn hard money established fifty years. Catalog free. Dodge's Institute, Four St., Valparaiso, Ind.

Wanted to Buy

Full Value Paid for Old Gold, Jewelry, Watches, Diamonds, crowns, bridges, dental gold, silver platinum, gold or silver ore, magnetite points, old false teeth. Packages returned if our offer is not satisfactory. United States Smelting Works (The Old Reliable), 120 So. State St., Dept. 16, Chicago, Ill.

Wireless

Radio Supplies, Tubes: WD11, WD12 CV199, CV201A, \$5.10. B. Batteries: Large size 22 1/2 volt, Eveready, \$3.00. Phones: Frost \$1.00, Brandes Superior \$6.00, Brandes Navy \$8.00, Baldwin \$12.00, Magnavox, the perfect reproducer \$36.00. Workrite variometers and variocouplers, \$3.50. Promote service. Order at once. Capital Radio Company, Box 522, Jefferson City, Missouri.

Radio cabinets made to order, single or in lots. E. H. Dinwiddie, wood specialties, Bennington, Vermont.

Edison Storage Batteries, \$1.00. Cost \$10.00. 821 North Fifth, Philadelphia, Pa.

Edison Storage "B" Battery elements. Large size, full capacity, 3c per pair, in lots of 100. Kindly send postage for 5 1/2 lbs. per 100 pair. Gilman's Battery Shop 57 Washinton Ave., Chelsea, Mass.

Radio Panel—White "Pyralin Ivory" makes the most beautiful set of all. Guaranteed satisfactory. Any size 3-10" thick, 3c per square inch. Sample sent. E. P. Hailom, 611 Main St., Fort Worth, Texas.

Wireless—(Continued)

Cabinets—Catalog on request. Special cabinets made to order at low cost. Manufacturers' and jobbers' inquiries invited. Panels—plywood; natural, 1/4 sq. in.; dull black finish, 1/4 sq. in., postpaid. Miami Cabinet Co., Yellow Springs, Ohio.

1 550-volt, 700-watt Generator with Field Rheostat \$40.00. 1 Thordarson I-K-W. Transformer with two 1500-volt Secondary \$15.00. 2 Deraun Indoor Telephones \$5.00. 1 Acme Portable Moving Picture Projector Electric Drive with 3000-foot Film \$100.00. 1 Thordarson 30-watt Filament Transformer \$7.50. 1 1/2 H.P. A.C. Motor with Chopper Rotor on Shaft \$20.00. 1 Automatic Double Tape Recorder \$20.00. 1 Amrad 3 Tubes @ \$5.00. 1 Amrad Filter Condensers @ \$5.00. 4 R. O. C. 50-watt Tubes @ \$24.00. 3 R. O. C. 250-watt Tubes @ \$75.00. 1 50-watt Sockets @ \$2.00. 1 ESCO Generator 225-watt 300-volt plate and 10-volt Filament \$30.00. 12 Hot Peep Hole Meters 0 to 10 volts \$2.00. 1 Jewell 0 to 2 1/2, 1 Jewell 0 to 5, 1 Jewell 0 to 10, 1 Jewell 0 to 15 Thermo Ammeters @ \$9.00. 1 Shilinton 0 to 1500 volts D. C. Meter \$17.00. 1 Sph.dorf 0 to 500 volts D. C. Meter \$9.00. 1 Thordarson 200-watt Filament Transformer \$10.00. Following 1 set: In First-Class condition. 1 1/2 K.W. Clapp-Eastman High Tone Set \$50.00. 1 1/2 H.P. Ball Bearing Synchronous Motor In I.H.P. Frame \$10.00. 1 Electric Blower (poor condition) \$7.50. 1 500-volt, 100-watt Motor Generator \$15.00. 1 Small Power Pack \$10.00. 1 Dubilier Condenser of M.F. 25,000 volts \$8.00. 1 Dubilier Condenser of M.F. 25,000 volts \$12.00. 12 I. C. 100 I. M.F. Filter Condensers, \$2.00. 12 I. C. 1627 1/2 M.F. Filter Condensers \$1.50. 1 R. O. C. Transmitting Inductance \$7.50. 1 10-Henry Choke 1 Amp. Capacity \$15.00. 1 1-Henry Choke 1 Amp. Capacity \$3.00. 1 2-Henry Choke 1 Amp. Capacity \$1.00. 1 1/2 H.P. Motor Generator 100-A.P. to 50-volts I.H.P. \$25.00. 1 1/2 H.P. 110-volts G. E. Motor \$35.00. 1 150 Ohms Hunsell Relay \$9.00. 1 Thordarson Oil Transmitting Condenser of M.F. \$5.00. Terms C.O.D. One-Dollar cash with order. G. L. Hill, Rome, Georgia.

Fifty assorted Hathall solid brass machine screws, nuts, washers copper lugs—50c. Eight initialed binding posts, set 60c. Twelve nickelled binding posts—50c. All three items—\$1.50. Radio List for stamp. All prepaid. Stamps accepted. Kludge Radio Laboratories, Kent, Ohio.

Save Money Radio Supplies Catalogue Free. Stewart Radio Supply, 3121 Cherokee, St. Louis, Mo.

Radio at cut prices. List free. Kale Radio, 2711 No. Troy St., Chicago, Ill.

Build your own electrolytic storage battery charger. Plates and complete instructions, \$1.00. Descriptive circular free. Peerless Electrical Parts Co., 105 Harris Rochester, N. Y.

Magnavox R3 or M1. Latest nationally advertised reproducers. List \$35. Introductory \$25. The factory sealed carton is your guarantee. Radio Central, Dept. R, Abilene, Kansas.

Radio Panels. Cut exactly to size and a guaranteed 14 hour shipment. 3/4" thick 0-1 1/4" per square inch 3-16" thick 0-1 1/4". Made of the highest grade black fibre. This material possesses electrical strength of 200 volts per mil. It is inextinguishable, unbreakable, easy to work and takes a fine finish. We pay postage. Radio Instrument & Panel Co., 561 W. Monroe St., Chicago, Illinois.

Immediate delivery. Tubes, Magnavox, Phones, Battery Chargers, Storage and "B" Batteries, Couplers, Variometers, Condensers and all parts with Radio Corporation, DeForest and "Neutrodine" Receiving Sets. R. B. Electric Co., Distributors, Galva, Ill.

Boys! Don't Overlook This. The "Bass" Baby Detector. Adjustable detector ever brought out with molded base. Fully greatest. See former advertisements in this publication or our outsize Detector with Galena crystal, complete 50c, the same detector as Radio Central's "Crystal" set. Paid. Send for yours today. Radio Specialty Company, 98-98 Park Place, New York City.

Attention!—50 Vacuum tube hook-ups. The greatest collection of vacuum tube circuits ever brought under two covers of such insignificant cost. These diagrams will be found in the great "Bass" catalog, which contains raw materials and parts in a greater profusion than any other catalog. In stamps, or coin, will place the catalog to you. Radio Specialty Co., 98-98 Park Place, N. Y.

Reflex Sets—Latest most economical book. Cost to cost—Only half the tubes. We specialize in parts and complete assemblies for ERLA and two tube and three tube reflex sets. Information on request. Other specialties and standard apparatus. Western Wireless Supply Company, 2162 North California Avenue, Chicago, Illinois.

Tube repairs, 201A, 199, W.D.11—\$2.25 each. Satisfaction Guaranteed. Also New Tubes in stock at unobtainable prices with amazing results obtainable. Request Circular One Day Service. Our Motto, S. Strobel & Co., 2923 N. 6th St., Philadelphia, Pa.

The How and Why of Radio Apparatus, by H. W. Secor, E. F. This newest book on radio matters fills a distinct gap in wireless literature in that, while the treatment is made as understandable and as free from mathematics as possible, it at the same time incorporates a wealth of technique and instructions for the Radio Amateur—the Radio Operator—the Installation and Designing Expert—as well as teachers and students of the subject in general. A very broad field has been covered by the author, at the same time giving a great deal of information not found in other text books. If you are engaged in any branch of the Radio or allied arts at all you will surely need this latest contribution to radio literature, which is destined to be found on every radio man's book shelf hereinafter. The following list of chapters gives but a very scant idea of the extensive and useful radio knowledge provided in its text. The Induction Coil; The Alternating Current Transformer; Radio Transmitting Condensers; The Spark Gaps; Radio Transmitting Inductances; Radio Receiving Tuners; Radio Receiving Condensers; Detectors; Telephone Receivers; Radio Amplifiers; Construction of a Direct Reading Voltmeter and Measurement of Inductances; Antenna; Antenna Tuning Tables, covering all subjects treated in this very unusual book. This newest of Radio Works, cloth bound in Vellum de Luxe, Gold Stamped and Hand Sewed, has 169 pages. Size of book 6 1/2 inches. The How and Why of Radio Apparatus. Postpaid, \$17.75. Experimenter Publishing Co., Book Dept., 53 Park Place, New York City.

For 19 years the best in the world for the money —
\$4⁰⁰ and \$4⁵⁰



Always ask for **MURDOCK HEADPHONES**
AT ALL RADIO DEALERS
Or Sent Direct If Your Dealer Cannot Supply You.

W.M. J. MURDOCK COMPANY
214 Washington Ave., Chelsea, Mass.

FURNESS BERMUDA LINE
(Bermuda Gov't's Official Contract Steamers)

BERMUDA
Playground of Eternal Springtime
(Average Yearly Temperature of 70°)
Only Two Days From New York

SAILINGS TWICE WEEKLY
LANDING passengers directly at Hamilton Dock avoiding inconvenience and delay of transfer a tender.
Tickets good on either Steamer, insuring unequalled expense service safety and via Palatial new Twin-Screw Oil-burning Steamers.

S. S. "FORT VICTORIA"
S. S. "FORT ST. GEORGE"
Each 14,000 Tons Displacement
From New York Wed. & Sat. From Bermuda Tues. & Sat.
Modern Hotels—No Passports—All Sports
Including Golf, Tennis, Sailing, Bathing, Horse Racing, Fishing, Riding, Driving, etc.

ST. GEORGE HOTEL, Bermuda. Finest Cuisine and Service, Tennis, Golf, Magnificent Tiled Swimming Pool.

WEST INDIES
Delightful Cruises to the Coast of the Caribbean Sea For Illustrated Booklet on Bermuda, St. George Hotel or West Indies, write

FURNESS BERMUDA LINE
34 Whitehall St., N. Y., or Any Local Tourist Agent

3 Brings you a Genuine UNDERWOOD TYPEWRITER

10 DAYS FREE TRIAL Your \$3.00 unconditionally returned if at end of 10 days you are not satisfied with this latest model UNDERWOOD typewriter rebuilt by the famous Shipman Ward process.

GREAT PRICE SAVINGS Direct to you from the largest typewriter factory in the world by our money saving methods.

EASY MONTHLY PAYMENTS So small that you will not notice it while you enjoy the use of this wonderful machine.

FREE BOOK OF FACTS Explaining Shipman Ward's wonderful system of rebuilding typewriters and also valuable information about the typewriter industry both instructive and entertaining.

Act Today! Mail Coupon **5 Year Guarantee**

Shipman Ward Mfg. Company
1852 Shipman Building
Montrose & Ravenswood Aves., Chicago

Please send me a copy of your free book of facts, explaining bargain offer.

Name.....
St. and No.....
City..... State.....

Bradleyleak

THE PERFECT GRID LEAK

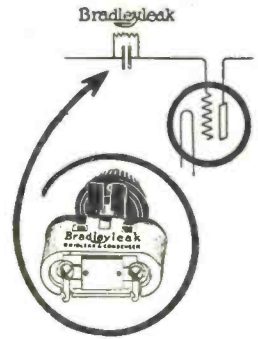
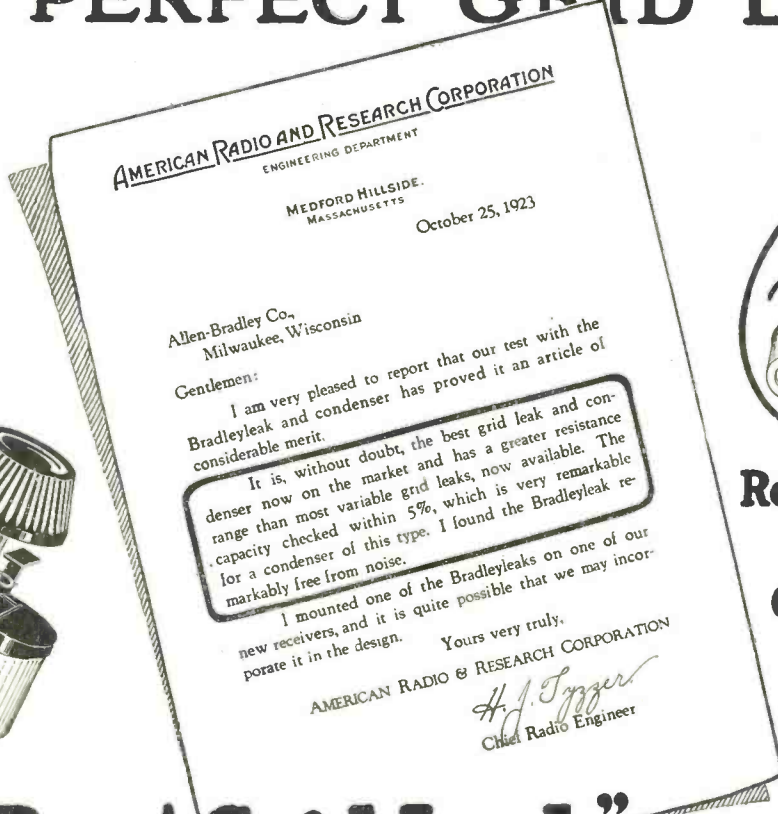

Retail Price
\$1.85
Condenser
 .00025 MF
35¢ Extra

AMERICAN RADIO AND RESEARCH CORPORATION
 ENGINEERING DEPARTMENT
 MEDFORD HILLSIDE,
 MASSACHUSETTS
 October 25, 1923

Allen-Bradley Co.,
 Milwaukee, Wisconsin

Gentlemen:

I am very pleased to report that our test with the Bradleyleak and condenser has proved it an article of considerable merit.

It is, without doubt, the best grid leak and condenser now on the market and has a greater resistance range than most variable grid leaks, now available. The capacity checked within 5%, which is very remarkable for a condenser of this type. I found the Bradleyleak remarkably free from noise.

I mounted one of the Bradleyleaks on one of our new receivers, and it is quite possible that we may incorporate it in the design.

Yours very truly,
H. J. Tzyzer
 Chief Radio Engineer

AMERICAN RADIO & RESEARCH CORPORATION

“The Best Grid Leak” Says Amrad

Radio has been waiting for an adjustable grid leak which is truly adjustable and reliable. Many attempts have been made to produce such a grid leak, but with little success. It has remained for the Allen-Bradley Co., backed by 20 years' experience with compression disc rheostats, to produce an adjustable grid leak which fulfills all the requirements of a perfect grid leak. To distinguish it from all other grid leaks, it bears the name “Bradleyleak.”

The Bradleyleak has been tested by such authorities in radio as Crosley, Kennedy and Amrad. They have all marveled at its noiseless, smooth control, its marvelous range from 1/4 to 10 megohms and also that it is not affected by atmospheric conditions. Radio set builders are using thousands of Bradleyleaks and the demand is increasing at an astounding rate. Your detector will work better if you use the Bradleyleak. Try one on your set, today.

For Special Hook-ups the Bradleyleak is a great favorite and frequently a Bradleyleak makes an obstinate set work perfectly.

Allen-Bradley Co.
 Electric Controlling Apparatus

287
 Greenfield
 Ave.



Milwaukee,
 Wisconsin

Send for Bulletins and learn the proper value of grid leak resistance for the popular radio tubes. Be sure to write today.

THE ALLEN-BRADLEY CO. HAS BUILT GRAPHITE DISC RHEOSTATS FOR OVER TWENTY YEARS

THE PERIODICAL PRESS, NEW YORK



E·D·Elliott of Milford, N.Y. establishes a record

Think of getting Fairbanks, Alaska and LaPalma, Panama, or London, England, when you live in New York! Yet this is the experience of Mr. Elliott, one of the thousands of enthusiastic users of MIRACO sets. With the inexpensive outfit shown here, priced at only \$29.50 he received the following list of stations—results that would do credit to a set costing three or four times as much.

- | | | |
|-------------------------|------------------------|------------------------|
| London, England | WCT Chicago | WTAM Cleveland, Ohio |
| WLAY Fairbanks, Alaska | WMC Memphis | WWJ Detroit, Mich. |
| NNW La Palma, Panama | WBAK Harrisburg | WJAZ Chicago, Ill. |
| PWY Havana, Cuba | WBAK Bellow Falls, Vt. | WDAP Chicago, Ill. |
| CFAC Calgary, Canada | WBAN Paterson, N. J. | WGY Schenectady, N. Y. |
| CJCY Calgary, Canada | WOC Bavenport | WEAF New York City |
| KSL San Francisco, Cal. | WPAP Winchester, Ky. | WOR Newark, N. J. |
| KFBC San Diego, Cal. | WJAM Beaumont, Texas | WHAS Louisville, Ky. |
| KHQ Seattle, Wash. | WWZ New York | WEAB Dodge, La. |
| KJAR Providence, R. I. | WBAY New York | WKD Gaitsville, Ga. |
| KFBU Lorine, Wyoming | WGL Philadelphia, Pa. | WUQ Washington, D. C. |
| WEV Houston, Texas | WBAP Dartmouth, Mass. | KMO Tacoma, Wash. |
| WMAT Duluth, Minn. | WBAG Bridgeport | KOB New Mexico |
| WPM Washington | WCAP Decatur | WDAR Philadelphia, Pa. |
| WRAA Houston, Tex. | WIN Idigewood | WFI Philadelphia, Pa. |
| WIB Kansas, Neb. | WIR Paducah | WIP Philadelphia, Pa. |
| KFHB Hood River, Ore | WRP Camden, N. Y. | KDKA Pittsburg, Pa. |
| CFCA Toronto, Canada | WGAR Fort Smith, Ark. | WCAE Pittsburg, Pa. |
| CKCE Toronto, Canada | WBAK Hartford, Mass. | KMN Butte, Mont. |
| CJCI St. John, Canada | WCAE New Orleans | KQP Hood River, Ore. |
| WRP Dallas, Texas | WJAY Wilmington | WHAZ Troy, N. Y. |
| NGE Miami, Fla. | WRAY Berantown, Pa. | WGR Buffalo, N. Y. |
| KGA Oakland, Cal. | WQAY Birmingham | WMAV Auburn, Ala. |
| KFEL Denver, Col. | WSB Atlanta, Ga. | KFDD Bois, Idaho |
| WIAZ Miami, Fla. | WMU Washington | WNAI Omaha, Neb. |
| WKY Oklahoma City | WCAT Rapid City | WCAP Washington, D. C. |
| WJAE Tampa, Fla. | WRC Washington | WQAB Springfield, Mo. |
| WEB St. Louis | KYW Chicago | WFE St. Louis, Mo. |
| WRK Hamilton | KFCB Phoenix | WDR Detroit, Mich. |
| WHAB Galveston, Tex. | WWT Buffalo, N. Y. | WNAK Boston, Mass. |
| 6ZV Salt Lake City | WHAS Louisville, Ky. | WBZ Columbus, Ohio |
| NAA Arlington, Va. | WCAY Milwaukee, Wis. | CFZC Montreal, Que. |
| WJAX Cleveland, Ohio | WLAW Cincinnati, Ohio | WMAK Lockport, N. Y. |
| WBZ Springfield | WDAW Omaha, Neb. | WGF Des Moines, Ia. |
| WOD Philadelphia, Pa. | WQK Kansas City | WHAM Rochester, N. Y. |
| WOS Jefferson City, Mo. | WPAAWilmington | WGAN Villa Nova, Pa. |
| WOK Pine Bluff, Ark. | WCE Minneapolis | WGAY Madison, Wis. |
| WLAG Minneapolis | WCX Detroit, Mich. | WWI Dearborn, Mich. |
| WFAZ Charleston | WLAZ Warren, Ohio | WGM Orangeburg, S. C. |
| WJAB Lincoln, Neb. | WAAS Decatur, Ga. | WWAJ Columbus, Ohio |



Radio's finest low-priced receivers

Here, in the improved MIRACOS, you'll find the same thrill of getting long distances, generally obtainable with only the most expensive and elaborate sets. To the whole family it will furnish entertainment, *unfailingly*, the whole year round—and at an initial price most every family can afford.

It isn't necessary, either, to be an expert at tuning in with the MIRACO. The operation is extremely simple. Scores of users everywhere tell us of the long-distance records they're making—Cincinnati hears 'Frisco, Denver hears Schenectady, New York hears Havana!

Such range as this is made possible through MIRACO'S many new refinements. Improved rheostats with multiple resistance windings enable you to use any type of tube, and a new aluminum shield prevents annoying body capacity effects. Shock absorbing pads prevent tube noises. Fully GUARANTEED against defects in material or workmanship. Price for 4-tube outfit shown above only \$54.50.

Other details of MIRACO receivers are explained more fully in our new bulletin. Write today for a copy.

The Midwest Radio Company
804 Main Street
Cincinnati, Ohio

The Improved
MIRACO

MAIL COUPON TODAY

THE MIDWEST RADIO CO.,
804 Main St., Cincinnati, Ohio.

Gentlemen: Kindly send at once:

- Free bulletin.
- Agents' proposition.
- Dealers' proposition.
- Jobbers' proposition.

Name

Street address

City

Radiotron

REG. U. S. PAT. OFF.



Radiotron W.C.-11
 Radiotron W.C.-12
 Radiotron UV-199
 Radiotron UV-200
 Radiotron UV-201-A

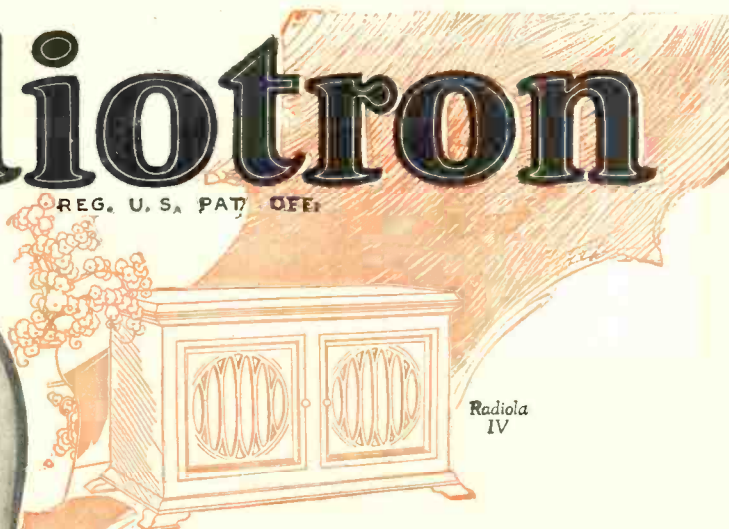

Radiola IV

In high quality receiving sets, the vacuum tubes — the heart of their fine performance — bear the name **Radiotron** and the **RCA** mark. Be sure to look for this identification when you replace your tubes.



This symbol of quality is your protection



Radiola Grand

Send for the free booklet that describes all Radiotrons and Radiolas.

RADIO CORPORATION OF AMERICA
 Dept. 22 (Address office nearest you.)
 Please send me your free Radio Booklet.

Name _____
 Street Address _____
 City _____ R.F.D. _____
 State _____

233 Broadway, New York 10 So. La Salle St., Chicago, Ill. 433 California St., San Francisco, Cal.

Radio Corporation of America

Sales Offices:

Radiola

REG. U. S. PAT. OFF.