

January, 1926

HERNDON'S 37-800 METER SET

RADIO

IN THE HOME

10¢

Conducted by HENRY M. NEELY



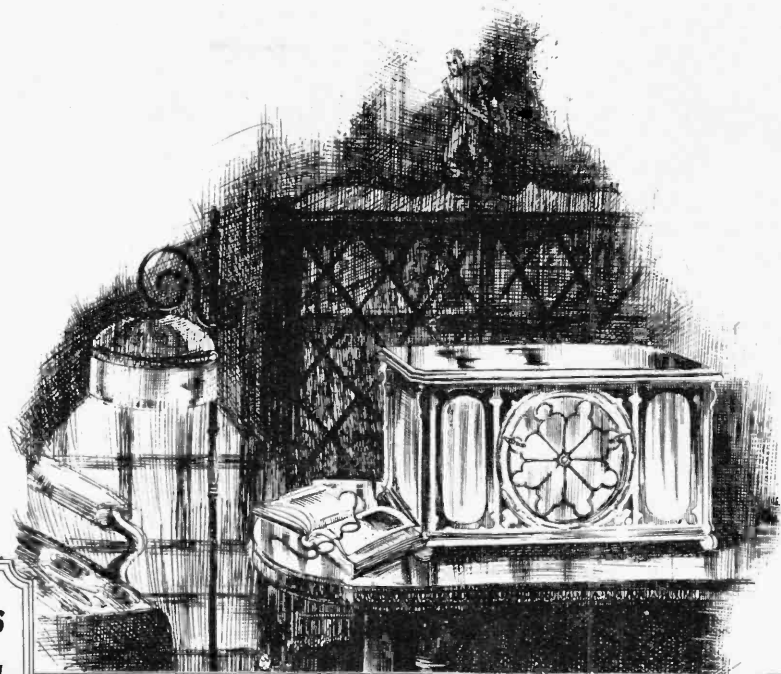

NO DIALS
NO PANEL
BUILT-IN
LOUDSPEAKER

For the Well Appointed Home

\$135.00

*West of the
Rocky Mountains \$140*

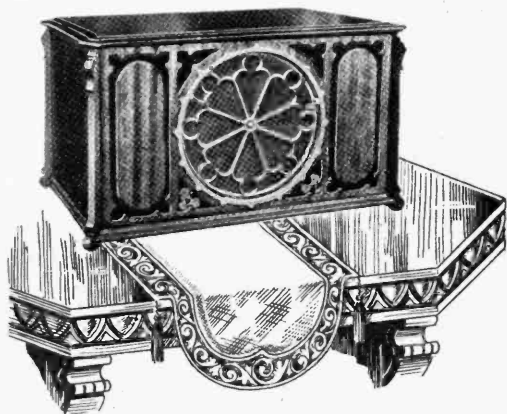

PEOPLE of taste will instantly recognize in the ULTRADYNE, Model L-3, the long-awaited perfection in *radio-musical instruments*. This new receiver offers complete mastery of the air's riches; effortless operation—as simple as playing a phonograph; and a new artistic form that blends harmoniously with its environment.

Better than the most exacting critics of radio ever demanded, more than the radio authorities themselves predicted. Complete freedom from entangling technicalities. "Belongs" in almost any scheme of furnishings. The perfect harmony of scientific skill and artistic genius.

Radio never held out more attractions for you than this new kind of receiver makes possible. See and hear it demonstrated at the higher standard radio shops and department stores.

The ULTRADYNE Model L-3, is a six-tube receiver employing the fundamental principles of the best circuits greatly refined and marvelously simplified. No dials—no panel; just two inconspicuous levers which constitute a station-selector. Volume adjustment, the only other control. Beautifully duco finished, duo-toned paneled mahogany cabinet.
Designed by R. E. Lacault, E.E., Chief



Engineer of this Company, and formerly Radio Research Engineer with the French Signal Corps, Radio Research Laboratories.

To protect the public, Mr. Lacault's personal monogram seal (R.E.L.) is placed on the assembly lock bolts of all genuine ULTRADYNE Model L-3 Receivers. All Ultradyne Receivers are guaranteed so long as these seals remain unbroken.

Write for illustrated descriptive folder

ULTRADYNE
MODEL L-3

PHENIX RADIO CORP., 116-L East 25th St., NEW YORK

A [EITHER or BOTH] B radio power from your house current

For 6-volt tube sets buy Socket Power "B" and Socket Power "A" in separate cases. Either may be used alone, but for *one-switch control* use both together. However, if you have a good storage "A" battery and charger, buy Socket Power "B" alone.

For 3-volt tube sets such as Radiola Super-Heterodyne, buy Socket Powers "A" and "B" built into one case and *controlled by one switch*. If you have a good storage "A" battery and charger, buy Socket Power "B" alone.

Philco "A" and "B" Socket Powers—plugged permanently into your lamp or wall socket—change your bumpy alternating house current into the smooth, *hum-free* power necessary for your radio.

No more dry batteries to replace. No more thought about battery recharging. As dependable as your electric current. Turned on exactly like an electric light.

Once you connect Philco Socket Power to your radio you never need change a single wire. You forget all about getting wires mixed and burning out the tubes of your set. You forget that radio is mysterious and technical. You just enjoy it.

When Socket Power "A" and Socket Power "B" are used together, *one switch controls everything*—"A" power, "B" power, even the radio set itself. Snap it "ON" and enjoy your radio. Snap it "OFF" and go to bed.

Sold and demonstrated by leading radio and music stores and by Philco Diamond-Grid Battery Dealers.

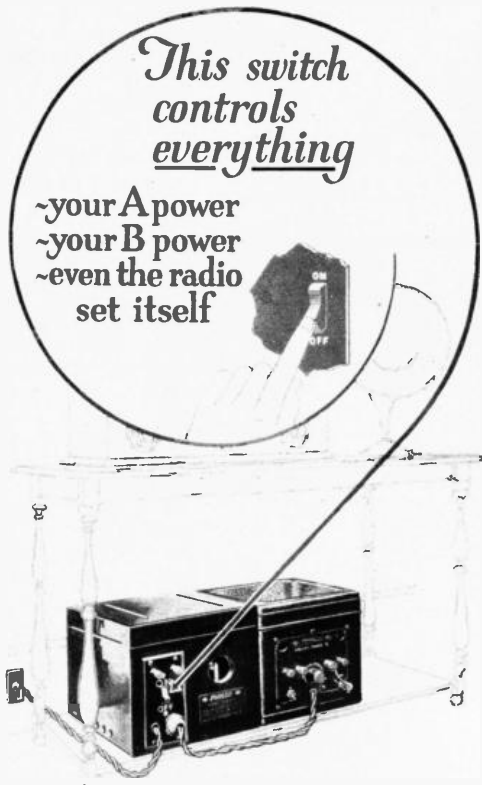

This switch controls everything

~your A power
~your B power
~even the radio set itself

Snap it ON and enjoy your radio
Snap it OFF and go to bed

For storage battery (6-volt tubes) either "A" or "B" Socket Power may be used alone, but for *one-switch control*, use both together. Plug the "B" into the built-in socket on the "A". Plug the "A" into your house current. Both "A" and "B" (and the radio set as well) are then controlled by the one SOCKET POWER "A" switch.

Socket Power "B" unlike ordinary "B" battery "Eliminators"—has no tubes to burn out—contains no sulphuric acid—requires no water—is full size and can be used on any set. It rectifies, filters and smooths out your house current, giving true, *hum-free*, undistorted reception at a cost of only 1/4c. a day.

For 50-60 cycle 105-125 volt alternating current \$47.50
For 25-40 cycle 105-125 volt alternating current \$52.50

(Prices complete—no rectifying tubes to buy)

Socket Power "A" is a complete "A" power unit for 6-volt tube sets. Plugged into a lamp or wall socket, it supplies "A" battery current automatically—without any thought about recharging. For 50-60 cycle 105-125 volt alternating current \$42.50
For 25-40 cycle 105-125 volt alternating current \$42.50

For Radiola Super-Heterodyne (old and new models) and other 3-volt dry-cell tube sets, use socket power "AB". Both "A" and "B" power are built into one cabinet, satin finished in brown mahogany. Connect permanently to your radio set—plug into a light socket—then turn your radio switch "ON" and leave it "ON". The one SOCKET POWER switch then controls everything.

For 50-60 cycle 105-125 volt alternating current \$65.00
For 25-40 cycle 105-125 volt alternating current \$68.50

Philadelphia Storage Battery Company, Philadelphia

PHILCO RADIO A AND B SOCKET POWERS

Philco also builds rechargeable batteries, unique because they may be permanently connected to your radio and safely charged in your living room without changing any wires. Easier than the periodical renewing and rewiring of dry cells.

Philco Standard "B" Battery—a complete Adam-brown mahogany-finish replacement for 90 volts of dry cells. Only \$19.85!

Buy a Philco Diamond Grid Battery for your automobile

Philco "A" Batteries in acid-tight glass cases—for dry cell tubes, \$8; 6-volt tubes, \$16. Built-in charge indicators.

In rubber cases, subdued mahogany color, \$14.85 and up.

Philco Radio Batteries are built *Dynamic*—DRY but CHARGED. Their life doesn't start until the dealer pours in the electrolyte. You can't get a stale *Dynamic* Philco.



EDITORIALLY SPEAKING



The International Radio Tests

ONCE more we are all getting ready to listen in for European stations during the week of international tests.

In spite of everything that has been said and written about the craze for distant reception dying out, there is undeniably a great lure in bringing in, however faintly and unsatisfactorily, the voice and music of a station 3000 miles away. We have become more or less sophisticated in the matter of radio and its marvels, but still we have not outgrown that thrill which comes with the experience of hearing a voice just a little farther away than any we have ever heard before.

While there are some aspects of this international week which I consider unfavorable to the future of radio, still there can be no question that the results from year to year do give a very fair basis of comparison between the efficiency of transmitting and receiving equipment from one season to another. This year, the number of Americans who will receive European stations ought to be three or four times as great as last year. Transmitting and receiving equipment has been improved during the past twelve months, and, what is probably even more important, a greater number of listeners have had twelve months of experience in tuning their sets. This experience cannot but be helpful in getting these signals, just as the experience of a year or more in driving an automobile stands us in good stead in weaving our way through the traffic of a congested metropolitan street.

It is wise, however, to give a word of warning right now to those who are about to buy a set for the purpose of taking part in these international tests. Just before these tests begin, newspapers in every city will carry the usual "gyp" advertising offering the public radio sets which are "certain" to achieve the desired results of logging several foreign radio broadcasters.

By *Henry M. Neely*

Now it cannot be too strongly emphasized that no human being can guarantee any set to perform in a certain way in any unknown locality. Location of the set probably has more to do with the number of stations that can be logged and the satisfactory nature of the signals than any other factor in radio. Read Mr. Foote's article in this issue and you will get an idea of the various things that govern radio reception.

We are constantly getting evidence of the truth of this statement at our laboratory at Station 3XP at Delanco, New Jersey. Reception conditions there are somewhat less satisfactory than the great average throughout the country. It is impossible to say why this is so; all we know is that it is true and we are having it proved to us month after month.

I think it would be wise, therefore, for you to give this advice to friends of yours who may be attracted by the advertising which will precede this international radio week. Tell them that under no consideration are they to believe any guarantee of a set made by a dealer or a manufacturer. All that any one can guarantee is that a certain set will perform as well as any other set in the same locality. Even this is a thing which I would not like to take my oath to, but a manufacturer could make such a guarantee with the understanding that the customer's money would be refunded if the set did not pass the test agreed upon.

It is because of this that I speak of a possible unfavorable aspect of international test week.

The advertising that precedes such an event and the solicitation of salesmen unfortunately lead the non-technical prospect

to believe that a set which does not receive Europe during this week is not a good set. In spite of everything that has been written on this subject, this impression still gains ground, and it is perfectly natural that it should, because these non-technical prospects are absolutely ignorant of things in radio and they must look for guidance either to the dealer or to friends of theirs who have radio sets.

This is where the educational influence of radio magazines should be exerted to the full. You who read this magazine, and all who read other radio magazines, know that the things which I have said here are true; it is, therefore, most desirable that you, when you hear of some non-radio friend who is thinking of buying a set, should tell him the truth about the salesman's guarantees.

Radio will never be sold widely as a competitor to the phonograph or the automobile so long as it is sold with the basic expectation of receiving great distance. The function of the radio set in the home is higher and nobler than the mere thrill of playing with a wonderful toy. That day has passed. The radio set is now an integral part of the daily cultural life of the better class family. It is on this basis that radio should be judged and on this basis alone. If, in addition to this, it should bring in the thrill of the unexpected, so much the better, but the thing to sell radio on is what can be regularly and dependably expected and not what can be accidentally brought in through a combination of circumstances which may never occur again.

So I wish all of our readers luck in getting the European stations during this test week, but I also wish them even better luck in getting steady and dependable night-after-night entertainment and education in their own homes from the wealth of material that is constantly filling the ether about us.

RADIO IN THE HOME

Published Monthly by the Henry M. Neely Publishing Company, Public Ledger Building, Philadelphia, Pa.
 Bell Telephone—Lombard 3431 Keystone Telephone—Main 4122 Experimental Station (3XP), Delanco, N. J.
 HENRY M. NEELY, President and Editor W. T. DIEHL, Chicago Representative
 G. W. KRAFT, Secretary and Treasurer 30 North Dearborn Street, Phone: Central 4510
 JAMES B. MCKEOWN, Advertising Manager New York Office, 110 West 42d Street, Room 301
 Phone Wisconsin 3343. Extension No. 15
 NORMAN NEELY, Art Director A. P. LEON, Advertising Director

Radio in the Home is sold at 10c per copy at all newsstands, radio shops and bookstores. Subscription rates in the United States, \$1.00; Canada, \$1.25; Foreign, \$2.00 per year.

Printed on the rotogravure presses of the Public Ledger, Phila., Pa. Copyright, 1925, by the Henry M. Neely Publishing Company.
 Entered as second-class matter May 26th, 1922, at the Postoffice, Philadelphia, Pennsylvania, under the act of March 3, 1879.

Radio in the Home is a Member of the Audit Bureau of Circulation

ATWATER KENT RADIO



In the home of REX BEACH, the author, you will find the Atwater Kent Model 20 Compact Receiving Set and the Model H Radio Speaker.

Radio is meant to be heard —not necessarily seen



Model H, with 9" flexible cord, \$22



Model 20 Compact, including battery cable, but without tubes, \$20

Prices slightly higher from the Rockies west, and in Canada

Hear the Atwater Kent Radio Artists every Sunday evening at 9:15 o'clock (Eastern Standard Time) through stations—

WRAP	New York
WIAH	Providence
WVPI	Boston
WCAP	Washington
WMAZ	Stamford
WGLS	Minneapolis-St. Paul
WBO	Philadelphia
WINS	alternating
WCAZ	Pittsburgh
WJAC	Buffalo
WVNC	Davenport
WTAG	Madison
WHD	St. Louis
WWJ	Detroit
WEAN	Cleveland

No longer than a row of a dozen books, no higher than your fountain pen, light enough to be carried on one hand—that's the Atwater Kent Model 20 Compact.

It is the Receiving Set of tomorrow, here today. It has all the power in half the space.

It is only 6½ inches high and 10¾ inches long. It is right in step with the modern trend of saving

space. You can put it anywhere—on a small table, beside your favorite arm-chair, among your books and flowers and magazines; no new furniture is needed.

For any room, in any home—for beauty, convenience and efficiency—you can do no better than to select the receiving set so satisfying in so many homes—the Model 20 Compact.

See it—hear it at any store where Atwater Kent Radio is sold—today.

Write for illustrated booklet telling the complete story of Atwater Kent Radio.

ATWATER KENT MANUFACTURING CO.
A. Atwater Kent, President
4701 WISCONSIN AVENUE PHILADELPHIA, PA.

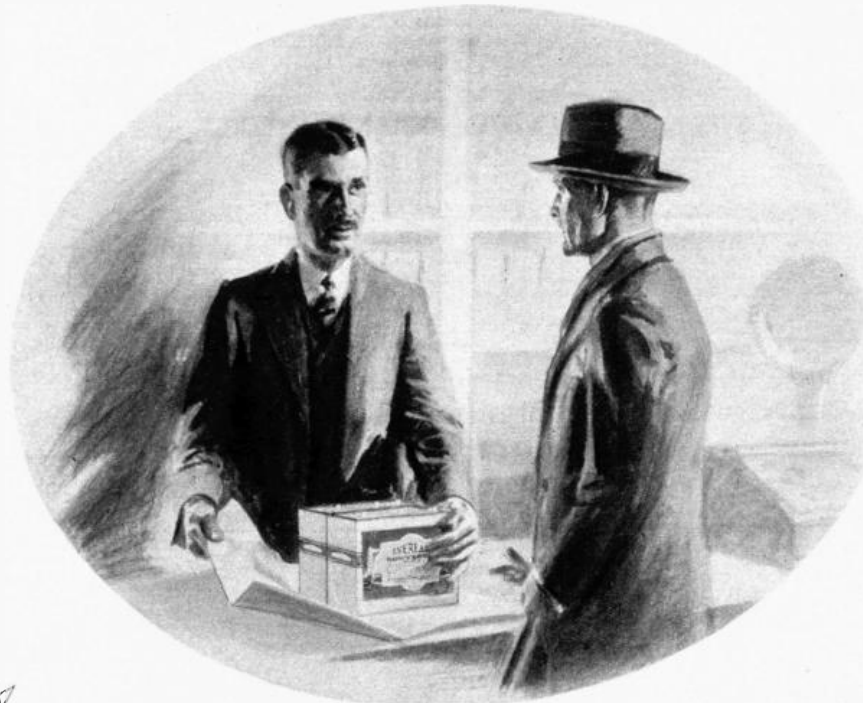

These Eveready Batteries are the correct size for your set. With average use they will last you a year or longer

"You have been one of the many who use 'B' batteries that are too small in capacity for their receivers. That is not economical. It makes you buy 'B' batteries twice as often as necessary. Fit the right size Evereadys to your set and add a 'C' battery,* if you haven't one, and you'll get maximum service at minimum cost."

The life of your Eveready "B" Battery depends on its capacity in relation to your set and how much you listen in. We know, through careful investigation, that the average year-round use of a set is two hours a day. Taking that average we have proved over and over that on sets of one to three tubes the No. 772 Eveready "B" Battery used with a "C" battery will last a year or

longer. On sets of four and five tubes, the larger heavy duty Eveready Batteries used with a "C" battery will last eight months or more.

Here is the secret of "B" battery satisfaction and economy:



LEFT - Eveready Layerbilt "B" Battery No. 486. 45 volts for maximum economy on four, five or more tubes.



RIGHT - Eveready Dry Cell Radio "A" Battery, 1 1/2 volts. The battery built especially for dry cell tubes.

EVEREADY

Radio Batteries

—they last longer

With sets of from 1 to 3 tubes, use Eveready No. 772.

With sets of 4 or more tubes, use either of the heavy duty batteries, No. 770 or the even longer-lived Eveready Layerbilt No. 486.

We have prepared for your individual use a new booklet, "Choosing and Using the Right Radio Batteries," which we will be glad to send you upon request. This booklet also tells about the proper battery equipment for use with the new power tubes.

Manufactured and guaranteed by
NATIONAL CARBON COMPANY, Inc.
 New York San Francisco
 Canadian National Carbon Co., Limited, Toronto, Ontario

EVEREADY HOUR—EVERY TUESDAY AT 9 P. M.
 Eastern Standard Time

For real radio enjoyment, tune in the "Eveready Group." Broadcast through stations—

WFAP—New York	WFI—Philadelphia	W541—Cincinnati
WJAR—Providence	WGR—Buffalo	WWJ—Detroit
WYU—Boston	WUAB—Pittsburgh	WOL—Des Moines
WAG—Worcester	WCCO—Minneapolis, St. Paul	KSH—St. Louis

*NOTE: In addition to the increased life which an Eveready "C" Battery gives to your "B" batteries, it will add a quality of reception unobtainable without it.

WHAT CAN I GET?

ARE you new in this radio game? Have you just bought your set and installed it? What did you expect to get out of the set once you had it?

Most folks are led into radio by a combination of urges—among which might be mentioned hearing some one else's receiver, listening to conversation among those already having sets, reading articles and advertisements in publications or viewing dealers' windows.

Some folks hope for education extension, but I believe most of us want entertainment—novelty—thrills—surprises. And although many claim to feel entirely satisfied to receive nearby stations altogether, few there are who do not some time experience the impulse to reach out beyond their own sphere of acquaintance. Even to hear the bare call letters from some far-off city tickles one's fancy, especially if there's a friend around to hear it too. It is not so much the actual enjoyment of long-distance receiving, but the mere potentiality of the thing.

I know a man who cared little about really tuning for weak stations, but who wanted to know and be able to tell his friends that he could hear St. Louis, Cuba, and so on, with his machine. The salesman had to go to this man's home and let him hear the announcements from three or four "DX" stations before he felt assured. And I doubt whether he ever bothered to get them again. He'd say, "Sure, this set will bring in anything this side of the Rockies, but what's the use? The best entertainment comes right from New York anyway!"

But to others the "itch for distance" is more compelling. We want to listen to the local stations for our chief entertainment, but we do wish at times to set our dials for some unfamiliar station.

Now, it is impossible for any one to predict just what one can get with any given radio set, regardless of its supposed sensitivity. "Coast-to-coast reception on a loud-speaker" cannot truthfully be claimed for ANY type of equipment unless we know



By Brainard Foote

We want to hear a voice from a thousand miles away announce the "Gold Metal Station, Minneapolis-St. Paul" or in those melodious Spanish tones give the call as PWX, Havana

the simplest sort of one-tube outfit and "log" or list sixty stations in an evening, whereas an unskilled operator may have a superheterodyne or five-tube receiver and get only two or three stations that are not classed as "locals" in the same night. Then again, the same man might use the same set erected in different locations and installed more or less efficiently and get widely varying results.

Therefore, we must think of all these things when we use the receiver. Seldom can we have everything perfect. The country lad, with ideal conditions so far as location is concerned, may not be able to afford the most sensitive outfit, while the city man with means can have a very sensitive receiver, but may have to get along with only an indoor aerial. However, it does surely pay to make all such

conditions governing reception as favorable as possible. Of course, if you care nothing for distance reception, the requirements for good local results are far less rigid. But just now we are thinking of those who do care about longer range—and few of us don't!

This factor, of course, is usually beyond our control. The set goes where we happen to dwell, naturally. But it may be well to know what to expect. In cities, especially close to big steel buildings, bridges, powerhouses, gas tanks and other metallic structures, the radio set is at a disadvantage. Iron and steel structures

(Continued on Page 30)

in addition certain other facts upon which the receiving power of a set depends.

The chief factors controlling this receiver power are:

1. Location (in relation to cities, buildings, etc.).
2. Installation (aerial, tubes, batteries, etc.).
3. Type of set (sensitivity and selectivity).
4. Skill of operation (time and dial settings for listening).

In a consideration of these factors it is not possible to state which is uppermost. Indeed, a skilled operator will often take

Vol. IV Contents for January, 1926

No. 8



Cover Design painted by Earl K. Bergey	PAGE
Editorially Speaking	4
What Can I Get?	7
Station KDKA	8
And Madame Enters	11
The Original Radio "Sandman"	14
Radio and the Music Student	17
Battery Connections for the New Tubes	20
37 to 800 Meters Without Changing Coils	24
Notes From the Lab at Station 3XP	31



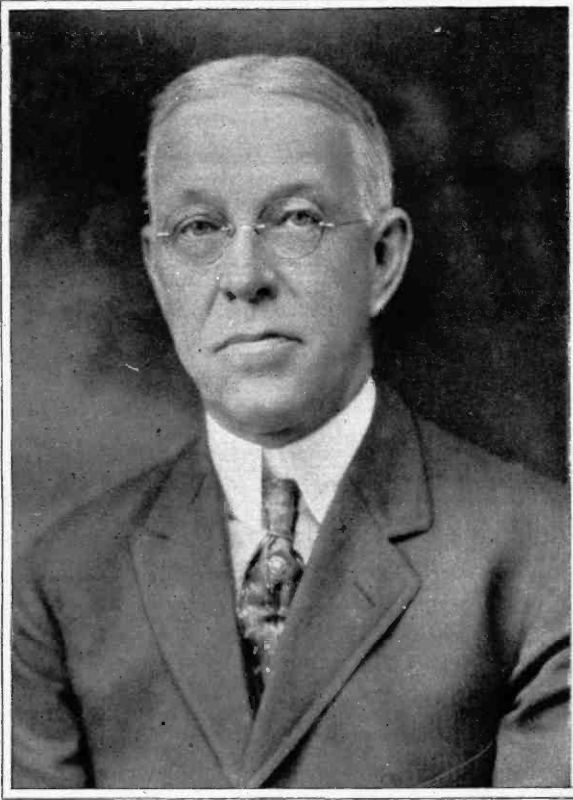

Station KDKA

By W. W. Rodgers

T. J. Vastine is conductor of the band, which plays a wide variety of classical and other selections adapted for use by concert bands.

Another KDKA organization was organized for the express purpose of being put on the air. This was the KDKA Little Symphony Orchestra.

*H. P. Davis,
Vice President
of the
Westinghouse
Electric and
Manufacturing
Company. He is
acknowledged to
be "The Father
of Radio
Broadcasting."*

In an average group made up of more than 100,000 residents of large American cities, there probably will be found a surprisingly large number of people who are amply qualified, by ability and training, to earn a good livelihood as professional musicians, but who find other forms of life work more attractive to them for various reasons. And while they do not choose to spend their entire time in concert or orchestral work, they nevertheless welcome an opportunity to play with a high-grade musical organization.

It is such players who make up the KDKA Little Symphony Orchestra. They were picked from among the 35,000 Westinghouse employes or their families.

Victor Saudek, musical director for the Westinghouse stations, conducts the orchestra. Although he still is a young man, he has had a long experience in orchestral and other musical work, having played in orchestras since he was 15. He received his musical training in America, and played in orchestras directed by such famous conductors as Mascagni, composer of "Cavalleria Rusticana"; Richard Strauss, Victor Herbert and Emil Paur, director of the old

THIS is a story of how various individuals, organizations and institutions were asked to go on the air from Westinghouse Station KDKA, consented, and because they found the experience of taking the air greatly multiplied their usefulness and happiness, have continued to take the air more or less regularly ever since.

One of the first of these "individuals, organizations and institutions" to take the air was the Westinghouse Employes' Band. This organization, made up of people employed by the Westinghouse Electric & Manufacturing Company at its main works and general offices in East Pittsburgh, was giving concerts long before the company established Station KDKA, the world's pioneer broadcasting station. When the early program makers were casting about for program-making material, the band was one of the first things that popped into their minds, and accordingly it was asked to give a program. The program makers, band and radio audience were well pleased, and giving a program weekly became a habit with the band.

The Westinghouse band and the station are almost synonymous terms among listeners in Europe, Australia and South Africa, for letters to the station show that the people who regularly listen to it abroad hear the Saturday night programs more often than those of other nights. This

is because people in these countries, to hear a program broadcast at from 8 to 10 o'clock in the evening in Pittsburgh, must listen in at 1 to 3 o'clock in the morning of the following day, and even later, due to the difference in time. Those who must stay up until the break of day to hear a program from across the sea prefer to do it on Sunday morning, as they have a chance to catch up on sleep during the day.



To the right is the KDKA Little Symphony Orchestra under the direction of Victor Saudek



Victor Saudek, Musical Director of Station KDKA

a Pittsburgh steel mill when he became interested in the KDKA Little Symphony Orchestra. He had studied the cello while at the University of Sofia, and when it was learned that he had a degree in science, he joined the research department of the company, doing work along chemical lines, and has been playing in the orchestra.

One of the members who developed into a skilled musician after the orchestra was organized was Leo Kruczek, who after playing for a time with the Little Symphony, at 17 years of age, went to the violin section of the Minneapolis Symphony Orchestra. He now is playing with the Little Symphony after a season with the Minneapolis organization, and is teaching violin in Pittsburgh.

One of the original members of the orchestra was R. R. Baker, an engineer, who had been a member of the company's general engineering department when the



B. Dare Fleck, Program Director of Station KDKA

Pittsburgh orchestra and conductor of the Royal Opera of Berlin. He is a member of the faculty of the school of music, Carnegie Institute of Technology, and during the war was instructor of army bandmasters.

When Mr. Saudek organized the orchestra in 1912, he found several Westinghouse men who had conservatory training and had played in noted orchestras and bands in America and Europe. Later musicians were attracted to the orchestra and through it became identified with the Westinghouse Company, while in a case or two, musicians have been developed in the families of Westinghouse employees and have joined the orchestra.

One of the musicians attracted to the orchestra after it went on the air is Natcho Vasileff, a native of Bulgaria, who came to America after the World War. Although a graduate in science of the University of Sofia, he had been unable to find in the strange land a position to which his training fitted him, and was doing manual labor in

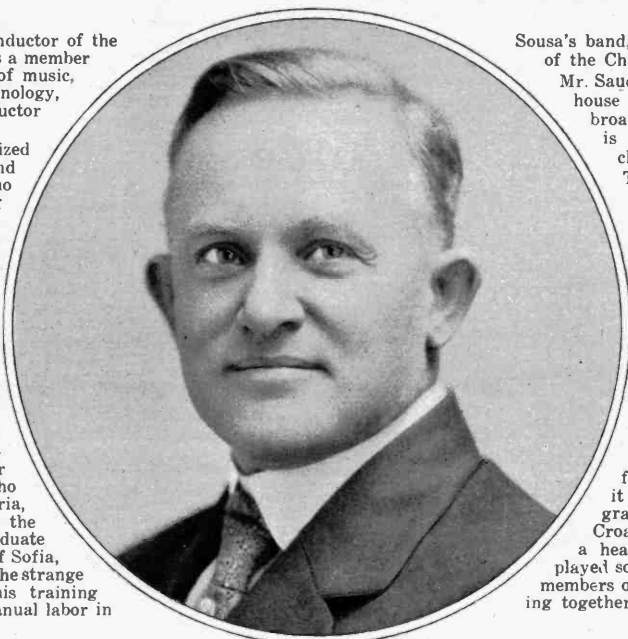

H. W. Arlin, Pioneer Announcer of Westinghouse Station, KDKA, Pittsburgh. He has resigned



Sousa's band, the St. Louis orchestra and of the Chicago Grand Opera.

Mr. Saudek also conducts the Westinghouse Symphony Orchestra which broadcasts Sunday afternoons, and is organizing an employees' orchestra of 100 pieces.

These organizations by no means complete the roll of Westinghouse musical groups that are popular with the great radio audience, for the Westinghouse community chorus, a mixed chorus of sixty voices under the direction of Alfred Bartletti, broadcasts programs, as does the Croatian Tamboritzza Orchestra.

The tamboritzza orchestra gave its first program only this year, but the demand on the part of the radio audience for repeat programs has made it a regular feature of the programs. The tamboritzza is a native Croatian instrument, shaped like a heart and of various sizes and played somewhat like a mandolin. The members of the orchestra had been playing together for several years, and their

J. C. McQuiston, Manager of the Publicity Department and Director of Westinghouse Radio Broadcasting

company took up broadcasting. His father was a professional musician, once a member of the Cincinnati Symphony Orchestra. The son had been trained as a musician from youth, and might have been expected, as a matter of course, to follow the bent of his early training and become a professional musician as his father was. He chose, however, to become an electrical engineer, and after completing his engineering course at the University of Michigan came to the Westinghouse Company, where he was located when the Little Symphony was organized.

The regular orchestra personnel is supplemented from time to time by players who have been with organizations like

Dr. Charles Heinroth, Organist of Carnegie Music Hall, Station KDKA





Frederick G. Rodgers, who has gained unusual popularity as a radio announcer at Station KDKA. He is also a singer and appears before the microphone from time to time

short-wave relay system. Richard Kountz appears at KDKA in the double role of pianist and composer. One of the younger of American composers, he has become a sort of "radio composer," as several of his songs have been heard for the first time over KDKA, and one of them was named by the station's audience. "Sleepy Hollow Tune," perhaps the most popular classical song produced in the last several years, was heard first over the station, and sixteen thousand of the station's listeners submitted names for another Kountz composition, the name chosen being "When the Dawn Breaks Through."

Mr. Kountz also is a native Pittsburgher. His compositions include songs, choruses and instrumental works. He frequently plays the piano during presentation of his compositions. He now is working on a radio opera.

Miss Irma Carpenter, one of the KDKA



Raymond Griffin, Bass, who appears on KDKA's program from time to time

native Croatian airs and other melodies, with the excellent transmission of this type of instrument, made a hit from the first program.

One of the KDKA vocal soloists has achieved the paradoxical distinction of retiring as a singer and later multiplying her audience many times, so that it includes people in parts of the world where she never before had been heard, although she has an international reputation as a concert singer. This singer is Christine Miller (Clemson), famous Pittsburgh contralto, who retired after her marriage and since has been heard only over KDKA, except for appearances at benefit concerts. Her new audience includes every part of the English-speaking world, in addition to every country of Europe, as practically every spot in the globe where radio receivers are generally operated is being regularly reached by the station's international

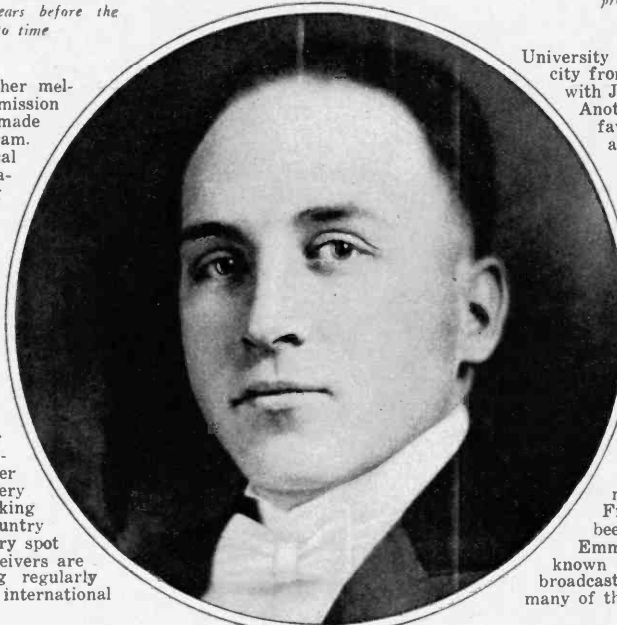

Miss Mabel King, Contralto, who appears on KDKA's program occasionally

Richard Kountz, composer and pianist of Station KDKA

soprano soloists, and Chaunsey Parsons, tenor, had singing over the radio thrust upon them. They were soloists at the Shadyside Presbyterian Church in Pittsburgh, and when the pastor, Dr. Hugh Thompson Kerr, began putting his Sunday evening vesper services on the air, their singing was broadcast as a matter of course. So kindly did the radio audience take to their voices that they have continued to sing regularly from the station, frequently appearing as soloists or members of an ensemble during the evening musical programs.

J. Lloyd Mahony, baritone, became interested in singing over the radio through the University of Pittsburgh studio. Mr. Mahony is a member of the faculty at the

University of Pittsburgh, coming to the city from New York, where he studied with Jerome Hays.

Another baritone who has been a favorite with the KDKA audience added a new role and was the anonymous announcer for the KDKA commercial concerts, whose identity baffled listeners-in for several months.

Although no reference was made by the station to the fact that a new announcer was on duty, people at once began writing to the station asking if the new voice was not that of various well-known announcers they had heard from other American stations.

Although the listeners did not recognize the voice, they had been hearing it regularly in previous concerts, for the new announcer was the baritone, Frederick W. Rodgers, who had been singing from the station.

Emma Bauman Lewis, soprano, well known in concert and oratorio before broadcasting was inaugurated, is said by many of the radio listeners to possess an

(Continued on Page 25)

C. W. Horn, Superintendent of Radio Operations at Westinghouse Electric & Manufacturing Co.



By Jean Sargent

And MADAME ENTERS

JUST a matter of a few years ago radio, while an accepted fact, was not known to any but a few enthusiasts, and they were the type that loved all sorts of soldering irons, ohms and condensers. They talked Morse, they lived in a state of picking up and they were what is now known as "hams."

Scarcely was there a woman who had any definite knowledge of what it was all about. She knew that the men folks in her family had a machine, many times covered with a cloth, that must not be disturbed. Why, one was not even allowed to dust near that contraption! Usually there was a key, and also the nastiest kind of batteries that more than likely leaked and ate holes in the floor covering. Of course, if the home contained an attic, then the whole proceeding moved there, much to the housewife's relief.

All that has changed and is still more changing. A radio set is now a part of the needed articles in the home, just as the vacuum sweeper, the food chopper and what not that is intelligent in its uses. And nowhere is there a more intelligent article of furniture than a radio set. One can have just as simple or as elaborate a set as means and taste afford. Period furniture can be matched, artistic design in receiver and table or console is achieved through study, and the radio of today is harmonious in every respect. In fact, the recent radio shows stressed beauty of construction in the cabinet and the equipment, such as loud-speaker and container for receiver and batteries, as much as they did points of quality.

So the man of a few years back has sacrificed nothing. In fact, he is much the gainer, as who knows that when listening for China the atmosphere surrounding the Chinese Chippendale cabinet housing his favorite make of receiver may bring China still clearer to him?

It was my good fortune to be associated with one of the earlier stations, when broadcast was an infant. At that time I was in charge of a direct-mail department of a store that sensed the value of radio publicity, perhaps chiefly because one of the men active in the store interests had a longer vision than many others, and he, so to speak, grabbed off a good thing when it was young and trained it.

Before the station was put in operation, and when the radio department



Jean Sargent, women's program director of Station WHT

JEAN SARGENT is a pioneer—in fact, is "the" pioneer—in putting on radio programs especially for women. There is probably no one in America—and that means the world—who is more closely in touch with the sentiments of women listeners in toward radio in the home. We, of "Radio in the Home," have been in close touch with her ever since the early days of which she writes so entertainingly in this article and we are glad that she has at last found time to write for us a series of articles telling of her work and of the things that women demand on their radio programs.

Miss Sargent started with Station W'N'AC in Boston. She is now in charge of women's features for Station WHT in Chicago and she has formed a most remarkable radio women's club from the latter station. Several thousand women have registered as members of this club and they have told her just what they want from their radio sets. In these articles for us, Miss Sargent will tell you something about these demands.

H. M. N.

was just a few counters and mighty little else, I was given certain correspondence to handle regarding radio material. Now writing .0005 seemed a mistake to me, but at that time I just went ahead and got out the stuff with no idea of what it was all about.

Then when the station went into active operation, I also handled all the mail, and my duties were to answer each letter or card with an acknowledgment, and if the letter we had received contained a direct inquiry I had to answer that. Of course, that meant many talks with the engineer and gradually a slight knowledge of what I was writing about.

About 99 per cent of the mail was from men. Nearly every letter had a very strange drawing, called a hook-up. At first I rather thought the writers were a most untidy lot, had spilled the ink and let a fly track through it and never troubled to throw it out.

But as each writer assured us that the hook-up was the best he had used and he was at radio from its birth, and moreover we could use that hook-up with his permission, I naturally thought I ought to consult with the boss, as we called him, regarding their value.

Now right there I learned what he knew about radio. It was what I knew, except that he owned a set and had seen several kinds and even one or more stations in operation, and when I questioned him regarding the drawings, he gave a most wise look, and said, "Better file them for reference." I did, and I guess they are still to be had if ever needed.

Then on top of that the news leaked out that the antenna had a lot to do with the reception from a station, so after a bit of information along that line by our engineer the public began to send in for information and those letters were accompanied by a great and weird drawing of a Queen Anne front and Mary Ann back type of house with poles and wires suspended therefrom, and how high should it be and East or West was to be settled. That was a trying period, especially when the stenographic force got a drawing mixed and sent the wrong measurements, and then we had an irate listener who advised us, just as now, that we had a punk operator and a few other choice but well-chosen statements.

Now and then came a letter from a woman—mostly, however, from some one who had a man in the family—writing to thank us for a concert.

Pretty soon more women remarked about programs, and now and then we found a real fan, some who had actual experience in "sending" in a small way, and could tune a set so as to get good reception. Then they truly began to be interested and expressed opinions regarding what they liked and what they didn't like. All this time they were still thinking of it as a man's pastime and plaything.

Concerts were usually of one or two hours' duration, as then all stations were on 360 meters and there was a gentleman's agreement regarding the amount of time each should have. One heard songs, an instrumental number, more songs and another instrumental number with a great deal of "just a minute please" that helped fill the evening. Once in a great while a really good speaker appeared.

Then came the church services, and then came the deluge of letters and they were glorious. Shut-ins who had been for years deprived of such things, hospitals, jails and even homes where church-going was not a part of the Sunday routine wrote. People sent in money and checks, and the following Sunday hundreds went to see the church and the rector and hear the music first-hand. That was a phase of broadcasting that meant much and by many was the least appreciated for some time. There was no creed or race in this air church service. After it left the church, it brought every kind together, most of them to their own several denominations.

Then the one big thing in that year was grand opera, and I have the most sincere respect and admiration for the director who made that possible. But the funny part as I now think of it was the fact that they installed several loud-speakers in the big restaurant and invited a most skeptical press to be among those present and secure a first-hand impression. Many of the press responded, looked utterly bored and left early to write their closing impressions. And again the man who was interested in opera for that city hoped they would have some letters on the opera so they could be guided in the future about the same thing.

Now that man directed that the letters be put on his desk. They were, and when he arrived at his office he couldn't find the desk, as there were mail sacks galore and tumbling around everywhere were letters, and he said no more regarding mail, but a second opera followed the first and so on.

Hundreds and hundreds of persons who had failed to respond to opera for a long time purchased tickets; many who had thought grand opera a pastime of the rich

and the learned went, and the response was immense. The opera owners were not over-impressed, as they are supposed never to be, and again they were guaranteed so much before they opened, but those who were instrumental in bringing opera there and who had on several occasions made up the deficit were impressed, as there is nothing that talks better than the box office receipts.

Prior to the opera opening, the advertising manager secured a batik exhibit.

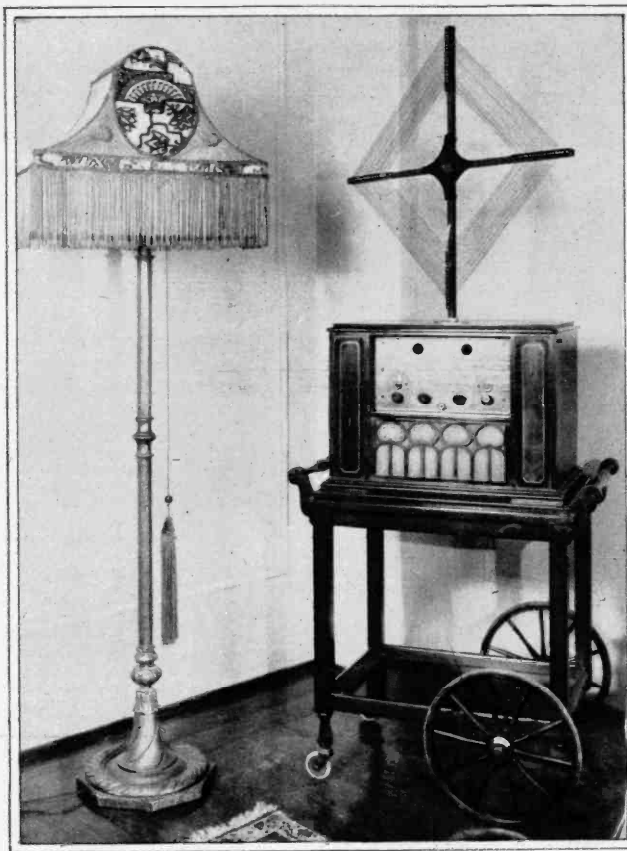

And Madame enters the radio factory also—not in person, but her influence as a buyer is shown by such tea-wagon installations as this one

There were lovely batiks displayed and just how to do the thing was most ably shown by bobbed-haired maidens imported direct from Greenwich Village. Cigarettes and smocks and atmosphere galore surrounded them. For some reason the advertising didn't hit and so they decided to try radio, and I was lugged into the scene.

Now, I loved the art and expressed it in my best way. The talk "went over," for soon came men and women saying they had heard about it through the radio.

So we tried other things and at Christmas time we told the world what to buy and whom to give it to and all sorts of information regarding the proper Christ-

mas spirit. If there were any that year who failed to get what they wanted, it was no fault of ours. We approached the talks each morning with the kindly help of a phonograph record fitted to the season. And at intervals we used many such talks, and at Easter again repeated the gift habit and lots of good cheer was thrown in with more records of the right kind. As the talks were of more or less appeal to women, we had the greatest response from women,

and I had offered my personal help in their gift selection so I was able to sense that they liked their own part in the program.

Some time before the talks were put on, the announcer who had the noon program failed to show up. The operator, with the transmitter all ready, buzzed to go ahead and there was no one to go. I rushed to the elevators and no one appeared and I didn't know how to reach the operator without going to the eighth floor, so I put a music roll on the player-piano and started it, pushing every switch in sight and, lo and behold, it went on the air.

After two attempts like that and with the operator still buzzing, I announced to the world what was going on. Imagine the operator's surprise to hear me in place of the bass of the usual announcer. Well, it got out and I was rather well pleased until some one telephoned the boss to take that squeaky man off the air. You see, women had not announced up to that time. Well, it hurt, but that is a mere nothing to what I have since heard said about women announcers.

All this time we were receiving more mail from women—good, kindly letters asking for features and giving genuinely constructive criticisms, and we really began in a small way to cater to them, and

I was more than passably interested, as I had put on several holiday seasons and wanted the reaction of them. It had been hard to get a real expression from them regarding what they wanted as a regular feature, but they did want something and began more and more to say so.

Mail in the meantime was most interesting, and one real funny letter that came from a man but concerned his wife read in part like this: "Dear Radio Folks—We, my wife and I, have been married twenty-six years. She is a good wife and I have been a home-loving man. But she had a bad habit of nagging, especially as I liked to be comfortable when I go home, and it was 'don't do this' and 'don't do that' until I belonged with the don'ts. You more than likely kept me from murder and this is how it happened. One of my neighbors asked me to take his radio set and use it, as he was

(Continued on Page 22)

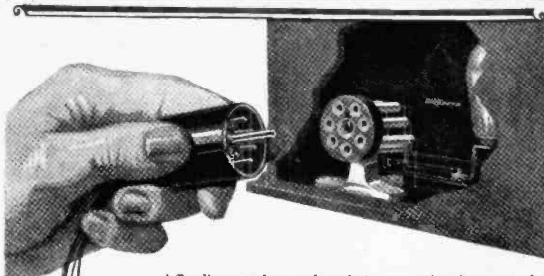

Affording a plug and socket connection between the radio set and all outside connections, Jones Multi-Plug is as essential to the radio as a cord and socket to the electric iron. For safety and convenience leading set manufacturers have adopted this item as standard equipment. You, too, need a Multi-Plug for the set you are building or the set you now have. See your dealer or write direct for descriptive folder B.

TYPE BM—For Set Building.....\$4.50
 TYPE BP—Adaptable to Any Set..... 5.00

HOWARD B. JONES CHICAGO, ILL.
 614-18 S. CANAL ST.



Jones MULTI-PLUG

THE STANDARD SET CONNECTOR

Two Good "Signal" Loops Take Your Choice

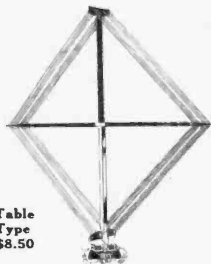
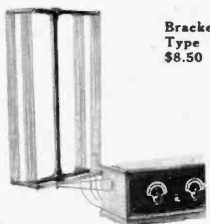

Table
Type
\$8.50



Bracket
Type
\$8.50

A bracket type that attaches right onto the end of your radio cabinet or a table type—you can't miss it in either one. When you buy a Signal Loop you're buying more than just good looks. You're buying an aerial backed by thirty years of experience in the manufacturing of electrical equipment.

Where quarters are close, remember the bracket type loop attaches right onto the end of your set and does away with that "extra piece of apparatus." It turns a complete 360° in the width of the standard cabinet.

Both aeriels are beautifully constructed. The bracket type is of solid walnut. The table type is mahogany finished. All metal parts are heavily nickel plated. A third tap is provided for sets requiring it. Ask your favorite dealer to show you the Signal Loops—either type \$8.50. You will surely want one.

JOBBERS & DEALERS—If you are not fully acquainted with Signal Radio Products, we will be pleased to send you complete information. Write us at once for literature.

SIGNAL ELECTRIC MANUFACTURING CO.
 Dept. 11-A Menominee, Mich.

Branches in All Principal Cities

TONE

Full, sweet, mellow and natural, without the slightest indication of distortion, is another achievement that is making the APEX SUPER FIVE the most popular of all receiving sets,

VOLUME

That supplies dance music or entertainment without any loss, is a feature for which the APEX SUPER FIVE is world famed.

DISTANCE

Lends added enjoyment to radio with an indescribable fascination of tuning-in far away stations, which is always possible with the APEX SUPER FIVE.

Ask your dealer for a demonstration. Your eyes and your ears will tell you that APEX stands at the high point of perfection in both performance and appearance. \$80 without accessories.



**SUPER
5**

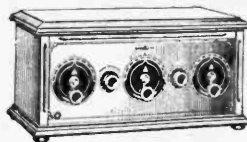

APEX ELECTRIC MANUFACTURING CO.
 1410 W. 59th St. Dept. 112 CHICAGO

B-T Counterphase and Nameless Circuits

Continue to Make Unequaled Records

Read what they say—

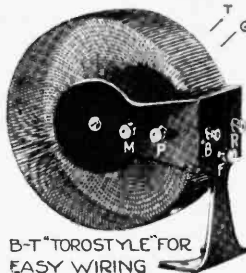

B-T "TOROSTYLE" FOR
EASY WIRING

Kansas City. The Counterphase is in every particular by far the most efficient receiving set that I have owned or heard in operation. One stage of audio is quite sufficient for ample loud speaker reception in five rooms of all class B stations in the U. S., and many class A.

Chicago. November 9th outside of the usual run of distant stations the following were picked up from Chicago Heights: Miami Beach, New Orleans, New York, Denver, Springfield, and FOUR DIFFERENT STATIONS IN CALIFORNIA.

Cincinnati. Summarizing tests on Counterphase Set I can safely say it has more volume, greater selectivity, greater sensitivity and produces higher quality of reproduction than any receiving set I have ever heard.

Torostyle Transformers in three styles: TA Antenna Coupler, TC Intermediate, T4 for one-stage radio, each \$4.00.

Kit No. 5 for the patented 5-tube Counterphase, \$28.50.
 Kit No. 6 for the 6-tube Counterphase, \$38.00.

The Counterphase 9-color wiring diagrams have never been approached in radio. They leave no room for error.

Have You Read "Better Tuning"?
 80 pages, postpaid 10c

BREMER-TULLY MFG. CO.

532 S. Canal St., Chicago

The ORIGINAL RADIO "SANDMAN"

By Eugene Konecky



Val McLaughlin, the original "Sandman," of Station WOC, who is now with Station WOAW

"AND so the handsome Prince rescued the beautiful Princess and they were married and lived happily ever after." Then comes a soothing lullaby and thousands of listening kiddies prepare for the Land of Nod at the behest and inspiration of the original radio "Sandman," Val McLaughlin, now at Radiophone WOAW, owned and operated by the Woodmen of the World Life Insurance Association at its headquarters in Omaha, Neb.

For many years the beautiful voice of the original radio "Sandman" was known to juvenile and adult radio listeners from the well-known Davenport WOC, where she met "her handsome Prince" and Cupid shot the barbed arrow of love-at-first-sight, which sent the beautiful Princess on her happy honeymoon. But the beautiful Princess could not forget her former role as the "Sandman" and she longed to impart to the thousands of kiddies, who she had once thrilled and entertained, the wonderful stories which she had whispered through the microphone into their attentive ears for so many years and so, she came back to radio and is now affiliated with WOAW in her former role.

Val McLaughlin is known as "the voice of a thousand smiles" and also "the best known woman's voice in America." This is not merely the consensus of opinion of her large radio audience, but the judgment of radio experts who have carefully tested her voice. Her popularity and the magic of her laughing voice combine to win for her the honor of becoming an exclusive Brunswick record artist and she records her "Sandman" stories and children's version of bible stories.

Miss McLaughlin's specialty is the entertainment of children, but this is by no means the field to which she is

confined. Among the thousands of letters which she has received from her radio listeners, a great portion are from grateful adults who enjoy her work. She is also a capable dramatic artist, and has successfully given interpretations of the leading roles in such plays as "Ten Nights in a Barroom" and Sudermann's great drama "Magda." In addition to her radio "Sandman" stories, she is in constant demand for public entertainment of children at band concerts in parks; schoolchildren's parties; Sunday schools and private parties. She is also very prominent in amateur theatricals under the auspices of leading civic organizations. In fact, it is impossible for her to comply with full demands for her services.

Miss McLaughlin is a fitting illustration of the old adage, "One cannot become an artist; one must be an artist from the first." Since the time when she was 4 years old she has done public entertaining. On that first occasion she gave the prelude at a church Christmas exercise, and since that she has launched upon the sea of professional entertainment with gratifying success.

She commenced her dramatic training at Dubuque, Ia., Mount St. Joseph College from where she was graduated and of which she is at present the First Vice President of the Alumni Association. For several years she studied dramatic art at the Columbia College of Expression in Chicago from which she is also a graduate.

Then followed several seasons on Chautauqua and Lyceum Circuits in which she traveled from "post to post" building up a reputation as a recognized entertainer by the sheer power of

her personality and talent. She was formerly associated with the John B. Rogers Production Company, of Fostoria, O., a pioneer amateur theatrical organization, and from this experience she derived a great deal of valuable knowledge in relation to public entertainment. In 1922 she created the character of the original radio "Sandman" and became associated with Radiophone WOC at Davenport.

Like many others, Val McLaughlin entered the radio field at a time when its possibilities were undreamed of. She first offered her radio "Sandman" stories incidental to her other duties as a public entertainer, but soon the demand for her services became so great that in a short time she was devoting her entire time to the "Sandman" work. In evidence of her immense popularity, we refer to the popularity contest held in Davenport, Ia., in 1923, under the auspices of the American Legion. She was awarded the popular prize of a diamond ring.

Many other gifts have been received by her as a direct evidence of the appreciation which her audience holds for her unique and inspiring entertainment. She has received as many as twenty-two boxes of candy in one week.

She understands children—their joys and their sorrows, their likes and their dislikes. She has the imagination to penetrate into the child's mind, and she knows that the most attractive element in anything for a child is the element of surprise, and all her stories are full of surprises.

Her voice is not only the "voice of smiles," but of tears; of sudden joy; of depression; of giddy happiness or fear. In fact, she is capable of expressing the gamut of human emotions and conveying it to her listeners just by the mere intonation of her voice. In that respect she is a supreme artist. Stacks of mail which are pouring into the studio of WOAW testify to the continuation of her popularity with her old friends and with the thousands of new friends which she is making from "the voice of the Woodmen of the World."



No matter what circuit— Far, Far Better Results with **KARAS** Orthometric Condensers and Harmonik Transformers

Karas Instruments have been tested and recommended by leading technical editors for use in all types of sets from the most elaborate super to the simplest low loss 3-tube receivers. The most exacting home set builders, the country over, demand Karas Transformers and Condensers—and will use nothing else. Nothing can take the place of these scientifically designed, precision instruments. Use them in your next set or improve your present set by installing them. It's easy to do—the results will be worth many times the cost.

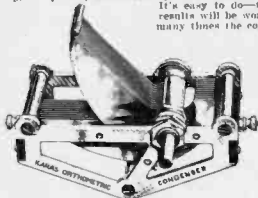

Spreads Stations Evenly Over the Dial—No Crowding Whatever

The Karas Orthometric Condenser positively separates all adjoining wavelengths by EQUAL distances on the dial—giving you full benefit of 16 Kilocycle frequency separation fixed by the government. Ordinary condensers jam 70 of the 100 government allotted wavelengths into the first 30 points on the dial—even straight-line-wavelength condensers crowd 57 of them below 30. But with Karas Orthometrics each point on the dial corresponds to one of the 100 allotted wavelengths. The result is marvelous simplicity in tuning—and better, clearer reception—all side bands without interference.

Brings in KDKA at 53 Not at 41—or 28, but at 53, where it belongs, leaving lots of room for the 52 wavelengths that must come in below it. The Karas Orthometric is a "precision job"—entirely of brass. Every joint soldered. Plates patent-levelled and securely braced.

If your dealer is out of Karas Instruments
Order Direct on This Coupon
Most good dealers everywhere sell Karas parts. If your dealer happens to be one who doesn't, we will supply you direct at no trouble on your part—our 30-day, money-back guarantee. Just fill in and mail this coupon at once. Send no money. You can pay the postman on delivery.

Karas Electric Co. 4045 N. Rockwell St. CHICAGO, ILL.
For more than 30 years makers of PRECISION Electrical Apparatus



For Long Distance with Big Volume and Keen Musical Quality

Karas Harmoniks deliver perfect music with loads of volume from stations one to two thousand miles distant. "DX" broadcasting becomes really enjoyable. "Flashing" for distant stations is only a matter of tuning programs you want to hear—not straining to catch only the bare announcement and making up a line of call letters. Even from far-away points, Karas Harmoniks bring out full, round musical tones. All the vital harmonics and rich overtones are fully retained. Low bass notes pour forth, rich, sweet, sonorous.

If you want music like this, you must have Karas Harmoniks in your set. Get a pair TODAY! The best transformer money can buy.

..... Karas Electric Co.,
4045 N. Rockwell St., Chicago

Please ship me the instruments checked below. I will pay the postman prices listed, plus postage, upon delivery. It is understood that I have the privilege of returning these goods, for full refund, within 30 days. If they do not prove entirely satisfactory,

..... Karas Harmonik Audio Transformers—(\$7.00 each)
..... Karas Orthometric Condensers: Size

(23 plate \$7 each, 17 plate \$6.75 each, 11 plate \$6.50)

Name

Address

If you send cash with order, we'll send package postpaid.

Product of over 30 years' Experience



The Favorite Voice of Radio in All Tongues

TO hear an Amplion in comparison with any or all other loud speakers is to appreciate at once why Amplions are the largest selling radio reproducers throughout the world—favorites of music lovers in all lands.

The actual originators and oldest makers of loud speakers, Alfred Graham & Co., London, England, evolved The Amplion. Its superbly life-like

reproduction and supreme clarity on all notes give eloquent testimony to Graham's more than thirty years' experience in sound reproduction.

Bring out the full musical quality of your set with an Amplion loud speaker or console unit. The prices are \$12 to \$42.50. All Amplions are completely equipped with cord and panel plugs. Write for the "Amplion Pedigree" and dealer's address.

THE AMPLION CORPORATION OF AMERICA
Executive Offices: Suite U, 280 Madison Ave., New York City
Canadian Distributors: Burndep of Canada, Ltd., Toronto

Associated Companies and Agents: Alfred Graham & Co., London, England; Patentees: Amplion Corporation of Canada, Limited, Toronto; Compagnie Francaise Amplion, Paris, France; Compagnie Continentale Amplion, Brussels, Belgium; Amalgamated Wireless (Australasia), Ltd., Sydney, and Melbourne; British General Electric Company, Ltd., Johannesburg and Branches: Indian States and Eastern Agency, Bombay and Calcutta; C. J. Christie E. Hijo, Buenos Ayres; David Wallace & Co., Valparaiso; Mettre & Platte, Rio de Janeiro; F. W. Hammond & Company, London and Tokio.



Unless it's meter equipped, it can't be a

Sterling

TUBE REACTIVATOR

"Renews your tubes and tests them, too"

THE STERLING WAY
Keep Tubes Tearing With Vitality and KNOW Exactly What They're Capable of Doing

No guesswork. The meter-reading shows whether reactivation necessary and proves to you how much amplification is improved by this tube treatment.

It pays for itself in better reception alone—then, too, think of the saving in tubes. Price \$2.50.

THE STERLING MFG. CO.
Cleveland, Ohio. Dept. K.

CARTER

New "FLAT" Plug

Pat. Pend.

Full Size 75c

CARTER

This plug was the sensation of the New York and Chicago Radio Shows. Again Carter originality scored a success. Fits flush against panel, cords hang down. Instantly connected or disconnected.

Any dealer can supply

In Canada
Carter Radio Co., Limited, Toronto

ALL-AMERICAN

TRADE MARK

Experienced set-builders do not experiment when they want results. They use ALL-AMERICAN parts because of their

Reliability

For consistent, year-after-year performance, look for the ALL-AMERICAN name-plate and the guarantee serial number on parts you buy.

Pioneers in the Radio Industry

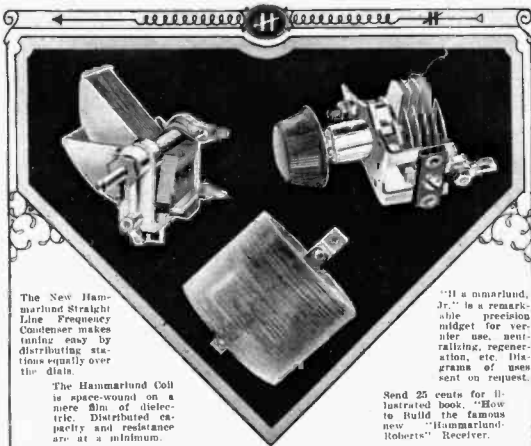

The New Hammarlund Straight Line Frequency Coupler makes tuning easy by distributing reactions equally over the dial.

The Hammarlund Coil is spaced-wound on a mere 5/16" of dielectric. Distributed capacity and resistance are at a minimum.

"It is Hammarlund, Jr." is a remarkable precision midget for ver-tiler use, acul-trating, regeneration, etc. His grams of use sent on request.

Send 25 cents for il-lustrated book, "How to Build the famous new "Hammarlund-Roberts" Receiver.

THEY WILL IMPROVE YOUR RECEPTION

The day of perfection in radio will arrive when set builders discover that quality parts results come only from quality parts.

Why construct a receiver from poor parts and then complain that radio has not yet been perfected?

- These Manufacturers Use Hammarlund Products
- DeForest Radio
 - Esule Radio Co.
 - F.B. Ferguson, Inc.
 - Malone-Lemon Co.
 - Music Master Corp.
 - Prices Radio Corp.
 - Steeper Radio Co.
 - Stinson
 - Electric Co.
 - Phonix Radio Co.
 - and many others

Hammarlund has been making precision instruments for tele- phone, telegraph and radio for fifteen years. Hammarlund Precision Condensers and Coils are acclaimed the world over by engineers and radio amateurs, who have learned the les-son of quality.

HAMMARLUND MANUFACTURING COMPANY
424-438 W. 33rd Street New York City

For Better Radio
Hammarlund
PRECISION
PRODUCTS

IMPROVE YOUR TUNING, USE—

**BIRNBACH
LOW-LOSS
TUNER**

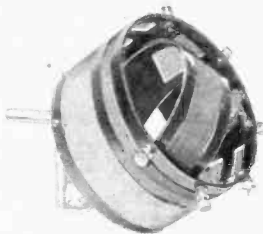

Price
\$2.00

For Distance, Volume and Selectivity

Birnbach Radio Frequency Coil **\$1.00**

For sale by

America's Greatest Chain Stores:
S. S. KRESGE CO. W. T. GRANT CO.

There's a Store in Your City

BIRNBACH RADIO CO.
370 Seventh Ave. New York City

Cadiz, O. 

Verified Reception from Paris by Cadiz, Ohio, Radio Fan

Coast to Coast On a Loop is easy with a

VICTOREEN Superheterodyne

4—No. 170 R. F. TRANSFORMERS at \$7.00 each and 1—No. 150 Oscillator Coil at \$5.50.

Constitute The Heart of The Circuit No oscillations, howls or squeals—no matching of tubes. Complete parts to build the "Victoreen" can be purchased of your dealers for between \$50.00 and \$75.00—depending on quality of material selected. Ask your dealer for free "Victoreen" folder which contains hook-up and complete information, or write us direct.

THE GEORGE W. WALKER CO.
6550 Carnegie Ave. Cleveland, Ohio

Branch Sales Offices Are Located at:
50 Church St., New York City
719 Raymond St., Philadelphia, Pa.
1323 Wall St., Dallas, Texas
910 Terminal Bldg., Seattle, Wash.
300 Sugar Bldg., Denver, Colo.
332 St. Catherine St., Montreal, Que., Can.

San Francisco, Calif.
Chicago, Ill.
Columbus, Ohio
Los Angeles, Calif.
Boise, Idaho

Send for this RADIO BOOK FREE 

1926 Catalog of RADIO BARGAINS Save 1/3 to 1/2

The World's Largest Exclusive Radio Mail Order House Will Send You This Wonderful Book FREE

64 illustrated pages containing thousands of bargains in radio sets, semi-finished sets and radio kits of all styles, sizes and approved circuits. Beautiful models of the very latest designs and types. Elaborate console models with **loud speakers built right into cabinets** of genuine mahogany and walnut. **ALL SETS GUARANTEED.** Coast to coast receiving range. Catalog also contains everything in radio supplies, including batteries, chargers, loud speakers, transformers, condensers, rheostats and any other parts you may want for improving your set or building a new one. **Guaranteed saving to you 1/3 to 1/2.**

What Others Say

"I received your radio from you in shipping time and I am very pleased with many... Yours very truly, W. J. Cantello, 1221 Ari St. Chicago, Ill."

"I received my Radio Radio from you in shipping time and I am very pleased with many... Yours very truly, William King, R. F. D. 1, Box 79, Trenton, N. J."

"We take pleasure in recommending your Radio Radio as one of the best in the market... The same set I received in shipping time... Yours very truly, W. J. Cantello, 1221 Ari St. Chicago, Ill."

"I received my Radio Radio from you in shipping time and I am very pleased with many... Yours very truly, W. J. Cantello, 1221 Ari St. Chicago, Ill."

"I received my American Bell Radio from you in shipping time and I am getting from you what I want... Yours very truly, W. J. Cantello, 1221 Ari St. Chicago, Ill."

Thousands more like these

DON'T BUY ANYTHING IN RADIO UNTIL YOU GET OUR BIG MONEY SAVING CATALOG.

RANDOLPH RADIO CORPORATION
The Largest Exclusive Radio Mail Order House in the World.
159 N. Union Ave. Dept. 230 Chicago, Ill.

You must have our catalog no matter what set or kit you want. Our line is complete and includes all popular sets and Superheterodyne, tetrode, Ultradyne, Reimartz, Regenerative, Radio Frequency, Browning, Drake, Relex and all other latest circuits. Kits, sets and parts manufactured by all well known manufacturers such as: Frost, Howard, Baldwin, Brandes, Western Electric, Columbia and others.

Our semi-finished sets come with all parts mounted on panel and base-board ready for wiring. Do not fail to send for our catalog. Remember, we are the largest exclusive radio mail order dealers in the world and carry the best of everything in radio.

Our Catalog includes complete list of broadcasting stations and general information and facts about our free service division. Our radio engineers will help you solve all your radio problems. Send your name and address on a card or in a letter and we will send catalog FREE.

RADIO and the MUSIC STUDENT

Schedule for Monday Evening, January 18

Broadcasting from WEAJ and many linked stations on Monday evening, January 18, from 10 to 11 o'clock, the WEAJ Grand Opera Company will present in tabloid form Gounod's opera

"Romeo and Juliet"

with the following cast of characters:
 Juliet, *Soprano*..... Genia Zielinska
 Gertrude, *Contralto*..... Grace Leslie
 Romeo, *Tenor*..... Giuseppe di Benedetto
 Mercutio, *Baritone*..... Carl Rollins
 Capulet, *Basso*..... Nino Ruisi
 Conductor—Cesare Sadero

Don't fail to tune in for this musical treat

Gounod's "Romeo and Juliet"

CHARLES FRANCOIS GOUNOD, if not the actual founder of modern French opera, is at least the source of its most pronounced characteristics. Before his time, in the witty paradox of R. A. Streetfield, "the most famous French composers had been either German or Italian" (for instance, Lulli, Gluck, Rossini and Meyerbeer). Gounod himself was trained in the school of Meyerbeer, but his own sympathies drew him rather toward the serene perfection of Mozart. The pure influence of that mighty master, combined with the strange mingling of sensuousness and mysticism which was the distinguishing trait of his own character, produced a musical personality of high intrinsic interest and historically of great importance to the development of operatic music.

Charles Francois Gounod was born in Paris on June 17, 1818. His father, Jean Francois Gounod, a painter and engraver of distinction, died when the boy was 4 years old. His mother, a most accomplished woman and a fine pianist, supervised his early education and trained him so well in music that he was a proficient pianist before he entered the Paris Conservatory in 1836. There he studied counterpoint with Helevy and composition with Paer and Lesueur. In 1837 he won the second Roman Prize for his cantata "Marie Stuart and Rizzio," and in 1839 his cantata "Fernand" won the Grand Prize by twenty-five votes out of the total of twenty-seven.

This entitled him to a sojourn of three years in Rome, where he studied ecclesiastical music, particularly the works of Palestrina, and produced his first important composition, a mass for three voices and full orchestra, in 1841. While on a visit to Vienna in 1842, he conducted a requiem of his own which made a deep impression. Returning to Paris, he became organist and precentor of the "Missions Etrangeres," and for two years took a course in theology. It was generally supposed among his friends that he would become a priest, and he was even called "Abbe Charles Gounod."

After several years of seclusion, the performance of parts of his "Solemn Mass" at a concert in London, in January, 1851,

(Continued on Page 19)

Conducted by
G. W. Harris

MUSIC at its best is the finest flowering of the human spirit.

The best music is a pre-eminent spiritual force and influence from which the soul draws nourishment.

Music not alone gives pleasure—very real and genuine pleasure of a unique kind, and the best kind known to the human mind and emotions—not alone delights, but thrills, uplifts, ennobles and inspires.

It cannot be too strongly emphasized that appreciation of the best music comes only by study about it or even studies of its form and the details and intricacies of its structure, but simply by frequently hearing it repeatedly, frequently—regularly—for familiarity with the music breeds not contempt but appreciation and love.

Only through this regular communion with the best performances or interpretations of the best music that the soul can obtain in fullest measure that joyous boon and that rich and lasting sustenance which the noblest of all the arts gives to its lovers.

Radio is doing some fine things for the growth of music appreciation in America—and is destined to do still greater things. When the radio brings to your hearing a musical masterpiece that appeals to you, do not rest content to wait for a second hearing until some radio station broadcasts it again—you may have to wait a very long time.

Instead of thus waiting until the impression and the enjoyment have faded into dimness, make whatever slight effort may be necessary to hear that masterpiece again, and yet again, by whatever means you can command. Go to concerts; hear the best musicians—whenever you can. And also make the best use of those marvelous inventions, the phonograph and the player-piano. There may be a few persons still alive who object to mechanism and sneer at "machine-made" music. But these wonderful modern mechanisms that reproduce musical interpretations have abundantly proved themselves an unrivaled aid to musical education—and, so long as we get good music, what does it matter how we get it?

To aid you to cultivate your appreciation and love of good music is the purpose of this Music Department.

Schedule for Tuesday Evening, January 19

The "Eveready Hour" Program to be broadcast from WEAJ and several linked stations on Tuesday evening, January 19, will include Richard Strauss's tone-poem

"Thus Spake Zarathustra"

played by a symphony orchestra conducted by Max Jacobs, as a background for recitation. Be sure to tune in for this musical treat.

Strauss' "Thus Spake Zarathustra"

RICHARD STRAUSS, for the last quarter of a century unquestionably the dominating figure among living composers, was born on June 11, 1864, in Munich, where his father, Franz Strauss (born, 1822; died, 1905), a famous horn virtuoso, was solo horn player in the opera house orchestra and professor of his instrument at the Royal Academy of Music. When 4 years old he began to receive regular musical instruction, and at 8 took up the study of the violin with the leader of the court orchestra. He was one of the most remarkable prodigies know to musical history, and there is something almost uncanny about his achievements before his twelfth year—achievements more remarkable than those of Mozart, Beethoven and most other masters at the same age.

He began to compose music when 6 years old, for "he wrote notes before he did the letters of the alphabet." From 1875 to 1880 he studied composition and orchestration with F. W. Meyer. Meanwhile, he composed nearly a hundred pieces—piano pieces, songs, choral works, sonatas, orchestral overtures and chamber works in great variety—before the publication of his Opus 1, a "Festival March," in 1881.

Under the direction of his father, a strict classicist and anti-Wagnerite, young Richard gave his attention exclusively to the works of the classic masters. Before he was 21 his first symphony, a serenade for wind instruments, a violin concerto and other works had been played and had won immediate recognition in Germany; and in 1884, Theodore Thomas gave the first performance anywhere of his Symphony in F Minor (Opus 12) at a concert of the New York Philharmonic Orchestra. About that time Hans von Buelow became interested in him, and in 1885 Strauss was appointed assistant conductor of von Buelow's orchestra at Meiningen.

While there Alexander Ritter revealed to him the full significance of the works of Wagner and Liszt, and this proved a turning point in his career as a composer. Abandoning his classic models, he now espoused the ideals of the new school of program music, which he proceeded to carry far beyond anything his predecessors



Cesare Sodero, Conductor and Director of the
W.E.A.F. Grand Opera Company

had ever attempted. It was in his tone-poems that Strauss first appeared as a composer of striking individuality. The form of the symphonic poem invented by Liszt, and expanded by Strauss to colossal proportions, afforded him full opportunity for the display of his brilliant originality, emotional intensity, soaring melodic invention, marvelous sense of orchestral color, extraordinary power of characterization and supreme command of technical resources, as well as for bold and startling innovations in harmony and orchestration that caused a veritable war of the critics. He has been more fought over than any other composer since Wagner, but it is pretty clear today that his great tone-poems have taken a firm place in the orchestral repertory and have established instrumental "program music" in a position of equal rank with the older forms of so-called "absolute music."

Richard Strauss has made two visits to the United States, coming first in 1904 and again in 1921, and has appeared as guest-conductor with several leading American orchestras. On the occasion of his first visit his "Domestic Symphony" had its world premiere, under his leadership, in Carnegie Hall, New York, March 21, 1904.

"Thus Spake Zarathustra, Tone-Poem (freely after Frederick Nietzsche) for Large Orchestra," Op. 30, was composed in the seven months of February-August, 1896, and had its first performance at Frankfurt-on-the-Main in November of that year. Its first American performance was given by Theodore Thomas in Chicago February 5, 1897. As Strauss' title implies, it is a tonal presentation of impressions derived from "Also Sprach Zarathustra" ("Thus Spake Zarathustra"), the remarkable philosophico-romantic fantasy of Frederick Nietzsche. The central figure of this prose rhapsody is, of course, Nietz-

sche himself, and has no near relationship to the founder of the Parsee religion ("Zoroaster" is the Greek form of the name, "Zarathustra" the Persian form).

When the tone-poem was first introduced Strauss was quoted as saying:

"I did not intend to write philosophical music or portray Nietzsche's great work musically. I meant to convey by means of music an idea of the development of the human race from its origin, through the various phases of development, religious as well as scientific, up to Nietzsche's idea of the superman." And when he was in New York in 1921 he said that in writing "Zarathustra" he wished "to embody the conflict between man's nature as it is and man's metaphysical attempts to lay hold of his nature with his intelligence—leading finally to the conquest of life by the release of laughter."

The music begins with a solemn and stately theme intoned by bass accompaniment against a rumbling in a companionment, culminating in the stupendous climax in which the full orchestra unites in the majestic tones of the organ to depict the glories of sunrise. In its blaze of radiating splendor and its thrilling cadence, this is the most beautiful and the most wonderful tonal painting of sunrise ever achieved by any composer.

Then Zarathustra goes down among men, and there follow new themes under headings from Nietzsche's book: "Of the Dwellers in the Rear World" and "Of the Great Yearning" (of those dwellers for higher things). Another theme, given out by the violins, sings of their "Joys and Passions," followed by the "Grave Song"—a tender melody for oboe, which is worked up to an accompaniment of the "Longing" music in the cellos. The despair of "Science" is treated as a fugal episode based on the opening theme, followed by furious and at times dissonant outbursts from the full orchestra. The next episode, "The Convalescent," is devoted to an optimistic vision of humanity. This is followed by the jubilations of the Overman in "The Dance Song," in the rhythm of a slow waltz. Night falls and Zarathustra dreams of love—a night-song of grave and tender beauty. The dance bursts forth again, but in the midst of it the twelve strokes of the midnight bell usher in the "Song of the Night Wanderer," and a short passage—the very spirit of perplexity and discord, being written in two different keys and involving a mysterious discord—brings to a mystically enigmatic close this stupendous and extraordinary work.

AIDS TO APPRECIATION

The best book in English about Strauss is Henry T. Finck's "Richard Strauss, The

Man and His Works," published by the Little, Brown & Co., Boston, at \$2.50. Despite Mr. Finck's parading of his prejudiced and violent hostility to most of Strauss' music, this is a highly interesting and valuable book.

An English translation of Nietzsche's "Zarathustra" is published by The Modern Library, Inc., New York, at 95 cents.

No "records" of Strauss' "Thus Spake Zarathustra" have as yet been issued for any kind of reproducing instrument.

Gounod's "Romeo and Juliet"

(Continued From Page 17)

evoked such high praise that he was commissioned to write a work for the Grand Opera. His first opera, "Sapho," was performed on April 16, 1851; but, despite excellent musical numbers, was not a theatrical success. However, the opera house was destined mainly to occupy Gounod for many years.

From 1852 to 1860 he was conductor of the "Orpheon," the united male singing societies and vocal schools of Paris. His second opera, "La Nonne Sanglante," founded on a weird legend in Lewis' "Monk," was produced in 1854. This, again, not being much of a success, he next tried his hand at a comic opera, bringing out in 1858 "Le Medecin Malgre Lui," based on Moliere's comedy of that title, which was given in England under the title "The Mock Doctor."

Gounod's success came in 1859 with "Faust," which speedily gave him world-wide fame, and remains his greatest masterpiece. "Philemon and Baucis" appeared in 1860, and "La Reine de Saba," afterward performed in English as "Irene," in 1862. In 1863 he brought out the pretty

Genia Zielinska, Coloratura Soprano of the
W.E.A.F. Grand Opera Company, as Romeo in
"Romeo and Juliet"



pastoral opera, "Mireille," and in 1866 "La Colombe," known in English as "The Pet Dove." The success of "Faust" was revived by "Romeo and Juliet" (1867), which in France is considered even superior to "Faust."

On the outbreak of the Franco-Prussian War in 1870 Gounod removed to London. There he founded a choral society, gave concerts, and at the exposition of 1871 produced "Gallia," and elegiac cantata to words from the "Lamentations of Jeremiah," and other works, which were well received. He did not return to Paris until 1875. Two years later he produced another opera, "Cinq-Mars"; in 1878 "Polyeucte," and in 1881 his last opera, "Le Tribut de Zamora."

He also composed much church music, including a "Stabat Mater," the oratorios "The Redemption" and "Mors et Vita," a "De Profundis," an "Ave Verum," and many hymns and songs among which "Nazareth" is universally popular. Especially famous is his "Meditation" (Ave Maria) on the first Prelude of Bach's "Well-Tempered Clavichord." The extensive list of his works for orchestra includes also a symphony and the popular "Saltarello" and "Funeral March of a Marionette."

Gounod was elected a member of the Institute of France in 1866, and was made a Commander of the Legion of Honor in 1880. He died in Paris, on October 17, 1893.

His music is of a highly poetic order, blending lyric joyousness with mysticism, and is expressed in instrumentation that is often original and masterly. He was a great musician and a thorough master of the orchestra.

"Romeo and Juliet," opera in five acts, libretto by Barbier and Carre, music by Gounod, the subject taken from Shakespeare's tragedy of the same title, was first produced at the Lyric Theatre, Paris, on April 27, 1867. The story as told by the French dramatists in the main follows Shakespeare's tragedy closely in its construction as well as in its dialogue.

Gounod fitted the immortal love story with music of enduring beauty and great charm.

AIDS TO APPRECIATION

Gounod's autobiography in an English translation by Annette E. Crocker entitled "Memories of an Artist" is published by Rand, McNally & Co., Chicago.

A good English biography is "Charles Gounod: His Life and His Works," by Marie Anne De Bovet, published in London in 1891.

The vocal score of "Romeo and Juliet," original French text

with English translation by Dr. Theodore Baker, is published by G. Schirmer, New York, at \$2.00.

Excerpts from "Romeo and Juliet" are available in phonograph records as follows:

Columbia Records—

Je veux vivre dans le reve, and Villanelle (Oft Have I Seen), sung by Florence Macbeth (A6163), \$1.50.

Ah! leve-toi soleil (Fairest Sun, Arise), sung by Charles Hackett (68043D), \$2.00.

Edison Records—

Ah! Ne fuis pas encore, sung by Alice Verlet and Ralph Errolle (82299), \$2.00.

Ange Adorable, sung by Alice Verlet and Ralph Errolle (82211), \$2.00.

Waltz Song, sung by Alice Verlet (83051), \$2.00.

Waltz Song, sung by Lucrezia Bori (82517), \$2.00.

Victor Records—

Ah! leve-toi soleil, sung by Fernand Anseau (6348), \$2.00.

Ah! ne fuis pas encore (Linger Yet a Moment), sung by Lucrezia Bori and Beniamino Gigli (3027), \$2.00.

Juliet's Waltz Song, sung by Lucrezia Bori (542), \$1.50.

Juliet's Waltz Song, sung by Gallia-Curci (6133), \$2.00.

Juliet's Waltz Song, sung by Luisa Tetrzini (Italian) (6345), \$2.00.

Ange Adorable (Lovely Angel), sung by Farrar and Clement (8020), \$2.50.

Principal Airs of the Opera, played by Pryor's Band (35234), \$1.25.

Vocalion Records—

Je veux vivre dans le reve, sung by Evelyn Scotney (70000), \$2.00.

Harmonica Instruction by Radio and Musical Programs to Be Resumed

AS a result of popular response to the series of harmonica programs and lessons broadcast last winter through WEAf, this unique series of radio performances known as the Hohner Harmony Hour has been resumed.

Commencing Friday evening, November 27, at 9 o'clock, the second series of musical programs and instruction on the harmonica began and is being continued every other week through stations WEAf, New York; WJAR, Providence; WEEI, Boston; WOO, Philadelphia; WCAP, Washington; WGR, Buffalo, and WWJ, Detroit.

This novel radio series is again being conducted by Douglas Wakefield Coutlee, who will be at the microphone through the courtesy of M. Hohner, Inc., and in charge of the group of players, ranging from eight to eighty years of age. In addition to a varied program of musical selections comprising the "bluest" of jazz numbers, popular, classical and operatic compositions, a series of lessons on the harmonica will be given by William J. Haussler, well-known harmonica expert and president of the National Musical Merchandise Association.

So far as is known, this is the first attempt ever made to give instruction on a musical instrument via radio.

Thinking of Radio for Christmas?

—then make sure of prolonging the joy of your gift throughout the year

Radio reception that is good today may be poor tomorrow and all because of one tube that has gone bad in your set.

You can now avoid disappointment resulting from tube failure checking the ever changing value of tubes with the new Sterling Universal Tester. It is more than a tube tester; for it tests A and B batteries, finds weak sockets and open circuits and as in fact the only device that insures continuously good radio. It operates right in the set and everybody can use it.

If you are thinking of adding something to the enjoyment of a radio friend or if he has a set, nothing could be more appreciated than the Sterling Universal Tester. If you are giving a set to a friend who is inexperienced in radio, then the Sterling Tester is even more necessary to his continuous enjoyment of your gift.

Here's the Radio Gift of Service

THE STERLING UNIVERSAL TESTER



Price, \$18.00
West of the Rockies
Slightly Higher

A Radio Gift of Service

Sterling
UNIVERSAL TUBE TESTER

THE STERLING MANUFACTURING CO.
CLEVELAND, OHIO



Send for this \$4 Page Book

This Book Has Shown 3187 Men

How to Make More Money

Sell radio, spare time—evenings. A demonstration means sure sale. Whip any competition—longest distance possible—lowest prices—big commissions. No selling or radio experience necessary. 12 sales lessons and 10 radio service lessons FREE. Local ads, attractive booklets and letterheads with your own name. Exclusive territory to proven men. Start right now to build a permanent business of your own.

\$100 Weekly in Spare Time

Many representatives making from \$50 to \$100 weekly, working evenings—you can do the same. Our \$4 page Ozarka plan will prove it—FREE copy for those who ask for Book No. 100. Better write today—territory going fast—only plan of its kind—a proven success for four years. Don't fail to give name of your county.

OZARKA, Inc. 128-D Avenue A, Chicago, Ill.

Today in every good set!



"I'm a MASTER OPERATOR"

AMPERITE never distinguishes between a novice and an experienced operator for the wonderful clarity and full, rich tones it makes possible. Just pull the switch and each individual tube does its utmost to outdo the other tubes. The "Self-Adjusting" rheostat that takes the average out of tube control. Used in all popular construction sets. Price, \$1.10. There is an AMPERITE for every tube. Write for free book-ops.

Radial Company

Dept. R.H.I., 54 Franklin St., N.Y. City

AMPERITE
The "SELF-ADJUSTING" Rheostat

By G. P.
Allen

WITH the advent of the new tubes, our mail has been flooded with requests for information as to how they should be used. There is also considerable doubt as to the proper method to use in connecting the batteries for those tubes that require either an increased "B" battery or "C" battery voltage.

Let us first take up the meaning of the new numbers that have appeared on the tubes. The old tubes had a prefix of "UV" or "C" preceding the number. The new tubes have their number preceded by the letters "UX" or "CX". The letters "CX" and "UX" mean that the tube has a standard base. With this base all prongs on all types of tubes have an identical meaning.

Do you have a hard job remembering which prong is filament, and which is grid,

when you change from the 199 to the 201A tube or vice versa? The prongs in the "UX" and "CX" tubes have the same relation to each other as those in the old 201A. Instead of having to change sockets or use adapters each time you change tubes, the one socket does for all of the "UX" and "CX" tubes. The only thing that you have to be careful of is that you have the proper size of rheostat for the tube you are using.

First, there are four changes of name that merely mean that the tube now is made with a standard base. For the sake of simplicity let us drop the discussion of both changes of lettering and consider that when we are talking about the UX199 we also mean the CX199. The difference between the U and the C merely means a difference in the company that made them and not a difference in the characteristics. The important letter to watch in this discussion is the change from V to X.

The UX200 is the UV200 with a standard base for the new sockets. There is no change in the internal characteristics. A similar change has occurred with the UV-199. It is now called the UX199. The tube is a detector and amplifier the same as it

has been and still uses the same filament and plate voltage. Our old friend, the UV-201A, has become the UX201A with the change of base. The WD11 and the WD12 become the WX12. You remember that the only difference between the WD11 and the WD12 was in the base that was used for them. If you will consider these new names in the way that you have been thinking of the WD11 and the WD12, you will have no difficulty in keeping them straight. You know your sweetheart is the same girl even if she does change her name when she marries you.

Now we come to the new members of the tube family. The UX120 and the UX-112 are used only in the last audio stage. These tubes are not intended to give greater volume, but they do enable the present sets to handle the volume they can deliver. Unless there is something fundamentally wrong with the design of a receiving set, distortion occurs through overloading in the last audio stage.

The UX120 will be of particular interest to owners of superheterodynes and other multi-tube sets employing 199 tubes at the present time. The UX120 is for use

using a transformer-coupled amplifier. Unless you are very sure that you know what you are doing it will be better for you to have some good radio man do this for you. This is particularly true in the case of a factory-built set. The factory set has been built and rebuilt in order to get things into the smallest possible space consistent with good design and construction. Unless you have had considerable practice in construction work you will have difficulty in doing a satisfactory job.

If your set is equipped with the type 201A tube, the new UX112 may be substituted in the last stage. This, too, requires a change in the wiring in order that the tube may function properly. The tube may be used in a 201A socket without an adapter. The UX112 uses one-half an ampere instead of the quarter ampere used by the 201A tube. The same rheostat may be used for the new tube as was used for the 201A. In the case of the UX112, it is possible to use the tube without change in wiring if no more than ninety volts of "B" battery are used, if the set is already equipped for a "C" battery. Use six volts of "C" battery instead of the customary

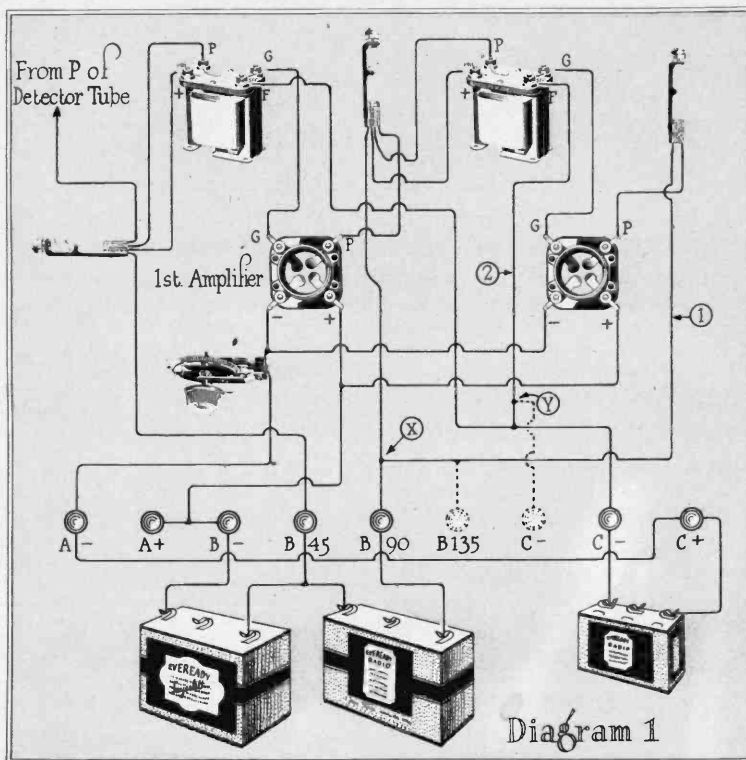

Fig. 1—Present hook-up of the amplifier with "C" Battery for UV199 or UV201-A tubes. The dotted lines indicate the changes of wiring necessary for the new tubes

on the same "A" battery as the 199 tube. In using this tube it should be considered as the equivalent of two 199 tubes in so far as "A" battery consumption is concerned. To use the UX120 in a set equipped with sockets for the 199 tube a special adapter is needed, as the tube will not fit the old socket.

In order that you may use a tube of this type it will be necessary for you to make some changes in the wiring of the audio-frequency amplifier. This is the last two tubes in most sets. A diagram is given showing you how to make these changes if you are

Battery Connections for the New Tubes

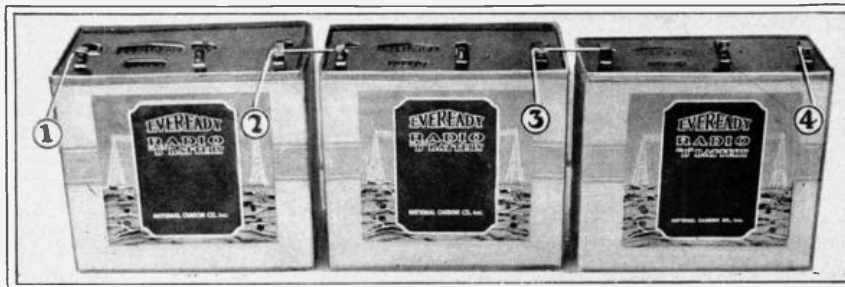

Fig. 2—The new "B" Battery connections for using the UX tubes in the last stage. Wire 1 is the minus, Wire 2 the plus 45 "B" detector. Wire 3 is the plus 90 "B" A amplifier, UV199 or UV201-A. Wire 4 plus 135 "B" Amplifier, UX120 only or UX112 only

four and one-half volts. If the set is not equipped for a "C" battery it will be necessary to make the wiring changes as given in the accompanying diagrams. It will be of passing interest

power loud-speaker. Unless you now possess the equipment, which is just coming on the market, a more complete description will be of no interest to you. If you do have the equipment, you already have the

transformer - coupled amplifier drawn in solid lines. On this diagram you will also see two wires and two binding posts drawn in dotted lines. These dotted lines indicate the changes necessary in your present set in order to convert it for use with one of the new UX tubes. To make these changes you will need two binding posts, a strip of bakelite or hard rubber and a few lengths of buss bar.

The first wire to change is that marked "1" in the diagram. In most of the transformer-coupled audio-amplifiers the wire supplying the amplifier "B" battery voltage is common to both stages. If we disconnect or sever this wire at the point marked "X" the last stage has no "B" battery supply, and the first stage still has the ninety-volt supply. Now connect this severed wire to one of the two binding posts that you have mounted on the hard rubber strip. This binding post becomes the plus 135-volt terminal of the "B" battery.

In a similar manner disconnect the wire marked "2," which is the common "C" battery lead of the amplifier, at the point marked "Y." Join this wire to the other binding post that you have mounted on the strip of bakelite. This becomes the new "C" minus terminal for the new tube.

Now for the batteries that you should use: If you wish to use the UX112 or the UX120 tube the proper battery connections for the "B" battery are shown in Fig. 2. The first two of these batteries should be of the "extra large" size, and the last one may be of the "large size." As the 135 volts is used only on the last tube this smaller size is plenty large enough to do the work.

If you are using the UX112 tube connect one "C" battery as you usually do. Use another "C" battery of the same size in series with the first as shown in Fig. 3. The extra wire goes to the new "C" post that you have installed. In the case of the UX-120 tubes you will need one of the large size horizontal 22½-volt "B" battery blocks to use as a "C" battery. If you get the

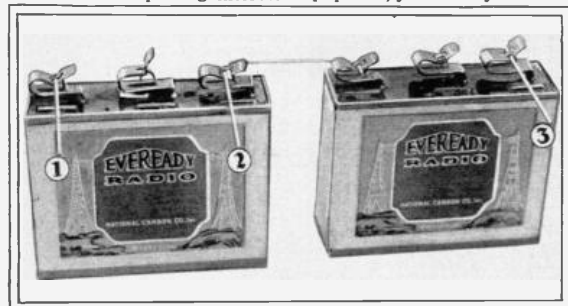

Fig. 3—The new "C" Battery connections for the UX112 tubes. Wire 1 is the plus, Wire 2 the minus, 4½ volts for first audio tube. Wire 3 minus, 9 volts for power tube only

to you to learn of several other types of tubes now on the market. Nearly all of these tubes bear the UX prefix and are intended for use with equipment designed to work from the electric light socket. This equipment is either a power unit or

tubes, and know of the names and uses of them. The tubes are supplied with the product at the time of purchase.

We now come to the consideration of the changes necessary to be made in existing sets in order to use the new tubes. If you will



Fig. 4—The new "C" Battery connections for the UX112 tubes. Wire 1 is the minus, 22½ volts for the UX120 tube. Wire 2 the minus, 4½ volts for the first audio tube UV199. Wire 3 the plus "C," common for UV199 and UX120

Better Tone!

with dry cells
and UX 120
than with storage
batteries



Note: The UX 120 is a new three-volt dry battery power tube. Used for audio frequency amplification, this tube will produce better quality and greater loud speaker volume than regular storage battery tubes.

Any set owner can easily install a UX tube in his set in a few minutes by using the new Na-Ald Number 120 Connectorald. It is a simple, efficient means of introducing the necessary additional "B" and "C" voltage required for this tube into the plate and grid circuit without rewiring the set. An easy to use as an adapter.

Just slip the Connectorald onto the UX 120 tube and put the tube in the socket. Connect the batteries—and—well, that's all there is to it. Except to enjoy a quality and volume you would not have believed possible. No need to fuss with charging-batteries. The simplicity, economy and freedom from attention characteristic of dry cells is now combined with the real volume and quality previously obtainable only with storage battery tubes.

The No. 120 Connectorald is suitable for all sockets—metal neck as well as insulated. For sale at radio, electrical and hardware stores. Price, \$1.25.

Na-Ald Adapters



Na-Ald Adapter 419-X
With this adapter the Na-Ald de Luxe Socket will take the new UX 199 small base tube. Price, 419-X, 35 cents.

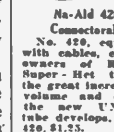

Na-Ald 420 Connectorald
No. 420, equipped with cables, enables owners of Radiola Super-Het to get the great increase in volume and clarity the new UX-120 tube develops. Price, 420, \$1.25.



Na-Ald Adapter 421-X
No. 421-X makes possible the shift from WD-11 to UX tubes. Especially designed to enable owners of Radiola III and III-A to enjoy the improved operation the new tubes provide. Price, 75c.

All Na-Ald products are for sale at radio, electrical and hardware stores everywhere. Read for complete data on adapters for new tubes.

ALDEN MANUFACTURING COMPANY
Also Makers of the Famous Na-Ald Sockets and Dials
Dept. J 13 Springfield, Mass.



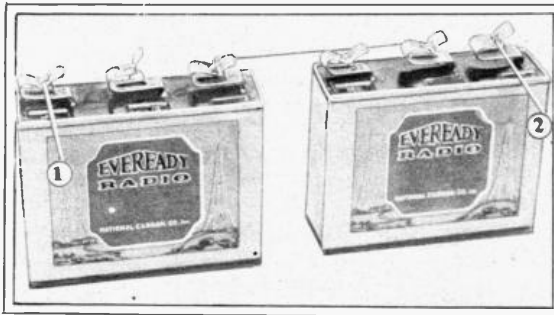

Fig. 5—Connections for "C" Battery if UX112 is used and no wiring change made

refer to diagram No. 1 you will see the hook-up of an ordinary usual size, these batteries are tapped so that it is possible to get both the minus $4\frac{1}{2}$ volts for

the UV199 tube in the first stage of audio and the minus 22 $\frac{1}{2}$ volts for the UX120 tube from the same battery. This is shown in Fig. 4.

If you decide to use the UX-120 tube and do not want to make wiring changes in your set see Fig. 5.

And Madame Enters

(Continued From Page 12)

going away for several months, and with fear and trembling I agreed. During the absence of my wife I set it up and, as I feared, I had no easy time about keeping it set when she discovered it. After I had mastered it, I invited her to listen. At first she refused and then her native curiosity overcame that scruple and she put on a head set. Suddenly she smiled—the first time in years—and actually reached over and patted my hand with the remark, 'Do you remember that tune, dear?' I almost passed away. Now you should see us. We have renewed our acquaintance and listen each evening, holding each other's hands and commenting on the program. We have even been to some of the shows you have put on, and I have the best radio set

purchased from you that can be had. You see how you restored a home and united two people. If in any way I can repay you, please let me know."

That man signed his own name, address and telephone number.

With the advent of easier tuning methods, radio became a part of every household and there were several stations putting on programs in the afternoon for the women at home. Now and then a talk on some household subject would be put on, and there was a good amount of response. Nevertheless, radio had not quite got under the skin of the women as it did the men, and men still owned the lion's share of the receivers. Many husbands would be generous and set the dials for their wives before leaving for business, but many said, "No; it's apt to burn out the tubes," and whatnot. But I know many a set was used without knowing how and with as good success as the man of the house ever had. It was just blind luck, but it gave the woman more and more confidence.

One feature that met with an instant response from men and women alike was the broadcasting of entire theatrical performances from the stage. It so happened that the boss and the director were both away on vacation, the station was left in charge of the chief operator and myself, program material was fairly well arranged in advance and I had enough experience to get what was needed by that time, but did not look for the unexpected.

The boss, the director and myself had talked about having the show folks come down and do stuff from the shows. Nothing had come of it and we were still in the talking stages, when the first day they were away a wise publicity man telephoned the station and asked for the director. I explained the situation and asked if I could help. He told me of the show and said he would like to give a late show with the principals and the musicians for those who could not get out. I asked him to come to the station with his publicity and material for program, and in the meantime a hurried conference with the operator was necessary and we agreed to put the show on the following night.

I wired the boss in great glee. The show, however, did not go on. That nice little union arrangement forbade it, all of which made the owners and producers very mad, and they insisted that it should and it did the following night, with all the principals, the chorus, the orchestra and whatnot. Even the producers were represented and to say I was in a flutter of excitement does not express the half.

That paved the way to a fine friendly feeling between that

Let the Pure Tones Through

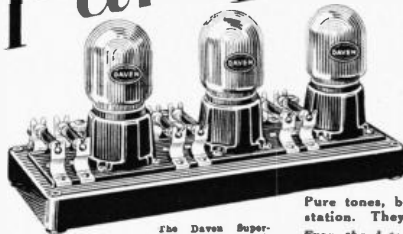

The Daven Super-Amplifier used with any set or circuit carries through the full, clear tones of the broadcasting station programs. If you prefer to assemble the Amplifier, obtain the Daven 2-stage Kit, which includes all parts except sockets.

The new Daven Special Coupling Condenser Type "A", for Resistance Coupled Amplification, sold separately and also included in all Daven Amplifiers, Kits and Resisto-Couplers. For greater volume and better quality.



The new Daven High MU Tube Type MU-30, used with the Daven Super-Amplifier, gives 50% more volume — 8 volt, $\frac{1}{2}$ ampere. A Daven Power Tube Type MU-3 in the last or output stage helps any set regardless of the method of amplification — 6 volt, $\frac{1}{2}$ ampere.

Make Your Old Set A 1926 Model!

Pure tones, beautifully clear and full, go out from the broadcasting station. They reach your detector still pure and clear. But what then? From the detector your amplifying apparatus operates. Distortion arises unless you take advantage of a method of amplifying that far-sighted manufacturers and thousands of set builders are now adopting—Resistance Coupled Amplification. Resistance Coupling is not new, but Resistance Coupling with real volume amplification is new. It is the most approved method of letting pure tones through.

The Daven Super-Amplifier costs little. It is easily and conveniently installed in any set made. Buy it complete to save hook-up labor. For those preferring to assemble, the Daven 3-stage Kit gives all the necessary parts except sockets. You will join hundreds of others who have written to thank us for the improvement Daven has given.

DAVEN PRODUCTS ARE SOLD ONLY BY GOOD DEALERS

The Sine of Merit
DAVEN RADIO CORPORATION
Resistor Specialists

Reg. U. S. Pat. Off. Newark New Jersey



CLIP THIS COUPON

DAVEN RADIO CORPORATION
150 Summit Street, Newark, New Jersey

Please send me the following on Resistance Coupled Amplification:

- Check One
 Resistor Manual. 30c is enclosed.
 Complete Catalog (free).

Name
 Address

For Dealers: Send your letterhead and we will have our nearest distributor communicate with you.

THE RESISTOR MANUAL is the handbook of Resistance Coupled Amplification. At your dealer's, Etc. By mail, postpaid, 30c.

THE BIG LITTLE THING OF RADIO

station and the show folks, and that station has produced more of the real show stuff than any other station and continues to do it. You should have seen the mail from the women folks that time, and more than one excellent actor man has had a wonderful chance after he had become known through the air.

When the station decided on a real honest-to-goodness program for women, it had a talk on cooking and other domestic problems and some talks on fashions, baby care and interior decorating, the material being put together and given by those connected with the owners of the station. Then a club was formed and at the first tea, with a scant three hundred members, five hundred appeared. It was a pretty affair, and how my hand ached that night when it was over. Before a week had passed it was found necessary to repeat it, and again there was a great success. I was certainly happy to have women tell me how happy I made them with my talks, and I gloried in the fine things they said to the woman who worked with me and who helped me to receive them.

Shortly after the regular daily program for women went on the air, this letter came to me: "Dear Lady of the Radio—Up here in this camp we are twenty men and my partner and myself. I cook and he looks after the books and things of that sort. Every day we tune in when you are on. It helps so much to while away the time. We like the music and the talks, and while we cannot dress the women folks we have as you say, we know how when we have to. But most especially are the recipes good. Will you tell me how to make a boiled frosting? The men like cake. I am sending two dollars for the two records you played this morning. We will always think of you both as friends."

Later on that same man sent me ten dollars to buy a birthday gift for his mother. He said she must have the best I could get for the money, and I loved that, and went to see the mother first and we became excellent friends.

When the Christmas season was on I used to talk at night on gifts and giving, and I talked most especially to the poor helpless men folks. It did lots of good if I can believe women who came in and thanked me.

One day a man came in and laid down a large box on my desk, saying, "You earned that." I didn't quite understand and he explained that before we put the woman's program on he used to suffer from being ripped and buttonless and his toes had not been covered in years. His wife would not mend. Lately he found she did mend and sew to

the tune of the radio. "Now," he said, "I have no loose buttons, my toes know the feel of covering and I have no dread of my being ripped as to clothes. It's a grand and glorious feeling, and my wife and I say it's all on account of what you are doing and will you accept this with our compliments and as soon as you have earned another you will get it."

It was a five-pound box of the best candy in Boston.

Many and many a groom who had no idea his wife could cook, and was taking a dreadful chance when he came home to a meal, has the radio to thank for perfectly prepared and well-served meals, and they are sure to write in and ask about things every time. It is no unusual practice for a bride to telephone for information from one of the many who give expert advice each day. Even the baby is

helped. One grateful mother was about as discouraged as she could be, living out in the country and hardly a neighbor to talk to. Her baby did not gain strength and one day a trained nurse, talking from the station, told of the symptoms of the trouble the baby had, then told what to do. In a very short while, the mother said, the baby responded to treatment as advised and the baby was a dear when she came in to thank us.

These are but a few things that radio programs do for women, and day by day the scope of the work is increasing. Many delightful, entertaining features are put on, valuable information is given, and it reaches far out into the country, benefiting most the women who are deprived of the activities dear to every woman. The woman in the country is better dressed and better versed in

many things now than she could otherwise be, and all because a program for women has been added to the radio station.

Of course, I have told of the nice things that have been said, but please don't think that is all. Women, for some reason or other, can say some catty things. Writing the management of a station condemning us poor females who are hoping to do something for our own sex in these radio programs is one thing many do. Nine cases out of ten it does no harm, and as it does not a bit of good, why do they do it? A woman's program should be handled by a woman—one who has a sympathetic understanding of women, one who has had experience and can help, one who has experienced the feel of a child and the ownership of a home of her own. Such a woman is a woman's woman and

(Continued on Page 28)



PROOF



\$50. to \$250 a week

IN WORK THAT IS ALMOST ROMANCE

Be a Radio Expert

Get into the great new Big-Pay Industry—Radio. If you're earning a penny less than \$50 a week, clip coupon now. Send for AMAZING FREE BOOK. Be a Radio Expert and draw down big money for the easiest and most fascinating work in the world. Positions everywhere. Thoroughly trained men are in big demand. Need for Radio Experts in every community. Short hours, BIG PAY.

Free book gives all the facts. Astonishing opportunities—thousands of them! Every day N. R. I. trained men are taking good places in the Radio field. Free book tells all about their success. Send for it now!

Learn Quickly and Easily AT HOME

Master Radio Engineers will show you how to qualify quickly and easily at home for Radio's fine jobs. We guarantee to train you successfully. Lack of experience no drawback—common schooling all you need. Our tested, clear methods make it easy for you. Send coupon now for free proof.

Instruments Given With Course
All instruments shown here and many others given to students for practice work while learning. Receiving sets, from simplest kind to thousand mile receiver. AN UNEQUALLED OFFER. Many other big features for limited time only.

Famous Training That "Pays" for Itself!
Spare time earnings are easy in Radio. Increase your income almost from the start through practical knowledge we give you. This is the famous practical training that pays its own way.

Technical Editor of Radio in the Home, an N. R. I. Graduate



Leslie G. Biles, shown above in the editorial office of Radio in the Home, has won his success and big position in Radio by training — by knowledge that is fully rounded out and exact. Mr. Biles learned Radio through the N. R. I. course.

Mr. Biles says: "Radio offers more in the way of salary, opportunity and interesting, pleasant work, I can heartily endorse the National Radio Institute's training as a thorough, practical preparation for Radio."

Get This Amazing Book

Most amazing book on Radio ever written — full, interesting facts about this great field and how we prepare you and help you start. You what others have done. GET THIS BOOK.

Send Coupon

Send coupon today for special limited offer, including all instruments—you'll get full particulars by return mail.

You get all of these!



MAIL THIS NOW

National Radio Institute

Dept. AV-6 Washington, D. C.

LARGEST RADIO SCHOOL IN THE WORLD

ORIGINATORS OF RADIO HOME-STUDY TRAINING

Without obligating me in any way, send me your free book "Rich Rewards in Radio" and all information about your practical, home-study Radio course.

Name

Address

Town State



For EVERY Radio Set

A stunning piece of furniture that restores order in the room where you have your Radio! No more cluttered table-tops, nor litter of equipment under-foot.

No unsightly horn in evidence, either! This console has its own loud speaker, in-built. It's out of sight, but with very apparent tonal superiorsities.

For it has the highest-developed type of unit. With horn built of special non-vibrating, extra-hard, ceramic material. Produces clear non-vibrant tone.

There's ample room for everything; space for largest A and B wet batteries—or battery eliminator—required for any home set; and for a big charging outfit, too.

Finished in mahogany, or walnut color. Dainty design of parqueterie on two front panels. Top, 38 in. x 18 in. Substantially built; the product of a 40-year old furniture maker.

The price, forty dollars, is for the complete console and includes the loudspeaker horn and unit. Thousands of dealers are showing this artistic addition to home radio equipment.

Rear View—Set Hooked Up



Non-Vibrant Ceramic Horn

The clearest tone producer on the market. Made of special composition which defeats vibration.

37 to 800 METERS Without Changing Coils

By L. C. Herndon

HERE is a very clever and very efficient solution of the problem of building a medium-short wave set and a broadcast range set, all in one and without the necessity of changing coils to go from short to long waves. This set, as it stands, will bring in all of the short-wave broadcasting that is at present worth hunting for. Everything below the range of this set is dot and dash code, which is unintelligible to the average listeners-in.

Mr. Herndon, the designer of the circuit and the writer of the article, is a U. S. Radio Inspector in the Third District, with offices in the Custom House, Baltimore. I am quite sure he would like to hear from those who build his set. H. M. N.

THE following article describes a receiver that tunes from 37 to 800 meters without the use of various size coils for covering various wave bands, solving a difficulty that has con-

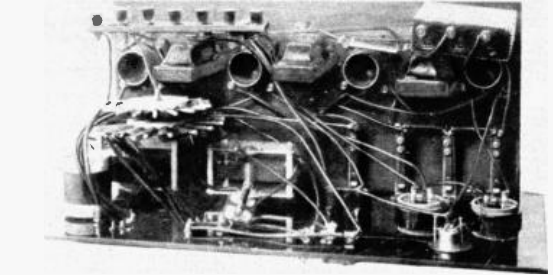

Above is a view looking down on the baseboard, showing the arrangement of the parts. Below is the panel of the set

majority of manufacturers in their efforts to eliminate controls, and likewise demanded by the public.

We know that a given wave length requires a certain amount of inductance and capacity in a

wave length. We increase the capacity by increasing the area of the condenser plates, by using more plates or by turning the rotary plates further inside the stationary plates, and vice versa. Similarly we increase the inductance of a coil by adding more turns or, if tapped, by moving the switch lever on taps that include more turns and vice versa.

There are still other methods of varying inductance; changing the relative position of two coils so that their fields oppose or assist as in the variometer; a coil with spaced turns has less inductance than a coil closely wound; a coil wound with small wire has a higher inductance than one wound with large wire on the same diameter form with the same number of turns. Inductance of coils is increased by connecting them in series and decreased by connecting in parallel.

Two coils connected in parallel have less total inductance than one of them alone, while three

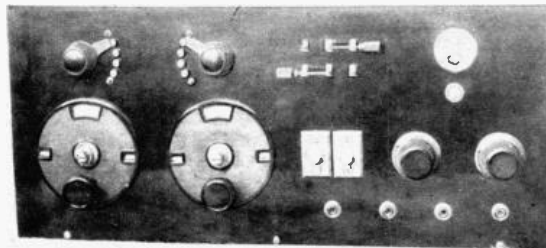

fronted both the amateur and broadcast listener ever since short waves passed the experimental stage and became a reality.

Receivers have been brought out which will cover the broadcast bands besides going down somewhere around 100 meters and up to 600 meters, but there is still lacking the desired flexibility. Ships and commercial stations only use 600 meters for calling and distress purposes, all traffic being handled above this wave. Our re-broadcasting stations operate below 40 meters as well as on intermediate bands, and the amateurs go all the way down below one meter.

Sooner or later our receivers must respond to waves much lower than the average 250-meter limit, which seems to be a medium arrived at by the ma-

circuit. An increase of either one or the other will increase the wave length, and likewise a decrease in either will decrease the

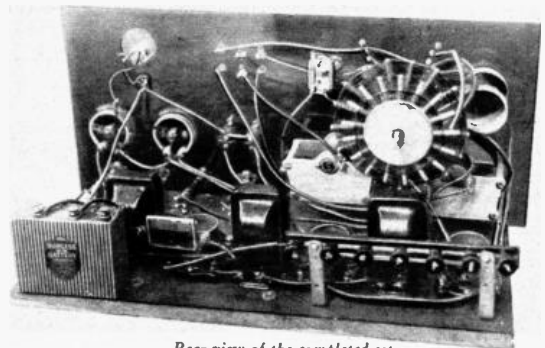

Rear view of the completed set

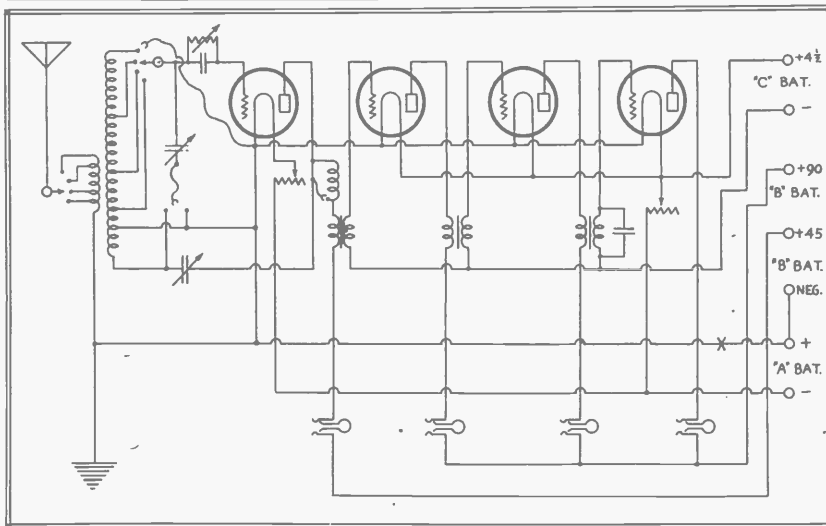

Above is the complete wiring diagram of the receiver, and below is a diagram showing not only the specifications for winding the coil in Fig. 1, but it also gives an enlarged plan of the detector connections. It does not show the complete connections which are shown in Fig. 1.

in parallel have less total inductance than two of them.

The last two methods are employed in this receiver, except only one coil is used in the secondary and tickler circuits as shown in the diagrams. The variation of inductance is accom-

plished by twisting the coil around in various ways, so to speak, part of the coil being connected in parallel with another part of it for decreasing its inductance and again connecting another part of it in parallel with the other two parts for further decreasing the total inductance. At the same time we eliminate dead end losses, as it

is the unused portions of the coil that we connect in parallel with the portions in use to lower the inductance. Employing the coil in its natural form gives sufficient inductance with the condenser used to reach 800 meters. We, therefore,

secondary inductance and controlled by a .0005 mfd. variable condenser.

This necessitates the use of a radio-frequency choke between the detector plate and filament, otherwise the radio-frequency energy at high frequencies would pass to the filament by virtue of the transformer capacity instead of going through the tickler coil. The reactance of the first audio-transformer primary, however, is sufficient on waves above 100 meters to force the energy through the tickler and the radio-frequency choke is accordingly shorted out by the clip 2 (Fig. 2). This is not absolutely necessary, however, as the set works very well on the higher waves with it, but trouble may be encountered in producing smooth control of regeneration.

This must be determined by experiment as a great deal depends upon the type of transformers used. If it is found that the set oscillates freely over the entire wave length range, then clip 2 may be eliminated.

Few will have the desire to receive on waves above 710 meters and can, therefore, eliminate clip 1 (Figs. 2, 5 and 10) as this simply shifts one side of the tuning condenser from the filament to plate end of the coil, placing 15 more turns across the condenser for tuning above 710 meters. In eliminating this clip connect one side of the tuning condenser permanently to the filament as shown in the position of clip 1 in Figs. 3 and 4, where the clip is placed on "A."

The secret of tuning below 100 meters lies with clip 3. When placed on the second contact of

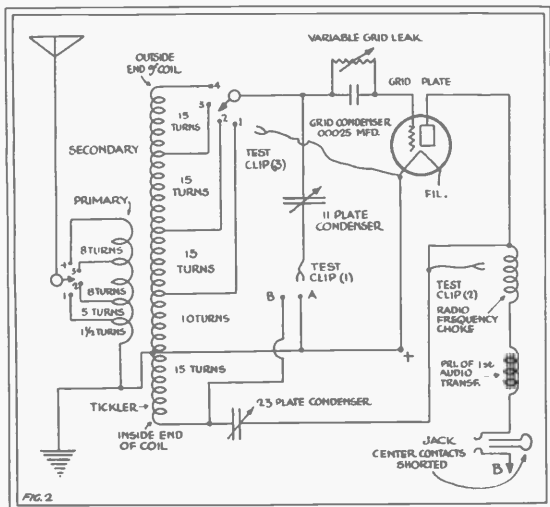

plished by twisting the coil around in various ways, so to speak, part of the coil being connected in parallel with another part of it for decreasing its inductance and again connecting another part of it in parallel with the other two parts for further decreasing the total inductance. At the same time we eliminate dead end losses, as it

have a tuning circuit from 37 to 800 meters using a single coil.

The circuit is an ordinary coupled regenerative circuit with three stages of audio-frequency amplification. Regeneration is accomplished by passing the radio-frequency in the detector plate circuit through a 15-turn fixed tickler coil, wound an integral part of the sec-

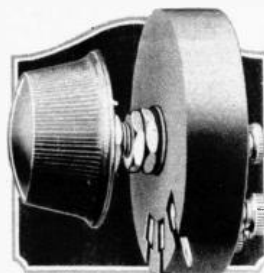

Centralab Modulator for Volume Control

THIS improved type of potentiometer takes the rough spots out of volume — smooths out powerful "locals", as well as difficult "DX". It provides noiseless control of tone volume without in any way affecting the tuning of your set. Has a total resistance of 500,000 ohms, specially tapered to give smooth, even control from a whisper to full volume — or vice versa — without detuning.

You will never know how much better results your set is capable of, until you have equipped it with this audio amplification control. It is easily installed and can be used in audio circuits with any transformers or with the new Thordarson "Autoformers".

Endorsed by the Thordarson Electric Mfg. Co., and used as a standard unit in many leading commercial sets.

CENTRAL RADIO LABORATORIES
18 Keefe Avenue Milwaukee, Wis

at your dealer—
or mailed direct.
Mail the coupon.
Get our literature
describing this
and other Centralab
controls.

\$2.00

Mail the Coupon

Centralab

CENTRAL RADIO LABORATORIES, 18 Keefe Avenue, Milwaukee, Wis.

- Send literature describing Centralab controls.
- Enc. me \$2.00 for which send me one of your Centralab Modulators. (Place X in squares opposite items wanted.)

Name _____
Address _____

now we'll have clear music



MAGNATRONS in your set will give sweet purity of tone—clear and complete rendition of all the wealth of overtones. Music and speech come from the loudspeaker of the Magnatron-equipped set with rich fidelity and generous volume, recreating in your home the actual performance itself, whether it be ten or a thousand miles away.

Magnatrons are the product of the oldest exclusive makers of vacuum tubes. That, in a large measure, explains their excellence. There's a Magnatron for every purpose. The DC-201A, the DC-199 (large or small base), the DC-129 (for super-voicings), and the Hex (for B Eliminators). All list for \$2.50 each.

Write for your **FREE** copy of "**POT POURRI**"—a snappy review of music and music to Department H

CONNWEY ELECTRIC LABS.
Magnatron Builder, Hoboken, N. J.

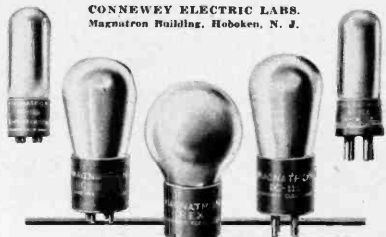

MAGNATRONS

Complete factory stock for Pacific Coast carried at Pacific Radio Labs.,
256 So. Los Angeles St., Los Angeles, Cal.



No. 107
Junior
Tube-Checker

TEST YOUR TUBES AT HOME

The reception of your set is no better than your poorest tube. One bad tube may be the cause of your poor reception.

Don't guess—send for our No. 735 Junior Tube-Checker circular.

Price, \$12.50

JEWELL ELECTRICAL INSTRUMENT CO.
1650 WALNUT ST., CHICAGO



At Last! 37 to 800 METERS WITHOUT CHANGING COILS

Tuning Unit for Herndon Circuit, Described in This Issue of **RADIO IN THE HOME**, Does the Trick.

Equally Efficient on Short or Long Waves

Straight Line Frequency Operation. Highly Selective. Something Long Awaited. Solves Problem of Short Wave Reception. With This New Device Set Is Prepared for Any or All Drastic Changes in Broadcast Station Wave Lengths. Try This Unit. Designed by Mr. Herndon. A Surprise Awaits You.

Distributed by

M&H SPORTING GOODS CO.
512 MARKET ST. PHILA. PA.

FREE RADIO STAMPS

36 beautiful copper-etched American, Canadian, and European stamps, each with the call letters of a station. FREE with ideal 48-page Music, Mystery, Album and Log. Also contains complete list of "favorite" radio personalities and their call letters. As you hear new stations, just put the correct stamps in your album. Album and stamps become a permanent and interesting record of the stations you receive. You and your children will enjoy it. Complete album, 2x11" heavy board covers. \$1 this postage.

Send No Money

Just pay postage after album and stamps arrive. We prefer to have you prefer to pay with order. **MONEY REFUNDED** if not DE-LIGHTED. Send order today—NOW. Postal will do IDEAL CO., Dept. 211, 366 Wesley Bldg., Chicago

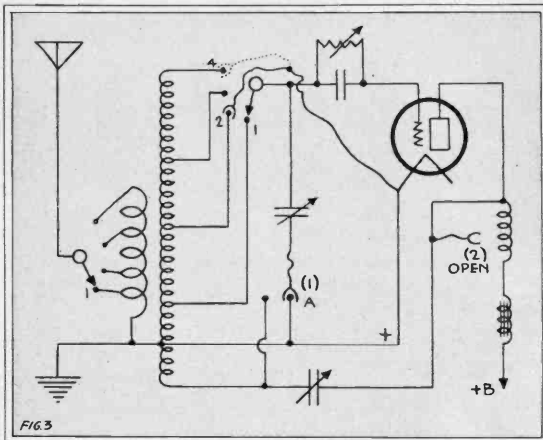

This diagram shows the position for 40 to 85 meters tuning. Additional clip placed on Tap 4 as shown by dotted line, makes the set tune from 37 to 72 meters. Clip 1 on A. Clip 2 open. Clip 3 on Tap 2. Primary on Tap 1. Secondary on Tap 1. For rest of circuit see Fig. 1

the secondary switch with the switch lever on the first contact, 10 turns are used between grid and filament with 15 turns in parallel, thus lowering the secondary inductance to a figure less than the inductance of the 10 turns alone. At the same time the resistance of the grid circuit is lowered as the two coils in parallel have less resistance than one; furthermore, the

amperes without overheating, having high capacity due to the great amount of surface of the size wire employed in spite of the various "low-loss" styles of winding with a resulting loss in inductance and in voltage applied to the grid.

Placing the additional clip, shown by the dotted line, in Fig. 3 on the fourth contact of the secondary switch places another

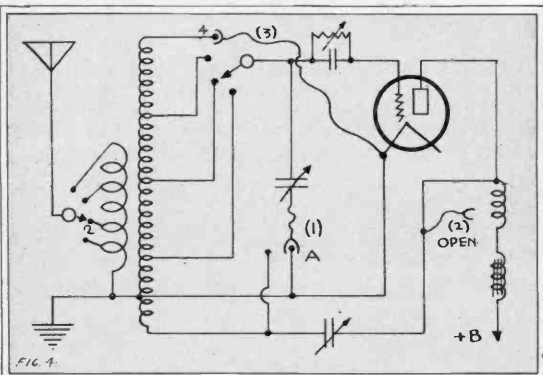

Showing position 75 to 115 meters tuning. Clip 1 on A. Clip 2 open. Clip 3 on Tap 4. Primary on Tap 2. Secondary on Tap 2. For rest of circuit see Fig. 1

shunt coil being in inductive relation with the antenna coil places its voltage upon the grid in addition to that furnished by the original 10 turns used for secondary. Fig. 8 shows the schematic circuit effected by this adjustment.

This explains why this receiver is more efficient on short waves than the average receiver, especially designed for short waves, with its ponderous coils large enough to carry 15

30 turns in parallel with the 15 turns already in parallel with the original 10 secondary turns, producing the circuit shown in Fig. 9. This causes the circuit to tune down to 37 meters.

Leaving the clip 3 disconnected produces the common circuit shown in Fig. 7, tuning from 100 to 710 meters, while shifting clip 1 from A to B extends the tuning range to 800 meters, indicated in Fig. 6.

It must be remembered that

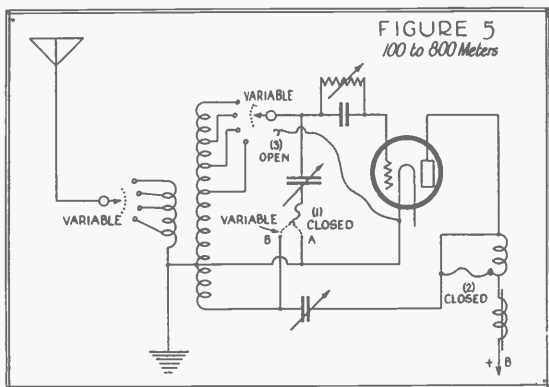

Primary and Secondary switches varied for waves desired. Clip 1 on A for 100 to 710 meters. B for 800 meters. Clip 2 cuts out radio frequency choke. For rest of circuit see Fig. 1

these wave-length ranges will not hold exactly as stated with different receivers, many things governing this point. The type condensers, location of coils and switches, and manner of running connecting wires within the set all will extend the tuning ranges

satisfactory, those having a straight-line frequency curve preferred. The coils are wound spider-web fashion on glass peg forms with No. 28 double silk-covered wire. Wooden peg forms can be used, but there will not be the efficiency obtained as with

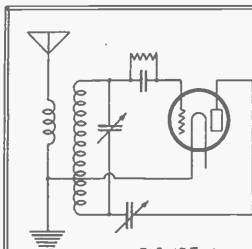

FIGURE 6
Over 710 Meters

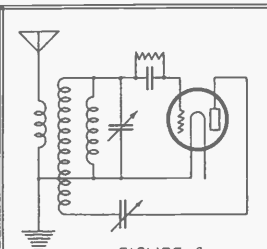

FIGURE 8
40 to 115 Meters

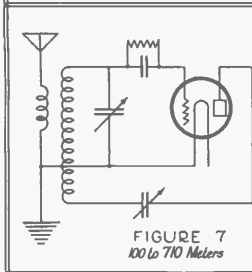

FIGURE 7
100 to 710 Meters

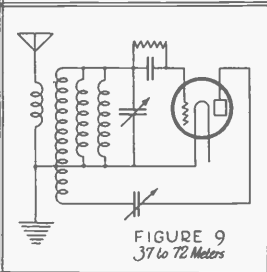

FIGURE 9
37 to 72 Meters

Figs. 6, 7, 8, 9. These are not separate hook-ups, but merely indicate what happens in the circuit when you make changes indicated with the clips or switches

up or down to some extent. The wave-length bands as stated, however, are sufficiently correct to hold the results approximately the same with any receiver constructed along these lines, if good condensers are used and all leads made as short as possible. If you wish to use switches, instead of clips, see connections on Fig. 10.

Any of the high-grade condensers now on the market are

glass pegs. The center of the spiderweb forms should be 2 1/2 inches in diameter. The transformers should be low ratio, otherwise distortion and howling will result. General Radio 2-to-1 ratio transformers are used here, giving abundant volume with good clarity. A grid leak or condenser across the secondary of the last transformer will be necessary to eliminate distortion or howling, the values best

New Herndon Complete Parts Kit
Newest Circuit in Radio
Special at \$49.50
37 to 800 Meter Selectivity
As Described in This Issue of Radio-in-the-Home

From amateur wave-lengths to broadcast wave-lengths without changing coils. If you like amateur dot-and-dash, tune in from 37 to 200 meters; want broadcast reception, tune in from 200 to 550 meters; ships and commercial stations, tune in from 550 to 800 meters. All this on the same set, with no change in coils.
 Selective over its entire wave-band, 37 to 800 meters. Cut through the locals and bring in real DX, exactly as broadcast, without whistles or distortion.
 Three stages Audio Frequency, so wired to give full amplification without distortion. This means loud speaker reception on all stations.

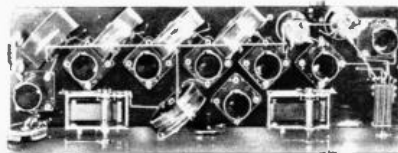

ANOTHER M. & H. SPECIAL
Kit Complete Parts VICTOREEN \$69.50
SUPERHETERODYNE Set

Exactly as Described in November "Radio in the Home"
 Illustrated above. The wonderful set exactly as described by Leslie G. Biles, Technical Editor, in November "Radio in the Home." This has been the phenomenal hook-up of the season.

Kit Complete Parts M. & H. \$60
Superheterodyne Set

The famous M. & H. Superformers and Precision Selectors may be called by any other name, but you can not improve on the parts. The Kit for the M. & H. Superheterodyne Set contains this famous Precision Selector and the Superformers, acknowledged by experts to be the best obtainable.

Build It Yourself and Save Money
KIT NEW 3-TUBE CIRCUIT \$19.50
Described by HARKNESS

The latest 3-tube set with range and volume of any 5-tube set on market, described by Harkness in many issues of "Radio in the Home." Neely, in "Radio in the Home," says: "Undoubtedly the two most popular circuits brought out during the past season were the Roberts' Knockout, developed by Radio Broadcast, and Harkness Counterlex, exploited by "Radio in the Home." Each circuit has its ardent advocates who claim it is better than the other. This is what makes Radio so fascinating."

We Still Have a Few Harkness Licensed Kits at \$17.50

Complete Parts for Quadroformer \$37.50
6-Tube Set

Many who hooked this kit up brought in the Pacific coast consistently. We consider this a hummer.

M. & H. Stands for Service in Its Dealings With Customers for Over 28 Years

We Specialize in Complete Kits
DESCRIBED IN THIS OR ANY
OTHER RADIO MAGAZINE

Hammarlund-Roberts, Silver-Marshall, Bremer-Tully, Harkness, Etc.
This Service Is Recommended by RADIO IN THE HOME

Only One Kind of Quality—the Best



28 Years' Experience Back of Each Sale

The Wilson B Radiopower Unit



In Walnut Case

This new unit will enable you to get the most out of your receiver. Provides uniform "B" voltage at minimum cost. Operates from light socket. Will not set up the slightest hum. Hook it to your set and forget it except to switch it on and off. Nothing to adjust. Nothing to get out of order. No acid to spill. No expensive replacements. The most dependable, convenient and economical plate current supply. Price complete \$35.

Write for complete information.

The Andrews Paddlewheel Coil



This coil is used in any hookup requiring a high-grade inductance. You will be pleased with results because of its negligible losses, minimum distributed capacity and exceptionally high ratio of inductance to resistance.

It greatly improves tone quality, making possible any desired volume without distortion. Used in such well-known receivers as the Derazandac and Buckingham. Ask your dealer for construction blueprints of tested circuits employing this superior coil.

Our Technical Dept. will assist you in any instance.



Pat. Pend.

Price \$3.00

It greatly improves tone quality, making possible any desired volume without distortion. Used in such well-known receivers as the Derazandac and Buckingham. Ask your dealer for construction blueprints of tested circuits employing this superior coil.

Our Technical Dept. will assist you in any instance.

Write for complete information.

Price \$3.00

Our Technical Dept. will assist you in any instance.

Write for complete information.

Price \$3.00

Our Technical Dept. will assist you in any instance.

What Can I Get?

(Continued From Page 7)

that are higher and more extensive than one's aerial absorb a great deal of radio wave energy.

Such structures as are in a direct line with the distant stations cause the most trouble, those in an opposite direction having little effect. Indeed, it has often been observed that large buildings have the power of reflecting radio waves somewhat.

Dwellers in suburbs have good locations, especially where there are not too many electric light and telephone wires overhead. If possible, the aerial should be higher than these wires. Where the buildings are largely of wood, brick or stone-and-stucco construction, conditions are good.

In the country conditions are even better, because of fewer metallic objects sticking up from the surrounding landscape. A loop receiver, which is supposed to function anywhere, may fail to operate well in a steel building because of the absorption of the waves by the building. It is often necessary to place the loop near a window in order that a location of least absorption may be found. In the cities, the loop does not always indicate the true direction of the station, on account of reflection and absorption.

In installation, we consider the aerial and accessory equipment like tubes and batteries. The ideal aerial is not too long, but fairly high. A good separation from nearby building walls and roofs is important. If possible, the aerial should all be one and the same piece of wire, from the end of the aerial all the way to the antenna binding post. The lead-in wire should preferably not come down alongside the building wall on porcelain insulators like a phone line, but be suspended about five or six feet out from the wall.

The ground connections should be good. Poor connections resist the passage of the currents set up by the passing waves and decrease the receiving range. They cause interference, too. The ground wire is attached, by a ground clamp, to the cold water pipe or radiator. It is a good idea to make connection with both. The galvanizing must be scraped cleanly off the pipe and the shiny wrought iron exposed before the clamp is screwed in place.

In locating the set in the house, it is best to put it in a direct line between the window at which the lead-in wires enters and the point where the ground wire is fastened. And the wires to the aerial and ground should be as short and direct as can be. While the ground wire may be a bare wire, nailed to the floor

to hold it in place, the aerial wire should not be so fastened. It should not follow a devious route over the picture moldings and doorways, but should come to the set away from contact with the wall—a foot or so out if possible.

Tubes do vary a lot, and the purchaser should have them tested—not only by the "squeal" method which many dealers employ on their counters, but by actually being put in a receiving set where they'll be tried as the detector and also as the radio-frequency amplifier.

As to batteries, so long as the storage battery is made by a reputable concern and is new, the buyer is safe. "B" batteries should be tested with a voltmeter—the usual kind measuring 45 volts or slightly over. One makes a serious mistake in buying "B" batteries from some hardware dealer or druggist who keeps a few odds and ends of radio equipment on hand. The "B" batteries usually are pretty badly shelf-worn.

As to the type of set, the writer is treading on rather dangerous ground. It is impossible to state with truth that any particular model excels in receptive ability. Sets having no radio-frequency amplification, but using simply a detector and an audio-frequency amplifier—three tubes—have fair sensitivity under good conditions. As a rule, there is only one tuning dial and, consequently, it is comparatively easy to "tune in." Usually, it is possible to tune in stations more quickly on a set of this kind than any other where the dial adjustments aren't known beforehand. It suffers from the fact that the selectivity is not especially good—that is, stations interfere with each other to some extent except for strictly local receiving.

Sets having radio-frequency are more sensitive and selective, but somewhat harder to tune, as there are more dials. Lately, these multi-dial sets have been fitted with various types of connections which enable several units to be tuned by a single control.

There is the item of expense to be thought of, for sets having the most tubes naturally require the most current from the storage and "B" batteries. Battery eliminators are appearing to solve this problem. "B" eliminators are well worked out and reliable, but eliminators for the storage battery are more of a problem and should receive careful trials before a purchase. Suffice it to sum up this part of our talk by stating that most sets, fitted with good accessories and attached to a fairly good aerial, will respond to distant stations.

Now here we come to a factor that's highly important—skill of

operation. Few radio sets are so absurdly simple that a "child can operate" them, except for nearby stations. Only practice in tuning radio sets can bring that sense of touch and control that is so essential to setting the dial at the exact spot. For nearby stations it's easy. If the dials are two or three degrees out of the way, it doesn't matter, the station is heard anyway.

The skill in dial "touch" acquired from practice is most essential to "DX" reception. The delicate control of the regeneration or "sensitivity" knob comes with use and not with printed explanations. And when one has mastered the control of his set, knows where and when to pick up new stations and tune for old ones again, has installed his set in as efficient a manner as he is able, the answers to the question "What'll I get?" become daily more numerous.

ZENITH RADIO

Brings in more stations—clearly and with volume—in a given length of time than any other set. Direct comparisons invited. Zenith receiving sets cost more, but they are more. The exclusive choice of MacMillan for his North Polar Expedition.

Zenith Radio Corporation
332 S. Michigan Avenue, Chicago

The New EHY Cushion Socket in Positive Contact on a Shock-Absorbing Base. Don't take a chance on twenty loose connections in a 8-v-tube set. Whether you build or buy, insist upon EHY Cushion Sockets.

H. H. EBY Mfg. Co., 4710 STENTON AVE., Philadelphia

Play Jazz in a week

on your Buescher Saxophone

You can do it—easy. 3 lessons free with each new instrument give you a sax's start. Practicing is fun because you learn so fast. And it will make you popular, in demand, the center of attraction everywhere you go. Always a hit. Even if you have failed with some other instrument, you can learn the simplified Buescher Saxophone. Don't delay. Get into the big fun. Any instrument supplied for 6 days' free trial. Easy terms if you decide to buy. Write now for beautiful free literature. Address:

Buescher Band Instrument Co. (1-2-1)
1360 Buescher Block, Elkhart, Indiana

EVERYTHING IN RADIO AT BARGAIN PRICES

Just look off the press—Big Radio Catalogue & Guide brimful of latest ideas, over 100 newest hook-ups with illustrations—all free. Shows savings as high as 25% on standard guaranteed radio parts, sets, kits. Be sure to get this thrifty book before you buy. It puts money in your pocket. Usual! You'll say so when you get it. Also always send name of radio friend. Write today.

THE BARWICK COMPANY
124-125 E. Canal St., Chicago, U.S.A.

"—results are truly amazing—"

NATIONAL Browning-Drake Transformer

A tuned radio-frequency transformer of highest efficiency. When used with a Browning-Drake receiver, the results are truly amazing. Write for Bulletin 190 R.H.

NATIONAL COMPANY, Inc.
W. A. Ruddy, President
110 Brookline St., Cambridge, Mass.

SAFETY DEMANDS BRACH VACUUM ARRESTERS FOR YOUR RADIO

They are made to give you maximum protection—need to meet a price. Insist on a Brach.

L. S. BRACH MFG. CO.
NEWARK, N. J.

FREE! To Each Purchaser of a WORLD "A" BATTERY

12-Cell—24-Volt Storage "B" Battery

Positively given free with each purchase of a WORLD "A" Storage Battery. You must send this ad with your order. WORLD Batteries are famous for their generous quality and service. Backed by years of successful experience and thousands of satisfied users, we guarantee our world and best, non-polluting and long-life 2-Year Guarantee.

Send in Writing WORLD Batteries are made in the U.S.A. and are the best made in the world. They are made in the U.S.A. and are the best made in the world. They are made in the U.S.A. and are the best made in the world.

Approved and Listed as Standard by Leading Authorities

WORLD BATTERY COMPANY
1219 So. Wabash Ave. CHICAGO, ILL.

World Storage Batteries

WORLD BATTERY COMPANY
1219 So. Wabash Ave. CHICAGO, ILL.

New Roberts' "Supercoils" using Capacity Feed Back

Higher Amplification Zero Coupling

Per Set Complete, \$7.00

P. P. C. O. D. if desired.

Mail Postcard for Details

Perfection Radio Mfg. Co.
24th & Race Sts., Phila.

NEW BIG POWERFUL MIRACO 5 RADIO

Factory prices have now 12 to 15% lower than ever. Get your money's worth. Get your money's worth. Get your money's worth.

MIRACO GETS 'EM COAST TO COAST

ELIMINATE Your STORAGE A BATTERY

AC. POLARIZER

For Harkness and other Reflex Sets, use Electric Light Current—saves you recharging overhead and bother. First small cost of Blax is last. Nothing to get out of order. Improves reception. Thousands of satisfied users. State representatives wanted. Act now.

ONLY \$1.00 Dealers selling BLAX are obtaining money.

BLACK BROS., INC.
800 Black Bldg., Los Angeles
Enclosed \$1.00 bill. Please Rush BLAX to me.

Name
Address

Notes from the Lab at Station 3XP

CARDWELL "SERIES "C" CONDENSER—Allen D. Cardwell Manufacturing Corporation, 81 Prospect street, Brooklyn, N. Y.

If you already have a Cardwell condenser in your set, it is possible to take advantage of this straight-line condenser

The Rauland Lyric Transformer

The clips are provided with the Leak-andenser. This form is particularly valuable where space is at a premium, as room does not have to be allowed for a condenser mount. The sizes run 2, 3, 4, 5 and 7 megohms. The Leakandensers have valuable to us at 3XP. We have about fifty fixed condensers and about the same number of grid leaks. It is a great time-saver for us to be able to change both condensers and leak at the same time without having to look through both boxes each time we do it for the correct sizes.



The Cardwell Series "C" Condenser

without redrilling your panel or remounting instruments. The Cardwell condensers are made from a standard template, so the change should be easy. The straight-line tuning is accomplished by cutting away part of the rotor. This feature gives you an easier separation of the lower wave-length stations and at the same time does not bring the stations in the upper broadcast band closer together.

RAULAND LYRIC TRANSFORMER—Rauland Manufacturing Company, Chicago, Ill.

The Rauland Lyric is one of the large winding transformers which bring out so well the low notes in orchestral music that we have been missing. One of the pleasing mechanical features of this transformer is the location of the binding posts. They have been located at the bottom so that short connections are possible between the transformers and the sockets.



Left: Carter Dialite

the fans who are splitting hairs on their dials for "DX." The Dialite resembles very closely the little lights we have on our dashboards in our automobiles. That is—we do, if we drive that kind of a car.

DAVEN LEAKANDENSER—Daven Radio Corporation, Newark, N. J.

The Leakandenser is made in five sizes to solve the question of the proper combination of grid condenser and grid leak. In form it resembles the ordinary fixed grid leak cartridge that is mounted on clips.

MacFADDEN B-POWER GENERATOR—MacFadden & Company, Inc., Philadelphia, Pa.

Earlier in the season we had a MacFadden unit for test. The company is now making a smaller-sized unit, although it performs the same amount of work. Provision is made for both detector and amplifier voltage.



The MacFadden B-Power Generator

How to Get the Most Out of Your Set



Learn the principles of radio from this remarkable book
514 PAGES

Compiled by HARRY F. DART, E.E., Formerly with the Western Electric Co., and U. S. Army Instructor of Radio. Technically edited by F. H. DOANE

STOP turning the dial blindly. Learn what happens when you turn them and why. Then you will get greater distance, greater volume, most enjoyable quality. The I.C.S. Radio Handbook will help you to get more enjoyment out of radio. It clears up the mysticism—tells you just what you want to know. Written by nationally known radio authorities in language that you can understand. An absolute necessity for every radio fan. A wonderful bargain at \$1. Note this partial list of contents—

Electrical terms and circuits, antennas, batteries, generators and motors, electron vacuum tubes, many receiving hook-ups, radio and audio frequency amplification, broadcast and commercial transmitters and receivers, super-regeneration, licenses, etc.

Send only \$1 with the coupon today and get this 514-page I.C.S. Radio Handbook. Money Back if Not Satisfied

International Correspondence Schools
Gen 62507, Scranton, Penna.

I enclose \$1. Please send me the 514-page I.C.S. Radio Handbook. It is understood that if I am not entirely satisfied I may return this book within the day of my purchase without any money.

Name

Address

Check here if you wish to pay in installments of \$1.00 per week for 10 weeks. Enclosed Edition



nothing like this radio set has ever been known before

Quadriformer

A new 8-tube set with all the power and most of the grip of the Super—made by Henry M. Nealey, Editor of Radio in the Home, Philadelphia.

Get This Book

Write today for this big fascinating 32-page booklet which tells how you can build the truly amazing new QUADRIFORMER receiver. Based on a new radio principle, five tubes give remarkable results.

Enclose 10c and you'll have it for return mail

Gearhart-Schlueter Radio Corp
718 Voorman Avenue, Fresno, California

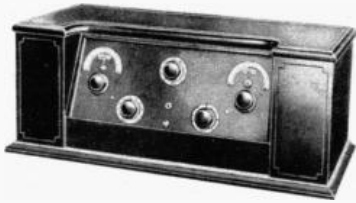

**CROSLY
SUPER-TRIRDYN SPECIAL**

The improved Super-Trirdyn panel is assembled in a new solid mahogany cabinet finished in duquesne. This cabinet with its striking lines and simple detailed decoration is of ample size to house all dry \$60.00 batteries required for dry cell tube operation.

Performance That Has No Peer in Any Field of Radio

Since the announcement of the present new Crosley models, Crosley sales have been leaping to sensational figures, literally taxing the production of all Crosley plants.

This new leadership in sales is based on Crosley's new leadership in value; and this latter resolves itself into two simple propositions:

Crosley sets consistently deliver a performance that has no peer in any field of radio—and this matchless performance is offered at the lower prices that only the economies of tremendous production make possible!

On this page are shown four of the new Crosleys—the two famous Super-Trirdyns and the two Special De Luxe models. Not only do they offer an effective beauty and accurate workmanship, but they provide a performance that cannot be surpassed in the \$23.50-\$60 price range or many dollars above it!

Make your own comparison on the basis of selectivity, distance, clarity and volume. Place the competing receivers side by side with lead-ins from the same antenna, and put them through their paces.

Forget the radical difference in price. Reach your conclusion solely on results. Then and only then will you understand why thousands upon thousands of radio buyers are singling these Crosleys out of the entire field—unwilling to pay more because a greater investment cannot provide greater enjoyment.

See the complete Crosley line at the nearest Crosley dealer's. Address Department 60 for his name and our illustrated catalogue.

THE CROSLY RADIO CORPORATION, CINCINNATI, OHIO

Cable Address: *Listenin-Cincinnati*

Owning and operating WLW, first remote control broadcasting station

Crosley manufacturers receiving sets which are licensed under Armstrong U. S. patent No. 1,113,149 and priced from \$9.75 to \$60.00 without accessories. None of the prices quoted include batteries, tubes, headphones, etc. Add 10% to all prices west of the Rocky Mountains.



**CROSLY
SUPER-TRIRDYN REGULAR**

Incorporating the famous Trirdyn hook-up, this set brings in stations sharp, clear and mellow on the Musicons. The cabinet is of oil-rubbed solid mahogany, exquisitely simple in design and beautifully finished. For above performance under all conditions the Super-Trirdyn \$45.00 can not be surpassed.....

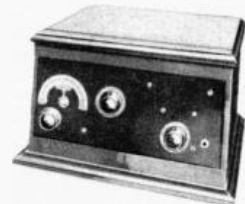

**CROSLY
3-TUBE S2 S. D.**

In this improved model are introduced radical refinements that increase its general efficiency. Refinement of parts and improvements in design have made it a truly remarkable value considering its nominal price. Genuine Armstrong regeneration with the double circuit to reduce radiation to a minimum. Beautifully proportioned with attractive sloping panel. Cabinet holds all necessary dry cells. A genuine long-range radio, easy to tune, easy to \$32.50 enjoy and easy to pay for.....



**CROSLY
2-TUBE S1 S. D.**

This superb long-range set combines Armstrong regeneration and one stage of audio frequency amplification. The handsome mahogany-finished cabinet, with sloping panel, holds all required dry batteries. Improvements include new worm-type trolley, new variable plate condenser and a double circuit to minimize radiation. Unusual selectivity and distance; extreme \$23.50 accuracy of control.....

CROSLY RADIO

BETTER COSTS LESS