

August, 1925

RADIO IN THE HOME

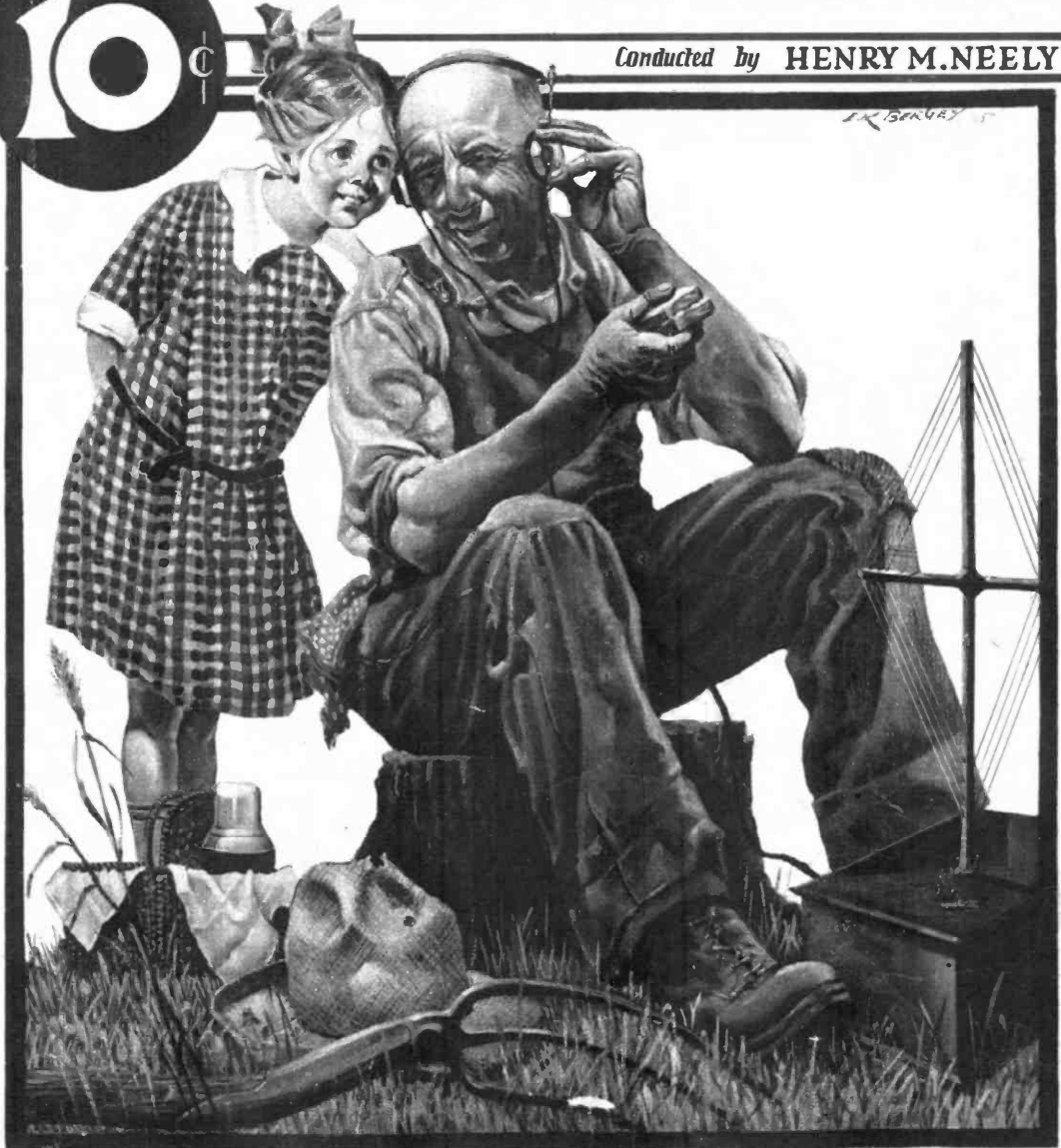

Conducted by HENRY M. NEELY



In this Issue: Flewelling's Super-Het Converter

Music Master Receiving Sets

Music Master
Resonant Wood
Insures Natural
Tone Quality

A Logical Development



Ten Models
\$50 to \$460
Guaranteed
Unconditionally

Type 300
Five Tubes, Entirely new circuit. Connect with standard bell or cabinet type Music Master Reproducer, or with specially designed art-model reproducer illustrated. Great selectivity, extraordinary volume, wonderful tone quality. Bold mahogany cabinet, beautifully ornamented, brown mahogany art satin finish.

Price, \$300

Music Master Reproducer Model XII, Drum Type. Specially designed art model, illustrated.

Price, \$35

(Canadian Prices Slightly Higher)

NOW, you will enjoy hearing over the radio songs as sung, words as spoken and music as played before the microphone.

For Music Master Receivers insure efficiency of reception equal to the quality of reproduction which has achieved a world-standard in Music Master Reproducer, the supreme *Musical Instrument of Radio*.

We know that you will really enjoy the wonderful entertainment of New Era Radio if you hear its varied offerings for young and old, for every variety of taste and need, through the proved powers of Music Master reception and the demonstrated supremacy of Music Master reproduction available in one splendid radio ensemble—Music Master Receiver.

Combining the functions of radio in one complete unit of supreme efficiency, Music Master reasserts its pre-eminent title as the *Musical Instrument of Radio*—there is no substitute.

Authorized dealers everywhere are ready to demonstrate radio as you have always wanted to hear it. See Music Master—hear—compare—before you buy ANY radio set.

Sold by Authorized Radio, Phonograph
and Music Dealers Everywhere

Music Master Corporation

Makers and Distributors of High-Grade Radio Apparatus

CHICAGO NEW YORK PHILADELPHIA, 128-130 N. Tenth St. PITTSBURGH MONTREAL
Canadian Factory: Kitchener, Ontario

Music Master

RADIO PRODUCTS

EDITORIALLY SPEAKING

RADIO is rapidly fulfilling the prediction made some time ago in these pages. This prediction was that, with the development of link broadcasting, an important event taking place anywhere in the country would be made a local event everywhere in the country.

So rapidly is this becoming a fact that there is no longer any basis for the excuse so often heard—"I'm not going to buy a radio set because I don't care anything about radio." The possession of a radio set this winter will not mean that its owner is a radio fan. The price of the set and the installation will be repaid many times if the owner does nothing but listen in to four or five of the important events that are now so commonly a part of our radio programs. In other words, radio is ceasing to be radio and is becoming an integral part of the necessary possessions of any man or woman who wishes to be considered intellectually up to date and abreast of the progress of the principal events of the country.

These reflections have been caused by the receipt from Station KSD in St. Louis of a resume of the three years of broadcasting by that station. There are few stations anywhere that can point to the very fine record shown by this log or who can claim to have maintained so steadfastly such a high standard of general excellence in programs. Here is one Middle Western station which has reached the ideal of not only adequately reflecting its own vital community life, but bringing to its community, as well, the reflections of the important phases of the life of the whole nation. Station KSD is local in body but national and international in spirit. It is such stations as this that are making radio so rapidly take its place as the most efficient tie that is binding all of the different sections of this country into one closely knit and homogeneous people.

The three years' record shown by the log of Station KSD is virtually a mirror of the history of the development of radio in the United States. The changes that have taken place, the growth in importance of the various programs from year to year, the evidence of a continued mighty endeavor even in the beginning to put on the air just as high-grade programs as it was possible to get at the time—all of these things are typical of the twoscore or more stations that have really become national figures in the broadcasting field. Nor is this station showing any sign of yielding to the natural impulse to take

By HENRY M. NEELY

things easy during the hot months of the summer and to assume that, just because there is a smaller radio audience during the hot months, it is not necessary to maintain a high standard. The plans made for this summer—plans which are probably already being fulfilled as you are reading this—show what a broadcasting station can do when it really determines not to relax for one moment in its efforts to give the best.

A special broadcasting feature of the summer season will be the sending out by radio of plays and musical dramas at the new open-air theatre in St. Louis County, to be opened July 6 by an association of public-spirited St. Louisans. This theatre is built in a beautiful glade on the banks of the River des Peres, just west of University City, a suburb of St. Louis. A natural proscenium of forest oaks makes a beautiful setting for the productions which will be presented on the stage at this theatre. A background of other greenery with the little river in the distance, and an artificial lagoon in front of the stage where the orchestra pit normally would be, will be other beauties of the setting.

The plans of the theatre, which is under the direction of Joseph Solari, a St. Louis director, are to use the natural scenic effects of the stage and to introduce as little in the way of artificial setting as possible.

The theatre was opened with a performance of Sophocles' "Electra" with Margaret Anglin in the principal role. The production was virtually the same as given in the Greek Theatre in Berkeley, Calif. under the auspices of the University of California, and is believed to be the first occasion on which a Greek drama has been presented under any auspices other than that of

an institution of learning. There were two weeks of "Electra," and on Tuesday evening in each of these weeks KSD broadcast the performance. The music score for "Electra," which is by Furst, was under the direction of William A. Parson, orchestral director of the Garden Theatre, formerly orchestral director of the Municipal Theatre in Forest Park, St. Louis.

The second offering at the theatre will be the fairy opera "Hansel and Gretel," by Humperdinck, with a cast composed of members of the Metropolitan and Chicago Opera companies, with the minor parts taken by local artists. Following this will be three weeks of a fashion pageant, a spectacle usually given in the Municipal Theatre at Forest Park, and the season will close with two weeks of a review especially arranged

(Continued on Page 22)

So That's How It's Done, Eh?

HERE is a little story from which you may get an idea of how these things are done:

A friend of mine is one of the feature writers for radio on a Philadelphia newspaper. It falls to his lot to receive and talk to the various manufacturers' agents who call at the office to try to get the names of their products in print. In the course of a recent day the agent of a certain manufacturer called upon him and became very friendly and confidential. They went out to lunch together and later that agent took my friend home in his motorcar. As he stopped at my friend's door, he said:

"Well, now, let's have the thing definitely understood. We will pay you \$500 in cash if you will specify our products in your articles for ten consecutive weeks."

My friend happened to have a fairly fluent and picturesque vocabulary, picked up through his service as wireless operator at sea, and he drew a vivid and hectic picture of just what he thought of the agent's proposition.

"Why," exclaimed the agent in surprise, "I don't see why you should take it that way. That is the arrangement we have with most of the New York radio editors and with the editors in other cities, and I supposed, of course, it was a usual thing in Philadelphia."

EVEREADY HOUR EVERY TUESDAY
AT 8 P. M.
(Eastern Standard Time)

For real radio enjoyment, tune in the
 "Eveready Group." Broadcast through

WEAF	New York	WEAR	Chicago
WEAR	Newark	WEAI	Chicago
WEEI	Boston	WJ	Chicago
WFI	Indianapolis	WCCO	Minneapolis
WGR	Rochester	WOC	St. Paul
WGAE	St. Louis		Des Moines

*Eveready
 Columbia
 Ignitor
 Dry Cell
 The
 proven
 dry cell
 for all
 radio
 dry cell
 tubes
 1 1/2
 volts*

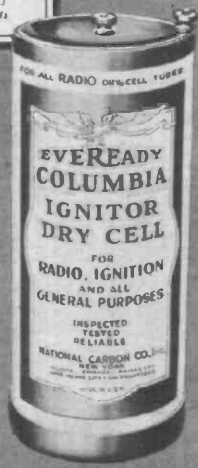

*No. 767
 45-volt
 Large
 Horizontal
 Price
 \$3.75
 With
 variable
 taps*



PREFERRED

It is no accident that more Eveready Radio Batteries are purchased by the radio public than any other radio battery made.

Such complete and voluntary endorsement can lead to but one conclusion—for best reception and longest life, Eveready Radio Batteries lead the field.

You can prove this for yourself by hooking Eveready Radio Batteries to your set. You will find that they deliver a steady, vigorous stream of power that lasts longer. It is Eveready economy that has created such an overwhelming preference for Evereadys. For every radio use there is a correct, long-lasting Eveready Radio Battery. There is an Eveready dealer nearby.

Manufactured and guaranteed by
NATIONAL CARBON COMPANY, INC.
 New York San Francisco
 Canadian National Carbon Co., Limited, Toronto, Ontario

EVEREADY Radio Batteries

- they last longer



*No. 772
 45-volt
 Large
 Vertical
 Price
 \$3.75*

Graham McNamee

By
GOLDA M.
GOLDMAN

SOMEHOW or other it is impossible to separate the voice of Graham McNamee from the impressions of radio announcing. Not that a talk with him suggests in any way the formalities of his work in the studio, but you become so accustomed to hearing his smooth and easy delivery coming in that friendly tone from your loud-speaker that even after a visit with him, your memory instinctively feels that you have heard it all through your radio receiving set. Last week I was fortunate enough to spend a delightful afternoon at the McNamee home, and when I left I decided to write the story in the form of the usual interview. It simply refused to be written in that way, however. My typewriter insisted upon transcribing my impressions just as though it were copying the words as they came from my loud-speaker and this is about the way they sounded:

GOOD morning, ladies and gentlemen!
If you really want to know anything

about me I wish you would wait until my wife comes home. She knows where everything is. She has a great big scrapbook with everything in it.

You know, my wife is a singer, a lyric soprano, and she is around the corner singing just now. No, indeed, she doesn't spend her time just sitting home waiting

When the last feature has been announced and the day and night's work is finished, Graham McNamee goes to his own home, where he is compiling a book dealing with experiences "Before the Microphone." The picture shows him going over the daily notes with Mrs. McNamee

Photo by United



for me to come in; on the contrary, she goes more than any other human being I ever saw!

She keeps herself tired out and on the jump all the time, but just the same she knows everything I do and keeps a careful eye on me. We had some pictures taken together recently, but I don't know where they are. When she comes in she'll be able to find them for you.

Oh, yes, I remember that I am supposed to be talking about myself. Well, it seems funny the impression people have about me.

They think I am an old newspaper man, or some kind of a sportsman, and I never wrote a word in my life, and while sports were my hobby, about all I did was play a little amateur baseball and hockey.

What I was before I went into radio was a concert singer, and I sang in churches as baritone soloist. I was born in Washington, D. C., and spent my younger life in St. Paul, where I started my professional singing. Then I came to New York to study, and from 1912 to 1923 did nothing but concert and church work. The way I first got into radio is

really funny. I happened to be on a jury away downtown and during recess one day I thought I'd like to see what the inside of a radio station looked like. WEAF proved so interesting that the first thing I knew I was working there temporarily. That was in May, 1923.

Of course, singers are not very busy during the summer months and this was just to be temporary work for three hours in the evening. I hadn't been doing anything much, so that most of my time was being spent in tearing up the sod of golf courses, and this looked like an interesting way to fill up my time. About six months later the temporary connection was made permanent.

The Greb-Wilson middleweight championship scrap came along just then. There didn't seem to be any one to cover it, so they sent me. I went and visited the boxers at their training camps and wrote stories on them which I read over the air on the two nights preceding the bout and then broadcast the bout itself.

That just seemed to get me started on the sport stuff. Shortly after this the World Series of 1923 came along; some one else did the first three games and then I took the microphone and finished the series. Last year's World Series I just fell into by a sort of inheritance. That 1924 series, by the way, brought out some amusing qualities of the listeners-in. They say baseball has be-



Graham McNamee—His voice has been heard by more persons than the voice of any other man in the history of the world

Photograph by Foto Topica, Inc.



come so commercialized and is done on so big a scale that people aren't interested in it the way they were. But if you could have seen some of the rabid letters I got, each accusing me of favoring the other side, you would not think the enthusiasm was dead.

Then I did the big college football games—all the games of the big three, Yale, Harvard and Princeton, and the Navy-Army game—eleven altogether.

The biggest job of all has been the political work, for I seem to have gone right through the whole national political cycle. This started with the first Coolidge message to the Sixty-eighth Congress. Then came the Republican Convention in Cleveland, then the Democratic Convention in New York, the acceptances of Davis, Coolidge and Dawes, and the election returns. That night I stayed with a microphone from 7 to 1:30. Last of all came the inauguration speech.

For two years now I have done practically all the sporting

(Continued on Page 26)

The Shriners' Radio Marathon

By
H. W. BERGMAN

The main antenna and the tower of the Los Angeles Times radio station, KHJ.



ONE hundred and fifty hours of continuous broadcast! Nine thousand minutes! Nearly two thousand five hundred people in front of the microphone, presenting seventeen hundred odd separate selections.

And this without a single break in the continuity except for a thunderstorm that put the entire city's lighting system out for a period of nineteen minutes and, of course, during this period, the generators that were driving the transmitter stopped. The lofty antenna, with its masts of steel, was struck six times by lightning during the storm, but when the electric service resumed its function, the motor generator again turned over and the carrier was back on the air.

This was the record made at KHJ, the Times station, in Los Angeles, Calif.

Once during an intermission the carrier was taken off while a new 250-watt oscillator tube was put into the transmitter, taking the place of one that had gone west.

But this only took thirty-six seconds and the listener was not even aware of the change. The longest delay between selections or between shifting from one remote control point to another was less than two minutes.

This marathon, as "Uncle John" Daggett called it, was not put on as a stunt, but was engineered and planned for the prime purpose of honoring the Ancient Arabic Order, Nobles of the Mystic Shrine, who held their fifty-first conclave in Los

Angeles during the week beginning June 1. It was done for the purpose of holding open house for the visiting Shriners, to permit them to come up to the Times radio studio, at any time, day or night and to broadcast greetings to their friends at home or to other members of the order, who, by reason of sickness were unable to attend the conclave.

And the Shriners certainly took advantage of the opportunity. At all hours, the studio, the visitors gallery and the roof of the Times Building, from which the large bands broadcast, was polka-dotted with the red fezzes of Shrinedom.

The station was officially put on the air by the Imperial Potentate "Jim" Chandler, at 7 o'clock P. M., June 1, and remained on the air continuously until 12:22 A. M. Monday, June 8, when Carl Buratti played "taps" on his cornet, and the poten-

The Marathon Boosted Radio Sales on the Pacific Coast

ACCOMPANYING this article, Mr. Bergman sent us a letter which gave an interesting side-light on radio conditions along the West Coast. He writes:

"The Marathon has created quite a furore among the radio fraternity here and I believe that it is a forerunner of many wonderful things to come. The radio dealers here considered it in the light of a godsend. Business had slumped almost to zero in spite of an attempt to revive it by holding a portable radio show. That is, the instruments on display were portable, not the show. But it didn't help much. The thing that keeps radio alive is broadcast, and the only way to re-create interest is by injecting novelty into the otherwise 'run of the mine' entertainment that is presented.

"Competition among the different broadcasters here is very keen; sometimes it is murderous. Two religious

organizations had a fight via radio a few months back. Suffice to say, both lost.

"There are at present almost as many broadcasters operating here as there are in New York or Chicago. KFI is now unofficially radiating about 2200 watts, KJS is putting out close to 1000 watts. KHJ, KNX, KFWB, KFSG are rated at 500 watts, but their antenna amperage runs all the way from 3½ to thirteen amps.

"Warner Brothers have a novelty in the broadcast line. The only motion-picture studio that supports a broadcasting station.

"The Pacific Coast is as much interested in distance reception as the East Coast, but we have difficulties to overcome that are not appreciated by the eastern fan. Summer static is not as bad here as in the east because of the absence of heavy thunderstorms. In fact, lightning arresters are conspicuous by their absence."

tiometer on the speech input was slowly moved downward until the last notes faded out, and with them the station faded from the air after one hundred and fifty hours and two minutes of operation. The unofficial opening was at 6 P. M., June 1, when Bob Harper, the night operator announced Jack Cronshaw's Orchestra playing by remote control from Leighton's Arcade Cafeteria.

Many will wonder how it was possible to provide talent for such a long program, particularly those who read the "doom" of broadcast, unless there is some way of making the listener pay for it. Strange as it may seem, KHJ did not pay one cent for talent and still was able to put on such artists as the Philharmony Orchestra, the Woodwind Quartette from the Los Angeles Philharmonic Orchestra; Chico De Verde and his string ensemble; Claire Mellonino, concert pianist; Frances Gabrielle, soprano; Melba French Barr, contralto; Joseph Heindle, 'cellist, and many other artists comparable with the best in the country.

This splendid assemblage of talent was made possible by an arrangement which we believe was originated at the Times station—that of presenting "patron" programs. Any one who wishes to put on a program over KHJ may do so if, in the judgment of the management, it reaches a certain definite standard. The station furnishes the radio personnel without charge to the patron and the patron reimburses the artists for their time. The only advertising that enters into this presentation, is the occasional mention of the name of the company or organization,

Helen Pirie, "Queen Titania of Fairyland." KHJ.

that is sponsoring the program. One particular company, the Los Angeles Soap

Company, by the way, spent more than \$1500 during the marathon, presenting one program every day during the run. This program began at 6 A. M., and every penny of that money was paid out to the artists employed. About 60 per cent of the time of the marathon was occupied by "paid programs" and the balance by Shrine organizations or programs presented through the courtesy of the artists themselves.

Another question that may enter the mind of the reader is: who would listen to broadcast at 3 or 4 or 5 o'clock in the morning? Well, the answer is that many did. During the early morning hours when Paul Adama, of the Orpheus Quartet, would sit down at the piano and the regular studio gang would assemble around him and sing old-fashioned songs, telephone and telegraph requests without number would come rolling in. In fact, many reports remarked that one of the most enjoyable features of this marathon was the informality and good fellowship that pervaded these early-morning broadcasts.

The idea of running this marathon came one Sunday morning when "Uncle John" got up from his bed at home and came down to the studio. The midnight to early morning broadcast of the "Lost Angels of K H J" was in progress and they were running a bit longer in response to a letter from a Mr. Scott in Tasman-Nelson, of New Zealand. The station had been on the air for over ten hours and the orchestra had just played "Three o'Clock in the Morning." Every one was trying to



figure out what time it was in New Zealand and could not reconcile themselves to a statement that had been made, "That it was then eleven P. M., Monday night at Mr. Scott's Island."

"Uncle John" came in and asked, "What are you folks trying to do—run a Marathon? Here KFI is trying to reach Australia, and you folks are trying to reach New Zealand!"

Later, after the station had signed off, he remarked with studied casualness, "How would it be to run a real radio Marathon during Shrine week? Open up when they arrive and stay on the air until they leave."

The possibilities were argued, pro and con; it looked like a monumental stunt to keep the carrier on the air that long; what about the batteries on the speech input lines? They wouldn't last that long. Well, get another set to run while the first was charging; put in switches to parallel the batteries; put one set on before the other set was taken off. Would the generator stand up that long without heating? Put fans on to cool it; put fans on the inductance coils to keep them from getting hot; put fans on the operator, etc., etc.

"It can be done!" was the spirit, and it was done. Operating shifts were arranged, announcing shifts and programs. That last word should

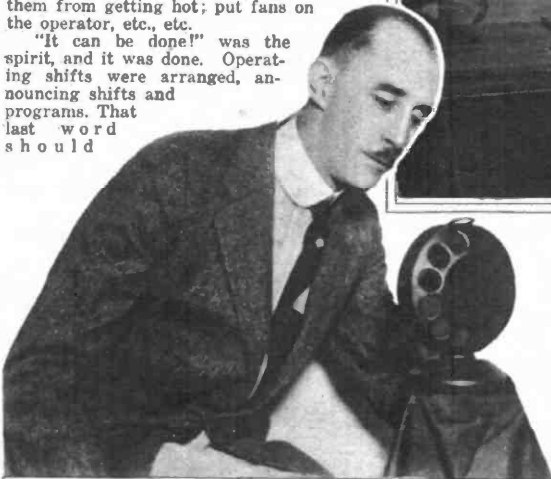

(Left) Mr. O. G. Pirie, better known as the "Sandman" during children's hour

(Below) Major and his orchestra that presented several noontime programs during the radio marathon



Below is "Uncle John" Daggett, the presiding genius of KHJ, and to the left he is shown with some of the radio kiddies presented during the children's hour.

have been "PROGRAMME!" because when it was made up it was about six feet long, closely typewritten. The sponsors included The Los Angeles Soap Company, The Pacific States Electric Company, the Martin Music Company, the Western Auto Supply Company, the Music Trades Association, The Hollywood Yale Corporation, The Piggly Wiggly Stores and other organizations that held the microphone all the way from one-half hour to six hours.

The Times has three remote control stations, and at the Biltmore Hotel three microphones were in use, one in the main ballroom, one in the music room and one in the dining room. The first Methodist Church has four "mikes." Leighton's Arcade Cafeteria has one, while the "Main" studio of KHJ employs three microphones. That makes a total of eleven microphones that were in use.

The roof of the Times building has another building set upon it and in this the studio is located. The balance of the roof is used to broadcast bands, and it was here that the large Shrine bands, such as the Aleppo Temple Band, of Boston, of one hundred and thirty-eight men, assembled for broadcast.

Twenty-one Shrine bands appeared before the microphone at KHJ during the week. The personnel of these bands numbered 1225 men and they played 126 selections. They ran all the way from the Hillah Temple Drum Corps, of Klamath Falls, Wash., numbering ten men and "Cap" Ellis' gang from Medinah Temple, Chicago, who had only three instruments



statistics it might be apt to say that there were:

694 Vocalists	giving 636 selections	
186 Instrumentalists	" 210 "	268 men.
17 Orchestras	" 388 "	
21 Bands	" 125 "	1225 "
36 Pianists	" 105 "	
14 Hawaiian Orchs.	" 110 "	44 "
88 Speakers and Readers	" 146 "	

making a grand total of 2441 persons who appeared before the microphone and giving a total of 1720 selections, making an average of five minutes and fourteen seconds for each selection. This is exclusive of announcements, news items or weather reports and time signals that were given regularly. During the course of the broadcast a gong was sounded each hour, and the time of the day was indicated as well as the number of hours already run and the number of hours to go on the Marathon.

Among the dance orchestras that were broadcasting were Art Hickman's Victor Recording Orchestra, Major and His Rendezvous Orchestra, the Orange Blossom Girls, the Majestic Six, White's Californians, Ory's Creole Orchestra, Owen Fallon's Californians and the Ben Ali Orchestra from Sacramento.

The rendition of comic opera selections and classics was given by the following orchestras: The Biltmore Concert Orchestra, directed by Edward Fitzpatrick; the Miniature Philharmony Symphony Orchestra, directed by Andre MacQuarre; the Philharmonic Wind Quintette,

(Continued on Page 25)

in their band (a bass horn, a bass drum and a trombone, the rest of the instruments being kazoos), to the nationally famous bands, such as the Medinah Temple Band, the Tehama Temple Band, of Hastings, Neb., that is often heard over "Kay Eff Kay Ex, at Hastings, Nebraska"; the Aleppo Band, of Boston, and the 160th Infantry Band, of Los Angeles. With so many bands available, the operating force of KHJ were able to develop a technique of instrument placing and "pick-up" that would otherwise take a year to obtain.

While on the subject of



At the top of the page is the "main" studio of the Times broadcasting station, KHJ. Circle—The Orange Blossom girls. Right—Mr. E. K. (East cake) Barnes, announcer and assistant studio manager. Left—Jose Arias, whose Mexican singers and dancers, with their music and dancing and even synthetic bull fights, enlivened the early morning hours during the radio marathon.



Logging the stations at San Antonio, Mrs. C. E. Schoff, of San Antonio, listens to WOAI or to distant stations from Southern Texas

IT IS probably safe to say that Elizabeth Hallam Bohn has received more letters from women radio fans than any one in the game at the present time.

All during last winter, Miss Bohn broadcast the rice recipes which were given during the hour's concert by the Astor Coffee Orchestra through WEAF and its link of broadcasting stations.

When I was in Miss Bohn's office in New York not long ago, I noticed a huge packing box filled with letters. I asked Miss Bohn what those letters were.

"Oh," she replied, "those are my radio friends. They are the women who have written me about my talks by radio and who have told me the most wonderful things about their own reaction to radio in general."

"Good," I replied, "those letters contain exactly the information which we in the radio business want. What do women want in radio? Those letters are the answer."

It was from this visit that the idea of this article originated. I hope that Miss Bohn will give us further information regarding the wealth of data that is included in that packing box full of letters from women fans.—H. M. N.

By **ELIZABETH HALLAM BOHN**



"What do Women Want in Radio?"

"WHAT do women want in radio programs?"

Man, captain of all industry, and master of the world, has always considered woman's wants a complex and incomprehensible maze, in which he invariably found himself lost, even when he most strived to please her. In moments of chagrin, he has been known to wail (with greater wisdom than he realized), that "All women are alike!" The woman who has been asked to answer this question is confident of that.

The time was (it has now passed), when women's life was composed of little more than a span of days and years spent in following with patient exactness the round of mundane duties which fell to her lot. However willingly she chained herself to her little sphere of washing and baking and mending and cleaning—however scrupulously she carried out her monotonous household program from her young-bride days to the rocking-chair period of life, however brightly she was surrounded by the reflected glory of her children's achievements—she lacked one essential element that is the heritage of all women, that puts brightness in their eyes, a lilt in their voices, and confidence in their hearts—that something that can best be summed up in the word—"variety."

The most casual glance over the pages of history offers testimony to the fact that not only women who were the reigning favorites of the day, but those who attained the most enviable distinction in cultural

accomplishments, were those whose means and position allowed of much varied activity, association with the distinguished figures of the day, changes of scene, and social gaiety.

The American woman of several generations ago, however high she stands among the world's women as a figure of nobility, was none the happier for her narrow, sheltered life.

The opposite extreme to which these commercial days have swung us may have its drawbacks, and authorities may maintain that we are undermining our health

by keeping late hours so as to hear every program on the air, but that opportunities for varied entertainment are legion, none can deny. And to no one is this new order opening more mental doors than to the woman in the home.

It is safe to say that only a very small number of present-day home-makers have enjoyed expensive and thorough training in scientific home-making in women's colleges before taking up their life jobs as wives and mothers. But that doesn't mean, in this progressive age, that they don't want to know all that can be read and heard on the subject of saving precious time and energy in their daily work.

The average home woman spends from one-half to three-fourths of her day within her four walls, and with a radio set to keep her company, she can learn how to market shrewdly, re-decorate the house, make her new dress in the accepted mode, master the most complicated electrical appliances, preserve her youthful figure (or reconstruct it if necessary), plant her garden, brush up on her French, make candy with professional finish, keep her husband company on his week-end round of golf, feed the children correctly balanced meals and become, by radio, the very image of Solomon's ideal wife, except that she need not rise so early to "set her house in order."

In answering the question "What do women want in radio programs?" we must remember the cross-section of any radio-owning community would include ladies of comparative leisure, the comfort-

THE average home woman spends from one-half to three-fourths of her day within her four walls, and with a radio set to keep her company she can become, by radio, the very image of Solomon's ideal wife, except that she need not rise so early to "set her house in order."

Home-makers all over the country are eagerly drinking in every bit of worth-while information the great radio stations have to offer, and I am willing to wager that very few cakes have fallen and still fewer male socks gone unended because of their new devotion to the game of listening in.



Radio in the home of Mr. and Mrs. C. S. Dickens, at Beaumont, Texas. Mr. Dickens is an official of the Magnolia Petroleum Company at Beaumont, which operates station KFDM. The set is a Freshman with a Magnavox loud-speaker

ably well-to-do, and the hard-working mother of many. The fact that a woman of exceptional musical training begs to be relieved of listening to jazz by no means proves that popular music may not bring a twinkle of pleasure to the lired eyes of a woman ten blocks away. But a few truths do hold, according to the mass of mail which lies before me.

I only wish it were possible to quote from the many letters which have touched and amused me—weighing one from a country town, expressing gratitude for an inspiring concert, against a plaintive request for assistance from a semi-invalid who was looking forward with the joy of a child to her first shopping trip in six months, under doctor's orders not to become over tired, on pain of returning to her sickbed. You can fancy what it meant to discover, through a talk on the air, that a former associate in war work, whose home was far distant, was lying ill in a New York hospital, whiling away painful hours by listening in.

Home-makers all over the country are eagerly drinking in every bit of worthwhile information the great radio stations have to offer, and I am willing to wager that very few cakes have fallen and still fewer male socks gone unmentioned because of their new devotion to the game of listening in.

Having for a period of time accepted without question everything that came over the air, a nice discrimination has begun to show itself among women. Their letters offer intelligent, constructive criticism, as well as praise where it is due. They have reached the stage where they object to platitudes and long-winded dissertations.

They want live, human, concise talks—not too long—on practical matters of home interest. Recipes and menu suggestions are always welcome, providing they are sanely arranged, with proper consideration for the types of home in which they will be eagerly scribbled down, to be tried out later with elaborate care. It is so thoughtless to broadcast suggestions calling for ingredients or quantities, which to the average family or suburban home-maker

THEIR letters offer intelligent, constructive criticism, as well as praise where it is due. They have reached the stage where they object to platitudes and long-winded dissertations. They want live, human, concise talks—not too long—on practical matters of home interest. Recipes and menu suggestions are always welcome, providing they are sanely arranged, with proper consideration for the types of home in which they will be eagerly scribbled down.

Women can never have enough of fashion talks—all my letters sound this note—but they want them intelligible, informative, and inclusive, carrying workable ideas rather than the frills of the latest Paris importation.

The feminine interest in the more violent forms of modern music is distinctly on the wane, and an unanimous desire is expressed of late for the dear old songs.

are unknown or extravagant.

Women can never have enough of fashion talks—all my letters sound this note—but they want them intelligible, informative and inclusive, carrying workable ideas rather than the frills of the latest Paris importation.

The feminine interest in the more violent forms of modern music is distinctly on the wane, and a unanimous desire is expressed of late for the dear old songs which have grown up with Americans for generations. Wide approval has been accorded to the songs of other nations, and following such programs come floods of letters from foreign-born men and women, many in quaint and laborious English, touching in their gratitude for the airs of home.

The popular hours for listening-in naturally vary according to the pursuits of the radio enthusiast. But it is safe to say that the average home-maker enjoys tucking in an hour with the radio between 11 and 12 in the morning, and late in the afternoon, before the approach of the dinner hour calls her into the kitchen again. For that matter, many women have proudly written me that through the thoughtfulness of their men-folk they are able to hear all the air offers while the lowly potato is peeled and the baking is superintended.

Of course, the universal love of sharing brings together all the family, young and old, with their tasks over for the day, in the evening, when from after-dinner-time to midnight the radio is next to impossible to leave. A very happy medium it proves, drawing relatives and neighbors around it in common enjoyment of its delights.

As many a man will probably testify, women are having their say in the purchase of the radio set to as great degree as they influence the choice of a motorcar, nowadays. And the lady of the house is to be thanked for the rapid improvement of the outward appearance of the radio set, from its original jumble of wires and batteries, to the dignified, ornamental pieces which are now to be found everywhere, as fine adjuncts as the piano and Victrola have been in days past.

Moreover, as the spiritual guide of the family, and the reigning spirit of the home, the woman is finding, thanks to the radio, helpful short-cuts in the fine art of home-making, new outlooks, a broadened horizon—having light thrown on the path which leads to contented family life—what every woman wants.

By
R. S. McBRIDE

Washington Correspondent of
(Radio in the Home)

IN THE outskirts of Washington, D. C., there is an institution which might truly be called the Supreme Court of science and technology. As a matter of fact it is known as the National Bureau of Standards. It was organized in 1901 for the fundamental purpose of the "development, construction, custody and maintenance of reference and working standards and their intercomparison, improvement and application in science, engineering, industry and commerce."

This is rather an imposing definition of responsibility, especially when one realizes that standards of measurement are only one of many kinds of scientific and technical standards which the Bureau must consider.

Two of the types of standards investigated by the Bureau which concern radio and the broadcast listener are "standards of practice" and "standards of performance." Standards of practice relate, for example, to matters of how an agency serving the public shall organize its work to give safe, efficient and adequate service to the public. Standards of performance relate to devices and machines, such as radio receiving sets, tubes, batteries, ear-phones, etc., for which definite requirements can be set up as a *measure of service value to the user.*

But no one should get the idea that the Bureau of Standards has either the desire or the authority to set up definite rules and regulations which all must obey. There is no such idea or intention involved in Bureau work. The purpose is rather to discover the facts and to serve in co-operation with industry in making available the best possible service and the best possible equipment.

In an earlier article the work which has been done by the Bureau in establishing standards of frequency for the guidance of broadcasting stations has been considered

at length. That work is rapidly leading to a much better understanding of radio-frequency measurements and the maintenance of the proper wave length at each broadcasting station. It is also gradually eliminating the very serious practical difficulty of the listener-in who has been unable hitherto to unscramble the assortment of broadcast waves served up for him by the numerous broadcasting stations.

The listener-in does not really care what is the particular standard of frequency at any one broadcasting station or how it is measured. But he is very anxious that each standard be such that there is not any interference between the station which he wishes to receive and others simultaneously sending out entertainment and information. After that is arranged, the question of frequency standards does not come into the living room or study except, perhaps, for the single purpose of calibrating the tuning dial on the receiving set.

For this latter purpose, Mr. Average Man really needs the services of the Bureau whenever he buys a new set or changes

station will be found when it comes on the air. And, too, the game of "fishing" for distance is much simplified, for at least the fisher knows about where to drop his hook in order to catch the desired variety of fish.

This matter of frequency standards, although exceedingly important, is perhaps the simplest of all the standardization problems in radio. The most important standard of all for the broadcast listener, and the most difficult to define, is the *standard of performance of the receiving set and its several accessories.*

The listener desires to get absolutely undistorted reproduction of the material which is being broadcast. He wants to get the desired program without any confusion or disturbance by other material. And he wishes to get this up to any desired intensity, that is, loudness, without any stray rattles or snarls or sputters.

In defining these desires for the radio set of *perfect performance*, one is describing an ideal, not any available machine. The definition is, in fact, much like the description of the ideal automobile which will never bump or

When the market offers us such beautiful radio sets as this, it is only fitting that we should insist that the quality of the reproduction be equal to the quality of this workmanship. It is for this end that the Bureau of Standards is working and to assure the owners of such sets that all of the parts which go into them will be up to a high standard of engineering.

The photograph shows the Royal Sixteen—the latest addition to the Kennedy line.

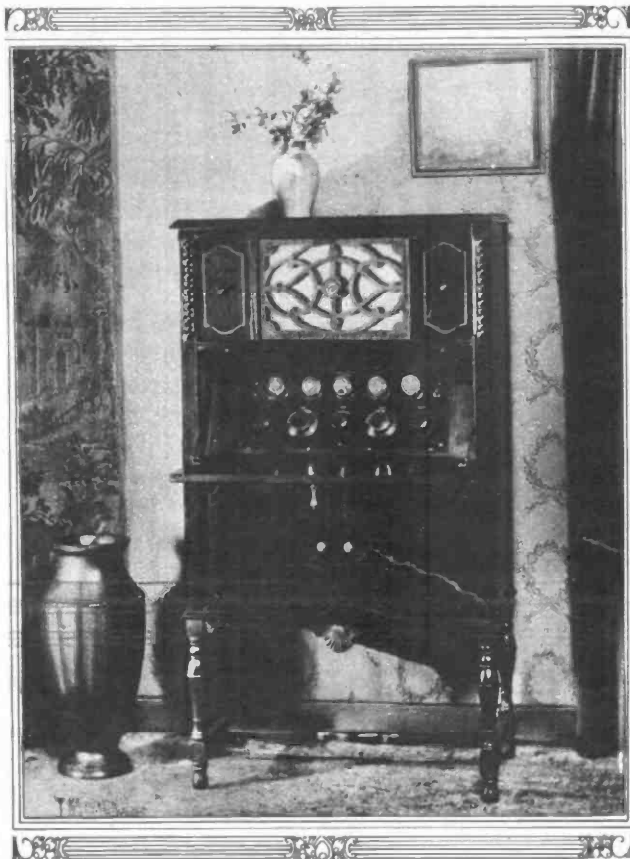

Making a "Yardstick" to Measure Quality



Coming!

Factories of this Company are in quantity production of the new Jewett Receiver. Deliveries have begun.

These facts are supremely significant. For this new Jewett constitutes beyond question, *the longest recent forward step toward perfect Radio Reception.*

In fundamentals, and in details, the Jewett is emphatically *new.*

Its tuning element is *new.*

Its method of audio amplification is *new.*

Its beauty of line and finish is *new* and distinctive.

Originality that can come only from genius—young, untrammelled, triumphant—such will be your confident verdict.

Make no Radio investment until you have seen this new Jewett and listened to the marvel of its performance!

The Jewett will be marketed in a beautiful cabinet of the new Clairmount Mahogany, at a price far below any receiver of comparable performance.

"THERE IS NO SUBSTITUTE FOR THE BEST"

JEWETT RADIO & PHONOGRAPH COMPANY
5682 TELEGRAPH ROAD PONTIAC, MICHIGAN

Factories: Allegan, Michigan—Pontiac, Michigan

In Canada:
Jewett Radio-Phonographs, Ltd.
Walkerville, Ont.

Export Sales Offices:
116 Broad St., New York City

The Jewett Receiver

Radio *the Beautiful* *As I*

By **GOLDA M. GOLDMAN**

RADIO as a pastime for mechanically inclined men and boys has been removed from the drawing room to the cellar. Gone are those happy days of only a brief year or two ago when one might with comfort, nay with pride, litter up all the available tables, desks, chairs and bookshelves with spare parts.

The building of enormous eight-tube sets is no longer considered an adequate reason for turning a house upside-down. Since the experimental stage is fairly a thing of the past, it is already considered safe to buy an expensive set of one make or another. Just as the horn of the old-fashioned talking machine disappeared much after the manner of an outgrown tail of a prehistoric monster once evolution had decreased its utility, so are

various radio set accessories disappearing, inclosed in a cabinet so attractive as to be a decoration of the highest order.

So far radio has not worked out for itself a set final form after the manner of all other musical instruments. The harp, the piano, the Victrola developed a recognizable standard shape early in their history. In fact, the Victor Company went so far as to patent the shape of the Victrola, standardizing it until a very recent flair for a more artistic article produced a Victrola masquerading as a console table; the radio, that great romance of the age, refuses to be tied down by tradition or shape. This great force is reaching out and clothing itself in the shape of works of art handed down through many ages. It is only one of the

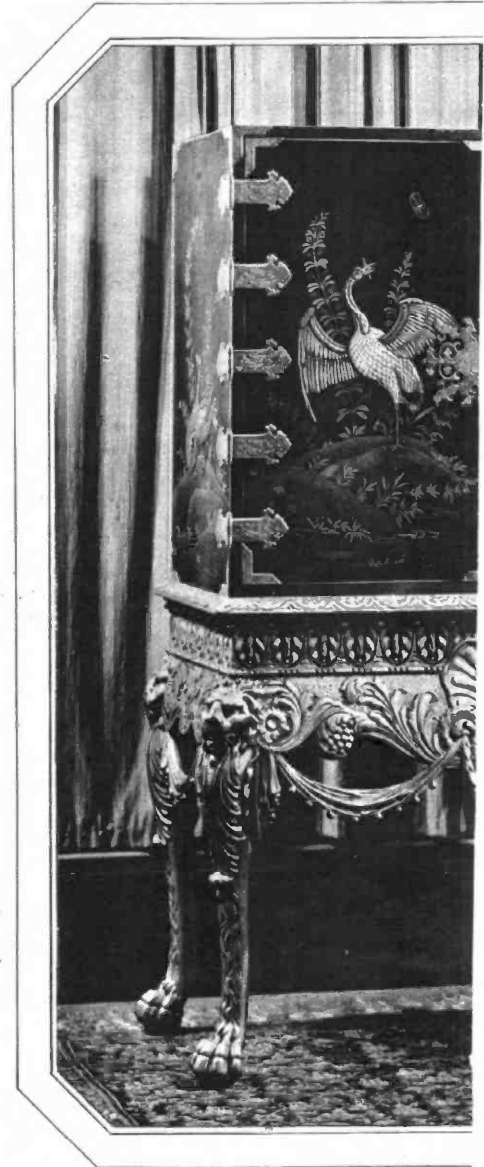

The photograph above shows a cabinet of the affair. It is lacquered and decorated with gold English gilt, glazed. It is by Wm. Baumgart.

To the left is a radio cabinet of the early six walnut with delicately inlaid panels. Design Aeolic

To the right is a cabinet of the Queen Anne; and executed by W. and J.

SHOULD Be in the Home

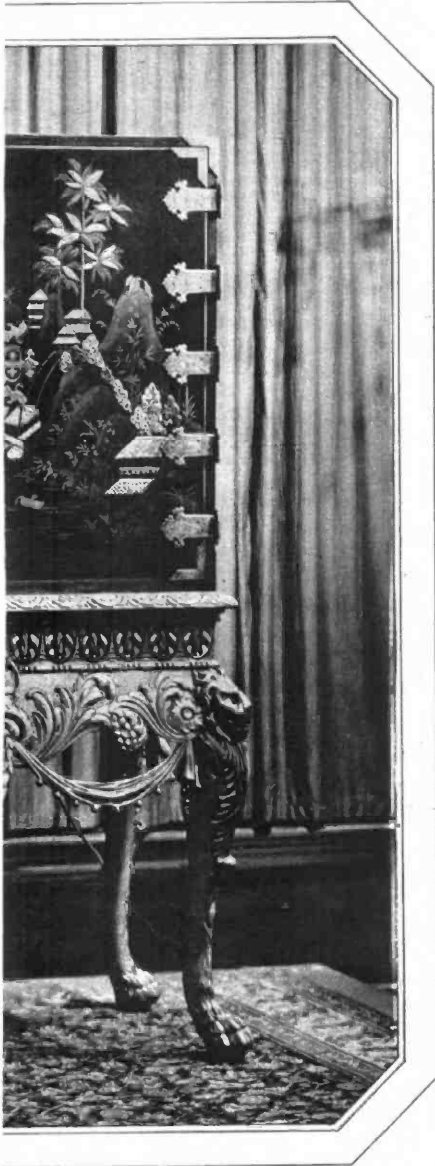

many qualities of this phenomenon that it can so adapt itself. It seems probable that the next year or so will give the world a new game to rival the interest taken in cross-word puzzles. The game will be "Find the Radio," for many and varied are the disguises under which it fits into the well-planned home of today.

Let us look, for instance, at this beautiful cabinet in the left corner; this is an excellent example of the work of the early sixteenth century Italian period. It is developed in Italian walnut, with delicately inlaid panels, and was designed and executed by H. F. Huber & Co. of New York. It is a copy of a piece which may have stood in the beautiful room of some Italian nobleman of long ago, and it may have housed "papers of dark intrigue,"

but today it contains no "dry as dust" documents, no material for romance, unless it be that most modern of all romances, for as you open its front panel you will have at your command the voices of all the world.

Or will you look at this massive piece of the early Georgian period (in the center). Here is a cabinet finished in green-blue lacquer, decorated with gold leaf and beautiful etched gold hinges. The heavy base is hand-carved and finished in English gold-gilt glaze. It was designed by Wm. Baumgarten & Co., Inc., and it houses not only a radio, but also a Victrola.

You may be interested in this cabinet of the Queen Anne period (in the right corner), which is of walnut, enriched with comino wood burr, (Continued on Page 24)



Georgian period, which is a most gorgeous
The base is hand-carved and finished in
., Inc., and is offered by the Aeolian Company

century Italian period, developed in Italian
executed by H. F. Huber & Co. for the
any

enriched with comino wood burr. Designed
for the Aeolian Company

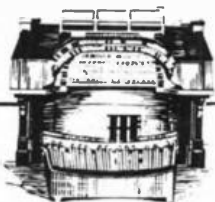

Majestic Roll of the Mighty Organ

Mighty tones from the depths of the noblest of musical instruments do not tax the resources of Rauland-Lyric. Accurately designed for faultless amplification, this instrument faithfully transmits all organ tones—from those of the piccolo stop down even to the lowest of the open diapason. This new accomplishment in radio reception has brought to Rauland-Lyric the unstinted praise of celebrated music critics.

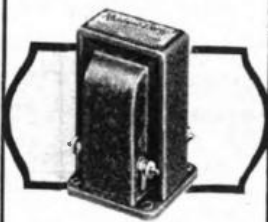

Rauland-Lyric is a laboratory-grade audio transformer designed especially for music lovers. The price is also delectable. Descriptive circular with amplification curve will be mailed on request. All-American Radio Corporation, 4201 Belmont Ave., Chicago.

Rauland-Lyric
ALL-AMERICAN
TRANSFORMER

The Choice of Noted Music Critics

The Flewelling Super-Het Converter

ONE of the greatest handicaps that our friend "Radio" has been called upon to overcome is the one caused by an over-supply of broadcasting stations. Most of the radio receivers now in general use were designed to receive the few stations that worked within a limited wave band, say from 300 to 500 meters. Under such conditions the receivers were quite satisfactory but we are now facing a greatly different situation and our receivers are fast becoming a very inadequate means of reception.

Let us consider for a moment just what the conditions are that the receiver of today may be called upon to meet.

First, we have 500 to 600 broadcasting stations in our own country, then we have half as many more in foreign countries. The waves upon which these, 900 to 1000 broadcasting stations transmit cover a tremendously larger band than our original pioneer stations did, and may run from 20 meters to 3000 meters or more.

Again, where we had one or two broadcasting stations in our local city, now we may have, as in the case of New York or Chicago, twenty to thirty stations sharing time with each other perhaps, but succeeding so well in keeping continuous broadcasting in the air that we are forced to ask them "please" to have at least one silent night in order that we might prove to ourselves that there actually are other stations, with perhaps more interest, broadcasting from more distant points.

So well is the local air filled with broadcasting in more than one location today that a large percentage (undoubtedly thousands) of receivers will be practically useless for any kind of reception this coming winter because of their inability to tune out unwanted stations. The receivers that we are using today, besides lacking in the required ability to select various stations to the exclusion of all others, are capable of tuning in only such transmitters as operate on waves between 250 to 550 meters. All other stations, foreign or domestic, are impossible to them. Another lack in our receivers is their general inability to operate from a loop antenna; or, given an out-door antenna, to bring in the more distant stations successfully.

If we admit these faults in the general run of our receivers, and it is not easy to do otherwise, then we are ready to consider ways and means of helping the situation. We might help the interference part of our problem by legislation against the establishing of any more broadcasting stations, but this does not seem to meet with universal approval so that we will probably attempt to help this part of the case by some such constructive control or co-operative guidance as that proposed by Mr. Neely. Mr. Neely sees the good that might be accomplished for radio were it to be guided by means similar to our other great public utilities (that really is what radio has come to), and placed in the

By E. T. FLEWELLING
Associate Editor, "Radio in the Home"

PART TWO

hands of a Public Service Commission made up of men nationally known to be working for the best interests of the art. Some such step may wisely be taken at this time. However, legislation, guidance or control—all are powerless to make our present receivers more selective, so that for most of us the greatest help will have to come through better receivers.

Let us stop now and draw a pretty picture of what we would require in an ideal receiver, for if we know what the ideal receiver is then we shall also know whether or not such a receiver is within our reach.

The ideal radio receiver of today should be able to tune over practically the entire wave-length band of radio-phones transmitting, say from 20 to 3000 meters, of if not such a large range then it should at least be capable of an approximation of it. The receiver should be so selective and sharp in its tuning that it is only broad enough to bring in the entire musical range; that we can hear the desired station, no more nor no less. Again our ideal receiver should be capable of doing its bit on a loop antenna if called upon to do so. Out-door antennas are becoming nuisances to more than one landlord and there's no telling when he might become a bit peevish and order them all off his roof.

Certainly, then, all of this constitutes a rather large order. It could easily be accomplished were we all to junk our present receivers, but we need not do such a thing if we consider the line of thought in our last month's article. Last month, you may

remember, we considered the application of the superheterodyne principal to all receivers in general use and wondered what could be done about it.

To apply the superheterodyne principal to present receivers successfully means that it must be done with a minimum amount of trouble. There must be no change necessary in the present receiver, no additional batteries, no cutting of cabinets, change of wiring or other requirements that might be objectionable. So that the question was, "Can it be done?"

Inquiry showed that it had been tried in several cases and had proven unsuccessful, but fortunately the reason for the lack of success was also made quite apparent at the same time. In one case it was necessary to couple the coils in the set to those of the heterodyne and this meant holes in the cabinet or change of coil location. In the majority of cases the trouble seemed to be that nothing could be heard but squeals and whistles, which meant that the detector tube was oscillating when it should not.

In the superheterodyne we have first a detector tube, then an oscillator tube; both tubes are coupled together and the output passed on to the final receiver where it may again be amplified. You will note that this calls for your present receiver plus another two-tube receiver. Or, if we use the so-called second harmonic principal, we may combine both detection and oscillation in one tube, passing on the output to our set and saving one tube.

Now saving one tube in the case of \$3 tubes is not so important as it was when tubes cost \$6, and we found that the use of the second harmonic principle to save a tube was a grave error because the detector part of the circuit seemed bound to oscillate when it shouldn't. There can be no denying that the second harmonic principle can be made to operate successfully, but also it is wise to admit that its use is most certainly not to be recommended to the novice unless the circuit be much better developed, and we therefore passed over this application until later and went to work on several two-tube detector and oscillator sets that were to be used in front of or before various typical receiving sets in our attempt to offer a means of making every receiver a superheterodyne.

Our first requirement called for a detector circuit and an oscillator circuit that would be tuned to most any wave that is likely to be used for broadcasting. Immediately we were forced to admit that tapping coils for different waves was a very poor way to solve the problem, because as the shorter waves were lost due to dead-end effects and hysteresis in the unused section of the coils became prohibitive. This made it desirable that interchangeable coils be used, and as the old-fashioned honeycomb coil was impossible, we used our own low-loss coils mounted on headphone cord tips and plugged into Carter imp jacks. This gave low-loss construction throughout the detector and oscillator circuits, enabled a change from 2000

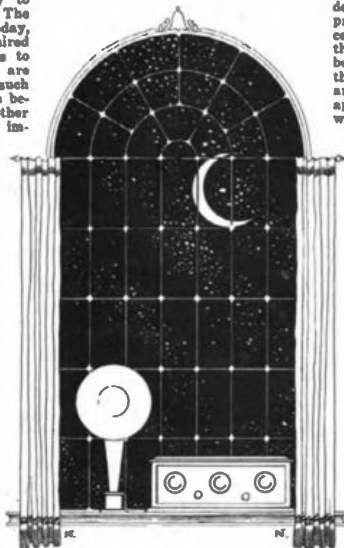

meters to 20 meters to be made readily or to tune in any wave between these extremes.

Having made it possible to cover any wave that might be desired, our next problem was to make the outfit operate as a detector-oscillator and pass the best note or output on to a neutrodyne or other receiver. Not so hard. It worked the very first time with the output coil coupled to the first coil in the neutrodyne set, but almost immediately it stopped working and offered instead a fine assortment of squeals, etc., even as the other sets that I referred to had done.

This action indicated that the detector tube had decided to copy the oscillator tube and oscillate also; I speak of this action particularly because it is a point well worth remembering in handling a circuit of this kind. Squeals and howls mean an oscillating detector and knowing this, one can confine his efforts at clearing the trouble to this point.

Finally getting the major parts of the problem solved and putting the outfit into operation we began to borrow neighborhood sets in order to see if we could improve on them by using our outfit with them.

The writer's location in Highland Park, Illinois, close to Chicago, Zion, Elgin and next door to WHT at Deerfield is a particularly trying location aside from the interference problem which you can see from the above description is bound to be an aggravate one. Even the best receivers seem unable to bring in distant stations with any consistency at our house, and these things make it difficult to judge the performance of a set. Because of this, the good old summer time, etc., we decided to go off on a camping trip with the car and our new detector-oscillator outfit hitched to the front end of a common five-tube tuned radio-frequency receiver. We spent the first part of our trip in the central part of Michigan, camping out in the open on the side of a friendly hill or beside some lake or pond where we had been assured "they were big and plentiful."

Working with radio out in the open country, under the stars, with evening dew, hot suns and rainy days will soon show one why portable sets do not always do as they are expected to do. Our combination receiver refused absolutely to do a thing for me, and I was asked quite pointedly once or twice what was doing on the radio before I began to practice what I have preached. I held the five-tube set in the heat of our gasoline stove and in this way dried out the coils sufficiently to allow the receiver to operate. From then on we listened to most anything that was on the air, using either a thirty-foot wire strung between two apple trees or a roughly made loop and on damp evenings drying out the sets as they needed it.

Most of the reception was on the loud-speaker and in the quiet of a country evening was audible a mile or so away across the lake. One evening for a little less than two hours I logged stations as fast as I could find them on the two tuning dials just to assure myself that the receiver would reach out. The result was very satisfactory for Central Michigan in June, a grand total of twenty-five stations was logged and this included Los Angeles, New Orleans and New York; in fact, the entire country seemed to be at our finger tips.

Now I have said that in Highland Park we tried the detector-oscillator on various neighbors' receivers. The results that we secured were practically the same as those in Michigan. At a point where interference is ordinarily so great as to make a set practically useless for long-distance work, or, out in the open country away from a broadcasting center, the re-

sults were about the same, i. e., we were able to pick out stations almost at will and this without a trace of interference. As a matter of interest the set tunes so sharply that a movement of 1-32 of an inch of the oscillator dial completely obliterates a station.

In my article last month I spoke of the need of three dials to tune a neutrodyne or tuned radio frequency receiver. Really one has need for more than three because rheostats, potentiometers, etc., must generally be adjusted for the best reception at stations operating on different waves are tuned in. Our present plan of placing a detector and oscillator system ahead of such receivers allows us to set the receivers at the point where they operate the best and once set to make no further adjustment. This allows for maximum and very stable action from our receiver and at the same time lets us confine all our efforts to just the two dials on the detector-oscillator set. No potentiometer or other balancing device is at all necessary or desirable, and it is hard to think of any more simple arrangement for reception.

Right here is a good place to speak of the greatest difficulty found in handling the set. The outfit tunes so sharply that about the best thing that one can do is to pass right over stations without knowing it. The settings of the two dials should be logged for the various stations, and once this is done no further trouble will be had from this source and we are ready to enjoy most of the advantages of a super-heterodyne without going to the expense of junking our present set and purchasing a new one.

To review our article; we have then a means, in the use of this detector-oscillator set, of converting our present receiver into one that is entirely controlled by two dials, and the settings of these dials for various stations can easily be logged for future use. Our outfit can tune in practically any wave that we wish it to, is not in the least troubled by interference, and we can, if we desire, operate our set from a loop or any other type of antenna.

All of these things are accomplished with our present receiver, plus the detector-oscillator set, and without cutting or making the slightest change in our receiver as it is. We use the same batteries as at present, and it is only necessary to run one single wire from the output binding post on the detector-oscillator to the antenna binding post on our receiver. Certainly it would be difficult to work out a more simple or valuable outfit.

In working out this scheme the writer was greatly impressed with the value of one or two things that proved to be important enough to emphasize in this article before bringing it a close.

Those of us who have had occasion to work with radio tubes operating in an oscillating condition have learned that they are about as cantankerous as anything could be unless definite precautions are taken to keep them in their places. We found that the construction or layout of the detector-oscillator was of the utmost importance because it is necessary to operate two tubes side by side in as compact an arrangement as possible.

The detector tube must not oscillate under any condition and the other tube must oscillate continuously at a wave comparatively close to that under which the detector tube is operating.

The solution of such problems is usually readily found in how the outfit is laid out or constructed, and I feel well merits space in our next issue, where I shall endeavor to give a full and complete description of the set and how to construct it.

B-T Universal

THE WORLD'S BEST SOCKET

Incorporating Newly Adopted A. M. E. S. Standards

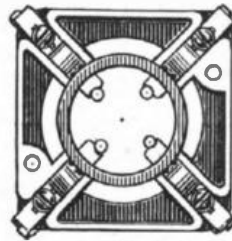

Patents Pending

Interior view from bottom showing new suspension method of self cleaning, side contact, low capacity, direct connected, elastic, phosphor-bronze spring assembly.

(Universal details not illustrated).

Examine this socket and you'll use no other.

See your dealer, he should have a stock by the time this announcement appears.

The B-T Torostyle Transformer

The mechanical perfection of this new B-T Product is a delightful surprise:

But its electrical superiority is the thing on which we stake the B-T reputation for never having put out a product that wasn't a success.

Send for descriptive circulars.

Learn the Latest in Radio

Read the B-T Booklet, "BETTER TUNING." The 8th edition is now ready. Outlines the coming radio season. Published bi-monthly. Send 10c for a copy or 60c for a year's subscription.



The B-T Torostyle Transformer

BREMER-TULLY MFG. CO.

532 S. Canal St.

Chicago, Ill.

Riga Prevents Trouble



Riga Battery Cables, \$1.00

Order Now

No. 100 RIGA-Five-Wire A & B-Battery Cable with type A Battery Clips and Soldered Lead Terminals. Each conductor is distinctively colored enabling easy identification of each battery strand.

AT YOUR DEALER

(Or Sent Postpaid, \$1.15)

BIRNBACH RADIO CO.
378 Seventh Avenue New York City

"...results are truly amazing!"

NATIONAL Browning-Drake Transformer

A tuned radio-frequency transformer of highest efficiency. Was used with a Browning-Drake receiver, the results are truly amazing.

Write for Bulletin 100 B12

NATIONAL COMPANY, Inc.
110 Brookline St., Cambridge, Mass.

Obsolete

Take the "GUESS" Out of Tube Control

110 Everywhere

Amperite automatically controls tube current, eliminates hand rheostats, filament meters, guessing and all tube worry. Simplifies wiring, tuning and operation. Permits the use of any type of tube or any combination of tubes. Tested and used by more than 80 set manufacturers and in every popular construction set.

RADIALL COMPANY
Dept. R.H.-10, 66 Franklin St., N.Y. City

Write for FREE Hook-ups

AMPERITE

The "SELF-ADJUSTING" Rheostat

The Counterflex - Minus the Flex!

By
**KENNETH
HARKNESS**

Associate Editor, Radio in the Home

Part 3 of a Series Describing Counterflex Circuits for Experimenters

THE two previous articles of this series were devoted to circuits using the reflex principle. This month I show how the Counterflex method of controlling self-oscillation can be applied to straight radio-frequency amplifying circuits in which the reflex principle is not employed.

Fig. 15 depicts the connections of a tuned radio-frequency amplifying receiver in which self-oscillation is controlled by the Counterflex method. The hook-up follows standard practice with the exception of the condensers C1 and C3. These condensers are inserted to control self-oscillation and perform exactly the same functions as the two similar capacities in the standard Counterflex circuit. If Fig. 15 is compared with Fig. 1 of this series, published in the June issue, it will be evident that the circuit of Fig. 15 is, in effect, the standard Counterflex circuit of Fig. 1 with the reflex feature removed. It is the Counterflex minus the "flex!" The two circuits are identical so far as the method of controlling self-oscillation is concerned. When reflex is used the secondary of the reflex audio-transformer is connected across the capacity C3 of Fig. 15. The capacity C1 is connected exactly as shown in both circuits.

In the second article of this series I briefly explained the principals of this method of checking oscillation, but a somewhat fuller explanation will probably be of assistance to those who are experimenting with these circuits.

In common with some other methods, the Counterflex utilizes the principle of the Wheatstone bridge.

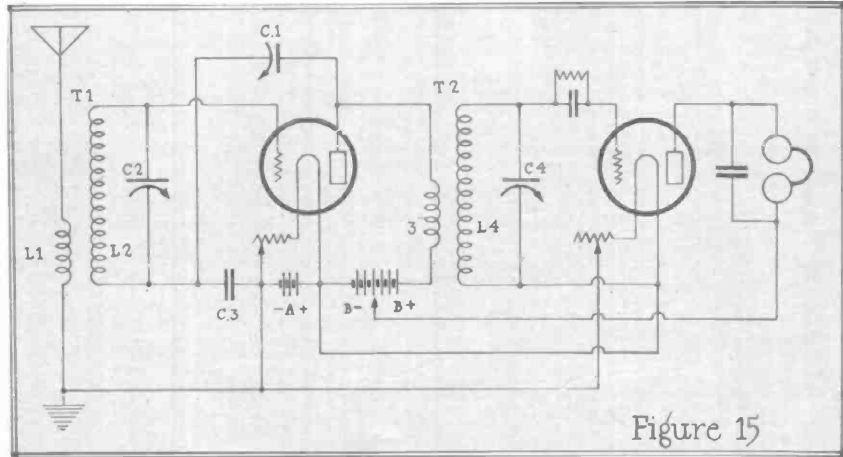
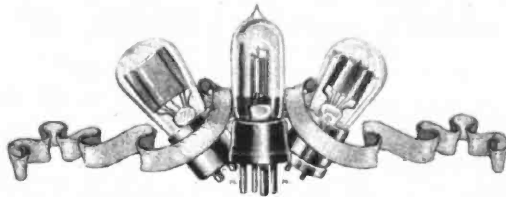

Figure 15



This circuit will form the basis of Mr. Harkness' article next month

This principle can be understood by referring to the diagram of Fig. 16A, which illustrates the connections of a simple resistance bridge. P, Q, R and S are resistances and form the arms of the bridge. G is a galvanometer, the needle of which is deflected if current passes through the meter. A battery is connected as indicated.

Now, if the values of the resistances P, Q, R and S are adjusted so that the ratio between R and S is the same as the ratio between P and Q, no current flows through the galvanometer G. This is the fundamental principle of the Wheatstone bridge. When P is to Q as R is to S no current flows through the galvanometer. Current passes through the resistances, but the portion of the circuit in which the galvanometer is connected is isolated, so to speak, from the remainder of the circuit. When the arms of the bridge are adjusted to produce this effect the bridge is said to be balanced.

The Wheatstone bridge, in many different forms, is used for measurement purposes in the laboratory. For instance, if we want to measure the resistance of some device we connect the unknown resistance so that it forms branch R of the bridge. The value of the resistance S is then varied until the bridge is balanced, no current passing through G when an e. m. f. is applied. When this condition of balance is secured the ratio between the unknown resistance R and the measuring resistance S must be the same as the ratio between P and Q. Since P, Q and S are known quantities we can easily determine the value of R.

$$\text{Since } \frac{P}{Q} \text{ equals } \frac{R}{S}$$

$$\text{Then } R \text{ equals } S \times \frac{P}{Q}$$

This simple example of the use of the Wheatstone bridge as a measuring instrument has no direct bearing on the subject of this article, but I mention it to help the reader to understand the principle underlying the bridge itself.

Another form of Wheatston bridge

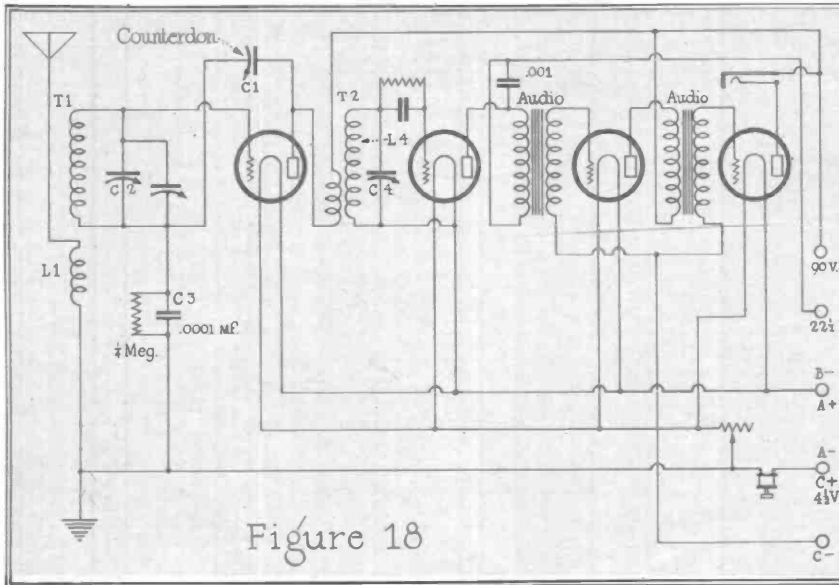

Figure 18

is shown in Fig. 16B. In place of resistances, all four arms of this bridge are capacities. In this case the bridge is balanced when the values of the capacities are such that the ratio of C1 to C2 is the same as the ratio of C3 to C4. If an alternating e. m. f. is applied to this balanced bridge across the points indicated in the diagram, no current is registered by the meter A.

Now refer to Fig. 17A which represents the circuits of the radio-frequency amplifying tube of the receiver illustrated in Fig. 15. Incoming signals oscillations are tuned to

in the grid circuit L2 C2, when oscillating e. m. f. is impressed across the plate and filament by the coil L3. In other words, feed-back from the plate to the grid circuit, through the plate-grid capacity of the tube, can be completely eliminated.

To balance the bridge it is only necessary to adjust the capacity of C1. This condenser is called the counteracting capacity of C1. This condenser is called the counteracting capacity or counteraction because the oscillating e. m. f. which it feeds back from the plate to the grid circuit is directly opposed to the react-

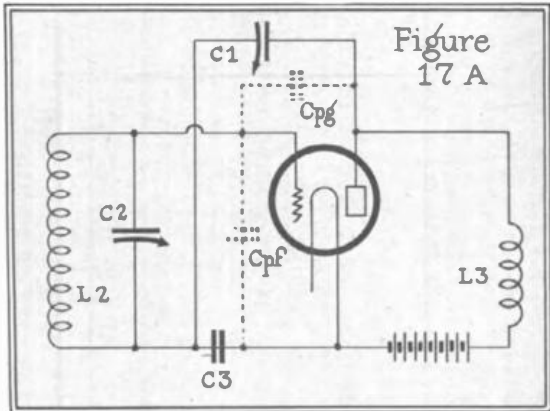

Figure 17 A

resonance by the L2C2 circuit and impressed across the grid and filament of the r. f. amplifying tube, through the capacity C3. Similar and amplified oscillations are set up across the coil L3 in the plate circuit, this coil being the primary of the interstage r. f. transformer. C1 is a small variable capacity, and self-oscillation can be easily and effectively started or stopped by varying the capacity of this condenser

ing e. m. f. fed back by the plate-grid capacity Cpg.

This method of controlling self-oscillation possesses some very important advantages. In the first place, it permits the use of efficient interstage r. f. transformers, which is more than can be said for a good many other systems. By an efficient transformer I mean a transformer whose primary has a high self-inductance (large number of turns), and is

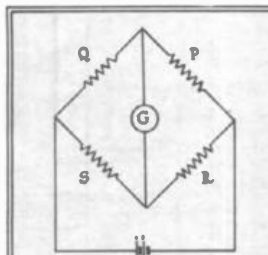

Figure 16 A

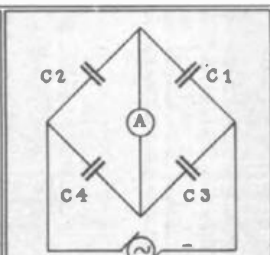

Figure 16 B

The reason for this will be understood by referring to Fig. 17B. This is exactly the same circuit as 17A. The units are merely rearranged to demonstrate more clearly that the plate-grid capacity (Cpg) and the grid-filament capacity (Cgf) of the tube to form the arms of an all-capacity Wheatstone bridge of the type illustrated in Fig. 16B. The grid oscillatory circuit L2C2 occupies the same position in this bridge as the meter A. The plate circuit is connected across the same points of the bridge as the source of alternating e. m. f. in Fig. 16B.

Now, just as the bridge of Fig. 16B can be balanced to prevent current from flowing through the meter A, the capacity bridge of Fig. 17 can similarly be balanced to prevent current oscillations from being produced

closely coupled to the secondary to produce high amplification per stage. It must be remembered that it is possible to construct a radio-frequency amplifier with such inefficient transformers that it does not oscillate at all. There are, in fact, many receivers of this type on the market today, but the amplification per stage is very poor, particularly of the high-wave lengths. To obtain good amplification it is absolutely necessary to use efficient transformers and then employ some means of controlling the continuous oscillation which are bound to be generated.

Another important advantage of controlling oscillation by means of this balanced capacity bridge lies in the fact that the balance is only slightly affected by changes in frequency. The amplification is fairly

(Continued on Page 22)

The Crosley Musicone

a startling improvement in looks and tone over loud-speakers. Already replacing thousands

\$1750

Add 10% West of Rocky Mountains

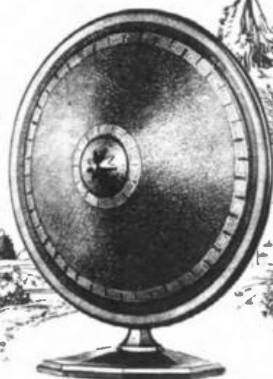

In camp or home, this remarkable development of radio reproduction will greatly increase your delight in radio.

It is a new idea. It diffuses the sound. Upon hearing it for the first time one is at loss to locate the source of the music. Its perfection of reproduction is uncannily real.

Its price, like all Crosley products, is very low because of the half-million production plans under which it is being built. Hear it at all Crosley dealers now.

Crosley owns and operates station WLW, Cincinnati, the first remotely controlled super-power broadcasting station.

Crosley manufactures receiving sets which are licensed under Armstrong U. S. Patent No. 1,118,148, and priced from \$14.50 to \$65, without accessories.

The Crosley Radio Corporation
Powell Crosley, Jr., President
860 Sassafras Street, Cincinnati

CROSLEY

Better - Costs Less

Announcing the New
BIRNBACH
LOW-LOSS TUNER

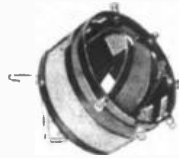

3-CIRCUIT

For Distance, Volume and Selectivity

Price of complete parts for a single-tube receiving set containing the BIRNBACH tuner. **\$7.50**

Information and Free Hook-up Diagram at all Stores of

W. T. Grant Co. S. S. Kresge Co.
There's a Store in Your City

BIRNBACH RADIO CO.
370 Seventh Avenue New York City

NEW

Cushion Socket

NOT only absorbs external and loud-speaker vibrations, but also provides direct contact with tube terminals without binding posts, either with above- or below-panel wiring. No spacers needed. Contact is positive. Signals increase in strength and clearness. Write Aiden Manufacturing Co., Dept. J-13, Springfield, Mass., Aiden Processer.

NA-ALD
Sockets and Dials

Make 100 Weekly-sell RADIO

Demonstrate Once - Receive Mean Sure Sale
Count to equal lowest prices, attract five four-tube instruments \$39.50. Big commission to you. Exclusive territory to proven salesman. Temporary going line, until today the large guaranteed book No. 100. Don't fail to name your country.



OZARKA, Inc.
583 Washington Blvd., Chicago, Ill.

Notes from the Lab at Station 3XP

STERLING HOME TUBE TESTER—The Sterling Manufacturing Company, 2931-53 Prospect avenue, Cleveland, O.

In the July, 1924, issue of this magazine a tube tester was described that is used in the Lab at 3XP. This tester is a rather elaborate one for the average person to own on account of the number of meters involved. Sterling has come out with a simple device that may be used in conjunction with the receiving set

account of the stator being stamped as one solid plate, the chances for losses are lessened. A template is furnished for drilling the panel.

WORLD 100-AMP.-HR. STORAGE BATTERY—World Storage Battery Company, Chicago, Ill.

Three World batteries have been undergoing wicked punishment on our test table for over a month. They have been in use on the life test for tubes. In this test tubes are run continuously until they are absolutely worn out. The batteries have been under an amp and a half drain until discharged. They were then charged and put on the line. Any battery that will give the service these are giving is worth buying.

No. 210 PILOT LIGHT SWITCH—Yaxley Manufacturing Company, 217 North Desplaines street, Chicago, Ill.

We have been using an ordinary porcelain socket and miniature bulb on the front of our permanently installed receivers at the laboratory so that a last glance around in the morning before we leave will show whether any sets have been left on or not. Now Yaxley goes us one better and produces a switch that has a pilot light on it to show when the filament current is on. A small glass bezel is fitted into the panel in front of the bulb. With such a convenient device so easily installed there is no longer any excuse for letting your battery run down by forgetting to turn the set off if the station signs off while you are out of the room. The light tells.

at less than the manufacturer's specifications the charger gave 3-16 amp. and charged two run-down B batteries with no trouble at all.

B. M. S. JACKS—Brooklyn Metal Stamping Company, Brooklyn, N. Y.

The label on the jack states that it is "designed for easy soldering." The lugs are so spaced

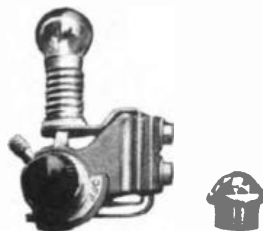

No. 210 Yaxley Pilot Light Switch

that they are always accessible. The lug tips are cupped for additional convenience." The label tells the truth. The jack answers nicely the problem of the beginner as to how he is to hold a wire, a piece of solder and a soldering iron and yet solder with only two hands. A terrible job was performed with the soldering iron and flux applied liberally in the hopes of ruining the jacks, but we did not succeed. They stood all our abuse.

JEWETT MICRO-DIALS—Jewett



The S-1800 Schickering Tube

equipped with a stop for the rotor the movement of the plates may be checked at zero and one hundred by means of the lugs and a small pin.

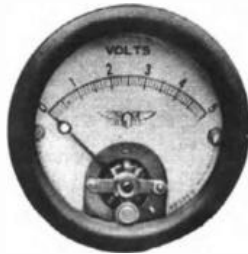

Pattern 135-Jewett Voltmeter

GOSILCO AERIAL AND HOOK-UP WIRE—American Luminous Products Company, Huntington Park, Calif.

The instructions received with this wire requested that we use solder



Ward-Leonard Vitrohm



The Sterling Home Tube Tester

itself without the necessity for a supply of meters of various sorts and does not require the use of any technical knowledge to operate. A scale attached to the bottom of the tester gives a direct reading. Curves are drawn of all tubes at our Lab before they are used. The rating of the Sterling Tester agreed closely with the curves we had taken and also with their actual performance in a set. A tester of this sort should be a good investment for the owners of multi-tube sets as it will quickly show if the unsatisfactory operation of a set is due to the tubes.

U. S. TOOL CONDENSER; RATED CAPACITY .00035 mfd.—U. S. Tool Company, Inc., Newark, N. J.

Measurements of this condenser were made at radio frequencies and the value of the condenser for the high reading checked as .00035 mfd., which was the rating given it by the manufacturer. The condenser has specially shaped plates which give a straight line curve of the capacity plotted against dial settings. On



The U. S. Tool Company's Condenser

S-1600 SCHICKERLING TUBE—Schickering Products Corporation, Newark, N. J.

The S-1600 tube is both a detector and amplifier. Six of these tubes have been on life test for a period that covers under ordinary conditions six months of use. These tubes are still standing up well and show no signs of giving out. The tube draws .16 amp. at 5 volts.

APCO B BATTERY CHARGER—Apco Manufacturing Company, Providence, R. I.

The member of the staff to whom this charger was given for test has had a decided opposition to vibrating chargers due to some unfortunate experiences with one in his early radio days. This Apco charger, however, did not reverse current, stick, discharge with the current off or do any of the terrible things he predicted for it. Adjustment is simple and the charger is self-polarizing. The instructions called for a 200-watt lamp, but all that the shaft disclosed was one 150-watt. Working



The World 100-Amp. Hour Storage "A" Battery

Radio and Phonograph Company, Pontiac, Mich.

The Micro-Dial is easily mounted by means of a single screw that engages the shaft. Three cork fingers grip the panel with sufficient force to hold the main dial while the vernier is in use, but do not prevent the use of the large dial for rapid changes of tuning. The ratio of the two dials is one turn of the vernier dial to four degrees of the large dial. A small lug is provided on the back so that if the condenser is not

ELECTRAD VARIOHM mentioned on Page 20, of July, 1925, is made by Electrad, Inc., 422-30 Broadway, New York, and not by the manufacturer stated. I regret that a mistake of this kind occurred and hope that no one was seriously inconvenienced by it. Will both Electrad, Inc. and the Electrical Research Laboratories please pardon me for the error?

sparingly, and only in a couple of places, instead of covering the joint with solder as is customary. We didn't believe it, so we tried it, and the solder not only stuck, but held the two pieces in spite of a very bungling job of soldering. The Lab staff has a mean disposition. It tries to make preparators of the manufacturers' advertising men, and in some cases succeeds. In this case we didn't. The wire makes a neat job when used for hooking up a set.

JEWELL VOLTMETER, PATTERN 125, 0-5 VOLTS, D. C.—Jewell Electrical Instrument Company, Chicago, Ill.

The arrival of this little panel-mounting voltmeter at 4XP brought forth many suggestions as to the best place to use it. Several sets that had gotten along beautifully without one immediately needed it, and many reasons were advanced as



B. M. S. Jack

WARD-LEONARD VITROHM — Ward - Leonard Electric Company, Mount Vernon, N. Y.

The Vitrohm is a tapped resistance intended to replace light bulbs in battery chargers to vary the charging rate. The resistance rating checked within 1 per cent. There are four possible rates of current by varying the tap connections. We were able to vary the charging rate on two 45-volt B batteries placed in series with a Tungar bulb rectifier as follows: 5-32 amp., 1/4 amp., 3-32 amp. and 1-16 amp. After twenty-four hours' use in charging the unit showed no signs of undue heat, and could be handled without any discomfort to the hands. It had maintained its charging rate to the end of the test period.

STORAD B BATTERY — The Cleveland Engineering Laboratories, Cleveland, O.

The Storad B Battery was received at the laboratory on February 15. To date it has been charged twice. Part of that time it has been in use as a B battery. Since its second charging it has been in use on the tube tester as a C battery, so that the voltage could be used by means of a center tap to give from plus ten to minus ten volts. This is no great drain so far as its current consumption is concerned, but it at least shows that the battery is able to hold its charge.



The Apex "B" Battery Charger

to which particular set should have it. So far it has escaped confinement, as you can see from the photograph. It won't remain free long. It is an extremely neat and compact instrument that will improve the panel of any set and that will prolong the life of tubes by allowing you to put only five volts on the filaments, because the scale doesn't go any higher.

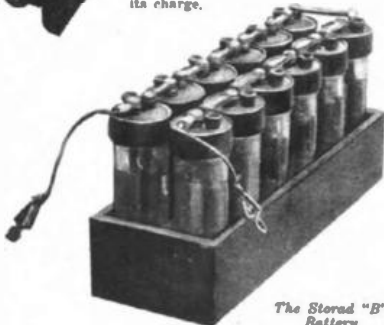

The Storad "B" Battery

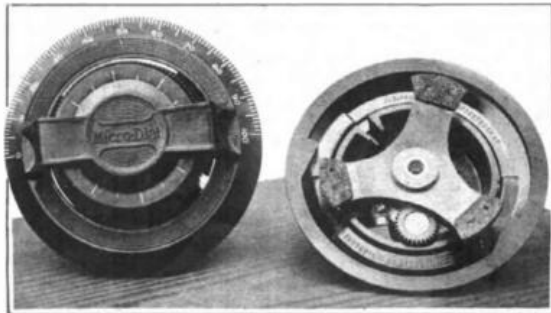

Front and rear views of the Jewell Micro-Dials

Build this phenomenal new radio in 45 minutes



The revolutionary Erla Circoild Five Factory. Build Kit—as you receive it.

Price \$49.50

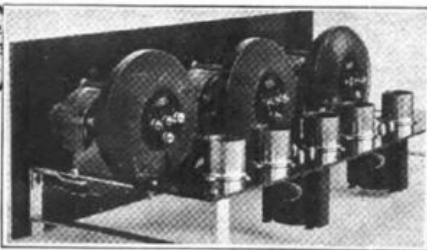

This new type kit is factory assembled. Ready cut, flexible, solderless leads make it ridiculously easy to wire. Amazing new inductance principle brings results hardly thought possible. Send for book, *Better Radio Reception*.

NOW anyone can build the finest of receivers in only a few minutes. No more wire bending or soldering. Merely attach a few ready cut, flexible cycled leads and the job is done. The finished set is unsurpassed even by the costliest factory-built receiver.

But most amazing is the new inductance principle incorporated in this last word in kits—called the Erla Circoild principle of amplification.

Four vital improvements result from this great discovery, which are not found in ordinary sets.

1. **Greater Distances:** Erla "Balloon" Circoilds have no external field, consequently do not affect adjacent coils or wiring circuits. This enables concentration of proportionately higher amplification in each stage, with materially increased sensitivity and range.

2. **More Volume:** Increased radio frequency amplification made possible by Erla Balloon Circoilds gives concert volume to distant signals inaudible with receivers of conventional type.

3. **Increased Selectivity:** Erla Balloon Circoilds have no pick-up quality of their own. Hence only signals flowing in the antenna circuit are amplified. Static is greatly reduced for this reason.

4. **Improved Tone Quality:** The self-enclosed field of Erla Balloon Circoilds eliminates stray feed backs between coils and consequently does away with mushing of signals and distortion. Tone is crystal clear and perfectly lifelike.

Write for free information on this—also book

See how 45 minutes of fun will give you the newest and most nearly perfected set known to radio science. Easy as A-B-C to finish. Examine it at any Erla dealer's, or send the coupon for full information, illustrations and diagrams free. Also ask for remarkable new book, "Better Radio Reception," describing the sensational new Circoild principle. Enclose 10c for mailing and postage on book.

ELECTRICAL RESEARCH LABORATORIES

2524 Cottage Grove Ave., Chicago

© Trade Mark Registered

ELECTRICAL RESEARCH LABORATORIES

2524 Cottage Grove Ave., Chicago, U. S. A.



Send me free information on kit Enclosure 10c for postage for book "Better Radio Reception."

Name

Address

City

State

Dealers

Exclusive franchises are available in high class districts in locations still open. Write or wire immediately.



Well Suited for Reflex

RUBICON transformers are giving remarkable satisfaction in all circuits where tubes do double duty. Types C and D, 3 1/2 and 5 to 1 ratios, work well in reflex stage, either with tuned coupling or with our Type R and R. F. transformer; also for straight audio. However, for the latter we particularly recommend Duplex Push-Pull for its pure, full tones.

Send for free folder

"The Inside Story" tells just what transformer to use for any specific purpose.

The RUBICON CO.

29 N. 6th St.

Philadelphia

Mail this Coupon for Illustrated Book

Kenneth Harkness Radio Corporation, 727-730 Frelinghuysen Avenue, Newark, N. J.

REM 8-25

Please send me a copy of your illustrated booklet describing the commercial model of the new, simplified 3-tube Harkness Counter-Box receiver with detailed building instructions and step-by-step wiring diagrams. I enclose 25 cents to cover cost of handling and mailing.

Name

Address

TIMMONS B-Liminator



Patented
May 15,
1923

After using the B-Liminator for six months in place of B batteries, the technical radio editor of the Newark Sunday Call wrote this:

"About three months ago I reported to you that a B-Liminator under test since the first week of January was still going fine.

"I beg to submit another report of the same B-Liminator and same rectifier tube, which is still working without any trouble whatsoever. This is just about six months' service for the device, and what is remarkable is the fact that in all this time not one adjustment has been made to the B-Liminator nor a tube changed. The device has been in nightly operation for at two or three hours each evening.

"In all this time I have forgotten about dry or wet cell B batteries."

ALBERT E. SONN,
Radio Technical Editor,
Newark Sunday Call.

B-Liminators operate from any 110 volt, 60 cycle, A. C. house current. Price, \$35, with special tube. Then there are B-Liminator Kits which you assemble yourself. Price, \$20, with tube.

We will be glad to send folders from users, telling how the B-Liminator operates on all kinds of sets.

TIMMONS
RADIO PRODUCTS
CORPORATION

GERMANTOWN

PHILADELPHIA



This is a sample of the more conservative cabinets designed by the Aeolian Company. It is an attractive Queen Anne design of the "highboy" type

Radio the Beautiful—As It Should Be in the Home

(Continued From Page 17)

with belts of rosewood. It has the finish of an exquisite piece of satin and will gleam against the wall of your room like a beautiful lady in a shimmering gown.

Here, indeed, in the provision for this new form of entertainment, is a place where you may work out your individuality and keep your radio in harmony with your furnishing scheme. There are many things which will enable you to decide just what type of article you desire. You may be confined by your scheme of interior decoration which calls for an article of a certain period. It may be that the wood scheme of your house could not be broken in upon; the richness of your library may demand a subdued and seasoned piece of walnut or oak; or the heavy hangings of your drawing room may cry out for a single splash of brilliant color, that can be furnished only by a Chinese lacquer. The person who has spent much time in Europe will probably come home interested in the old French and Italian masterpieces; while the habitue of Palm Beach and St. Augustine will return desiring something in the Spanish type, like that shown here. After the style of design has been decided upon the question of size must be considered and, "Here again," says Mr. Dentz, designer for Huber, "radio shows its elasticity. There is no one size cabinet to which radio must be confined. If you desire a large piece of

furniture in order to fill a given space, you may have a piece the size of the aforementioned article which stands 36 x 36 inches high, and which might house not only the radio itself but a great variety of other things as shown by the interior view. Here we have: A—Loud-speaker of the radio set; B—Phonograph; C—Radio receiving set; D—A desk drawer; E—Space for radio batteries; F—Space for phonograph record album."

We have here an antique wood cabinet with statuettes copied from original Spanish works, and the whole thing compact and set in every detail while maintaining an artistic point of view. Some of this interior space in the large cabinets may be used for a desk or for book shelves.

It must not be thought that this wide berth which radio's adaptability gives to the designer allows for the laxity of artistic treatment. Mr. Zaiser says, "Radio in its swaddling clothes was a collection of parts; the question was how to house and assemble them. The horn, for instance, had to strike the room at a certain level, space had to be provided for the placing of dry and wet batteries; but once these things are taken into consideration, it is then possible for the artist consistently to design the type of thing liked. This is, of course, only possible after intelligent study of period furniture. In the 'old highboy' or 'chest on chest,' which was orig-

inally two chests superimposed and which was really the forerunner of the early Georgian lacquer piece, we have a particularly good form for the radio, but it is not necessary to have anything so massive as this. In fact, the 'lowboy' will do equally well if the room is more limited in space."

Of course, not every one can afford custom-made articles of the type considered in this article, and, of course, for those provision is made in the form of more conservatively designed things, such as the one shown here and offered by the Aeolian Company as a substitute for the more expensive articles. This is an attractive Queen Anne of the "highboy" type, with a fret to admit of the sound passage. Many cabinets of this class are to be found within reach of the general pocketbook, and it is possible to select colorings, size and style consistent with the simpler home furnishings.

The A. C. Tube

(Continued From Page 5)

from time to time. I am publishing the diagrams in the hope that some one who understands tubes better than I do can tell me what it all means. We have never seen radio tubes which gave such curves as these and we are unable to make a satisfactory explanation of the phenomena.

The curves can best be explained by merely reprinting the report made to me by Mr. G. P. Allen, chief of our laboratory staff at Station 3XP, and it follows here just as he handed it to me:

Results in Operation

These tubes do not perform well in a set using radio-frequency. The volume is poor and hum is heard. The hum is also noticeable in a reflex set. In a small set consisting of a regenerative detector and one stage of audio-frequency amplification very satisfactory results were obtained for a short time. The hum was not noticeable even on ear phones, but as the test continued, the hum became more and more pronounced, until finally it could be heard on the loud-speaker. Very careful tests were made to be sure that this hum was not caused by other apparatus in the laboratory. All chargers were shut off and longer leads were placed on the tube transformer to be sure that the hum was not coming from it. The volume from the two-tube set was very satisfactory, and the set not at all unpleasant until the hum appeared. The tubes are still burning and able to bring in reception on the loud-speaker from local stations at the end of 441 hours.

Report on McCullough AC Tubes

Procedure — The Gearhart-Schluster quadraformer set which uses transformer coupling for audio-frequency was remodeled in order to give the proper connections for the AC tubes. All connections were made in accordance with the instructions furnished with the carton for the tubes. The five McCullough tubes were placed in this set and allowed to operate continuously. Emission tests were made in the customary manner with 90 volt on grid plate every twenty-four hours. An emission tester was constructed to meet the requirements of the AC tubes. After each emission test the tubes were placed in a two-tube regenerative receiver, consisting of a regenerative detector and one stage of transformer coupled audio-frequency amplification. During the course of the test two of the tubes were destroyed. The remaining tubes were placed in the detector of the quadraformer set in place of the ones that burnt out. At this stage of the test there are three

tubes left; two being used as radio-frequency amplifiers, and the other as a detector.

Results Obtained

These tubes have been numbered from one to five for purpose of identification. In attempting to make an emission test on Tubes No. 1 and 2 it was found that a steady reading could not be obtained. No special attention was paid to this as

be a definite time value to each reading. For purposes of comparison, two sets of emission curves are shown of regular quarter ampere, thoriated filament tubes. (Fig. 3.) These have all been plotted to the same scale. A glance will show that the McCullough tubes give much higher emission readings than the quarter ampere tubes. However, the curves of the quarter ampere tubes are much steadier. In all emission curves there is a slight

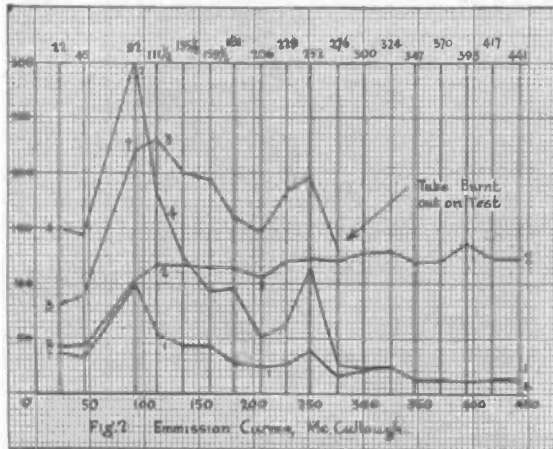

it quite frequently happens that tubes of independent manufacture are not aged before shipment. Until such tubes have been in use for a short length of time a steady emission test cannot be obtained.

In attempting to show one of the staff that a steady reading could not be obtained at the end of five minutes

rise and fall from day to day, but none that have been tested at this laboratory show such wide variations as those shown by the McCullough tubes.

In the emission curves of the McCullough tubes it will be noted that there is a large rise at ninety-two hours in Tubes Nos. 3 and 4.

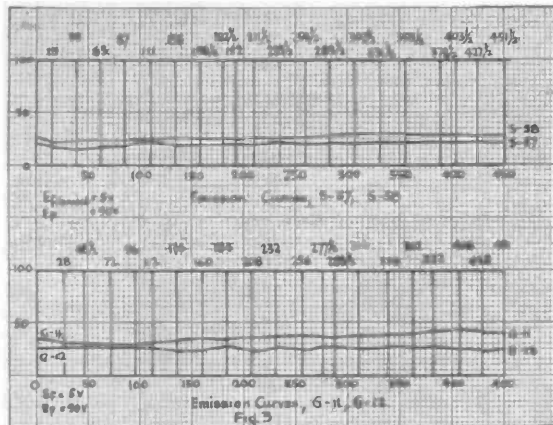

it was discovered that an entirely different reading was found for the same tube after a length of one minute. (Fig. 1A emission test.) Thereafter emission tests were made in the following manner—the tube was lighted and readings taken every fifteen seconds for five minutes. The tube was turned off for one minute, relighted and records taken as before for five minutes. A curve is given here which has been called "emission curve" (Fig. 2.) The values on this curve are in every instance the value found at the end of the fifth minute of the second run (see Fig. 1A.) This was done in order that there might

There has been a question mark placed above this point on the curve. The reason for this is that the milliammeter climbed so high and so rapidly that it was feared that the elements of the tube were touching and there was danger of burning out the milliammeter. (See Fig. 1, Tubes 3 and 4; ninety-two hours.) Immediately thereafter, these tubes were placed in a receiving set and functioned perfectly. So their test was continued.

Of the five original tubes but three remain. Tube No. 5 broke, or exploded, in the hands of the observer while he was attempting to remove



Announcing the Results of an Ideal

THREE YEARS ago a group of men organized the Radio Frequency Laboratories, Inc., because they believed in the future of the radio industry. One result has been the development of a broadcast receiving system which is unique in its combination of power with simplicity.

This new receiver is believed to be a near approach to the ideal home radio equipment. It employs a novel high frequency amplifier and filter system which opens an entirely new range of possibilities in radio reception.

The usual complication of tuning dials gives place to a single illuminated selector. The uncertain hunt for stations and wave-lengths is eliminated, since this selector carries a permanent wave-length scale which is accurate under all operating conditions.

A group of well-known and substantial manufacturers will make available to the radio public the RFL receiver—certain models of which will appear on the market during the present year. Further announcements later.

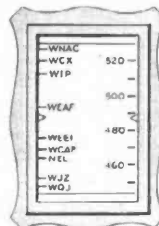

ILLUMINATED
Station Selector operated by knob at right of panel. Volume control at left.

RADIO FREQUENCY LABORATORIES, Inc.
Bonton, New Jersey

AMPLION
The World's Standard
Alfred Graham & Co., England, Patented

Low tone travel with gradual angle. Reaction controlled by the non-resonating, fringed-ribbed tone conduct.

High tone travel with gradual angle. Reaction controlled by the non-resonating, fringed-ribbed tone conduct.

Illustrated here with gradual angle. Reaction controlled by the non-resonating, fringed-ribbed tone conduct.

To enjoy unequalled sensitivity, clear full tone and freedom from "chatter," buy an Amplion, World's largest seller, \$15.00 and up.

THE AMPLION CORPORATION OF AMERICA
Suite U, 26 Madison Ave., New York

Thirty years have perfected and made the Amplion the finest loud speaker.

"More Than Just a Name"

CALVERT

LABORATORIES

WE are pleased to announce that the services and facilities of our laboratories are now available to the Radio Public and that Mr. Henry M. Neely has designated this laboratory as the official Service Station of "Radio in the Home." Working in close contact with the elaborate research laboratory of "Radio in the Home," we are in a position to offer their readers first-hand information and service on sets that have been built from circuits published by them. If you are having trouble with your set, no matter what circuit or make, ship it to us. We are fully equipped to test, repair or build sets, parts or accessories, and we carry a complete line of Radio from the smallest nut to the largest set. Mail orders will receive prompt attention.

12th Floor, Jefferson Bldg.
1015 Chestnut St., Philadelphia

I will buy for you!

Free 24-Hour Shopping Service for Readers of Radio in the Home
I will buy any apparatus mentioned in this magazine and send it to you at its Regular Price plus only Postal Postage and Insurance.

I MAKE NO CHARGE FOR THIS SERVICE
It is conducted in co-operation with Radio in the Home, and is for the convenience of its readers.
Don't fail to build the
QUADRAFORMER SET
as described in May and June

Kit of Quadra coils . . . \$15.00
Complete Kit of Parts . . . \$60.00
McCullough A. C. Tubes . . . \$6 each

E. M. CLARKE

1523 Chestnut St., Philadelphia

Make Money Building the Super-Selector

A 4-tube set with 5-tube volume and a wonderfully sweet tone. It is not retested, but employs the circuit (with improvements) which made the Green Concert Selector such a favorite in the East.

The secret is the L-K Variable Clarifying Selector and the VT28 Variotransformer, so widely praised by radio authorities.

We'll supply all the parts and charts, and free expert advice to install this excellent set. Get just one set working in your neighborhood and you'll soon be busy on very profitable work. Write for Free Diagram, priced and particulars.

The Langbein-Kaufman Radio Co.
511 Chapel St., Dept. R
New Haven, Conn.

L-K PRODUCTS

TUNERS **ELKAY** SETS-KITS

The Five Tube Set which started the World!

FRESHMAN MASTERPIECE

The Greatest Value Ever Offered in A Radio Receiving Set

At Authorized Freshman Dealers Only



33 RADIO Storage "B" Battery

33 Cells. Lasts Indefinitely—Pays for Itself
Economy and performance unheard of before. Recharged in a negligible cost. Approved and listed as Standard by the U. S. Dept. of Commerce, Bureau of Standards. For full details see "Radio" Magazine, June, 1925, page 22. Also see advertisement in "Radio" Magazine, July, 1925, page 22. This battery is guaranteed for 100 hours of use. Extra heavy steel case. Heavy, rugged cells. Better than any other.

SEND NO MONEY Just state number of batteries you wish to order. Each one is packed and we will ship, they will be prepaid in 100% radio batteries. A 100% guarantee. No return. Write for literature. 100% guarantee. No return. Write for literature.

WORLD BATTERY COMPANY
1719 So. Wabash Ave., Dept. 44 Chicago, Ill.
Branches: 1000 Broadway, New York, N. Y. 11101 1st Ave., N. Y. 100
From: 1000 Broadway, New York, N. Y. 11101 1st Ave., N. Y. 100

World FOR RADIO STORAGE BATTERIES

It from the socket just after the test had started. Tube No. 3 gave out after 276 hours continual operation. At the end of the first five minutes of the customary emission test the current was turned off. Fifteen seconds later a crackling noise was heard and a flash seen in the tube. No emission showed during the entire period of the second run on the milliammeter of the emission tester. The filament, or "cathode heater," as it should be called, still glowed, and the tube would pass audio-frequency without any amplification. It was no good as a detector. Graphs are shown for some of the emission tests made. (Fig. 1A.)

The graph of tube No. 1, Fig. 1, after ninety-two hours is a characteristic one for the ordinary run of the emission tests. On this graph both run one and run two are plotted. By looking directly across the graph the condition of the same tube at the end of 11 1/2 hours, and also at the end of 300 hours may be seen. Directly beneath this a graph for Tube No. 2 is shown at the end of ninety-two hours and 11 1/2 hours.

Tubes No. 3 and 4 have shown very erratic behavior. This first started at the end of 92 hours when the emission test was discontinued for fear of burning out the milliammeter. At the end of 11 1/2 hours a pronounced hump appeared in the curve on the first run of both tubes. This hump was present in Tube 3, and until it burned out at 276 hours. The hump was present in the curve of Tube 4 until after 135 hours. After it had disappeared the emission fell until 252 hours was reached. During run one on this test the emission suddenly jumped to 300. This jump occurred after four and one-half minutes of the second run the value does not appear on the emission curves. Thereafter the emission of this tube remains low and is shown by the graph of run two of Tube 4 at the end of 300 hours.

The static curves for these tubes are shown in Fig. B. Alongside of them is shown the static curves for the ordinary one-quarter ampere tube. On account of the difference in shape of the plate of the McCullough tubes, and those of the quarter ampere tubes; and also the difference in the methods of obtaining electron emission no great significance is attached to them. The curves are merely given so that some idea may be obtained on their relative behavior.

The report of the other co-operating laboratory is more technical than Mr. Allen's statement, but it goes into a different phase of the subject and is, therefore, of value to readers who are connected with the industry, or who understand the characteristics of tubes. Here is the report as it was sent to me:

"Since our letter of May 27 on the subject of McCullough tubes, we have obtained some additional data on these tubes, and, thinking it may be of interest to you, we are giving it to you herewith.

"It might be well to state at this time that these tests were run by a reputable concern with a view to developing a receiving set to use McCullough tubes. Tests were made on twenty-five tubes, which makes the results a little more reliable than our previous results, which were obtained on only three tubes. At the present time no life tests have been run on these tubes. These people have confined themselves to determination of the mutual conductance of the tubes and to the uniformity as represented by this sample lot of twenty-five tubes.

"The mutual conductance was measured with 4.0 volts on the heater element, sixty-seven volts on the plate and four and one-half volts negative bias on the grid. Under these conditions the average figure was 54

per cent. This variation was not due to one of two freakish tubes. No two of the tubes had the same mutual conductance, but the results of this test showed that, so far as these twenty-five tubes are concerned, the mutual conductance was distributed fairly evenly throughout the range of 324 micromhos, plus or minus 27 per cent. To obtain comparisons, mutual conductance measurements were made on fifteen UV201A tubes under the same conditions as the McCullough tubes. The comparison was not exactly fair, inasmuch as the McCullough tubes were new and had never been used, whereas all of the fifteen UV-201A tubes had seen varying amounts of service. However, under these same conditions the average mutual conductance of the UV201A tubes was 870 micromhos with a variation from this average of only 17 per cent. "This more comprehensive test confirms the conclusions which we drew from the previous test of only three tubes, that as far as the McCullough tube in its present state is concerned there is still considerable room for improvement, either in their operating characteristics or in uniformity. It is, perhaps, needless to state, that with the showing made by these twenty-five McCullough tubes, this particular manufacturer has dropped all plans for developing a receiving set using these tubes."

Graham McNamee

(Continued From Page 7)

work and political work from WEAF. I find these two most interesting and enjoy all political work, even the Democratic Convention. Come, by the sport work is interesting! If you are reporting instead of just announcing, you are trying to draw word-pictures of what goes on before you so that your listeners-in who are depending upon you may see just as much as you are seeing.

One of the nicest things about radio announcing is the close personal feeling which you have for the people to whom you are talking, and the friendly regard which so many show for the announcer. I get thousands of letters a year and presents—well, I will just let Mrs. McNamee tell you all about them—here she is now. She really knows lots more about all this than I do. Come in dear, I will just tune in and see what's on the air while you do a little broadcasting for me. Allow me to introduce my wife, Josephine Garrett McNamee.

Then my loud-speaker was silent for the moment and it seemed as though Mrs. McNamee were coming up to the microphone. She spoke in this way:

Good morning! When Graham and I were married four years ago, I certainly never expected that I would become a "radio widow." At that time I had never been in a radio studio. We were doing a great deal of singing together and became so closely identified that once somebody referred to Graham as Garrett McNamee. For instance, we did the Harding Memorial Service together in the Collegiate Church of St. Nicholas and had also sung in Divine Paternity and other places.

I don't suppose you got a great deal out of talking to Graham. You just have to pump him and give him leads. Dad and I are helping him write his "radio reminiscences," for we find that as we read it over with him and talk over past events, it serves to refresh his memory and in this way we have accomplished 37,000 words, but there is a tremendous amount of work to be done before we can give it to the publisher.

When Graham first started his radio work we didn't have a radio at

home, and I really think he didn't get one so that I would have to go around to different places and hear his broadcasting under all kinds of circumstances so that he might have a frank report on how things went over. For this reason I have heard his announcing in all sort of queer places.

For instance, during the World Series I came down the drive on a Sunday afternoon when all the radio shops were closed, and found the street packed. In a third-story apartment window a man had placed his loud-speaker and the mob outside was listening to Graham's voice announcing the game. I stood in the crowd and I can tell you it gave me a real thrill to hear these strangers say to each other, "He surely is doing a good job!"

Graham has never talked on any important subject that I haven't listened in. I went out to the Republican Convention with him, and the first thing I do when I come into the house is to tune in to see whether he is on the air. Of course this gives me an excellent check on him because if he doesn't come home within a certain amount of time after he has signed off, he has to have a pretty good alibi!

Did he tell you that during the Democratic Convention, the Boston Post and the Evening Telegraph of New York published his report of the convention under the title of "The Convention via Radio"? Sometimes I forget that he is home. For instance, the other day when I was home, I forgot that he was in the house and when I heard his voice I thought I had turned on a radio and that I was listening to him broadcast, so I didn't answer him when he spoke to me.

When Graham started out to do so much radio work I decided that the only thing to do was to keep myself busy also and be just as tired as he was, so I take as many singing engagements as is possible for me to handle and still be free whenever Graham is free. We have our mornings together and midnight suppers are usual events here.

Has Graham told you that he received 25,000 letters last year? Here are some of the gifts he has received. Do look at the radio fans from Vineyard Haven, Mass. This billfold was made of pigskin by a man who listened to the entire Democratic Convention. It is almost impossible to tell you the varieties of things which he receives. Why, one day there came an enormous box of apples from Northern New York and tangerines from Florida! One man wanted to send us a box of farm vegetables. First he wanted to know how many there were in the family, but since there were only the two of us we lost out on the vegetables.

Editorially Speaking

(Continued From Page 3)

by Solari and with music by Parson, which will introduce artists and comedians of national reputation. An outstanding feature of the review will be an operatic cantata by the American composer, Charles Wakefield Cadman, which will be conducted by Cadman himself, and will be one of the really notable dramatic events of the year in St. Louis.

KSD will broadcast from the Garden Theatre each Tuesday night beginning at 8 o'clock and will send out the entire performance each time, music and dialogue. A special broadcasting "hut" has been erected off stage at the theatre for the apparatus and announcer, and in cases where the action is not accompanied by words a running description will be given by the announcer at the same time the music is being broadcast, so that listeners can easily

visualize the performance. Flint Garrison, editor of "The Drygoodsman" one of the "Economist" group of American trade papers, is president of the Garden Theatre Association, and is personally directing the season's productions.

The record of the past three years of this station is well worthy of preservation in the scrapbooks of radio enthusiasts. It is also a very convincing argument in answer to those friends of yours who refuse to invest in a radio set because they do not think that a set will give them anything which they want in their homes. Show them this record, point out to them how each year has added the big things of importance in our national and community life, and ask them if they can really consider themselves up-to-date citizens while they are neglecting the opportunity of having such entertainment and education as this in their own homes at a nominal cost. Here is the log of Station KSD, the broadcasting station of the St. Louis Post Dispatch, for the three years from June 26, 1922, to June 26, 1925:

**Programs Broadcast by Station KSD
June 26, 1922, to June 26, 1925**

Number of programs.....	1434
First Year	
Studio.....	337
Outside of Studio.....	107
Second Year	
Studio.....	129
Outside of Studio.....	276
Out of Town.....	4
Third Year	
Studio.....	305
Outside of Studio.....	258
Out of Town.....	18

*This includes Commercial Broadcasting:

Laclede Gas Light Co.....	59
Lane-Bryant.....	5
Gardner Motor Co.....	8
National Bank of Commerce.....	3

Artists Taking Part in KSD Programs

Number of Individuals taking part in KSD Programs June 26, 1922, to June 26, 1925.....1383

Pianists.....	379
Vocalists.....	310
Cellists.....	5
Readers.....	41
Speakers.....	423
Violinists.....	101
Children.....	71
Miscellaneous.....	54

Number of Bands.....	30
Number of Choirs and Choral Clubs.....	39
Number of Orchestras.....	60
Number of Quartets (Instrumental and vocal).....	23
Number of Trios.....	3

NOTE: The above artists represent persons from:

- 15 Different Countries of the World.
 - 25 States of the United States.
 - 115 Cities of the United States.
- All five races.

**Outside Broadcasting
First Year**

June 26, 1922, to June 26, 1923	
Number of Events broadcast outside of KSD studio.....	107
Municipal Opera.....	26
Symphony Orchestra (Odeon).....	15
Statler Hotel Orchestra.....	25
Missouri Theatre.....	12
Grand Central Theatre.....	11
Miscellaneous.....	18

NOTE: The outstanding outside broadcasting event of the first year was broadcasting the address of the late President Harding at the Coliseum in St. Louis, June 21, 1923. This was the first time a voice of a President of the United States was

sent out by radio, thus making KSD a pioneer in this field.

**Outside Broadcasting
Second Year**

June 26, 1923, to June 26, 1924	
Number of events broadcast outside of KSD studio.....	276
Municipal Opera.....	11
Missouri Theatre.....	56
Grand Central.....	52
Symphony Orchestra (Odeon).....	15
Statler Hotel Orchestra (Dinner and Dance Orchestras).....	78
Miscellaneous.....	42
Empress Theatre.....	7
Famous-Barr Radio Show.....	6
Hotel Jefferson Dance Orchestra.....	7
Delmonico Theatre.....	2
Lyric Skydome.....	1

Broadcasting from Out of Town
President Coolidge's address to Congress, Washington, D. C.
President Coolidge's address to Associated Press, New York, N. Y.
Republican National Convention, Cleveland, O. (Three days.)
Democratic National Convention, New York, N. Y. (Three days.)

**Outside Broadcasting
Third Year**

June 26, 1924, to June 26, 1925	
Number of events broadcast outside of KSD studio.....	258
Symphony Orchestra (Odeon).....	15
Grand Central Theatre.....	45
Missouri Theatre.....	42
West End Lyric Theatre.....	10
Lyric Skydome.....	12
Loew's State Theatre.....	3
Hotel Jefferson Dance Orchestra.....	9
Missouri Athletic Ass'n Orchestra.....	31
Hotel Statler Dinner Orchestra.....	36
Miscellaneous.....	26
Famous-Barr Radio Show.....	8
Scruggs Radio Show.....	7
Jefferson Barracks Band.....	6
City Club Dance Orchestra.....	14
Political Speeches broadcast from Coliseum.....	4

Political Speeches Broadcast from St. Louis

La Follette's Speech, Coliseum, St. Louis.
Davis' Speech, Coliseum, St. Louis.
Wheeler's Speech, Coliseum, St. Louis.
Dawes' Speech, Coliseum, St. Louis.
Verne Reynolds' Speech, KSD Studio, (Socialist-Labor V.-P. Candidate.)
Faris' Speech, KSD Studio, (Prohibition Presidential Candidate.)

**Out-of-Town Broadcasting
Third Year**

Democratic National Convention (eleven days), New York, N. Y.
Davis' Speech of Acceptance, Clarksville, W. Va.
Coolidge's Speech of Acceptance, Washington, D. C.
Dawes' Speech of Acceptance, Evans-ton, Ill.
Davis' Labor Day Speech, Clarksville, W. Va.
La Follette's Labor Day Speech, Washington, D. C.
National Defense Test, Washington, D. C. (Non-Political.)
Davis' Speech, Topeka, Kan.
Davis' Speech, Bunston, Mo.
Coolidge's Speech, Philadelphia, Pa.
Hoover's Speech, Washington, D. C. (Non-Political.)
Hoover's Speech, Washington, D. C. (Non-Political.)
Coolidge's Speech, Washington, D. C.
Hughes' Speech, St. Paul, Minn.
Reed's Speech, Kansas City, Mo.
Hughes' Speech, New York, N. Y.
Davis' Speech, New York, N. Y.
Coolidge's Speech, Washington, D. C.

That Very Natural Tone



of the Bristol Loud-Speaker is not due to chance, but to a long-time experience in the manufacture of finely adjusted scientific instruments.

For over 36 years the Bristol Company has been manufacturing Bristol's Recording Instruments—which measure and record the minute changes in heat, cold, humidity, electrical current and numerous other properties.

That this experience and factory fitness is reflected in the sweet tone of the Bristol Loud-Speaker is a very natural thing.

BRISTOL AUDIOPHONE LOUD SPEAKER

For \$25 and \$30 you can get a Bristol Speaker; and there are others as low as \$12.50. Ask your dealer to send one out. Write us for Folder No. 3022-Q, telling why the Bristol is such a delight to the ear.

THE BRISTOL COMPANY WATERBURY, CONN.
The Bristol Company Waterbury, Connecticut
BRISTOL'S RECORDING INSTRUMENTS

A Perfect Combination

It has been conclusively proven with the DAVEN SUPER AMPLIFIER that Resistance Coupled Amplification is the best known method to procure quality and volume without distortion, and now, to add to the efficiency of the SUPER AMPLIFIER, the Daven engineers have created a new product — the Daven High Mu Vacuum Tubes. This combination will bring perfection of amplification to you.

Super Amplifier	High MU Tubes MU-20 \$4.00	3-Stage Amplifier Kit, MU-6 \$5.00
\$15.00		\$9.00

Daven Products Are Sold Only by Good Dealers

Read the RESISTOR MANUAL Price 25c from your Dealer, Price 35c postpaid.

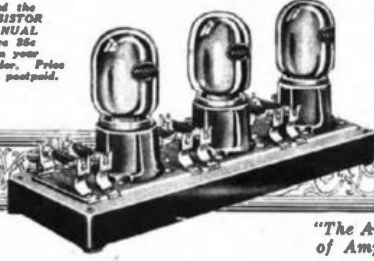

"The Aristocrat of Amplifiers"

The Star of World
DAVEN RADIO CORPORATION
NEWARK, N. J.

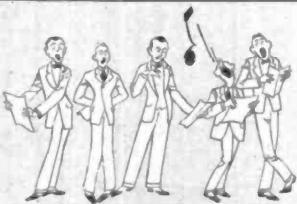

ONE BAD VOICE IN THE CHORUS

Does As Much Harm
As One Bad Tube
In Your Set!

Find the
Trouble-Making
Tube by Testing the
Quick, Easy Sterling Way

No trouble to find your trouble with the Sterling Tube Tester. More than a tube tester, too, helping you locate many other troubles. Start with the tubes. Make sure they're right—and you'll find your set behaves a whole lot better than ever before! Ask for interesting Bulletin on Tube Testing

THE STERLING MANUFACTURING CO.

Cleveland Dept. K Ohio

Sterling

HOME TUBE TESTER

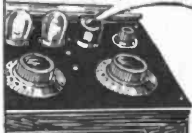

Price
only
\$8.50

AMPLIFIER AND DETECTOR

5 VOLT TUBE

DISTANCE MAKES NO DIFFERENCE

SEA GULL



A GOOD receiving set deserves "quality tubes," and an indifferent one is marvelously improved by using high quality tubes such as Sea Gulls. Greater tone differentiation, improved clarity, wonderful brilliancy, and increased volume are features that give Sea Gull tubes their reputation for superiority.

Overloading under usual operating conditions is impossible. Sea Gull tubes are the result of expert care and skill in manufacture, and are inspected and tested for actual performance many times before leaving the factory.

We make a special high capacity rectifier tube for "B" battery eliminators." Write for information.

Send us your order today for Sea Gull Tubes.

\$3.00 per tube
p. p. c. o. d.

ABERDEEN SPECIALTY CO., Inc.

Mail Order Dept. 316
1520 Chestnut St.
Philadelphia

Making a "Yardstick" to Measure Quality

(Continued From Page 14)

rattle, which will give an infinite number of miles per gallon, which will take us anywhere in any weather without puncture or breakdown, regardless of whether we grease, clean or service the machine or not. With the countryman on his first view of the giraffe, we can safely say, "There ain't no such animal."

There are, however, all degrees of poor, fair and good performance from impossibly bad sets up to those that approach so dangerously near perfection that one hardly believes even the truthful tales he hears of them. To make these better sets, a great deal of work has been done on standards both by careful laboratory investigators and by practical radio engineers. It is one of the jobs of the Bureau of Standards to see to it that the physicist and the engineer in doing such research and development has the necessary fundamental information of all sorts needed. Just a few of the special tasks involved in this work need to be considered to make clear how important to the listener is the work of this Federal bureau.

It was the invention of the electron tube which has really made modern radio possible. It is the work going on now on such tubes that is going to make the highly improved radio of the future a practical certainty. In no other phase of radio are the matters of standards of construction and standards of performance so conspicuous and so essential.

Take simply the question of size and form of tubes and one will at once see the absolute necessity for standardization. When one goes to the store to buy a new tube, either because the old one appears to be exhausted or because it has burned out through careless connection of "B" batteries to "A" battery binding posts, it is not enough to tell the clerk that one wants a radio tube. There have been three widely used forms of tube bases and several variations in tube form for each base style. Even if the base fits, the bulb may be so large that it will not go into the receptacle space or so small that it is very inconvenient to hold the bulb while putting it in place.

The electrical characteristics of the tube, of which the average listener knows even less than regarding style of base, are still more important. In replacement it is necessary to get a tube which uses the proper voltage in the filament circuit, that takes the proper number of amperes, and that has "performance constants" which are correct for the particular set in which the tube is to be used.

At the present time there is no way for the average listener to know about such matters or to describe the tube which he wants, except by asking for another one which has the same label as the old exhausted or burned-out tube. That scheme works fairly well, but even it is rather unsatisfactory in some particulars, notably when the dealer suggests another brand of tube which he says is equivalent to the old form and "just as good" or "better." This difficulty has led to a very general feeling that the time is at hand when some steps must be taken for a uniform designation of tubes so that a particular name will mean a particular type, without use of any single manufacturer's copyrighted brand or labels.

As the matter now stands we list-

eners all talk glibly about our sets and say we use WD11, UV201A or UV199 tubes. In doing so we are using the terms which are really copyright trade-mark designations of the product of the Radio Corporation. But by common usage they have attained almost general significance, for it is not uncommon to drop the UV from the term "UV201A" in order to describe any tube of similar style.

The American Engineering Standards Committee has already taken account of this matter and has appointed a sectional committee to deal with radio standards. One of the sub-committees, of which a radio engineer on the staff of the Bureau of Standards is chairman, has as its particular task the question of tube standards. This committee is going to tackle the job of defining different sorts of tubes in some general system so that regardless of make or brand all of like physical and electrical characteristics can be given a like designation.

There is one very interesting scheme that has been proposed by a certain individual for this description of tubes. The listener can well take a minute to consider that scheme because it makes clear just what must be described by one who goes shopping for tube replacements. This scheme proposes a numbering of any type of tube to show the following four important characteristics:

1. The degree of exhaustion, whether containing a high vacuum (V) or a so-called gaseous tube (G).
2. The terminal filament voltage, that is, necessary voltage from the "A" battery.
3. The type of base, whether (A) "standard" like tubes UV201A, or (B) with four short knobs like UV199, or (C) with four long prongs like WD11 tubes.
4. The filament current, that is, the number of hundredths of amperes which pass through the tube filament when a normal voltage is applied.

If such a system of labels were adopted by any committee you and I could go to the store and demand a tube of type V5A25 if we wanted a vacuum tube for a 5-volt "A" battery using the so-called standard base and taking about 25-hundredths of an ampere. In other words, we should use that term "V5A25" when we wanted a UV201A tube or its equivalent of some other make. Such a scheme of numbering, or any one of a dozen others that may be quite as satisfactory, will make it unnecessary to remember a particular maker's number. We need remember only the general characteristics of the radio set, and we can then probably find several makes to fit.

But the question of tube standards is not fully and simply solved by getting suitable series of names and numbers for each style. It is also absolutely necessary for many types of radio sets that all the tubes used at one time be very nearly identical in their electrical performance.

For example, with certain 5-tube neutrodyne it is very difficult to replace one or more of the tubes without replacing all of them, unless the new tubes have exactly the same electrical characteristics as all of the old tubes which are not replaced. This emphasizes the importance of having standards which will enable us to duplicate or replace only part of the tubes at a time. If this is not possible, we are in the unfortunate position of the owner of a flivver after a bad smash-up, when he found it most economical to jack up the

steering wheel and put a new car under it.

As time goes on and superbetrodynes, neutrodynes and other forms of refined receiving equipment are built, the matter of tube selection will become constantly more important.

Dealers in high-class equipment recognise this fact and are providing, for careful counter tests for all tubes which are sold, to make certain that at a proper grid and plate voltage the plate current is exactly what it should be for the tube and the set desired.

This question of improved service from the radio dealer is going to be one of the big problems of the industry in which the public is very directly concerned. Early in the radio art, advertisements made much of the fact that the dealer would come out and install the set and guarantee it to work. Moreover, many dealers offered, for a given period of time, free service for sets that they had installed. That practice was quite necessary in the early days, not only to get people started in the use of expensive equipment, because few of us will buy a \$200 device before we are guaranteed that it will work; but also because the early sets were very likely to be frequently in need of service. Now the business seems to be passing through the stage which our lawyer friends describe in their naive way as "caveat emptor," or in plain English, "let the buyer beware." In fact, sometimes the purchaser thinks that even stronger language than "beware" is intended.

The time is going to come, and very soon, too, in the opinion of Government officials, when service on radio equipment will be just as common and regular a detail of the business as service on automobiles or service on any other mechanical device. No one of us will buy an automobile if we do not feel sure that we can get expert assistance at a suitably equipped station from mechanics and inspectors who know the car and its accessories in every detail. No more can the average householder afford to buy a \$200 or \$300 radio set unless he feels certain that somewhere about his town he can get aid when things go wrong. He can get it on vacuum cleaners and phonographs which cost a quarter or half as much. Naturally he wants the same for radio.

It is, however, quite proper to assume that all tubes should be built to a common standard as to their means of attachment to a set. Every one gladly accepts the standardization of connecting wires which has already been adopted by the radio manufacturers so that "B" batteries always are attached by a cord of a given color, head phones by distinctively designated cords, and so on. Certainly there is no harm in having the 15-cell and 30-cell "B" batteries almost universally adopted for the plate circuit so that 22½ volts or some multiple of that voltage can be our universal unit in "B" batteries. Such standards tend to simplify and to eliminate unnecessary types, spare parts and strange repair problems, all of which would cost excessively in servicing a set.

The listener finds other great advantages, too, in the maintenance of standards for such equipment. The manufacturer can make a million units all alike much cheaper than a thousand each of a thousand varieties of any apparatus or device. The price to the user is, therefore, correspondingly less and the stock in the

dealer's shop is up-to-date and fresh. All of this means that there is a minimum of difficulty when we listeners go for replacements or repairs.

The question of standards for radio batteries brings out still another great advantage to the public from this type of scientific work. This is the advantage of improved quality which comes from the regular testing and inspection of radio accessories.

In the radio field the outstanding professional organization is the Institute of Radio Engineers. No other agency is more influential in the development of scientific and technical aspects of this marvelous business. It is safe to say, therefore, that the Institute of Radio Engineers was expressing its judgment as to the importance of standards, quite as much as its confidence in the individual, when it selected for its President, Dr. J. Howard Dellinger, the head of the Radio Standards Laboratory of the National Bureau of Standards. Knowing that the profession and the industry have this fine appreciation of the importance of standards, the listener can look forward with confidence to further improvements in the art and the science. Stimulated by real knowledge of fundamentals, that advance is sure to be no less spectacular in the next decade than the advance of radio during the last ten years.

The Shriners' Radio Marathon

(Continued from Page 11)

the Arian Trio, the Titan Trio, Chico Le Verde and his Russian String Quartette, the Colombian Trio, the KJH Trio and many others.

There was no padding; at all times the high standard of broadcast from KJH was held up. At times, informality reigned, but it was always good, clean entertainment, and it reached a high spot, when on Saturday night at 11.30 the "Lost Angels of KJH," an aggregation of all the popular KJH artists and their friends, assembled and held a radio wedding. A real wedding with an ordained minister of the gospel officiating, Rev. A. L. Webb. After the wedding, the bride and groom and even the minister were initiated into the mysteries of the "Lost Angels," and then came a wedding breakfast, presented and served through the courtesy of John Talt's restaurant; chicken and salads and pickles and all the fixings. The couple received many wedding gifts from different firms interested in radio.

The last evening of the broadcast was given over to an all-colored program, "An Evening on the Swanes River," presented by the Martin Music Company.

Radio dealers in the city and in nearby communities reported a phenomenal increase in sales; in fact, many persons purchased sets for the first time, purposely to listen to the Shrine Radio Marathon of KJH. As the Town Crier of KNX said, when he visited the Times station, "The time is coming when there will be continuous broadcast, day and night, and KJH has shown where there is not only a demand for it but that the industry, as a whole, will be furthered and improved, both in transmitters and in receivers."

So the conclave ended, the last twitter of the canary birds and "Uncle John's" announcement: "Kay Aitch—Jay, the Times, Lohs Ahngyalis, California."

Then the clear notes of a trumpet blowing "Taps."

Another milestone in the onward march of radio.

"pep up" your radio for good summer reception

JEFFERSON TUBE REJUVENATOR

keeps tubes like NEW!

YOU can't get good summer reception with weak tubes. All radio tubes weaken with use—especially in summer when burned at highest voltage. Keep your radio tubes efficient this summer with the Jefferson Tube Rejuvenator. Just attach to a convenient electric light socket in your own home—"bring back" each tube in 10 minutes!

For HOME Use



Repeat once a month—note how it improves reception; restores and retards tube life. Quickly pays for itself through saving tubes and batteries. A home rejuvenator for tubes is as essential to satisfactory radio reception as a changer for storage batteries. Completely restores paralyzed or exhausted tubes. Takes larger size tubes—201-A, 301-A, UV-199, C-299. Fully guaranteed. At leading stores selling radio. If your dealer can't supply you, send \$7.50 to

JEFFERSON ELECTRIC MFG. CO. 501 So. Green St., Chicago, Ill.

Members of Jefferson Radio, Bell Kaminog and Top Manufacturers, Jefferson Circuit Calls for Automobile, Stationary and Marine Engineers, Jefferson Oil Burner Installation Code and Transmitters.

\$7.50
\$10 in Canada



CARTER

"IMP" Lock Switch

Pat. 1-20-23



75c

Half Size

A product that upholds the widely known high quality and excellence of Carter workmanship.

The Carter "IMP" Lock Switch switches off your "A" Battery and locks your set at the same time.

"Off and On" name plate and key show position of switch at all times.

The Carter "IMP" Lock Switch operates exactly as the ignition switch of your automobile.

Each switch equipped with 3 keys. Truly the finest, best made lock switch on the market today. You'll not find its equal.

Any dealer can supply

In Canada—Carter Radio Co., Ltd., Toronto

Carter Radio Co.

There's a Reason!

The fine, clear tone and volume of the Kellogg Symphony Reproducer is due to the Kellogg unit with the magnetic diaphragm control.

This exclusive Kellogg principle has produced wonders in the accurate reproduction of voice and music; piano music is unusually fine, the lowest tones of the saxophone or the highest of the violin are as clear as a bell, the soprano voice can really be admired.

Observe the rigid construction of this unit, the exactness of every detail, the size of the magnets. The unit is the reason.

For attractive proposition ask your jobber's salesman or write direct to us.



Kellogg Switchboard & Supply Co.

1066 W. Adams St., Chicago, Ill.

Made to order especially for radio

Radion is the material with highest insulating characteristics proved by tests. It keeps down leakage and losses. Send 10 cents for helpful booklet, "Building Your Own Set." American Hard Rubber Co., Dept. N-8, 11 Mercer St., New York City.

RADION

The Supreme Insulation

Panels, Dials, Sockets, Binding Post Panels, etc.

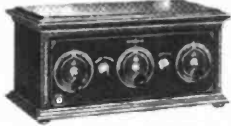

APEX SUPER 5

Superb Tone Quality. Unparalleled selectivity. Volume beyond compare. Dependable efficiency setting ability. Price \$95.00—without accessories. Ask your dealer. Should be unable to supply you, write for descriptive folder. APEX ELECTRIC MFG. CO. 1810 West 59th Street, Dept. 512, Chicago

For Better Radio Hammarlund PRECISION CONDENSER

All capacities: plain and variable. Single, Double and Triple Models. Also "HAMMARLUND, JR."—the Precision Midget.

Write for Literature Hammarlund Manufacturing Co. 424-436 W. 33d St., New York

DURHAM



GLASS TUBE Plunger Pat. Grid Leaks

Patented plunger guarantees satisfaction. Three sizes for tubes; hard and soft, and for audio stages. 75c

DURHAM & CO., Inc. 1930 Market St., Philadelphia

Investigate! before you buy radio parts. Demand the best—ask for

Pacent RADIO ESSENTIALS

Built by America's pioneer radio engineer. Read for FREE illustrated catalog.

PACENT ELECTRIC CO., INC. 91 Seventh Avenue, New York City

Protection

Isn't your home and radio worth the best protection you can buy?

Safety demands the

BRACH VACUUM ARRESTER

STANDARD FOR 19 YEARS

The Counterflex—Minus the Flex!

(Continued From Page 21)

constant over the entire tuning range of the receiver, provided the transformers are correctly designed. There are very few other systems which possess this important advantage. In most cases, when no adjustment of the oscillation control is possible, the amplification is good at low wave lengths, but poor at high wave lengths. If the oscillation control is adjustable it is necessary to vary this control with each change of fre-

quency. Theoretically, it should not be necessary to vary the counteracting capacity of the Counterflex circuit at all, but, in practice, I find there is usually one frequency which produces the greatest amplification. When the Counterdon is adjusted to prevent self-oscillation at this frequency the amplification of other frequencies is a trifle lower. If desired, greater amplification of these other frequencies can be secured by slightly reduc-

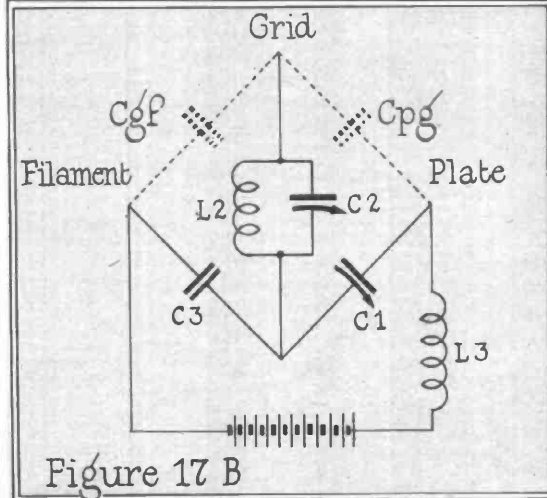

ing the capacity of the Counterdon. A third advantage is the ease with which self-oscillation can be controlled. The Counterdon is not a tiny little capacity requiring delicate and accurate adjustment. Its capacity can be quite large and the balancing value is not critical. As I pointed out last month, while there is one value which accurately balances the bridge, this value must be very considerably increased or decreased to produce continuous oscillation. Fig. 18 shows the connections of a four-tube receiver of this type with

one stage of tuned radio-frequency amplification, detector and two stages of audio. This makes one of the nicest receivers I have ever operated. The amplification is extremely good and the operation is just about as simple as it could be. I am going to devote next month's article to a complete description of a receiver which I have just designed using this circuit, so I shall ask you to wait until then for the complete data.

The receiver I shall describe has only one tuning dial. The r. f. transformers are unusually efficient and of somewhat different design to the ordinary type. I shall describe these transformers and give all other details of this receiver next month. Fig. 19 shows how to use two stages of radio-frequency amplification, each tube being balanced to prevent oscillation. Very high amplification per stage is afforded by this circuit, en-

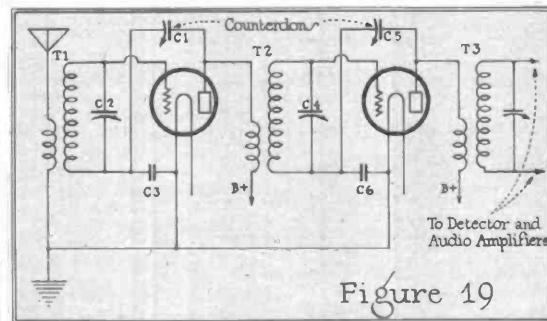

abling the construction of an unusually sensitive receiver. In a future issue I shall give complete details of this hook-up. I expect a number of readers will want to know if these straight radio-frequency amplifying circuits are better than the Counterflex circuits using the reflex principle. Is the four-tube circuit of Fig. 18 any better than the standard 4-tube Counterflex circuit? Well, it depends. The new transformers which I have designed increase the amplification, but the same

well, it depends. The new transformers which I have designed increase the amplification, but the same

World Battery advertisement featuring 'FREE!' offers, '12-Cell—24-Volt Storage'B Battery', and '3-Year Guarantee'. Includes a list of battery specifications and contact information for World Battery Company, Chicago, Ill.

Advertisement for 'New Jersey to California on Loud Speaker with new Quadroformer 6-Tube Circuit'. Features 'Complete Parts \$47.25 Special at...' and 'Base and Panel Included Regular Price \$60.58'.

Advertisement for 'M&H SPORTING GOODS CO.' featuring 'Commercial 3-Tube HARKNESS Type Counterflex Circuit \$17.50' and 'Complete Parts New Licensed'.

Advertisement for 'B.M.S. FAN-TAIL-JACK' by Brooklyn Metal Stamping Co., featuring 'For Easy Soldering' and 'At All Good Dealers!'.

Advertisement for 'KARON TRADE MARK READY-WIRED UNITS' by Kardon Products Co., Philadelphia, Pa., featuring 'Detector unit', 'Detector and two steps', and 'Two-step amplifier'.

The Great
Manufacturers'
Exposition.
Attended by
Leading
Jobbers and
Dealers

The Official 1925 RMA Show

THE SECOND RADIO WORLD'S FAIR NEW YORK CITY

U. J. HERRMANN, MANAGING DIRECTOR
SEPTEMBER 14th to 19th
MONDAY NOON TO SATURDAY MIDNIGHT
ENTIRE EXHIBITION ON GROUND FLOOR
IN THE LARGEST HALL IN THE WORLD
258th Field Artillery Armory

NEW YORK OFFICES
1500 TIMES BLDG.
NEW YORK CITY



Price \$18.50
Complete with Cord,
Battery Leads and Clips.

Valley Battery Chargers
with
Ten Points of Superiority
VALLEY ELECTRIC CO.
3157 S. Kingshighway, St. Louis, Mo.

ZENITH RADIO

Tunes straight through
the locals, gets distance,
Brings in more stations—clearly and
with volume—in a given length of time
than any other set. Direct connections in-
vited. Zenith receiving sets cost more, but
they do more.—The exclusive choice of
MacMillan for his North Polar Expedition.

Zenith Radio Corporation
332 S. Michigan Avenue, Chicago

"Long Distance"

No better tube made
for getting distant
stations than the
SCHICKERLING. Tube
noises and distortion
eliminated by patented
stabilizing plates.

\$3

Model
S-4000
5 volt. Stand-
ard Base, 1/2
amp. Detector-
Amplifier

Mail orders filled promptly
**SCHICKERLING
PRODUCTS CORP.**
401-407 Mulberry Street
Newark, N. J.

Write for list of other models

transformers can probably be used in the three-tube Counterflex circuit, although I have not yet adapted them to that circuit. As a matter of fact, the four-tube straight r. f. amplifying circuit is probably only slightly more sensitive than the standard three-tube Counterflex. However, it has other advantages which will appeal to those who live near high-power broadcasting stations. It is more selective and it does not howl when a very strong local signal is tuned in. The reflex tube of the Counterflex circuit has a tendency to produce howling when strong local signals are tuned in. This effect is only noticeable when the receiver is located near a high-power transmitting station, but there are so many stations now using 2000 watts or more that it has become much more of a problem than formerly. It is difficult to prevent reflex tube from being overloaded and causing howling if the receiver is located near one of these super-power stations. The use of a C battery helps but does not always prevent overloading and howling. Similarly, it is difficult to obtain good selectivity if a reflex receiver is located near high-power stations. Strong signals are rectified by the reflex tube and amplified by the second audio tube. The tuning of the inter-stage r. f. transformer does not affect these signals. Consequently, it is difficult to keep them out.

In some future issue I shall continue this series of articles on Counterflex circuits for experimenters. There are many variations of the underlying principle of these circuits which make interesting material for the experimenter to work on. I shall have to postpone discussion of these booklets, however, until after I have described receivers using some of the circuits already published.

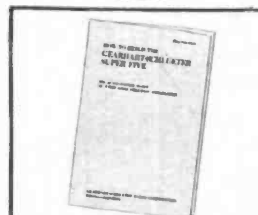
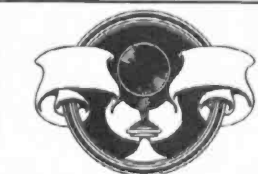

Write today for the **QUADRAFORMER BOOK**. It will start you on the way toward a new radio experience.

Profusely illustrated with photographs and drawings, it takes you step-by-step through the making of a 5-tube **GEARHART-SCHLUETER** receiver. The method of description simply takes all the difficulties right out of the set construction.

Don't doubt—know for yourself what the **QUADRAFORMER** System is. Just write and ask for the **QUADRAFORMER BOOK**, enclose 25c to cover cost of handling and mailing and you'll have it by return mail. But don't delay—the number of copies available for this offer is limited.

**Gearhart-Schlueter
Radio Corporation**
P. O. Box 212, Fresno, California

**WHERE DOES KDKA
COME IN ON YOUR DIAL?**
Enjoy phenomenal tuning with this
NEW Orthometric Condenser.

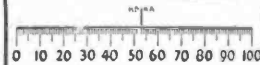

Karas Orthometric Condensers bring in KDKA at 31, where it belongs. With ordinary condensers KDKA comes in at about 27. Even with the recent straight-line wavelength condensers KDKA comes in low—at about 28—leaving very little room for the 117 odd wavelengths that must come in below it.

KARAS Orthometric Condenser

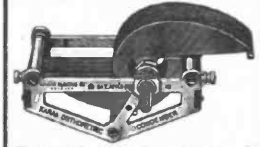

Karas Orthometric Condensers surpass all wavelengths evenly by 10 kilocycle intervals, point by point on the dial, exactly as the wavelengths are separated and allocated by the U. S. Government.

With Karas Orthometrics every point on a 100 point dial corresponds to one of the officially allotted wavelengths.

With Karas Orthometrics, there is positively **NO CROWDING** of stations on the lower end of the dial. Crowding is inevitable with ordinary condensers that jam half of the 100 wavelengths into the first 15 points; or even with straight-line wavelength condensers that crowd the lower 50 wavelengths into the first 25 points of the dial.

Distribution of this wonderful **NEW** condenser starts August 1st. Prices, 25 plate 8008 MFD. capacity \$7.00—17 plate .00537 MFD. capacity \$6.75—11 plate .00555 MFD. capacity \$6.50. Protect yourself by ordering **NOW!**

Karas Electric Company
4044 North Rockwell Street, Chicago

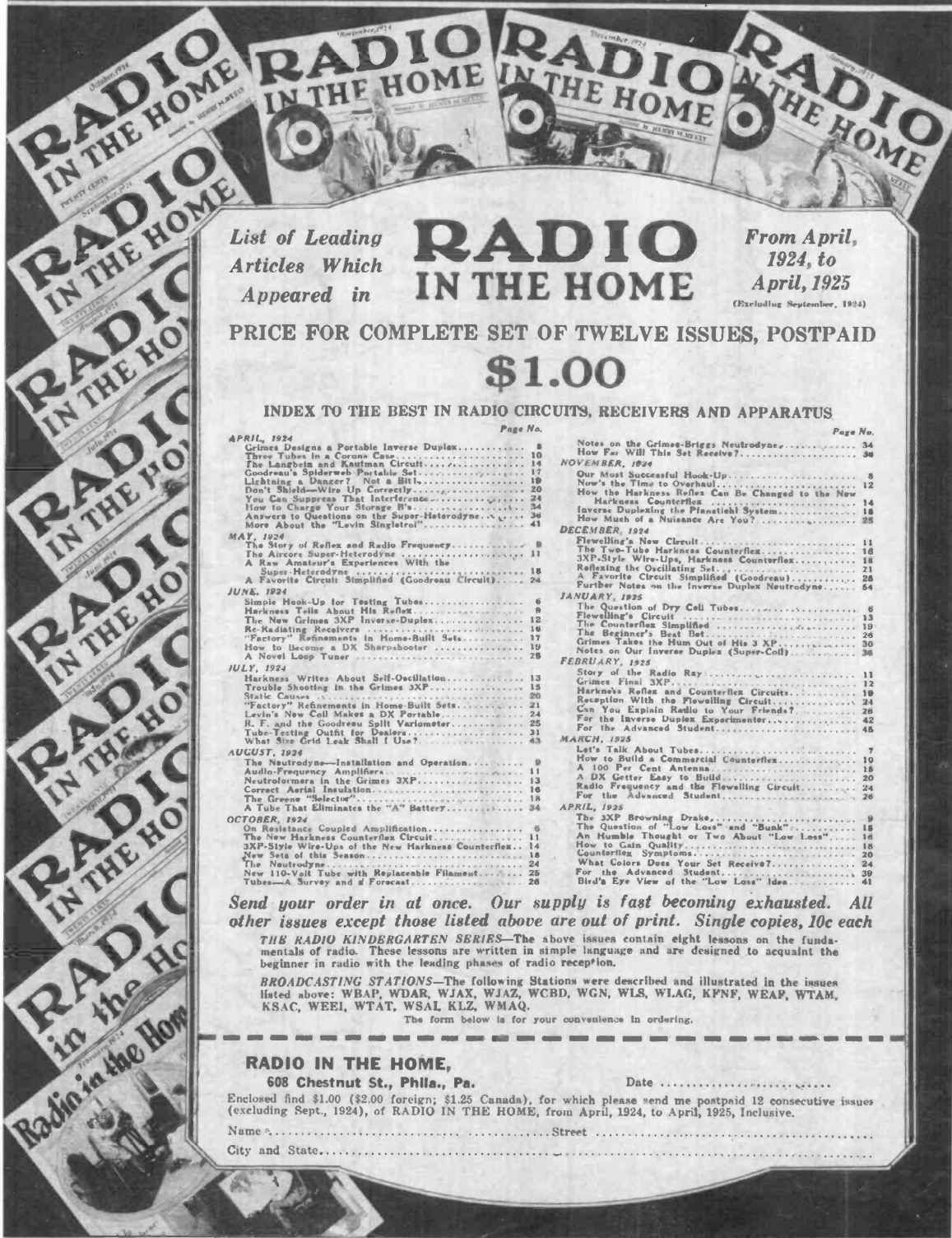

List of Leading
Articles Which
Appeared in

RADIO IN THE HOME

From April,
1924, to
April, 1925

(Excluding September, 1924)

PRICE FOR COMPLETE SET OF TWELVE ISSUES, POSTPAID
\$1.00

INDEX TO THE BEST IN RADIO CIRCUITS, RECEIVERS AND APPARATUS

	Page No.	Page No.	
APRIL, 1924			
Grimes Designs a Portable Inverse Duplex.....	8	Notes on the Grimes-Briggs Neutrodyne.....	34
Three Tubes in a Corona Case.....	10	How Far Will This Set Receive?.....	36
The Langbein and Kautman Circuit.....	14	NOVEMBER, 1924	
Goodreau's Spiderweb Portable Set.....	17	Our Most Successful Hook-Up.....	8
Lighting a Dancer? Not a Bit!.....	19	Now's the Time to Overhaul.....	12
Don't Shield—Wire Up Correctly.....	20	Now the Harkness Reflex Can Be Changed to the New Harkness Counterflex.....	14
You Can Suppress That Interference.....	24	Inverse Duplexing the Flansfeld System.....	18
How to Charge Your Storage B's.....	34	How Much of a Nuisance Are You?.....	25
Answers to Questions on the Super-Heterodyne.....	34	DECEMBER, 1924	
More About the "Levin Singletree".....	41	Flawelling's New Circuit.....	11
MAY, 1924		The Two-Tube Harkness Counterflex.....	16
The Story of Reflex and Radio Frequency.....	9	3XP-Style Wire-Ups, Harkness Counterflex.....	18
The Ancient Super-Heterodyne.....	11	Releasing the Oscillating Set.....	21
A Raw Amateur's Experiences With the Super-Heterodyne.....	18	A Favorite Circuit Simplified (Goodreau).....	28
A Favorite Circuit Simplified (Goodreau Circuit).....	24	Further Notes on the Inverse Duplex Neutrodyne.....	54
JUNE, 1924		JANUARY, 1925	
Simple Hook-Up for Testing Tubes.....	6	The Question of Dry Cell Tubes.....	6
Harkness Tells About His Reflex.....	8	Flawelling's Circuit.....	13
The New Grimes 3XP Inverse-Duplex.....	12	The Counterflex Simplified.....	19
Re-Radiating Receivers.....	16	The Beginner's Best Bet.....	26
"Factory" Refinements in Home-Built Sets.....	17	Grimes Takes the Hum Out of His 3 XP.....	30
How to Become a DX Sharpshooter.....	19	Notes on Our Inverse Duplex (Super-Coil).....	36
A Novel Loop Tuner.....	28	FEBRUARY, 1925	
JULY, 1924		Story of the Radio Ray.....	11
Harkness Writes About Self-Oscillation.....	13	Grimes Final 3XP.....	12
Trouble Shooting in the Grimes 3XP.....	15	Harkness Reflex and Counterflex Circuits.....	19
Strate Causes.....	20	Reception With the Flawelling Circuit.....	24
"Factory" Refinements in Home-Built Sets.....	21	Can You Explain Radio to Your Friends?.....	26
Levin's New Coil Makes a DX Portable.....	24	For the Inverse Duplex Experimenter.....	42
R. F. and the Goodreau Split Variometer.....	25	For the Advanced Student.....	45
Tube-Testing Outfit for Dealers.....	31	MARCH, 1925	
What Size Grid Leak Shall I Use?.....	43	Let's Talk About Tubes.....	7
AUGUST, 1924		How to Build a Commercial Counterflex.....	10
The Neutrodyne—Installation and Operation.....	9	A 100 Per Cent Antenna.....	15
Audio-Frequency Amplifiers.....	11	A DX Getter Easy to Build.....	20
Neutroformers in the Grimes 3XP.....	13	Radio Frequency and the Flawelling Circuit.....	24
Correct Aerial Insulation.....	16	For the Advanced Student.....	26
The Greene "Selector".....	18	APRIL, 1925	
A Tube That Eliminates the "A" Battery.....	24	The 3XP Browning Drake.....	9
OCTOBER, 1924		The Question of "Low Loss" and "Bunk".....	18
On Resistance Coupled Amplification.....	6	An Humble Thought or Two About "Low Loss".....	16
The New Harkness Counterflex Circuit.....	11	How to Gain Quality.....	18
3XP-Style Wire-Ups of the New Harkness Counterflex.....	14	Counterflex Symptoms.....	20
New Sets of this Season.....	16	What Colors Does Your Set Receive?.....	24
The Neutrodyne.....	24	For the Advanced Student.....	39
New 110-Volt Tube with Replaceable Filament.....	25	Bird's Eye View of the "Low Loss" Idea.....	41
Tubes—A Survey and a Forecast.....	26		

Send your order in at once. Our supply is fast becoming exhausted. All other issues except those listed above are out of print. Single copies, 10c each

THE RADIO KINDERGARTEN SERIES—The above issues contain eight lessons on the fundamentals of radio. These lessons are written in simple language and are designed to acquaint the beginner in radio with the leading phases of radio reception.

BROADCASTING STATIONS—The following Stations were described and illustrated in the issues listed above: WBAP, WDAR, WJAX, WJAZ, WCBD, WGN, WLS, WLAG, KPNE, WEAP, WTAM, KSSAC, WEEL, WTAT, WSAL, KLZ, WMAQ.

The form below is for your convenience in ordering.

RADIO IN THE HOME,
608 Chestnut St., Phila., Pa.

Date

Enclosed find \$1.00 (\$2.00 foreign; \$1.25 Canada), for which please send me postpaid 12 consecutive issues (excluding Sept., 1924), of RADIO IN THE HOME, from April, 1924, to April, 1925, inclusive.

Name Street

City and State.....