

LEARN HOW TO FIX YOUR TV

# Radio **Electronics**

OCTOBER 1990

TECHNOLOGY - VIDEO - STEREO - COMPUTERS - SERVICE

## BUILD THIS ROCKET ALTIMETER

Digital readout gives a second-by-second playback of your rocket's flight

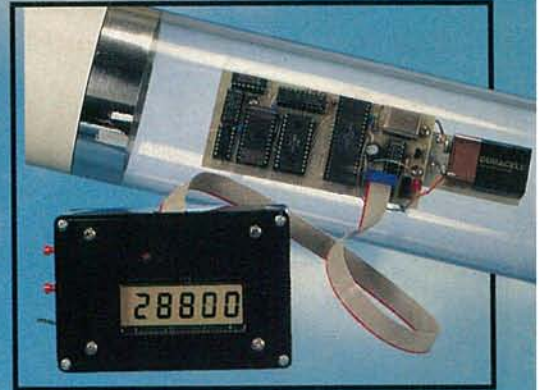

## LASER-PRINTER MEMORY CARD

Add up to 4 megabytes to your LaserJet for a fraction of HP's price

## FREQUENCY-COUNTER PRESCALER

Stretch your counter's performance to 1.6 GHz!

## NTSC-TO-RGB CONVERTER

Display standard video on your computer monitor

## MICROWAVE TECHNOLOGY

How magnetrons work



\$2.50 U.S.  
\$2.95 CAN

A  
**GERNSBACK**  
PUBLICATION

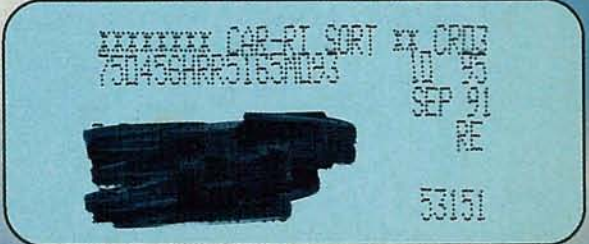



**FLUKE**



**PHILIPS**

**High Resolution Digital Meter:**  
4000 count digital readout; 20,000 count mode (Fluke 87) for 4 1/2 digit resolution

**Backlit display:** Makes it easy to read the DMM in dark, cramped quarters. Automatically shuts off after 68 seconds to save the battery.

**Recorder:** records minimums and maximums, plus true arithmetic average; audible Min Max Alert; selectable response times — 1 second and 100 ms (all models) plus 1 ms Peak Min Max (Fluke 87)

**Holster with Flex Stand™:** Protects meter and provides test lead storage. Flexible leg allows meter to be hung from peg, bent around a pipe, or used almost anywhere.

**Analog Meter:** High-speed analog display updates 40 times/second — as fast as the eye can follow; X10 Zoom bargraph mode (Fluke 83 and 85) makes high resolution offset measurements a snap.

**Frequency counter:** Accurate down to 0.5 Hz; also measures duty cycle

**Capacitance meter:** Autoranging, with manual ranging at the touch of a button



FLUKE 83	FLUKE 85	FLUKE 87
Volts, ohms, amps, diode test, audible continuity, frequency and duty cycle, capacitance, Touch Hold® relative, protective holster with Flex-Stand™	Volts, ohms, amps, diode test, audible continuity, frequency and duty cycle, capacitance, Touch Hold® relative, protective holster with Flex-Stand™	Volts, ohms, amps, diode test, audible continuity, frequency and duty cycle, capacitance, Touch Hold® relative, protective holster with Flex-Stand™
\$199*	\$229*	\$289*
0.3% basic dc accuracy	0.1% basic dc accuracy	0.1% basic dc accuracy
5 kHz acV	20 kHz acV	20 kHz acV
Analog bargraph and zoom	Analog bargraph and zoom	High resolution analog pointer
Three year warranty	Three year warranty	True-rms ac
		1 ms PEAK MIN MAX
		4 1/2 digit mode
		Backlit display
		Three year warranty

\*Suggested U.S. list price

# Multi-Meter

Meet the meter that brings an entire test bench to your job. The versatile Fluke 80 Series do-just-about-everything "Multi" Meter.

It offers everything you'd expect from an advanced handheld DMM, plus a lot you'd find only in dedicated instruments. Plus Fluke-exclusive features you can't buy anywhere else. All built with the most advanced surface mount design and single-chip ASIC technology for a thinner, tougher, more reliable package.

There's a fully annunciated display for clear operation. Duty cycle function. High-speed analog indicator. A protective holster with innovative Flex-Stand™ for easy, adaptable operation. Audible Input Alert™ to reduce the risk of damage to the meter, the user, and the unit being tested. Plus the strongest warranty in the business.

All good reasons to move up to the truly-multi Fluke 80 Series today. You'll find 80 Series DMMs at your Fluke distributor. For immediate, off-the-shelf delivery. Call

1-800-44-FLUKE, ext. 33 for the name of your nearest distributor.

John Fluke Mfg. Co., Inc. P.O. Box 9090 M/S 250C, Everett, WA 98206 U.S. (206) 347-5400 CANADA: 416-890-7500 OTHER COUNTRIES: (206) 356-5500

© Copyright 1989, John Fluke Mfg. Co., Inc. All rights reserved. Prices and specifications subject to change without notice. Ad no. 0102-F80

FROM THE WORLD LEADER IN DIGITAL MULTIMETERS.

**FLUKE**

CIRCLE 121 ON FREE INFORMATION CARD



## BUILD THIS

### 37 ROCKET ALTIMETER

Follow the flights of model rockets with a second-by-second electronic playback.

**John Fleischer**

### 47 1.6-GHz COUNTER PRESCALER

Update your old frequency counter with this low-cost, high-performance amplifier/prescaler.

**Fred J. Hufft**

### 55 LASER JET MEMORY CARD

Build a 4-megabyte memory expansion board for your LaserJet IIP or III printer.

**Bill Green**

### 59 NTSC-TO-RGB CONVERTER

This inexpensive circuit lets your VGA monitor work as a TV.

**Jim Harrigfeld**

## SERVICING

### 67 TV SERVICE CASE HISTORIES

Servicing tips and tricks gleaned from real-life cases.

**Cleo Zymarie**

## TECHNOLOGY

### 71 INTRODUCTION TO MICROWAVE TECHNOLOGY

A look at the principles of magnetron tubes.

**Joseph J. Carr**

## COMPUTERS

### 86 COMPUTER CONNECTIONS

Create MIDI-compatible music scores with Audio F/X and use UltraVision to control your monitor's display.

**Jeff Holtzman**

## DEPARTMENTS

### 10 VIDEO NEWS

What's new in this fast-changing field.

**David Lachenbruch**

### 20 EQUIPMENT REPORTS

Optoelectronics Handi-Counter UTC3000 and the Analyx Powercard PC-controlled power supply.

### 77 HARDWARE HACKER

A variety of filters, and a unique digital thermometer.

**Don Lancaster**

### 84 AUDIO UPDATE

An Audio Engineering Society conference report.

**Larry Klein**



### BUILD THIS LASER JET MEMORY CARD

Build this 4-megabyte memory expansion board for your LaserJet Model IIP/III printer.

**Bill Green**

The game of laser printers is a competitive one. As the market for these devices grows, manufacturers are vying to offer the most powerful, reliable, and cost-effective models. One of the key factors in this competition is the amount of memory available to the printer. More memory allows for larger print jobs, faster processing times, and the ability to handle more complex graphics. This article provides a step-by-step guide to building a 4-megabyte memory expansion board for your LaserJet IIP or III printer. The board is designed to be compatible with the existing memory architecture of these printers, allowing you to significantly increase their capacity without the need for a complete printer replacement. The project is suitable for hobbyists and those interested in customizing their equipment. Components are readily available, and the construction process is straightforward. The finished board will be a valuable addition to your printer's capabilities, enabling you to take full advantage of the advanced features offered by these high-quality devices.

**PAGE 55**

Here are a few tricks of the trade that may help you with your next TV repair.



### TV SERVICE CASE HISTORIES

**Cleo Zymarie**

Television repair is a complex task that often requires a combination of technical knowledge and practical experience. This section provides a collection of real-life case histories, offering valuable insights into common problems and their solutions. Each case is presented with a clear description of the issue, the diagnostic process, and the final repair. The cases cover a wide range of television models and components, including tuners, video heads, and power supplies. The author, Cleo Zymarie, is an experienced technician who shares his expertise to help readers troubleshoot their own TV problems. The cases are presented in a concise and easy-to-understand format, making them a useful resource for both novice and professional technicians. By studying these case histories, readers can learn from the experiences of others and improve their own skills in television servicing.

**PAGE 67**

## AND MORE

98 Advertising and Sales Offices

98 Advertising Index

12 Ask R-E

97 Free Information Card

14 Letters

89 Market Center

30 New Lit

22 New Products

8 What's News



## ON THE COVER



For those who already enjoy model rocketry—and for anyone who's thinking of trying it—our cover project offers a whole new dimension to the hobby. The Rocket Altimeter charts the flight path of rockets with an accuracy and ease unheard of with visual tracking methods. The device consists of an on-board flight recorder and an LCD module that's used to display the data back on the ground. The flight recorder takes four pressure samples during every second of flight time. When it's connected to the LCD module back on earth, it displays the rocket's peak altitude and gives a 1/4-speed playback of the entire flight. If you'd like to create your own small-scale space program, check out the Rocket Altimeter on page 37.

## COMING NEXT MONTH

### THE NOVEMBER ISSUE GOES ON SALE OCTOBER 2.

#### BUILD A SOLID-STATE LASER

Use the new visible-light laser diode to build a hand-held, battery-powered visible-light laser.

#### PHONE-CALL SCREENING SYSTEM

Build a system that puts an end to junk calls by requiring a special code.

#### BUILD A PORTABLE QUAD ANTENNA

Our 2-meter quad antenna is ideal for hill-top DX'ing.

#### AUDIO SWEEP/MARKER GENERATOR

Build this test gear designed for audio applications.

As a service to readers, RADIO-ELECTRONICS publishes available plans or information relating to newsworthy products, techniques and scientific and technological developments. Because of possible variances in the quality and condition of materials and workmanship used by readers, RADIO-ELECTRONICS disclaims any responsibility for the safe and proper functioning of reader-built projects based upon or from plans or information published in this magazine.

Since some of the equipment and circuitry described in RADIO-ELECTRONICS may relate to or be covered by U.S. patents, RADIO-ELECTRONICS disclaims any liability for the infringement of such patents by the making, using, or selling of any such equipment or circuitry, and suggests that anyone interested in such projects consult a patent attorney.

RADIO-ELECTRONICS, (ISSN 0033-7862) October 1990. Published monthly by Gernsback Publications, Inc., 500-B Bi-County Boulevard, Farmingdale, NY 11735 Second-Class Postage paid at Farmingdale, NY and additional mailing offices. Second-Class mail registration No. 9242 authorized at Toronto, Canada. One-year subscription rate U.S.A. and possessions \$17.97, Canada \$23.97, all other countries \$26.97. All subscription orders payable in U.S.A. funds only, via international postal money order or check drawn on a U.S.A. bank. Single copies \$2.50. © 1990 by Gernsback Publications, Inc. All rights reserved. Printed in U.S.A.

**POSTMASTER:** Please send address changes to RADIO-ELECTRONICS, Subscription Dept., Box 55115, Boulder, CO 80321-5115.

A stamped self-addressed envelope must accompany all submitted manuscripts and/or artwork or photographs if their return is desired should they be rejected. We disclaim any responsibility for the loss or damage of manuscripts and/or artwork or photographs while in our possession or otherwise.

## Radio Electronics®

Hugo Gernsback (1884-1967) founder  
M. Harvey Gernsback,  
editor-in-chief, emeritus

Larry Steckler, EHF, CET,  
editor-in-chief and publisher

#### EDITORIAL DEPARTMENT

Brian C. Fenton, editor  
Marc Spiwak, associate editor  
Daniel Goodman, technical editor  
Kim Dunleavy,  
assistant technical editor  
Teri Scaduto, assistant editor  
Jeffrey K. Holtzman  
computer editor  
Robert Grossblatt, circuits editor  
Larry Klein, audio editor  
David Lachenbruch  
contributing editor  
Don Lancaster  
contributing editor  
Richard D. Fitch  
contributing editor  
Kathy Campbell, editorial assistant

#### ART DEPARTMENT

Andre Duzant, art director  
Injae Lee, illustrator  
Russell C. Truelson, illustrator

#### PRODUCTION DEPARTMENT

Ruby M. Yee, production director  
Janice Box,  
editorial production  
Karen S. Tucker  
advertising production  
Marcella Amoroso  
production assistant

#### CIRCULATION DEPARTMENT

Jacqueline P. Cheeseboro  
circulation director  
Wendy Alanko  
circulation analyst  
Theresa Lombardo  
circulation assistant  
Michele Torriolo, reprint bookstore

Typography by Mates Graphics  
Cover photo by Diversified Photo  
Services

Radio-Electronics is indexed in  
*Applied Science & Technology Index*  
and *Readers Guide to Periodical Literature*.

Microfilm & Microfiche editions are  
available. Contact circulation department  
for details.

#### Advertising Sales Offices listed on page 98.

Radio-Electronics Executive and  
Administrative Offices:  
1-516-293-3000.  
Subscriber Customer Service:  
1-800-288-0652.  
Order Entry for New Subscribers:  
1-800-999-7139.

The  
Audit  
Bureau  
of Circulation





# 5 WAYS TO STOP WASTING TIME IN ELECTRONICS.

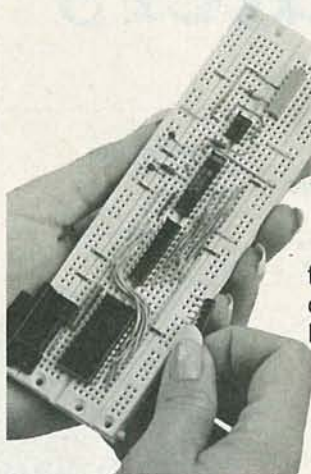

**Stop wasting your time soldering.** Save hours of soldering, desoldering, resoldering with Quick Test™ sockets and bus strips. Connect/disconnect resistors, capacitors, transistors, ICs, etc. as fast as you can push in/pull out leads. Interlock for limitless expandability. Priced as low as \$1.60, you'll wonder how you've done without them!

5-color coded binding posts and 17 sockets, for over 4,560 contact points. Lifetime guarantee. American-made. Affordably priced.



## 2. Stop wasting your time breadboarding.

Here are three popular PROTO BOARD® Brand solderless breadboarding systems that meet any budget or time schedule. First the diminutive PB-10's 840 contact points and 3-color binding posts. PB-102 has 1,240 tie points, accepting up to 12 16-pin ICs. Finally, PB-103, with 2,250 contact points, and up to 24 16-pin capacity. They're affordable, American-made, lifetime guaranteed. You'll soon see why PROTO BOARD Brand is Today's Standard for Quality in Breadboarding.



## 3. Stop wasting your time jury-rigging

**large numbers of circuits.** Here are two oversized PROTO BOARDS Brand, with expanded area, tie points, and more to keep your ideas together. PB-104 features 3,060 tie points, which can handle to 32 16-pin ICs with ease. Four color coded binding posts, and roomy 9.2" x 8" metal panel make it big...but simple. The humungous PB-105 lets you load up to 48 16-pin ICs, and much more onto its

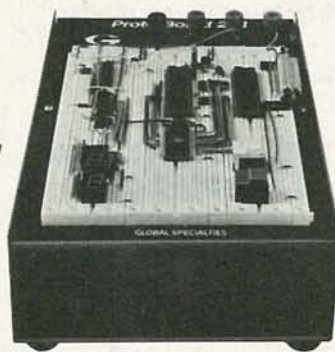

## 4. Stop wasting your time plugging-in external power.

We've added the power to the breadboard. And, what power! Up to triple voltage power, +5V, +12V, -12V, regulated/current limited and DC. Up to 2,250 tie points, with 24 IC capacity and 14 pin DIPs. Now you can create, test and modify TTL, CMOS, Op-Amps and even microprocessor circuits. Plus, there is the standard Global Lifetime Guarantee on the sockets. And, wait 'til you see the modest prices!

## 5. NEW!

**Stop wasting time designing computer circuits.** Now you can use your solderless breadboard concepts for designing accessory circuits. PROTOCARD® is a PROTO BOARD Brand which fits any standard slot in your IBM, PC/XT or PC/AT computer. Some modules even include built-in basic decoder circuits for memory and I/O addressing. Breadboard areas up to 3,360 contact points. Buffered versions eliminate loading of pc buses.

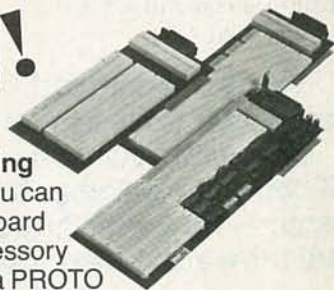

Call toll-free for details  
**1-800-572-1028**

  
**GLOBAL SPECIALTIES**

Global Specialties. An Interplex Electronics Company.  
70 Fulton Terrace. New Haven, CT 06512.  
Telephone: (203) 624-3103. © Interplex Electronics 1989.  
All Global Specialties breadboarding products made in USA.

*Easy does it!™*



# No other training—anywhere—shows you service computers

Only NRI walks you through the step-by-step assembly of a powerful AT-compatible computer system you keep—giving you the hands-on experience you need to work with, troubleshoot, and service all of today's most widely used computer systems. With NRI at-home training, you get everything you need to start a money-making career, even a computer service business of your own.

No doubt about it. The best way to learn to service computers is to actually *build* a state-of-the-art computer from the keyboard on up. As you put the machine together, performing key tests and demonstrations at each stage of assembly, you see for yourself how each part of it works, what can go wrong, and how you can fix it.

Only NRI, the leader in career-building electronics training for more than 75 years, gives you such practical, real-world computer servicing experience. Indeed, no other training—in school, on the job, *anywhere*—shows you how to troubleshoot and service computers like NRI.

**You get in-demand computer skills as you train with your own AT-compatible computer system—now with 20 meg hard drive and 1 meg RAM**

With NRI's exclusive hands-on training, you actually build and keep the powerful new AT-compatible West Coast 1010 ES computer, complete with 1 meg RAM and 20 meg hard disk drive.

You start by assembling and testing the "intelligent" keyboard, move on to test the circuitry on the main logic board, install the power supply and 5-1/4" floppy disk drive,

**NEW!**  
Now includes AT-compatible computer with 1 meg RAM and 20 meg hard drive!

then interface your high-resolution monitor. But that's not all.

**Only NRI gives you a top-rated micro with complete training built into the assembly process**

Your NRI hands-on training continues as you install the powerful 20 megabyte hard disk drive—today's most-wanted computer peripheral—included in your course to dramatically increase your computer's data storage capacity while giving you lightning-quick data access.

Having fully assembled your West Coast 1010 ES, you take it through a complete series of diagnostic tests, mastering professional computer servicing techniques as you take command of the full power of your computer's high-speed 80286 microprocessor.

In no time at all, you have the confidence and the know-how to work with, troubleshoot, and service every computer on the market today. Indeed, you have what it takes to step into a full-time,

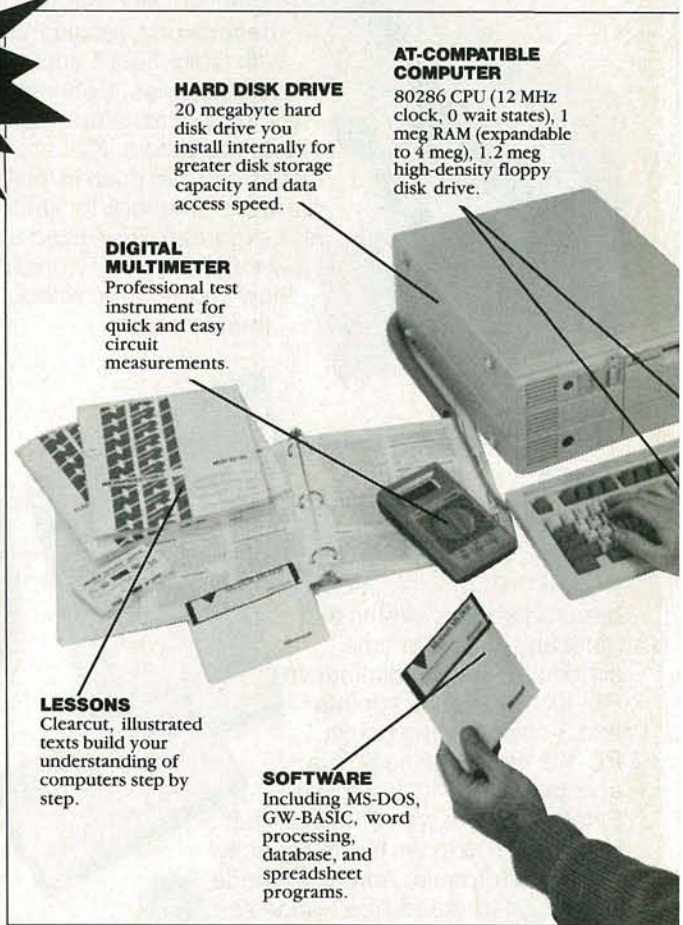

**HARD DISK DRIVE**  
20 megabyte hard disk drive you install internally for greater disk storage capacity and data access speed.

**AT-COMPATIBLE COMPUTER**  
80286 CPU (12 MHz clock, 0 wait states), 1 meg RAM (expandable to 4 meg), 1.2 meg high-density floppy disk drive.

**DIGITAL MULTIMETER**  
Professional test instrument for quick and easy circuit measurements.

**LESSONS**  
Clearcut, illustrated texts build your understanding of computers step by step.

**SOFTWARE**  
Including MS-DOS, GW-BASIC, word processing, database, and spreadsheet programs.

money-making career as an industry technician, even start a computer service business of your own.

**Voice synthesis training adds an exciting new dimension to your computer skills**

Now NRI even includes innovative hands-on training in voice synthesis, one of today's most exciting and widely applied new developments in computer technology.

You now train with and keep a full-featured 8-bit D/A converter that attaches in-line with your computer's parallel printer port.

**NEW!**



# in school, on the job, how to troubleshoot and like NRI

## MONITOR

High-resolution, nonglare, 12" TTL monochrome monitor with tilt and swivel base.

## TECHNICAL MANUALS

You get "inside" your Packard Bell computer system with exclusive NRI Training Kit Manuals plus technical specs direct from the manufacturer.

## DISCOVERY LAB

Complete breadboarding system to let you design and modify circuits, diagnose and repair faults.

## DIGITAL LOGIC PROBE

Gives you first-hand experience analyzing digital circuit operation.

one more way NRI gives you the confidence-building experience you need to feel at home with the latest advances in computer technology.

## No experience needed, NRI builds it in

You need no previous experience in computers or electronics to succeed with NRI. You start with the basics, following easy-to-read instructions and diagrams, moving step by step from the fundamentals of electronics to sophisticated computer servicing techniques.

With NRI's unique Discovery Learning Method, you're sure to get the kind of practical hands-on experience that will make you fully prepared to take

advantage of every opportunity in today's top-growth field of computer service.

With NRI, you learn at your own pace in your own home. No classroom pressures, no night school, no need to quit your present job until you're ready to make your move. And all throughout your training, you have the full support of your personal NRI instructor and the NRI technical staff.

## Your FREE NRI catalog tells more

Send today for your free full-color catalog describing every aspect of NRI's innovative computer training, as well as hands-on training in robotics, video/audio servicing, telecommunications, electronic music technology, and other growing high-tech career fields.

If the coupon is missing, write to NRI School of Electronics, McGraw-Hill Continuing Education Center, 4401 Connecticut Avenue, NW, Washington, DC 20008.

AT is a registered trademark of International Business Machines Corporation

Using your D/A converter along with the exclusive text-to-speech software also included, you explore the fascinating technology behind both digitized and synthesized computer speech.

You discover how you can use your computer to access and play back a variety of prerecorded sounds . . . you see how to add speech and sound effects to programs written in BASIC, C, Pascal, and others . . . you even learn how to produce high-quality speech directly from your own original printed text.

NRI's exclusive new hands-on training in voice synthesis is just

## NRI School of Electronics

McGraw-Hill Continuing Education Center  
4401 Connecticut Avenue, NW  
Washington, DC 20008



For career courses approved under GI Bill

check for details

### CHECK ONE FREE CATALOG ONLY

- Computers and Microprocessors
- Robotics
- TV/Video/Audio Servicing
- Computer Programming

- Security Electronics
- Electronic Music Technology
- Basic Electronics
- Telecommunications

Name \_\_\_\_\_ (Please Print) \_\_\_\_\_ Age \_\_\_\_\_

Address \_\_\_\_\_

City/State/Zip \_\_\_\_\_ Accredited Member, National Home Study Council 3-100



# WHAT'S NEWS

*A review of the latest happenings in electronics.*

## Progress in handwriting recognition

IBM researchers in Yorktown Heights, NY, have reported the first accurate, real-time computer recognition of run-on, hand-printed characters—even those that run together, touch, or overlap. Previous handwriting-recognition systems could recognize only hand-printed characters that were spatially separated or confined to boxed areas.

The research effort, centered on the experimental IBM computer system called the Paperlike Interface, has as its ultimate goal computer recognition of natural, cursive writing. The recognition of run-on characters is considered a significant step toward that goal.

With the Paperlike Interface, a user "writes" with a stylus on a transparent digitizing tablet that is placed over a flat LCD. The tablet has a layer that allows the computer to sense the position of the stylus on the paper. The path of the stylus appears as "electronic ink" on the flat display directly below it.

In the traditional, "segment-then-recognize" approach, a group of strokes—a stroke is the stylus motion from the point where it first touches the tablet until it is lifted—is held in the computer's memory until the group forms a discrete character that the computer can recognize. In the IBM approach, called "recognize-then-segment," character samples are broken down into stroke templates that the computer can recognize. Written strokes are matched against the stroke templates and labeled to describe the possible character parts they might represent, and sequences of labels are examined to see if they correspond to the components of particular characters.

There are several advantages to the "recognize-then-segment" approach. Because a single template can represent a stroke common to several letters, the number of template-matching steps can be significantly smaller. In addition, the recognition process can begin as

BOXED DISCRETE CHARACTERS

Spaced Discrete Characters

Run-on discretely written characters

Cursive script writing

**IBM'S PAPERLIKE INTERFACE** computer system can recognize run-on characters, compared to existing handwriting recognition systems which are limited to boxed or spaced discrete characters. IBM hopes eventually to achieve real-time computer recognition of cursive script writing.

soon as a stroke is complete, rather than waiting for the completion of a character. Stroke labeling also allows built-in constraint functions—dictionaries, for example—so that irrelevant characters or words can be pruned at early stages of the recognition process. Finally, with stroke matching it is possible for the system to adapt to a particular writer, through an optional training process involving customized templates.

In addition to hand-printed letters,

the recognizable writing could include hand-drawn "gestures" such as lines, proofreader's marks, mathematical symbols, and musical notes. Gestures could be used as computer commands, and the stylus could be used to perform mouse-like functions. It is possible that handwriting and gesture analysis could become as popular as the use of keyboards and mice, providing a more natural and convenient way to use and control computers. **R-E**

## Consumer electronics trials



**CHRIS OSTERLOH (LEFT) AND CHARLES (TOMMY) WOOD (RIGHT) WON THEIR SEMIFINAL ROUNDS** in the consumer-electronics trials held in Washington, DC during a three-day competition hosted by the Electronic Industries Association (EIA) and the Vocational Industrial Clubs of America (VICA). Competitors were required to assemble a stereo receiver, take a written theory exam, and troubleshoot 15 different pieces of consumer-electronic equipment. The 19-year-old semifinalists started the year-long industry training programs in June—Osterloh with Matsushita and Wood with Sony—and will receive additional training from EIA instructors. One of the two will be selected in May, 1991 to represent the United States in the International Youth Skill Olympics in Amsterdam next summer.



# Radio Shack Parts Place <sup>SM</sup>

## YOUR SOURCE FOR PROJECT AND REPAIR ELECTRONICS Try Our Special-Order "Hotline" Battery Special-Order Service



### ICs, Crystals, Tubes, Much More

Your Radio Shack store manager can special-order a wide variety of parts and accessories from our main warehouse. Over 200,000 items are available including vacuum tubes, ICs, microprocessors, phono cartridges and styli, crystals for scanners and computers, even SAMS Photofacts® manuals. Best of all, there are no handling charges or minimum order requirements. Your order is sent directly to the Radio Shack near you and we notify you when it arrives. Delivery time for most items is about a week.



### Hundreds of Types Available

In addition to our large in-store stock, Radio Shack can now supply almost any currently manufactured consumer-type battery—for cordless phones, computer memory, camcorders, walkie-talkies, pagers and more. Batteries are sent from our main warehouse to the Radio Shack near you. We notify you when they arrive and there's no postage or handling charge.

### Infrared Module

#### Complete, Easy-to-Use IR Detector



Heart of a remote-control project! Combines detector, limiter, band-pass, demod, integrator and comparator in a compact 3-lead module. #276-137 ..... 3.49

### Neater Wiring

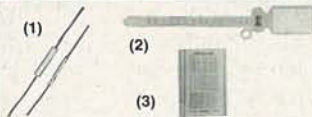

- (1) Heat-Shrink Tubing. 1/16 to 1/2" sizes. #278-1627 ..... Pkg. of 7/1.79
- (2) Cable Tie/Markers. For cables up to 5/8" dia. #278-1648 ... Pkg. of 10/2.49
- (3) Wire Markers. 630 "peel and stick" characters. #278-1650 ..... Set/1.79

### Tantalum Caps

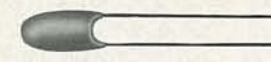

High capacitance in a tiny size.

µF	WVDC	Cat. No.	Each
0.1	35	272-1432	.59
0.47	35	272-1433	.59
1.0	35	272-1434	.59
2.2	35	272-1435	.69
10	16	272-1436	.79
22	16	272-1437	1.19

### "Snap" RFI Choke



Snap-Together Toroid Cores. Effective "roadblock" to radio-frequency interference. Just wind on AC, phone, computer, coax or audio cable, then snap choke together. #273-104 ..... Set of 2/7.95

### Resistance Items

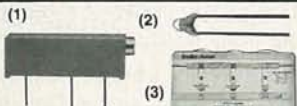

- (1) 15-Turn Trimmers. 1k, #271-342, 10k, #271-343, 20k, #271-340, Each 1.49
- (2) Precision Thermistor. Resistance changes in proportion to temperature. -50 to +110° C. #271-110 ..... 1.99
- (3) Color-Code Decoder. #271-1210 ..... 79c

### Shielded D-Sub Hoods

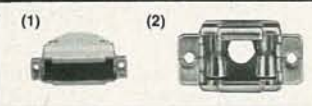

Fig.	Description	Cat. No.	Each
1	9-Position Metal	276-1508	2.19
...	25-Position Metal	276-1510	2.79
2	9-Pos. Metalized	276-1513	1.49
...	25-Pos. Metalized	276-1536	1.99

### "Ding-Dong" Chime

#### Great Entry Alserter



This IC and mini-speaker combo has a pleasant chime output and it's ideal for a customer-entry alert, doorbell or event indicator. Operates from 6 to 18 VDC. Produces 80 dB sound pressure at 12 VDC. 5" leads. #273-071 ..... 8.99

### Rod Antennas



For projects or replacing damaged antennas on cordless handsets and bases, walkie-talkies and radios. We have over a dozen styles in stock. For example:

Sections	Extended	Cat. No.	Each
5	13"	270-1407	2.79
6	17 3/4"	270-1409	2.59
4	34 3/4"	270-1402	3.79

### TNC and Mini-UHF Connectors



- (1) TNC Twist-On Male for RG-58 Cable. #278-140 ..... 1.99
- (2) TNC Double-Female. #278-142, 1.99
- (3) PL-259 Female. #278-118, 3.49
- (4) BNC Male. #278-145, 4.99
- (5) Mini-UHF Double-Female. Joins two male mini-UHFs. #278-172 ..... 2.49
- (6) Mini-UHF T Adapter. Female-male-female power divider. #278-173 ..... 3.99
- (7) UHF Adapter. Accepts PL-259. Fits female Mini-UHF. #278-174 ..... 3.99

### Solderless IDC-Type Connectors

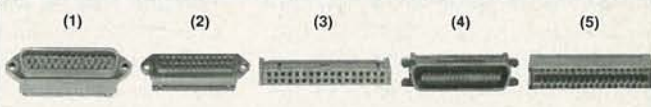
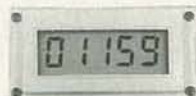

Fig.	Description	Cat. No.	Each
1	25-Position D-Sub Male	276-1559	3.99
2	25-Position D-Sub Female	276-1565	3.99
3	34-Position Header	276-1525	2.49
4	36-Position Male Printer Connector	276-1533	4.99
5	34-Position Card-Edge Connector	276-1564	1.99

### Electronic Counter Module



Prewired! Great for a traffic or event counter. Counts up to 99,999. Advanced (or reset) by external switch closure or digital circuit. Accepts count rate up to 7 Hz. Has 1/2" liquid crystal display. Requires "AA" battery. With data. #277-302 ..... 16.95

### Foldup Autoranging DVM



Select the function and this precision Micronta® meter sets the range. Has automatic power-off when shut, detented hinge for best viewing angle. Measures to 1000 VDC, 500 VAC, 10A AC/DC, 2 megohms resistance. Requires 2 "AA" batteries. #22-193 ..... 69.95

### Dual-Power Soldering Iron



Go from 15 to 30 watts with the flick of a switch. Has replaceable tip. 8 1/4" long. UL listed AC. #64-2055 ..... 9.49  
Replacement Tip. #64-2065 ..... 1.19  
Chisel Tip. #64-2056 ..... 1.19

Since 1921 Radio Shack has been the place to obtain up-to-date electronic parts as well as quality tools, test equipment and accessories. Today, with our big in-store selection and convenient special-order service, Radio Shack continues its tradition of supplying high-tech products at competitive prices. We're America's Technology Store with over 7000 locations—NOBODY COMPARES

Prices apply at participating Radio Shack stores and dealers. Radio Shack is a division of Tandy Corporation

CIRCLE 78 ON FREE INFORMATION CARD

**Radio Shack**  
AMERICA'S  
TECHNOLOGY  
STORE <sup>SM</sup>

OCTOBER 1990



# VIDEO NEWS

What's new in the fast-changing video industry.

DAVID LACHENBRUCH

## • Instant VCR programming.

Several proposals to make programming a VCR "as simple as pushing a button" have cropped up recently—and at least two are close to reaching the public. Widespread attention—including a reference by President Bush and jokes by stand-up comics—has been focused on the difficulty of programming VCR's. Is help finally on the way? Three systems are described below.

**VCR Plus.** Several major newspapers and magazines, including *The New York Times*, the *Los Angeles Times*, the *San Francisco Chronicle*, and some editions of *TV Guide* will soon begin programming their readers' VCR's for them. That will be done by printing special six- or seven-digit code numbers along with the program listings. Viewers can punch those codes into a wireless remote gadget that will automatically set up VCR's and cable boxes to record the programs.

The \$59.95 gadget, VCR Plus, which is being marketed in selected areas by Gemstar Development Corp., Monterey Park, CA, contains a 14-event timer that substitutes for the VCR's timer. The numerical code printed in the TV program listing contains all the information needed to set up the VCR (and cable box, if any) to record the specific program. The device operates both VCR's and cable boxes, so it can be used to record cable programs on different channels (including premium channels) without any extra equipment. It can also "remember" cable channels. For example, if HBO is on cable Channel 33 on one system and Channel 11 on another, the same code number may be used for both systems. The key is in the initial setup of the home unit. It comes supplied with special numbers to correspond to the IR remote-control frequencies of various brands of VCR and cable boxes. Another part of the setup consists of informing VCR Plus of the channel numbers occupied by various cable networks. Thus the code numbers printed in the program listings automatically switch

the user's VCR or cable box to the proper channel. The system's proponents hope to go nationwide with VCR Plus next year.

**Instant Guide.** Gemstar's VCR Plus is just one approach to solving the VCR-programming problem. Something much more elaborate is in the wind. InSight Telecast of Palo Alto, CA, which is partly owned by the Japanese trading company Sumitomo, is cooperating with Public Broadcasting Service (PBS) on an on-screen program guide to be transmitted during the TV picture's vertical blanking interval. Using a VCR with a special adaptor, the viewer merely can select the program to record from the program listings without worrying about the time or channel. Pushing a button on the remote control automatically sets up the VCR to record the program.

The "Instant Guide" program service will be by subscription and will cost viewers about \$5 a month. VCR adaptors are expected to cost around \$100, but should be much less when built into a new VCR. The service is scheduled to start next year in the United States, with Sumitomo estimating that adaptors and adaptor-equipped decks will sell at the rate of one million per year.

**SuperGuide.** But Instant Guide also has some competition. Would you believe "SuperGuide?" The system, developed by a North Carolina company, was the subject of a paper at this year's International Conference on Consumer Electronics in Chicago. SuperGuide is described as "a low-cost, home-oriented, interactive, electronic, on-screen programming guide," designed to be "integrated with the TV tuner, remote control, and other devices." The TV set receives a broadcast database of "programming for only those services to which a viewer subscribes." The hardware is described as costing less than \$40. "Operation of the menus, as well as the Guide itself, requires six buttons on the handheld remote: cursor keys up and down, page forward and page back keys, a

select key, and a return key ... SuperGuide takes a show you want to record and passes the information to a standard event timer in a VCR or satellite receiver." Eventually, the system's proponents say, "SuperGuide will be ready to make recording on your VCR truly as simple as finding the show you want to record and pressing a single button."

**• Widescreen VCR.** A VCR that will play both widescreen (16:9 aspect ratio) and pictures of standard (4:3) TV proportions is under development by the VHS group. It already has been demonstrated in Europe by Thomson Consumer Electronics. In its normal mode, the VCR records conventional TV pictures. In the widescreen mode, tapes of 16:9 pictures are stored on the tape in horizontally squeezed form. A special signal on the sync track will automatically adjust future TV sets to display a "letterbox" picture, or on future widescreen sets the picture will fill the screen automatically. Letterbox pictures may be accommodated by many conventional sets without the automatic-adjustment facility by manual adjustment of the height control to obtain the proper picture proportion. TV sets that come equipped with widescreen picture tubes are expected to be on the European market some time this fall.

**• Dual-deck VCR's.** Go-Video, which filed lawsuits against several Japanese manufacturers, claiming that they refused to make double-deck VCR's for it, is finally marketing its two-slot VCR. The unit, made for Go-Video by Samsung of Korea, will copy tapes (except for those using Macrovision anti-copy encoding), play back one tape while another is being recorded, or record two tapes sequentially. The suggested list price is \$995. In Europe, Amstrad has announced its own similar unit, which it calls the "Double Decker," for about \$695, but says it has no plans to make one for sale in the American market.

R-E



# ELENCO & HITACHI PRODUCTS AT DISCOUNT PRICES

**NEW!** RSOs (Real-Time & Storage Oscilloscopes) From HITACHI **NEW!**  
The RSO - its the new solution  
View, Acquire, Test, Transfer and Document Your Waveform Data

**4-Channel, 100MS/s Model** **Introductory Price**  
100MS/s (25MS/s on 4 channels simultaneously), 100MHz, 4kw x 1ch., 2kw x 2ch., 1kw x 4ch. VC-6145 \$4,695.00

**Compact, Full Feature Models**  
40MS/s, 100MHz, 4kw x 1ch., 2kw x 2ch. VC-6045 \$3,049.00  
20MS/s, 50MHz, 2kw x 2ch. VC-6025 \$2,295.00

**Low Cost/High Value Models**  
20MS/s, 50MHz, 2kw x 2ch. VC-6024 \$2,049.00  
20MS/s, 20MHz, 2kw x 2ch. VC-6023 \$1,749.00

RSOs from Hitachi feature such functions as roll mode, averaging, save memory, smoothing, interpolation, pretriggering, cursor measurements, plotter interface, and RS-232C interface. With the comfort of analog and the power of digital.



V-422 40MHz Dual Trace \$795

**Hitachi Portable Scopes**  
**\$435** DC to 50MHz, 2-Channel, DC offset function, Alternate magnifier function  
V-525 CRT Readout, Cursor Meas. \$1,025  
V-523 Delayed Sweep \$995  
V-522 Basic Model \$895

## 20MHz Elenco Oscilloscope



**\$375**  
MO-1251  
• Dual Trace  
• Component Tester  
• 6" CRT  
• X-Y Operation  
• TV Sync  
• 2 p-1 Probes

## FREE DMM

with purchase of  
**ANY SCOPE**

## SCOPE PROBES

P-1 65MHz, 1x, 10x \$19.95  
P-2 100MHz, 1x, 10x \$23.95

## Compact Series Scopes



Delayed Sweep  
Lightweight (13lbs)  
2mV Sens  
3 Yr Warranty

Model V-1065  
Shown

This series provides many new functions such as CRT Readout, Cursor measurements (V-1085/1065/665), Frequency Ctr (V-1085), Sweeptime Autoranging and Trigger Lock using a 6-inch CRT. You don't feel the compactness in terms of performance and operation.

V-660 60MHz Dual Trace \$1,195  
V-665 60MHz Dual Trace w/Cursor \$1,345  
V-1060 100MHz Dual Trace \$1,425  
V-1065 100MHz Dual Trace w/Cursor \$1,695  
V-1085 100MHz Quad Trace w/Cursor \$2,045  
V-1100A 100MHz Quad Trace w/Cursor \$2,295  
V-1150 150MHz Quad Trace w/Cursor \$2,775

## Elenco 35MHz Dual Trace Good to 50MHz

**\$495**

MO-1252



- High luminance 6" CRT
- 1mV Sensitivity
- 6KV Acceleration Voltage
- 10ns Rise Time
- X-Y Operation + Z Axis
- Delayed Triggering Sweep
- Includes 2 P-1 Probes

All scopes include probes, schematics, operators manual, and 3 year (2 yrs for Elenco scopes) world wide warranty on parts & labor. Many accessories available for all Hitachi scopes. Call or write for complete specifications on these and many other fine oscilloscopes.

**WE NOW CARRY COMPLETE LINE OF FLUKE MULTIMETERS Models**

- 21F 83
- 23F 85
- 25F 87
- 27F 8050A
- 73 8060A
- 75 8062A
- 77F + More

**CALL FOR SPECIAL PRICING**

**True RMS 4 1/2 Digit Multimeter M-7000**  
**\$135**  
.05% DC Accuracy  
.1% Resistance with Freq. Counter and deluxe case

**10 Function Multimeter CM-365**  
**\$65**  
AC + DC Voltage & Amps Resistance to 2000MΩ Diode, Logic, & Trans test Capacitance to 200uF

**Digital Capacitance Meter CM-1550**  
**\$58.95**  
9 Ranges  
.1pf-20,000ufd  
.5% basic acy  
Zero control with case

**Digital LCR Meter LC-1801**  
**\$125**  
Measures:  
Coils 1uH-200H  
Caps .1pf-200uf  
Res .01-20M

**Function Generator Blox #9600**  
**\$28.95**  
Provides sine, triangle, square wave from 1Hz to 1MHz AM or FM capability

**Triple Power Supply XP-620**  
**Assembled \$65 Kit \$45**  
2 to 15V at 1A,  
-2 to -15V at 1A (or 4 to 30V at 1A) and 5V at 3A  
Contains all the desired features for doing experiments. Features short circuit protection, all supplies.

**Wide Band Signal Generators SG-9000**  
**\$129**  
RF Freq 100K-450MHz  
AM Modulation of 1KHz  
Variable RF output  
SG-9500 w Digital Display and 150MHz built-in Counter \$249

**AC Current Meter ST-1010**  
**\$69.95**  
1000 Amps  
Data & Peak hold  
8 Functions  
Deluxe Case

**Decade Blox #9610 or #9620**  
**\$18.95**  
#9610 Resistor Blox  
47 ohm to 1M & 100K pot  
#9620 Capacitor Blox  
47pf to 10MFD

**Quad Power Supply XP-580**  
**\$59.95**  
2-20V at 2A  
12V at 1A  
5V at 3A  
-5V at .5A  
Fully regulated and short circuit protected  
XP-575 without meters \$39.95

**LEARN TO BUILD AND PROGRAM COMPUTERS WITH THIS KIT!**  
INCLUDES: All Parts, Assembly and Lesson Manual  
**Model MM-8000**  
**\$129.00**

**Digital Triple Power Supply XP-765**  
**\$249**  
0-20V at 1A  
0-20V at 1A  
5V at 5A  
Fully regulated, Short circuit protected with 2 limit control, 3 separate supplies  
XP-660 with Analog Meters \$175

**GF-8016 Function Generator with Freq. Counter**  
**\$249**  
Sine, Square, Triangle Pulse, Ramp, .2 to 2MHz  
Freq Counter .1 - 10MHz  
GF-8015 without Freq. Meter \$179

Starting from scratch you build a complete system. Our Micro-Master trainer teaches you to write into RAMs, ROMs and run a 8085 microprocessor, which uses similar machine language as IBM PC. You will write the initial instructions to tell the 8085 processor to get started and store these instructions in permanent memory in a 2816 EPROM. Teaches you all about input and output ports, computer timers. Build your own keyboard and learn how to scan keyboard and display. No previous computer knowledge required. Simple easy to understand instruction teaches you to write in machine language.  
**ROBOTICS KIT FOR ABOVE (MM-8010) \$71.95**

**WE WILL NOT BE UNDERSOLD!**  
UPS Shipping: 48 States 5% (\$10 Max) IL Res., 7% Tax

**C & S SALES INC.**  
1245 Rosewood, Deerfield, IL 60015  
(800) 292-7711 (708) 541-0710

**15 Day Money Back Guarantee**  
**2 Year Warranty** Prices subject to change  
**WRITE FOR FREE CATALOG**

CIRCLE 109 ON FREE INFORMATION CARD



# ASK R-E

Write to Ask R-E, Radio-Electronics, 500-B Bi-County Blvd., Farmingdale, NY 11735

## EGA TO CGA CONVERSION

**I'm trying to build a circuit that would slow down the sync of EGA video to CGA speed. The reason I want to do this is so I can use a cheaper composite monitor or RF modulator/TV combination. I have a circuit that will allow me to convert an RGB signal into composite video but it doesn't work when I try it with an EGA signal. Would I be on the right track if I used the 5321 Video Sync Generator IC or some kind of video buffer? Any help would be appreciated.—J. Ayala, Fort Lee, NJ**

Whenever someone upgrades their computer from CGA to EGA or VGA, they're faced with the same problem and, so it would appear, the same thoughts cross their minds. Since they already have a CGA monitor, there must be something that can be done to convert it for use with EGA or VGA.

While it's certainly not impossible, converting a CGA monitor for use with a higher video standard is far from being a trivial task. You're correct in assuming that the sync rates are very different for the two video standards, but this difference is a lot more than a simple obstacle.

The chart in Fig. 1 lists the scan rates for several popular IBM video standards. As you can see, the CGA horizontal sync rate is a rather familiar number—15.75 kHz. This is exactly the same as NTSC video so it's possible to use a standard NTSC monitor along with the computer. Things are quite different when you switch to EGA or VGA and there's more involved than just worrying about the horizontal sync signal.

Since your EGA card is putting out video with a horizontal sync rate of 21.8 kHz, it's about 38% higher than the rate for which the NTSC-compatible CGA monitor was designed. If you were absolutely determined to use the CGA monitor for EGA, there are three approaches you could take. We'll look at them in the order of decreasing complexity.

Assuming that there's nothing you can do to your EGA card to make it work with a CGA monitor (some cards can be configured that way), the first way to solve the problem would be the one you're trying to take—convert the EGA signal to something compatible with CGA. Even though it is possible, it's going to be a lot of work, and the resulting image will probably be terrible.

Your first step would be to build an NTSC sync generator (using a chip like the 5321 or discrete components), and then you'd have to design a circuit that would detect the horizontal sync on the EGA signal and gen lock it to the sync from the NTSC generator. You'd need a phase locked loop to keep both of the signals in phase. Of course you have to strip the sync from the EGA signal as well.

The stuff I've described so far is a major undertaking in itself, and we're not even near the end. Since EGA video is being generated much faster than can be handled by a CGA monitor, you're going to need a bunch of memory to store the lines of EGA video until they can be sent out to the monitor at CGA speed. I haven't done the arithmetic but you'll need a lot of memory for the job. The good news is that there's probably enough time in the EGA vertical interval to finish sending out the stored video before the next frame begins. Since

both EGA and CGA operate at a vertical sync rate of 60 Hz, that's one less thing to worry about.

The second approach to the problem would be to look at the CGA monitor rather than the video being fed to it. If you're lucky enough to have the schematic of the monitor, it might be possible to increase the sweep speed of the flyback so the monitor's horizontal circuitry can lock to the EGA sync. Chances are you'll have to rebuild a good part of the monitor circuitry since the flyback transformer might not be able to handle the increased frequency. Even if you managed to overcome all this, you'll have to make sure that the persistence in the picture tube is up to EGA and that the dot pitch of the tube is at least 0.28 mm, since any larger pitch will create a really fuzzy image.

The third approach to the problem is to donate the CGA monitor to a worthy charity and spend the bucks for an EGA monitor. That's the quickest, easiest, and probably least costly way to solve the problem (depending on how you value your time and eyesight).

What you'd like to do isn't impossible, but the chances of getting a resulting image that's worth the time and money that it takes to work through all the design problems is about the same as finding intelligent life on Pluto.

## A NOISY SOLUTION

**Do you have a circuit for a simple analog noise generator? I'd like to use the output to generate random clocking edges for a circuit based around a 7474 flip-flop.—D. Gates, Wichita, KS**

Since you didn't specify the kind of noise you were looking for (pink or white), I'm guessing that it doesn't matter. And from what little you did mention about the application you have in mind indicates that all you're looking for is random-frequency sound.

There are two ways you can easily generate the random pulses you're

**IBM VIDEO STANDARDS**

VIDEO TYPE	ACRONYM	COLOR	SCAN RATE
MONOCHROME DISPLAY ADAPTER	MDA	B&W	18432 Hz
HERCULES GRAPHICS ADAPTER	HGA	B&W	18432 Hz
COLOR GRAPHICS ADAPTER	CGA	B	15750 Hz
ENHANCED GRAPHICS ADAPTER	EGA	16	21800 Hz
PROF. GRAPHICS ADAPTER	PGC	256	30480 Hz
VIDEO GRAPHICS ARRAY	VGA	256	31500 Hz



looking for. The first is to use a MM5837N noise generator chip, and the second is to use the old trick of reverse biasing any small-signal transistor. Neither of those methods will produce true analog signals but, since you're feeding them to a digital circuit, you're probably better off with square waves anyway.

Both methods are shown in Fig. 2. The component values aren't very critical and, as long as you stay within ten percent or so of the values shown, you won't have any problems with either circuit. The circuits are both self-starting and will produce the kind of random pulses you're looking for, but you'll more than likely need some buffering circuitry between them and the flip-flop.

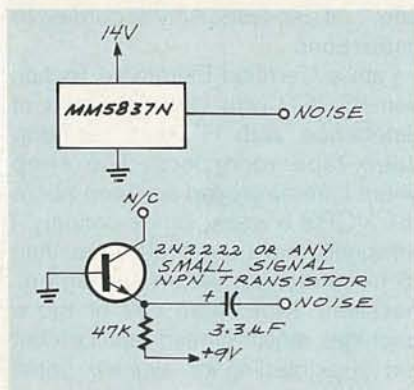

#### SURROUND SOUND VCR

**I recently purchased an LXI TV from Sears with Dolby Surround Sound. Do I have to buy a VCR with Surround Sound to get the most out of my TV, or will a regular stereo VCR decode the Surround signals from my pre-recorded tapes? Also, is anyone manufacturing VCR's that include Dolby Surround Sound?—George Foster, Detroit, MI**

In answer to your first question, the Surround signals are encoded in the standard left- and right-channel audio signals. As long as you are able to feed the left and right signals into a Surround-Sound decoder, the decoder will be able to do its job, regardless of where it is located. As for your second question, there are no Surround-Sound VCR's that I know of, but that doesn't mean that they don't exist. And, considering Surround Sound's increasing popularity, I'm sure you'll see it incorporated into VCR's in the near future. **R-E**

## Extend Your Frequency Counter Range To 1.3GHz Without Extending Your Budget.

### FC130A Frequency Counter

- .01Hz to 1.3GHz Frequency Range
- 8-Digit LED Display

- Measures Frequency, Period and Rate per Minute (RPM)

- 10mV Sensitivity (Typical)



**\$595**

### Beckman Industrial™

An Affiliate of Emerson Electric Co.

For more information and the location of your nearest authorized Beckman Industrial dealer call 1-800-854-2708 (in California 1-800-227-9781). Instrumentation Products Division, 3883 Ruffin Road, San Diego, CA 92123-1898  
© 1989 Beckman Industrial Corporation. Specifications are subject to change without notice.

CIRCLE 183 ON FREE INFORMATION CARD

JN161-01-1090

## Cable TV Descrambler Article Parts

We stock the exact Parts for several articles published in Radio-Electronics magazine on building your own Cable TV Descrambler.

### February 1984 SB-3 Type

701 Parts Pkg.....\$19.00  
Includes all original parts.

702 PC Board.....7.95  
Original 3X4 etched, drilled and Silk-Screen pc board.

704 AC Adaptor.....7.95  
12 to 18 Volt DC @ 200ma.

701, 702 & 704.....29.00  
All three for special saving.

### February 1987 Tri-Mode

301 Parts Pkg.....29.00  
Includes all original parts.

302 PC Board.....7.95  
Original 5X8 etched, drilled and Silk-Screen pc board.

304 AC Adaptor.....7.95  
12 to 18 Volt DC @ 200ma.

301, 302 & 304.....39.00  
All three for special savings.

Tri-Mode Tutorial..7.95  
26 pages of in-depth info.

### May 1990 Universal

901 Parts Pkg.....\$49.00  
Includes all original parts.

902 PC Board.....9.95  
Original 4X7 etched, drilled and Silk-Screened pc board.

904 AC Adaptor.....8.95  
12 Volts AC @ 350ma.

901, 902 & 904.....59.00  
All three for special savings.

CD22402E.....12.95  
Video sync IC (IC-9)

### Snooper Stopper...\$39.00

Prevent Descrambler detection with snooper stopper/data blocker and protect your privacy. Includes free article on Cable Snooping.

### Macrovision Kit...\$29.00

Macrovision.....now you see it, now you don't with our macro-scrubber kit. Originally Published in Radio-Electronics.

### 58 Channel Cable TV Converter with infra-red remote .....\$69.95

Re-Manufactured Jerrold 400 with new remote. Channel 3 output. Compatible with all External Descramblers.

## CALL TOLL FREE 1-800-332-3557

Outside USA Call 1-508-699-6935

Visa, MasterCard and COD. Free Catalog.  
Add \$4.00 S&H, \$6.50 Outside USA.

VISA

MC

D & D Electronics, Inc. PO Box 3310, N. Attleboro, Ma. 02761

CIRCLE 201 ON FREE INFORMATION CARD



## Which symbol represents a variable inductor?

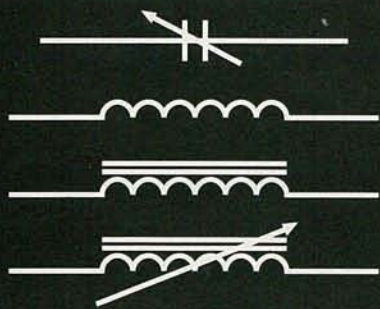

What is the principle disadvantage of neon lights?

What are out-of-phase signals?

## Heath Video Courses speed your learning curve!

Learn basic electronics at home at your own pace with four, 60-minute video tapes. Know the variable inductor symbol. Recognize a PN junction. Understand oscillator fundamentals. Clearly SEE what most basic electronic books can only describe.

**DC ELECTRONICS.** Covers electron movement to troubleshooting and repairing a simple electronic circuit. **EV-3101-A.**

**AC ELECTRONICS.** Follow-up to DC Electronics. Covers the principles of AC, voltage and electrical measurement. Includes motors, generators and test instrument meter movements. **EV-3102-A.**

**SEMICONDUCTORS.** Complete the DC/AC videos and you're ready to learn how semiconductor devices are made, plus the principles of discrete devices, integrated circuits & optoelectronic devices. **EV-3103-A.**

**ELECTRONIC CIRCUITS.** Complete the basic course with amplifier configurations, biasing, coupling, audio amplifiers, closed-loop vs. open-loop operation and more. **EV-3104-A.**

An activity-filled workbook and explanation of how to solve each problem comes with each tape so you learn three ways — video, workbook and hands-on!

Order today!  
Call Toll free,  
24-hours a day.  
1-800-253-0570.

We accept VISA,  
MasterCard, American  
Express and Heath Revolving  
Charge card. Use Order Code 601-023

# Heath®

Benton Harbor, MI

Call for a FREE catalog 1-800-44HEATH.

\*Price does not include shipping and handling, or applicable sales tax.

©1990, Heath Company  
Subsidiary of Bull Data Systems, Inc.

CIRCLE 86 ON FREE INFORMATION CARD

## LETTERS

Write to Letters, Radio-Electronics,  
500-B Bi-County Blvd., Farmingdale, NY 11735

### BELLS A'RINGING

I had the same problem as the author of "Ring My Phone" (*Ask R-E*, **Radio-Electronics**, July 1990), due to the old-style phones with bell ringers. The newer phones with electronic ringers use very little current.

At first, I shut off the ringers, or disconnected some of them. I found that Motorola made an excellent "Telephone Tone Ringer," so I decided to either make one for each phone or run another phone line and place it in a central location so that it could be heard throughout the house. I turned off all of my old phones and I disconnected one wire to the ringer. I ran the ringer line down to the front doorbell box and installed my electronic ringer in it. If you want you can run another line to the garage workshop and another to the back patio. My phone rings loud enough now to be heard all over the house.

Motorola has an excellent book entitled "Telecommunications Device Data" (#DL136, Rev. 1). See pages 2-201 and 2-241. Everything is in the IC and outside requires 3 resistors, four capacitors, and one piezo sound element. The cost is only about \$4.80.

Figure 1 shows a complete telephone-bell replacement circuit with minimum external components, on-chip diode bridge and transient protection, direct drive for piezoelectric transducers. It rejects rotary dial transients and has an input impedance signature that meets Bell and EIA standards.

Three versions of MC34012 (-1, -2, and -3) are available. Motorola's other options are the MC34017-1, MC34017-2, and MC34017-3.

I hope that will be of interest to everyone. That's a much simpler circuit than the one in *Ask R-E*.

LLOYD F. THOMAS  
Oxnard, CA

### SERVICING VCR'S

After reading Larry Klein's *Audio Update* in the July issue of **Radio-Electronics**, I was very disturbed that he would extrapolate his unique experience with head cleaners in his older VCR to recommend them as safe "... if used precisely according to instructions ..."

I am a Certified Electronic Technician (ISCET) with over 20 years of experience, with 11 years servicing video tape recorders. The shop where I am employed services about 250 VCR's a week. Since January, I personally have removed more than 25 head cleaners from customers' machines. More than half of those machines required head replacement and straightening or aligning some part of the transport or basket assembly. *Not one* of the machines was over five years old.

To refute some of Mr. Klein's statements: Our shop is not "Factory Authorized" anything. The price we charge for a cleaning is \$9.95. For a complete mechanical overhaul—replace belts, clutched idler, resurface pinch roller, and complete lubrications—we charge \$79.95. That comes with a one-year warranty, which is void if a head cleaner is used.

Based on Mr. Klein's recommendations on protecting the cassettes, I assume he also covers his VCR and lives in a sterile, dust-free environment. I am sorry to say that the majority of VCR's passing through our

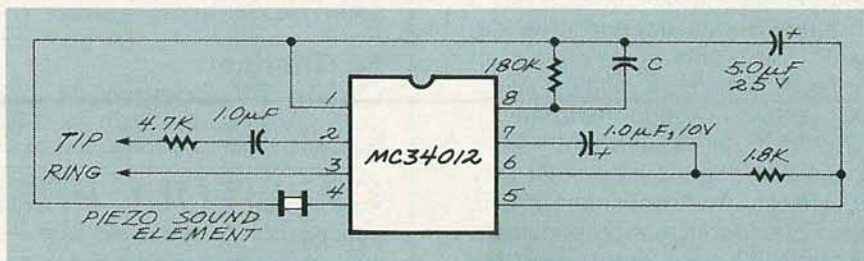

Fig. 1.



shop are so full of dust, fur, and assorted debris that we wear face masks to clean them.

To generalize from my experience, if your VCR weighs over 40 pounds and is more than six years old, you can probably follow Mr. Klein's advice without endangering more than the video heads. Those machines were very tough and could withstand abuse.

My own advice is to buy the very best high-grade tape, and, if the head clogs from a rented movie or cheap tape, put the new tape in and record for 15 minutes. The chemicals the tape manufacturer puts on the tape do a good job of cleaning.

JO ANNE ABBOT, CET  
Portland, OR

Is Ms. Abbott implying that head-cleaner cassettes tend to jam in machines? That doesn't seem to happen in my neck of the woods. (Of course, cassettes of any type will sometimes jam.) Perhaps things are cheaper in Oregon than New York, but the cheapest price I've found a head-cleaning locally is \$35.00. The complete overhaul sounds like a great deal—it would cost a fortune in New York. I don't cover my VCR or live in a "sterile, dust-free environment and my consultants don't think that the new machines are more fragile than the old, although they are lighter. The cleaning method Ms. Abbott recommends is news to me.—Larry Klein, Audio Editor

### INGENUITY PAYS OFF

I have a Sabtronics multimeter similar to the one illustrated in the "Capacitance Adapter" article in the April issue of **Radio-Electronics**. A couple of years ago the high-current range indicated a malfunction while the meter was monitoring a battery-charging circuit that was supplying less than 4 amps. The 0.1-ohm power resistor was open.

I couldn't find a resistor of that value and tolerance, so the high-current range was useless. Then, recently, I stumbled onto a somewhat unlikely remedy—wind a coil! I'd like to pass the procedure along for any other readers who might encounter the same problem.

A few days ago, when I was checking an AWG table, I noticed that #18 wire has a resistance of one ohm-per 156 feet. It occurred to me that about 15.6 feet of #18 wire would give me

## More Features Give This 100MHz Counter Universal Appeal At \$339.

### UC10A Universal Counter

- 5Hz to 100MHz Frequency Range
- 8-Digit LED Display
- Measures Frequency, Period, Frequency Ratio, Time Interval and Unit Count
- 4 Selectable Gate Times

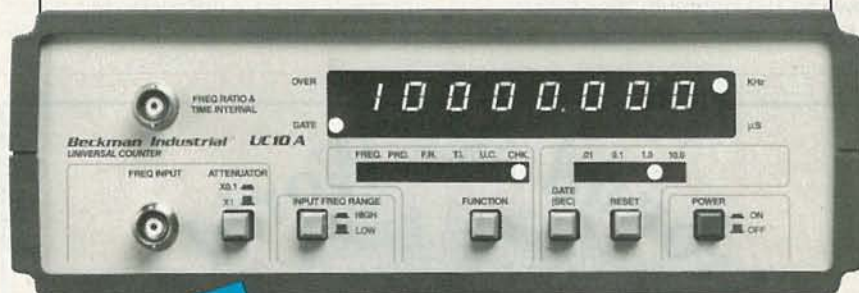

**\$339**

### Beckman Industrial™

An Affiliate of Emerson Electric Co.

For more information and the location of your nearest authorized Beckman Industrial dealer call 1-800-854-2708 (in California 1-800-227-9781). Instrumentation Products Division, 3883 Ruffin Road, San Diego, CA 92123-1898

© 1989 Beckman Industrial Corporation.

Specifications are subject to change without notice.

CIRCLE 184 ON FREE INFORMATION CARD

JN162-01-1090

## Be an FCC LICENSED ELECTRONIC TECHNICIAN!



No costly school. No commuting to class. The Original Home-Study course prepares you for the "FCC Commercial Radio-telephone License." This valuable license is your professional "ticket" to thousands of exciting jobs in Communications, Radio-TV, Microwave, Maritime, Radar, Avionics and more...even start your own business! You don't need a college degree to qualify, but you do need an FCC License.

**No Need to Quit Your Job or Go To School**  
This proven course is easy, fast and low cost! **GUARANTEED PASS**—You get your FCC License or money refunded. **Send for FREE facts now. MAIL COUPON TODAY!**

### COMMAND PRODUCTIONS

FCC LICENSE TRAINING, Dept. 90  
P.O. Box 2824, San Francisco, CA 94126  
Please rush FREE details immediately!

NAME \_\_\_\_\_  
ADDRESS \_\_\_\_\_  
CITY \_\_\_\_\_ STATE \_\_\_\_\_ ZIP \_\_\_\_\_

## YEAR AFTER YEAR

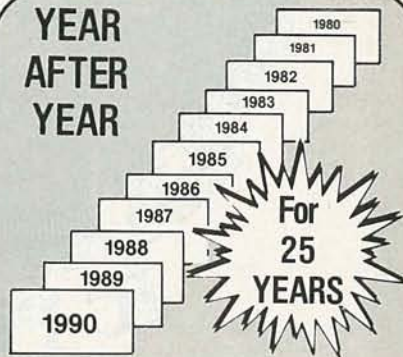

We've Become  
Better For You with

- MODERN FACILITIES
- LOW PRICES
- HIGH QUALITY
- PROMPT SERVICE

For Telecommunications • Industry • Two-Way  
• Amateur-Marine • Microprocessor  
• Radio Control • Satellite

Let Us Solve  
Your Crystal Needs

"A CUT ABOVE THE REST"

## JAN CRYSTALS

P.O. Box 06017  
Ft. Myers, FL 33906  
(813) 936-2397



TOLL FREE 1-800-526-9825  
FAX ORDERS 1-813-936-3750

CIRCLE 104 ON FREE INFORMATION CARD

OCTOBER 1990

15











Put Professional Knowledge and a  
**COLLEGE DEGREE**  
 in your Technical Career through  
**HOME  
 STUDY**

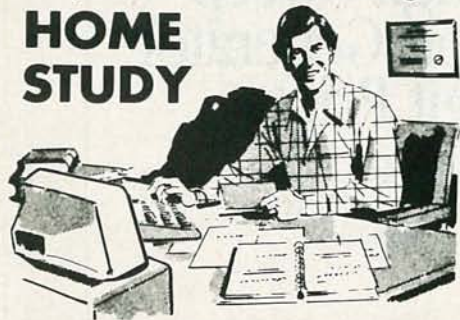

Add prestige and earning power to your technical career by earning your Associate or Bachelor degree through directed home study.

Grantham College of Engineering awards accredited degrees in **electronics and computers.**

An important part of being prepared to *move up* is holding the right college degree, and the absolutely necessary part is knowing your field. Grantham can help you both ways—to learn more and to earn your degree in the process.

Grantham offers two degree programs—one with major emphasis in **electronics**, the other with major emphasis in **computers**. Associate and bachelor degrees are awarded in each program, and both programs are available completely by correspondence.

No commuting to class. Study at your own pace, while continuing on your present job. Learn from easy-to-understand lessons, with help from your Grantham instructors when you need it.

Write for our free catalog (see address below), or phone us at toll-free 1-800-955-2527 (for catalog requests only) and ask for our "degree catalog."

Accredited by  
 the Accrediting Commission of the  
 National Home Study Council

**GRANTHAM**  
 College of Engineering  
 250 Frontage Road  
 Slidell, LA 70460

articles and continually sticking your necks out. Keep up the good work.  
 RAYMOND C. MINICH  
 Bradford, PA

**FREE CABLE TV**

I enjoy reading *Drawing Board* in **Radio-Electronics**, especially Robert Grossblatt's editorializing in the July issue. I agree that once the signal is inside your television set, you should be free to modify the TV for your own personal reasons in any manner you choose.

I also feel that signals should not be scrambled. Subscriptions to cable should be on a pay-one-price basis, similar to admission to amusement parks (unlimited rides for one price), subway fares (unlimited rides for one token), and the cost of a postage stamp (25 cents to send a letter across the country or across the street). After the cable enters your home, you should be responsible for running the cable to all of your cable-ready TV's. The responsibility of the cable company should end at an interface box on the side of your home, which would prevent a problem on your end from loading down the line.

Another gripe of mine is not knowing the channel allocations on my friends' cable systems. I propose that all channels be assigned a 3-digit identifier. For example, Showtime might be "347." Then, wherever I am, I could enter 347 in the cable box to receive Showtime. Cable boxes could even be configured to map channels in two modes—the current two-digit randomly assigned channel and a three-digit universal identifier—by pressing a selector button.  
 ROBERT ELBURN  
 Hicksville, NY

**DIGITAL DISPLAYS**

I have used the LCD display module mentioned in "Add a Digital Display to Your Project" in the June and July issues of **Radio-Electronics** in a Morse-code translator based on an 8085 microprocessor. I have found that, while it will respond to a 1-microsecond (minimum) write pulse on the E pin, it requires a minimum delay of 1 millisecond between data entries; that is, individual ASCII letter entries must be spaced 1-millisecond apart, even though they will write into the module with a 1-microsecond pulse on the E pin. The standard 6.144-MHz clock crystal was replaced to lengthen the T states.

Everything is done with software rather than hardware, as is done in other display devices. For example, if one wants to enter new data at the right of the display and push the old data off to the left, the shifting must be done by software addressing individual locations in the LCD. That gives flexibility, but with the limitation that the slow speed of the device is not compatible with normal Z80 or 8085 systems.

ADELBERT KELLEY  
 Tampa, FL

**THROWING CAUTION TO THE WIND**

In practically every article on using CMOS integrated circuits, repeated warnings are given on how to avoid static-charge damage and overheating. As a matter of fact, one is always advised to use sockets, rather than direct soldering.

Recently, I bought a kit to assemble a "Radalert" Geiger counter (**Radio-Electronics**, June 1988, updated June 1989). Presumably due to space limitations, the 16 IC's had to be soldered directly to the PC board,

**Use KLOCKIT's Quick-Mount Inserts To Complete Your Electronics Project**

Turn Projects Into Profit!  
**FREE 64-page 1990 Fall Catalog**

KLOCKIT is your best source for complementing electronic projects with hygrometers, thermometers, barometers and mini clock inserts. Our catalog features quartz clock movements and exclusive clock kits. Build a clock for yourself or to give as a gift! Call for large volume pricing.

Call toll-free: 1-800-KLOCKIT (that's 556-2548)

**KLOCKIT™**  
 P.O. Box 542, Dept. RE1090  
 Lake Geneva, WI 53147

CIRCLE 200 ON FREE INFORMATION CARD



with no sockets. The instructions outlined many items to avoid, especially overheating, and said to use a temperature-controlled iron (if not available, then a 25-watt iron) and to allow a short period of time between soldering the pins to prevent heat buildup.

In spite of all those warnings, I somehow managed to solder one IC in backward. That error was not discovered until all the chips, and most of the other components, were installed. Of course, I was dismayed to realize it.

There seemed to be three options: start over, with a new board and new components; remove the IC and buy a new one, or try to salvage the old one. It was obvious that to remove the chip, all 16 pins had to be unsoldered at the same time—impossible to do.

Since it was Sunday, I couldn't get any new parts, and waiting seemed intolerable, so I decided to throw caution to the wind. By jamming a small screwdriver under the offending IC, while using the soldering iron up and down over the rows of pins, I pried and jerked the thing out. It took about a half hour; all the pins were bent and one was broken about half way up. By that time, all the remaining pin holes were filled with solder, and I had to use a very small drill to remove it. I straightened the pins and put the chip back in, but I made sure that I did it properly this time.

Much to my amazement and relief, the IC worked beautifully. (It was the one that provides the pulse for the Radalert to measure the counts per minute.)

That experience leads me to believe that the extreme caution urged in handling IC's is overplayed and, quite often, unnecessary. There were also a few diodes that got in backwards, but they caused no particular problems. In the end, the project worked very well, and the Radalert is now measuring counts in 12-hour periods around the house to check the radon level.

J.F. BURTON

Downers Grove, IL

*It might have worked for you, but we'd hesitate to recommend your technique to others! By the way, haven't you heard of any of commonly-used solder removal techniques? They would have saved you a lot of grief.—Editor*

## At \$215 This Function Generator Makes More Waves.

### FG2A Function Generator

- 7 Frequency Ranges from 0.2Hz to 2MHz
- Sine, Square, Triangle, Ramp and TTL Pulse Output

### ■ Duty Cycle Control

- Voltage Controlled Frequency (VCF)

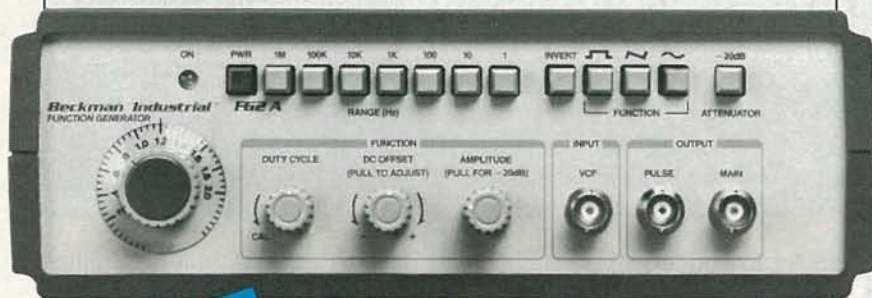

**\$215**

**Beckman Industrial™**

An Affiliate of Emerson Electric Co.

For more information and the location of your nearest authorized Beckman Industrial dealer call 1-800-854-2708 (in California 1-800-227-9781). Instrumentation Products Division, 3883 Ruffin Road, San Diego, CA 92123-1898  
© 1989 Beckman Industrial Corporation. Specifications are subject to change without notice.

CIRCLE 181 ON FREE INFORMATION CARD

JN163-01-1090

### Get A Complete Course In

## ELECTRONIC ENGINEERING

8 volumes, over 2000 pages, including all necessary math and physics. 29 examinations to help you gauge your personal progress. A truly great learning experience.

Prepare now to take advantage of the growing demand for people able to work at the engineering level.

Ask for our brochure giving complete details of content. Use your free information card number, or write us directly. **\$99.95**, Postage Included. Satisfaction guaranteed or money refunded.



**Banner Technical Books, Inc.**

1203 Grant Ave.  
Rockford, IL 61103

CIRCLE 67 ON FREE INFORMATION CARD

## SUPER LONG PLAY TAPE RECORDERS

12 Hour Model —  
USES D-120 TAPE

**\$119.00\***

Modified Panasonic Slimline, high quality AC-DC provide 6 continuous hours of quality recording & playback on each side of cassette for 12 hours total. Includes • Voice level control • Digital counter, etc. TDK D-120 Cassette Furnished.



### PHONE RECORDING ADAPTER

Records calls automatically. All Solid state connects to your telephone jack and tape recorder. Starts recording when phone is lifted. Stops when you hang up.

**\$28.50\***

FCC APPROVED

**VOX VOICE ACTIVATED CONTROL SWITCH**

Solid state. Self contained. Adjustable sensitivity. Voices or other sounds automatically activate and control recorder. Uses either recorder or remote mike.

**\$28.50\***

\*Add for ship & hdg. Phone Adapter & Vox \$1.50 ea. Recorders \$4.00 ea. Cal. Res. add tax. Mail order, VISA, M/C, COD's OK. Money Back Guarantee. Qty. disc. avail.. Dealer Inquiries invited, Free data.  
**AMC SALES INC.** Dept. A 9335 Lubec St.  
Downey, CA. 90241.  
Phone (213) 869-8519  
Box 928. Downey, CA. 90241.  
FAX (213) 923-1478

CIRCLE 108 ON FREE INFORMATION CARD

OCTOBER 1990

19



## Optoelectronics Handi-Counter UTC3000

*A 10 Hz–2.4 GHz universal counter that lives up to its name.*

CIRCLE 315 ON FREE INFORMATION CARD

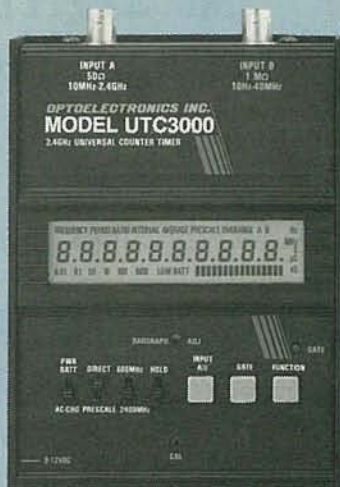

Thanks to surface-mount technology and MMIC's (monolithic microwave integrated circuits), handheld frequency counters are rapidly approaching the capabilities of benchtop models. A good illustration of that trend is the *UTC3000 Handi-Counter* from Optoelectronics, Inc. (5821 N.E. 14th Avenue, Fort Lauderdale, FL 33334).

The *UTC3000* is truly a handheld counter, measuring about  $5\frac{1}{2} \times 4 \times 1\frac{1}{2}$  inches. Even with its extruded-aluminum case and built-in Ni-Cd battery pack, the *Handi-Counter* weighs less than one pound. But don't let those statistics lead you to thinking that the counter is short on capabilities and features.

The *Handi-Counter* has two input

channels that provide a basic measurement range from 10 Hz to 2.4 GHz. One channel, input A, has an input impedance of 50 ohms, and can be used to measure signals from 10 MHz to 2.4 GHz. A whip antenna is perfect as a probe for input A, and is a good choice for RF measurements. The second channel, input B, has a high input-impedance (1 megohm, 30 pF) and can be used to measure signals from 10 Hz to 40 MHz.

The input sensitivity of the 50-ohm input is  $<1$  mV for signals with frequencies to 200 MHz, decreasing to  $<5$  mV to 2 GHz, and to  $<10$  mV to 2.4 GHz. Although outside the rated capabilities of the counter, the *Handi-Counter* can typically measure signals up to 3 GHz, but with reduced sensitivity.

The rated sensitivity for the high-impedance input B is  $<10$  mV to 20 MHz, and  $<20$  mV to 40 MHz. Typical maximum readings extend up to 80 MHz, again with reduced sensitivity.

The front panel of the counter features a 10-digit LCD readout. The display features a built-in 16-segment

## Analyx Powercard PC-controlled Power Supply

*Transform your PC into a triple-output programmable power supply.*

CIRCLE 316 ON FREE INFORMATION CARD

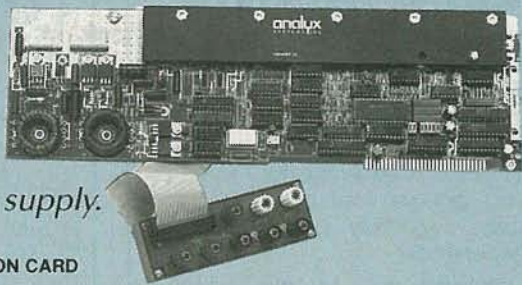

Although the IEEE-488 or General-Purpose Interface Bus (GPIB) is in no danger of becoming obsolete, test equipment controlled by the PC bus is becoming increasingly popular. That's great news for small test labs and even hobbyists who are looking for a lower-cost way to get automatic test and measurement capabilities. The latest example we've seen is the *Powercard* programmable power supply from Analyx, Inc. (P.O. Box 14644, Fremont, CA 94539).

The *Powercard* model *PPS-1606* is

an add-on board that turns any IBM PC or compatible computer into a triple-output programmable instrumentation power supply and multimeter. It features one 0–6-volt, 2-amp supply, and two  $-15.7$ – $+15.7$ -volt, 200-mA bipolar supplies. This "power supply on a board" is completely contained within the PC; voltages are brought out to the user by a 26-pin ribbon cable and, if desired, into a convenient terminal box with 5-way binding posts.

Installing the *Powercard* is easy. You simply plug the card into an emp-

ty slot in the PC, and connect it to the computer's power supply. (If you don't have any free power-supply cables, there's no need to worry—a set of "Y" adapters is included.) Then you plug one end of the ribbon cable into the rear of the card, and the other end to the terminal box. If the *Powercard* conflicts with any other installed card, its base address can be changed by moving a set of jumpers.

The *Powercard* is controlled by an easy-to-use, intuitive program. The voltage and current output of each power supply is indicated numerically and with a bar graph. Voltage and current settings and limits can be entered numerically or they can be incremented using the cursor keys. Power-supply settings can be saved in files, and readings can be logged automatically. Our only complaint about the software is a minor one: The selected field is sometimes difficult to find because it is made dim rather than being highlighted. In color, the selected field is much more obvious.



bargraph that indicates the relative strength of the input signal. That feature makes the counter ideal for relative field-strength measurements or even for locating hidden transmitters or bugs.

While the *Handi-Counter's* basic specifications are impressive, its additional features, including period-, time-interval-, and ratio-measurement modes, are what make it approach the capabilities of a bench-top unit.

The additional modes are selected by using a FUNCTION switch, which scrolls through the different options. When the power switch is turned on, the counter comes up in the frequency mode. Successive presses of the function switch will select period, interval, and ratio functions; the selected mode is indicated by LCD annunciators.

In the time-interval mode, the pulses that start and stop the timing must be applied to the A and B inputs respectively. In the ratio-measurement mode, the counter displays the ratio of the frequency of the signal at

the A input to that of the B input. Averaging modes for time-interval and period measurements can increase the resolution of the display. Averages of 10, 100, or 1000 measurements can be selected.

The *Handi-Counter* is supplied with a high-accuracy crystal timebase with a rated stability of 1 ppm (part-per-million). A TCXO (temperature-compensated crystal oscillator) timebase, with a rated accuracy of 0.2 ppm is available as an option.

With a base price of \$375, the *UTC3000* is a tough competitor that should come out a winner in most battles. The precision TCXO timebase will add \$80 to the counter's cost, and an extra Ni-Cd battery pack (that doubles the operation time to more than two hours) will cost an additional \$24. A custom-fit protective vinyl carrying case is available for \$15.

If you've been thinking of a benchtop counter, we encourage you to look at Optoelectronics' handheld that seems to offer the best of two worlds. **R-E**

While the software supplied with the *Powercard* is adequate for most purposes, complete instructions are provided for reading from and writing to on-board registers so that the board can be controlled by user-written software.

We found the *Powercard* to perform flawlessly and according to the manufacturer's specifications. We liked the fact that—because our computer is already on our test bench—the supply added virtually no clutter to our already-crowded work surface. We also liked that, unlike other computer-controlled supplies, the *Powercard* is self-contained. A separate host interface card (as is required for GPIB equipment) isn't necessary. And since it's directly controlled from the PC bus, it's fast

Of course, since the *Powercard* gets its power from the PC's supply, its output power is limited. And even though most PC's have plenty of excess power-supply capacity (the *Powercard* consumes a maximum of 30 watts), there is the possibility of overtaxing the computer's supply.

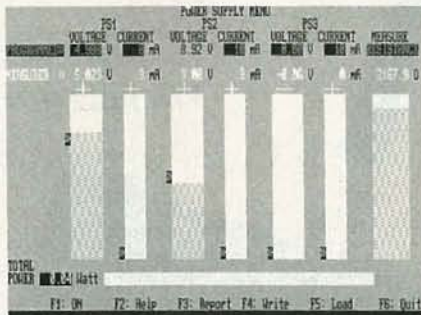

**THIS SAMPLE SCREEN DISPLAY** shows the settings of the three power supplies, and their readings as measured by the on-board 12-bit A/D converter. The multimeter section in this example is set to its resistance mode.

You don't have to be worried about system crashes, however; the software continuously monitors the PC's supply voltage and displays a warning if the voltage drops below 4.75 volts. The *Powercard* will automatically shut down if the PC's supply voltage drops below 4.6 volts.

Although it's sure to be copied, the *Powercard* is for the time being a one-of-a-kind instrument. It's priced at \$995. **R-E**

# Coax It Your Way.



Pomona's Universal Adapter Kit lets you make your own connections on the spot. You get two each of industry's most popular styles; BNC, TNC, SMA, plus "N" males and females. Plus, a special Double Banana Plug and Double Binding Post. And, four intermediate couplers to make it your way. **Kit No. 5698**



**A Case For Reliable Connections.** There's quality in every piece, with gold plated center pins and silver plated bodies. And everything's in a hinged, plastic case for years of dependable use. You'll find

the best selection of coaxial adapters in the pages of the new Pomona Catalog.

See your nearest Authorized Pomona Distributor.

**POMONA ELECTRONICS,**

1500 E. Ninth St.,

P.O. Box 2767,

Pomona, CA 91769

(714) 623-3463

FAX (714) 629-3317

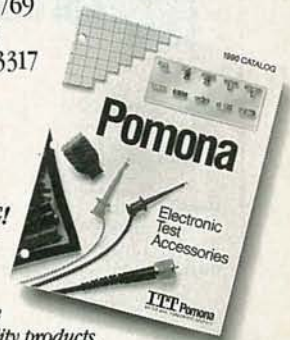

**FREE 1990 CATALOG!**

Thousands of test solutions and accessories in this new, 138-page handbook of quality products. It's Free! Call or write today.

**ITT Pomona**  
AN ITT EMC WORLDWIDE COMPANY  
*Discover our strengths.*

CIRCLE 101 ON FREE INFORMATION CARD



# NEW PRODUCTS

Use the Free Information Card for more details on these products.

**DIAGNOSTIC DISPLAY CARD.** THE *JDR POST Code* display card provides system designers, engineers, integrators, and computer enthusiasts with a tool that locates the source of a system failure and displays a diagnostic code. Designed to alleviate the frustrating hours often spent trying to track down system failures, the card saves time, energy, and resources. In fact, the card can often solve problems in a matter of minutes, that would have taken hours.

The easy-to-use *POST Code* card plugs into an available bus slot and uses LED indicators to display

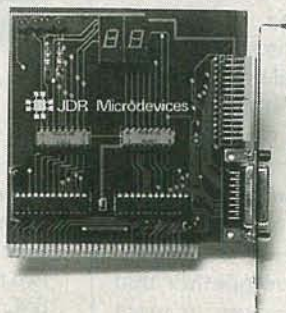

CIRCLE 12 ON FREE INFORMATION CARD

the code that corresponds to the problem. The meaning of the code can be found in the BIOS listings in the manual that comes with the card. That will help you to quickly locate almost any problem.

The 80286- and 80386-compatible card features switchless and jumperless design for easy installation and LED indicators for all power-supply voltages. Display LED's may be placed on-board, or on a back-panel bracket for easy readouts with a closed case. Because the circuit uses a dual GAL-chip design, it ensures ultra-low current operation and low noise.

The *POST Code* diagnostic card costs \$49.95.—**JDR Microdevices**, 2233 Branham Lane, San Jose, CA 95124; Tel: 408-559-1200; Fax: 408-559-0250.

**OPTOELECTRONIC INTERFACES.** Dubbed the "Byte-to-Light" solution, the *FOX1* transmitter and receiver integrated circuits from *Advanced Micro Devices, Inc. (AMD)* and *BT&D Technologies* convert light waves directly to computer-readable data, thus eliminating the technical problems that once made optical connections difficult to use. The devices make it as easy for engineers to design optical links into electronic systems as it is to install any other integrated circuit. AMD expects the "first intelligent optoelectronic interface circuits" to dramatically increase the use of photonics in computing

## OEI OPTOELECTRONICS

The only name in HANDI-COUNTERS



Model	UTC3000	2600H	2210A	1300HA
Function	Freq. Period Ratio, Interval, Avg, Prescale	Frequency	Frequency	Frequency
Range	10Hz-2.4GHz	10MHz-2.4GHz	10Hz-2.4GHz	1MHz-1.3GHz
Display	10 Digit LCD w/Function Annunciators	10 Digit LCD	8 Digit LED	8Digit LED
RF Signal Strength Indicator	16 Segment Adjustable Bargraph	16 Segment Adjustable Bargraph	•	•
Price	\$375.	\$325.	\$239.	\$179.

Sensitivity: <1 to <10mV typical. Time Base: ± 1.ppm.; ± .5ppm. add \$75 - LED Models; ± .2ppm add \$80. - LCD Models. Nicads & AC charger adapter included. Carry Case, Antennas and Probes extra. One year parts & labor warranty on all products.



### Check These Incredible Features On The All New UTC3000

- **10Hz to 2.4GHz Range.**  
Simply amazing!
- **10 Digit LCD Display.**  
1Hz resolution to over 150 MHz direct. Readable in bright sunlight.
- **RF Signal Strength Bargraph.**  
16 Segment, Zero, & Full Scale adjustment. SEE the input signal!
- **Super Sensitivity.** <1mV 10-200MHz, <5mV to 2GHz for efficient antenna pickup.
- **6 Functions.** Frequency, Period, Ratio Time Interval, Average, & Prescale.
- **Hold Button.**  
"Locks in" your exact Measurement FAST!
- **Extruded Aluminum Enclosure.**  
Designed to fit every hand.
- **Priced Right! Only \$375.**  
Includes Nicads, AC Charger/Adapter. Or Select Our Most Popular **HANDI-COUNTER**, the model 2210A that set the standard in handheld frequency counter technology!  
**Value Priced at only \$239.**

Professionals and Hobbyists all over the world have chosen OEI for 16 years! **Shouldn't YOU?**

**HANDI-COUNTERS! ...Only from OEI!**  
Choose the model that fits your needs... and your budget! **CALL NOW!**

**Toll Free Order Line: 1-800-327-5912** FL(305)771-2050 • FAX(305)771-2052



5821 NE 14th Avenue • Ft. Lauderdale, FL 33334  
Visa, MC, COD, Cash, M.O. accepted. Personal Check allow 3 weeks. 5% Shipping, Handling, (Maximum \$10 U.S. & Canada. 15% outside continental U.S.A.  
In FL add 6% sales tax. Full-line Product and Accessory Catalog available on request.

CIRCLE 194 ON FREE INFORMATION CARD



# Discover Your Career Potential In The Fast Growing Field Of High-Tech Electronics!

CIE Gives You The Training You Need to *Succeed...*  
At Your Own Pace...& In Your Own Home!

If you're anxious to get ahead...and build a *real* career...you owe it to yourself to find out about the Cleveland Institute of Electronics!

CIE can help you discover your career potential in the fast growing field of high-tech electronics. A career that will challenge and excite you every day...reward you with a powerful feeling of personal accomplishment...and deliver a level of financial security you may have only dreamed of before!

As the leading school in home-study electronics, CIE has helped over 150,000 students in the U.S.A. and over 70 foreign countries get started in this exciting field. To find out how CIE could be helping you...read on...then send for a CIE catalog TODAY!

## A Growing Need For Trained Professionals!

The career opportunities shown here are only a few of the challenging, high-paying careers you could enjoy as an electronics technician.

You could be the "brains" behind the scenes of an exciting TV broadcast...trouble-shoot life-saving medical equipment...design exotic new aeronautics systems...CIE's job-oriented programs offer you the quickest possible path to the career of your dreams! And CIE also features military and union re-training, to build on what you already know.

## Dozens Of Fascinating Careers To Choose From!

Even if you aren't sure which career is best for you, CIE can get you started with core lessons applicable to *all* areas of electronics. As you advance, CIE makes job opportunities available to you through the bimonthly school paper, *The Electron*.



Data Communications



Automotive Electronics



Avionics



Computer-Assisted Manufacturing



Consumer Electronics



Military Electronics

## Personal Training From A Renowned Faculty.

Unlike the impersonal approach of large classroom study, CIE offers you one-on-one instructional help 6 days a week, toll-free. Each CIE lesson is authored by an independent specialist, backed by CIE instructors who work directly with you to answer your questions and provide technical assistance when you need it.

## Practical Training... At Your Own Pace.

Through CIE, you can train for your new career while you keep your present job. Each course allows a generous completion time, and there are no limitations on how fast you can study. Should you already have some electronics experience, CIE offers several courses which start at the intermediate level.

## "State-Of-The-Art" Facilities & Equipment.

In 1969, CIE pioneered the first electronics laboratory course, and in 1984, the first Microprocessor Laboratory. Today, no other home study school can match CIE's state-of-the-art equipment. And all your laboratory equipment is included in your tuition cost. There is no extra charge—it's yours to use while you study at home and on the job after you complete your course!

## Earn Your Degree To Become A Professional In Electronics!

Every CIE course you take earns you credit towards the completion of your Associate in Applied Science Degree, so you can work towards your degree in stages. And CIE is the only school that awards you for fast study, which can save you thousands of dollars in obtaining the same electronics education found in four-year Bachelor's Degree programs! Write for details today!

## Send For Your Catalog Today!



### CIE World Headquarters

Cleveland Institute of Electronics, Inc.  
1776 East 17th St., Cleveland, Ohio 44114

**YES!** Please send me your independent study catalog (For your convenience, CIE will have a representative contact you—there is no obligation.)

Print Name \_\_\_\_\_

Address \_\_\_\_\_ Apt # \_\_\_\_\_

City/State/Zip \_\_\_\_\_

Age \_\_\_\_\_ Area Code/Phone No. \_\_\_\_\_

Check box for G.I. Bill bulletin on educational benefits:  Veteran  Active Duty

**Mail This Coupon Today!** ARE-176

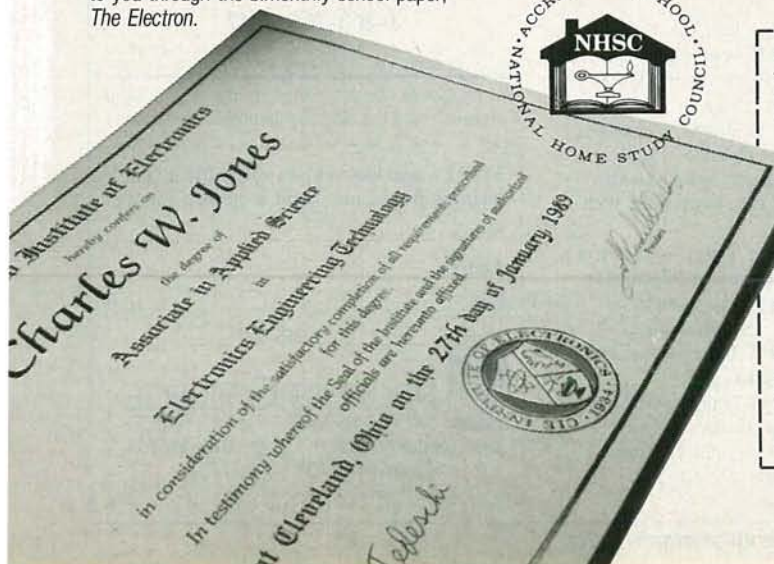





CIRCLE 13 ON FREE INFORMATION CARD

and networking.

The *FOXI* transmitter converts bytes to light waves; the receiver retrieves the light wave signal from a fiber-optic cable and converts it into electronic data ready for use in computer systems. Each piece occupies the same amount of space on a PC board as does a standard 28-pin IC. The result is that designers—even hobbyists—can easily interface normal computer data to fiber-optic media to take advantage of the power of fiber-optic

cable in applications such as computer backplanes, switching in PBX's, and proprietary local area networks. *FOXI* is a 1300-nanometer LED solution, practical in high-end designs where lasers—the other light source used in light wave communications—would either be too expensive or require too much power.

The circuits are pin-compatible with AMD's *TAXI* chip set, a monolithic intelligent electronic interface that can be applied to optical systems; the IC's can therefore be used to lengthen data-transmission distances on boards that are already set up for coaxial cable. *FOXI* (actually an acronym for fiber optic TAXI), incorporates the *TAXI* chip solution and optical data links in a single package for a quick, cost-effective, and easy-to-use optoelectronic interface.

The *FOXI* set operates

up to a speed of 125 MHz and can transmit data at a rate of up to 12.5-million bytes per second—the equivalent of 150 million words per minute, and about ten times faster than most current wire-based connections.

The two-piece (Am79h-1068/69) *FOXI* set is priced at \$295 per set in lots of 1,000.—**Advanced Micro Devices, Inc.**, 901 Thompson Place, P.O. Box 3453, Sunnyvale, CA 94088-3000; Tel. 800-538-8450, Ext. 45667 or 408-749-5667.

#### LABELING SYSTEM.

Designed to take the guesswork out of computer-system hookups, *AMT Communications' Label Logic* kit includes 144 high-quality, silk-screened labels and an EZ Reference card. When used to mark ports, cables, drives, expansion slots, peripherals,



CIRCLE 14 ON FREE INFORMATION CARD

etc., the labels will completely identify the parts of almost any PC system. The EZ Reference card provides definitions for all the terms that are printed on the labels, as well as convenient places to write in peripheral information, set-up information, hard-disk partitions, error mapping, and documentation for installing the labels.

*Label Logic* has a suggested retail price of \$6.95.—**AMT Communications**, 2741 Plaza Del Amo #201, Torrance, CA 90503; Tel: 213-320-7757.

## Train at Home to be an Electronics Technician!

Professional training and equipment can help you qualify for a dynamic, high-paying career in your spare time.

As the demand for computers and microprocessors in business and manufacturing continues to grow, so does the need for qualified technicians. It's not unusual for experienced technicians to earn from \$35,000 to more than \$40,000 a year.\* Now there's a way you can train for this exciting field without interrupting your job or home life.

#### Choose From These Programs of Study

- Electronics & Microprocessor Technology
- Industrial Electronics & Microprocessor Technology
- Computer Servicing & Electronics Technology
- Specialized Associate Degree In Electronics Technology

#### You Get Professional Equipment For Professional Training

Depending on the program you select, you'll perfect your skills using this advanced equipment, included in the price of tuition:

- IBM-Compatible Personal Computer
- Digital Multimeter
- Digital Logic Probe
- Elenco Oscilloscope

#### Exclusive Extras That Enhance Your Training

Peoples College introduces some training firsts to make your learning experience more complete:

- Accelerated Learning System — a scientifically proven study system that lets you learn faster and easier than ever before.
- Optional One-Week Seminar — available with our advanced programs. Conducted on our campus near Orlando, Fla. Not required for graduation, but a valuable opportunity to fine tune your skills with personal guidance.
- Video Tutor Training Tapes — give you a permanent, visual record of informative lectures and close-up demonstrations.
- Experience Labs — professionally designed experiments that give you hands-on "bench" experience.
- Industry Certification Training Guide — provided with three of our programs. Gives you first-hand insight into the examination you may take for your professional license.



For COLOR CATALOG Mail Coupon or Call TOLL FREE

1-800-765-7247

Programs offered only in United States, Canada, Puerto Rico and Virgin Islands. No Obligation. No sales person will call.

Our programs are accredited by the Accrediting Commission of the National Home Study Council

YES! I would like to know more about your training programs. Send a catalog to:

Name \_\_\_\_\_

Address \_\_\_\_\_

City \_\_\_\_\_

State \_\_\_\_\_ Zip \_\_\_\_\_

**PEOPLES COLLEGE**  
OF INDEPENDENT STUDIES  
233 Academy Drive • P.O. Box 421768  
Kissimmee, FL 34742-1768

Member, D.I., Peoples Group R1090

\* Source: U.S. Bureau of Labor Statistics



**PARTS TESTER.** Designed for field-service, industrial, and hobbyist applications, the model 815 from B&K-Precision tests capacitance and resistance in a variety of components and tests transistors, SCR's, diodes, LED's, and batteries in 26 ranges. The rugged handheld instrument is designed to withstand a five-foot drop, and is water- and

**SURGE SUPPRESSORS.** Philips ECG is offering three surge suppressors that are each designed for the protection of specific types of electronic equipment. Used with TV's, VCR's, cable converters, satellite receivers, and audio receivers, the EMF-TV3 offers protection against transient voltage spikes on TV-signal lines from signal



CIRCLE 16 ON FREE INFORMATION CARD

to ground and from signal ground to AC-power ground. The EMF-325 tele-

communications surge suppressor offers protection against transient voltage spikes on all telephone lines—ring (red), tip (green), common (yellow), and auxiliary (black). It is intended for use with modems, fax machines, cordless phones, telephones, and answering machines. Both the EMF-TV3 and the EMF-325 protect the AC-power line in all three



B&K PRECISION

Model 815  
Parts Tester

CIRCLE 15 ON FREE INFORMATION CARD

overload-resistant as well. Its case seals out rain, grease, dirt, and other contaminants. The tester features a 3½-digit LCD readout, a stand for bench use, test leads, and component-insertion sockets.

The 815 tests capacitance from 0.1 pF to 20 mF in capacitors, cables, switches, and other components, with accuracies ranging from 0.75% to 1.5%. Resistance measurements span from 0.1 ohm to 20 megohms. Transistors can be tested for both gain and leakage; SCR's, diodes, and LED's are tested for forward junction voltage, and batteries are tested under load for voltage output.

The model 815 parts tester has a suggested list price of \$99.00.—**B&K-Precision**, Division of Maxtec International Corp., 6470 West Cortland Street, Chicago 60635; Tel: 312-889-9087.

**Test them  
all for  
just \$99.**

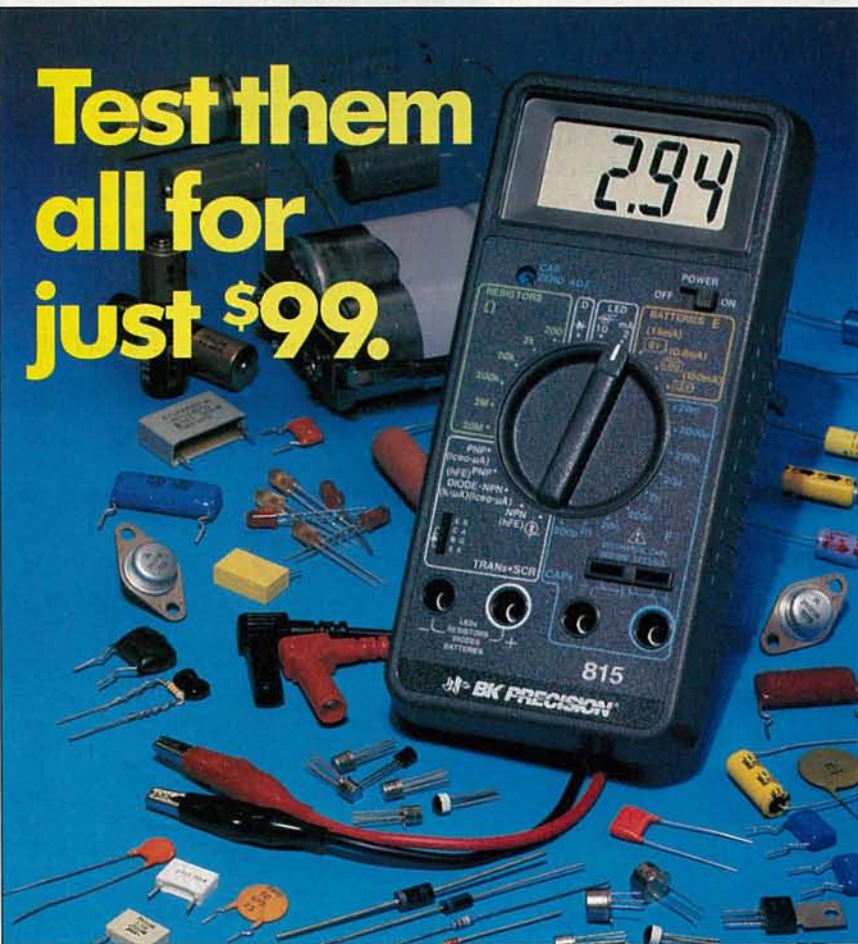

**New B&K-PRECISION Parts Tester checks capacitors, resistors, transistors, diodes, SCRs, LEDs and more.**

There's no need to guess about components with B&K-PRECISION's 815 Parts Tester. It accurately measures the most-used components and displays their values on a large 0.8" LCD readout. Rugged design and tilt stand make it well suited for field or bench.

One look at this quality instrument will convince you the B&K-PRECISION 815 is the best buy. For detailed specifications or immediate delivery, contact your local distributor.

- Tests capacitance from 0.1pF to 20mF in capacitors, cables, switches; other components.
- Tests resistance from 0.1 ohm to 20 megohms.
- Tests SCRs, diodes and LEDs.
- Tests transistor gain and leakage.
- Tests batteries under true load conditions.
- 26 measurement ranges.
- 5 foot drop-resistant case.
- Tilt stand for bench use.
- Includes test leads



Domestic and International Sales  
6470 W. Cortland St., Chicago, IL 60635  
312-889-1448 • FAX: 312-794-9740  
Canadian Sales, Atlas Electronics, Ontario

CIRCLE 77 ON FREE INFORMATION CARD



modes—hot to neutral, hot to ground, and neutral to ground. The surge suppressors have fused output and surge circuitry and a power/protection indicator lamp.

Designed to protect modems, computers, and peripherals using the RS-232 port from power surges that can cause loss of data and damage to sensitive microprocessors, the EMF-232C data-line protector features RX (receive), TX (transmit), and SG (signal ground) data-line protection. The device shunts transient voltage spikes through high-quality metal-oxide varistors (MOV's).

The EMF-TV3, EMF-325, and EMF-232C have suggested retail prices of \$18.70, \$16.25, and \$8.35, respectively.—**Philips ECG**, 1025 Westminister Drive, Williamsport, PA 17701; Tel: 800-526-9354.

**DIGITAL AND ANALOG MULTIMETER.** Called the "DAMM," model A-445 from Protek is a full-function digital and analog multimeter. Its easy-to-read,



CIRCLE 17 ON FREE INFORMATION CARD

clean-looking, 4½-inch mirrored analog scale provides nulling, peaking, and trend indications, and the bold 3½-digit LCD readout delivers precise measurement values. The DAMM indicates true RMS for AC

voltage and current. Offering AC frequency responses over 100 kHz on the 200-mV range and 20 kHz on the 2-volt range, as well as dB-measurement capabilities, the meter is a useful tool for telecommunications, audio, and industrial technicians. Seven ranges of AC and DC current allow measurement from 10 amperes to a low 10 nA, which is convenient for checking circuits and components for leakage. Diode test and audible continuity check functions are also provided.

The DAMM digital and analog multimeter, complete with safety probes, battery, and spare fuse, costs less than \$100.00.—**Protek Inc.**, P.O. Box 59, Norwood, NJ 07648.

**ELECTRICAL TESTER.** Although it looks (and works) like an ordinary pocket-sized screwdriver,



CIRCLE 18 ON FREE INFORMATION CARD

A.W. Sperry's model ST-400A does double duty as a high-voltage circuit tester. The fully-insulated tool checks voltages from 90 to 250 volts. It clips onto a shirt pocket, and comes in handy for driving or removing screws, too.

The model ST-400A electrical tester/screwdriver has a suggested retail price of \$2.99.—**A.W. Sperry Instruments, Inc.**, 245 Marcus Boulevard, Hauppauge, NY 11788; Tel: 516-231-7050.

**SURFACE-MOUNT TEST-CLIP SERIES.** ITT Pomona has introduced a family of clips for breaking out high-density leads of surface-mounted plastic-

# KENWOOD OSCILLOSCOPES

## ANALOG OSCILLOSCOPES W/O READOUT

**MODEL CS-5135**  
40 MHz, Dual Channel.  
Delayed Sweep.  
REG. \$895.00 SALE \$719.95

**MODEL CS-5155**  
50 MHz, 3 Channel.  
6-Trace, Delayed Sweep.  
REG. \$995.00 SALE \$819.95

**MODEL CS-5165**  
60 MHz, 3 Channel.  
6-Trace, Delayed Sweep.  
REG. \$1095.00 SALE \$899.95

**MODEL CS-2150**  
150 MHz, 4 Channel.  
8-Trace, Delayed Sweep.  
REG. \$2395.00 SALE \$1495.95

## ANALOG OSCILLOSCOPES W/READOUT/CUSORS

**MODEL CS-5130**  
40 MHz, Dual Channel.  
4-Trace, Delayed Sweep.  
REG. \$1095.00 SALE \$899.95

**MODEL CS-5170**  
100 MHz, Dual Channel.  
4-Trace, Delayed Sweep.  
REG. \$1695.00 SALE \$1399.95

**MODEL CS-6010**  
100 MHz, 4 Channel.  
10-Trace, Delayed Sweep.  
REG. \$1995.00 SALE \$1699.95

**MODEL CS-6020**  
150 MHz, 4 Channel.  
10-Trace, Delayed Sweep.  
REG. \$2395.00 SALE \$1999.95



**MODEL CS-4025**  
20 MHz, Dual Channel  
Oscilloscope.  
REG. \$495.00

**SALE \$349.95**



**Products International**  
8931 Brookville Rd.  
Silver Spring, MD 20910  
(800)638-2020 (301)587-7824  
FAX# 301-585-5402  
EASY ORDER FAX LINE (800)545-0058

800-638-2020



CIRCLE 199 ON FREE INFORMATION CARD

# CABLE - TV

## SIGNAL REMOVERS

- FOR ELIMINATION OF SEVERE INTERFERENCE
- FOR "CENSORING" OF ADULT BROADCASTS



FOR FULL DESCRIPTION OF USES ask for our free brochure

- ATTENUATION - 45 dB TYPICAL
- BANDWIDTH - 4 MHz AT 5 dB POINTS
- INSERTION LOSS - 2 dB

MODEL	TUNING RANGE	FOR CHANNELS	PASSBAND	PRICE	SHIPPING
23H	50-66 MHz	2,3 (or 6 meter ham)	50-300 MHz	\$30	NO SHIPPING or C.O.D. CHARGES
46FM	66-108 MHz	4,5,6 (or any FM)	50-300 MHz	\$30	
1417	120-144 MHz	14(A) 15(B) 16 (C) 17(D)	50-400 MHz	\$30	
1822	144-174 MHz	18(E) 19(F) 20(G) 21(H) 22 (I)	50-400 MHz	\$30	
713	174-216 MHz	7,8,9,10,11,12,13	50-400 MHz	\$30	

3 for \$75 - 10 for \$200 - mix or match

CALL TOLL FREE FOR C.O.D. OR SEND CHECK TO ORDER  
FAST DELIVERY  
30 DAY MONEY BACK GUARANTEE (3 FILTER LIMIT)

**Star Circuits**

P. O. Box 94917  
Las Vegas, NV 89193-4917

1-800-433-6319



quad flat-pack (PQFP) devices with 100 to 160 pins. The 5640 Series of clips fit EIAJ IC's of 100, 120, and 160 pins, spaced on 0.65-mm (0.025-inch) and 0.80-mm (0.0315-inch) centers. Model 5643 fits the 120-pin (20 × 30), model 5644 fits the 120-pin (30 × 30), and model 5645 fits the 160-pin (40 × 40) devices. They "break out" each IC pin to a more accessible 0.64-mm (0.025-inch) square post.

The clips, which are cost effective compared to hand wiring or accessing difficult-to-test leads, feature a press-on design to fit directly over the surface-mounted IC's, keyed by a No. 1 pin locator. Contact with the IC's gull-wing leads is via specially configured, gold-plated, beryllium-copper pins. The clips' bodies are made of black, molded, liquid-crystal polymer. Multiple rows of gold-

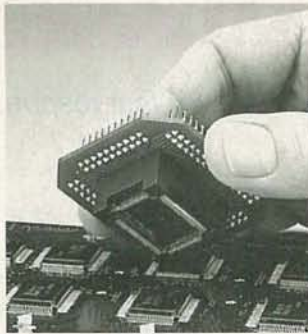

CIRCLE 19 ON FREE INFORMATION CARD

plated, phosphor-bronze square pins are positioned on a grid designed to match commercially available headers.

In single quantities, the list prices of the models 5643, 5644, and 5645 PQFP IC clips are \$317.00, \$353.00, and \$425.00, respectively.—**ITT Pomona Electronics**, an ITT EMC Worldwide Company, 1500 East Ninth Street, Pomona, CA 91769; Tel: 714-623-3463; Fax: 714-629-3317.

**DIGITAL TROUBLE-SHOOTING KITS.** For field-service and educational applications, *Global Specialties* has introduced three digital-logic test kits that are TTL and CMOS compatible. The models *LTC-6*, *LTC-7*, and *LTC-8* each feature a logic probe, a 16-channel logic monitor, a logic pulser, a tone-ohmmeter, and an accessory kit, all packaged in a rugged plastic carrying case. Each kit contains a logic probe to find pulses too fast for oscilloscopes: The *LTC-6* contains a 10-MHz probe, the *LTC-7* contains a 35-MHz probe, and the *LTC-8* contains a 100-MHz probe. The static and dynamic states of 16 logic inputs are simultaneously displayed on the logic monitor. The digital pulser is a pocket-size pulse generator used to stimulate logic circuits with a single pulse or a continuous pulse



CIRCLE 20 ON FREE INFORMATION CARD

train. The tone-ohmmeter locates bad IC's and circuit shorts without unsoldering parts. The accessory kit includes probe tips, ground clips, tip adapters, and quick hook cables, allowing "hands-free" testing.

Prices for the *LTC-6*, *LTC-7*, and *LTC-8* digital-logic test kits range from \$299.00 to \$379.00 each.—**Global Specialties**, 70 Fulton Terrace, New Haven, CT 06512; Tel: 1-800-572-1028. **R-E**



#### STANDARD FEATURES

- **FULL FUNCTION:** Direct and prescaled Frequency, Periods (or averages), Time Intervals (or averages), Frequency Ratios.
- **WIDE FREQUENCY RANGE:** 10 Hz to 2.4 GHz, useful 1 Hz to 3 GHz
- **HIGH RESOLUTION:** 1 sec gate time displays 1 Hz in 200 MHz.
- **HIGH ACCURACY:** TCXO ± 1 ppm standard
- 16 element signal strength meter
- 10 digit LCD readout
- NBS traceable calibration

ONLY **\$579**

OEI's model UTC 8030 is a full-featured Universal Counter-Timer with a Frequency Finder built in a unique bench/portable enclosure.

The Frequency Finder's 10 mV antenna sensitivity and NiCad batteries provide true off-the-air measurements at maximum distance from any transmitter up to 3 GHz.



**OPTOELECTRONICS, INC.**

5821 NE 14TH AVENUE  
FORT LAUDERDALE, FL 33334  
FLORIDA PHONE (305) 771-2050

CIRCLE 195 ON FREE INFORMATION CARD

# MORE THAN JUST A FREQUENCY COUNTER

#### OPTIONS

- TCXO 80** ..... \$125  
High precision ±0.1 ppm sealed 10 MHz  
20°-40°C temp controlled xtal oscillator
- NICAD 80** ..... \$75  
Internal rechargeable NiCad battery  
pack for >2 hours field use without  
recharging
- BL 80** ..... \$40  
Display backlight for nighttime use

**ASK ABOUT  
USEFUL ACCESSORIES**

**1-800-327-5912**  
**FAX (305) 771-2052**

OCTOBER 1990



# NEW LIT

Use the Free Information Card for fast response

**1990 INDUSTRIAL HANDBOOK AND APPLICATION GUIDE.** Acculex, A MetraByte Company, 440 Myles Standish Blvd., Taunton, MA 02780; Tel: 508-880-3660; free.

Newly expanded to 80 pages, this catalog contains full product specifications and prices for a variety of industrial monitoring and control products for instrument manufacturers, industrial OEM's, and end users. Also included are applications, wiring diagrams, and 4-20-mA Process Loop accessories. Six sub-miniature thermocouple and RTD-input DPM's have



CIRCLE 22 ON FREE INFORMATION CARD

been added to the Acculex line of digital panel meters. Other new items include a full line of calibrators, signal-conditioning modules, counters/timers, and the "Acupac" 4-20-mA Rack Mount Signal Conditioning

System. The wide array of products described covers virtually all industrial applications from temperature, position, pressure, pH, high/low-level voltage input, dynamic watt measurements, level sensing, and resistance bridges.

**1990 FULL LINE CATALOG.** Sencore, Inc., 3200 Sencore Drive, Sioux Falls, SD 57107; Tel: 1-800-SENCORE; free.

Sencore's entire line of products—all made in the U.S.A., and 93% patented—is described in this catalog. Included are the latest in instruments for testing audio, video, and cable systems. Also fea-

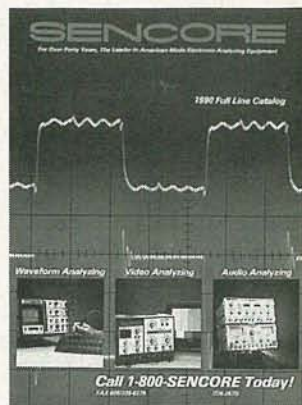

CIRCLE 24 ON FREE INFORMATION CARD

tured are component and waveform analyzers, IEEE/RS232 instruments, and a full line of accessories. Specifications and application information are also provided. **R-E**

## MARK V ELECTRONICS, INC.

Competitive Pricing \* Fast Shipping

ORDER IN CALIFORNIA 800-521-MARK

ORDER OUTSIDE CA 800-423-3483

FREE CATALOG & INFORMATION (213)888-8988

FAX (213) 888-6868

▲ indicates the level of difficulty in the assembling of our Products. ▲ Beginner ▲▲ Intermediate ▲▲▲ Advanced ★ Fully Assembled

Amplifier	TA-3600	TA-477	TA-802	TA-1000A
+ Metal Cabinet	LG-1925	LG-1925	LG-1924	LG-1924
+ Transformer	#007	#003	#001	#001
Kit Set	\$ 138.60	\$ 115.20	\$ 91.75	\$ 104.12
Assmb. Set	\$ 160.20	\$ 130.50	\$ 104.15	\$ 122.92

\* Due to this special offer & low price, we can only exchange or repair any of these units (TA-3600, TA-477, TA-802 & TA-1000A) within 15 days of your receipt.

\* The above prices are for the complete sets. For separate unit price, please see below.

Model	Description	Kit	Assmb.
SM-328	Stereo Loudspeaker Protector ▲▲▲	\$ 139.00	\$ 158.00
SM-333	4 Channel Professional Color Light Controller ★	70.00	88.00
TA-2500	Audio/Video Surround Sound Processor ▲▲▲	68.80	98.00
TA-2400A	Dynamic Noise Reduction ▲	96.00	116.00

MODEL	DESCRIPTION	KIT	ASSMB.
TA-28MK2	Digital Voice Memo ▲▲	\$ 30.00	
TA-50A/B	Multi-Purpose Melody Generator ▲	12.84	\$ 17.20
TA-50C	Multi-Purpose Melody Generator ▲	13.65	18.71
TA-120MK2	35W Class "A" Main Power Mono Amp ▲▲	28.50	39.80
TA-300	30W Multi-Purpose Single Channel Amp ▲	20.00	29.00
TA-302	60W Stereo Power Booster (w/case) ▲▲		70.00
TA-323A	30Wx2 Stereo Pre-main Amp ▲	29.50	38.35
TA-377A	Hi-Quality FET Stereo Pre-Amp ▲▲▲	59.95	75.00
TA-400	40W Solid State Mono Amp ▲	28.00	34.93
TA-477	120W Mosfet Power Mono Amp ▲▲	68.00	85.00
TA-800	80W+80W DC Pre-Main & Power Amp ▲▲	60.92	79.20
TA-802	80W+80W DC Stereo Main Power Amp ▲▲	45.94	59.72
TA-820A	60W+60W OCL DC Pre-Main Stereo Amp ▲▲	40.39	49.37
TA-1000A	100W Dynamic Class "A" Main Power Mono Amp ▲▲	59.69	80.58
TA-1500	100Wx2 Class "A" DC Stereo Pre-Main Amp ▲▲	73.70	95.81
TA-2200	FET Super class "A" DC Pre-Amp ▲▲▲	47.70	58.24
TA-2400A	Electronic Echo & Reverberation Amp ▲▲▲		95.00
TA-2500	HQ Pre-Amp w/10 band graphic equalizer ★		68.80
TA-2800	Hi-FET IC Pre-Amp w/3 way tone control ▲	48.90	63.57
TA-3000	Stereo Simulator (mono TV / any mono source) ▲▲	27.00	38.50
TA-3600	300W HQ Hi-Fi Power Mono Amp ▲▲	79.00	103.00

MODEL	DESCRIPTION	KIT	ASSMB.
TR-100A	O-15V 2A Regulated DC Power Supply (w/case) ▲▲▲	\$ 14.55	\$ 69.50
TR-355A	O-15V 5A Regulated DC Power Supply ▲	14.55	20.76
TR-355B	O-30V 3A Regulated DC Power Supply ▲	14.55	20.76
TR-503	O-50V 3A Regulated DC Power Supply ▲▲	15.75	22.65

MODEL	DESCRIPTION	KIT	ASSMB.
SM-43	3 1/2" Multi-Functional Led D.P.M. (w/ABS plastic case) ▲▲	\$ 34.50	\$ 43.00
SM-48	4 1/2" Hi-Precision D.P.M. ▲▲▲	38.00	48.00
SM-48A	4 1/2" Hi-Precision D.P.M. (w/ABS plastic case) ▲▲▲	41.20	52.00
SM-49	3 1/2" Multi-Functional LCD D.P.M. (w/hold function) ▲▲	36.00	44.50
SM-100	150 MC Digital Frequency Counter ▲▲▲	79.00	90.00
FC-1000A	1 GHz Frequency Counter ★		179.00

MODEL	DESCRIPTION	Kit	Assmb.
TY-23B	3 Channel Color Light Controller ▲▲▲	\$ 51.20	\$ 65.00
TY-25	Stereo Loudspeaker Protector ▲▲	13.85	19.85
TY-35	FM Wireless Microphone	10.22	
TY-36	AC/DC Quartz Digital Clock ▲	19.00	26.20
TY-38	Sound/Touch Control Switch ▲	12.00	
TY-41MKV	Infrared Remote Control Unit w/case ▲▲	20.00	35.00
TY-42	Bar/Dot Level Meter ▲	24.15	
TY-43	3 1/2" Digital Panel Meter ▲	29.00	38.00
TY-45	20 Steps Bar/Dot Audio Level Display ▲	38.45	46.14
TY-47	Superior Electronic Roulette ▲▲	19.46	27.24
SM-222	7 Band Hi-Fi Graphic Equalizer ▲▲	26.80	38.80
SM-328	4 Channel Professional Color Light Controller ★		139.00
SM-333	Audio/Video Surround Sound Processor ▲▲▲	62.00	70.00
SM-666	Dynamic Noise Reduction ▲	26.00	34.00

MODEL	H" x W" x D"	MATCHING	PRICE
LG-1273	3" x 12" x 7"	TA-2800, TA-377A, TA-2200	\$ 22.16
LG-1684	4" x 16" x 8"	TA-323A, TA-377A, TA-2200	26.64
LG-1924	4" x 19" x 11 1/2"	TA-802, TA-820A, TA-1500, TA-120MK 2, TA-800, TA-1000A	32.00
LG-1925	5" x 19" x 11 1/2"	TA-477, TA-800, TA-1500, TA-1000A, TA-3600	35.00
LG-1983	2 3/4" x 19" x 8"	TA-377A, TA-2800, TA-2200, TA-120MK 2	28.50

MODEL	DESCRIPTION	MATCHING	PRICE
#001	56VCT, 60VCT 6A	TA-800, TA-802, TA-820A, TA-1000A, TA-1500	\$ 26.00
#002	72VCT 3A	TR-503, TA-323A, TA-400, TA-300	21.00
#003	80VCT 6A	TA-477	27.00
#004	48VCT 6A	TA-120 MK 2	21.00
#005	52VCT 3A	TR-355B	15.00
#006	36VCT 5A	TR-355A	14.50
#007	112VCT 8A	TA-3600	42.00

We accept major Credit Cards. Money Orders. Check and C.O.D. Orders. C.O.D. fee is \$5.00. Minimum order is \$20.00. We ship by UPS ground inside US (incl. \$3.00) and ship by US mail Business & Showroom hours: (Pacific Time) Mon, thru Fri, 9:30 am to 5:00 pm Sat, 10:00 am to 5:00 pm

**MARK V ELECTRONICS, INC. - 8019 E. Slauson Ave, Montebello, CA 90640**



CIRCLE 93 ON FREE INFORMATION CARD



# WITH CIE, THE WORLD OF ELECTRONICS CAN BE YOUR WORLD, TOO.

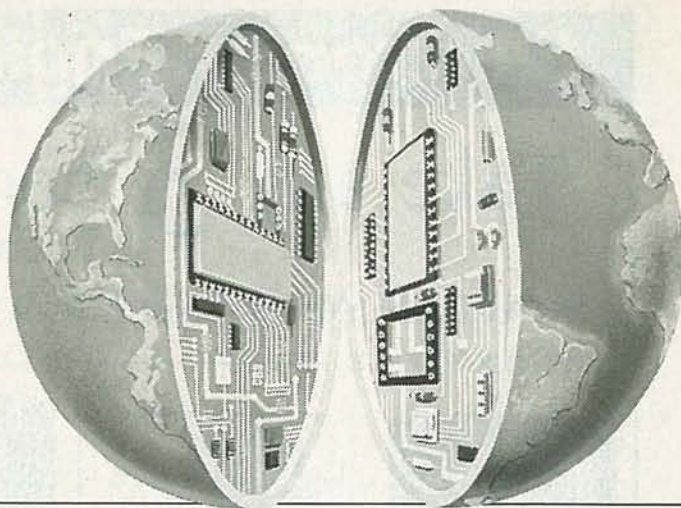

**L**ook at the world as it was 20 years ago and as it is today. Now, try to name another field that's grown faster in those 20 years than electronics. Everywhere you look, you'll find electronics in action. In industry, aerospace, business, medicine, science, government, communications—you name it. And as high technology grows, electronics will grow. Which means few other fields, if any, offer more career opportunities, more job security, more room for advancement—if you have the right skills.

## SPECIALISTS NEED SPECIALIZED TRAINING.

It stands to reason that you learn anything best from a specialist, and CIE is the largest independent home study school specializing exclusively in electronics, with a record that speaks for itself. According to a recent survey, 92% of CIE graduates are employed in electronics or a closely related field. When you're investing your time and money, you deserve results like that.

## INDEPENDENT STUDY BACKED BY PERSONAL ATTENTION.

We believe in independent study because it puts you in a classroom of one. So you can study where and when you want. At your pace, not somebody else's. And with over 50 years of experience, we've developed proven programs to give you the support

such study demands. Programs that give you the theory you need backed with practical experience using some of the most sophisticated electronics tools available anywhere, including our Microprocessor Training Laboratory with 4K of random access memory. Of course, if you ever have a question or problem, our instructors are only a phone call away.



## START WHERE YOU WANT, GO AS FAR AS YOU WANT.

CIE's broad range of entry, intermediate, and advanced level courses in a variety of career areas gives you many options. Start with the Career Course that best suits your talents and interests and go as far as you want—all the way, if you wish, to your Associate in Applied Science Degree in Electronics Engineering Technology. But wherever you start, the time to start is **now**. Simply use the coupon below to send for your FREE CIE catalog and complete package of career information. Or phone us, toll-free, at **1-800-321-2155** (in Ohio, 1-800-523-9109). Don't wait, ask for your free catalog now. After all, there's a whole world of electronics out there waiting for you.

# CIE

**Cleveland Institute of Electronics, Inc.**  
1776 East 17th Street, Cleveland, Ohio 44114

Member NHSC  
Accredited Member National Home Study Council

ARE-177

**CIE** **Cleveland Institute of Electronics, Inc.**  
1776 East 17th Street, Cleveland, Ohio 44114

**YES...** I want to learn from the specialists in electronics—CIE. Please send me my FREE CIE school catalog, including details about CIE's Associate Degree program, plus my FREE package of home study information.

Name (print): \_\_\_\_\_

Address: \_\_\_\_\_

City: \_\_\_\_\_ State: \_\_\_\_\_ Zip: \_\_\_\_\_

Age: \_\_\_\_\_ Area Code/Phone No.: \_\_\_\_\_ / \_\_\_\_\_

Check box for G.I. Bill bulletin on educational benefits:

Veteran  Active Duty

**MAIL  
TODAY!**



# Electronics Engineers & Designers!

Take any **3** books for only **\$4<sup>95</sup>**  
(Values to \$168.40)

**SHARPEN YOUR SKILLS**—With Quality, Affordable Professional Books

## COMPUTER SCIENCE

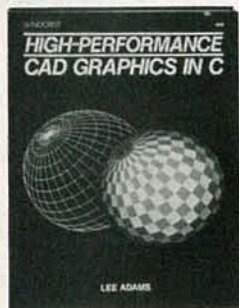

**3059** **\$34.95**  
Master the art of modeling, rendering, and animating on your IBM® PC. 524 pp. *Counts as 2.*

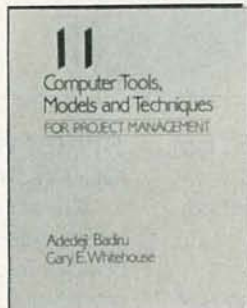

**3200** **\$32.95**  
Guidelines for enhancing software-driven project management in large or small businesses. 320 pp. *Counts as 2.*

## ENGINEERING MATH

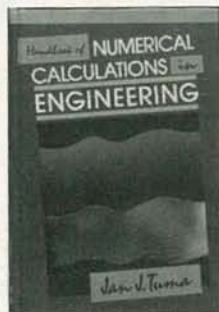

**9321** **\$49.50**  
This time-saving handbook provides problem-solving calculations for engineering design, production and research. 416 pp. *Counts as 2*



**3429** **\$29.95**  
Your source for well-developed, ready-to-use computer algorithm codes. 180 pp.



**3241P** **\$16.95**  
Get immediate access to information on calculations for all types of projects and phenomena with this handy reference. 280 pp.

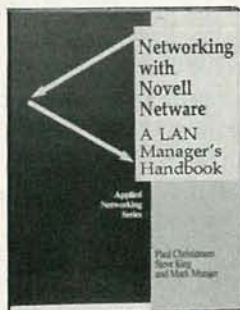

**3283** **\$28.95**  
Covers all aspects of LAN planning, installation, and operation, including standard and non-standard arrangements. 240 pp.

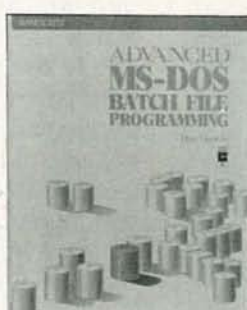

**3197P** **\$24.95**  
Provides all the information needed to begin programming with batch files. 400 pp.



**3237P** **\$24.95**  
This handy guide demonstrates such advanced features as debugging applications and Virtual 8086 Mode. 432 pp.

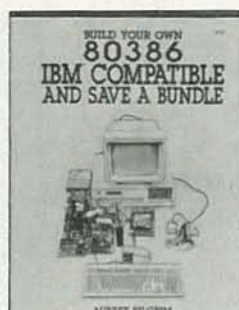

**3131** **\$26.95**  
Assemble your own powerful microcomputer system... it's easy and inexpensive. 224 pp.

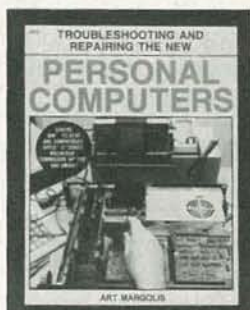

**2809** **\$29.95**  
This hands-on servicing manual covers IBM-PC/XT/AT and compatibles, MAC, Apple II series, C-64&128 and more. 416 pp.

## ELECTRONIC CIRCUITS



**3258** **\$27.95**  
Step-by-step instructions for troubleshooting and repairing the latest in electrical equipment. 310 pp.

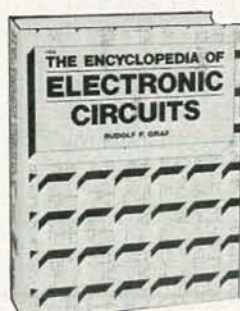

**1938** **\$60.00**  
Over 1,300 useful and versatile electronic circuit designs. 768 pp. *Counts as 2*

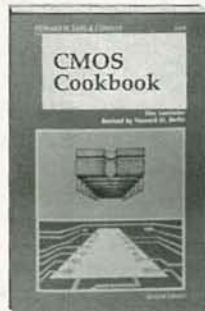

**9244P** **\$18.95**  
This revised and updated edition is both a comprehensive, industry-wide reference, and a valuable collection of project ideas. 512 pp.



**9243P** **\$12.95**  
This book will eliminate the guesswork in choosing the best circuit or tracking down malfunctions in a completed circuit. 282 pp.



**9825** **\$49.95**  
A comprehensive manual for soldering and cleaning printed circuit boards. 430 pp.



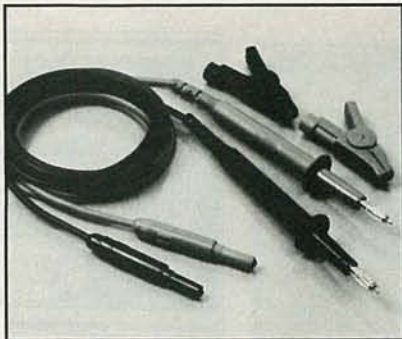

### ECONOMICAL SILICONE RUBBER TEST LEADS

Best value in moderately priced leads. High quality, soft, silicone rubber cable. Banana plug on measuring tip accepts push-on accessories; alligator clips included. Plugs have spring-loaded safety sleeves. Model TL1000 \$14.00 Satisfaction guaranteed.

**TEST PROBES, INC.** Call toll-free for catalog: 1-800-368-5719

**CIRCLE 225 ON FREE INFORMATION CARD**



### FREE PROBE REFERENCE GUIDE

One-page chart lists TPI probes for most oscilloscopes. Also cross references other probes to less expensive TPI equivalents. Performance and satisfaction guaranteed.

**TEST PROBES, INC.** Call toll-free for guide and catalog. 1-800-368-5719

**CIRCLE 226 ON FREE INFORMATION CARD**

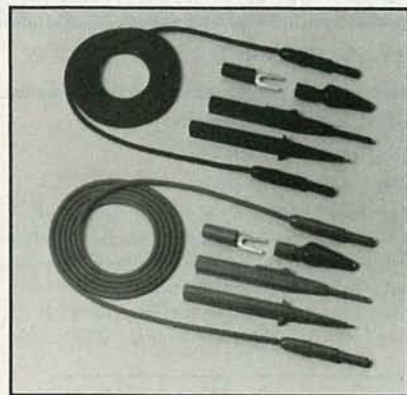

### DELUXE TEST LEAD KIT

Users call TPI leads **The Absolute Best**. The TLS2000 features the highest quality cable in the industry - with spring-loaded safety-sleeved plugs. U.L. listed (file E79581). Kit: \$30 Leads and probes only: \$19 Satisfaction guaranteed.

**TEST PROBES, INC.** Call toll-free for catalog: 1-800-368-5719

**CIRCLE 227 ON FREE INFORMATION CARD**



### COAX ADAPTER KIT

- Create any adapter in seconds
- Make all combinations of BNC, TNC, SMA, N, UHF, Mini-UHF, F and RCA.

The TPI 3000A kit contains male and female connectors of all 8 types, and 6 universal interfaces. Simply screw any combination of 24 connectors to one of the interfaces to create the desired adapter. \$150

**TEST PROBES, INC.** 9178 Brown Deer Road, San Diego, CA 92121. Call toll-free for catalog: 1-800-368-5719

**CIRCLE 189 ON FREE INFORMATION CARD**

## The World's Most Popular Probe

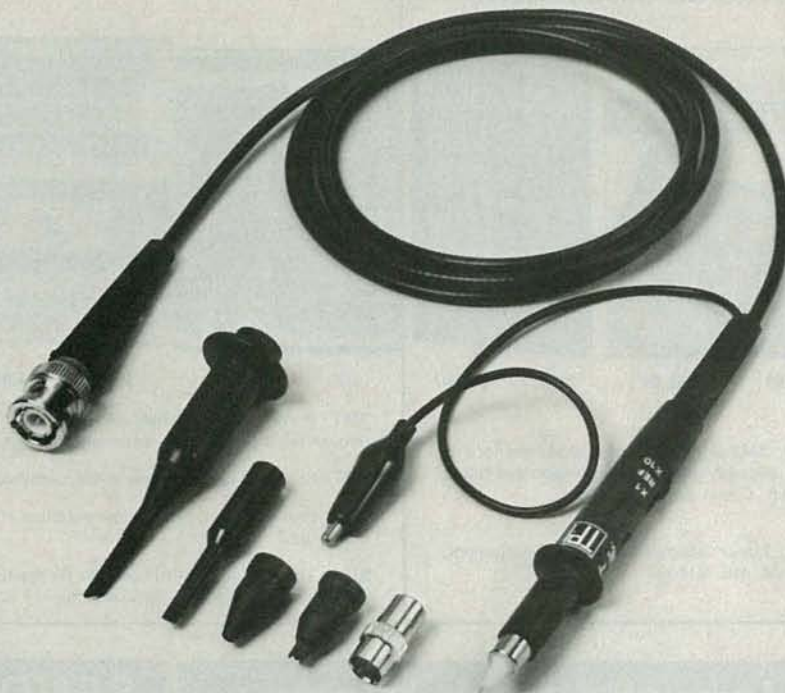

Model SP100  
100 MHz Switchable 1x-10x ..... **\$43**

**CIRCLE 228 ON FREE INFORMATION CARD**

### More SP100 Probes Have Been Sold Worldwide Than Any Other Probe Ever Made

- For Tektronix, Hewlett Packard, Philips, Leader, B&K, Kikusui, Hitachi, Beckman and other oscilloscopes
- Immediate delivery from distributor stock
- **Economical** - Substantial savings compared to OEM probes
- **Durable** - Unique cable is slim, very flexible and resists breakage
- 10 day return policy - Guaranteed performance and quality

Free cross reference chart for all makes of scopes and probes. Call toll-free for chart and name of your local distributor.

**TEST PROBES, INC.** 

9178 Brown Deer Road  
San Diego, CA 92121  
Toll Free 1-800-368-5719

**CIRCLE 123 ON FREE INFORMATION CARD**



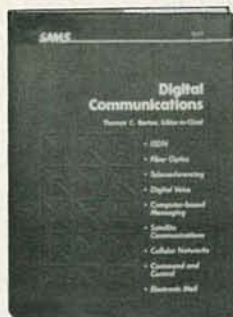

**9773**      **\$44.95**  
Examines the significant advances in communications technology. 406 pp.

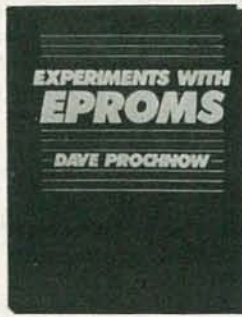

**2962P**      **\$17.95**  
Complete schematic diagrams, parts lists, and photos for building a variety of projects. 296 pp.



**9781**      **\$68.95**  
Designed to help deal effectively with today's fast-paced EMC technology. 707 pp.

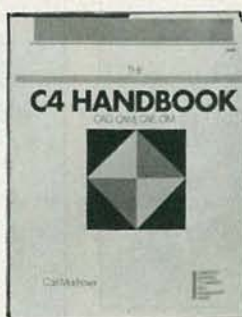

**3098**      **\$44.50**  
A comprehensive overview of CAD/CAM, CAE, and CIM concepts, capabilities and applications. 438 pp. *Counts as 2*



**3140**      **\$49.95**  
Includes details on PLD technology: architectural characteristics, tech. tradeoffs, logic synthesis, software tools, development systems, and hardware. 480 pp. *Counts as 2*

**ELECTRONIC COMPONENTS**



**3199**      **\$52.00**

**3199** SMT layout and design guidelines for efficient assembly processing, inspection and repair. 180 pp. *Counts as 2*



**2672**      **\$49.50**

**2672** Linear integrated circuits—specifications, prices & data. 614 pp.



**3151**      **\$39.95**

**3151** Provides detailed insight into every aspect of the engineering design process—from the preconcept phase through the life-cycle costs and commercial applications. 334 pp. *Counts as 2*

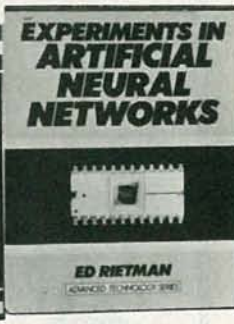

**3037**      **\$24.95**

**3037** Build your own neural networking breadboards—systems that can store and retrieve like the brain! 160 pp.



**9290**      **\$36.00**

**9290** Provides many never-before-published troubleshooting techniques and case histories. 315 pp. *Counts as 2*



**9305**      **\$59.50**

**9305** The solution-oriented handbook for practicing engineers at all levels. Contains hundreds of informative illustrations and diagrams demonstrating key principles. 600 pp. *Counts as 3*

**How the Club Works:**

**YOUR BENEFITS:** You get 3 books for \$4.95 plus shipping & handling when you join. You keep on saving with discounts of up to 50% as a member.

**YOUR PROFESSIONAL BOOKSTORE BY MAIL:** Every 3-4 weeks, you will receive the EE&D Book Club News describing the Main Selection and Alternates, as well as bonus offers and special sales, with scores of titles to choose from.

**AUTOMATIC ORDER:** If you want the Main selection, do nothing and it will be sent to you automatically. If you prefer another selection, or no selection at all, simply indicate your choice on the reply form provided. You will have at least 10 days to decide. As a member, you agree to purchase at least 3 books within the next 2 years and may resign at any time thereafter.

**BONUS BOOKS:** Starting immediately you will be eligible for our *Bonus Book Plan* with savings of up to 80% off publishers' prices.

**IRONCLAD NO-RISK GUARANTEE:** If not satisfied with your books, return them within 10 days without obligation!

**EXCEPTIONAL QUALITY:** All books are quality publishers' editions especially selected by our Editorial Board.

All books are hardcover unless number is followed by a "P" for paperback. (Publishers' Prices Shown)

©1990 EEDBC, Blue Ridge Summit, PA 17294-0860

**SEND NO MONEY NOW!**

**INTRODUCTORY 10-DAY FREE EXAMINATION**



**ELECTRONICS ENGINEERS & DESIGNERS BOOK CLUB<sup>SM</sup>**

Blue Ridge Summit, PA 17294-0860

**YES!** Please accept my membership in the *Electronics Engineers & Designers Book Club* and send my 3 volumes listed below billing me \$4.95. If not satisfied, I may return the books within 10 days and have my membership cancelled. I agree to purchase 3 or more books at regular Club prices during the next 2 years, and may resign at any time thereafter. A shipping/handling charge and sales tax will be added to each order.

--	--	--

Name \_\_\_\_\_

Address \_\_\_\_\_

City \_\_\_\_\_

State \_\_\_\_\_ Zip \_\_\_\_\_ Phone \_\_\_\_\_

Signature \_\_\_\_\_

Valid for new members only. Foreign applicants will receive special ordering instructions. Canada must remit in U.S. funds. This order is subject to acceptance by the *Electronics Engineers & Designers Book Club*. DRE1090



# ROCKET ALTIMETER

*Four...three...two...one...  
ignition! Model rocketry  
catches up with  
technology with this  
electronic altimeter.*

JOHN FLEISCHER

THE SPORT OF MODEL ROCKETRY allows hobbyists to manage their own miniature space program. Small-scale rockets, usually constructed from paper, plastic, and balsa wood, are routinely launched with commercially made solid-fuel motors. Reaching altitudes between 100 feet and several miles, model rockets are safely recovered by parachute to allow repeated flights and to reduce the risk of personal injury.

In NAR (National Association of Rocketry) contest events, a visual tracking system using triangulation is used to determine the peak altitude of each model. The contestant who launches his rocket out-of-sight, or through the clouds, will receive a "track lost" rating instead of altitude points. Visual tracking, dependent upon weather conditions and operator skill, can often be difficult, and the sport flyer who wants to know how high his model went will rarely take the time to set up and operate visual trackers.

Our rocket altimeter was developed to help contest and sport rocketeers determine their models' altitude without tracking. This airborne "flight-recorder" is an all-CMOS microcomputer that is coupled to an atmospheric pressure sensor via signal-conditioning circuitry. Powered by a 9-volt battery, the unit is small enough to be launched in a D-, E-, or F-motor powered model rocket. (The letters indicate the relative power of each engine; in alphabetical order, each engine is twice as powerful as the previous one.) The unit takes a pressure sample every  $\frac{1}{4}$  second and stores 1000 data values in memory during the flight.

The completed system contains two sections: the flight-recorder section that goes up in the rocket, and an LCD module that's used to display flight data back on the ground. When the rocket returns to Earth, the LCD module is connected to the flight recorder and the peak altitude achieved can be displayed in 50-foot increments, along with a  $\frac{1}{4}$ -speed "playback" of the entire flight. Rocketeers now

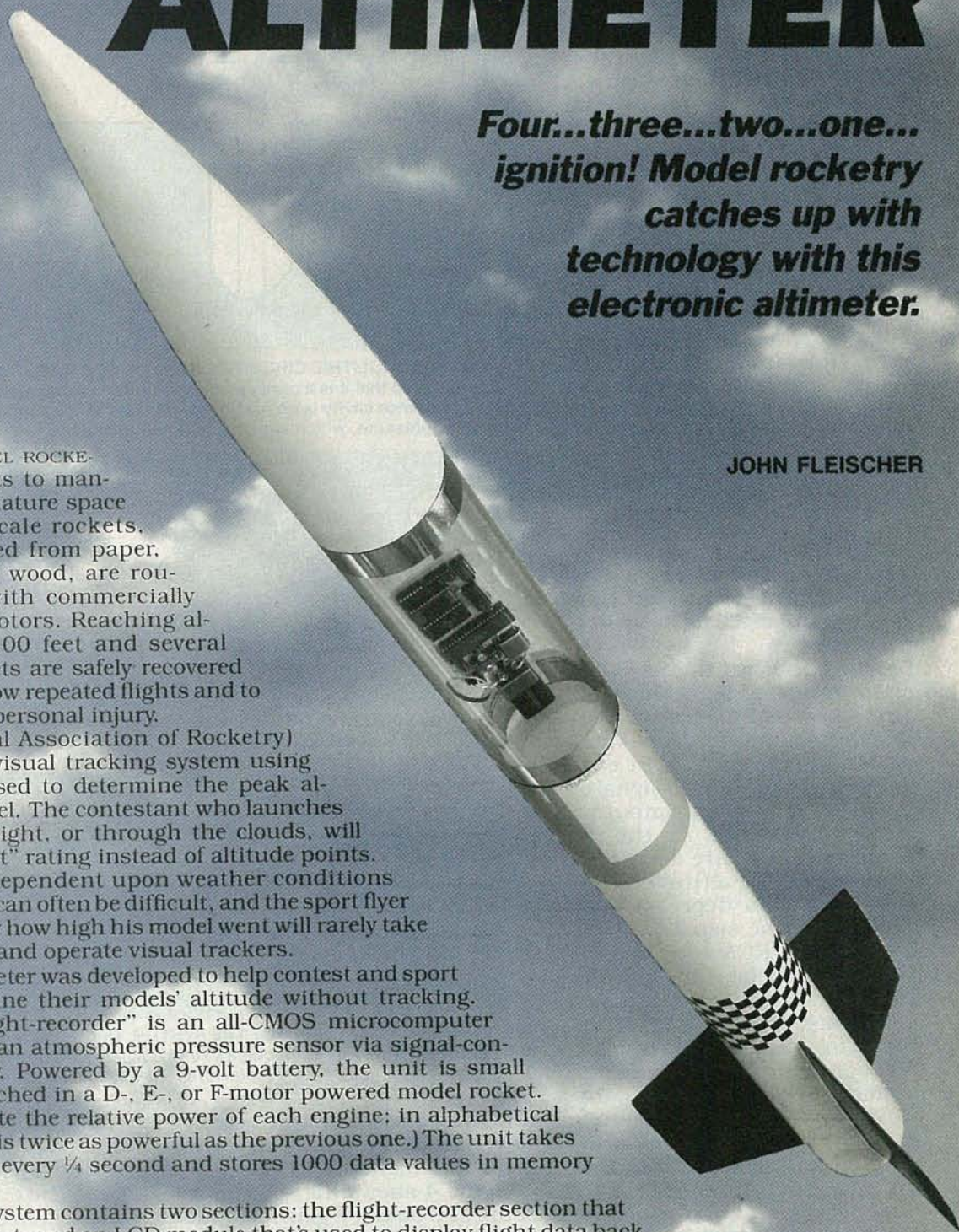



have a reliable and accurate means to measure the altitude that a model reaches. The data obtained can then be used to calculate the speed and acceleration of the rocket.

Figure 1 shows the construction and pinout of the SCX15AN pressure sensor used in the altimeter. The sensor, manufactured by Sensym (1255 Reamwood Ave., Sunnyvale, CA 94089), is a low-cost (about \$42) piezoresistive IC in a strain-gauge bridge configuration. The monolithic circuitry inside the sensor (see Fig. 2) is deposited on a silicon chip that has a cavity etched out to form a diaphragm. A port is on top, and a vacuum reference cavity is on the bottom. The result is a sensor that measures absolute barometric pressure. Output voltage ( $V_1 - V_2$ ) ranges from 10–50 mV, and is proportional to atmospheric pressure—which, of course, varies with altitude. Although the entire unit is not temperature compensated, the sensor itself is, by means of two built-in thermistors. Best accuracy for the altimeter is achieved in the 55–75°F range. Outside that range, a shift of 2% for every 10°F will occur.

Figure 3 shows the block diagram of the system. The pressure sensor is buffered with an LM324 op-amp to feed an LM331 voltage-to-frequency (V/F) converter. At ground level, a signal of about 3.7 kHz will be output by the V/F converter. As the atmospheric pressure decreases (with increasing altitude), that frequency also decreases; at 15,000 feet, the signal is about 2.9 kHz. An RCA 1802 microprocessor calculates the altitude data from the frequency input.

The entire system is made up from three separate PC boards, although only two ever leave the ground. The pressure sensor, the LM324 buffer, the V/F converter, and other support circuitry is located on an "analog" PC board, and the microprocessor and data-logging circuitry are on a "CPU" board. The two boards are held together with screws, and electrical connections are jumpered between the two. The display module is built on a separate PC board, and it stays on the ground; the module must be con-

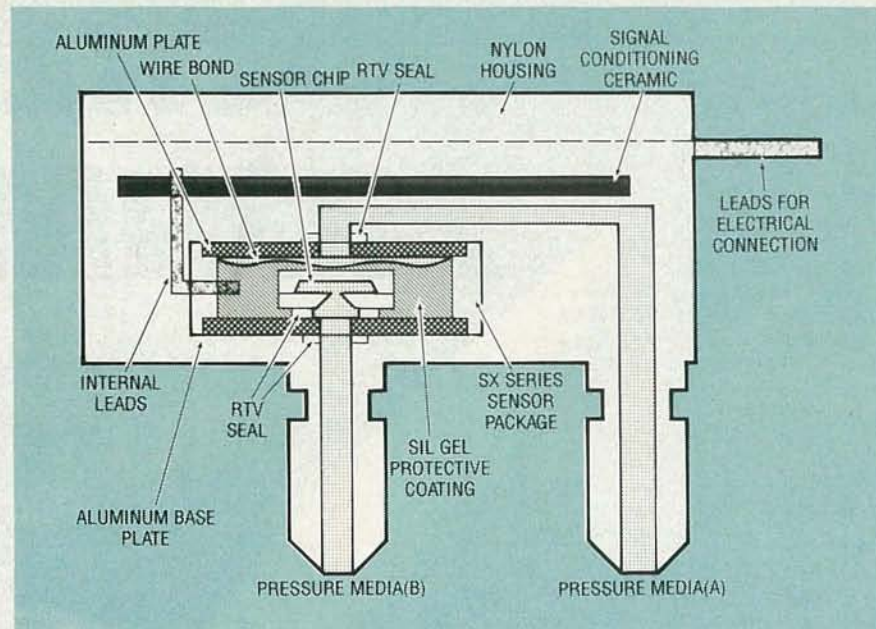

FIG. 1—THE MONOLITHIC CIRCUITRY inside the SCX15AN pressure sensor is deposited on a silicon chip that has a cavity etched out to form a diaphragm. A port is on top, and a vacuum reference cavity is on the bottom. The result is a sensor that measures absolute barometric pressure, which is then converted to altitude.

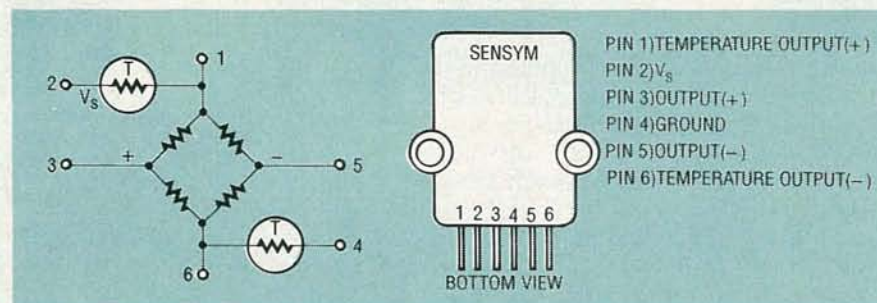

FIG. 2—THE SENSOR'S OUTPUT VOLTAGE ( $V_1 - V_2$ ) ranges from 10–50 mV, and is proportional to atmospheric pressure.

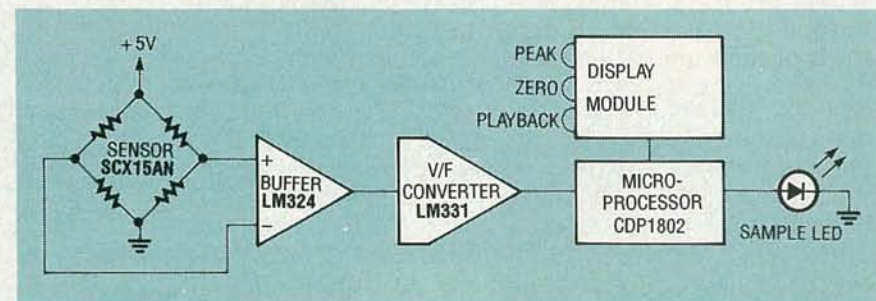

FIG. 3—THE BLOCK DIAGRAM OF THE SYSTEM. The pressure sensor is buffered with an op-amp to feed a voltage-to-frequency (V/F) converter. At ground level, a signal of about 3.7 kHz will be output by the V/F converter; at 15,000 feet, the signal is about 2.9 kHz.

nected to the other two boards via a ribbon cable to play back flight information.

Figure 4 shows the schematic of the CPU board; it gets its input from the analog board and logs the data every 1/4 second. The circuit consists of the microprocessor which calculates the altitude, the EPROM containing the operating software, and the RAM where the altitude data is

stored. Figure 5 shows the schematic of the analog board; the pressure sensor is located on this board. The output from the sensor is buffered and fed to the V/F converter, which provides the frequency input for the microprocessor. Figure 6 shows the schematic of the display module board. It is basically made up of the display driver and the display itself, but also contains the con-



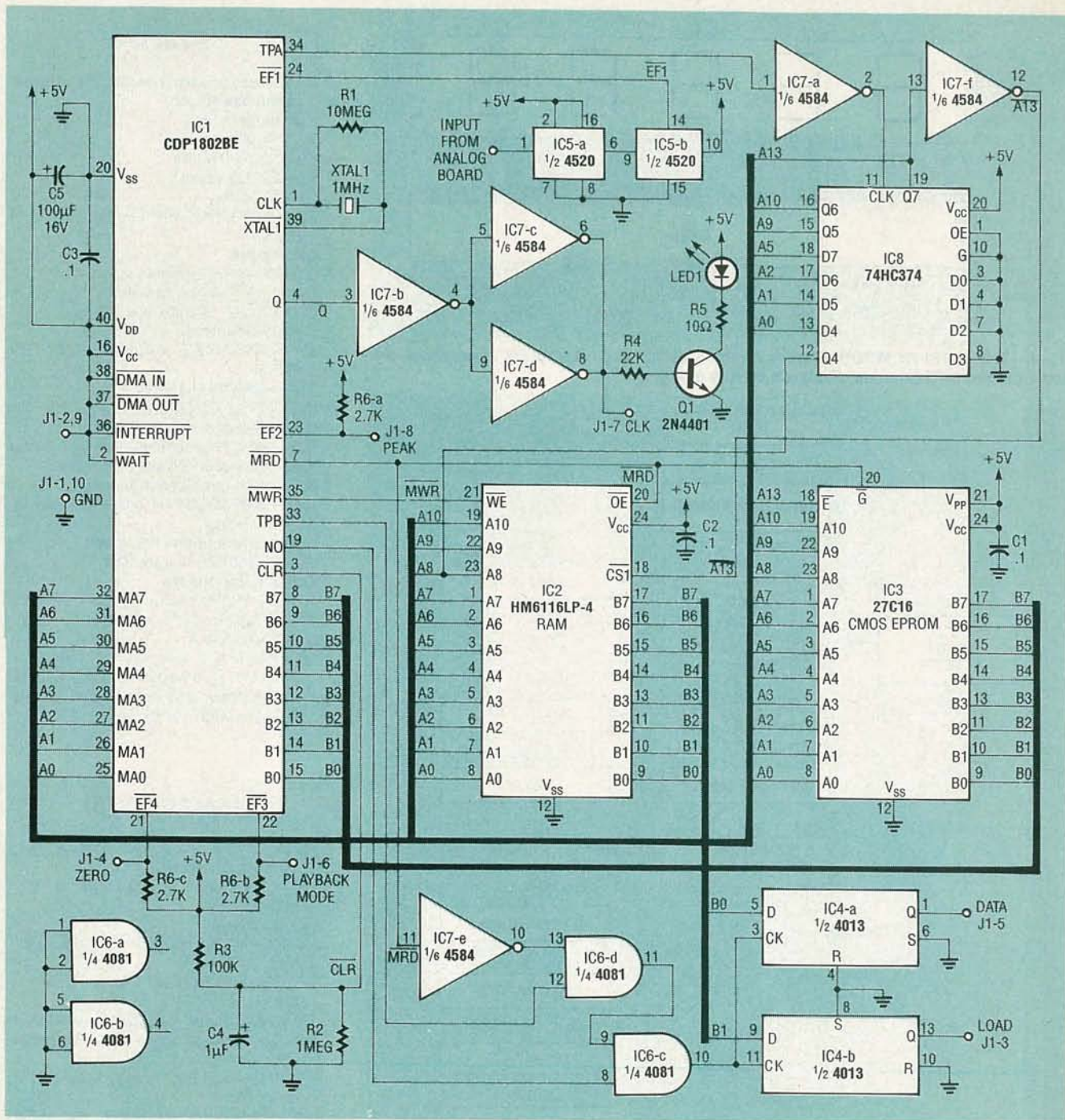

FIG. 4—THE SCHEMATIC OF THE CPU BOARD. It logs the data to be read back when the rocket returns to Earth.

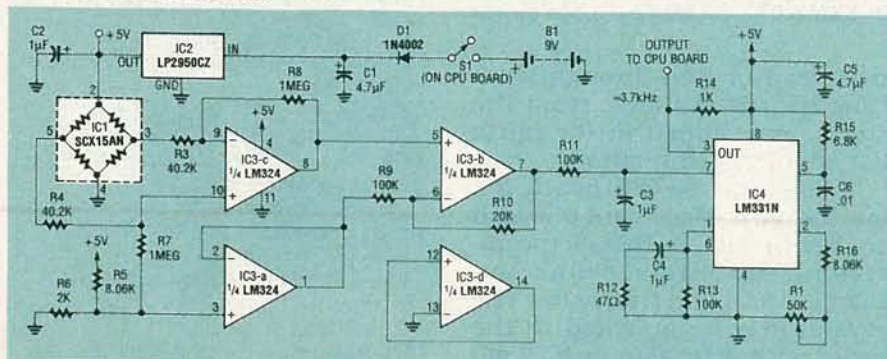

FIG. 5—THE ANALOG BOARD outputs a frequency that's proportional to altitude. The sensor (IC1) is located on this board.

control switches. Power for the display module comes from the other two boards via the ribbon cable.

The software for the altimeter is available on the R-E BBS—516-293-2283. (For those who prefer to type, the machine code for the EPROM is shown in Listing 1.) The flowchart for the program is shown in Fig. 7. The software handles data logging (the sample LED flashes every 1/4 second), mode switch input, and LCD interfacing.



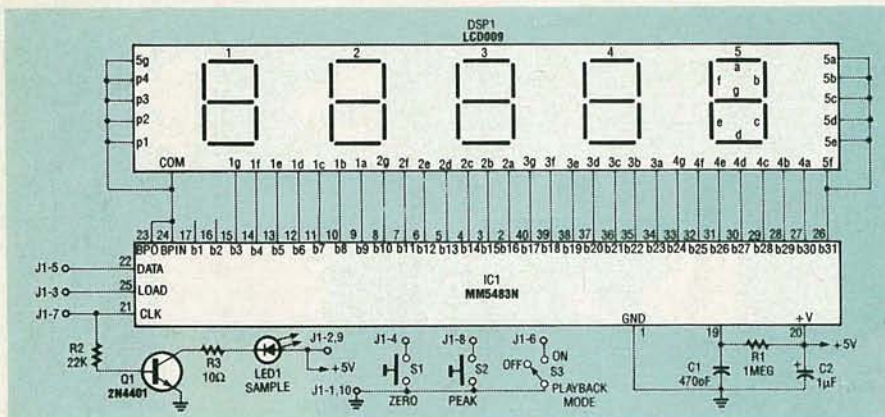

FIG. 6—THE DISPLAY MODULE stays on the ground; when the rocket is retrieved, the data from the CPU board is displayed on this module.

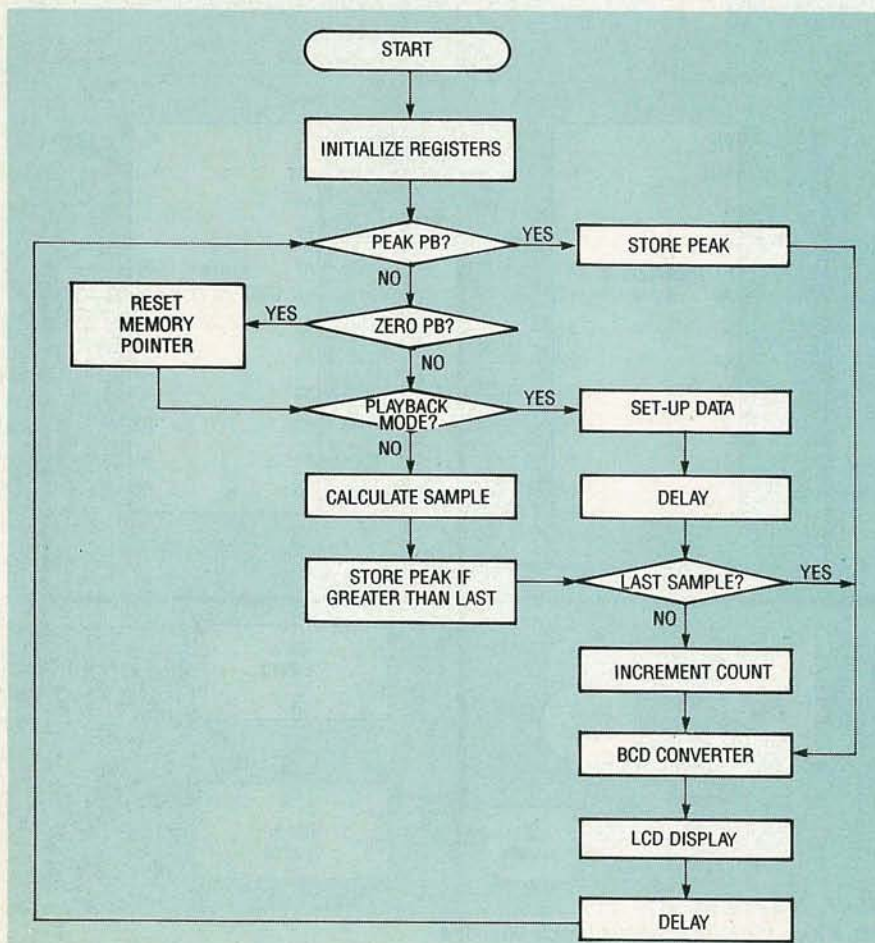

FIG. 7—THE SOFTWARE FOR THE ALTIMETER HANDLES data logging, mode switch input, and LCD interfacing.

### Construction

Three printed-circuit boards are used. The pressure sensor and analog section are combined on a single-sided PC board. The CPU board is double-sided, as is the board for the display module. If the holes in either of the double-sided boards are not plated-through, feed-through wires must be used instead. All pads on the top and bottom of the boards must be soldered to the compo-

nent lead or feed-through wire. (The boards available from the source mentioned in the parts list are plated-through.)

To assemble the CPU board, follow the parts-placement diagram shown in Fig. 8. Install the resistors, capacitors, connector, switch, LED, and transistor. The crystal may be fastened to the board with foam tape or RTV silicone cement. IC sockets should be used to ease any future repairs

### CPU BOARD

All resistors are 1/4-watt, 5%, unless otherwise noted.

- R1—10 megohms
- R2—1 megohm
- R3—100,000 ohms
- R4—22,000 ohms
- R5—10 ohms
- R6—2700 ohms, SIP resistor (cut to fit board)

### Capacitors

- C1—C3—0.1  $\mu$ F, monolithic
- C4—1  $\mu$ F, 25 volts, tantalum
- C5—100  $\mu$ F, 16 volts, electrolytic

### Semiconductors

- IC1—CDP1802CE microprocessor (GE/RCA)
- IC2—HM6116LP-4 RAM
- IC3—27C16 CMOS EPROM
- IC4—4013 dual D-type flip flop
- IC5—4520 dual synchronous up counter
- IC6—4081 quad 2-input AND gate
- IC7—4584 hex Schmitt trigger
- IC8—MM74HC374N octal tri-state D-type flip-flop

LED1—red light-emitting diode

Q1—2N4401 NPN transistor

### Other components

- XTAL1—2 MHz crystal
- S1—PC-mount slide switch
- J1—10-pin header

### Miscellaneous:

- 10-conductor ribbon cable, 3 1/4-inch #6 spacers, 3 #6-32  $\times$  1/2-inch screws and nuts, PC board, IC sockets, wire, solder, etc..

### ANALOG BOARD

All resistors are 1/4-watt, 5%, unless otherwise noted.

- R1—50,000 ohms, 25-turn trimmer potentiometer
- R2—not used
- R3, R4—40,200 ohms, 1/8-watt, 1%, metal-film
- R5, R16—8060 ohms, 1/8-watt, 1%, metal-film
- R6—2000 ohms, 1/8-watt, 1%, metal-film
- R7, R8—1 megohm, 1/8-watt, 1%, metal-film
- R9, R13—100,000 ohms, 1/8-watt, 1%, metal-film
- R10—20,000 ohms, 1/8-watt, 1%, metal-film
- R11—100,000 ohms, 5% resistor, 1/4W
- R12—47 ohms
- R14—1000 ohms
- R15—6800 ohms, 1/8-watt, 1%, metal-film

### Capacitors

- C1, C5—4.7  $\mu$ F, 16 volts, tantalum
- C2—C4—1  $\mu$ F, 25 volts, tantalum
- C6—0.01  $\mu$ F, 50 volts, 5% film-type

### Semiconductor

- IC1—SCX15AN pressure sensor
- IC2—LP2950CZ-5.0, 5-volt regulator
- IC3—LM324N op-amp
- IC4—LM331N voltage-to-frequency converter
- D1—1N4002 diode

Miscellaneous: 9-volt battery and clip, PC board, IC sockets, wire, solder, etc..



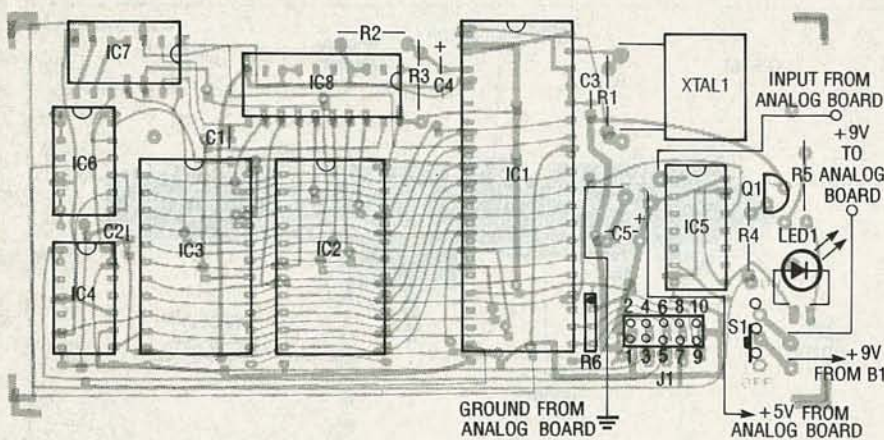

FIG. 8—WHEN ASSEMBLING THE CPU BOARD, the crystal should be fastened to the board with foam tape or RTV silicone cement to prevent damage due to vibration.

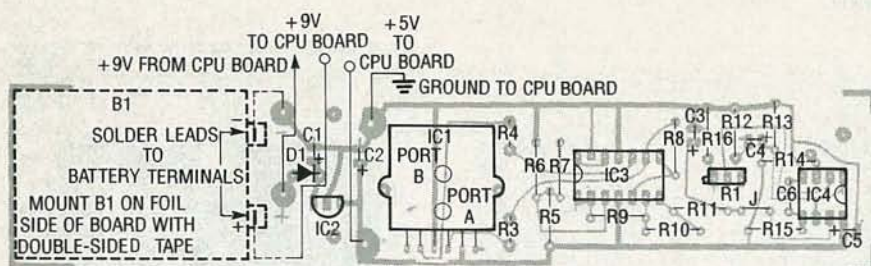

FIG. 9—THE ANALOG-BOARD PARTS LAYOUT. Carefully install the pressure sensor and, if you ever clean the PC board, do not allow any solvent or moisture to enter the sensor port.

#### DISPLAY MODULE

All resistors are ¼-watt, 5%, unless otherwise noted.

R1—1 megohm  
R2—22,000 ohms  
R3—10 ohms

#### Capacitors

C1—470 pF, ceramic disc  
C2—1 µF, 25 volts, tantalum

#### Semiconductors

IC1—MM5483N display driver  
DSP1—LCD009 LCD module  
LED1—red light-emitting diode  
Q1—2N4401 NPN transistor

#### Other components

J1—10-pin header  
S1, S2—momentary pushbutton switch  
S3—SPST toggle switch

**Miscellaneous:** 4 #6-32 × 1-inch screws and nuts, 8 ¼-inch #6 spacers, case, clear plastic sheet for display window, 40-pin wirewrap socket strip, PC board, wire, solder, etc..

**Note:** The following items are available from Transolve Corporation, 13361 Shady Lane, Chesterland, Ohio 44026 (216) 341-5970: Pressure sensor, \$42; PC board set, \$35; complete kit (except case), \$135; EPROM only, \$15; machined case and custom EPROM's available on request. For large-scale rocket kits contact North Coast Rocketry, P.O. Box 24468, Mayfield Heights, Ohio 44124. For more information on model rocketry in general, contact the National Association of Rocketry, 2140 Colburn Drive, Shakopee, MN 55379.

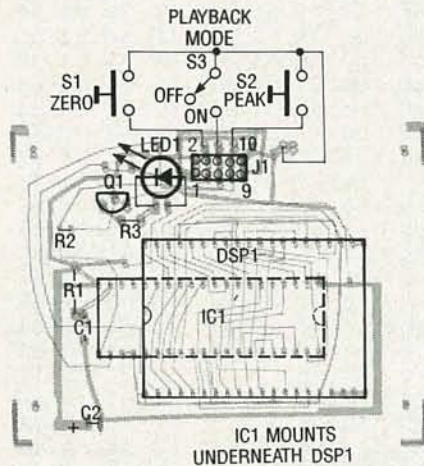

FIG. 10—DISPLAY BOARD parts-placement diagram. The LCD module is plugged into wire wrap socket strips above IC1.

(Transolve Corp. will not service any non-socketed unit).

Follow the analog-board parts layout shown in Fig. 9, and install the resistors, jumper wire, diode, and capacitors. Note that C6 must be a film-type capacitor—a disc capacitor will cause excessive drift with temperature. Next install the trimmer potentiometer and the IC's. Carefully install the pressure sensor as

shown. If you ever clean the PC board, do not allow any solvent or moisture to enter the sensor port, or you'll damage it. You must test the analog board before attaching it to the CPU board.

The display board parts-placement diagram is shown in Fig. 10. Install the resistors, capacitors, connector, LED, and IC1. The LCD module is plugged into wire-wrap socket strips above IC1. Space the top of the strips ¼-inch from the board. Make sure the LCD pins are perfectly straight, and press the display into the socket strips. The finished analog/CPU assembly is shown in Fig. 11, and the display module in Fig. 12.

#### Testing and calibration

Connect a 9-volt battery to the + and - battery input pads on the analog board. Connect your DVM and scope ground leads to battery -. The regulator output (IC3 pin 4) should measure 5 volts. Set R1 to midpoint. Connect scope probe to IC4 pin 3; this output signal should be a short, negative-going pulse, repeating at about 3.7 kHz. Adjust R1 to obtain that value. Use a frequency counter if one is available. Apply suction to sensor port A (draw a vacuum with your mouth) and verify that the signal frequency decreases slightly.

If the analog board is functioning, it can now be attached to the CPU board. The wire attachment points are designated in the three parts layouts. The 9-volt battery's positive lead connects to the CPU board, and the 9 volts from the CPU board is jumped over to the analog board. Also remember to connect ground, +5 volts, and the analog output between the two boards. A rocket is a very high vibration environment, so the 9-volt battery snap must be taped on, or the leads must be soldered to the battery. After the electrical connections are made between the two boards, the analog board is fastened to the CPU board with three screws, spacers, and nuts.

Wire the pushbutton and toggle switches to the display PC board as shown in the display-module parts-placement diagram. One of the normally open pushbuttons is used to select



PEAK, and the other ZERO. The toggle switch selects the playback mode (when closed). Install the header connectors on the ribbon cable that goes between the CPU and display boards, and connect the two boards together.

Turn the power switch on and open the playback switch. The sample LED on the CPU and display boards should be flashing four times per second. A value of several thousand feet should be displayed. Adjust R1 on the analog board for a reading of 100 feet, then 50 feet, and the unit will then be calibrated for ground level. Do not adjust past that threshold, or the altitude mea-

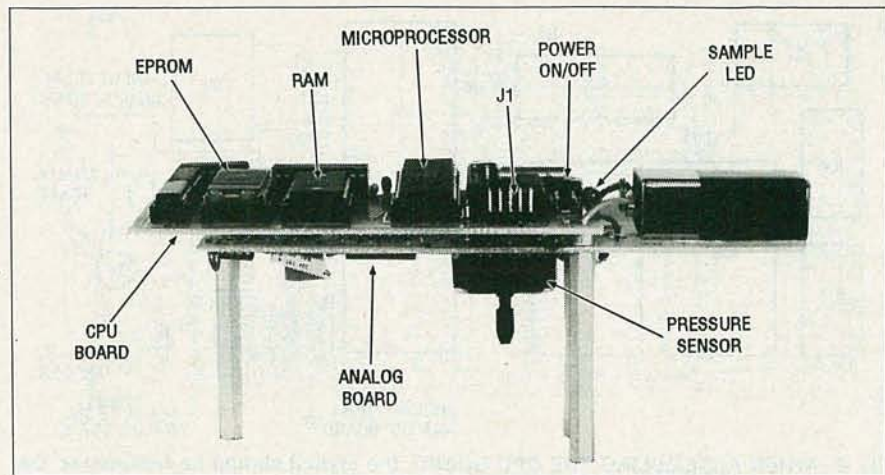

FIG. 11—THE FINISHED ANALOG/CPU ASSEMBLY. It fits in the payload section of a rocket.

LISTING 1

```

000000 c0 00 c5 f8 00 b3 f8 fa a3 7a e3 65 7b 7a 7b 7a
000010 f8 20 b5 b1 f8 06 a5 f8 02 a1 f8 00 b2 f8 f0 a2
000020 f8 02 55 e1 82 f4 a2 e5 02 f2 32 31 f8 fb a3 30
000030 34 f8 fa a3 7a e3 65 7b 7a 05 fe 55 3a 27 11 81
000040 fb 06 3a 1a f8 fb a3 7a e3 65 7b 7a 65 65 f8 00
000050 a9 b9 19 99 fb 10 3a 52 c0 00 db f8 00 a4 b4 3c
000060 5f 34 61 14 3c 63 f8 00 a5 f8 05 b5 c0 01 85 fb
000070 00 3a 6c c0 01 0e f8 05 a1 f8 20 b1 e1 f8 00 73
000080 73 73 51 c4 c4 f8 05 a1 01 32 90 f8 00 51 30 95
000090 f8 05 51 30 bb 21 01 fb 09 32 a1 f8 01 f4 51 30
0000a0 bb f8 00 73 01 fb 09 32 af f8 01 f4 51 30 bb f8
0000b0 00 73 01 fb 09 32 bb f8 01 f4 51 24 94 3a 85 84
0000c0 3a 85 c0 00 03 f8 00 a6 b6 a7 b7 f8 20 ad bd c0
0000d0 01 c0 c4 c4 c4 c4 c4 c4 c4 c4 c4 c4 c4 c4 c4
0000e0 ea c0 01 45 c0 01 07 c0 01 00 c0 01 78 c4 c4 c4
0000f0 fc 60 da f2 66 b6 be e0 fe e6 00 01 02 00 c4 c4
000100 96 b4 86 a4 c0 00 76 f8 00 a7 b7 f8 20 ad bd c0
000110 00 df c4 c4 c4 c4 c4 c4 c4 c4 c4 c4 c4 c4 c4
000120 84 af 96 be 86 ae 9f 3a 2c 8f 32 36 2f 9e 3a 33
000130 8e 32 26 2e 30 26 9e 3a 3c 8e 32 3e 30 42 94 b6
000140 84 a6 c0 01 a0 f8 00 a4 b4 3c 49 34 4b 14 3c 4d
000150 f8 00 a5 f8 05 b5 94 3a 61 84 fb 01 3a 61 c0 01
000160 70 24 25 95 3a 56 30 5e c4 c4 c4 c4 c4 c4 c4 c4
000170 94 5d 1d 84 5d 1d 30 1e 4d b4 4d a4 f8 00 a9 b9
000180 19 99 fb 30 3a 80 30 a0 c4 c4 c4 c4 c4 c4 c4 c4
000190 c4 c4 c4 c4 c4 c4 c4 c4 c4 c4 c4 c4 c4 c4 c4 c4
0001a0 97 fb 03 3a af 87 fb f0 3a af 2d 2d c0 00 76 17
0001b0 30 ac c4 c4 c4 c4 c4 c4 c4 c4 c4 c4 c4 c4 c4 c4
0001c0 f8 20 a5 b5 f8 00 55 15 f8 01 55 15 95 fb 28 3a
0001d0 c4 c0 00 db c4 c4 c4 c4 c4 c4 c4 c4 c4 c4 c4 c4
0001e0 c4 c4 c4 c4 c4 c4 c4 c4 c4 c4 c4 c4 c4 c4 c4 c4
0001f0 c4 c4 c4 c4 c4 c4 c4 c4 c4 c4 c4 c4 c4 c4 c4 c4
000200 c4 ...

```

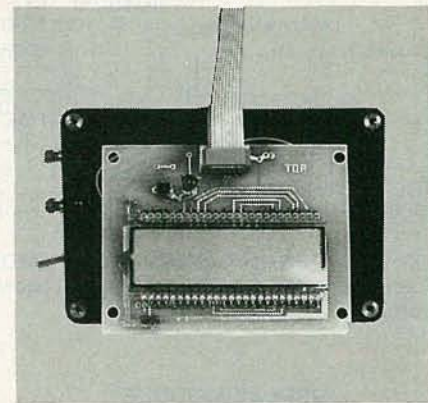
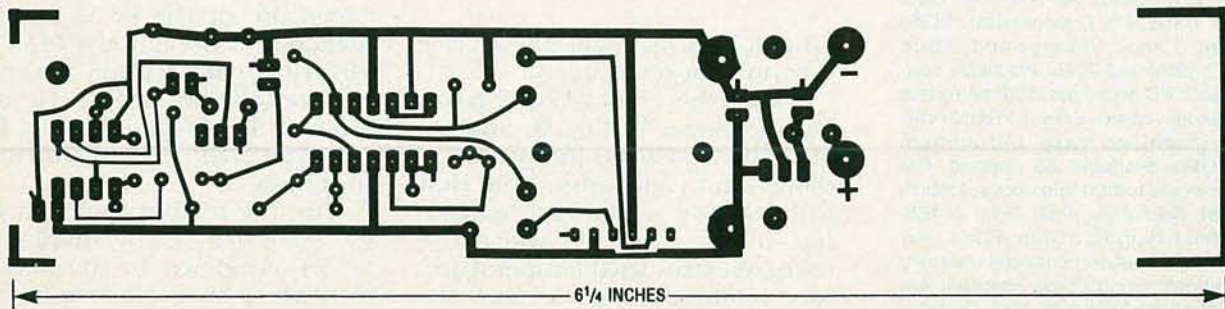

FIG. 12—THE DISPLAY MODULE can be housed in any kind of project case you can find.



THE ANALOG BOARD USES THIS FOIL PATTERN.



surements may be inaccurate. If the potentiometer adjustment is far off, the microprocessor may

not cycle. If a 50-foot reading cannot be achieved, your altitude above sea level may be excessive.

In that case, simply adjust the value of R16 on the analog board: increase it by 1K to decrease the reading by 1000 feet, or decrease it by 1K to increase the reading by 1000 feet. Note that the potentiometer has enough range to allow for "simulated flights" of thousands of feet.

If the unit doesn't run, check for correct parts placement, solder bridges, and other defects. Verify that a 2-MHz signal exists on IC1 pin 1. The crystal circuit has a very high impedance. Any moisture or contamination may prevent oscillation (rosin flux won't hurt). Touching pins 1 or 39 of the microprocessor can cause the program to crash! Spraying the crystal area with clear lacquer is recommended. To reset the program, turn the power off for 5 seconds, then turn it back on. Removing the battery power will erase data. Switching the **PLAYBACK** switch to off will resume data logging at whatever sample was last displayed. The unit must be reset (turn off for 5 seconds, then on) before the next flight.

#### Prepare for launch

Mount the flight-recorder in the rocket payload section. Pack it securely with foam or some other support so that it will not rattle during flight. Punch several 1/4-inch holes in the body tube near the sensor. An access port may be cut out to allow the ribbon cable to be attached.

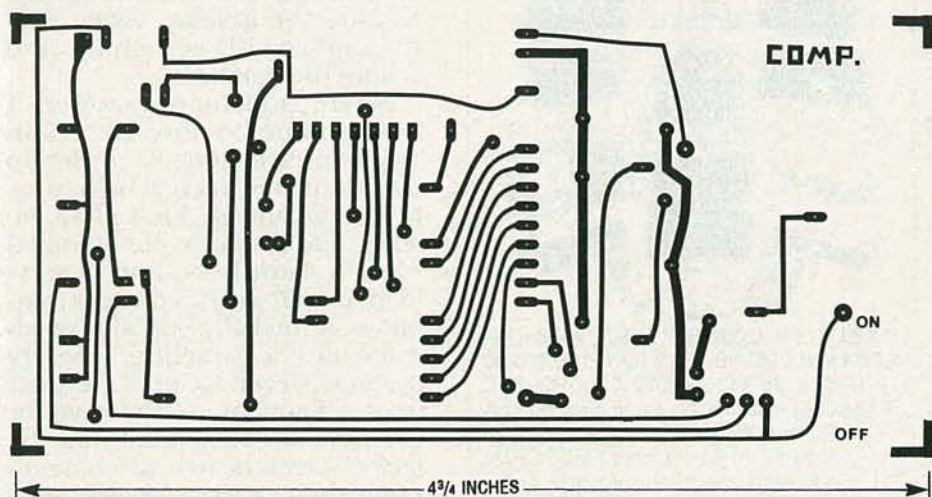

THE COMPONENT SIDE OF THE CPU BOARD.

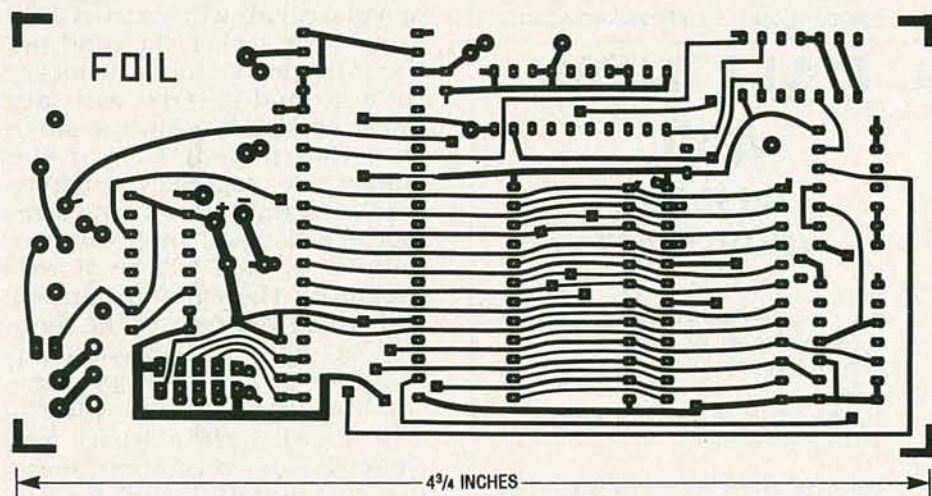

THE SOLDER SIDE OF THE CPU BOARD.

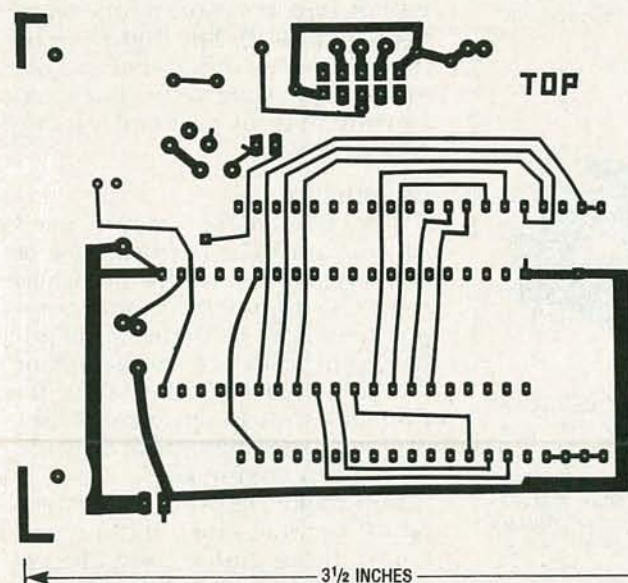

DISPLAY MODULE COMPONENT SIDE.

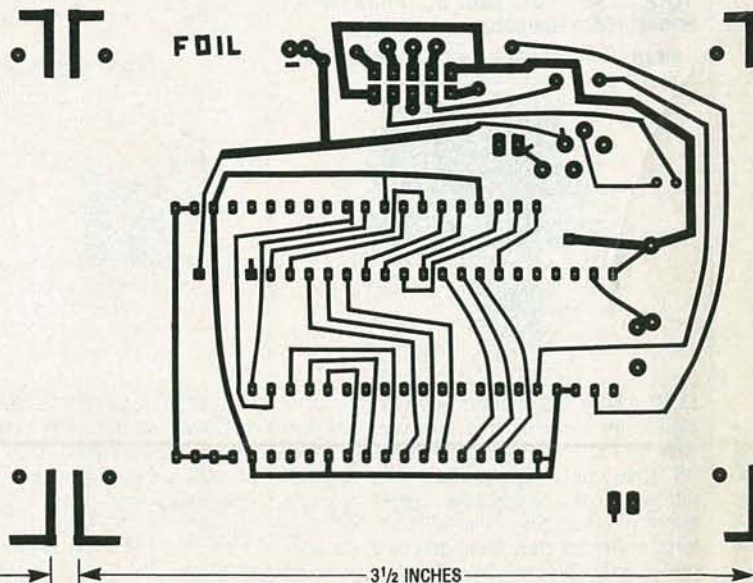

DISPLAY MODULE SOLDER SIDE.



# Radio Electronics® mini-ADS

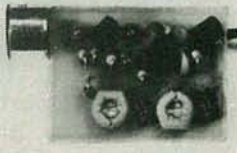

**SIMPLY SNAP THE WAT-50 MINIATURE FM TRANSMITTER** on top of a 9v battery and hear every sound in an entire house up to 1 mile away! Adjustable from 70-130 MHZ. Use with any FM radio. Complete kit **\$29.95 + \$1.50 S + H**. Free shipping on 2 or more! COD add \$4. Call or send VISA, MC, MO. **DECO INDUSTRIES, Box 607, Bedford Hills, NY 10507. (914) 232-3878.**

CIRCLE 127 ON FREE INFORMATION CARD



**CABLE TV CONVERTERS AND DE-SCRAMBLERS** SB-3 **\$79.00** TRI-BI **\$95.00** MLD-**\$79.00** M35B **\$69.00** DRZ-DIC **\$149.00**. Special combos available. We ship COD. Quantity discounts. Call for pricing on other products. Dealers wanted. FREE CATALOG. We stand behind our products where others fail. One year warranty. **ACE PRODUCTS, P.O. Box 582, Saco, ME 04072 1 (800) 234-0726.**

CIRCLE 75 ON FREE INFORMATION CARD



**FREE CATALOG OF HARD-TO-FIND TOOLS** is packed with more than 2000 quality items. Your single source for precision tools used by electronic technicians, engineers, instrument mechanics, schools, laboratories and government agencies. Also contains Jensen's line of more than 40 tool kits. Send for your free copy today! **JENSEN TOOLS INC., 7815 46th St., Phoenix, AZ 85044. (602) 968-6231.**

CIRCLE 115 ON FREE INFORMATION CARD

## CALL NOW AND RESERVE YOUR SPACE

- 6 x rate \$940.00 per each insertion.
- Fast reader service cycle.
- Short lead time for the placement of ads.
- We typeset and layout the ad at no additional charge.

Call **516-293-3000** to reserve space. Ask for Arline Fishman. Limited number of pages available. Mail materials to: mini-ADS, RADIO-ELECTRONICS, 500-B Bi-County Blvd., Farmingdale, NY 11735.

FAX: 516-293-3315

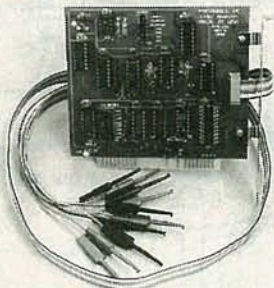

**LOW COST PC LOGIC ANALYZER.** Designed for students and hobbyists working with 5V TTI/CMOS signals in the Khz range. 36" data cable—eight channels, external clock, ground. Selectable trigger & clock edge, internal clock (1Hz-100Khz). Full-featured software, state table graphics, file/print utilities, etc. Over 100,000 samples/sec on 12 Mhz AT. LA1—**\$99.95**. **PHOTRONICS, INC. 109 Camille St., Amite, LA 70422 (504) 222-4146.**

CIRCLE 179 ON FREE INFORMATION CARD



**THE MODEL WTT-20 IS ONLY THE SIZE OF A DIME**, yet transmits both sides of a telephone conversation to any FM radio with crystal clarity. Telephone line powered - never needs a battery! Up to 1/4 mile range. Adjustable from 70-130 MHZ. Complete kit **\$29.95 + \$1.50 S + H**. Free Shipping on 2 or more! COD add \$4. Call or send VISA, MC, MO. **DECO INDUSTRIES, Box 607, Bedford Hills, NY 10507. (914) 232-3878.**

CIRCLE 127 ON FREE INFORMATION CARD

Activate the unit with the display connected and verify ground calibration (a 50-foot reading). Unplug the display, verify that the sample LED is flashing, and secure the hatch.

Before launching, however, it is important to observe certain safety precautions in order to avoid unnecessary injury or property damage. First of all, always use properly constructed rockets, launchers, and factory-loaded NAR-certified rocket engines. A model rocket should always have a parachute recovery system. Never launch a rocket with a flammable, explosive, or live payload. Make sure that the launch area is free of obstructions such as trees, power lines, and low-flying planes. Also avoid launching rockets on windy days or when clouds will obstruct your view of the rocket. To avoid fire hazards, never launch a rocket from ground covered with dry grass or shrubs. Always make sure that nobody is near the launch site, especially children.

Launch the rocket using a remote ignition system. About four minutes of data will be stored, including the time on launch pad. When you recover the rocket, plug in the display, press the PEAK button, and the peak altitude achieved will be displayed.

Next, switch the playback toggle to the closed position. Press the ZERO button (hold it for two sample LED flashes) and release. This will start playback from location zero at 1/4 speed (one sample per second). The flight can be played back as many times as desired by pushing ZERO. The ZERO button may be pushed at any time to restart.

### Conclusion

The collected data may be used to determine the performance of a model rocket. Many modelers are flying high-performance composite motors in their "birds" allowing altitudes of thousands of feet to be reached. Use of the altimeter can help optimize rocket designs to get maximum altitude for a given engine size.

Non-rocket uses of the system might include kites, hot-air balloons, hang-gliders, skydivers, and mountain climbers. Whatever your application, be careful...and have fun!

R-E



# BUILD THIS 1.6-GHZ COUNTER PRESCALER

FRED J. HUFFT



**Build this low-cost, high-performance, 1.6-GHz amplifier/prescaler. You may want to keep that old frequency counter a while longer.**

ENGINEERS, TECHNICIANS, AND EXPERIMENTERS who work with state-of-the-art electronics have an almost continuous need to update their test equipment in this rapidly changing field. Higher-frequency, less expensive circuits have brought forth a new generation of inexpensive frequency counters with improved sensitivity that can measure into the microwave region.

With the increased usage of higher frequencies, many quality-built counters are being discarded mainly due to inadequate range. Many of these instruments may only work up to 50–100 MHz, but have valuable features, including ultra-stable time bases that might yield much greater accuracy than could be found in newer, less expensive models.

Enter our solution, a two-stage amplifier and divide-by-10 or -100 prescaler, with 10-segment LED signal strength indicator. It's inexpensive, compact, and can fit into a much larger instrument, like the Hewlett-Packard (HP) Corp. 5245L counter shown in Fig. 1. It has a typical sensitivity of 5 millivolts RMS from 50 MHz–1.6 GHz, and used with such a high-quality, low-range counter, is a practical way to update your gear.

Many high-quality, major brand, low-range counters are available as surplus for \$50–200. They're worth at least that much, if only for the time base, while a newer comparable counter may cost several times as much. The prescaler isn't just for old counters; it's for any counter you'd like to extend the range or sensitivity of, or provide with an LED bargraph indicator.

Several divider schemes were considered for the prescaler, trading off bandwidth against cost; the original goal was 50 MHz–1.5 GHz performance with excellent sensitivity. The prescaler divides (prescales) by 10 from 30–500 MHz, and by 100 from 300 MHz–1.6 GHz, for optimal resolution from a basic counter.

If you want to use a direct 50-MHz counter with 1-Hz resolution and a one-second gate to measure up to 450 MHz, you'd have to prescale by 10 for a 7-digit resolution in one second, compared with 6-digit resolution if you prescaled by 100. To maximize display resolution requires that the prescaler be able to divide by 10 to reach 500 MHz. Binary dividers are cheaper and more common than decimal versions, and prescaling by 256, 512 or 1024 is easier than by 100 or

1000, but decimal division lets you move a decimal point mentally, and easily understand the reading.

## Circuit description

Figure 2 shows the block diagram of the prescaler, and Fig. 3 shows its schematic. IC5 has both  $\div 2$  and  $\div 5$  outputs, the one in use being selected using S2. With S2 set to  $\div 100$ , IC3 is a  $\div 4$ , and IC4 and IC5 are  $\div 5$ 's, for a  $\div 100$ . With S2 set to  $\div 10$ , the input is routed around IC3 to IC4 by PIN diode D4 (acting as a bandswitch). IC4 is a  $\div 5$  counter, and IC5 is a  $\div 2$  counter, creating a  $\div 10$  counter overall. IC1 and IC2 are broadband Monolithic Microwave IC (MMIC) amplifiers used on both ranges. The output of IC1 drives LED bargraph DSP1, the RF signal strength indicator. It's very useful as a relative field strength meter, for peaking the output of a circuit, or just as a convenient indication of signal presence.

In the prescaler, D4 is used for bandswitching. When reverse-biased, its capacitance is almost constant from 0.65–0.75 pF. When forward-biased, its capacitance rises rapidly to 6 pF or more. Its cathode is kept at about +2.5 volts DC by voltage divider R7-R8; the drop across L4 is neg-



ligible. S2-a and S2-b switch the anode of D4 between +5 volts DC and ground, so there's  $\pm 2.5$  volts DC across D4, relative to the cathode.

With S2 set to  $\div 10$ , D4 is forward-biased, so its capacitance increases as noted above, and the total impedance looking into the anode of D4 goes down, routing the output of IC2 through D4 and C9 to IC4. When S2 is set to  $\div 10$ , IC3 is off, since pin 1 ( $V_{CC}$ ) is connected to +5 volts DC through R5. The R5-IC3 voltage divider reduces the potential at pin 1 to about 1.25 volts DC, turning IC3 off. However, you might wonder: Why not just turn off IC3 altogether?

The reason is that C10 still looks into pin 7 (OUT 2), and would see too low an impedance if IC3 were totally off, and too much of IC2's output would be diverted away from IC4. The value of R5 was found by trial-and-error, to maximize the impedance looking into pin 7 (OUT 2), while keeping IC3 off. Conversely, when S2 is on  $\div 100$ , IC3 is now on, since it's now connected to +5 volts DC through R5 and R6, and their parallel value is under 1.5 ohms. The cathode of D4 is still at +2.5 volts DC, but the anode is effectively grounded, so D4 is reverse-biased.

The capacitance of D4 is now about 10% of its forward-biased value, increasing capacitive reactance by about a factor of 10. The impedance looking into the anode of D4 thus increases, and almost no output from IC2 reaches IC4 directly. The output of IC2 enters IC3, is divided, and passed to IC4.

To avoid splitting the output of IC3 between IC4 and the path along C9, trial-and-error again resulted in a high-impedance path looking into the top of C9. In other words, the high impedance of a reverse-biased D4 works both ways. It keeps the output of IC2 from being diverted to IC4, while keeping the output of IC3 from being diverted backward. The loss of output of IC3 through C9-L4-R8 is minimal.

The input enters through J1 and is AC-coupled through IC1 and IC2, Avantek MSA0104 MMIC amplifiers. They have double grounds and indirect biasing, through R1-L1-C26 for IC1, and



FIG. 1—THE PANEL-MOUNTED VERSION of the prescaler, in an HP 5245L frequency counter. The HP5245L is often available as surplus for about \$200, and the prescaler is a good way to update it.

R2-L2-C15 for IC2. Carbon-composition resistors R1 and R2 temperature-compensate collector current in IC1 and IC2. L1 and L2 prevent R1 and R2 from affecting the load impedance, which would reduce amplifier gain. IC3 is an NEC UPB582  $\div 4$  MMIC prescaler, with R3, C8, C9, and D4 as its bypass for the  $\div 10$ . D4 is a Motorola MPN3401 PIN diode, while R7 and R8 produce a +2.5-

volt DC bias at the cathode (the output) of D4 via L4. D4 is biased on or off by the 0 or 5 volts DC switched through L3 at its anode.

Device IC4 is a Motorola MC12009 emitter-coupled logic (ECL)  $\div 5$  prescaler, with a built-in ECL-to-TTL output level converter. R9 keeps the circuit stable with no signal input. IC5 is a TI 74S196 presettable binary/de-

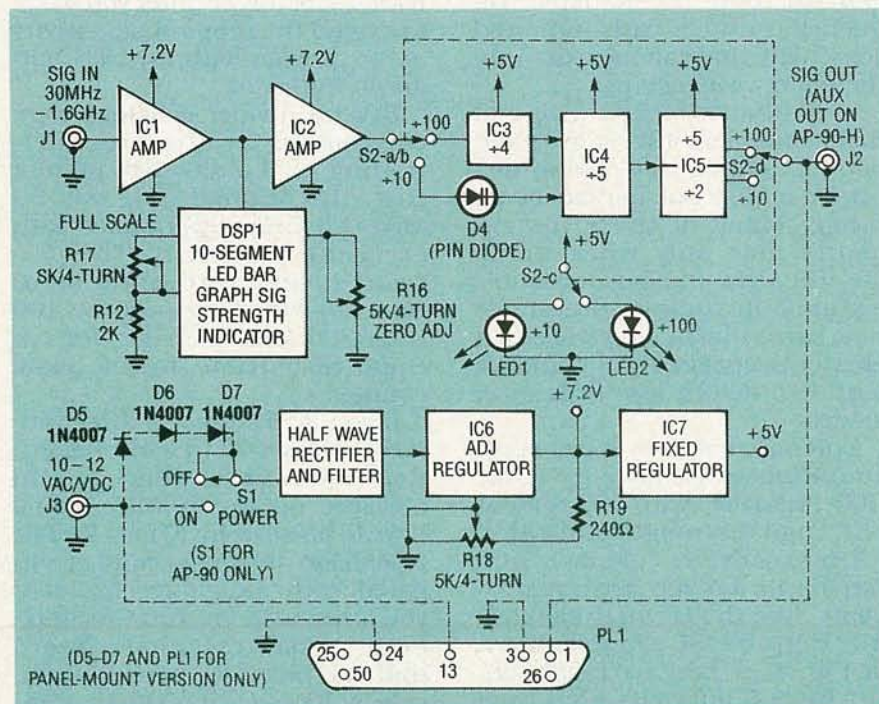
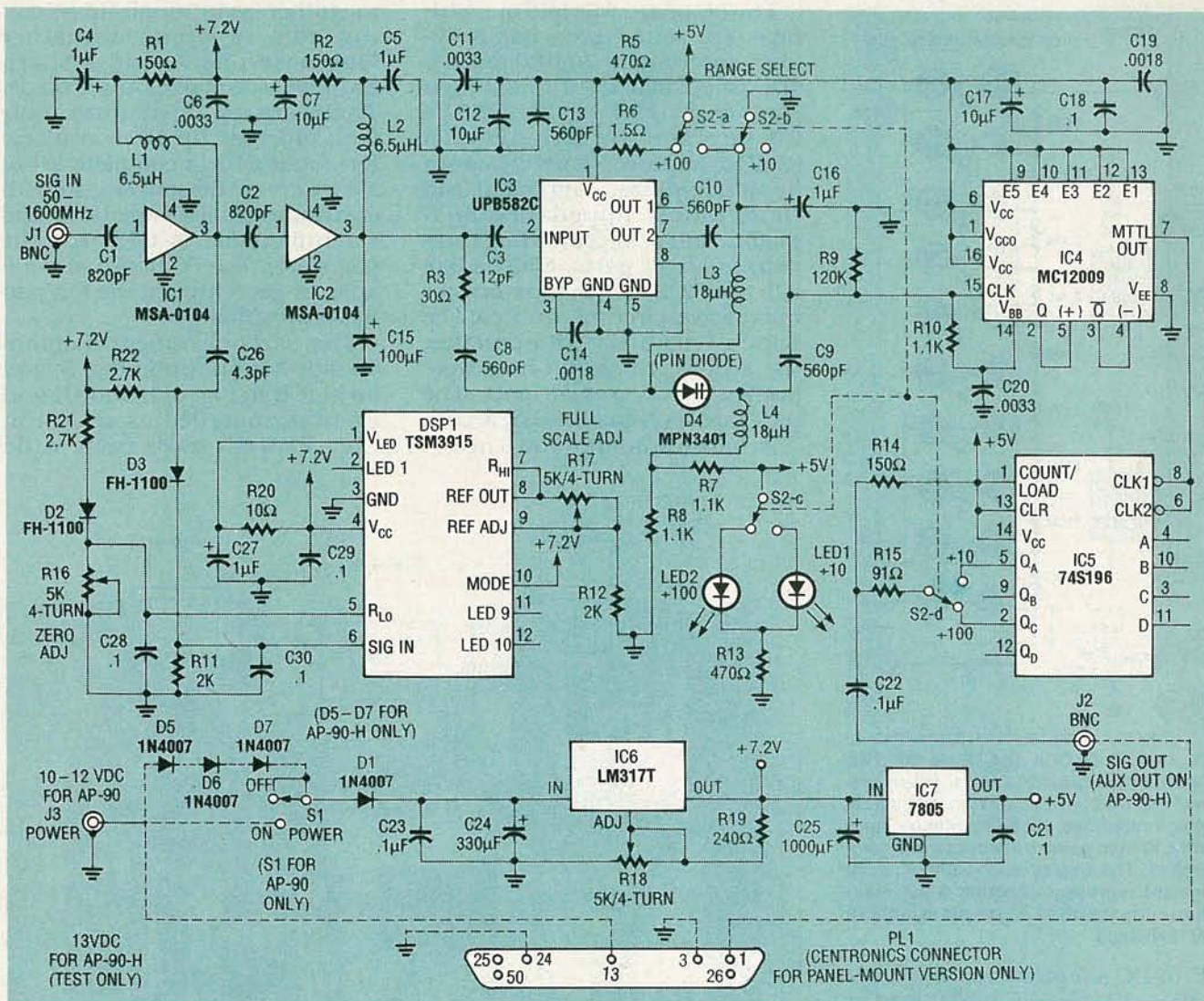

FIG. 2—THE BLOCK DIAGRAM OF THE prescaler. IC1 and IC2 are MMIC amplifiers, IC3 is a  $\div 4$  counter, IC4 is a  $\div 5$  counter, and IC5 has  $\div 2$  and  $\div 5$  outputs selected by S2. With S2 on  $\div 100$ , the input passes through IC3 and IC4, and IC5 is a  $\div 5$  counter. With S2 on  $\div 10$ , the input goes around IC3, through PIN diode D4 to IC4, and IC5 is a  $\div 2$  counter. IC1 drives DSP1, the RF signal indicator. PL1 is for the panel-mounted version only.





**FIG. 3—THE SCHEMATIC DIAGRAM OF THE PRESCALER.** DSP1 is a TSM3915 10-segment LED bar-graph display; R16 and R17 adjust zero and full-scale. D4 performs band-switching; its reverse-biased capacitance is 0.65–0.75 pF, and over 6 pF forward-biased. With S2 on  $\div 10$ , D4 is forward-biased, so its impedance goes down, and it passes the signal to IC4. IC3 is off, but pin 1 ( $V_{CC}$ ) is at 1.25 volts DC to raise the impedance on pin 7 (out 2). With S2 on  $\div 100$ , D4 blocks the signal, and it's now passed to IC3.

cade counter. It has separate  $\div 2$  and  $\div 5$  sections; the prescaler drives both, and you select the desired output using S2. R14 and R15 shape and pull up the output; the output will be 1–2 volts peak-to-peak into a load of 50 ohms or more.

Display DSP1 is the Three-Five Systems, Inc. TSM3915 (formerly the National Semiconductor NSM3915) 10-segment LED bar-graph display; Fig. 4 shows the block diagram. It has an on-board monolithic IC with an adjustable internal voltage reference, high-impedance input buffer, accurate 10-step voltage divider, and 10 comparators. R11 and R22 bias D3 as an RF level

detector coupled by C26 from IC1. D2 is directly connected to the high impedance input buffer at pin 6. Within DSP1, the signal is applied to 10 comparators, each biased differently by the precision voltage divider, and driving one LED.

A low-voltage reference signal from R21-D2-R16 is applied to pin 5, to offset the input bias voltage making R16 the zero adjustment. R17 sets full-scale sensitivity by varying the internal reference voltage across the comparators. The current from REF OUT (pin 8) determines the display current and brightness. About 10 times this current is drawn through a lit segment, and

is fairly constant despite voltage and temperature changes.

The display is logarithmic, with segment thresholds at 3-dB intervals. If you remove  $V_{CC}$  from MODE (pin 10) and join MODE (pin 10) and LED 9 (pin 11), the display changes from a bar graph to a dot graph, with only the top LED of a reading lit. That saves current, but the bar graph is easier to read.

The power supply provides regulated +7.2 volts DC from IC6 for IC1, IC2, and DSP1, and +5 volts DC from IC7 for all else. IC6 is an LM317T adjustable regulator set by R18 and R19. The input is polarity protected by D1. Capacitor C23 bypasses high-frequencies avoid instability, and C24 filters 60-Hz ripples. Power jack J3 needs a center-positive, 2.1–2.5-millimeter coaxial plug.

The maximum current through DSP1 with all segments lit is about 400 milliamperes. An







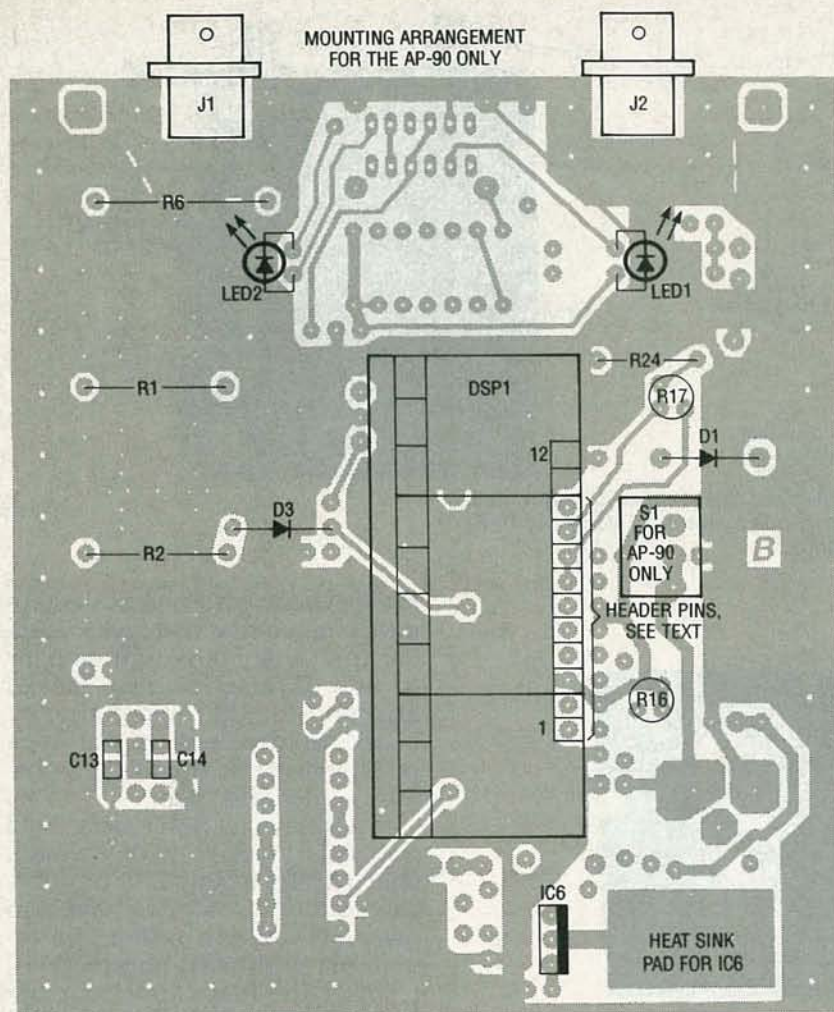

FIG. 6—PARTS PLACEMENT DIAGRAM FOR side B of the PC board. In the cabinet-mounted version, the header pins protrude from side A to holes 1–10 of DSP1 on side B; the separator is on side A. In the panel-mounted version, the header pins are inserted into side B; their other ends go to holes 1–10 on DSP1, with the separator on side B.

groove. Use a medium iron for them, and the small iron elsewhere. The kit in the parts list has IC socket pins for IC3 and IC4, to shorten the leads and get them closer to the ground plane for better frequency response. For IC5, use a regular 14-pin DIP socket, since it operates over a lower frequency range.

Install the SMD's next; note the polarity of amplifiers IC1 and IC2, tantalums C4, C5, C7, and C16, and LED1 and LED2, and install all parts from smallest to largest. IC1 and IC2 should both have dots indicating their outputs (pin 3); the input (pin 1) is opposite this, and pins 2 and 4 are the grounds. With the dot on pin 3 pointing toward the bottom as in Fig. 5, pin 1 points upward, pin 2 points left, and pin 4 points right.

For the SMD tantalums, C4, C5, and C16 are the same size,

while C7 is much larger. In the prototypes and the kit in the parts list, C4, C5, and C16 are orange in the center and silver on each end. They have a small tip on the positive end, and a green dot on the top side, C7 is yellow, with a brown band on the top of the positive end. Capacitor C15, at the middle right, will partially block IC2 and L2, so install them first. There's a hole for the negative lead of C15, but the positive lead is tack soldered to the foil where R3 meets L2. Insert the negative lead into its proper hole, and bend the positive lead outward at right angles. Diode D4 is black, rectangular, and has a brown ridge on the cathode end; the brown ridge faces to the right.

Install LED1 and LED2 last in the prescaler. For the case-mounted version, insert the LED's into their PC board holes

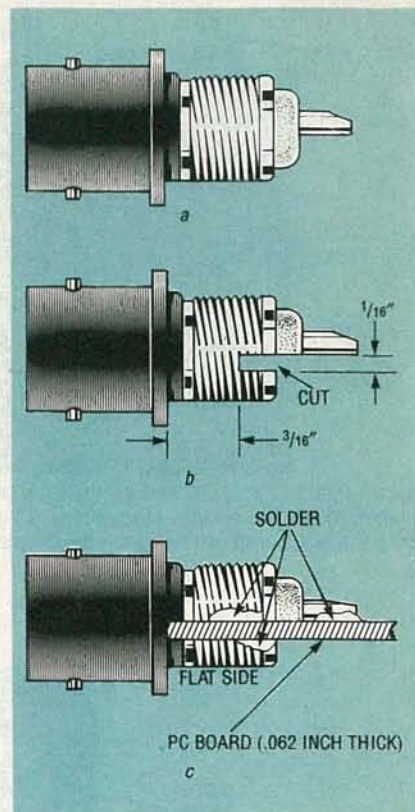

FIG. 7—BNC SOCKET MODIFICATION for the cabinet-mounted version. In (a) a side view is shown of a female BNC panel-mount socket. In (b), a slot is cut in the threads with a hacksaw or file. In (c), the slot fits snugly over its PC board notch. Solder it on both sides of the PC board; the center pin goes on side A.

without soldering. Hold them in place with your fingers and pull the leads through the holes, until they both almost touch the surface of side B. Fold the leads over slightly, so they can't fall out. Insert the PC board into the case, with side A facing out. Bend the LED leads back to vertical so they slide freely, maneuver the LED's so they protrude through their holes in front, then solder and trim. If you remove the PC board from the case, the LED's should slide out freely. When you put the PC board back in the case, the LED's should slide back into their holes.

For the panel-mounted version, don't install the LED's until you attach J1 and J2 to the faceplate, and are ready to attach the PC board. Pull the LED's through their holes in the PC board, and bend the leads to hold them in place. Insert the center pins and ground lugs of J1 and J2 into the holes next to the notches, and bolt the bottom of the PC board to



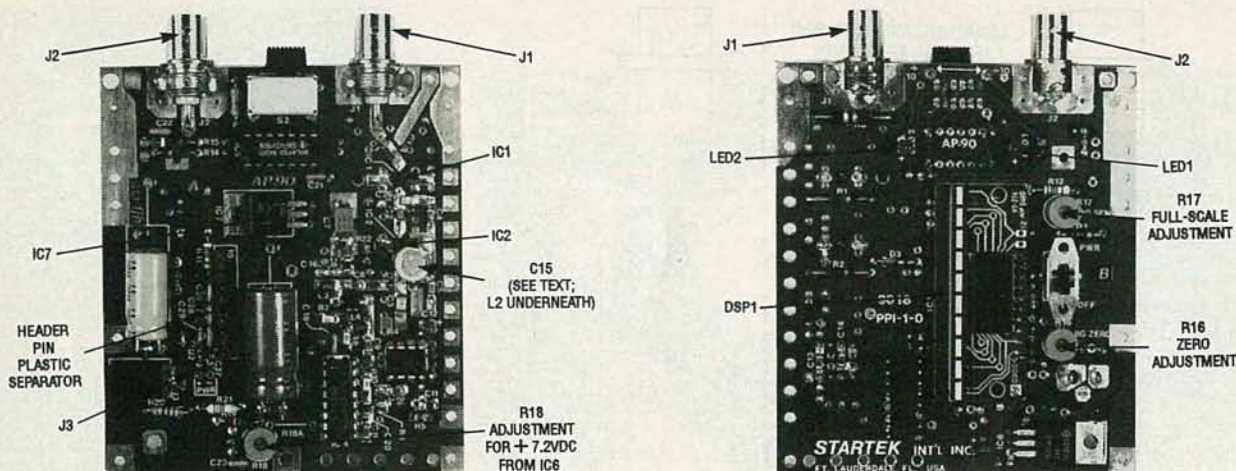

FIG. 8—PROTOTYPE OF THE CABINET-MOUNTED version; side A appears in (a), side B appears in (b). The header pins protrude through from side A, and are soldered to DSP1 using the bottom 10 pin holes on the display PC board.

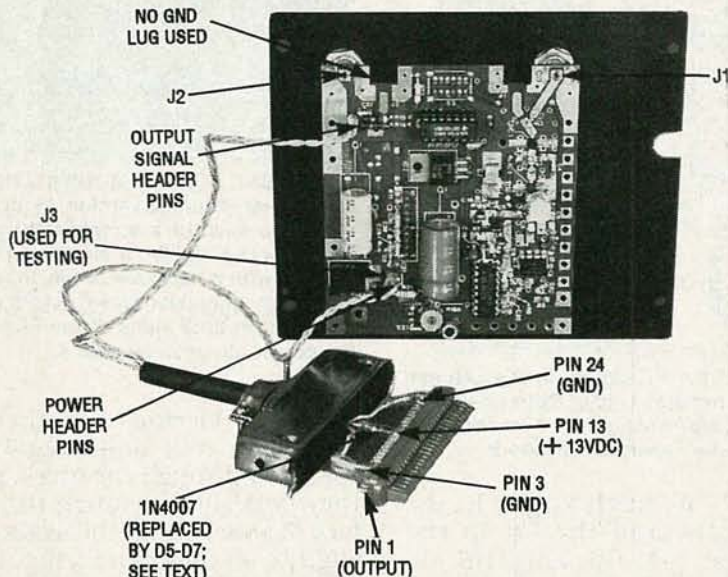

FIG. 9—PROTOTYPE OF THE PANEL-MOUNTED version, showing side A. The header pins are inserted into side B; the separator is on the same side. PL1 connects two twisted pairs; the output to the HP 5245L is from the header pins at upper left, and the +13 volts DC from the HP 5245L to those at lower right. The 1N4007 on pin 13 of PL1 has been replaced by D5-D7 at S1's location (see text), to avoid damaging IC6. Use heatshrink tubing with all four wires to avoid shorts.

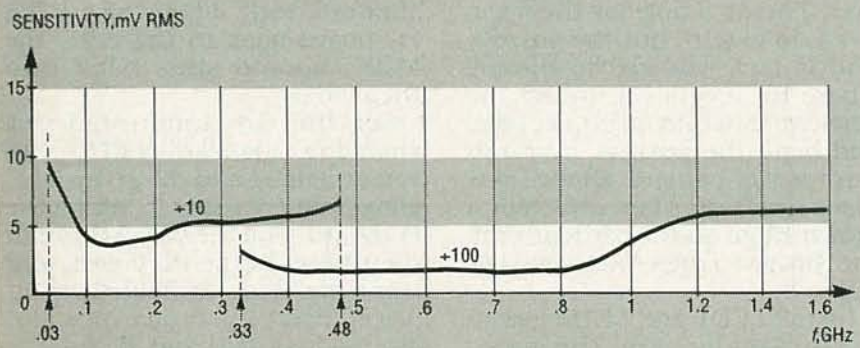

FIG. 10—SENSITIVITY CURVES FOR BOTH the  $\pm 10$  and  $\pm 100$  ranges. The  $\pm 10$  range covers 30–480 MHz, and the  $\pm 100$  range covers 330 MHz–1.6 GHz.

the faceplate with nylon washers and a nonconductive spacer. Solder the center pins and lugs for J1 and J2; use two lugs for J1, and one for J2. When the PC board is attached to the faceplate, maneuver the LED's as before, solder and trim.

If you have no SMD tools, hold the SMD in place with a small, sharp knife, a pencil, or a probe. Tack solder one side to hold it in place so you can solder the remainder with both hands; then, resolder the first side. There are kits of SMD tools available that can make working with the devices easier.

Solder creme is powdered solder mixed with flux. With a gun dispenser, place a very tiny spot on each SMD solder pad, and position the SMD with a vacuum tool; it should stick to the solder creme. Heat the foil, and the solder creme should melt; never heat the solder creme directly.

Figure 8-a shows side A of the cabinet-mounted prototype, and Fig. 8-b shows side B. In Fig. 8-a, IC7 has been folded over to lie on its heatsink pad. You can't bolt the heatsink to the PC board in the prescaler, since DSP1 is in the way, but even if you could, it's unnecessary. The center pins of J1 and J2 are on side A; both the threads and center pins were separately soldered. In Fig. 8-b, IC6 has been folded over like IC7, but also needn't be bolted down. The header pins protrude through from side A, and are soldered to holes 1–10 on DSP1 on side B; the plastic separator is on side A.

Figure 9 shows side A of the



## PARTS LIST

**All resistors are 1/4-watt, 5%, carbon-composition or film, unless otherwise noted.**

R1, R2—150 ohms carbon-composition  
R3—30 ohms, SMD  
R4—unused  
R5—470 ohms, SMD  
R6—1.5 ohms  
R7, R8, R10—1100 ohms, SMD  
R9—120,000 ohms, SMD  
R11, R12—2000 ohms, 1%  
R13—470 ohms  
R14—150 ohms, 10%  
R15—91 ohms, 10%  
R16—R18—5000-ohm, 4-turn, sub-miniature, PC-mounted potentiometer  
R19—240 ohms  
R20—10 ohms  
R21—2700 ohms  
R22—2700 ohms, SMD

### Capacitors

C1, C2—820 pF, SMD  
C3—12 pF, SMD  
C4, C5, C16—1  $\mu$ F, tantalum, SMD  
C6, C11, C20—0.0033  $\mu$ F, SMD  
C7—10  $\mu$ F, tantalum, SMD  
C8—C10, C13, C14—560 pF, SMD  
C12, C17—10  $\mu$ F, tantalum, axial leads  
C15—100  $\mu$ F, electrolytic, axial leads  
C18, C21—C23, C28—C30—0.1  $\mu$ F, monolithic ceramic, axial leads  
C19—0.0018  $\mu$ F, SMD  
C24—330  $\mu$ F, 25-volt, electrolytic  
C25—1000  $\mu$ F, 10-volt, electrolytic  
C26—4.3 pF, SMD  
C27—1  $\mu$ F, 16-volt, tantalum

### Inductors

L1, L2—6.5  $\mu$ H, SMD  
L3, L4—18  $\mu$ H, SMD

### Semiconductors

D1, D5—D7—1N4007 silicon diode  
D2, D3—FH-1100 diode  
D4—Motorola MPN3401 PIN diode  
DSP1—Three-Five Systems TSM3915 10-segment LED bargraph display

LED1, LED2—subminiature red LED  
IC1, IC2—Avantek MSA-0104 MMIC amplifier  
IC3—NEC UPB582C MMIC divide-by-4 prescaler  
IC4—Motorola MC12009P ECL two-mode prescaler  
IC5—TI 74S196 presettable binary/decade counter  
IC6—LM317T adjustable 1.25–37-volt DC regulator  
IC7—LM340T-5 or 7805 fixed 5-volt DC regulator

### Other components

S1—SPDT PC-mount slide switch (used in the cabinet-mounted version)  
S2—4PDT right-angle PC-mount slide switch (used in the cabinet-mounted version)  
S2—4PDT PC-mount slide switch (for the panel-mounted version)  
PL1—Centronics 50-pin male plug with hood  
J1, J2—UG1094-U female BNC socket (see text)  
J3—2.1-millimeter coaxial power jack

**Miscellaneous: Case for the cabinet-mounted version (two-piece anodized aluminum, four machine screws, with specially punched and printed front), red lens for DSP1 (0.03 × 1 × 3-inches), front panel (optional for the panel-mounted version), three BNC socket solder lugs, 4-40 × 0.25-inch black Phillips pan head screws (for the cabinet-mounted version enclosure), two 6-32 × 0.5-inch black Phillips pan head screws, two 8-32 × 0.5-inch black Phillips pan head screws, 4-40 nylon locknut, 4-40 × 0.3-inch threaded spacer, nylon washer, 2 feet of #22 stranded twisted-pair wire, two BNC socket lock-washers, one 10-pin header pin with plastic separator (for both**

the cabinet-mounted version and the panel-mounted version), two 2-pin header pins with plastic separators (for the panel-mounted version), heatshrink tubing, AC power adapter with an output of 10–12 volts DC at 400 mA.

**NOTE:** The following items are available from STARTEK International, Inc., 5200 N Federal Hwy., Suite #2-1181, Ft. Lauderdale, FL 33308, (305) 783-0008 or (800) 638-8050. A complete set of all parts (#AP-90K) for the cabinet-mounted version is \$99.95, an enclosure (#CAB-90) is \$25.00, and the AC adaptor (#AC-90) is \$9.00. A factory-assembled and tested version with the aforementioned items (#AP-90) is \$179.00. The telescoping antenna with BNC plug (#TA-90) is \$12.00, and the PC board (#PCB-90) only is \$25.00. All seven IC's (#ICS-90), including voltage regulators and DSP1, is \$55.00. A complete kit of parts for custom installation of the panel-mounted version into the HP 5245L (#AP-90-HK) is \$159.00, and an assembled and factory-tested version (#AP-90-H) is \$199.95. A partially assembled kit (SMD components installed) is available. Call Startek or send SASE for information. For SMD tools, a Vac Tweezer pick-and-place tool kit (#VT-1) is \$9.50, and a Dot.Maker solder creme dispenser kit containing the Vac Tweezer kit and an assortment of about 20 solder creme caplettes (#DMK-1) is \$75.00. Add 5% (a minimum of \$4.00 to a maximum of \$10.00) for shipping/handling. Visa, MasterCard, C.O.D., cash, or money orders accepted; allow three weeks for personal checks.

panel-mounted prototype. PL1 is connected to the PC board by two twisted pairs and two pairs of header pins. The output fed back into the HP 5245L comes from the header pins at upper left. The upper pin is the output, the lower pin is ground. Power goes into the header pins at lower left; the left one goes to the +13 volts DC from the HP 5245L, and the right one is ground.

The prototype was built before using D5–D7; the anode of a

1N4007 was soldered to pin 13 of PL1, and the cathode to the positive power wire (blocked by the black heatshrink tubing). PL1 is a standard male Centronics plug. Cover both ends of all four wires with heatshrink tubing to avoid shorts. However, one 1N4007 didn't provide a sufficient drop, so D5–D7 were used thereafter.

Figures 2, 3, and 6 all show D5–D7; in the panel-mounted version they replace S1, to pro-

vide an additional 1.8–2.1-volt DC drop, as mentioned above, to reduce the +13 volts DC from the HP 5245L. IC6 doesn't overheat to the point of exceeding specification. The drops across D1 and D5–D7 reduce the +13 volts DC from the HP 5245L to +10.2–10.6 volts DC, enough to run IC6 with minimum heat dissipation.

To install D5–D7, wrap the cathode of D5 around the anode of D6, and the anode of D7



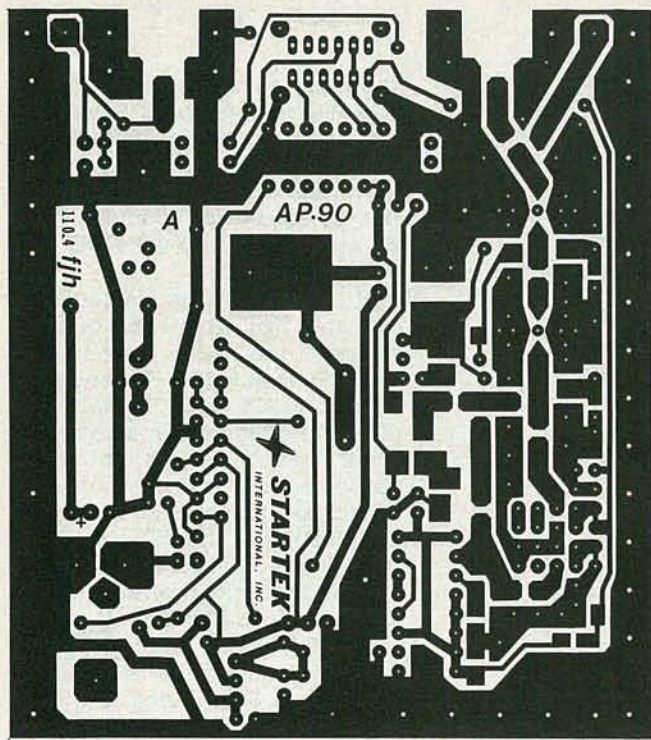

COMPONENT SIDE OF THE PRESCALER.

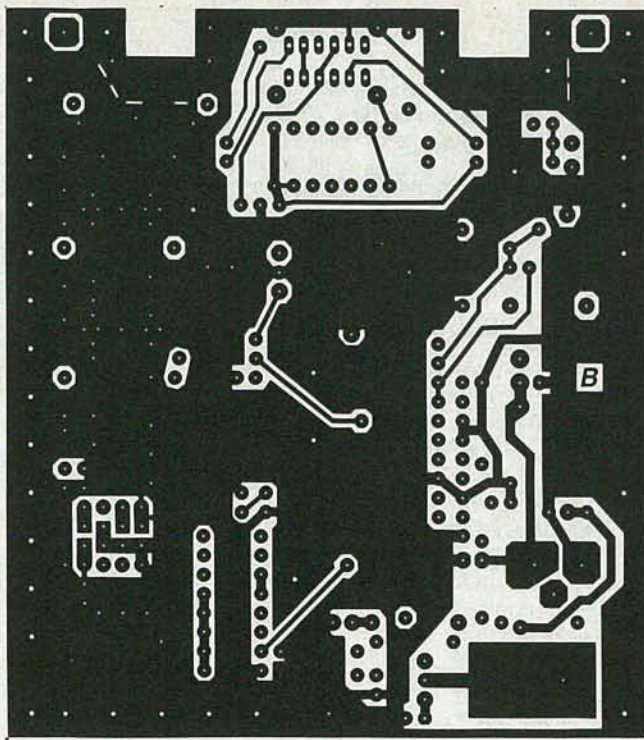

SOLDER SIDE OF THE PRESCALER.

around the cathode of D6, solder and trim. Insert the anode of D5 and the cathode of D7 into their PC board holes, and leave enough lead length on side B to bend D5–D7 flat to the PC board.

In the panel-mount version, install the DSP1 header pins with the plastic separator on side B (the separator is on side A for cabinet installation) to hold

DSP1 off the PC board and flush with the red lens and panel.

The PC board and red lens is a precise fit inside the case and shouldn't move around. In the panel-mounted version, the lens is sandwiched between DSP1 and the rear of the faceplate, and has a hole drilled in its bottom for the screw that attaches the PC board to the bottom of the faceplate.

The lens goes between the rear of the faceplate and the nylon washer at the base of the nonconducting spacer.

#### Power-on checkout

Turn the power on, and check for proper voltages:

- At J3, +10–+12 volts DC, input power.
- At the output of IC6, +7.1–+7.3 volts DC (adjust R18).
- At the output of IC7, +4.9–+5.1 volts DC.
- At the outputs of IC1 and IC2, a bias of 4.6–4.7 volts DC (with no input signal).

For the panel-mounted version, J3 is included to let you test it without connecting it to the HP 5245L. If all voltages are right, adjust R16 to zero the bar graph, and R17 for full scale. The two potentiometers interact, but you should get a good setting with a signal generator and some experimenting. The bar graph varies with frequency, but is a convenient relative RF signal strength indicator. With careful assembly, sensitivity should be 1–9 millivolts RMS from 50 MHz–1.6 GHz, consistent with the curves shown in Fig. 10. R-E

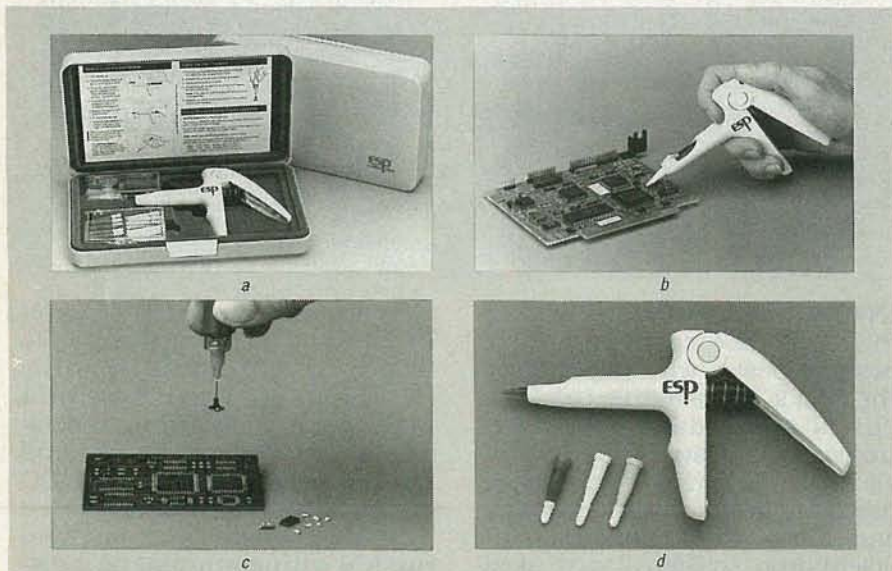

IF YOU WANT SMD TOOLS, (a) shows a kit mentioned in the parts list. Solder creme is powdered solder mixed with flux. With the gun in (b), place a spot on each pad, and position the SMD with the vacuum tool in (c); it should stick to the solder creme. Heat the foil, and the solder creme should melt. In (d) a close-up of the gun and three caplettes is shown.



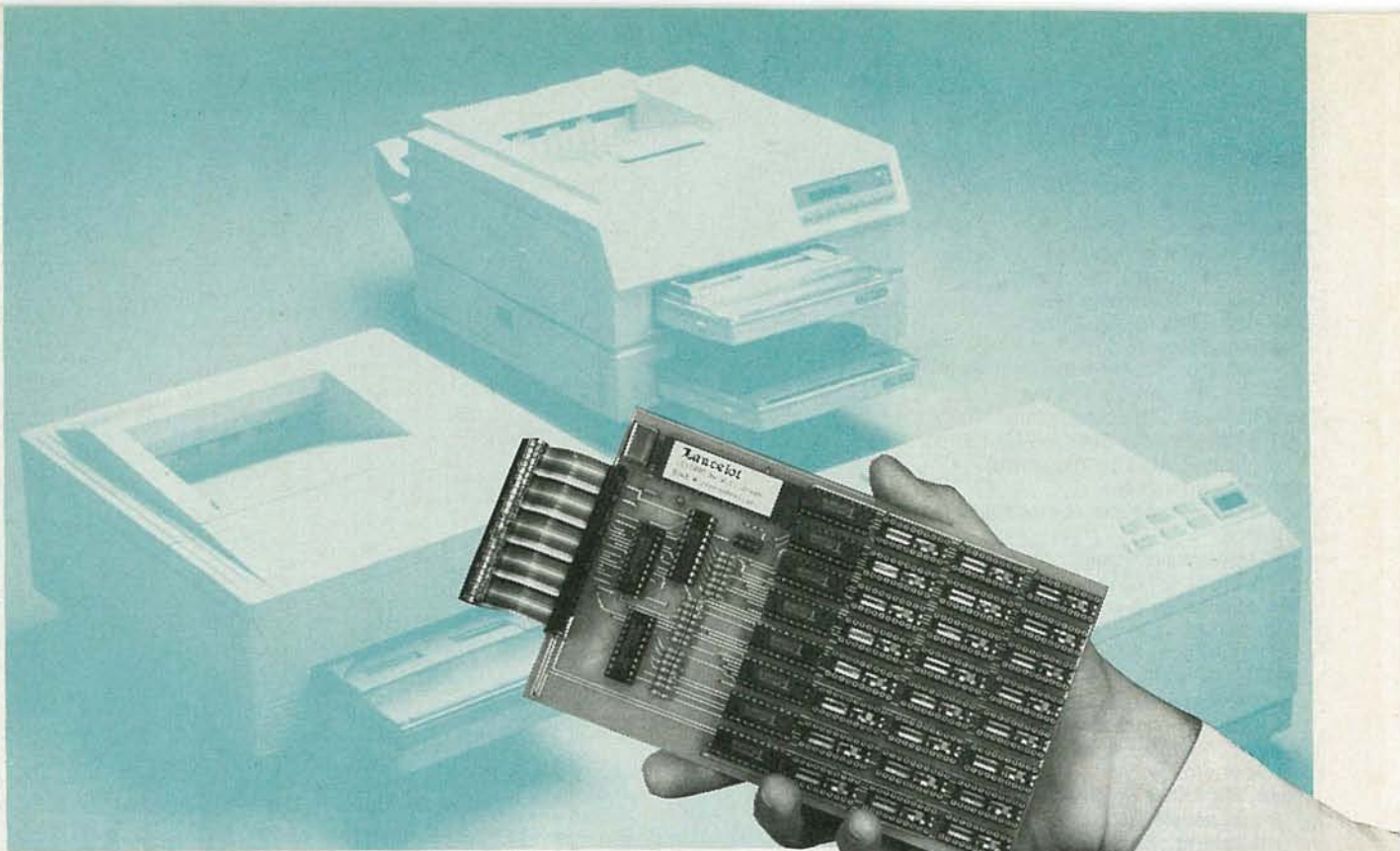

# BUILD THIS LASER JET MEMORY CARD

***Build this 4-megabyte memory expansion board  
for your LaserJet Model IIP/III printer.***

**BILL GREEN**

LASER PRINTERS HAVE BEEN AROUND for some time but, until recently, they have been expensive. About a year ago Hewlett Packard introduced their LaserJet IIP, the first low-priced entry in the market. It lists for \$1495 but can be purchased through mail-order outlets for under \$1000, making it a truly "personal" laser printer. The Model IIP has many of the features of HP's newest and substantially more expensive entry, the Model III. The Model IIP falls short of the Model III in that it is half as fast and has half the built-in memory.

The Model IIP has 512K of memory built in, but that amount won't even allow you to

print a full page of graphics at 300 dpi (300 dots-per-inch) resolution, let alone store a couple of softfonts (downloadable typefaces) in the printer. The fact is, laser printers are powerful in such applications as desktop publishing and for printing the output of CAD and CAM software (the PC board foil patterns for this project were printed on a LaserJet IIP), as well as for everyday printing. But having only 512K of memory severely limits the power.

You can, of course, expand the memory in the printer, but the cost to purchase 4-megabytes of memory from Hewlett Packard will set you back a cool \$2000.

The prices of laser printers have come down, and they now fit into the personal-computer market, but the price of expansion memory has kept the cost of laser printing well above what it should be.

The memory-board construction project which we will detail here can add up to 4-megabytes of additional memory to your LaserJet IIP, and also works with Hewlett Packard's newest laser printer, the Model III. A kit is available to build it (see parts list) for under \$100. Memory is not included at that price, but is available for around \$56 per megabyte through a number of mail-order sources. You can now add up to 4-megabytes to your



## PARTS LIST

### Resistors

R1-R3—7 × 47-ohm DIP resistor pack or discrete resistors

### Capacitors

C1—1 μF, 30 volts, tantalum  
C2—0.1 μF, 10 volts, monolithic  
C3, C4—27 pF, ceramic disc  
C5—100 μF, 10 volts, electrolytic

### Semiconductors

IC1—8048 programmed microcontroller  
IC2—011273 memory decoder  
IC3, IC4—74LS244 octal buffers  
IC5-IC36—514256 256K × 4-bit 120 ns dynamic RAM (8 per megabyte)

### Other components

J1—8-pin male header or 4-position DIP switch

J2—48-pin male header

XTAL1—6 MHz HC-18 crystal

**Miscellaneous:** 2-inch long 48-conductor ribbon cable with a 48-pin female IDC connector on each end, 35 20-pin IC sockets with built-in 0.1 μF bypass capacitors or standard 20-pin sockets with 0.1 μF capacitors installed on the board, 1 40-pin IC socket, PC board, solder, etc..

**Note:** The following items are available from Lancelot, P.O. Box 541005, Merritt Island, Florida 32954-1005: a complete kit for the memory board (less memory IC's), \$99.95 plus \$5.00 P&H; a partial kit including the PC board, programmed 8048, and the 011273 decoder, \$63.00 plus \$5.00 P&H. Canadian orders add \$3.00. All other countries add sufficient postage for air shipment and insurance. Florida orders add 6% state sales tax. Orders by check or money order only. For technical information and dealer inquiries call 407-454-9082.

printer for less than \$325—that's megabytes without the megabucks!

### About the circuit

The circuit, shown in Fig. 1, is quite simple because dynamic RAM memory refresh and address multiplexing is done in the laser printer. The interface to the printer is through a 48-pin connector. The data bus is 16 bits (one 16-bit word) wide, and the 18-bit address bus is multiplexed into 9 bits. The remaining pins are for power, ground, memory enable, write enable, and for the controller serial communications.

The 1-megabit dynamic RAM's are organized 256K × 4 bits. They are addressed in quads by the printer as 256K 16-bit words. The four memory-enable signals from the printer are decoded by IC2 into  $\overline{\text{CAS}}$  (column-address-

*Text continued on page 75*

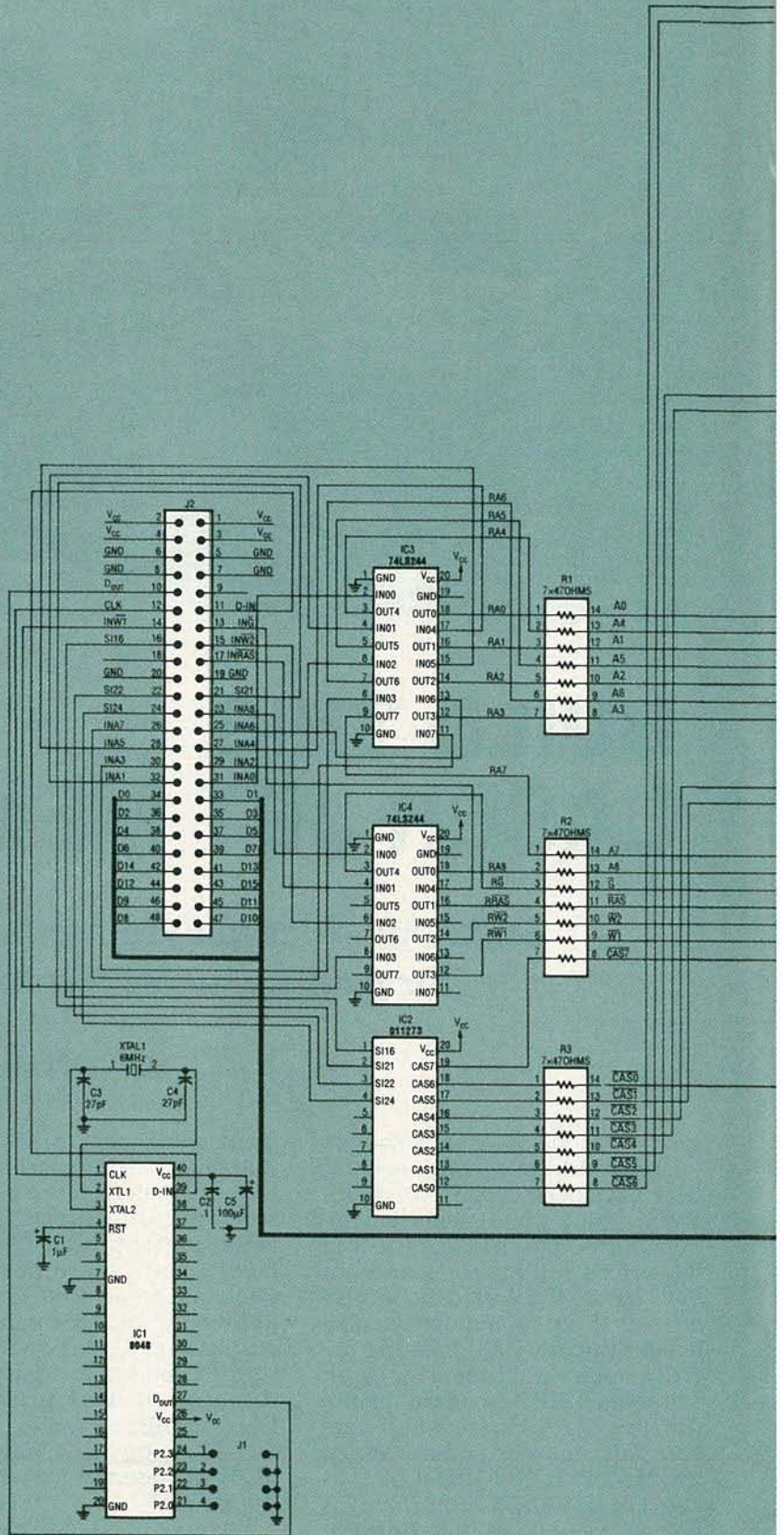



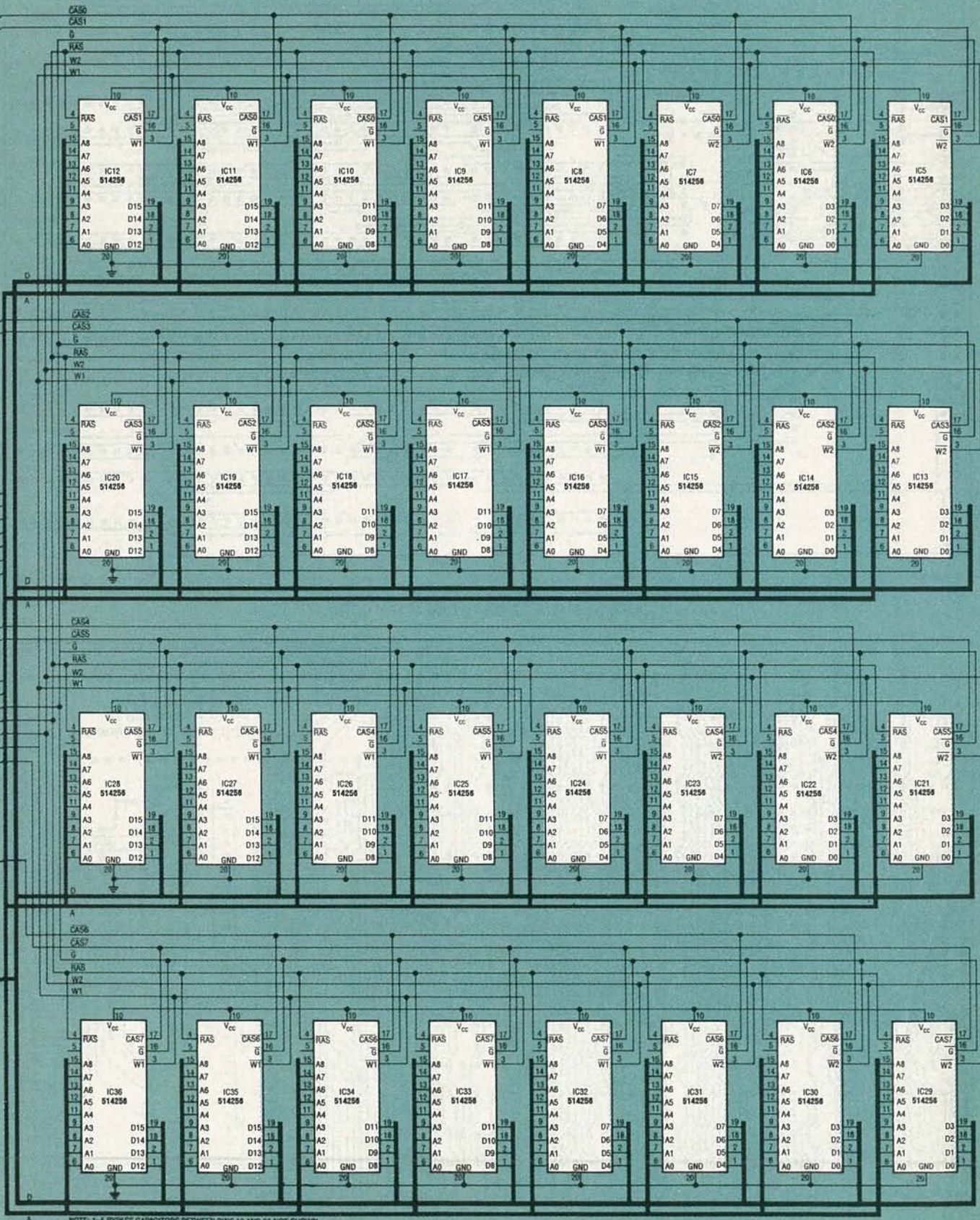
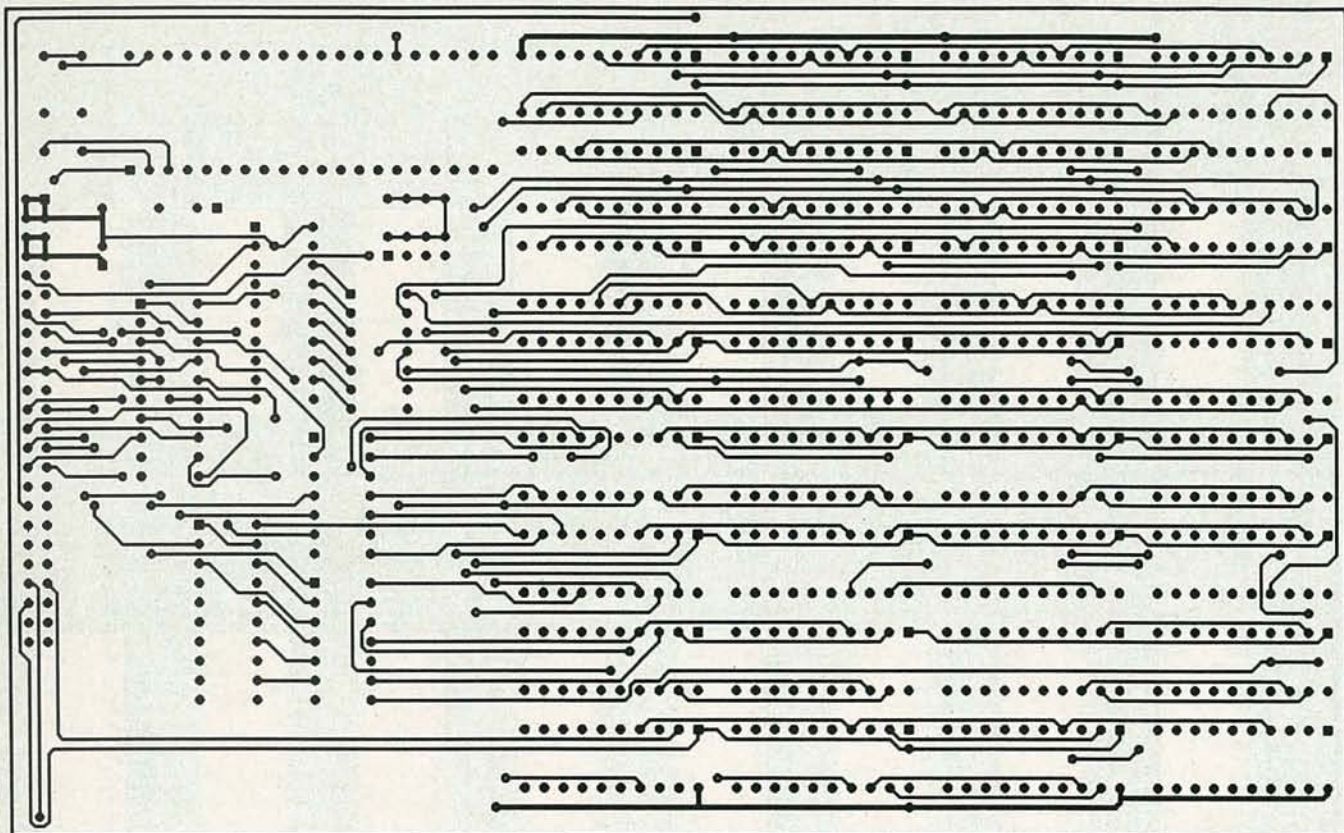

FIG. 1—THIS CIRCUIT WILL ALLOW YOU TO ADD UP TO 4 MEGABYTES OF EXTRA MEMORY TO A Hewlett-Packard LaserJet IIP or the more expensive Model III.





7 INCHES

COMPONENT SIDE OF THE MEMORY CARD.

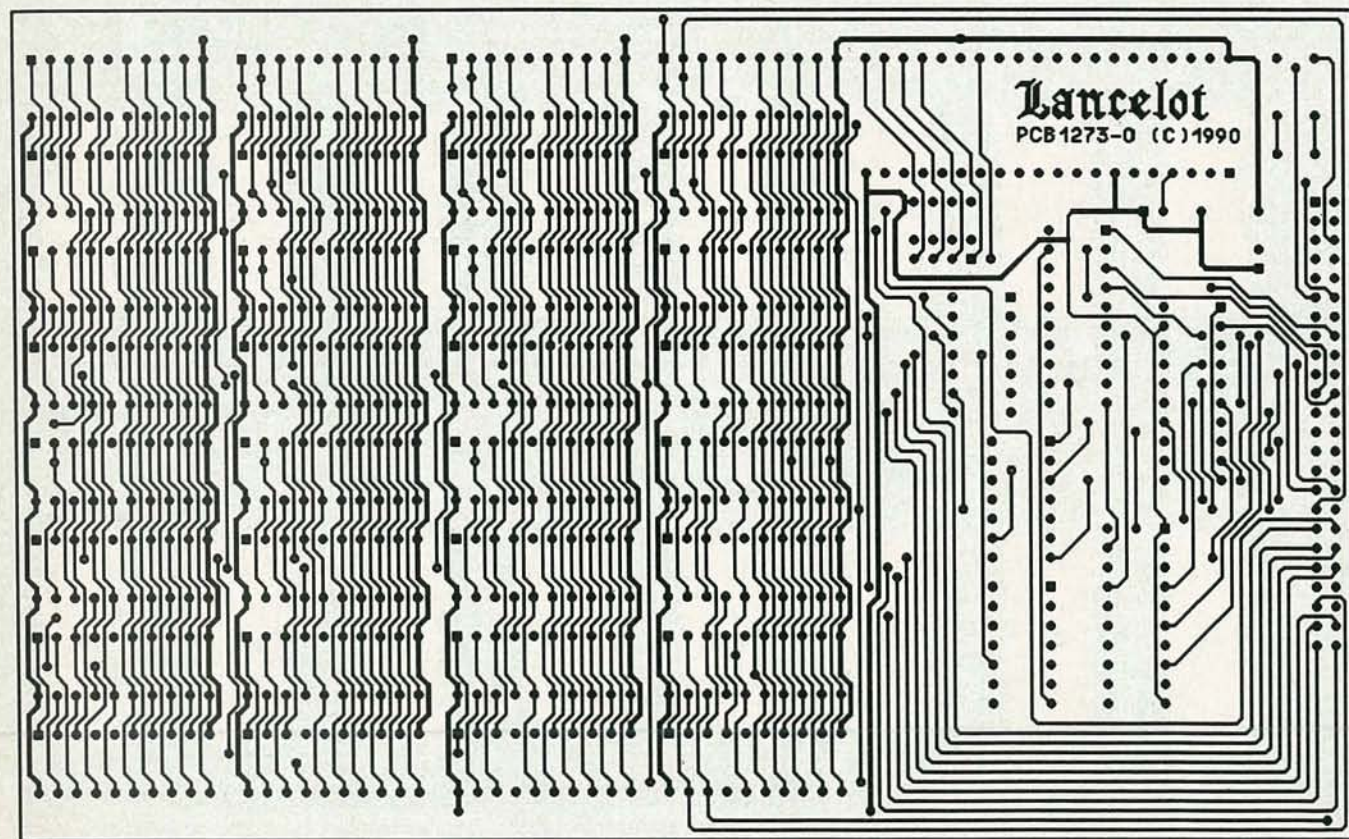

7 INCHES

SOLDER SIDE OF THE MEMORY CARD.



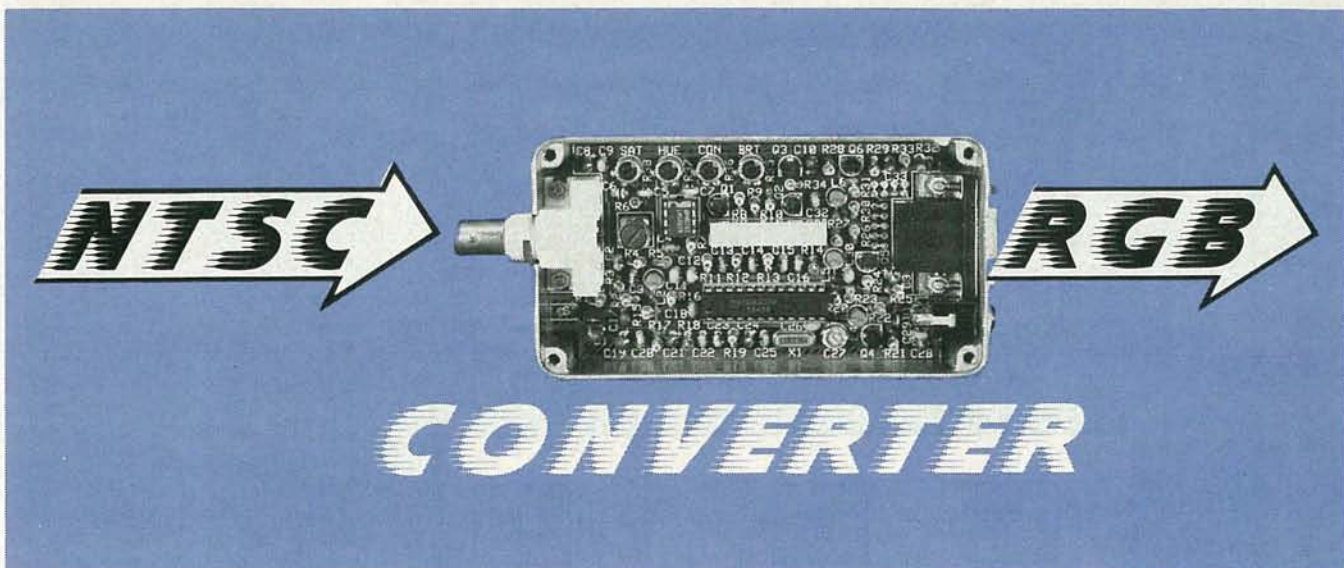

## Put a TV in your VGA monitor.

JIM HARRIGFELD

AT BOTTOM, A TV AND A COMPUTER monitor are more alike than they are different. As a matter of fact, a monitor is really just a TV in disguise less a few circuit boards and knobs.

At one time, when computers used teletypewriters for display, television pictures were considered high-resolution. Today, even the best TV sets cannot compare with the latest breed of computer monitors in terms of resolution, stability, convergence, and fidelity. So wouldn't it be nice if you could simply connect a VCR or camcorder to your monitor and enjoy some of that extra fidelity?

This article will show you how to build a simple decoder that will take any standard NTSC video signal (from a VCR, camera, tuner, or what have you), and convert it into the analog RGB signals that computer monitors work with. The circuit costs well under \$100 to build, and requires no fancy test equipment to align. In addition, if you would like to build one, partial and complete kits are available.

### Some basics

A color monitor has a simple interface. It generally requires four separate signals to operate: red, green, blue, and sync. Sync tells the monitor where and when to start each scan line, and the RGB signals determine how much red, green, or blue to dis-

play in the picture at any instant in time.

The composite video signal used in a television is more complicated, because it combines all the RGB signals, as well as other timing information, into a single high-frequency signal. In the United States, this signal is based on the NTSC/RS-170A video standard.

The disadvantage of composite video is that a great amount of processing is required to combine and encode the separate signals into one composite signal. The advantage of composite video, of course, is that the signal may be broadcast over the air or sent down a single piece of coaxial cable. But to be displayed, eventually the signal must be broken down into its individual red, green, blue, and sync components. By contrast, the advantage of the RGB system is that no decoding circuitry is required, so circuit designs are simpler and cheaper. The disadvantage of the RGB system is that several wires and multi-pin connectors are required to make connections.

Given the similarity between a television and a monitor, what exactly is required to display NTSC video on an RGB monitor? First and foremost, we need an analog monitor that is capable of scanning at standard NTSC video rates (60 Hz vertical, 15,750 Hz horizontal). That requirement immediately eliminates most

fixed-frequency (digital) monitors—i.e., most CGA and EGA types. However, most multi-frequency type monitors work beautifully.

We also need a video source. You can choose any VCR, video camera, camcorder, or component tuner that has a video output in the NTSC/RS-170A format. Those devices usually have some kind of audio output that you can use to drive a pair of headphones or your home stereo system.

Of course, there's still one thing missing: a gadget that can be used to convert the composite video from your source device into the separate RGB signals that your monitor understands.

### About the circuit

Figure 1 shows a block diagram of the circuit, and Fig. 2 shows the complete schematic. The heart of the circuit is IC2, a TDA3330. That highly integrated Motorola IC is specifically designed to break a composite video signal down into its individual components. The TDA3330 requires three inputs to operate: chroma (color information), luminance (brightness information), and burst flag (timing information).

The other major component is IC1, an LM1881 video-sync separator made by National Semiconductor. It extracts most of the important timing information



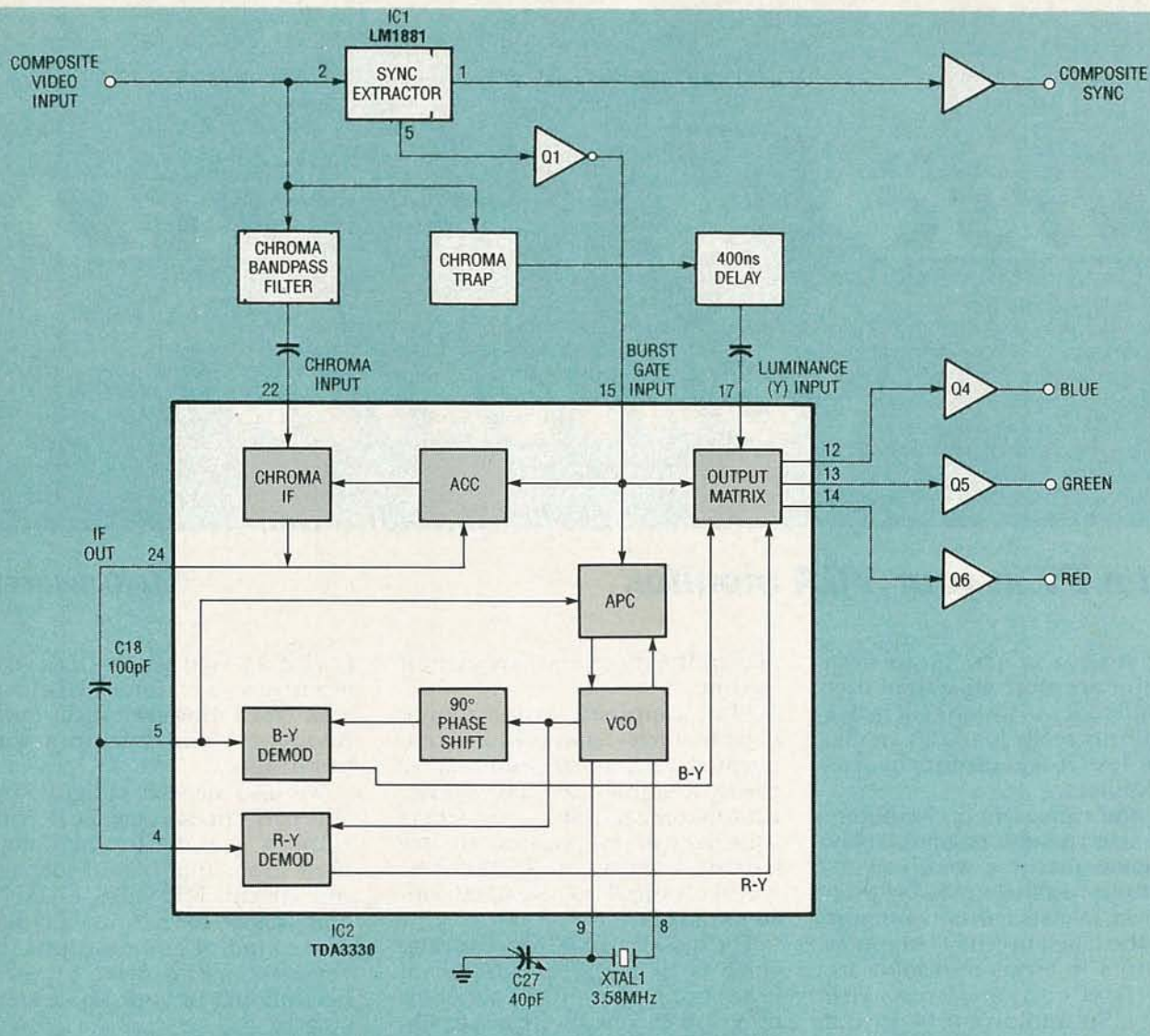

FIG. 1—BLOCK DIAGRAM. IC1 derives the sync signal and timing information. IC2 uses the latter to decode the red, green, and blue outputs.

from a standard video signal, and it needs only three external (passive) components to operate. Our circuit uses two of its three outputs: composite sync, which after buffering becomes one of our outputs; and the burst flag, which is inverted by Q1 to furnish the necessary timing information to IC2.

The other signals that are needed by IC2 are derived from the composite video input signal by means of several passive filters. The chroma bandpass filter consists of R2, L2, C11, and C12. That circuit works by allowing only 3.58-MHz signals to pass into pin 22 of IC2, while blocking all others. The luminance input (pin 17) is just the opposite, in that the 3.58-MHz component must be blocked and all other frequencies allowed to pass

through. That is accomplished with the chroma trap consisting of L1, R3, R4, C2, and C3. Basically, the output of the chroma trap is monochrome video. To meet NTSC timing requirements, that signal must also be delayed (by R5, R14, and L3) before entering IC2.

With proper input signals, IC2 requires only a few more passive components to enable it to lock on to the incoming signals. Once locked, the IC performs all I/Q demodulation, quadrature decoding, R-Y, and B-Y processing, and it then delivers red, green, and blue signals at pins 14, 13, and 12, respectively. Those signals are buffered in turn by Q4, Q5, and Q6, which are set up as emitter followers designed to drive 75-ohm loads.

The circuit has four controls

for setting operational characteristics. The brightness control (R35) sets the black level of the RGB outputs; for most applications, it should be set at minimum. The three other controls (hue, R37; saturation, R38; and contrast, R36) work much like their counterparts on a standard TV. After they have been properly adjusted, none of those controls should require operator intervention. The brightness control shifts the black level without affecting the overall peak-to-peak amplitude of the signal. On the other hand, the contrast control varies the peak-to-peak amplitude without affecting the black level.

Figure 3 shows several waveforms and timing relationships for a color-bar input signal at several points in the circuit: (a) The



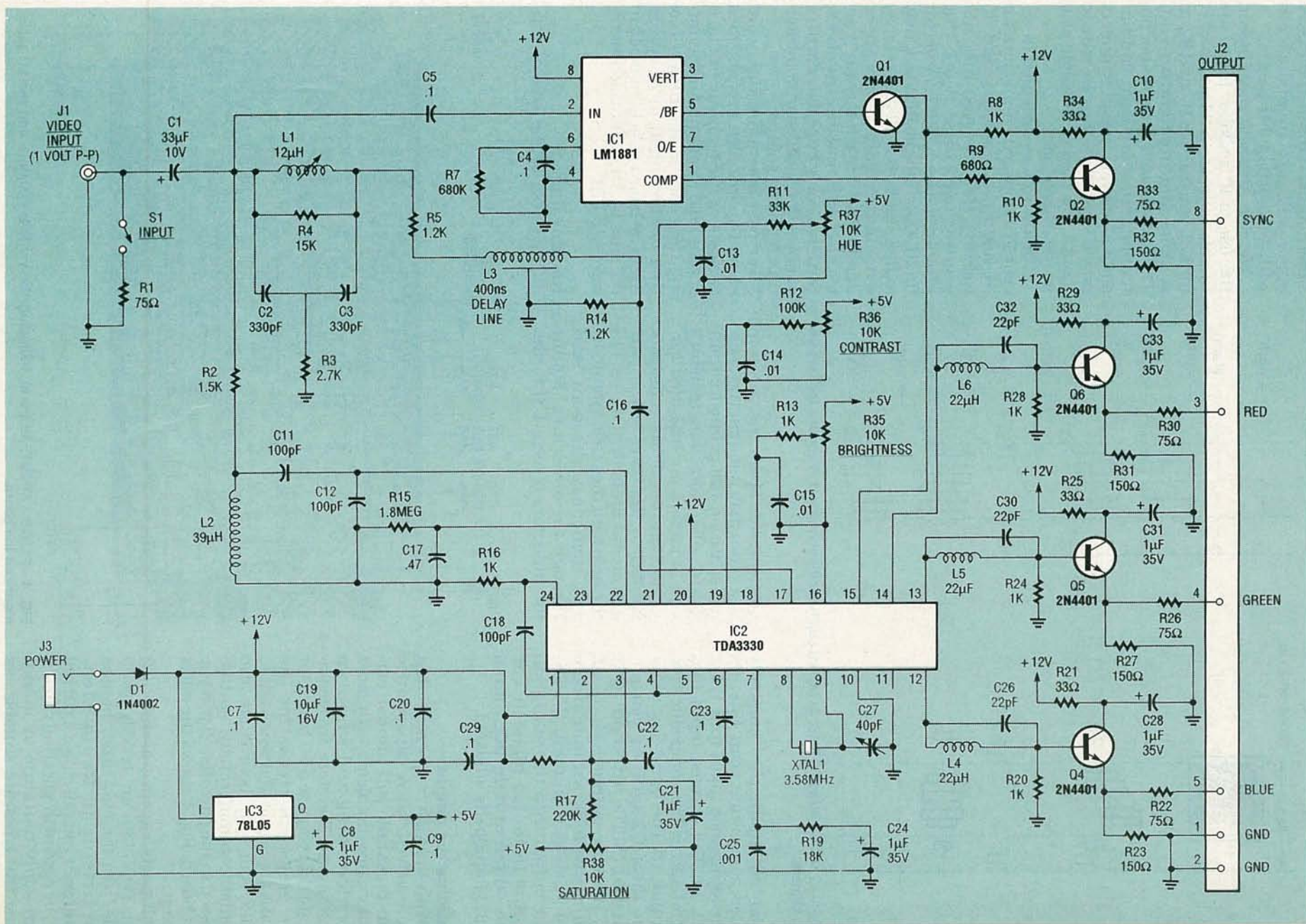

FIG. 2—COMPLETE SCHEMATIC. The circuit accepts a 1-volt peak-to-peak composite input, and delivers RGB and sync outputs, also with a swing of 1 volt peak-to-peak.



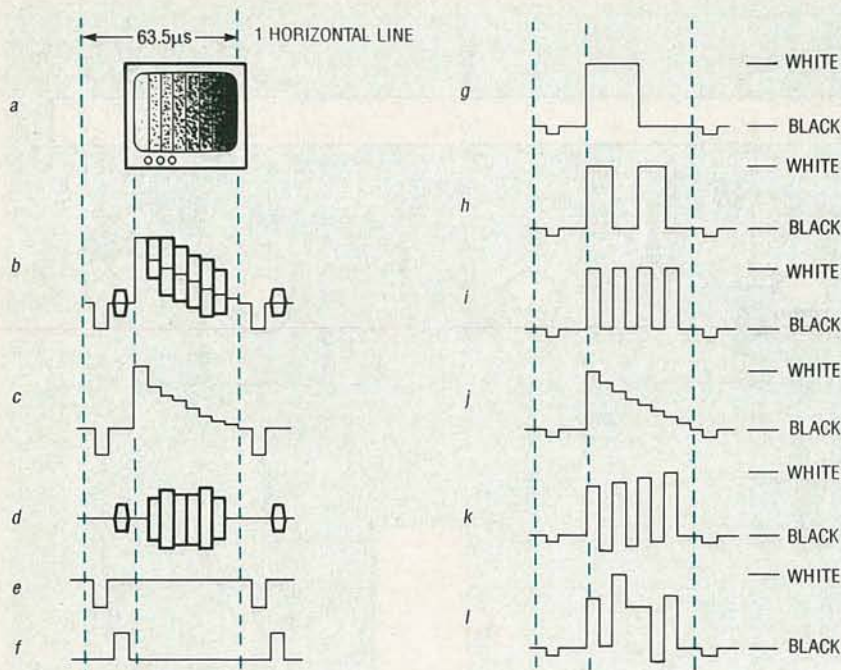

FIG. 3—SAMPLE WAVEFORMS. At (a) is a color-bar input; the text describes the remaining signals.

color-bar input. (b) Composite video across one scan line. (c) The luminance input (pin 17) of IC2. (d) The chroma input (pin 22) of IC2. (e) The composite sync output. (f) The burst-flag input (pin 15) of IC2. (g) The green output (Q5). (h) The red output (Q6). (i) The blue output (Q4). (j) All outputs with the saturation control (R38) at minimum. (k) The blue output with the saturation control (R38) too high. (l) The blue output with the hue control (R37) improperly adjusted.

### Building the circuit

With the high frequencies that are involved, stray capacitance and crosstalk will almost certainly cause problems with most breadboarding and wirewrap techniques. Therefore, we recommend that you use a PC board for the project. Patterns for the board are provided if you wish to make your own; boards are also available commercially, as discussed in the parts list. If you use our board, Fig. 4 shows the parts layout.

All parts except possibly IC2 (the TDA3330) are readily available from the mail-order houses advertising in **Radio-Electronics**. If you purchase a partial kit, be careful in selecting capacitors. Only tantalum or monolithic DIP types are suitable, as

electrolytic, Mylar, or ceramic disc types may not fit in the allotted space on the printed circuit board. Also note that resistors and inductors are mounted vertically. Bend one of the leads back parallel to the body of the part and mount the body of the part in the hole with the circle around it, and then pass the bent lead through the other hole. Mount the inductors (except L3) in the

same manner. This method saves space and also furnishes you with good debug/test points.

We also strongly recommend the use of IC sockets. If you are unable to locate a 24-pin socket for IC2, you can use 16- and 8-pin sockets mounted end-to-end. The pads around the trimmer potentiometers have been laid out so that several types of trimmers may be installed. Just be sure to mount the trimmer's wiper arm in the correct pad.

The board was designed to accept PC-mounted connectors for J1 (input), J2 (output), and J3 (power). However, you may not want or need these types. Our prototype uses a BNC connector for J1, but a simple RCA jack may suffice. Likewise, J2 and J3 may be eliminated entirely or changed depending on what your particular application involves. Switch S1 may be replaced with a simple jumper/header combination for most setups.

For best operation, the board should be installed in a shielded enclosure. The template in Fig. 5 shows hole locations for mounting the board in the project box that is mentioned in the parts list. The board is held in place in the box by the connector hardware (J1-J3).

### Hooking it up

Regardless of the type of con-

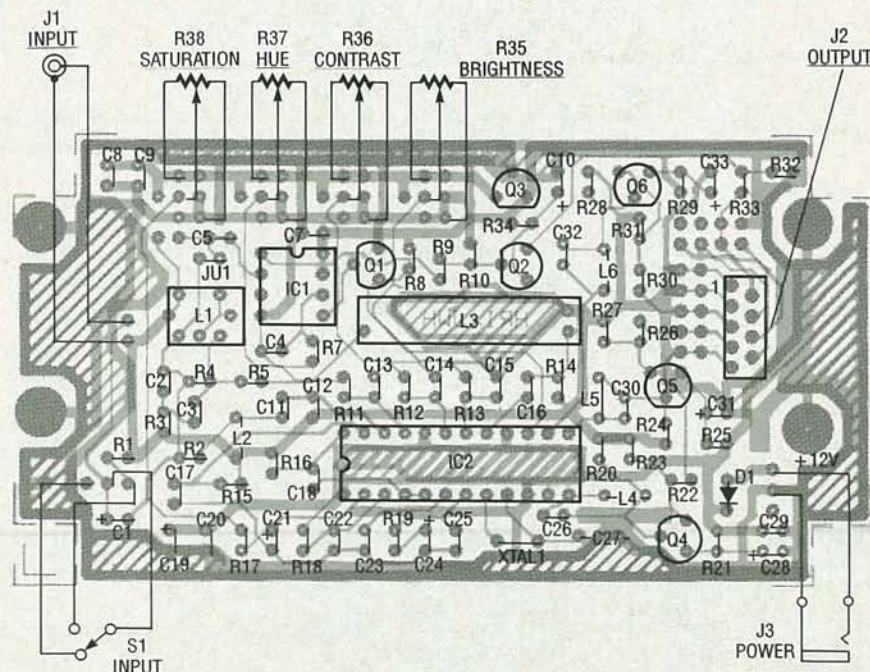

FIG. 4—PARTS LAYOUT. All parts, including the variable resistors and the I/O jacks, mount on the board.



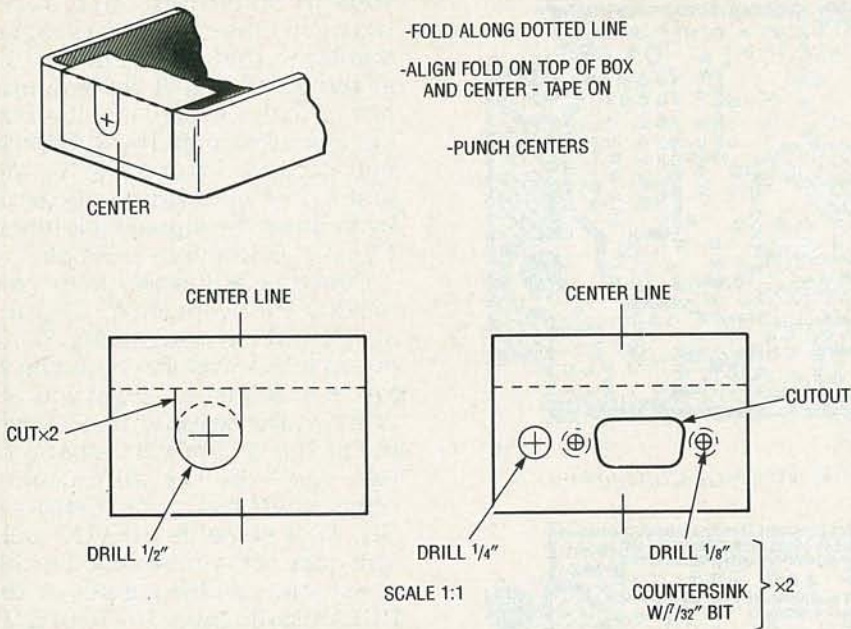

FIG. 5—DRILLING TEMPLATE. If you use our board and the box mentioned in the parts list, drill the box as shown here.

## PARTS LIST

All resistors are 1/4-watt, 5%, unless otherwise noted.

R1, R22, R26, R30, R33—75 ohms  
 R2—1500 ohms  
 R3—2700 ohms  
 R4—15,000 ohms  
 R5, R14—1200 ohms  
 R6—not used  
 R7—680,000 ohms  
 R8, R10, R13, R16, R20, R24, R28—1000 ohms  
 R9—680 ohms  
 R11, R18—33,000 ohms  
 R12—100,000 ohms  
 R15—1.8 megohms  
 R17—220,000 ohms  
 R19—18,000 ohms  
 R21, R25, R29, R34—33 ohms  
 R23, R27, R31, R32—150 ohms  
 R35—R38—10,000 ohms, cermet potentiometer, Panasonic #SOGAO1B1

### Capacitors

C1—33  $\mu$ F, 10 volts, tantalum  
 C2, C3—330 pf, 50 volts, monolithic  
 C4, C5, C7, C9, C16, C20, C22, C23, C29—0.1  $\mu$ F, 50 volts, monolithic  
 C6—not used  
 C8, C10, C21, C24, C28, C31, C33—1  $\mu$ F, 35 volts, tantalum  
 C11, C12, C18—100 pF, 50 volts, monolithic  
 C13—C15—0.01  $\mu$ F, 50 volts, monolithic  
 C17—0.47  $\mu$ F, 50 volts, monolithic  
 C19—10  $\mu$ F, 16 volts, tantalum  
 C25—0.001  $\mu$ F, 50 volts, monolithic  
 C26, C30, C32—22 pf, 50 volts, monolithic  
 C27—5–30 pF, trimmer

### Semiconductors

IC1—LM1881N video sync separator (National)  
 IC2—TDA3330 NTSC to RGB decoder (Motorola)  
 IC3—78L05 low-power 5-volt regulator  
 Q1, Q2, Q4–Q6—2N4401  
 Q3—not used  
 D1—1N4002 rectifier diode

### Other components

J1—PC-mount BNC connector (AMP #226978-1)  
 J2—9-pin D connector, female, PC mount  
 J3—3.5mm mono phone jack  
 L1—12  $\mu$ H variable inductor (Toko #A119ANS-T1034)  
 L2—47  $\mu$ H fixed inductor (Toko #348LS-470K)  
 L3—400 ns delay line (Toko #H321LNP-1436P)  
 L4–L6—22  $\mu$ H fixed inductor (Toko #348LS-220K)  
 S1—SPST, PC board right-angle mount  
 XTAL1—3.579-MHz crystal

**Miscellaneous:** Metal case—(Hammond #1590B), 12-volt regulated wall transformer, solder, etc..

**Note:** The following items are available from Harmonic Research, Inc., 193 Villanova Drive, Paramus, NJ 07652 (201) 652-3277: Complete kit including PC board and all parts except wall transformer, \$95.95; Partial kit including all parts except box, S1 and J1, \$81.50; Etched, drilled, and silk-screened PC board, \$20; TDA3330 (IC2), \$4.75. All orders add \$2.50 for shipping and handling. New Jersey residents add appropriate sales tax.

nectors that you use, the input should be wired using high-quality coaxial cable for best results. Your VCR or camera may have come from the factory with a cable of this type. Otherwise you can buy or build an input cable with RG59U coax and either BNC or RCA connectors.

The output cable depends on your application and use. Refer to your monitor's manual to determine its input wiring requirements. The decoder's output (J3) is a DB-9 connector that conforms to the PC standard. Many multi-frequency monitors adhere to that standard; but it's a good idea to check the manual just to be sure. With a little luck, you should be able to unplug the cable from the display adapter in your PC and plug it directly into the decoder.

If you're not so lucky, you'll have to wire up a cable or an adapter. In addition, we left a row of pads just behind J2 on the PC board; you might find it easier to simply cut the traces between the two rows and add jumpers to reconfigure the pinout of J2. That could save you from having to modify a cable.

The power supply for the NTSC converter can be any well-regulated 12-volt supply that is capable of furnishing 250 mA of current on a continuous basis. Apply power to J3 through a 1/8" phono plug with positive tip and grounded shield.

### Testing and adjustment

Before applying power, check the PC board for solder splashes, bad or shorted connections, etc.. Do not install the IC's in their sockets yet; rather, first apply power to the circuit and check for smoke and overheated components. Using a DMM, verify that pins 1 and 20 of IC2, and pin 8 of IC1, are all about +12 volts. In addition, verify that the positive side of C8 is +5 volts.

After everything checks out, remove power from the board, install the IC's in their sockets, and make the external connections. A color-bar generator is nice for making the adjustments, but if you don't have access to one, any stable video signal will do. Use a camera or an off-the-air signal; don't try to set up from a tape. Turn the saturation, hue, and



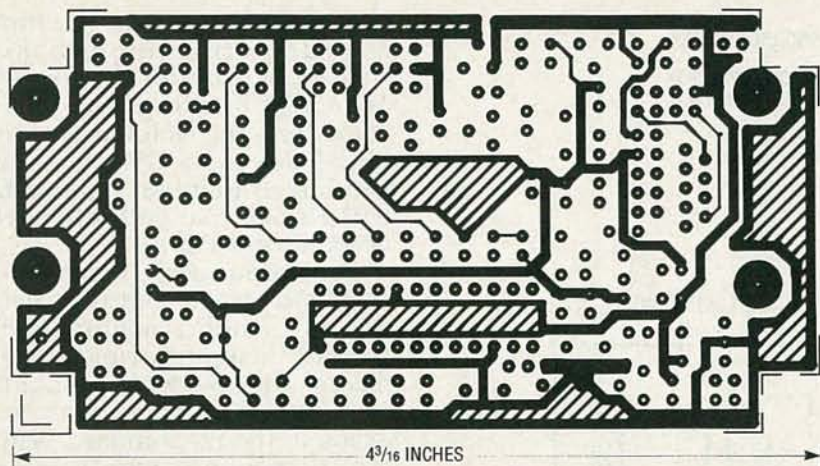

HERE'S THE COMPONENT SIDE OF THE NTSC/RGB CONVERTER

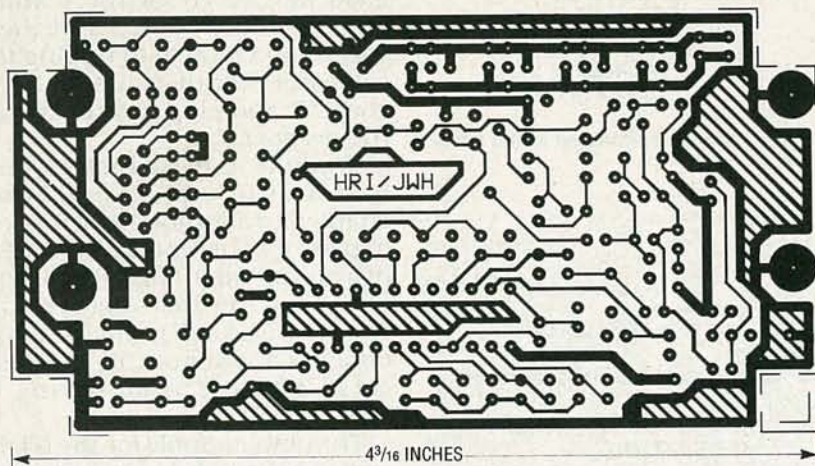

HERE'S THE SOLDER SIDE OF THE NTSC/RGB CONVERTER.

contrast controls (R36-R38) to maximum, and the brightness control (R35) to minimum.

**Adjusting without test equipment.** With everything hooked up and the monitor on, plug in the power supply. You should immediately see some kind of picture, although it will probably be black and white and possibly flashing on and off. Adjust C27 with a small screwdriver for the most stable picture and the best color. You may find two spots where performance seems equal; either will do. Next, adjust L1 for the deepest, richest color. Then adjust the saturation, hue, and contrast controls for the most natural look, just as you would on a normal television. You should leave the brightness control set at minimum unless you have a specific reason for wanting the black level set higher than it already is. That's all it takes to adjust the unit, and you will probably be very close to the optimum settings.

#### Adjustment with color-bar generator and oscilloscope.

With S1 closed, verify with the scope that you have a 1-volt peak-to-peak signal similar to that shown in Fig. 3-a at the input connector. Next, verify that a burst-flag pulse is present at pin 15 of IC2. That signal should look like the waveform shown in Fig. 3-f, and must be at least eight

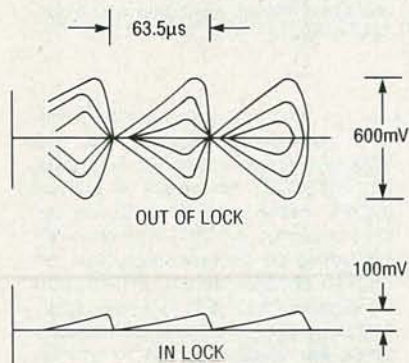

FIG. 6—VCO LOCK AT PIN 7 OF IC2. In (a) is an incorrectly adjusted signal; (b) shows the correct wavelshape.

volts in amplitude. Also, verify that you have a chroma signal similar to that shown in Fig. 3-d at pin 22 of IC2. If you examine pin 17 with a scope, it will probably resemble something halfway between Fig. 3-b and Fig. 3-c. Adjust L1 for minimum subcarrier by making the signal look like in Fig. 3-c as much as possible.

Continue adjustments by connecting the scope probe to pin 7 of IC2 and referring to Fig. 6. An out-of-lock waveform is shown in Fig. 6-a; adjust C1 until you obtain a stable waveform as shown in Fig. 6-b. There will probably be two spots in the adjustment range where lock occurs; either is OK. That signal is the VCO lock, and once set, you should be able to see nice, stable signals at the RGB outputs (pins 12-14 of IC2). Refer to the output waveforms in Fig. 3 and watch your monitor while adjusting the saturation, hue, and contrast controls to your liking. Outputs should be set anywhere from 0.7 to 1.0 volt peak-to-peak.

#### I want my MTV/2!

After making all of the adjustments to the unit itself, leave them alone; instead use the brightness and contrast controls on your monitor to compensate for ambient lighting. The decoder should be able to lock on to anything that comes anywhere close to NTSC video, but it can't deal with some of the copy-protection schemes that many pre-recorded tapes use. However, you may be able to compensate by running the composite video signal through a descrambler or stabilizer first.

You may notice that some video looks better on your monitor than on a TV, whereas other video looks worse. The reason is that a high-resolution display cannot improve a low-resolution input, and in some cases the high resolution might even bring out some unwanted artifact that a low-resolution display would cover up.

Some day, with all the hoopla over HDTV and multimedia, video and graphics displays will most likely merge. We will be running our CAD program on the same screen that we sit back and watch STAR WARS 15 on. Until then, projects like this will inch us a little closer.

R-E



**Here are a few tricks of the trade that may help you with your next TV repair.**

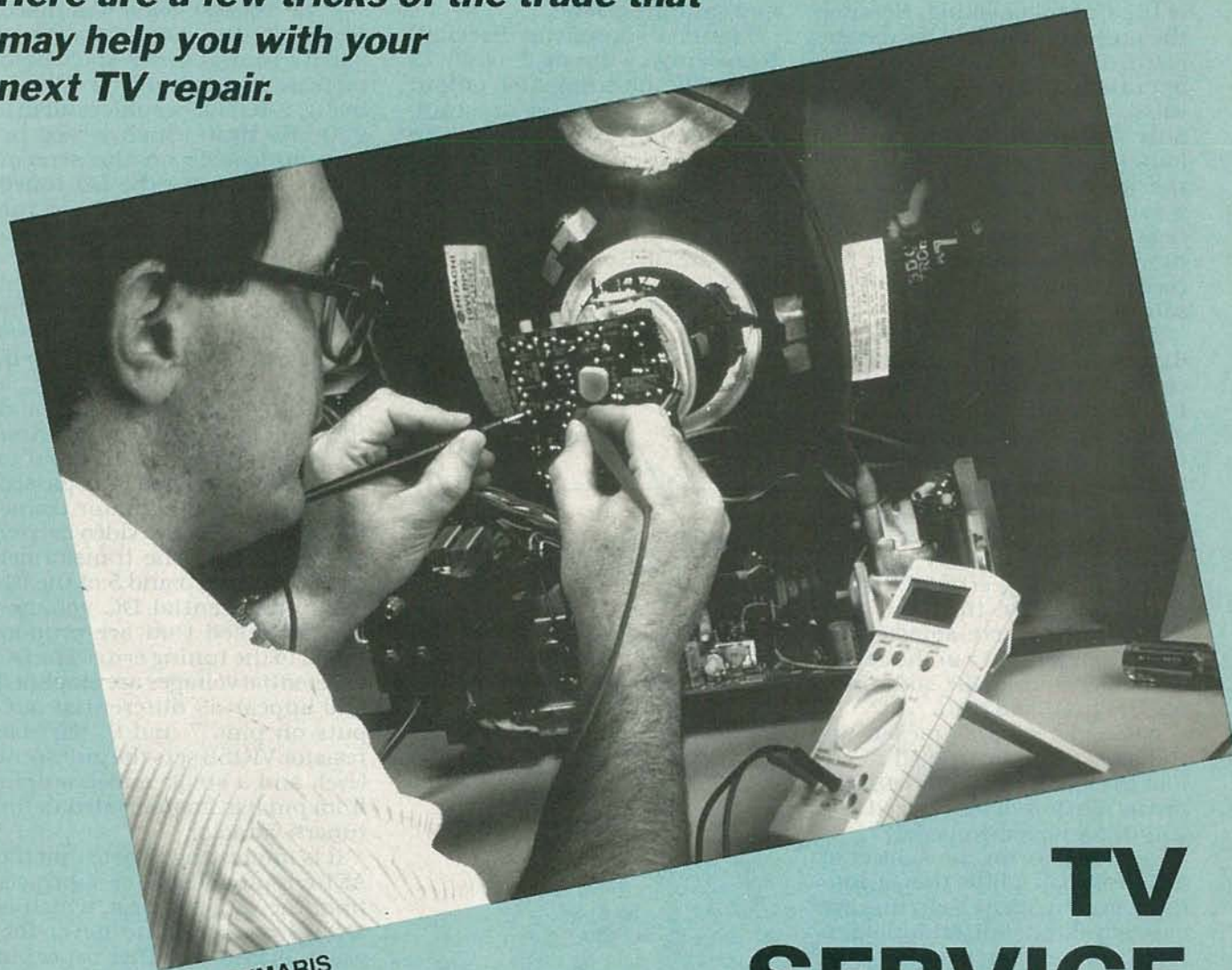

CLEO ZYMARIS

## TV SERVICE CASE HISTORIES

TV SERVICING CAN BE A PRECARIOUS business, but with a little intuition—and a firm background in TV repair fundamentals—your job can be made easier. We'll discuss a few examples of some common problems a service technician might come across, and how that intuition and background can lead to a solution.

### **An AFT problem**

Many TV repairs are fairly obvious examples of cause-and-effect; sometimes the cause is created by the customer! A customer came into the shop with a Samsung model CT-510AL, complaining that several channels

were distorted, with unsynchronized video and an annoying audio buzz. Luckily, raster, sound, and video were present. Those symptoms indicated a tuning problem, perhaps a malfunction of the fine tuning circuit or simply a misadjustment. The receiver had a preset button that set the tint, contrast and color. In addition, another button energized the automatic fine tuning (AFT) circuit. The customer was probably unaware that he misadjusted the preset and AFT buttons.

If the fine-tuning control was adjusted with the AFT activated, no change would occur in the pic-

ture until the frequency was so far from its correct value that the AFT lost control and the set tuned off-channel. A common characteristic of an AFT circuit is that the hold-in range is greater than the pull-in range. A fine tuning adjustment, with the AFT on, would initially produce no change to the picture because of the hold-in characteristic. If the channel was changed, however, and then returned to the original channel, the picture might be completely detuned because the pull-in capability had been exceeded. In the case of the Samsung model, that was indeed what happened.



The customer wanted to modify the tint to his liking. Because the preset button had been energized, the set controls were inoperative. With the AFT activated, he proceeded to rotate the only control available to him (other than volume) which was the fine tuning. As each channel was detuned he proceeded to the next. The icing on the cake was his fiddling around with a few control shafts on the back of the set.

The repair was obvious. First, I disabled the AFT, then each channel was adjusted properly for good color. The automatic gain control (AGC) was adjusted for minimum snow and no overload on any channel. I touched up the vertical controls that had been disturbed and sprayed clean the front panel controls that were acting erratic. Finally, the preset color, tint, and contrast controls were adjusted for good flesh tones. I ran the set for a few hours to make sure there was no front end drift.

When the set was picked up, the owner was instructed to adjust the fine tuning *only* with the preset button de-energized. Do you think he remembered?

Since we are on the subject of AFT, let's look a little deeper into its operation. All AFT circuits are basically limiter-discriminators. The discriminator is tuned to the video intermediate frequency (IF) at 45.75 MHz. If the set is tuned properly, the discriminator will produce zero volts with respect to a reference. Tuning too high or too low produces a more positive or more negative output from the discriminator. It should be noted that the polarity depends on circuit wiring and the maximum amplitude depends on the tuned

circuit bandpass, circuit gain, and saturation level.

Figure 1 shows the discriminator curve with an IF of 45.75 MHz. The discriminator output is routed to a varactor, or a transistor acting like a varactor, in the local oscillator (LO) tuning circuit. With proper polarities chosen, any detuning of the set would result in an error signal from the AFT circuit that would change the varactor's capacitance to properly tune the LO.

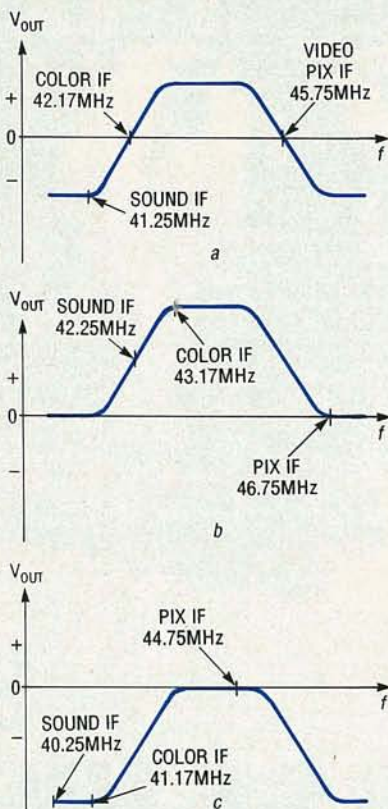

FIG. 2—INTERMEDIATE FREQUENCY RESPONSE as the local oscillator (LO) frequency is varied; (a) is the LO properly tuned, (b) is the LO tuned high and (c) is the LO tuned low.

Figure 2 shows the IF response as the LO frequency varies. For proper tuning, the video IF carrier at 45.75 MHz and the color subcarrier at 42.17 MHz (45.75 MHz minus 3.58 MHz) should appear at the proper amplitude points on the IF response curve. Figure 2-a is a graph of amplitude versus frequency of a correctly tuned LO. In this receiver, the video IF carrier and color subcarrier frequencies are located at 50% of the mid-range amplitude. In addition, the sound carrier, which operates at 41.25 MHz, is

located at a low amplitude point.

If the local oscillator was tuned too high, the color subcarrier and the sound carrier would both increase in amplitude, as shown in Fig. 2-b. That would result in a 920-kHz beat which would be very noticeable on the screen. Figure 2-c shows the LO tuned too low—the amplitude of the color subcarrier is reduced, resulting in a loss of color.

The Samsung model discussed here used an IC to perform the AFT function. Figure 3 shows that portion of the circuit. An IF sample is fed to pin 11 of the IC, a TA7070. The IF is amplified and the level stabilized by the first section of the IC and is output to pin 4. The amplified IF is passed through a discriminator transformer tuned to the video carrier at 45.75 MHz. The transformer feeds into pins 3 and 5 of the IC, where differential DC voltages are produced that are proportional to the tuning error. The DC differential voltages are amplified and appear as differential outputs on pins 7 and 8. Variable resistor VR158 sets the quiescent level, and a single ended output from pin 8 is finally routed to the tuner's varactor.

It is interesting to note that the AFT circuit adds to, or subtracts from the varactor bias, which is always reverse-, and never forward-biased. Another aspect of the AFT circuit is that the operating voltages for the IC's are stabilized by an internal shunt regulator, in conjunction with an external dropping resistor R173.

### An orphan TV

When a set comes into the shop for repair, it's comforting to go to the file cabinet and pull out its service information. Even before getting too deeply involved in the problem at hand, it can be helpful to identify major components and controls from the layout drawing. Take a look at the schematic and try to spot some clues for the repair. Is the power supply connected directly to the line? What form of voltage regulation is being used? How are the major components accessible? Are there plug-in modules?

The owner of a Supre-Macy model 20MK came into the shop with a complaint of no operation. I had no Supre-Macy service in-

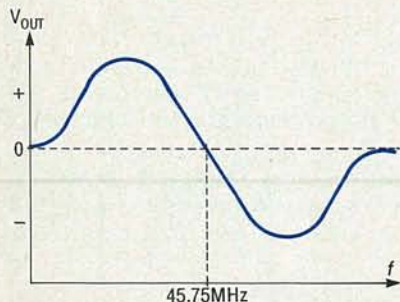

FIG. 1—DISCRIMINATOR OUTPUT TUNED to video IF at 45.75 MHz and zero volts with respect to reference.



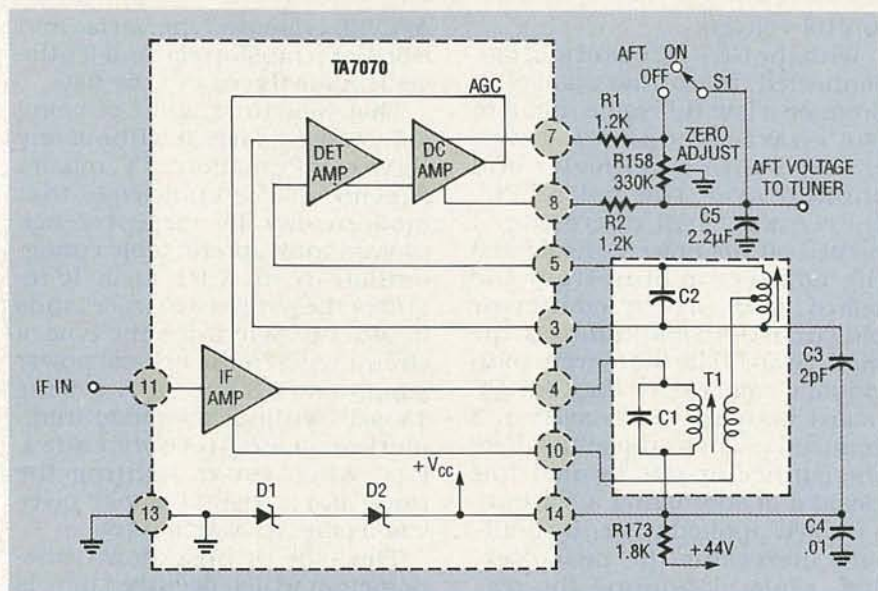

FIG. 3—THE AUTOMATIC FINE TUNING (AFT) IC and associated circuitry. The discriminator transformer is tuned to the video carrier at 45.75 MHz.

formation on file. *Sams Photofacts* index, the serviceman's bible, was of no help either. Macy's was a local department store and that was their private label. I was sure that by contacting the store, I would eventually find a source for service information. For the time being, however, this was an orphan TV. Here's how I attempted to repair the set without the security of a schematic to fall back on.

The back was removed and revealed a neat printed circuit board onto which several modules were plugged. The main board had a fuse wired directly on the PCB, with a smoky look indicating a blown fuse. Tracing a few lands on the bottom of the board showed the fuse in series with the AC line. A single rectifier and 200 volt filter capacitor indicated half-wave rectification.

The back of the set conveniently identified the modules in English and French. On the regulator/audio module, a TO-3 transistor Q1 and a TO-220 transistor Q3 were mounted on heat sinks. The module was unplugged and some lands were traced. The collector of Q1 was connected to the unregulated B+ source, shown in Fig. 4. The base was connected to a small plastic transistor Q2 with the emitter wired on the board. That was the regulator section. A little more tracing showed that Q3 operated as a single ended or class-A audio output amplifier, in conjunction

with a main board transformer. The three transistors were checked for shorts with an ohmmeter and found to be normal.

The regulator/audio module was plugged in and a few continuity measurements were made to check for AC or DC short circuits. The load side of the blown AC fuse showed a resistance of approximately 350 ohms with reference to ground—a little low, but not a short. Disconnecting the degaussing coil increased that value to a more reasonable value in the range of tens of kilohms. Of course! The degaussing coil was in series with a thermal resistor, as it heated up its resistance increased, degaussing only on turn-on. Those measurements were made with a cold re-

sistor. Continuity measurements with respect to ground were made at the cathode of the rectifier diode, and at the collector of the horizontal output transistor. No shorts were revealed.

Access into the set was difficult, so I decided to make life easier by mounting the fuse onto a stiff fuseholder on the PCB. Fuse replacement would be much quicker using a clip-type fuseholder.

The set was connected to a Variac and an isolation transformer. I adjusted the variac to produce a low value of about 30 volts DC at the rectifier cathode. The presence of B+ voltages were checked at the regulator output, the audio output transistor, and at the horizontal output transistor. I carefully increased the voltage gradually until audio noise was heard. The set seemed ready to work. The aroma of burning plastic was becoming noticeable and a wisp of smoke was seen coming from the PCB attached to the CRT socket. Shut off the power!

Inspection of the PCB showed charring around the connector pins leading off the board, which indicated a dielectric breakdown between the PCB land patterns. Unplugging the connector showed burning between pins 3 and 4. Pin 4 had continuity to ground, pin 3 was on the high side of the screen control.

Typically, a set with an in-line CRT has a circuit similar to that shown in Figure 5, where the connector details have been added. The high side of the screen

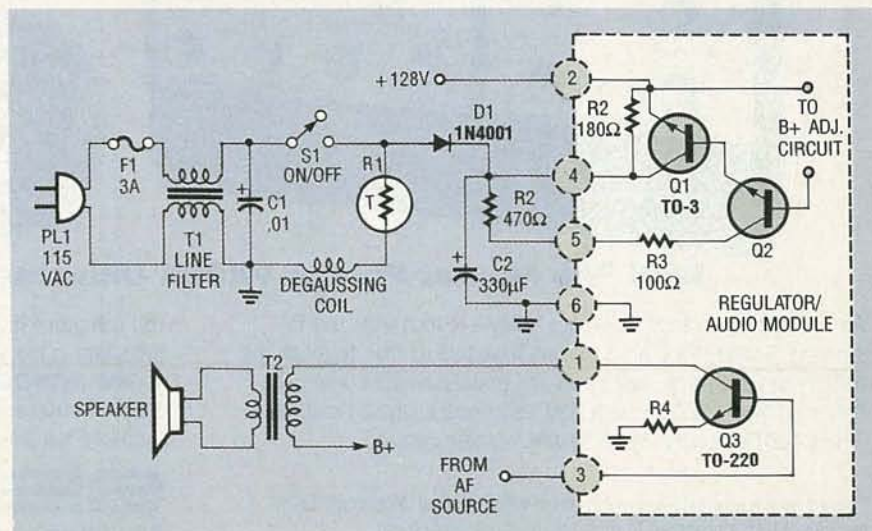

FIG. 4—POWER SUPPLY CIRCUIT.



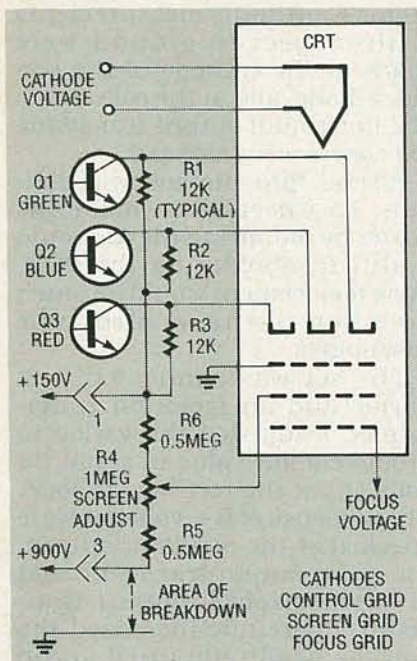

FIG. 5—CRT CIRCUIT SHOWING connector details.

control usually operates at about eight or nine hundred volts, derived from either a B+ boost circuit or from a tap-off in the focus circuit. It is important to determine the presence of the screen

control voltage.

With the CRT PC board still disconnected, the variac was set to produce a low B+ value. Pin 3 of the charred connector was checked with a voltmeter and showed over 100 volts. The source was still operating. I turned off the power, unsoldered the connector pins from the board, and cut the connector plug from the cable leading to the main board. The wires were individually soldered to the CRT PC board without the benefit of a connector. Then, the area where the connector was located was cleaned of soot using a solvent.

I slowly applied power by gradually increasing the variac setting, while monitoring the regulator emitter and observing the CRT PCB. Soon sound was heard and a picture was visible. The input voltage was increased until 110 volts AC was applied. The regulator's output leveled off at +128 volts and there was no evidence of breakdown at the repaired PCB. I cleaned up the controls and adjusted the fine tuning for each channel, with the

AFC off. I removed the Variac and isolation transformer and let the set run for the rest of the day.

That was an example of being able to make a repair without any service information. TV repairs depend on the knowledge that modern day TV circuitry has evolved into a predictable configuration in the CRT area. It requires the patience to trace lands in order to determine the type of circuit used in the critical power supply and CRT areas. Servicing TV sets without adequate information is not recommended. But, when you're fighting the clock and a wisp of smoke gives you a clue, it's worth a try.

The type of breakdown phenomenon which occurred here is not unusual. A dielectric breakdown can occur on terminal boards, between PCB land patterns, as it did in this case, or between adjacent connector pins.

A postscript—further inquiry uncovered that the manufacturer of the Supre-Macy model was Technika, which is listed in *Sams Photofacts*. R-E



## Cut Your Video Servicing Time by 54%\*



**\$3,495**  
Patented

### With The Market Proven VA62A Universal Video Analyzer™

Are you finding it tough to service today's hi-tech VCR and TV circuits? Successful video servicers have told us that, to them, the new technology meant lost profit and troubleshooting grief until they tried the VA62A's time tested, functional analyzing methods. "The VA62A cuts servicing time and increases profits . . ."

\*Based on a nationwide survey of users who reported an average time savings of 54% compared to their previous test equipment.

You can prove it to yourself, in your shop, absolutely risk free—and share in the profits successful video servicing can bring. Call **1-800-SENCORE (736-2673)** and ask about our exclusive VA62A instrument evaluation program. Tech-Tape Video Preview and FREE full line color catalog are also available.

**SENCORE®**  
3200 Sencore Drive, Sioux Falls, SD 57107  
100% American Made



# INTRODUCTION TO MICROWAVE TECHNOLOGY

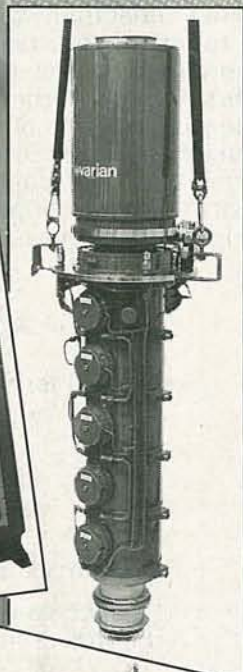
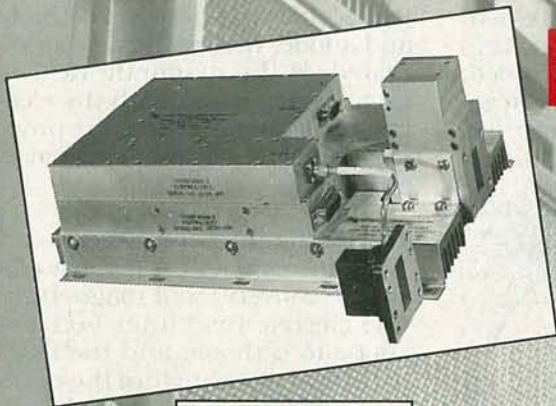

Last time, we covered the major factors that kept classical vacuum tubes from generating microwaves in normal use: inter-electrode capacitance, lead inductance, gain-bandwidth product, and transit-time effects. The major effort in the 1930's and 1940's was to either circumvent those limitations, or exploit them to good advantage.

In a magnetron, electrons accelerate toward the anode as in a classical vacuum tube, but are deliberately returned to the cathode by a magnetic field as their speed increases. If an RF wave of the right frequency is in the cavity when the magnetic field returns the electrons, and the electrons move at the right speed (the phase velocity) they transfer

kinetic energy to the RF wave by resonance.

The electrons re-bombard the cathode, and the process repeats. Only those electrons transferring enough energy to the RF wave at resonance reach the anode, and only if they're close enough to be attracted to it. M-type magnetrons are efficient, so very few electrons reach the anode.

The whole point of classical vacuum tubes is anode current. The goal of a magnetron is to *not* generate anode current, since an electron reaching the anode can't be reexcited to generate more kinetic energy to transfer to the RF wave by resonance. An RF probe in the cathode-anode interaction space conducts the RF energy to an outside waveguide. The RF wave is the output, not the anode current.

## Learn the principles of magnetron tubes.

JOSEPH J. CARR

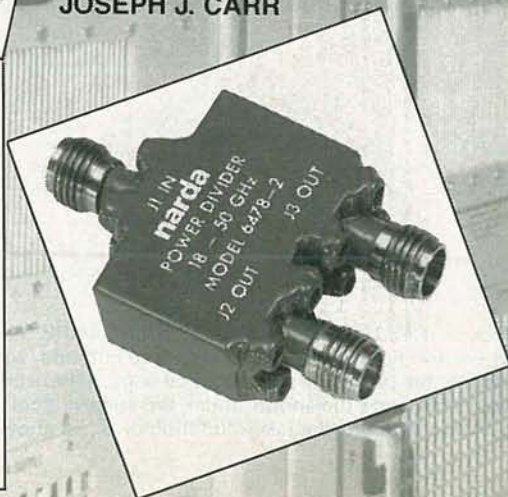
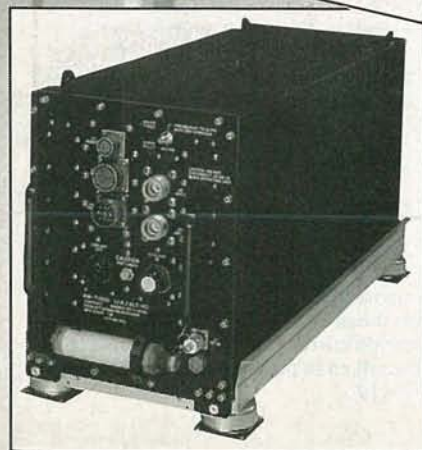

### Electric and magnetic fields

There are really four quantities relevant in electromagnetics: electric field intensity  $E_0$ , magnetic field intensity  $H_0$ , electric flux density  $D_0$ , and magnetic flux density  $B_0$ . The British physicist James Clerk Maxwell, in the 19th century, found the complex equations governing all four quantities.

The units of electric field intensity are volts per meter, or volts/m. The units of magnetic field intensity are amps per meter, or amps/m. The units of electric flux density are coulombs per square meter, or coulomb/m<sup>2</sup>, where

$$1 \text{ coulomb} = 6.25 \times 10^{18} \text{ electrons.}$$

The unit of magnetic flux density is the tesla, where

$$1 \text{ tesla} = 1 \text{ weber/m}^2.$$



The weber is the metric unit of magnetic flux (not flux density), and is the magnetic analog of the coulomb. Just as

$$1 \text{ coulomb} = 1 \text{ amp} \times \text{s}$$

in the electric case,

$$1 \text{ weber} = 1 \text{ volt} \times \text{s}$$

in the magnetic case.

In most simple materials and vacuum, flux density is linearly proportional to field intensity. For the electric case,

$$D_o = \epsilon \times E_o,$$

and for the magnetic case,

$$B_o = \mu \times H_o.$$

The permittivity of free space is  $\epsilon_o$ , and the permeability of free space is  $\mu_o$ . In other than free space (or vacuum),

$$\epsilon = \epsilon_r \times \epsilon_o,$$

and,

$$\mu = \mu_r \times \mu_o.$$

The permittivity of free space is

$$\epsilon_o = 10^{-9} / (36 \times \pi) \text{ farads/m} = 8.85 \text{ pF/m},$$

and the permeability of free space is

$$\mu_o = 4 \times \pi \times 10^{-7} \text{ henry/m} = 1.26 \text{ } \mu\text{H/m}.$$

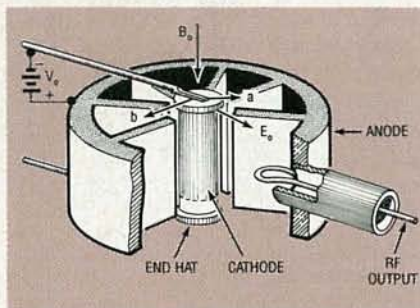

FIG. 1—A BASIC CONVENTIONAL cylindrical or conventional magnetron. The individual chambers between the spokes are the reentrant cavities, and connected to the gaps between the walls of the cavities. They're cavity resonators, metallic enclosures that confine RF energy.

### The M-type magnetron

A conventional cylindrical magnetron is shown in Fig. 1. The chambers are reentrant cavity resonators—metallic enclosures confining RF energy, connected at the gaps between their walls. They have an infinite number of oscillating modes, the lowest-frequency one being dominant. At resonance, a standing wave is generated, and the peak electric and magnetic field energies are equal.

There's a DC operating poten-

tial  $V_o$  between cathode and anode, while magnetic flux density is in the +z-direction, into the page. The anode is grounded, and the cathode is highly negative. If the anode were positive,

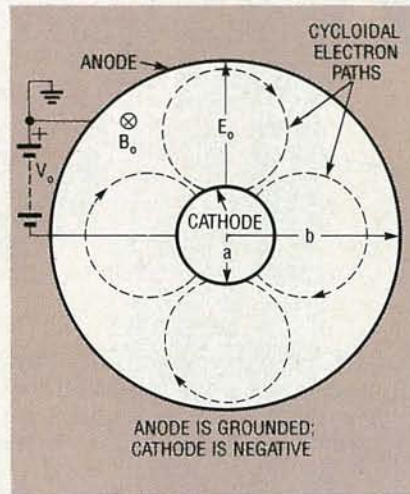

FIG. 2—ELECTRON PATHS IN A conventional magnetron. If an electron is injected into the electric field  $E_o$  between cathode and anode, it accelerates linearly. If the lines of magnetic flux density  $B_o$  is present into the page, and both  $E_o$  and  $B_o$  are properly adjusted, the electron moves cycloidally.

both it and the output waveguide would need insulation, and be dangerous to service.

Figure 2 shows electron paths in a conventional magnetron;

when electrons are injected into the electric field between cathode and anode, they're linearly accelerated. If the magnetic field is into the page, and both the electric and magnetic fields are properly adjusted, the electron moves cycloidally.

### The Hull cutoff condition

Figure 3 shows three views of a simple conventional magnetron. The electric field lines go from anode to cathode, and the magnetic field lines are into the page. For a constant magnetic field, operation is governed by the Hull magnetic cutoff criterion. The first form gives the Hull cutoff potential in terms of magnetic flux density. The second form gives the Hull cutoff magnetic flux density in terms of operating potential. The first form is

$$V_{oc} = \left( \frac{e}{8m} \right) B_o^2 b^2 \left( 1 - \frac{a^2}{b^2} \right)^2.$$

The second form is

$$B_o = \frac{\left( \frac{8V_o m}{e} \right)^{1/2}}{b \left( 1 - \frac{a^2}{b^2} \right)}.$$

In the above expressions

$V_o$  is the operating potential,  $V_{oc}$  is the Hull cutoff potential in volts,

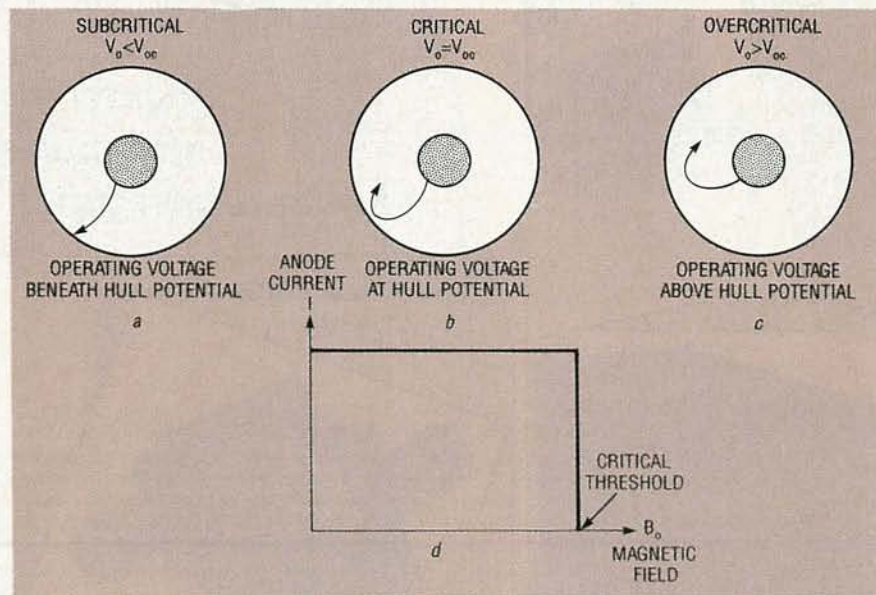

FIG. 3—THE THREE ELECTRON TRAJECTORIES in conventional magnetrons. The lines of electric field  $E_o$  goes from anode to cathode, while those of magnetic flux density  $B_o$  are into the page. The subcritical case (a) yields true anode current. In the critical case (b), electrons graze the anode, and in the supercritical (cutoff) case (c), they never reach it. A plot of anode current  $I$  as a function of  $B_o$  is shown in (d).



$a$  is the cathode radius in meters,  $b$  is the anode radius in meters,  $e = 1.6 \times 10^{-19}$  coulombs, the electron charge,  $m = 9.11 \times 10^{-31}$  kilograms, the electron mass,  $B_o$  is the magnetic flux density in webers per square meter ( $\text{Wb}/\text{m}^2$ ),  $B_{oc}$  is the Hull cutoff magnetic flux density in webers per square meter ( $\text{Wb}/\text{m}^2$ ).

The relative values of operating potential and magnetic flux density govern magnetron operation. For the first form, if magnetic flux density is above cutoff for a given operating potential, the electrons don't reach the anode. The reverse holds true for the second form; if the operating voltage is under the Hull cutoff potential for a given magnetic flux density, the electrons again don't reach the anode.

Figure 4 shows the three conditions for the second form of the Hull cutoff criterion. Figure 3-a shows the subcritical case, where the operating potential is below cutoff, with a true anode current. Figure 3-b shows the critical case, where the operating potential is at cutoff, and the electrons graze the anode before returning. Figure 3-c shows the supercritical case, where the operating potential is above cutoff, and the electrons are deflected back before hitting the anode. Figure 3-d shows anode current  $I$  as a function of magnetic flux density  $B_o$ .

### Magnetron anodes

The circular anodes in Fig. 3 have an infinite number of modes, and are useless. Real magnetrons use cavity resonators like those in Fig. 1; each is

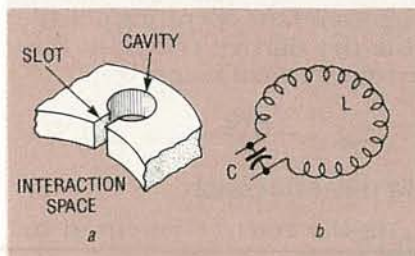

FIG. 4—THE CAVITY RESONATORS IN Fig. 2 act like a resonant L-C tank. The cavity walls primarily contribute to cavity inductance, while the spacing between the walls of the gap at the base of the cavity primarily contributes to cavity capacitance.

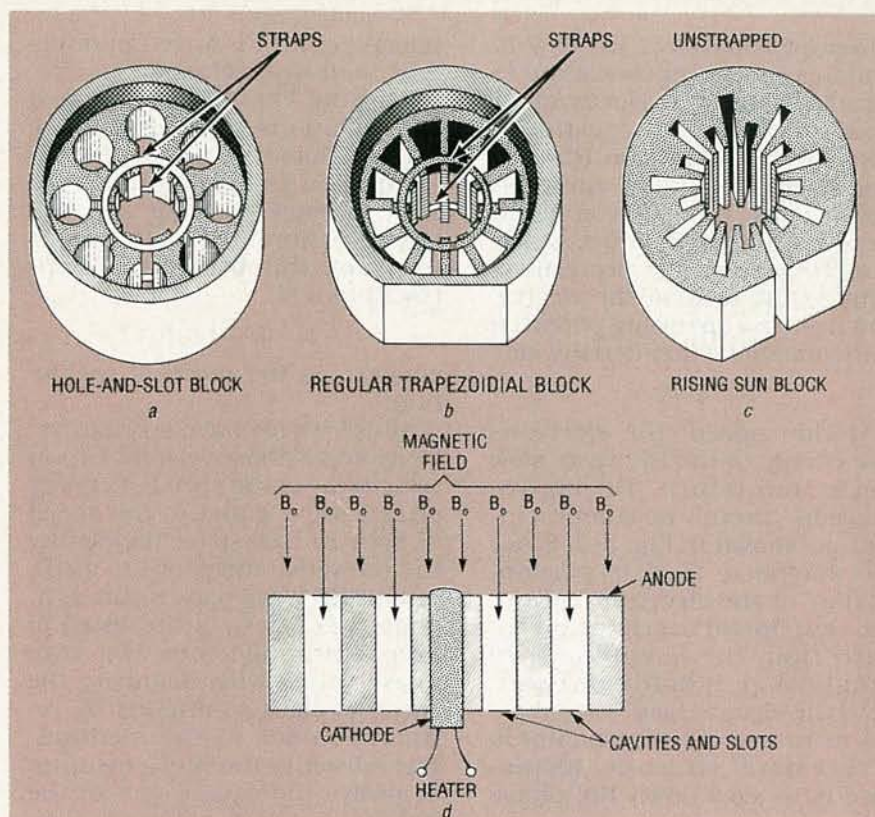

FIG. 5—SEVERAL DIFFERENT MAGNETRON ANODES; a hole-and-slot block (a), a regular trapezoidal block (b), and a rising sun block (c). In each, the cavities and anode are made from a single metal block;  $B_o$  is arranged as in (d).

a resonant L-C tank as in Fig. 4; the cavity walls fix inductance, the wall conductivity fixes resistance (not shown). Several versions are shown in Fig. 5; each is a single metal block, and  $B_o$  appears in Fig. 5-d.

Consider the hole-and-slot block in Fig. 5-a; the others are similar. For unstrapped (unshorted) anodes, the tanks are in series, as in Fig. 6-a. However, if alternate cavities are strapped (shorted) as in Fig. 6-b, the anode is an array of parallel L-C tanks, as in Fig. 6-c. That's normal for most magnetrons; due to the strapping of alternate cavities, adjacent resonators are  $180^\circ$  out of phase.

### Pi-mode operation

Most magnetrons work in  $\pi$ -mode, where the phase shift between adjacent resonators is  $\pi$  radians, or  $180^\circ$ . The radian is an alternate unit of angle, where 1 radian =  $57.3^\circ$ . When a magnetron is turned on, the electron cloud shock-excites (rings) the cavities, setting up a spatially- and time-varying electric field in the cathode-anode interaction space, adding to that due to the

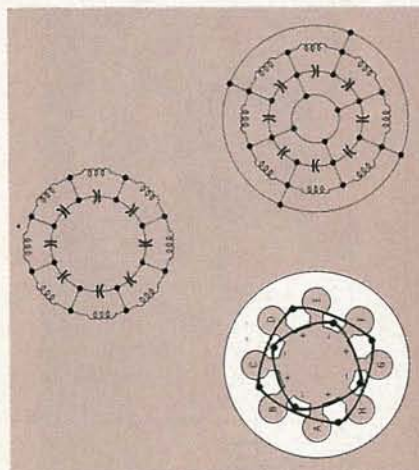

FIG. 6—EACH HOLE AND SLOT CAVITY IS A parallel-resonant L-C tank. In unstrapped (unshorted) anode, the tanks are in series, as in (a). If alternate cavities are strapped (shorted) as in (b), the magnetron becomes an array of parallel L-C tanks, as in (c). Magnetrons are normally strapped, so adjacent resonators are  $180^\circ$  out of phase.

operating potential. It varies the acceleration of the electrons due to the operating potential  $V_o$ , modulating their velocity and  $V_o$  density, creating a "bunched up" pattern.

Figure 7-a shows the electric field due to the operating potential for a hole-and-slot block, and



for a trapezoidal block in Fig. 7-b, both in  $\pi$ -mode. For oscillation to occur, the electron velocity must equal the phase velocity of the RF wave, so resonance can transfer kinetic energy into RF energy. If that occurs, the electron cloud keeps ringing the cavities, generating RF waves. The electron velocity is the ratio of the electric field from the operating potential to the magnetic flux density, or

$$v_o = E_o / B_o.$$

At that speed, the electrons lose energy to the RF wave, slow down, and return. During oscillation, there's no anode current, as shown in Fig. 3-d. Since the magnetic field is perpendicular to the electron motion, the centripetal acceleration inward from the magnetic field equals that radially outward from the electric field.

A reentrant cavity resonator is a "slow-wave" structure; its purpose is to slow down the phase

velocity of an RF wave (more below), so it interacts with an electron beam. The cavity is designed so oscillations occur only if the total phase shift around the anode is a multiple of  $360^\circ$  or  $2 \times \pi$  radians, creating a standing wave. For an N-cavity anode, the phase shift between adjacent resonators is

$$\phi_n = (2 \times \pi \times n) / N,$$

where n is the mode of oscillation.

All RF waves have a group velocity and a phase velocity. Group velocity  $v_G$  is the speed of energy propagation, equal to the speed of light in free space divided by the refractive index of the medium an RF wave passes through. Phase velocity  $v_p$  is the speed of phase propagation, the rate phase varies with distance, the speed of light multiplied by refractive index of the medium. The refractive index of a medium is always the square root of the product of its relative permeability and permittivity, so that

$$v_G = c / \sqrt{\mu_r \times \epsilon_r},$$

and

$$v_p = c \times \sqrt{\mu_r \times \epsilon_r},$$

where

$$c = 3 \times 10^8 \text{ m/s}$$

is the speed of light in free space. In the vacuum of a magnetron, both group and phase velocities equal c.

Another way to think about these two speeds is that group velocity means, "So many joules of energy per square meter pass a point per unit time," while phase velocity means, "So many radians of a wave pass a point per unit time." For a magnetron to oscillate, the electron tangential speed must equal the phase velocity, or

$$v_o = v_p.$$

In Fig. 7, the electric fields shown are for two different eight-cavity blocks, or  $N=8$ . For those two blocks, the mode can be found since

$$\phi_N = (2 \times \pi \times n) / 8 = \pi,$$

so that those two anode blocks exhibit fourth-order modes, or  $n=4$ . The successive adjacent cavities create a traveling RF wave along the surface of the

slow-wave structure. The "spokes" in Fig. 7-b represent segments of the space-charge cloud as it revolves.

For a magnetron operating in  $\pi$ -mode, the number of cavities has to be even, or  $N=2, 4, 6, \dots$ . Since the phase shift between adjacent cavities is  $180^\circ$ , each pair of cavities shifts the phase  $360^\circ$ , or one cycle, maintaining a standing wave. The operating frequency of a magnetron is the speed of light divided by the product of the number of cavities N and the mean distance L between them, or

$$f = c / \lambda = c / (N \times L).$$

### The Hartree cutoff condition

The Hull condition expresses the cutoff potential in terms of magnetic flux density, or vice-versa. A more complex companion condition relating magnetic flux

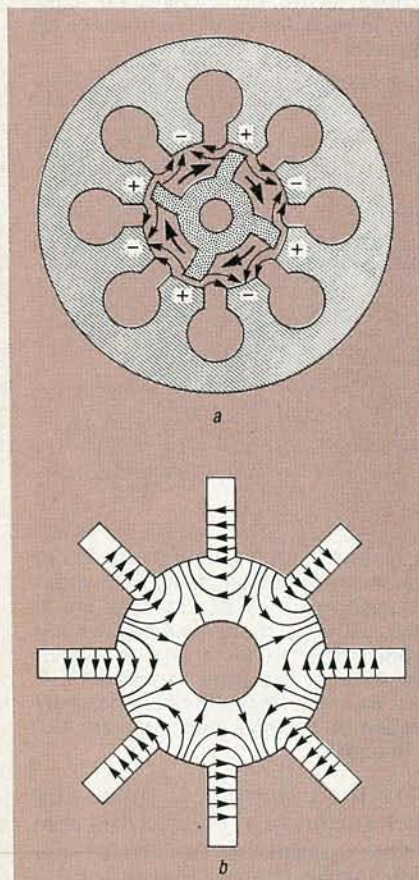

FIG. 7—THE SHOCK-EXCITED, spatially-varying  $\pi$ -mode  $E_o$  for a hole-and-slot block in (a), and a trapezoidal block in (b), both with  $N=8$ . They cause nonuniform electron acceleration resulting in velocity and density modulation, and "bunching up" of electrons.

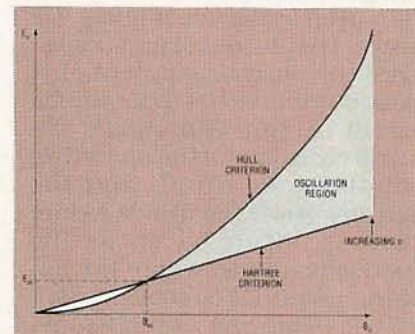

FIG. 8—THE RELATIVE EFFECTS of the hull and Hartree criteria, plotting the electric field  $E_o$  versus the magnetic flux density  $B_o$ . The electric field is directly proportional to the operating potential  $V_o$ , since the cathode-anode spacing is fixed. The Hull criterion is above, the Hartree criterion below, and they intersect both at the origin and when  $V_{oc} = V_{oh}$ . If  $V_o > V_{oi}$  and  $B_o > B_{oi}$ , oscillation occurs; if not, the RF energy is cutoff.

density to the cathode-anode spacing and the operating potential is the Hartree criterion. For the conventional magnetron

$$V_{oh} = \frac{2\pi f B_o}{Nc} (b^2 - a^2).$$

In this expression

$V_{oh}$  is the Hartree potential in volts,

$B_o$  is the magnetic flux density in webers per square meter ( $\text{Wb/m}^2$ ),

$f$  is the frequency in Hz,

$N$  is the number of resonators,

$b$  is the anode radius in meters,

continued on page 76



## MEMORY CARD

continued from page 58

strobe) enable signals for the RAM. In order to keep the board size small, a PEEL programmable logic device was used for IC2. For those interested in programming their own device, or for those simply interested in how the decoding works, the truth table for IC2 is shown in Table 1.

The address and control signals to the RAM are buffered by IC3 and IC4. A four-position jumper, J1, is used to select the amount of on-board memory you will use and whether the printer is a IIP or III. The 8048 microcontroller is programmed to communicate to the printer such information as "I am here," and "I have 1 megabyte of memory installed," etc., and its hex code is shown in Listing 1.

### Assembly

Although the circuit is simple, the need to accommodate up to 4-megabytes of memory (32 IC's) makes the PC board rather complex. The foil patterns are provided for the board, but you will have to drill 945 holes if you wish to make your own.

Referring to the parts-placement diagram in Fig. 2, install the parts in the following order. Start by installing and soldering all of the IC sockets. The 20-pin sockets should have built-in 0.1  $\mu$ F decoupling capacitors. (The finished board is shown in Fig. 3, where you can see the IC sockets with the built-in decoupling capacitors.) Orientation of these sockets is important, as the capacitor must go to pins 10 and 20 of the pads on the board. However, you can use regular sockets and mount the capacitors on the bottom side of the board or underneath the sockets. Because you don't have to install the full 4 megabytes of memory on the board, you might want to install only as many sockets as needed. Install 8 sockets per row per megabyte, starting in the row next to IC1.

Install capacitors C1 through C5. Make sure you properly orient the polarized capacitors, C1 and C5.

Jumper block J1 may be either an 8-pin dual-row male header

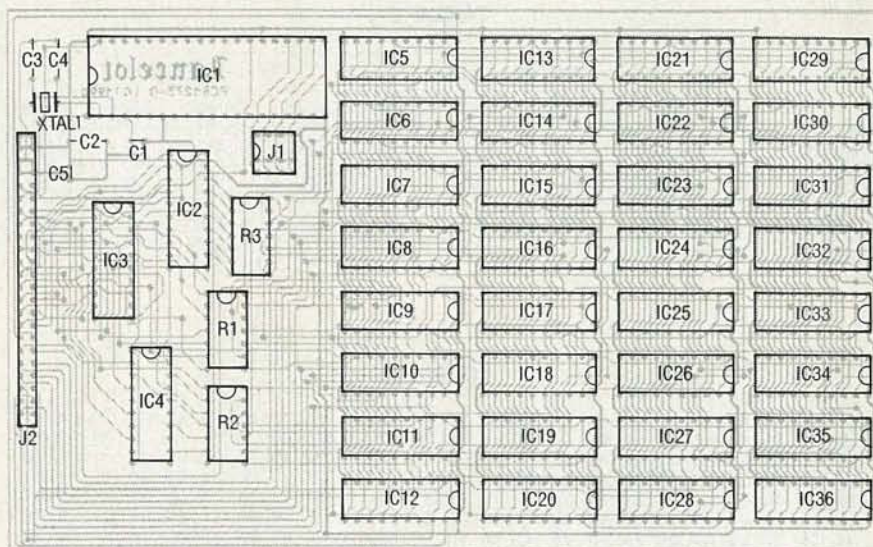

FIG. 2—ALTHOUGH THE CIRCUIT IS QUITE SIMPLE, the PC board is rather complex, in order to accommodate up to 32 dynamic RAM IC's.

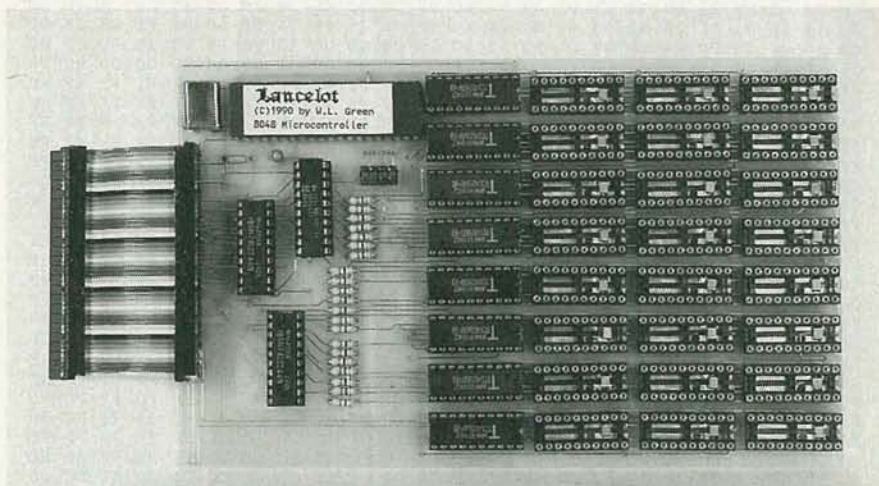

FIG. 3—THE PROTOTYPE BOARD uses IC sockets with built-in decoupling capacitors. Orientation of these sockets is important, as the capacitor must go to pins 10 and 20. You can also use regular sockets and mount the capacitor under the socket or on the solder side of the board.

TABLE 1  
TRUTH TABLE FOR 011273 DECODER

Inputs				Outputs							
1	2	3	4	12	13	14	15	16	17	18	19
1	X	X	X	H	H	H	H	H	H	H	H
0	0	0	0	L	H	H	H	H	H	H	H
0	1	0	0	H	L	H	H	H	H	H	H
0	0	1	0	H	H	L	H	H	H	H	H
0	1	1	0	H	H	H	L	H	H	H	H
0	0	0	1	H	H	H	H	L	H	H	H
0	1	0	1	H	H	H	H	H	L	H	H
0	0	1	1	H	H	H	H	H	H	L	H
0	1	1	1	H	H	H	H	H	H	H	L

"X" = Don't Care







# HARDWARE HACKER

This month we look at various types of filters and a digital thermometer.

DON LANCASTER

Our no-charge Hardware Hacker helpline sure gets a lot of traffic on filters and filtering. So this month, I thought we might go over some filter fundamentals, especially in deciding just what kind of filter should get used where.

## Passive filters

An electronic *filter* is some frequency-selective network that favors certain frequencies at the expense of others. Filters are normally used to strengthen wanted signals while trying to reject unwanted ones.

Traditionally, filters were built by using combinations of inductors and capacitors. These are called *passive filters*, and three examples appear in Fig. 1.

In 1-a, we have an example of a *low-pass* filter. At very low frequencies the inductor appears as a piece of straight wire and the capacitor's reactance is extremely high. So DC and very low audio frequencies are readily passed. At very high frequencies, the inductor looks like a high blocking impedance and the capacitor looks like a very low shunting impedance, so all the high frequencies will get strongly attenuated.

The one-two punch of this example makes it a *second order* filter. At low frequencies, the response is flat. At very high frequencies, the response

will quarter with each doubling of frequency, or fall off at a  $-12$ -decibel-per octave rate.

What will happen at the *corner frequency* with this circuit? Well, that depends on the *ratio* of the inductance to capacitance. Should you want the smoothest possible response, you can adjust the ratio of L to C so your response ends up precisely 3 decibels down, or roughly 70 percent of the amplitude at the corner frequency. This  $-3$ -decibel point could also be called the *cutoff frequency*. Such a low-pass filter with the smoothest possible passband is usually called a *Butterworth filter*.

The L/C ratio of the circuit is also known as the *damping*. If you are *critically damped*, you will get the smoothest possible response. If you are *underdamped*, you get a rising or a peaked response at your corner frequency. If you are *overdamped*, you get a very droopy result.

A simple *treble control* on a Hi-Fi is an example of a low-pass filter.

A *band-pass* filter appears in Fig. 1-b. At rather low frequencies, the capacitor provides a high reactance, and your response *increases* at a  $+6$ -decibel per octave rate. At resonance, otherwise called the *center frequency*, the reactances cancel, giving you unity gain. At the higher frequencies, the inductor provides a

high series reactance, and the response *decreases* at a  $-6$ -decibel-per-octave rate.

The ratio of the inductance to the capacitance sets the damping, which in turn will set the sharpness of your resonant peak. Since very low damping values are usually involved, a factor called the "Q" is used instead. The Q, or "quality" factor is the inverse of the damping. The Q is also the bandwidth of the center peak between its  $-3$  decibel points.

Note that, no matter how high the Q, the slopes at very low and very high frequencies will stay at  $+6$  and  $-6$  decibels per octave. Your choice of Q determines only the narrowness and the peakedness of the response *at or near resonance*. The tuning dial on an AM radio is an example of a band-pass filter.

A second-order *high-pass* filter appears in Fig. 1-c. Here, the high impedance of the series capacitor and the low impedance of that shunting inductor attenuates the very low frequencies, creating a double whammy attenuation rate of  $+12$  decibels per octave. At higher frequencies, the capacitor's reactance is low and the inductor's is high, freely passing the highs without attenuation.

Once again at the corner frequency, you will get a peaked, smooth, or drooping response depending on your L/C ratio and its damping factor.

The *bass control* on a Hi-Fi is one example of a high-pass filter.

Actually, there is no such thing as a true electronic high-pass filter, since one of these would also have to pass microwaves, heat, light, and X-rays. At very high frequencies, the circuit strays (such as a capacitor self-resonating on its own leads) can alter the response.

High-pass filters also tend to be "noisy," since they freely pass all the harmonics of all supposedly rejected waveforms. Compared to a low-pass filter, which performs one or more integrations, a high-pass filter does

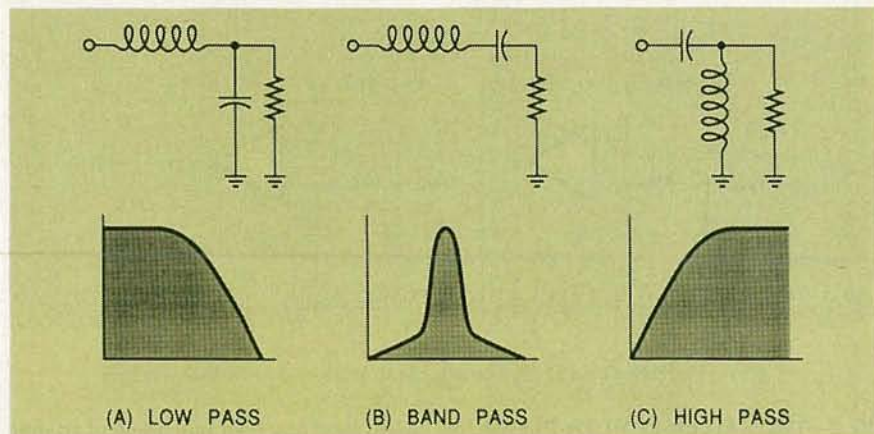

FIG. 1—THREE EXAMPLES OF SECOND-ORDER passive LC filter sections.



one or more differentiations, or slope extractions. This also can add to the overall noise.

Fancier filter responses are picked up by using additional inductors and extra capacitors to increase the order of your filter. Unfortunately, you can not just "stack up" passive sections. Each in turn has to play a specific and non-obvious part in your overall desired response.

My favorite design book on passive filters remains Louis Weinberg's almost ancient *Network Analysis and Synthesis* (McGraw Hill, 1962). The *Radio Amateur's Handbook* also has lots of good passive filter design information in it, as do most college-level circuit or network texts.

These days, you usually try to avoid passive filters like the plague, since they are bulky and expensive, and hard to redesign, calibrate, or adjust. They also lack gain and do need carefully controlled source and load impedances. So, you'll want to avoid passive filters at all costs—unless you happen to be working with ex-

## NEED HELP?

Phone or write your **Hardware Hacker** questions directly to:  
 Don Lancaster  
**Synergetics**  
 Box 809  
 Thatcher, AZ 85552  
 (602) 428-4073

tremely low signals, at very high power levels, or at very high frequencies where nothing else will do the job. The usual way of filtering stuff today involves...

## Active filters

With an *active filter*, you can use combinations of resistors, capacitors, and operational amplifiers to fake the response you would get from a passive LC filter. The energy from the power supply is used to substitute for the energy normally stored in an inductor's magnetic field.

Important advantages of the active filters are that there are no inductors involved, they are easy to design, and they are easy to tune.

Since active filters can also provide buffering and gain, they are far less

sensitive to source or load impedances than passive filters.

While there have been many different active-filter design methods in the past, only two have really survived and stay popular today. These are the everyday *Sallen-Key* single op-amp filters and higher performance *State Variable* filters that need three or four op-amps per second-order section.

Figure 2-a shows to you a second-order Sallen-Key low-pass filter, normalized to a 10K impedance level and a 1-kHz cutoff frequency.

The original horse's mouth on this was R. Sallen and Key's *A practical method of designing RC active filters* from the IRE Transactions on Circuit Theory, March 1955, pp 74–85.

Their prototype Sallen-Key filters were intended for use with cathode followers, the vacuum-tube precursor to a transistor emitter-follower circuit. These were designed to work with a unity or slightly lower gain, which forced you to select weird ratios of capacitors and caused an interaction between the corner frequency and the desired damping.

Many years ago, I played around with the Sallen-Key math in detail and came up with a twist that made these filters far simpler to design and use. I

## NEW FROM DON LANCASTER

### HANDS-ON BOOKS

Hardware Hacker Reprints II	24.50
Ask The Guru Reprints I or II	24.50
CMOS Cookbook	18.50
TTL Cookbook	16.50
Active Filter Cookbook	15.50
Micro Cookbook vol I or II	16.50
Lancaster Classics Library	99.50
Enhancing your Apple I or II	17.50
AppleWriter Cookbook	19.50
Apple Assembly Cookbook	21.50
Incredible Secret Money Machine	10.50
LaserWriter Reference (Apple)	19.50
PostScript Cookbook (Adobe)	16.50
PostScript Ref. Man. (Adobe)	22.50
PostScript Prog. Design (Adobe)	22.50
Type I Font Format (Adobe)	15.50
Real World Postscript (Roth)	22.50

### UNLOCKED SOFTWARE

LaserWriter Secrets (Ile/Mac/PC)	29.50
PostScript Show & Tell	39.50
Intro to PostScript VHS Video	39.50
PostScript Beginner Stuff	39.50
PostScript BBS Stuff	19.50
The Whole Works (all PostScript)	249.50
Absolute Reset Ile & Ilc	19.50
Enhance I or II Companion Disk	19.50
AppleWriter CB or Assy CB Disk	24.50

FREE VOICE HELPLINE

VISA/MC

## SYNERGETICS

Box 809-RE  
 Thatcher, AZ 85552  
 (602) 428-4073

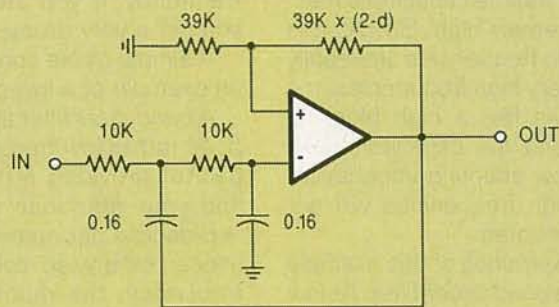

(A) SIMPLE SECOND ORDER SALLEN-KEY SECTION

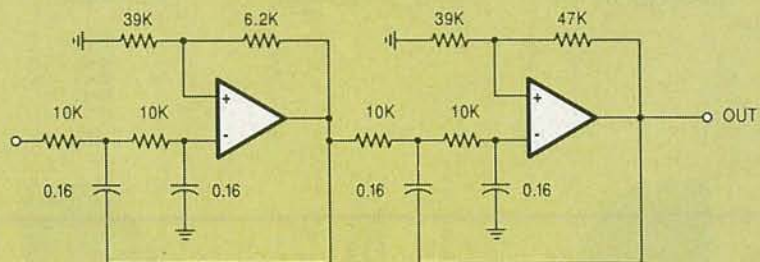

(B) FOURTH ORDER BUTTERWORTH LOW PASS AUDIO FILTER

FIG. 2—TWO SALLEN-KEY LOW-PASS active filters. Most any premium grade of op-amp can be used. Components should be 5% or better.



renamed it the *Equal Component Value* Sallen-Key filter. In the Fig. 2-a design, both capacitors are of identical value and set only frequency. Both resistors are of identical value and also set only frequency. The op-amp gain independently sets the damping.

To scale your frequency, you just *increase* either resistor pair or either capacitor pair to *lower* frequency, and vice versa. To scale impedance, proportionately raise the resistors and lower the capacitors. Full details appear in my *Active Filter Cookbook*.

Normally, you combine, or *cascade* second order sections to build up a fancier filter of higher order. By very carefully selecting the damping value

and that corner frequency of each second-order section, you can produce an overall filter response of most any desired complexity.

Some of these fancier responses do have specific names. For instance, a *Bessel* filter will give you the flattest possible time delay at the expense of the amplitude fall-off. As we've just seen, a *Butterworth* filter can give you the smoothest possible amplitude response. If you are willing to allow some ripple in the passband, you end up with a *Chebyshev* filter. Popular Chebyshev filters could be created with one, two, or even three decibels of passband ripple. Finally, the *Cauer*, or *Elliptical* type filter will

### NAMES AND NUMBERS

#### Emulation Technology

2344 Walsh Avenue, Bldg. F  
Santa Clara, CA 95051  
(408) 982-0660

CIRCLE 244 ON FREE INFORMATION CARD

#### Extraordinary Science

High Energy Enterprises  
P.O. Box 5636  
Security, CO 80931

CIRCLE 245 ON FREE INFORMATION CARD

#### GENIE

401 N Washington Street  
Rockville, MD 20850  
(800) 638-9636

CIRCLE 246 ON FREE INFORMATION CARD

#### Hewlett-Packard

P.O. Box 10161  
Palo Alto, CA 94303  
(415) 857-1501

CIRCLE 247 ON FREE INFORMATION CARD

#### Hoechst/Plastics Division

P.O. Box 58160  
Houston, TX 77258  
(800) 242-8469

CIRCLE 248 ON FREE INFORMATION CARD

#### International Rectifier

233 Kansas Street  
El Segundo, CA 90245  
(213) 772-2000

CIRCLE 249 ON FREE INFORMATION CARD

#### Loch Ness, Inc.

3700 Colfax Avenue South  
Minneapolis, MN 55409  
(800) 323-8623

CIRCLE 250 ON FREE INFORMATION CARD

#### Peer Protocols

3176 Pullman, Ste 101  
Costa Mesa, CA 92626  
(714) 662-1929

CIRCLE 251 ON FREE INFORMATION CARD

#### Science Frontiers

The Sourcebook Project  
PO Box 107  
Glen Arm, MD 21057

CIRCLE 252 ON FREE INFORMATION CARD

#### Sharp

Sharp Plaza  
Mahwah, NJ 07430  
(201) 529-8757

CIRCLE 253 ON FREE INFORMATION CARD

#### Siemens

2191 Laurelwood Road  
Santa Clara, CA 95054  
(408) 980-4500

CIRCLE 254 ON FREE INFORMATION CARD

#### Surplus News

PO Box 276  
Alburt, VT 05440  
(514) 739-9328

CIRCLE 255 ON FREE INFORMATION CARD

#### Telefunken

PO Box 3800  
Somerville, NJ 08876  
(201) 722-9800

CIRCLE 256 ON FREE INFORMATION CARD

#### Texas Instruments

PO Box 1443  
Houston, TX 77001  
(800) 232-3200

CIRCLE 257 ON FREE INFORMATION CARD

#### Unitrode

580 Pleasant Street  
Watertown, MA 02172  
(617) 926-0404

CIRCLE 258 ON FREE INFORMATION CARD

#### Watlow Controls

1241 Bundy Blvd.  
Winona, MN 55987  
(507) 454-5300

CIRCLE 259 ON FREE INFORMATION CARD

# It's no fluke.



Made in the U.S.A.

Building the best DMM for the money is no accident. The new RMS225 was carefully designed to give you what you wanted at a price you could afford. Visit your local distributor today and you'll agree the choice is obvious.

Fluke Model 77	Beckman Industrial RMS225
3-1/2 Digits	4 Digits
3,200 Counts	10,000 Counts
0.3% Accuracy	0.25% Accuracy
Touch Hold®	Probe Hold™
31 Segment Analog Bar Graph	41 Segment Analog Bar Graph
2,000 Hour Battery Life	1,000 Hour Battery Life
10A Range (Fused)	10A Range (Unfused)
Protective Holster	Protective Holster
3 Yr. Warranty	3 Yr. Warranty
—	True RMS
—	Auto Min Max™
—	Relative Mode
—	Self-Resetting Fuse (40mA input)
\$159*	\$149

® Touch Hold is a registered trademark of the John Fluke Mfg. Co., Inc. \*1990 Fluke and Philips Catalog

**Beckman Industrial™**  
An Affiliate of Emerson Electric Co.

Instrumentation Products Division  
3883 Ruffin Road, San Diego, CA 92123-1898  
(619) 495-3200 • FAX (619) 268-0172 • TLX 249031  
Outside California 1-800-854-2708 Within California 1-800-227-9781  
© 1990 Beckman Industrial Corporation. Specifications subject to change without notice. Fluke is a registered trademark of John Fluke Mfg. Co., Inc.  
JN190-01-1090

CIRCLE 98 ON FREE INFORMATION CARD



## DIGITAL VIDEO STABILIZER ELIMINATES ALL VIDEO COPY PROTECTIONS



While watching rental movies, you will notice annoying periodic color darkening, color shift, unwanted lines, flashing or jagged edges. This is caused by the copy protection jamming signals embedded in the video tape, such as Macrovision copy protection. Digital Video Stabilizer: RXII completely eliminates all copy protections and jamming signals and brings you crystal clear pictures.

### FEATURES:

- Easy to use and a snap to install
- State-of-the-art integrated circuit technology
- 100% automatic - no need for any troublesome adjustments
- Compatible to all types of VCRs and TVs
- The best and most exciting Video Stabilizer in the market
- Light weight (8 ounces) and Compact (1x3.5x5")
- Beautiful deluxe gift box
- Uses a standard 9 Volt battery which will last 1-2 years.

**WARNING :**  
**SCO**  
**Electronics and**  
**RXII dealers do**  
**not encourage**  
**people to use**  
**the Digital**  
**Video Stabilizer**  
**to duplicate**  
**rental movies**  
**or copyrighted**  
**video tapes.**  
**RXII is in-**  
**tended to stabi-**  
**lize and restore**  
**crystal clear**  
**picture quality**  
**for private**  
**home use only.**

(Dealers Welcome)

To Order: \$49.95 ea + \$4 for FAST UPS SHIPPING

**1-800-445-9285** or **516-694-1240**

Visa, M/C, COD M-F: 9-6 (battery not included)  
SCO ELECTRONICS INC.

Dept. CBY10 581 W. Merrick Rd. Valley Stream NY 11580  
Unconditional 30 days Money Back Guarantee

CIRCLE 202 ON FREE INFORMATION CARD

## CABLE TV DESCRAMBLER



	1 Unit	10 +
Jerrold S.B.	.....\$74	.....\$55
Jerrold SB w/Trimode	.....\$90	.....\$70
Oak N-12 (w/VS)	.....\$89	.....\$65
Scientific Atlanta	.....\$109	.....\$75
Pioneer	.....\$109	.....\$75
Panasonic converter	.....\$98	.....\$79
73 channel converter	.....\$79	.....\$59

**We Beat Anyone's Price!**

**30 Days Money Back Quaranty**

**Free Catalog**

Visa, M/C, COD or send money order to:

**US Cable TV Inc.** Dept.KCT10

4100 N.Powerline Rd., Suite F-4

Pompano Beach, FL 33073

**1-800-445-9285**

Please have make and model number of the equipment used in your area ready.

**No Florida Sales!**

It's not the intent of US Cable TV Inc. to defraud any pay TV operator and we will not assist any company or individual in doing so.

CIRCLE 203 ON FREE INFORMATION CARD

also add "zeros" to your stop band, giving you the fastest possible fall-off.

One thing that many beginning hackers miss: if your filter is made up of cascaded and isolated second-order sections, *the only difference between these filter types lies in how you select the damping and the corner frequency of each section.* That's all. Thus, once you have a filter built, all you need do is change the damping and the corner frequency of each section to get any desired result from Bessel on through Chebychev.

As with passive filters, you do not simply stack up identical second-order sections. Instead, you must carefully select your damping and corner frequency of each section to properly interact with the others to get the final desired response.

Figure 2-b shows a fourth-order Butterworth low-pass filter having a 1-

kHz cutoff frequency and a -24-deci-bel per octave rolloff. Note that the two sections are *not* identical. Also note that a DC return path to ground must be provided back through the input source resistance for a low-pass active filter to work properly.

It has been pretty much proven to everyone's satisfaction that you can *not* build up a high-Q active band-pass filter using only a single op-amp. The impedance levels, interactions, and gain requirements all gang up on you as you raise the Q.

Figure 3 shows you the best of a sorry lot of single op-amp second-order band-pass filters. This one is called a *multiple feedback* circuit. It is recommended only for Q values much less than 10. Thus, while that type of filter is useful for such things as an equalizer or a simple psychedelic lighting filter, it is strictly limited

### ACTIVE FILTER RESOURCES

#### Analog Devices

One Technology Way  
Norwood, MA 02062  
(617) 329-4700

CIRCLE 230 ON FREE INFORMATION CARD

#### Burr-Brown

6730 South Tucson Blvd  
Tucson, AZ 85706  
(602) 746-1111

CIRCLE 231 ON FREE INFORMATION CARD

#### Exar

Box 49007  
San Jose, CA 95161  
(408) 732-7970

CIRCLE 232 ON FREE INFORMATION CARD

#### Linear Technology

1630 McCarthy Blvd  
Milpitas, CA 95035  
(408) 432-1900

CIRCLE 233 ON FREE INFORMATION CARD

#### Maxim

120 San Gabriel Drive  
Sunnyvale, CA 94086  
(408) 737-7600

CIRCLE 234 ON FREE INFORMATION CARD

#### Motorola

Box 20924  
Phoenix, AZ 85036  
(800) 521-6274

CIRCLE 235 ON FREE INFORMATION CARD

#### National

2900 Semiconductor Drive  
Santa Clara, CA 95051  
(408) 721-5000

CIRCLE 236 ON FREE INFORMATION CARD

#### Nuts & Volts

Box 1111  
Placentia, CA 92670  
(714) 632-7721

CIRCLE 237 ON FREE INFORMATION CARD

#### Plessey Signal Technology

9630 Ridgehaven Court  
San Diego, CA 92123  
(619) 571-7715

CIRCLE 238 ON FREE INFORMATION CARD

#### PMI

1500 Space Park Drive  
Santa Clara, CA 95052  
(408) 727-9222

CIRCLE 239 ON FREE INFORMATION CARD

#### Synergetics

Box 809  
Thatcher, AZ 85552  
(602) 428-4073

CIRCLE 240 ON FREE INFORMATION CARD

#### Teledyne Semiconductor

1300 Terra Bella Avenue  
Mountain View, CA 94043  
(415) 968-9241

CIRCLE 241 ON FREE INFORMATION CARD

#### Texas Instruments

P.O. Box 1443  
Houston, TX 77001  
(800) 232-3200

CIRCLE 242 ON FREE INFORMATION CARD

#### TRW

Box 2472  
La Jolla, CA 92038  
(619) 475-1000

CIRCLE 243 ON FREE INFORMATION CARD



to lower Q applications.

The higher performance work-horse second-order active filter circuit is called a *state variable filter* and is built using three or four op-amps per Fig. 4. This one has three separate low-pass, band-pass, and high-pass outputs, is very well behaved, and can work with very high Q or low damping values. A fourth op-amp can be added to the circuit shown to make the gain independent of the damping.

Finally, Fig. 5 shows you a Sallen-Key single op-amp high-pass circuit. This one is simply the low-pass circuit of Fig. 2 "insided out" to get the complementary response.

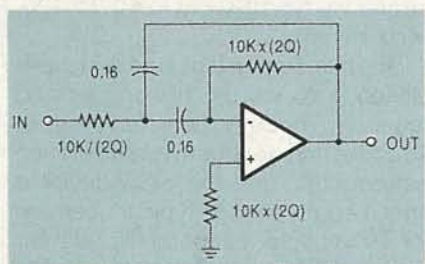

FIG. 3—THIS SINGLE-AMPLIFIER multi-feedback band-pass active filter can be used only for Q values of 10 or less.

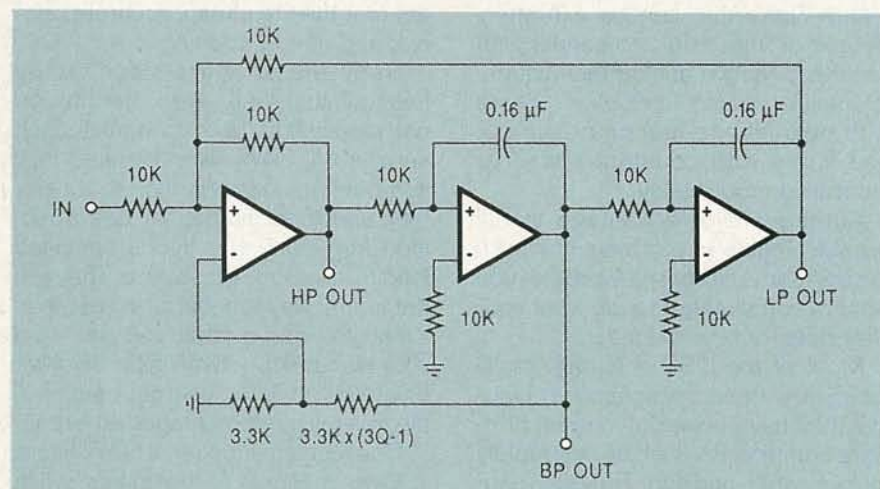

FIG. 4—THIS STATE-VARIABLE ACTIVE FILTER gives low-pass, band-pass, and high-pass outputs and is best used for high-Q or low-damping applications.

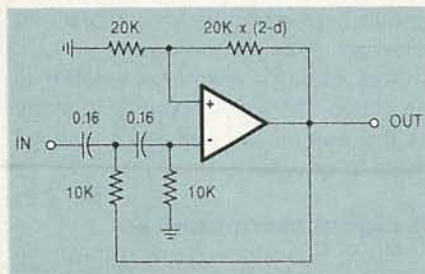

FIG. 5—THE SALLEN-KEY HIGH-PASS second-order filter section is simply the low-pass circuit of Fig. 2-a inside out. Values are for 1 kHz.

Active filters are limited by the frequency response, the slew rate, distortion, and noise floor of the op-amp used. They are best used at audio and low video frequencies having signals which are neither very small nor excessively large. Quality op-amps for active filters are available from *Linear Technology, Burr-Brown, Analog Devices, Maxim, National, and PMI.*

By one of those utterly astounding coincidences that seem to infest this column, I've written an *Active Filter Cookbook* that somehow has gotten up to its fifteenth printing. It includes everything you need to build all your own real-world active filters. Write or call for an autographed copy.

### Other filter types

Besides passive and active filters, there are several other major new methods of filtering electronic signals that are of more than passing hacker interest. These now include *switched capacitor filters, digital signal processing, and surface wave devices.*

A *switched capacitor filter* is just that—some integrated circuit which contains a bunch of small capacitors

that are switched on and off to sample an input signal. If the switching is just right, the charge on the capacitor will follow and reinforce the input signal. If it is wrong, the charge on the capacitor will average out to zero. By carefully arranging the network of properly switched capacitors, you can favor certain frequencies and reject other ones.

The big advantages of switched capacitor filters are electronic tunability and minimum cost. In the past,

**cordata**

**386SX COMPUTER WITH VGA MONITOR**



- 100% IBM compatible.
- 80386SX-16/8 MHz speed, zero wait state, upgradable to 20 MHz.
- One 3-1/2" 1.44 MB floppy disk drive.
- One 5-1/4" 1.2 MB floppy disk drive.
- 40 MB hard drive/28 millisecond access time.
- 1 MB RAM on motherboard, expandable to 8 MB.
- Expansion slots: four IBM AT slots.
- Two serial ports.
- One parallel port.
- Built-in VGA video support.
- Battery backed real time clock/calendar.
- 80387SX-16 math co-processor socket.
- 101 key detachable IBM style keyboard.
- Phoenix BIOS.
- Included MS-DOS 4.0. Does not include software shown on screen.
- Dim.: 16"Wx18"Dx5"H.
- Model # CPC8248.
- **One Year Warranty through Cordata.**
- **Factory New! Factory Perfect!**

### VGA monitor:

- 14" non-glare color monitor.
- 100% IBM compatible.
- .42 mm dot pitch.
- 256 colors.
- Resolution: 640x480.
- Dim.: 14.72"W x 12.40"H x 15.64"D.

Mfr. Sugg. Retail:

**\$2,968.00**

**DAMARK PRICE:**

**\$1499<sup>99</sup>**

Item No. B-2284-143578  
Insured Ship/Hand.: \$49.00

**DAMARK**  
INTERNATIONAL, INC.

**FOR FASTEST SERVICE  
CALL TOLL FREE**

**1-800-729-9000**



DAMARK INTERNATIONAL, INC.  
7101 Winnetka Ave. N., Minneapolis, MN 55428-1619  
Customer Service • 612-531-0082

Please rush me: \_\_\_\_\_ Cordata Computer(s)  
@ \$1499.99 each, plus \$49.00 s/h each.  
Item No. B-2284-143578 MN res. add 6% sales tax.

Name \_\_\_\_\_

Address \_\_\_\_\_

City, State, Zip \_\_\_\_\_

Check/MO  VISA  Master Card  Discover

Card No. \_\_\_\_\_

Exp. Date \_\_\_\_\_ Ph. # ( ) \_\_\_\_\_

Signature \_\_\_\_\_

Copyright 1990 DAMARK International, Inc. All rights reserved.

**DELIVERY TO 48 U.S. STATES ONLY**

OCTOBER 1990



# LEARN VCR

CLEANING/MAINTENANCE/REPAIR

EARN UP TO \$1000 A WEEK, WORKING PART TIME FROM YOUR OWN HOME!



Secrets Revealed!

NO Special Tools or Equipment Needed.

EARN UP TO \$60 AN HOUR AND MORE!

## THE MONEY MAKING OPPORTUNITY OF THE 1990'S

IF you are able to work with common small hand tools, and are familiar with basic electronics (i.e. able to use voltmeter, understand DC electronics) . . .

IF you possess average mechanical ability, and have a VCR on which to practice and learn. . . then we can teach YOU VCR maintenance and repair!

**FACT:** up to 90% of ALL VCR malfunctions are due to simple MECHANICAL or ELECTRO-MECHANICAL breakdowns!

**FACT:** over 77 million VCRs in use today nationwide! Average VCR needs service or repair every 12 to 18 months!

Viejo's 400 PAGE TRAINING MANUAL (over 500 photos and illustrations) and AWARD-WINNING VIDEO TRAINING TAPE reveals the SECRETS of VCR maintenance and repair—"real world" information that is NOT available elsewhere!

Also includes all the info you'll need regarding the BUSINESS-SIDE of running a successful service operation!

### FREE INFORMATION

CALL TOLL-FREE 1-800-537-0589

Or write to: Viejo Publications Inc.

5329 Fountain Ave.

Los Angeles, CA 90029 Dept. RE

CIRCLE 190 ON FREE INFORMATION CARD

## The LOW COST, EASY Way To Learn About Computers



Video Tape Is A Great Teacher

\*HOW TO BUILD YOUR OWN IBM 286/386 CLONE\*

\$39.95 + SHIPPING AND SALES TAX

\*SHAKE HANDS WITH YOUR IBM PC/XT/AT COMPUTER\*

\$29.95 + SHIPPING AND SALES TAX

\*UPGRADE YOUR PC TO A 286-AT FOR UNDER \$150\*

\$24.95 + SHIPPING AND SALES TAX

\*HOW LASER PRINTERS WORK\*

\$39.95 + SHIPPING AND SALES TAX

## ORDER NOW!



Friendly Videos  
PO Box 5684



Garden Grove, CA 92645  
(714) 898-4055

switched capacitor filters were noisy and produced significant distortion. Today's circuits are far better, but they still don't handle extremely small input signals very well.

Important uses for these switched capacitor filters are modems, touch-tone detection, disk drives, CD players, industrial instrumentation, and data acquisition.

Several large suppliers of switched capacitor filters now include *Linear Technology*, *Maxim*, and *Exar*. All three sources have detailed data sheets and ap notes available.

A *digital signal processor* is just a specialized type of microcomputer. To do filtering using digital signal processing, you first analog-to-digital (A/D) convert your input signal into strings of numbers in memory. Then you use digital techniques to modify these numbers in memory. Finally, you digital-to-analog (D/A) convert your filtered results.

While that may sound like a real runaround, these days you can digital signal process in one single and reasonably priced chip. There are many big advantages to DSP filtering. One major advantage is that you can easily create filters that can be extremely difficult or impossible to handle with passive or active analog techniques. Examples include "brickwall" filters with near-infinite response slopes, and filters with constant phase or controlled group delay.

Another major advantage is full programmability. Nothing changes except some software words if you want to completely change what your filter does or how it does it.

Most of the DSP chips are really specialized microprocessors. Usually they have powerful internal firmware commands which let you rapidly multiply, shift, and add. They also usually provide specialized functions such as barrel shifting and zero time testing and branching. Both fixed point and floating point processors are available today.

DSP is obviously limited to lower frequencies unless you do not need real time results. You also have the usual aliasing problems and the A/D quantization noise limitations to cope with as well.

Important use areas for DSP include geophysics, for biological research, in speech synthesis and recognition, radar, and electronic music. Just about all of the latest per-

sonal computers and synthesizers have gone the DSP route for most of their sound capabilities. The main manufacturers of DSP products include *Analog Devices*, *Texas Instruments*, *Motorola*, and *TRW*. All of these folks have extensive data books and detailed application notes available.

*Surface acoustical wave*, or SAW devices are a specialized type of low-cost filter which is quite popular in television and cable systems. They consist of a piezoelectric disk which has an acoustical transmitter and an acoustical receiver on it. Unlike your usual audio devices, these acoustical waves involve sound waves whose frequency typically lies in 40- to 400-MHz range.

Special finger-like contacts are placed between the transmitter and receiver. These fingers cause constructive and destructive interference patterns that give the SAW device a specified response. Typical uses are for TV vestigial sideband filtering, for various descrambling circuits, and to set the IF amplifier passband in TV receivers.

The big advantages of SAW filters are that they're cheap, accurate, stable, and need no tuning.

Sadly, the SAW filters don't really hack all that well, even though you can readily find them for a buck each surplus. A SAW filter handles one and only one specified job in a carefully specified manner at one specified frequency and into a specified load from a specific source. They are not in any way tunable or adjustable. What you got is what you get. And your own custom SAW filter involves a very steep setup charge, comparable to a full custom integrated circuit.

One leading supplier of SAW filters is *Plessey Signal Technologies*, while bunches of surplus sources are available.

Let me know if you need any more details or use circuits for any of these alternate filter technologies.

This month's resource sidebar is on active filters and shows you many of the names and numbers you will need to get started.

### A digital thermometer

*Radio Shack* now has an amazingly sophisticated digital thermometer that sells for less than twenty bucks. It is part number 277-123.

This beauty runs off a single AA



# R-E Engineering Admart

Rates: Ads are 2 1/4" x 2 7/8". One insertion \$950. Six insertions \$925. each Twelve insertions \$895. each. Closing date same as regular rate card. Send order with remittance to **Engineering Admart**, Radio Electronics Magazine, 500-B Bi-County Blvd., Farmingdale, NY 11735. Direct telephone inquiries to Arline Fishman, area code-516-293-3000. *Only 100% Engineering ads are accepted for this Admart.*

## INCREASE YOUR EARNING POWER!

LEARN TO DESIGN WITH SINGLE CHIP MICROCOMPUTERS!

SINGLE CHIP MICROCOMPUTER PRIMER FOR MOTOROLA 6805

- Includes:
- Professional Quality MS-DOS Software
  - Editor
  - Assembler
  - Simulator/Debugger
  - Programmer Schematics
  - Single Chip Microcomputer Primer Lesson Book

Price ..... \$195

MCPM-1 Programmer for Motorola MC68705P3, P5, U3, U5, R3, R5  
Parts kit w/driver program ..... \$150  
Fully assembled w/driver program ..... \$325  
Fully assembled w/driver, assembler, simulator/debugger . . \$449

MCPM-3 Programmer for Motorola MC68HC705C8, 805C4  
Parts kit w/driver program ..... \$175  
Fully assembled w/driver program ..... \$360  
Fully assembled w/driver, assembler, simulator/debugger . . \$495

**TECI**  
The Engineers Collaborative Inc.

Emulators Programmers Assemblers Simulators/Debuggers  
Rt. #3, Box 8C TEL: (802) 525-3458  
Barton, VT, USA 05822 FAX: (802) 525-3451

CIRCLE 196 ON FREE INFORMATION CARD

## FCC LICENSE PREPARATION

The FCC has revised and updated the commercial license exam. The **NEW EXAM** covers updated marine and aviation rules and regulations, transistor and digital circuitry.

**THE GENERAL RADIOTELEPHONE OPERATOR LICENSE - STUDY GUIDE** contains vital information. **VIDEO SEMINAR KITS ARE NOW AVAILABLE.**

WPT PUBLICATION  
979 Young Street, Suite E  
Woodburn, Oregon 97071  
Phone (503) 981-5159 Dept. 50

CIRCLE 191 ON FREE INFORMATION CARD

## Surface Mount Chip Component Prototyping Kits—

Only \$49.95



CC-1 Capacitor Kit contains 365 pieces, 5 ea. of every 10% value from 1pf to .33µf. CR-1 Resistor Kit contains 1540 pieces; 10 ea. of every 5% value from 10Ω to 10 megΩ. Sizes are 0805 and 1206. Each kit is ONLY \$49.95 and available for Immediate One Day Delivery!

Order by toll-free phone, FAX, or mail. We accept VISA, MC, AMEX, COD, or Pre-paid orders. Company P.O.'s accepted with approved credit. Call for free detailed brochure.

**COMMUNICATIONS SPECIALISTS, INC.**  
426 West Taft Ave. • Orange, CA 92665-4296  
Local (714) 998-3021 • FAX (714) 974-3420

Entire USA 1-800-854-0547

CIRCLE 185 ON FREE INFORMATION CARD

battery and has a four-digit LCD to display temperature in Fahrenheit or Centigrade over a -40- to 122-degree F range.

Incredibly, there is both a recording *max-min* feature and a settable alarm and controller capability. Both on-off levels and a 2-kHz piezo tone are provided as outputs.

You have a choice of a one-second or a fifteen-second update for your display. Total operating current is in the microamp range.

The out-of-the-box accuracy is only a degree or so Fahrenheit, but the circuit seems stable enough that you might custom calibrate it for such things as a hot-tub controller or for cave-stream temperature logging. Unit-to-unit variations are also within a degree. The resolution is a tenth of a degree and seems real. Although not waterproof, that is easily fixed with a tube of silicon bathtub caulk.

As received, the device displays Centigrade at fifteen seconds per update. To select Fahrenheit with a one-second update, just jumper pins 13, 14, and 16 on the edge connector.

We'll probably look at this gem in more detail in a future column. For now, let's make a contest out of it. We'll have all the usual *Incredible Secret Money Machine* book prizes, along with an all-expense-paid (FOB Thatcher, AZ) *tinaja quest* for two going to the very best of all.

Either (A) show me a new and un-

usual application for a miniature and micropowered max-min thermometer, or (B) show me some simple and clean way to get the digital data out of the 277-123 thermometer into a remote computer. Send your written entries directly to me, and *not* to the **Radio-Electronics** editorial offices.

### New tech literature

New data books this month include the *Microcontroller Handbook* from Siemens, a new *Optoelectronics Data Book* from Sharp, an *Op-Amp Macromodel Data Manual* and *Disk* from Texas Instruments, and that *Semiconductor Data Book* and *Ap Notes* from Unitrode.

From International Rectifier, a *Microelectronic Relay Design Manual*, and an *IGBT product catalog*.

There's a stupendously impressive *Selection Guide to Integrated Circuits* from Telefunken that is chock full of unusual TV and auto chips.

Inks which let you plot patterns directly onto all your printed circuit boards are available through Loch Ness. They also have some low-end multilayer prototyping systems you may find of interest.

Testing surface-mount devices and other weird or tiny packages can be a real hacker challenge. So, *Emulation Technology* has all sorts of adaptors and accessories that ease interfacing. Ask for their current catalog.

*An Overview of SCSI Concepts* is a great new manual available free from *Peer Protocols*. Three off-the-wall odd magazines are *Extraordinary Science*, *Surplus News*, and *Science Frontiers*.

Free software demos this month include the 48SX calculator disk from Hewlett-Packard, and the 945 heater controller demo from Watlow.

A free mechanical sample of *GUR* is available from Hoechst. This is a new plastic which is tough, cheap, self-healing and slippery.

Turning to my own products, for the fundamentals of digital integrated circuits, check into either my *TTL Cookbook* or *CMOS Cookbook*. And for those of you interested in the PostScript language or in Book-on-Demand publishing, our ongoing roundtable is doing fine on *Genie*. By the time you read this, over 1000 free downloads should be available.

Finally, I do have a new and free mailer for you which includes dozens of insider hardware hacking secret sources. Write or call for info.

Our usual reminder here that most of the items mentioned appear either in the *Names and Numbers* or in the *Active Filter Resources* sidebars.

As always, this is your column and you can get technical help and off-the-wall networking per that *Need Help?* box. The best calling times are weekdays 8-5, *Mountain Standard Time*. Let's hear from you. **R-E**



# AUDIO UPDATE

## The Sound of Audio: An AES conference report, Part 2

LARRY KLEIN

Last month I started my report on a special Audio Engineering Society Conference held early last May in Washington, D.C. The four-day conference was a wide-ranging exploration of the latest findings on the perception, measurement, and reproduction of sound. I regret that because of space and time limitations, these two reports are at best a once-over-lightly review of an extremely enlightening series of lectures and discussions.

The audibility of distortion has been a controversial matter, probably from the moment the very first amplifier was designed. In the beginning, there was simple harmonic distortion (HD) that had an important virtue: It was easy to measure. However, the correlation between high HD and sonic unpleasantness was far from perfect—which lead researchers to discover/invent other types of distortions and new ways to measure them. During the 1950's, intermodulation distortion (IM), which is the unwanted arithmetic sum and difference products of two interacting frequencies, achieved instant fame as being more audibly obnoxious than HD. That was said to be true because, unlike HD, its spurious products are not harmonically related to the desired signals.

In any case, as I've said in these pages and Richard Cabot stated in his conference paper, "Audible Effects vs. Electrical Measurements in the Electrical Signal Path," HD and IM are *not* different kinds of distortion as much as they are different effects of the same nonlinearities in the equipment being tested. And because with most amplifiers there is a predictable relationship between IM and HD levels, either measurement can be used to somewhat predict audible performance.

### Distortion data

As I did for the authors in Part 1, I'll extract and paraphrase (when necessary) some of Mr. Cabot's more interesting points. In his bibliography, Cabot cites the previous relevant researches of more than 50(!) inves-

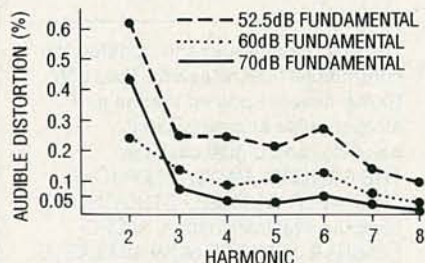

FIG. 1—THREE TEST-TONE LEVELS showing the amounts of just-audible distortions up to the 8th harmonic.

tigators, certainly a daunting task to evaluate and synopsize!

- The audibility of distortion clearly does not depend on its relative percentages alone. Other significant factors are: (1) the characteristics of the equipment's nonlinearity; (2) the instantaneous level of the reproduced sound; (3) the type and complexity of the audio test signal; (4) the spatial qualities in the reproduced sound field; (5) the characteristics of the listening environment; (6) the distortion levels in the associated equipment and in the program material itself; and (7) the listener's ability to marshal his talents, if any, as a "golden ear."

- Crossover distortion (CD), which became an important factor during the early days of transistor amplifiers, results from a push-pull amplifier's nonlinearity in the area where the signal passes through zero on its way to the set of output device(s). A "witch's brew" of high-order HD and IM products are produced whose relative amplitudes increase as the signal level decreases. This means that, like noise, CD is *more* audible at low signal levels.

- Different nonlinear conditions that measure the same with a given test setup may afflict the ear quite differently depending upon the levels and frequencies of the test program.

- Although the distortion in today's best analog audio equipment is barely measurable and (to most listeners)

completely inaudible, digital has introduced several potentially ear-disturbing phenomena. For example, the digital sampling process introduces a new and different type of distortion known as "aliasing." Spurious harmonics are produced in the audio band in the range above half the sampling-rate frequency. For example, with a 44-kHz sampling clock, the third-harmonic of a 10-kHz tone will appear at 14 kHz (44 kHz minus 30 kHz). Such problems can occur even in units with well-designed anti-alias filters, if nonlinearity is present after the filtering. Today, the problem seems well taken care of, but it illustrates the fact that new circuitry can produce new distortions.

### Dynamic range results

Dynamic range does not appear to be an important factor in distortion, other than in the obvious situation where the signal level exceeds the capabilities of a component. Clipping and other overload effects are the prices paid for pushing a component too hard. However, the other side of the dynamic-range coin—noise level—also has a great deal to do with the audibility of distortion effects. Here, we are looking at very low-level distortions and the masking effects on them of electronic and environmental noise. Specifically, if the noise is high enough in level and occurs in the same frequency areas as the distortion, the distortion will be masked.

### Audibility of distortion

As I noted earlier, the minimum level of distortion that can be detected by the human ear has been the subject of much ill-informed controversy over the years. The graph in Fig. 1 illustrates the results of a research project on the perception of HD using a 357-Hz test tone. At a listening level of 70 dB, fourth-harmonic distortion as low as 0.05%(!) was audible. It was noted that the basic sensitivity of the human ear was the limiting factor in detecting distortion. That should come as no surprise, since distortion of pure tones or simple music such as



a solo flute is *not* heard as a wave-form aberration—which is what it looks like on a scope—but rather as a distinct and separate tone or noise.

That's why the addition of high-order harmonic distortion to single mid-range frequencies is so readily audible. But in real life, with complex classical or rock music, distortion has to reach 6% or so before even the most golden of ears become upset. There's no mystery to all this—it's our old friend *masking* at work. If there happen to be loud musical frequencies present in the same areas where the spurious harmonic and IM frequencies occur, the distortions simply won't be heard. All this reaffirms the difficulty in generalizing about what we can and can't hear, and under what conditions.

I can't resist adding a personal distortion-oriented note to this report. More than 10 years ago, the Nakamichi Corporation held a press party to celebrate the opening of their East Coast offices. Part of the new facility was a small demonstration recording studio completely outfitted

with Nakamichi tape decks, microphones, monitors, amplifiers, and so forth. As I came in through the control-room door, Etsuro Nakamichi greeted me and pointed out that a live string quartet, specially hired for the

The AES is an international organization whose membership includes more than 10,000 persons involved on a professional, semi-professional, and amateur level in all aspects of audio. For further information on The Sound of Audio Conference, on how to become a member of the AES, and/or a catalog of available publications and technical papers, write to: Audio Engineering Society, 60 East 42nd Street, New York, NY 10165-0075.

occasion, was about to perform in the small studio area.

To my ears, the sound of the live musicians as reproduced in the control room has a harsh, distorted quality. I wondered what to say to Mr. Nakamichi, who was obviously proud

of his new installation. I decided that honesty was the best policy, and opined that the sound we were hearing was "a little shrill." To my surprise, Etsuro agreed with a grin, and ushered me through the sound-proofed door into the studio. I was shocked to discover that the live musicians in the studio sounded exactly as distorted as their reproduction in the control room—which was a real tribute to the fidelity of the Nakamichi equipment. Etsuro explained that the acoustic design of the studio still needed some work—increased damping mostly—to control an over-emphasis of the highs, but they hadn't had time to complete the work before the scheduled opening.

Two distortion-related morals can be drawn from that story: A boost in the upper half of the audio spectrum (due to room reflectivity or other causes) where the higher musical harmonics can easily be misinterpreted by the ear as gross HD or IM. And even unamplified *live* music can sound distorted under (im)proper conditions. **R-E**



**IS CET**  
**VCR**  
**Cross Reference**  
VCR Model Number Cross Reference  
and VCR Parts Cross Reference

**UPDATED** - Feb. 1990. 272-page reference guide. \$35 plus \$3 shipping.

**DISC** - IBM-compatible disc with expandable data base. \$99 plus \$1 shipping.

**COMBO OFFER:** Book and disc for only \$125 plus \$3 shipping.

**MORE INFO?** Contact IS CET, 2708 West Berry St. Fort Worth TX 76109 (817) 921-9101

---

Allow 4-6 weeks delivery when using personal checks or VISA and MasterCard. Money orders and cashiers checks processed immediately.

Amount \_\_\_\_\_ VISA  MasterCard   
 Card No. \_\_\_\_\_ Exp. \_\_\_\_\_  
 Name \_\_\_\_\_  
 Business \_\_\_\_\_  
 Address \_\_\_\_\_  
 City \_\_\_\_\_ State \_\_\_\_\_ Zip \_\_\_\_\_  
 Phone \_\_\_\_\_ Member:  IS CET;  NESDA  
Texas residents multiply dollar value x 7.75% for taxes.  
 Foreign shipments please add international postage.  
 Send to: IS CET, 2708 W. Berry St., Ft. Worth TX 76109

## Buy American



Ask about quantity discounts  
 Model Shown: 510-SW-1  
 100 MHz, Switchable X1-X10.....\$36

- ★ Complete range of monolithic & modular probes from 60MHz - 300 MHz. Available with read-out feature.
- ★ Compatible with all oscilloscopes.
- ★ Complete accessory pack (as shown).
- ★ Tek and HP users: try us and compare our high quality low cost probes!
- ★ **Made in the U.S.A.**

**Call for Free catalog**  
**1-800-87-PROBE**

## Attention All Oscilloscope Users

## Try API Probes *FREE* for 30 days.

We are so sure that our probes will meet or exceed your performance requirements that we will send qualified buyers a sample for a 30 day evaluation. After 30 days, either keep the probe and we will bill you, or simply return it to us. It's that easy.



**Avex Probes Inc.**  
 1683 Winchester Road • P. O. Box 1026  
 Bensalem, PA 19020  
 Phone 215-638-3300 • Fax 215-638-9108

**For More Information Circle 28**

CIRCLE 197 ON FREE INFORMATION CARD



# COMPUTER CONNECTIONS

**Create MIDI-compatible stereo musical scores with Audio F/X, and get full control over your monitor's display with UltraVision.**

**JEFF HOLTZMAN**

**F**orte, a small company in upstate New York, has combined a Z80 running a home-brew multitasking operating system, a pair of 6582 SID's (sound interface devices, used in several Commodore computers), and a high-speed analog-to-digital converter. The result is a full-length card that fits in any 8- or 16-bit IBM-compatible expansion slot, and that gives you an extremely powerful environment for creating MIDI-compatible stereo musical scores, and for digitizing and editing any sound with a maximum frequency of about 40 kHz. The \$350 package is called Audio F/X.

The card provides a line-level mono input for digitizing external sounds, and line-level stereo outputs suitable for driving a quality stereo system. When playing back digitized sound, the output is mono; when playing back scored music, each channel is driven independently by one of the SID's.

The hardware is controlled by several different graphically oriented software modules. The music scoring module is called Sonata; it uses the GEM graphical interface (also used by Ventura Publisher), as shown in Fig. 1. A series of drop-down menus allow you to load and save files, choose notes and rests, key signatures, instrument parameters, etc. A control panel at the bottom of the screen allows you to set volume, balance, tempo, instrument, and to initiate playback (either from the current position or from the beginning).

The options menu brings up a dialog box that allows you great freedom in creating instruments. You can choose a basic waveform (sawtooth, square, triangle, or white noise), and then vary its attack time, sustain level and time, delay time, and release time, all independently of one another. Advanced features allow you to modulate an instrument, filter it in various ways (lowpass, bandpass, highpass), and add resonance. The

software makes it easy to create just the right sound, because you can play a sample note or scale from within the dialog box, as well as hear the effect, modify settings, play another sample, and so on.

Scoring music is fairly efficient, due to the presence of a number of keyboard shortcuts. There are keys to select notes and rests (whole, half, quarter, etc.), load and save files, interact with a MIDI device, add sharps and flats, change keys, and more. A "floating" toolbox (as in PageMaker) would allow convenient mouse-only operation. You can add repeats, fermatas, and dotted notes. Other effects includes slurs, crescendos, and decrescendos.

Sonata provides an option to print your score, but only a few common dot-matrix printers are supported, so graphics printing is *slow*; laser-printer support would be another welcome addition.

The editor provides an overall

range of eight octaves, four of which display at any time. Scroll bars along the side of the screen allow you to switch octaves; horizontal scroll bars move you through the score.

Editing functions allow you to define a block of notes and then copy it, delete it, and shift it up or down. A function to shift a block up or down an entire octave at once would be useful.

MIDI functions allow you to record from a Roland or compatible keyboard, to "quantize" notes to ensure perfect timing, and play back scored music through the MIDI device. Although the built-in playback hardware offers six voices—three for the left channel and three for the right—eight voices can be recorded from and played back through a MIDI device.

You can't score some notes and subsequently create an instrument and apply it to those notes; however you can modify the instrument associated with a voice at any time.

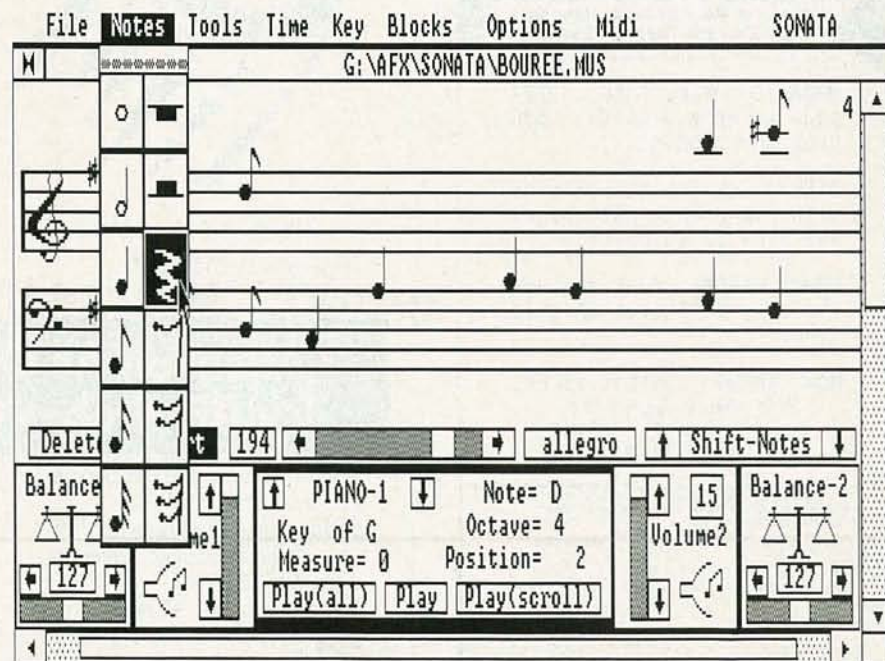

**FIG. 1—THE MUSIC SCORING MODULE, called Sonata, uses the GEM graphical interface. A series of drop-down menus allow you to load and save files, choose notes and rests, key signatures, instrument parameters, etc.**



# R-E Computer Admart

Rates: Ads are 2 1/4" x 2 7/8". One insertion \$950. Six insertions \$925 each. Twelve insertions \$895 each. Closing date same as regular rate card. Send order with remittance to **Computer Admart**, Radio Electronics Magazine, 500-B Bi-County Blvd., Farmingdale, NY 11735. Direct telephone inquiries to Arline Fishman, area code-516-293-3000. *Only 100% Computer ads are accepted for this Admart.*

## GETTING THE MOST FROM YOUR PRINTER

Getting The Most From Your Printer



**BP181**—It is probable that 80% of dot-matrix printer users only ever use 20% of the features offered by their printers. This book will help you unlock the special features and capabilities that you probably don't even know exist. To order your copy send **\$6.95 plus \$1.50 for shipping** in the U.S. to **Electronic Technology Today Inc., P.O. Box 240, Massapequa Park, NY 11762-0240.**

## PT68K4 68000-16MHZ

Upgraded version of PT68K2 featured in OCT 87 RE.

- 4 MB of onboard DRAM
  - 4 RS232 + 2 Parallel Ports
  - Floppy Disk Controller
  - 7 XT Expansion Slots
- 12 MHZ Kits from \$220  
Assembled Boards from \$599  
Professional OS9/68000 \$299

**Peripheral Technology**  
1480 Terrell Mill Rd. Suite 870  
Marietta, GA 30067  
404/984-0742

CIRCLE 180 ON FREE INFORMATION CARD

## ICs PROMPT DELIVERY!!!

SAME DAY SHIPPING (USUALLY)  
QUANTITY ONE PRICES SHOWN for JULY 29, 1990

OUTSIDE OKLAHOMA: NO SALES TAX

2MB Upgrade LJ IIP & III	\$183.00
<b>DYNAMIC RAM</b>	
1MB COMP DeskPro 386S	\$225.00
SIMM AST Prem386 33Mhz	160.00
SIMM 1Mx9 80 ns	72.00
SIMM 256Kx9 100 ns	23.00
1Mbit 1Mx1 80 ns	7.15
41256 256Kx1 60 ns	4.10
41256 256Kx1 80 ns	3.10
41256 256Kx1 100 ns	2.15
41256 256Kx1 120 ns	1.95
4464 64Kx4 100 ns	2.45
41264* 64Kx4 100 ns	5.95
<b>EPROM</b>	
27C1000 128Kx8 200 ns	\$17.50
27512 64Kx8 200 ns	7.50
27256 32Kx8 200 ns	5.75
27128 16Kx8 250 ns	3.75
<b>STATIC RAM</b>	
62256P-10 32Kx8 100 ns	\$7.50
6264P-12 8Kx8 120 ns	4.50

OPEN 6 DAYS, 7:30 AM-10 PM. SHIP VIA FED-EX ON SAT.

SAT DELIVERY INCLUDED ON FED-EX ORDERS RECEIVED BY: Th: 52 \$6.25 4h Fr: 41 \$17.00 1h

MasterCard VISA or UPS CASH COD  
**MICROPROCESSORS UNLIMITED, INC.**  
24 000 S. Peoria Ave.  
BEGGS, OK 74421  
(918) 267-4961  
No minimum order. Please note: prices subject to change.  
Shipping, insurance extra: up to \$1 for packing materials.

CIRCLE 61 ON FREE INFORMATION CARD

## Sound editor

The other main software component of Audio F/X is the sound editor. It, too, runs in a graphical mode, as shown in Fig. 2, but all commands must be executed from the keyboard, which is less convenient than the GEM environment of Sonata.

Basic functions allow you to record and edit sound. To record, you press Alt-F3, and specify the number of samples to record; the range is 1-65,000. Sampling rate is specified elsewhere, before you enter the record function. Naturally, the more often you sample, the higher the fidelity of the sound that is recorded, but the more disk space is used. A demo file containing a fairly hi-fi rendition of a popular song requires almost one megabyte of space for about 50 seconds of music. An 8-bit A/D converter is used, so each sample comprises of one byte with a decimal value of 0-255.

After you specify the sample rate, the program displays a simulated VU meter that allows you to set the level of your source, after which you press any key to begin. The program then digitizes sound at the specified sample rate. After all samples have been collected (or you press the space bar to halt prematurely), the waveform is displayed, and you can play it back (Shift-F3), edit it, and save it to disk.

The program supplies two cursors, L and R, that generally define an editing area. Separate pairs of function keys move the two cursors; another key allows you to zoom the area between them; yet others allow you to mark that area (for subsequent copying), or to delete, reverse, amplify, or attenuate it.

You can split the screen, and copy

a marked block from one window to another. The split-screen mode is useful for creating special effects, particularly reverb and echo. It's also useful for assembling a waveform from bits and pieces of other waveforms. To create a reverb effect, you mark a block, move the left cursor slightly to the right of its initial position, and then execute the mix com-

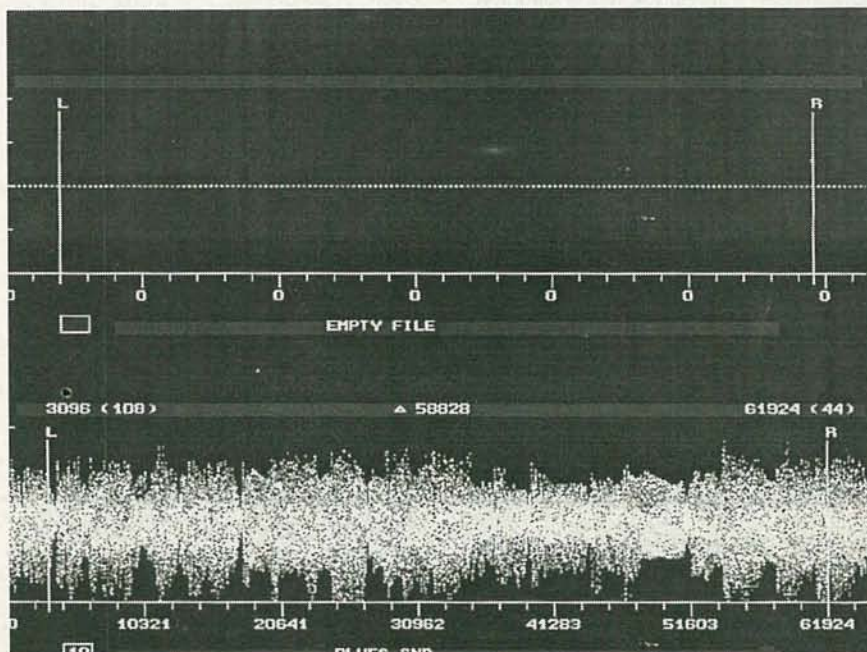

FIG. 2—THE SOUND EDITOR runs in a graphical mode, but all commands must be executed from the keyboard. Basic functions allow you to record and edit sound.



# Data Acquisition and Control the Easy Way

## What is the A-Bus?

A-Bus is a system for connecting devices to your computer. Whatever your computer, use A-Bus for:

**Sensing.** Detecting or reading a switch closure or voltage presence.

**Measuring.** Determining a force, frequency, temperature, weight, or any other quantity.

**Control.** Open or close a circuit. Switch any type of electrical device. Adjust level or position.

## Why should you choose A-Bus?

**It's affordable.** From a \$65 Digital Input Card to a \$299 Motor Controller, you get much more than your money's worth.

**It's simple.** Easy to connect to your computer and to your application. Designed to adapt to your software easily.

**It's versatile.** You mix and match low cost boards to fit your project.

**It's proven.** Thousands of applications installed around the world.

## Call for a Catalog (800) 221-0916

### A Sampling of our Products

**Relay Card:** 8 individually controlled relays. 3A at 120VAC, SPST. **RE-140: \$142**

**High-Speed 12-bit A/D converter:** 8  $10\mu\text{s}$  analog inputs. 0-5V, amp. **FA-154: \$179**

**8 Bit A/D:** 8 inputs, 0-5.1V in 20mV steps, 7500 conversions/second. **AD-142: \$142**

**12 Bit A/D:**  $\pm 4\text{V}$ . On-board amp. 7 readings/sec. 1 input, expandable **AN-146: \$153**

**Temperature Sensor:** 0-200° **TS-111: \$12**

**Digital Input:** 8 opto-isolated. Read voltage presence or switch closures. **IN-141: \$65**

**Latched Input:** Each of 8 inputs is latched to catch switch closures **LI-157: \$85**

**Digital Output Driver:** 8 outputs: 250mA at 12V. For relays, solenoids... **ST-143: \$78**

**Smart Quad Stepper Controller:** On board processor controls 4 motors simultaneously. Simple English commands to set position, speed, units, read limits, etc. **SC-149: \$299**

**D/A:** 4 Channel, 8 Bit Output **DA-147: \$149**

**24 line TTL I/O:** Connect TTL 0/5V levels or switches. (8255A) **DG-148: \$72**

**32 Channel Multiplexer:** Switches up to 32 channels to a single common. **MX-155: \$83**

**Touch Tone Decoder:** **PH-145: \$87**

**Counter Timer:** 3 16-bit counters. Count pulses, measure frequency **CT-150: \$132**

**A-Bus Prototyping card:** **PR-152: \$16**

**Odin Software:** For PC's Control relays from inputs or time schedules **OS-189: \$129**

**Motherboard:** For 5 cards. **MB-120: \$108**

**A-Bus Adapters:**

**IBM XT/AT & compatibles.** **AR-133: \$69**

**MicroChannel Adapter:** **AR-170: \$93**

**Parallel Adapters** also available for Apple II, Commodore 64, 128, TRS-80

**Serial Adapter:** RS-232 **SA-129: \$149**

**Serial Processor:** Built in BASIC for off-line monitoring, logging. **SP-127: \$189**

**New! C-Net:** Connect thousands of RS-232 serial devices to one computer port. Printers, modems, data acquisition devices, etc.

**ALPHA Products**

242-RE West Avenue, Darien, CT 06820  
Call (203) 656-1806 or Fax 203 656 0756

CIRCLE 198 ON FREE INFORMATION CARD

mand. Creating an echo is similar; you just move the cursor a little further to the right before mixing. Some experimentation is necessary to determine the amount of cursor motion required to achieve a particular effect.

Each sound file normally consists of a maximum of 65,500 bytes. However, the program supplies a direct-to-disk mode, in which larger files can be created and played back. When editing a large file, you can scroll through it in 32K chunks.

A set of filters (lowpass, bandpass, highpass) is available for the sound editor. In addition, drivers for Show Partner and GRASP are included; those programs allow you to create interactive, animated computer-based tutorials and training. The Audio F/X drivers allow you to synchronize sound with the on-screen presentation. Other companies have written drivers for other "multimedia" programs, including Autodesk's wonderful Animator; contact Forte for more information.

## Options and upgrades

A programmer's kit is available; it allows you to get directly at the hardware. In addition, the company sells an amplifier/filter box that allows you to drive the Audio F/X board with an inexpensive microphone.

## Impressions

The first time I installed the board and played a demo Sonata piece, I was entranced. Sure, other computers (Macs, Ataris) have sound capabilities—but I'm mostly a PC chauvinist. So hearing full-bodied sound emanate from a board controlled by my PC was thrilling. In short, I haven't had as much fun playing with a PC product in a long time.

## UltraVision 2.0

Most VGA cards (and EGA cards as well) provide numerous hardware-enhanced modes, but DOS supports only the least-common denominator. As a consequence, that extra capability often goes unused. A program called UltraVision provides a way of tapping those capabilities. In particular, it gives you full control over screen colors, the ability to change the display font, and the ability to use text-mode programs with more rows and columns than usual. The program also provides its own enhanced video BIOS, which speeds up video output

two to five times.

UltraVision's enhancements depend on the specific capabilities of your video adapter; I tested the program with a Video 7 VRAM board. With UltraVision installed, I could run text modes with just about any combination of 80, 94, 108, 120, or 132 columns, and 25, 36, 50, or 63 rows. (A maximum of 60 rows are available at 132 columns.)

## ITEMS DISCUSSED

● Audio F/X (\$350), Forte, 72 Karenlee Drive, Rochester, NY 14618. (716) 427-8595.

CIRCLE 10 ON FREE INFORMATION CARD

● UltraVision 2.0 (\$119.95), Personics, 63 Great Road, Maynard, MA 01754. (508) 897-1575.

CIRCLE 11 ON FREE INFORMATION CARD

DOS itself won't recognize the enhanced modes, but many applications will. Qedit, for example, picks up screen dimensions automatically. WordStar can be patched easily. The company also provides drivers and usage hints for many other programs, including 1-2-3, AutoCAD, Crosstalk, dBASE, Magellan, Word, WordPerfect, and many others. I found that a  $36 \times 80$  mode in Word running on a 19-inch NEC MultiSync XL was quite legible. A standard VGA system can run with a maximum of  $94 \times 63$ .

The software driver occupies about 20K of memory, and in addition to the functional enhancements it provides, it also operates faster than the built-in BIOS, because it runs from RAM, rather than relatively slow ROM. In addition, the driver runs just fine from "high" memory on either a 386 or EMS 4.0 system (both of which I tested).

UltraVision provides similar enhancements for EGA systems, including a hardware accelerator that provides VGA resolution for some EGA boards with multi-synchronous monitors.

A separate program allows you to change screen colors; laptop and monochrome VGA users could use that capability to remap illegible screen-color combinations. Several other utilities are provided, including an enhanced version of ANSI.SYS.

If you're tired of the feeling that there is capability in your video system that is being wasted, UltraVision 2.0 can help.

R-E



# MARKET CENTER

## FOR SALE

**GREAT buys!** Surplus prices, ICs, linears, transformers, PS, stepping motors, vacuum pump, phototransistor, meters, LSASE, **FERTIK'S**, 5400 Ella, Phila., PA 19120.

**DESCRAMBLERS.** All brands. Special: Combo Jerrold 400 and SB3 \$165.00. Complete cable descrambler kit \$39.00. Complete satellite descrambler kit \$45.00. Free catalog. **MJM INDUSTRY**, Box 531, Bronx, NY 10461-0208.

**TUBES:** "oldest," "latest." Parts, schematics. SASE for list. **STEINMETZ**, 7519 Maplewood Ave., RE, Hammond, IN 46324.

**ENGINEERING** software, PC/MSDOS. Hobbyists — students — engineers. Circuit design \$49.00, PCB layout \$99.00, Logic simulation \$29.00, FFT analysis \$69.00, Mathematics \$39.00, Circuit analysis \$29.00. Call or write for free catalog. (614) 491-0832, **BSOFT SOFTWARE**, 444 Colton Rd., Columbus, OH 43207.

**RESTRICTED** technical information: Electronic surveillance, schematics, locksmithing, covert sciences, hacking, etc. **Huge selection. Free brochures.** **MENTOR-Z**, Drawer 1549, Asbury Park, NJ 07712.

**RENTAL movie stabilizer.** Connect between VCRs or to monitor. Satisfaction guaranteed. \$69.95, \$4.00 handling. **1 (800) 367-7909.**

## CB RADIO OWNERS!

We specialize in a wide variety of technical information, parts and services for CB radios. 10-Meter and FM conversion kits, repair books, plans, high-performance accessories. Thousands of satisfied customers since 1976! Catalog \$2.

**CBC INTERNATIONAL**  
P.O. BOX 31500RE, PHOENIX, AZ 85046

**CABLE TV** converters: Jerrold, Oak, Scientific Atlantic, Zenith and many others. "New MTS" stereo add-on: mute & volume. Ideal for 400 and 450 owners! **1 (800) 826-7623**, Amex, Visa, M/C accepted. **B & B INC.**, 4030 Beau-D-Rue Drive, Eagan, MN 55122.

**TUBES**, new, up to 90% off, SASE, **KIRBY**, 298 West Carmel Drive, Carmel, IN 46032.

**PROGRAMMABLE stepper** motor drive & control for under \$100, **IBM PC/XT** compatible, **Commodore 64**, or other with 25 pin parallel port. PCB, interface, & software. Send for detailed literature to: **MASE**, R.D. #2 Box 166, Mohrsville, PA 19541.

**CABLE TV converters and descramblers.** We sell only the best. Low prices. **SB-3 \$79.00.** We ship C.O.D. Free catalog. **ACE PRODUCTS**, PO Box 582, Dept. E, Saco, ME 04072. **1 (800) 234-0726.**

**FREE catalog.** Interfaces for IBM compatibles. Digital I/O and analog input. Control relays, motors, lights, measure temperature, voltage. **JOHN BELL ENGINEERING, INC.**, 400 Oxford Way, Belmont, CA 94002. (415) 592-8411.

**CABLE** descramblers (Jerrold) from \$40.00. Tocom VIP test chip. Fully activates unit. Also Zenith test board. Fully activates Z-Tacs. \$50.00. Call **(213) 867-0081.**

**PRINTED** circuit boards etched & drilled. Free delivery. **K & F ELECTRONICS, INC.**, 33041 Groesbeck, Fraser, MI 48026. (313) 294-8720.

**DESCRAMBLERS**, all brands, wholesale prices, full warranty, COD ok, example Oak RTC-56 \$150.00, brand new Tocom \$125.00. **(503) 253-0459.**



**Quality Microwave TV Antennas**  
WIRELESS CABLE - IFTS - MMDS - Amateur TV  
Ultra High Gain 50db(+) • Tuneable 1.9 to 2.7 Ghz.  
• 36-Channel System Complete \$149.95  
• 12-Channel System Complete \$114.95  
• Call or write (SASE) for "FREE" Catalog  
**PHILLIPS-TECH ELECTRONICS**  
P.O. Box 8533 • Scottsdale, AZ 85252  
**(602) 947-7700** (\$3.00 Credit all phone orders)  
MasterCard • Visa • COD's • Quantity Pricing

LIFETIME WARRANTY

**LASERS.** 1mw to 2kw, worlds largest selection of new & used surplus. Free catalog. **MWK INDUSTRIES**, 1269 Pomona Road, Corona, CA 91720. (714) 278-0563.

**TEST equipment** pre-owned now at affordable prices. Signal generators from \$50.00. Oscilloscopes from \$50.00. Other equipment, including manuals available. Send \$1.00 for catalog, refund on 1st order. **J.B. ELECTRONICS**, 3446 Dempster, Skokie, IL 60076. (708) 982-1973.

**CABLE** boxes, Zenith \$225.00, Tocom \$125.00, Hamlin \$125.00 combo, Jerrold combo \$125.00, Oak RTC-56 combo \$150.00, M-35-B \$45.00, S.A.C., orders 1 (800) 622-3799, info (702) 647-3799.

**LOTTERY** - IBM computer disk for all lotteries \$10.00. **ROBERTS**, Box 63/6025, Margate, FL 33063.

**OAK** Sigma descrambler, channel 3 output, rare hard-to-find factory equipment, with free documentation, \$150.00. Oak Sigma modification documentation \$20.00 postpaid. Oak VN12-4 (or Hamlin) descramblers with free remote control converter, \$85.00. Eagle remote control converter descrambler combos, \$100.00. Send moneyorder, ship postpaid within 3 days. **SURPLUS ELECTRONICS**, POB 10009, Colorado Springs, CO 80932.

## FREE CATALOG

**FAMOUS "FIRESTIK" BRAND CB ANTENNAS AND ACCESSORIES. QUALITY PRODUCTS FOR THE SERIOUS CB'er. SINCE 1962**  
**FIRESTIK ANTENNA COMPANY**  
2614 EAST ADAMS  
PHOENIX, ARIZONA 85034

**MINIATURE** electronics like James Bond. Catalog \$4.00, refundable. **F & P ENTERPRISES**, Box 51272, Palo Alto, CA 94303-L.

**CABLE-TV Scientific Atlanta 8580** Qty/price each 1/289, 5/249, 10/239, 6PM to 10PM EDT weekdays, **(301) 791-5019.** No Maryland orders accepted.

**SURPLUS** electronics, motors, speakers, power supplies, adapters, etc... send for free catalog. **WINDSOR DISTRIBUTORS**, 19 Freeman Street, Newark, NJ 07105.

**DESCRAMBLERS**, all brands in stock, need help selecting the right unit? **COD orders ok. S.A.C., (702) 647-3799.**

**PROTOQUICK Z8**, single board computer with prototype area, \$69.00. **SOFTWARE SCIENCE**, 3750 Roundbottom Road, Cincinnati, OH 45244. (513) 561-2060.

**TOCOM** VIP converters w/remote from \$199.00 Tocom super chips turn on everything, \$69.00 each. Phone **(219) 935-4128.**

**TUBES** Sylvania 6LQ6, 6L6GC, 20LF6 etc. Huge discounts. **ARLEN SUPPLY**, 7409 West Chester Pike, Upper Darby, PA 19082. **1 (800) 458-1301.**

**PHOTOFACT** folders under #1400 \$4.00. Others \$6.00. Postpaid. **LOEB**, 414 Chestnut Lane, East Meadow, NY 11554.

**COMMUNICATIONS/Electronic** equipment sales, service, FCC licensed, Catalog \$1.00, **RAYS**, PO Box 14862, Fort Worth, TX 76117-0862.

**CONVERTERS** all major brands. Info & orders 1 (800) 782-0552. **FREWAY, INC.**, SMP PO# 5036, Burnsville, MN 55337. No MN sales.

**FREE** catalogue. Computers. Electronic parts and kits. Filters, amplifiers, power supplies. Radio Shack dealer. **MCDOWELL ELECTRONICS**, Box 1206, Brewton, AL 36427. (205) 867-8805.

**INCREASE** your radar detector's range up to 50%. Lens and instructions \$15.00. Send moneyorder to **GREG MEADE**, 11169 Riverview, Grand Blanc, MI 48439.

**CABLE-TV** Scientific Atlanta 8580. Save \$200.00 add-on descrambler for receiving Pay Per View for subscribers without telephone or unlisted number. Authorization from your cable company is required to use this device. Qty/price each 1/\$100, 5/\$85, 10/\$75. 6pm to 10pm weekdays **(301) 791-5019.** No Maryland orders accepted.

## CABLE TV DESCRAMBLERS! BARGAIN HEADQUARTERS!



- JERROLD™ • TOCOM • HAMLIN
- OAK • ZENITH
- SCIENTIFIC ATLANTA

6 month warranty! We ship C.O.D.!  
Lowest retail/wholesale prices!

**FREE CATALOG:**  
Global Cable Network  
1032 Irving St. Suite 109  
S.F., CA 94122  
NO CALIFORNIA SALES!!!

**ORDER TODAY! 800-327-8544**

**TV troubleshooting solutions** 450 solutions by area and component. Symptom remedy make model Sams ref. Save time, you'll love it. Send \$24.50 to **BOX 222**, Chanhassen, MN 55317.

**S-A** test chips. Enables full tiering. 8550: \$22.00 each/10 \$180.00. 8500: \$20.00 each/10 \$160.00. Money order or COD. **R.V.**, Box 771, Ridgefield, CT 06877.

**BOOKS!** Catalog of most exciting electronic and science books, free!, **Box 596-I**, Logan, Utah 84321. **1 (800) 359-0466.**

**TOUCH Tone Decoder** displays dialed numbers from telephones, scanners, tapes. Connects easily to phone line, radio, recorder. Information for SASE. **W.E.B.**, PO Box 2771-R, Spring Valley, CA 92077.

**BELOW** wholesale: Capacitors, ICs, transistors. Special: new 27128A \$3.00, flyer SASE **SANTECH ELECTRONICS**, 11 Revere Place, Tappan, NY 10983. (914) 359-1130.

**PRINTED** circuit boards made to order - layout engineering, assembly available, high quality fully fabricated boards - short or long run. Call or write for products and pricing. **SHORE PROTO CIRCUIT**, 36 Fairview Avenue, Little Silver, NJ 07739. **1 (800) 752-1574.**

**QUALITY** electronic parts at bargain prices. Free catalog with SASE. **EAGLE TRADING**, Box 341, Bigfork, MT 59911. Phone (406) 837-5409.



## THE ELECTRONIC GOLDMINE

### BATTERY OPERATED BLACK LIGHT KIT

- \* Detects Invisible Fluorescent Inks, Fluorescent Minerals, etc.
- \* Uses Large Unfiltered U Shaped Black Light Tube



**UNIQUE**

- \* Comes with PC Board, Parts, Tube and Instructions
- \* Operates from Any 6V Battery Source (not Incl.)
- \* Size of Board: 7" x 1.8"

**C6356 \$13.95**

### MINI GEIGER COUNTER KIT

- \* Detects ALL Types of Radiation
- \* Uses Sensitive Alpha Window Tube
- \* Operates from 9V Battery (not Incl.)
- \* Comes with PC Board, Parts, Tube and Instructions
- \* Size of PC Board: 3" x 1.5"



**C6430 \$59.95**

### 20W + 20W STEREO AMP KIT

- \* Boost Car Stereos, Tape Players, Portable Radios, etc.
- \* Features 2 Separate 20W RMS Amps with Level Controls
- \* Operates on Standard 12V Car Battery
- \* Comes with PC Board, Parts and Instructions-you supply speakers
- \* Size of PC Board: 6" x 2.25"

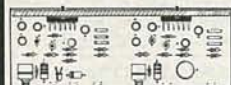

**C6442 \$19.95**

### INFRARED DETECTOR KIT

- \* Detects ALL Types of Infrared (TV/VCR Remotes, LEDs)
- \* Produces Sound and Bright Red LED Output
- \* Operates on 9V Battery (not Incl.)
- \* Comes with PC Board, Parts and Instructions
- \* Size of PC Board: 2.5" x 1.4"

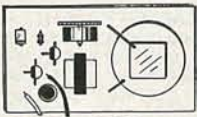

**C6441 \$5.95**

### INFRARED MODULE

Small infrared receiver module is sensitive to almost all infrared remote controllers and features high gain. Has only 3 hookup pins. Operates from 9VDC and is very sensitive (it will light an LED or close a low voltage relay from up to 50ft away). Module and hookup diagram only-you provide output device of LED or relay. Size of PC Board: 5" x 3" x .4"



**G514 \$1.29**

### INFRARED LED

Jumbo clear case.

A1013 2\$1.00 100\$40.00

### INVERTER TRANSFORMER

Small 4 lead transformer to be used with 555 IC circuit to convert 12VDC to 250VAC for strobes fluorescent tubes. Comes with schematic.

N1703 \$2.00 EACH 100\$170.00

MINIMUM ORDER: \$10.00 plus \$3.00 shipping and handling  
We accept MC, Visa and Money Orders.  
SEND ORDERS TO: The Electronic Goldmine  
P.O. Box 5408 Scottsdale, AZ 85261  
PHONE ORDERS: (602) 451-7454

CIRCLE 186 ON FREE INFORMATION CARD

## WIRELESS CABLE RECEIVERS 1.9 TO 2.7 GHz



30 CH PARABOLIC DISH SYSTEM \$173.90  
30 CH ROD ANTENNA SYSTEM \$193.90  
30 CH CRYSTAL CONTROLLED SYSTEM \$294.95

SUN MICROWAVE INT'L. INC. SEND \$1.00 FOR P.O. BOX #34522 CATALOG ON THESE PHOENIX, AZ 85067 AND OTHER FINE VIDEO PRODUCTS (602) 230-0640 QUANTITY DISCOUNTS LIFETIME WARRANTY

MEMBER OF THE BETTER BUSINESS BUREAU

TOCOM VIP test chip with Torx #7 wrench \$45.00. R&S, (817) 293-4113. No Texas sales.

TEST equipment bargains. Includes Tektronix, H-P, GR, etc. Sold as is. Technician's and hobbyist's dream. Some units require minor repair or calibration. Some useful for replacement parts. Prices start at \$25.00. Nothing above \$250.00. Catalog \$5.00 (refundable with purchase). EDI, 180 Rodeo Drive, Brentwood, NY 11717. (516) 242-6400.

TRANSISTORS, diodes, resistors, capacitors, MOVs, new, up to 60% off. Catalog. MINUTEMAN SYSTEMS, Box 1427, Concord, MA 01742.

HELP!! If you buy cable TV units, interference filters any channel. Computer equipment and software. All types of electronic components, integrated circuits, capacitors, resistors, power supplies and lots more. Stop!! whatever you're doing and call our toll-free number 9am to 6pm EST Monday thru Friday 1 (800) 762-9730 we guarantee you won't be sorry. Pick-up your phone now!! (Recorded message after daytime hours.)

\$1.99 software for IBM Compatibles. Quality at affordable prices!! Huge selection: business, games, graphics, utilities, database, spreadsheets. Send \$1.00 for catalog. AULT, 1556 Halford Avenue, #242, Santa Clara, CA 95051.

## WANTED

INVENTORS! Confused? Need help? Call IMPAC for free information package. In US and Canada: 1 (800) 225-5800.

## PLANS AND KITS

BUILD this five-digit panel meter and square-wave generator including an ohms, capacitance and frequency meter. Detailed instructions \$2.50. BAGNALL ELECTRONICS, 179 May, Fairfield, CT 06430.

MINIATURE FM transmitters! Tracking transmitters! Voice disguisers! Bug detectors! Phone Devices! More! Available in kits or assembled! Catalog \$2.00: XANDI ELECTRONICS, Box 25647, Dept. 60J, Tempe, AZ 85285-5647.

CATALOG: hobby/broadcasting/HAM/CB: Cable TV, transmitters, amplifiers, surveillance devices, computers, more! PANAXIS, Box 130-F10, Paradise, CA 95967.

SURVEILLANCE transmitter kits! Four models of each; telephone, room, combination telephone/room transmitters tune from 65 to 305 MHz. Catalog with Popular Communications and Popular Electronics book reviews of "Electronic Eavesdropping Equipment Design," \$1.00. SHEFFIELD ELECTRONICS, 7223 Stony Island Ave., Chicago, IL 60649-2806.

## REMOTE CONTROL KEYCHAIN



Complete w/mini-transmitter and +5 vdc RF receiver Fully assembled including plans to build your own auto alarm Quantity discounts available

\$24.95 Check, Visa or M/C Add \$3 shipping

VISITECT INC./Dept. R (415) 872-0128 PO BOX 5442, SO. SAN FRAN., CA 94080

INVESTIGATORS, experimenters — Quality plans. Micro and restricted devices. Free catalog. Self addressed stamped envelope required KELLEY SECURITY INC., Suite 90, 2531 Sawtelle Blvd., Los Angeles, CA 90064.

CB Tricks II book. Power amplifier design and theory, UHF CB tune ups. Send \$19.95 MEDICINE MAN CB, PO Box 37, Clarksville, AR 72830.

STRANGE stuff. Get the advantage! Laser listener, surveillance, descrambling, underground information. Plans, kits, complete items. Informational package \$3.00 refundable. DIRIJO/BOND, Box 212, Lowell, N.C. 28098.

TRANSFORMERS. Learn to build your own. Easy. Smart. Send \$1.00 (refundable). W. CHARLES TECHNOLOGIES, 28740 S.W. Parkway #A1, Wilsonville, OR 97070.

## COMPUTER KITS

General Technics Computer Kits include a complete line of 8088, 286, and 386 models. They are designed to offer the highest degree of quality and reliability available today. They're also fun, easy to build, educational, fully IBM compatible, very powerful, and at wholesale prices. All kits are pre-tested and include a free step by step assembly manual, software, one year warranty and our 24 hour support/over phone line. Assembly is available.



General Technics Quality Computer Systems Post Office Box 2676 Lake Ronkonkoma, NY 11779 (516) 951-9473

ask for your free catalog

Try the  
**Radio Electronics**

bulletin board system

(RE-BBS)  
516-293-2283

The more you use it the more useful it becomes.

We support 300 and 1200 baud operation.

Parameters: 8N1 (8 data bits, no parity, 1 stop bit) or 7E1 (7 data bits, even parity, 1 stop bit).

Add yourself to our user files to increase your access.

Communicate with other R-E readers.

Leave your comments on R-E with the SYSOP.

RE-BBS  
516-293-2283

# CABLE TV

TB-3 (Tri-Bi) or SA-3

Quantity Prices

10	20
<b>\$48.</b>	<b>\$43.</b>
Each	Each
50	100
<b>\$39.</b>	<b>\$35.</b>
Each	Each

Hours open 10:00 am to 4:00 pm Eastern time  
Minimum order 5 units 55.00 ea.  
Dealers wanted. We ship COD.

King Wholesale  
1-800-729-0036  
Fax number 6173400053

"No one beats the King's prices!"

## DESCRAMBLERS







# CATV CONVERTERS AT LOWEST PRICES

Panasonic, Jerrold, Tocom, Pioneer, Scientific Atlanta, Zenith, Oak, Hamlin, Eagle, and all other brands  
**Microwave Antennas** (wireless cable) with matching descramblers

Call Mon-Fri 10AM - 5:30PM Eastern time or write for **FREE CATALOG**



NO CONNECTICUT SALES. It is not the intent of Universal View to defraud any pay television operator and we will not assist any company or individual in doing so. WAIVER: I, the undersigned, am a consenting adult of at least 21 years of age, and fully understand that ownership of a cable decoder does not give the owner of the decoder the right to decode or view premium cable channels without proper authorization from their local cable company, and hereby declare under penalty of perjury that all products purchased at any time, will only be used on cable TV systems with proper authorization from local officials or cable company officers in accordance with all applicable federal and state laws. Federal and various state laws provide for substantial criminal and civil penalties for unauthorized use.

SIGNATURE \_\_\_\_\_ DATE \_\_\_\_\_

## UNIVERSAL VIEW

520 GLENBROOK ROAD, SUITE NO 202  
STAMFORD, CT 06906

Orders Only: **1-800-622-9022**  
Catalog & Info: **(203) 975-7543**

CIRCLE 64 ON FREE INFORMATION CARD

## CABLE DESCRAMBLERS OAK M35B COMBO \$39.95

Jerrold, Zenith, Hamlin, Sci. Atlanta, Pioneer & MORE! OUR PRICES ARE BELOW WHOLESALE!

### CABLE+PLUS

14417 Chase St. #481-A Panorama City, CA 91402  
1-800-822-9955 • Other Info: 1-818-785-4500  
NO CALIF. SALES - DEALERS WANTED

## SATELLITE TV

**VIDEOCYPER II** manuals. **Volume 1** - Hardware, **Volume 2** - Software - either \$34.95. **Volume 3** - Projects/Software, **Volume 5** - Documentation or **Volume 6** - Experimentation \$44.95 each. **Volume 4** - Repair \$99.95. **Cable Hacker's Bible** - \$34.95. **Clone Hacker's Bible** - \$34.95. Catalog - \$3.00. COD's (602) 782-2316. TELECODE, PO Box 6426-PE, Yuma, AZ 85366-6426.

**FREE catalog** - Lowest prices worldwide, save 40-60%. Systems, upgrades, parts, all major brands factory fresh and warrantied. **SKYVISION**, 2009 Collegeway, Fergus Falls, MN 56537. 1 (800) 334-6455.

### SCRAMBLE NEWS MONTHLY still the best original information

Focus this month is wireless cable receiving equipment and descrambling hardware/software and turn-one. Subscription \$19.95/yr. Sample \$3. The Pay TV and Satellite Descrambling series: 1990 Edition \$14.95, 1988 Edition \$14.95, Volume I (basics of all systems) \$14.95, Build Satellite Systems Under \$600 \$12.95, Wireless Cable Manual \$9.95. Any 3/29 or 5/42. New fall catalog \$1 or call. COD's are OK. 716-874-2088.

Scrambling News, 1552 Herfel Ave., #123, Buffalo, NY, 14216. (716) 874-2088

**CABLE TV secrets** - the outlaw publication the cable companies tried to ban. HBO, Movie Channel, Showtime, descramblers, converters, etc. Suppliers list included. \$9.95. **CABLE FACTS**, Box 711-R, Pataskala, OH 43062.

## CABLE TV EQUIPMENT

Converters, Remote Controls, Descramblers, CD Players.



**JERROLD-OAK-SCIENTIFIC ATLANTA-HAMLIN ZENITH MANY MORE CALL TODAY!**

✓ Only quality products sold ✓ Easy to use  
✓ Satisfaction guaranteed ✓ Knowledgeable sales staff  
✓ Most orders shipped within 24 hours

**CALL FOR YOUR FREE CATALOG**

**MC 1-800-228-7404 VISA**

**MAKE THE CONNECTION**

**WITH**

**NU-TEK ELECTRONICS**

5114 Balcones Wood Dr.#307 Dept.298  
Austin, TX. 78759

**VIDEOCYPER II descrambling manual.** Schematics, video and audio, Explains DES, EPROM, CloneMaster, 3Musketeeer, Pay-per-view (HBO, Cinemax, Showtime, adult, etc.) \$13.95, \$2.00 postage. Collection of software to copy and alter EPROM codes, \$25.00. **CABLETRONICS**, Box 30502R, Bethesda, MD 20824.

## BUSINESS OPPORTUNITIES

**EASY work!** Excellent pay! Assemble products at home. Call for information. (504) 641-8003 Ext. 5192.

## UNICORN - YOUR I.C. SOURCE!

### COLLIMATOR PEN (INFRA-RED)



- Output: 2.5 mW (max.)
- Current: 90-150 mA
- Operating Voltage: 2.2-2.5V
- Wavelength: 820nm
- Collimation: .18mrad (typ.)
- Size: 11mm diameter

STOCK# PRICE  
**SB1052 \$39.99**

### LASER DIODE (INFRA-RED)



- Output: 10 mW (max.)
- Current: 90-150 mA
- Operating Voltage: 2.2-2.5V
- Wavelength: 820nm

STOCK# PRICE  
**SB1053 \$9.99**

### LASER DIODE (VISIBLE-RED)



- Output: 5 mW (max.)
- Current: 65-100 mA
- Operating Voltage: 1.75-2.2V
- Wavelength: 780nm

STOCK# PRICE  
**LS022 \$19.99**

### LASER DIODE (VISIBLE-RED)

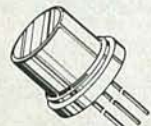

- Output: 4 mW (max.)
- Current: 20 mA
- Operating Voltage: 2.2-3.0V
- Wavelength: 665nm

STOCK# PRICE  
**LS3200 \$129.99**

## EPROMS

STOCK#	PINS	DESCRIPTION	1-24	25-99	100+
1702	24	256 x 4 1us	3.99	3.79	3.41
2708	24	1024 x 8 450ns	6.49	6.17	5.55
2758	24	1024 x 8 450ns	3.99	3.79	3.41
2716	24	2048 x 8 450ns (25v)	3.29	3.13	2.82
2716-1	24	2048 x 8 350ns (25v)	3.79	3.60	3.24
TMS2716	24	2048 x 8 450ns	6.29	5.98	5.38
27C16	24	2048 x 8 450ns (25v-CMOS)	3.99	3.79	3.41
2732	24	4096 x 8 450ns (25v)	3.79	3.60	3.24
2732A-2	24	4096 x 8 200ns (21v)	3.79	3.60	3.24
2732A	24	4096 x 8 250ns (21v)	3.69	3.51	3.16
2732A-4	24	4096 x 8 450ns (21v)	3.19	3.03	2.73
TMS2532	24	4096 x 8 450ns (25v)	5.79	5.50	4.95
TMS2532P	24	4096 x 8 450ns (25v-One Time Programmable)	1.99	1.89	1.70
27C32	24	4096 x 8 450ns (25v-CMOS)	4.19	3.98	3.58
2764-20	28	8192 x 8 200ns (21v)	3.99	3.79	3.41
2764	28	8192 x 8 250ns (21v)	3.79	3.60	3.24
2764A-20	28	8192 x 8 200ns (12.5v)	3.99	3.79	3.41
2764A	28	8192 x 8 250ns (12.5v)	3.29	3.13	2.82
TMS2564	28	8192 x 8 250ns (25v)	6.79	6.45	5.81
27C64	28	8192 x 8 250ns (21v-CMOS)	4.19	3.98	3.58
27128-20	28	16,384 x 8 200ns (21v)	5.79	5.50	4.95
27128	28	16,384 x 8 250ns (21v)	5.09	4.84	4.35
27128A	28	16,384 x 8 250ns (21v)	5.79	5.50	4.95
27C128	28	16,384 x 8 250ns (21v)	5.79	5.50	4.95
27256-20	28	32,768 x 8 200ns (12.5v)	5.29	5.03	4.53
27256	28	32,768 x 8 250ns (12.5v)	4.79	4.55	4.09
27C256	28	32,768 x 8 250ns (12.5v-CMOS)	5.29	5.03	4.53
27512-20	28	65,536 x 8 200ns (12.5v)	7.49	7.12	6.41
27512	28	65,536 x 8 250ns (12.5v)	6.99	6.64	5.98
27C512	28	65,536 x 8 250ns (12.5v-CMOS)	6.99	6.64	5.98
27C1024	32	131,072 x 8 200ns (12.5v-CMOS)	17.99	17.09	15.38
68764	24	8192 x 8 450ns	13.99	13.29	11.96
68766	24	8192 x 8 450ns	14.99	14.24	12.82



10010 Canoga Ave., Unit B-8 • Chatsworth, CA 91311  
OUTSIDE CALIFORNIA: (800) 824-3432 (Orders Only)  
IN CALIFORNIA: (818) 341-8833  
ORDER BY FAX: (818) 998-7975



Minimum Order: \$15.00



## ANTIQUE RADIO CLASSIFIED

Free Sample!

Antique Radio's

Largest Circulation Monthly.

Articles, Ads & Classifieds.

6-Month Trial: \$13. 1-Yr: \$24 (\$36-1st Class).  
A.R.C., P.O. Box 802-L6, Carlisle, MA 01741



**MAKE** \$50/hr working evenings or weekends in your own electronics business. Send for free facts. **INDUSTRY**, Box 531, Bronx, NY 10461-0208.

**YOUR own radio station!** AM, FM, TV, cable. Licensed/unlicensed. **BROADCASTING**, Box 130-F10, Paradise, CA 95967.

**INVENTORS:** We submit ideas to industry. Find out what we can do for you. Call 1 (800) 288-IDEA.

**LET** the government finance your small business. Grants/loans to \$500,000. Free recorded message: (707) 449-8600. (KS1).

**EASY! Moneymaking** one man CRT rebuilding machinery. \$6,500.00 — \$11,900.00. **CRT**, 1909 Louise, Crystalake, IL 60014. (815) 459-0666.

**MAKE** \$75,000 to \$250,000 yearly or more fixing IBM color monitors (and most brands). No investment. Start doing it from your home. (A telephone required.) Information, USA, Canada \$1.00 cash. US funds. other countries \$8.00 **RANDALL DISPLAY**, Box 2168-R, Van Nuys, CA 91404 USA.

**PROJECTION TV...** Make \$\$\$'s assembling projectors. Easy!... Results comparable to \$2,500 projectors... **Plans, 8" lens** & dealers information \$25.50... Professional systems available... Illustrated catalog free. **MACROCOMA**, 15GBX Main Street, Washington Crossing, PA 18977... Credit-card orders 24Hrs. (215) 736-2880.

**LEARN** to clean/repair fax machines. Huge new market! Earn \$85/hour. No experience necessary. Free details call 1 (800) 537-0589 or write to: **VIEJO PUBLICATIONS**, 5329 Fountain Ave., Dept. FX200, Los Angeles, CA 90029.

## FREE CATALOG!

1-800-648-7938

For all information 1-702-362-9026

JERROLD HAMLIN OAK ETC.

## CABLE TV DESCRAMBLERS

• Compare our low Low Retail Prices!

• Guaranteed Prices & Warranties!

• Orders Shipped Immediately!

**REPUBLIC CABLE PRODUCTS INC.**

4080 Paradise Rd. #15 Dept. RE-90

Las Vegas, NV 89109

**WHY** rent? Homes for \$1.00, repos. Gov't give away programs! For information (504) 649-0670 Ext. R-5192.

**NEW** electronics products are waiting to be produced. **TED**, (416) 747-5793.

## INVENTORS

**INVENTORS!** Can you patent and profit from your idea? Call **AMERICAN INVENTORS CORPORATION** for free information. Over a decade of service 1 (800) 338-5656. In Massachusetts or Canada call (413) 568-3753.

## SERVICES

**ENTHUSIASTS** Why not use PALs in your designs? We program from your logic equations or MS-DOS media. Call or write about our "Janey's Ranch" special. **NEVADA COMPUTER ASSOC.**, Box 978, Battle Mtn., NV 89820 (213) 666-2152.

## COMPUTERS FOR LESS

JCI 10 MHz 8088 System ..... \$ 399.00

- 10 MHz Motherboard w/ 640KB RAM
- Math Co-Processor Socket
- One 5.25" 360 KB Floppy & Controller
- 101-Key Enhanced Keyboard
- 150 Watt Power Supply & Case
- MonoGraphics Card w/ Parallel Port
- 12" Amber Monochrome Monitor

JCI Standard Configuration:

- 1 MB RAM on board 0 Wait State
- Built-In Real Time Clock & Calendar
- Math Co-Processor Socket
- One 1.2 MB or 1.44 MB Floppy Drive
- 1:1 Hard / Floppy Disk Controller
- 2 Serial, 1 Parallel, and 1 Game Port
- 101-Key Enhanced Keyboard
- Deluxe Case w/ 200 Watt Power Supply
- MonoGraphics Card w/ Parallel Port
- 12" Amber Monochrome Monitor

JCI 12 MHz 80286 System ..... \$ 649.00

JCI 16 MHz 386SX System..... \$ 869.00

JCI 20 MHz 80386 System ..... \$ 1149.00

JCI 25 MHz 386 32K Cache..... \$ 1495.00

JCI 33 MHz 386 32K Cache..... \$ 1850.00

Please Call For Custom Configurations

One Year Parts & Labor Warranty  
30 Day Satisfaction Guarantee  
Shipping & Handling Extra  
VISA & M/C add 3% Amex add 4%

## JINCO COMPUTERS INC.

5122 Walnut Grove Avenue  
San Gabriel, CA 91776

Tel: (818) 309-1108 - Fax: (818) 309-1107

CIRCLE 187 ON FREE INFORMATION CARD



### 2-1/2" SANYO TWEETER

Paper cone with gold tone dust cap. 8 oz. magnet. 8 ohm. 1/2" ferro fluid voice coil. Power handling: 50W RMS, 70W max. Frequency response: 3K-20KHz.



#RM-271-020 \$1<sup>95</sup> \$1<sup>75</sup> 95c  
(1-9) (10-59) (80-up)

### SUPER HORN TWEETER

Original piezo tweeter made by Motorola. SPL=94 dB 2.83V/1M. Response: 4KHz-27KHz. Handles approximately 50 watts.



#RM-270-010 \$5<sup>30</sup> \$4<sup>50</sup> \$3<sup>95</sup>  
(1-9) (10-79) (80-up)

### 2" DOME MIDRANGE

Textile dome midrange made by Phillips. 8 ohm. SPL=90 dB 1W/1M. 30W RMS, 40W max. Response: 550-5KHz.



#RM-280-210 \$27<sup>30</sup> \$25<sup>70</sup>  
(1-3) (4-up)

### 15" SUBWOOFER



Dual voice coil. 40 oz. magnet. 6 ohm imp. 100W RMS, 140W max. Response: 20-1.2KHz. Resonant frequency: 21Hz. SPL=93 dB 1W/1M.

#RM-290-190 \$54<sup>50</sup> \$49<sup>80</sup>  
(1-3) (4-up)

### SUBWOOFER XOVER



200W RMS crossover designed specifically for use with dual voice coil sub woofers. 12 dB per octave roll-off at 150Hz.

#RM-260-220 \$28<sup>80</sup> \$24<sup>40</sup>

### 10" POLY WOOFER

Medium duty. 60W RMS, 80W max. 14 oz. magnet. Response: 25-2.5KHz. fs=28Hz.



#RM-290-096 \$18<sup>50</sup> \$16<sup>90</sup>  
(1-3) (4-up)

### TITANIUM COMPOSITE TWEETER

The advantages of both hard and soft dome technologies. 8 ohm. Ferro fluid cooled voice coil. SPL=90 dB 1W/1M 50W RMS, 70W max. 4" round. Polydax #DTW100T125.

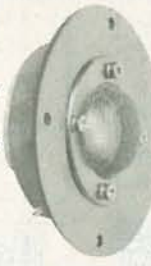

#RM-270-047 \$27<sup>50</sup> \$24<sup>80</sup>  
(1-9) (10-up)

### SPEAKER BUILDING BOOK

Revised edition of David Weems' best selling book. Learn to build low cost speakers that rival the high priced models.



#RM-500-021 \$16<sup>95</sup>

### 12" CAST FRAME WOOFER



12" woofer made in the USA by Eminence. Paper cone and dust cap with treated cloth surround. 80 oz. magnet. 2-1/2" vented voice coil. 8 ohm. 170W RMS, 235W max. 40-4.5KHz response.

#RM-290-147 \$72<sup>90</sup> \$69<sup>50</sup>  
(1-3) (4-up)



FREE CATALOG



340 E. First St., Dayton, Ohio 45402  
Local: 1-513-222-0173  
FAX: 513-222-4644

• 15 day money back guarantee • \$15.00 minimum order • We accept Mastercard, Visa, Discover, and C.O.D. orders. • 24 hour shipping • Shipping charge = UPS chart rate + \$1.00 (\$3.00 minimum charge) • Hours 8:30 am-7:00 pm EST, Monday - Friday • Mail order customers, please call for shipping estimate on orders exceeding 5 lbs. Foreign customers please send \$5.00 U.S. funds for catalog postage.

CALL TOLL FREE  
1-800-338-0531

CIRCLE 56 ON FREE INFORMATION CARD



# CONSOLIDATED ELECTRONICS

COMPLETE WITH  
NEW PRICE LIST!

CONSUMER & INDUSTRIAL ELECTRONICS CATALOG • 17TH EDITION

## THE ULTIMATE ELECTRONICS CATALOG

Order your 260 page catalog and price list with over 14,000 money saving electronic parts and equipment! Send \$3.00 in a check or money order, or call 1-800-543-3568 today and use your Mastercard or Visa. Consolidated Electronics, Incorporated  
705 Watervliet Ave., Dayton, Ohio 45420-2599

Name \_\_\_\_\_  
Address \_\_\_\_\_  
City \_\_\_\_\_ State \_\_\_\_\_ Zip \_\_\_\_\_

CIRCLE 70 ON FREE INFORMATION CARD

### CABLE TV CONVERTERS WHY PAY A HIGH MONTHLY FEE?

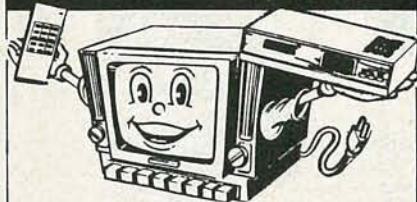

All Jerrold, Oak, Hamlin, Zenith, Scientific Atlanta, Magnavox and all specialized cable equipment available for shipment within 24 hours. For fast service MC / VISA or C.O.D. telephone orders accepted (800) 648-3030 60 Day Guarantee (Quantity Discounts) 8 A.M. to 5 P.M. C.S.T. **CLOSED WEEK-ENDS.** Send self-addressed Stamped envelope (60¢ postage) for Catalog.

**MIDWEST ELECTRONICS INC.**  
P.O. Box 5000  
Suite 311 (R)  
Carpentersville, IL 60110

No Illinois Orders Accepted.

### EDUCATION & INSTRUCTION

**MAGIC!** Four illustrated lessons plus inside information shows you how. We provide almost 50 tricks including equipment for four professional effects. You get a binder to keep the materials in, and a one-year membership in the International Performing Magicians with a plastic membership card that has your name gold-embossed. You get a one-year subscription to our quarterly newsletter "IT'S MAGIC!" Order now! \$29.95 for each course + \$3.50 postage and handling. (New York residents add applicable state and local sales tax). **THE MAGIC COURSE**, 500-B BiCounty Boulevard, Farmingdale, NY 11735.

\*\*\*\*\*PRESENTING\*\*\*\*\*  
**CABLE TV  
DESCRAMBLERS**  
\*\*\*\*\* STARRING \*\*\*\*\*  
**JERROLD, HAMLIN, OAK**  
AND OTHER FAMOUS MANUFACTURERS

- FINEST WARRANTY PROGRAM AVAILABLE
- LOWEST RETAIL/WHOLESALE PRICES IN U.S.
- ORDERS SHIPPED FROM STOCK WITHIN 24 HOURS

FOR FREE CATALOG ONLY 1-800-345-8927  
FOR ALL INFORMATION 1-818-709-9937

**PACIFIC CABLE CO., INC.**  
7325 1/2 Reseda Blvd., Dept. 1000  
Reseda, CA 91335

**F.C.C. Commercial General Radiotelephone license.** Electronics home study. Fast, inexpensive! "Free" details. **COMMAND**, D-176, Box 2824, San Francisco, CA 94126.

**VIDEO** tape VHS basic cleaning and maintenance. TV one and a half hours. VCR one hour. \$38.00 each. **JAMES BRADFORD**, PO Box 38359, Detroit, MI 48238.

**LEARN IBM PC assembly language.** 80 programs. Disk \$5.00. Book \$18.00. **ZIPFAST**, Box 12238, Lexington, KY 40581-2238.

**TURN** your love into a living! The professional video industry needs qualified technicians. Institute of Audio Research, the world leader in audio education, announces the **Video Technology Program** for people like you. In under a year turn your flair for electronics into highly marketable skills. Grads work in broadcast television, production companies, manufacturers, corporate communications, etc. Financial aid available if qualified. HS diploma or GED required. **INSTITUTE OF AUDIO RESEARCH**, 64 University Place, New York, NY 10003. 1 (800) 544-2501. NY, NJ, CT (212) 777-8550.

**LOW power radio broadcasting** - Your own station! License unnecessary! Reach entire communities! **Comprehensive** book! \$29.95 money order or certified check - **SOUTHEASTERN TECHNICAL SERVICES**, Box 8, Stonewall, OK 74871.

## Cable TV Descramblers

If you find a better deal,  
we'll better our deal.

\*Jerrold \*Tocom \*Hamlin \*Oak  
\*Scientific Atlanta \*Zenith  
Ask about our extended warranty program.

COD, Visa, M/C welcome.  
Free Call - Free Catalog.

Video Tech **800-562-6884**  
2702 S. Virginia St., Ste. 160-304  
Reno, NV 89502.

## CABLE TV "BOXES"

Converters - Descramblers  
Remote Controls - Accessories

- \* Guaranteed Best Prices \*
- \* 1 Year Warranty - C.O.D.'s \*
- \* Immediate Shipping \*
- \* FREE CATALOG \*

Call or Write  
**TRANS-WORLD CABLE CO.**  
12062 Southwest 117th Court, Suite 126  
Miami, Florida 33186  
1-800-442-9333



## LASER JET MEMORY

continued from page 76

of printer. An "X" indicates a closed switch or that a jumper is installed. An "O" indicates the opposite. J1 is viewed with pin 1 to the left.

### Installation and checkout

Plug the 48-conductor cable onto J2 so that the cable runs out and over the front edge of the board. After turning the power off and removing the power cord, remove the memory expansion panels of your printer (see the manual supplied with the printer). Slip the memory board into the card guides inside the printer and plug the free end of the cable into the 48-pin connector.

Power up the printer and run a memory test as described in the printer's manual. Check to see that the amount of memory reported is correct. If problems occur refer to the guide in that manual, and check your work. **R-E**

## BEST BY MAIL

Rates: Write National, Box 5, Sarasota, FL 34230

BOOKS/CATALOGS/MAGAZINES

**FREE CATALOG** - DESIGNER Clothing. OMEGA, 101(RE) Clematis, Pensacola, FL 32503-2834.

**50,000 + CATALOG LISTING!** \$5.95: Catalogs, Box 92452GT, Atlanta, GA 30314.

**MONEYMAKING OPPORTUNITIES**

**\$50,000 IN 3 Months:** Only 3 pieces of paper, no membership or company start up fees. Our whole program cost you just \$3.00, send to: TSCOA, POB 670(RE), Lewiston, NY 14092.

**CLOSEOUTS EXTREMELY PROFITABLE** Postcard Program. \$5,000.00 weekly possible! 1-800-284-2625.

## CABLE TV DESCRAMBLER LIQUIDATION!

- Major Makes & Models!
- Will match or beat anyone's prices!
- Dealer discounts at 5 units!
- Examples:  
HAMLIN COMBOS . \$44 ea. (Min. 5)  
OAK ADD/ON . . . . . \$40 ea. (Min. 5)  
OAK M35B . . . . . \$60 ea. (Min. 5)

**WEST COAST ELECTRONICS**

For Information: 818-709-1758  
Catalogs & Orders: 800-628-9656

## NUTS & VOLTS MAGAZINE

P.O. Box 1111-E  
Placencia, CA 92670  
714-632-7721

**GIVE YOURSELF A BREAK - A PRICE BREAK!**  
**NUTS & VOLTS WILL Save YOU MONEY**  
ON ELECTRONIC PARTS & EQUIPMENT  
**Plus SHOW YOU WHERE TO FIND UNIQUE,  
UNUSUAL AND HARD-TO-FIND ITEMS.**  
SUBSCRIBE TODAY!  
Orders Only 800-783-4624





**Subscription Rates**  
U.S. - CANADA - MEXICO  
3rd Class Mail - USA  
One Year \$12.00  
Two Years \$21.00  
Lifetime \$60.00  
1st Class Mail  
One Year USA \$30.00  
Canada, Mexico \$32.00  
Air Mail  
Foreign 1 Yr \$55.00

A National Publication For The Buying And Selling Of Electronic Equipment

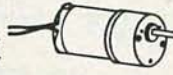
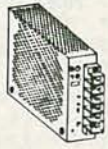

QUALITY PARTS • DISCOUNT PRICES • FAST SHIPPING

# ALL ELECTRONICS CORP.

<b>PIEZOE BUZZER</b> Star# HMB-06 Operates from 4-6 Vdc. TTL compatible. Draws 20 mA @ 6 Vdc. Emits high pitched signal. 0.62 diameter, 0.55" high. PC pins. <b>CAT# PBZ-06 \$1.50 each</b> 	<b>16 CHARACTER LCD DISPLAY</b> Hitachi# LM015 16 character dot matrix LCD display with built-in controller/driver. Interfaces with 4 or 8 bit MPU. Displays alphanumerics, kana characters and symbols. CMOS - low power dissipation. Operates on 5 Vdc. Module size: 3.14" X 1.40". Display area: 2.53" X 0.54". Character size: 0.25" high X 0.115" wide. Programming and hook-up instructions included. <b>CAT# LCD-1 \$9.50 each</b> 	<b>12 VDC GEARHEAD MOTOR</b> Soho# GBL 35-DH-21080-10Y Powerful little gearhead motor. 40 RPM @ 12 Vdc. 0.5 amps (no load). 32 RPM with load. Operates at lower voltages with reduced speed and torque. 6.3 pound inches torque. Stall: 27 pound inches. 3.1" long X 1.375" diameter. Shaft: 0.187" dia. X 0.75" long. <b>CAT# MOTG-14 \$11.50 each</b> 10 for \$100.00 	<b>12 VDC 2.1 AMP POWER SUPPLY</b> Lambda# LUS-9A-12 Fully enclosed switching power supply with screw terminal connections. Input: 120 Vac 60 Hz. Output: 12 Vdc ± 5% @ 2.1A overvoltage and overcurrent protection. Compact ventilated case measures 5.24" X 3.81" X 1.38" overall. Includes instruction sheet. <b>CAT# PS-122 \$23.50 each</b> 
<b>PHOTO RESISTOR</b> 100 ohms light 16K ohms dark. 0.182" dia. X .08" high. 0.18" long leads. <b>CAT# PRE-7 2 for \$1.00</b> 100 for \$45.00 • 1000 for \$400.00 			

**SWITCHES**  
**ITT PUSH BUTTON**  
 ITT MDPL series. 3/4" X 1/2" grey rectangular key cap. S.P.S.T. N.O. Push to close. RATED: 0.1 amp switching, 0.25 amp carry current. P.C. mount.  
**CAT# PB-8 65¢ each • 10 for \$6.00**  
 100 for \$50.00
 
  
**SPDT PUSHBUTTON**  
 Marquand# 1843  
 Rated 6 amps @ 125/250 Vac. Black plastic pushbutton. Switch body: .92" X .94" X .65".  
**CAT# PB-18 \$1.65 ea. • 10 for \$15.00**

  
**PUSHBUTTON SWITCH**  
 GC/Thornes# 35-420  
 S.P.S.T. normally open momentary pushbutton switch. Red plastic actuator 0.57" diameter. Chrome bezel 0.68" diameter. Threaded bushing mounts in .50" diameter hole. Rated 3 amp @ 250Vac. Solder loop terminals.  
**CAT# PB-20 \$1.00 each**

**NICKEL-CAD BATTERIES (RECHARGEABLE)**  

  
**AAA SIZE \$1.50 each**  
 1.2 volts 180 mAh  
**CAT# NCB-AAA**  
**AA SIZE \$2.00 each**  
 1.25 volts 500 mAh  
**CAT# NCB-AA**  
**AA SIZE \$2.20 each**  
 WITH SOLDER TABS  
**CAT# NCB-SAA**  
**C SIZE \$4.25 each**  
 1.2 volts 1200 mAh  
**CAT# NCB-C**  
**D SIZE \$4.50 each**  
 1.2 volts 1200 mAh  
**CAT# NCB-D**
**0-6 HOUR AUTO SHUT-OFF TIMER**  
 M.H. Rhodes, Inc. Mark-Time# 90007  
 Timer fits standard 3" deep wallbox. Rated 20 amps @ 125 Vac. Turn knob to desired time. Includes hardware, beige wallplate, and knob. UL and CSA listed. **CAT# TMC-6 \$5.75 each • 10 for \$50.00**

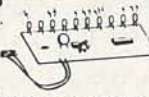
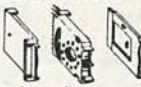
  
**SPECIAL PURCHASE**  
**210 MFD 330 V PHOTOFLASH CAPACITOR**  
 Rubicon CE photoflash capacitor. 0.79" dia. X 1.1" high. These are new capacitors that have been prepped with 1.4" black and red wire leads soldered to the terminals.  
**CAT# PPC-210 \$2.50 each**  
 10 for \$22.50 • 100 for \$200.00  
 Large quantities available. Call for pricing.
 
**LED'S**  
**STANDARD JUMBO DIFFUSED T-1-3/4 size**  
**RED CAT# LED-1** 10 for \$1.50 • 100 for \$13.00  
**GREEN CAT# LED-2** 10 for \$2.00 • 100 for \$17.00  
**YELLOW CAT# LED-3** 10 for \$2.00 • 100 for \$17.00  
**FLASHING LED**  
 with built in flashing circuit operates on 5 volts...  
**RED \$1.00 each**  
**CAT# LED-4 10 for \$9.50**  
**GREEN \$1.00 each**  
**CAT# LED-4G 10 for \$9.50**  
**LED HOLDER**  
 Two piece holder.  
**CAT# HLED 10 for 65¢**  
**RECTANGULAR L.E.D. SPECIAL**  
 #HLMP0301  
 Red diffused rectangle. 0.28" X 0.1" X 0.29" high. Ideal for bargraphs, chasers, etc. **CAT# RLED-4 10 for \$1.50 • 100 for \$12.00**  
 1000 for \$100.00
 
**L.E.D. FLASHER KIT**  
 Two L.E.D.'s flash in unison when a 9 volt battery is attached. This kit includes a p.c. board, all the parts and instructions to make a simple flasher circuit. A quick and easy project for anyone with basic soldering skills.  
**CAT# LEDKIT \$1.75 per kit**

  
**LED CHASER KIT**  
 Build this variable speed led chaser. 10 leds flash sequentially at whatever speed you set them for. Easy to build kit includes pc board, parts and instructions. Ideal for special lighting effects, costumes, etc. Operates on 3 to 9 volts. PC board is 5" X 2.25". A great one hour project. **CAT# AEC \$6.50 each**

**THUMBWHEEL SWITCH**  
 1 pole 10 position decimal encoded switches which interlock to make up desired number or digits. Terminates to 11 pc pins (1 common and 10 poles). Each section measures .31" wide X .20" high X .78" deep. End plates can be added to form a .94" high bezel.  
**CAT# SWTH-9 \$1.25 each**  
 10 for \$10.00  
**2 END PLATES - CAT# SW-9EC \$1.00/2**

**XENON TUBE**  
 1" long flashtube with 3 1/2" red and black leads. Ideal for electronic flash or strobe projects.  
**CAT# FLT-3 2 for \$1.00**

  
**RELAYS**  
**6 VOLT D.C. - S.P.D.T.**  
 Aromat # RSD-6V  
 Super small relay.  
 Rated: 1 amp @ 30 Vdc. TTL direct drive possible. Operates on 4.3 to 14 Vdc. Coil: 220 ohms. 1 3/16" X 1 3/32" X 7/16". **CAT# RSD-6V \$1.50 each • 10 for \$13.50**

  
**12 VOLT D.C. D.P.D.T. DIP RELAY**  
 Miniature relay fits standard 16 pin (dip) sockets or will directly mount to p.c. boards. GI Clare# LM44D00 • 280 ohm • 30 va switching.  
**CAT# CRLV-12 \$2.50 each**

  
**24 VOLT D.C. COIL**  
 KUP style 11 pin base can be socketed, direct soldered or quick connect terminals can be used. 1 3/8" x 1 1/2" x 2". 3.P.D.T. • 5 amp contacts • 470 ohm  
**CAT# RLY-3524 \$2.25 each**

**STEPPER MOTOR**  
 Airpax P/N C82711-M1  
 17 Vdc dual coil, permanent magnet stepper. 23.25 ohm coil. 7.5 degrees per step.  
**CAT# SMT-6 \$6.00 each • 10 for \$50.00**

  
**INSTRUMENT ENCLOSURES**  
 High quality molded ABS instrument enclosures. Integrated PC board standoffs and two sets of vertical mounting slots for front and rear sub panels. All enclosures are 6" wide X 6 1/4" deep. Choice of three hts. Includes non-skid rubber feet and hardware. Available in beige, ivory, black, and blue.  
 Panel ht. **CAT#**  
 2 1/4" **CAT# MB-A \$7.50 each** 10 for \$65.00  
 2 5/8" **CAT# MB-B \$7.75 each** 10 for \$67.50  
 3" **CAT# MB-C \$8.00 each** 10 for \$70.00  
 Please specify color.
 
**LED GRAB BAG**  
 50 assorted L.E.D.'s  
 Many different shapes, colors, sizes. Round, rectangular, curved, etc.  
**CAT# GRLED \$4.00 per assortment**

**STEPPING MOTOR CONTROLLER KIT**  
 Learn about stepping motors while building this simple circuit. Includes circuit board and all parts except 12 Vdc power supply.  
**CAT# SMKIT \$18.00 each**

**WALL TRANSFORMERS**  
 ALL PLUG DIRECTLY INTO 120 VAC OUTLET
 
  
 6 Vac @ 600 ma. **CAT# ACTX-600 \$3.50**  
 8.3 Vdc @ 10 ma. **CAT# DCTX-8310 \$1.50**  
 12 Vdc @ 500 ma. **CAT# DCTX-125 \$4.50**  
 9 Vdc @ 1 amp. **CAT# DCTX-951 \$5.00**  
 24 Vac @ 625 ma. **CAT# ACTX-2462 \$3.00**
**OPTO SENSOR**  
 U shaped package with mounting ears.  
 1/8" opening.  
 3/4" mounting ears.  
**CAT# OSU-6 50¢ each**  
 10 for \$4.50 • 100 for \$40.00
 
**RG-11/U 75 OHM VIDEO CABLE**  
 100 ft. or 200 ft. rolls of RG 11/U terminated to heavy duty F connectors. Includes 75 ohm terminator and F-61 splicer on one end. New cables manufactured for IBM PC networks. IBM P/N 1501908 COMSCOPE.  
**CAT# RG-11-1 100 ft. roll \$15.00**  
**CAT# RG-11-2 200 ft. roll \$27.50**

**REFLECTIVE OPTO SENSOR**  
 Optek# K-8711  
 Wedge shaped device with IR emitter and receiver pointing from same direction. Light rays from emitter bounce off nearby object and register on receiver. Effective range approx. 0.15".  
**CAT# OSR-1 75¢ each**

**ELECTROLUMINESCENT STRIP (GLOW STRIP) AND INVERTER**  
 Used for backlighting control panels or as decorative or emergency prime lighting source. Thin, tough and flexible, they operate on low current AC voltage. The preferred power source is a miniature DC to AC inverter. These have a bit of an odd shape. The strips are 2.15" wide X 5.88" long and are 0.035" thick. The luminescent area is 5.3" long X 1.72" wide and has one corner cut off, leaving a useful area of fairly good proportions. We are selling the strips and inverters as a package. Inverter operates on 6 Vdc. Glow strip, inverter and hook-up diagram. **CAT# GS-500 \$5.00 per set**

**TELEPHONE COUPLING TRANSFORMER**  
 Multi Products International# A19N-HO-1D/1  
 Primary: 600 ohm  
 Secondary: 600/600 ohm  
 0.77" X 0.61" X 0.63" high. 6 p.c. pins on 0.187" centers. Primary inductance: 300 mH min., at 1kHz, 1 volt.  
**CAT# TCTX-1 \$1.25 each • 10 for \$11.00**

**EXTRA INVERTERS**  
 Input: 6 Vdc Output: 225 Vac  
**CAT# INV-1 \$2.00 each**

## ORDER TOLL FREE 1-800-826-5432

FAX (818) 781-2653 • INFORMATION (818) 904-0524

Call Or Write For Our Free 60 Page Catalog  
 Outside the U.S.A. send \$2.00 postage for a catalog.

Minimum Order \$10.00 • All Orders Can Be Charged To Visa, Mastercard Or Discovercard • California, Add Sales Tax • Shipping And Handling \$3.50 For the 48 Continental United States - All Others Including Alaska, Hawaii, P.R. And Canada Must Pay Full Shipping • Quantities Limited • No C.O.D. • Prices Subject to change without notice.

DISCOVER

VISA

MasterCard

MAIL ORDERS TO: ALL ELECTRONICS CORP. • P.O. BOX 567 • VAN NUYS, CA 91408

CIRCLE 107 ON FREE INFORMATION CARD

OCTOBER 1990



**Intel Math Coprocessors**

**8088 or 8086 Systems**

8087	5MHz	\$89.95
8087-2	8MHz	\$129.95
8087-1	10MHz	\$169.95

**80286 Systems**

80287	6MHz	\$139.95
80287-8	8MHz	\$209.95
80287-10	10MHz	\$239.95

**80386 Systems**

80387-16	16MHz	\$349.95
80387-20	20MHz	\$399.95
80387-25	25MHz	\$499.95
80387-33	33MHz	\$649.95

**Memory Modules**

**SIPPs**

41256A9A-80	80ns, 256Kx9	\$32.95
41256A9A-10	100ns, 256Kx9	\$29.95
421000A9A-70	70ns, 1 Megx9	\$104.95
421000A9A-80	80ns, 1 Megx9	\$99.95
421000A9A-100	100ns, 1 Megx9	\$89.95
94000L-80	80ns, 4 Megx9	\$449.95

**SIMMs**

41256A9B-80	80ns, 256Kx9	\$32.95
41256A9B-10	100ns, 256Kx9	\$29.95
421000A8B-100	100ns, 1 Megx8	\$79.95
421000A9B-70	70ns, 1 Megx9	\$109.95
421000A9B-80	80ns, 1 Megx9	\$99.95
421000A9B-100	100ns, 1 Megx9	\$89.95
94000S-80	80ns, 4 Megx9	\$449.95

**NEC V20 & V30 Chips**

UPD70108-5	5MHz, V20 Chip	\$5.25
UPD70108-8	8MHz, V20 Chip	\$6.95
UPD70108-10	10MHz, V20 Chip	\$10.95
UPD70116-8	8MHz, V30 Chip	\$7.95
UPD70116-10	10MHz, V30 Chip	\$12.95

**Dynamic RAMs**

TMS4416-12	120ns, 16Kx4	\$2.49
TMS4416-15	150ns, 16Kx4	\$2.25
4116-12	120ns, 16Kx1	\$1.49
4116-15	150ns, 16Kx1	\$1.19
4116-20	200ns, 16Kx1	\$.99
4164-100	100ns, 64Kx1	\$2.25
4164-120	120ns, 64Kx1	\$2.09
4164-150	150ns, 64Kx1	\$1.95
4164-200	200ns, 64Kx1	\$1.75
41256-60	60ns, 256Kx1	\$4.95
41256-80	80ns, 256Kx1	\$3.75
41256-100	100ns, 256Kx1	\$3.15
41256-120	120ns, 256Kx1	\$2.95
41256-150	150ns, 256Kx1	\$2.59
41464-80	80ns, 64Kx4	\$3.95
41464-10	100ns, 64Kx4	\$3.25
41464-12	120ns, 64Kx4	\$2.95
41464-15	150ns, 64Kx4	\$2.49
511000P-70	70ns, 1 Megx1	\$10.49
511000P-80	80ns, 1 Megx1	\$9.95
511000P-10	100ns, 1 Megx1	\$8.95
514256P-80	80ns, 256Kx4	\$10.49
514256P-10	100ns, 256Kx4	\$10.25

**Static RAMs**

6116P-3	150ns, 16K (CMOS)	\$2.59
6264LP-10	100ns, 64K (CMOS)	\$5.49
6264LP-15	150ns, 64K (CMOS)	\$4.95
43256-10L	100ns, 256K	\$8.95
43256-15L	150ns, 256K	\$8.49
62256LP-15	150ns, 256K (CMOS)	\$9.49

**PROTOTYPING PRODUCTS**  
 Jameco Solderless Breadboards

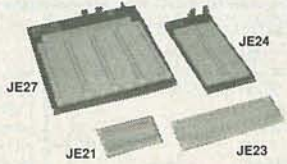

Part No.	Dim. L" x W"	Contact Points	Binding Posts	Price
JE21	3.25 x 2.125	400	0	\$4.95
JE23	6.5 x 2.125	830	0	\$6.95
JE24	6.5 x 3.125	1,360	2	\$12.95
JE25	6.5 x 4.25	1,660	3	\$17.95
JE26	6.875 x 5.75	2,390	4	\$22.95
JE27	7.25 x 7.5	3,220	4	\$32.95

**Oscilloscope Probes**

- Attenuation: x1 / x10
- Capacitance: 180pF / 22pF
- Bandwidth: 3MHz/40MHz
- Length: 60"



LF180	40MHz Oscilloscope Probe	\$19.95
-------	--------------------------	---------

**GoldStar 20MHz Oscilloscope and 1GHz Frequency Counter**



- Large 6" rectangular display
- High sensitivity: 1 mV/div

GS7020	Oscilloscope	\$399.95
--------	--------------	----------

- Wide measuring range
- Measured value hold function

FC7102	Frequency Counter	\$299.95
--------	-------------------	----------

**Metex Digital Multimeters**



**General Specs:**

- Handheld, high accuracy • AC/DC voltage, AC/DC current, resistance, diodes, continuity, transistor hFE
- Manual ranging w/ overload protection

**M3650, 3650B & M4650 only:**

- Also measure frequency and capacitance

**M4650 only:** • Data hold switch • 4.5 digit

M3610	3.5 Digit Multimeter	\$49.95
M3650	3.5 Digit Multimeter w/Frequency & Capacitance	\$69.95
M3650B	Same as M3650 w/Bargraph	\$74.95
M4650	4.5 Digit w/Frequency, Capacitance and Data Hold Switch	\$99.95

**Multimeter Specials**

**M80:**

- AC/DC voltage, AC/DC current, resistance, diodes, continuity & frequency • Full auto-ranging on DC voltage • High/low semi-automating for AC/DC current and ohms • Data hold switch • Extra-large display

M80	3.75 Digit Multimeter	\$59.95
-----	-----------------------	---------

**M3900:**

- AC/DC voltage, AC/DC current, resistance, diodes, continuity, dwell angle and engine RPM • High surge voltage protection

M3900	3.5 Digit Multimeter	\$59.95
-------	----------------------	---------

**Prototype Design Stations**

**WM1 & WM2 Features:** • Removable solderless breadboard • Variable and fixed DC power supply • Multi-frequency signal generator • Analog multimeter • 8 bicolor LEDs (red & green) • 8 logic switches • Logic probe • Lighted power switch • Fuse overload protected • Sturdy ruggedized case

**WM1 Special Features:** • 4 potentiometers • Built-in speaker

**WM2 Special Features:** • Pulse Generator • Binary coded decimal (BCD) to 7-segment decoder/driver • DB25 connector • Frequency counter (1Hz to 1MHz)

**WM1 Analog Prototype Station .....\$199.95**  
**WM2 Digital Prototype Station .....\$249.95**

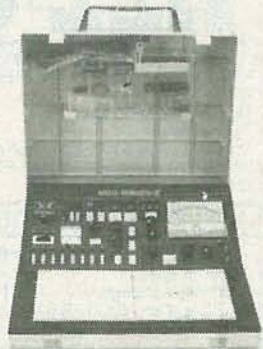

**A.R.T. EPROM Programmer**



- Programs all current EPROMs in the 2716 to 27512 range plus the X2864 EEPROM
- RS232 port • Software included

**EPP.....\$179.95**

**UVP EPROM Eraser**



- Erases all EPROM's • Erases 1 chip in 15 Min. and 8 chips in 21 min. • UV intensity: 6800 UW/CM<sup>2</sup>

**DE4.....\$69.95**

**Soldering and Desoldering Stations**

**60 Watt Analog Display Soldering Station • Electronic temperature control from 200° to 878°F • Cartridge heating element for a longer life of the soldering tip**

**XY1683 .....\$59.95**

**60 Watt Analog Display Soldering Station • Electronic temperature control from 200° to 878°F • Ceramic heating element for a steady temperature and long life**

**XY2660 .....\$89.95**

**60 Watt Digital Display Soldering Station • Electronic temperature control from 200° to 878°F • Temperature displayed on easy to read .560"H 3-digit LED readout • Nichrome heating element**

**XY960 .....\$99.95**

**30 Watt Electronic Temperature Controlled Desoldering Station • Electronic temperature control from 212° to 842°F • Self-contained high rotary vacuum pump**

**XY999 .....\$279.95**



**51-Piece Electronic Tool Kit**

The MS305 provides the tools needed for building, repairing and general maintenance of most electronic equipment. A convenient and durable carry-along combination lock case safely protects and secures this 51-piece tool kit. From the digital multimeter to the desoldering pump this kit is the perfect item for technicians and electronic enthusiasts.



**Tools Included in Kit**

- 10' measuring tape
- Electric tape
- 6" long tweezers
- 7" brush and scraper
- 7" fine point probe
- 7" slotted probe
- Rosin core solder
- 30 watt soldering iron
- Desoldering pump
- Soldering stand
- Stainless steel scissors
- Utility components box
- 8 pcs. hex key wrench
- Digital Multimeter
- Round needle file
- Flat needle file
- 6" adjustable wrench
- Utility knife with extra blade
- Bent needle nose pliers
- Diagonal cutting pliers
- 5.25" needle nose pliers
- 6 piece precision screwdriver set
- Brush
- 10 piece screwdriver set: 5 Slotted & 5 Phillips
- Flat nose pliers
- Carrying case: 17.63"W x 12.5"D x 3.5"H

**MS305.....\$119.95**



Request Jameco's 1990 Catalog for a Complete Listing of Components, Test/Measurement Equipment and Computer Products



**Jameco 20MHz 80386 Desktop Computer Kit**

- Fully IBM Compatible
- Free! Concurrent 386 (Disk Operating System) Software Included
- 4MB RAM Included, Expandable to 8MB on board, 16MB with optional expansion board
- 8/20MHz Keyboard Switchable Operation
- AMI BIOS ROMs Included
- Floptop Case w/200 Watt Power Supply
- Conner High-Performance IDE 3.5" 40MB Hard Disk Drive
- Teac 1.2MB Floppy DSHD Disk Drive
- Multi I/O Card with Universal Floppy Controller
- Fujitsu 101-Key (Enhanced) Keyboard



Shown with VGA Option (not included)  
 JE2059 Multiscan Monitor and VGA Card...\$669.90 (See Below)

**JE3551** 20MHz 80386 Compatible Kit.....\$1949.95

**Jameco IBM PC/XT/AT Compatible Cards**

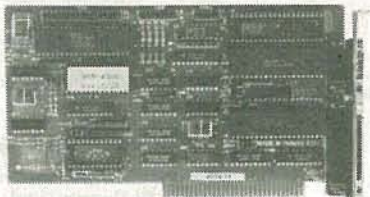

JE1077

- JE1043** 360KB/720KB/1.2MB/1.44MB Floppy Disk Controller Card (PC/XT/AT) ..\$49.95
- JE1050** Monochrome Graphics Card w/Parallel Printer Port (PC/XT/AT).....\$49.95
- JE1052** Color Graphics Card w/ Parallel Printer Port (PC/XT/AT).....\$49.95
- JE1055** EGA Card w/ 256KB Video RAM (PC/XT/AT) .....\$139.95
- JE1060** I/O Card w/ Serial, Game, Printer Port & Real Time Clock (PC/XT)....\$59.95
- JE1062** RS232 Serial Half Card (PC/XT/AT) .....\$29.95
- JE1065** I/O Card w/ Serial, Game and Parallel Printer Port (AT) .....\$59.95
- JE1077** Multi I/O Card w/ 360KB/720KB/1.2MB/1.44MB Floppy Controller (AT) ...\$99.95

**EGA, VGA & Multiscan Monitor Packages**

Relisys 14" EGA monitor and EGA card package (640 x 350 max. resolution)

**JE1059** EGA Monitor & EGA Card.....\$509.90

Relisys 14" Multiscan monitor and 16-bit VGA card package (640 x 480 max. resolution)

**JE2059** Multiscan Monitor & VGA Card.....\$669.90

Relisys 14" VGA monitor and 16-bit VGA card package (640 x 480 max. resolution)

**JE2061** VGA Monitor & VGA Card.....\$629.90



JE2061

**IBM PC/XT/AT Compatible Keyboards**



FKB4700

**JE2015** 84-Key Standard AT Style Layout .....\$59.95

**FKB4700** 101-Key Enhanced Layout with 12 Function Keys .....\$69.95

**MEI 100-Key Microtype Keyboard**

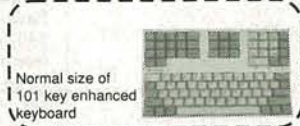

Normal size of 101 key enhanced keyboard

- IBM PC/XT/AT/386 Compatible
- Saves an amazing 60% of the desk space used by equivalent standard keyboards

**MIRU**.....\$129.95

**Jameco Digitizer Tablet**



- AutoCAD 10 template and four-button puck • Resolution: up to 1016 lines per inch • Accuracy: ±.025" • Emulates three of the worlds most popular formats: Summagraphics MM, Summagraphics Bit Pad One, Calcomp 2000 • EEPROM allows custom configuration

**JCAD** Digitizer Tablet \$199.95  
**Stylus** Two Button Stylus .....\$39.95

**DFI Handy Scanner**

- IBM PC/XT/AT Compatible
- 4" Scanning Window
- 400 dpi



**HS3000**.....\$129.95  
 Limited Quantity in Stock!

**Logitech Mice**



**MSER** Serial Mouse & MouseWare Software .....\$89.95

**MBUS** Mouse w/Bus Board & MouseWare Software .....\$99.95

**MPS2** PS/2 Mouse & MouseWare Software .....\$79.95

**Modems**



9600E Pictured

**External Modems**

**1200C** Datatronics 1200 Baud .....\$89.95  
**2400C** Datatronics 2400 Baud .....\$149.95  
**9600E** Prometheus 9600 Baud .....\$699.95

**Internal Modems**

**1200B** Jameco 1200 Baud .....\$49.95  
**2400B** Jameco 2400 Baud .....\$99.95  
 Modems listed above include ProComm Software

**IBM Compatible Cases and Power Supply**



JE1032



JE1010

**JE1010** Flip-Top Standard PC/XT Case.....\$39.95  
**JE1011** Side Standard PC/XT Case .....\$39.95  
**JE1032** 200 watt Baby AT Power Supply .....\$89.95  
**DFTC** Vertical Case w/230W Pwr. Supply \$259.95

**Floppy Disk Drives**

MF353B



Sony

**MPF11** 3.5" 720KB Disk Drive .....\$69.95  
**SMK** 5.25" Installation Kit for MPF11 ..\$14.95

**Mitsubishi**

**MF353B** 3.5" 720KB Internal Drive .....\$99.95  
**MF355B** 3.5" 1.44MB Internal Drive ..\$119.95  
**DD1** MF355B Software for systems without 1.44MB disk drive BIOS capability ...\$14.95

**Teac**

**FD55B** 5.25" 360KB Internal Drive ...\$89.95  
**FD55G** 5.25" 1.2MB Internal Drive ....\$99.95

**Hard Drives & Tape Back-Up**



XT Hard Drives also available

**Conner (16-bit IDE)**

**CP3044** 40MB (25ms) 3.5"Low Profile..\$429.95  
**CP3184** 80MB (25ms) 3.5"HH .....\$649.95  
**CP3104** 100MB (25ms) 3.5"HH.....\$699.95

Above Drives Include Hard Disk Drive, Controller & Cables

**Micropolis (ESDI)**

**1654-7** 150MB (16ms) 5.25"HH....\$1199.95  
**1558-15** 300MB(18ms) 5.25"FH \$1699.95

**Colorado Memory Systems**

• IBM PC/XT/AT/386 Compatible • Back-up 40MB in 40 minutes • Back-up 60 to 120MB with extended tapes and data compression software • Includes 40MB tape cartridge

**DJ10** 40MB Tape Back-Up.....\$329.95

**KE10** External Enclosure Kit .....\$149.95

**TB40** 40MB Tape Cartridge .....\$24.95

**TB60** 60MB Tape Cartridge .....\$32.95

1355 Shoreway Road, Belmont, CA 94002

**24 Hour Order Hotline**  
**(415) 592-8097**

\$50.00 Minimum Order

FAX's (415) 592-2503 or (415) 595-2664  
 Telex 176043 - Ans. Back: Jameco Blmt  
 Data Sheets - 50c each  
 For a FREE 48-Page Flier send \$2.00 to cover First Class Postage and Handling  
 © 1990 Jameco Electronics 10/90

**CA Residents Add**  
 6.25%, 6.75% or 7.25% Sales Tax  
 Shipping - Add 5% plus \$1.50 Insurance (May vary according to weight and shipping method)  
 Terms: Prices subject to change without notice. Items subject to availability and prior sale.  
 Complete list of terms/warranties is available upon request. IBM is a registered trademark of International Business Machines



Please refer to Mail Key 2 when ordering





# AMAZING SCIENTIFIC & ELECTRONIC PRODUCTS

**PARTS ARE IN STOCK**

GRA1 — ANTI GRAVITY GENERATOR	\$10.00
LC7 — 40 WATT BURNING CUTTING LASER	\$20.00
RUB4 — HI POWER PULSED DRILLING LASER	\$20.00
BTC5 — 1 MILLION VOLT TESLA COIL	\$20.00
MCP1 — HI VELOCITY COIL GUN	\$15.00
LLS1 — LASER LIGHT SHOW 3 METHODS	\$20.00
EH1 — ELECTRONIC HYPNOTISM TECHNIQUES	\$8.00
EML1 — LOWER POWERED COIL GUN LAUNCHER	\$8.00
JL3 — JACOB LADDER 3 MODELS	\$10.00
SD5 — SEE IN THE DARK	\$10.00
LEV1 — LEVITATION DEVICE	\$10.00

**PLANS AVAILABLE**

FMV1K — 3 MILE FM VOICE TRANSMITTER	\$34.50
PFS1K — HAND CONTROLLED PLASMA FIRE SABER	\$49.50
NI7K — HI FLUX NEGATIVE ION GENERATOR	\$34.50
PG5K — PLASMA LIGHTNING GLOBE	\$49.50
LHC2K — VISIBLE SIMULATED 3 COLOR LASER	\$44.50
HOD1K — HOMING/TRACKING BEEPER TRANSMITTER	\$44.50
LGU6K — 2.5 MW HAND-HELD VISIBLE LASER GUN	\$249.50
BTC3K — 250,000 VOLT TABLE TOP TESLA COIL	\$249.50
IG2K — ION RAY GUN, project energy without wires	\$129.95
TK1K — TELEKINETIC ENHANCER/ELECTRIC MAN	\$79.50
VWPM7K — 3 MILE AUTO TELEPHONE TRANSMITTER	\$49.50

**ASSEMBLED**

LIST10 — INFINITY XMTR Listen in via phone lines	\$199.50
IPG70 — INVISIBLE PAIN FIELD BLAST WAVE GENERATOR	\$74.50
ITM10 — 100,000 VOLT INTIMIDATOR UP TO 20'	\$99.50
JAT30 — AUTOMATIC TELEPHONE RECORDING DEVICE	\$24.50
PSP40 — PHASOR SONIC BLAST WAVE PISTOL	\$89.50
DNE10 — ALL NEW 26" VIVID COLORED NEON STICK	\$74.50
LGU20 — 5 TO 1MW VISIBLE RED HeNe LASER GUN	\$199.50
BL510 — 100,000 WATT BLASTER DEFENSE WAND	\$89.50

**EASY ORDERING PROCEDURE** - TOLL FREE 1-800-221-1705 or 24 HRS ON 1-603-673-4730 or FAX IT TO 1-603-672-5406  
VISA, MC, CHECK, MO IN US FUNDS. INCLUDE 10% SHIPPING. ORDERS \$100.00 & UP ONLY ADD \$10.00. CATALOG \$1.00 OR FREE WITH ORDER.

**INFORMATION UNLIMITED**  
P.O. BOX 716, DEPT. R2, AMHERST, NH 03031

## CABLE TV DESCRAMBLERS

JERROLD™ Tri-Bi Mode	\$105.00	10 Lot \$85.00
JERROLD™ SB-3 OR 2	\$89.00	\$65.00
Hamlin MLD-1200	\$99.95	\$62.00
Oak N-12 W/V.S.	\$99.95	\$62.00
Oak-M-35-B W/V.S.	\$99.00	\$78.00
OAK E-13	\$99.95	\$58.00
Zenith SSAVL	\$185.00	\$145.00
Eagle PD-3	\$120.00	\$85.00
Scientific Atlanta	\$129.95	\$105.00
S.A-Combo's	CALL	\$Call
Tocom	\$350.00	\$295.00
Oak N-12 W/ Auto	\$140.00	\$105.00
Jerrold Starcom CSV	\$139.95	Call

**M.D. ELECTRONICS WILL MATCH ANY ADVERTISED PRICE IN THIS MAGAZINE**

## \*NEW STARGATE 2000 CABLE CONVERTER



1-\$89.00 10-\$69.00 100-Call  
Last channel recall-Favorite channel select-75 channel-Channel scan-Manual fine tune-One year warranty-surge protection-HRC & Standard switchable- and much more. **Call Today!**

INFORMATION(402)554-0417

Orders Call Toll Free  
**1-800-624-1150**  
**M.D. ELECTRONICS**  
115 NEW YORK MALL  
SUITE 133E  
OMAHA, NE. 68114

M.C.  
VISA  
C.O.D.

CIRCLE 53 ON FREE INFORMATION CARD

## ADVERTISING INDEX

RADIO-ELECTRONICS does not assume any responsibility for errors that may appear in the index below.

Free Information Number	Page	188	People's College of Indep. Study	26	
108	AMC Sales	19	180	Peripheral Technology	87
75	Ace Products	46	179	Photronics, Inc.	46
107	All Electronics	95	101	Pomona Electronics	21
198	Alpha Products	88	199	Print Products International	28
—	Amazing Concepts	98	—	R.E. Video	CV3
197	Avex Probes	85	78	Radio Shack	9
77	B&K Precision	27	176	Sencore	70
67	Banner Technical Books	19	—	Star Circuits	28
181,182	Beckman Industrial	13,15	196	TECI	83
183,184	Beckman Industrial	17,19	92	Tektronix	CV4
98	Beckman Industrial	79	123, 189	Test Probes	36
109	C & S Sales	11	225-228	Test Probes	36
70	CEI	94	192	Unicorn	92
—	CIE	25, 31	64	Universal View	92
—	Command Productions	15	190	Viejo Publications	82
185	Communications Specialists	83	191	WPT Publications	83
58	Cook's Institute	17			
201	D&D Electronics	13			
—	Damark International	81			
127	Deco Industries	46			
186	Electronic Goldmine	90			
—	Electronics Book Club	32			
121	Fluke Manufacturing	CV2			
—	Friendly Videos	82			
—	Global Engineering	16			
193	Global Specialties	3			
—	Grantham College	18			
86	Heathkit	14			
—	ISCET	85			
114	Jameco	96, 97			
104	Jan Crystals	15			
115	Jensen Tools	46			
187	Jinco Computers	93			
—	King Wholesale	90			
200	Klockit	18			
53	MD Electronics	98			
93	Mark V. Electronics	30			
61	Microprocessors Unltd.	87			
117	Mouser	17			
—	NRI Schools	7			
194,195	Optoelectronics	22, 29			
—	Pacific Cable	91, 94			
56	Parts Express	93			

### ADVERTISING SALES OFFICE

**Gernsback Publications, Inc.**  
500-B Bi-County Blvd.  
Farmingdale, NY 11735  
1-(516) 293-3000  
President: Larry Steckler  
Vice President: Cathy Steckler

**For Advertising ONLY**  
516-293-3000  
Fax 1-516-293-3115  
Larry Steckler  
publisher

**Arline Fishman**  
advertising director  
**Denise Haven**  
advertising assistant  
**Christina Estrada**  
advertising associate  
**Kelly McQuade**  
credit manager

**Subscriber Customer Service**  
1-800-288-0652  
**Order Entry for New Subscribers**  
1-800-999-7139  
7:00 AM - 6:00 PM M-F MST

### SALES OFFICES

**EAST/SOUTHEAST**  
**Stanley Levitan**, Eastern Sales Manager  
Radio-Electronics  
259-23 57th Avenue  
Little Neck, NY 11362  
1-718-428-6037, 1-516-293-3000  
Fax 1-718-225-8594

**MIDWEST/Texas/Arkansas/Okla.**  
**Ralph Bergen**, Midwest Sales Manager  
Radio-Electronics  
540 Frontage Road—Suite 339  
Northfield, IL 60093  
1-708-446-1444  
Fax 1-708-446-8451

**PACIFIC COAST/ Mountain States**  
**Marvin Green**, Pacific Sales Manager  
Radio-Electronics  
5430 Van Nuys Blvd. Suite 316  
Van Nuys, CA 91401  
1-818-986-2001  
Fax 1-818-986-2009



# Countersurveillance

*Never before has so much professional information on the art of detecting and eliminating electronic snooping devices—and how to defend against experienced information thieves—been placed in one VHS video. If you are a Fortune 500 CEO, an executive in any hi-tech industry, or a novice seeking entry into an honorable, rewarding field of work in countersurveillance, you must view this video presentation again and again.*

**ORDER LINE—1-800-522-6260**

*Wake up!* You may be the victim of stolen words—precious ideas that would have made you very wealthy! Yes, professionals, even rank amateurs, may be listening to your most private conversations.

*Wake up!* If you are not the victim, then you are surrounded by countless victims who need your help if you know how to discover telephone taps, locate bugs, or “sweep” a room clean.

There is a thriving professional service steeped in high-tech techniques that you can become a part of! But first, you must know and understand Countersurveillance Technology. Your very first insight into this highly rewarding field is made possible by a video VHS presentation that you cannot view on broadcast television, satellite, or cable. It presents an informative program prepared by professionals in the field who know their industry, its techniques, kinks and loopholes. Men who can tell you more in 45 minutes in a straightforward, exclusive talk than was ever attempted before.

## Foiling Information Thieves

Discover the targets professional snoopers seek out! The prey are stock brokers, arbitrage firms, manufacturers, high-tech companies, any competitive industry, or even small businesses in the same community. The valuable information they filch may be marketing strategies, customer lists, product formulas, manufacturing techniques, even advertising plans. Information thieves eavesdrop on court decisions, bidding information, financial data. The list is unlimited in the mind of man—especially if he is a thief!

You know that the Russians secretly installed countless microphones in the concrete work of the American Embassy building in Moscow. They converted what was to be an embassy and private residence into the most sophisticated recording studio the world had ever

known. The building had to be torn down in order to remove all the bugs.

## Stolen Information

The open taps from where the information pours out may be from FAX's, computer communications, telephone calls, and everyday business meetings and lunchtime encounters. Businessmen need counselling on how to eliminate this information drain. Basic telephone use coupled with the user's understanding that someone may be listening or recording vital data and information greatly reduces the opportunity for others to purloin meaningful information.

The professional discussions seen on the TV screen in your home reveals how to detect and disable wiretaps, midget radio-frequency transmitters, and other bugs, plus when to use disinformation to confuse the unwanted listener, and the technique of voice scrambling telephone communications. In fact, do you know how to look for a bug, where to look for a bug, and what to do when you find it?

Bugs of a very small size are easy to build and they can be placed quickly in a matter of seconds, in any object or room. Today you may have used a telephone handset that was bugged. It probably contained three bugs. One was a phony bug to fool you into believing you found a bug and secured the telephone. The second bug placates the investigator when he finds the real thing! And the third bug is found only by the professional, who continued to search just in case there were more bugs.

The professional is not without his tools. Special equipment has been designed so that the professional can sweep a room so that he can detect voice-activated (VOX) and remote-activated bugs. Some of this equipment can be operated by novices, others require a trained countersurveillance professional.

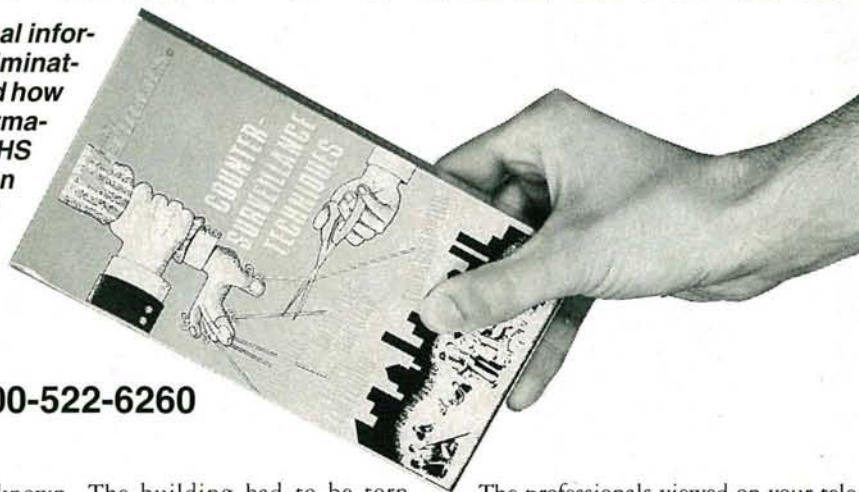

The professionals viewed on your television screen reveal information on the latest technological advances like laser-beam snoopers that are installed hundreds of feet away from the room they snoop on. The professionals disclose that computers yield information too easily.

This advertisement was not written by a countersurveillance professional, but by a beginner whose only experience came from viewing the video tape in the privacy of his home. After you review the video carefully and understand its contents, you have taken the first important step in either acquiring professional help with your surveillance problems, or you may very well consider a career as a countersurveillance professional.

## The Dollars You Save

To obtain the information contained in the video VHS cassette, you would attend a professional seminar costing \$350-750 and possibly pay hundreds of dollars more if you had to travel to a distant city to attend. Now, for only \$49.95 (plus \$4.00 P&H) you can view *Countersurveillance Techniques* at home and take refresher views often. To obtain your copy, complete the coupon below.

<b>RADIO-ELECTRONICS VIDEO OFFER</b>	<b>RE</b>
500-B Bi-County Blvd. Farmingdale, NY 11735	
Please rush my copy of the Countersurveillance Techniques Video VHS Cassette for \$49.95 plus \$4.00 for postage and handling.	
No. of Cassettes ordered _____	
Amount of payment \$ _____	
Bill my <input type="checkbox"/> VISA <input type="checkbox"/> MasterCard	
Card No. _____	
Expire Date _____ / _____	
Signature _____	
Name _____	
Address _____	
City _____ State _____ ZIP _____	
All payments in U.S.A. funds. Canadians add \$4.00 per VHS cassette. No foreign orders. New York State residents add applicable sales tax.	

**CALL TODAY TO ORDER 1-800-522-6260**



# On the line, on the bench, or on the road. The low- cost solution is Tek.

Do you debug the design? Verify the production run? Service the finished product? Then for low-cost solutions built for your application, there's only one place to go.



Tek's 2200 Series oscilloscope family.

There are ten scopes in the 2200 Series, from 20 to 100 MHz and \$695 to \$5495. And three of them demonstrate functional power at its best: the 100 MHz 2232, 50 MHz 2211, and 100 MHz 2245A.

If you can't afford to miss a thing, get the 2232 digital storage oscilloscope.

With 100 MS/s sampling, ten nanosecond glitch capture, waveform cursors, a 4K record length and 30K of battery-backed memory, it makes routine work of problems other scopes can't even see.

For the best performance value in digital storage, try the Tek 2211.

It offers a standard hardcopy interface, measurement cursors, 20 MS/s sampling and a 4K record length per channel, plus digital/analog operation — all for only \$2695.

And for the ultimate in low-cost troubleshooting: the \$1995 2245A. It's a 100 MHz real-time scope with auto setup, cursors, four independent channels, dual time bases and more.

So if you want the best low-cost solution on the line, on the bench, or on the road with you, just get on the phone.

And call your local Tek representative today.

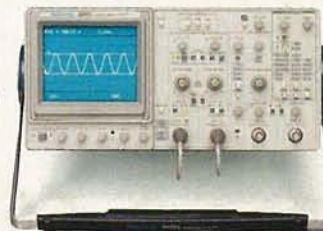

## It's on us.

Purchase a 2232, 2211, or 2245A by October 15, 1990 and you can receive a **\$345 digital multimeter free!**\*



The CDM250 measures current, voltage and resistance, has overload protection and is UL certified. To get yours, contact

your local representative or distributor and place your order with **Option 4X**. Or call Tek direct at:

# 1-800-426-2200 Ext. 225



**Tektronix**  
COMMITTED TO EXCELLENCE

CIRCLE 92 ON FREE INFORMATION CARD

\*Offer valid in U.S. only. You must ask for Option 4X and date purchase order between July 15 and October 15, 1990 to qualify.

© 1990 Tektronix Inc. BOB-101