

48783

Radio-TV SIGNAL DESCRAMBLING

MAY 1990

# Electronics

TECHNOLOGY - VIDEO - STEREO - COMPUTERS - SERVICE

## BUILD THIS UNIVERSAL DESCRAMBLER

### BUILD A MORSE/RTTY DETECTOR

Display Morse code and radioteletype signals on your computer

### INSIDE THE DIGITAL OSCILLOSCOPE

Will the DSO make analog scopes obsolete?

### WHY ARE THERE SO MANY TRANSISTORS?

How to choose the right component for your next design

### CIRCUIT COOKBOOK

Practical security-system circuits

### COMPUTER DIGEST

Waveform processing using a PC



\$2.50 U.S.  
\$2.95 CAN

A  
**GERNSBACK**  
PUBLICATION

XXXXXXXX CAR-RT SORT \*\* CR03  
 750456HRR5165M093 05 99  
 SEP 90  
 RE



**FLUKE**



**PHILIPS**

**High Resolution Digital Meter:**  
4000 count digital readout; 20,000 count mode (Fluke 87) for 4 1/2 digit resolution

**Backlit display:** Makes it easy to read the DMM in dark, cramped quarters. Automatically shuts off after 68 seconds to save the battery.

**Recorder:** records minimums and maximums, plus true arithmetic average; audible Min Max Alert; selectable response times—1 second and 100 ms (all models) plus 1 ms Peak Min Max (Fluke 87)

**Holster with Flex Stand™:** Protects meter and provides test lead storage. Flexible leg allows meter to be hung from peg, bent around a pipe, or used almost anywhere.

**Analog Meter:** High-speed analog display updates 40 times/second—as fast as the eye can follow; X10 Zoom bargraph mode (Fluke 83 and 85) makes high resolution offset measurements a snap.

**Frequency counter:** Accurate down to 0.5 Hz; also measures duty cycle

**Capacitance meter:** Autoranging, with manual ranging at the touch of a button

FLUKE 83	FLUKE 85	FLUKE 87
Volts, ohms, amps, diode test, audible continuity, frequency and duty cycle, capacitance, Touch Hold® relative, protective holster with Flex-Stand™	Volts, ohms, amps, diode test, audible continuity, frequency and duty cycle, capacitance, Touch Hold® relative, protective holster with Flex-Stand™	Volts, ohms, amps, diode test, audible continuity, frequency and duty cycle, capacitance, Touch Hold® relative, protective holster with Flex-Stand™
\$199*	\$229*	\$289*
0.3% basic dc accuracy	0.1% basic dc accuracy	0.1% basic dc accuracy
5 kHz acV	20 kHz acV	20 kHz acV
Analog bargraph and zoom	Analog bargraph and zoom	High resolution analog pointer
Three year warranty	Three year warranty	True-rms ac
		1 ms PEAK MIN MAX
		4 1/2 digit mode
		Backlit display
		Three year warranty

\*Suggested U.S. list price

# Multi-Meter

**Meet the meter that brings an entire test bench to your job. The versatile Fluke 80 Series do-just-about-everything "Multi" Meter.**

It offers everything you'd expect from an advanced handheld DMM, plus a lot you'd find only in dedicated instruments. Plus Fluke-exclusive features you can't buy anywhere else. All built with the most advanced surface mount design and single-chip ASIC technology for a thinner, tougher, more reliable package.

There's a fully annunciated display for clear operation. Duty cycle function. High-speed analog indicator. A protective holster with innovative Flex-Stand™ for easy, adaptable operation. Audible Input Alert™ to reduce the risk of damage to the meter, the user, and the unit being tested. Plus the strongest warranty in the business.

All good reasons to move up to the truly-multi Fluke 80 Series today. You'll find 80 Series DMMs at your Fluke distributor. For immediate, off-the-shelf delivery. Call

**1-800-44-FLUKE, ext. 33** for the name of your nearest distributor.

John Fluke Mfg. Co., Inc. P.O. Box 9090 M/S 250C, Everett, WA 98206 U.S.; (206) 347-5400 CANADA: 416-890-7600 OTHER COUNTRIES: (206) 356-5500

© Copyright 1989, John Fluke Mfg. Co., Inc. All rights reserved. Prices and specifications subject to change without notice. Ad no. 0102-F80

FROM THE WORLD LEADER  
IN DIGITAL MULTIMETERS.

**FLUKE**



## BUILD THIS

- 37 UNIVERSAL DESCRAMBLER**  
Restore missing video signals with the universal decoder.  
**Rudolf F. Graf and William Sheets**
- 49 MORSE/RTTY DETECTOR**  
Get the detector up and running.  
**Larry Ashworth, KA7AFR**

## TECHNOLOGY

- 44 INSIDE DIGITAL OSCILLOSCOPES**  
A look at some state-of-the-art test equipment.  
**Allan C. Stover**

## CIRCUITS

- 53 WHY ARE THERE SO MANY TRANSISTORS?**  
Learn how to select the right one.  
**Josef Bernard**
- 61 SECURITY-CIRCUIT COOKBOOK**  
The basics of modern home-security systems.  
**Ray Marston**

## COMPUTERS

- 81 WAVEFORM PROCESSING WITH YOUR PC**  
The hows and whys of numerical analysis.  
**Robert W. Ramirez**

## DEPARTMENTS

- |  |   |
|--|---|
| <b>6 VIDEO NEWS</b><br>What's new in this fast-changing field.<br><b>David Lachenbruch</b>   | <b>76 AUDIO UPDATE</b><br>The search for the perfect tweeter.<br><b>Larry Klein</b> |
| <b>22 EQUIPMENT REPORTS</b><br>Jameco Electronics Metex M-3900 Digital Multimeter and Integrity Electronics 60-Hz Magnetic Field Meter | <b>78 DRAWING BOARD</b><br>Video-sync generator.<br><b>Robert Grossblatt</b>        |
| <b>70 HARDWARE HACKER</b><br>Cycolor printing.<br><b>Don Lancaster</b>   | <b>81 EDITOR'S WORKBENCH</b><br>The talking PC.<br><b>Jeff Holtzman</b>             |

## COMPUTER DIGEST



### EDITOR'S WORKBENCH

**Waveform processing with your PC**  
EDITOR'S WORKBENCH

**Waveform processing with your PC**  
EDITOR'S WORKBENCH

**Waveform processing with your PC**  
EDITOR'S WORKBENCH

### PAGE 81



ALAN C. STOVER

ALAN C. STOVER

### INSIDE DIGITAL OSCILLOSCOPES

INSIDE DIGITAL OSCILLOSCOPES

### PAGE 44

## AND MORE

- 104 Advertising and Sales Offices**
- 104 Advertising Index**
- 8 Ask R-E**
- 105 Free Information Card**
- 14 Letters**
- 89 Market Center**
- 33 New Lit**
- 24 New Products**
- 66 PC Service**
- 4 What's News**



## ON THE COVER



You must have noticed that video sync signals are often scrambled or altered in some way. That's the case if you try to copy a macrovision-encoded tape; but sometimes just trying to view the tape also presents problems. You'll run into similar sync problems if you try to watch a scrambled cable channel without the proper decoder or if you try to watch one scrambled show while recording another. . .and that's inconvenient. But not if you build our Universal Descrambler. See page 37.

## COMING NEXT MONTH

### THE JUNE ISSUE GOES ON SALE MAY 1.

#### BUILD THE "LAWN RANGER"

This robotic lawnmower takes the work out of cutting the grass.

#### ALL ABOUT SURROUND SOUND

Straightforward explanations of all the different surround-sound techniques.

#### ADD A DISPLAY TO YOUR NEXT PROJECT

Use LCD display modules to enhance the operation of your next design project.

#### COMPUTERDIGEST

A look at computer benchmarks—what they mean and how you can write your own.

As a service to readers, RADIO-ELECTRONICS publishes available plans or information relating to newsworthy products, techniques and scientific and technological developments. Because of possible variances in the quality and condition of materials and workmanship used by readers, RADIO-ELECTRONICS disclaims any responsibility for the safe and proper functioning of reader-built projects based upon or from plans or information published in this magazine.

Since some of the equipment and circuitry described in RADIO-ELECTRONICS may relate to or be covered by U.S. patents, RADIO-ELECTRONICS disclaims any liability for the infringement of such patents by the making, using, or selling of any such equipment or circuitry, and suggests that anyone interested in such projects consult a patent attorney.

RADIO-ELECTRONICS, (ISSN 0033-7862) May 1990. Published monthly by Gernsback Publications, Inc., 500-B Bi-County Boulevard, Farmingdale, NY 11735 Second-Class Postage paid at Farmingdale, NY and additional mailing offices. Second-Class mail registration No. 9242 authorized at Toronto, Canada. One-year subscription rate U.S.A. and possessions \$17.97, Canada \$23.97, all other countries \$26.97. All subscription orders payable in U.S.A. funds only, via international postal money order or check drawn on a U.S.A. bank. Single copies \$2.50. © 1990 by Gernsback Publications, Inc. All rights reserved. Printed in U.S.A.

**POSTMASTER:** Please send address changes to RADIO-ELECTRONICS, Subscription Dept., Box 55115, Boulder, CO 80321-5115.

A stamped self-addressed envelope must accompany all submitted manuscripts and/or artwork or photographs if their return is desired should they be rejected. We disclaim any responsibility for the loss or damage of manuscripts and/or artwork or photographs while in our possession or otherwise.

## Radio Electronics®

Hugo Gernsback (1884-1967) founder  
M. Harvey Gernsback,  
editor-in-chief, emeritus

Larry Steckler, EHF, CET,  
editor-in-chief and publisher

#### EDITORIAL DEPARTMENT

Brian C. Fenton, editor  
Marc Spiwak, associate editor  
Daniel Goodman, technical editor  
Teri Scaduto, assistant editor  
Jeffrey K. Holtzman  
computer editor

Robert Grossblatt, circuits editor

Larry Klein, audio editor

David Lachenbruch  
contributing editor

Don Lancaster  
contributing editor

Richard D. Fitch  
contributing editor

Kathy Campbell, editorial assistant

#### ART DEPARTMENT

Andre Duzant, art director

Injae Lee, illustrator

Russell C. Truelson, illustrator

#### PRODUCTION DEPARTMENT

Ruby M. Yee, production director

Robert A. W. Lowndes,  
editorial production

Karen S. Tucker  
advertising production

Marcella Amoroso  
production assistant

#### CIRCULATION DEPARTMENT

Jacqueline P. Cheeseboro  
circulation director

Wendy Alanko  
circulation analyst

Theresa Lombardo  
circulation assistant

Michele Torrillo, reprint bookstore

Typography by Mates Graphics

Cover photo by Diversified Photo  
Services

Radio-Electronics is indexed in  
*Applied Science & Technology Index*  
and *Readers Guide to Periodical Literature*.

Microfilm & Microfiche editions are  
available. Contact circulation department  
for details.

Advertising Sales Offices listed  
on page 104.



The  
Audit  
Bureau  
of Circulation





# WITH CIE, THE WORLD OF ELECTRONICS CAN BE YOUR WORLD, TOO.

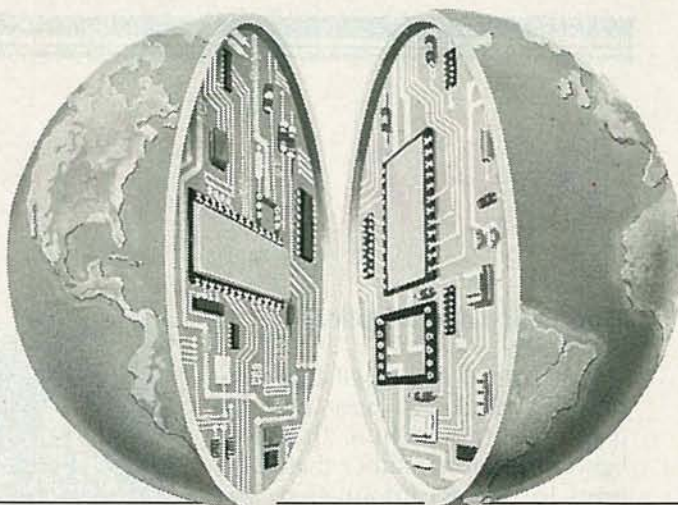

**L**ook at the world as it was 20 years ago and as it is today. Now, try to name another field that's grown faster in those 20 years than electronics. Everywhere you look, you'll find electronics in action. In industry, aerospace, business, medicine, science, government, communications—you name it. And as high technology grows, electronics will grow. Which means few other fields, if any, offer more career opportunities, more job security, more room for advancement—if you have the right skills.

## SPECIALISTS NEED SPECIALIZED TRAINING.

It stands to reason that you learn anything best from a specialist, and CIE is the largest independent home study school specializing exclusively in electronics, with a record that speaks for itself. According to a recent survey, 92% of CIE graduates are employed in electronics or a closely related field. When you're investing your time and money, you deserve results like that.

## INDEPENDENT STUDY BACKED BY PERSONAL ATTENTION.

We believe in independent study because it puts you in a classroom of one. So you can study where and when you want. At your pace, not somebody else's. And with over 50 years of experience, we've developed proven programs to give you the support

such study demands. Programs that give you the theory you need backed with practical experience using some of the most sophisticated electronics tools available anywhere, including our Microprocessor Training Laboratory with 4K of random access memory. Of course, if you ever have a question or problem, our instructors are only a phone call away.



## START WHERE YOU WANT, GO AS FAR AS YOU WANT.

CIE's broad range of entry, intermediate, and advanced level courses in a variety of career areas gives you many options. Start with the Career Course that best suits your talents and interests and go as far as you want—all the way, if you wish, to your Associate in Applied Science Degree in Electronics Engineering Technology. But wherever you start, the time to start is **now**. Simply use the coupon below to send for your FREE CIE catalog and complete package of career information. Or phone us, toll-free, at **1-800-321-2155** (in Ohio, 1-800-523-9109). Don't wait, ask for your free catalog now. After all, there's a whole world of electronics out there waiting for you.

# CIE

**Cleveland Institute of Electronics, Inc.**  
1776 East 17th Street, Cleveland, Ohio 44114  
Member NHSC  
Accredited Member National Home Study Council

**CIE** Cleveland Institute of Electronics, Inc.  
1776 East 17th Street, Cleveland, Ohio 44114

ARE-166

**YES...** I want to learn from the specialists in electronics—CIE. Please send me my FREE CIE school catalog, including details about CIE's Associate Degree program, plus my FREE package of home study information.

Name (print): \_\_\_\_\_

Address: \_\_\_\_\_

City: \_\_\_\_\_ State: \_\_\_\_\_ Zip: \_\_\_\_\_

Age: \_\_\_\_\_ Area Code/Phone No.: \_\_\_\_\_ / \_\_\_\_\_

Check box for G.I. Bill bulletin on educational benefits:

Veteran  Active Duty

**MAIL  
TODAY!**



# WHAT'S NEWS

## World's first digital optical processor

Scientists at AT&T Bell Laboratories (Holmdel, NJ) have built an experimental machine that uses light, or photons, rather than electrons to process information. The wireless processor uses lasers to transmit information internally and optical devices to process the information.

Since optics can handle many light beams at once without interference, future optical processors might be able to process more than 1,000 times as much information as their electronic counterparts. Although the digital optical processor's capabilities are "very modest," the experimental machine demonstrates that the technology is possible. AT&T's optical processor operates at 1 million cycles per second (slower than most personal computers), but its developers believe that operating speeds of several hundred million cycles per second (which is faster than most supercomputers) can be achieved in the near future.

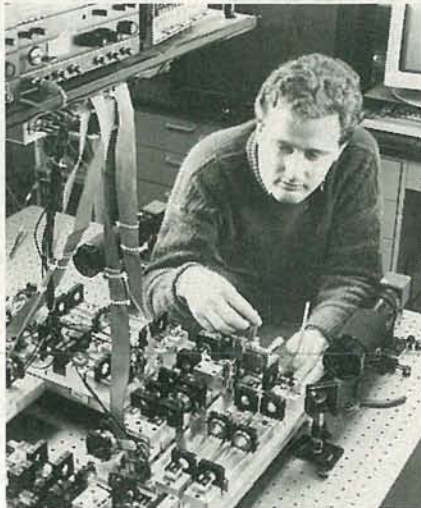

SCIENTIST AT AT&T Bell Laboratories, Michael E. Prise, adjusts a component of the first digital optical processor.

"This processor is a major step toward such a computer," said Alan Huang, head of the Optical Computing Research Department, where the processor was built. However, he added that "significant research must be done before the new technology can be turned into commercial products." Huang pre-

dicts that the first uses of the digital optical processor will involve problems requiring parallel processing, with applications in speech and vision recognition, switching, and general computing to follow as the price becomes competitive.

## Nationwide radio-computer network

In a joint venture, IBM and Motorola have introduced a radio network that will let portable-computer users link to central computers from almost anywhere in the U.S.—without using telephone lines. The 50-50 partnership, which is based in Lincolnshire, IL under the name of Ardis, combines similar services previously offered by Motorola to clients in New York, Chicago, and Los Angeles with a nationwide in-house system designed by Motorola for IBM service technicians. A Motorola radio modem allows virtually any brand of portable computer to be linked to the Ardis network.

The new system, scheduled to begin in April, is said to have several advantages over its major data-communications competitor in the portable market: cellular phones used with modems. The Ardis network is on line all the time, so there is no need to dial up a computer. Messages that are sent to the terminal when the user isn't monitoring it can be stored and recalled later. And, since radio waves of the proposed frequency can travel where higher-frequency cellular-phone waves cannot, the service can be used to link various locations inside a building.

Potential users include police officers, field-service personnel, delivery workers, and real-estate brokers. Billing is to be based on the amount of use, with the projected cost per terminal per month estimated to range between \$100 and \$150. The cost per modem is not yet available.

R-E

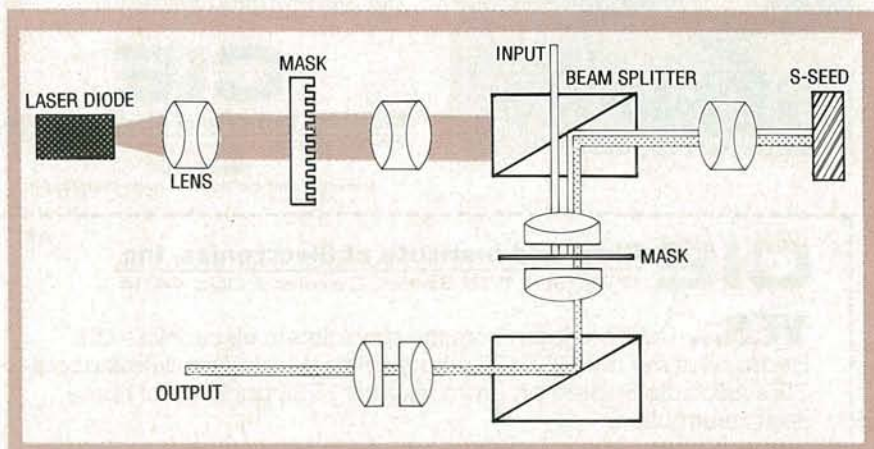

AT&T'S DIGITAL OPTICAL PROCESSOR EMPLOYS 32 S-SEED's (Symmetric Self-Electro-optic Effect Devices) on each of four arrays. The microscopic optical switches have a potential speed of 1 billion operations per second and each can drive two inputs. Each S-SEED contains two mirrors with controllable reflectivity to infrared light, and functions as a NOR gate. Each array contains two 10-milliwatt modulated laser diodes that emit in the near infrared and are divided into many separate beams that provide communications between the arrays. The lenses and masks that separate the arrays serve the same function as connective wiring in an electronic processor. Input/output functions may be accomplished via optical fibers or laser beams transmitted in free space.



# Now Look What Hand Held Frequency Counters Can Do!

## New from OPTOELECTRONICS



Introducing two advanced hand held frequency counters incorporating many unique features usually found only on laboratory bench counters.

These counters are designed for virtually every measurement application from DC through Microwave including measuring RF transmission frequencies at the maximum possible distance.

The UTC 3000 does all of this and is also the world's first Hand Held universal counter timer with Period, Time Interval, and Ratio measurement capability.

- 10 Digit LCD Display with Gate, Function, and Input Annunciators.
- Direct count (1 Hz resolution in 1 Sec) to over 150 MHz.
- 16 Segment Bargraph displays Input Signal Level. Ensures reliable counting, proven effective in locating concealed transmitters.
- High Accuracy, 1 ppm 10 MHz Crystal Time Base is standard with optional 0.2 ppm TCXO available.
- More usable Sensitivity than in any other counter for efficient antenna pick up measurements.
- Four push button selectable Gate times.
- Ni-Cad battery pack and AC adapter-charger included.

In addition, The Model UTC3000 features:

- In addition to Frequency, additional Functions Include: Period, Ratio, and Time Interval and Average.
- Single Shot Time Interval 100 ns, .1 ns averaged.
- Two input channels with High Impedance and 50 ohm input



Also Available from Optoelectronics, 8 Digit LED Hand Held Frequency Counters:

- Model 2210 10 Hz - 2.2 GHz General Purpose Audio to Microwave . . . \$219
- Model 1300H/A 1 MHz - 1.3 GHz RF Counter . . . \$169
- Model CCB Relative RF Signal Strength Bar Graph Meter With 10 Segment LED Display . . . \$99

- Model 2600H . . . . . \$325
- Model UTC 3000 . . . . . \$375
- Model TCXO-30 . . . . . \$ 80
- Model TA100S Telescoping Whip Antenna . . . \$ 12

# **OPTOELECTRONICS INC.**

5821 N.E. 14th Avenue, Fort Lauderdale, Florida 33334  
1-800-327-5912 • FL (305) 771-2050 • FAX (305) 771-2052

CIRCLE 192 ON FREE INFORMATION CARD



# VIDEO NEWS



**DAVID LACHENBRUCH,**  
CONTRIBUTING EDITOR

• **HDTV proponents combine.** Two of the leading proponents of high-definition TV systems for the U.S. market have agreed to merge their efforts at developing a system, thereby significantly narrowing the field of candidates for compatible HDTV broadcasting here. In the systems merger, Philips Consumer Electronics (part of the Dutch Philips group) agreed to work with the combination of Thomson Consumer Electronics (RCA and GE brand TV sets), NBC, and the David Sarnoff Research Center in developing an HDTV system. Thomson is a French-owned company that bought the RCA and GE consumer-electronics operations from General Electric. The Sarnoff Center is the former RCA Laboratories, now a part of the Stanford Research Institute.

The two groups had been developing separate systems. Philips had been working on a single-step approach, permitting a move from the current broadcast system to HDTV. The NBC-Thomson-Sarnoff combine has espoused a system called *ACTV* (Advanced Compatible Television) that provides a compatible widescreen picture with improved (but not high) definition as an intermediate step. Philips now has agreed to accept the two-step approach. In turn, NBC-Thomson-Sarnoff has committed itself to the "simulcast" approach to HDTV. That involves the use of a second channel for HDTV, while continuing to broadcast the same program in the standard NTSC system or one compatible with it, instead of maintaining NTSC compatibility on one channel while using a second as an "augmentation" channel to add the HDTV information. The new partners-in-research urged other system proponents to join with them in developing a unified industry approach to HDTV.

Although the merger of systems was hailed in most quarters as a positive step toward an American HDTV system, there were those observers who saw some danger in the endorsement of a two-step approach to HDTV. Those expressing apprehension were concerned that the extended-definition step (called *ACTV I*) would satisfy the vast majority of viewers—particularly since it calls for compatible widescreen transmission—and thus would preclude the future development of a true high-definition system.

• **Return to the 1950's.** Old TV brand names continue to be revived—some 30 years or so after they disappeared. The latest comeback is the Majestic brand, a TV line that will be fielded by a new company affiliated with a former major distributor of RCA TV sets. RCA recently eliminated most distributors, and the Majestic line is being developed to fill the void and provide a brand for distributors who traditionally serve smaller neighborhood dealers. The revival of the Majestic line comes less than a year after the Crosley TV line made a comeback under more-or-less the same circumstances—a line of products to be sold to dealers through distributors (**Radio-Electronics**, August 1989). Other brand names that were dropped and resuscitated by companies unaffiliated with their originators include Emerson, Capehart, DuMont, and Symphonic.

Note: The Crosley line was designed to replace the Philco brand, which is being discontinued (on TV sets, at least) by its owner, Philips Consumer Electronics. In case you're wondering what brand will be revived next—how about Philco?

• **Pioneer's hot "secret."** Pioneer has introduced a videodisc player in England that is selling so well it's going to be taken off the market. In fact, Pioneer's *Model 1450* is the only videodisc player that is selling worth a darn in the U.K. The reason that player sales have been so poor is the lack of recorded material in the PAL format.

The secret of the *1450* is that it can play NTSC (U.S. standard) videodiscs through British PAL TV sets (as well as PAL recordings, of course). Pioneer has never conceded that the player will do that—but it's an open secret. With some 7,000 titles available on NTSC videodiscs, videophiles are snapping the machines up. However, Pioneer is becoming increasingly nervous about the whole thing, concerned that it might jeopardize its relations with the American programs' copyright owners—some movies are available on U.S. discs before they're even released to theaters in Europe. So the hottest videodisc player is likely to be replaced by another model that can't play NTSC discs—in effect, the *Model 1450* is going to become a victim of its own popularity.

**R-E**



# HITACHI SCOPES AT DISCOUNT PRICES

## Digital Storage Scopes



**VC-6025 20MS/S**  
50MHz Bandwidth  
2K Word Memory Capacity  
**\$2349.00**

Advanced storage functions create new dimensions in scopes such as one shot observation, flicker free display, bright display for even high speed event, trace observation for low speed event, hard copy by plotter and data output to computer.

**VC-6045 100MHz 40MS/S 4K word Memory cap (Call)**

All Hitachi scopes include probes, schematics, and Hitachi's 3 year worldwide warranty on parts and labor. Many accessories available for all scopes.



**V-212**

**\$425**  
List \$595  
Save \$170

DC to 20MHz  
Dual Channel



**V-1060**

List \$1595 **\$1,359**

- DC to 100MHz
- Dual Channel
- Delayed Sweep
- CRT Readout
- Sweep Time
- Autoranging
- Trigger Lock
- 2mV Sensitivity

	V-422	40MHz	D.T., 1mV sens, DC Offset Vert Mode Trigger, Alt Mag	\$940	PRICE	SAVE
	V-423	40MHz	D.T., 1mV sens, Delayed Sweep, DC Offset, Alt Mag	\$1,025	\$740	\$200
	V-425	40MHz	D.T., 1mV sens, DC Offset, CRT Readout, Cursor Meas	\$1,070	\$849	\$221
	V-660	60MHz	D.T., 2mV sens, Delayed Sweep, CRT Readout	\$1,295	\$1,145	\$150
	V-1065	100MHz	D.T., 2mV sens, Delayed Sweep, CRT Readout, Cursor Meas	\$1,895	\$1,670	\$225
	V-1100A	100MHz	Q.T., 1mV sens, Delayed Sweep, CRT Readout, DVM, Counter	\$2,450	\$2,095	\$355
	V-1150	150MHz	Q.T., 1mV sens, Delayed Sweep, Cursor Meas, DVM, Counter	\$3,100	\$2,675	\$425

# ELENCO PRODUCTS AT DISCOUNT PRICES

## 20MHz Dual Trace Oscilloscope



**\$375**  
**MO-1251**

- 6" CRT
- Built in component tester
- TV Sync

## FREE DMM

with purchase of  
ANY SCOPE

### SCOPE PROBES

P-1 65MHz, 1x, 10x \$19.95

P-2 100MHz, 1x, 10x \$23.95

## 35MHz Dual Trace Oscilloscope



**\$495**  
**MO-1252**

- High luminance 6" CRT
- 1mV Sensitivity
- 6KV Acceleration Voltage
- 10ns Rise Time
- X-Y Operation • Z Axis
- Delayed Triggering Sweep

Top quality scopes at a very reasonable price. Contains all desired features. Two 1x, 10x probes, diagrams and manual. Two year guarantee.

## PRICE BREAKTHRU on Auto Ranging DMMs



3 to choose from:  
**MDM-1180 \$24.95**  
**MDM-1181 \$27.95**  
**MDM-1182 \$29.95**

- 3 1/2 LCD Display
- 27 Functions
- Auto/Manual Ranges
- Audible Continuity
- Data Hold (MDM-1182)
- .1% Accuracy (MDM-1181)



**True RMS 4 1/2 Digit Multimeter**  
**\$135 M-7000**

.05% DC Accuracy  
.1% Resistance  
with Freq. Counter and deluxe case



**Multimeter with Capacitance and Transistor Tester**  
**\$55 CM-1500**

Reads Volts, Ohms, Current, Capacitors, Transistors and Diodes with case



**Digital Capacitance Meter**  
**CM-1550 \$58.95**

9 Ranges  
.1pf-20,000ufd  
.5% basic accy  
Zero control with case



**Digital LCR Meter**  
**LC-1801 \$125**

Measures  
Coils 1uH-200H  
Caps .1pf-200uf  
Res .01-20M



## Bench DMMs

**M-3500 \$125** 3 1/2 digit .1% accy  
**M-4500 \$175** 4 1/2 digit .05% accy



**AC Current Meter**  
**ST-1010 \$69.95**

1000 Amps Data/Peak Hold  
8 Functions  
Deluxe Case

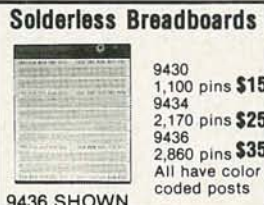

## Solderless Breadboards

9430 1,100 pins \$15  
9434 2,170 pins \$25  
9436 2,860 pins \$35  
All have color coded posts



## AC Clamp-On

Current Adapter  
**ST-265 \$25.00**  
0-1000A AC  
Works with most DMM

## Wide Band Signal Generators



**SG-9000 \$129**  
RF Freq 100K-450MHz  
AM Modulation of 1KHz  
Variable RF output

**SG-9500 with Digital Display and 150MHz built-in Freq Ctr \$249**



**AUDIO GENERATOR**  
**SG-9200 \$129**

Low distortion (<.05%)  
10-1MHz Sine/Square Wave  
600 ohm Output Impedance, High Output Voltage



**Function Generator**  
**Blox #9600 \$28.95**

Provides sine, tri, squ wave from 1Hz to 1MHz  
AM or FM capability



**Decade Blox #9610 or #9620 \$18.95**

#9610 Resistor Blox 47 ohm to 1M & 100K pot  
#9620 Capacitor Blox 47pf to 10MFD

## Digital Triple Power Supply



**XP-765 \$249**

0-20V at 1A  
0-20V at 1A  
5V at 5A

Fully Regulated, Short circuit protected with 2 Limit Cont., 3 Separate supplies

**XP-660 with Analog Meters \$175**

## Quad Power Supply



**XP-580 \$59.95**

2-20V at 2A  
12V at 1A  
5V at 3A  
-5V at 5A

Fully regulated and short circuit protected

**XP-575 without meters \$39.95**

## AM/FM TRANSISTOR RADIO KIT with TRAINING COURSE

Makes a great school project  
Model AM/FM-108

14 Transistors + 5 Diodes **\$26.95**

Circuits are laid out in systematic order on an oversized PC board for easy understanding of the flow of radio signals, from antenna to speaker. Complete course includes all parts, PC board and training manual. When completed you will be proud to display your masterpiece.

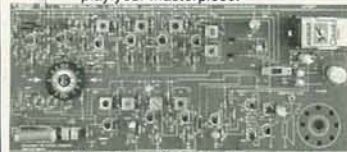

**7 Transistor AM RADIO KIT \$16.95**

## Four-Function Frequency Counters



**F-100 120MH \$179**  
**F-1000 1.2GH \$259**

Frequency, Period, Totalize, Self Check with High Stabilized Crystal Oven Oscillator, 8 digit LED display

## GF-8016 Function Generator with Freq. Counter



**\$249**

Sine, Square, Triangle Pulse, Ramp, .2 to 2MHz  
Freq Counter .1 - 10MHz

**GF-8015 without Freq. Meter \$179**

**WE WILL NOT BE UNDERSOLD!**  
UPS Shipping: 48 States 5%  
(\$10 Max) IL Res., 7% Tax



**C & S SALES INC.**  
1245 Rosewood, Deerfield, IL 60015  
(800) 292-7711 (708) 541-0710

**15 Day Money Back Guarantee**  
**2 Year Warranty** Prices subject to change  
**WRITE FOR FREE CATALOG**



# ASK R-E

## WRITE TO:

ASK R-E  
Radio-Electronics  
500-B Bi-County Blvd.  
Farmingdale, NY 11735

## VOLTAGE READOUT

Some time ago I bought a variable power supply for my bench. I had the option of getting a fixed supply but decided that a variable one would be more flexible. That has turned out to be true for my work but the only drawback I've come across is that I don't have any handy way of pre-setting particular voltages. Do you have any easy addition I can build that will let me know when my supply is outputting five, twelve, or fifteen volts?—R. James, Brooklyn, New York

It seems to us that all you have to do is use a voltmeter but that might be a pain in the neck—especially if you want to have the ability to switch back and forth between various output voltages.

Fortunately, there's a simple way you can add some indicators to your supply using only a handful of parts and some LED's as indicators. The circuit shown in Fig. 1 is just about the easiest voltage-detection circuit we can come up with. You'll notice that there's a fairly loose tolerance for the Zener diode. That is intentional since it's often hard to find Zeners with really specific break-

The values in the schematic will work for a five-volt indicator but you don't have to be a rocket scientist to make the changes needed to have it work for just about any voltage you want. The only thing that has to be done is to change the Zener. Since you're using a trimmer to adjust the circuit's trip point, keep the Zener rating a bit below the voltage you want to detect. That means a 10- or 11-volt Zener for a 12-volt circuit, a 13- or 14-volt Zener for 15 volts, and so on.

You'll need a meter to set the trip points but once that's done, the circuit will reliably indicate the output voltage. Remember that you'll need a separate circuit for each voltage you want an indicator for. The parts are cheap and the circuit is minimal so expense and space shouldn't be a problem.

The circuit is drawing its power from the supply, but the impedance is high enough to keep it from loading down the supply. If you find that the draw is too much (although I can't imagine that), increase the value of the trimmer. The rule here is that the larger the value of the trimmer, the lower the draw but the harder you'll find it is to calibrate. Try to keep the trimmer potentiometer under 15K.

## VIDEO UPGRADE

I'm about to spend some money to upgrade the video display on my IBM-compatible computer. I currently have a monochrome graphics card and an amber monitor but I want to move on to color. The problem I have is deciding between EGA and VGA, how much memory to get for the video card, and what's the difference between register compatible and BIOS compatible?—J. Robert, Chalfont, PA

One of the most paradoxical

things about computers is that while they might be designed to make your life easier, trying to understand them can be anything but easy. They've given a whole new meaning to the idea of standards.

But let's take your questions one at a time.

All of the IBM color systems are designed to be downwardly compatible with each other—or at least that's what it says on page 12 of the manual. When the VGA standard was introduced with IBM's PS2 series, there was a big price differential between it and EGA, the previous system. The way things stand now, VGA cards aren't much more expensive than EGA cards (only about \$75 to \$100 in difference—the same goes for the price of the monitors themselves), so it really doesn't pay to get an EGA system. VGA is capable of much more colors and better resolution, and since you're going to be using it for a few years, it pays to get the better system. Remember that you buy the hardware to run the software and, as time goes by, more and more software is going to show up that's written exclusively for VGA.

If you do go with an EGA system, you might want to upgrade to VGA in the future, and the chances are good that you'll have a hard time unloading the EGA card and monitor.

The issue of memory is a bit simpler. The more memory you have on the card the better the resolution. EGA cards have the hardware to talk to a maximum of 256K but VGA cards can handle half a megabyte. In the original IBM cards, the EGA standard was 64K (expandable to 128K) and the VGA standard had a maximum of 256K. As more manufacturers began making cards,

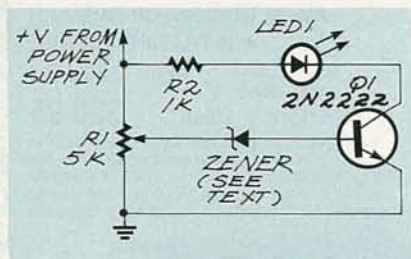

FIG. 1

down voltages. You can use the trimmer to tweak the voltage applied to the Zener and have it conduct at a particular voltage. When the Zener diode is triggered, the transistor will turn on, and the LED will then light.



# Discover Your Career Potential In The Fast Growing Field Of High-Tech Electronics!

CIE Gives You The Training You Need to Succeed...  
At Your Own Pace...& In Your Own Home!

If you're anxious to get ahead...and build a real career...you owe it to yourself to find out about the Cleveland Institute of Electronics!

CIE can help you discover your career potential in the fast growing field of high-tech electronics. A career that will challenge and excite you every day...reward you with a powerful feeling of personal accomplishment...and deliver a level of financial security you may have only dreamed of before!

As the leading school in home-study electronics, CIE has helped over 150,000 students in the U.S.A. and over 70 foreign countries get started in this exciting field. To find out how CIE could be helping you...read on...then send for a CIE catalog TODAY!

## A Growing Need For Trained Professionals!

The career opportunities shown here are only a few of the challenging, high-paying careers you could enjoy as an electronics technician.

You could be the "brains" behind the scenes of an exciting TV broadcast...trouble-shoot life-saving medical equipment...design exotic new aeronautics systems...CIE's job-oriented programs offer you the quickest possible path to the career of your dreams! And CIE also features military and union re-training, to build on what you already know.

## Dozens Of Fascinating Careers To Choose From!

Even if you aren't sure which career is best for you, CIE can get you started with core lessons applicable to all areas of electronics. As you advance, CIE makes job opportunities available to you through the bimonthly school paper, *The Electron*.

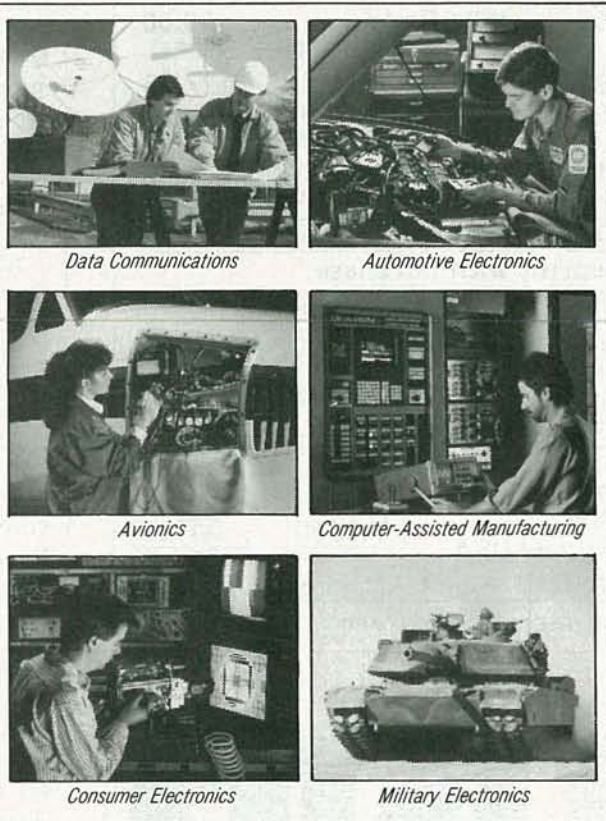

Data Communications

Automotive Electronics

Avionics

Computer-Assisted Manufacturing

Consumer Electronics

Military Electronics

## Personal Training From A Renowned Faculty.

Unlike the impersonal approach of large classroom study, CIE offers you one-on-one instructional help 6 days a week, toll-free. Each CIE lesson is authored by an independent specialist, backed by CIE instructors who work directly with you to answer your questions and provide technical assistance when you need it.

## Practical Training... At Your Own Pace.

Through CIE, you can train for your new career while you keep your present job. Each course allows a generous completion time, and there are no limitations on how fast you can study. Should you already have some electronics experience, CIE offers several courses which start at the intermediate level.

## "State-Of-The-Art" Facilities & Equipment.

In 1969, CIE pioneered the first electronics laboratory course, and in 1984, the first Microprocessor Laboratory. Today, no other home study school can match CIE's state-of-the-art equipment. And all your laboratory equipment is included in your tuition cost. There is no extra charge—it's yours to use while you study at home and on the job after you complete your course!

## Earn Your Degree To Become A Professional In Electronics!

Every CIE course you take earns you credit towards the completion of your Associate in Applied Science Degree, so you can work towards your degree in stages. And CIE is the only school that awards you for fast study, which can save you thousands of dollars in obtaining the same electronics education found in four-year Bachelor's Degree programs! Write for details today!

## Send For Your Catalog Today!



### CIE World Headquarters

Cleveland Institute of Electronics, Inc.  
1776 East 17th St., Cleveland, Ohio 44114

ARE-167

YES! Please send me your independent study catalog (For your convenience, CIE will have a representative contact you—there is no obligation.)

Print Name \_\_\_\_\_

Address \_\_\_\_\_ Apt # \_\_\_\_\_

City/State/Zip \_\_\_\_\_

Age \_\_\_\_\_ Area Code/Phone No. \_\_\_\_\_

Check box for G.I. Bill bulletin on educational benefits:  Veteran  Active Duty

## Mail This Coupon Today!

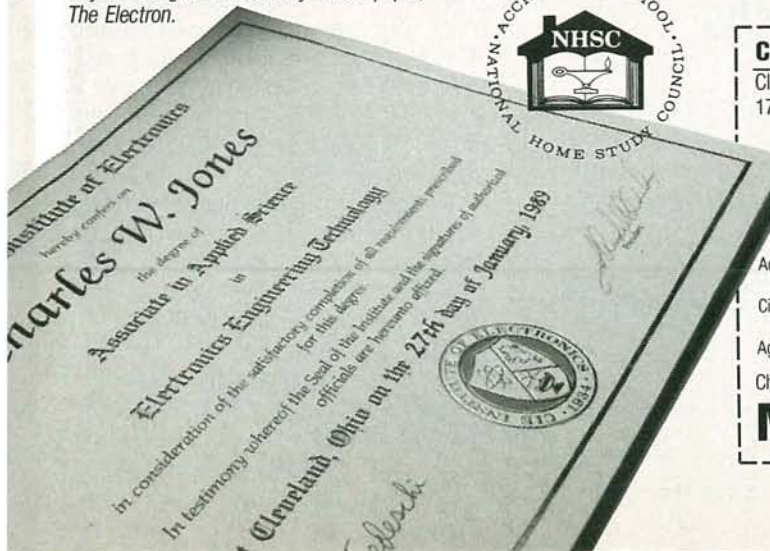



# Cable TV

## Descrambler Article Parts

We stock the exact parts, PC Board and AC Adaptor for two articles published in Radio-Electronics magazine on building your own CABLE TV DESCRAMBLER.

### February 1984 issue

#701 Parts.....19.00  
Includes all original parts.

#702 PC Board.....7.95  
Original 3x4 etched, drilled  
and silk-screened pc board.

#704 AC Adaptor.....7.95  
Original 18 Volt DC @ 200ma.

#701, 702 & 704.....29.00

### February 1987 issue

#301 Parts.....29.00  
Includes all original parts.

#302 PC Board.....7.95  
Original 5x8 etched, drilled  
and silk-screened pc board.

#304 AC Adaptor.....7.95  
Original 18 Volt DC @ 200ma.

#301, 302 & 304.....39.00

Free article reprint with purchase.

Snooper Stopper.....39.00

Cable TV descramblers can be detected, protect your privacy with the Snooper Stopper. Free article on Cable Snooping.

Macrovision Kit.....29.00

Macrovision..now you see it, now you don't with our macroscrubber kit. Article was published in Radio Electronics 1987 issue.

CALL TOLL FREE 1-800-332-3557

Out side USA 1-508-699-6935

Visa, Master Card and C.O.D.

Add \$3.50 S & H, \$6.00 outside USA.

Visa

MC

D & D Electronics, Inc., PO Box 3310, N. Attleboro, Ma. 02761

CIRCLE 195 ON FREE INFORMATION CARD

they also began adding features to their products that went beyond the IBM specifications. That usually meant higher display resolutions.

The problem with that is that having the extra capability on the card is rather useless unless software knows how to take advantage of it. Since all the expanded display capabilities of the various cards are outside the standards set down by IBM, most software houses don't support them. You might be able to get 1024 x 768 resolution from a 512K VGA card but, since that isn't a standard resolution, the chances are that your favorite paint program has no driver to support it.

Most card manufacturers supply software to adapt a few major pieces of software (AutoCAD, Microsoft Windows, GEM, etc.), to the higher resolutions that their hardware can display. The rule here is to make sure your software can run on the hardware you buy.

The question of BIOS and register compatibility is one of hardware and the final difference is mostly speed. Both EGA and VGA cards are microprocessor-controlled devices and, as such, they need instructions to work—and that's what the BIOS is. The BIOS takes video commands from the computer and translates them into values that are then stuffed into the internal registers of the display microprocessor.

Being "BIOS compatible" means that the entry point for the video routines in the card's firmware is the same as those in the IBM. Being register compatible means that the microprocessor is organized in the same way as the IBM. The former is software compatible and the latter is hardware compatible.

People who write graphics software are always trying to make things happen as quickly as possible, and the fastest way to drive a display is to write directly to the registers. Talking to the BIOS is both slow and limiting.

The bottom line is that you should get yourself a VGA system and it makes a lot of sense to get a VGA card that specifically features both BIOS and register compatibility.

The only other thing to keep in mind is that most of the enhanced display features of a 512K VGA can be used only on a multisync

*continued on page 32*

M O R E T H A N

# SOUND



## Surround Sound Processor by Heathkit®

Surround yourself with a vast assortment of kit or ready-to-use electronic products from the **FREE Heathkit Catalog**. The Heathkit Catalog contains innovative home theater components, amateur radio and weather equipment, laptop computers, self-study electronics courses and challenging starter kits for the first-time builder. Order your **FREE Heathkit Catalog NOW!**

**1-800-44-HEATH**  
(1-800-444-3284)

Send to: Heath Company, Dept. 020-894  
Benton Harbor, Michigan 49022

Name \_\_\_\_\_

Address \_\_\_\_\_

City \_\_\_\_\_ State \_\_\_\_\_ Zip \_\_\_\_\_

CIRCLE 86 ON FREE INFORMATION CARD



# AT \$299.95, NO OTHER DESIGN WORKSTATION GIVES YOU SO MUCH FOR SO LITTLE.

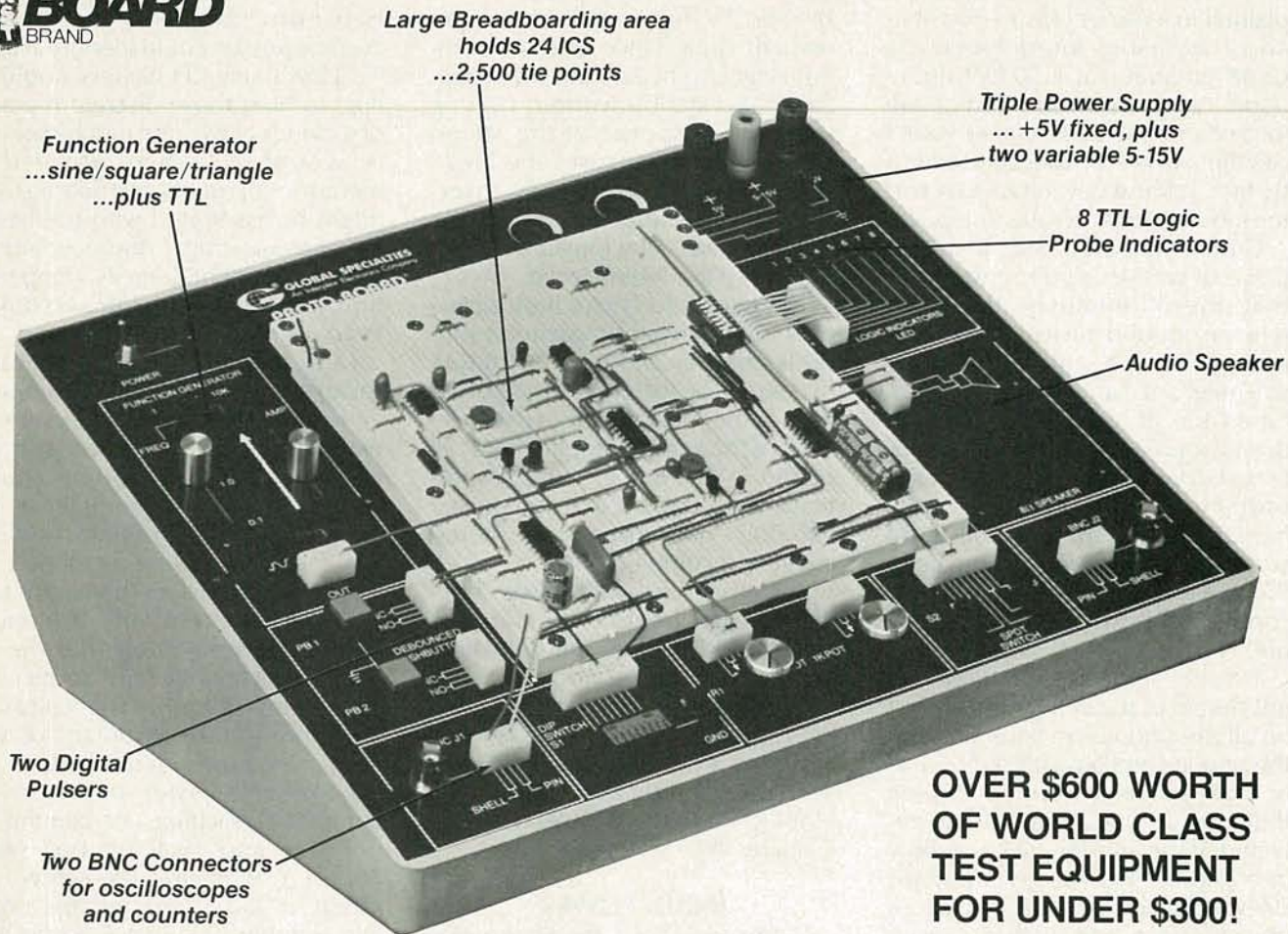

**OVER \$600 WORTH  
OF WORLD CLASS  
TEST EQUIPMENT  
FOR UNDER \$300!**

Here's PB-503, the total design workstation. It has everything! **Instrumentation**, including a function generator with continuously variable sine/square/triangle wave forms—plus TTL pulses. **Breadboards** with 8 logic probe circuits.

And a **Triple Power Supply** with fixed 5VDC, plus two variable outputs (+ 5 to 15VDC and - 5 to 15VDC). Throw-in 8 TTL compatible LED indicators, switches, pulsers,

potentiometers, audio experimentation speaker...plus a lifetime guarantee on all breadboarding sockets! You have everything you need right there in front of you! PB-503—one super test station for under \$300! Order yours today!!



Call toll-free for details  
**1-800-572-1028**

  
**GLOBAL  
SPECIALTIES**

CIRCLE 191 ON FREE INFORMATION CARD

Global Specialties,  
70 Fulton Terrace, New Haven, CT 06512.  
Telephone: (203) 624-3103. © Interplex Electronics, 1990.  
All Global Specialties breadboarding products made in USA.  
ProtoBoard is a registered trademark of Global Specialties.

A016

an  
**Interplex  
Industries**  
company

MAY 1990



# LETTERS



## AVOIDING AM INTERFERENCE

The "Ask R-E" column in the March issue of **Radio-Electronics** explained to a reader how to rid a stereo of AM-radio interference. As Chief Engineer of a 50-kW directional AM station (our studios are located in about a 20mV/m RF field) I can think of a few easier solutions to try first. I almost never have to resort to soldering caps across an input.

Ground the amp with a decent piece of wire to a good ground. If that doesn't eliminate the interference, ground the rest of the components to the same ground. Or you might try an AC-line RF filter. Often the RF gets in through the power supply. The filters can be obtained disguised as computer surge protectors—but make sure they have the filter in them as well as the surge protector. Also, try to keep the speaker and component interconnection leads as short as possible.

Here are some tips for telephone interference. If you hear the station on all the phones on your line, call the phone company; it's often a wet or faulty connection out on a pole that causes the audio to be detected. If the interference is on only one phone, you can try a 0.01- $\mu$ F, 200-volt capacitor connected across the red-green pair. If that doesn't work, AT&T phone centers sell an effective filter for just that sort of problem.

As a last resort, call the engineer at the station for more advice. We are not obligated to work on your equipment, but it is in our best interest as good neighbors to help you get rid of the problem.

STUART ENGELKE

Whitehouse Station, NJ

## AND MORE....

The solution proposed in "Ask

R-E" for "Overpowering AM Interference" works fine on interference from VHF and UHF stations, such as FM and TV, but you can never get enough capacitance across the input stages to bypass an AM broadcast radio station without ruining the audio response of the stereo amplifier. In many cases the medium- and high-frequency interference rides into the set via the speaker leads—the longer the lead, the worse the interference.

The cure is to choke it off or bypass it. The bypass-capacitor method is cheaper and easier. A 0.1- $\mu$ F bypass capacitor connected across each of the speaker terminals on the back of the set usually eliminates all of the interference. What is particularly nice about that cure is that you don't have to enter the stereo cabinet to complete the job.

The other solution involves choking the signal before it enters the set, using RF chokes. One very-low-resistance RF choke would be used in each lead. The best way to choke it off is by winding the speaker leads around a ferrite rod or torroid core as close to the set as possible.

HAROLD ISENRING, W9BTI  
Colgate, WI

## BRAIN POWER

I subscribe to **Radio-Electronics** and I've always enjoyed Don Lancaster's *Hardware Hacker* column—particularly his item on the "Santa Clause Machine," which he picked up at least a week before any of the other publications that I read did.

I was extremely displeased by misinformation in the January 1990 column. One does not need to understand the workings or structure of the brain to realize that the stated capacity of "four billion memory bits or so" must be an infinitesimal fraction of its actual capacity. For an ex-

ample, let's use the CD platter analogy, but this time let's imagine the CD's are storing digitized music: How many songs do you think the average person could identify at age 40? How many CD platters would it take to hold those discrete memories alone? Now, how much memory would it take to store the memories of events and people that might be associated with the hearing of those songs? And how much to store the sights, smells, temperature, and tactile sensations accumulated over the span of 60 years?

I am equally disturbed by Mr. Lancaster's "threshold effect." Computer languages, operating systems, expert systems, etc., are just algorithms. Those algorithms could be carried out by a computer or by people using filing cabinets and index cards. Increasing a computer's memory space does not automatically imply the ability to create more sophisticated algorithms. At the most, it might inspire some person to think of a more sophisticated algorithm to take advantage of the new, more powerful machine.

I am familiar with the theory of computers reaching a certain memory size and "waking up" (see Robert A. Heinlein's *The Moon is a Harsh Mistress*), and perhaps a certain number of synapses could be the only requirement for intelligence. But even if that were true, Mr. Lancaster's estimate is staggeringly inadequate.

Just look at existing systems. My desktop workstation at my job is linked to a network that has about 3.5 gigabytes of disk memory. That is by no means a large network; in fact, there are only 14 workstations on it. But that is already seven times the capacity of his original 4 gigabit "human brain" capacity. That network is hooked into the division



LAN, where it can access another 5 gigabytes or so. If we consider this very typical computer installation as one of (shall we underestimate) 500 local computer networks hooked to the internet.... So far I have seen no signs of that network waking up. Nor has it inspired anyone to create a new category of algorithm that will change the face of the world (unless you'd place a destructive virus in that category).

Hardware Hacker and other such information sources are the forces that help shape the technical minds of this and other countries. When such poorly thought out concepts are presented as facts, I worry that someone might believe them and set us all back a few paces. I would hate to go back to the times when some people were afraid of the phonograph because it could "talk."

JON ROLPH  
San Diego, CA

#### EASIER IC REMOVAL

Regarding "Chip Removal" (*Ask R-E, Radio-Electronics*, March 1990), I was sad to see the answer given. The first method mentioned, using a solder pot and extractor, requires equipment not likely to be available to the average home technician. And, as you suggested, the chances of failure are very high.

A method that has been around for many years—the only one approved by government organizations—will work, and with practice it is virtually foolproof. Dip "solder-wick" desoldering braid (the fine braid jacket from coax will do nicely) into liquid flux. Hold the end on the joint to be cleaned and press a hot iron on the braid above the solder joint. The joint will almost instantly be as clean as it was before the DIP was first installed. Each joint can be treated that way, and the chip will be easy to remove.

I would recommend practicing on a defunct board to get a feel for the best iron heat and the wick and iron placement. A somewhat hotter iron than usual is best so that the heat is on the board a minimum time, to avoid damaged components and loosened foil. After each solder joint wicking, the loaded end of the braid is cut off, dipped in liquid flux again, and moved to the next joint.

JOE D. PERDUE  
Nellysford, VA

## The Only 5-Digit Sweep AM/FM Function Generator At A 3-Digit Price.

- **FG3A Sweep/Function Generator**
- 7 Frequency Ranges from 0.2Hz to 2MHz
- Sine, Square, Triangle, Ramp, TTL and CMOS Outputs
- Linear or Logarithmic Sweep
- Internal/External AM or FM Modulation



**\$475**

**Beckman Industrial™**  
An Affiliate of Emerson Electric Co.

For more information and the location of your nearest authorized Beckman Industrial dealer call 1-800-854-2708 (in California 1-800-227-9781). Instrumentation Products Division, 3883 Ruffin Road, San Diego, CA 92123-1898  
© 1989 Beckman Industrial Corporation. Specifications are subject to change without notice.

CIRCLE 177 ON FREE INFORMATION CARD

JN164-01-0590

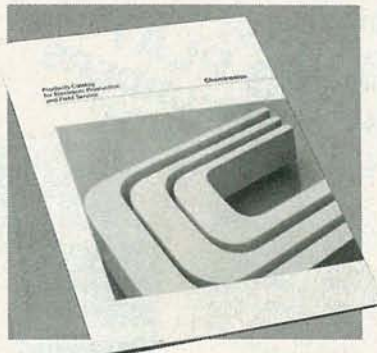

### CHEMICAL SOLUTIONS

#### FREE CHEMTRONICS CATALOG!

Comprehensive new source for over 200 products used in electronic manufacturing and field service. Precision cleaning agents, flux removers, bulk solvents, circuit refrigerants, precision dusters, non-residual wipers, foam swabs, premoistened pads/swabs, antistatic compounds, conformal coatings, lubricants, adhesives, desoldering braids, rosin core solder and solder masking agents. Complete with technical specifications and application guide.

 Chemtronics Inc.  
681 Old Willets Path  
Hauppauge, N.Y. 11788  
516-582-3322

CIRCLE 54 ON FREE INFORMATION CARD

## ATTENTION! ELECTRONICS TECHNICIANS

EARN YOUR  
**B.S.E.E.  
DEGREE**

THROUGH HOME STUDY

Our New and Highly Effective Advanced-Placement Program for experienced Electronic Technicians grants credit for previous Schooling and Professional Experience, and can greatly reduce the time required to complete Program and reach graduation. No residence schooling required for qualified Electronic Technicians. Through this Special Program you can pull all of the loose ends of your electronics background together and earn your B.S.E.E. Degree. Upgrade your status and pay to the Engineering Level. Advance Rapidly! Many finish in 12 months or less. Students and graduates in all 50 States and throughout the World. Established Over 40 Years! Write for free Descriptive Literature.

**COOK'S INSTITUTE**  
OF ELECTRONICS ENGINEERING

 4251 CYPRESS DRIVE  
JACKSON, MISSISSIPPI 39212

CIRCLE 58 ON FREE INFORMATION CARD

MAY 1990

15



# Extend Your Frequency Counter Range To 1.3GHz Without Extending Your Budget.

## FC130A Frequency Counter

- .01Hz to 1.3GHz Frequency Range
- 8-Digit LED Display
- Measures Frequency, Period and Rate per Minute (RPM)
- 10mV Sensitivity (Typical)



**\$595**

## Beckman Industrial™

An Affiliate of Emerson Electric Co.

For more information and the location of your nearest authorized Beckman Industrial dealer call 1-800-854-2708 (in California 1-800-227-9781). Instrumentation Products Division, 3883 Ruffin Road, San Diego, CA 92123-1898  
© 1989 Beckman Industrial Corporation. Specifications are subject to change without notice.

CIRCLE 98 ON FREE INFORMATION CARD

JN161-01-0490

## IMPROPER IMPEDANCE MEASUREMENTS

Impedance measurements do indeed conjure up an image of complex test equipment and tricky calculations. However, the method suggested in Mike Rogalski's "Test Methods" (*Radio-Electronics*, March 1990) will not make things easier.

When the impedance of a signal source is complex—that is, consists of resistance and either inductive or capacitive reactance—there is no fixed relationship between the applied resistive load, the resulting drop in output voltage, and the equivalent resistance of the source impedance. The reason is that the phase angle of the impedance vector is unknown. A bridge, such as the Wheatstone type, drives the unknown impedance with a signal of its own and therefore obtains phase-angle information—the phase angle between the voltage across the unknown impedance and the current the bridge provides to produce that voltage.

Mike's method will work for signal sources that are generally purely resistive, such as the line or speaker outputs of audio equipment. However, the drop in output when  $R1$  equals the signal source impedance is not 3 but 6 dB—half the open circuit voltage. One must be careful when measuring the output impedance of audio power amplifiers that employ large amounts of voltage feedback since their dynamic impedance is very low (on the order of fractions of an ohm). *Do not attempt this measurement without experience.* That could be the subject of a complete article in itself.

ARMAND LUCCHESI  
Jersey City, NJ

## ETCHING TANK TIPS

Regarding the article, "Make Your Own Etching Tank" (*Radio-Electronics*, December 1989), I'd like to add a couple of pointers.

I built the board using 5/16-inch Plexiglas that I cut with a radial arm saw using a plywood blade. It made a smooth cut, and I didn't have to file or sand any edges. Slow is the way to go when cutting the Plexiglas! As no cement was suggested in the article, I asked at my local hardware store and was advised that methyl-ethyl-ketone would work as

*continued on page 35*

## Be an FCC LICENSED ELECTRONIC TECHNICIAN!



No costly School. No commuting to class. The Original Home-Study course prepares you for the "FCC Commercial Radiotelephone License". This valuable license is your "ticket" to thousands of exciting jobs in Communications, Radio-TV, Microwave, Computers, Radar, Avionics and more! You don't need a college degree to qualify, but you do need an FCC License.

**No Need to Quit Your Job or Go To School**  
This proven course is easy, fast and low cost! **GUARANTEED PASS** — You get your FCC License or money refunded. **Send for FREE facts now. MAIL COUPON TODAY!**

### COMMAND PRODUCTIONS

FCC LICENSE TRAINING, Dept. 90  
P.O. Box 2824, San Francisco, CA 94126

Please rush FREE details immediately!

NAME \_\_\_\_\_  
ADDRESS \_\_\_\_\_  
CITY \_\_\_\_\_ STATE \_\_\_\_\_ ZIP \_\_\_\_\_

## NEW SUPER LONG PLAY TAPE RECORDERS

12 Hour Model — \$119.00\*

Modified Panasonic Slimline, high quality, AC-DC Recorders provide 6 continuous hours of quality recording & playback on each side of cassette for a total of 12 hours.  
Built-in features include:  
• Voice level control. • Digital counter, etc. TDK DC 120 Cassette Furnished.



### PHONE RECORDING ADAPTER

Records calls automatically. All Solid state connects to your telephone jack and tape recorder. Starts recording when phone is lifted. Stops when you hang up. **\$28.50\***  
FCC APPROVED

**VOX VOICE ACTIVATED CONTROL SWITCH**  
Solid state. Self contained. Adjustable sensitivity. Voices or other sounds automatically activate and control recorder. Uses either recorder or remote mike. **\$28.50\***

\*Add for ship & hdlg. Phone Adapter & Vox \$1.50 ea. Recorders \$4.00 ea. Cal. Res. add tax. Mail order, VISA, M.C., COD's OK. Money Back Guarantee. Free data. avail.. Dealer inquiries invited. © 1989  
**AMC SALES INC.** Dept. A9335 Lubec St., Box 928, Downey, CA 90241 Phone (213) 869-8519

CIRCLE 108 ON FREE INFORMATION CARD



# Radio Shack<sup>SM</sup> Parts Place

## YOUR ONE-STOP STORE FOR BIG ELECTRONIC VALUES

Build with the Best—Over 1000 Components in Stock!

**Parts "Hotline" Service!**  
Thousands of Items Available

Your Radio Shack store manager can special-order a huge variety of parts and accessories direct from our electronics warehouse—Realistic<sup>®</sup> Long-Life tubes, linear and digital ICs, microprocessors, support chips, phono cartridges and styli, crystals, special-purpose batteries, diodes, selected modules for TVs and audio equipment, autousound wiring harnesses, accessories, even SAMS Photofacts<sup>®</sup>. No handling charge, no shipping charge—just speedy delivery to the Radio Shack near you!

**Amateur Radio License Guides**

**495 to 1995**

Home Study Courses  
For FCC License Tests

Novice Voice Class License  
Prep Course. With cassettes.  
#62-2402 ..... 19.95  
Technician Class Manual.  
#62-2403 ..... 4.95  
General Class FCC License  
Course. #62-2404 ..... 19.95



### Brushless Fan



**16<sup>95</sup>**

Operates  
On 12VDC

Tiny, tough and efficient! Rated 150 mA. 1<sup>1</sup>/<sub>16</sub> x 1<sup>1</sup>/<sub>16</sub> x 1<sup>3</sup>/<sub>16</sub>". #273-244

### IR Detector

**349**

Module operates on 5VDC, board mountable. 5/8 x 1/2 x 19/32". With data. #276-137



Simplifies  
IR Design

### IC Tool Set

**695**  
Set



Install and remove 6-pin to 40-pin DIPs without damage. Works with LSI, MSI, and DIP devices. Both tools are groundable. #276-1581

### Motor and Chime



(1) 1.5-3V DC Motor. For robotics, projects. 1<sup>1</sup>/<sub>2</sub> x 1<sup>9</sup>/<sub>16</sub>" dia. #273-223  
(2) Doorbell Chime. IC/mini-speaker combo. 6-18VDC. 5" leads. #273-071

### Diode Rectifiers



3-Amp "Barrel" Type Diodes  
200-Amp Surge

Type	Peak Inverse Voltage	Cat. No.	Pkg. of 2
1N5400	50	276-1141	.99
1N5402	200	276-1143	1.19
1N5404	400	276-1144	1.29

### Speaker Stuff

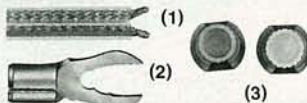

(1) MEGACABLE<sup>™</sup>. Hi-wattage, 12-gauge. #278-1268 ... Per Foot 99¢  
(2) Gold Terminals for MEGACABLE. #64-401 ... Set of 8/4.99  
(3) Terminal Knobs. Screw-down large cable. #274-619 ... Set 5.95

### Dress It Up



(1) Classy Two-Piece Enclosure. Accepts PC board and 9V battery. 5<sup>5</sup>/<sub>16</sub> x 2<sup>1</sup>/<sub>4</sub> x 1<sup>1</sup>/<sub>16</sub>". #270-257 ... 4.99  
(2) Project Labels. Four 7<sup>7</sup>/<sub>8</sub> x 3" sheets of rub-on letters and symbols. #270-201 ..... Set 2.99

### Halogen Lamps

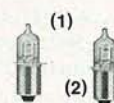

**395**  
Each

(1) HPR50. For 4-cell flashlights and 6-volt lanterns. #272-1189  
(2) HPR52. For 2-cell flashlights and 3-volt lanterns. #272-1190

### Gold-Plated Plugs and Jacks



(1) Phono Plug. #274-850 ... 2.49  
(2) Chassis-Mount Phono Jack. #274-852 ..... 2-pk./2.49  
(3) Straight Inline Phono Jack. #274-854 ..... 2.99  
(4) 2-Conductor 1/4" Phone Plug. Monaural. #274-855 ..... 3.49  
(5) Three-Conductor (Stereo) 1/4" Phone Plug. #274-856 ..... 3.99  
(6) 1/8" Plug. #274-857 ..... 2.79  
(7) 3-Conductor. 1/8" Phone Plug. Stereo. #274-858 ..... 3.49  
(8) 3-Conductor 1/4" Inline Phone Jack. #274-859 ..... 3.99

### Wire Connectors & Accessories

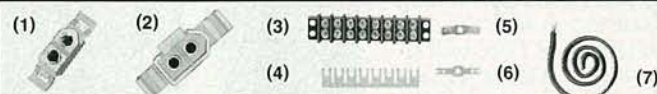

(1) 2-Pin Connector. #274-151 ..... .99  
(2) 4-Pin Connector. #274-152 ..... 1.69  
(3) 6-Pin Connector. #274-153 ..... 1.99  
(4) 2-Row Strip. #274-670 ... 1.99  
(5) Jumper. 8-pos. #274-650, 1.59  
(6) 45° T-Lugs. #274-645 ... 4/79¢  
(7) Dual Solder-Lug Adapters. #274-644 ..... Pkg. of 4/79¢  
(8) Heavy-Duty Bonded Wire. 25 ft., 2 x 18-gauge. #278-1250 ... 3.99

### Engineering Calculator



**3995**

Uses Standard  
Electronic Symbols

EC-4035 makes design math a snap! Has 110 functions, memory. With case and batteries. #65-983

### 30-Range Multimeter



**7995**

Tests Capacitors  
and Transistors

A great value! Measures to 1000VDC and 750VAC. With 0.5" digital display. Battery extra. #22-194

### Panel-Mount Counter

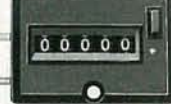

**1495**

Electromechanical — Counts to 99,999

One count per 12VDC pulse, pushbutton reset. Mounts in 1<sup>1</sup>/<sub>16</sub> x 1" hole. Depth: 1<sup>1</sup>/<sub>16</sub>". With leads and data. #277-222

Over 1000 items in stock! Binding Posts, Books, Breadboards, Buzzers, Capacitors, Chokes, Clips, Coax, Connectors, Fuses, Hardware, ICs, Jacks, Knobs, Lamps, Multitesters, PC Boards, Plugs, Rectifiers, Resistors, Switches, Tools, Transformers, Transistors, Wire, Zeners, More!

Prices apply at participating Radio Shack stores and dealers

**Radio Shack**  
**AMERICA'S**  
**TECHNOLOGY**  
**STORE**  
A DIVISION OF TANDY CORPORATION

CIRCLE 78 ON FREE INFORMATION CARD



# Learn to troubleshoot and service today's computer systems as you build a fully AT-compatible micro, complete with 1 meg RAM, and powerful 20 meg hard drive

## Train the NRI Way— and Earn Good Money Servicing Any Brand of Computer

Jobs for computer service technicians will almost double in the next 10 years according to Department of Labor statistics, making computer service one of the top 10 growth fields in the nation.

Now you can cash in on this exciting opportunity—either as a full-time industry technician or in a computer service business of your own—once you've mastered electronics and computers the NRI way.

NRI's practical combination of "reason-why" theory and hands-on building skills starts you with the fundamentals of electronics, then guides you through more sophisticated circuitry all the way up to the latest advances in computer technology.

### Train With a Powerful AT-Compatible—Now with 20 Meg Hard Drive and 1 Meg RAM!

To give you hands-on training with the absolute in state-of-the-art computer technology, NRI includes the powerful West Coast 1010 ES computer as the centerpiece of your training. As you assemble this fully IBM AT-compatible micro from the keyboard on up, you actually see for yourself how every section of your computer works.



**You build this powerful West Coast 1010 ES computer, all the while gaining a true mastery of computer electronics. Best of all, it's yours to keep for all your professional and personal computing needs.**



You assemble and test your computer's "intelligent" keyboard, install the power supply and 5¼" disk drive, then interface the high-resolution monitor. But that's not all.

Your hands-on training continues as you install a powerful 20 megabyte hard disk drive—today's most-wanted computer peripheral—now included in your course to dramatically increase the data storage capacity of your computer while giving you lightning-quick data access. Plus you work with exclusive word processing, database, and spreadsheet software, yours to use for your own professional and personal applications.

As you build your computer, performing key demonstrations and experiments at each stage of assembly, you get the confidence-building, real-



Your NRI computer training includes all this: • NRI's unique Discovery Lab® for circuit design and diagnosis • NRI's hand-held digital multimeter featuring "talk-you-through" instructions on audio cassette • A digital logic probe that lets you visually examine computer circuits • The new AT-compatible West Coast 1010 ES computer with high-speed 80286 CPU, 101-key "intelligent" keyboard, 1.2 meg high-density floppy disk drive, 1 meg RAM (expandable to 4 meg), 64K ROM • 20 megabyte hard disk drive • MS-DOS, GW-BASIC, word processing, spreadsheet, and database software • Reference manuals with programming guidelines and schematics

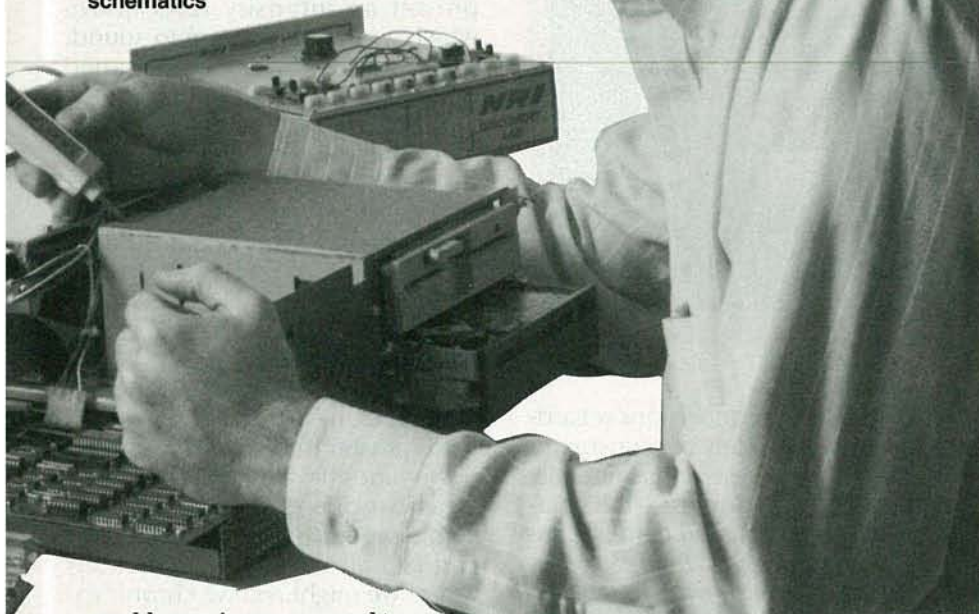

**NOW!**  
AT-compatible  
computer and 20  
meg hard drive!

prepared to take advantage of today's opportunities in computer service. You learn at your own convenience in your own home.

No classroom pressures, no night school, no need to quit your present job until you're ready to make your move. And all throughout your training, you've got the full support of your personal NRI instructor and the NRI technical staff, always ready to answer your questions and help you whenever you need it.

**FREE 100-Page Catalog Tells More**

Send today for NRI's big, 100-page catalog that describes every aspect of NRI's innovative computer training, as well as hands-on training in other growing high-tech career fields. If the coupon is missing, write to: NRI School of Electronics, McGraw-Hill Continuing Education Center, 4401 Connecticut Avenue, NW, Washington, DC 20008.

world experience you need to work with, troubleshoot, and service today's most widely used computer systems.

**New! Explore the Latest Advances in Voice Synthesis**

Now NRI also includes innovative hands-on training in voice synthesis, one of today's most exciting and widely applied new developments in computer technology.

You now train with and keep a full-featured 8-bit D/A converter that attaches in-line with your computer's parallel printer port. Working with the exclusive text-to-speech software also included with your course, you explore the fascinating technology behind both digitized and synthesized computer speech.

NRI's new hands-on training in voice synthesis is just one more way you get the confidence-building experience you need to feel at home with the latest advances in computer technology.

**No Experience Needed, NRI Builds It In**

This is the kind of practical, hands-on experience that makes you uniquely

**NRI** School of Electronics

McGraw-Hill Continuing Education Center  
4401 Connecticut Avenue, NW  
Washington, DC 20008

IBM and AT are registered trademarks of International Business Machines Corporation



**SEND TODAY FOR FREE CATALOG!**



McGraw-Hill Continuing Education Center  
4401 Connecticut Avenue, NW, Washington, DC 20008

For Career courses approved under GI Bill  
 check for details.

- CHECK ONE FREE CATALOG ONLY
- Computer Electronics
  - TV/Video/Audio Servicing
  - Robotics
  - Electronic Music Technology
  - Security Electronics
  - Digital Electronics Servicing

- Telecommunications
- Industrial Electronics
- Electronic Circuit Design
- Basic Electronics
- Bookkeeping & Accounting
- Building Construction
- Automotive Servicing



- Air Conditioning, Heating, & Refrigeration
- Small Engine Repair
- Electrician
- Locksmithing
- Travel Careers
- Writing
- Paralegal
- Computer Programming

Name (Please print) \_\_\_\_\_ Age \_\_\_\_\_

Street \_\_\_\_\_

City/State/Zip \_\_\_\_\_ We'll give you tomorrow. \_\_\_\_\_ Accredited Member National Home Study Council \_\_\_\_\_ 3-505



# EQUIPMENT REPORTS

## Integrity Electronics IER-109 60-Hz Magnetic Field Meter

*Keep tabs on your exposure  
to potentially dangerous 60-  
Hz magnetic fields.*

CIRCLE 19 ON FREE INFORMATION CARD



LONG TAKEN FOR GRANTED, THE 60-Hz power lines criss-crossing our neighborhoods and running through the walls of our homes are emerging as a potential health threat. The issue is being discussed more and more frequently in the popular press, and it shows no signs of going away.

The subject has been studied by many respected organizations, including the World Health Organization, the American Institute of Biological Sciences, and the New York State Department of Health. There seems no doubt that exposures to ELF (*Extremely Low Frequency*) magnetic fields can cause biological effects. Just what effects are unknown at this time, and many studies are underway to determine safe exposure levels. However, the report issued by the New York State Department of Health recommended that a major research be undertaken by utilities, appliance makers, and the like to find ways to reduce exposures to ELF magnetic fields in homes.

We're not holding our breath waiting for the scientific community

to come to firm conclusions regarding the relative safety of exposure to the 60-Hz magnetic fields generally assumed to be harmless—the studies will take years, and conflicts are sure to arise. Because we're so entrenched in our power-generation and -distribution system, it's unclear whether we'll be willing—or able—to change even if the threat is substantiated.

However, it seems prudent to us to at least be aware of the potential danger, and to be aware of the strength of fields we encounter every day. We recently found a good way to do just that: the model IER-109 60-Hz Magnetic Field Meter from Integrity Electronics and Research (558 Breckenridge Street, Buffalo, NY 14222; 716-886-6985).

The IER-109 measures magnetic field intensity, or magnetic flux density, in three ranges: 2, 20, and 2000 milligauss. A narrow bandpass filter gives the unit a sharp frequency response centered around 60 Hz—its 3-dB bandwidth is specified as 11 Hz. That sharp response is important because harmonics can cause havoc with proper measurements.

The meter measures roughly 3×4×7 inches and weighs about a pound. It features a 3-1/2-digit LCD readout and runs on a single 9-volt alkaline battery.

An alarm feature allows you to pre-set an intensity level above which you want an alarm to sound. If you wish, the alarm can be turned off, and the alarm condition will be indicated by a front-panel LED.

For those more interested in total exposure than simply the intensity at a given instant, the IER-109 features a 200-millivolt output to a recorder for dosimetry measurements.

### Using the meter

Since some reports have indicated that continuous exposure to fields greater than 3 milligauss from power lines have been linked to increased incidence of childhood leukemia, we set the alarm for that level and examined various situations where we might receive chronic exposure. In front of the computer on which this report was prepared, the field was measured at 1.5 milligauss at the normal operating position. Under an electric blanket, the field was measured at 66 milligauss! It's not surprising that such blankets are often referenced in reports concerned with magnetic-field safety. The field inside the wall closest to our power-line drop was better than 4 milligauss, but fell rapidly only a few inches from the wall. Since our test site was not located near a distribution transformer, that was expected.

The IER-109 sells for \$595. Because many potential customers may be curious about their field exposure, and not need the meter on a day-to-day basis, Integrity also offers a rental service for a fee of \$50 per week. It seems a small price to pay for peace of mind. **R-E**



## Jameco Electronics Metex M-3900 Digital Multimeter and Dwell/ Tach Meter

*A multimeter at home on  
your test bench—or in your  
garage.*

CIRCLE 20 ON FREE INFORMATION CARD



WE ALWAYS CRINGE A LITTLE BIT WHEN we have to take our digital multimeter out to our car to check on the condition of its battery, or to diagnose a wiring problem. There's really no logical reason for that, except that it just doesn't seem right to get grease on our expensive, high-accuracy instrument—even though the meter's seals will protect it. That meter just doesn't fit in with the wrenches and our other automotive tools.

We have, however, found a new digital meter that cries out to be used in automotive applications: the Metex 3900, available in the U.S. from Jameco Electronics (1355 Shoreway Road, Belmont, CA 94002). The Metex 3900 adds tachometer and dwell-angle functions to the usual resistance, current and voltage ranges.

### Basic specifications

The M-3900 is housed in a rugged, yellow plastic case that measures about 6×3½×1¾ inches. Its front panel features a 3½-digit LCD readout, a 30-position rotary function selector, four input jacks, and a power switch. A 9-volt battery provides power to operate the meter.

The meter offers five ranges, from 200 millivolts to 1000 volts, for measuring DC volts. The specified accuracy is ±0.3%, +1 digit. Two AC voltage ranges, 200 and 750 volts, provide a worst-case measurement accuracy of 1.2%, +3 digits. Both DC and AC current can be measured in two ranges of 2 and 20 amps, with a worst-case accuracy of ±3%, +7 digits. Six resistance ranges, from 200 ohms to 20 megohms, provide a measurement accuracy within ±1%, +2 digits. An audible continuity test, along with a diode-test function (which displays

the forward voltage drop of a diode) is also offered.

Those basic features are just what you'd expect from a basic digital multimeter. But the M-3900 isn't just a bench-top meter. Dwell-angle measurements and tachometer readings are also available. Tachometer readings, in two ranges of 2000 and 10,000 RPM, can be made on 4-, 5-, 6-, and 8-cylinder engines with a rated accuracy of ±2%, +1 digit. Dwell-angle measurements can also be made on 4-, 5-, 6-, and 8-cylinder engines with the same accuracy.

### Automotive measurements

Although electronic ignition has taken over most new automobiles, many cars still use points to control spark generation. The dwell angle is a measurement of the time that the points remain closed during the ignition cycle. One result of setting the engine dwell incorrectly is that sufficient energy cannot be built up in the coil to provide good spark. Poor acceleration, or missing at higher engine speeds, is the usual complaint. Excessive dwell shortens the life of the points.

Although the increasing use of electronics under the hood makes it difficult for Saturday mechanics to perform many maintenance functions, a tachometer is still useful to determine whether the engine is operating efficiently, the choke is working according to specifications, the idle speed is correctly set, and the like.

To make the automotive measurements easier, the M-3900 comes equipped with an extra set of test leads with clips, and a manual that details automotive measurements. The total cost of the Metex M-3900 is \$69.95.

R-E

# Some Good Tips On Our Cable.

Go ahead, examine them closely. Pomona has the best tips around. From an SMD Grabber® to a BNC Coax connector, you can choose both ends just the way you want them to meet your exact applications.

**The Best Quality You Can Buy.** From the wire or cable itself to the tip you want—like gold plated contacts, beryllium copper springs, swaged banana plugs, and molded on stress relief. And, here's the best tip yet: Pomona's cable assemblies will give you many years of accurate contact.

See your nearest Authorized Pomona Distributor, or contact  
POMONA ELECTRONICS  
1500 E. Ninth St.,  
P.O. Box 2767  
Pomona, CA 91769  
(714) 623-3463  
FAX (714) 629-3317

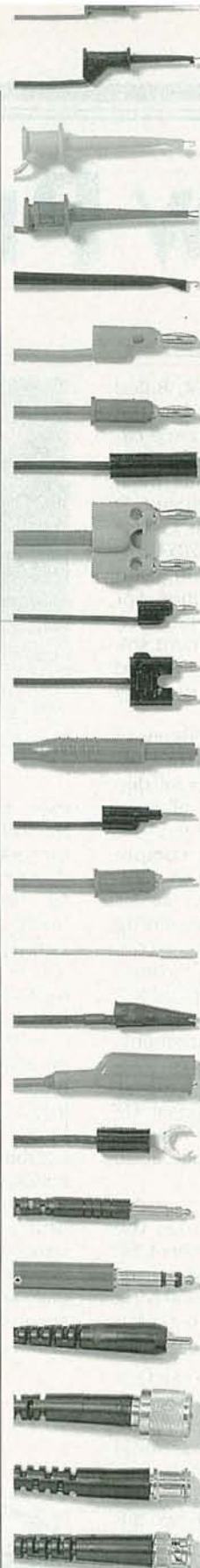

**FREE  
1990 CATALOG!**  
Thousands of test solutions  
and accessories in this new,  
138-page handbook of quality  
products. It's Free! Call or  
write today.

# ITT Pomona

AN ITT EMC WORLDWIDE COMPANY

*Discover our strengths.*

CIRCLE 101 ON FREE INFORMATION CARD



# NEW PRODUCTS

**DIGITAL LCR METER.** Billed by Hewlett-Packard as the first digital inductance-capacitance-resistance meter capable of automatic measurements and direct-Q measurements from 75 kHz to 30 MHz, the *HP 4285A* also provides high throughput and 6 digits of resolution. For improved testing efficiency, 10 error-free instrument setups can be quickly loaded from an external memory card.

With a basic accuracy of 0.1%, the instrument has 100-Hz resolution and six full digits of resolution for all measurement parameters. The *HP 4285A* can test components and materials to commercial and military RF standards. For demanding military tests, it has a constant test-signal-level feature that controls the applied test signal at the device. Direct quality-factor measurements can be performed in fractions of a second with the *HP 4285A* and the optional *HP 42851A* precision-Q adapter, yielding 5% accuracy at 30 MHz.

To test inductors under operating conditions, the meter uses the optional *HP 42841A* bias-current source to test a device up to 30 MHz at 10 amps DC of bias. For



CIRCLE 10 ON FREE INFORMATION CARD

even more measurement flexibility—and to simplify integration with handlers, scanners, and environmental chambers without sacrificing accuracy—specifications apply at the front panel and at one- and two-meter cable lengths when Hewlett-Packard cable sets are used.

Several other options can be added to customize the meter. For high-volume testing, a handler interface and built-in comparator can be combined with component-handling equipment. A scanner interface and switch/text unit provide optimal environmental-chamber testing. Test fixtures for axial, radial, and chip components are also available.

The *HP 4285A* has a built-in HP-BIB interface and uses a standard language that is compatible with IEEE 488.2 (1987). That allows the use of generic commands.

The *HP 4285A* digital LCR meter costs \$12,900. The *HP 42851A* precision-Q adapter, *HP 42841A* bias-current source, and *HP 42842C* bias-current test fixture cost \$4,850, \$6,800, and \$2,500, respectively. The 001 DC bias, 002 accessory-control interface, 202 handler interface, and 301 scanner interface cost \$920, \$280, \$310, and \$600, respectively.—**Hewlett-Packard Company**, Customer Inquiries, 19310 Pruneridge Avenue, Cupertino, CA 95014.

## BURGLAR-ALARM SYSTEM.

Offering advanced features such as a built-in telephone dialer, an emergency-message system, and a speaking computerized central console, the *Dicon 3000* home burglar-alarm system can be installed in any house or apartment in minutes without tools. In addition to detecting intruders, the system monitors itself for proper operation and vocally reports its status to the homeowner.

The heart of the system is the console, which vocally guides the user through a brief set-up procedure and provides prompts and messages during regular use. The console has a built-in microphone and can store a 15-second emergency message in its digital memory. If a break-in occurs, the console automatically places calls to as many as four numbers, which are selected by the homeowner during initial setup. A built-in back-up battery pack is continually monitored by the system, which notifies the homeowner when replacement batteries are needed.



CIRCLE 12 ON FREE INFORMATION CARD

Other components include a passive infrared motion detector, a siren, and accessories. The motion detector, which must be placed within 500 feet of the central console, transmits FM radio signals using 16-bit digital encoding to the console. Accessories in the basic *Dicon 3000* package include an ex-

**SOLDERING-IRON STAND.** A heavy-duty soldering-iron stand, *M.M. Newman's Antex ST-5*, features a metal base for added stability. Its coil-spring holder dissipates heat and comes with two different types of bezels to accommodate all popular irons. The tray holds a 1/2-inch-thick sponge that is used for wiping soldering-iron tips, and has a center hole for collecting dross. Conforming to Department



CIRCLE 11 ON FREE INFORMATION CARD

of Defense requirements for soldering-iron holders, the *Antex ST-5* soldering-iron stand leaves the soldering tip unsupported, eliminating contact between the soldering tip and the coil-spring holder, to prevent heat sinking and to protect the user from burns.

The *Antex ST-5* soldering-iron stand costs \$11.95.—**M.M. Newman Corporation**, 24 Tioga Way, P.O. Box 615, Marblehead, MA 01945.



tended-range antenna, window decals, and an owner's manual. Additional sensors and a remote-control keypad are available as options.

The *Dicon 3000* home burglar-alarm system has a suggested retail price of \$399.00.—**Dicon Systems Inc.**, 651 Executive Drive, Willowbrook, IL 60521; Tel. 708-850-7370.

**UNIVERSAL EPROM PROGRAMMER.** Providing extra flexibility, the *Wintek UEP02* universal EPROM programmer can be used either with a personal computer or as a stand-alone unit, making it particularly well suited for PC-based microcomputer development software. It can also be moved easily between machines, since it does not require the installation of a circuit board in the computer, but connects via the PC's serial port instead. The *UEP02* includes 2716, 2732, 2764, 27128, and 27256 EPROM's, and accepts most industry-standard byte-wide EPROM's. The programmer

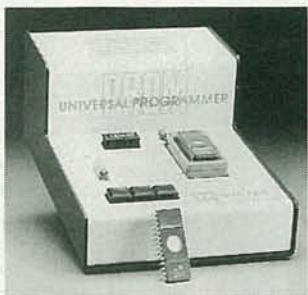

**CIRCLE 13 ON FREE INFORMATION CARD**

also comes with comprehensive documentation, software, configuration plugs, and cables for both 9- and 25-pin serial ports.

The *UEP02* universal EPROM programmer costs \$495.00.—**Wintek Corporation**, 1801 South Street, Lafayette, IN 47904-2993; Tel. 800-742-6809.

**PULSE GENERATOR.** An easy-to-use, 125-MHz, fully programmable pulse generator, the *PM 5781* from *John Fluke Mfg.*, has many applications in automated testing systems (including digital or analog circuitry and components)

and in radar, sonar, and communications. The instrument produces high-speed, high-performance pulses, has a normal frequency range of 0.1-125 MHz (which can be extended to 0.025 MHz), and provides individually programmable rise and fall times from 2 ns to 100 ms.

The *PM 5781* provides two outputs for both positive- and negative-going pulses. It has independent DC-offset control on the second channel output, plus a third switchable TTL/ECL level output. Thanks to the inclusion of internal 50-ohm back-matching terminations, the generator provides clean pulses even with mismatched loads.



**CIRCLE 14 ON FREE INFORMATION CARD**

Operating modes include the generation of continuous, externally triggered

(single), and externally gated pulses. In addition, a burst mode allows the number of pulses in a burst to be specified, eliminating the need for a separate generator. Single- and double-pulse, square-wave, programmable-duty-cycle, externally controlled pulse-duration, and manual operation modes are also featured. All ten pulse parameters are displayed simultaneously on the unit's front-panel LCD.

Several features ensure reliable operation. A track mode maintains a programmable fixed relationship between specified pulse parameters, which can be locked to prevent accidental modification. Output-amplitude limits can be set to prevent damage to connected loads. All pulse parameters are automatically checked for inconsistencies, and the output can be inhibited until all parameters have been defined and validated.

The *PM 5781* pulse generator has a list price of \$9585.00.—**John Fluke Mfg.**

# 22,356 ELECTRONIC COMPONENTS

Whether you order 1 part or all 22,356... **MOUSER** stocks to meet your needs and... *can ship today!!*

**MOUSER** also makes it easy to do business.

Try us! Call today for your **FREE CATALOG**  
**(800) 992-9943**

2401 Hwy 287 North  
Mansfield, TX 76063

**MOUSER**  
ELECTRONICS

Sales & Stocking Locations Nationwide

**CIRCLE 117 ON FREE INFORMATION CARD**

## At \$215 This Function Generator Makes More Waves.

### FG2A Function Generator

- 7 Frequency Ranges from 0.2Hz to 2MHz
- Sine, Square, Triangle, Ramp and TTL Pulse Output

- Duty Cycle Control
- Voltage Controlled Frequency (VCF)

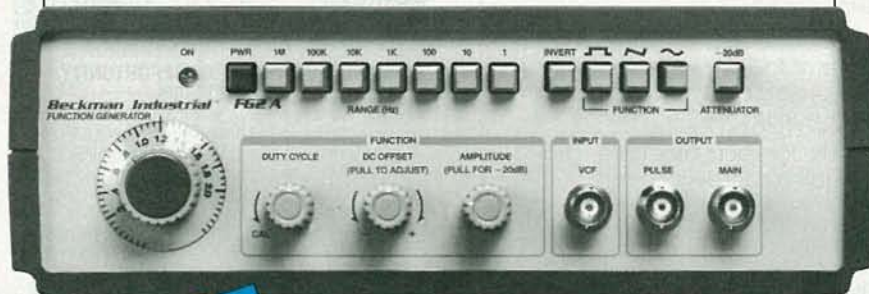

**\$215**

**Beckman Industrial™**  
An Affiliate of Emerson Electric Co.

For more information and the location of your nearest authorized Beckman Industrial dealer call 1-800-854-2708 (in California 1-800-227-9781). Instrumentation Products Division, 3883 Ruffin Road, San Diego, CA 92123-1898

© 1989 Beckman Industrial Corporation.

Specifications are subject to change without notice.

**CIRCLE 178 ON FREE INFORMATION CARD**

JN163-01-0590



# More Features Give This 100MHz Counter Universal Appeal At \$339.

## UC10A Universal Counter

- 5Hz to 100MHz Frequency Range
- 8-Digit LED Display
- Measures Frequency, Period, Frequency Ratio, Time Interval and Unit Count
- 4 Selectable Gate Times

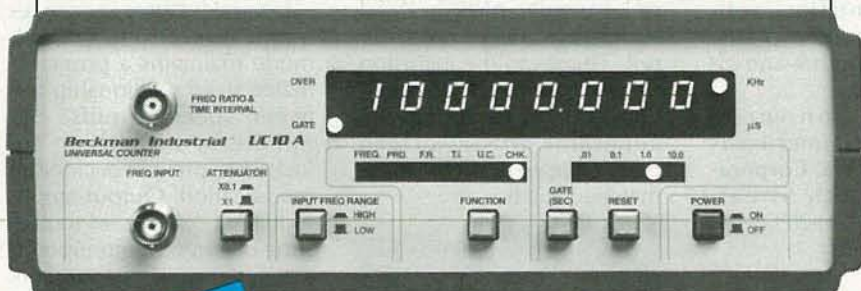

**\$339**

**Beckman Industrial™**

An Affiliate of Emerson Electric Co.

For more information and the location of your nearest authorized Beckman Industrial dealer call 1-800-854-2708 (in California 1-800-227-9781). Instrumentation Products Division, 3883 Ruffin Road, San Diego, CA 92123-1898

© 1989 Beckman Industrial Corporation. Specifications are subject to change without notice.

CIRCLE 176 ON FREE INFORMATION CARD

JN162-01-0590

Co., Inc., P.O. Box 9090, Everett, WA 98206; Tel. 800-443-5853, ext. 77.

**COMMUNICATIONS-MAINTENANCE KIT.** Designed to handle service requirements in facilities with multi-system communications, *Jensen Tools' JTK-46C* communications-maintenance kit contains every tool needed to access, test, and repair phones, modems, fax machines, teletypes, switches, and distribution systems. The kit contains cabinet/chassis access tools, including hollow-shafted nut-drivers, Phillips and slotted screwdrivers, an adjustable wrench, and hex keys. A selection of strippers for work with stranded or solid wire, a wire-wrapping tool, pin- and IC-insertion/extraction tools, a modular line tester, pliers, and other tools for wire termination and telecom/datacom applications are also included.



CIRCLE 15 ON FREE INFORMATION CARD

A gray Cordura zipper case holds the more than 50 tools. The case features a roomy internal pouch, three exterior pockets, and durable webstrap handles. An internal restraining strap can hold an optional rotary/tone handset. Other options include the Triplet Fox/Hound tracer/tester, and a punchdown tool.

The *JTK-46C* communications-maintenance tool kit costs \$319.00.—**Jensen Tools, Inc.**, 7815 South 46th Street, Phoenix, AZ 85044; Tel. 602-968-6241.

**SWITCH AND INDICATOR LINE.** Sleek European-styling highlights *Eaton's* new line of rocker switches, pushbutton switches, and indicators. Designed for convenient snap-in front-panel mounting, they feature contoured corners and matte finishes. The

Get A Complete Course In

## ELECTRONIC ENGINEERING

8 volumes, over 2000 pages, including all necessary math and physics. 29 examinations to help you gauge your personal progress. A truly great learning experience.

Prepare now to take advantage of the growing demand for people able to work at the engineering level.

Ask for our brochure giving complete details of content. Use your free information card number, or write us directly. **\$99.95**, Postage Included. Satisfaction guaranteed or money refunded.



**Banner  
Technical  
Books, Inc.**

1203 Grant Ave.  
Rockford, IL 61103

## LEARN VCR CLEANING/MAINTENANCE/REPAIR EARN UP TO \$1000 A WEEK, WORKING PART TIME FROM YOUR OWN HOME!



Secrets  
Revealed!

NO Special  
Tools or  
Equipment  
Needed.

EARN UP TO \$600  
AN HOUR AND  
MORE!

### THE MONEY MAKING OPPORTUNITY OF THE 1990'S

IF you are able to work with common small hand tools, and are familiar with basic electronics (i.e. able to use voltmeter, understand DC electronics)...

IF you possess average mechanical ability, and have a VCR on which to practice and learn... then we can teach YOU VCR maintenance and repair!

**FACT:** up to 90% of ALL VCR malfunctions are due to simple MECHANICAL or ELECTRO-MECHANICAL breakdowns!

**FACT:** over 77 million VCRs in use today nationwide! Average VCR needs service or repair every 12 to 18 months!

Viejo's **400 PAGE TRAINING MANUAL** (over 500 photos and illustrations) and **AWARD-WINNING VIDEO TRAINING TAPE** reveals the **SECRETS** of VCR maintenance and repair—"real world" information that is **NOT** available elsewhere!

Also includes all the info you'll need regarding the **BUSINESS-SIDE** of running a successful service operation!

#### FREE INFORMATION

CALL TOLL-FREE 1-800-537-0589

Or write to: Viejo Publications Inc.

3540 Wilshire BL. STE. 310  
Los Angeles, CA 90010 Dept. RE

CIRCLE 184 ON FREE INFORMATION CARD





CIRCLE 16 ON FREE INFORMATION CARD

switches and indicators can be unlighted, or illuminated with incandescent, neon, and fluorescent lamps.

The units meet both domestic and international electrical/electronics standards. Suitable for AC and low-voltage DC applications, the switches have a power-switching capability of up to 20 amps and a switching capability of one to four poles in both maintained and momentary circuits. They also have a wide range of termination types. The double-insulated units are available with display indicators and come in a variety of operator and housing colors. The most popular types are avail-

able in sealed versions. They can withstand temperatures to 120°C.

The switches and indicators are available in quantities of 1,000 pieces or more, and range in price from \$0.60 to \$3.00.—Eaton Corporation, 4201 North 27th Street, Milwaukee, WI 53216.

**ESD FIELD-SERVICE KIT.** A fully portable field-service kit, the *Statfree CP636* comes in a canvas pouch and easily fits inside a standard briefcase to create a static-safe work area outside the plant



CIRCLE 17 ON FREE INFORMATION CARD

environment. The kit, from *Charleswater Products* includes everything needed to create a static-safe electronic repair station while making service calls. Included are a static-dissipative vinyl work surface, an elastic wrist band, two grounding cords, and a canvas storage pouch. The kit can drain electrostatic charges from personnel, spare parts, and equipment, helping to prevent costly electrostatic-discharge-related repair failures. The 18 x 22-inch work surface provides a surface resistivity of 10<sup>9</sup> ohms/sq. The wristband includes a 6-foot coiled cord, and a 10-foot grounding cord with an alligator clip.

The *Statfree CP636* ESD field-service kit has a list price of \$40.00.—Charleswater Products, Inc., 93 Border Street, West Newton, MA 02164.

**STAND-ALONE RADIO MODEM.** *Megadata's SA9600* stand-alone radio modem allows mini- and mainframe

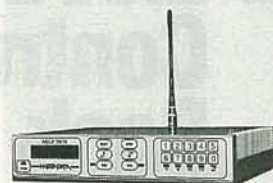

CIRCLE 18 ON FREE INFORMATION CARD

computers to communicate at data rates up to 9600 bits per second via a narrow-band UHF radio line. Connecting to a synchronous serial port of the host computer, the radio modem converts the serial data stream to radio packets transparently. Because the host computer perceives the *SA9600* as a conventional synchronous telephone modem, no software modification is required to establish a wireless link.

The radio modem allows data communication where conventional wiring is impractical, expensive, or impossible. Potential applications include land mobile, ship-to-ship, building-to-

# CONNECTION PROTECTION

SWITCHES & RELAYS

EDGE CONNECTORS

PLUGS & SOCKETS

POTENTIOMETERS



CONNECTING CABLES

TERMINAL STRIPS

GOLD PLATED CONNECTORS

BATTERY CONTACTS

## CRAMOLIN®

Even the finest equipment in the world cannot guarantee noise-free operation. One "dirty" connection anywhere in the electrical path can cause unwanted noise or signal loss.

"MORE THAN A CONTACT CLEANER"

**CRAMOLIN®** is a fast-acting, anti-oxidizing lubricant that cleans and preserves all metal surfaces, including gold.

When applied to metal contacts and connectors, **CRAMOLIN®** removes resistive oxides as it forms a protective molecular layer that adheres to the metal surfaces and maintains maximum electrical conductivity.

**CRAMOLIN®** - USED BY THOSE WHO DEMAND THE BEST:

Bell & Howell	Hewlett Packard	MCI(Sony)	Nakamichi
Boeing	John Fluke Mfg.	Motorola	RCA
Capitol Records	McIntosh Labs	NASA	Switchcraft

SINCE 1956

**CAIG LABORATORIES INC**

1175-O Industrial Ave., (P.O. Box J) - Escondido, CA 92025-0051 U.S.A. • (619) 743-7143

CIRCLE 50 ON FREE INFORMATION CARD

# CABLE - TV

## SIGNAL REMOVERS

- FOR ELIMINATION OF SEVERE INTERFERENCE
- FOR "CENSORING" OF ADULT BROADCASTS



FOR FULL DESCRIPTION OF USES ask for our free brochure

- ATTENUATION - 45 dB TYPICAL
- BANDWIDTH - 4 MHz AT 5 dB POINTS
- INSERTION LOSS - 2 dB

MODEL	TUNING RANGE	FOR CHANNELS	PASSBAND	PRICE	SHIPPING
23H	50-66 MHz	2,3 (or 6 meter ham)	50-300 MHz	\$30	NO SHIPPING OF C.O.D. CHARGES
46FM	66-108 MHz	4,5,6 (or any FM)	50-300 MHz	\$30	
1417	120-144 MHz	14(A) 15(B) 16 (C) 17 (D)	50-400 MHz	\$30	
1822	144-174 MHz	18(E) 19(F) 20(G) 21(H) 22 (I)	50-400 MHz	\$30	
713	174-216 MHz	7,8,9,10,11,12,13	50-400 MHz	\$30	

3 for \$75 - 10 for \$200 - mix or match

CALL TOLL FREE FOR C.O.D. OR SEND CHECK TO ORDER  
FAST DELIVERY  
30 DAY MONEY BACK GUARANTEE (3 FILTER LIMIT)

**Star Circuits**

P. O. Box 94917  
Las Vegas, NV 89193-4917

1-800-433-6319

MAY 1990

27



# Join the Electronics and Control Engineers' Book Club®

**TROUBLESHOOTING ELECTRONIC EQUIPMENT WITHOUT SERVICE DATA, Second Edition.** By R.G. Middleton. 320 pp., *illus.* This indispensable new edition features all the information that made the first edition so successful, plus the latest developments in digital testing, phase checks, IC troubleshooting, and repair of VCRs, stereos, TVs, tape recorders, and much, much more.  
585092-3 Pub. Pr., \$30.00 Club Pr., \$22.50

**PRINTED CIRCUITS HANDBOOK, Third Edition.** By C.F. Coombs, Jr. 960 pp., 556 *illus.* Here in one handy volume is all the information you need to design, manufacture, test, and repair printed wiring boards and assemblies. This new edition features ten all-new chapters, including three on SMT.  
126/097 Pub. Pr., \$64.95 Club Pr., \$45.50

**SOUND SYSTEM ENGINEERING, Second Edition.** By D. Davis and C. Davis. 665 pp., *illus.* The definitive source for all professionals responsible for audio system design, covering everything from concert halls to virtually every oscillator in use today. Packed with proven strategies for solving design and engineering problems and cutting your clients' costs.  
584657-8 Pub. Pr., \$39.95 Club Pr., \$31.50

**McGRAW-HILL ENCYCLOPEDIA OF ELECTRONICS AND COMPUTERS, Second Edition.** S. Parker, Editor-in-Chief. 1,047 pp., 1,250 *illus.* Featuring 160 new and revised articles, this new edition treats the entire spectrum of applications, devices, systems, and theory in areas ranging from the flow of electricity to hardware, software, robotics, and IC fabrication.  
454/99X Pub. Pr., \$79.50 Club Pr., \$54.95

**COMMUNICATIONS RECEIVERS: Principles and Design.** By Ulrich L. Rohde and T.T.N. Bucher. 608 pp., 402 *illus.* Everything you need to know if you design or work with communications receivers, from theory to practical design approaches. Coverage includes all types of receivers: shortwave, broadcast, radar, military, marine, aeronautical, and more.  
535/701 Pub. Pr., \$64.95 Club Pr., \$44.50

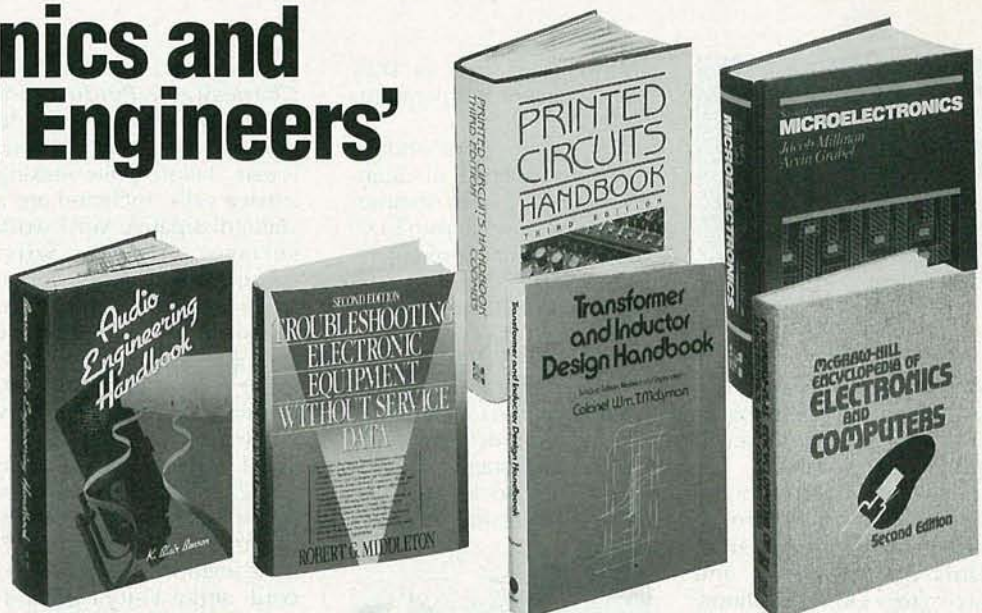

- your one source for engineering books from over 100 different publishers
- the latest and best information in your field
- discounts of up to 40% off publishers' list prices

New Members!  
Take any one of these great professional books **\$289** for only as a premium with your first selection!

Spectacular values up to **\$199.50**

**ENGINEERING FUNDAMENTALS FOR THE PROFESSIONAL ENGINEERS' EXAM, Third Ed.** By L. M. Polentz. 432 pp., 170 *illus.* Features worked-out solutions and full explanations for all sample problems so you can learn how to solve them. It's a dependable way to prepare for the exam or a perfect on-the-job reference.  
503/931 Pub. Pr., \$39.50 Club Pr., \$27.95

**AUTOMATIC CONTROL SYSTEMS, Fifth Ed.** By B. C. Kuo. 736 pp., *illus.* Provides an overview of automatic control systems, including in-depth coverage of classical control techniques, optimal control theory, and analog and digital control system design. This up-dated edition discusses the latest ideas on the use of computers to design control systems and as components of such systems.  
583706-4 Pub. Pr., \$57.40 Club Pr., \$43.50

**CIARCIA'S CIRCUIT CELLAR, Volume VII.** By S. Ciarcia. 256 pp., 100 *illus.*, *softcover*. More do-it-yourself circuits from the master—Steve Ciarcia. Step-by-step guidance on projects ranging from a gray-scale video digitizer and the Circuit Cellar AT Computer to parallel interfacing and the Neighborhood Strategic Defense Initiative.  
109/699 Pub. Pr., \$19.95 Club Pr., \$15.95

**THE COMPACT DISC: A Handbook of Theory and Use.** By K. C. Pohlmann. 288 pp., *illus.*, *softcover*. The most readable and comprehensive guide to CD technology offers clear descriptions of disc design and manufacturing . . . player circuitry . . . and comparisons of different types of players—all without complicated theoretical or mathematical discussions.  
585096-6 Pub. Pr., \$29.95 Club Pr. \$22.50

**MOBILE CELLULAR TELECOMMUNICATIONS SYSTEMS.** By W.C.Y. Lee. 442 pp., 215 *illus.* A to Z coverage of state-of-the-art cellular systems, from design to implementation and troubleshooting. Clearly explains spectrum efficiency, propagation models and prediction, interference treatment, and more.  
370/303 Pub. Pr., \$62.95 Club Pr., \$44.50

**TRANSFORMER AND INDUCTOR DESIGN HANDBOOK, Second Edition.** By Col. W.T. McLyman. 440 pp., *illus.* All the information you need to design today's lighter, smaller transformers and inductors, without relying on out-moded approximation methods. In ready-reference tabular format, this new edition covers the latest equations in transformer and gapped design applications.  
584646-2 Pub. Pr., \$55.00 Club Pr., \$38.50

**MICROCOMPUTER TROUBLESHOOTING AND REPAIR.** By J. G. Stephenson and B. Cahill. 354 pp., *illus.*, *softcover*. This nuts-and-bolts guide provides expert tips, troubleshooting tools and shortcuts, and practical help on deciding if you really *do* have to bring it in to the shop. It also explains techniques for anticipating and defending against most common computer problems.  
585106-7 Pub. Pr., \$24.95 Club Pr., \$18.95

**MICROELECTRONICS, Second Ed.** By J. Millman and A. Grabel. 1,001 pp., 646 *illus.* Takes you from the basics of semiconductor properties to an understanding of the operation of solid-state devices, and then to more advanced topics. Its up-to-date coverage, real-life examples, and practical data make this an ideal reference for the working engineer.  
423/30X Pub. Pr., \$56.95 Club Pr., \$41.50

**ENGINEERING MATHEMATICS HANDBOOK, Third Ed.** By J. J. Tuma. 512 pp., *illus.* This best-selling handbook gives you the essential mathematical tools—formulas, definitions, theorems, tables, and models for computer programming—that you need for your day-to-day engineering calculations.  
654/433 Pub. Pr., \$52.50 Club Pr., \$34.50

**PORTABLE ELECTRONICS DATA BOOK**  
360 pp., 6 x 9, *illus.*, *softcover* 585390-6

A-to-Z coverage of all the essential facts, figures, and formulas you need, in a format that's easy to use and easy to carry. John Douglas-Young has filled this handy on-the-job companion with equations, algorithms, calculus formulas, and BASIC programs in areas ranging from alternating current and amplifiers to transducers and waveguides . . . and they're all yours **ABSOLUTELY FREE!**

**A \$19.95 Value — Yours ABSOLUTELY FREE when you join!**



**BASIC TELEVISION AND VIDEO SYSTEMS, Fifth Ed.** By B. Grob. 592 pp., illus. Provides the clearest picture of how television and video systems work, and what to do when they don't. Covers television receivers, VCR's, video cameras, and cable systems — all in readable, practical detail.  
249/334 Pub. Pr., \$39.95 Club Pr., \$24.95

**BUILD YOUR OWN UNIVERSAL COMPUTER INTERFACE.** By B. Chubb. 309 pp., illus., softcover. Guiding you from theory to step-by-step assembly instructions, this lively manual shows you how to construct a computer interface and hook it up to virtually any IBM or IBM compatible personal computer, including the XT, XT-286, AT, and System/2 Model 30. 585080-X Pub. Pr., \$19.95 Club Pr., \$15.95

**HANDBOOK OF ELECTRICAL NOISE MEASUREMENT AND TECHNOLOGY, Second Ed.** By C.A. Vergers. 440 pp., 213 illus. Provides answers to all your questions about noise origins, causes, effects. Also shows you how to predict and measure noise, and how to design low-noise circuits.  
583947-4 Pub. Pr., \$39.95 Club Pr., \$29.95

**SWITCHGEAR AND CONTROL HANDBOOK, Second Ed.** Edited by R. W. Smeaton. 1,056 pp., 789 illus. The only handbook that treats all aspects of switchgear control, including design, applications, safety, and maintenance. Updated to reflect the changes brought about by the use of computers, solid-state devices, and programmable controls.  
584/494 Pub. Pr., \$83.00 Club Pr., \$56.95

**ANTENNA APPLICATIONS REFERENCE GUIDE.** Edited by R. C. Johnson and H. Jaski. 496 pp., 368 illus. and tables. Covers the major applications of antenna technology in all areas of communications and their design methods. Emphasizes important new applications such as earth station, satellite, seeker, aircraft, and microwave-relay antennas.  
322/848 Pub. Pr., \$59.95 Club Pr., \$42.50

**RADIO HANDBOOK, Twenty-Third Ed.** Edited by W. I. Orr. 667 pp., 1,073 illus. and tables. The latest edition of the most complete, current resource on radio technology and its applications. Expert contributors show you how to select, design, build, test and operate all kinds of equipment.  
584638-1 Pub. Pr., \$29.95 Club Pr., \$23.95

**AUDIO ENGINEERING HANDBOOK.** Edited by K. B. Benson. 1056 pp., 722 illus. The ideal on-the-job reference for professionals who design, operate, and service audio equipment. It's a one-volume source of fundamental audio acoustics engineering information and practical how-to source book covering generation, transmission, storage, and reproduction of the audio signal.  
047/774 Pub. Pr., \$83.50 Club Pr., \$59.95

**Be sure to consider these important titles as well!**

**BUCHSBAUM'S COMPLETE HANDBOOK OF PRACTICAL ELECTRONIC REFERENCE DATA, Third Ed.** By W.H. Buchsbaum. 583880-X Pub. Pr., \$34.95 Club Pr., \$26.50

**ON-LINE ELECTRICAL TROUBLESHOOTING.** By L. Lundquist. 391/106 Pub. Pr., \$34.50 Club Pr., \$26.50

**ESSENTIAL CIRCUITS REFERENCE GUIDE.** By J. Markus & C. Weston. 404/623 Pub. Pr., \$59.95 Club Pr., \$47.50

**INTRODUCING PC-DOS AND MS-DOS, Second Ed.** By T. Sheldon. 565/651 Pub. Pr., \$28.95 Club Pr., \$19.95

**HANDBOOK OF ELECTRONICS CALCULATIONS FOR ENGINEERS AND TECHNICIANS, Second Ed.** Edited by M. Kaufman & A. H. Seidman. 335/281 Pub. Pr., \$49.95 Club Pr., \$37.50

**INTRODUCTION TO DIGITAL SIGNAL PROCESSING.** By J. G. Proakis and D. G. Manolakis. 584954-2 Pub. Pr., \$50.00 Club Pr., \$37.50

**CIRCUIT DESIGN FOR ELECTRONIC INSTRUMENTATION: Analog and Digital Devices from Sensor to Display, Second Ed.** By D. Wobschall. 712/31X Pub. Pr., \$52.95 Club Pr., \$36.95

**BOB MIDDLETON'S HANDBOOK OF ELECTRONIC TIME-SAVERS AND SHORTCUTS.** By R. G. Middleton. 583865-6 Pub. Pr., \$29.95 Club Pr., \$22.50

**DIGITAL AND MICROPROCESSOR TECHNOLOGY, Second Ed.** By P. J. O'Connor. 585184-9 Pub. Pr., \$42.00 Club Pr., \$33.50

**OP-AMP HANDBOOK, Second Ed.** By F.W. Hughes. 583651-3 Pub. Pr., \$39.00 Club Pr., \$27.50

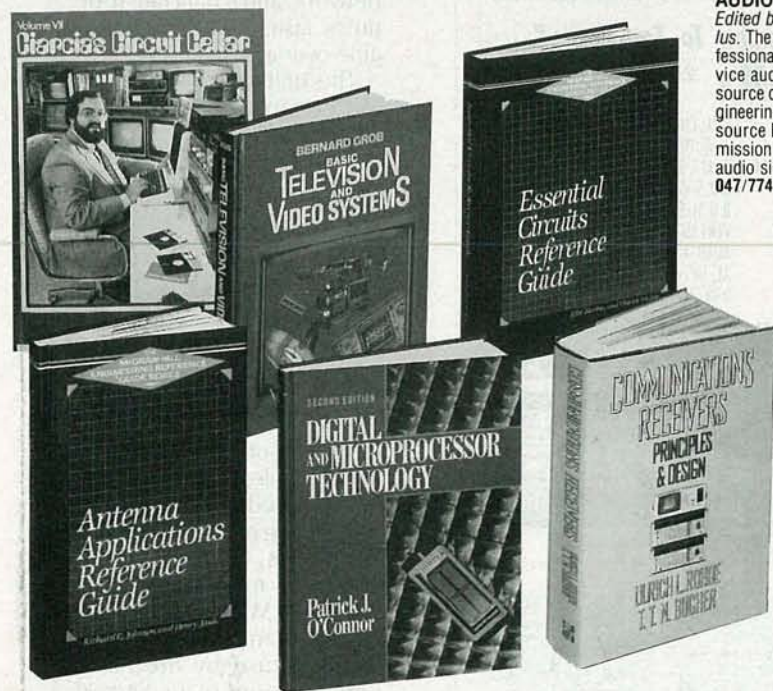

## Here's how the Club works to serve YOU:

### ■ IMPORTANT INFORMATION... WE MAKE IT EASY TO GET!

In our rapidly changing world, those who perform best are those who are best informed. Designed exclusively for the practicing engineer, the Electronics and Control Engineers' Book Club provides you with information that is relevant, reliable, and specific enough to meet your needs. Each Club bulletin comes your way 14-16 times a year and offers you more than 30 books to choose from — the best and newest books from all publishers!

### ■ DEPENDABLE SERVICE... WE'RE HERE TO HELP!

Whether you want information about a book or have a question about your membership, our qualified staff is here to help. Just call us toll-free or write to our Customer Service. We also make sure you get only the books you want. All you do is simply tell us your choice on the Reply Card and return it to us by the specified date. If you want the Main Selection, do nothing — it will be sent to you automatically. (A small shipping and handling charge is added to each shipment.)

### ■ CLUB CONVENIENCE... WE DO THE WORK!

Beyond the benefit of timely information, Club membership offers many other benefits. For example, you get a wide choice of books that cannot be matched by any bookstore — anywhere. And all your books are conveniently delivered right to your door. You also get the luxury of 10 full days to decide whether you want the Main Selection. If you should ever receive a Main Selection you don't want because the Club bulletin came late, just return it for credit at our expense.

### ■ SUBSTANTIAL SAVINGS... AND A BONUS PROGRAM TOO!

In keeping with our goal to provide you with the best information at the greatest possible savings, you will enjoy substantial discounts — up to 40%! — on every book you buy. Plus, you're automatically eligible for our Bonus Book Plan which allows you savings up to 70% on a wide selection of books.

### ■ EASY MEMBERSHIP TERMS... IT'S WORTHWHILE TO BELONG!

Your only obligation is to purchase one more book — at a handsome discount — during the next 12 months, after which you enjoy the benefits of membership with no further obligation. Either you or the Club may cancel membership anytime thereafter.

**FOR FASTER SERVICE IN ENROLLING  
CALL TOLL-FREE 1-800-2-MCGRAW**

**MAIL THIS COUPON TODAY**

### McGraw-Hill Book Clubs Electronics and Control Engineers' Book Club®

P.O. Box 582, Hightstown, NJ 08520-9959

Please enroll me as a member and send me the two books indicated, plus the PORTABLE ELECTRONICS DATA BOOK. I am to receive one book for just \$2.89, the other at the discounted member's price, plus local tax, shipping and handling charges. I agree to purchase a minimum of one additional book during my first year of membership as outlined under the Club plan described in this ad. I understand that a shipping and handling charge is added to all shipments.

Your FREE Data Book	
585390-6	
Write Code No. of the \$2.89 selection here	Write Code No. for the First selection here
<input type="text"/>	<input type="text"/>

Signature \_\_\_\_\_

Name \_\_\_\_\_

Address/Apt. # \_\_\_\_\_

City \_\_\_\_\_

State \_\_\_\_\_ Zip \_\_\_\_\_

This order subject to acceptance by McGraw-Hill. All prices subject to change without notice. Offer good only to new members. Foreign member acceptance subject to special conditions.

ECGA-034

MAY 1990



# VALUE PRICING ON KENWOOD OSCILLOSCOPES FROM Joseph ELECTRONICS

- DIGITAL READOUT
- DELAYED SWEEP
- VIDEO CLAMP
- CURSOR FUNCTIONS
- HIGH SENSITIVITY
- AUTOMATIC TRIGGERING
- HIGH RESOLUTION 12 KV CRT
- 2-YEAR WARRANTY

Model CS-5170



Call Joseph Electronics for value quotes on all KENWOOD models.

KENWOOD "The Company You've Been Listening To For Years."

**40 MHz DUAL-CHANNEL OSCILLOSCOPE**

**VERTICAL MODE** CH1, CH2, DUAL (ALT, CHOP), ADD  
**SENSITIVITY** 1mV/DIV to 5 V/DIV IN 12 RANGES  
**HORIZONTAL MODE** A, ALT, B, X-Y  
**SWEEP TIME** A 0.2 $\mu$ S TO 0.5 S/DIV  $\pm$ 3% (20 ranges)  
 B 0.2 $\mu$ S TO 50mS  $\pm$ 3% (17 ranges)  
**TRIGGER SOURCE** VERT MODE, CH1, CH2, EXT, LINE  
**TRIGGER MODE** AUTO, NORM, FIX, SINGLE-RESET  
**COUPLING** HF rej, DC, TV FRAME, TV LINE  
**PROBES** 2 PC-33 PROBES Included

**100 MHz 2-CHANNEL 4-TRACE OSCILLOSCOPE**

**VERTICAL MODE** CH1, CH2, ALT, CHOP, ADD  
**SENSITIVITY** 1mV/DIV to 5 V/DIV IN 12 RANGES  
**HORIZONTAL MODE** A, ALT, B, X-Y  
**SWEEP TIME** A 0.5 $\mu$ S TO 0.5 S/div  $\pm$ 3% (22 ranges)  
 B 0.5 $\mu$ S TO 50mS/div  $\pm$ 3% (19 ranges)  
**TRIGGER SOURCE** VERT MODE, CH1, CH2, EXT, LINE  
**TRIGGER MODE** AUTO, NORM, FIX, SINGLE-RESET  
**COUPLING** AC, HF rej, DC, TV FRAME, TV LINE  
**PROBES** 2 PC-31 PROBES Included

Model CS-5130  
 Reg. \$1095 **\$899**

**\$1399** Model CS-5170  
 Reg. \$1695

Call or write for our 528 pg. Catalog. Only \$4.95 — FREE with order.

CALL TOLL-FREE - SAME-DAY SHIPPING

**1.800.323.5925**

8830 N. Milwaukee Av. Niles, IL 60648  
 708-297-4200 FAX:708-297-6923

Add \$7.50 Shipping and Handling for each unit ordered. IL Residents add 7% Sales Tax



CIRCLE 190 ON FREE INFORMATION CARD

## ASK R-E

continued from page 12

monitor since the horizontal frequency needed to do 1024  $\times$  768 resolution is beyond the 31-kHz VGA standard. Multisync monitors aren't that much more expensive than regular VGA's, and they are a lot more versatile.

### TWO INTO ONE

I have a stereo amplifier and I want to connect both outputs to one speaker. My reasons for doing that are complicated but it will solve a need I have. The problem is that I don't know exactly how to go about wiring the speaker to the left and right outputs. I'm not that experienced in electronics but it does not seem that all I have to do is connect the two speaker outputs together.—G. Offrey Madison, AL

What you're missing in experience you obviously make up for in intuition. Connecting the two outputs together is more than not a good idea—it's definitely a bad idea. If you did that, you would be running the risk of having one output

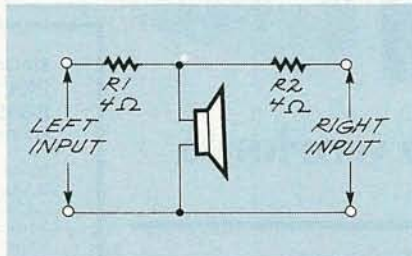

FIG. 2

drive the other. You didn't tell me how powerful your amplifier is but, no matter how many watts you have pouring out of each channel, driving one directly into the other is a sure recipe for an enormous electronic disaster.

The way around the problem is to connect things so that each of the outputs always sees a reasonable load. That's pretty easy to do, and the most straightforward solution is shown in Fig. 2. Make sure the resistors are chunky enough to handle the power output of the amplifier. You didn't give me any numbers but start out with some 2-watt resistors and see how warm they get. If they seem to get much too hot, replace them with a pair of higher wattage resistors. R-E

building, communication to remote sites where telephone service is unreliable or non-existent, and communications within a building where computers are frequently relocated. The SA9600 offers some advantages over other wireless data-communication methods like cellular radio, including lower cost, independence from the telephone network, and a data rate four times faster than that available over a cellular link.

The unit's specialized FM radio transceiver and advanced data-modulation techniques provide a 9600-bits-per-second data rate while requiring less than 3-kHz of bandwidth. The narrow bandwidth allows repeaters normally used for voice data communications to be used for data communications. With a 2-watt transmit output power, the SA9600 can achieve an outdoor line-of-sight range of up to 15 miles. The range can be extended to hundreds of miles using repeaters, power amplifiers, and antennas. The radio modem operates at 450–470 MHz, the UHF frequency band allocated for business use by the FCC. Other versions of the SA9600 operate in the 406–420-MHz federal government band, or in the 420–450-MHz amateur-radio band.

The SA9600 radio modem has a list price of \$3,000.—Megadata Corporation, 35 Orville Drive, Bohemia, NY 11716-2598.

## Lower the numbers and raise the odds.

Controlling your blood pressure can reduce your risk of heart disease.

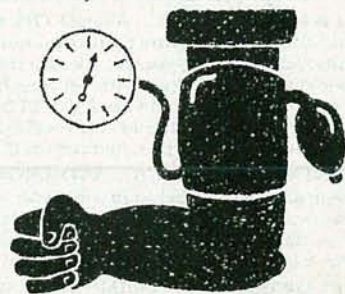

American Heart Association



# NEW LIT

**ELECTRONIC TEST ACCESSORIES.** Five new product groups are featured in *Pomona Electronics'* 138-page *Electronic Test Accessories* catalog. Those include IC test clips, low-cost cable assemblies, and a family of digital multimeter test-lead kits. An index makes it easy

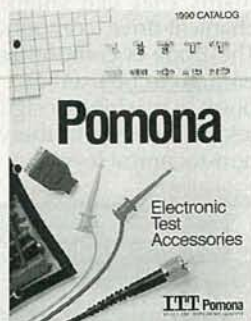

**CIRCLE 21 ON FREE INFORMATION CARD**

to find items in each of ten major product categories, and helpful selection guides are provided for the reader. The brochure contains complete descriptions of Pomona's popular selection of jumpers and cables, boxes, connectors, plugs and jacks, adapters, single-point test clips, and static-control devices. The catalog is free upon request.—**ITT Pomona Electronics**, 1500 East Ninth Street, P.O. Box 2767, Pomona, CA 91769; Tel. 714-629-3317.

**REMOTE-CONTROL REPLACEMENTS.** Designed for servicers, the 1990 edition of *Thomson's* publication, *Remote Controls for RCA and GE Instruments* (#1F5790), contains all avail-

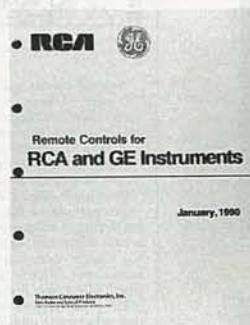

**CIRCLE 22 ON FREE INFORMATION CARD**

able direct-replacement remote-control hand units for RCA and GE televisions, video recorders, videodisc players, camcorders, and audio components. The catalog is divided into three sections. The first two parts contain cross-reference material

both in model-number and remote-type-number sequences. The last section contains photographs of over 220 different remotes, to help the reader identify the correct model.—**Thomson Consumer Electronics**, Distributor and Special Products, 2000 Clements Bridge Road, Deptford, NJ 08096-2088, ATTN: Service Dealer Merchandising.

**TEST & MEASUREMENT INSTRUMENTS.** The 1990 *Fluke and Philips Test & Measurement Catalog* highlights 20 new products in a full-color introduction section. Several features designed to help customers choose the equipment that best fits their test and measurement re-

**With Just One Probe Connection, You Can Confidently Analyze Any Waveform To 100 MHz, 10 Times Faster, 10 Times More Accurately, Absolutely Error Free, Guaranteed — Or Your Money Back!**

**SC61 Waveform Analyzer™**  
Patented  
**\$3295**



There are other digital readout oscilloscopes, but none of them completely eliminate graticule counting and calculations like the SC61 Waveform Analyzer. The innovative, time-saving **AUTO-TRACKING™** digital readout automatically gives you every waveform parameter you need for fast troubleshooting.

The SC61 Waveform Analyzer is a triple patented high performance scope that provides you with a digital LCD read-out of all key waveform parameters (DC volts, peak-to-peak volts, and frequency) at the push of a button, and all with one probe connection.

Other time-saving features include exclusive ECL sync circuits that allow you to lock quickly onto waveforms up to 100 MHz. Plus, with 3000 volts of input protection, you never have to worry about an expensive front end repair job.

Call **1-800-SENCORE** to find out more about what the SC61 can do for your service business. In Canada call **1-800-SENCORE**.

**SENCORE**

3200 Sencore Drive, Sioux Falls, SD 57107

100% American Made

**CIRCLE 188 ON FREE INFORMATION CARD**

MAY 1990

33



## ! STOP ! COMPUTER RADIATION

Have you ever observed the situation where an electric device is adversely affected by a nearby computer? We look at the waveform in the time domain and think we understand it.

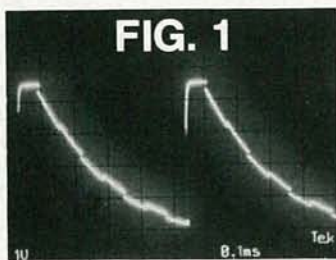

time

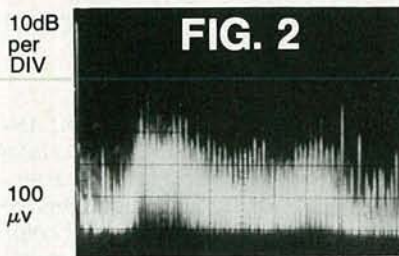

frequency 100MHz

The scope photos show the wave form being conducted by ribbon between shielded circuit and keyboard within a computer, in both time (fig. 1) and frequency (fig. 2) domain. The Spectrum Probe is placed directly on the line and has no effect on the waveform because of the low capacity input. Clock and waveform harmonics are low — but unnecessary spurious is radiated by this lead up to about 70MHz.

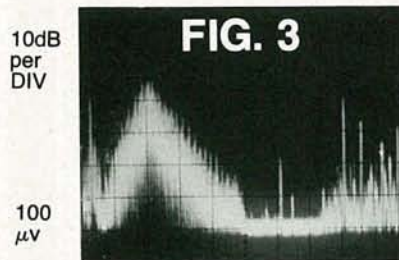

frequency 100 MHz

Fig. 3 shows the waveform being connected to the outside world (read "radiated") by a rear panel connector. There is no digital information present, yet there is extremely high and completely unnecessary spurious energy at about 20MHz. Most spectral lines above 50MHz are due to residual pickup of RF, even without connecting an exterior lead, indicating that a reasonably good radiating antenna is present!

**107 SPECTRUM PROBE**  
converts any scope into a  
100MHz spectrum analyzer

**\$199** direct

Smith Design 1324 Harris Rd.  
Dresher, PA 19025 (215) 643-6340

CIRCLE 196 ON FREE INFORMATION CARD



New solid-state and digital TV sets, stereos, and video recorders are tougher to repair than old-fashioned tube type sets and require special training for the service technician who works on them.

Only a few states have laws requiring competency tests for licensing technicians who repair consumer electronics, but fifteen years ago the International Society of Certified Electronic Technicians (CET) began its own certification program to qualify these technicians and those in industry. To carry the CET designation, technicians must have four years experience and pass a rigid examination on general electronics and a specific area of expertise such as audio or radio-TV.

Many consumers look for a Certified Electronic Technician in the shop when they need any electronic item repaired.

**Free Consumer Checklist**  
A consumer checklist for selecting a service shop is available free by sending a stamped, self-addressed envelope to: Checklist, IS CET, 2708 West Berry, Fort Worth, TX 76109. The list reminds consumers to check such items as "Does the business have the parts for your particular brand?", "Did you get an estimated price?", and "Did you check this company with the Better Business Bureau?"



Modern electronic equipment such as digital TVs or stereos should be repaired by specially trained people.

available free by sending a stamped, self-addressed envelope to: Checklist, IS CET, 2708 West Berry, Fort Worth, TX 76109. The list reminds consumers to check such items as "Does the business have the parts for your particular brand?", "Did you get an estimated price?", and "Did you check this company with the Better Business Bureau?"



CIRCLE 23 ON FREE  
INFORMATION CARD

requirements have also been added. Those include a rack-mount selection guide, a glossary of terms, and an abbreviations and symbols section. All products and services are also indexed both alphabetically and numerically. The 536-page publication provides descriptions, photographs, product-selection guides, and ordering information for more than 650 products, accessories, and software programs. Product lines in 18 major categories are included, as well as listings of available technical literature and worldwide sales offices, technical centers, and authorized distributors. There is no charge for the catalog.—**John Fluke Mfg. Co., Inc.**, P.O. Box 9090, Everett, WA 98206; Tel. 1-800-443-5853.

**ENGINEERING SOFTWARE.** *BSOFT Software Engineering Tools #3* contains descriptions and ordering information for several new products and new versions of existing software. Designed for students, hobbyists, and professional engineers, it includes low-cost stand-alone engineering programs for IBM-PC's and compatibles. Programs are offered for drawing schematics, simulat-

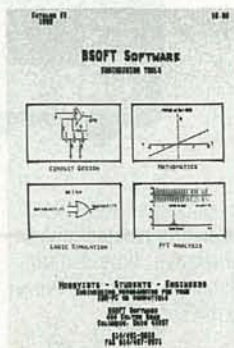

CIRCLE 24 ON FREE  
INFORMATION CARD

ing logic-control circuits, and circuit analysis. CAD programs for designing circuits and PC boards are offered, along with computer-aided mathematics and waveform-viewer software. The catalog is free upon request.—**BSOFT Software**, 444 Colton Road, Columbus, OH 43207; Tel. 614-491-0832.

**SMALL-MECHANISM DESIGN.** A 784-page technical data book from *Stock Drive Products*, titled *Design and Application of Small Standardized Component* (Data Book 757), helps the reader learn how to design mechanisms that use small mechanical-drive components. The book is comprehensive enough to be used as a textbook in machine design and related courses at the vocational-technical level.



CIRCLE 25 ON FREE  
INFORMATION CARD

A special 51-page section on robotic component design includes a detailed specification guide comparing 42 performance features of 147 industrial- and teaching-class robots. Other major sections in the book cover design procedure, selection, and application data for designing with small gears, belt and chain drives, speed reducers, AC motors, miniature DC motors, gear trains, stepper motors, constant force springs, universal joints, and vibration mounts. A "Designer's Data Section" includes more than 50 tables such as mathematical formulas, conversion and units, and material properties.

Data Book 757 costs \$7.95 postpaid in paperback, or \$12.95 for hardcover.—**Educational Products**, P.O. Box 606, Mineola, NY 11501. R-E



## LETTERS

continued from page 16

a cement. Avoid breathing the fumes.

I bought the 100-watt heater at an electronics parts store, and later found the same unit, but marked for aquarium use, for less money at a pet supply store. The air pump I bought is designed for medium-size aquariums.

Your magazine and its predecessors have been on my workbench for about 50 years, and I've built so many of your projects that I've lost count. I like the editorial mix the way it is now—some new stuff, some like the etching tank, and some on computers. Don't forget us old "tube-type" guys who know how tubes work, but aren't really sure about solid-state circuits. I use a TI-99/4A computer, and I'd like to see some programs written in pure BASIC so I could convert them to TI BASIC (although I'm one of the few who use the orphan).

Thanks for a great magazine, and keep it coming.

DAVID C. SWARTZ  
Aurora, CO

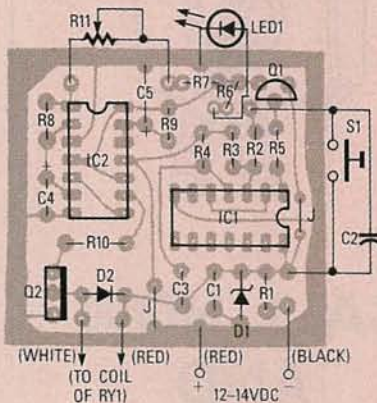

### CORRECTION

Due to a printing error, the parts-placement diagram in our "Solid State Wiper Control" story (*Radio Electronics*, April 1990) was shown improperly registered. We have correctly reprinted that figure here.

### CONSUMER ASSISTANCE

Radio-Electronics readers might be interested in the Consumer Complaint Assistance/Inquiries Program of the Electronic Industries As-

sociation's Consumer Electronic Group (EIA/CEG). The EIA/CEG represents major manufacturers of televisions, VCR's, audio and video systems, telephones, personal computers, and home-office products. The program was set up to help individual consumers who are having difficulties resolving complaints with manufacturers. Our office acts as a catalyst, mediator, or arbitrator in disputes between the consumer and the (member or non-member) manufacturer.

There is a standard procedure: First, the consumer should try to resolve the complaint at the retail level. If that fails, the manufacturer whose address is on the warranty card should be contacted. If the consumer feels that the manufacturer has not resolved the problem satisfactorily, the consumer should contact this office, by mail or by phone (collect calls are accepted only on safety-related problems). The consumer must be prepared to supply his name, address and phone number; the product's brand name, model number, and serial number; date of purchase; dealer's name and address; service history, including itemized invoices and work orders. The consumer will be asked for a brief, concise statement of the problem and of the resolution being sought.

All complainants will receive individual replies. Our office forwards the complaint to corporate personnel who are in a position to handle it, and each case is followed to its conclusion. If this office is not involved in the dispute, we will arbitrate. Our decision is binding on the manufacturer involved, but not on the consumer.

The EIA/CEG also publishes consumer-education materials in the form of pamphlets. Send a letter to SASE EIA/CEG, P.O. Box 19100, Washington, DC 20036 to receive the Consumer Publications List, which provides titles and postage costs for these pamphlets.

SALLY BROWNE,  
EXECUTIVE DIRECTOR  
STEPHANIE L. BROWN,  
STAFF DIRECTOR  
EIA/CEG

Consumer Complaint Assistance/  
Inquiries Program  
2001 Eye Street, N.W.  
Washington, DC 20006

R-E

## Put Professional Knowledge and a COLLEGE DEGREE in your Technical Career through HOME STUDY

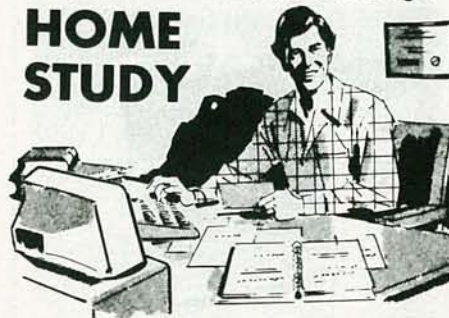

Add prestige and earning power to your technical career by earning your Associate or Bachelor degree through directed home study.

Grantham College of Engineering awards accredited degrees in

### electronics and computers.

An important part of being prepared to *move up* is holding the right college degree, and the absolutely necessary part is knowing your field. Grantham can help you both ways—to learn more and to earn your degree in the process.

Grantham offers two degree programs—one with major emphasis in **electronics**, the other with major emphasis in **computers**. Associate and bachelor degrees are awarded in each program, and both programs are available completely by correspondence.

No commuting to class. Study at your own pace, while continuing on your present job. Learn from easy-to-understand lessons, with help from your Grantham instructors when you need it.

Write for our free catalog (see address below), or phone us at toll-free 1-800-955-2527 (for catalog requests only) and ask for our "degree catalog."

Accredited by  
the Accrediting Commission of the  
National Home Study Council

**GRANTHAM**  
College of Engineering  
10570 Humbolt Street  
Los Alamitos, CA 90720

MAY 1990



# Radio-Electronics mini-ADS



**FREE CATALOG OF HARD-TO-FIND TOOLS** is packed with more than 2000 quality items. Your single source for precision tools used by electronic technicians, engineers, instrument mechanics, schools, laboratories and government agencies. Also contains Jensen's line of more than 40 tool kits. Send for your free copy today! **JENSEN TOOLS INC., 7815 46th St., Phoenix, AZ 85044. (602) 968-6231.**

CIRCLE 115 ON FREE INFORMATION CARD



**GET YOUR RECHARGE CATALOG FREE...EARN BIG \$\$ IN YOUR SPARE TIME**—All supplies and Do-It-Yourself kits with complete instructions available. Supplies cost from **\$9.95** in qty and you can sell recharged toner cartridges for **\$40.00** to **\$55.00** each. Printers include HP LaserJet and Series II, Apple LaserWriter, QMS, etc. Canon PC-25 Copier also. **CHENESKO PRODUCTS, 62 N Colemam Rd., Centereach, NY 11720, 516-736-7977, 800-221-3516, Fax: 516-732-4650**

CIRCLE 193 ON FREE INFORMATION CARD



**THE MODEL WTT-20 IS ONLY THE SIZE OF A DIME**, yet transmits both sides of a telephone conversation to any FM radio with crystal clarity. Telephone line powered - never needs a battery! Up to 1/4 mile range. Adjustable from 70-130 MHz. Complete kit **\$29.95 + \$1.50 S+H**. Free Shipping on 2 or more! COD add \$4. Call or send VISA, MC, MO. **DECO INDUSTRIES, Box 607, Bedford Hills, NY 10507. (914) 232-3878.**

CIRCLE 127 ON FREE INFORMATION CARD



**CABLE TV CONVERTERS AND DE-SCRAMBLERS** SB-3 \$79.00 TRI-BI \$95.00 MLD-\$79.00 M35B \$69.00 DRZ-DIC \$149.00. Special combos available. We ship COD. Quantity discounts. Call for pricing on other products. Dealers wanted. **FREE CATALOG**. We stand behind our products where others fail. One year warranty. **ACE PRODUCTS, P.O. Box 582, Saco, ME 04072 1 (800) 234-0726.**

CIRCLE 75 ON FREE INFORMATION CARD



**APPLIANCE REPAIR HANDBOOKS**—13 volumes by service experts; easy-to-understand diagrams, illustrations. For major appliances (air conditioners, refrigerators, washers, dryers, microwaves, etc.), elec. housewares, personal-care appliances. Basics of solid state, setting up shop, test instruments. **\$2.65 to \$7.90 each**. Free brochure. **APPLIANCE SERVICE, P.O. Box 789, Lombard, IL 60148. (312) 932-9550.**

CIRCLE 84 ON FREE INFORMATION CARD

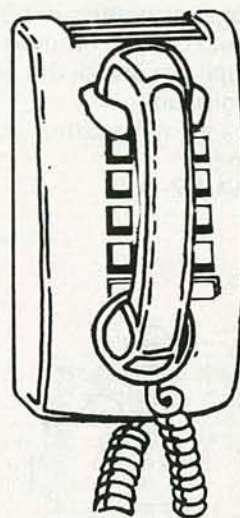

## CALL NOW AND RESERVE YOUR SPACE

- 6 x rate \$940.00 per each insertion.
- Fast reader service cycle.
- Short lead time for the placement of ads.
- We typeset and layout the ad at no additional charge.

Call **516-293-3000** to reserve space. Ask for Arline Fishman. Limited number of pages available. Mail materials to: mini-ADS, RADIO-ELECTRONICS, 500-B Bi-County Blvd., Farmingdale, NY 11735.

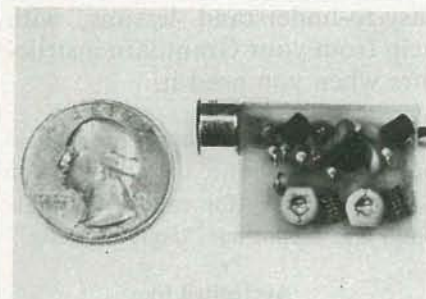

**SIMPLY SNAP THE WAT-50 MINIATURE FM TRANSMITTER** on top of a 9v battery and hear every sound in an entire house up to 1 mile away! Adjustable from 70-130 MHz. Use with any FM radio. Complete kit **\$29.95 + \$1.50 S+H**. Free shipping on 2 or more! COD add \$4. Call or send VISA, MC, MO. **DECO INDUSTRIES, Box 607, Bedford Hills, NY 10507. (914) 232-3878.**

CIRCLE 127 ON FREE INFORMATION CARD



**ELEVEN-PIECE RACHET TOOL KIT** Includes reversible ratchet handle, extension bar, six bits, two precision screwdrivers, and a cutter. Comes in fitted case. Get one for your shop, another for your car, another for your tool kit. To order send **\$11.75** USA shipping only. **ELECTRONIC TECHNOLOGY TODAY INC., PO Box 240, Massapequa Park, NY 11762-0240.**



## WARNING

Please note that unauthorized (i) reception of cable service, (ii) satellite decoding, or (iii) video decoding or copying is illegal under Federal and State law. Federal law renders illegal both the interception and reception of any communication service offered over a cable or satellite system, or the decoding or copying of videos unless specifically authorized by law. Federal law imposes both civil and criminal penalties for violations of the applicable statutes. In addition, most if not all of the states have enacted "theft of cable services" statutes imposing penalties for violation thereof. Thus, the use of the unit described in this article should be restricted to educational, scientific, and/or informational purposes and prior to the use thereof authorization should be obtained from your cable service company, satellite transmission service or video producer. This is not intended to constitute legal advice as to the propriety of their use thereof based upon their individual circumstances and jurisdictions.

**RUDOLF F. GRAF and WILLIAM SHEETS**

WE'VE ALL ENCOUNTERED VIDEO SIGNALS with missing, weak, or noisy sync pulses that can make it difficult or impossible to use the signal. Those disturbances may cause rolling, tearing, or other instability in the displayed video image. The example we're most familiar with is a scrambled TV signal, or a Macrovision-encoded video tape. The unit will restore usable sync to virtually any video signal. You can use it to watch one scrambled show while taping another, to clean up Macrovision when watching a video tape, or to simply restore clean sync to a noisy video signal.

Another difficulty is that the video itself may be incorrectly phased (negative, for example). While that is more of an interface problem than a transmission problem, it usually results in a picture that has its tones reversed or colors shifted in hue due to phasing differences between the correct burst (reference) signal and the burst signal actually received.

Very often, the distortions are deliberately introduced into the video signal to prevent unauthorized reception, or to introduce other obstacles to

# UNIVERSAL DESCRAMBLER

*Restore missing video sync signals with our universal decoder.*

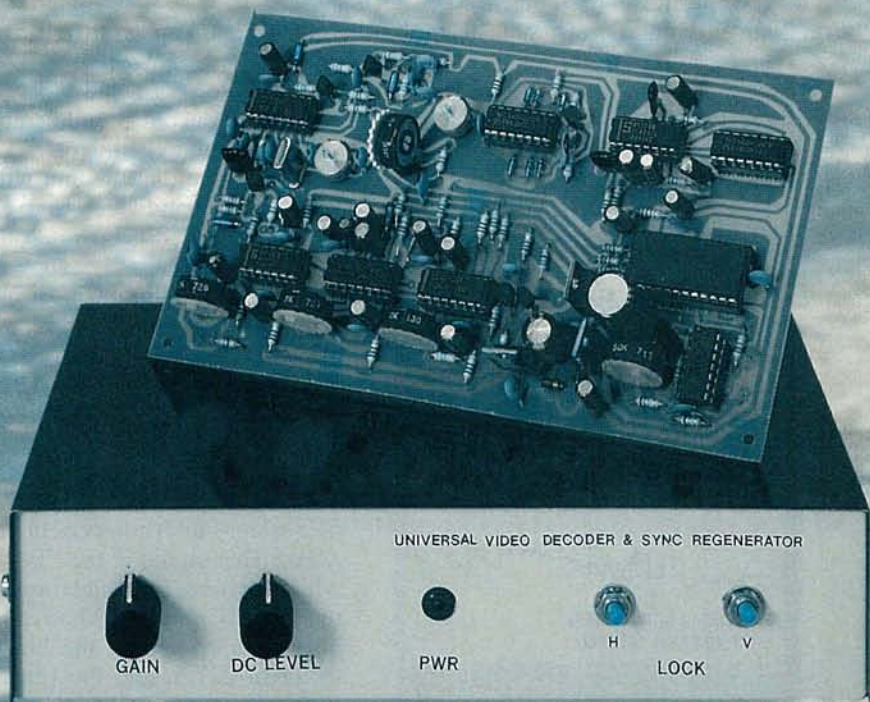

their misuse. One example is "copy guard," a technique used to discourage unauthorized copying of video tapes, and another case is scrambling, used on cable systems to prevent unauthorized viewing.

In order to deal with those problems, a dedicated "decoder" box or other such device is used. The device is generally useful for only one type of coding or scrambling scheme.

The technique of sync suppression and/or video inversion is used on both cable and satellite video transmissions. How that works is simple; the sync pulses are altered in either level

or total amplitude, or omitted entirely from the video (see Fig. 1). The video may also be inverted, although that is not always done. Sometimes the sync pulses may be suppressed to random levels, at different times. That is done to "confuse" unsophisticated decoders, and make video piracy more difficult.

With all of those schemes, a "key" or pilot signal must be sent along with the scrambled signal in order to properly reconstruct the missing or distorted sync signal. The key or pilot signal may take several forms. An audio subcarrier, usually 15.7, 31.5 or



94 kHz (or some other frequency that has a fixed ratio to the horizontal-sync frequency of 15.734 kHz) is added to the video signal, and is used by the decoder as a reference to reconstruct the sync signal. Sometimes a digital "addressing" signal is used to activate and deactivate the decoder. For our purposes, though, the addressing signals can be ignored since they are not involved in the scrambling and descrambling process.

Another method makes use of a series of horizontal pulses immediately following the vertical-sync pulses to phase lock a horizontal frequency oscillator in the decoder. That, in turn, is used to regenerate the missing or suppressed horizontal sync. That system is known as a "pilotless" method, and that's because no pilot subcarrier is sent along with the audio.

All of those methods have one thing in common: They all alter the sync information. But in order to decode the signal, there must be a key of some kind present in the signal that can be used to reconstruct the sync.

Sometimes, as a scrambling tech-

versed. Dark areas will be light, greens will appear as red, etc. One would assume that simply inverting the video would correct that problem. However, only the video must be inverted, not the sync. Sync must be left in original form. That requires separate sync and video channels and a means of splitting the video from the sync.

This article will discuss a single-circuit device that can be used to regenerate any of those distorted video signals. The device will:

1. Regenerate missing or distorted sync.
2. Remove interfering signals from the sync pulses due to scrambling, noise, etc.
3. Invert (or revert) video polarity.
4. Change the DC level of video (brightness).
5. Adjust the contrast levels (luminance).
6. Correct tint distortion (color shifts).
7. Generate scrambled video signals for testing decoders and scrambling/descrambling experiments.

Please note that the unit will work only on baseband video from DC to 4 MHz. It does not operate on audio signals.

**WARNING:** this device is intended for experimental use, and is definitely not intended for the theft of scrambled material. See the box in the beginning of this article.

### How it works

Present in all (NTSC) video signals is a color-burst component at 3.58 MHz. That signal is the "key" from which all other sync and timing information is derived. The horizontal frequency is related to the burst by a factor of  $227\frac{1}{2}$ , and the vertical frequency is related to the horizontal frequency by a factor of 525 (NTSC video only). If there is some burst signal present, even if noisy, the decoder system will be able to use it to generate the necessary signals. It will not remove video noise during the scan intervals (noisy picture), only the sync so that lockup is possible. Figure 2 is a block diagram of the sync regenerator.

Video input at J1 is split two ways: One portion goes through level-control R2 into a video amplifier. It is amplified by a factor of ten and fed to a polarity-selector circuit. The switch selects the desired polarity (usually

negative) and feeds it to a clamp circuit. There the blanking pedestal (blackest black) is clamped at zero volts DC, and the DC video level is established by referencing the scan portion (line scan) to a variable DC level set by the clamp or DC-level control. That feature allows independent control of scene brightness. Next, the video-plus-blanking signal is fed to a sync combiner where a pulse of approximately  $-0.4$  volts is added to the video. The output of the sync combiner is fed to a burst keyer where a new burst signal is added to the signal. Now we have a complete NTSC signal at the output of the burst keyer, having a zero-volt DC blanking level,  $-0.4$ -volt negative sync, and a 0- to 1-volt video level. A video output driver is used to interface a 75-ohm load to the output of the burst keyer.

The requisite components of the sync portion are derived from a CD2240 CMOS LSI video sync generator that operates from a 1.08-MHz clock circuit. The clock signal is generated by a clock oscillator that is phase locked to a reference derived from the original "defective" video signal as follows: The 3.58-MHz components are extracted by a 3.58-MHz filter and fed to a 3.58-MHz oscillator circuit. The circuit is similar to the 3.58-MHz oscillator circuit used in color TV reception. The oscillator is keyed on during the burst interval so it "looks" only at the burst signal on the original video signal. The signal then feeds both the burst keyer and a divide-by-455 circuit that has an output at 7.9 kHz (nominally). Next, the 7.9-kHz signal is used as a reference to phase-lock the 1.08-MHz clock oscillator. The 1.08-MHz oscillator is therefore phase coherent with the original video signal's color burst.

Note that the sync portion of the original video signal (if present) is simply discarded. Therefore it does not matter if the sync was noisy, missing, or at the wrong level. A new sync is generated and inserted.

### Circuitry

Figure 3 is a detailed circuit schematic. Input video at J1 appears across termination resistor R1. If desired, R1 may be omitted for a 1K input impedance rather than 75 ohms. Resistor R2 controls the level of video signal fed to IC1, an LM733 differen-

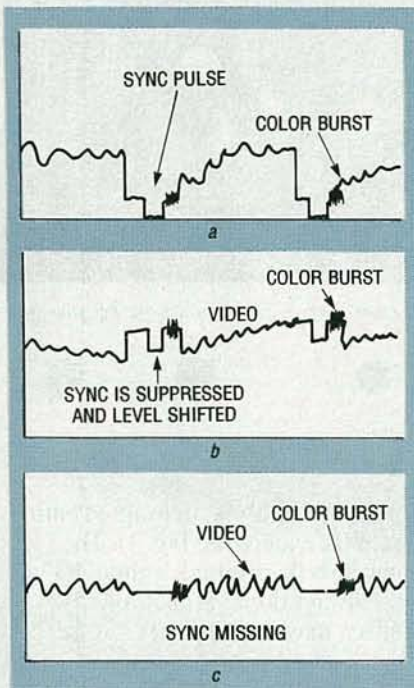

**FIG. 1—THE SYNC PULSES** are altered in either level or total amplitude, or omitted entirely from the video. The video may also be inverted. Sometimes the sync pulses may be suppressed to random levels, at different times.

nique, the video is inverted. If that's the case, you would see a picture, but the tones and colors would be re-



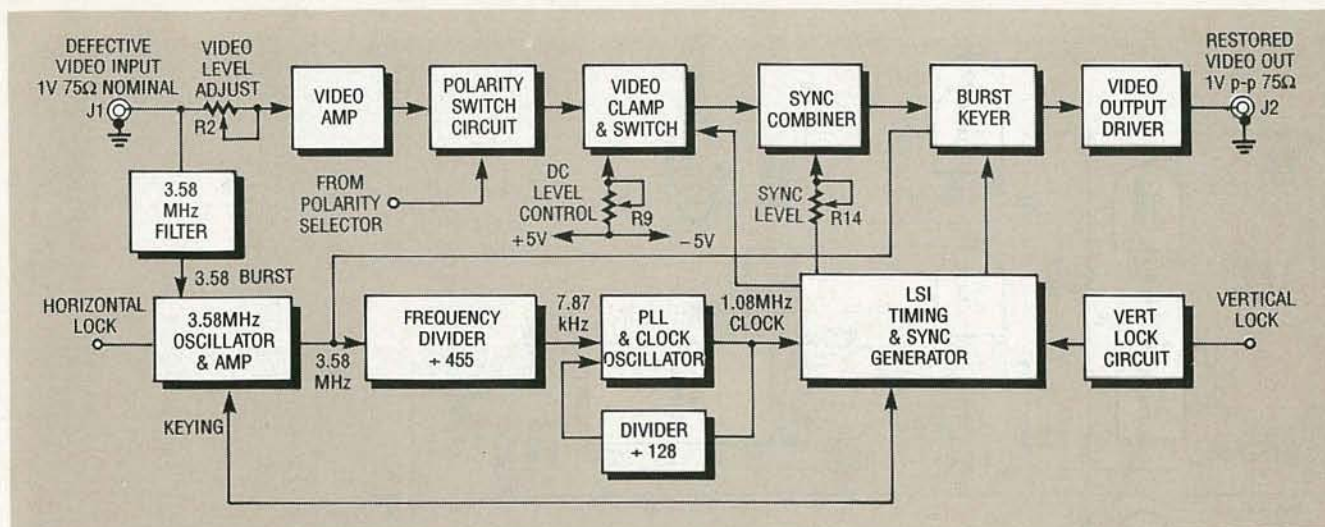

FIG. 2—HERE IS A BLOCK DIAGRAM of the sync regenerator. The circuit removes the "defective" sync and replaces it with a good one.

tial video amplifier, through coupling capacitor C1. R3 and R4 are bias resistors for IC1, which obtains DC power through decoupling networks R5, C2, and C3, and R6, C4, and C5; IC1 produces both an in-phase and a 180° out-of-phase signal at pins 8 and 9.

The two signals from IC1 are fed to a portion of IC2, a CD4053BE triple 2-channel analog multiplexer, which is used like an analog switch. The video polarity is controlled by the logic level at pin 10; S3 grounds pin 10 if reverse polarity is desired. R7 is a pull-up resistor for pin 10. The signal from the common pole of the switch is coupled through C6 to clamp-switch IC2-b and to switch IC2-c. During horizontal back-porch (black) periods, pin 3 of IC2-b and the negative side of C6 is clamped to a DC voltage determined by R9. Capacitors C11 and C12 form a bipolar bypass electrolytic. That sets the DC clamping level of the video signal.

During blanking intervals, the output at IC2-c pin 4 is switched from video to ground. Therefore, pin 4 has a ground level during blanking intervals and video during scan intervals. The original "defective" sync is not passed along. Instead, a new, ground-level blanking pedestal is inserted. Power-supply decoupling networks for IC2 are formed by C9, C10, and R12, together with R8, C7, and C8.

Video that has been stripped of its original sync at pin 4 of IC2-c is fed to pin 1 of IC3-a and on to the output of IC3-a at pin 15. During sync intervals, a -0.4-volt level (set by R14) is fed to pin 15. Therefore, the output

from IC3-a at pin 15 is a video signal with zero volts blanking level and -0.4-volt sync tips added. Resistor R13 and C13 are decoupling and bypass components.

All that's missing now is the 3.58-MHz color-burst signal. That is added through switch IC3-b. The burst signal comes from the oscillator and amplifier circuit to be discussed later via R45. The signal rise time to the control input of IC3-b is limited by R44, and R15 is a bias resistor. Components Q5, Q6, R16, C16, R17, and R18 form a unity-gain video driver. The output (corrected video) across R18 is fed to output jack J2.

In order to correctly perform all of the switching, timing signals are necessary. The 3.58-MHz components of the input video are picked off by filter C17 and L1 and fed to IC5 via R20, R21, and C18. When the horizontal-lock switch S1 is closed, Q1 is turned on, shorting the 3.58-MHz signal to ground. That function is used for both setup and establishing proper sync relations upon initial lockup. Since the oscillator initially cannot "know" which portion of the 3.58-MHz signal is the burst, pushbutton S1 is momentarily depressed. That causes the restored video image to roll horizontally on the video display. Switch S1 is held depressed until the image is correctly formed (centered). At that point, the sync relations are correct and the oscillator will lock up to correct phase. Actually, that will happen eventually anyway, since the only constant 3.58-MHz signal is the burst and, sooner or later, it will slip in and lock up. Once locked up, the circuit is

stable. A momentary loss of video may cause loss of lock in some instances. To correct that, depress S1 and reestablish lock.

Oscillator IC5 generates a 3.58-MHz signal that's phase-locked to the input signal. Components C19, R24, C21, and C22 form a loop filter, and C16, C27, and L3 are for power-supply decoupling. Crystal XTAL1, R25, C23, C24, and C25 form the oscillator circuit for IC5, and Q2, R26, R27, and R28 form a pulse-inverter circuit. The PLL circuit in IC5 is keyed on only during burst intervals; a burst-key pulse at pin 9 (produced by Q2) is used for that. Without that pulse, IC5 will not maintain a stable lock to the burst component from C18. Trimmer C24 adjusts the oscillator free-run frequency.

The 3.58 MHz CW signal, referenced to the burst from the input signal, is fed to amplifier Q3, and associated components (R30, R31, bypass-capacitor C29, R31, and L2—R32 is a bias resistor). Trimmer capacitor C32 and C30 tune L2 to 3.58 MHz; C32 is used to adjust the phase of the 3.58-MHz burst reference to compensate for tint (hue) variations, and C31 is a DC blocking capacitor. The 3.58-MHz signal (about 8–10 volts p-p) is fed to R34 and IC6. Components R34, R35, C41, and L4 form a network for coupling the 3.58-MHz signal through R45 to IC3-b, the burst keyer. Potentiometer R34 sets the burst level that appears on the corrected-video output at J2.

CMOS frequency divider IC6, along with diodes D1–D6, Q4, R36, R37, and C34, is used as a divide-



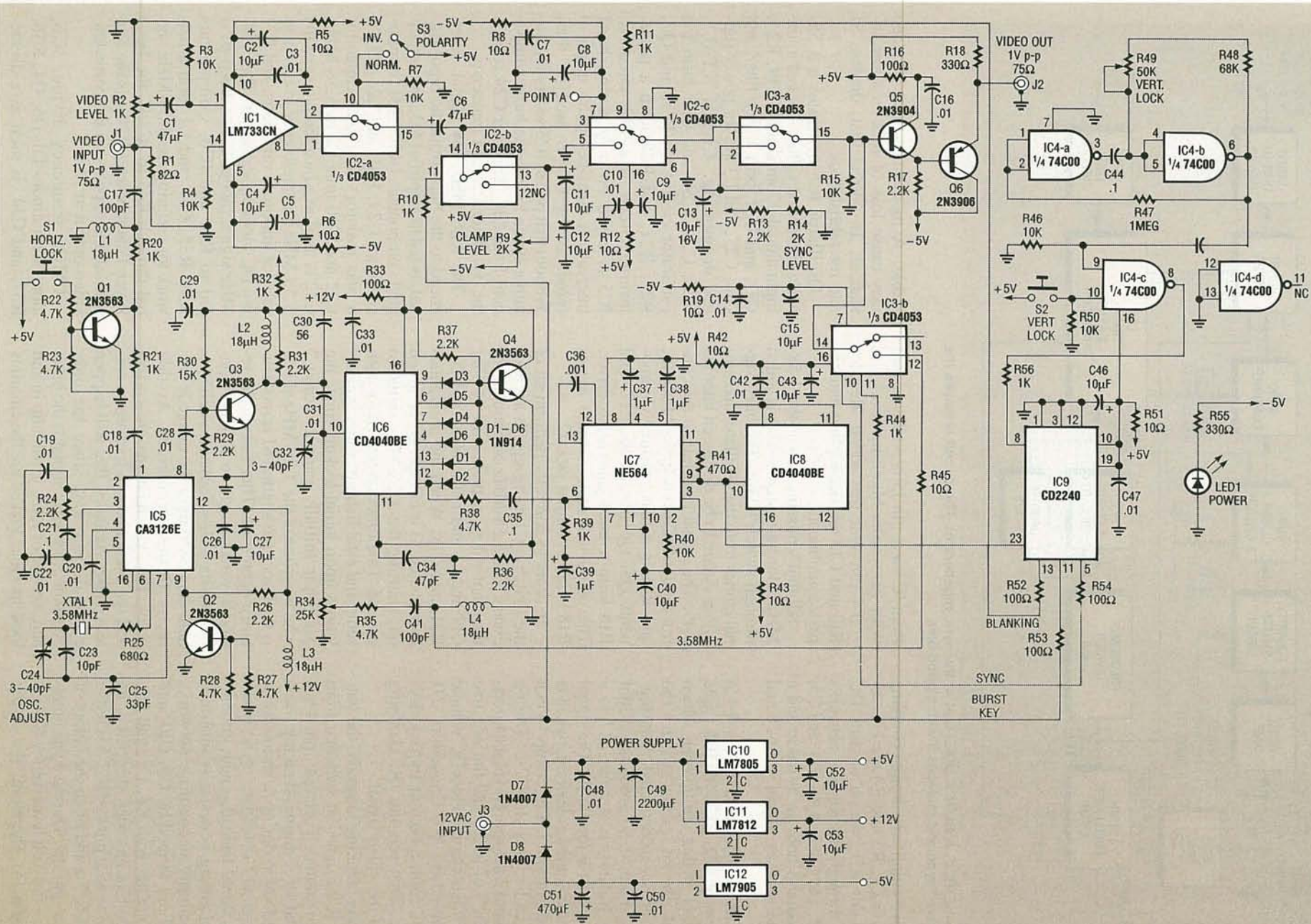

FIG. 3—SYNC REGENERATOR SCHEMATIC. "Defective" video is input at J1. It is then stripped of its sync, given new sync, and then output at J2.



## PARTS LIST

All resistors are 1/4-watt, 5%, unless otherwise noted.

R1—82 ohms  
 R2—1000 ohms, potentiometer with shaft  
 R3, R4, R7, R15, R40, R46, R50—10,000 ohms  
 R5, R6, R8, R12, R19, R42, R43, R45, R51—10 ohms  
 R9—2000 ohms, potentiometer with shaft  
 R10, R11, R20, R21, R32, R39, R44, R56—1000 ohms  
 R13, R17, R24, R26, R29, R31, R36, R37—2200 ohms  
 R14—2000 ohms, potentiometer  
 R16, R33, R52—R54—100 ohms  
 R18, R55—330 ohms  
 R22, R23, R27, R28, R35, R38—4700 ohms  
 R25—680 ohms  
 R30—15,000 ohms  
 R34—25,000 ohms, potentiometer  
 R41—470 ohms  
 R47—1 megohm  
 R48—68,000 ohms  
 R49—50,000 ohms, potentiometer

### Capacitors

C1, C6—47  $\mu$ F, 16 volts, electrolytic  
 C2, C4, C8, C9, C11—C13, C15, C27, C40, C43, C46, C52, C53—10  $\mu$ F, 16 volts, electrolytic  
 C3, C5, C7, C10, C14, C16,

C18—C20, C22, C26, C28, C29, C31, C33, C42, C45, C47, C48, C50—0.01  $\mu$ F, ceramic disc  
 C17, C41—100 pF, NPO  
 C21, C35, C44—0.1  $\mu$ F, Mylar  
 C23—10 pF, NPO  
 C24, C32—3–40 pF, trimmer  
 C25—33 pF, NPO  
 C30—56 pF, NPO  
 C39—47 pF, NPO  
 C36—0.001  $\mu$ F, Mylar  
 C37—C39—1  $\mu$ F, 50 volts, electrolytic  
 C49—2200  $\mu$ F, 16 or 25 volts, electrolytic  
 C51—470  $\mu$ F, 16 or 25 volts, electrolytic

### Semiconductors

IC1—LM733CN differential video amplifier  
 IC2, IC3—CD4053BE triple 2-channel analog multiplexer  
 IC4—74C00N quad 2-input NAND gate  
 IC5—CA3126E TV chroma processor  
 IC6, IC8—CD4040BE ripple carry binary counter/divider  
 IC7—NE564N—phase-locked loop  
 IC9—CD2240 CMOS LSI video sync generator  
 IC10—LM7805 +5-volt regulator  
 IC11—LM7812 +12-volt regulator  
 IC12—LM7905 -5-volt regulator  
 D1—D6—1N914B small signal diode  
 D7, D8—1N4007 rectifier diode  
 LED1—light-emitting diode, any color

D7, D8—1N4007 rectifier diode  
 LED1—light-emitting diode, any color

### Other components

L1—L4—18  $\mu$ H choke  
 XTAL1—3.58 MHz crystal, 0.005%, 32 pF, fundamental mode, parallel resonant  
 J1, J2—RCA-type phono jack  
 J3—2.5 mm power jack  
 S1, S2—N.O. pushbutton switch  
 S3—SPST toggle switch

**Miscellaneous:** cabinet (Radio Shack # 270-272A is perfectly suited), hardware as required, IC sockets (if desired), 12-volt AC, 350 mA wall transformer or other power transformer (see text)

**Note:** A complete parts kit, including the PC board, switches, potentiometers, jacks and plugs, and all parts that mount on the PC board is available from North Country Radio, P.O. Box 53, Wykagyl Station, NY 10804. Price for the kit is \$92.50 + \$2.50 shipping and handling. A wall transformer is available for \$8.75 extra when ordered with the kit. A partial kit consisting of only the PC board and IC1 through IC12 is available for \$72.50 + \$2.50 shipping and handling. Case is not included in either kit.

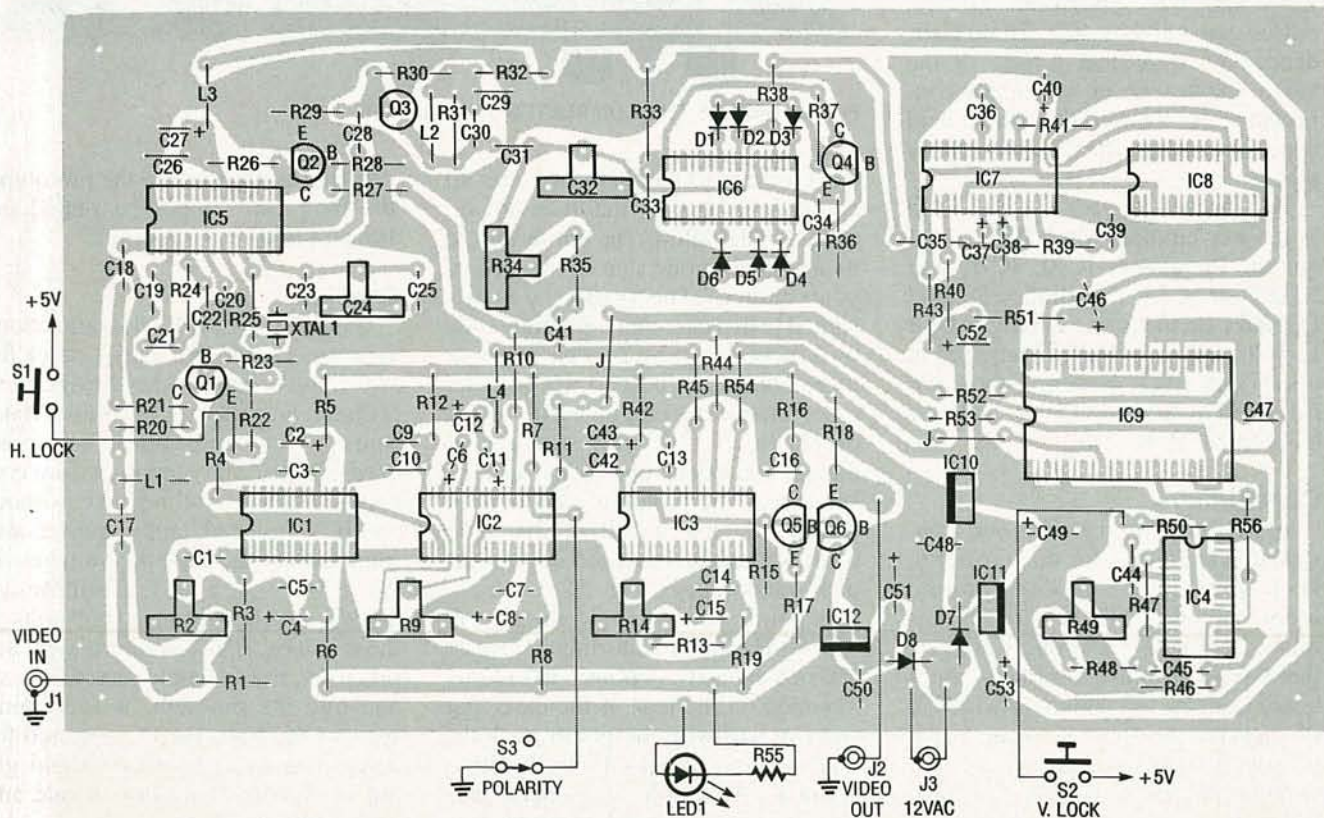

FIG. 4—PARTS-PLACEMENT DIAGRAM for the sync regenerator.



by-455 circuit. That results in a 7.87-kHz signal at pin 12 of IC6; the signal is coupled via R38 and C35 to IC7, an NE564 phase-locked loop frequency multiplier that operates at about 1.08 MHz. Capacitor C36 determines the initial frequency, and C37 and C38 determine loop characteristics. The 1-MHz VCO output from IC2 is fed to IC8, a CD4040 CMOS binary counter, that divides by 128 and feeds the nominal 7.87-kHz result back to the phase detector of IC7. That produces a lock condition and the 1.08-MHz signal from IC7 is phase-locked to the 7.87 kHz input signal. Resistor R40 sets the gain of PLL IC7, C40 and C37 are bypass capacitors, and R43 is a supply decoupling resistor.

The 1.08-MHz clock signal is fed to video sync generator IC9 that produces requisite timing signals from that clock signal. IC9 supplies burst-keying, blanking, and sync signals to analog switches IC2 and IC3, and also to Q2. Resistors R52, R53, and R54 provide short-circuit protection as well as test points for those signals. R51, C46, and C47 are power-supply decoupling components.

Even if horizontal locking is correct in phase, vertical locking may not be, so IC9 must be locked up by pulses from lock-oscillator circuit IC4. Pressing S2 enables pulses from IC4-a and -b to synchronize vertical pulses generated by IC9. That is evidenced by a vertical rolling of the video image seen on a monitor connected to J2. Switch S2 must be held depressed until vertical lockup (framing) is correct.

DC power (-5V, +5V, and +12V) is supplied to all IC's, as required. Regulators IC10, IC11, and IC12, C48-C53, and diodes D7 and D8 make up the power supply. About 12-volts AC at 350 mA is required at power-jack J3. A power-on indicator is formed by R55 and LED1, and may be omitted, if desired.

### Construction

A PC board is the preferred construction technique for this project to keep stray-signal pickup, ground loops, or other glitches to a minimum. Therefore we strongly suggest that you either make a printed-circuit board from the foil pattern provided in PC Service, or use a PC board from the source mentioned in the parts list. A parts-placement diagram is shown in Fig. 4.

Begin assembly by first installing all fixed resistors. Next, install the diodes, the four chokes, then the capacitors. Then install the five potentiometers. The two potentiometers R2 and R9 should be fitted with shafts, as they are front-panel controls. The use of sockets for all IC's is recommended, though not essential; that makes testing easier. Do not install any IC's until the last components are installed on the board.

Switches S1-S3, J1-J3, and LED1

the case along with the PC board if preferred. If you exceed 14-volts AC, the voltage regulators (IC10-IC12) may run too warm as they are not heat sunk. C49 and C51 should be increased to 25-volt ratings and IC10-IC12 should be heat sunk if more than 14-volts AC is used.

A DC power source cannot be used, since we use both positive and negative half cycles of an AC waveform to derive the +12-, +5-, and -5-volt DC supplies. A power

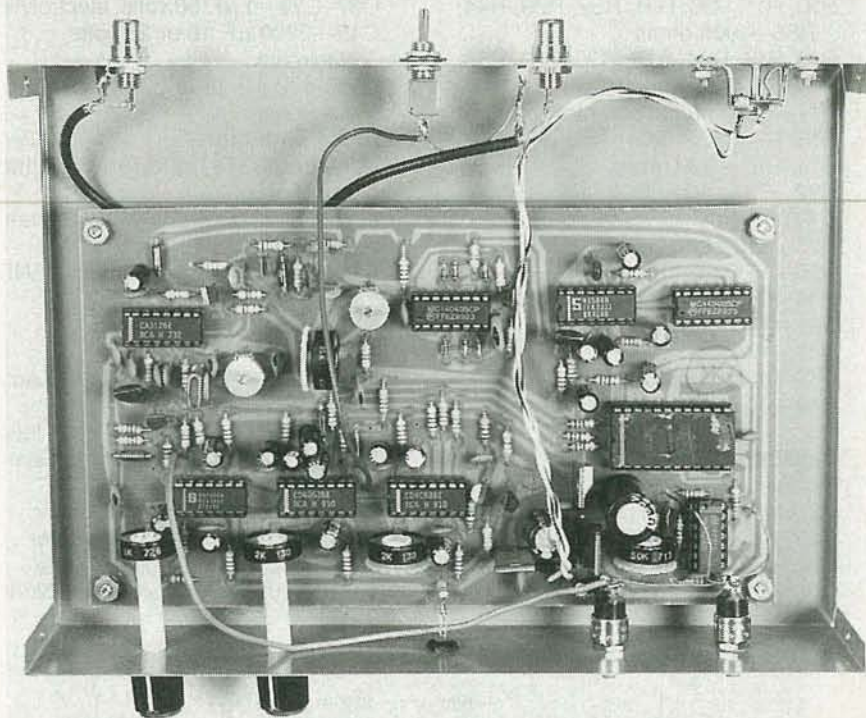

FIG. 5—HERE IS THE COMPLETED prototype unit.

can be wired to the PC board after all components except the IC's are installed. That allows the entire unit to be installed in one step in the case of your choice. The project was designed to fit a case that's 8 inches wide by 6 inches deep by 2 inches high, or thereabouts. It's best to use a metal case; other cases can be used—wood or plastic is OK—but stray-signal pickup can occur due to the lack of shielding. The prototype was built in Radio Shack's # 270-272A. The board should be mounted on four 1/2-inch standoffs (see Fig. 5).

A power source can be any 12-volt AC, 60-Hz wall transformer of at least 350 mA capacity. A power jack (J3) is mounted on the rear of the case, but you can hardwire the power pack directly to the board—J3 is therefore optional. A 12-volt AC general-purpose transformer can be mounted in

switch was not used on the prototype; the plug can simply be pulled out from J3 to turn the unit off.

### Checkout

Carefully inspect all connections for correct soldering. Next, check for any inadvertent solder bridges especially around the IC pins. Make sure correct components have been used and that all components are correctly oriented. At this point, without the IC's inserted, apply power and immediately measure the voltages on the +5-, -5-, and +12-volt buses. They should be within  $\pm 0.25$  volts of those values. If any of the voltages are incorrect, immediately remove power and find the problem. If everything seems OK, keep the PC powered for several minutes; nothing should get hot or smoke. If it does, locate and correct the problem.



When the power-supply section is working, check for the following voltages ( $\pm 10\%$  unless otherwise noted) before inserting the IC's.

- IC1 pin 5: +5V
- IC1 pin 10: -5V
- IC2 and IC3 pin 7: -5V
- IC2 and IC3 pin 16: +5V
- IC5 pin 12: +12V
- IC6 pin 16: +12V
- Collector of Q2: +12V
- Collector of Q3: +4 to +8V
- Emitter of Q5: -0.6V
- Emitter of Q6: 0V  $\pm 0.3$ V
- IC7 pins 1 and 10: +5V
- IC8 pin 16: +5V
- IC9 pins 10 and 19: +5V
- IC4 pin 16: +5V
- IC2 pin 13: +5 to -5V (should vary with setting of R9)
- IC2 pin 2: 0 to -2.2V (should vary with setting of R14, adjust R14 for -0.45V)

Remove power from J3 and insert all IC's in the board. Next, set all trimmer potentiometers and capacitors at midpoint except R14, which was initially set during checkout. Now apply power to the board and quickly check for the following voltages. Note that the voltages can vary by as much as 20%.

- IC1 pins 7 and 8: +1.5 to +3.0V
- IC5 pin 9: -0.2V
- IC9 pin 13: +3.6V
- IC9 pin 11: +4.1V
- IC9 pin 5: +4.6V
- IC2 pin 9: +3.6V
- IC2 pin 10: +4.9V
- IC2 pin 11: +4.1V
- IC3 pin 10: +4.6V
- IC3 pin 11: +4.1V
- IC4 pin 6: +2.5V

### Testing and using

Hook up the unit as shown in Fig. 6. Connect a video monitor to J2. If no such device is available, you can use an ordinary TV tuned to CH3 or CH4 with an RF modulator connected as shown in Fig. 6. Rotate R9; there should be a blank raster on the screen, white, gray, or black, adjustable with R9. Figure 7 shows what the waveform at J2 should look like on an oscilloscope at this point.

Now apply a video signal to J1. Adjust R2 and then R9 for a visible image as shown in Fig. 8. It may roll, but that's normal. Set R9 for barely visible white clipping, and then back off a bit. Adjust R2 for proper contrast. Next, depress vertical-lock switch S2. A bar should roll visibly

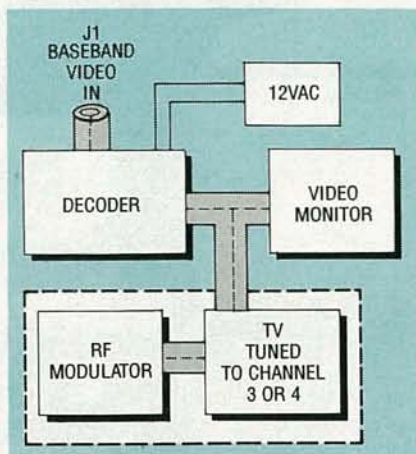

**FIG. 6—HOOK UP THE UNIT** as shown here. The unit requires a baseband-video input, and it outputs baseband video. If you don't have a baseband video source, then you need something like a VCR with an RF input and a baseband-video output jack. If you don't have a monitor that accepts baseband video, then you need an RF modulator or a VCR with a baseband-video input jack and an RF output.

up and down. Adjust R49 for a slow roll. By "tapping" S2 you should be able to lock the picture vertically. Set S3 to positive polarity (open). Now depress S1, the horizontal-lock switch. The picture should roll horizontally and possibly vertically, as well. Adjust trimmer-capacitor C24 until the roll is slow. By "tapping" S1 you should be able to lock in the image horizontally.

Adjust R2 and R9 for a good image. Misadjustment of R9 will either wash out the picture or cause horizontal tearing and loss of lock. Actually,

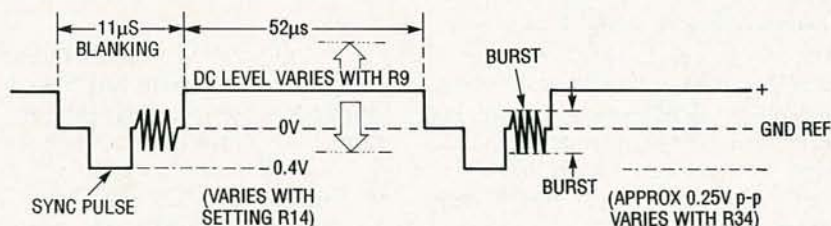

**FIG. 7—THE WAVEFORM AT J2** should look like this when the circuit is powered up with no video input to J1.

you can deliberately scramble a picture by adjusting R9 so that the new sync pulses are suppressed with respect to the video. Toggle-switch S3 should invert the video yielding a negative picture.

If the resultant image has weak color, adjust the burst-level control R34. Tint shifts can be adjusted with C32, if necessary. Instability in the color of the received picture normally

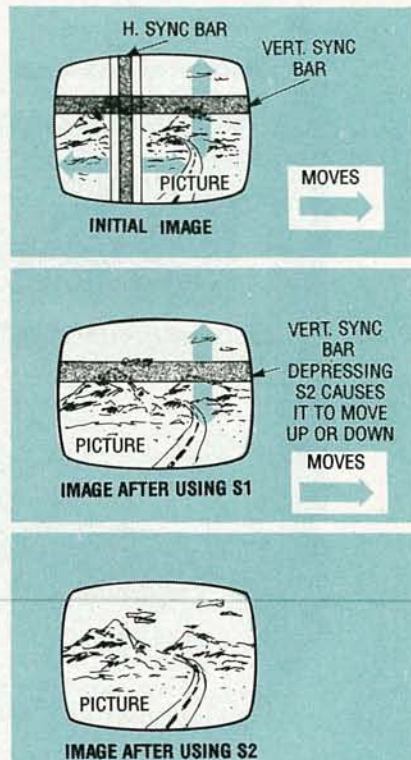

**FIG. 8—AFTER APPLYING A SIGNAL TO J1**, adjust R2 and R9 for a visible image as shown here; it may roll, but that's normal.

indicates incorrect lockup. Tap S1 (horizontal lock) to correct the problem. S3 can be used to change video polarity, but that will normally require a slight readjustment of R9 to correctly set the DC levels.

In case you have any difficulty in getting the decoder working, first check for a 1-volt p-p video signal at J1. It is assumed that +5, -5, and +12 volts are present. Next check to

see that IC5 is producing a 3.58-MHz signal. Also check for about 8–12 volts p-p at 3.58 MHz at pin 10 of IC6. Check for a 7.8-kHz pulse train at pin 12 of IC6. Check for a 1.08-MHz clock signal at pin 23 of IC9. Those are just a few troubleshooting tips in case you have any problems. However, you shouldn't experience any problems if your workmanship is good.

R-E





*Join the modern era  
with an instrument that gives you  
a whole new way of looking at waveforms!*

#### ALLAN C. STOVER

WHILE MOST ENGINEERS AND TECHNICIANS can't keep their hands off the newest and latest test instruments, others have to be convinced that the newest equipment is actually better than what they're using. It took many years for the digital multimeter to supplant the analog variety as most popular. And, undoubtedly, a comparable period of time will be required before *Digital Storage Oscilloscopes* (DSO's) will be able to outsell their analog predecessors.

DSO's aren't ideal for all applications, so understanding how they work can help you decide if they're right for you. They offer some features that analog versions can't match:

- Digital timing, more accurate than that of analog versions.
- Waveforms can be manipulated to highlight certain features for special analysis, letting a user zoom in on areas of interest.
- Waveforms can be stored indefi-

## INSIDE DIGITAL OSCILLOSCOPES

nately and recalled from memory for comparison, a feature not shared by analog storage oscilloscopes, which store a waveform for a limited period on a CRT, but not in memory.

- The DSO is essential in Automatic Test Equipment (ATE), where a computer acts as controller, receiving measured values and changing measurement parameters like vertical sensitivity and sweep (or, in this case, sampling) rate.

#### Analog oscilloscopes

Before diving into how DSO's work, you should first be familiar with the characteristics of an analog version; a block diagram of a two-channel model is shown in Fig. 1. The two inputs pass through a front-end

attenuator and vertical preamplifier in each channel, and are then multiplexed to a delay line and the vertical output amplifier. The amplified vertical signals deflect the electron beam from the Cathode-Ray Tube (CRT) in proportion to their levels.

The delay line slows the vertical signal long enough for the sawtooth waveform from the horizontal sweep generator to move the electron beam across the CRT, after the oscilloscope is triggered. Without the delay line, the initial part of the signal waveform prior to the trigger point would be lost at the left side of the CRT. Since the inputs pass through the entire vertical channel circuitry before reaching the CRT, the inherent vertical channel delay is usually longer than that experi-



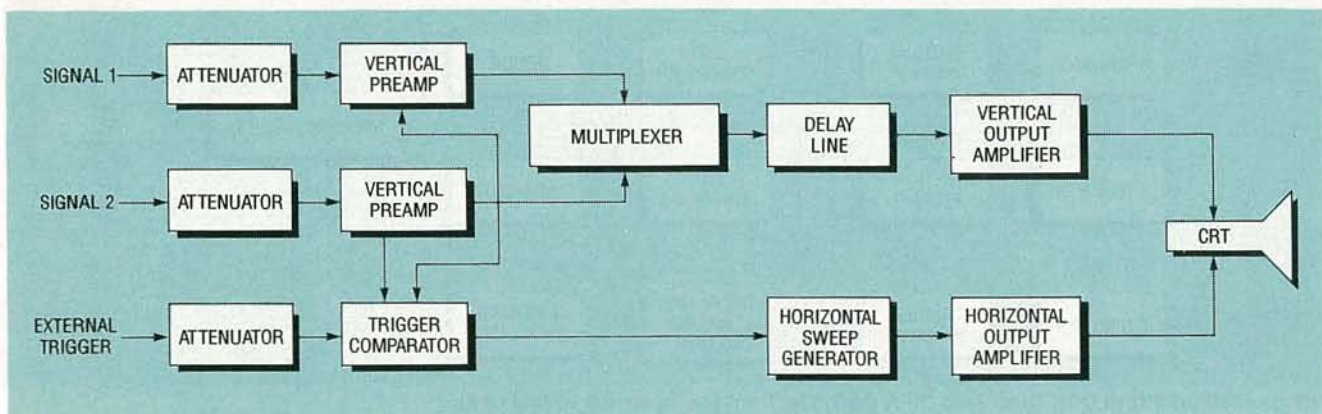

**FIG. 1—SIMPLIFIED BLOCK DIAGRAM** of an analog oscilloscope, with two vertical channels and an external signal input. The two vertical channels are multiplexed before application to the vertical and horizontal circuitry. The external and internal triggers can trigger the horizontal sweep, whose output is applied to the horizontal input of the CRT.

enced by the trigger signal as it passes through the trigger circuits and horizontal sweep generator.

A vertical amplifier needs enough bandwidth to pass an applied input without distortion, which translates into increased cost. Both vertical preamplifiers use part of their individual inputs for triggering purposes. Triggering can also be external, with the user selecting the desired option by manual switching. The trigger-comparator starts the horizontal sweep generator, determining the vertical level in a given waveform where the oscilloscope is triggered.

### Triggering basics

Since triggering is important in DSO operation, let's cover some basics. Suppose an external trigger arrives before a signal. The beam starts sweeping, and the signal appears somewhere later (toward the right side) on the CRT. In fact, if the triggering occurs long enough before the signal, the sweep would finish before the signal arrives, and no waveform would appear on the CRT. If the trigger occurs after the signal begins, the CRT will display a later portion of the signal at the left-hand side of the CRT.

Fig. 2-a shows an example of early, or pre-triggering, Fig. 2-b shows normal, on-time triggering, and Fig. 2-c late, or post-triggering. This idea will be important later, when discussing DSO triggering.

### Inside DSO's

The DSO is similar to an analog oscilloscope in certain regards, but different in others. Figure 3 shows a block diagram of a two-channel DSO;

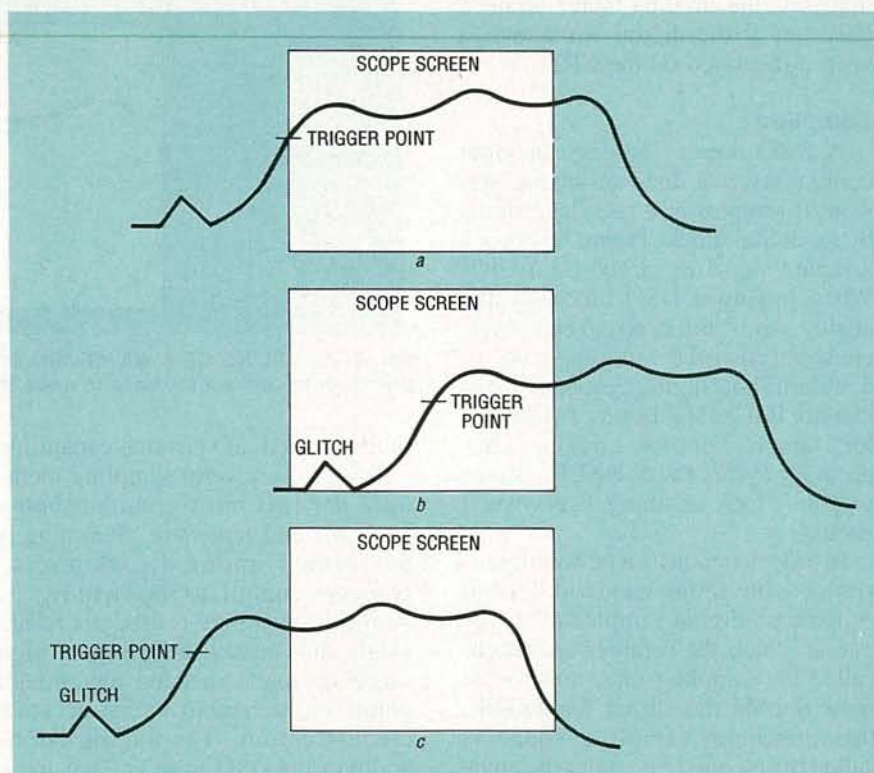

**FIG. 2—THREE EXAMPLES OF TRIGGERED WAVEFORMS.** An example of the CRT with normal triggering on the positive-going slope is shown in (a). An example of early, or pre-triggering is shown in (b), where the normal trigger point is visible in the early part of the display, letting the glitch before the main waveform to be detected and observed. Finally, (c) shows an example of late, or post-triggering, where the trigger occurs early in time, letting the latter portion of the waveform be observed.

the front end consists of attenuator, vertical preamplifier, and trigger, each with the same function as in the analog version of Fig. 1. However, the two vertical channels of the DSO aren't multiplexed as they are in the analog version; each has a separate path to the microprocessor, permitting data to be captured on both channels simultaneously.

An input goes through an Analog-to-Digital (A/D) converter, with the

digitized version stored in memory until the microprocessor can display it on the CRT. The available waveform storage memory is determined by the DSO's *record length*. The longer the record length, the longer the waveform you can store, although you may be able to display only a piece at a time. The bandwidth of all circuitry after the A/D converters, including the CRT, can be much lower (sometimes called *slower*) than the DSO's



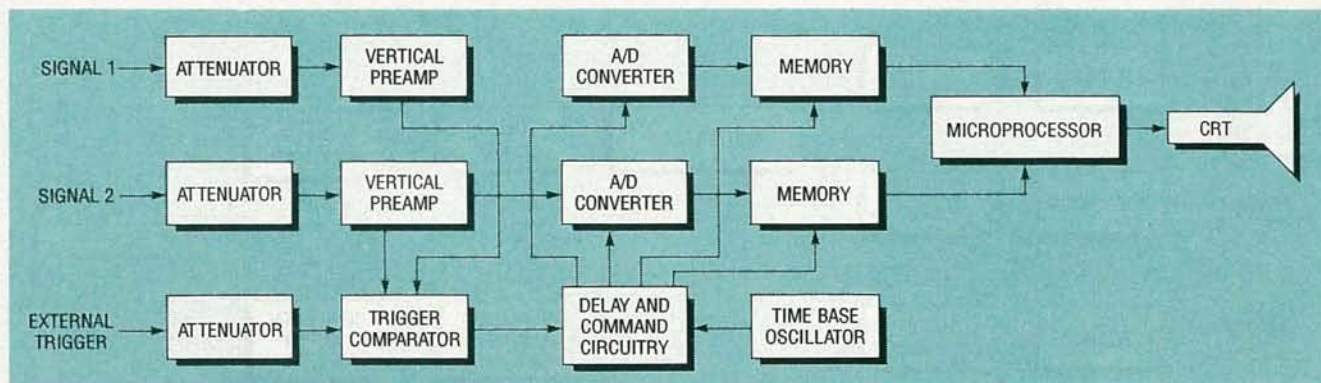

FIG. 3—SIMPLIFIED BLOCK DIAGRAM OF A DSO. The front end is similar to that of its analog predecessor. After the vertical preamplifier, however, the inputs are digitized by an A/D converter, and stored in memory until the microprocessor can process them and display the waveform on the CRT.

rated bandwidth. Once an input is digitized, the circuitry thereafter need only run at the digital word rate to keep it displayed on the CRT.

### Sampling

A DSO doesn't process an input continuously as does an analog version; it samples at a rate determined by its digital clock. Figure 4 shows a sampled signal displayed on a CRT. When buying a DSO, not only the analog bandwidth needs to be considered, but also the sampling rate, to determine how high a frequency it can handle. If it had to display a sinusoid, for example, but took a random sample every cycle or two, the CRT image wouldn't look anything like what it should.

In order to reconstruct a continuous signal with finite bandwidth from equispaced digital samples of it, the rate at which the samples are taken, called the sampling rate, must be *at least* double the signal bandwidth; this minimum sampling speed is called the Nyquist rate, after the engineer who discovered this principle. Sampling slower than the Nyquist rate causes *aliasing*, a form of signal distortion which can render a reconstructed signal useless.

Some DSO manufacturers use the Nyquist rate to calculate their digital bandwidth, which gives a higher specification than others that use four or more points per period. You need to know how individual manufacturers calculate bandwidth to compare DSO's. The higher the actual sampling rate, the better the resulting reconstructed CRT signal will appear. If aliasing occurs during measurement, you may need to change the sweep speed, or switch to an unaliased

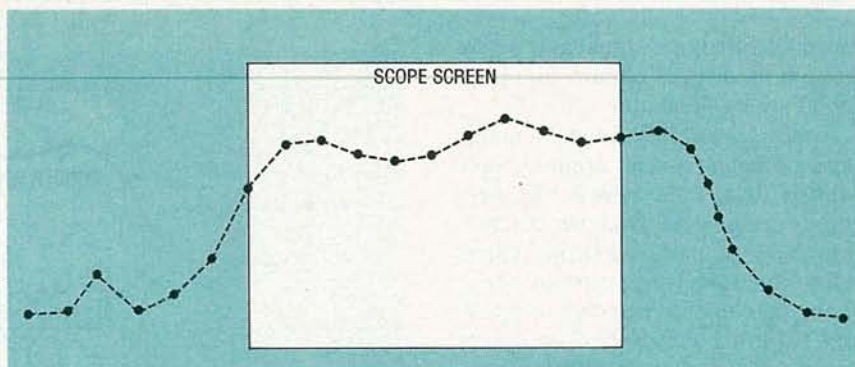

FIG. 4—SAMPLING OF A WAVEFORM ON A DSO. The DSO either needs more sample points, or to connect the dots, to make the waveform appear continuous.

mode, if the DSO has that capability.

DSO's use several sampling methods, the two most common being *real-time* and *repetitive*. Sampling is performed under direct microprocessor control, as shown in Fig. 3. Real-time sampling is used to capture single-shot waveforms, since a high sampling rate is needed for enough points in one sweep for an accurate reconstruction. The analog bandwidth of the DSO front end has to be high enough in order to prevent analog distortion.

Repetitive sampling is used for periodic waveforms that can be sampled over an adequate period of time, not single-shot events. The two types of repetitive sampling are random and sequential equivalent-time sampling. The former is done constantly without waiting for triggering. The DSO stores the time each sample is taken, and when enough points are gathered, reconstructs them on the CRT in the order they occurred after triggering. The latter is done with the DSO waiting a certain interval after triggering, and then taking a sample. On each pass, the time between trig-

gering and sampling is increased, giving a string of samples in time appearing on the CRT.

The visual results of both random and sequential sampling are identical. Each gives the same number of samples on the CRT, so the user sees the same signal with either method. The main difference is that random repetitive sampling samples the signal without regard to triggering, so many samples are taken before the trigger occurs, letting the signal before the trigger be reconstructed; this is useful in troubleshooting glitches. Since random sampling collects signal information both before and after triggering, then puts it together in relation to the trigger time, both before and after, the DSO provides pre-trigger capability.

The timebase oscillator block in Fig. 3 performs the same function as the horizontal sweep block in Fig. 1, except that the timing is digital and considerably more accurate than in the analog case. The delay and command block in Fig. 3 is timed by the timebase oscillator, and in turn coordinates the operation of the A/D con-



verters and the waveform storage memories for both channels.

### Automatic testing

Figure 5 shows a DSO in a simple ATE system. The ATE computer controls the test equipment and reads measurement results transmitted via General Purpose Interface Bus (GPIB). (See **Radio-Electronics**, July 1988, Page 57, *The General Purpose Interface Bus*, by Vaughn D. Martin.) The ATE computer can analyze sampled signals to determine amplitude, frequency, pulse width, and other characteristics.

Since the DSO has a microprocessor, it can analyze waveforms by itself, and send the results to the ATE computer via GPIB. Product testing that once required technicians to make complex judgments of oscilloscope signals can now be done via ATE using a DSO to analyze signals at high speeds and without human error.

### DSO features

A DSO can store waveforms indefinitely, provided power is continuously available, and the signal isn't overwritten. In the DSO block diagram in Fig. 3, there's volatile digital memory between the A/D converter and the microprocessor. DSO's have several features that allow signals to be manipulated, have certain characteristics highlighted, or compared to one another. Some of these are:

- **Automatic measurements:** A DSO can measure a number of digital waveform characteristics and display them on its CRT, including rise time, fall time, delay after trigger, peak-to-peak voltage, offset, frequency, overshoot, pulse width, and duty cycle, among others. A user can also control the position of cursors on the CRT to display the difference in time and amplitude between two points on a waveform. These features speed up measurements, improve accuracy, and eliminate human error.

- **Infinite persistence:** This feature, also called point-accumulate mode, lets a technician see the total jitter in a signal. The signal on the CRT is never erased; it just accumulates on the CRT. The stable parts of the signal show up as solid lines, but any jitter become "fuzzy," and the width of the fuzzy region indicates the amount.

- **Envelope mode:** Similar to the infinite persistence feature, in that it dis-

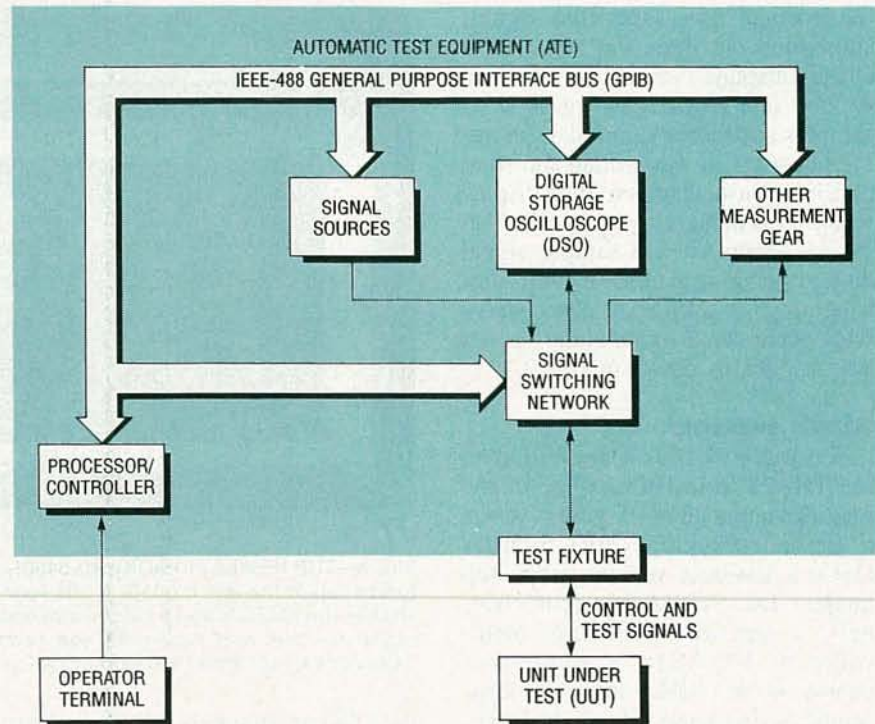

FIG. 5—BLOCK DIAGRAM OF A TEST SETUP where a DSO is used in conjunction with ATE. The computer controls the DSO via GPIB, as are all the other test equipment in the system. Waveform parameters can be sent to the computer via GPIB for processing.

TABLE 1—DIGITAL STORAGE OSCILLOSCOPE (DSO) MANUFACTURERS

#### Analogic Corp.

8 Centennial Dr.  
Peabody, MA 01961  
(508) 977-3000  
(800) 343-8333

#### B&K-Precision Maxtec Intl. Corp.

6470 W. Cortland St.  
Chicago, IL 60635  
(312) 889-1448

#### Hameg, Inc.

88-90 Harbor Rd.  
Port Washington, NY 11050  
(516) 883-3837  
(800) 247-1241

#### Heath Co.

Hilltop Rd.  
St. Joseph, MI 49085  
(616) 982-3200

#### Hewlett-Packard Co.

1820 Embarcadero  
Palo Alto, CA 94303  
(415) 857-8500

#### Hitachi Denshi America, Ltd.

175 Crossways Park W.  
Woodbury, NY 11797  
(516) 921-7200

#### John Fluke Mfg. Co., Inc.

6920 Seaway Blvd.  
Everett, WA 98203  
(206) 347-6100  
(800) 443-5853

#### Kikusui Intl. Corp.

19601 Mariner Ave.  
Torrance, CA 90503  
(213) 371-4662  
(800) 545-8784

#### Leader Instruments Corp.

380 Oser Ave.  
Hauppauge, NY 11788  
(516) 231-6900  
(800) 645-5104

#### Nicolet Oscilloscope Div.

5225 Verona Road  
Madison, WI 53711  
(608) 273-5008  
(800) 356-3090

#### Tektronix, Inc.

P.O. Box 500  
Beaverton, OR 97077  
(503) 627-9000  
(800) TEK-WIDE

plays minimum and maximum excursions of a waveform over time, thereby showing the maximum and minimum points of jitter.

- **Hardcopy output:** Some DSO's

can be connected to a graphic printer or plotter for a hard copy of a CRT image without needing an oscilloscope camera.

- **Averaging:** This lets you display



the average of a repetitive signal, smoothing out jitter and noise for a clearer display.

- *Pre- and post-triggering*: A DSO samples and stores signal data in numerous ways. It can sample and store data in a constant stream, then display whatever is in memory whenever triggering occurs. It can sample signal data either long before or long after triggering. A technician can observe what occurs on a signal either pre- or post-trigger, as shown in Fig. 2.

### What's available

A variety of DSO's are available; see Table 1 for a list of some of the major manufacturers. Figure 6 shows a Hewlett-Packard (HP) 54501A DSO, a low-cost version of its top model. The 54501A has four channels, a repetitive waveform bandwidth of 100 MHz, a single-shot bandwidth of 1 MHz, and a 10-megasample/s digitizing rate. It also features time-base and channel controls similar to those of analog oscilloscopes, but controlled via an on-screen menu and universal controls.

Operating an HP 54501A is different from and much easier than operating an analog oscilloscope. When a user presses a menu key, a list of available functions appears on the right side of the CRT, each one in-line with a function key just to the right. A user selects the desired function, and enters the desired value via either the keypad or the universal knob on the front panel. The following features are also controlled via on-screen menus:

- *Display Menu* provides variable persistence for display of worst-case jitter, noise averaging, and envelope display modes, as well as the ability to "connect the dots" whenever individual data points are visible on the CRT.
- *Delta V/Delta T* controls the positioning of cursors to read the differences in voltage and time between two points on a waveform.
- *Waveform Math* lets a user mathematically manipulate two signals. The math includes  $A + B$ ,  $A - B$ ,  $A \times B$ , and  $A$  versus  $B$ .
- *Waveform Save* lets a user store waveforms for later use in four non-volatile waveform memories, and two volatile pixel memories.
- *Measurement Definition* lets a user set measurement limits, and lets the DSO itself determine if a waveform passes the test. A user can even leave

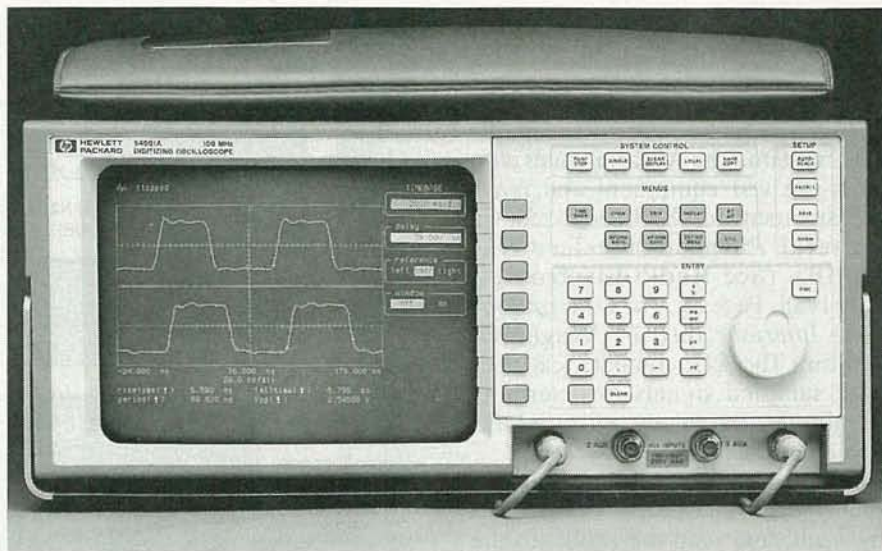

FIG. 6—THE HEWLETT-PACKARD 54501A DSO is a low-budget version of the manufacturer's top-of-the-line models. It has four channels, a repetitive waveform bandwidth of 100 MHz bandwidth, and a single-shot bandwidth of 1 MHz. It features a 10-megasample/s digitizing rate, and time-base and channel controls similar to those of analog oscilloscopes, but controlled through an on-screen menu and universal controls.

the DSO unattended. If the waveform exceeds a limit, the results can be stored, printed, or sent to a computer. This mode allows automatic measurement of 16 different pulse parameters, and lets a user define measurement thresholds, like the standard rise-time measurement from 10% to 90%.

The Hewlett-Packard 54501A has a number of other useful features.

*Timebase Windowing* lets a user zoom in on a specific waveform area. The *HARDCOPY* key prints a hardcopy output of the DSO CRT. The *SAVE* and *RECALL* keys let a user store and recall four instrument setups in nonvolatile memory. The *AUTOSCALE* key automatically scales time, voltage, and trigger level for a stable display.

*continued on page 69*



FIG. 7—THE TEKTRONIX 2432A DSO has a 300-MHz bandwidth and a 250-megasample/s digitizing rate. The 2432A includes signal averaging that reduces noise on repetitive signals. A smoothing feature uses a digital low-pass filter to improve the SNR for single-shot waveforms. There's also an AutoStep feature that lets a user build and run test procedures automatically, or by computer via GPIB.



# BUILD THIS

## MORSE/RTTY DETECTOR

LAST MONTH WE WENT OVER MOST OF THE internal circuitry of the PMX-200, including the front end, input-filter, AGC, detectors, and the tuning indicator. Now we will finish up our discussion on the rest of the circuitry, which includes the AFSK section and the power supply. We will then show you how to build and test the unit. Finally, we'll discuss the necessary software, and show you how to get the detector up and running with your computer.

The AFSK (Audio-Frequency Shift Keying) and interface section, shown in Fig. 4, contains a DB25 connector that can be plugged into your IBM PC/compatible serial port for decoding CW with your computer. (While any computer with a serial port can theoretically be used, the software provided on the R-E BBS will run only on IBM PC's and compatibles.) There is also an input from the computer that can drive a relay to provide an output for transmitting CW.

To enable a radio amateur to use the system to communicate in RTTY mode, an FSK generator (IC35-IC40) is on board, that uses a digital sine-wave generator to produce stable, high-quality audio output at J4. A CMOS counter (IC41) is used in a walking-ring configuration to produce a digitized sine-wave approximation. The output is very clean, since the first harmonic is many times the output frequency and very low in amplitude. After filtering, we have a signal that is virtually switching-transient free.

The low-level audio signal is designed to be sent to the microphone input of an SSB transmitter. A relay output is provided to key the mike from the computer. A separate relay output is included to key the CW key input on an amateur transmitter for CW operation. Both relay outputs are fully isolated from internal circuitry.

The schematic for the power supply

*Let your computer decypher Morse Code  
and radioteletype signals even if you  
don't know a det from a dah*

LARRY ASHWORTH, KA7AFR

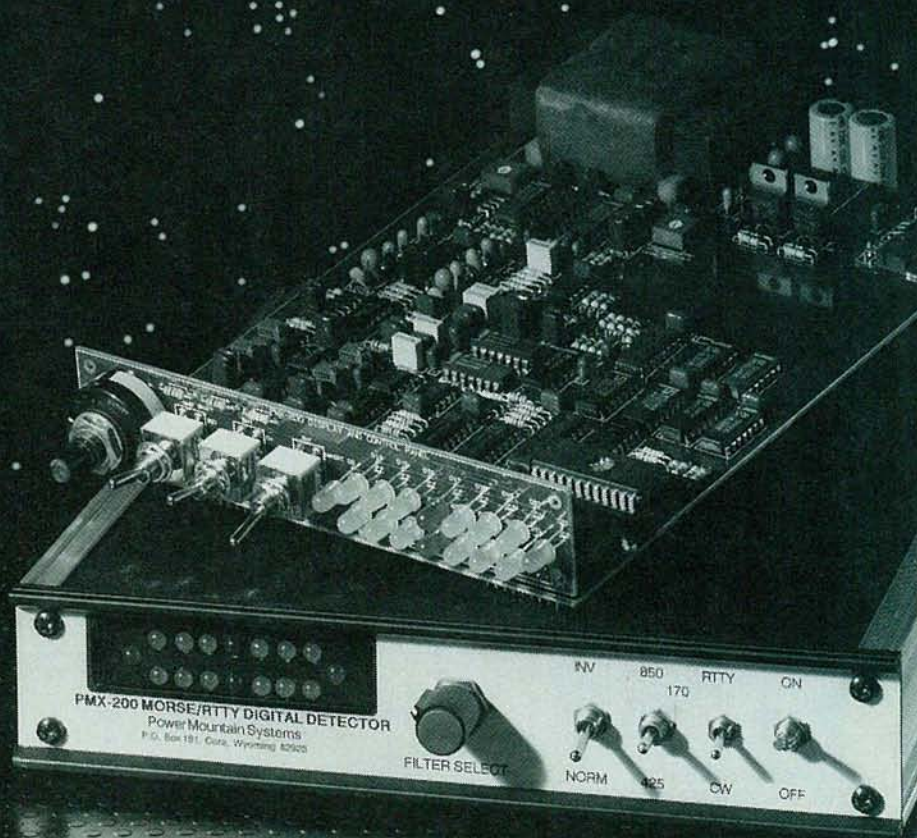



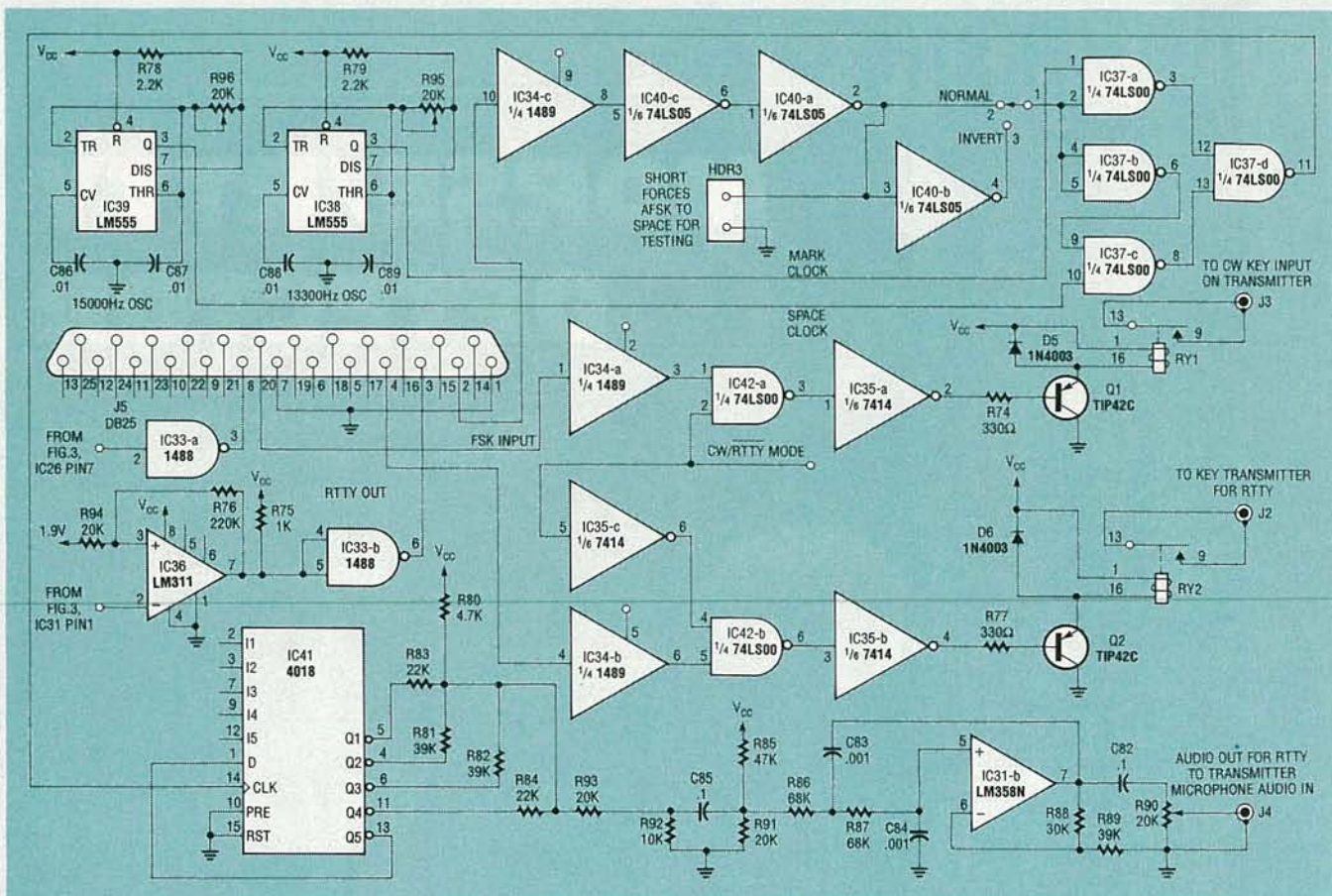

FIG. 4—THE AFSK AND INTERFACE SECTION contains a DB25 connector that can be plugged into your IBM PC/compatible series port for decoding CW with your computer.

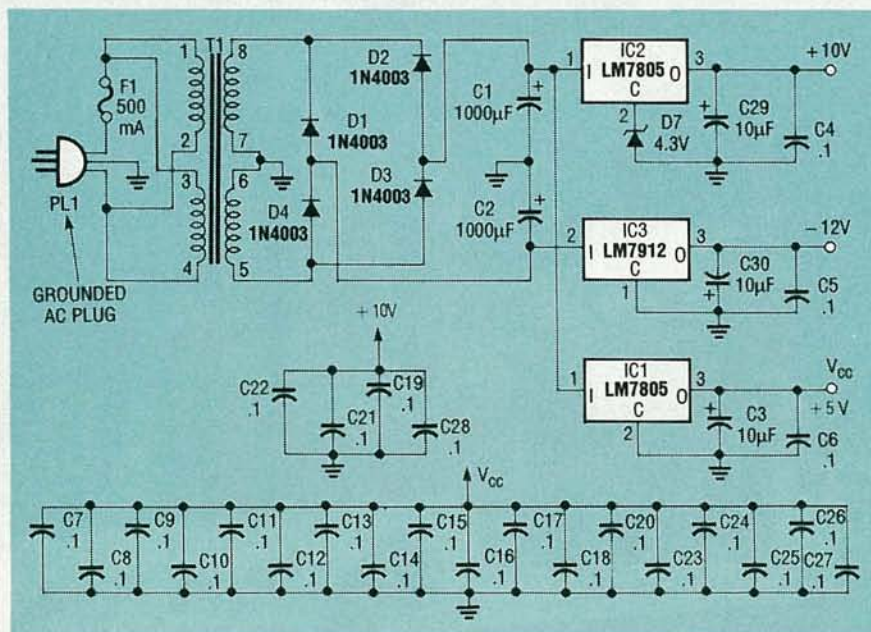

FIG. 5—SCHEMATIC FOR THE POWER SUPPLY. Power consumption is about 5 watts.

is shown in Fig. 5. Power consumption is about 5 watts, and all of it goes through the voltage regulators (IC1-IC3). Therefore, one of the 5-volt regulators (IC1) must be heat-sinked or else it will overheat during operation.

The other 7805 (IC2) is set up to output about 10 volts by attaching the ground terminal to a 4.3-volt Zener diode, D7. A 7912 (IC3) provides -12 volts. Since current demands are low, those two regulators do not require heatsinking.

## Construction

Various parts and kits of parts are available from the source mentioned in the parts list. Foil patterns for the two PC boards (the main board and the display board) are provided in PC Service. However, because of their complexity, they are not recommended for beginners. Parts-placement diagrams for the two boards are shown in Fig. 6; the two boards are connected together by two 18-pin right-angle headers (HDR1 and HDR2—HDR2 is not shown schematically, as it is used in various places throughout the circuitry).

You should mount the 5-volt regulator to the case (a metal case can dissipate a lot of heat), and mount the circuit board in the case in such a way as to keep lead lengths under four inches. The other two regulators (IC2 and IC3) don't dissipate enough heat to require off-board mounting.

After you've assembled the boards and checked them carefully for poor soldering, etc., you must install them in an appropriate case. The one used for the prototype measures 9.8- × 1.75- × 10.25-inches, and an identi-



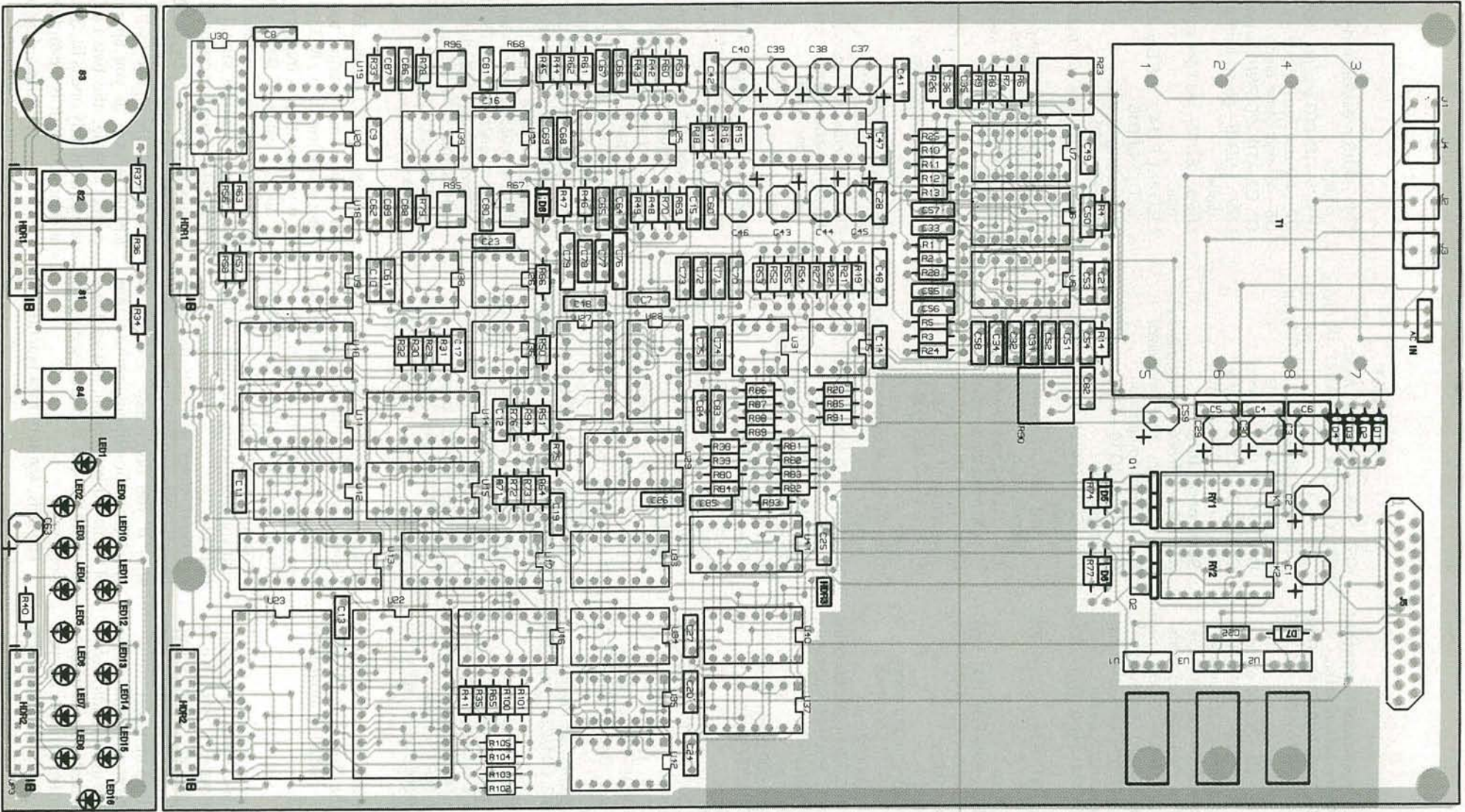

FIG. 6—PARTS-PLACEMENT DIAGRAMS for the main board and the display board. The main board is very complex, so you probably won't want to make it yourself.



## PARTS LIST

All resistors are 1/4-watt film except where otherwise indicated.

R1, R3, R6, R12, R43, R45, R49, R55, R81, R82, R89—39,000 ohms  
 R2, R9, R52, R53—27,000 ohms  
 R4, R7, R8, R19, R22, R24, R59—R62, R85—47,000 ohms  
 R5, R13, R86, R87—68,000 ohms  
 R10, R11, R14, R28—15,000 ohms  
 R15—R18, R69, R70—33,000 ohms  
 R21, R51, R76—220,000 ohms  
 R23, R90—20,000 ohms, 3/8-inch single-turn potentiometer  
 R25, R26, R34, R74, R77—330 ohms  
 R27, R30, R31, R78, R79—2200 ohms  
 R20—270 ohms  
 R29, R32, R33, R35—R39, R41, R50, R56—R58, R63—R65, R71—R73, R75—1000 ohms  
 R40—470 ohms  
 R42, R44, R48—48,000 ohms  
 R46, R47, R92—10,000 ohms  
 R54, R88—30,000 ohms  
 R66, R91, R93, R94—20,000 ohms  
 R67, R68, R95, R96—20,000 ohms, 10-turn potentiometer  
 R80—4700 ohms  
 R83, R84—22,000 ohms  
 R100—R105—2000 ohms

### Capacitors

C1, C2—1000  $\mu$ F, electrolytic  
 C3, C29, C30, C40, C46, C63—10  $\mu$ F, electrolytic  
 C4—C28, C41, C47, C77, C78, C80—C82, C85—0.1  $\mu$ F, mylar  
 C31, C34—C36, C49, C51—0.0047  $\mu$ F, mylar  
 C32, C33—0.0027  $\mu$ F, mylar  
 C37, C38, C43, C44, C59—1  $\mu$ F, tantalum  
 C39, C45—2  $\mu$ F, tantalum  
 C42, C60—30 pF, ceramic  
 C48, C76, C79—0.22  $\mu$ F, mylar  
 C50, C52—0.002  $\mu$ F, mylar  
 C53, C55—0.003  $\mu$ F, mylar  
 C54, C56—0.0005  $\mu$ F, mylar

C57, C58—0.0068  $\mu$ F, mylar  
 C61, C62, C64, C65—0.047  $\mu$ F, mylar  
 C66—C69, C86—C89—0.01  $\mu$ F, mylar  
 C70, C71—0.15  $\mu$ F, mylar  
 C72, C73—0.068  $\mu$ F, mylar  
 C74, C75—0.03  $\mu$ F, mylar  
 C83, C84—0.001  $\mu$ F, mylar

### Semiconductors

IC1, IC2—LM7805 5-volt regulator  
 IC3—LM7912 -12-volt regulator  
 IC4—NE570 compander  
 IC5, IC26, IC36—LM311 voltage comparator  
 IC6, IC25—LM324 low-power quad op-amp  
 IC7, IC8, IC27, IC28—4066 quad bilateral switch  
 IC9—74LS14 hex low-power Schottky Schmitt-trigger inverter  
 IC10, IC11, IC14, IC15—74LS161 synchronous binary counter  
 IC12, IC16—74LS30 8-input NAND gate  
 IC13, IC17—74LS244 octal tri-state buffer  
 IC18—74LS10 triple 3-input NAND gate  
 IC19—2.4576-MHz crystal oscillator  
 IC20—74LS90 decade counter  
 IC21, IC24—not used  
 IC22—2732 EPROM  
 IC23—74154 4-to-16 line decoder  
 IC29—7416 hex inverter buffer with high-voltage open-collector outputs  
 IC30—74LS147 10-line decimal to 4-line BCD encoder  
 IC31, IC32—LM358N low-power dual op-amp  
 IC33—1488 quad MDTL line driver  
 IC34—1489 quad MDTL line receiver  
 IC35—7414 hex Schmitt-trigger inverter  
 IC37, IC42—74LS00 quad 2-input NAND gate  
 IC38, IC39—LM555 timer  
 IC40—74LS05 open collector hex inverter

IC41—4018 presettable divide-by-N counter  
 D1—D6—1N4003 rectifier diode  
 D7—4.3-volt Zener diode  
 D8—4.7-volt Zener diode  
 Q1, Q2—TIP42C PNP transistor  
 LED1, LED16—green light emitting diode  
 LED5, LED12—red light emitting diode  
 LED2—LED4, LED6—LED11, LED13—LED16

### Other components

T1—FP24-500.....  
 HDR1, HDR2—18-pin right angle header  
 HDR3—2-pin jumper header  
 S1, S4—DPDT PC-mount switch  
 S2—DPDT PC-mount switch with center off  
 S3—12-position rotary PC-mount switch  
 J1—J4—RCA-type jack, chassis mount  
 J5—DB25 connector  
 RY1, RY2—16-pin PC-mount relay  
 PL1—grounded AC line cord  
**Miscellaneous:** case, hardware, wire, solder, etc.

**Note:** The following items for the **PMX-200 Morse Detector** are available from **Power Mountain Systems, P.O. Box 161, Cora, Wyoming 82925. Double-sided silk-screened PC boards, \$79.95; discrete parts kit (no boards or case), \$159.95; pre-programmed EPROM, \$15.95; detector software package for IBM/compatible, \$19.95; black brushed-aluminum case ready for you to drill, \$79.95; complete kit (contains everything), \$269.95; an assembled, aligned, and tested unit, \$389.95. All prices include UPS Ground, or mailing charges in the USA.**

cal one is available from the source mentioned in the Parts List. A photograph of the installed boards is shown in Fig. 7.

### Tune up

The master oscillator is crystal-controlled and preset. Since we're dealing with a digital system, set up isn't very difficult. However, a few tips will make tune up easier.

If you want the best possible performance you should use an audio-signal generator and a frequency counter to verify that the filter circuits are performing as designed. Remember that

when you change S2 (170-, 425-, and 850-Hz) you are changing the input bandpass filter width. You must make your measurements at IC6 pin 1, which is prior to the NE570 AGC circuit; otherwise the AGC will prevent you from seeing the filter's actual response.

Potentiometer R23 sets the input level, but the setting is not very critical. If you don't have a scope to check for audio-clipping at the output of the front filter section, just set it to a level where the detector seems to work well.

The 20K, ten-turn trim potentiom-

eter, R68, on IC32 sets the DC threshold voltage for squaring up the AC input waveform (VAD1, IC32 pin 1). To set it you must use a frequency counter and a clean sine-wave generator. Set your generator to 1500 Hz and feed about a 1-volt signal into the PMX-200, using the counter as a frequency reference. Set the potentiometer so that the center LED on the upper row is lit. Normally you will see two LED's lit and, as you approach the correct setting, the two LED's will merge until only one is lit. So, as long as your generator is clean, the adjust-

*continued on page 88*



# Why Are There so Many Transistors?

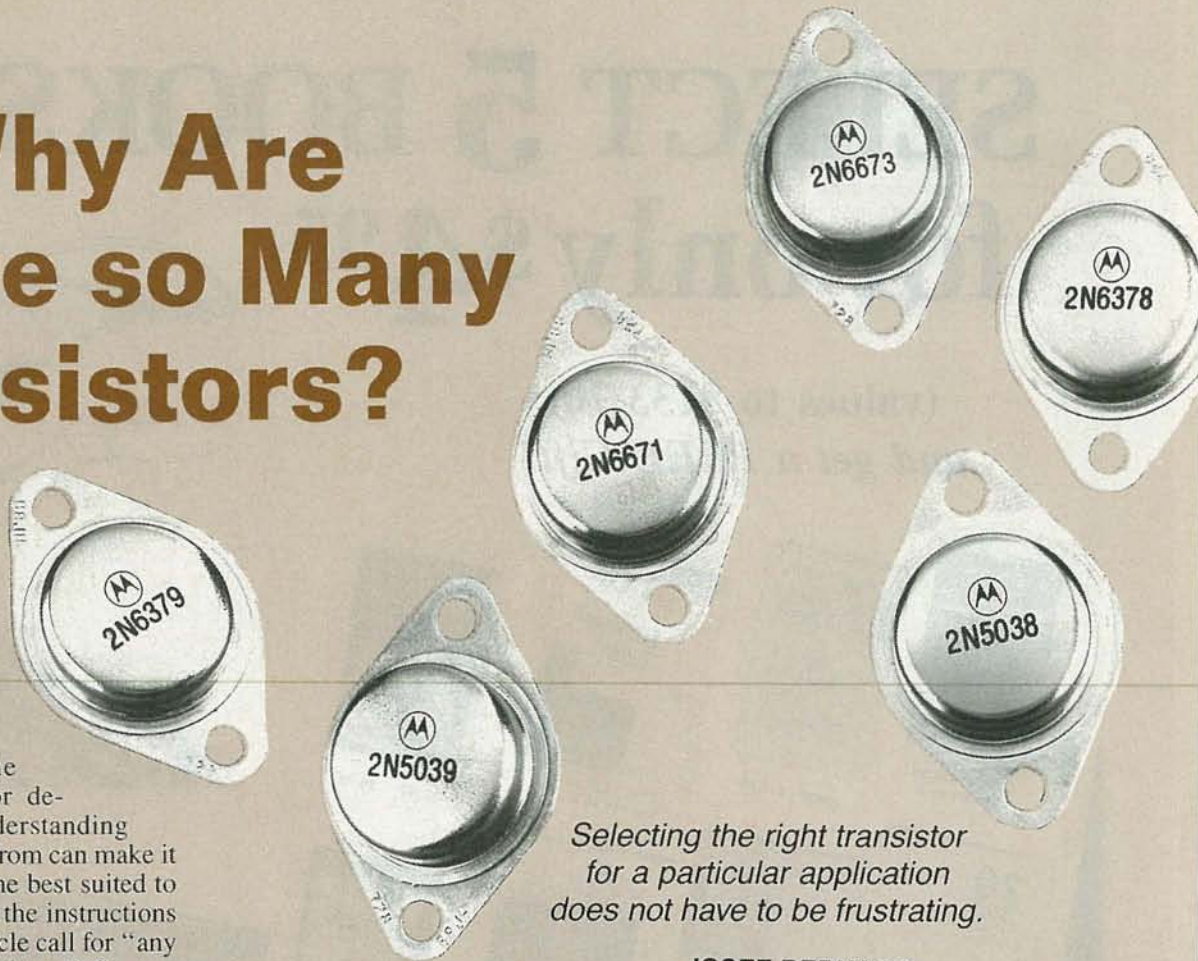

IT'S EASY TO BECOME overwhelmed by the number of transistor devices available. Understanding where they all come from can make it easier to select the one best suited to your needs. Suppose the instructions in a given project article call for "any general-purpose transistor." So you leaf through the back of **Radio-Electronics**, or pull out the pile of catalogs you've accumulated as the result of filling out reader-service cards month after month, and look to see who's got a good deal on general-purpose devices.

Let's see, where are they? "RF transistors?" "Power transistors?" "Small-signal transistors?" "Switching transistors?" Since you're building a little audio amplifier, you probably want "small-signal" transistors; after all it'll be handling only a small signal. Fine. OK, let's see what there is in that category: Hmmm . . . 2N2222, 2N3904, 2N3906, and about 15 other types. Maybe your procured-with-difficulty data book will give you a better idea.

Well, that's no help either. With something on the order of 30,000 different types of bipolar transistors alone, there are at least 15 pages of small-signal devices, and only one or two also appear in your Jameco or Digi-Key catalog. How do you decide which is the right one? Why are there so many?

## Transistor classes

Even the most confused parts hunter will have to agree that dividing

transistors into classes according to the purpose makes sense. To use a bulky heavy-duty power transistor that costs several dollars to do a job that could just as easily be handled by a smaller, less-expensive version is foolish. The question is, which specifications make it "just right?"

Each class of transistor is designed specifically for a particular type of operation, and those characteristics are what makes it suitable for a particular job. In some cases, the main criterion is the maximum frequency that a device can function at for rated performance, called unity-gain bandwidth, or  $f_T$ ; it is the frequency at which the voltage gain drops to one. RF transistors, for instance, can have  $f_T$ 's of hundreds—or even thousands—of megahertz, while good old "general purpose" types get by with a much lower value.

Gain is another factor used to divide devices into classes. Whether or not a specific transistor has a specific gain can be a matter of either design or practical limitations. Power transistors, for example, are built primarily for high-power loads. While their gain may not be as impressive as that of other varieties, they can handle

*Selecting the right transistor for a particular application does not have to be frustrating.*

## JOSEF BERNARD

high currents or voltages without overheating, melting, or exploding.

Another important characteristic is breakdown voltage, or the maximum voltage that a particular device can handle. Depending on whether it's in the millivolt, volt, or kilovolt range, the required size, packaging, operating characteristics, and price of a transistor can be affected. There are small-signal transistors designed for only a few volts and milliamperes of current, and power transistors designed for massive amperages.

Another class of transistor altogether is the switching transistor, or saturated switching device. While switching transistors can be, and often are, used for small-signal amplification (and vice-versa), they're really designed just to turn a low-level current on or off. They do that by being driven to saturation with a base-emitter voltage beyond the level for useful amplifications. Depending on component type, application, and packaging, transistors can be divided into over three dozen classifications.

## Where transistors come from

No device in a data book slips in by



# SELECT 5 BOOKS for only \$4<sup>95</sup>

(values to \$133.70)  
and get a **FREE Gift!**

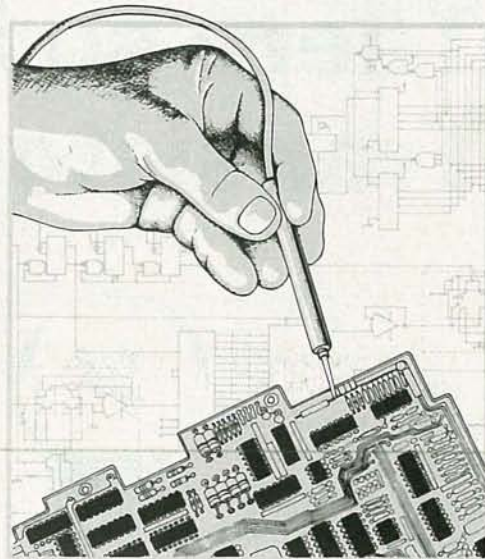

2707 \$26.95  
Counts as 2



2883P \$17.95



3195 \$28.95  
Counts as 2



2728P \$9.95



2947P \$13.95



3034 \$19.95



3090 \$25.95  
Counts as 2



1625P \$22.95



2987P \$16.95



2826P \$15.95



3234 \$24.95



3155 \$19.95

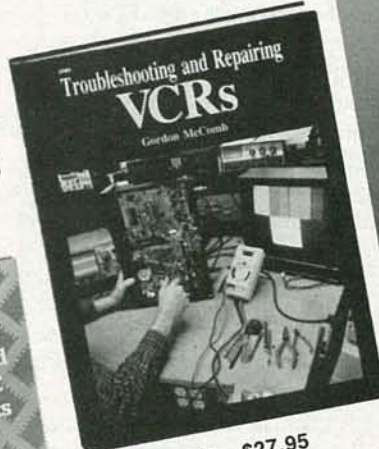

2960 \$27.95  
Counts as 2



3185 \$34.95  
Counts as 2



3219 \$27.95  
Counts as 2



2898 \$23.95



2985 \$24.95



2875 \$17.95

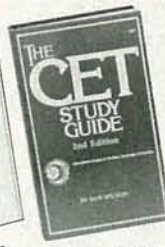

2941 \$23.95



2800P \$15.95

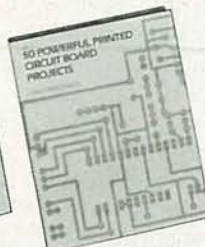

2972 \$23.95



2926 \$25.95



1133P \$14.95



2996P \$12.95



1897P \$14.95



# For 25 years, your most complete source for electronics books.

An Absolutely No-Risk Guarantee.

**FREE when you join!**

**15 Easy Electronic Projects From Delton T. Horn**

Projects you can build—some unique, some old favorites—from the author's vast treasury of electronics know-how.

**\$7.95 Value!**



## ELECTRONICS BOOK CLUB<sup>SM</sup>

Blue Ridge Summit, PA 17294-0810

Please accept my membership in the Electronics Book Club and send the 5 volumes listed below, plus my FREE copy of Delton T. Horn's All-Time Favorite Electronic Projects (3105P), billing me \$4.95 plus shipping and handling charges. If not satisfied, I may return the books within ten days without obligation and have my membership cancelled. I agree to purchase at least 3 books at regular Club prices (plus shipping/handling) during the next 12 months and may resign any time thereafter.

--	--	--	--

**50% MONEY-SAVING OPTION:** I also wish to order my first Club Selection at 50% off the Publisher's price (plus shipping/handling). I then need to purchase only 2 or more books within the next 12 months.

Name

Address

City

State  Zip  Phone

Signature

Valid for new members only. Foreign applicants will receive special ordering instructions. Canada must remit in U.S. currency. This order subject to acceptance by the Electronics Book Club. RE590

**Membership Benefits • Big Savings.** In addition to this introductory offer, you keep saving substantially with members' prices of up to 50% off the publishers' prices. • **Bonus Books.** Starting immediately, you will be eligible for our Bonus Book Plan, with savings of up to 80% off publishers' prices. • **Club News Bulletins.** 14 times per year you will receive the Book Club News, describing all the current selections—mains, alternates, extras—plus bonus offers and special sales, with scores of titles to choose from. • **Automatic Order.** If you want the Main Selection, do nothing and it will be sent to you automatically. If you prefer another selection, or no book at all, simply indicate your choice on the reply form provided. You will always have at least 10 days to decide. As a member, you agree to purchase at least 3 books within the next 12 months and may resign at any time thereafter. • **Ironclad No-Risk Guarantee.** If not satisfied with your books, return them within 10 days without obligation! • **Exceptional Quality.** All books are quality publishers' editions especially selected by our Editorial Board.

All books are hardcover unless number is followed by a "P" for paperback. (Publishers' Prices Shown)  
© 1990 ELECTRONICS BOOK CLUB, Blue Ridge Summit, PA 17294-0810

**Call Toll-Free  
1-800-233-1123 to join Now!**

MAY 1990



accident; they're all there for a reason. Many new designs come about as the result of technological advance, or improved manufacturing. For example, when power MOSFET's became practical to produce in large commercial quantities, a whole new product line was launched. That obviously didn't mean that all previous power transistors already in use were now obsolete. Rather, those older products continued to be manufactured because there were many circuits where they performed well in, possibly at lower cost.

Take the 2N2222 general-purpose NPN bipolar transistor; it drives relays, small audio amplifiers, digital inverters, etc. However, not all 2N2222's are alike, and the four dies in Fig. 1 prove it; a die is an actual chip, minus packaging and leads. When you buy a Digi-Key 2N2222, even though it's electrically identical to all others, its geometry might be any of those shown. Unless you find out which die is used, you'll probably never know the difference. For example, Fig. 1-c is the type of die typically associated with 2N2222A-class transistors.

Different die geometries have slightly different operating parameters. The unity-gain bandwidths for the dies in Figs. 1-a-1-d are:  $f_T = 340, 420, 300,$  and  $400$  MHz, while their typical maximum collector-base breakdown voltages are:  $V_{CBO} = 140, 130, 110,$  and  $95$  volts, respectively. Obviously, parameters like rise time and gain ( $\beta$ ) also vary between models.

Quite a few new products arise from the requirements of design engineers. The calculations for a specific circuit may call for product specifications that can't be met, at least within required tolerances, by any existing device. If a large enough quantity of a new device is required, or if the manufacturer sees a general-market potential, he'll set his engineers to work, and the product will eventually be manufactured and wind up in the next data book.

A small manufacturing company in search of a transistor may take the time to investigate preexisting devices in the hope of finding one for a specific job. Sometimes redesigning a circuit around an existing device to take advantage of its characteristics may avoid the expense of having a special part manufactured.

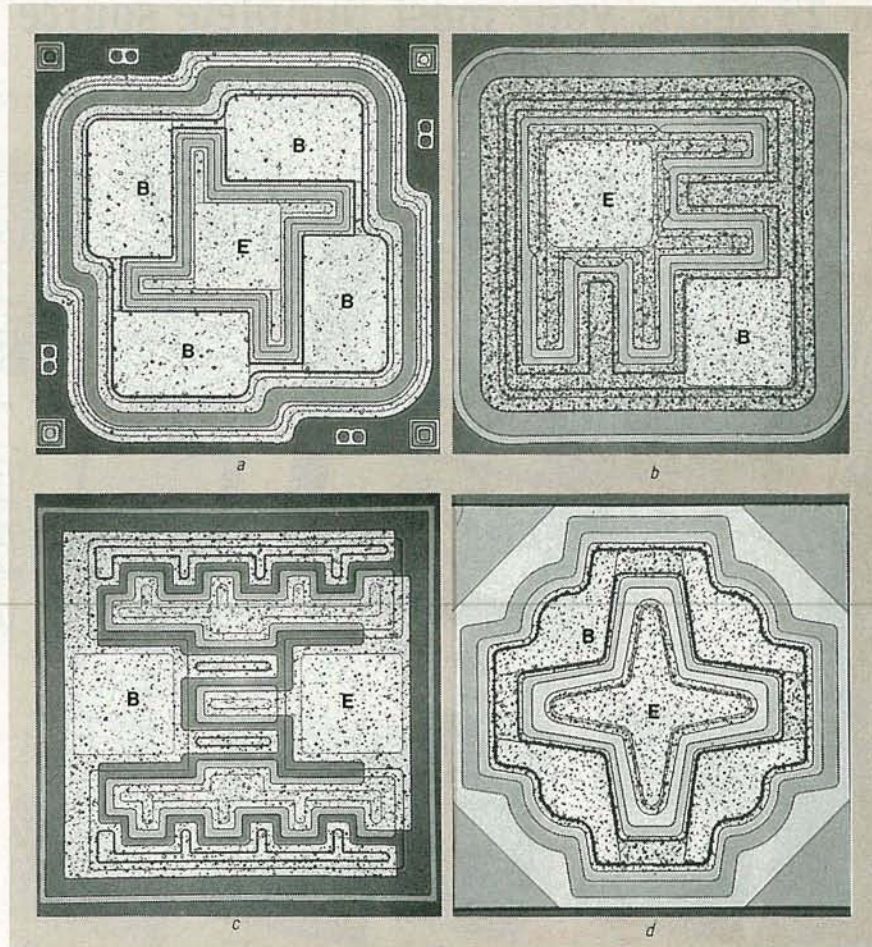

FIG. 1—THIS IS WHAT TRANSISTOR DIES look like under a microscope. The names of the different geometries are: (a) BBC, (b) JGA, (c) DCA, and (d) TNL.

However, for a company that anticipates the purchase of millions of a specific device to request that a part be produced to exact specifications may well be more economical. Taking that route is often cheaper than using a device that may already exist, but of questionable availability. It may be identical in all but one minor characteristic to another that already exists, but no semiconductor manufacturer will turn down an order worth millions. He'll produce it, and another part number will find its way into a data book.

Adding to the proliferation of device types is the fact that solid-state manufacturing isn't an exact process. It's certainly much less of an arcane art and more of a science than it was many years ago. There are still numerous variables, however, that can't be precisely controlled. During a manufacturing run, there are always some devices that either fall short of or exceed specified tolerances; examples are gain, breakdown voltage, and power dissipation.

Those devices exceeding specifications can be marketed as a premium product for those who need superior characteristics. For example, the mean desired cutoff frequency might be 200 MHz, but a number of devices might be made with much higher values, say 300 MHz. While those could be used by the original buyer, they're really wasted. There are probably other uses for such a high-performance part, so it's culled out and sold separately—at a premium price.

Some devices meeting very high tolerances may be classed as "mil-spec" or "high-rel(iability)" parts. They have to meet stringent test criteria and, if they pass, they get their own part numbers. Similarly, there may be a significant number of parts with a cutoff frequency of only 125 MHz. The buyer certainly can't use them, but they're not worthless, and they aren't discarded. Someone is out there with less critical design needs, who can use such out-of-spec parts. Actually, many "general purpose" parts originate that way.



# CATALOGS ON FLOPPIES

To make the job of selecting transistors easier, several companies now let you enlist the aid of a computer. Here are two examples.

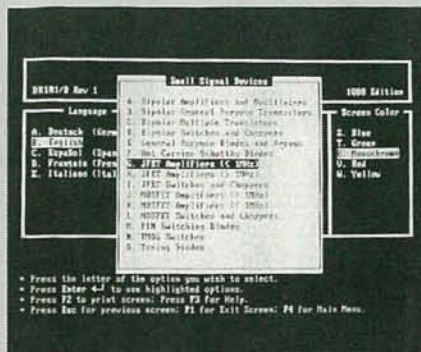

FIG. 1—FROM THE *SPECS IN SECS* menu "Small Signal Devices," option G is "JFET Amplifiers (< 1 MHz)."

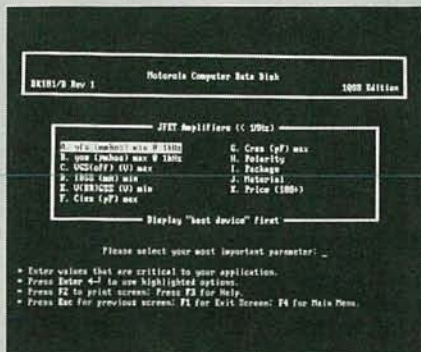

FIG. 2—IN THE "PARAMETRIC SEARCH mode," the user can select one or more parameters of the desired transistor.

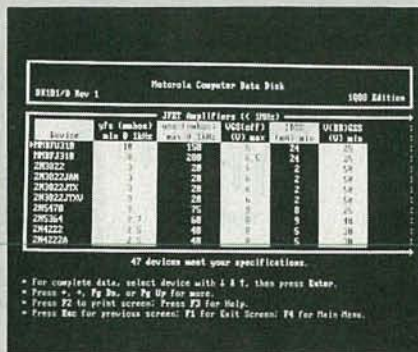

FIG. 3—A LIST OF MOTOROLA devices satisfying the selected parameters, with some specifications on each.

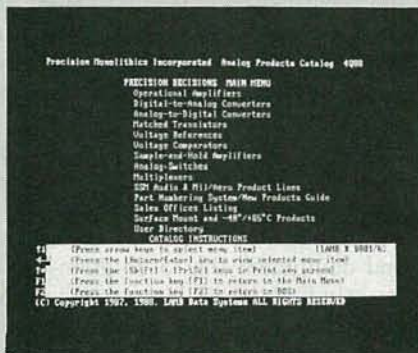

FIG. 4—*PRECISION DECISIONS* MAIN menu; the user can select from the different part types shown.

A similar set of examples for *PRECISION DECISIONS* is shown in Figs. 4-6. Figure 4 shows the main menu; the user can select from the different part types shown. Figure 5 shows the data-entry screen for a parametric search of matched transistors; the parameter values shown are the minimum and maximum permissible. You can also get data on a specific part, if you know the one you're interested in. Finally, Fig. 6 shows the results of the parametric search from Fig. 5 for matched transistors from the PMI database meeting the specified parameters.

The *SPECS IN SECS* Motorola Data Disk floppy-disk component selection guide from **CyberSoft, Inc.**, 440 E. Harmony Ave., Mesa, AZ 85204, (602) 962-0075, has significantly modernized device selection.

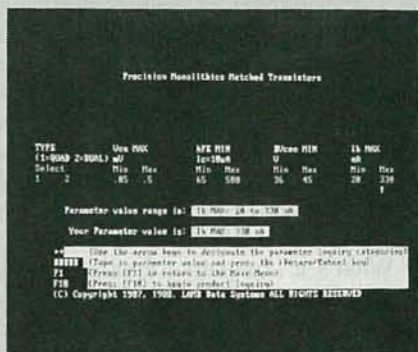

FIG. 5—DATA-ENTRY SCREEN for the Precision Decisions parametric search for matched transistors.

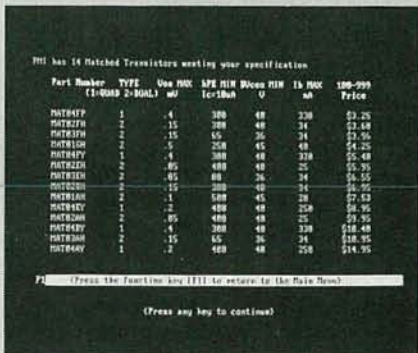

FIG. 6—PARAMETRIC SEARCH results for matched transistors from the PMI database.

The floppy catalog *SPECS IN SECS* handles all discrete Motorola products, over 7,500 parts; you can then use a databook for specifications. Also, *PRECISION DECISIONS* from Precision Monolithic, Inc. (PMI), accesses a complete line of analog signal-conditioning and data-conversion IC's; both use parametric search methods.

To illustrate how such software operates, simple parametric search will be shown using both packages. In *SPECS IN SECS*, the user can select different languages, product categories, and screen colors. On selecting a specific entry in each column, and performing a search, the entries are stored to save time on the next run. Here, "English" (option B), "Small Signal Devices" (option P), and "Monochrome" (option U) were used. On hitting Enter, a menu appears (see Fig. 1); "JFET Amplifiers (< 1 MHz)" was selected.

Another menu (not shown) displays the types of JFET amplifiers. Selecting the "Parametric Search" mode from that menu gives the one shown in Fig. 2. *SPECS IN SECS* tells whether the values in the menus and prompts are minimum or maximum, and the limits on the values that can be entered. Figure 3 shows a list of appropriate Motorola devices, with specifications on each.

It has 7,000 devices and 20,000 cross-references in 58 categories, for Motorola's entire discrete product line, including optoelectronics, RF, power, small-signal, and specialty items, and has both part number and parametric search modes. Once satisfactory devices are displayed, you can use a catalog for more data. Copies are \$2.00 from the Motorola Semiconductor Literature Distribution Center, PO Box 20912, Phoenix, AZ 85036, (602) 994-6561 or (800) 521-6274 (part number DK101/D REV-1).

Precision Monolithics, Inc. (PMI), also has a floppy-disk catalog called *PRECISION DECISIONS*, with their complete line of analog signal-conditioning and data-conversion IC's, using both part number and parametric search modes. Packaging, pricing, and competitive cross-referencing are included. Available categories are op-amps, D/A and A/D converters, matched transistors, voltage references and comparators, sample-and-holds, analog switches, multiplexers, military/aerospace products, the part numbering scheme, new products, sales offices, surface-mount and extreme temperature range devices, and a user directory. For a free copy, call the PMI Communications Dept., Santa Clara, CA 95052, (408) 562-7470. **R-E**



The number of devices that won't meet specifications in a given run can be predicted statistically, and there are frequently enough to be included in a catalog as a new product with a separate part number. That's not to say that quality control or manufacturing are at fault—it's just that some parts meet specifications and some don't. What's a company supposed to do, just throw them away? The name of the game is profit, and if somebody can use them, why not wring out the maximum profit possible?

### The case for cases

A given part isn't set apart from all others only by ratings and electrical characteristics. The same part can be packaged several different ways, each with its own part number, or with suffixes to differentiate them. Certain applications may need "ruggedized" parts to withstand extreme temperature, humidity, or shock, or special ceramic or metal packaging instead of plastic. A part originally specified for such extremes may be worth producing in a less rugged version for more ordinary use. Bingo, another part number.

Power dissipation is another factor that can add part numbers to data books, and can vary according to packaging. A transistor in a plastic TO-92 case may safely dissipate only a few hundred milliwatts. A TO-220 tab-type case may raise that to a few watts, while a heavy duty metal TO-3 case can push it even higher. The contents are identical; the point is that cases affect device characteristics. Sometimes the part numbers may be identical, with only the suffix changed to denote the different case, although new cases sometimes get entirely new numbers. Some common cases appear in Fig. 2.

Size and shape are also important. Someone designing a high-density PC board may need a part in a case of specific shape or size, so he can fit as many devices as possible in a given space. Such custom packaging isn't cheap and manufacturers may deem it worthwhile to make a part available in a cheaper, more conventional case to increase availability.

### Where do they get them?

As you browse through your Jamco, Digi-Key, or other catalog searching for parts, the selection of transistors offered by your favorite

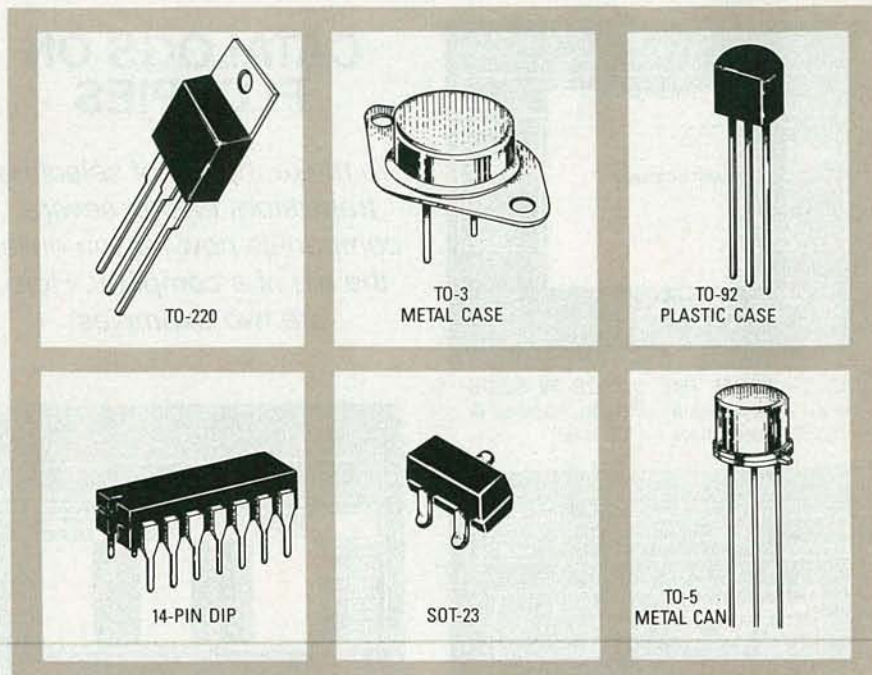

FIG. 2—TRANSISTORS CASES come in a wide variety. These are a few of the more common versions.

supplier is obviously much smaller than the range of offerings from even the smallest manufacturer. How do those people narrow down the choices? The line stocked by a company like those advertising in **Radio-Electronics** depends on two main factors: availability and customer need, which works out to the familiar law of supply and demand.

Manufacturers—both of transistors and equipment that uses them—frequently find themselves with more of a particular part than they need. There's no problem with quality, just inventory, solved by selling the excess. There are firms specializing in disposing of excess inventory, taking it off an overstocked company's hands for a price probably less than that originally paid or asked. Sometimes an over-inventoried manufacturer can sell directly to a vendor through an ad indicating his excess stock placed in the classified ads of a trade publication. The low price you may pay isn't a reflection of item quality, but rather the sacrifice that the overstocked manufacturer had to make to dispose of the excess.

Many devices in a vendor's catalog are there simply because they're consistent best-sellers. As long as people keep buying 2N2222's, they'll keep appearing in vendor price lists. Depending on supply, their price may vary, but they'll still be there. Sometimes, a device is a frequent "special-

request." Vendors receive many phone calls and letters from people trying to locate such-and-such a part. On occasion, such requests arise from specific projects that appear in such magazines as **Radio-Electronics**.

The individual responsible for the project may have used an "orphan" transistor he found at the bottom of a junk box. Some people (and you know who you are!) are unwilling (or unable) to look for a more readily available substitute, and so they request the oddball one. If there are enough such requests, a vendor will see a profit and add the item to his list. Sometimes, albeit rarely, there's no readily available substitute; that, too, is a reason to stock it. Whatever the reason, if there are enough requests for an item, a source will be located, and it'll find its way into a catalog.

### How do you choose?

Selecting the right part may at first seem difficult from the plethora of transistors available; all you need is common sense. First, determine the category. If you're building a huge audio amplifier, you need a power device. If your project will operate at moderate power, perhaps an audio device of some sort such as a small-signal transistor will work. If it'll be oscillating or switching at high frequencies, a switching transistor may be needed, although at audio frequen-

*Continued on page 68*



# HOME-SECURITY COOKBOOK

*An introduction to modern home-security systems.*

RAY MARSTON

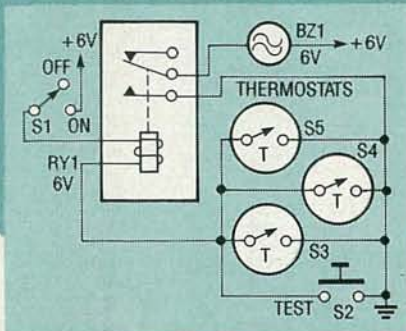

FIG. 1—SIMPLE RELAY-AIDED non-latching fire alarm using thermostat temperature sensors.

ALTHOUGH IT'S UNFORTUNATE, THE chance of being attacked, robbed, or incinerated in your own home is steadily increasing. Fortunately, the odds against those kinds of disasters can be greatly improved by taking a few common-sense precautions, like using good locks on all doors and locking all windows at night. The odds can be improved even further with a good electronic home-security system.

Home security is a fairly large and involved subject. To understand it, you first need to understand the basic principles of security-system installation, some criminal psychology, and to examine some actual burglar alarm systems. We'll deal with all of those topics here, and continue the subject in future articles. Let's start with some of the basic principles that are involved in a modern home-security system.

## Basic precautions

The disasters most likely to strike you at home are fire and intruders. Most home fires are caused by things like lit cigarettes, pieces of smoldering coal or wood falling onto rugs, overheated electric appliances, or cloth igniting from the heat of gas or electric stoves.

The first line of defense against fire is common sense, and the second is a fire-alarm system. The latter can be sophisticated, including smoke and gas detectors, or simple, like a number of Normally-Open (N.O.) thermostats, mounted at ceiling height, connected in parallel and arranged so that they trigger an alarm if any of them close. Any fire alarm is better than none at all, provided it's reliable, and a simple thermostat system like the version shown in Fig. 1 can easily be used with most burglar alarms.

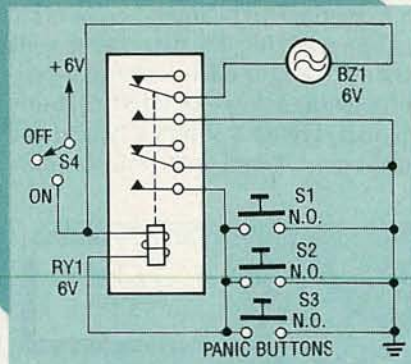

FIG. 2—THIS SIMPLE SELF-LATCHING panic burglar alarm with N.O. panic buttons or pressure pads is adequate for many domestic applications.

## Intruder prevention

Intruders are a very real menace, and are generally divided into either thugs or burglars. Thugs generally operate by having one or more males attack you either as you open your front door. Sometimes, an attack can occur late at night after or during a break-in.

The first defense against thugs, as with fire, is common sense: have a peep hole and chain on the front door. An excellent second defense is permanently armed panic buttons near likely attack points, like the front and rear doors, living room, and bedroom, arranged to operate a self-latching alarm when they're momentarily activated, as shown in Fig 2. Panic buttons are ordinary N.O. push-button switches. A simple panic system like Fig. 2, can easily be used with most burglar alarms. Of course, ON/OFF key switch S4 is an absolute necessity to make the circuit practical, to let it be shut off once it's activated.

## Burglary prevention

Any burglar alarm system can be broken down into the three blocks shown in Fig. 3. The first is the "sensor network," which detects an actual or possible intrusion at one or more protected points, and sends a signal to

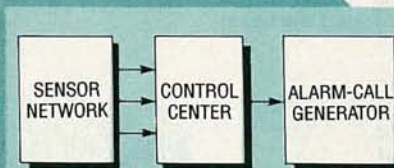

FIG. 3—BLOCK DIAGRAM of a burglar alarm system.

the "control center." That block checks the sensor signals for validity, and trips the "alarm-call generator" (a bell, buzzer, or siren), when conditions are appropriate.

Four basic types are available: the radar, ultrasonic, infra-red, and microswitch varieties. The most important performance characteristic of any burglar alarm system is its reliability, or immunity to false alarms. Many sophisticated systems that give frequent false alarms (99% of all alarms are false) will be ignored by both the police and the owner, and are thus useless. Many can be false-triggered by electrical interference from sources like lightning or electric motors.

Radar systems generate a microwave field over the whole house, and sound an alarm when the field is disturbed. Unfortunately, they can sometimes be falsely triggered by large vehicles passing by, and may have poor reliability. Ultrasonic alarms usually protect an individual room. They generate an ultrasonic field in the room, and sound an alarm if physical movement within the room



causes a significant Doppler shift. Such systems can be falsely triggered by a draft moving curtains or drapes, or by insects close to the ultrasonic sensors.

Infra-red systems normally monitor along an invisible line-of-sight beam, and sound an alarm if the beam is broken by a physical object. Most alarms of that type use single beams, and can easily be falsely triggered by insects, as shown in Fig. 4. A few such systems use dual beams, as shown in Fig. 5, activating only when both are broken simultaneously. Those beams are separated by 10–25 cm, to prevent being falsely triggered by insects.

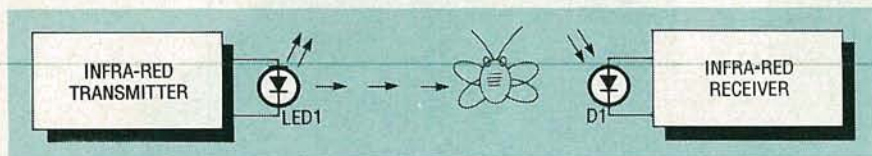

FIG. 4—A SINGLE-BEAM IR ALARM SYSTEM CAN easily be false-triggered by an insect breaking the beam.

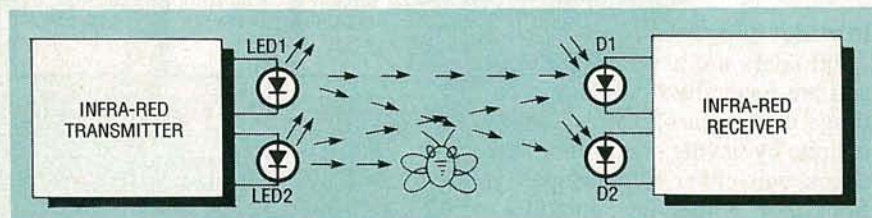

FIG. 5—A DUAL-BEAM IR ALARM ACTIVATES ONLY when both beams are broken simultaneously, and can not be false-triggered by small insects.

The most popular system type is the electro-mechanical switch variety. These switches can be either micro-switches or reed relays connected to doors or windows, or pressure pads under rugs. They can all be of the Normally-Open (N.O.) variety (activate by closing), or the Normally-Closed (N.C.) type (activate by opening), or a combination thereof. If N.O. switches are used exclusively, a self-latching burglar alarm can be made by wiring all switches in parallel and connecting them to buzzer BZ1 via relay RY1, as shown in Fig. 2. That may involve a lot of wiring, but the circuit consumes zero standby current.

If N.C. switches are used exclusively, a self-latching burglar alarm can be made by wiring all switches in series and connecting them to BZ1 via a transistor-aided relay, as shown in the version in Fig. 6. That circuit uses minimum wiring,

but consumes 1 mA of quiescent current via R1-Q1 (in practice, that can be reduced to a negligible level with a more elegant relay driver). It can also be easily modified for N.O. switches, as shown in Fig. 7.

In a practical contact-operated alarm system, the sensor switches actually connect to the inputs of a control center, which houses the electronics and battery, plus a number of switches that allow different system sections to be turned on or off, or to be tested. Ideally, the control center should be housed in a burglar-proof box with a key-operated ON/OFF switch. Figure 8 shows a typical control-center panel with six switches.

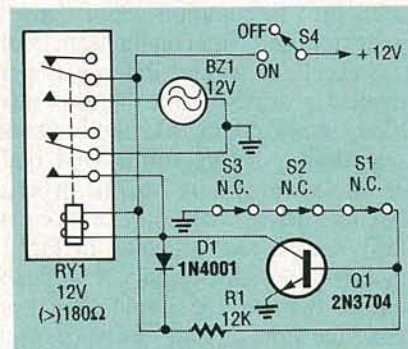

FIG. 6—SIMPLE BURGLAR ALARM WITH N.C. switches, drawing 1 mA of quiescent current.

The main ON/OFF switch is (S1) of the key type, and S2 is a pushbutton that enables the alarm and battery for a functional check. The remaining four switches are toggle types, allowing sensors to be enabled or disabled.

Figures 9 and 10 show the connections for turning individual sections of the sensor network on and off. Se-

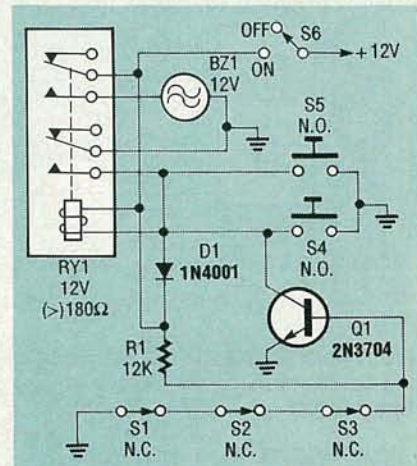

FIG. 7—BURGLAR ALARM CIRCUIT using N.C. and N.O. sensor switches.

ries-connected N.C. sensor networks can be enabled or disabled by wiring such a series string of N.C. sensors in parallel with S1, as shown in Fig. 9. Here, the sensors are enabled with S1 open, and disabled with S1 closed. Parallel-connected N.O. sensor networks can be controlled by wiring such a series of parallel N.O. sensors in series with S1, as shown in Fig. 10. In that case, the sensors are enabled when S1 is closed, and disabled when S1 is open.

### Planning a system

The most popular burglar alarm type uses switch sensors. Let's look at the actual techniques of planning such an installation in a house. A building can, for the present, be regarded as a box with an enclosing "perimeter" around a number of interconnected compartments. That perimeter is the shell, containing walls, floors, ceilings, doors and windows. To commit a crime, an intruder must penetrate the perimeter, the owner's first line of defense.

Once an intruder enters a building, he can move from one room to the next only along paths determined by internal doors and passages. In doing so, he must pass over or through certain "spots," or checkpoints, as shown in Fig. 11, the ground-floor plan of a medium-sized mid-terrace house. To move between the kitchen (a likely break-in area in the average home) and the living room requires passing through the kitchen door, adjacent point "X," and the living room door. Those "spot" locations represent the owner's second line of defense.

The house owner can use perimeter



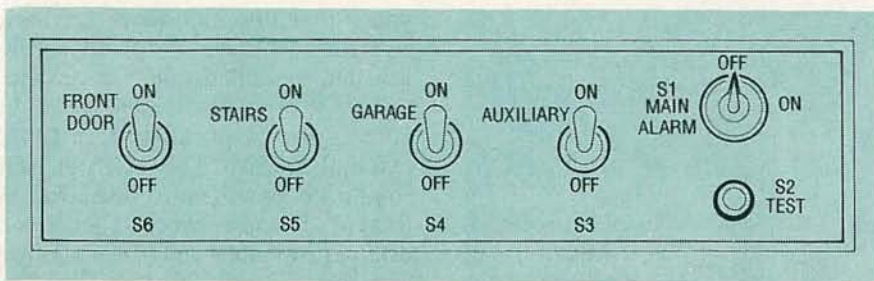

FIG. 8—TYPICAL CONTROL-CENTER INSTRUMENT PANEL.

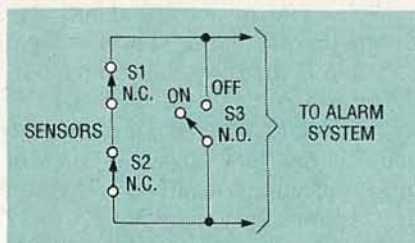

FIG. 9—METHOD OF ENABLING/DISABLING series N.C. sensor switches by operating S3.

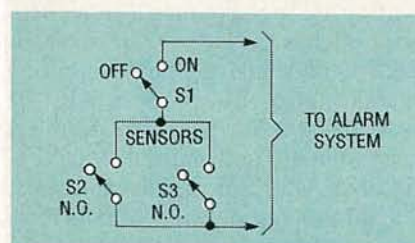

FIG. 10—METHOD OF ENABLING/DISABLING parallel N.O. sensor switches via S1.

defense, spot defense, or a combination thereof. Perimeter sensors include microswitches or reed-relay/magnet combinations fitted to external doors and windows, and window foil fitted to the windows on external doors, windows, and skylights. Spot sensors include pressure-pad switches fitted under rugs or carpets, micro-switch or reed-relay/magnet door switches, and baited traps using an attractive or valuable item (like a clock) placed on top of a concealed microswitch.

When planning an installation, you should try to think like a burglar. Normally, a burglar enters from an easy access point obscured from the view of neighbors, like a back door or window. Often, they'll even break in using tools from your own garage, so include the garage in any system layout. Almost invariably, a burglar's first action after gaining entry to your home is to provide for rapid escape by opening a back door, and then to start stealing.

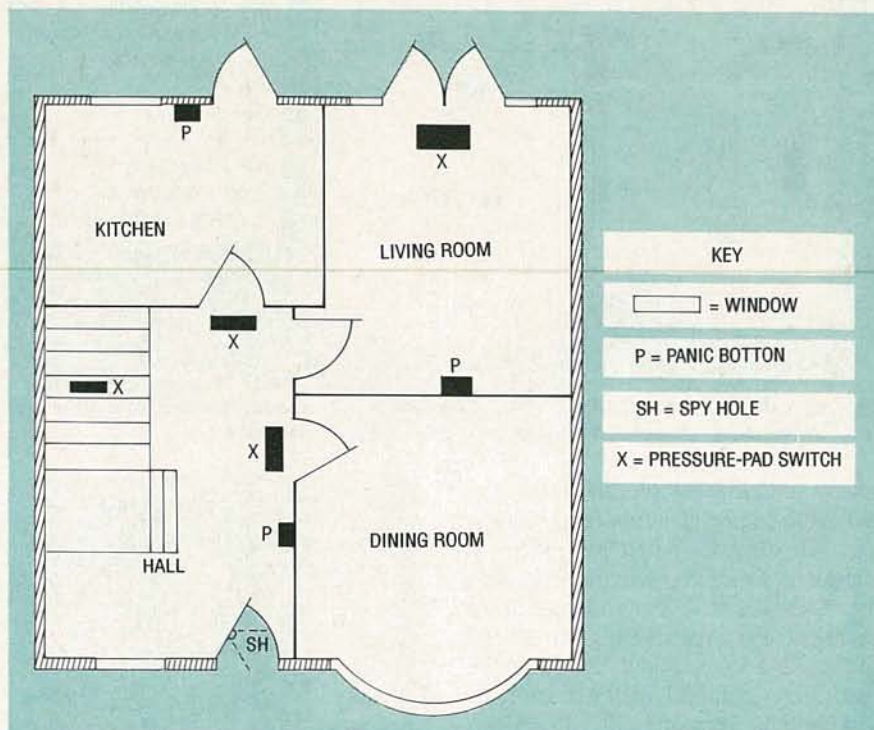

FIG. 11—GROUND-FLOOR PLAN OF A MEDIUM-SIZED mid-terrace house with minimal spot and panic defenses.

### Two examples

Figures 11 and 12 show alternate ways of installing security systems in the ground floor of a medium-sized mid-terrace house. In both cases, a peep hole is installed in the front door, with panic buttons at three likely attack points. The two houses differ considerably, however, in the methods of burglary protection that are used.

Figure 11 presupposes that a burglar will most likely enter via the French windows of the living room, or the kitchen door or window. If he uses the French windows, he'll be detected by a pressure pad under a mat or carpet, but if he enters via the kitchen, he'll find nothing worth stealing. So, he'll open the kitchen door into the hall, where he'll be detected by another pressure pad.

In the unlikely event that a burglar enters the house from the front, he'll eventually be detected by yet another

pressure pad in the hall near the dining room door, or one on the stairs. That arrangement makes no attempt to keep a burglar out, but uses "spot" defense to detect him once he's inside. The approach is highly cost-effective, and gives reasonably good protection.

By contrast, Fig. 12 assumes extensive perimeter and spot defense. Its owner has decided to try to scare off

potential burglars by using clearly visible window foil on selected windows, both in front and in back. Some foil is really connected into the alarm system, and some is dummy foil. All external and internal doors are protected by door switches, and two pressure pads are on the stairway. Also, baited traps are placed in both the living and dining rooms. That house has excellent protection.

### Installation notes

Pressure pads are available as small mats; they're excellent spot defense devices, easily hidden under rugs and carpets. Both standard and stair types are available. However, they're fairly sensitive and can be set off easily by large cats and dogs; if you own a pet, make sure it's confined when the pressure pads are on.

Window foil is adhesive-backed aluminum stripping that bonds to



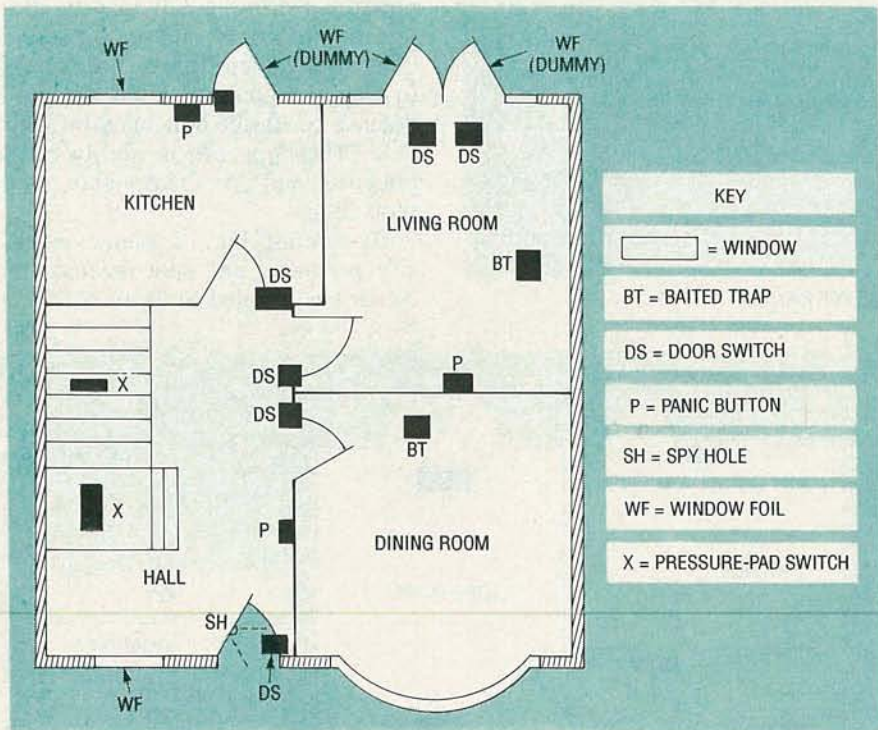

FIG. 12—GROUND-FLOOR PLAN OF A MEDIUM-SIZED mid-terrace house with a high level of perimeter and spot defenses, plus minimal panic defenses.

glass, and couples into an alarm system using special connector blocks. The strip breaks when a window is shattered. Door and window switches are usually a reed-relay/magnet combination. The magnet goes in the edge of the door or window, opposite the reed-relay installed in the frame, as shown in the version in Fig. 13. When a door or window is closed, the magnet holds the reed-relay in one position. When it's open, the magnet moves away, making the reed-relay switch states. Most commercial versions have two sets of output wires in the reed-relay, one giving N.O. operation, and the other N.C. operation.

When you plan your installation, don't forget to provide for some means of bypassing the front door, so

you can enter and leave without sounding an alarm. Keep all wiring neat and concealed, and test each section as it's installed. If possible, fit your system with both internal and external alarms. The external unit should be prominently displayed in front of the house, where it'll act as a deterrent; weather-proof housings are available.

### Home-security circuits

We've already looked at the very simple burglar alarms shown in Figs. 2, 6, and 7. In reality, they need modification to be practical. A major defect of the circuits shown in the Figs. 6 and 7 is that they consume 1 mA of quiescent current via R1-Q1. That can be overcome by increasing R1 to 12 megohms, and using a CMOS inverter as a buffer between R1 and Q1, as shown in Fig. 14. That circuit consumes 1  $\mu$ A of quiescent current.

In practical installations, long wires used to interconnect series sensor switches tend to pick up spurious pulses and signals, especially during thunderstorms. The purpose of R2-C1 is to act as a low-pass filter to reject such signals, and minimize susceptibility to false alarms. Note that Figs. 2 and 14 each show the left-hand relay contacts being used to provide self-latching action. An alternative is shown in Fig. 15. Here, self-latching is performed by a bistable made from IC1-a and IC1-b, and low-pass filter R5-C2 causes the bistable output to latch low when S6 is first closed.

If any sensor switches are then activated, a logic high is fed to pin 2 of the bistable via the low-pass filter R3-C1, which latches high and turns on Q1 and RY1, activating buzzer BZ1. In Fig. 15, R2 is in series with the sensor switches, letting the circuit be activated by either the series switches or parallel pressure pads across R1. That

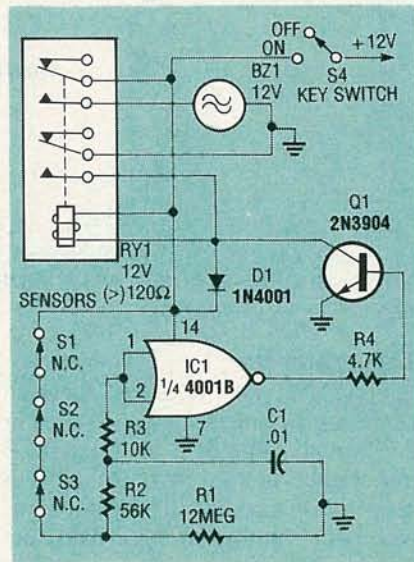

FIG. 14—THIS CMOS-AIDED ALARM draws only 1  $\mu$ A of standby current.

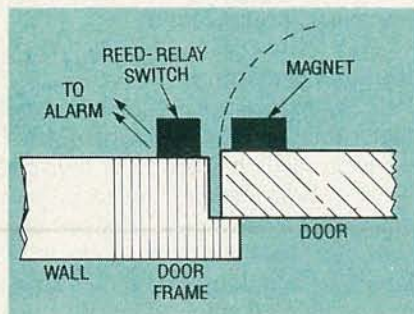

FIG. 13—PLANS SHOWING METHOD OF CONNECTING a reed-relay/magnet combination to form a door/window-activated switch.

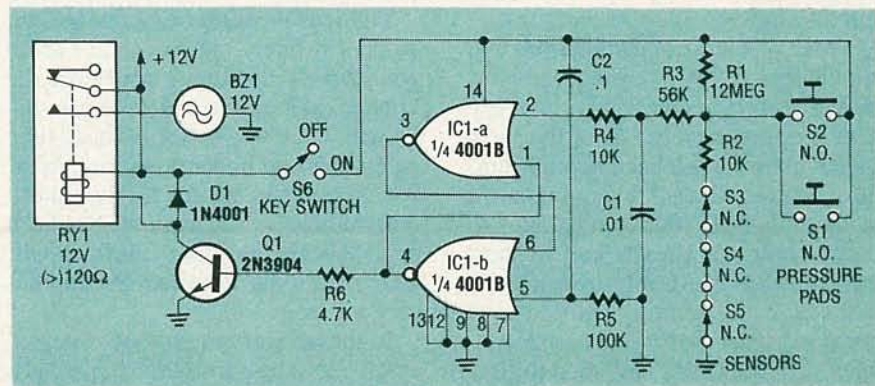

FIG. 15—A SIMPLE SELF-LATCHING BURGLAR ALARM.



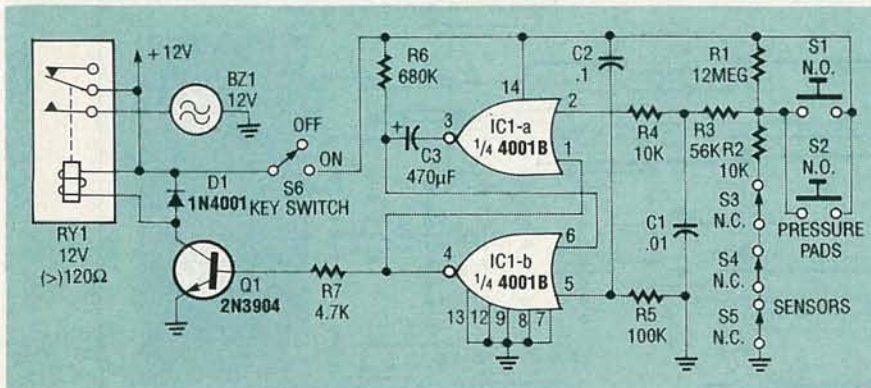

FIG. 16—AN AUTO-TURN-OFF BURGLAR ALARM with 4-minute turn-off delay.

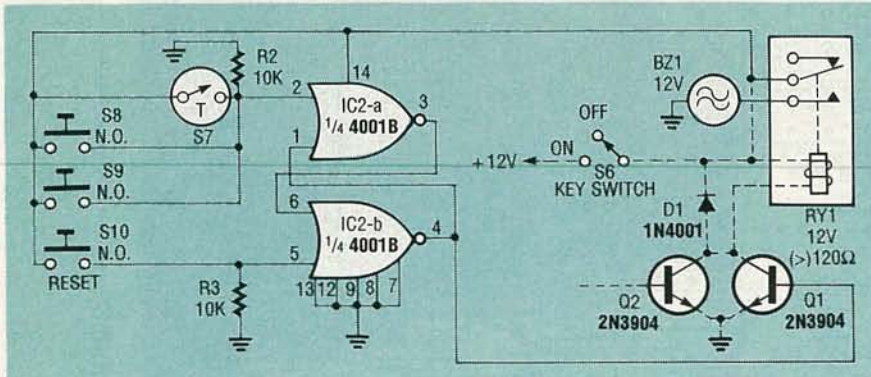

FIG. 17—PANIC AND FIRE ALARM CIRCUIT that can be added to the circuits of Figs. 16 and 17.

makes a very versatile burglar alarm; ideally, the alarm generator (BZ1) should be powered by a completely separate supply.

Figure 16 shows how Fig. 15 can be modified for auto-turn-off action, so the alarm sounds as soon as an intrusion is detected, but turns off automatically after four minutes. That

sensors. In Figs. 15 and 16, Q1 and RY1 are permanently connected to the power supply, even when S6 is open and the sensors disabled. That makes adding accessories like fire detectors and panic switches, which must be permanently enabled, easy.

Figure 17 shows a practical add-on panic and fire alarm circuit for use

via any of a number of parallel panic switches or thermostats. If you combine the circuits shown in Figs. 16 and 17, you'll still need an independent IC1 and IC2, since they need separate supplies.

### A comprehensive system

Most of the burglar alarms examined thus far give useful but limited performance. The final version, shown in Fig. 18, gives outstanding performance and has several sophisticated features. It uses a +12-volt supply and draws a few  $\mu\text{A}$  of quiescent current. The +12-volt power to the CMOS circuitry is smoothed via D3 and C4, enabling the circuit and alarm generator (BZ1) to use the same supply. Normally, with S7 closed and all sensors inactive, LED1, RY1, and BZ1 are all off. Low-pass filters R3-C1 and R6-C2 suppress any transients.

If any sensor switches activate, the inputs of IC1-a and IC1-b go high, turning on LED1 and RY1, the latter through Q1, IC1-c, and IC1-d. As RY1 turns on it self-latches via the left-hand contacts, and activates BZ1 via the right-hand contacts. Note that the self-latching relay is permanently wired to the +12-volt supply, and can be activated at any time by either the panic buttons or thermostats.

If key-switch S7 is initially closed, or if pushbutton S6 is pressed and released, the R7-C3-IC1-c network disables Q1 for about 100 seconds. At the end of that period, the circuit returns to normal operation. That's of

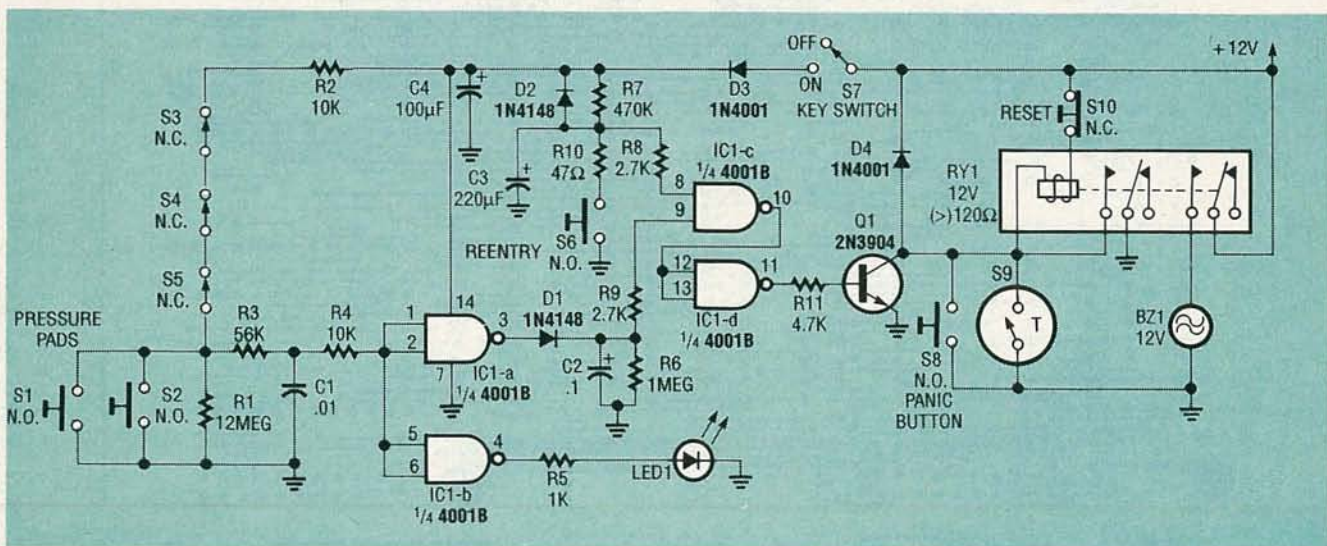

FIG. 18—COMPREHENSIVE HIGH-PERFORMANCE home security system.

action is obtained via IC1-a and IC1-b, which act as a monostable that drives RY1 via Q1, and is triggered via the

with the circuits shown in Figs. 15 and 16. Here, IC2-a and IC2-b make up a flip-flop that turns RY1 on through Q2

great practical value, since when the system is first turned on via S7, LED1 should stay off.

R-E



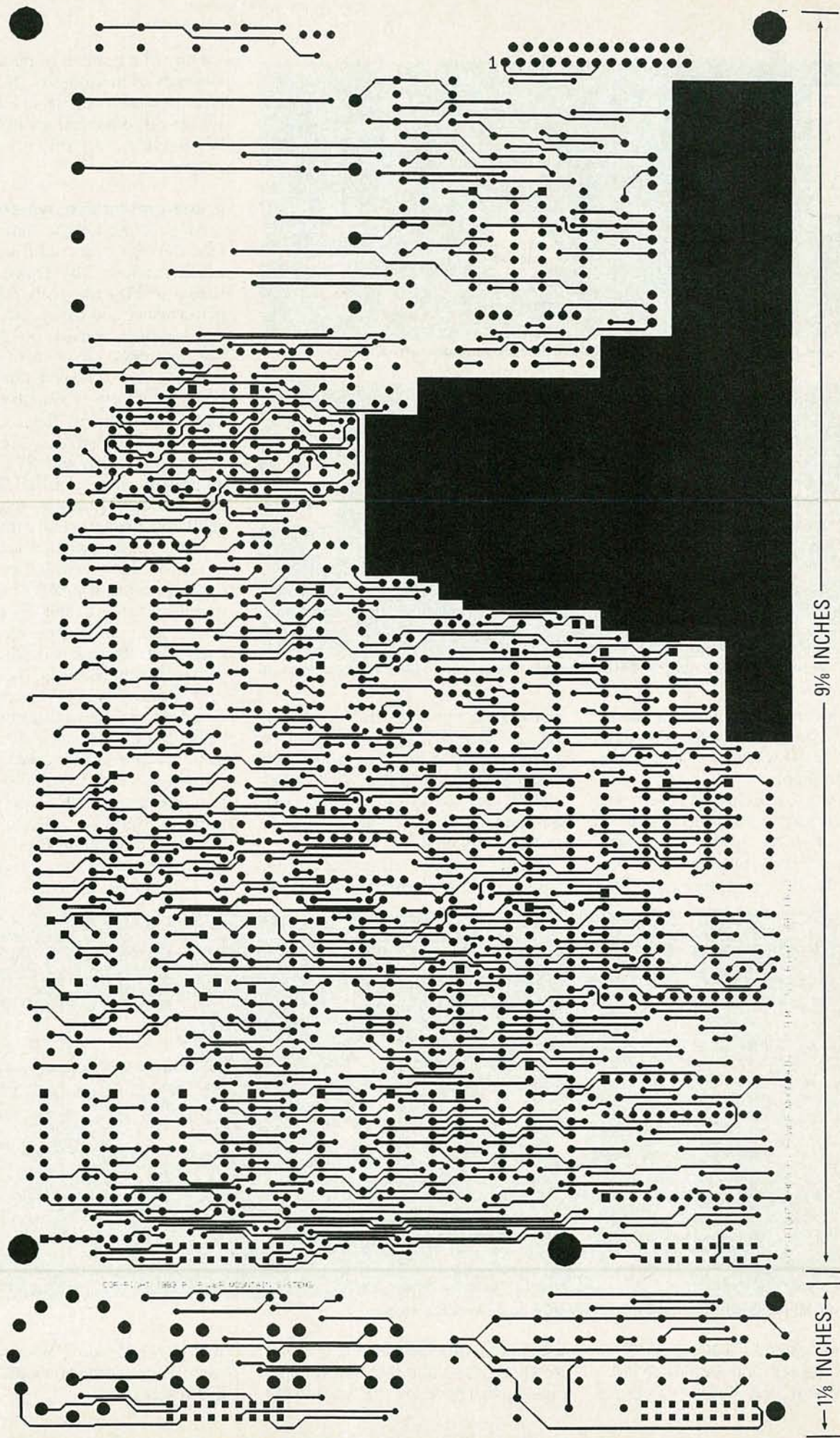

COPYRIGHT 1969 BY EVER MOUNTAIN SYSTEMS

PC BOARD DESIGN BY EVER MOUNTAIN SYSTEMS

9 1/8 INCHES

1 1/8 INCHES

COMPONENT SIDE of the RTTY decoder.



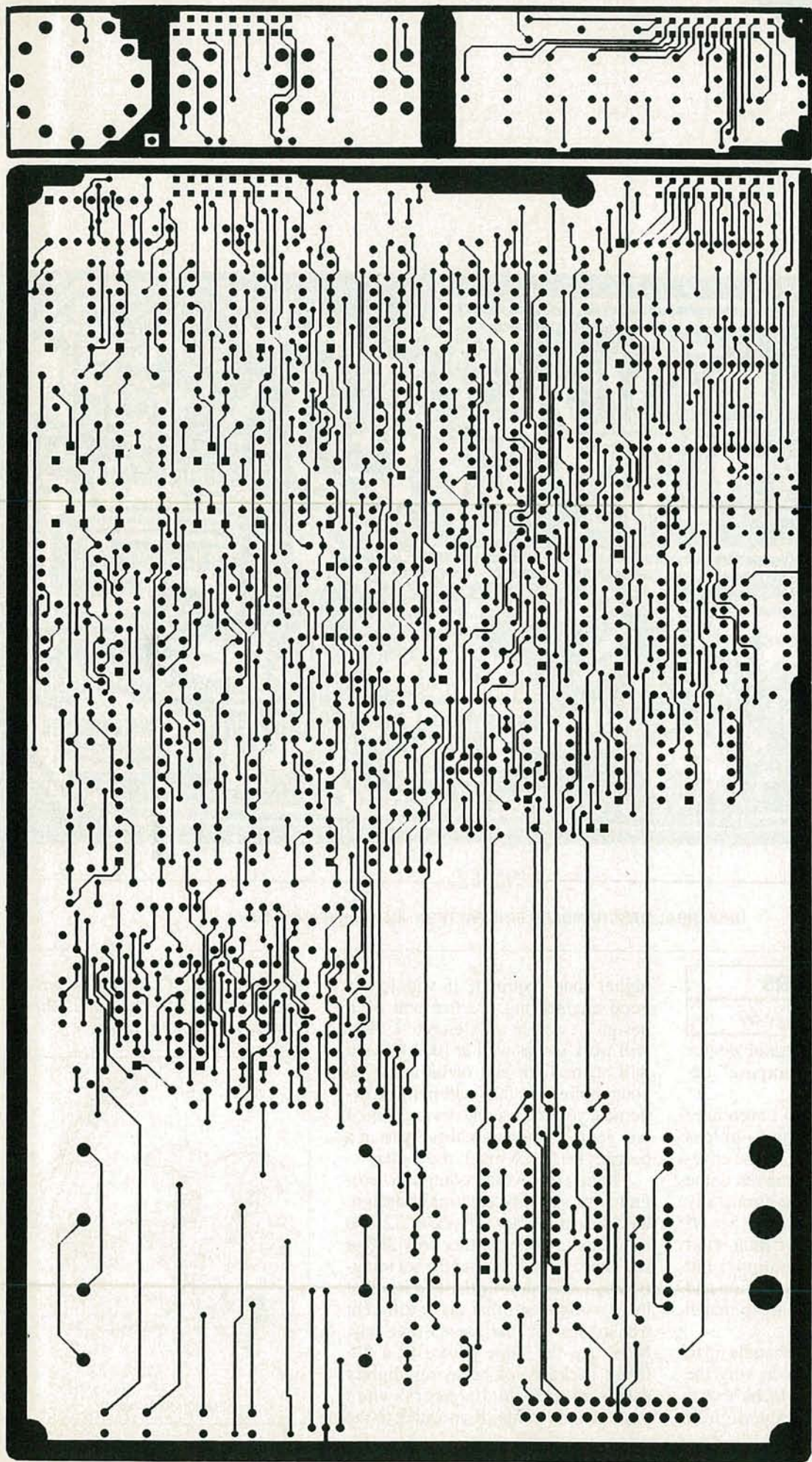

← 1 1/8 INCHES →

9 1/8 INCHES

SOLDER SIDE of the RTTY decoder.



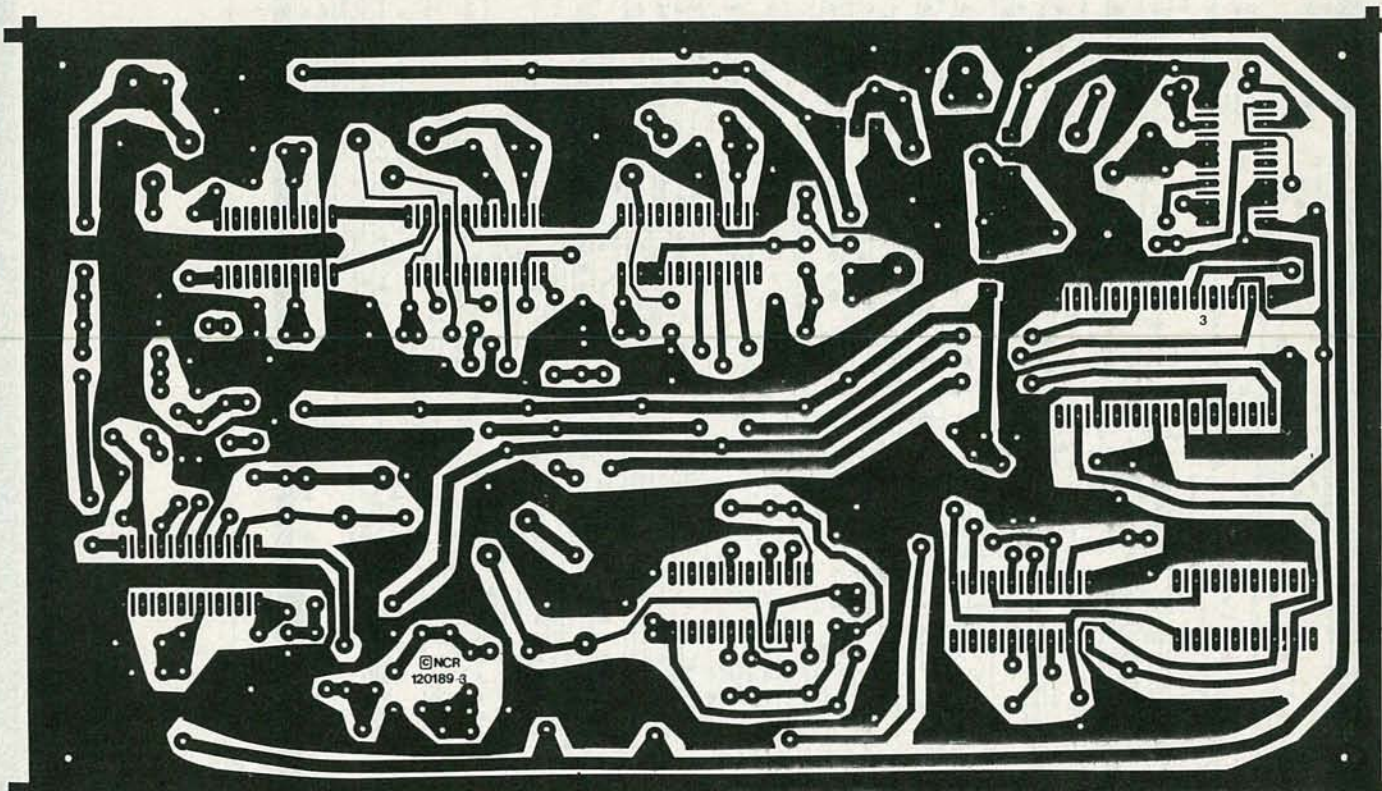

7 INCHES

UNIVERSAL DESCRAMBLER FOIL PATTERN. It's a single-sided board.

## TRANSISTORS

*continued from page 60*

cies that same small-signal device (most likely a "general-purpose" device) will also do.

In most cases you don't even have to look at specifications—unless you're "pushing the edge of the envelope," working somewhere out at the outer fringes of a category, almost any transistor in a class will do suffice. If you want to be more particular, start scrutinizing the specifications, but bear in mind that your application and the specifications don't have to match perfectly.

If your amplifier has to handle up to 100 kHz, there's no reason why the cutoff frequencies have to be exact. You can establish cutoffs slightly

higher than required, if you follow good engineering practice and over-design. A device usable up to 1 MHz will work just as well at 100 kHz as it will at the high end of its range. If your application falls within those extremes, you can use the device. And if you get the "higher-quality" part at a bargain price, so much the better.

There are several computer programs to simplify electronic design. One has a library of about 12,000 transistors, while another only 200 or so. The rationale behind the seemingly small selection in the latter is that there really aren't that many different transistors—it just seems that way. Many are the same device in a different package, or behaving slightly differently from its peers when pushed to its limits. If you stick to the

middle ground, it's hard to go wrong. Once you're in the ballpark, there's no absolute right or wrong. R-E



"Great color bars!"



# R-E Engineering Admart

Rates: Ads are 2 1/4" x 2 1/8". One insertion \$950. Six insertions \$925. each. Twelve insertions \$895. each. Closing date same as regular rate card. Send order with remittance to **Engineering Admart**, Radio Electronics Magazine, 500-B Bi-County Blvd., Farmingdale, NY 11735. Direct telephone inquiries to Arline Fishman, area code-516-293-3000. **Only 100% Engineering ads are accepted for this Admart.**

## MIDI PROJECTS



**BP182**—MIDI interfacing enables any so equipped instruments, regardless of the manufacturer, to be easily connected together and used as a system with easy computer control of these music systems. Combine a computer and some MIDI instruments and you can have what is virtually a programmable orchestra. To get your copy send \$6.95 plus \$1.25 for shipping in the U.S. to **Electronic Technology Today Inc.**, P.O. Box 240, Massapequa Park, NY 11762-0240.

## FCC LICENSE PREPARATION

The FCC has revised and updated the commercial license exam. The **NEW EXAM** covers updated marine and aviation rules and regulations, transistor and digital circuitry. **THE GENERAL RADIOTELEPHONE OPERATOR LICENSE - STUDY GUIDE** contains vital information. **VIDEO SEMINAR KITS ARE NOW AVAILABLE.**

WPT PUBLICATION  
979 Young Street, Suite A  
Woodburn, Oregon 97071  
Phone (503) 981-5159

CIRCLE 185 ON FREE INFORMATION CARD

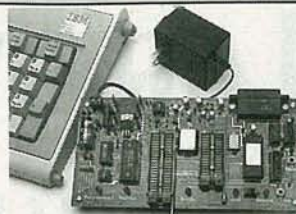

## 6805 MICROCOMPUTER DEVELOPMENT SYSTEM

The MCPM-1 system allows the IBM PC and compatibles to be used as a complete development system for the Motorola MC68705P3, P5, U3, U5, R3 and R5 single chip microcomputers. The system includes a cross assembler program, a simulator/debugger program and a programming board that connects to a serial port. Price—\$449.00 VISA and MASTERCARD accepted.

**TECI** THE ENGINEERS COLLABORATIVE INC.

RR#3, BOX 8C Barton, Vermont 05822  
Phone (802) 525-3458 FAX (802) 525-3451

CIRCLE 194 ON FREE INFORMATION CARD

## OSCILLOSCOPES

continued from page 48

The triggering capability of the HP 54501A shows the versatility of DSO's. Users can select a "time-qualified pattern trigger," for example, where the DSO will trigger only on a glitch. Logic triggering allows triggering only for certain user-defined conditions. A user can select a particular pattern of either positive- or negative-going edges to trigger on for each of the four channels. Triggering occurs only when the selected pattern occurs. A user can also specify a pattern using any three channels, with

the fourth as a clock. A TV/Video Sync Pod option can capture unclamped video waveforms; the HP 54501A also has an internal TV trigger.

Figure 7 shows the Tektronix 2432A, with a 300-MHz bandwidth and a 250-megasample/s digitizing rate. The single-shot bandwidth is 100 MHz for band-limited signals. The repetitive mode uses an equivalent-time sampling technique (random and multiple point). The Tektronix 2432A has a number of other useful features, including envelope mode, averaging, and smoothing. Averaging reduces noise on repetitive signals, while smoothing greatly improves Signal-

to-Noise Ratio (SNR) of single-shot waveforms.

One of the most impressive DSO manufacturers is Analogic Corp. of Peabody, MA. Their DSO, the Data 6100 Waveform Analyzer shown in Fig. 8, is *much* more powerful than most, with numerous accessories, including plug-in front ends from 100 kHz-125 MHz in bandwidth, RS-232C serial and GPIB interfaces, preprogrammed handshaking, a programming language, and an incredible array of math functions. There's also a calculator-style keyboard, and soft keys on the display.

It's not just a DSO, but a spectrum analyzer. There are two or four independent channels, letting you display magnitude, phase, real, and imaginary parts of frequency spectra simultaneously. You can add, subtract, multiply, divide, differentiate, and integrate signals, and display power spectra or histograms, do convolution, auto- and cross-correlation, find fundamental frequency, RMS, peak-to-peak, mean, standard deviation, and rise time, and signal averaging, all in real-time, and store up to 32K points per waveform. There's also a double floppy-disk drive add-on for storing waveforms and programs, and extensive technical support.

Since DSO's are here to stay, you should get familiar with them. Most manufacturers provide a tutorial handbook that you should read if you have access to one.

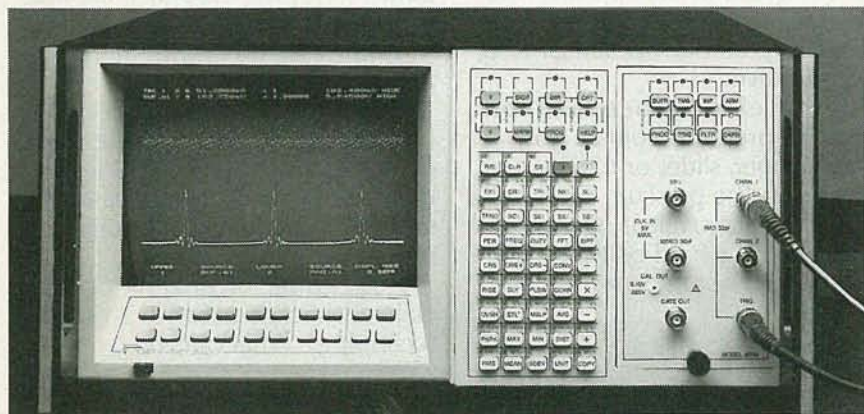

**FIG. 8**—THE ANALOGIC CORP. DATA 6100 WAVEFORM ANALYZER is *much* more powerful than most DSO's, with many accessories, including plug-in front ends from 100 kHz-125 MHz in bandwidth, RS-232C serial and GPIB interfaces, preprogrammed handshaking, a programming language, and soft display keys. It's also a two- or four-channel spectrum analyzer, with numerous math functions on the calculator-style keyboard (see text), and can both work in real-time and store up to 32K points per waveform. There's a double floppy-disk drive add-on to store waveforms and programs, and extensive technical support.

MAY 1990

R-E



# HARDWARE HACKER

Hall Effect Resources  
Shape Memory Alloys  
Cycolor Printing Secrets  
Low Noise Amplification  
Unusual Mechanical Stuff

DON LANCASTER

## Cycolor printing secrets

IF YOU EVER FIND OUT WHATEVER IT IS WE are doing here, please be sure and let me know. At any rate, this month's goodies include a brand-new color imaging process, low-noise amplifiers, *Hall-Effect* devices, and some unusual new non-electronic items that cry out for hacker use. As usual, all of our referenced sources appear in either the upcoming *Hall Effect* resource sidebar or in the *Names and Numbers* box. Please check out those sidebars before using the free help line. And please make your product and your literature requests to anyone listed in either sidebar specific, rather than general. Onward and upward...

### The Cycolor process

Color copiers are getting better and better. While they cannot today challenge production color printing or photographic processes for cost or clarity, the handwriting is on the wall. As you might expect, there are now dozens of new color technologies in one stage of development or another. Several of the obvious needs that any color system must meet are accurate color registration, low materials cost, dense resolution, and the ability to faithfully reproduce an original.

One of the candidate systems is called the *Cycolor* process. That one is in volume production, solves most registration problems in one swell foop, and appears to be eminently hackable.

The key *Cycolor* secret lies in the materials used. Figure 1 shows details. Picture three different egg-like packages called *cyliths*. Each *cylith* is around one-third of a mil (0.0003")

in diameter. Zillions of them are uniformly spread out one *cylith* deep over a polyester carrier, similar to a piece of photo film.

Each *cylith* starts out with a soft outer shell. The first *cylith* type is full of a liquid cyan (process blue) *leuco* dye. The second *cylith* type is full of magenta (reddish-purple) dye. The third *cylith* type is full of yellow dye.

The *cylith* shells are sensitive to different color light. On exposure, the *cyliths* will *harden*. For instance, red light will harden the cyan *cyliths* but leave the magenta and yellow ones soft. White light will harden all of the *cyliths*, while black (no light at all) will leave all the *cyliths* soft.

To create a color print or slide, an image is projected onto the developer sheet containing all the *cyliths*. After exposure, your developer sheet will consist of a mixture of hard and soft *cyliths*. You now have a *latent image* on your sheet that is somewhat similar to a color negative.

The developer sheet is then placed in pressure contact with a suitable paper, slide, or transparency material. The pressure breaks all of the soft *cyliths*, releasing their internal dyes. The hard *cyliths* remain intact and do not release their dye.

### NEED HELP?

Phone or write your **Hardware Hacker** questions directly to:  
Don Lancaster  
**Synergetics**  
Box 809  
Thatcher, AZ 85552  
(602) 428-4073

For instance, if you've got hard cyan *cyliths* and soft magenta and yellow *cyliths*, then the magenta and yellow dyes will get released and will mix to form a red image. For a blue image, those yellow *cyliths* harden, leaving the magenta and cyan *cyliths* soft. Squashing the soft *cyliths* mixes a magenta and cyan to produce a deep blue. And so on.

One more time. Bunches of *cylith* capsules are on the polyester carrier. Some of the capsules get selectively hardened when exposed to light. A pressure roller then squashes the soft capsules, releasing their dye onto a suitable final paper, plastic, or slide material. Like stomping on balloons. A brief heating completes the imaging process. Neat stuff.

A free and interesting brochure on *Cycolor* is available through *Mead Imaging*, while leading companies offering *Cycolor* machines include *Brother*, *Noritsu*, *Pic-Mount*, and the folks at *Seiko-Mead*.

Probably the best way to start off hacking that stuff is to get free demos of the various machines and then rip off small quantities of the supplies for your own testing and use.

I can think of dozens of specialized hacker uses for this new technology. What can you come up with?

### Low-noise amplifiers

The best of new integrated circuit amplifiers now offer noise levels that are much lower than a circuit built from discrete components, and significantly lower than what vacuum tubes used to be able to



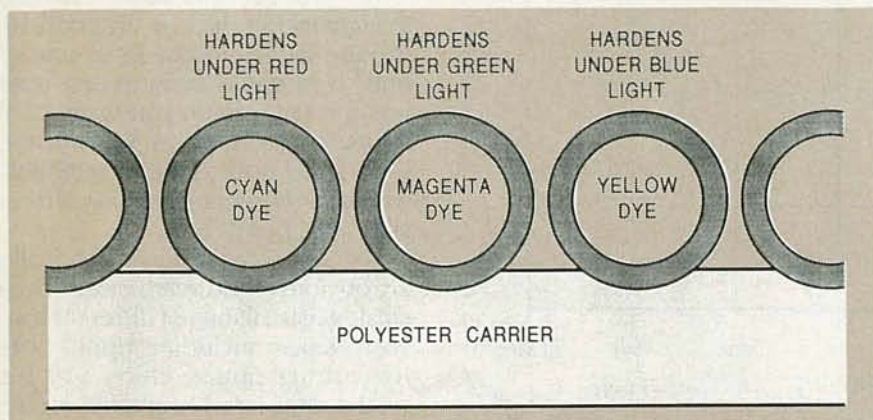

FIG. 1—THE CYCOLOR PROCESS uses tiny cylith microspheres. Each of the cyliths is initially soft, but hardens under exposure to certain light wavelengths. Crushing the soft cyliths releases a dye that creates the final image.

accomplish eons ago.

Four of the leaders in the field of ultra-low-noise chips include *Linear Technology*, *Precision Monolithics*, *Burr-Brown*, and *Analog Devices*.

While all of those sources have lots of free and excellent technical info available, I am most impressed with the *Linear Technology* offerings at the present time.

But, before we really get into this, let us shatter a few hacker myths involving low-noise amplification. First off, in no way will a low-noise amplifier by itself *reduce* the noise from an already noisy source. All a low-noise amplifier can do is limit the amount of extra noise *added* by its own amplification process.

Second, in the overwhelming majority of hacker circuits, most noise problems are caused by improper circuit layout, sloppy decoupling, instabilities, poor shielding, and undesired ground currents. Switching from an ordinary amplifier to a low-noise one in such instances will not in any significant way reduce your apparent output noise. It could even make things much worse.

Third, the wider the bandwidth, the more noise you are going to have. The wideband circuits are inherently noisier than narrowband ones. All other things being equal, noise will increase as the *square root* of your bandwidth. Most often, if you quadruple your bandwidth, you double the noise involved.

Fourth, integrated-circuit noise tends to increase dramatically at extremely low frequencies. If a precision DC response is not needed, you will be better off capacitively coupling an AC or audio amplifier.

Fifth and finally, circuit noise is a very strong function of frequency and source impedance. There is no such thing as a universal "low noise" amplifier. In fact, a "low noise" amp run in the wrong frequency range or at the wrong input impedance will actually generate *more* noise than might a plain old op-amp.

Thus, if you want low noise, it is super important that you have all the data sheets and applications literature on hand for the device you want to use, along with a thorough understanding of the options available in other chips.

There are two types of noise that the first stage of an integrated amplifier can generate. They are *voltage noise* and *current noise*. It turns out that current noise is *directly* proportional to the square root of the first stage collector current, while voltage noise is *inversely* proportional to the square root of the collector current.

If the right one don't git ya, the left one will.

Voltage noise tends to be constant with frequency and more important at *low* impedance levels, while current noise tends to increase sharply below a *noise corner* (or "1/f") frequency in the low audio range. Current noise is more important at *higher* input impedance levels than low ones.

Voltage noise is usually measured in *nanovolts per square root of bandwidth* (nV $\sqrt{\text{Hz}}$ ), with any value under 1.0 being fairly decent. Current noise gets measured in *picoamperes per square root of bandwidth* (pA $\sqrt{\text{Hz}}$ ), again with anything under 1.0 being desirable.

Figure 2 shows some possible choices for *Linear Technology* amplifiers that will give you the "best" noise performance for a given impedance level or frequency range. Of the previous generation devices, the *Precision Monolithics* OP-37 is considered the "parent" of the newer low-noise devices in the same way that the original 741 started the whole op-amp universe.

Let's look at a typical device. The *Linear Technology* LT1115 is an ultra-low-noise and low-distortion audio op amp. It works best when AC coupled at higher gains and over an optimum input source impedance of 30 to 300 ohms. Figure 3 shows you a simple microphone preamplifier that receives balanced inputs (for hum cancellation) and provides a single-ended output with a gain of 300. The total of combined noise and harmonic distortion is under 0.028 percent over a 20-Hz to 20-kHz bandwidth.

Should you truly and genuinely need the lowest voltage noise you can possibly get, and already have total and absolute control over all the usual ground, hum, stability, and stray noise sources that usually swamp hacker-circuit first-stage noise figures, there is one sneaky trick you can pull. At least it's theoretically possible.

Simply arrange several low-noise amplifiers in parallel and sum all of their outputs into a second-stage low-noise amplifier. The gain goes up with the number of amplifiers, while the noise only goes up as the square root of the number of amplifiers in use.

Five parallel amplifiers seems a practical limit, which, in theory, can reduce your first stage noise by a factor of slightly over two. In the real world, that works only for input impedances less than ten ohms. Worse yet, circuit strays are likely to eat you alive if you attempt it. More details on the LT1028 data sheet.

### Unusual mechanical goodies

There has been plenty of unusual non-electronic stuff piling up here lately, much of it with great hacker potential. Time for a rundown.

First and foremost, if you really want to get a handle on things, pick up your free sample kit from *GripWorks*.

A new material known as *Trovicel*



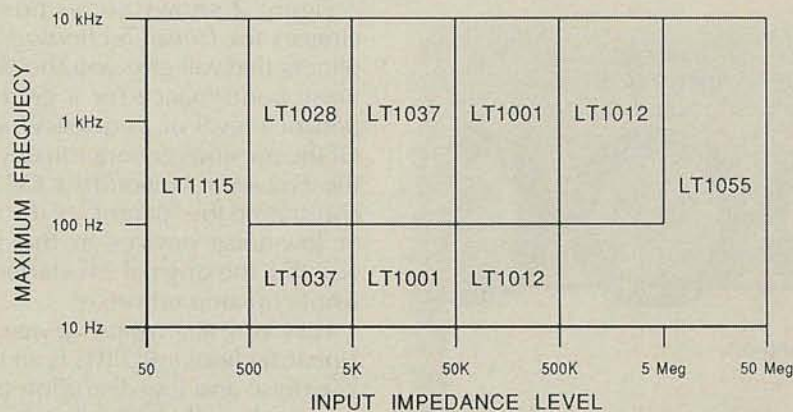

FIG. 2—ANY LOW-NOISE AMPLIFIER has to be specified over a certain input-impedance level and a certain frequency range. Here are Linear Technology's selections for the "best" low-noise op-amps. Note that a misapplied "low-noise" amplifier can actually be noisier than a regular one.

looks like a really good board product for use on everything hacker from cases through prototype models and displays. Trovicel is a rigid foam center plastic sheet that comes in lots of attractive colors and in several thicknesses. It is lightweight, tough, paintable, outdoor rated, printable, worky, and self-extinguishing. You work it with pretty near any hand or power tool, al-

though hacksawing and power shearing are not recommended. You can bond it with ordinary PVC cement, and even grind or weld it. Free samples are available.

Should you need any curved plywood in tubes, quarter-round, half-round, or with a radiused end, try some of the *Deco Shapes* product from *Laminates Incorporated*.

There seems to be a lot of interest lately in *machinable waxes*. Besides being obviously ideal for CAD/CAM training and program debugging, the material is well suited for one-of-a-kind mockups, proof-of-concept models, and for "does-it-fit?" product verification.

With a machinable wax, your tools stay sharp, the chips are safe, and you can easily recycle your final

material simply by remelting it.

The product is available from two to eight inches thick, in cylinders up to nine inches in diameter, and in bulk. You could easily recast their wax into any shape you want to. It melts at 310 degrees Fahrenheit. One good source for machinable waxes is *Freeman Supply*. Prices start at \$4 per pound.

The *American Safety Razor* folks are obviously one sharp outfit. Their catalog lists zillions of different low-cost blades, including ripple ones for cutting potato chips and big mutha ones nearly *eighteen inches* long! The variety here is amazing.

One obvious project around here is a \$5 cutter for laser-printed business cards. I'm wondering if you couldn't use their blades for a clamping paper cutter as well. A proper support, of course, would be essential for it to work.

In what just might be the most obscure free trade journal in the entire world, *Power and Bulk Solids* covers such things as bin-level detectors and similar goodies. Amazingly, several hacker helpline callers per week are asking for that sort of stuff, especially for agricultural electronics.

A new product called *Scotch 9703 Conductive Adhesive Transfer Tape* from 3-M has a very unusual property. It conducts electricity *through its thickness* but not along its length. From face to face, the resistance is under 0.1 ohms. Yet, along its length, it insulates to the point of allowing 500 volts across a ten mil gap!

Embedded silver-plated particles apparently do the trick. Adhesion values are in the 50-ounces-per-inch range for most substrates. Free test samples are available.

Finally, short shape metal alloy wire samples are available free from *Beta Phase*. These magic wires can be bent into any shape at all and will stay that way until heated to hot coffee temperatures. Then they'll rapidly spring back to their original size and shape. You can repeat the shape-and-restore process zillions of times. Applications include everything from high-density zero-insertion-force connectors to dentistry.

Tellyawhat. For this month's contest, just dream up an off-the-wall use for any of those unique new

## NEW FROM DON LANCASTER

### HANDS-ON BOOKS

Hardware Hacker Reprints II	24.50
Ask The Guru Reprints I or II	24.50
CMOS Cookbook	18.50
TTL Cookbook	16.50
Active Filter Cookbook	15.50
Micro Cookbook vol I or II	16.50
Enhancing your Apple I or II	17.50
AppleWriter Cookbook	19.50
Apple Assembly Cookbook	21.50
Incredible Secret Money Machine	10.50
LaserWriter Reference (Apple)	19.50
PostScript Cookbook (Adobe)	16.50
PostScript Ref. Man. (Adobe)	22.50
PostScript Prog. Design (Adobe)	22.50
Real World Postscript (Roth)	22.50

### UNLOCKED SOFTWARE

LaserWriter Secrets (Ile/Mac/PC)	29.50
PostScript Show & Tell	39.50
Intro to PostScript VHS Video	39.50
PostScript Beginner Stuff	39.50
PostScript Perspective Draw	39.50
PostScript Technical Illustrations	39.50
PostScript Work in Progress	39.50
PostScript BBS stuff	19.50
Absolute Reset Ile & Ilc	19.50
AppleWriter/Laserwriter Utilities	49.50
Enhance I or II Companion Disk	19.50
AppleWriter CB or Assy CB Disk	24.50

FREE VOICE HELPLINE

VISA/MC

## SYNERGETICS

Box 809-RE  
Thatcher, AZ 85552  
(602) 428-4073

CIRCLE 83 ON FREE INFORMATION CARD

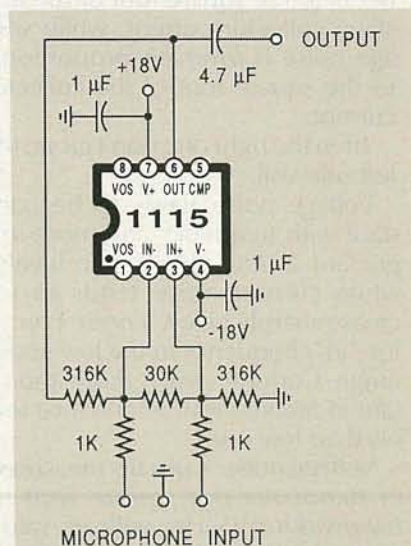

FIG. 3—AN ULTRA-LOW-NOISE balanced preamp circuit that uses the Linear Technology LT1115. Combined noise and distortion is under 0.028 percent.



**NAMES AND NUMBERS**

**American Safety Razor**

Razor Blade Lane  
Verona, VA 24482  
(703) 248-8000  
CIRCLE 226 ON FREE INFORMATION CARD

**Analog Devices**

One Technology Way  
Norwood, MA 02062  
(617) 329-4700  
CIRCLE 227 ON FREE INFORMATION CARD

**Beta Phase**

1200 Chrysler Drive  
Menlo Park, CA 94025  
(415) 494-8410  
CIRCLE 228 ON FREE INFORMATION CARD

**Burr-Brown**

6730 South Tucson Blvd  
Tucson, Az 85706  
(602) 746-1111  
CIRCLE 229 ON FREE INFORMATION CARD

**Freeman Supply**

1246 West 70th Street  
Cleveland, OH 44102  
(800) 321-8511  
CIRCLE 230 ON FREE INFORMATION CARD

**Grip Works**

6916 South Broadway  
St. Louis, MO 63111  
(800) 827-GRIP  
CIRCLE 231 ON FREE INFORMATION CARD

**Laminates Inc.**

35 Engineers Road  
Hauppauge, NY 11788  
(800) 221-5454  
CIRCLE 232 ON FREE INFORMATION CARD

**Linear Technology**

1630 McCarthy Blvd  
Milpitas, CA 95035  
(408) 432-1900  
CIRCLE 233 ON FREE INFORMATION CARD

**Maxim**

120 San Gabriel Drive  
Sunnyvale, CA 94086  
(408) 737-7600  
CIRCLE 234 ON FREE INFORMATION CARD

**Mead Imaging**

3495 NewMark Drive  
Miamisburg, OH 45342  
(513) 495-9100  
CIRCLE 235 ON FREE INFORMATION CARD

**Motorola**

5005 East McDowell Road  
Phoenix, AZ 85008  
(602) 244-6900  
CIRCLE 236 ON FREE INFORMATION CARD

**MWK Industries**

1440 S State College Blvd, 3B  
Anaheim, CA 92806  
(800) 356-7714  
CIRCLE 237 ON FREE INFORMATION CARD

**Omega Engineering**

Box 4047  
Stamford, CT 06907  
(203) 359-1660  
CIRCLE 238 ON FREE INFORMATION CARD

**Power/Bulk Solids**

PO Box 650  
Morris Plains, NJ 07950  
(201) 292-5100  
CIRCLE 239 ON FREE INFORMATION CARD

**Precision Monolithics**

1500 Space Park Drive  
Santa Clara, CA 95052  
(408) 727-9222  
CIRCLE 240 ON FREE INFORMATION CARD

**Raytheon**

350 Ellis Street  
Mountain View, CA 94039  
(415) 968-9211  
CIRCLE 241 ON FREE INFORMATION CARD

**Sharp**

Sharp Plaza  
Mahwah, NJ 07430  
(201) 529-8757  
CIRCLE 242 ON FREE INFORMATION CARD

**Silicon Valley Surplus**

4222 East 12th  
Oakland, CA 94601  
(415) 261-4506  
CIRCLE 243 ON FREE INFORMATION CARD

**Teledyne**

1300 Terra Bella Avenue  
Mountain View, CA 94039  
(415) 968-9241  
CIRCLE 244 ON FREE INFORMATION CARD

**Texas Instruments**

PO Box 1443  
Houston, TX 77001  
(800) 232-3200  
CIRCLE 245 ON FREE INFORMATION CARD

**3-M/Scotch**

3M Center Bldg. 220-7E-01  
St Paul, MN 55144  
CIRCLE 246 ON FREE INFORMATION CARD

**Trovicel Huls**

Turner Place Box 365  
Piscataway, NJ 08855  
(201) 981-5000  
CIRCLE 247 ON FREE INFORMATION CARD

**ZENITH**

**TURBOSPORT 386  
PORTABLE LAPTOP  
COMPUTER**



386  
40 MB  
Hard  
Drive!

- 80386 32-bit processor, 12/6 MHz (switchable).
- 40 MB (28ms) hard drive.
- One 3.5" 1.4 MB floppy disk drive.
- 2 MB RAM (expandable to 3 MB).
- MS-DOS 3.21 included. • 100% IBM compatible.
- "Page-White" fluorescent backlit LCD display with 10.5" viewing area.
- Supports: MS OS/2 version 1.0, Xenix, and also Microsoft Windows/386 environments.
- Zero wait state.
- Socket for 80387 numeric co-processor.
- Internal Hayes 2400 Baud modem.
- Serial & parallel printer ports.
- Resolution: 640 x 400 pixels.
- 79-key full function detachable keyboard.
- "Fast" charge NiCad battery pack included.
- Dim.: 13.25"W x 14.75"D x 4.75"H.
- Wt: 14.7 lbs. • One Year Warranty!
- Factory New & Perfect!

Due to a special arrangement, we were able to obtain a large inventory of these laptop computers. As a result, we can now offer them to you at HUGE SAVINGS!

\* Expansion Slot 1 MB Memory, Carry Case, Battery Pack also available.

Manufacturer's Suggested Retail  
**\$8,499.00**

**DAMARK PRICE:**

**\$ 2999<sup>99</sup>**

Item No. B-1970-128686  
Insured Ship/Hand.: \$20.00

**FOR FASTEST  
SERVICE CALL  
TOLL FREE**

**1-800-729-9000**



**DAMARK INTERNATIONAL, INC.**  
6707 Shingle Creek Parkway, Minneapolis, MN 55430  
Customer Service • 612-566-4940

Please rush me: \_\_\_\_\_ Zenith Laptop Computer(s)  
@ \$2999.99 each, plus \$20.00 s/h each.  
Item No. B-1970-128686  
**MN res. add 6% sales tax.**

Name \_\_\_\_\_  
Address \_\_\_\_\_  
City, State, Zip \_\_\_\_\_  
 Check/MO  VISA  MasterCard  Discover  
Card No. \_\_\_\_\_  
Exp. Date \_\_\_\_\_ Ph. # ( ) \_\_\_\_\_  
Signature \_\_\_\_\_

**DELIVERY TO 48 U.S. STATES ONLY**

MAY 1990



materials. There will be the usual dozen or so *Incredible Secret Money Machine* book prizes, along with an all-expense-paid (FOB Thatcher, AZ) *tinaja quest* for two going to the very best of all.

As usual, send all your written entries directly to me at *Synergetics*, rather than to **Radio-Electronics**.

### Hall-effect devices

There are lots of different ways of sensing magnetic fields, ranging from a compass on up. In past issues and in the *Hardware Hacker* reprints, we've looked at the *flux gate magnetometer*, that appears to be far and away the best method for sensing and measuring the Earth's magnetic field.

Another magnetic-field sensor is called a *Hall-Effect device*. While not nearly sensitive enough for accurate electronic compass uses, a wide range of Hall devices are available for use in position- and speed-sensing devices that can interact with nearby magnetic materials. Our resource sidebar for this month shows you a few of the leading sources of useful Hall-Effect products and information.

Figure 4 shows you how the Hall Effect works. A thin film of selected semiconducting material has a current applied to it from a top-edge terminal to a bottom-edge terminal. Two additional contacts are placed midway along the sides of the film. The Hall voltage will develop across

those terminals. In the absence of any magnetic field, your current will be uniform across the film, and there will be no Hall output voltage.

Now, should a magnetic field be applied into the film, the current will shift towards one edge or the other, and a Hall voltage will be generated whose strength is proportional to the magnetic field and whose polarity depends on the polarity of the applied magnetic field.

The Hall action is related to the magnetic deflection phenomenon used in a television picture tube and follows the "right-hand rule" where the resultant force of a magnetic field causes an electron beam current to move sideways.

The Hall voltage is usually rather low, and is typically in the tens of millivolts. In most Hall applications, fairly strong magnets are required to be placed quite close for reliable operation.

In general, there are two types of Hall-Effect sensors, *linear* and *digital*. Linear sensors are used whenever you wish to measure the actual strength of a magnetic field. A *Gaussmeter* is one instrument that can use Hall-Effect devices to measure medium-strength magnetic fields. *F.W. Bell* is a major source for the precision linear Hall devices and instruments.

Digital sensors are used whenever the presence or absence of a magnetic field is intended to produce a "yes-no" output. Figure 5

shows you one typical digital Hall-Effect sensor, the Sprague UGN-3013, which is a three-terminal device about the size and shape of a small signal transistor. The price is under a dollar.

A supply voltage is applied. While that can range from 4.5 to 25 volts, the usual +5 is typical. There is an open-collector output that is *off* in the absence of a magnetic field. Note that you must provide an external pull-up resistor to get an output. Typical supply current is three milliamperes, plus the "on" current through the load resistor.

The chip is guaranteed to turn on with a magnetic field of 500 Gauss, or roughly 500 times the strength of Earth's magnetic field. It's also guaranteed to turn off with a magnetic field of less than 30 Gauss. To prevent any chattering, a snap-action hysteresis of 75 Gauss or so is usually provided via an input Schmitt trigger.

A cheap *Alnico* magnet a third of an inch in diameter and a quarter inch thick will activate your chip from a distance of 0.15 inches. Sensitivity drops off dramatically with distance. On the other hand, *flux concentrating* pole pieces can be added for extended range, as can stronger magnets.

Other devices are available with different sensitivity. Some are *bipolar* in which you purposely *reverse* the applied field, rather than dropping it to zero. That can give you a more reliable sensing as alternate poles of a magnet go flipping on by.

Two excellent and sometimes free books on the Hall Effect include the *Hall Effect Sensors* data book SN-500 from *Sprague*, and the *Hall Effect Transducers* applications book from *Micro Switch*. The latter shows a \$10 optional list price.

There are bunches of hacker uses for Hall-Effect devices, since they can sense though a modest non-contacting distance in a dirty environment. Obvious digital uses now include high-reliability keyboards, automotive ignition contacts, shaft-angle encoders, position detectors, model-railroad controls, speed sensing, brushless DC motor commutation, and tilt switches.

Linear applications include current sensing, circuit breakers, and direct magnetic-field measure-

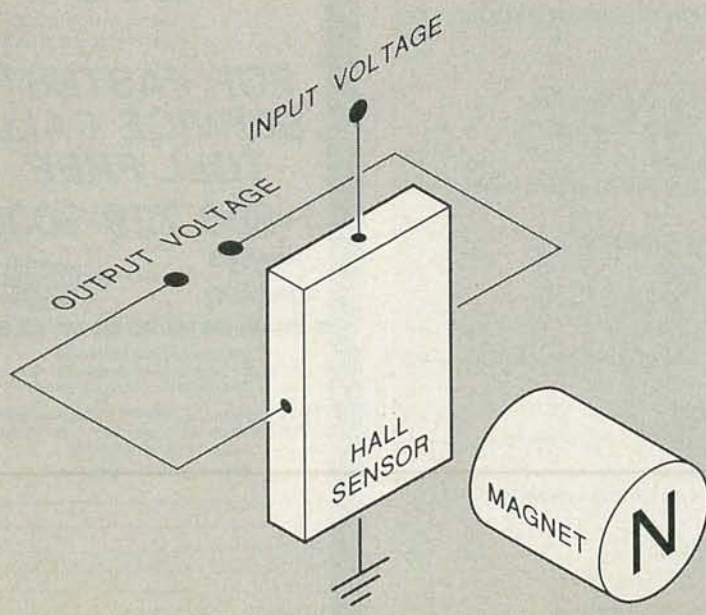

FIG. 4—THE HALL EFFECT in a semiconductor will produce a transverse output voltage that is proportional to the strength and direction of a magnetic field.



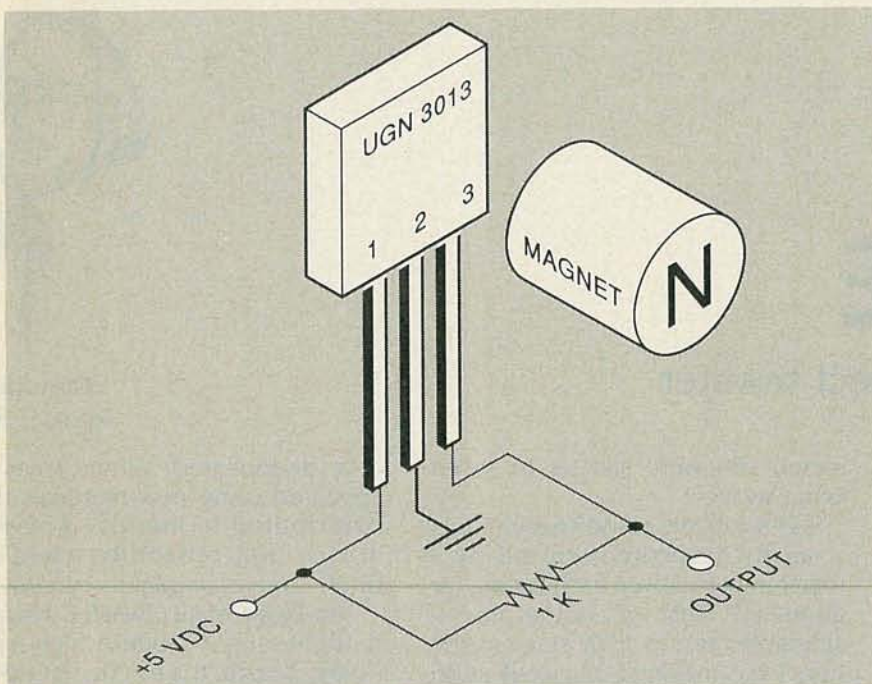

FIG. 5—THE SPRAGUE UGN3013 is a low-cost Hall-Effect sensor having a snap-action digital output. The open-collector output remains high in the absence of a magnetic field and goes low when a field is present.

ments. Hall devices also show up in all the usual surplus catalogs, and in many of the ads that you'll find right here in **Radio-Electronics**.

#### New tech literature

Certainly the fanciest data books in the industry are in the free series available from *Omega Engineering*. These thick hardback volumes now include their *Temperature; Flow*

*and Level; Data Acquisition; Conductivity and PH; Pressure, Strain, and Force; and Electrical Heaters* handbooks. They all include useful engineering info. And, all of them are available free upon a professional-sounding request. Unfortunately, the Omega prices are extremely high. Then again, they would have to be to pay for the aggressive distribution of all their exotic catalogs.

#### HALL EFFECT DEVICES AND RESOURCES

##### F.W. Bell

6120 Hanging Moss Road  
Orlando, FL 32807  
(407) 678-6900

CIRCLE 248 ON FREE INFORMATION CARD

##### M & C Magazine

2994 West Liberty Avenue  
Pittsburgh, PA 15216  
(412) 343-9666

CIRCLE 249 ON FREE INFORMATION CARD

##### Micro Switch

11 West Spring Street  
Freeport, IL 61032  
(815) 235-6600

CIRCLE 250 ON FREE INFORMATION CARD

##### Sensors Magazine

1244 Reamwood Avenue  
Sunnyvale, CA 94089  
(408) 744-1500

CIRCLE 251 ON FREE INFORMATION CARD

##### Siemens

19000 Homestead Road  
Cupertino, CA 95014  
(408) 257-7910

CIRCLE 252 ON FREE INFORMATION CARD

##### Sprague

70 Pembroke Road  
Concord, NH 03301  
(603) 224-1961

CIRCLE 253 ON FREE INFORMATION CARD

##### Texas Instruments

PO Box 809066  
Dallas, TX 75380  
(800) 232-3200

CIRCLE 254 ON FREE INFORMATION CARD

##### Wabash Magnetics

1375 Swan Street  
Huntington, IN 46750  
(219) 356-8300

CIRCLE 255 ON FREE INFORMATION CARD

Other data books this month include the new *Precision Analog and Power Control IC Handbook* from *Teledyne*, and a new *Linear Integrated Circuits* databook from *Raytheon*. Looking at short forms, *Sharp* has a pair of them out, one titled *RF Components for CATV Systems*, and the other *RF Components for Satellite Receivers*.

And two free new surplus flyers: *MWK Industries* for lasers and optics, plus *Silicon Valley Surplus* for great robotics prices.

What appears to be a stupendous breakthrough is described in *A light source smaller than the optical wavelength*, beginning on page 59 of the January 5, 1990 issue of *Science*. That one is downright scary in its potential.

Free samples this month include a MC14507 single supply RS-232 driver from *Motorola*, a Johnny-come-lately imitation of the *Maxim* chips that pioneered this field. Also, there are a bunch of freebie chips from *Texas Instruments*. Those include their TL499A battery-backup DC-DC converter, a TL1451A pulse-width modulator chip, and their SN75C188 line-driver circuit.

Turning to my own products, for the fundamentals of digital integrated circuits, check into both my classic million-selling *TTL* and *CMOS Cookbooks*. I do have some autographed copies on hand here for you.

I also have a new and free mailer for you which includes dozens of insider hardware hacking secret sources. Write or call for a copy.

As always, this is your column and you can get technical help and off-the-wall networking per that *Need Help?* box. The best calling times are weekdays 8-5, *Mountain Standard Time*. Let's hear from you. **R-E**

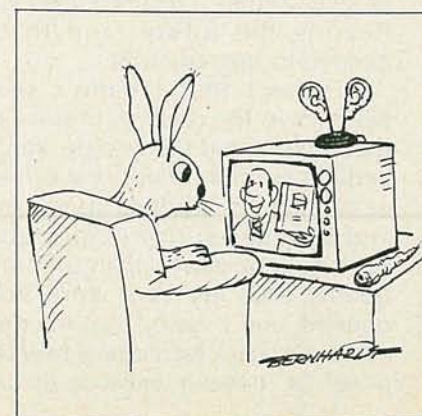

MAY 1990



# AUDIO UPDATE

## The search for the perfect tweeter

IN EVERY YOUNG MAN'S LIFE THERE ARE certain milestones on the road to maturation. For example, I recall the circumstances surrounding my first tweeter and crossover as though it were yesterday. The time was 1951, and I had recently assembled my very first audio system—a Garrard changer with a GE phono cartridge feeding a Bell 8-watt integrated amplifier driving a GE 1201 single-cone, 12-inch "full-range" speaker. The speaker was housed in a home-built and—as I learned later—badly mistuned bass-reflex cabinet.

I was satisfied with the sound of my modest setup until a chance acquaintance invited me to audition his system. Little did I know as I took the Lexington Avenue subway uptown that I was about to experience an audio epiphany. My friend's system turned out to be overwhelming in its sophistication; it actually had a separate little horn-loaded speaker called a tweeter designed specifically to reproduce the high frequencies! And, furthermore, he owned two special demonstration discs with highs on them for the tweeter to reproduce. As I sat there in his living room regaled by the recorded sounds of shattering glass and whistling tea kettles, I realized that I was hearing the future, and that I needed to upgrade to it.

It wasn't that I hadn't seen tweeters in the catalogs, it was just that I misjudged them to be simply another example of pricey audio excess (such as separate tone arms and turntables) that contributed more to snob appeal than to sound quality. But my ears were now opened, and I vowed that my next audio purchase would be a tweeter. (I say "a" tweeter because in 1951

stereo LP's were still six to seven years away.)

As I recall, my friend's tweeter was a small University horn fed by a matching crossover, each selling for about \$12. That was not an inconsiderable sum in 1951, since at the time I was making \$70 a week as an electronic technician. Unfortunately, after several listening sessions my friend's tweeter no longer sounded quite as miraculous as it had at first hearing. Its sound had a nasal, raspy quality that considerably dampened my pleasure with the newly heard highs. (Damping, as a matter of fact, was exactly what was missing from the University horn; as I learned later, it suffered from severe diaphragm and horn resonances.) That was the start of my Great Hi-Fi Tweeter/Crossover Hunt that lasted for at least a decade.

### Tweeters I have known

Virtually all tweeters in the early Fifties were horn-loaded, and their designers apparently had lots to learn about resonance control. In general, the tweeters were directional, harsh, and hollow sounding. After making a pest of myself at numerous hi-fi salons (as they were called in those days), I finally settled on the only cone tweeter I could find: a 5-inch model and associated 3,000 cps (Hz) beeswax-filled crossover, both made by Wharfedale, a British manufacturer. My new tweeter didn't provide instant audio ecstasy, but at least I finally had highs without harshness.

In the next two decades, there was a proliferation of tweeter designs driven, I think, by the newly acknowledged inadequacies of existing models. Some of the designs

have disappeared; others have reappeared using new materials that contributed to improved performance and reliability. Here's a brief—and incomplete—rundown:

**The Electrostatic Tweeter.** Usually thought of as a modern high-technology device, the electrostatic driver—or at least the concept of such a device—has been around since about 1925. As a tweeter, it consists of a very thin conductive diaphragm supported in close proximity to a perforated metal plate—or sandwiched between a pair of plates as in Fig. 1. A fixed high-voltage charge is applied between the metal plates (P) and the diaphragm (D). The audio signal voltage is stepped up by a transformer to an appropriately high value to override the fixed elec-



Larry Klein,  
Audio Editor

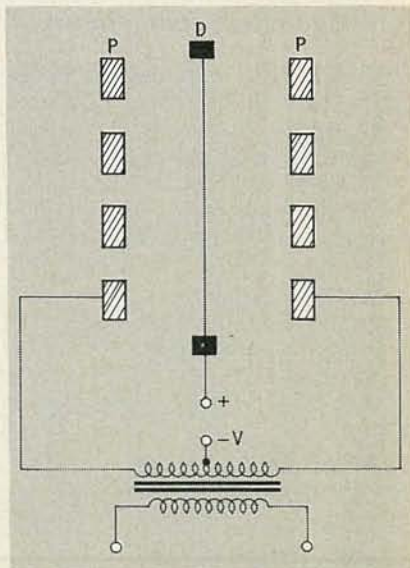

Fig. 1: FLEXIBLE DIAPHRAGM D is suspended between plates P in a typical push-pull electrostatic tweeter. The polarizing high-voltage DC supply is applied at the secondary of the matching audio-input transformer.



trostatic charge and thereby produce diaphragm motion. Transient response can be quite good as a direct result of the very low-mass diaphragm. At the present time, it appears that dynamic cone/dome tweeters have progressed sufficiently that to many listeners they audibly compete with the electrostatic designs—and don't require a high-voltage power supply.

**The Ionvac Tweeter.** Invented by a French engineer named Sigmund Klein (no relation), it used a high-voltage RF signal to ionize the air in a small open-ended quartz element. To produce sound, the RF voltage was audio modulated, causing the ionized air to expand and contract at audio frequencies. This truly massless "diaphragm" was free of resonances and had exceptional high-frequency bandwidth and transient response. The tweeter appeared briefly in the U.S. under the DuKane brand name, and in England as the Ionofane. The need for a high-power RF oscillator—along with the machined quartz cell—ultimately limited its popularity.

**The Ribbon Tweeter.** This is another old-timer (c. 1923), but there are several current speaker systems using ribbons as tweeters. Simpler in both concept and execution than the ionic and electrostatic tweeters, the ribbon is merely a thin strip of corrugated conducting foil suspended in a powerful magnetic field. In the latest designs, the field is created by groupings of many small magnets epoxied into position, instead of two (or four) large magnets as shown in Fig. 2. Basically, the ribbon can be consid-

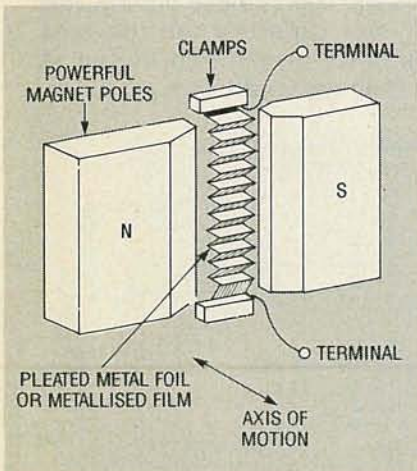

Fig. 2: RIBBON TWEETER in simplified form.

ered a single long voice-coil/diaphragm that is both low mass and driven over its entire length.

**The Dome Tweeter.** Developed by Edgar Villchur in 1957, dome tweeter designs are currently found in more speaker systems than any other type of high-frequency reproducer. Mr. Villchur, incidentally, was also the founder of Acoustic Research and the developer of the acoustic-suspension speaker system, which also has achieved world-wide acceptance. The dome was the first truly successful attempt to produce a small radiating surface (which ensures good dispersion) that also had substantial power response. (Fig. 3) Unlike a conventional cone diaphragm (which is driven at its apex

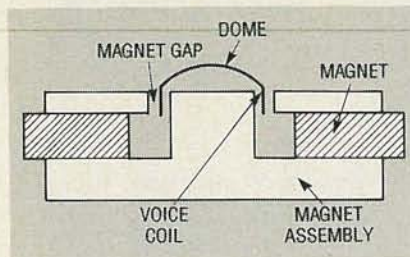

Fig. 3: SIMPLIFIED DOME TWEETER. The dome/voice-coil assembly in the original design was supported by four drops of butyl-rubber compound.

with resulting flexing and resonances), the dome sits directly on its driving voice coil and has essentially the same diameter. Various hard and soft materials are now used in domes: phenolic, butyl, copper, aluminum, titanium, and mixtures of boron, carbon fibers, diamond dust, and heaven knows what else. The intention is to decrease the mass and stabilize the dome shape without introducing resonances. Incidentally, in a recent conversion, Ed Villchur said that because of its superior dispersion characteristics, he regards the convex diaphragm tweeter (which is sort of a dome with skirts, developed by Allison Acoustics) as a basic improvement on the dome configuration.

Tweeter progress over the years has been truly astonishing, and today it's possible to realize exceptional high-frequency performance from designs that are simpler and cost far less than those of yesteryear. That's just as well, considering the quantity and *quality* of the recorded high frequencies found on the best of today's digital recordings. R-E

## DIGITAL VIDEO STABILIZER ELIMINATES ALL VIDEO COPY PROTECTIONS



While watching rental movies, you will notice annoying periodic color darkening, color shift, unwanted lines, flashing or jagged edges. This is caused by the copy protection jamming signals embedded in the video tape, such as Macrovision copy protection. Digital Video Stabilizer: RXII completely eliminates all copy protections and jamming signals and brings you crystal clear pictures.

**WARNING :**  
SCO  
Electronics and  
RXII dealers do  
not encourage  
people to use  
the Digital  
Video Stabilizer  
to duplicate  
rental movies  
or copyrighted  
video tapes.  
RXII is in-  
tended to stabi-  
lize and restore  
crystal clear  
picture quality  
for private  
home use only.

- FEATURES:**
- Easy to use and a snap to install
  - State-of-the-art integrated circuit technology
  - 100% automatic - no need for any troublesome adjustments
  - Compatible to all types of VCRs and TVs
  - The best and most exciting Video Stabilizer in the market
  - Light weight (8 ounces) and Compact (1x3.5x5")
  - Beautiful deluxe gift box
  - Uses a standard 9 Volt battery which will last 1-2 years.

(Dealers Welcome)

To Order: \$49.95 ea + \$4 for FAST UPS SHIPPING

1-800-445-9285 or 516-694-1240

Visa, M/C, COD M-F: 9-6 (battery not included)

SCO ELECTRONICS INC.

Dept. CBY 581 W. Merrick Rd. Valley Stream NY 11580

Unconditional 30 days Money Back Guarantee

CIRCLE 197 ON FREE INFORMATION CARD

## CABLE TV DESCRAMBLER



	1 Unit	10 +
Jerrold S.B. ....	\$74	.....\$55
Jerrold SB w/Trimode.....	\$90	.....\$70
Oak N-12 (w/VS).....	\$89	.....\$65
Scientific Atlanta.....	\$109	.....\$75
Pioneer.....	\$109	.....\$75
Panasonic converter.....	\$98	.....\$79
73 channel converter.....	\$79	.....\$59

**We Beat Anyone's Price!**

**30 Days Money Back Quaranty**

**Free Catalog**

Visa, M/C, COD or send money order to:

**US Cable TV Inc.** Dept. KCT

4100 N. Powerline Rd., Suite F-4

Pompano Beach, FL 33073

**1-800-445-9285**

Please have make and model number of the equipment used in your area ready.

**No Florida Sales!**

It's not the intent of US Cable TV Inc. to defraud any pay TV operator and we will not assist any company or individual in doing so.

CIRCLE 198 ON FREE INFORMATION CARD



# DRAWING BOARD

## Video-sync generator

THE VIDEO CIRCUIT WE'VE BEEN BUILDING isn't quite at the point where you can use it to tune in the news, but it's getting there.

Way back when we first started our adventures in videoland (*Radio-Electronics*, January and February 1990), we looked at a simple block diagram of the circuit we needed. If you refer to it now, you'll see that most of the work is finished. We've got the master clock generator and have just finished the arithmetic circuits that generate the frequencies we need to produce NTSC video.

The last part of the timing circuit we have to come up with is the one that produces the actual pulses to control the electron beam in the television. What we've done so far is create the triggers that will enable horizontal and vertical sync, but we still have to design the pulse circuits themselves.

### Horizontal sync pulse

There's certainly no shortage of monostable multivibrators, also known as pulse generators. You can build them from something as simple as a resistor and capacitor or as standard as a plain old 555. There are some special considerations in our application (pulse width and shape), meaning that we have to go a bit beyond those methods.

The diagram in Fig. 1 shows all the timing information for the parts of the horizontal interval and, if you take a good look at the numbers, you'll understand the problem. We have to have a horizontal sync pulse with short rise and fall times, and the pulse width has to be, according to the NTSC standard,  $4.71 \pm 0.05$  microseconds. When you need that

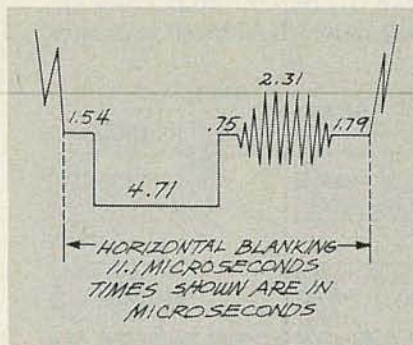

FIG. 1

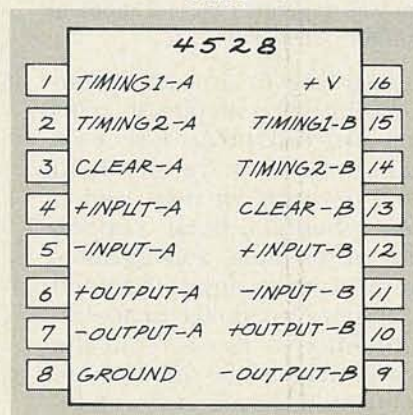

FIG. 2

short a pulse and you want to keep the shoulders nice and sharp, you need something other than a 555.

The most common way to make accurate monostables is to use a D-type flip flop in combination with an RC network. That is such a routine combination, that special MSI chips were developed for it. Those IC's have been around for a while, and one of them, the 4528 dual monostable multivibrator, is a good choice for us to use. You can see the pinouts in Fig. 2.

Since that is a dual chip, and each half can be used independently, we can use one section to generate the

horizontal sync pulse. As you can see from Fig. 3, it takes only two parts to make it work. The width of the output pulse is determined by the RC product. We're talking about straight multiplication. Due to the fact that we're using a capacitor in the timing chain, there's a delay between the time you trigger the chip and the time the output pulse is generated—but that is more of a drawback when you want to produce long pulses. The problem can be minimized by using small-value capacitors and, since we want a 5-μs pulse, the inherent charge-discharge delay in the capacitor won't be much of a problem.

The timing circuit we developed produces positive-going signals, so we'll be feeding them to pin 4, the positive trigger input of the 4528. The resistor and capacitor values will generate a pulse width of about 4.7 μs. The actual value you'll get depends entirely on the components you use. A metal-film resistor and mica capacitor are the best choices for overall stability but, if you can't get your hands on those,

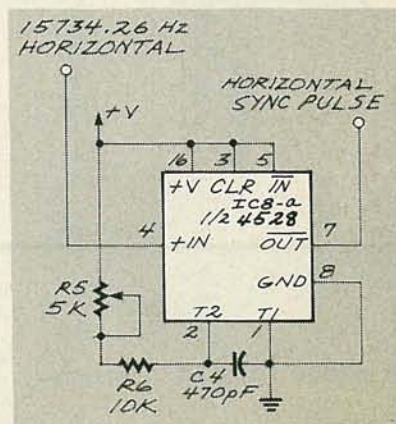

FIG. 3



ROBERT GROSSBLATT,  
CIRCUITS EDITOR



standard carbon resistors are fine. Try to avoid using a ceramic-disc capacitor since the value stamped on them is usually nothing more than wishful thinking. Should you have any problems, you can add the trimmer shown in the schematic to tweak the pulse width.

### The vertical interval

Just as the horizontal sync pulse is only one of the signals found in the horizontal interval, a vertical sync pulse is only one of several signals you'll find in the vertical interval. Just what sort of stuff will show up there depends on the broadcaster, the area you live in, and the open mindedness of the FCC. The only thing that really has to be there, however, is vertical sync...and a bit more.

Several things have to happen during the vertical interval. Things get a bit complicated because the NTSC standard calls for interlaced video. Remember that field one scans all the odd-numbered horizontal lines (1, 3, 5, etc.), and field two scans the even-numbered lines. Each field covers the entire picture area on the screen. Both fields contain a complete vertical-blanking interval and they both have the same information during the interval. But each field carries different picture information so there has to be a way of telling them apart.

In the NTSC standard, there are 262½ lines per field (525 lines per frame), and it's that half line that forms the basis for distinguishing between field one and field two. That is evident in Fig. 4 where the two fields are drawn as you would see them on the screen. You can see how the two fields are combined to make up one frame. And, as you might guess, the control signals are exactly the same for both.

You must keep in mind that the two fields differ from each other in timing, not signals. The movement of the electron beam in the tube is controlled by the hardware in the TV. The beam's deflection angle as it goes from left to right and back again is not controlled by the signals sent to the TV. It's determined by the hardware in the TV's deflection circuitry. The only control that the video signal has over the movement of the beam is to make it go to the beginning of the next line on the left

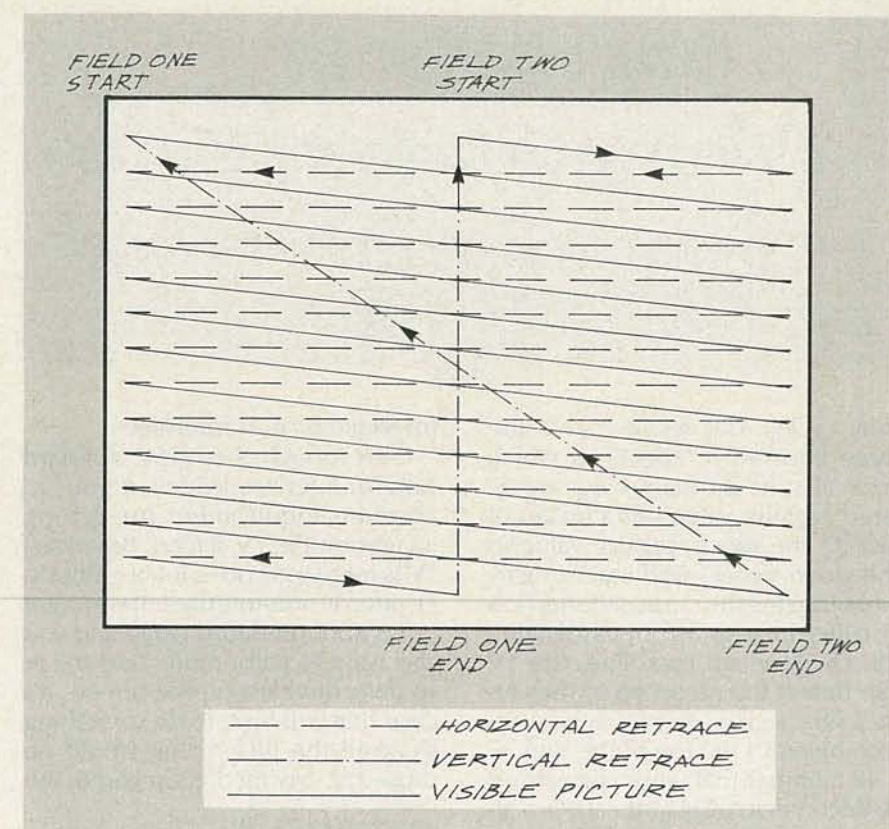

FIG. 4

side of the screen (horizontal sync), or to the top of the screen (vertical sync).

If you think of field one as beginning with the end of a vertical interval, then the first field starts with a full line of video and the second field starts with a half line of video. That means that field one starts at the upper left of the screen and ends at the center of the bottom. It follows that field two starts at the top center and ends at the bottom right.

Those differences between the two fields may be evident to the eye but they're not the sort of distinctions that are needed to provide a means of electronically knowing which field is being painted on the screen. In order to understand that we have to take a close look at the anatomy of the vertical interval.

The first nine lines in each field's vertical interval are shown in Fig. 5 I've put one right on top of another to help you see the difference between them. The two contain the same number of pulses but they differ in their timing relationship (phase) with the rest of the video signal.

The beginning of the vertical interval is marked by a series of six

pre-equalizing pulses (two per line for three lines of video). If you look carefully at Fig. 5 you'll see that the first pre-equalizing pulse for field one occurs a full line after a horizontal sync pulse while the first pre-equalizing pulse in field two occurs a half line after horizontal sync. That difference in timing is the mechanism used to identify which field is being painted on the screen.

It's important to notice that there are no real horizontal sync pulses during the first nine lines of the vertical interval. In order to maintain the horizontal sync in the receiver during that period, there are two pre-equalizing pulses per line. Each pulse is half the width of a horizontal sync pulse and, since they occur twice as often, they provide the same DC level as one horizontal sync pulse. That is done because the circuitry in your TV integrates the DC level on each line of video to determine what to do with the electron beam. One level will be interpreted as horizontal sync and, as we'll see in a minute, a greater level will be interpreted as vertical sync.

The vertical sync signal is really just an inverted version of the pre-equalizing pulses and that means that each pulse is very wide (92%



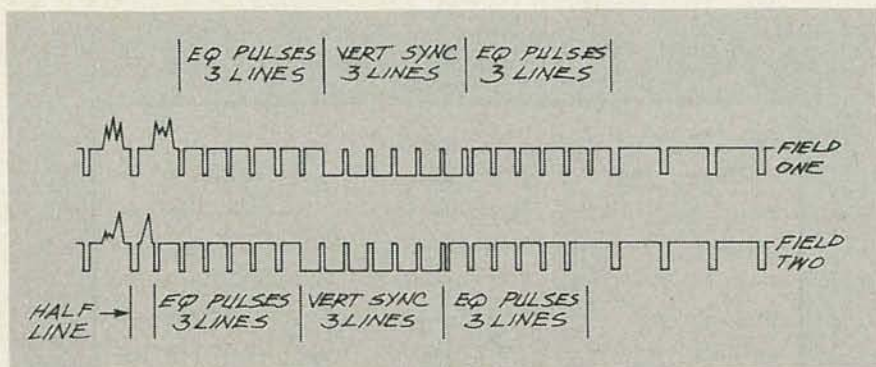

FIG. 5

duty cycle). The result is that the three lines (4, 5, and 6) in which vertical sync appears have a very large negative value—as a matter of fact it's the most negative value in the video signal—and that's exactly what triggers the vertical-deflection circuitry in your TV. By integrating the DC level on each line, the TV can detect the presence of the vertical sync signal and move the electron beam to the top of the tube.

Remember that when the vertical deflection circuitry in the TV is activated by detecting the vertical sync in the video signal, it only moves the beam to the top of the screen—not the top left corner of the screen. Moving the beam to the left is the job of horizontal sync. Since field one starts at the top left of the screen and field two starts at the top center, you can understand why the TV has to be told which field it's about to paint. In order to build a correctly aligned frame from two fields, the two fields have to be lined up. If vertical sync doesn't appear at the right time, a properly interlaced image is impossible.

Figure 5 shows that there are six more equalizing pulses in the three lines (7, 8, and 9) following the vertical sync signal. Although they are identical to the pre-equalizing pulses, they're officially the—you guessed it—post-equalizing pulses. In the early days of TV, they were needed to maintain interlace but, as with so many other things, modern technology has made them obsolete. You'll still find them in the signal but they're not really used for anything at all. Even the distinction between pre-equalizing pulses and post-equalizing pulses has disappeared. Most people today just consider the vertical interval as having two signals: equalizing pulses (sans prefix), and vertical sync.

### Interlace or non-interlace

Even though the NTSC standard calls for interlaced video, it's not an absolute requirement for getting images on the TV screen. Broadcast TV is interlaced but a lot of computer video is non-interlace. If you want to do non-interlaced video and you also want to paint more than 400 or so lines of video on the screen, it's clear that you have to do something to avoid the flicker that would be caused by having the top part of the

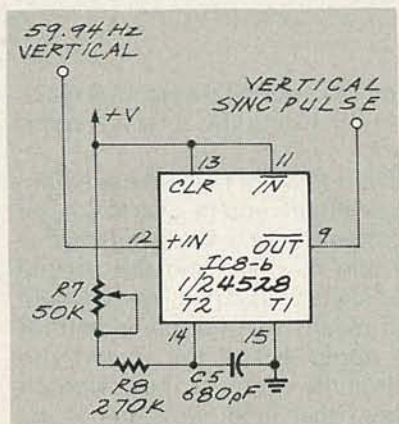

FIG. 6

image start to fade before the electron beam worked its way down to the last line on the screen. That means either using a tube with a high-persistence phosphor (like IBM monochrome monitors), or increasing the horizontal scan rate (IBM EGA and VGA monitors).

### Generating vertical sync

A properly constructed video signal will have all the equalizing and sync pulses we've been talking about but, as you can imagine, the circuitry needed to properly construct the vertical interval can get to be really complex. You'd need a separate pulse generator for the equalizing pulses (and an inverter to make the vertical sync pulses), and

the circuitry needed to make sure they showed up at the correct time would have to be designed as well. That is why most of the early sync generators were really expensive.

That kind of stuff isn't designed from discrete parts these days because there are sync-generator chips that do the whole job for you. For our purposes, we can generate non-interlaced video and produce a single vertical sync pulse that's wide enough to be detected by the TV's vertical-deflection circuitry. The only signal we'll need in the vertical interval will be a long vertical sync pulse; the equalizing pulses are unnecessary since we're not going to interlace the image.

The field of video we're going to produce will be 262 lines long but some of that has to be reserved for vertical blanking. That is for two reasons: The first is that most TV sets overscan the image so that some of the lines fall outside the screen area, and the second is that a certain amount of time is needed for vertical sync.

We can solve the first problem by not putting any picture information at the very beginning and end of the image; we'll leave the beam turned off. The second problem can be handled by following the NTSC standard and making our long vertical sync pulse at least three horizontal lines wide.

Actually generating the vertical sync pulse is simple since we have half of the 4528 available. By using the values shown in Fig. 6, the chip will output a negative-going vertical sync pulse with a width that's exactly three lines long. As I mentioned earlier, you should use metal-film and mica parts to make the pulse as accurate and stable as possible but, once again, add the trimmer shown in the schematic if you're in doubt as to the measured values of the parts you're using.

Once you assemble the circuits we've discussed and add them to the circuitry we've developed so far, you'll have a working video-sync generator. I know I promised we would get some images up on the tube this month, but it took a bit longer than I had planned on to get this far. Next month we'll produce a real 75-ohm video signal, and we'll put more than dots on the screen—I swear.

R-E



# COMPUTER DIGEST

## Waveform processing with your PC

ROBERT W. RAMIREZ

Just about any observable activity can be represented as a series of numbers, and, using the techniques described in this article, you can write simple BASIC programs to analyze those numbers in any manner desired.

For example, standard electronic waveforms (sine waves, square waves, sawtooth waves, etc.) can be expressed as a series of numbers computed from standard equations. In addition, you can capture that type of series from real-life waveforms generated by an ADC (Analog-to-Digital Converter) or a digital-storage oscilloscope.

Not only that, but non-electronic phenomena are also amenable to the same types of analyses. For example, you could analyze the Dow Jones industrial average over a period of time, or you could track the performance of any individual stock. Even lottery results are candidates for that type of analysis.

The point is that each of those

phenomena can be thought of and analyzed just like a waveform, be it an electronic waveform, a stock "waveform," or a lotto "waveform." More generally, those things can be thought of simply as a series of events occurring over a period of time. Any such series of events can be subjected to what mathematicians and scientists refer to as *numerical analysis* or *time-series analysis*.

Don't be intimidated by the terminology. Time-series analysis is nothing more than basic mathematics applied to a series of numbers. To see how easy it really is, let's look at some examples.

### Tables

To analyze a series of numbers, the numbers need to be organized into some form for easy reference. The most familiar and easiest form of organization is a simple table of values like the one shown in Table 1. You might re-

*continued on page 83*

## EDITOR'S WORKBENCH

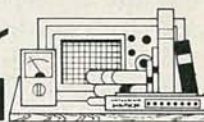

### The Talking PC

Speech synthesis on a PC is hard to come by, if not expensive—usually. Street Electronics has come to the rescue with the Echo PC+, an under \$200 (depending on host PC) setup that includes a PC board, an external speaker with volume control, and software. The software (which is supplied on both 5-1/4- and 3-1/2-inch diskettes) includes several speech generators, demonstration programs, and assorted miscellany. A 50-page booklet explains how to install and use the Echo PC+. Special versions of the card are available for PS/2's with the MicroChannel bus, for Tandy 1000's, and the Apple II. I looked at the PC version.

The half-length board plugs into any 8- or 16-bit PC expansion slot and has two connectors. One connector (a 1/8-inch mini plug) is for the external speaker; the other (a standard 17-pin D connector) is an IBM-compatible game port. The board includes half-a-dozen logic devices (bus buffers, a PAL presumably used for decoding, etc.), an NE558 quad op-amp, an LM380 for audio output, and a proprietary speech chip. The board is laid out well, and construction is excellent.

The software consists of two programs: Talk and Words. Both load as memory-resident programs that capture ASCII text sent to a phantom output device (LPT3, for example).



## Talk and Words

Talk is a generic text-to-speech converter that can pronounce any word based on a set of rules stored in the program. Talk's "voice" is synthesized and mechanical sounding. It is based on the LPC (Linear Predictive Coding) technology used in TI's Speak 'n' Spell games.

Words, on the other hand, speaks in a more natural sounding way. Words has a limited 700-word vocabulary consisting of the actual digitized sounds of a female voice. Words' vocabulary includes all the letters of the alphabet, numbers from 0-9, the months of the year, and many common words (electronics, hello, good-bye, you, me, question, multiply, etc.). There are some strange omissions, however. *Boy* and *man* are both included, but neither *girl* nor *woman* is.

You can increase Words' vocabulary in a limited way by adding one of seven prefixes and suffixes (dis-, ex-, re-, un-, -d, -t, -s) to a word by enclosing the addition in parentheses. For example:

I like her.  
I (dis)like her.  
I like(t) her.  
I (dis)like(t) her.

The version of the product that I saw doesn't allow you to add to the digitized vocabulary, but around the time you read this, the company should be introducing a DSP (Digital Signal Processing) board for about \$500 that will allow you to digitize any audio signal and convert it to a form suitable for playback through the Echo PC+.

## Fine tuning

Several parameters affect how both Talk and Words speak. For example, you can vary the speech rate of either program by sending this command:

\*RATE = *n*

where *n* has a value from 0 (slow) to 15 (fast). The default value is 2. You may find, as you gain experience with Echo PC+, that you can increase the rate somewhat.

Other parameters common to both programs include pitch, volume, and delay. Pitch can vary from -63 to +63, with 0 being the

default. Although the external speaker has its own volume control, you can also set volume under program control using the Volume parameter, which may range from 0-15 (14 is default). The Delay command allows you to specify a delay between each spoken word; values are specified in tenths of a second, and may range from 0-20. Delay is independent of Rate; 0 is the default.

In addition, each program has several unique performance parameters. Since it has its own limited "intelligence" for deciding how to pronounce any given combination of letters, Talk allows you a fair amount of control over how it forms its interpretation. For example, the program can operate in either of two basic modes: Word or Letter. In Letter mode, every letter of every word is pronounced separately. In Word mode, however, the product's intelligence is put to the test.



FIG. 1

Within Word mode, there are several punctuation modes: Some, Most, and All. In All mode, every punctuation mark is pronounced. In Some mode, Talk tries to pronounce sentences with end-stops (question mark, period, semicolon) correctly. Questions, for example, end in English with a slight rise in pitch.

One other mode ("Caps") available in Talk forces words spelled in all caps to be pronounced letter by letter. That mode could be useful in creating an interactive spelling tutorial.

Words' special features include the prefixes and suffixes discussed above, and the ability to speak several complete pre-programmed phrases, including *disk drive*, *I am*, *I win*, *it is*, *select one of fol*, *that is correct*, *that is right*, *United States*, *when*

*was that*, *you are*, and *you win*.

One way of overcoming Words' limited vocabulary is to load both Talk and Words into memory. Then when you send a string to Words, any text that it can't process it will send on to Talk. However, the two voices are so different that maintaining continuity is impossible.

One problem with Talk is its inability to deal with compound words and words that break the "rules" of English pronunciation. For example, Talk pronounces *typewriter* as tip-eh-writer. However, by breaking compounds up into the component parts, it will often pronounce them correctly. To get Talk to pronounce rule-breakers correctly, you must misspell the word. For example, for the first syllable to be pronounced *ee* rather than *eh*, *electrolyte* must be spelled *eelectrolyte*.

I also had trouble getting the Echo PC+ to pronounce other words correctly. *Rigid*, for example, sounded more like a croaking frog than a word. And though it did all right with words like Brian, Jeff, Marc, Carl, Bob, John, Julian, Larry, Kathy, Terry, I had to spell Byron as two words (*bie ron*), and I was unsuccessful in getting it to say the first syllable of Andre (*an dray*) to rhyme with the first syllable of father; it insisted on rhyming it with hand. (Sorry, Andre!)

## How it works

Both Talk and Words work by hooking into the appropriate BIOS interrupt and capturing output sent to a COM or LPT port. Then you force the board to speak simply by "printing" the desired text to the appropriate port. For example, if you start Words like this

Words lpt3:

any ASCII data you send to LPT3 will be interpreted and pronounced by the program, if possible. You can set the software up to respond as any legal COM or LPT port.

The demo programs allow you to type a line at a time at the keyboard and send it to the Echo PC+. To get it to talk from your own programs, you just PRINT or



WRITE the desired string to the appropriate port. For example, the manual supplies the following BASIC program:

```
10 OPEN "LPT3:" FOR OUTPUT
AS #1
20 PRINT
30 INPUT "Enter text: ";AS
40 PRINT #1,AS
50 GOTO 20
60 END
```

Some versions of BASIC won't let you PRINT in that fashion; the manual includes another example with some in-line assembler code that does the same thing. Examples are also provided in several varieties of Pascal and C.

All in all, considering the price of the product, my complaints are really just nit-picking. If you'd like to add speech to a science-fair project, an interactive demo, or a self-paced, PC-based tutorial, the Echo PC+ is an excellent buy. **CD**



### War of the Words

Word processors have been evolving rapidly over the past few years. Due to my work with different clients, I have checked out all the major contenders during the past year or so, including Word Perfect 5.0, Word 5.0, WordStar 5.5, XyWrite III Plus, and several lesser packages. I can state unequivocally that Word Perfect was my least favorite, due mainly to the lack of any logic in the way its commands are assigned. Many people would claim the same of WordStar, but that's false; WordStar commands are for the most part well organized, it just takes a while for the system to sink in. And there's no question that WordStar has the best page preview of any non-graphical word processor. XyWrite offers a lot of

power, but its on-screen display is mighty ugly for this day and age, and its spelling checker is almost more trouble to use than it's worth. (However, a new version of the program is due out in early spring; we'll see....)

That leaves Word. Even though I've only used it a few weeks so far, it has grown on me quickly. It is highly customizable, offers a wealth of display modes (including, on a VGA, very nice 30- and 34-line graphics modes that do a decent job of displaying italics and boldface text). Like Word Perfect, its macro facility amounts to a miniature programming language. One of Word's most famous (and justly so) capabilities is the style sheet, or set of formatting attributes you can apply to text. Even though you can't see fonts, etc., on-screen, you can enable a so-called style bar along the left side of the screen that provides a one- or two-letter indication of the style of each paragraph. The style bar thus gives you the ability to produce nicely formatted documents without requiring the expensive hardware resources required by graphical word processors (Word for Windows, Ami) and desktop publishing packages.

Word has many other features, including on-line help, a good spelling checker and thesaurus, multiple windows, support for many printers (including Laser-Jets and PostScript devices), and a document-management function that allows you to create a summary sheet that remains with the document and that specifies the original author, date of creation, and a one-line summary of contents. You can then search for a specific document based on the summary using a special load function.

Word also has a built-in outlining function that, although no match for Symantec's GrandView, is better than nothing, and has the benefit of being built-in, so you can do things like apply styles to different outline levels.

Word naturally stores documents in its own format, but it can also load and store ASCII text directly, in both line- and paragraph-delimited forms. That ca-

pability is indispensable if you do much work with on-line systems, E-MAIL, etc.

There's a lot more to Word, but no space to give it justice. For me, it seems to have the right balance between formatting tools and text creation tools, unlike much of the competition, which tend to push too far one way or the other, or are simply disorganized conglomerations of features. Word 5.0 lists for \$450, but you can pick it up mail order for little more than \$200. **CD**

### ITEMS DISCUSSED

- Echo PC+ (\$179.95 (PC), \$134.95 (Apple II), \$199.95 (MicroChannel), \$249.95 (RS-232), Street Electronics Corporation, 6420 Via Real, Carpinteria, CA 93013. (805) 684-4593.

CIRCLE 256 ON FREE INFORMATION CARD

- Word (\$450), Microsoft Corp., 16011 NE 36th Way, Box 97017, Redmond, WA 98073-9717. (206) 882-8080.

CIRCLE 257 ON FREE INFORMATION CARD

### WAVEFORM

*continued from page 81*

ognize it as the solution to a typical beginning algebra problem: For five values of X ranging from zero to two compute a table of values for  $Y = X^2$ .

TABLE 1— $Y = X^2$

Entry	X	Y
1	0	0
2	0.5	0.25
3	1.0	1.0
4	1.5	2.25
5	2.0	4.0

Essentially the same approach can be taken on a PC using any standard spreadsheet program, as illustrated in Fig. 1. In this case, the five values of X have been entered manually in the five cells or elements of column A. The values in column B are obtained by entering the necessary formula in each of the B cells. For example, the formula in B1 would



	a	b	c
1	0	0	
2	0.5	0.25	
3	1.0	1.00	
4	1.5	2.25	
5	2.0	4.00	
6			
7			

**Fig. 1.** STORE DATA FOR  $Y=X^2$  in a spreadsheet program. The  $X$  values are stored in column A, and the  $Y$  values in column B.

```

FOR I=1 TO 5
LET Y(I)=X(I)*X(I)
NEXT I

```

	ARRAY X		ARRAY Y
X(1)	0	Y(1)	0
X(2)	0.5	Y(2)	0.25
X(3)	1.0	Y(3)	1.00
X(4)	1.5	Y(4)	2.25
X(5)	2.0	Y(5)	4.00

**Fig. 2.** STORE DATA FOR  $Y=X^2$  in a two-dimensional array in a high-level programming language (BASIC, Pascal, etc.).

be  $A1 \times A1$ , the formula in B2 would be  $A2 \times A2$ , and so on.

The same principles apply when using numeric arrays in any high-level programming language (BASIC, Pascal, C, Fortran, etc.). We'll show basic techniques in BASIC here; it certainly wouldn't be difficult to adapt our techniques to other languages.

### Arrays

An array is a set of subscripted variables or elements; you can think of it as shown in Fig. 2. In that figure, array X has five elements (with subscripts 1–5). The first element is X(1), the second is X(2), and so on. Array Y also has five elements, subscripted the same way.

The nice thing about creating and manipulating an array in a programming language is that the elements of the array can be referred to and operated on with FOR loops. That allows a single general formula to be applied to every element in the array. Enter-

ing five items of data in a spreadsheet is not so bad, but think about entering (and performing calculations on) 500 items by hand!

To gain a better understanding of how the problem might be generalized and attacked using BASIC, consider the program in Listing 1.

The first few lines of the program prepare an array of the desired size. The statement in line 10 specifies that arrays are numbered from one (1), not zero (0), because computations are usually easier. Line 20 asks you to enter the number of values you want to calculate, and line 30 uses an INPUT statement to assign the desired number to variable  $n$ . Now that the program knows how many numbers you want to process, the arrays for storing those numbers are created with one or more DIMension statements.

### LISTING 1

```

10 OPTION BASE 1
20 PRINT "ENTER THE NUMBER OF X VALUES TO PROCESS."
30 INPUT N
40 DIM X(N), Y(N)
50 FOR I=1 TO N
60 PRINT "ENTER THE ";I;"th VALUE OF X."
70 INPUT X(I)
80 NEXT I
90 FOR I=1 TO N
100 LET Y(I)=X(I)*X(I)
110 NEXT I
120 FOR I=1 TO N:PRINT X(I),Y(I):NEXT I
130 END

```

The next step is to get some numbers into those arrays for processing. Lines 50–80 handle that chore by requesting values from you  $n$  times, one at a time. The process of squaring each array value occurs in lines 90–110. Last, line 120 prints all  $X$  and  $Y$  values.

Even though that program is quite simple, it contains all of the essential steps necessary for array processing:

1. Dimension the necessary array variables.
2. Input the values for use in computations.
3. Do the element-by-element array computations.
4. Output the results of the computations.

### Getting the data in

Typing data into the program gets old fast; it would be nice if we were able to bring data into the program directly.

For example, a digitizing oscilloscope could be a source of data. The data would be a series of numbers representing the amplitude of a waveform captured at discrete points in time; each value is stored in the scope's memory. Then, if the scope has an RS-232 interface, the data could be transferred to a disk file on your PC and subsequently read into a numeric array of the type discussed earlier. The waveform data could then be processed just like data typed in by hand. Of course, the method of transferring data to the PC depends on the scope, data-capture software running on the PC, etc. However, most digitizing scopes provide transfer utilities for dealing with their scope's data format.

For some applications (purely theoretical analyses, for example), input data can be generated by a program. For example, the program in Listing 2 can be used to generate a sine wave (SWAVE) composed of any number of points ( $n$ ) and cycles ( $cy$ ) that you choose.

A plot of the data generated by that program is shown in Fig. 3. The plot was created using a program called Graph-in-the-Box, which captures data printed to the PC screen. Of course you could write your own custom graphics routine, but Graph-in-the-Box works well with many types of programs.

As a point of interest, the sine wave in Fig. 3 was generated with



### LISTING 2

```

10 OPTION BASE 1
20 PRINT "ENTER NUMBER OF POINTS TO USE."
30 INPUT N
40 DIM SWAVE(N)
50 PI=3.141593
60 PRINT "ENTER NUMBER OF CYCLES DESIRED."
70 INPUT CY
80 FOR I=1 TO N
90 SWAVE(I)=I-1/N
100 SWAVE(I)=CY*SWAVE(I)
110 SWAVE(I)=SIN(2*PI*SWAVE(I))
120 NEXT I
130 OPEN "O",#1,"B:SWAVE.DAT"
140 FOR I=1 TO N
150 WRITE #1,SWAVE(I)
160 NEXT I
170 CLOSE

```

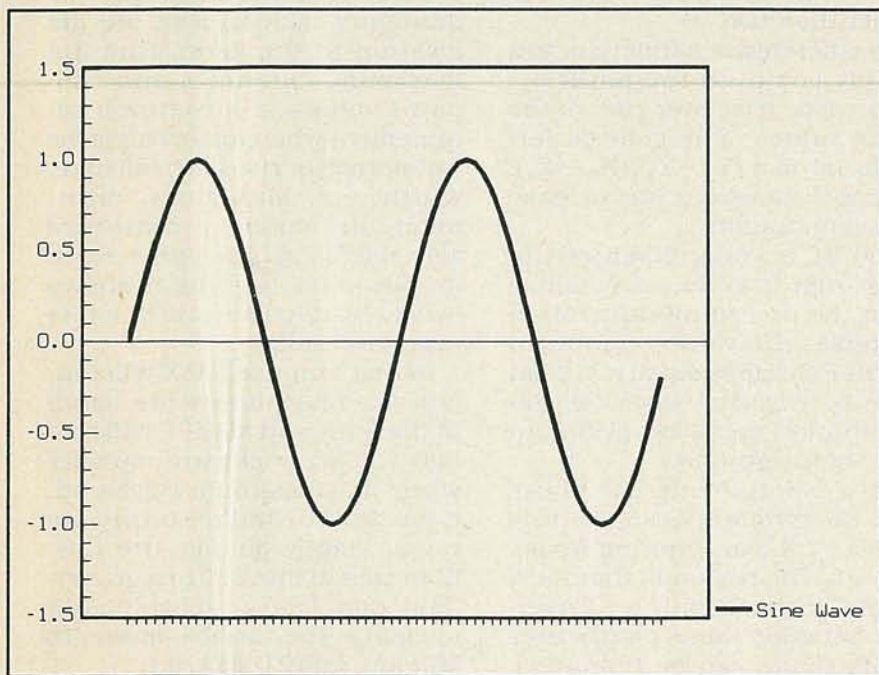

**Fig. 3.** THIS GRAPH REPRESENTS two cycles of a sine wave. The data was generated by the BASIC program shown in Listing 2.

64 equally spaced points over two full cycles. There is no "frequency" inherent in that representation. Frequency enters the picture only when you assume that each point represents some increment of time, which could be picoseconds, microseconds, seconds, minutes, months, or whatever you choose.

For example, let's say you want Fig. 3 to represent a sine wave of 1 kHz. Then you would assume that each point represents an increment of 1 ms (the period,  $\frac{1}{1000}$  Hz) divided by the number of points covering one cycle (32 points/cycle in this case), giving 0.03125 ms per point. The

amount of time per point is generally referred to as the sampling interval.

#### Simple analysis operations

Once you have an array of data—however you get it—you can begin analyzing it with waveform-processing techniques.

For example, you might want to scale the data upward or downward in value. Let's say you want to double the value of every array element. That can be done by multiplying the array by a constant as shown in Listing 3.

Or say you want to know the average (mean) value of the data stored in an array with  $n$  ele-

ments. That's a simple computation. Just add up all the values in the array and divide the result by  $n$ . For the sine wave in Fig. 3, that would be done as shown in Listing 4.

The RMS (root-mean-square) value of that waveform could be computed in a similar manner as shown in Listing 5.

When computing average, RMS, or similar values from waveform data arrays, keep in mind the definitions of the calculations and how they apply to the data. For example, you would expect the average value of a sine wave (or similarly symmetric waveform) to be zero. But that will be the case only if array SWAVE contains an integral number of sine wave cycles. If SWAVE contains a nonintegral number of cycles, say 1.5 cycles, the average value of the array would be nonzero by an amount determined by the extra half cycle. To get the correct value in that case, you would have to restrict the calculations to just the array elements covering an integer number of cycles.

### LISTING 3

```

200 FOR I=1 TO N
210 SWAVE(I)=SWAVE(I)*2
220 NEXT I

```

### LISTING 4

```

300 AVG=0
310 FOR I=1 TO N
320 AVG=AVG+SWAVE(I)
330 NEXT I
340 AVG=AVG/N
350 PRINT AVG

```

The key point here is that your program simply operates on the numbers that you give it, nothing more, and nothing less. It makes no assumptions about the meaning of those numbers.

#### Calculus made simple

The greatest attribute of array or waveform processing is that it dramatically simplifies what would otherwise be extremely difficult calculations. Take calculus for example. Pencil-and-paper integration of anything but the simplest functions can be a nightmarish task. But with array



### LISTING 5

```
400 AVG=0
410 FOR I=1 TO N
420 SWAVE(I)=SWAVE(I)*SWAVE(I)
430 AVG=AVG+SWAVE(I)
440 NEXT I
450 AVG=AVG/N
460 RMS=SQR(AVG)
470 PRINT RMS
```

processing, any function represented by a series of numbers can be quickly and easily integrated or differentiated.

Integration, for example, is the process of computing the area under a curve. In array processing, that means multiplying each element of the array by the sampling interval value (e.g. the time increment represented by each sample). Integration is then completed by computing at each point the sum of the samples preceding that point. Listing 6 shows one example.

In that program segment, FUNC is the array containing the waveform or function values to be integrated, and INTEGRAL is the array containing the results of integrating FUNC. If, for example, FUNC has 30 elements ( $n=30$ ), if all elements are equal to one (1), and if the sample interval is one ( $dt=1$ ), the computed values for INTEGRAL will be 0, 1, 2, 3,...29. The computation assumes that there are no values (and thus zero area) preceding element number one. Hence, element one always has a value of

zero and element two equals the first incremental area ( $0+1$ ). Alternatively, you could assume that the first element of INTEGRAL should contain the first incremental value of FUNC, in which case the FOR loop should start incrementing from one rather than two.

To differentiate a function, you simply compute the point-by-point slope (rise over run) of the array values. The general formula is:  $m = (Y_2 - Y_1)/(X_2 - X_1)$ . Listing 7 shows one way to make the computation.

If FUNC is a ramp of values running from 0 to 29, as obtained from the preceding integration example, the values computed for DIFF will all be equal to 1. That is to be expected since the differentiation operation is the inverse of integration.

As a point of interest, notice that the differentiation routine uses a FOR loop running from 1 to  $n-1$ . The reason is that for  $n$  points, there are only  $n-1$  intervals between those points over which slopes can be computed. Also, there isn't a final interval for

computing the value of  $n$ . To get around that problem, the last value (the value for  $n$ ) is assumed to be equal to the preceding value ( $n-1$ ).

### A sampling of statistics

Until now all of our examples have been of calculations on array values. Sometimes, however, especially in statistics, the analysis may be more a matter of searching out specific array values or rearranging array values to cast a new slant on the data.

For example, after accumulating a large array of data, you may need to find the maximum or minimum value of data and its location in the array. Finding maximum, minimum, and midpoint values is a common requirement when analyzing pulse waveforms for rise time, fall time, width, etc. Maximum, minimum, and midpoint values are also useful in analyzing stock market data. Listing 8 shows how to search an array (X) for its maximum value.

In that example, MAX will contain the maximum value found in the array and MAXPT will contain the array element number where that maximum was found. If you want to find the minimum value, simply change the less-than sign in line 820 to a greater-than sign. (You'll probably want to change the variable names to MIN and MINPT as well.)

It should be noted that, in the

### LISTING 6

```
600 PRINT "ENTER SAMPLE INTERVAL VALUE"
610 INPUT DT
615 SUM=0
620 FOR I=2 TO N
630 FUNC(I)=FUNC(I)*DT
635 SUM=SUM+FUNC(I)
640 INTEGRAL(I)=SUM
650 NEXT I
```

### LISTING 7

```
700 PRINT "ENTER SAMPLE INTERVAL VALUE"
710 INPUT DT
720 FOR I=1 TO N-1
730 DIFF(I)=(FUNC(I+1)-FUNC(I))/DT
740 NEXT I
750 DIFF(N)=DIFF(N-1)
```

### LISTING 8

```
800 MAX=X(1)
810 FOR I=2 TO N
820 IF MAX<X(I) THEN MAX=X(I)
830 IF MAX=X(I) THEN MAXPT=I
840 NEXT I
```

### LISTING 9

```
145 DIM HIST(44)
150 FOR N=1 TO 44
155 FOR I=1 TO COUNT-1
160 IF N1(I)=N THEN HIST(N)=HIST(N)+1
165 IF N2(I)=N THEN HIST(N)=HIST(N)+1
170 IF N3(I)=N THEN HIST(N)=HIST(N)+1
175 IF N4(I)=N THEN HIST(N)=HIST(N)+1
180 IF N5(I)=N THEN HIST(N)=HIST(N)+1
185 IF N6(I)=N THEN HIST(N)=HIST(N)+1
190 NEXT I
195 NEXT N
```



# R-E Computer Admart

Rates: Ads are 2 1/4" x 2 7/8". One insertion \$950. Six insertions \$925 each. Twelve insertions \$895 each. Closing date same as regular rate card. Send order with remittance to **Computer Admart**, Radio Electronics Magazine, 500-B Bi-County Blvd., Farmingdale, NY 11735. Direct telephone inquiries to Arline Fishman, area code-516-293-3000. **Only 100% Computer ads are accepted for this Admart.**

## GETTING THE MOST FROM YOUR PRINTER

Getting The Most From Your Printer



**BP181**—It is probable that 80% of dot-matrix printer users only ever use 20% of the features offered by their printers. This book will help you unlock the special features and capabilities that you probably don't even know exist. To order your copy send **\$6.95 plus \$1.50 for shipping** in the U.S. to **Electronic Technology Today Inc., P.O. Box 240, Massapequa Park, NY 11762-0240.**

## SECRETS OF THE COMMODORE 64

Secrets of the COMMODORE 64



**BP135**—A beginners guide to the Commodore 64 presents masses of useful data and programming tips, as well as describing how to get the best from the powerful sound and graphics facilities. We look at how the memory is organized, random numbers and ways of generating them, graphics-color-and simple animation, and even a chapter on machine code. Get your copy today. Send **\$5.00 plus \$1.25 for shipping** in the U.S. to **Electronic Technology Today Inc., P.O. Box 240, Massapequa Park, NY 11762-0240.**

## ICs PROMPT DELIVERY!!!

SAME DAY SHIPPING (USUALLY)

QUANTITY ONE PRICES SHOWN for MAR. 4, 1990

OUTSIDE OKLAHOMA NO SALES TAX

DYNAMIC RAM		
1MB	COMP DeskPro 386/20	\$295.00
SIMM	AST Prem386/33Mhz	225.00
SIMM	1Mx9 80 ns	92.00
SIMM	256Kx9 100 ns	35.00
1Mbit	1Mx1 80 ns	8.75
41256	256Kx1 60 ns	4.15
41256	256Kx1 80 ns	2.50
41256	256Kx1 100 ns	2.20
41256	256Kx1 120 ns	1.95
4464	64Kx4 120 ns	2.50
41264*	64Kx4 100 ns	7.50
EPROM		
27C1000	128Kx8 200 ns	\$18.00
27512	64Kx8 200 ns	7.80
27256	32Kx8 150 ns	6.50
27128	16Kx8 250 ns	3.75
STATIC RAM		
62256P-10	32Kx8 100 ns.	\$9.75
6264P-12	8Kx8 120 ns	4.50
6116AP-12	2Kx8 120 ns	4.25

OPEN 6 DAYS, 7:30 AM-10 PM SHIP VIA FED-EX ON SAT.

SAT DELIVERY INCLUDED ON FED-EX ORDERS RECEIVED BY: TR \$2 \$6.25 48 FR \$1 \$15.00 18  
MasterCard/VISA or UPS CASH COD MICROPROCESSORS UNLIMITED, INC. 24,000 S. Peoria Ave. (918) 267-4961 BEGGS, OK. 74421  
No minimum order. Please note: prices subject to change! Shipping, insurance extra, up to \$1 for packing materials.

CIRCLE 61 ON FREE INFORMATION CARD

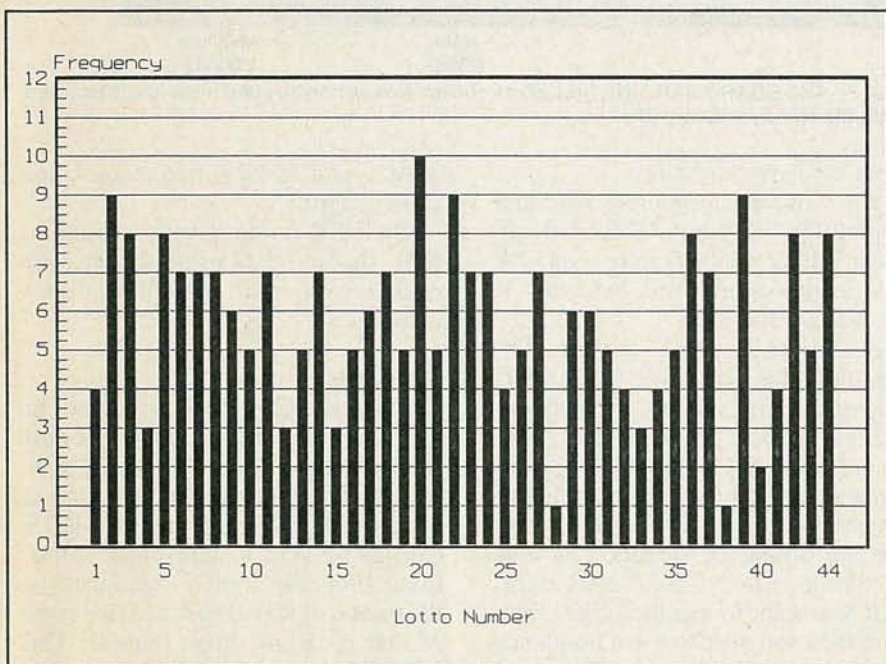

Fig. 4. THIS HISTOGRAM SHOWS THE FREQUENCY with which numbers from 1 to 44 appeared in 42 drawings of a state lottery.

MAX search, if array X contains several values equal to MAX, only the last occurrence of the maximum will be retained in MAXPT. Capturing the location of each maximum point could be done by using an array for MAXPT.

Another way to provide insight into data is with a histogram. A histogram shows you how many times each value occurs in an array. For example, running a histogram on a series of winning

lotto numbers will tell you how often each number occurred. For example, Figure 4 shows a histogram plot of number frequencies from a series of 42 winning lotto numbers. The 42 sets of winning numbers were compiled and stored in six arrays (N1-N6). Listing 9 shows a BASIC program that increments the values in each of the 44 bins in HIST depending on the values in the corresponding bins of n.

So what does the histogram data tell you? Well, out of 42 lotto drawings, lotto numbers 28 and 38 only came up once. Are 28 and 38 due to come up soon, or are they slightly defective lotto balls that will continue to come up less frequently than the others? How about lotto number 20? It came up more frequently than the others. Maybe 20 will continue that trend and should be included in your lotto picks as long as the trend continues. Perhaps, by showing you the "hot" and "cold" numbers, a histogram can weigh the odds slightly in your

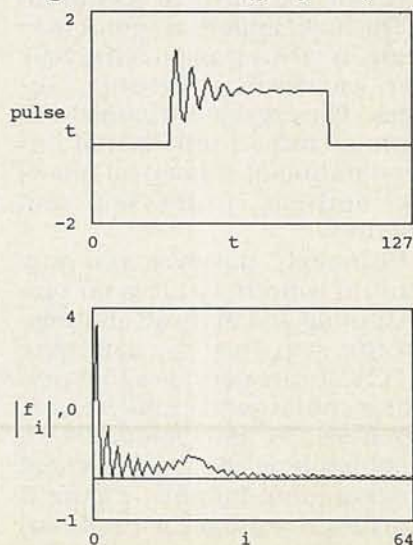

Fig. 5. MATHCAD lets you enter equations in an algebraic form, and then see plots of the results.



favor. Probably not—but it's fun to try anyway.

Histograms can also be used to analyze non-integer data as well (for example, digitized waveforms and stock market prices). When that is the case, you need to write a more complex histogram routine where "bins" are defined to cover a range of numbers (0-1, 1-2, etc.).

### Into the stratosphere

Whatever your area of interest, you can create analysis programs to enhance and broaden your understanding. When you start out, your analysis routines should be kept relatively simple; the example routines presented here will get you started. But as you progress, you'll want to enhance those routines or create other more specialized routines of your own.

Whenever you modify an existing routine or create a new one, you should test it on known data. For example, a MAXimum search routine can be tested by setting one point in an array to a higher value than all others. You know what value you entered in the array and at what element, and those are the values the MAX routine should return. For routines that must interpolate values between points, such as a midpoint search routine, you may need to print the test array values and manually compute the midpoint value and location as a means of verifying the routine's operation.

The most important point is to begin by writing and testing your own waveform processing routines. The experience gained will build a strong fundamental understanding of numerical analysis methods, processes, and nuances.

Ultimately, however, you may want to concentrate less on programming and more on analysis. For this step, there are a number of PC software packages that provide sophisticated analysis capabilities, in both menu-driven and high-level equation-oriented programming formats. Figure 5 provides an example of equation-oriented programming with MathCAD.

*continued on page 97*

## MORSE/RTTY DETECTOR

*continued from page 52*

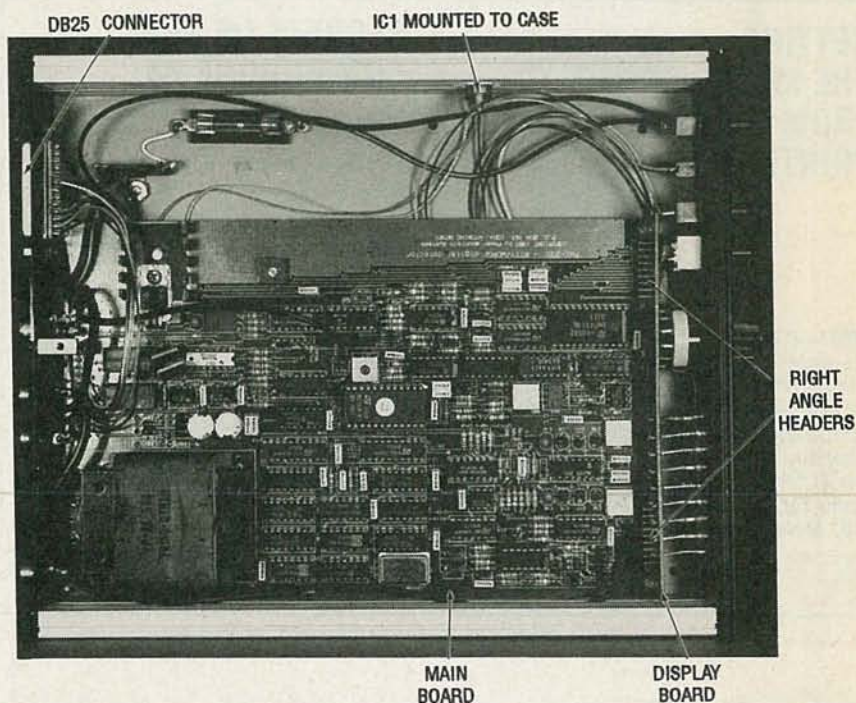

FIG. 7—THE BOARDS ARE INSTALLED as shown. Notice how the two right-angle headers hold the two boards together.

ment isn't very difficult.

You will have a problem with that adjustment if your AC waveform doesn't have a 50/50 duty cycle. A low distortion sine-wave generator is the best for the job.

Potentiometer R67 sets the DC threshold for the LM311 Schmidt-trigger limiters, and the schematic indicates "1.9V." You want to set R67 for 1.9 volts on IC32 pin 7. The potentiometer should be adjusted for optimum performance on RTTY and CW on off-the-air signals. 1.9 volts should be close, if not exactly right.

If you want to use the FSK generator, then you need to use a frequency counter to set the two oscillators to 15,000 Hz and 13,300 Hz. Notice that those frequencies are ten times the actual output. Be certain that you use temperature-stable capacitors such as Mylar, polypropylene, or polystyrene for the 555 timer circuitry.

Remember that the MARK or idle frequency is the lower of the two. If you short JP4, then the output will stay at the SPACE (higher) frequency so you can make the adjustment. You can do the same thing by setting the NORMAL/INVERT switch to the "invert" position. The actual output frequencies will be 1500 Hz and 1330 Hz for

SPACE and MARK frequencies, for 170-Hz shift.

The FSK output-level-set control, R90, should be adjusted for the best results with your particular transceiver.

### Software

There is a CW receive program in the public domain, which works well with the detector on IBM PC's or clones. The software, MORSE.ARC, is also available on the RE-BBS (516-293-2283). If you order something from the source mentioned in the parts list, you'll be sent a free copy of that program, upon request. The BBS file also contains the source code for the EPROM.

The designers of the detector have also designed custom software for their decoder, along with software that will get you started on designing your own CW program, as well as on designing your own EPROM. See the Parts List for ordering information.

The computer has forever changed communications by making CW and RTTY a lot easier. Now, even without knowledge of CW, you can listen in on people all over the world with a PC, a general-coverage receiver, and our PMX-200 detector.

R-E



# MARKET CENTER

## FOR SALE

**GREAT buys!** Surplus prices, ICs, linears, transformers, PS, stepping motors, vacuum pump, phototransistor, meters, LSASE, **FERTIK'S**, 5400 Ella, Phila., PA 19120.

**DESCRAMBLERS.** All brands. Special: Combo Jerrold 400 and SB3 \$165. Complete cable descrambler kit \$39. Complete satellite descrambler kit \$45. Free catalog. **MJM INDUSTRY**, Box 531, Bronx, NY 10461-0531.

T.V. notch filters, surveillance equipment, brochure \$1.00. **D.K. VIDEO**, Box 63/6025, Margate, FL 33063. (305) 752-9202.

**TUBES:** "oldest," "latest." Parts and schematics. SASE for lists. **STEINMETZ**, 7519 Maplewood Ave., RE, Hammond, IN 46324.

**LASER Listener II**, other projects. Surveillance, descrambling, false identification, information. Plans, kits, other strange stuff. Informational package \$3.00 refundable. **DIRIJO/BOND ELECTRONICS**, Box 212, Lowell, NC 28098.

## CB RADIO OWNERS!

We specialize in a wide variety of technical information, parts and services for CB radios. 10-Meter and FM conversion kits, repair books, plans, kits, other strange stuff. Informational package \$3.00 refundable. **DIRIJO/BOND ELECTRONICS**, Box 212, Lowell, NC 28098.

### CBC INTERNATIONAL

P.O. BOX 31500RE, PHOENIX, AZ 85046

**ENGINEERING** software, PC/MSDOS. Hobbyists — students — engineers. Circuit design \$59.00, FFT analysis \$69.00, Mathematics \$49.00, Logic Simulation \$49.00, Circuit Analysis \$29.00. Free catalog, (614) 491-0832, **BSOFT SOFTWARE**, 444 Colton Rd., Columbus, OH 43207.

**RESTRICTED** technical information: Electronic surveillance, schematics, locksmithing, covert sciences, hacking, etc. **Huge selection. Free brochures.** **MENTOR-Z**, Drawer 1549, Asbury Park, NJ 07712.

**RENTAL movie stabilizer.** Connect between VCRs or to monitor. Satisfaction guaranteed. \$69.95, \$4.00 handling. **1 (800) 367-7909.**

**CABLE TV** converters: Jerrold, Oak, Scientific Atlantic, Zenith & many others. "New MTS" stereo add-on: mute & volume. Ideal for 400 and 450 owners! 1 (800) 826-7623, Amex, Visa, M/C accepted. **B & B INC.**, 4030 Beau-D-Rue Drive, Eagan, MN 55122.

**TRANSISTOR tester** checks gain & leakage under simulated "in circuit" conditions. \$38.80 includes shipping. **LATCOMPINT**, Box 953, Mt. Pleasant, SC 29464.

**3-1/2" HD 1.44MB disks \$2.29 each** includes formatting! 3M, Sony, Maxell others. Our choice of brand. Guaranteed. Add 10% shipping. By 10 or more and receive our electronic surplus and software lists on 5-1/4" or 3-1/2" disks (state which) free! Otherwise \$2.50. **BEACH RADIO AND APPLIANCES**, 271 Shirley Street, Boston, MA 02152.

## CABLE TV DESCRAMBLERS!



## BARGAIN HEADQUARTERS!

• JERROLD • TOCOM • HAMLIN  
• SCIENTIFIC ATLANTA • ZENITH  
Oak M35B ONLY \$60  
6 month warranty! We ship C.O.D.!  
Lowest retail/wholesale prices!  
FREE CATALOG:  
Global Cable Network  
1032 Irving St. Suite 109  
S.F., CA 94122

**ORDER TODAY! 800-327-8544**

**MAKE the most of your schematics.** VCR/Camcorder cross-reference manual for RCA, Wards, Maganavox, Penneys, Sears, Panasonic, and many more. \$19.95 plus \$2.50 postage and handling. **CROSSPULSE IMAGING**, Box 73, Stanton, CA 90680.

**DESCRAMBLERS** — RTC-56 \$150.00, Jerrold 400 \$125.00, Z-TAC \$225.00, SA3 with remote \$129.00, Tri-Bi with remote \$129.00, Tocom with remote \$199.00, MLD-1200-3 or 2 \$49.00, M35B \$49.00, TC-35 \$49.00, VIP all channel IC \$35.00, COD ok. **MOUNT HOOD ELECTRONICS**, (206) 896-6837.

**TUBES**, new, up to 90% off, SASE, **KIRBY**, 298 West Carmel Drive, Carmel, IN 46032.

## The Best Electronic Parts Catalog Is As Near As Your Phone!

Dial 1-800-543-4330

To Start Your **FREE**

**ONE-YEAR SUBSCRIPTION To The MCM Electronics Catalog**

Just one finger and two minutes are all you'll need to dial up your own FREE copy of the best electronic parts catalog available today.

From the beginning, you'll enjoy convenient ordering; a huge selection of more than 15,000 in-stock items; competitive prices; quick delivery; flexible payment terms and lots more!

So, punch-up that TOLL-FREE number now and find out why thousands of satisfied MCM customers keep coming back, order after order — year after year!



**MCM Electronics Is Now An Authorized Distributor Of RCA/GE Replacement Parts.**

SOURCE NO. RE-64



**MCM ELECTRONICS**  
650 CONGRESS PARK DR.  
CENTERVILLE, OH 45459-4072  
A PREMIER Company



# AMAZING SCIENTIFIC & ELECTRONIC PRODUCTS

PLANS  
PARTS ARE  
IN STOCK

GRA1 — ANTI GRAVITY GENERATOR	\$10.00
LC7 — 40 WATT BURNING CUTTING LASER	\$20.00
RUB4 — HI POWER PULSED DRILLING LASER	\$20.00
BTC5 — 1 MILLION VOLT TESLA COIL	\$20.00
MCP1 — HI VELOCITY COIL GUN	\$15.00
LLS1 — LASER LIGHT SHOW 3 METHODS	\$20.00
EH1 — ELECTRONIC HYPNOTISM TECHNIQUES	\$8.00
EML1 — LOWER POWERED COIL GUN LAUNCHER	\$8.00
JL3 — JACOB LADDER 3 MODELS	\$10.00
SD5 — SEE IN THE DARK	\$10.00
LEV1 — LEVITATION DEVICE	\$10.00

KITS  
ASSISTANCE  
PROGRAM  
AVAILABLE

FMV1K — 3 MILE FM VOICE TRANSMITTER	\$34.50
PFS1K — HAND CONTROLLED PLASMA FIRE SABER	\$49.50
NIG7K — HI FLUX NEGATIVE ION GENERATOR	\$34.50
PG5K — PLASMA LIGHTNING GLOBE	\$49.50
LHC2K — VISIBLE SIMULATED 3 COLOR LASER	\$44.50
HDD1K — HOMING/TRACKING BEEPER TRANSMITTER	\$44.50
LGU6K — 2.5 MW HAND-HELD VISIBLE LASER GUN	\$249.50
BTC3K — 250,000 VOLT TABLE TOP TESLA COIL	\$249.50
IOG2K — ION RAY GUN, project energy without wires	\$129.95
TKE1K — TELEKINETIC ENHANCER/ELECTRIC MAN	\$79.50
VWPM7K — 3 MILE AUTO TELEPHONE TRANSMITTER	\$49.50

ASSEMBLED

### ASSEMBLED IN OUR LABS

LIST10 — INFINITY XMTR Listen in via phone lines	\$199.50
IPG70 — INVISIBLE PAIN FIELD BLAST WAVE GENERATOR	\$74.50
ITM10 — 100,000 VOLT INTIMIDATOR UP TO 20'	\$99.50
JAT30 — AUTOMATIC TELEPHONE RECORDING DEVICE	\$24.50
PSP40 — PHASOR SONIC BLAST WAVE PISTOL	\$89.50
DNE10 — ALL NEW 26" VIVID COLORED NEON STICK	\$74.50
LGU20 — 5 TO 1MW VISIBLE RED HeNe LASER GUN	\$199.50
BLS10 — 100,000 WATT BLASTER DEFENSE WAND	\$89.50

EASY ORDERING PROCEDURE - TOLL FREE 1-800-221-1705  
or 24 HRS ON 1-603-673-4730 or FAX IT TO 1-603-672-5406

VISA, MC, CHECK, MO IN US FUNDS. INCLUDE 10% SHIPPING. ORDERS  
\$100.00 & UP ONLY ADD \$10.00. CATALOG \$1.00 OR FREE WITH ORDER.

## INFORMATION UNLIMITED

P.O. BOX 716, DEPT. R2, AMHERST, NH 03031

## FREE CATALOG

FAMOUS "FIRESTIK" BRAND CB ANTENNAS  
AND ACCESSORIES. QUALITY PRODUCTS  
FOR THE SERIOUS CB'er. SINCE 1962

FIRESTIK ANTENNA COMPANY  
2614 EAST ADAMS  
PHOENIX, ARIZONA 85034

**PROGRAMMABLE stepper** motor drive & control  
for under \$100, IBM PC/XT compatible, **Com-  
modore 64**, or other with 25 pin parallel port. PCB,  
interface, & software. Send for detailed literature to:  
**MASE, R.D. #2 Box 166, Mohrsville, PA 19541.**

**TOCOM** converters w/r from \$199.00. Tocom super  
chips turn on everything \$69.00 each Phone (219)  
935-4128.

**SURVEILLANCE** — Privacy control — debugging  
— protection. (kits — assembled) large new catalog  
\$5.00. **TRI-TRON**, 2209F Lapalco, Harvey, LA  
70058.

**MAKE money selling electronic information**  
mail order Own your own business. Manual tells  
how, step by step. \$10.95 + \$2.00 postage.  
**CABLETRONICS**, Box 30502R, Bethesda, MD  
20824.

**SURVEILLANCE** countersurveillance equipment  
catalog \$5.00. **EAVESDROPPING DETECTION**  
**EQUIPMENT**, PO Box 1087, Williamsville, NY  
14231.

### MICROWAVE TV RECEIVERS 1.9 to 2.7 Ghz



2 CH Compact Dish System - \$77.95  
5 CH Dish System - \$93.95  
12 CH Yagi (Rod) System - \$123.95  
30 CH Dish System - \$163.90 Yagi - \$183.90  
**SUN MICROWAVE INT'L. INC.** Send \$1.00 for  
P.O. BOX 34522 catalog on these  
PHOENIX, AZ 85067 and other fine  
(602) 230-0640 video products.  
QUANTITY DISCOUNTS LIFETIME WARRANTY

VISA/MC/COD

**CABLE TV** converters and descramblers.  
We sell only the best. Low prices. SB-3  
\$79.00. We ship C.O.D. Free catalog. **ACE**  
**PRODUCTS**, PO Box 582, Dept. E, Saco, ME  
04072. 1 (800) 234-0726.

**SAMS** closeout sale. #2 to #2600 \$6.00 each  
postpaid. MC/Visa. Call 1 (800) 274-2081. 9-5 CST.

**PRINTHEAD** repairs — Okidata, Epson NEC,  
Toshiba, Digital, Texas Inst., also do board repair —  
**DATAFIX**, (201) 322-7666.

**CABLE converters descramblers, RTC-56,**  
**Zenith Z-TAC, 400-DIC, M35B, SA-3, Tri-Bi 2-3,**  
**Tocom, Hamlin, VIP IC all ch all formats, all**  
**brands of remote converters, special this month**  
**TC-35 with decoder, Raw \$25.00, S.A.C., info**  
**(702) 647-3799 orders 1 (800) 622-3799.**

## ANTIQUÉ RADIO CLASSIFIED

Free Sample!

Antique Radio's

Largest Circulation Monthly.  
Articles, Ads & Classifieds.



6-Month Trial: \$11. 1-Yr: \$20 (\$30-1st Class).  
A.R.C., P.O. Box 802-L4, Carlisle, MA 01741

**TUBES** Sylvania 6LQ6 6L6GC 20L6F etc. Huge  
discounts. **ARLEN SUPPLY**, 7409 West Chester  
Pike, Upper Darby, PA 19082. 1 (800) 458-1301.

**TJ SERVICES** is here to serve you! Our quality  
products, quick courteous service, knowledgeable  
sales people and rock bottom prices prove it! Not  
sure what you need? Call (313) 979-8356 we'll help!  
We specialize in **Jerrold, Hamlin, interference fil-  
ters** and most **SA** equipment.

**FEBRUARY 1984 Project complete parts**  
**with power supply. \$38.00. Postpaid. JIM**  
**RHODES, INC., Box 3421, Bristol, TN**  
**37625.**

**COMMUNICATIONS/electronic equipment**  
**sales, service, FCC licensed, free catalog,**  
**RAYS, PO Box 14862, Fort Worth, TX 76117-0862.**

**HOW to design and build your own comput-  
erized product!** New manual makes it easy! Simple  
step-by-step details from idea to finished product.  
Includes introduction to design, choosing the proper  
CPU, comparison between many CPUs and micro-  
controllers, circuit layout, sample schematics, pro-  
gramming, debugging, hints, tips, and more! \$8.00  
complete, satisfaction guaranteed, details free,  
**TRAVCO**, 107 E. Vallette, Suite 1301D, Elmhurst, IL  
60126.

### Quality Microwave TV Antennas

**WIRELESS CABLE**—1.9 to 2.7 Ghz. 40db Gain (+)  
36-Channel System Complete \$149.95  
12-Channel System Complete \$114.95  
Call or Write for "FREE" Catalog

**Phillips-Tech Electronics**  
P.O. Box 8533 • Scottsdale, AZ 85252



LIFETIME WARRANTY MasterCard • Visa • COD's Quantity Pricing

**EXTEND** light bulb life 100X. Set 6/\$9.95 U.S. **T&S**  
**PUBLISHING**, Dept.-R1, #30-3550 Adanac Street,  
Vancouver, B.C., V5K-4Y6.

**DIGITIZER** for IBM compatible PCs 640 by 480  
resolution from VCR video camera \$85.00 demon-  
stration disk \$3.00. **CODEWARE**, Box 3091,  
Nashua, NH 03061.

**FREE catalog.** Interfaces for IBM compatibles. Dig-  
ital I/O and analog input. Control relays, motors,  
lights, measure temperature, voltage. **JOHN BELL**  
**ENGINEERING, INC.**, 400 Oxford Way, Belmont,  
CA 94002. (415) 592-8411.

**ABSOLUTELY lowest prices** on computers, soft-  
ware and accessories - guaranteed. Write for free  
information: **SEABIRD**, 4P Militia Drive, Lexington,  
MA 02173.

**CABLE** descramblers (Jerrold) from \$40.00. Tocom  
VIP test chip. Fully activates unit. \$50.00 Call (213)  
867-0081.

# CABLE TV

## TB-3 (Tri-Bi) or SA-3

### Quantity Prices

10

**\$48.**  
Each

20

**\$43.**  
Each

50

**\$39.**  
Each

100

**\$35.**  
Each

Hours open 10:00 am to 4:00 pm Eastern time  
Minimum order 5 units 55.00 ea.  
Dealers wanted. We ship COD.

King Wholesale  
1-800-729-0036  
Fax number 6173400053

"No one beats the King's prices!"

# DESCRAMBLERS



One tree can make  
3,000,000 matches.



One match can burn  
3,000,000 trees.



A Public Service of This Magazine  
& The Advertising Council







## UNICORN YOUR I.C. SOURCE

### COLLIMATOR PEN



A low power collimator pen containing a MOVPE grown gain guided GaAlAs laser. This collimator pen delivers a maximum CW output power of 2.5 mW at 25 °C.

These collimated laser sources are designed for industrial applications such as data retrieval,

telemetry, alignment etc.

The non-hermetic stainless steel encapsulation of the pen is specifically designed for easy alignment in an optical read or write system, and consists of a lens and a laser device. The lens system collimates the diverging laser light. The wavefront quality is diffraction limited.

The housing is circular and precision manufactured with a diameter of 11.0 mm and an accuracy between + and - 11 µm.

LIST PRICE ~~\$180.00~~ PRICE **\$39.99**

Quality Components — Low Prices Since 1983

### LASER DIODE

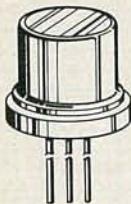

Designed for general industrial low power applications such as reading optical discs, optical memories, bar code scanners, security systems, alignment etc.

The gain guided laser is constructed on a n-type gallium arsenide substrate with a Metal

Organic Vapor Phase Epitaxial process (MOVPE). The device is mounted in an hermetic SOT148D (diameter 9.0 mm) encapsulation.

The SB1053 is standard equipped with a monitor diode, isolated from the case and optically coupled to the rear emitting facet of the laser. This fast responding monitor diode can be used as a sensor to control the laser optical output level.

LIST PRICE ~~\$38.00~~ PRICE **\$9.99**

We Carry A Full Line of Components

CALL FOR FREE CATALOG

### EPROMS

STOCK #	PINS	DESCRIPTION	1-24	25-99	100+
1702	24	256 x 4 1ns	3.99	3.79	3.41
2708	24	1024 x 8 450ns	5.79	5.50	4.95
2758	24	1024 x 8 450ns	3.99	3.79	3.41
2716	24	2048 x 8 450ns (25v)	3.19	3.03	2.73
2716-1	24	2048 x 8 350ns (25v)	3.39	3.22	2.90
TMS2716	24	2048 x 8 450ns	6.29	5.98	5.38
27C16	24	2048 x 8 450ns (25v-CMOS)	3.59	3.41	3.07
2732	24	4096 x 8 450ns (25v)	3.79	3.60	3.24
2732A-2	24	4096 x 8 200ns (21v)	3.79	3.60	3.24
2732A	24	4096 x 8 250ns (21v)	3.69	3.51	3.16
2732A-4	24	4096 x 8 450ns (21v)	3.09	2.94	2.65
TMS2532	24	4096 x 8 450ns (25v)	5.79	5.50	4.95
27C32	24	4096 x 8 450ns (25v-CMOS)	4.19	3.98	3.58
27B4-20	28	8192 x 8 200ns (21v)	3.99	3.79	3.41
27B4	28	8192 x 8 250ns (21v)	3.59	3.41	3.07
27B4A-20	28	8192 x 8 200ns (12.5v)	3.99	3.79	3.41
27B4A	28	8192 x 8 250ns (12.5v)	3.59	3.41	3.07
TMS2564	28	8192 x 8 250ns (25v)	6.79	6.45	5.81
27128-20	28	16,384 x 8 200ns (21v)	5.79	5.50	4.95
27128	28	16,384 x 8 250ns (21v)	4.79	4.55	4.10
27C128	28	16,384 x 8 250ns (21v)	5.39	5.12	4.61
27256-20	28	32,768 x 8 200ns (12.5v)	5.99	5.69	5.12
27256	28	32,768 x 8 250ns (12.5v)	4.99	4.74	4.27
27C256	28	32,768 x 8 250ns (12.5v-CMOS)	5.99	5.69	5.12
27512-20	28	65,536 x 8 200ns (12.5v)	10.49	9.97	8.97
27512	28	65,536 x 8 250ns (12.5v)	9.49	9.02	8.12
27C512	28	65,536 x 8 250ns (12.5v-CMOS)	9.99	9.49	8.54
27C1024	32	131,072 x 8 200ns (12.5v-CMOS)	27.99	26.59	23.93
68764	24	8192 x 8 450ns	18.99	18.04	16.24
68765	24	8192 x 8 450ns	15.99	15.19	13.67

### UNICORN ELECTRONICS

10010 Canoga Ave., Unit B-8

Chatsworth, CA 91311

ORDER BY PHONE (TOLL FREE)

(800) 824-3432 (OUTSIDE CALIFORNIA)

IN CALIFORNIA (818) 341-8833

ORDER BY FAX (818) 998-7975

## ASSEMBLE YOUR OWN COMPUTER FOR LESS

### 10 MHz 8088 Compatible Kit .....\$379

- 4.77/10 MHz 8088 Motherboard
- 256KB RAM (640KB max)
- 150W Power Supply
- Floppy Disk Controller
- One 5 1/4" 360KB Drive
- MonoGraphics Card w/ P
- 101 Key Keyboard
- Case (3LED,2Button,Key)
- 12" Amber Mono Monitor
- Installation Guide & Manual



### 12 MHz 80286 Compatible Kit .....\$669

- 12 MHz 80286 Motherboard
- 512 KB RAM (4 MB max)
- 200W Power Supply
- Floppy Disk Controller
- One 5 1/4" 1.2 MB Drive
- MonoGraphics Card w/ P
- 101 Key Keyboard
- Case (3LED,2Button,Key)
- 12" Amber Mono Monitor
- Installation Guide & Manual



### 20 MHz 80386 Compatible Kit .....\$1399

All Components Fully Tested Before Ship  
One Year Warranty on All Parts  
Installation Available at No Extra Charge !!!  
VISA & M/C add 3% Amex add 4%  
Price & Quantity subject to change without prior notice  
15% Restocking Fee on All Non-Defective Items

### JINCO COMPUTERS INC.

5122 WALNUT GROVE AVE.

SAN GABRIEL, CA 91776

Tel: (818) 309-1108

Fax: (818) 309-1107

CIRCLE 180 ON FREE INFORMATION CARD

**BUILD remote control car starter.** Without keys from home turns on/off engine, heater/air conditioning, lights etc.... Locates car in crowded parking lot. Send \$5.00 SASE, for detailed instruction. Assembled unit with programmable 300ft range key-chain transmitter \$169.95. **N.Y. ENGINEERING CENTER**, PO Box 0831, Syosset, NY 11791-0831.

**IBM PC development tools** timing software extender boards. **DETROIT DATACOMM**, 1409 West Mile, Mod Hgts, MI 48071.

**PRINTED circuit boards** made to your concept. Full service — short runs — 25 years in business. Write or call — **SHORE PROTO CIRCUITS**, 36 Fairview Avenue, Little Silver, NJ 07739. (201) 747-6300 — (201) 747-6301 (fax #)

**FUZZ buster buster.** Activates radar detectors. Great for testing radar detectors at hamventions. Build from parts in your shack. For complete plans, assembly instructions and parts list send \$19.95 to **RICH CONSULTING**, Box 8206, Fort Wayne, IN 46898-8206.

**BARGAIN plan.** Desk top computer stand. Easily built. Personal pride. Send \$4.00, now... **CREATE**, PO Box 440062, Aurora, CO 80044.

**INSTANTANEOUSLY** reduce stereo volume. Device mutes stereo while phone in use. PC board, complete instructions only \$14.95. **TRIAD TECHNOLOGIES**, 7184 Manchester, St. Louis, MO 63143-2408.

**NUTS & VOLTS** P.O. Box 1111-E  
MAGAZINE Placencia, CA 92670  
714-632-7721

**GIVE YOURSELF A BREAK — A PRICE BREAK!**  
NUTS & VOLTS WILL SAVE YOU MONEY  
ON ELECTRONIC PARTS & EQUIPMENT  
Plus SHOW YOU WHERE TO FIND UNIQUE,  
UNUSUAL AND HARD-TO-FIND ITEMS.  
SUBSCRIBE TODAY!  
Orders Only 800-783-4624

**Subscription Rates**  
3-5 Years Also: \$50.00  
1st Class Mail: USA  
One Year \$12.00  
Two Years \$21.00  
Lifetime \$50.00  
1st Class Mail  
One Year USA \$20.00  
Canada/Mexico \$22.00  
Air Mail  
Foreign 1 Yr. \$55.00

*A National Publication For The Buying And Selling Of Electronic Equipment*

## BEST BY MAIL

Rates: Write National, Box 5, Sarasota, FL 34230

### MONEYMAKING OPPORTUNITIES

EARN \$50,000+. OBTAIN 100 bankcards. Send stamp. Universal, 3010 Wilshire, #414, Los Angeles, CA 90010.

## BUY BONDS

**MASTERCARD AND VISA** are now accepted for payment of your advertising. Simply complete the form on the first page of the Market Center and we will bill.

### EDUCATION & INSTRUCTION

**LEARN IBM PC assembly language.** 80 sample programs. Disk \$5. Book \$18. **ZIPFAST**, Box 12238, Lexington, KY 40581-2238.

**MAGIC!** Four illustrated lessons plus inside information shows you how. We provide almost 50 tricks including equipment for four professional effects. You get a binder to keep the materials in, and a one-year membership in the International Performing Magicians with a plastic membership card that has your name gold-embossed. You get a one-year subscription to our quarterly newsletter "IT'S MAGIC!" Order now! \$29.95 for each course + \$3.50 postage and handling. (New York residents add applicable state and local sales tax). **THE MAGIC COURSE**, 500-B BiCounty Boulevard, Farmingdale, NY 11735.

## FREE CATALOG!

1-800-648-7938

For all information 1-702-362-9026

JERROLD HAMLIN OAK ETC.

## CABLE TV DESCRAMBLERS

• Compare our low Low Retail Prices!

• Guaranteed Prices & Warranties!

• Orders Shipped Immediately!

REPUBLIC CABLE PRODUCTS INC.

4080 Paradise Rd. #15 Dept. RE-90

Las Vegas, NV 89109



### Computer Kits

They're Fun, Easy to build, IBM Compatible, Educational, Powerful with Wholesale Prices. All Kits include a Free Assembly Manual Free Software, One Year Warranty and 24 hour Phone Support Line

Ask for our Free Catalog

(516) 981-9473

General Technics

Quality Computer Systems  
P.O. Box 2676  
Lake Ronkonkoma, NY 11779

Assembly & Testing Available



## CABLE TV EQUIPMENT

Converters, Remote Controls,  
Descramblers, CD Players.



JERROLD-OAK-SCIENTIFIC ATLANTA-HAMLIN  
ZENITH MANY MORE CALL TODAY!

- ✓ Only quality products sold ✓ Easy to use
- ✓ Satisfaction guaranteed ✓ Knowledgeable sales staff
- ✓ Most orders shipped within 24 hours

CALL FOR YOUR FREE CATALOG

MC 1-800-228-7404 VISA

MAKE THE CONNECTION

WITH

**NU-TEK ELECTRONICS**

5114 Balcones Wood Dr.#307 Dept.298  
Austin, TX. 78759

BE a recording engineer; Train at home for high paying — exciting careers. Free information. **AUDIO INSTITUTE**, 2174 Union St., Suite 22K, San Francisco, CA 94123.

BASIC cleaning and maintenance TV one half hour, VCR one hour \$38.00 each. **JAMES BRADFORD**, PO Box 38359, Detroit, MI 48238.

FREE subscriptions to over 200 major computer and business magazines — guaranteed. Write for free information: **SEABIRD**, 4N Militia Drive, Lexington, MA 02173.

## SATELLITE TV

FREE catalog — Do-it-yourself save 40-60%. Lowest prices worldwide, systems, upgrades, parts, all major brands factory fresh and warranted. **SKYVISION, INC.**, 2009 Collegeway, Fergus Falls, MN 56537. 1 (800) 334-6455.

**DESCRAMBLER:** Build our low cost video only, satellite TV descrambler for most satellite channels. Uses easy to get, everyday parts. Board & plans \$35.00 US funds. Board, plans & parts \$99.00 US funds. Wired & tested unit \$189.00 US funds. Send check, money order or Visa to: **VALLEY MICROWAVE ELECTRONICS**, Bear River, Nova Scotia, Canada B0S 1B0 or phone (902) 467-3577. 8am to 4pm eastern time. Note: educational project only. Not to be used illegally.

**CABLE TV secrets** — the outlaw publication the cable companies tried to ban. HBO, Movie Channel, Showtime, descramblers, converters, etc. Suppliers list included. \$8.95. **CABLE FACTS**, Box 711-R, Pataskala, OH 43062.

\*\*\*\*\*PRESENTING\*\*\*\*\*

### CABLE TV DESCRAMBLERS

\*\*\*\*\* STARRING \*\*\*\*\*

**JERROLD, HAMLIN, OAK**  
AND OTHER FAMOUS MANUFACTURERS

- FINEST WARRANTY PROGRAM AVAILABLE
- LOWEST RETAIL/WHOLESALE PRICES IN U.S.
- ORDERS SHIPPED FROM STOCK WITHIN 24 HOURS

FOR FREE CATALOG ONLY **1-800-345-8927**  
FOR ALL INFORMATION 1-818-716-5914

**PACIFIC CABLE CO. INC.**  
7325 W. RESEDA BLVD., DEPT. RE189  
RESEDA, CA 91335

# 3 FOR 1 SPECIAL

## ON SUB-MINIATURE VOICE FM TRANSMITTERS.

### KITS CONTAIN PC BOARDS



\***FMX-1 LONG RANGE (3 MI) ULTRA SENSITIVE FM VOICE XMTR** with fine tune, range control plus.....\$29.50



\***TELX-1 TELEPHONE FM XMTR (3 MI)** automatically operates when phone is used. Crystal clear clarity with fine tune and range control. Non detectable.....\$29.50



\***ATR-1 AUTOMATIC TELEPHONE RECORDING DEVICE** tapes telephone conversation all automatically.....\$19.50

**ALL THREE OF ABOVE FOR.....\$59.50**

CALL OR SEND VISA, MASTER CHARGE, MONEY ORDER, ETC. TO **AMAZING CONCEPTS**, BOX 716, AMHERST, NH 03031. (603) 673-4730.

# MARK V ELECTRONICS, INC.

## QUALITY COMPONENTS \* COMPETITIVE PRICING

CATALOG & INFORMATION (213) 888-8988

ORDER TOLL FREE 800-423-3483

IN CALIFORNIA 800-521-MARK

FAX (213) 888-6868

▲ indicates the level of difficulty in the assembling of our Products. ▲ Beginner ▲▲ Intermediate ▲▲▲ Advanced ★ Fully Assembled



We provide transformers for most of our Mark V amplifier kits.

AMPLIFIERS		KIT	ASSMB.
MODEL	DESCRIPTION		
TA-28MK2	Digital Voice Recorder ▲▲▲	30.00	
TA-50A/B	Multi-Purpose Melody Generator ▲	11.84	\$ 16.58
TA-50C	Multi-Purpose Melody Generator ▲	12.65	17.71
TA-120MK2	35W Class "A" Main Power Mono Amp ▲▲	27.16	38.81
TA-300	30W Multi-Purpose Single Channel Amp ▲	20.00	29.00
TA-302	60W Stereo Power Booster	50.00	70.00
TA-323A	30Wx2 Stereo Pre-main Amp. ▲	29.50	38.35
TA-377A	HI-QUALITY FET Stereo Pre-Amp. ▲▲▲	59.95	75.00
TA-400	40W Solid State Mono Amp ▲	28.00	34.93
TA-477	120W Mosfet Power Mono Amp ▲▲	68.00	95.00
TA-800	80W+80W DC Pre-Main & Power Amp. ▲▲	60.92	79.20
TA-802	80W+80W DC Stereo Main Power Amp. ▲▲	45.94	59.72
TA-820A	60W+60W OCL DC Pre-Main Stereo Amp. ▲▲	40.39	49.37
TA-1000A	100W Dynamic Class "A" Main Power Mono Amp.	59.69	80.58
TA-1500	100W x 2 Class "A" DC Stereo Pre-Main Amp. ▲▲▲	73.70	95.81
TA-2200	FET Super class "A" DC Pre-Amp. ▲▲▲	47.70	58.24
TA-2400A	Electronic Echo & Revelation Amp ▲▲▲★	93.30	116.80
TA-2500	HQ Pre-Amp. w/10 band graphic equalizer★	90.80	90.80
TA-2800	BI-FET IC Pre-Amp. w/3 way tone control ▲▲	48.90	63.57
TA-3000	Stereo Simulator (For mono TV or any mono source)	30.20	41.38
TA-3600	300W HQ HI-FI Power Mono Amp. ▲▲▲	79.00	103.00

POWER SUPPLIES		KIT	ASSMB.
TR-100A	O-15V 2A Regulated DC Power Supply (w/case) ▲▲▲	59.50	69.50
TR-355A	O-15V 5A Regulated DC Power Supply ▲	14.55	20.76
TR-355B	O-30V 3A Regulated DC Power Supply ▲	14.55	20.76
TR-503	O-50V 3A Regulated DC Power Supply ▲	15.75	22.65

MISCELLANEOUS		KIT	ASSMB.
MODEL	DESCRIPTION		
TY-23B	3 Channel Color Light Controller ▲▲▲★	\$ 56.04	\$74.50
TY-25	Stereo Loudspeaker Protector ▲	12.65	18.88
TY-36	AC/DC Quartz Digital Clock ▲	18.00	25.20
TY-38	Sound/Touch Control Switch ▲	12.00	
TY-41 MKV	Infrared Remote Control Unit w/case ▲▲▲	20.00	35.00
TY-42	Bar/Dot Level Meter ▲▲	24.15	
TY-43	3 1/2" Digital Panel Meter ▲	29.00	38.00
TY-45	20 Steps Bar/Dot Audio Level Display ▲▲	38.45	46.14
TY-47	Superior Electronic Roulette ▲	19.46	27.24
SM-222	7 Band HI-FI Graphic Equalizer ▲▲▲★	26.80	38.80
SM-328	4 Channel Professional Color Light Controller ★		150.00
SM-333	Audio/Video Surround Sound Processor ▲▲▲★	62.00	83.00
SM-666	Dynamic Noise Reduction ▲	26.00	34.00

INSTRUMENTS		KIT	ASSMB.
SM-43	3 1/2" Multi-Functional Led D.P.M. (w/ABS plastic case) ▲▲▲	34.50	43.00
SM-48	4 1/2" HI-Precision D.P.M. ▲▲▲	38.00	48.00
SM-48A	4 1/2" HI-Precision D.P.M. w/ABS plastic case ▲▲▲	41.20	52.00
SM-49	3 1/2" Multi-Functional LCDD.P.M. (w/hold function) ▲▲	36.00	44.50
SM-100	150 MC Digital Frequency Counter ▲▲▲	79.00	90.00
FC-1000A	1 GHz Frequency Counter ★		179.00

METAL CABINETS WITH ALUMINUM PANEL:		MATCHING	
MODEL	H" x W" x D"		
LG-1273	3" 12" 7"	TA-2800, TA-377A	
LG-1684	4" 16" 8"	TA-3221, TA-323A, TA-377A	
LG-1924	4" 19" 11 1/2"	TA-802, TA-820A, TA-1500, TA-120, TA-800, TA-1000A	
LG-1925	5" 19" 11 1/2"	TA-477, TA-800, TA-1500, TA-1000A	
LG-1983	2 1/4" 19" 8"	TA-377A, TA-2800, TA-2200, TA-120MKII	

— WE ACCEPT MAJOR CREDIT CARDS, MONEY ORDERS AND CHECKS — BUSINESS & SHOWROOM HOURS (PACIFIC TIME) MON. - FRI. 9:30 A.M. - 5:00 P.M., SAT. 10:00 A.M. - 5:00 P.M. TERMS: \$10.00 MIN. ORDER \* \$20 MIN. CHARGE CARD ORDER \* WE SHIP UPS GROUND \* ADD 10% OF TOTAL ORDER (MIN \$3.00) FOR SHIPPING OUTSIDE USA. ADD 20% (MIN \$5.00) \* TRANSIT INSURANCE \* ADD 5% OF TOTAL (OUTSIDE USA ONLY, CA RESIDENTS ADD SALES TAX \* ALL MERCHANDISE SUBJECT TO PRIOR SALE \* PRICES ARE SUBJECT TO CHANGE WITHOUT NOTICE \* WE ARE NOT RESPONSIBLE FOR TYPOGRAPHICAL ERRORS

**MARK V ELECTRONICS, INC.** — 8019 E. Slauson Ave., Montebello, CA 90640



MAY 1990

93





### CABLE TV CONVERTERS & EQUIPMENT

	ONE UNIT	10+ UNITS
PANASONIC WIRELESS CONVERTER	85.00	69.00
JERROLD 400 COMBO W/REMOTE (DRX3DIC)	134.00	95.00
JERROLD 400 OR 450 REMOTE HAND UNIT	24.00	15.00
JERROLD JRX 3DIC	84.00	65.00
JERROLD SB ADD ON	74.00	55.00
JERROLD SB ADD ON WITH TRI-BI	95.00	70.00
OAK M-35 COMBO	79.00	50.00
OAK MINICODE (N-12)	84.00	59.00
HAMLIN MLD 1200	64.00	45.00
SCIENTIFIC ATLANTA SA-3 ADD ON	109.00	75.00
INTERFERENCE FILTER (CHANNEL 3 OR 6)	24.00	14.00
NEW SCIENTIFIC ATLANTA COMBO	275.00	215.00
PIONEER DESCRAMBLER	250.00	200.00
TOCOM VIP	200.00	175.00
ZENITH FLASHING	175.00	150.00
ZENITH SSAVI	125.00	90.00
EAGLE PD-3	95.00	75.00

### VIDEO-LINK Enterprises, Inc.

520 GLENBROOK RD., SUITE 202  
STAMFORD, CT 06906

ORDERS: 1-800-622-9022

CATALOG & INFO: 203-975-7543

MONDAY - FRIDAY 10 AM — 5:30 PM, E.S.T.

**IMPORTANT:** Have make and model # of the equipment used in your area.

QTY	ITEM	OUTPUT CHANNEL	PRICE EACH	TOTAL PRICE

NO CONNECTICUT SALES. It is not the intent of VIDEO-LINK to defraud any pay television operator and we will not assist any company or individual in doing so.

SUBTOT.
Shipping \$3 / Unit
COD: Add 5%
TOTAL

**PLEASE PRINT:**

CASHIER'S CHECK  M.O.  C.O.D.

NAME \_\_\_\_\_

ADDRESS \_\_\_\_\_

CITY/STATE/ZIP \_\_\_\_\_

PHONE \_\_\_\_\_

SIGNATURE \_\_\_\_\_

**WAIVER.** Since I, the undersigned, fully understand that the ownership of a cable decoder does not give the owner of the decoder the right to decode or view premium cable channels without proper authorization from their local cable company, hereby declare under penalty of perjury that all products purchased, at any time, will only be used on cable TV systems with proper authorization from local officials or cable company officers in accordance with all applicable federal and state laws. Federal and various state laws provide for substantial criminal and civil penalties for unauthorized use.

Dated: \_\_\_\_\_ Signed: \_\_\_\_\_

CIRCLE 64 ON FREE INFORMATION CARD

### CONSOLIDATED ELECTRONICS



### THE ULTIMATE ELECTRONICS CATALOG

Order your 260 page catalog and price list with over 14,000 money saving electronic parts and equipment! Send \$3.00 in a check or money order, or call 1-800-643-3568 today and use your Mastercard or Visa. Consolidated Electronics, Incorporated  
705 Watervliet Ave., Dayton, Ohio 45420-2599

Name \_\_\_\_\_  
Address \_\_\_\_\_  
City \_\_\_\_\_ State \_\_\_\_\_ Zip \_\_\_\_\_

CIRCLE 70 ON FREE INFORMATION CARD

**SATELLITE** descramblers, all types, reasonable prices. Catalog \$4.00. **SKYWATCH**, 238 Davenport Road, Toronto, Ontario, Canada, M5R 1J6.

**VIDEOCIPHER II** manuals. Volume 1 — hardware, Volume 2 — software. Either \$32.45. Volume 3 — projects/software — \$42.45. Volume 4 — repair — \$97.45. Volume 5 documentation — \$42.45. Volume 6 — Experimentation — \$42.45. **Cable Hacker's Bible** — \$32.45. **Clone Hacker's Bible** — \$32.95 CODs: (602) 782-2316. 220 + Megabytes IBM-PC/XT software — catalog-\$3.00. **TELECODE**, Box 6426-RE, Yuma, AZ 85366-6426.

**ATLANTIC GROUP ENTERPRISES INC.** Buy satellite equipment. Dealing directly with the seller. We can show you how. Toll free 1 (800) 446-4039.

**VIDEOCIPHER II descrambling manual.** Schematics, video and audio. Explains DES, EPROM, CloneMaster, 3Musketeer, pay-per-view (HBO, Cinemax, Showtime, adult, etc.) \$13.95, \$2.00 postage. Collection of software to copy and alter EPROM codes, \$25. **CABLETRONICS**, Box 30502R, Bethesda, MD 20824.

### CABLE TV DESCRAMBLER LIQUIDATION!

- Major Makes & Models!
- Will match or beat anyone's prices!
- Dealer discounts at 5 units!
- Examples:  
HAMLIN COMBOS . . . \$44 ea. (Min. 5)  
OAK ADD/ON . . . . . \$40 ea. (Min. 5)  
OAK M35B . . . . . \$60 ea. (Min. 5)

**WEST COAST ELECTRONICS**  
For Information: 818-709-1758  
Catalogs & Orders: 800-628-9656

### CABLE T.V. CONVERTERS WHY PAY A HIGH MONTHLY FEE?



All Jerrold, Oak, Hamlin, Zenith, Scientific Atlanta, Magnavox and all specialized cable equipment available for shipment within 24 hours. For fast service MC / VISA or C.O.D. telephone orders accepted (800) 648-3030 60 Day Guarantee (Quantity Discounts) 8 A.M. to 5 P.M. C.S.T. **CLOSED WEEK-ENDS.** Send self-addressed Stamped envelope (60¢ postage) for Catalog.

**MIDWEST ELECTRONICS INC.** P.O. Box 5000 Suite 311 (R) Carpentersville, IL 60110

No Illinois Orders Accepted.

### BUSINESS OPPORTUNITIES

**EASY** work! Excellent pay! Assemble products at home. Call for information. (504) 641-8003 Ext. 5192.

**MAKE** \$50/hr working evenings or weekends in your own electronics business. Send for free facts. **INDUSTRY**, Box 531, Bronx, NY 10461.

**YOUR** own radio station! AM, FM, TV, cable. Licensed/unlicensed. **BROADCASTING**, Box 130-F5, Paradise, CA 95967.

### GET IN NOW ON THE \$12 BILLION A YEAR COMPUTER SERVICE INDUSTRY



**LEARN HOW TO CLEAN/ MAINTAIN/REPAIR PRINTERS...**  
VIEJO'S AWARD-WINNING TRAINING VIDEO AND COMPANION TRAINING MANUAL (OVER 300 ACTION-PACKED PAGES) REVEALS SECRETS OF PRINTER REPAIR WITH YOUR AVERAGE MECHANICAL ABILITY WE CAN SHOW YOU HOW TO REPAIR UP TO 95% OF ALL PRINTERS - START EARNING EXTRA CASH IN DAYS!

**HUGE UNTAPPED MARKET!**  
SERIOUS LACK OF TRAINED TECHNICIANS  
OVER 37 MILLION PCs IN USE... APPROXIMATELY 85% HAVE A PRINTER ATTACHED... **VAST MAJORITY** OF PRINTER BREAKDOWNS ARE DUE TO SIMPLE MECHANICAL OR ELECTRO-MECHANICAL FAILURE.

**FREE INFO** OR WRITE TO: **VIEJO PUBLICATIONS** 3540 WILSHIRE BL. # 310 DEPT. RE2, L.A. CA 90010

**INVENTORS:** We submit ideas to industry. Find out what we can do for you. Call 1 (800) 288-IDEA.

**LET** the government finance your small business. Grants/loans to \$500,000. Free recorded message: (707) 449-8600. (KS1).

**EARN \$1000's extra** as a part-time computer dealer. Where to buy products at big discounts. Who to sell to. Financing without cash. Obtaining free software. Exclusive dealer trade shows. Step-by-step check list. Industry inside knowledge. Written by industry pioneer. Order now, only \$24.95 plus \$4.00 shipping/handling, CA residents add \$1.81 sales tax. **CORNERSTONE PUBLICATIONS**, Dept BA, PO Box 5151, San Jose, CA 95150. Allow 2-4 weeks.

**EASY! Moneymaking** one man CRT rebuilding machinery. \$6,500.00 - \$11,900.00. **CRT**, 1909 Louise, Crystalake, IL 60014. (815) 459-0666.

### BUY BONDS



**SINGERS!** Sing With The World's Best Bands!

The Thompson Vocal Eliminator removes lead vocal from standard stereo records & CD's! Unlimited Supply of Background Music! Easily Record or Perform with the Backgrounds. Used Professionally, yet connects easily to home component stereo. Manufactured and Sold Exclusively by LT Sound. For Free Brochure & Demo Record, Call: LT Sound, Dept. RL-1, 7981 LT Parkway, Lithonia, GA 30058 (404)482-4724 24 Hr. Phone Demo/Info Request Line: (404)482-2485

**WANTED**

**INVENTORS!** Confused? Need help? Call **IMPAC** for free information package. In US and Canada: 1 (800) 225-5800.

**INVENTIONS/new products/ideas wanted:** Call **TLCI** for free information 1 (800) 468-7200 24 hours/day - USA/Canada.

**COMPUTER BOOKS**

**DISCOUNT computer books.** All titles available, including recent releases. Please call or write for our latest catalog. **BOOKWARE**, 147 Campville Road, Northfield, CT 06778. 1 (800) 288-5662.

**TELEPHONE CALL SCREENING**

**REAL telephone call screening!** Protect telephones, Fax, computer, hearing impaired, day sleepers. Eliminate wrong numbers, prank and sales calls. Plugin unit provides variable ring cadence signaling. True unlisted number on any touchtone private line. Automatic call routing. Send \$13.95 for complete theory and construction manual. **ELECTRONIC CONTROL SYSTEMS**, R.D. 2 Box 3308, Wernersville, PA 19565.

**CABLE TV "BOXES"**

Converters — Descramblers  
Remote Controls — Accessories

★ Guaranteed Best Prices ★  
★ 1 Year Warranty — C.O.D.s ★  
★ Immediate Shipping ★  
★ FREE CATALOG ★

Call or Write  
**TRANS-WORLD CABLE CO.**  
12062 Southwest 117th Court, Suite 126  
Miami, Florida 33186  
1-800-442-9333



**INVENTORS**

**INVENTORS!** Can you patent and profit from your idea? Call **AMERICAN INVENTORS CORPORATION** for free information. Over a decade of service 1 (800) 338-5656. In Massachusetts or Canada call (413) 568-3753.

**TUBES - 2000 TYPES DISCOUNT PRICES!**

Early, hard-to-find, and modern tubes. Also transformers, capacitors and parts for tube equipment. Send \$2.00 for 24 page wholesale catalog.

**ANTIQUE ELECTRONIC SUPPLY**  
688 W. First St. • Tempe, AZ 85281 • 602/894-9503



**THE ELECTRONIC GOLDMINE**

**INFRARED DETECTOR KIT**  
Uses sensitive sensor and electronic circuitry to respond to all types of infrared TV, VCR, etc. remote controllers and LEDs by producing sound and lighting a bright red LED. Great for testing and verification of infrared output - sees what you can not see. Small size: 2.5" x 1.4". Operates on 9V battery (not included). Kit comes with all parts and PC board.  
C6441 \$5.95



**MINI GEIGER COUNTER KIT**  
This useful kit lets you detect the radiation that you are being exposed to! Use it to detect radium dials on old watches, camping fluorescent lanterns, radioactive emeralds, background radiation, etc. Kit detects alpha, beta, gamma and X-ray radiation and features sensitive alpha window GM tube with R. Circuit. Limits clicks in proportion to intensity of radiation! Size only 1.9" x 3". Operates from one 9V battery (not included). With all parts and PC board.  
C6430 \$59.95



**20W + 20W STEREO AMP KIT**  
Two separate high power amps on one PC board. Each amp has its own level control and puts out an incredible 20 Watts RMS. Features red LED "on" indicator and low distortion circuitry. Great stereo booster amp for your car sound system. Use with any speakers capable of handling at least 20 watts. Operates on 12VDC. With all parts and pc board. C6442 \$19.95



**10W + 10W STEREO AMP KIT**  
Similar to the amp above only this one puts out 10 watts RMS in each channel. Features one level control that sets level in both channels and red LED "on" indicator. Use this amp with your speakers to boost portable tape players, radios, or CD players to full rich room filling volume. Operates from 12VDC. With all parts and pc board.  
C6443 \$16.95



**20 WATT RMS MONO AMP KIT**  
High power amp for various booster applications. Kit features short circuit and open circuit protection and has very low distortion (1% or less). Amplifier has red LED "on" indicator and will boost any tuner, radio, cassette, CD player to room filling volume out of your speaker! Operates from 12VDC. With all parts and pc board.  
C6444 \$14.95



**FREE CATALOG!** We include our catalog containing over 130 kits and hundreds of unique components FREE with each order. We are continually adding new items to our catalog and once you order we will place your name on our preferred customer mailing list to receive it!

**MINIMUM ORDER \$10.00 plus 3.00 shipping and handling.** We accept M/C, Visa and money orders, COD fees 2.50 in addition to 3.00 shipping charge.  
SEND ORDERS TO: The Electronic Goldmine  
P.O. Box 5408 Scottsdale, AZ 85261  
PHONE ORDERS: (602) 451-7454

CIRCLE 179 ON FREE INFORMATION CARD

**When You Need Resistors, We Sell You Resistors (And Gravy), But Not Printed Matter!**

Resistors are one of the most common of electronic component parts and having a good reliable source for them is a necessity. For years we have been the lowest price leader in this (and many other) areas, and the following price comparison table proves that although we ask for a yearly Membership Fee of \$35.00, you can recover your investment quickly after purchasing just a few thousand resistors, and what you will save on more than 10,000 additional items that we stock, is the so-called 'gravy' part of the whole deal.

Resistor Type	Quantity	Electronic Buyers Club	Digi-Key® (No Discount)	Digi-Key® (Max Discount)	Jameco Electronics®	JDR Microdevices®	Sintec®
1/4 Watt, 5% Carbon-Film (Bulk)	10	--	\$ 0.50	\$ 0.375	\$ 0.50	\$ 0.50	--
	100	\$ 0.77	1.70	1.275	2.50	2.00	\$ 4.00
	1,000	4.76	8.10	8.10	11.95	15.00	12.00
	10,000	43.20	72.00	72.00	99.50	--	--
1/4 Watt, 1% Metal-Film (Bulk)	10	0.32	1.00	0.75	--	--	--
	100	1.16	3.90	2.925	3.29	--	8.00
	1,000	8.25	20.00	20.00	17.95	--	30.00

**12 Months Saving Guarantee**  
We will refund the first year Membership Fee of any member who has purchased \$300 or more worth of products from Electronic Buyers Club and has not saved an amount greater than the first year Membership Fee, if buying the same items elsewhere.

It is not that these other firms are trying to rip you off, the fact is that advertising in several Trade Magazines each month and printing and mailing hundreds of thousands of virtually the same catalog every few months cost a lot of money and they **have** to charge more. Call us today and start receiving components for your money instead of printed matter.

**30 Days Money Back Guarantee**  
We will refund the full Membership Fee of any new member of Electronic Buyers Club who within 30 Days after receiving the Membership Binder, returns the Binder to EBC and asks for the cancellation of Membership.



A Division of International Components Corporation

1803 N.W. Lincoln Way • Toledo, OR 97391  
PHONE (All 50 States & Canada): 1-800-325-0101  
FAX: (503) 336-4400 • Hours: 6:00 AM - 6:00 PM PST



CIRCLE 187 ON FREE INFORMATION CARD

MAY 1990



# AMERICAN DESIGN COMPONENTS

## COMPUTER BUFFS HOBBYISTS, AND SHARP SHOPPERS

Smart shoppers always look for components & parts that are hard to find, easy to use, and ridiculously low in price. If you're one of those people, we are your kind of store!

### TURBO XT COMPUTER

100% PC/XT Compatible!  
16-Bit 8088-10 Turbo Microprocessor

- Runs at 4.77Mhz or 10 Mhz @ (0+1 wait state)
- Speed switchable by software, keyboard or jumpers
- Includes video support for Hercules & CGA Color



Low Profile — CPU Dim.: 3.4"H x 14.1" x 15.7"

- One 5-1/4" Floppy Drive
- Clock Calendar w/battery b/up
- One Serial & One Parallel Port
- 8087 Coprocessor Socket
- 640K RAM
- 84-Key Keyboard
- Two 8-Bit Expansion Slots

With 12" Monochrome Monitor... Item #27190 NEW — \$399.00

With 12" Color Monitor... Item #27191 NEW — \$499.00

### Upgrade your PC... TURBO XT MOTHERBOARD (12 Mhz.)

- Fully 8088 compatible!
- \* Speed Selectable
  - \* 8 Expansion Slots
  - \* Memory expandable to 640K (OK installed)
  - Mfr.: ALP; documentation included. (Customer Upgrades)

Item #25674 Special! \$75.00

### 20Mb HARD DISK DRIVES HALF HEIGHT

Item #26533 RFE — \$179.00

### FULL HEIGHT

Item #20060 RFE — \$159.95

### 12" COMPOSITE MONITOR

Green. (Removed from operating systems, may have slight phosphor marks on screen.)

Item #26621 \$39.95

### COMPUTER CARRYING CASE

Super sturdy construction w/water-resistant Cordura nylon shell; padded interior with zipper lock. Heavy-duty shoulder strap and padded handles; interior & exterior pockets for accessories, manuals, etc. Fits the Mac Plus & SE (w/standard keyboard). Dim.: 17-1/4" x 15-1/2" x 12"

Item #26616 NEW — \$39.95

### PARALLEL PRINTER CABLE

Connects printer to computer's parallel port. 5-ft. length. DB25 to 36-pin Centronics; fully shielded.

Item #27142 NEW — \$7.95

### SURGE SUPPRESSOR

Protect your equipment from damaging power surges. 6 AC outlets, UL approved!

- 15 A. maximum load
- 6 ft., 14 Awg grounded power cord
- Lighted ON/OFF switch
- Full 3-line EMI/RF protection

Item #27139 NEW — \$12.95

### DISKETTE FILE ORGANIZER

Holds up to 100 Diskettes. Includes file dividers, & lock for added security. High-Impact plastic; white with smoked lid.

Item #27143 NEW — \$12.95

### 5-1/4" DISKETTES

For the "AT" — High Density, 1.2Mb DS/DD, 96 TPI Item #27140 NEW — \$12.95/box

For the "XT" — 360K DS/DD, 48 TPI Item #27141 NEW — \$5.95/box

### RIBBON CARTRIDGE

Item #27144 NEW — \$3.95 ea. or 3/\$10.00

1 - (800) 776-3700

### American Design Components

815 Fairview Ave., P.O. Box 220, Fairview, NJ 07022

Thousands more items in our FREE CATALOG! Please send me one!  RE 590

Item #	Desc.	Qty.	Price	Total

Name \_\_\_\_\_

Address \_\_\_\_\_

Phone \_\_\_\_\_

Visa/MC/Amex \_\_\_\_\_ Exp. \_\_\_\_\_

Min. Order \$15.00 — S & H: 10% of order + \$3.00

In NJ (201) 941-5000 • Fax: (201) 939-8918

CIRCLE 106 ON FREE INFORMATION CARD

## CABLE TV CONVERTERS

CABLE TV converters and descramblers discount center. Zenith, Tocom, Hamlin, Oak, Scientific Atlanta, Jerrold. Quantity discount, order yours today 1 (800) 962-6836.

### MULTI CHANNEL MICROWAVE ANTENNAS

- CRYSTAL CONTROLLED MICROWAVE ANTENNAS FOR OVER THE AIR CABLE SYSTEMS (WIRELESS CABLE)
- CAPABLE OF RECEIVING 30 CHANNELS
- CONVERTERS AVAILABLE FOR ZENITH SYSTEMS

### VIDEO-LINK ENTERPRISES

520 GLENBROOK RD., SUITE 202, STAMFORD CT 06906



United Way

It brings out the best in all of us.

©1987 UNITED WAY



## Join the Crossword Puzzles of the Month Club and put your crossword skills to the test!

Become a member and receive five intriguing, fun and challenging new puzzles — mailed right to your home every month! These are not reprints, but original, full-size puzzles edited especially for our members by the noted crossword puzzle expert Henry Hook. Month after month, you'll receive five brand-new puzzles and their solutions... five fiendishly clever puzzles with the same degree of difficulty as those in the Sunday New York Times!

**Join today! A perfect gift!**  
An entire year's membership is just \$29.95. (We pay the postage.) Send your check or money order to:

**Crossword Puzzles of the Month Club**  
629 Green Bay Road, Dept. 701  
Wilmette, Illinois 60091

Or call toll-free: 1-800-433-4386 and charge it to your MasterCard or Visa. — 24 hours a day, 7 days a week —

Your satisfaction is guaranteed.

©1990, CPMC

## SPECIAL FROM ETT SAVE \$\$ TODAY

2617T—BUILD A REMOTE-CONTROLLED ROBOT ..... regular \$9.95 ..... SPECIAL \$8.95. Fool-proof instructions for putting together your own full-size working robot at a fraction of the commercial cost.



2645T—117 PRACTICAL IC PROJECTS YOU CAN BUILD ..... regular \$10.95 ..... SPECIAL \$9.95. Dozens of fully tested ready-to-build circuits you can put together from readily available, low-cost IC's.

BP53—PRACTICAL ELECTRONICS CALCULATIONS AND FORMULAE ..... regular \$6.95 ..... SPECIAL \$5.95. Six basic sections: Units and Constants, Direct Current Circuits, Passive Components, Alternating Current Circuits, Networks and Theorems, Measurements.



2706T—BUILDING METAL LOCATORS ..... regular \$9.95 ..... SPECIAL \$8.95. A treasure hunter's project book. Build your own high-quality metal detector for a fraction of the factory-built cost.



BP234—TRANSISTOR SELECTOR GUIDE ..... regular \$10.00 ..... SPECIAL \$9.00. Offers a range of selection tables compiled so as to be of maximum use to all electronics engineers, designers and hobbyists.



ETTCAT—ELECTRONIC TECHNOLOGY TODAY INC. CATALOG ..... \$2.00. 36-pages list a wide variety of electronics books. Included with catalog is a coupon good for \$3.00 off your first purchase.

MAIL TO: Electronic Technology Today, Inc.  
P.O. Box 240  
Massapequa Park, NY 11762-0240

### SHIPPING CHARGES IN USA AND CANADA

\$0.01 to \$5.00	... \$1.25	\$30.01 to \$40.00	\$5.00
\$5.01 to 10.00	... \$2.00	\$40.01 to \$50.00	\$6.00
\$10.01 to \$20.00	\$3.00	\$50.01 and above	\$7.50
\$20.01 to \$30.00	\$4.00		

**SORRY, No orders accepted outside of USA and Canada**

Total price of merchandise	..... \$
Shipping (see chart)	..... \$
Subtotal	..... \$
Sales Tax (NYS only)	..... \$
Total Enclosed	..... \$

Name \_\_\_\_\_  
Address \_\_\_\_\_  
City \_\_\_\_\_ State \_\_\_\_\_ Zip \_\_\_\_\_

RADIO-ELECTRONICS 96



## WORKBENCH

continued from page 88

Notice in Fig. 5 how values are computed simply by stating an equation or function equivalence. For example, the average or mean value is subtracted from array PULSE by simply stating:

pulse := pulse - mean(pulse)

In the same manner, the maximum value in array PULSE can be assigned to variable mx by:

mx := max(pulse)

MathCAD is thus simple, quick, and clean, even for sophisticated functions such as the fast Fourier transform (FFT), which is the numerical-analysis equivalent of a spectrum analyzer, except that this spectrum analyzer can be applied to any array of numerical data. In fact, Fourier techniques and FFT's have been used to define and extract business-cycle information from economic indicators, stock market data, and weather data.

Analysis packages such as MathCAD offer a wide range of

capabilities from simple to sophisticated. You can go from maximums and minimums to histograms, linear regressions, FFT's, Bessel functions, etc. However, don't let the power of sophisticated analysis subvert your common sense, or belie the importance of a fundamental understanding of the data being analyzed. That final point is perhaps best stated by Alfred North Whitehead (1861-1947), a prominent mathematician and philosopher, who said:

*There is no more common error than to assume that, because prolonged and accurate mathematical calculations have been made, the application of the result to some fact of nature is absolutely certain.* ♦CD♦

### Vendors

- Graph-in-the-Box, New England Software, Inc., Greenwich Office, Park #3, Greenwich, CT 06831 (203) 625-0062
- MathCAD, MathSoft, 201 Broadway, Cambridge, MA 02139 (800) MATHCAD.

## CABLE TV DESCRAMBLERS

JERROLD™ Tri-Bi Mode.....	\$105.00	10 Lot	\$85.00
JERROLD™ SB-3 OR 2.....	\$89.00		\$65.00
Hamlin MLD-1200.....	\$99.95		\$62.00
Oak N-12 W/V.S.....	\$99.95		\$62.00
Oak-M-35-B W/V.S.....	\$99.00		\$78.00
OAK E-13.....	\$99.95		\$58.00
Zenith SSAVI.....	\$185.00		\$145.00
Eagle PD-3.....	\$120.00		\$85.00
Scientific Atlanta.....	\$129.95		\$105.00
SA-Combo's.....	CALL		\$Call
Tocom.....	\$350.00		\$295.00
Oak N-12 W/ Auto.....	\$140.00		\$105.00
Jerrold Starcom CSV....	\$139.95		Call

M.D. ELECTRONICS  
WILL MATCH ANY  
ADVERTISED PRICE  
IN THIS MAGAZINE

### \*NEW STARGATE 2000 CABLE CONVERTER



1-\$89.00 10-\$69.00 100-Call  
Last channel recall-Favorite channel select-  
75 channel-Channel scan-Manual fine tune-  
One year warranty-surge protection-HRC & Stand-  
ard switchable- and much more. Call Today!

INFORMATION(402)554-0417

Orders Call Toll Free  
1-800-624-1150

M.D. ELECTRONICS  
115 NEW YORK MALL  
SUITE 133E  
OMAHA, NE. 68114

M.C.  
VISA  
C.O.D.

CIRCLE 53 ON FREE INFORMATION CARD

**Parts Express**  
International Inc.

EMINENCE



MOTOROLA

Polydax

1-800-338-0531

PIONEER

### 3-WAY 100W CROSSOVER

12 dB/octave rolloff.  
800Hz, 5000Hz  
crossover points. 8  
ohm. 100 watts RMS.



#260-210 \$12.50 \$9.95  
(1-9) (10-up)

### SPEAKER CONTROL PANEL

Panel with 50 watt L-pads  
for tweeter and midrange  
and built-in LED power  
meter. 5" x 2 1/2" 100  
watt version available



#260-235 \$14.50 \$12.90  
(1-5) (6-up)

### 12" POLY WOOFER

Super duty, 40 oz. magnet.  
100 watts RMS, 145 watts  
max. 4 and 8 ohm compat-  
ible (6 ohm). 2" voice coil.  
fs = 25 Hz. QTS = .166,  
VAS = 10.8 cu ft.  
Response: 25-1500 Hz. Net  
weight: 9 lbs. Pioneer  
#A30GU40-51D



#290-125 \$36.80 \$34.50  
(1-3) (4-up)

### 15" WOOFER

Original Sanyo  
woofer. Paper  
cone with vented  
dust cap and  
treated cloth  
surround. 12 oz.  
magnet. 60 watts  
RMS, 85 watts  
max. 8 ohm.  
Resonance: 26 Hz.  
Response: 25-  
2,500 Hz.



#291-155 \$23.00 \$21.90  
(1-5) (6-up)

### PIONEER HORN TWEETER

Mylar dome. 2.93 oz.  
barium ferrite magnet. 8  
ohm. Response: 1800-  
20000 Hz. 35W RMS,  
50W max. fs = 2000 Hz,  
SPL = 106 dB. Pioneer  
#AHE60-51F



#270-050 \$6.50 \$5.90  
(1-9) (10-up)

### 12" SUB WOOFER

Dual voice coil sub woofer.  
30 oz. magnet, 2" voice  
coils. 100 watts RMS, 145  
watts max. fs = 25 Hz. 6 ohm  
(4 and 8 ohm compatible).  
SPL = 89 dB 1W/1M.  
Response: 25-700 Hz.  
QTS = .31, VAS = 10.3 cu. ft.  
Pioneer #A30GU30-5SD.  
Net weight: 6 lbs.



#290-145 \$39.80 \$36.80  
(1-3) (4-up)

### 15" THRUSTER WOOFER

Thruster by Eminence.  
Made in USA. Poly foam  
surround, 56 oz. magnet.  
2-1/2", 2 layer voice coil.  
150 watts RMS, 210 watts  
max. 4 ohm. fs = 23.5  
Hz, QTS = .33, VAS = 17.9  
cu ft. SPL = 94.8 dB 1W/  
1M. Net weight: 15 lbs.



#290-180 \$43.50 \$39.80  
(1-3) (4-up)

### GRILL FRAME KIT

With this kit you  
can make speaker  
grill frames up to  
30" x 40". Kit  
includes 4 corner  
pieces, 2 "T"  
brackets, and 7  
frame bars. Grill  
mounting kit  
included.

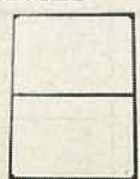

#260-333 \$8.50 \$7.80  
(1-9) (10-up)

### 18" EMINENCE WOOFER

MADE IN USA

100 oz. magnet, 3" voice  
coil. 250 watts RMS, 350  
watts max. 8 ohm, 30 Hz  
resonant frequency. 22-  
2700 Hz response.  
Efficiency: 98 dB 1W/1M.  
Paper cone, treated  
acordian surround. Net  
weight: 29 lbs.



#290-200 \$98.90 \$89.50  
(1-3) (4-up)

### TITANIUM COMPOSITE TWEETER

Titanium is deposited on a polymer  
dome to combine the advantages of  
both hard and soft dome  
technologies. 8 ohm. Ferro fluid  
cooled voice coil. fs = 1200 Hz.  
SPL = 90 dB 1W/1M. 90 watts RMS.  
70 watts max. 4" round. Polydax  
part #DTW100T125.



#270-047 \$27.50 \$24.80  
(1-9) (10-up)

**Parts Express**  
340 E. First St., Dayton, Ohio 45402  
Local: 1-513-222-0173  
FAX: 513-222-4644

\* 15 day money back guarantee \*\$15.00 minimum order \*We accept  
Mastercard, Visa, Discover, and C.O.D. orders \*24 hour shipping  
\*Shipping charge = UPS chart rate \$1.00 (\$3.00 minimum charge)  
\*Hours: 8:30 am- 6:00 pm EST, Monday - Friday \*Mail order  
customers, please call for shipping estimate on orders exceeding  
5 lbs.

CIRCLE 56 ON FREE INFORMATION CARD

**Parts Express**  
INTERNATIONAL INC.  
CALL TOLL FREE 1-800-338-0531  
1989 CATALOG  
FREE CATALOG

MAY 1990

97



**SIP & SIMM MODULES**

Part No.	Function	Price
512KIT*	IBM PS-2 100ns 256K x 9 SIMM (2 each)	99.95
2MEGKIT*	IBM PS-2 100ns 1MEG x 9 SIMM (2 each)	369.95
41256A9A-10	262,144x9 100ns 256K x 9 SIMM (Has Leads)	44.95
41256A9B-80	262,144x9 80ns 256K x 9 SIMM	49.95
42100A9B-10	1,048,576x8 100ns 1MEG x 8 SIMM	109.95
42100A9A-80	1,048,576x8 80ns 1MEG x 8 SIMM (Has Leads)	124.95
42100A9B-80	1,048,576x8 80ns 1MEG x 8 SIMM	119.95

\*Upgrade for Models 30, 50Z and 60

**7400**

Part No.	1-9	10+	Part No.	1-9	10+
7400	29	19	7474	39	29
7402	29	19	7475	49	39
7404	29	19	7476	45	35
7405	35	25	7483	59	49
7406	39	29	7485	65	55
7407	39	29	7486	45	35
7408	35	25	7489	2.25	2.15
7410	29	19	7490	49	39
7411	35	25	7493	45	35
7414	49	39	7495	59	49
7416	35	25	74107	29	19
7417	35	25	74121	39	29
7420	29	19	74123	49	39
7427	29	19	74125	49	39
7430	29	19	74147	1.99	1.89
7432	39	29	74150	1.35	1.25
7438	39	29	74151	39	29
7442	49	39	74166	1.38	1.25
7445	65	55	74161	69	59
7446	89	79	74174	59	49
7447	89	79	74175	59	49
7473	39	29	74193	79	69

**74LS**

Part No.	26	16	74LS139	49	39
74LS00	26	16	74LS139	49	39
74LS02	28	18	74LS151	49	39
74LS03	28	18	74LS153	49	39
74LS04	28	18	74LS154	1.29	1.19
74LS05	28	18	74LS157	45	35
74LS06	59	49	74LS161	49	39
74LS07	59	49	74LS163	49	39
74LS08	28	18	74LS164	59	49
74LS09	28	18	74LS165	75	65
74LS10	26	16	74LS166	39	29
74LS11	29	19	74LS173	45	35
74LS14	49	39	74LS174	39	29
74LS20	28	18	74LS175	39	29
74LS21	29	19	74LS191	59	49
74LS27	35	25	74LS192	69	59
74LS30	28	18	74LS193	69	59
74LS32	28	18	74LS194	69	59
74LS38	35	25	74LS221	69	59
74LS42	49	39	74LS240	59	49
74LS47	85	75	74LS241	59	49
74LS73	39	29	74LS244	59	49
74LS74	35	25	74LS275	49	39
74LS75	39	29	74LS257	49	39
74LS76	39	29	74LS259	99	89
74LS83	55	45	74LS273	89	79
74LS85	55	45	74LS279	49	39
74LS86	29	19	74LS367	49	39
74LS90	49	39	74LS373	79	69
74LS93	39	29	74LS374	79	69
74LS123	49	39	74LS393	89	79
74LS125	49	39	74LS541	1.29	1.19
74LS132	49	39	74LS590	5.95	5.85
74LS138	49	39	74LS688	2.39	2.29

**74S/PROMS\***

Part No.	25	74S188*	1.49
74S00	25	74S188*	1.49
74S04	25	74S189	1.49
74S32	25	74S205	1.49
74S74	25	74S244	99
74S112	25	74S287	1.49
74S124	1.25	74S288*	1.49
74S138	49	74S378	1.49
74S153	15	74S374	1.49
74S163	75	74S371	1.29
74S174	15	74S472*	2.95
74S175	39	74S571*	2.49

**CD-CMOS**

Part No.	19	CD4051	59
CD4001	19	CD4051	59
CD4002	19	CD4052	59
CD4007	19	CD4053	59
CD4011	19	CD4060	65
CD4012	25	CD4066	29
CD4013	29	CD4069	25
CD4015	29	CD4070	29
CD4016	29	CD4071	19
CD4017	49	CD4072	19
CD4018	49	CD4073	19
CD4020	59	CD4081	19
CD4021	49	CD4093	35
CD4024	45	CD4094	89
CD4027	35	CD4503	39
CD4029	69	CD4511	59
CD4030	35	CD4518	75
CD4040	65	CD4520	69
CD4042	49	CD4528	75
CD4043	59	CD4538	69
CD4046	65	CD4543	79
CD4047	65	CD4584	69
CD4049	29	CD4585	69
CD4050	29		

**NEC V20 & V30 CHIPS**

Replace the 8086 or 8088 in Your IBM PC and Increase its Speed by up to 30% Price

Part No.	Function	Price
UPD70108-5	(5MHz) V20 Chip	5.25
UPD70108-8	(8MHz) V20 Chip	6.95
UPD70108-10	(10MHz) V20 Chip	10.95
UPD70116-8	(8MHz) V30 Chip	7.95
UPD70116-10	(10MHz) V30 Chip	13.49

**MICROPROCESSOR COMPONENTS**

Z80, Z80A, Z80B, SERIES		8000 SERIES Continued		8000 SERIES Continued	
Part No.	Price	Part No.	Price	Part No.	Price
Z80	1.25	8155-2	3.75	8241	2.29
Z80A	1.25	81C55	4.25	8246	9.49
Z80A-CTC	1.65	8205	9.95	8742	14.95
Z80A-DART	4.95	82C11	6.95	8748 (25V)	7.95
Z80A-PIO	1.89	82C12	1.99	8748H (HMOS) (21V)	9.95
Z80B	3.95	82C16	1.39	8749	3.95
Z80B-CTC	3.95	8224	1.49	8755	13.95
Z80B-PIO	3.95	8237-5	4.25	80286-10 (10MHz) Loc	29.95
Z8400HB1 CPU-8MHz	1.95	8243	1.95	80287-3 (5MHz)	109.95

**8000 SERIES**

8001	3.95	8250A	4.95
80C31	8.95	8251A (For IBM)	5.95
8005	1.25	8253	1.89
8039	1.59	8253-5	1.95
8052AHBASIC	24.95	82C53-5	5.95
8080A	1.95	8254	4.95
8085A	1.95	82C55A-5	4.49
8085A-2	3.59	8256	11.95
8086	5.95	8259-5	2.25
8087 (5MHz)	89.95	8272	3.49
8087-1 (10MHz)	169.95	8274	4.75
8087-2 (8MHz)	129.95	8275-5	2.95
8088 (5MHz)	4.95	8282	2.95
8088-2 (8MHz)	6.95	8284A	1.95
8155	2.49		

**STATIC RAMS**

Part No.	Function	Price
2016-12	2048x8 120ns	2.95
2102	1024x1 350ns	.89
2112	256x4 450ns MOS	2.49
2114N	1024x4 450ns	.99
2114N-2L	1024x4 200ns Low Power	1.49
21C14	1024x4 200ns (CMOS)	1.95
5101	256x4 450ns (CMOS)	1.95
8116P-1	2048x8 100ns (16K) CMOS	3.19
8116P-3	2048x8 150ns (16K) CMOS	2.79
8116LP-1	2048x8 100ns (16K) LP CMOS	3.59
8116LP-3	2048x8 150ns (16K) LP CMOS	3.09
8264P-10	8192x8 100ns (64K) CMOS	6.75
8264P-15	8192x8 150ns (64K) CMOS	4.95
8264LP-10	8192x8 100ns (64K) LP CMOS	6.49
8264LP-12	8192x8 120ns (64K) LP CMOS	6.49
8264LP-15	8192x8 150ns (64K) LP CMOS	4.95
6514	1024x4 350ns CMOS	3.25
43256-10L	32,768x8 100ns (256K) Low Power	10.95
43256-15L	32,768x8 150ns (256K) Low Power	9.95
82256LP-10	32,768x8 100ns (256K) LP CMOS	11.95
82256LP-12	32,768x8 120ns (256K) LP CMOS	11.25
82256LP-15	32,768x8 150ns (256K) LP CMOS	10.95

**DYNAMIC RAMS**

Part No.	Function	Price
TMS4416-12	16,384x4 120ns	3.95
TMS4416-15	16,384x4 150ns	3.75
4116-15	16,384x1 150ns (MM5290N-2)	1.09
4128-15	131,072x1 150ns (Piggyback)	4.49
4164-100	65,536x1 100ns	2.75
4164-120	65,536x1 120ns	2.39
4164-150	65,536x1 150ns	2.15
41256-60	262,144x1 60ns	5.25
41256-80	262,144x1 80ns	3.75
41256-100	262,144x1 100ns	3.15
41256-120	262,144x1 120ns	2.95
41256-150	262,144x1 150ns	2.59
41264-12	64Kx4 120ns Video RAM	10.95
41464-80	65,536x4 80ns	5.95
41464-120	65,536x4 120ns	3.95
41464-150	65,536x4 150ns	3.59
51258-10	262,144x1 100ns Static Column	8.95
511000P-80	1,048,576x1 80ns (1 Meg)	12.95
511000P-10	1,048,576x1 100ns (1 Meg)	12.35
514256P-10	262,144x4 100ns (1 Meg)	12.95
514256-10	262,144x4 100ns Static Column	26.95

**EPROMS**

Part No.	Function	Price
TMS2516	2048x8 450ns (25V)	4.95
TMS2532	4096x8 450ns (25V)	5.95
TMS2532A	4096x8 450ns (12.5V)	5.25
TMS2564	8192x8 450ns (25V)	6.95
TMS2716	2048x8 450ns (-5V, +5V, +12V)	6.49
1702A	256x8 2K (1µs)	4.25
2708	1024x8 450ns (25V)	6.95
2716	2048x8 450ns (25V)	3.49
2716A	2048x8 350ns (25V)	3.95
27C16	2048x8 450ns (25V) CMOS	4.25
2732	4096x8 450ns (25V)	3.95
2732A-20	4096x8 200ns (21V)	3.95
27C32	4096x8 450ns (25V) CMOS	4.25
2764-25	8192x8 250ns (21V)	3.95
2764A-25	8192x8 250ns (12.5V)	4.19
2784A-25	8192x8 250ns (12.5V)	4.49
27C64-15	8192x8 150ns (12.5V) CMOS	4.95
27128-20	16,384x8 200ns (21V)	5.95
27128-25	16,384x8 250ns (21V)	5.25
27128A-15	16,384x8 150ns (12.5V)	6.95
27128A-20	16,384x8 200ns (12.5V)	4.75
270128-25	16,384x8 250ns (21V) CMOS	5.95
27256-15	32,768x8 150ns (12.5V)	8.49
27256-20	32,768x8 200ns (12.5V)	5.49
27256-25	32,768x8 250ns (12.5V)	4.95
27C256-15	32,7	



# Now Available...Jameco's NEW Flyer 142 with 48 pages of Computer Peripherals & More!

## Oscilloscope Probes

Attenuation: x1 / x10  
Capacitance  
80): 180pF  
Impedance: (LF210):  
= / 17pF



80 40MHz Oscilloscope  
Probe ..... \$19.95  
10 100MHz Oscilloscope  
Probe ..... \$29.95

## TEST EQUIPMENT

**GS7020** 20MHz Oscilloscope  
1GHz Frequency Counter



GS7020 Oscilloscope.....\$399.95  
Large 6" rectangular display • High  
sensitivity: 1 mV/div  
GS7020 Oscilloscope.....\$399.95  
Wide measuring range • Measured  
data hold function  
GS7010 Frequency Counter \$299.95

## Metheus 9600 Baud Demodulator



9600 External 9600 Baud .... \$699.95  
9600 Internal 1200 Baud ..... \$49.95  
9600 Internal 2400 Baud ..... \$99.95

## Metex Digital Multimeters

**General Specs:**  
Handheld, high accuracy  
DC Voltage, AC/DC  
Current, Resistance, Diodes,  
Continuity, Transistor hFE  
Manual ranging w/overload  
protection



M4650  
M50, 3650B & M4650 only:  
to measure frequency and capacitance  
M50 only: • Data Hold Switch • 4.5 Digit

M50 3.5 Digit Multimeter .....\$49.95  
M50 3.5 Digit Multimeter w/Frequency &  
Capacitance.....\$69.95  
M50B Same as M3650 w/Bargraph.....\$74.95  
M50 4.5 Digit w/Frequency, Capacitance and  
Data Hold Switch.....\$99.95

## PROTOTYPING PRODUCTS

**Jameco Solderless Breadboards**



JE24  
JE27  
JE21  
JE23

Dim. L" x W"	Contact Points	Binding Posts	Price
21 3.25 x 2.125	400	0	\$4.95
23 6.5 x 2.125	830	0	\$6.95
24 6.5 x 3.125	1,360	2	\$12.95
25 6.5 x 4.25	1,660	3	\$17.95
26 6.875 x 5.75	2,390	4	\$22.95
27 7.25 x 7.5	3,220	4	\$32.95

## Prototype Design Stations

WM2

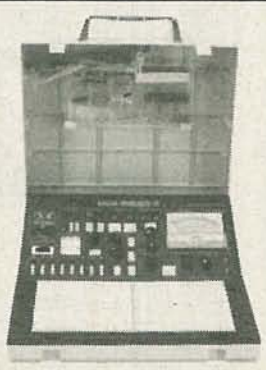

**WM1 & WM2 Features:** • Removable solderless breadboard • Variable and fixed DC power supply • Multi-frequency signal generator • Analog multimeter • 8 bicolor LEDs (red & green) • 8 logic switches • Logic probe • Lighted power switch • Fuse overload protected • Sturdy ruggedized case

**WM1 Special Features:** • 4 potentiometers • Built-in speaker

**WM2 Special Features:** • Pulse Generator • Binary coded decimal (BCD) to 7-segment decoder/driver • DB25 connector • Frequency counter (1Hz to 1MHz)

**WM1 Analog Prototype Station .... \$199.95**

**WM2 Digital Prototype Station .... \$249.95**

## IBM Compatible Cases and Power Supplies

JE2012



JE1030

JE1010 Flip-Top Standard PC/XT Case ..... \$39.95  
JE1011 Side Standard PC/XT Case ..... \$39.95  
JE1030 150 watt PC/XT Power Supply ..... \$59.95  
JE1032 200 watt Baby AT Power Supply ..... \$89.95  
JE1035 300 watt AT Power Supply ..... \$139.95  
JE2011 Vertical Case w/300W Pwr. Supply ..... \$249.95  
JE2012 Mini-Vertical Case w/200W Pwr. Supply ..... \$149.95  
JE2014 Flip-Top Baby XT Turbo Case ..... \$69.95  
JE2019 Flip-Top Baby AT Case ..... \$69.95

## EGA & Multiscan Monitor Packages

Casper 14" EGA monitor and EGA card package  
(720 x 350 max. resolution)

**JE1059 EGA Monitor & EGA Card ..... \$459.95**

Relisys 14" Multiscan monitor and EGA card  
package (800 x 600 max. resolution)

**JE2057 Multiscan Monitor & EGA Card ..... \$559.95**



## A.R.T. EPROM Programmer



• Programs all current EPROMs in the  
2716 to 27512 range plus the X2864  
EEPROM • RS232 port • Software incl.

**EPP ..... \$179.95**

## UVP EPROM Eraser



• Erases all EPROM's • Erases 1  
chip in 15 Min. and 8 chips in 21  
min. • UV intensity: 6800 UW/CM<sup>2</sup>

**DE4 ..... \$69.95**

## Soldering and Desoldering Stations

60 Watt Analog Display Soldering Station • Electronic temperature  
control from 200° to 878°F • Cartridge heating element for a  
longer life of the soldering tip

**XY1683 ..... \$59.95**

60 Watt Analog Display Soldering Station • Electronic temperature  
control from 200° to 878°F • Ceramic heating element for a  
steady temperature and long life

**XY2660 ..... \$89.95**

60 Watt Digital Display Soldering Station • Electronic temperature  
control from 200° to 878°F • Temperature displayed on easy  
to read .560"H 3-digit LED readout • Nichrome heating  
element

**XY960 ..... \$99.95**

30 Watt Electronic Temperature Controlled Desoldering Station  
• Electronic temperature control from 212° to 842°F • Self-  
contained high rotary vacuum pump

**XY999 ..... \$279.95**



## IBM PC/XT/AT Compatible Keyboards



JE2017

JE2015 84-Key Standard AT Style  
Layout ..... \$59.95  
FKB4700 101-Key Enhanced Layout  
with 12 Function Keys ..... \$69.95  
JE2016 111-Key Enhanced with Solar  
Powered Calculator ..... \$79.95  
JE2017 104-Key Enhanced with Trackball  
(Microsoft Compatible) .... \$99.95

## 3.5" and 5.25" Floppy Disk Drives

MPF11 Pictured

**Sony**  
MPF11 3.5" 720Kb Internal Drive .... \$49.95  
SMK 5.25" Installation Kit w/Faceplate .. \$14.95

**TEAC**

FD55B 5.25" 360Kb Half Ht. .... \$89.95  
FD55G 5.25" 1.2Mb Half Ht. .... \$99.95

**Mitsubishi**

MF353B 3.5" 720Kb Half Height .... \$99.95  
MF355B 3.5" 1.44Mb Half Height \$119.95

## Hard & Hard/Floppy Disk Controller Cards

Computer Type	MFM Hard		RLI Hard		MFM Hard/Floppy		RLI Hard/Floppy	
	Part No. / Price	Part No. / Price	Part No. / Price	Part No. / Price	Part No. / Price	Part No. / Price	Part No. / Price	
8088 (PC/XT) @ 3:1 Interleave	XTGEN \$79.95	1004A27X \$89.95	JE1044 \$109.95					
80286 (AT) @ 2:1 Interleave	1003VMM1 \$129.95	1003VSR1 \$149.95	1003VMM2 \$149.95	1003VSR2 \$169.95				
80286 (AT) @ 1:1 Interleave	1005VMM1 \$149.95	1005VSR1 \$169.95	1005VMM2 \$169.95	1005VSR2 \$189.95				

5 Shoreway Road  
Fremont, CA 94002  
Hour Order Hotline (415) 592-8097  
Fax (415) 592-2503 or (415) 595-2664  
Fax 176043 - Ans. Back: Jameco Blmt  
50c each  
Add \$2.00 Postage for a FREE 80-Page Catalog  
990 Jameco Electronics 5/90  
is a registered trademark of  
National Business Machines



Mail Order Electronics - Worldwide®  
**Jameco  
ELECTRONICS**



\$50.00 Minimum Order - U.S. Funds Only  
CA Residents Add 6%, 6.5% or 7% Sales Tax  
Shipping - Add 5% plus \$1.50 Insurance  
(May vary according to weight and shipping method)  
Terms: Prices subject to change without notice.  
We are not responsible for typographical errors.  
We reserve the right to substitute manufacturers.  
Items subject to availability and prior sale.  
Products pictured may only be representative.  
Complete list of terms/warranties is available upon request.

24-Hour Order Hotline (415) 592-8097 • The Following Services Are Also Available Through (415) 592-8097 From 7AM - 5PM P.S.T.:

• Customer Service • Technical Assistance • Credit Department • All Other Inquiries



# Hi-Key CORPORATION

## 1-800-344-4539

AK, Puerto Rico - 218-681-6674 FAX - 218-681-3380 TWX - 9103508982 DIGI KEY CORP

### INTEGRATED CIRCUITS

Part	Price	Part	Price	Part	Price	Part	Price
7400 TTL	74LS258N 88	74LS259N 88	74LS260N 88	74LS261N 88	74LS262N 88	74LS263N 88	74LS264N 88
7400N 35	74LS265N 88	74LS266N 88	74LS267N 88	74LS268N 88	74LS269N 88	74LS270N 88	74LS271N 88
7400N 35	74LS272N 88	74LS273N 88	74LS274N 88	74LS275N 88	74LS276N 88	74LS277N 88	74LS278N 88
7400N 35	74LS279N 88	74LS280N 88	74LS281N 88	74LS282N 88	74LS283N 88	74LS284N 88	74LS285N 88
7400N 35	74LS286N 88	74LS287N 88	74LS288N 88	74LS289N 88	74LS290N 88	74LS291N 88	74LS292N 88
7400N 35	74LS293N 88	74LS294N 88	74LS295N 88	74LS296N 88	74LS297N 88	74LS298N 88	74LS299N 88
7400N 35	74LS300N 88	74LS301N 88	74LS302N 88	74LS303N 88	74LS304N 88	74LS305N 88	74LS306N 88
7400N 35	74LS307N 88	74LS308N 88	74LS309N 88	74LS310N 88	74LS311N 88	74LS312N 88	74LS313N 88
7400N 35	74LS314N 88	74LS315N 88	74LS316N 88	74LS317N 88	74LS318N 88	74LS319N 88	74LS320N 88
7400N 35	74LS321N 88	74LS322N 88	74LS323N 88	74LS324N 88	74LS325N 88	74LS326N 88	74LS327N 88
7400N 35	74LS328N 88	74LS329N 88	74LS330N 88	74LS331N 88	74LS332N 88	74LS333N 88	74LS334N 88
7400N 35	74LS335N 88	74LS336N 88	74LS337N 88	74LS338N 88	74LS339N 88	74LS340N 88	74LS341N 88
7400N 35	74LS342N 88	74LS343N 88	74LS344N 88	74LS345N 88	74LS346N 88	74LS347N 88	74LS348N 88
7400N 35	74LS349N 88	74LS350N 88	74LS351N 88	74LS352N 88	74LS353N 88	74LS354N 88	74LS355N 88
7400N 35	74LS356N 88	74LS357N 88	74LS358N 88	74LS359N 88	74LS360N 88	74LS361N 88	74LS362N 88
7400N 35	74LS363N 88	74LS364N 88	74LS365N 88	74LS366N 88	74LS367N 88	74LS368N 88	74LS369N 88
7400N 35	74LS370N 88	74LS371N 88	74LS372N 88	74LS373N 88	74LS374N 88	74LS375N 88	74LS376N 88
7400N 35	74LS377N 88	74LS378N 88	74LS379N 88	74LS380N 88	74LS381N 88	74LS382N 88	74LS383N 88
7400N 35	74LS384N 88	74LS385N 88	74LS386N 88	74LS387N 88	74LS388N 88	74LS389N 88	74LS390N 88
7400N 35	74LS391N 88	74LS392N 88	74LS393N 88	74LS394N 88	74LS395N 88	74LS396N 88	74LS397N 88
7400N 35	74LS398N 88	74LS399N 88	74LS400N 88	74LS401N 88	74LS402N 88	74LS403N 88	74LS404N 88
7400N 35	74LS405N 88	74LS406N 88	74LS407N 88	74LS408N 88	74LS409N 88	74LS410N 88	74LS411N 88
7400N 35	74LS412N 88	74LS413N 88	74LS414N 88	74LS415N 88	74LS416N 88	74LS417N 88	74LS418N 88
7400N 35	74LS419N 88	74LS420N 88	74LS421N 88	74LS422N 88	74LS423N 88	74LS424N 88	74LS425N 88
7400N 35	74LS426N 88	74LS427N 88	74LS428N 88	74LS429N 88	74LS430N 88	74LS431N 88	74LS432N 88
7400N 35	74LS433N 88	74LS434N 88	74LS435N 88	74LS436N 88	74LS437N 88	74LS438N 88	74LS439N 88
7400N 35	74LS440N 88	74LS441N 88	74LS442N 88	74LS443N 88	74LS444N 88	74LS445N 88	74LS446N 88
7400N 35	74LS447N 88	74LS448N 88	74LS449N 88	74LS450N 88	74LS451N 88	74LS452N 88	74LS453N 88
7400N 35	74LS454N 88	74LS455N 88	74LS456N 88	74LS457N 88	74LS458N 88	74LS459N 88	74LS460N 88
7400N 35	74LS461N 88	74LS462N 88	74LS463N 88	74LS464N 88	74LS465N 88	74LS466N 88	74LS467N 88
7400N 35	74LS468N 88	74LS469N 88	74LS470N 88	74LS471N 88	74LS472N 88	74LS473N 88	74LS474N 88
7400N 35	74LS475N 88	74LS476N 88	74LS477N 88	74LS478N 88	74LS479N 88	74LS480N 88	74LS481N 88
7400N 35	74LS482N 88	74LS483N 88	74LS484N 88	74LS485N 88	74LS486N 88	74LS487N 88	74LS488N 88
7400N 35	74LS489N 88	74LS490N 88	74LS491N 88	74LS492N 88	74LS493N 88	74LS494N 88	74LS495N 88
7400N 35	74LS496N 88	74LS497N 88	74LS498N 88	74LS499N 88	74LS500N 88	74LS501N 88	74LS502N 88
7400N 35	74LS503N 88	74LS504N 88	74LS505N 88	74LS506N 88	74LS507N 88	74LS508N 88	74LS509N 88
7400N 35	74LS510N 88	74LS511N 88	74LS512N 88	74LS513N 88	74LS514N 88	74LS515N 88	74LS516N 88
7400N 35	74LS517N 88	74LS518N 88	74LS519N 88	74LS520N 88	74LS521N 88	74LS522N 88	74LS523N 88
7400N 35	74LS524N 88	74LS525N 88	74LS526N 88	74LS527N 88	74LS528N 88	74LS529N 88	74LS530N 88
7400N 35	74LS531N 88	74LS532N 88	74LS533N 88	74LS534N 88	74LS535N 88	74LS536N 88	74LS537N 88
7400N 35	74LS538N 88	74LS539N 88	74LS540N 88	74LS541N 88	74LS542N 88	74LS543N 88	74LS544N 88
7400N 35	74LS545N 88	74LS546N 88	74LS547N 88	74LS548N 88	74LS549N 88	74LS550N 88	74LS551N 88
7400N 35	74LS552N 88	74LS553N 88	74LS554N 88	74LS555N 88	74LS556N 88	74LS557N 88	74LS558N 88
7400N 35	74LS559N 88	74LS560N 88	74LS561N 88	74LS562N 88	74LS563N 88	74LS564N 88	74LS565N 88
7400N 35	74LS566N 88	74LS567N 88	74LS568N 88	74LS569N 88	74LS570N 88	74LS571N 88	74LS572N 88
7400N 35	74LS573N 88	74LS574N 88	74LS575N 88	74LS576N 88	74LS577N 88	74LS578N 88	74LS579N 88
7400N 35	74LS580N 88	74LS581N 88	74LS582N 88	74LS583N 88	74LS584N 88	74LS585N 88	74LS586N 88
7400N 35	74LS587N 88	74LS588N 88	74LS589N 88	74LS590N 88	74LS591N 88	74LS592N 88	74LS593N 88
7400N 35	74LS594N 88	74LS595N 88	74LS596N 88	74LS597N 88	74LS598N 88	74LS599N 88	74LS600N 88
7400N 35	74LS601N 88	74LS602N 88	74LS603N 88	74LS604N 88	74LS605N 88	74LS606N 88	74LS607N 88
7400N 35	74LS608N 88	74LS609N 88	74LS610N 88	74LS611N 88	74LS612N 88	74LS613N 88	74LS614N 88
7400N 35	74LS615N 88	74LS616N 88	74LS617N 88	74LS618N 88	74LS619N 88	74LS620N 88	74LS621N 88
7400N 35	74LS622N 88	74LS623N 88	74LS624N 88	74LS625N 88	74LS626N 88	74LS627N 88	74LS628N 88
7400N 35	74LS629N 88	74LS630N 88	74LS631N 88	74LS632N 88	74LS633N 88	74LS634N 88	74LS635N 88
7400N 35	74LS636N 88	74LS637N 88	74LS638N 88	74LS639N 88	74LS640N 88	74LS641N 88	74LS642N 88
7400N 35	74LS643N 88	74LS644N 88	74LS645N 88	74LS646N 88	74LS647N 88	74LS648N 88	74LS649N 88
7400N 35	74LS650N 88	74LS651N 88	74LS652N 88	74LS653N 88	74LS654N 88	74LS655N 88	74LS656N 88
7400N 35	74LS657N 88	74LS658N 88	74LS659N 88	74LS660N 88	74LS661N 88	74LS662N 88	74LS663N 88
7400N 35	74LS664N 88	74LS665N 88	74LS666N 88	74LS667N 88	74LS668N 88	74LS669N 88	74LS670N 88
7400N 35	74LS671N 88	74LS672N 88	74LS673N 88	74LS674N 88	74LS675N 88	74LS676N 88	74LS677N 88
7400N 35	74LS678N 88	74LS679N 88	74LS680N 88	74LS681N 88	74LS682N 88	74LS683N 88	74LS684N 88
7400N 35	74LS685N 88	74LS686N 88	74LS687N 88	74LS688N 88	74LS689N 88	74LS690N 88	74LS691N 88
7400N 35	74LS692N 88	74LS693N 88	74LS694N 88	74LS695N 88	74LS696N 88	74LS697N 88	74LS698N 88
7400N 35	74LS699N 88	74LS700N 88	74LS701N 88	74LS702N 88	74LS703N 88	74LS704N 88	74LS705N 88
7400N 35	74LS706N 88	74LS707N 88	74LS708N 88	74LS709N 88	74LS710N 88	74LS711N 88	74LS712N 88
7400N 35	74LS713N 88	74LS714N 88	74LS715N 88	74LS716N 88	74LS717N 88	74LS718N 88	74LS719N 88
7400N 35	74LS720N 88	74LS721N 88	74LS722N 88	74LS723N 88	74LS724N 88	74LS725N 88	74LS726N 88
7400N 35	74LS727N 88	74LS728N 88	74LS729N 88	74LS730N 88	74LS731N 88	74LS732N 88	74LS733N 88
7400N 35	74LS734N 88	74LS735N 88	74LS736N 88	74LS737N 88	74LS738N 88	74LS739N 88	74LS740N 88
7400N 35	74LS741N 88	74LS742N 88	74LS743N 88	74LS744N 88	74LS745N 88	74LS746N 88	74LS747N 88
7400N 35	74LS748N 88	74LS749N 88	74LS750N 88	74LS751N 88	74LS752N 88	74LS753N 88	74LS754N 88
7400N 35	74LS755N 88	74LS756N 88	74LS757N 88	74LS758N 88	74LS759N 88	74LS760N 88	74LS761N 88
7400N 35	74LS762N 88	74LS763N 88	74LS764N 88	74LS765N 88	74LS766N 88	74LS767N 88	74LS768N 88
7400N 35	74LS769N 88	74LS770N 88	74LS771N 88	74LS772N 88	74LS773N 88	74LS774N 88	74LS775N 88
7400N 35	74LS776N 88	74LS777N 88	74LS778N 88	74LS779N 88	74LS780N 88	74LS781N 88	74LS782N 88
7400N 35	74LS783N 88	74LS784N 88	74LS785N 88	74LS786N 88	74LS787N 88	74LS788N 88	74LS789N 88
7400N 35	74LS790N 88	74LS791N 88	74LS792N 88	74LS793N 88	74LS794N 88	74LS795N 88	74LS796N 88
7400N 35	74LS797N 88	74LS798N 88	74LS799N 88	74LS800N 88	74LS801N 88	74LS802N 88	74LS803N 88
7400N 35	74LS804N 88	74LS805N 88	74LS806N 88	74LS807N 88	74LS808N 88	74LS809N 88	74LS810N 88
7400N 35	74LS811N 88	74LS812N 88	74LS813N 88	74LS814N 88	74LS815N 88	74LS816N 88	74LS817N 88
7400N 35	74LS818N 88	74LS819N 88	74LS820N 88	74LS821N 88	74LS822N 88	74LS823N 88	74LS824N 88
7400N 35	74LS825N 88	74LS826N 88	74LS827N 88	74LS828N 88	74LS829N 88	74LS830N 88	74LS831N 88
7400N 35	74LS832N 88	74LS833N 88	74LS834N 88	74LS835N 88	74LS836N 88	74LS837N 88	74LS838N 88
7400N 35	74LS839N 88	74LS840N 88	74LS841N 88	74LS842N 88	74LS843N 88	74LS844N 88	74LS845N 88
7400N 35	74LS846N 88	74LS847N 88	74LS848N 88	74LS849N 88	74LS850N 88	74LS851N 88	74LS852N 88
7400N 35	74LS853N 88	74LS854N 88	74LS855N 88	74LS856N 88	74LS857N 88	74LS858N 88	74LS859N 88
7400N 35	74LS860N 88	74LS861N 88	74LS862N 88	74LS863N 88	74LS864N 88	74LS865N 88	74LS866N 88
7400N 35	74LS867N 88	74LS868N 88	74LS869N 88	74LS870N 88	74LS871N 88	74LS872N 88	74LS873N 88
7400N 35	74LS874N 88	74LS875N 88	74LS876N 88	74LS877N 88	74LS878N 88	74LS879N 88	74LS880N 88
7400N 35	74LS881N 88	74LS882N 88	74LS883N 88	74LS884N 88	74LS885N 88	74LS886N 88	74LS887N 88
7400N 35	74LS888N 88	74LS889N 88	74LS890N 88	74LS891N 88	74LS892N 88	74LS893N 88	74LS894N 88
7							



★QUALITY PARTS ★DISCOUNT PRICES ★FAST SHIPPING

# ALL ELECTRONICS CORP.

## THUMBWHEEL SWITCH

1 pole 10 position decimal encoded switches which interlock to make up desired number or digits. Terminates to 11 pc pins (1 common and 10 poles). Each section measures .31" wide X .20" high X .78" deep. End plates can be added to form a .94" high bezel.

**CAT# SWTH-9 \$1.25 each**  
10 for \$10.00

**END PLATES - CAT# SW-9EC**  
\$1.00 per set

## 0 - 6 HOUR AUTO SHUT-OFF TIMER

M.H. Rhodes, Inc. Mark-Time# 90007

Wall-box timer fits standard 3" deep wall box. Rated 20 amps @ 125 Vac. Turn knob to desired time. Includes hardware, beige wall plate, and knob. UL and CSA listed.

**CAT# TMC-6 \$5.75 each**

## INSTRUMENT ENCLOSURES

High quality molded ABS instrument enclosures. Integrated PC board standoffs and two sets of vertical mounting slots for front and rear sub panels. All enclosures are 6" wide X 6 1/4" deep. Choice of three heights. Includes non-skid rubber feet and hardware. Available in beige, ivory, black, and blue.

Panel ht. CAT# 1-9 10-99

2 1/4" CAT# MB-A \$7.50 each 10 for \$65.00  
2 5/8" CAT# MB-B \$7.75 each 10 for \$65.00  
3" CAT# MB-C \$8.00 each 10 for \$70.00

Please specify color.

## RECHARGEABLE BATTERY PACK (USED)

Four AA nickel cadmium batteries connected in series to make a 4.8 volt pack. Batteries are in a 2 X 2 configuration with a 2 pin connector attached. The four batteries can be separated into single AA size solder tab nickel cadmium batteries or resoldered into other configurations.

**SPECIAL SALE PRICE NOW**  
\$3.00 per pack • 10 packs for \$25.00

**CAT# NCB-41AAU**

## TIL-99 PHOTO TRANSISTOR

TO-18 case with window. For wide-angle viewing applications. Spectrally and mechanically compatible with TIL-31B.

**CAT# TIL-99 \$1.00 each • 10 for \$9.00**

## TIL-31B PHOTO DIODE

TO-18 case with window. Infrared emitting photo diode.

**CAT# TIL-31B \$1.00 ea. • 10 for \$9.50**

## SWITCHES

### ITT PUSH BUTTON

ITT MDPL series. 3/4" X 1/2" grey rectangular key cap. S.P.S.T. N.O.

Push to close. RATED: 0.1 amp switching, 0.25 amp carry current. P.C. mount.

**CAT# PB-8 65¢ each • 10 for \$6.00**  
100 for \$50.00

### SPDT PUSHBUTTON

Marquardt# 1843

Rated 6 amps @ 125/250 Vac. Black plastic pushbutton. Switch body: .92" X .94" X .65".

**CAT# PB-18 \$1.65 ea. • 10 for \$15.00**

### PUSHBUTTON SWITCH

GC/Thomson# 35-420

S.P.S.T. normally open momentary pushbutton switch. Red plastic actuator 0.57" diameter. Chrome bezel 0.68" diameter. Threaded bushing mounts in .50" diameter hole. Rated 3 amp @ 250Vac. Solder loop terminals.

**CAT# PB-20 \$1.00 each**

## WALL TRANSFORMERS

ALL PLUG DIRECTLY INTO 120 VAC OUTLET

12 Vdc @ 500 ma. **CAT# DCTX-125 \$4.50**  
6 Vdc @ 200 ma. **CAT# DCTX-420 \$2.25**  
9 Vdc @ 1 amp. **CAT# DCTX-461 \$5.00**  
24 Vdc @ 625 ma. **CAT# ACTX-2482 \$3.25**

## SERVO MOTOR

3 Vdc servo with potentiometer. Ideal for robotics or remote control model experimentation. Rotates approx. 140 degrees. Pot connected to motor varies from either 500 to 3000 ohms. 1.53" X 0.95" X 1.65". 0.87" diameter rubber wheel attached to motor shaft can be used as a capstan or can be easily removed. Prepped with capacitors, chokes and wire leads.

**CAT# SVO-2 2 for \$1.00**

## NICKEL-CAD BATTERIES (RECHARGEABLE)

AAA SIZE \$1.50 each  
1.2 volts 180 mAh  
**CAT# NCB-AAA**

AA SIZE \$2.00 each  
1.25 volts 500 mAh  
**CAT# NCB-AA**

AA SIZE \$2.20 each  
WITH SOLDER TABS  
**CAT# NCB-SAA**

C SIZE \$4.25 each  
1.2 volts 1200 mAh  
**CAT# NCB-C**

D SIZE \$4.50 each  
1.2 volts 1200 mAh  
**CAT# NCB-D**

## XENON TUBE

1" long flashtube with 3 1/2" red and black leads. Ideal for electronic flash or strobe projects.

**CAT# FLT-3 2 for \$1.00**

## RELAYS

5-VDC SIP REED RELAY

Electrol "Blue Boy" BBS1A05A10

5-6 Vdc, 500 ohm coil. S.P.S.T. normally open reed relay. 0.5 amp contacts. SIP configuration. 1" X .375" X .3".

**CAT# RRLY-SIPS \$1.10 each • 10 for \$10.00**

5 VDC LATCHING RELAY

Aromat# RSL2D-5V

Miniature SPDT, dual coil latching relay. 5 Vdc, 170 ohm coils. 1 amp. TTL compatible. UL and CSA recognized. 0.78" X 0.394" X 0.394"

**CAT# RLRY-5DC \$2.50 each**

12 VOLT D.C. COIL S.P.D.T.

Orrmont# G2E-184P

4 amp contacts. 335 ohm coil. Sugar cube size. .61" X .42" X .44" high. P.C. mount with pins on DIP spacing.

**CAT# RLY-787 \$1.50 each**

## LED CHASER KIT

Build this variable speed led chaser. 10 leds flash sequentially at whatever speed you set them for. Easy to build kit includes pc board, parts and instructions. Ideal for special lighting effects, costumes, etc. Operates on 3 to 9 volts. PC board is 5" X 2.25". A great one hour project.

**CAT# AEC \$6.50 each**

## SPECIAL PURCHASE 210 MFD 330 V PHOTOFLASH CAPACITOR

Rubicon CE photoflash capacitor. 0.79" dia. X 1.1" high. These are new capacitors that have been prepped with 1.4" black and red wire leads soldered to the terminals.

**CAT# PPC-210 \$2.50 each**  
10 for \$22.50 • 100 for \$200.00

## 22/44 PIN CONNECTOR

.156" pin spacing, 0.200" between double rows, gold contacts, P.C. mounting.

**SPECIAL Same as AMP# 2-530655-6. CAT# EBC-1G \$1.00 each • 10 for \$8.00**

## ELECTRONIC GAME BOARD

The inner workings of an electronic Scrabble game. Operates on 6 Vdc. 8 digit alpha-numeric readout, 45 button keypad, 14 transistors, 2 I.C.'s, 1 piezo element and other goodies. Top and bottom row of keypad buttons are function keys, middle 3 rows are alphabetic. No instructions available. 6" X 4.45".

**CAT# ST-4 \$1.75 each 10 for \$15.00**

## TELEPHONE COUPLING TRANSFORMER

Multi Products International# A19N-HD-1D/1

Primary: 600 ohm  
Secondary: 600/600 ohm  
0.77" X 0.61" X 0.63" high.  
6 p.c. pins on 0.187" centers.  
Primary inductance: 300 mH min., at 1kHz, 1 volt.

**CAT# CTX-1 \$1.25 each • 10 for \$11.00**

## LED'S

STANDARD JUMBO DIFFUSED T 1-3/4 size

**RED CAT# LED-1**  
10 for \$1.50 • 100 for \$13.00

**GREEN CAT# LED-2**  
10 for \$2.00 • 100 for \$17.00

**YELLOW CAT# LED-3**  
10 for \$2.00 • 100 for \$17.00

FLASHING LED

with built in flashing circuit operates on 5 volts...

**RED CAT# LED-4** 10 for \$9.50  
**GREEN CAT# LED-5** 10 for \$9.50  
**CAT# LED-4G** 10 for \$9.50

BI-POLAR LED

Lights RED one direction, GREEN the other. Two leads.

**CAT# LED-6 2 for \$1.70**

LED HOLDER

Two piece holder.

**CAT# HLED 10 for 65¢**

## 10 AMP SOLID STATE RELAY

ELECTROL# S2178

CONTROL: Rated 5.5 to 10 Vdc (will operate on 3-32 Vdc). LOAD: 10 amp @ 240 Vac

2 1/4" X 1 3/4" X 7/8".

**CAT# SSRLY-10B \$9.50 ea.**

QUANTITY DISCOUNT  
10 for \$85.00 • 25 for \$175.00  
50 for \$300.00 • 100 for \$500.00

## OPTO SENSOR

U shaped package with mounting ears. 1/8" opening. 3/4" mounting ears.

**CAT# OSU-8 50¢ each**  
10 for \$4.50 • 100 for \$40.00

## A.C. LINE CORDS

Black 6ft., 182, SPT-2

**NON POLARIZED PLUG CAT# LCAC 2 for \$1.00**  
100 for \$45.00

**POLARIZED PLUG CAT# LCP-1 60¢ each**  
100 for \$50.00

## L.E.D. FLASHER KIT

Two L.E.D.'s flash in unison when a 9 volt battery is attached. This kit includes a p.c. board, all the parts and instructions to make a simple flasher circuit. A quick and easy project for anyone with basic soldering skills.

**CAT# LEDKIT \$1.75 per kit**

## LOOK WHAT \$1.00 WILL BUY

200 ASSORTED 1/4 WATT RESISTORS  
Bent leads, carbon comp. and carbon film.  
**CAT# GRES \$1.00 per assortment**

200 ASSORTED 1/2 WATT RESISTORS  
Bent leads, carbon comp. and film.  
**CAT# GRABRE \$1.00 per assortment**

50 ASSORTED DISC CAPACITORS  
Most are cut (p.c. leads). Some to 500 volts.  
**CAT# GRABDC \$1.00 per assortment**

15 VALUES OF ELECTROLYTICS  
Contains both axial and radial styles from 1 mfd.  
**CAT# GRABCP \$1.00 per assortment**

## LOOK WHAT \$2.00 WILL BUY

15 AMP SNAP-ACTION SWITCH  
5 pieces of a 15 amp 125-250 Vac normally open switch. Body is 1 3/4" X 5/8" X 5/8". Button extends 3/16" above switch body.  
**CAT# GRABMS \$2.00 per package**

TO-92 TRANSISTORS  
20 assorted TO-92 plastic case transistors. Various styles of NPN and PNP. Some house marked, some standard marking.  
**CAT# GRTRN \$2.00 per assortment**

SWITCHES  
10 assorted slide, toggle, rotary, pushbutton and rocker switches. Our choice.  
**CAT# GRABSW \$2.00 per assortment**

CALL OR WRITE FOR OUR FREE 60 PAGE CATALOG OVER 4000 PARTS!



OUTSIDE THE U.S.A. SEND \$2.00 POSTAGE FOR A CATALOG!!

ORDER TOLL FREE 1-800-826-5432

MAIL ORDERS TO:  
ALL ELECTRONICS  
P.O. BOX 567  
VAN NUYS, CA 91408

INFO: (818)904-0524  
FAX: (818)781-2653  
MINIMUM ORDER \$10.00  
QUANTITIES LIMITED  
CALIF. ADD SALES TAX  
USA: \$3.50 SHIPPING  
FOREIGN ORDERS  
INCLUDE SUFFICIENT SHIPPING. NO C.O.D.



MAY 1990



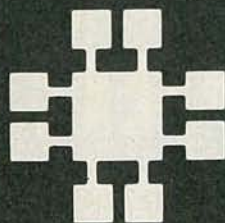

# JDR Microdevices

**MMC**  
MICROCOMPUTER  
MARKETING COUNCIL  
of the Direct Marketing Association, Inc.

30 DAY MONEY BACK GUARANTEE • 1 YEAR WARRANTY ON ALL PRODUCTS • TOLL-FREE TECHNICAL SUPPORT

## DYNAMIC RAMS

PART#	SIZE	SPEED	PINS	PRICE
4164-150	65536x1	150ns	16	2.49
4164-120	65536x1	120ns	16	2.89
4164-100	65536x1	100ns	16	3.39
TMS4464-15	65536x4	150ns	16	3.59
TMS4464-12	65536x4	120ns	16	3.95
TMS4464-10	65536x4	100ns	16	4.95
41256-150	262144x1	150ns	16	2.59
41256-120	262144x1	120ns	16	2.95
41256-100	262144x1	100ns	16	3.15
41256-80	262144x1	80ns	16	3.75
41256-60	262144x1	60ns	16	5.25
41256-100	262144x4	100ns	20	12.95
41256-80	262144x4	80ns	20	13.45
1 MB-120	1048576x1	120ns	18	11.95
1 MB-100	1048576x1	100ns	18	12.35
1 MB-80	1048576x1	80ns	18	12.95

## SIMM/SIP MODULES

PART#	SIZE	SPEED	TYPE	PRICE
41256A9B-12	256K x 9	120ns	SIMM/PC	36.95
41256A9B-80	256K x 9	80ns	SIMM/PC	49.95
421000A9B-10	1MB x 8	100ns	SIMM/MAC	109.95
421000A9B-10	1MB x 9	100ns	SIMM/PC	113.95
421000A9B-80	1MB x 9	80ns	SIMM/PC	119.95
256KX9SIP-80	256K x 9	80ns	SIP/PC	54.95
256KX9SIP-60	256K x 9	60ns	SIP/PC	64.95
1MBX9SIP-80	1MB x 9	80ns	SIP/PC	124.95

## STATIC RAMS

PART#	SIZE	SPEED	PINS	PRICE
HM6116LP-2	2048x8	120ns	24	5.49
HM6264LP-15	8192x8	150ns	28	4.95
HM6264LP-12	8192x8	120ns	28	6.49
HM43256LP-12	32768x8	120ns	28	14.95
HM43256LP-10	32768x8	100ns	28	15.95

## MATH COPROCESSORS

### 8-BIT COPROCESSORS

8087	5 MHz	89.95
8087-2	8 MHz	129.95
8087-1	10 MHz	169.95

### 16-BIT COPROCESSORS

80287	6 MHz	139.95
80287-8	8 MHz	209.95
80287-10	10 MHz	239.95
80C287	12 MHz	299.95

### 32-BIT COPROCESSORS

80387-16	16 MHz	359.95
80387-SX	16 MHz	319.95
80387-20	20 MHz	399.95
80387-25	25 MHz	499.95
80387-33	33MHz	649.00

**intel** 5 YEAR WARRANTY



INCLUDES MANUAL & SOFTWARE GUIDE

## 74 SERIES LOGIC

7400	.19	74LS32	.18	74LS245	.79
74LS00	.16	74LS73	.29	74LS273	.79
74LS02	.17	7474	.33	74S288	1.69
7404	.19	74LS74	.24	74LS322	3.95
74LS04	.16	74S74	.49	74LS367	.39
74S04	.29	74LS38	.39	74LS373	.79
7406	.29	74LS155	.59	74LS374	.79
7408	.24	74LS163	.39	74LS393	.79
74LS08	.18	74LS240	.69	74LS682	3.20
7432	.29	74LS244	.69	74LS688	2.40

## C.P.U.'s

### 8000

8052AH	34.95
BASIC	34.95
8088	5.99
8250	6.95
8251A	1.69
8253-5	1.95
8254	9.95
8255-5	2.49
8741	9.95
8748	7.95
8749	9.95
8755	14.95

### 6500

65C02*	7.95
6522	2.95

### V-20

V20	6.95
V20-8	8.95
V20-10	11.95
V30	13.95

## MISC

### DAC0800

DAC0800	3.29
1793	9.95
COM8116	8.95
MC146818	5.95
MM58167	9.95
INS8250	6.95
NS16450	10.95
LM317T	.69
NE555	.29
LM741	.29
7805T	.49
7812T	.49
75150	1.95
75154	1.95
14411	9.95

### CRYSTAL OSCILLATORS

1.0MHz	5.95
1.8432	5.95
20.0	4.95
24.0	4.95

## PALS

### 16L8

16L8	2.95
16R4	2.95
16R6	2.95
16R8	2.95
20L8	4.95
20R4A	4.95
20R6	4.95
20R8	4.95
20X8	4.95

## PAL KIT

### AN ENTRY-LEVEL PAL DEVELOPMENT KIT FROM CUPL, FULL SUPPORT FOR

16L8, 16R4, 16R6, 16R8, 20L8, 20R4, 20R6, 20R8, AND 20X8.  
MOD-MPL-SOFT \$99.95



## Derick's HIGH-TECH SPOTLIGHT

Call our BBS: (408) 559-0253 for more info in SIG file "Hitech"

For some time now JDR, and nearly all the computer industry, have listed Norton SI and Landmark benchmark figures in their advertisements. One of the first things I look at when comparing computers is their benchmark ratings.

As relative measures of speed between various systems, these ratings will generally tell you which is the fastest, but they can mislead and hide information if the buyer doesn't pay close attention to the complete system.

The rating numbers only indicate the amount of work that the processor is able to do in a period of time. Because the program that tests for speed is very small, it is unable to evaluate the systems response in many real world situations.

Just as you would select speakers rated compatible with your stereo amplifier, matching a computer system's components to each other and to the job to be performed is the key.

So compare speed ratings, and look for these features:

- Memory Type: 1MB RAM is more cost effective than 256K RAM
- Interleaving: Interleaved memory runs faster with fewer wait states
- Memory Cache: Bigger is better, but more expensive
- Cache Design: 4-way set associative is better than 2-way, which is better than direct mapped

Derick Moore, Director of Engineering

## EPROMS

PART#	SIZE	SPEED	Vpp	PINS	PRICE
2716-1	2048x8	350ns	25V	24	3.95
2732A	4096x8	250ns	21V	24	3.95
2764	8192x8	450ns	12.5V	28	3.49
2764-250	8192x8	250ns	12.5V	28	3.69
2764-200	8192x8	200ns	12.5V	28	4.25
27C64	8192x8	250ns	12.5V	28	4.95
27128	16384x8	250ns	12.5V	28	4.25
27128A-200	16384x8	200ns	12.5V	28	5.95
27256	32768x8	250ns	12.5V	28	4.95
27256-200	32768x8	200ns	12.5V	28	5.95
27C256	32768x8	250ns	12.5V	28	5.95
27512	65536x8	250ns	12.5V	28	7.95
27C512	65536x8	250ns	12.5V	28	8.95
27C101-20	131072x8	200ns	12.5V	32	24.95

## EPROM ERASERS

**DATABASE II \$39.95**  
• SHIRT POCKET SIZE!  
• ALL SIZES UP TO 4 AT A TIME  
• ERASES MOST EPROMS IN 3 MINUTES

### DATABASE II

Model	Timer	# of Chips	Intensity (uW/Cm <sup>2</sup> )	Unit Cost
PE-140	NO	9	8,000	\$89.95
PE-140T	YES	9	8,000	\$139.95
PE-240T	YES	12	9,600	\$189.95
PL-265T	YES	30	9,600	\$255.95



## POWER SUPPLIES

### 135 WATT FOR 8088

- 110-220V SWITCH • UL APPRVD.
- +5V @ 15A, +12V @ 4.2A, -5V @ 5A, -12V @ 5A
- PS-135 ..... \$59.95
- PS-150 150W (8088) ..... \$69.95
- PS-200X 200W (8088) ..... \$89.95
- PS-200 200W (286/386) ..... \$89.95
- PS-250 250W (286/386) ..... \$129.95

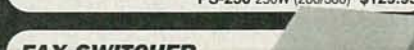

## FAX SWITCHER

ROUTES CALLS FROM 1 PHONE LINE TO PHONE, FAX, MODEM & ANSWERING MACHINE  
• FOR SINGLE OR MULTI-LINE SYSTEMS  
• AUX. PORT FOR MODEM, CORDLESS PHONE, ALARM, ETC.  
FAXM-SWITCH ..... \$109.95

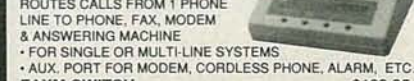

## PROTOTYPE CARDS

FR-4 EPOXY GLASS LAMINATE WITH GOLD PLATED EDGECARD FINGERS AND SILK SCREENED LEGENDS



### FOR XT

JDR-PR1	WITH +5V AND GROUND PLANE	27.95
JDR-PR2	ABOVE WITH I/O DECODING LAYOUT	29.95
JDR-PR2-PK	PARTS KIT FOR JDR-PR2 ABOVE	8.95

### FOR AT

JDR-PR10	16-BIT WITH I/O DECODING LAYOUT	34.95
JDR-PR10-PK	PARTS KIT FOR JDR-PR10 ABOVE	12.95

### FOR PS/2

JDR-PR32	32-BIT PROTOTYPE CARD	69.95
JDR-PR16	16-BIT WITH I/O DECODING LAYOUT	49.95
JDR-PR16-PK	PARTS KIT FOR JDR-PR16 ABOVE	15.95
JDR-PR16V	16 BIT FOR VIDEO APPLICATIONS	39.95

## EXTENDER CARDS

SIMPLIFY PROTOTYPING AND TESTING

EXT-8088	8-BIT FOR 8088 MOTHERBOARDS	29.95
EXT-80286	16-BIT FOR 286/386 MOTHERBOARDS	39.95
EXT-16	MICROCHANNEL 16-BIT	69.95
EXT-32	MICROCHANNEL 32-BIT	99.95

## PC BREADBOARD-ON-A-CARD



- 62 BUS LINES
- USE UP TO 24 14-PIN ICs
- 1940 TIE POINTS
- DB25 D-SUB CONNECT.
- PDS-604 ..... \$49.95

## SOLDER STATION

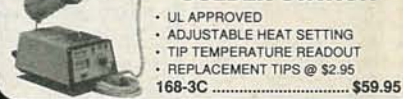

- UL APPROVED
- ADJUSTABLE HEAT SETTING
- TIP TEMPERATURE READOUT
- REPLACEMENT TIPS @ \$2.95
- 168-3C ..... \$59.95

## IC SOCKETS/DIP CONNECTORS

SOLDERTAIL	WIREWRAP	ZIF SOCKETS
8 PIN ST .11	8 PIN WW .59	ZIF-14 5.95
14 PIN ST .11	14 PIN WW .69	ZIF-16 5.95
16 PIN ST .12	16 PIN WW .69	ZIF-20 6.95
18 PIN ST .15	18 PIN WW .99	ZIF-24 7.95
20 PIN ST .18	20 PIN WW 1.09	ZIF-28 7.95
24 PIN ST .20	24 PIN WW 1.49	ZIF-40 10.95
28 PIN ST .22	28 PIN WW 1.69	
40 PIN ST .30	40 PIN WW 1.99	

VOLUME DISCOUNTS CALL!

## SOLDER-CUP D-SUBS

MALE	FEMALE	IDE20
DB09P .45	DB09S .49	IDE20 .55
DB15P .59	DB15S .69	IDE34 .89
HDB15P 1.49	HDB15S 1.59	IDS20 .65
DB19P .69	DB19S .75	IDS34 .75
DB25P .69	DB25S .75	IDB09P 1.49
DB37P 1.35	DB37S 1.39	IDB09S 1.39
DB50P 1.85	DB50S 2.29	IDB25P 2.25
		IDB25S 2.35

## ICD'S

## CABLES AND GENDER CHANGERS

MOLDED; GOLD-PLATED CONTACTS; 100% SHIELDED

CBL-PRINTER	6 FT. PC PRINTER CABLE	9.95
CBL-PRINTR-25	25 FT. PC PRINTER CABLE	15.95
CBL-PRINTR-RA	RIGHT ANGLE PRINTER CABLE	15.95
CBL-DB25-MM	DB25 MALE-DB25 MALE 6 FT.	9.95
CBL-DB25-MF	DB25 MALE-DB25 FEMALE 6 FT.	9.95
CBL-9-SERIAL	DB9 FEMALE-DB25 MALE 6 FT.	6.95
CBL-KBD-EXT	5 FT. KEYBOARD EXTENSION	7.95
CBL-CNT-MM	36-PIN CENTRONICS-MM	14.95
CBL-FDC-EXT	37-PIN EXT. FLOPPY CABLE	9.95
CBL-MNT-9	9-PIN MONITOR EXTENSION	6.95
CBL-MNT-15	15-PIN MONITOR EXTENSION CABLE	9.95
CBL-MODEM	MODEM-DB25-DB25 FEMALE	6.95
GENDER-VGA	DB9-DB15 ADAPTOR	4.95
GENDER-9-25	DB9-DB25 SERIAL ADAPTOR	4.95

PARTIAL LISTINGS ONLY—CALL FOR FREE 100-PG CATALOG!

COPYRIGHT 1990 JDR MICRODEVICES

JDR MICRODEVICES AND THE JDR MICRODEVICES LOGO ARE REGISTERED TRADEMARKS OF JDR MICRODEVICES. IBM, AT, PS/2 ARE TRADEMARKS OF INTERNATIONAL BUSINESS MACHINES.



### 4800/2400 BAUD FAX/DATA MODEM \$119<sup>95</sup>

- FAX TRANSMISSION ONLY
- 4800 BAUD FAX CAPABILITY TO ANY GROUP III FAX
- 2400 BAUD V.22BIX DATA MODEM
- XT/AT COMPATIBLE HALF CARD
- MENU-DRIVEN SOFTWARE
- MULTIPLE FAX TRANSMISSIONS TO GROUPED ADDRESSES



MCT-FAXM

### 2400 BAUD MODEM \$89<sup>95</sup>

- 2400/1200/300 BAUD
- FULL Hayes COMPATIBILITY
- CONFIGURE AS COM1, COM2, COM3 OR COM4
- BUILT-IN SPEAKER
- AUTO WAIT-FOR-DIAL TONE AND AUTO-REDIAL
- PROCOMM COMMUNICATIONS SOFTWARE
- MADE IN THE USA

MCT-241

MCT-121 1200 BAUD INTERNAL MODEM ..... \$59.95

### Minifoot™ CASE \$199<sup>95</sup>

- SMALL FOOTPRINT MINI-UPRIGHT FOR 8088 OR MINI 286/386 MOTHERBOARDS
- ROOM FOR 6 EXPANSION CARDS
- HOLDS 3 5-1/4" & 1 3-1/2" DRIVES (1/2 HT)
- 200 WATT POWER SUPPLY
- 2-DIGIT LED SPEED DISPLAY
- 12" H X 16" L X 8" W

CASE-120

### Littlefoot™ CASE \$249<sup>95</sup>

- SPACE SAVING DESIGN HOLDS ALL SIZES OF MOTHERBOARDS AND INCLUDES: • 250W POWER SUPPLY
- MOUNTS FOR 3 FLOPPY & 4 HARD DRIVES
- TURBO & RESET SWITCH • LED SPEED DISPLAY • POWER & DISK LED'S
- ALL HARDWARE, FACEPLATES & SPEAKER

CASE-100

- CASE-FLIP FOR 8088 MB'S ..... \$39.95
- CASE-SLIDE FOR 8088 MB'S ..... \$39.95
- CASE-70 FOR 286 MB'S ..... \$89.95
- CASE-50 FOR MINI 286 MB'S ..... \$59.95
- CASE-JR MINI-286 W/150W PS \$149.95

### MODULAR PROGRAMMING SYSTEM

MODULES USE A COMMON HOST ADAPTOR CARD-- 1 SLOT PROGRAMS EPROMS, PROMS, PALS, MORE!

#### HOST ADAPTOR CARD \$29.95

- UNIVERSAL INTERFACE FOR ALL PROGRAMMING MODULES!
- SELECTABLE ADDRESSES
- PREVENTS CONFLICTS
- MOLDED CABLE

MOD-MAC

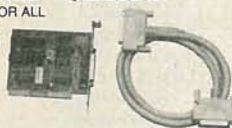

#### UNIVERSAL MODULE \$499.95

- PROGRAMS EPROMS, EEPROMS, PALS, BI-POLAR PROMS, 8748 & 8751 SERIES DEVICES; 16V8 AND 20V8 GALS (GENERIC ARRAY LOGIC) FROM LATTICE, NS, SGS • TESTS TTL, CMOS, DYNAMIC & STATIC RAMS • LOAD DISK, SAVE DISK, EDIT, BLANK CHECK, PROGRAM, AUTO, READ MASTER, VERIFY AND COMPARE • TEXT TOOL SOCKET FOR 3" 6" W. IC'S (8-40 PINS)

MOD-MUP

#### EPROM MODULE \$119.95

- PROGRAMS 24-32 PIN EPROMS, CMOS EPROMS & EEPROMS FROM 16K TO 1024K • HEX TO OBJ CONVERTER • AUTO, BLANK CHECK/PROGRAM/VERIFY • VPP 5, 12.5, 12.75, 13, 21 & 25 VOLTS • NORMAL, INTELLIGENT, INTERACTIVE & QUICK PULSE PROGRAMMING ALGORITHMS

MOD-MEP

- MOD-MEP-4 4-EPROM PROGRAMMER ..... \$169.95
- MOD-MEP-8 8-EPROM PROGRAMMER ..... \$259.95
- MOD-MEP-16 16-EPROM PROGRAMMER ..... \$499.95

#### OTHER MODULES

- MOD-MPL PAL MODULE ..... \$249.95
- MOD-MIC DIGITAL TESTER MODULE ..... \$129.95
- MOD-MBP BI-POLAR PROGRAMMING MODULE ..... \$259.95
- MOD-MMP MICROPROCESSOR PROG. MODULE ..... \$179.95
- MOD-MPL-SOFT CUPL SOFTWARE ..... \$99.95

### VGA COMPATIBLE PACKAGE \$499<sup>95</sup>

- 720 X 540 MAX RESOLUTION, 640 X 480 IN 16 COLORS, 528 X 480 RESOLUTION IN 256 COLORS • IBM STYLE MONITOR
- VGA, EGA, CGA, AND MGA COMPATIBLE
- VGA-PKG (INCLUDES VGA CARD AND MONITOR)

#### VGA MONITOR \$359.95

- 14" ANALOG VGA • GLARE RESISTANT SCREEN • 720 X 480
- TILT/SWIVEL BASE • FRONT MOUNTED POWER SWITCH

VGA-MONITOR

#### RELISYS MULTISYNCH \$429.95

- FULL FEATURED MULTISYNCH MONITOR WITH UNLIMITED COLORS • 800 X 560 RESOLUTION, 14" NON-GLARE DISPLAY
- AUTO SWITCHING • TTL/ANALOG VIDEO INPUT

JDR-MULTI

#### EGA SPECIAL! CARD & MONITOR--JUST \$479

- JDR-RGB 14" RGB MONITOR ..... \$239.95
- NEC-MULTI-3D DIGITAL 1024X768 RESOLUTION ..... \$649.95
- JDR-MONO 12" TTL MONOCHROME--GREEN ..... \$69.95
- JDR-AMBER 12" TTL MONOCHROME--AMBER ..... \$69.95



### QUALITY KEYBOARDS

#### STANDARD KEYBOARDS:

- BTC-5060 AUTOSENSE FOR XT/AT ..... \$59.95
- MAX-5060 WITH TACTILE FEEDBACK (286 ONLY) ..... \$64.95

#### ENHANCED KEYBOARDS:

- BTC-5339 AUTOSENSE FOR XT/AT, AUTOREPEAT ..... \$69.95
- K103-A AUDIBLE "CLICK" STYLE ..... \$84.95
- MAX-5339 MAXI-SWITCH W/TACTILE (286 ONLY) ..... \$84.95

### MODULAR CIRCUIT TECHNOLOGY

#### DRIVE CONTROLLERS:

- MCT-FDC FLOPPY DISK CONTROLLER ..... \$29.95
- MCT-FDC-HD 1.44MB FLOPPY CONTROLLER ..... \$49.95
- MCT-FDC-HD4 4-FLOPPY DISK CONTROLLER ..... \$59.95
- MCT-HDC HARD DISK CONTROLLER ..... \$79.95
- MCT-RLL RLL CONTROLLER ..... \$89.95
- MCT-FH FLOPPY/HARD CONTROLLER ..... \$139.95
- MCT-AFH 286/386 FLOPPY/HARD ..... \$149.95
- MCT-AFH-RLL 286/386 RLL CONTROLLER ..... \$199.95

#### DISPLAY ADAPTOR CARDS:

- MCT-MGP MONOCHROME GRAPHICS ..... \$49.95
- MCT-CG COLOR GRAPHICS ADAPTOR ..... \$44.95
- MCT-EGA ENHANCED GRAPHICS ADAPTOR ..... \$149.95
- MCT-VGA-8 8-BIT VGA, ANALOG OUTPUT ..... \$169.95
- MCT-VGA-16 16-BIT VGA, ANALOG OUTPUT ..... \$199.95
- MCT-MGMIO MONOGRAPHICS MULTI I/O ..... \$119.75

#### MULTIFUNCTION CARDS:

- MCT-MIO MULTI I/O FLOPPY CONTROLLER ..... \$79.95
- MCT-IO MULTI I/O CARD ..... \$59.95
- MCT-AMF 286/386 MULTIFUNCTION ..... \$139.95
- MCT-AIO 286/386 MULTI I/O CARD ..... \$59.95

#### MEMORY CARDS:

- MCT-RAM 576K RAM CARD ..... \$49.95
- MCT-EMS EXPANDED MEMORY CARD ..... \$99.95
- MCT-AEMS 286/386 EMS CARD ..... \$129.95

### GeniScan 400 DPI \$199<sup>95</sup>

- UP TO 400 DPI • 32 LEVELS OF GRAY SCALE • B&W OR 3 HALF-TONE MODES • SPEED OVER-RUN WARNING LIGHT • INCLUDES SCANNED II AND DR. GENIUS SOFTWARE

GS-4500



### EPROM PROGRAMMER \$129.95

- PROGRAMS 27XX AND 27XXX EPROMS UP TO 27512
- SUPPORTS VARIOUS PROGRAMMING FORMATS & VOLTAGES
- SPLIT OR COMBINE CONTENTS OF SEVERAL EPROMS OF DIFFERENT SIZES
- READ, WRITE, COPY, BLANK CHECK & VERIFY
- SOFTWARE FOR HEX AND INTEL HEX FORMATS

MOD-EPROM



### HARD DISKS KITS

- 21.4 MB \$199
- 21.4 MB \$249
- 32.7 MB \$219
- 32.1 MB \$279
- 42.8 MB \$339
- 65.5 MB \$389
- 80.2 MB \$569



Seagate

SIZE	MODEL	AVG. SPEED	FORM FACTOR	DRIVE ONLY	XT KIT	AT F/H KIT
21.4MB	ST-225	65 MS	5-1/4"	\$199	\$249	\$309
32.7MB RLL	ST-238	65 MS	5-1/4"	\$219	\$279	\$379
42.8MB	ST-251-1	28 MS	5-1/4"	\$339	\$389	\$449
65.5MB RLL	ST-277-1	28 MS	5-1/4"	\$389	\$449	\$549
80.2MB	ST-4096	28 MS	5-1/4"	\$569	—	\$679
122.7MBRLL	ST-4144R	28 MS	5-1/4"	\$699	\$759	\$859
21.4MB	ST-125	40 MS	3-1/2"	\$259	\$299	\$373
32.1MB RLL	ST-138R	40 MS	3-1/2"	\$289	\$339	\$429

### 157.5MB ESDI DRIVE KIT \$1049

- 5-1/4" HARD DISK, FLOPPY/HARD CONTROLLER, CABLES, MOUNTING HARDWARE & SOFTWARE. 1355-PKG

### 1.44MB 3-1/2" DRIVE \$99<sup>95</sup>

- ULTRA HIGH DENSITY
- READ/WRITE 720K DISKS, TOO
- FDD-1.44X BLACK FACEPLATE
- FDD-1.44A BEIGE FACEPLATE
- FDD-1.44 SOFT SOFTWARE DRIVER \$19.95

#### 1/2 HEIGHT FLOPPY DISK DRIVES:

- FD-55B 5-1/4" TEAC DS/DD 360K ..... \$99.95
- FD-55G 5-1/4" TEAC DS/HD 1.2M ..... \$129.95
- FDD-360 5-1/4" DS/DD 360K ..... \$69.95
- FDD-1.2 5-1/4" DS/HD 1.2M ..... \$95.95



### MOTHERBOARDS

#### 20MHZ 386 \$629 UPGRADE!

- 16/20 MHZ
- 16 MB RAM CAPACITY - 8MB ON BOARD(OK), 8 MB RAM CARD
- USES 256K OR 1MB SIP RAMS
- 8 SLOTS: 1X32-BIT RAM 2X 8-BIT & 5X 16-BIT
- MEMORY INTERLEAVING
- AMI BIOS • XT-SIZE BOARD

- MCT-M386-20 25MHZ MINI 386 W/CACHE ..... \$1199.00
- MCT-C386-25 1/2"AMB RAM CARD (OK) ..... \$99.95
- MCT-C386-M4 10/20MHZ 386 ..... \$799.00
- MCT-386MB20S 10/25MHZ 386 ..... \$999.00

#### 10MHZ MINI-286 \$189<sup>95</sup>

- AT COMPATIBLE • KEYBOARD SELECTABLE 6/10MHZ
- EXPANDABLE TO 4MB ON-BOARD WITH 1MB DRAMS (OK)
- SIX 16-BIT, TWO 8-BIT SLOTS • AMI BIOS • LED SUPPORT

- MCT-M286-10 8/12MHZ MINI-286 ..... \$199.95
- MCT-M286-12 8/16MHZ 286 ..... \$289.95
- MCT-M286-16N 10/20MHZ 286 ..... \$389.95
- MCT-M286-20N STANDARD 4.77MHZ 8088 ..... \$87.95
- MCT-XMB 4.77/8MHZ 8088 ..... \$95.95
- MCT-TURBO 4.77/10MHZ SINGLE CHIP 8088 ..... \$99.95

### LOGITECH MICE

- THREE-BUTTON SERIES 9
- 320 DPI RESOLUTION
- SERIAL PS/2 COMPATIBLE.

- LOGC9 SERIAL MOUSE ..... \$98.95
- LOGC9-C SERIAL (NOT PS/2 COMPATIBLE) ..... \$79.95
- LOGC9-P SERIAL MOUSE WITH PAINTSHOW ..... \$109.95
- LOGC9-PC SERIAL MOUSE WITH PAINT/CAD ..... \$154.95
- LOGB9 BUS MOUSE ..... \$89.95
- LOGB9-P BUS MOUSE WITH PAINTSHOW ..... \$104.95
- LOGB9-PC BUS MOUSE WITH PAINT/CAD ..... \$149.95



JDR MICRODEVICES, 2233 BRANHAM LANE, SAN JOSE 95124  
LOCAL (408) 559-1200 FAX (408) 559-0250 TELEX 171-110

RETAIL STORE: 1256 S. BASCOM AVE., SAN JOSE, CA  
(408) 947-8881 HOURS: M-F 9-7 SAT. 9-5 SUN. 12-4

Terms: Minimum order \$10.00. For shipping & handling include \$4.00 for ground and \$5.00 for air. Orders over 1 lb and foreign orders may require additional shipping charges—please contact the sales department for the amount. CA residents must include applicable sales tax. Prices subject to change without notice. We are not responsible for typographical errors. We reserve the right to limit quantities and to substitute manufacturer. All merchandise subject to prior sales. A full copy of our terms is available upon request. Items pictured may only be representative.

# ORDER TOLL FREE 800-538-5000

CUSTOMER SERVICE TOLL-FREE 800-538-5001 • TECHNICAL SUPPORT TOLL-FREE 800-538-5002

CIRCLE 113 ON FREE INFORMATION CARD  
DEALERS CIRCLE 170 ON FREE INFORMATION CARD

MAY 1990



**VALUE-PRICED TEST EQUIPMENT ALL WITH A 2 YEAR WARRANTY!**

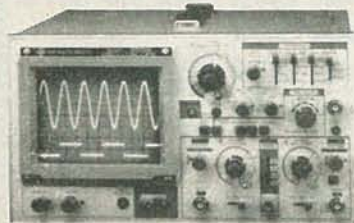

**35 MHZ DUAL TRACE OSCILLOSCOPE \$499.95**

- WIDE BAND WIDTH • VARIABLE HOLDOFF
- 1X/10X PROBES

MODEL-3500 (SHOWN)

**20 MHZ DUAL TRACE OSCILLOSCOPE \$389.95**

- TV SYNC FILTER • COMPONENTS TESTER
- 1X/10X PROBES

MODEL 2000

**THE ULTIMATE 3.5 DIGIT DMM \$79.95**

- BASIC DC ACCURACY  $\pm 0.25\%$
- 34 RANGES
- TEMPERATURE, TRANSISTOR & RESISTANCE FEATURES

DMM-300 (SHOWN)

**3.5 DIGIT FULL FUNCTION DMM \$49.95**

- BASIC DC ACCURACY  $\pm 0.25\%$
- 22 RANGES

DMM-200 \$49.95

**3.5 DIGIT POCKET SIZE DMM \$29.95**

- BASIC DC ACCURACY  $\pm 0.5\%$  • 14 RANGES

DMM-100

**3.5 DIGIT PROBE TYPE DMM \$54.95**

- AUTORANGING
- AC/DC 2V - 500V,
- RESISTANCE: 2K-2M

DPM-1000 (SHOWN)

**HIGH/LOW LOGIC PROBE \$17.95**

- DETECTS TTL/CMOS LOGIC STATES
- MEMORY FUNCTION FREEZES DATA FOR LATER USE

LP-2800

**PULSER PROBE FOR QUICK DEBUGGING \$19.95**

- INJECTS PULSE INTO TEST CIRCUIT-VARIABLE WIDTH
- TTL, DTL, TRL, HTL, HINIL, MOS, & CMOS COMPATIBLE

LP-540



**JIM'S BARGAIN HUNTERS CORNER**

Jim Wharton  
JDR's VP Sales

**3.5 DIGIT MULTIMETER**

REGULAR LIST \$29.95

- 3.5 DIGIT LCD • OVERRANGE INDICATION
- 550V MAXIMUM COMMON MODE VOLTAGE
- OVERLOAD PROTECTION
- LOW BATTERY INDICATOR
- 200 HOUR BATTERY LIFE
- BASIC DC ACCURACY .7%

DMM-301 EXPIRES 5/3190



**JDR Microdevices**  
2233 BRANHAM LANE, SAN JOSE, CA 95124

**ORDER TOLL-FREE 800-538-5000**

LOCAL (408) 559-1200 CUSTOMER SERVICE 800-538-5001  
TECH SUPPORT 800-538-5002 FAX (408) 559-0250

**ADVERTISING INDEX**

RADIO-ELECTRONICS does not assume any responsibility for errors that may appear in the index below.

Free Information Number	Page	192	Optoelectronics.....5
108	AMC Sales .....	16	Pacific Cable.....91
75	Ace Products.....	36	Parts Express.....97
107	All Electronics .....	101	Pomona Electronics.....23
—	Amazing Concepts.....	90, 93	78 Radio Shack.....17
106	American Design Components.....	96	197 SCO Electronics.....77
84	Appliance Service.....	36	188,189 Sencore.....33, CV4
67	Banner Technical Books.....	26	196 Smith Design.....34
98,176	Beckman Industrial.....	15, 16	— Star Circuits.....27
177,178	Beckman Industrial.....	25, 26	83 Synergetics.....72
109	C&S Sales.....	7	194 TECI.....69
70	CEI.....	94	198 U.S. Cable TV.....77
—	CIE.....	3, 11	186 Unicorn.....92
50	Caig Laboratories.....	27	64 Video-Link.....94
54	Chemtronics.....	15	184 Viejo Publications.....26
193	Chenesko Products.....	36	185 WPT Publications.....69
—	Command Productions.....	16	
58	Cook's Institute.....	15	
—	Crossword Puzzles Club.....	96	
195	D&D Electronics.....	12	
—	Damark International.....	73	
127	Deco Industries.....	36	
82	Digi-Key.....	100	
179	Electronic Goldmine.....	95	
—	Electronic Technology Today CV3.....	96	
—	Electronics Book Club.....	54	
121	Fluke Manufacturing.....	CV2	
191	Global Specialties.....	13	
—	Grantham College of Engineering.....	35	
86	Heathkit.....	12	
187	International Components Corp.....	95	
113,170	JDR Microdevices.....	102-104	
114	Jameco.....	98, 99	
115	Jensen Tools.....	36	
180	Jinco Computers.....	92	
190	Joseph Electronics.....	32	
—	King Wholesale.....	90	
87	MCM Electronics.....	89	
53	MD Electronics.....	97	
93	Mark V. Electronics.....	93	
—	McGraw Hill Book Club.....	28	
61	Microprocessors Unltd.....	87	
117	Mouser.....	25	
—	NRI Schools.....	18	

**Gernsback Publications, Inc.**  
500-B Bi-County Blvd.  
Farmingdale, NY 11735  
1-516-293-3000  
Fax 1-516-293-3115  
President: **Larry Steckler**  
Vice President: **Cathy Steckler**

**For Advertising ONLY**  
1-516-293-3000  
Fax 1-516-293-3115  
**Larry Steckler**  
publisher  
**Arline Fishman**  
advertising director  
**Lisa Strassman**  
credit manager  
**Denise Haven**  
advertising assistant

**SALES OFFICES**

**EAST/SOUTHEAST**  
**Stanley Levitan**  
Eastern Sales Manager  
Radio-Electronics  
259-23 57th Avenue  
Little Neck, NY 11362  
1-718-428-6037, 1-516-293-3000

**MIDWEST/Texas/Arkansas/Okla.**  
**Ralph Bergen**  
Midwest Sales Manager  
Radio-Electronics  
540 Frontage Road—Suite 339  
Northfield, IL 60093  
1-312-446-1444  
Fax 1-312-446-8451

**PACIFIC COAST/ Mountain States**  
**Marvin Green**  
Pacific Sales Manager  
Radio-Electronics  
5430 Van Nuys Blvd. Suite 316  
Van Nuys, CA 91401  
1-818-986-2001  
Fax 1-818-986-2009



# Electronics Paperback Books

GREAT PAPERBACKS AT SPECIAL PRICES

**BP248—TEST EQUIPMENT CONSTRUCTION** ..... \$5.95. Details construction of simple, inexpensive, but extremely useful test equipment. AF Gen, Test Bench Ampl, Audio Millivoltmeter, Transistor Tester and six more.



**BP267—HOW TO USE OSCILLOSCOPES AND OTHER TEST EQUIPMENT** ..... \$6.95. Mastering the oscilloscope is not really too difficult. This book explains all the standard controls and functions. Other equipment is also described.

**BP265—MORE ADVANCED USES OF THE MULTIMETER** ..... \$5.95. Use these techniques to test and analyze the performance of a variety of components. Also see how to build add-ons to extend multimeter capabilities.

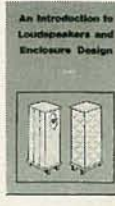

**BP256—INTRO TO LOUDSPEAKERS AND ENCLOSURE DESIGN** ..... \$5.95. We explore the variety of enclosure and speaker designs in use today so the reader can understand the principles involved.

**BP263—A CONCISE INTRO TO dBASE** ..... \$6.95. The dBASE series of programs are probably the best known database programs for microcomputers. This book is designed to help you get started working with them.



**BP260—CONCISE INTRO TO OS/2** ..... \$5.95. If you are a multitasking PC user and want to get the most out of your computer, then you must learn its OS/2 operating system. This book shows you just how to do that, quickly and easily.



**BP249—MORE ADVANCED TEST EQUIPMENT CONSTRUCTION** ..... \$6.95. Eleven more test equipment construction projects. They include a digital voltmeter, capacitance meter, current tracer and more.



Digital Audio Projects



**BP245—DIGITAL AUDIO PROJECTS** ..... \$5.95. Practical circuits to build and experiment with. Includes A/D converter, input amplifier, digital delay line, compander, echo effect and more.

**BP247—MORE ADVANCED MIDI PROJECTS** ..... \$5.95. Circuits included are a MIDI indicator, THRU box, merge unit, code generator, pedal, programmer, channelizer, and analyzer.



**BP257—INTRO TO AMATEUR RADIO** ..... \$6.95. Amateur is a unique and fascinating hobby. This book gives the newcomer a comprehensive and easy to understand guide to the subject.



**PCP102—INTRODUCING DIGITAL AUDIO** ..... \$9.95. Covers all kinds of digital recording methods—CD, DAT and Sampling. Bridges the gap between the technician and the enthusiast. Principles and methods are explained.

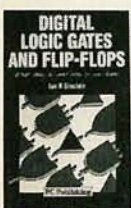

**PCP107—DIGITAL LOGIC GATES AND FLIP-FLOPS** ..... \$10.00. Thorough treatment of gates and flip-flops for enthusiasts, student and technicians. Only a basic knowledge of electronics is needed.

**BP251—COMPUTER HOBBYISTS HANDBOOK** ..... \$8.95. A wrapup of everything the computer hobbyist needs to know in one easy to use volume. Provides a range of useful reference material in a single source.



**PCP108—COMPUTERS AND MUSIC** ..... \$9.95. Explains the basics of computers and music with no previous knowledge of computers needed. Covers types of music software and explains how to set up your own computer music studio.

- BP195—INTRODUCTION TO SATELLITE TV**..... \$9.95. A definitive introduction to the subject written for the professional engineer, electronics enthusiast, or others who want to know more before they buy. 8 x 10 in.
- BP190—ADVANCED ELECTRONIC SECURITY PROJECTS**.....\$5.95. Includes a passive infra-red detector, a fiber-optic loop alarm, computer-based alarms and an unusual form of ultrasonic intruder detector.
- BP235—POWER SELECTOR GUIDE**.....\$10.00. Complete guide to semiconductor power devices. More than 1000 power handling devices are included. They are tabulated in alpha-numeric sequence, by technical specs. Includes power diodes, Thyristors, Triacs, Power Transistors and FET's.
- BP234—TRANSISTOR SELECTOR GUIDE**.....\$10.00. Companion volume to BP235. Book covers more than 1400 JEDEC, JIS, and brand-specific devices. Also contains listing by case type, and electronic parameters. Includes Darlington transistors, high-voltage devices, high-current devices, high power devices.
- BP99—MINI-MATRIX BOARD PROJECTS**.....\$5.50. Here are 20 useful circuits that can be built on a mini-matrix board that is just 24 holes by ten copper-foil strips.
- BP82—ELECTRONIC PROJECTS USING SOLAR CELLS**.....\$5.50. Circuits with applications around the home that are powered by the energy of the sun. Everything from radio receivers, to a bicycle speedometer, to timers, audio projects and more.
- BP117—PRACTICAL ELECTRONIC BUILDING BLOCKS—Book 1**.....\$5.75. Oscillators, Timers, Noise Generators, Rectifiers, Comparators, Triggers and more.
- BP184—INTRO TO 68000 ASSEMBLY LANGUAGE**..... \$6.95. The 68000 is a great new breed of microprocessor. Programming in assembly language increases the running speed of your programs. Here's what you need to know.
- BP179—ELECTRONIC CIRCUITS FOR THE COMPUTER CONTROL OF ROBOTS** ..... \$7.50. Data and circuits for interfacing the computer to the robot's motors and sensors.

- BP239—GETTING THE MOST FROM YOUR MULTIMETER**..... \$5.95. Covers basics of analog and digital meters. Methods of component testing includes transistors, thyristors, resistors, capacitors and other active and passive devices.
- BP97—IC PROJECTS FOR BEGINNERS**.....\$5.50. Power supplies, radio and audio circuits, oscillators, timers, switches, and more. If you can use a soldering iron you can build these devices.
- BP37—50 PROJECTS USING RELAYS, SCR'S & TRIACS**.....\$5.50. Build priority indicators, light modulators, warning devices, light dimmers and more.
- RADIO—100 RADIO HOOKUPS**.....\$3.00. Reprint of 1924 booklet presents radio circuits of the era including regenerative, neutrodyne, reflex & more.
- BP42—SIMPLE LED CIRCUITS**..... \$5.50. A large selection of simple applications for this simple electronic component.
- BP127—HOW TO DESIGN ELECTRONIC PROJECTS**.....\$5.75. Helps the reader to put projects together from standard circuit blocks with a minimum of trial and error.
- BP122—AUDIO AMPLIFIER CONSTRUCTION**.....\$5.75. Construction details for preamps and power amplifiers up through a 100-watt DC-coupled FED amplifier.
- BP92—CRYSTAL SET CONSTRUCTION**.....\$5.50. Everything you need to know about building crystal radio receivers.
- BP45—PROJECTS IN OPTOELECTRONICS**..... \$5.50. Includes infra-red detectors, transmitters, modulated light transmission and photographic applications.

**BP185—ELECTRONIC SYNTHESIZER CONSTRUCTION** ..... \$5.95. Use this book to learn how to build a reasonably low cost, yet worthwhile monophonic synthesizer and learn a lot about electronic music synthesis in the process.

## CHECK OFF THE BOOKS YOU WANT

**ELECTRONIC TECHNOLOGY TODAY INC.**  
P.O. Box 240, Massapequa Park, NY 11762-0240

Name \_\_\_\_\_  
Address \_\_\_\_\_  
City \_\_\_\_\_ State \_\_\_\_\_ Zip \_\_\_\_\_

**SHIPPING CHARGES IN USA AND CANADA**

\$0.01 to \$5.00	... \$1.25
\$5.01 to 10.00	... \$2.00
\$10.01 to \$20.00	... \$3.00
\$20.01 to \$30.00	... \$4.00
\$30.01 to \$40.00	... \$5.00
\$40.01 to \$50.00	... \$6.00
\$50.01 and above	... \$7.50

**SORRY No orders accepted outside of USA & Canada**

Number of books ordered

Total price of merchandise ..... \$ \_\_\_\_\_  
Sales Tax (New York State Residents only) ..... \$ \_\_\_\_\_  
Shipping (see chart) ..... \$ \_\_\_\_\_

**All payments must be in U.S. funds**

Total Enclosed .. \$ \_\_\_\_\_

RE-590



# Introducing The SG80 AM Stereo-FM Stereo Analyzer™

Now For The First Time, A High-Performance AM Stereo (C-QUAM)® - FM Stereo Analyzer Integrated Into One Unit, Allowing You To Performance Test, Troubleshoot, And Align To Manufacturers' Requirements

**New**



**\$3,995**  
Patented

Licensed Under Motorola Patent No. 4,218,586

- Complete AM Stereo-FM Stereo Analyzer—exceeds manufacturers' requirements.
- Patented FM analyzing signals isolate any FM receiver defect.
- Exclusive integrated AM Stereo C-QUAM analyzer.
- Digitally accurate performance tests meet EIA/IHF requirements.
- Exclusive, tuneable FM-IF Sweep and Markers—aligns all IF stages.
- Expandable FM features for future service needs, plus SCA compatible.
- Twice the capability for less than 1/2 the cost of stand-alone instruments.

C-QUAM is a registered trademark of Motorola, Inc.



**RS232**  
Compatible

**SENCORE**  
3200 Sencore Drive, Sioux Falls, South Dakota 57107

Call 1-800-SENCORE  
(736-2673)  
CIRCLE 189 ON FREE INFORMATION CARD

Ask About  
A 10 Day  
Video Preview

