

48783

Radio - HOW TO BUY A CD PLAYER

JANUARY 1990

Electronics

TECHNOLOGY - VIDEO - STEREO - COMPUTERS - SERVICE

BUILD R-E's ACOUSTIC FIELD GENERATOR

Transform your living room with movie-theater sound!



BUILD A PHONE-ACTIVATED AUDIO-MUTING CIRCUIT

Never miss a phone call again—no matter how loud you play your stereo!

BUILD A SIMPLE LOGIC ANALYZER

An easy 3-chip circuit

HOW TO FIGHT ESD

Protect your equipment and components from electrostatic discharge

COMPUTER DIGEST

Build the Port-A-Matic and keep track of your computer's ports!



\$2.25 U.S.
\$2.75 CAN

A
GERNSBACK
PUBLICATION



FLUKE



PHILIPS

Other meters show half the picture

The new Fluke 45 has dual display versatility.

With 2 multifunction displays and 16 different measurement capabilities, the new Fluke 45 does virtually everything you want a meter to do. And for a surprisingly affordable price.



Get everything you've ever wanted.

Dual displays. 16 functions. Even the security of an optional two-year warranty extension for only \$35. For all the information on the new Fluke 45, contact your local distributor. Or call toll-free 1-800-44-FLUKE, ext. 33.

The 5-digit, 100,000 count dual displays give you more information in less time — and with less effort. For example, measure the VDC output of a power supply while measuring the VAC ripple. Or check the amplitude and frequency of an AC signal. From a single test connection!

And the Fluke 45 is designed to make complex measurements easier, with standard features like a 1 MHz frequency counter, Min Max, limits testing (Hi/Lo/Pass), Touch Hold® and Relative modes. There are 21 different reference impedances for dB measurements; in the 2 Ω to 16 Ω ranges, audio power can be automatically displayed in watts.

Accuracy to get the job done right.

The Fluke 45 is a true-rms meter, with 0.02% basic dc voltage accuracy and 100,000 count resolution on both displays. Basic dc current accuracy is 0.05%, making the 45 ideal for servicing 4-20 mA current loops. Closed-case calibration simplifies the calibration process and increases uptime.

Even an RS-232 interface is standard.

Connecting the Fluke 45 to PCs, RS-232 printers and modems is as easy as attaching the cable. An IEEE-488.2 interface and rechargeable batteries are available as options.

FLUKE 45 DUAL DISPLAY MULTIMETER

\$595*	Compare and Relative functions
Dual Display	Min Max and Touch Hold® functions
True-rms voltage and current, including ac+dc	Optional PC software for RS-232 applications
0.02% basic dc voltage accuracy	Optional IEEE-488.2 interface, battery pack
0.05% basic dc current accuracy	One year warranty
1 MHz frequency counter	Optional two year warranty extension \$35*
RS-232 interface standard	
dB, with 21 reference impedances, and audio power calculations.	
*Suggested U.S. List Price	

John Fluke Mfg. Co., Inc. P.O. Box C9090 M/S 250C Everett, WA 98206
U.S.: 206-356-5400 Canada: 416-890-7600 Other Countries: 206-356-5500

© Copyright 1989 John Fluke Mfg. Co., Inc. All rights reserved. IBM PC is a registered trademark of International Business Machines Corporation. Ad No. 0591-F45.

CIRCLE 121 ON FREE INFORMATION CARD

FLUKE

BUILD THIS

- 35 ACOUSTIC FIELD GENERATOR**
Bring high-quality, multichannel surround sound into your living room.
Tod T. Templin
- 41 3-CHIP LOGIC ANALYZER**
Build this 8-bit word-recognition logic analyzer for only six dollars!
J.J. Robinson II
- 43 PHONE-ACTIVATED AUDIO MUTING CIRCUIT**
Let your telephone's ringer automatically shut off the sound on your stereo or TV.
Mark A. Vaught

TECHNOLOGY

- 45 WHAT'S NEW IN CD PLAYERS**
A consumer's guide to the latest CD technology.
Josef Bernard
- 54 ELECTROSTATIC DISCHARGE**
How to prevent ESD from damaging your components.
Dave Hollander

COMPUTERS

- 81 BUILD THE PORT-A-MATIC**
Keep tabs on your expansion bus.
Robert Grossblatt

DEPARTMENTS

- | | |
|---|--|
| <ul style="list-style-type: none">6 VIDEO NEWS
What's new in this fast-changing field.
David Lachenbruch22 EQUIPMENT REPORTS
Hameg HM8028 Spectrum Analyzer and Elenco Micro-Master 8000 Microprocessor Training System.61 HARDWARE HACKER
The science of Chaos.
Don Lancaster | <ul style="list-style-type: none">71 AUDIO UPDATE
The Audio Answerman strikes again!
Larry Klein73 SHORTWAVE RADIO
The future of shortwave broadcasting.
Stanley Leinwoll79 DRAWING BOARD
The world of video.
Robert Grossblatt81 EDITOR'S WORKBENCH
Floppy heaven.
Jeff Holtzman |
|---|--|

COMPUTER DIGEST



PAGE 81



The 1989 Annual Index begins on page 57.

AND MORE

- 108 Advertising and Sales Offices**
- 108 Advertising Index**
- 12 Ask R-E**
- 109 Free Information Card**
- 16 Letters**
- 92 Market Center**
- 26 New Products**
- 4 What's News**

ON THE COVER



Chances are you've already joined the hoards of people who have abandoned the long lines and high prices of local movie houses for the convenience and comfort of their favorite armchairs? Now, if only the films you watch on your VCR sounded as good as they look. . .

Enter our Acoustic Field Generator, which goes a couple of steps past the standard surround-sound decoder project. The apparent separation of the stereo image from the front speakers is greatly increased, while a center dialogue channel keeps the actors' voices realistically near the screen. The AFG is simple to connect into the pre-amp/power-amp loop of your home-entertainment system, and the built-in 75-Hz active low-pass filter provides a sub-woofer output. Turn to page 35.

COMING NEXT MONTH

THE FEBRUARY ISSUE GOES ON SALE JANUARY 2.

BUILD A FREQUENCY PROBE

Our easy-to-build, 100-MHz frequency counter is the size of a logic probe.

THE PRIVATE EYE

All about a new miniature display that promises to revolutionize the computer, videogame, and maybe even the TV marketplace.

BUILD A RADAR-DETECTOR TESTER

Is your radar detector working properly? Test it with our transmitter.

CIRCUIT COOKBOOK

How to use dual audio-preamplifier IC's for pre-amps, playback amps, audio mixers, filters, and more!

COMPUTER DIGEST

Get the construction details for the Port-A-Matic.

As a service to readers, RADIO-ELECTRONICS publishes available plans or information relating to newsworthy products, techniques and scientific and technological developments. Because of possible variances in the quality and condition of materials and workmanship used by readers, RADIO-ELECTRONICS disclaims any responsibility for the safe and proper functioning of reader-built projects based upon or from plans or information published in this magazine.

Since some of the equipment and circuitry described in RADIO-ELECTRONICS may relate to or be covered by U.S. patents, RADIO-ELECTRONICS disclaims any liability for the infringement of such patents by the making, using, or selling of any such equipment or circuitry, and suggests that anyone interested in such projects consult a patent attorney.

RADIO-ELECTRONICS, (ISSN 0033-7862) January 1990. Published monthly by Gernsback Publications, Inc., 500-B Bi-County Boulevard, Farmingdale, NY 11735 Second-Class Postage paid at Farmingdale, NY and additional mailing offices. Second-Class mail registration No. 9242 authorized at Toronto, Canada. One-year subscription rate U.S.A. and possessions \$17.97, Canada \$23.97, all other countries \$26.97. All subscription orders payable in U.S.A. funds only, via international postal money order or check drawn on a U.S.A. bank. Single copies \$2.25. © 1989 by Gernsback Publications, Inc. All rights reserved. Printed in U.S.A.

POSTMASTER: Please send address changes to RADIO-ELECTRONICS, Subscription Dept., Box 55115, Boulder, CO 80321-5115.

A stamped self-addressed envelope must accompany all submitted manuscripts and/or artwork or photographs if their return is desired should they be rejected. We disclaim any responsibility for the loss or damage of manuscripts and/or artwork or photographs while in our possession or otherwise.

Radio Electronics

Hugo Gernsback (1884-1967) founder
M. Harvey Gernsback,
editor-in-chief, emeritus

Larry Steckler, EHF, CET,
editor-in-chief and publisher

EDITORIAL DEPARTMENT

Brian C. Fenton, editor
Marc Spiwak, associate editor
Daniel Goodman, technical editor
Teri Scaduto, assistant editor
Jeffrey K. Holtzman,
computer editor
Robert Grossblatt, circuits editor
Larry Klein, audio editor
David Lachenbruch,
contributing editor
Don Lancaster,
contributing editor
Richard D. Fitch,
contributing editor
Kathy Campbell, editorial assistant

ART DEPARTMENT

Andre Duzant, art director
Injae Lee, illustrator
Russell C. Truelson, illustrator

PRODUCTION DEPARTMENT

Ruby M. Yee, production director
Robert A. W. Lowndes,
editorial production
Karen S. Tucker,
advertising production
Marcella Amoroso,
production assistant

CIRCULATION DEPARTMENT

Jacqueline P. Cheeseboro,
circulation director
Wendy Alanko,
circulation analyst
Theresa Lombardo,
circulation assistant
Michele Torrillo, reprint bookstore

Typography by Mates Graphics
Cover photo by Diversified Photo
Services

Illustration by Del Studios

Radio-Electronics is indexed in
Applied Science & Technology Index
and *Readers Guide to Periodical Literature*.

Microfilm & Microfiche editions are
available. Contact circulation depart-
ment for details.

Advertising Sales Offices listed
on page 108.



The
Audit
Bureau
of Circulation



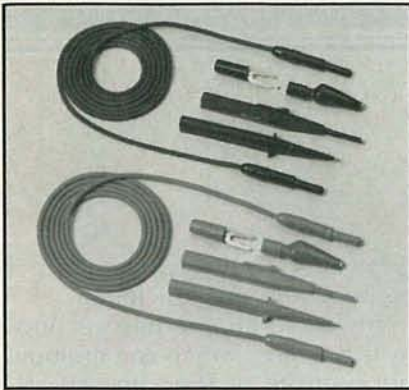

DELUXE TEST LEAD KIT

Users call TPI test leads **The Absolute Best**. The TLS2000 features the highest quality cable in the industry — with spring-loaded safety-sleeved plugs. U.L. listed (file E79581). Kit: \$29. Leads & probes only: \$19. Satisfaction guaranteed. **TEST PROBES INC.** Call toll-free for catalog: 1-800-368-5719.

CIRCLE 251 ON FREE INFORMATION CARD

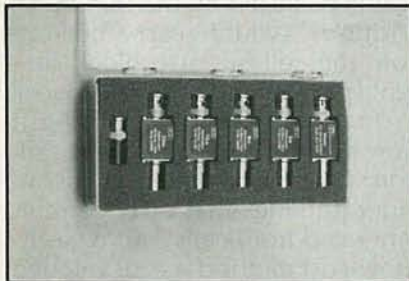

BNC ATTENUATOR KIT

Contains 4 attenuators — 3dB, 6dB, 10dB, 20dB; 1 feedthrough and 1 termination. Thick-film circuitry for low reactances. Rugged design resists shock and lasts longer. Rectangular shape stays put on the bench. **Impedance:** 50Ω **Frequency:** 1GHz. **Maximum Power:** 1kW peak, 1W avg. **VSWR:** 1.2:1. Attenuator Accuracy: ±0.2dB. Terminations Resistance Tolerance: ±1%. \$150.

TEST PROBES INC. Call toll-free for catalog: 1-800-368-5719.

CIRCLE 252 ON FREE INFORMATION CARD

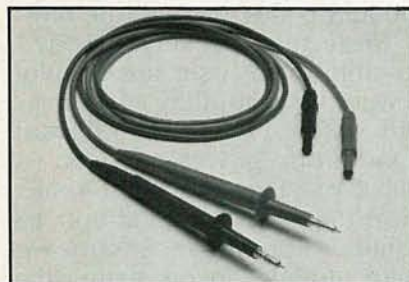

ECONOMICAL SILICON RUBBER TEST LEADS

Best value in moderately priced leads. High quality, soft, silicon rubber cable. Banana plug on measuring tip accepts push-on accessories. Plugs have spring-loaded safety sleeves. Model TL1000 \$14. Satisfaction guaranteed. **TEST PROBES INC.** Call toll-free for catalog: 1-800-368-5719.

CIRCLE 253 ON FREE INFORMATION CARD



COAX ADAPTER KIT

- Create any adapter in seconds
- Make all combinations of BNC, TNC, SMA, N, UHF, Mini-UHF, F and RCA

The TPI 3000A kit contains male and female connectors of all 8 types, and 6 universal interfaces. Simply screw any combination of 24 connectors to one of the interfaces to create the desired adapter. \$150.

TEST PROBES INC. 9178 Brown Deer, San Diego, California 92121. Call toll-free for catalog: 1-800-368-5719.

CIRCLE 250 ON FREE INFORMATION CARD



No Better Probe Ever at This Price!



CIRCLE 254 ON FREE INFORMATION CARD

Risetime less than 1.5 nsec.

- **Universal** - works with all oscilloscopes
- **Removable Ground Lead**
- **Excludes External Interference** - even on scope's most sensitive range
- **Rugged** - withstands harsh environments including high temperature and humidity
- **Advanced Strain Relief** - cables last longer
- **Available in 10x, 1x and switchable 1x-10x**
- **10 day return policy** - performance and satisfaction guaranteed

TEST PROBES, INC. 

9178 Brown Deer Road
San Diego, CA 92121
Toll Free 1-800-368-5719
1-800-643-8382 in CA

Call for free catalog and Distributor in your area

CIRCLE 123 ON FREE INFORMATION CARD

WHAT'S NEWS

20%-efficient solar module

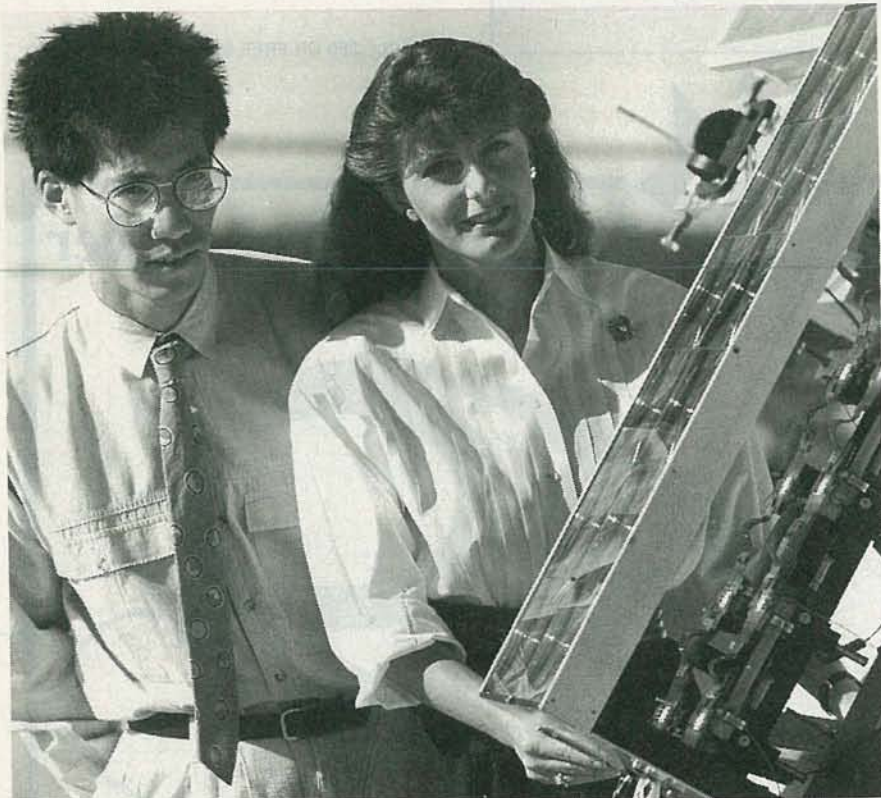

SANDIA RESEARCHERS CLEMENT CHIANG AND ELIZABETH RICHARDS show the experimental photovoltaic concentrator used to achieve a record-breaking 20.3 peak solar-to-electric conversion efficiency.

Twenty-percent efficiency might not be considered impressive in most instances, but when it means that 20% of the solar energy falling on a solar concentrator module is being converted directly into electric energy, that figure takes on new dimensions. The photovoltaic concentrator module developed by researchers at Sandia National Laboratories—an arrangement of 12 plastic lenses that concentrate sunlight to 100 times its normal

level onto 12 silicon solar cells—has achieved a peak solar-to-electric conversion of 20.3%.

The module incorporates a new silicon concentrator cell with up to 25% efficiency and a transparent cell cover molded directly to the cells to reduce gridline reflection losses. A new technique of soldering cells directly to copper heat spreaders reduces costs and improves performance and reliability, and an anti-reflective coat-

ing improves lens efficiency.

The key to the module's economy is the lens, which can multiply the intensity of the sun several-hundred times and focus it on a cell. The module uses an essentially module-ready, about half-inch square, low-resistivity cell that was developed by Martin Green at the University of New South Wales in Australia. A prismatic cell cover deals with the problem caused by the thin metal gridlines—which carry current from the cell but also block sunlight from falling on the silicon cell surface—by bending sunlight away from the gridlines to the silicon surface. That allows the use of wider gridlines that carry current, generated from cells, more easily. A low-cost method was developed for cleaning the surfaces and soldering them together, allowing the cells to be soldered directly to the heat spreader beneath them, eliminating a ceramic insulator that separates them in conventional modules. Finally, an anti-reflective layer of magnesium fluoride solution was applied to both surfaces.

According to Eldon C. Boes, supervisor of Sandia's Photovoltaic Technology Division, "Industry should be able to duplicate most of these features very quickly." Possible initial uses are in pilot power plants at utility companies and small, 10- to 1000-kilowatt stand-alone power systems. (A 1000-kW system will meet the electrical requirements of about 300 homes.) Boes expects concentrator modules incorporating the innovations to be on the market within about three years.

High quality AM sound

The National Association of Broadcasters and the Consumer Electronics Group of the Electronic Industries Association have agreed to enter a joint program to promote high-quality AM sound

using the standards of the National Radio Standards Committee or NRSC. The NRSC standards improve AM radio transmission and reception quality and reduce interference between stations, thus improving the quality of sound.

The first task for the groups is to establish a certification mark or logo that will be used on the faceplate of high-quality AM receivers that are equipped to comply with NRSC deemphasis and bandwidth specifications. **R-E**

WITH CIE, THE WORLD OF ELECTRONICS CAN BE YOUR WORLD, TOO.

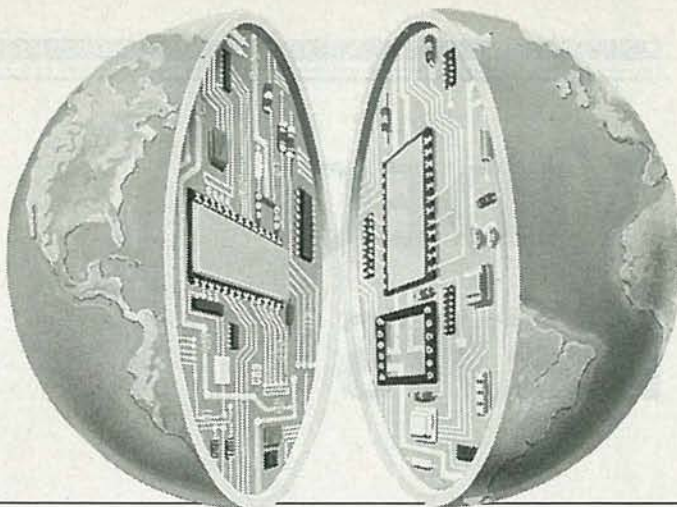

Look at the world as it was 20 years ago and as it is today. Now, try to name another field that's grown faster in those 20 years than electronics. Everywhere you look, you'll find electronics in action. In industry, aerospace, business, medicine, science, government, communications—you name it. And as high technology grows, electronics will grow. Which means few other fields, if any, offer more career opportunities, more job security, more room for advancement—if you have the right skills.

SPECIALISTS NEED SPECIALIZED TRAINING.

It stands to reason that you learn anything best from a specialist, and CIE is the largest independent home study school specializing exclusively in electronics, with a record that speaks for itself. According to a recent survey, 92% of CIE graduates are employed in electronics or a closely related field. When you're investing your time and money, you deserve results like that.

INDEPENDENT STUDY BACKED BY PERSONAL ATTENTION.

We believe in independent study because it puts you in a classroom of one. So you can study where and when you want. At your pace, not somebody else's. And with over 50 years of experience, we've developed proven programs to give you the support

such study demands. Programs that give you the theory you need backed with practical experience using some of the most sophisticated electronics tools available anywhere, including our Microprocessor Training Laboratory with 4K of random access memory. Of course, if you ever have a question or problem, our instructors are only a phone call away.



START WHERE YOU WANT, GO AS FAR AS YOU WANT.

CIE's broad range of entry, intermediate, and advanced level courses in a variety of career areas gives you many options. Start with the Career Course that best suits your talents and interests and go as far as you want—all the way, if you wish, to your Associate in Applied Science Degree in Electronics Engineering Technology. But wherever you start, the time to start is **now**. Simply use the coupon below to send for your FREE CIE catalog and complete package of career information. Or phone us, toll-free, at 1-800-321-2155 (in Ohio, 1-800-523-9109). Don't wait, ask for your free catalog now. After all, there's a whole world of electronics out there waiting for you.

CIE

Cleveland Institute of Electronics, Inc.
1776 East 17th Street, Cleveland, Ohio 44114

Member NHSC
Accredited Member National Home Study Council

ARE-156

CIE **Cleveland Institute of Electronics, Inc.**
1776 East 17th Street, Cleveland, Ohio 44114

YES... I want to learn from the specialists in electronics—CIE. Please send me my FREE CIE school catalog, including details about CIE's Associate Degree program, plus my FREE package of home study information.

Name (print): _____

Address: _____

City: _____ State: _____ Zip: _____

Age: _____ Area Code/Phone No.: _____ / _____

Check box for G.I. Bill bulletin on educational benefits:

Veteran Active Duty

**MAIL
TODAY!**

VIDEO NEWS



DAVID LACHENBRUCH,
CONTRIBUTING EDITOR

● **Zenith sticks with TV.** After a long and fruitless effort to sell its consumer-electronics business, Zenith, in a sudden move, agreed to sell its computer business to Groupe Bull of France. The company said that the move will enable it to strengthen its "original core business" of making and selling TV sets and its work on high-definition TV. The pioneering company now says that it is renewing its commitment to TV and video. Zenith plans to build on its longtime strengths in "consumer electronics and display technologies," according to President Jerry Pearlman. Since the sale of the RCA and GE television business to Thomson of France, Zenith has been the only major American-owned TV manufacturer.

● **LCD developments.** Japanese manufacturers and government agencies appear convinced that the liquid-crystal device will be the ultimate successor to the cathode ray tube as the direct-view and projection-display system for television. Two major Japanese-government-backed projects are aimed at that goal. JTV, a consortium consisting of 17 private companies with the backing of the Ministry of International Trade and Industry (MITI), has a goal of developing a 40-inch flat-screen color display with a resolution of 6,000,000 pixels. The other group, HDTEC, consists of five private firms and the Post Ministry, and is charged with developing a 50-inch rear-projection system with a resolution of 2,000,000 pixels and a light source four times the brightness of a CRT. HDTEC is capitalized at \$24,500,000; JTV, at \$20,000,000.

● **Pay to view as you fly.** The airlines have figured out a new way to keep you spending while you fly. Lockheed is demonstrating to its aviation customers an in-flight entertainment system consisting of a seat-back LCD color display—with a slot for credit cards. The system can provide eight channels of movies or video games that can be paid for by sliding a card through the slot. In addition, the system includes special films advertising products that can be ordered by touching the screen at the proper time and using the credit card. Before you can change your

mind—while the aircraft is still in flight—an on-board computer sends your order by satellite to an on-the-ground sales center, which tallies your bill for watching the movie and for any purchases and dispatches it to your home by mail—perhaps even before you land.

● **EDTV broadcasting starts.** "Clearvision," Japan's Extended-Definition TeleVision (EDTV) system is now being broadcast for five hours each day by many of that country's stations. The compatible system results in an improved picture on Clearvision television receivers without affecting the image on standard sets. The current "Phase I" Clearvision system, employing the standard 4:3 aspect ratio, involves the following improvements at the TV station: (1) better camera performance through the use of high-definition or progressive-scan cameras, with the improved signal downconverted to a standard interlaced NTSC-compatible signal; (2) gamma correction to improve color, particularly at high saturation levels; (3) picture sharpness and signal-to-noise ratio improved by "adaptive emphasis;" and (4) ghost-canceling reference signal.

Clearvision receivers improve the signal by using 3-D comb filters for Y/C separation, and use digital memory to convert the interlace picture to progressive scan. They might also have an optional ghost-reduction circuit, which eliminates ghosts by comparing the received waveform with the transmitted waveform carried on the reference signal (sent on line 18 of the vertical interval). Ghost reducers, which work with standard as well as Clearvision sets, are also available as add-on "black-box" attachments. The Japanese ghost-canceling system is one of several being explored for use in the United States (**Radio-Electronics**, *Video News*, November 1989).

Phase II of Clearvision is expected to use a widescreen 16:9 aspect ratio, extension of chrominance- and luminance-signal bandwidth, and PCM digital audio—without sacrificing compatibility. There's no timetable yet for that second phase.

R-E

HIGH PLACES



TIGHT SPACES



No matter where you go, Tek's new 222 is a perfect fit.

Introducing Tek's new 222 Digital Oscilloscope. Weighing in at under 4.5 pounds, the new Tek 222 is an ultra-portable, 10-MHz digital storage scope that's perfect for service applications. So tough, rugged, and totally self-contained, it can go just about anywhere. And it's incredibly easy to use—even in extreme conditions.

Extraordinary capability and reliability at a great price. The 222 is a dual-channel scope that can measure a wide variety of electronic instrumentation and circuitry. It has rechargeable on-board batteries with a floating ground to 400 volts, and meets tough environmental standards.



Plus, the 222 lets you pre-define front-panel setups, and call them up with a single button in the field. You can also save waveforms in the scope's memory, then transfer them to a PC for analysis and hard-copy output when you get back to the shop.

Best of all, the 222 is yours for only \$2350. And that includes Tek's remarkable three-year warranty on parts, labor, and CRT.

Get one to go! Pack a handful of power with you wherever you go. To order your 222, or for a free brochure, contact your local Tek representative or authorized distributor.

In a hurry? Call
1-800-426-2200.

No other training— anywhere—shows you service computers

Only NRI walks you through the step-by-step assembly of a powerful XT-compatible computer system you keep—giving you the hands-on experience you need to work with, troubleshoot, and service all of today's most widely used computer systems. With NRI at-home training, you get everything you need to start a money-making career, even a computer service business of your own.

No doubt about it. The best way to learn to service computers is to actually *build* a state-of-the-art computer from the keyboard on up. As you put the machine together, performing key tests and demonstrations at each stage of assembly, you see for yourself how each part of it works, what can go wrong, and how you can fix it.

Only NRI, the leader in career-building electronics training for more than 75 years, gives you such practical, real-world computer servicing experience. Indeed, no other training—in school, on the job, *anywhere*—shows you how to troubleshoot and service computers like NRI.

You get in-demand computer skills as you train with your own XT-compatible system—now with 20 meg hard drive and 640K RAM

With NRI's exclusive hands-on training, you actually build and keep the powerful new Packard Bell VX88 PC/XT compatible computer, complete with 640K RAM and 20 meg hard disk drive.

You start by assembling and testing the "intelligent" keyboard, move on to test the circuitry on the main logic board, install the power supply and 5- $\frac{1}{4}$ " floppy disk drive,

NEW!
Hard drive and voice synthesis training included!

then interface your high-resolution monitor. But that's not all.

Only NRI gives you a top-rated micro with complete training built into the assembly process

Your NRI hands-on training continues as you install the powerful 20 megabyte hard disk drive—today's most-wanted computer peripheral—included in your course to dramatically increase your computer's data storage capacity while giving you lightning-quick data access.

Having fully assembled your Packard Bell VX88, you take it through a complete series of diagnostic tests, mastering professional computer servicing techniques as you take command of the full power of the VX88's high-speed V40 microprocessor.

In no time at all, you have the confidence and the know-how to work with, troubleshoot, and service every computer on the market today. Indeed, you have what it takes to step into a full-time,

HARD DISK DRIVE
20 megabyte hard disk drive you install internally for greater disk storage capacity and data access speed.

DIGITAL MULTIMETER
Professional test instrument for quick and easy circuit measurements.

LESSONS
Clearcut, illustrated texts build your understanding of computers step by step.

SOFTWARE
Including MS-DOS, GW-BASIC, word processing, database, and spreadsheet programs.

PACKARD BELL COMPUTER
NEC V40 dual-speed (4.77 MHz/8 MHz) CPU, 640K RAM, 360K double-sided floppy disk drive.

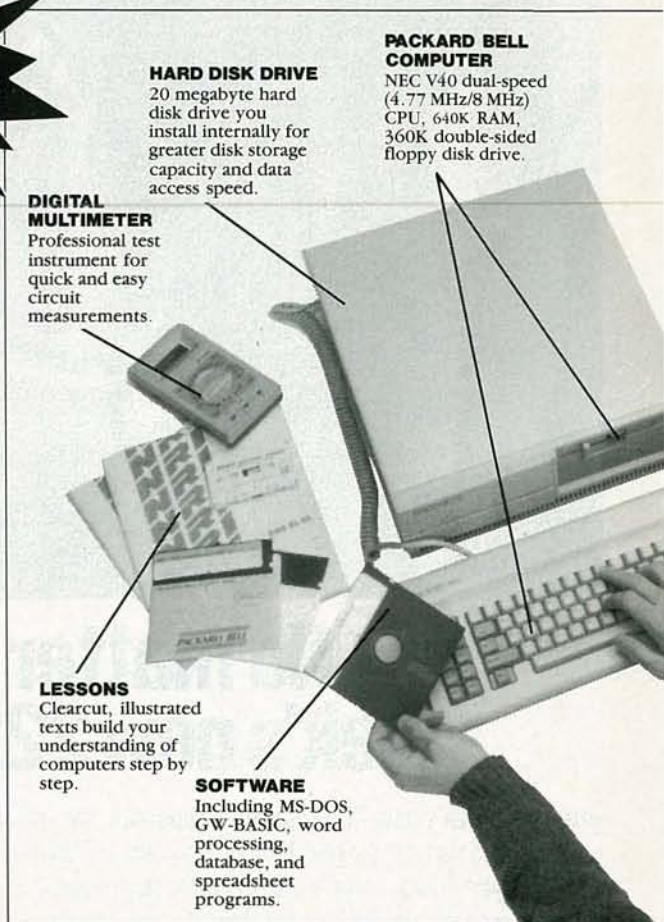

money-making career as an industry technician, even start a computer service business of your own.

New voice synthesis training adds an exciting new dimension to your computer skills

Now NRI even includes innovative hands-on training in voice synthesis, one of today's most exciting and widely applied new developments in computer technology.

You now train with and keep a full-featured 8-bit D/A converter that attaches in-line with your computer's parallel printer port.

in school, on the job, how to troubleshoot and like NRI

MONITOR

High-resolution, nonglare, 12" TTL monochrome monitor with tilt and swivel base.

TECHNICAL MANUALS

You get "inside" your Packard Bell computer system with exclusive NRI Training Kit Manuals plus technical specs direct from the manufacturer.

DISCOVERY LAB

Complete breadboarding system to let you design and modify circuits, diagnose and repair faults.

DIGITAL LOGIC PROBE

Gives you first-hand experience analyzing digital circuit operation.

one more way NRI gives you the confidence-building experience you need to feel at home with the latest advances in computer technology.

No experience needed, NRI builds it in

You need no previous experience in computers or electronics to succeed with NRI. You start with the basics, following easy-to-read instructions and diagrams, moving step by step from the fundamentals of electronics to sophisticated computer servicing techniques.

With NRI's unique Discovery Learning Method, you're sure to get the kind of practical hands-on experience that will make you fully prepared to take

advantage of every opportunity in today's top-growth field of computer service.

With NRI, you learn at your own pace in your own home. No classroom pressures, no night school, no need to quit your present job until you're ready to make your move. And all throughout your training, you have the full support of your personal NRI instructor and the NRI technical staff.

Your FREE NRI catalog tells more

Send today for your free full-color catalog describing every aspect of NRI's innovative computer training, as well as hands-on training in robotics, video/audio servicing, telecommunications, electronic music technology, and other growing high-tech career fields.

If the coupon is missing, write to NRI School of Electronics, McGraw-Hill Continuing Education Center, 4401 Connecticut Avenue, NW, Washington, DC 20008.

PC/XT and XT are registered trademarks of International Business Machines Corporation

Using your D/A converter along with the exclusive text-to-speech software also included, you explore the fascinating technology behind both digitized and synthesized computer speech.

You discover how you can use your computer to access and play back a variety of prerecorded sounds... you see how to add speech and sound effects to programs written in BASIC, C, Pascal, and others... you even learn how to produce high-quality speech directly from your own original printed text.

NRI's exclusive new hands-on training in voice synthesis is just

NRI School of Electronics

McGraw-Hill Continuing Education Center
4401 Connecticut Avenue, NW
Washington, DC 20008



For career courses approved under GI Bill

check for details

CHECK ONE FREE CATALOG ONLY

- | | |
|--|--|
| <input type="checkbox"/> Computers and Microprocessors | <input type="checkbox"/> Security Electronics |
| <input type="checkbox"/> Robotics | <input type="checkbox"/> Electronic Music Technology |
| <input type="checkbox"/> TV/Video/Audio Servicing | <input type="checkbox"/> Basic Electronics |
| <input type="checkbox"/> Computer Programming | <input type="checkbox"/> Telecommunications |

Name _____ (Please Print) _____ Age _____

Address _____

City/State/Zip _____ Accredited Member, National Home Study Council 3-010

ASK R-E

WRITE TO:

ASK R-E
Radio-Electronics
500-B Bi-County Blvd.
Farmingdale, NY 11735

BINARY CODING

I've seen lots of information on how numbers are encoded in binary and I've come across IC's that convert one system to the other. What is not clear to me is how binary is used to represent the characters of the alphabet. How is it done and are there any IC's around that can do that?—N. Cohen, Hagerstown, Maryland

You're asking a really basic question, so it seems that you're a bit confused about basic issues. There are quite a few books that do a good job of introducing readers to the standards that have been adopted for number systems and how they're used to encode data. Since you already understand how numbers are represented in binary, you won't have any trouble understanding how the same thing is done with alphabetic characters.

There's a direct relationship between the decimal representation of numbers and their binary counterparts. You can see that in Table 1.

In binary, only two symbols (1 and 0) are used while ten (0 to 9) are used in decimal. The binary symbols are referred to as "bits," and the decimal symbols are referred to as "numbers."

Somewhere back in pre-history, it was decided that eight bits would be referred to as a "byte," and that a different byte would be used to encode each of the characters of the alphabet, the numbers, and the standard punctuation symbols. Each symbol was assigned to a unique two-byte value—an upper-case "A" would be represented by the two bytes 0100 0001 (or 65 decimal), the number "3" would be given the two bytes 0011 0011 (or 51 decimal), and so on. The standard codes became known as "ASCII" (pronounced "as-key," for American Standard Code for Information Interchange), and they are still used as the basis of all data transmission and digital technology.

Since the major use for the ASCII standard was initially in sending information over teletypes, several places in the two-byte table were reserved for additional codes to control the teletype machines as well as make sure that information was transmitted without errors. A "Line Feed" became a 0000 1010 (or 10 decimal), and a "Carriage Return" was a 0000 1101 (or 13 decimal).

You can find a complete ASCII table in most computer manuals or any good book on data transmission. What you'll notice is that only half of the table is used. Even though the two-byte table has room for 256 entries, only the first 128 are used for the standard symbols and the control codes—the upper half of the standard table is empty. The reason for that is that while only seven bits (128 places) were needed to accommodate all the required characters, most digital

technology was built around the idea of eight-bit data.

When computers started becoming popular in the late seventies, the eighth bit in the two-byte table was used by hardware manufacturers to convey extra information. The Apple computer, for example, used the eighth bit to indicate how the character would appear on the screen—normal, inverse, or flashing. Other manufacturers, such as IBM, used the top half of the table to house an "extended ASCII" character set. Those include some foreign-language characters, graphics symbols, and other non-standard things that are unique to the IBM character set.

One of the things that's probably confusing you is the difference between a character's symbol and its value. The number 7, for example, has a particular arithmetic value (one more than 6), but the ASCII character set doesn't deal with arithmetic—it's only used to convey character symbols, not values. The numerical value of 7 can be represented by using "7," "0111," or even "VII." The symbols may be different but they're all being used to represent the same number.

Binary-to-decimal number conversion is such a common job that there are several standard IC's designed specifically for that purpose; a 4514, 74154, and other chips will take a binary input and give you a decimal output.

Converting binary representations of ASCII characters to alphabetic symbols means using "Character Generators." They

TABLE 1

BINARY	DECIMAL
0000	0
0001	1
0010	2
0011	3
0100	4
0101	5
0110	6
0111	7
1000	8
1001	9
and so on	

Radio Shack Parts PlaceSM

OUR 69th YEAR OF BARGAINS FOR BUILDERS!

Parts Special-Order Hotline

No Minimum Order



Your Radio Shack store manager can special-order a wide variety of parts and accessories from our warehouse, including vacuum tubes, ICs, microprocessors, phono cartridges and styli, crystals, even SAMS PhotofactsSM. There's no minimum order, no postage or handling charges. Fast delivery to our store near you!

New! Battery Hotline Service



In addition to our large in-store stock, Radio Shack can now supply almost any currently manufactured battery—even special types. There's no postage or handling charge. Delivery to your nearby Radio Shack!

Build it Better With Archer[®] Tools

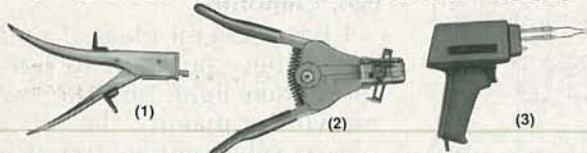

- (1) Nibbling Tool. Chassis holes and car stereo installation made easy! Neatly cuts up to 18-gauge steel. #64-823 **10.95**
- (2) "Pro" Wire Stripper. Our best! This high-quality tool gives you perfect strips every time on 8 to 22-gauge wires. #64-1919 **11.95**
- (3) 100-Watt Soldering Gun. UL listed AC. #64-2193 **10.95**

Computer RS-232 Connections



Fig.	Description	Cat. No.	Only
1	D-Sub 9 Male	276-1537	.99
2	D-Sub 9 Fem.	276-1538	1.99
3	Metal Hood	276-1508	2.19
..	D-Sub 25 Male	276-1547	1.49
..	D-Sub 25 Fem.	276-1548	2.49
..	Metal Hood	276-1510	2.79

- (4) 9-Cond. Double-Shielded Cable. #278-775 .. Per Foot **59¢**
- (5) 25-Cond. Double-Shielded Cable #278-776 Per Foot **1.19**
- (5) RS-232 Tester. Connect in line and dual-color LEDs help you pinpoint line problems. D-sub 25. #276-1401 **14.95**

Temp Module



Prewired, use "as-is" for a thermometer or add simple support parts to build a controller or alarm. With circuit data. LCD display. #277-123, **19.95**

More Bargains!

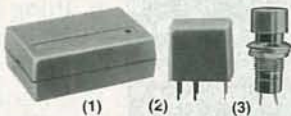

- (1) Box/Board. With 2 x 3 1/8" PC board. #270-291 **4.99**
- (2) SPDT 1A Micro Relay. 12VDC coil. #275-241 **1.99**
- (3) SPST Push On/Push Off Switch. #275-011 **1.39**

PC-Board Kit



995

Two blank boards, pen, solvent, etchant, layout resist strips, tank, drill bit and complete instructions. #276-1576

Etch Your Own Boards!

Add Action



- (1) Mini DC Motor. Requires 1 1/2 to 3VDC. #273-223 .. **99¢**
- (2) Mini Piezo Buzzer. Only 7 mA 12VDC. #273-074 .. **2.99**
- (3) Jumbo 5000 mcd LED. Big, bright! #276-086 ... **4.99**

Solar Values

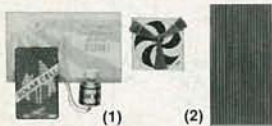

- (1) Solar Fun Kit. With solar cell, motor and project book. #277-1201 **10.95**
- (2) 2 x 4 cm Solar Cell. Top quality! Rated 0.3A, 0.55VDC in full sun. #276-124 ... **3.95**

Factory-Fresh ICs



Low As **79¢**

Device	Cat. No.	Only
741 Op Amp	276-007	.79
1458 Dual Op Amp	276-038	.99
LM324 Quad Op Amp	276-1711	.99
555 Timer IC	276-1723	1.19

Unusual Parts



- (1) Low-pF Capacitor Kit. Set of 50. #272-806 Set, **2.99**
- (2) Thermistor. Range is -50 to +110° C. #271-110 **1.99**
- (3) 1:1 Audio Transformer. Z: 600-900Ω. #273-1374 **3.59**

Chime/Alarm

24⁹⁵
Mounts On Door



Easy to install and has two modes: super-loud alarm or a pleasant chime to announce guests or customers. Keyboard arming. Battery extra. #49-422

General Ham Course



19⁹⁵

Radio Shack's General Class FCC License Preparation Package makes it easy to upgrade from novice or technician class. Includes sample questions, correct answers and full explanations, two speed-building code cassettes and sturdy binder. #62-2404

Extra-Feature DVM

NEW! 79⁹⁵

Here is everything you'd expect in a quality digital volt-ohmmeter PLUS capacitance and transistor-gain ranges! Easy-to-read 0.5" LC display. Measures AC/DC volts and current, resistance, capacitance and transistor gain. With probes and manual. #22-194



Breadboard & Jumpers



- (1) Deluxe Breadboard. Molded 2 1/4 x 6 1/2" board is mounted on a 7 x 4" steel base with rubber feet. Features 640 plug-in points and three binding posts. #276-169 **19.95**
- (2) NEW! Breadboard Jumper Wire Kit. Includes 140 insulated, pre-stripped wires in a snap-shut plastic box. #276-173 ... Set **4.95**

Over 1000 items in stock! Binding Posts, Books, Breadboards, Buzzers, Capacitors, Chokes, Clips, Coax, Connectors, Fuses, Hardware, ICs, Jacks, Knobs, Lamps, Multitesters, PC Boards, Plugs, Rectifiers, Resistors, Switches, Tools, Transformers, Transistors, Wire, Zeners, More!

Prices apply at participating Radio Shack stores and dealers

Radio Shack
The Technology StoreSM

A DIVISION OF TANDY CORPORATION

CIRCLE 78 ON FREE INFORMATION CARD

JANUARY 1990

are just memory IC's that have been programmed with the ASCII character set. They take binary values at their input and present the ASCII equivalent code at their output. Chips like a 4511, or others designed to drive seven-segment LED displays, convert binary data to information you can use to directly display ASCII characters.

Remember that there's a difference between the value of a number and the character used

to represent it—one has nothing to do with another. As a matter of fact, that kind of confusion can only come about when you talk about numbers since they're the only members of the ASCII character set that have an absolute arithmetic value. The letters, punctuation marks, and control codes that make up the rest of the standard ASCII set may be able to convey lots of meaning, but you can't use them to balance your checkbook.

2N2222 AND GATE

I learned the basics of digital electronics in the navy, and have even made basic gates from discrete components. At the moment, I'm trying to hook up a third brake light that will light up when the other two light. I need an AND gate to do the job but I'm not sure how to build one with individual components. I haven't experimented yet, but I don't think I can do the job with a pair of 2N2222's and some resistors. Do you have any ideas?—V. Sandoval, San Diego, California

I have several ideas. I understand that you want to light a third brake light, but it seems to me you're making the job unnecessarily complicated. While there's no electronic reason why you can't build an AND gate out of discrete hardware, it seems like a lot of extra work. Of course, there's no rule about that sort of thing and one nice thing about re-inventing the wheel is that you really learn how the wheel works.

One way to do it is shown in Fig. 1. The transistors are operating as simple switches, and when both of your existing tail lights are on, you'll wind up with voltage across the third tail light. I seriously doubt that you can get by with a

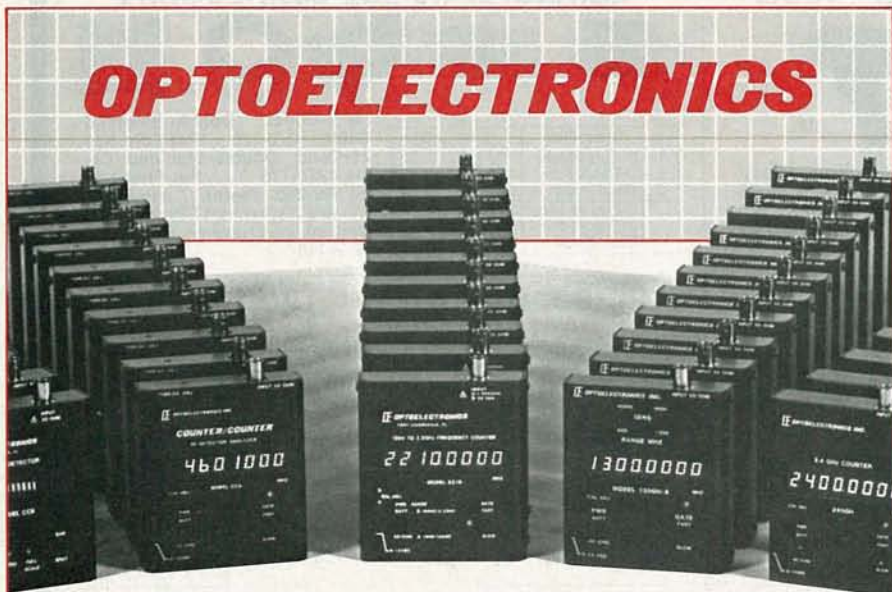

You Have Counted on Us for 15 Years

You have counted on OPTOELECTRONICS Hand Held Frequency Counters to be the best quality, to be affordable and reliable. We have been there for you with Frequency Counters that are compact and ultra sensitive.

And more and more of you are counting on us, technicians, engineers, law enforcement officers, private investigators, two-way radio operators, scanner hobbyists, and amateur radio operators, just to name a few.

Hand Held Series Frequency Counters and Instruments

MODEL	2210	1300H/A	2400H	CCA	CCB
RANGE: FROM TO	10 Hz 2.2 GHz	1 MHz 1.3 GHz	10 MHz 2.4 GHz	10 MHz 550 MHz	10 MHz 1.8 GHz
APPLICATIONS	General Purpose Audio-Microwave	RF	Microwave	Security	Security
PRICE	\$219	\$169	\$189	\$299	\$99
SENSITIVITY					
1 KHz	< 5 mv	NA	NA	NA	NA
100 MHz	< 3 mv	< 1 mv	< 3 mv	< .5 mv	< 5 mv
450 MHz	< 3 mv	< 5 mv	< 3 mv	< 1 mv	< 5 mv
850 MHz	< 3 mv	< 20 mv	< 5 mv	NA	< 5 mv
1.3 GHz	< 7 mv	< 100 mv	< 7 mv	NA	< 10 mv
2.2 GHz	< 30 mv	NA	< 30 mv	NA	< 30 mv

ACCURACY ALL HAVE +/- 1 PPM TCXO TIME BASE.

All counters have 8 digit red .28" LED displays. Aluminum cabinet is 3.9" H x 3.5" x 1". Internal Ni-Cad batteries provide 2-5 hour portable operation with continuous operation from AC line charger/power supply supplied. Model CCB uses a 9 volt alkaline battery. One year parts and labor guarantee. A full line of probes, antennas, and accessories is available. Orders to U.S. and Canada add 5% to total (\$2 min, \$10 max). Florida residents, add 6% sales tax. COD fee \$3. Foreign orders add 15%. MasterCard and VISA accepted.

Orders to U.S. and Canada add 5% to total (\$2 min, \$10 max). Florida residents, add 6% sales tax. COD fee \$3. Foreign orders add 15%. MasterCard and VISA accepted.

OPTOELECTRONICS INC.

5821 N.E. 14th Avenue • Fort Lauderdale, Florida 33334
1-800-327-5912 FL (305) 771-2050 FAX (305) 771-2052

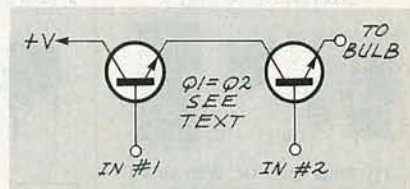

FIG. 1

pair of 2N2222's, because most automotive bulbs draw much more current than can be handled by a small-signal NPN. You can either use beefier transistors or, if you want to complicate your life even further, you can have the transistors drive a relay with contacts rated for a high enough current.

The relay isn't such a bad idea since driving the bulb directly with the transistors will leave you with a working voltage of some 1.2 volts less than battery voltage. Remember that you're going to lose about 0.6 volts through each of the transistors. If you use a relay, you'll be able to power the third bulb directly off the battery.

continued on page 99

TAB The Electronics Book Source



NEW
Computer Technician's Handbook—3rd. Ed.

by A. Margolis.
 Repair components and systems, perform routine maintenance, and diagnose defective equipment with this completely revised edition of the popular bestseller on microcomputers. 590 pp., 409 illus.
 #3279H, \$34.95

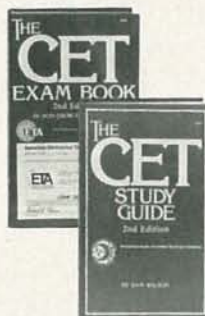

Pass the Associate and Journeyman Exams with Flying Colors and Save \$10 on the Set!

The CET Exam Book—2nd Ed.
 by R. Crow and D. Glass
The CET Study Guide—2nd Ed.
 by S. Wilson
Two-Volume Set (#5300C)
 Yours for \$35.90 (regularly \$45.90)

Save 15% and Build, Build, Build!

49 Battery-Powered One-IC Projects by D.T. Horn.
 168 pp., 153 illus.

49 Battery-Powered Two-IC Projects by D.T. Horn.
 126 pp., 125 illus.

Two-Volume Set (#5381C)
 Yours for \$31.95! (regularly \$37.90)



NEW

SAVE \$15

International Encyclopedia of Integrated Circuits by S. Gibilisco.

Take advantage of the latest foreign and domestic IC technologies. Create circuits for any job, project, gadget, and device imaginable using over 4500 pinouts, diagrams, and schematics. 1200 pp., illustrated
 #3100H, \$59.95 (regularly \$75.00)



The 8088 Project Book by R. Grossblatt. Design and construct an 8088 computer and 17 hardware and software enhancements! 264 pp., 125 illus.
 #3171H, \$27.95

Troubleshooting and Repairing the New Personal Computers by A. Margolis. Save time... earn hundreds of dollars! 416 pp., 350 illus.
 #2809H, \$27.95

Build Your Own Universal Computer Interface by B. Chubb. Use your computer to control almost anything! 285 pp., 224 illus. #3122H, \$27.95

Build Your Own 80386 and Save a Bundle by A. Pilgrim. Get power and efficiency at a down-to-earth price! 232 pp., 84 illus. #3131H, \$24.95

General Radiotelephone Operator's License Study Guide—2nd Ed. by T. LeBlanc, NX7P. Get the edge you need to pass this important test! 259 pp., 125 illus. #3118H, \$23.95

How to Draw Schematics and Design Circuit Boards with Your IBM PC by S. Sokolowski. Perform computer-aided engineering for a fraction of the cost! 187 pp., 113 illus. #3034H, \$19.95

Build the Ultimate in High-Tech Projects—Save 20% on the Set!

Experiments in CMOS Technology
 304 pp. 249 illus., #3062H, \$24.95

Experiments in Gallium Arsenide Technology
 256 pp., 177 illus., #3052H, \$24.95

Experiments with EPROMS 240 pp., 218 illus., #2962H, \$24.95

Three-Volume Set (#5356C) Only \$59.88
 (regularly \$74.85)

BESTSELLERS

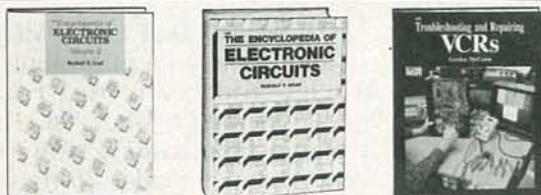

Save Over \$10 on the Complete Circuit Library!
Order Volumes 1 & 2 for Only \$49.95 (#5376C)
 (regularly \$59.90)

The Encyclopedia of Electronic Circuits—Vol. 1 by R. Graf. Get hundreds of different circuits in one handy guide! 768 pp., 1762 illus. No. 1938P, \$29.95

The Encyclopedia of Electronic Circuits—Vol. 2 by R. Graf. 700+ circuits you'll use again and again! 744 pp., 728 illus. #3138P, \$29.95

Troubleshooting and Repairing VCRs by G. McComb. Save money or make money doing VCR repairs! 336 pp., 200 illus. #2960H, \$27.95

TO ORDER, Call Toll Free: 1-800-822-8158

(in PA and AK call 1-717-794-2191) or mail coupon to:
 TAB BOOKS Inc., Blue Ridge Summit, PA 17294-0840

Please send me the book(s) below.

No. _____ Price _____ No. _____ Price _____ No. _____ Price _____

PA, NY, and ME residents add applicable sales tax
 (Outside the U.S. add \$5.00 shipping & handling.)

TOTAL _____

Check or money order enclosed (made payable to TAB BOOKS Inc.)
 Charge my VISA MasterCard American Express

Acct. No. _____ Exp. _____

Signature _____

Name _____

Address _____

City/State/Zip _____

Offer good until March 1, 1990

Satisfaction Guaranteed—If you are not satisfied, return the books for a complete refund. RE 190

CIRCLE 146 ON FREE INFORMATION CARD

LETTERS

HELPFUL HINTS

I would like to offer some comments and suggestions concerning some recent items in **Radio-Electronics**.

First, a better way to control a pump than that presented in *Ask R-E* (November 1989) is to use the LM 1830 fluid-detector IC. Its advantages over a simple transistor circuit are fully described in the National Semiconductor *Linear Databook*, along with typical circuits, etc. The most important of those advantages is that the LM 1830 uses a very low-level AC signal (typically 7 kHz) for the sensing function, which eliminates the "plating" that can and does occur over a long period with DC signals. It can control a low-current relay directly, a larger relay via an intermediate transistor, and a triac or quadac via simple intermediate circuitry. I have used that IC and associated components to control a pump that removes water from an area subject to flooding during heavy rains, and as a much more reliable alternative to the high-priced (but poor quality) switches sold to control 12-volt bilge pumps in boats.

Concerning the infrared-controlled A/B switch (**Radio-Electronics**, October 1988), relay switching is enhanced by using a double-pole-double-throw RF relay that connects the input that is not being used to a 75-ohm load resistor. That both improves isolation and avoids any problems that a mismatch could cause.

The Radio Shack 276-137 detector module (\$3.49) is convenient to use for IR controllers. It includes an IR phototransistor, amplifier, filter, and detector in a small PC-mountable package. The IR source should be turned on and off at a

40-kHz rate. That 40-kHz signal should then be pulsed at an audio rate. The output of the Radio Shack detector is the audio rate. It is detected by one or more 567 tone-detector chips. The transmitter is, conveniently, a 556 dual timer. One half of it operates at 40 kHz to drive the IR emitter diode (or, preferably, two diodes in series). The other half operates at the audio rate and pulses the 40-kHz oscillator via its reset pin.

I built a circuit that allows me to select one of three sources (A, B, or C) using two RF relays and small SCR's for latching. Instead of simply toggling back and forth between signals, the receiver has three 567 tone decoders and the logic to select the desired source corresponding to the tone sent by the IR transmitter. The modulation frequency in the hand-held transmitter is selected by pressing one of three buttons. All three buttons turn on both halves of the 567; two of them also control diode switches to change the audio-modulation frequency. Simple diode logic allows the use of single-pole push-buttons. The audio-modulating frequencies are about 700, 1000, and 1300 Hz. When a button is pressed, the one desired is selected by means of diode switches that change the capacitor value in the half of the 556 used in the transmitter to generate the audio tone. The frequencies are not accurately adjusted; the 567 tone decoders are tuned to whatever the modulating frequencies happen to be with the capacitors used in the transmitter. L.D. THOMAS
Georgetown, DE

NTSC/PAL VCR CONVERSIONS

I read a letter in a recent issue of **Radio-Electronics** that discussed



the possibility of converting PAL VCR tapes to NTSC. That is a major dilemma for servicemen stationed in Europe. Here we sit with American TV's and VCR's, unable to watch EURO-TV or rent PAL VCR tapes. To do so we must purchase another TV and VCR in PAL format.

I have searched here in England for a converter device, as the EURO-TV presents American TV shows. There is such a "black box" that has extras required for professional broadcasting (color and sound mixing, enhancers, etc.)—but it costs about \$2500. I would like to find one that just converts either the RF signal or the video and audio signals between PAL and NTSC.

I have also found a Motorola chip, the MC1377P, that converts a video RGB signal to a switchable NTSC/PAL composite signal. I have tried to find a way, but I can't find the solution to make it work.

Could you possibly run an article on the merits or disadvantages of doing that, and maybe a design for a do-it-yourself kit?

CHARLES MAY, TSgt USAF
RAF Alconbury, UK

AUTOMATIC TEST EQUIPMENT

I appreciate your publishing my article, "Automatic Test Equipment," in the October 1989 issue of **Radio-Electronics**. However, some changes made during editing might give readers some erroneous impressions.

A computer and a controller are mentioned, on page 61, as being separate parts of an ATE. Actually, they are one and the same, as stated in my manuscript. The computer controls things in the ATE.

Figure 1 in the article is mislabeled, giving the impression that the ATE is to the bottom of the

dashed lines. The ATE is actually the portion that is shown above the dashed lines. The portion below the dashed lines and the two interface rectangles is the outside world.

Finally, the next-to-last paragraph on page 62 states that functional testers test signals at UUT inputs. In reality, they apply test signals at UUT inputs, and then check the response at the UUT output.

Although the differences are minimal, I felt you and your readers would want to know about them.

ALLAN C. STOVER

CHEMICAL CONFUSION

I appreciate Robert Grossblatt's series of articles on printed circuit-board construction (*Designer's Notebook*, October–December 1989), and I'd like to pass on some information that might benefit other readers. The Kodak chemicals described in the November 1989 column are no longer carried by Kodak. Apparently Kodak sold the division that produces those chemicals to Union Carbide, who placed them in their own KTI division. KTI sells only through distributors and only one of those distributors sells the chemicals in small quantities.

The bottom line is that a company in Pennsylvania called PCE (why do chemical companies always use initials?) will sell to individuals. Their phone number is 215-296-8585. They accept American Express or ship UPS-COD. The prices are roughly \$61.00 for one quart of photo resist, \$30.00 for the developer, and \$7.00 for the booklet. The catalog numbers in the article haven't changed. PCE carries a wide variety of chemicals, so it is important to have the catalog numbers in hand when placing an order.

Thanks for your efforts to keep the hobbyist informed. I look forward to finally making quality printed-circuit boards. Keep up the good work.

DR. BARRY C. MEARS
Florissant, MO

FAX-MATE FACTS

It has come to our attention that there are a few errors concerning

the Fax-Mate article (*Radio-Electronics*, October, 1989). In the schematic of Fig. 2, R3 should be moved into the feedback loop of IC1, and the primary (right side) and secondary (left side) of T1 were not labelled. In the parts-placement diagram of Fig. 3, the labels of the primary and secondary sides of T1 should be transposed. That's because T1 is actually being used in reverse; a voltage input to the *secondary* is stepped up and output at the *primary*.—*Editor*

IR REMOTE EXTENDER

If you built the IR remote-control extender (*Radio-Electronics*, May 1989), and noticed noise or snow on your TV screen when using the device, a 0.1- μ F ceramic-disc capacitor connected between the intersection of D1 and R6 and ground will cure the problem. Other problems with the unit's operation may be caused by a poorly regulated +9-volt DC supply (which is often true with many of the inexpensive plug-in power adapters). The addition of a 9-volt Zener diode across the +9-volts (cathode to positive, anode to negative) will eliminate the possibility of any power-supply related problems.—*Editor*

DIGI-COMPASS

Certain errors made their way into the Digi-Compass story (*Radio-Electronics*, November, 1989). In the schematic of Fig. 3, the labels V_{CC} and V_{DD} should be transposed, and V_{DD} should be 6.8 volts instead of 6.5. Also, the two voltages are outputs, and should therefore have open circles instead of arrows. The labels for pins 2 and 3 of IC3 should also be transposed; pin 2 is INP and should be connected to IC2 pin 7, and pin 3 is REF- and should be connected to IC2 pin 8. On page 51, in the right-hand column toward the bottom of the page, the text states that "the number of data acquisition averages can be changed by pushing the '.,' keys." It should have read "by pushing the ">" and "<" keys." And, last, on page 82, "TEXTCOMPLPTn10" should contain spaces between arguments; it should be written as "TEXTCOMP LPTn 10."—*Editor*

R-E

NEW SUPER LONG PLAY TAPE RECORDERS

12 Hour Model — \$119.00*
USES D-120 TAPE

Modified Panasonic Slimline, high quality, AC-DC Recorders provide 6 continuous hours of quality recording & playback on each side of cassette for a total of 12 hours. Built-in features include:
• Voice level control • Digital counter, etc. TDK DC 120 Cassette Furnished.



PHONE RECORDING ADAPTER

Records calls automatically. All Solid state connects to your telephone jack and tape recorder. Starts recording when phone is lifted. Stops when you hang up. FCC APPROVED



VOX VOICE ACTIVATED CONTROL SWITCH
Solid state. Self contained. Adjustable sensitivity. Voices or other sounds automatically activate and control recorder. Uses either recorder or remote mike. FCC APPROVED



*Add for ship & hdlg. Phone Adapter & Vox \$1.50 ea. Recorders \$4.00 ea. Cal. Res. add tax. Mail order, VISA, M/C, COD's OK. Money Back Guarantee. Qty. disc. avail.. Dealer Inquiries invited, Free data. © AMC SALES INC. Dept. A9335 Lubec St., Box 928, Downey, CA 90241 Phone (213) 869-8519

CIRCLE 108 ON FREE INFORMATION CARD

Be an FCC LICENSED ELECTRONIC TECHNICIAN!



Learn up to \$30 an hour and more!
Learn at home in spare time. No previous experience needed!

No costly School. No commuting to class. The Original Home-Study course prepares you for the "FCC Commercial Radio-telephone License". This valuable license is your "ticket" to thousands of exciting jobs in Communications, Radio-TV, Microwave, Computers, Radar, Avionics and more! You don't need a college degree to qualify, but you do need an FCC License. **No Need to Quit Your Job or Go To School** This proven course is easy, fast and low cost! **GUARANTEED PASS** — You get your FCC License or money refunded. **Send for FREE facts now. MAIL COUPON TODAY!**

COMMAND PRODUCTIONS
FCC LICENSE TRAINING, Dept. 90
P.O. Box 2824, San Francisco, CA 94126
Please rush FREE details immediately!
NAME _____
ADDRESS _____
CITY _____ STATE _____ ZIP _____

JANUARY 1990

17

BEST FOR LO

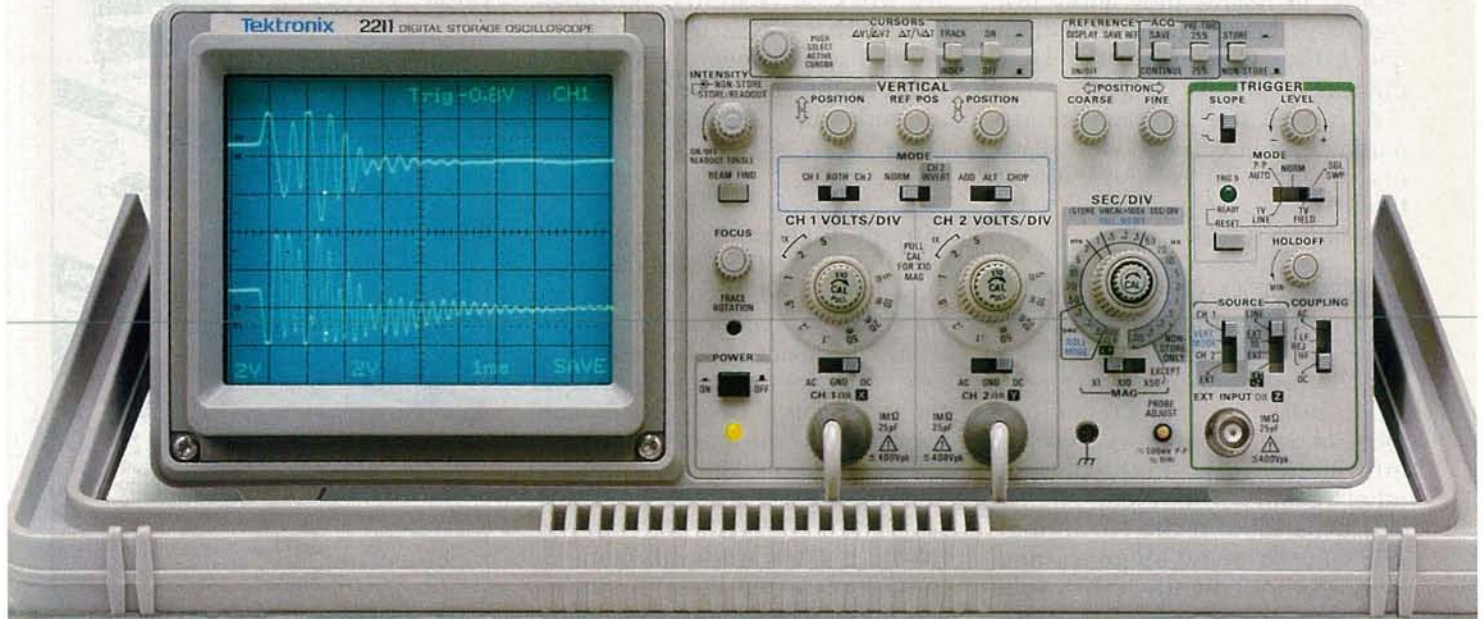

Tek's new 50 MHz 2211 gives you more measurement power for the money than any scope in its class. If you want the performance of an expensive digital scope, but not the cost, our new 2211 is the perfect solution. It represents Tek know-how and quality at its affordable best.

It combines powerful 20 MS/s digital sampling with the familiar operation of an analog scope. In digital storage mode you can capture and display single-shot events, see what happened before a trigger event, or compare newly-acquired signals to a stored waveform.

And if you need to analyze fast or complex signals in real time, simply switch to analog mode with the push of a button.

Productivity-enhancing features are in abundant supply. For instance, all measurements and front-panel scale factors appear on the CRT. Waveform cursors automatically calculate time and voltage. A 4K record length and X50 magnification give you excellent timing resolution, plus analog-quality displays. And trigger levels can be read directly on the screen.

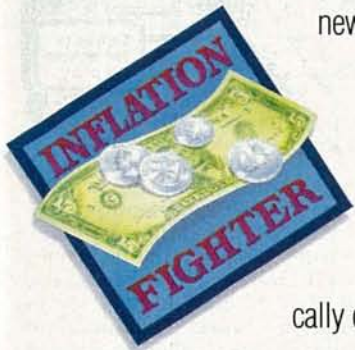

Copyright © Tektronix, Inc. 1989 *Prices subject to change and valid in U.S. only. Educational discounts available on request.

LOW-COST TEST

There's even a standard hardcopy interface that lets you connect the 2211 to Epson printers or HPGL-compatible plotters, such as the Tek HC100, for convenient automatic 4-color documentation.

Of course, the true indication of why the 2211 is "best for low-cost test" is price: it's only **\$2495**. A sum that includes Tek's remarkable 3-year warranty on all parts and labor—even the CRT.

**Three
value-packed
companions
starting at
\$695.**

Model Number	2211	2201	2225	2205
Bandwidth	50 MHz	20 MHz	50 MHz	20 MHz
Storage Bandwidth	1 MHz	1 MHz	N/A	N/A
Sample Rate	20 MS/s/ch	10 MS/s/ch	N/A	N/A
Vert. Sensitivity	500 μ V/div	5 mV/div	500 μ V/div	5 mV/div
Cursors/Readout	Yes	No	No	No
Hardcopy Interface	Yes	Option	No	No
Record Length	4K/ch	2K/ch	N/A	N/A
Vertical Resolution	8 bit	8 bit	N/A	N/A
Price*	\$2495	\$1495	\$1095	\$695



For low-cost testing from 20 to 50 MHz, Tek has the best line-up in the business.

There's the 50 MHz 2225, which offers superb vertical sensitivity, delay, and horizontal magnification up to X50 for only **\$1095**. The 20 MHz, 10 MS/s 2201 is an economical introduction to digital storage at **\$1495**. And for reliable, ultra low-cost analog measurement, get the 20 MHz 2205 for an incredible **\$695**.

It's easy to get the best. To order your low-cost Tek oscilloscope or get more information, contact your local Tek representative. Or call Tek direct at:



1-800-426-2200

Tektronix
COMMITTED TO EXCELLENCE

EQUIPMENT REPORTS

Elenco Micro-Master 8000 Computer System Course

Learn computer theory,
construction, and
programming with hands-
on experience.

CIRCLE 45 ON FREE INFORMATION CARD



THERE IS, PERHAPS, NO BETTER WAY TO learn the fundamental concepts of computer operation than by building and programming a computer. The best way to accomplish that is through some sort of structured course, such as the *Micro-Master 8000* microprocessor training system from Elenco Electronics, Inc. (150 West Carpenter Avenue, Wheeling, IL 60090).

The *MM-8000* offers a 14-lesson course that covers the fundamentals of number systems through the writing of practical machine-language programs. The heart of the system is the Intel 8085 8-bit microprocessor. While the 8085 is not the latest and greatest microprocessor, it is a good choice to demonstrate important concepts.

While we examined an assembled version of the trainer, the course is most instructive in its kit form, wherein the *MM-8000* PC board is built step by step as each lesson progresses, and experiments demonstrate the operation of the various subsystems.

Step by step

The first lesson in the course describes the basics of number

systems. Specific attention is paid to the decimal number system with which we are all familiar, and the hexadecimal and binary systems used by computers. The second lesson introduces the concepts of computer data, and data buses, and guides the student through the installation of data-bus indicators and switches.

Intel's 8156 static RAM IC with I/O ports and timer is the subject of lessons 3 through 5. Various on-board switches are used to manually write to and read from the RAM. Once that concept is demonstrated, 7-segment LED displays are added, and the I/O ports of the 8156 are used to control the display. The timer portion of the 8156 is also programmed and run. In lesson 6, a 2816 monitor ROM is added to the setup, and the differences between ROM and RAM are demonstrated.

The 8085 microprocessor is the topic of lessons 7 and 8. Items discussed include the chip's internal registers, flags, and interrupts. The microprocessor's memory-read and -write cycles are described with the help of timing diagrams, and the function of each

pin is explained. Finally the complete instruction set of the 8085 is detailed.

Lessons 9 through 13 describe what the monitor program is, and how it fits in the memory-allocation scheme of the *MM-8000*. The monitor is loaded into a 2816 E²PROM one program at a time. The main components include the initialization, display, keyboard-scan, and function-key sections.

In the final lesson, the complete system is used to execute an external program, adding two numbers and displaying the result. That certainly doesn't sound like any great feat to anyone who has ever operated a pocket calculator—but then again, most people have no concept of how a calculator performs its magic.

The student who completes the *MM-8000* course, however, will understand the basic operation of the 8085 microprocessors, and of microprocessors in general. He will also have an understanding of the basic subsystems of microcomputers, and how they are programmed.

While a dedicated student might find the *MM-8000* ideal as a self-training course, we feel it would be more useful in a school laboratory course, where a teacher and auxiliary texts could augment the course manual. We feel that the manual needs some supplementation because it leaves out what we think is important information. For example, the 2816 is never referenced as an E²PROM, and the functions of some of the other IC's are not well detailed. Granted, those points may not be considered important in a microprocessor course, but they are important nonetheless.

The *Micro-Master 8000* kit costs \$129. We recommend it as an excellent introduction to microprocessors. **R-E**

Hameg HM8028 Spectrum Analyzer Module

Convert any oscilloscope to
a 500-MHz spectrum
analyzer



CIRCLE 46 ON FREE INFORMATION CARD

IF YOU'RE IN THE MARKET FOR A SPECTRUM analyzer but need to keep costs to a minimum, you might find that you can make substantial savings by converting your oscilloscope to do the job. One device that makes it easy to do just that is the *HM8028* spectrum analyzer module from Hameg (88-90 Harbor Road, Port Washington, NY 11050).

The *HM8028* is designed as part of Hameg's *HM8000* modular system series. It can be used, however, with any oscilloscope that offers an X-Y operating mode. The heart of the *HM8000* modular sys-

tem is the *HM8001* mainframe. The mainframe accommodates up to two plug-in modules, and supplies them with power and a signal bus.

The *HM8028* spectrum-analyzer module offers a frequency range of 500 kHz–500 MHz. Its front panel features a clean layout, which is dominated by a 3-digit LED display of the center frequency. A ten-turn potentiometer is used to adjust the frequency. The SCAN WIDTH control, which is used to adjust how much of the spectrum you want to observe around the center frequency, is an 11-position rotary switch. It is adjustable from 50

kHz/div to 50 MHz/div, and a zero-scan position is also available.

Other front-panel controls include an RF gain potentiometer, a 4-pushbutton input attenuator, and bandwidth and video-filter switches.

Input to the analyzer is provided by a 50-ohm BNC connector. A twin BNC connector, along with a special cable, provides output to the X and Y amplifiers of an oscilloscope.

Setting up the spectrum analyzer is quite easy. The analyzer's output is connected to the X and Y inputs of the scope, and the scope is set to its X-Y mode. Both scope channels are set to a sensitivity of 5 volts/div, the input-coupling switches are set to ground, and the beam is adjusted so that it is centered on the graticule. When the scope's input coupling is set to DC, a trace will appear across the bottom of the screen. Adjustment of two trimmers on the analyzer module is required to match the output voltages of the analyzer to the scope being used. When that's

**With Just One Probe Connection, You Can Confidently Analyze Any
Waveform To 100 MHz, 10 Times Faster, 10 Times More Accurately,
Absolutely Error Free, Guaranteed — Or Your Money Back!**

SC61 Waveform Analyzer™
Patented
\$3295



There are other digital readout oscilloscopes, but none of them completely eliminate graticule counting and calculations like the SC61 Waveform Analyzer. The innovative, time-saving AUTO-TRACKING™ digital readout automatically gives you every waveform parameter you need for fast troubleshooting.

The SC61 Waveform Analyzer is a triple patented high performance scope that provides you with a digital LCD read-out of all key waveform parameters (DC volts, peak-to-peak volts, and frequency) at the push of a button, and all with one probe connection.

Other time-saving features include exclusive ECL sync circuits that allow you to lock quickly onto waveforms up to 100 MHz. Plus, with 3000 volts of input protection, you never have to worry about an expensive front end repair job.

Call 1-800-SENCORE to find out more about what the SC61 can do for your service business. In Canada call 1-800-851-8866.

SENCORE

3200 Sencore Drive, Sioux Falls, SD 57107

100% American Made

CIRCLE 155 ON FREE INFORMATION CARD

ATTENTION! ELECTRONICS TECHNICIANS

EARN YOUR
**B.S.E.E.
DEGREE**



THROUGH HOME STUDY

Our New and Highly Effective Advanced-Placement Program for experienced Electronic Technicians grants credit for previous Schooling and Professional Experience, and can greatly reduce the time required to complete Program and reach graduation. No residence schooling required for qualified Electronic Technicians. Through this Special Program you can pull all of the loose ends of your electronics background together and earn your B.S.E.E. Degree. Upgrade your status and pay to the Engineering Level. Advance Rapidly! Many finish in 12 months or less. Students and graduates in all 50 States and throughout the World. Established Over 40 Years! Write for free Descriptive Literature.

COOK'S INSTITUTE
OF ELECTRONICS ENGINEERING

 4251 CYPRESS DRIVE
JACKSON, MISSISSIPPI 39212

CIRCLE 58 ON FREE INFORMATION CARD

complete, the setup is ready to make meaningful measurements.

The *HM8028* spectrum-analyzer module comes complete with a connecting cables and a reasonably well written manual. As we mentioned previously, the *HM8028* is part of a series of modular instruments that are designed to use the *HM8000* mainframe. By adding a companion tracking generator, the spectrum analyzer becomes a complete RF test setup.

The tracking generator provides a signal source that tracks the tuning frequency of the analyzer. The combination of analyzer and tracking generator makes it possible to measure the frequency response and insertion loss of any two-port network. Other available accessories include sniffer probes to assist in tracking sources of electromagnetic interference.

While the *HM8028* won't deliver some of the features of full-blown spectrum analyzers, it deserves credit for doing a good job at the reasonable price of \$768. The *HM8001* mainframe costs \$236. R-E

Try the

**Radio
Electronics**

bulletin board
system

(RE-BBS)
516-293-2283

The more you use it the more
useful it becomes.

We support 300 and 1200 baud
operation.

Parameters: 8N1 (8 data bits, no
parity, 1 stop bit) or 7E1 (7 data
bits, even parity, 1 stop bit).

Add yourself to our user files to
increase your access.

Communicate with other R-E
readers.

Leave your comments on R-E with
the SYSOP.

RE-BBS
516-293-2283

MOVIE TIME

CABLE CONVERTERS

NEW!

78 Channel Wireless Remote • Remote Fine Tuning • Parental Control
10 dB Amplifier Favorite Channel Memory • Fine Tune Centering
24 MONTH WARRANTY

(#1) V7800-3 V7800-2

15 Lot **\$62.95**

10 Lot **\$64.95**

(3-9) \$69.95 (1-2) \$89.95



(#2) with Volume & Mute Control
Last Channel Recall
Audio...Output
• Decoder Loop

10 Lot **\$79.95**

(3-9) \$89.95 (1-2) \$109.95

JERROLD

(#3)

JERROLD - 450

68 Channels
Automatic Fine Tune
Rebuilt
Ch. 3 Only
90 Day Warranty



10 Lot **\$53.95**

(3-9) \$63.95 (1-2) \$73.95

(#4)

JERROLD - JSX

36 Channels
Fine Tuning
Rebuilt
Ch. 3 Only
90 Day Warranty



10 Lot **\$29.95**

(3-9) \$34.95 (1-2) \$39.95

MOVIE TIME REPLACEMENT HAND UNITS

\$14.95

24 Lot

Single Lot \$24.95

#6 JERROLD-550
#7 JERROLD-450
#9 JERROLD-400
#10 TEXSCAN
AND MORE
(13-23) \$16.95
(2-12) \$19.95

(#5)

HAMLIN - 4000

42 Channels
Fine Tuning
Wired Remote or
Set top
Rebuilt
Ch. 2 Only
90 Day Warranty



10 Lot

\$29.95

(3-9) \$34.95 (1-2) \$39.95

ALL OF THE ABOVE CABLE CONVERTERS ARE COMPATIBLE WITH ALL CABLE DECODERS
* NONE OF THE ABOVE UNITS ARE CABLE DECODERS

MOVIE TIME

20203 N.E. 15th Court • Miami, FL 33179
FAX: (305) 653-8102

For More Information Call For Orders Only Call

1-305-652-1981

1-800-843-9845

Minimum Shipping Charge \$8.50 + \$1.00 for ea. additional converter
or .25 for ea. Hand Unit.
BLUE Label 2nd day air: \$12.50 Min. + \$3.50 for additional
converter, or .30 for ea. Hand Unit.
RED Label 1st day air: \$18.50 Min. + \$3.50 for additional
converter, or \$1.00 for ea. Hand Unit.
Puerto Rico, Hawaii & Alaska add \$5.00.
No COD Orders will be shipped by Air.
Shipping Charges are not Refundable.

C.O.D.



CIRCLE 160 ON FREE INFORMATION CARD

5 WAYS TO STOP WASTING TIME IN ELECTRONICS.

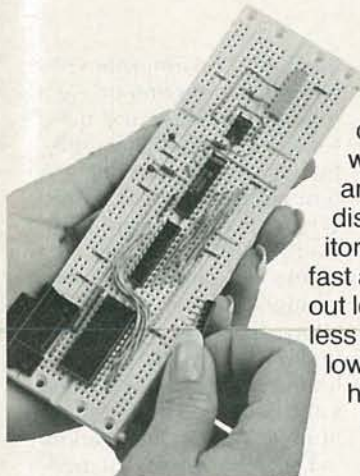

Stop wasting your time soldering. Save hours of soldering, desoldering, resoldering with Quick Test™ sockets and bus strips. Connect/disconnect resistors, capacitors, transistors, ICs, etc. as fast as you can push in/pull out leads. Interlock for limitless expandability. Priced as low as \$1.60, you'll wonder how you've done without them!

5-color coded binding posts and 17 sockets, for over 4,560 contact points. Lifetime guarantee. American-made. Affordably priced.

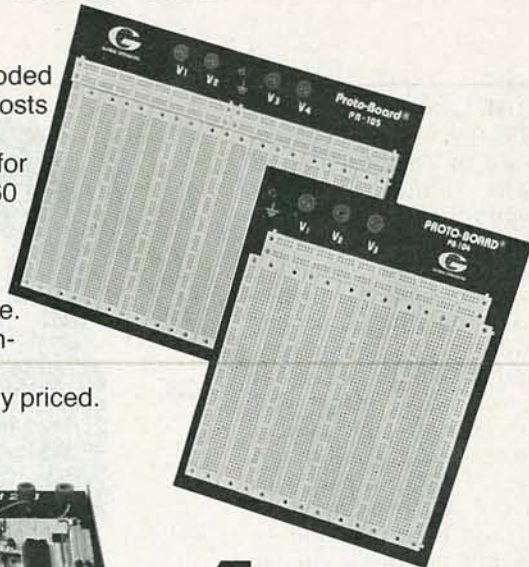

2. Stop wasting your time breadboarding.

Here are three popular PROTO BOARD® Brand solderless breadboarding systems that meet any budget or time schedule. First the diminutive PB-10's 840 contact points and 3-color binding posts. PB-102 has 1,240 tie points, accepting up to 12 16-pin ICs. Finally, PB-103, with 2,250 contact points, and up to 24 16-pin capacity. They're affordable, American-made, lifetime guaranteed. You'll soon see why PROTO BOARD Brand is Today's Standard for Quality in Breadboarding.

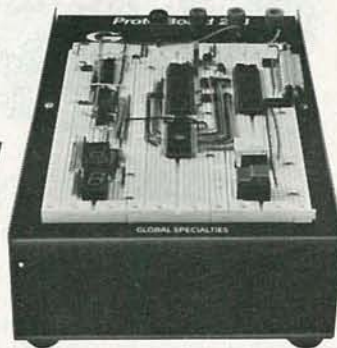

4. Stop wasting your time plugging-in external power.

We've added the power to the breadboard. And, what power! Up to triple voltage power, +5V, +12V, -12V, regulated/current limited and DC. Up to 2,250 tie points, with 24 IC capacity and 14 pin DIPs. Now you can create, test and modify TTL, CMOS, Op-Amps and even microprocessor circuits. Plus, there is the standard Global Lifetime Guarantee on the sockets. And, wait 'til you see the modest prices!

3. Stop wasting your time jury-rigging

large numbers of circuits. Here are two oversized PROTO BOARDS Brand, with expanded area, tie points, and more to keep your ideas together. PB-104 features 3,060 tie points, which can handle to 32 16-pin ICs with ease. Four color coded binding posts, and roomy 9.2" x 8" metal panel make it big...but simple. The humungous PB-105 lets you load up to 48 16-pin ICs, and much more onto its



5. NEW!

Stop wasting time designing computer circuits. Now you can use your solderless breadboard concepts for designing accessory circuits. PROTOCARD® is a PROTO BOARD Brand which fits any standard slot in your IBM, PC/XT or PC/AT computer. Some modules even include built-in basic decoder circuits for memory and I/O addressing. Breadboard areas up to 3,360 contact points. Buffered versions eliminate loading of pc buses.

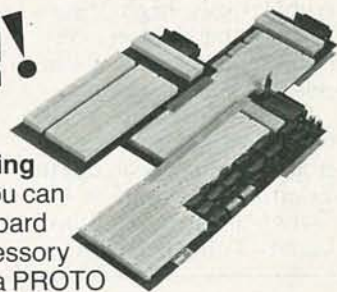

GLOBAL SPECIALTIES

Easy does it!™



Call toll-free for details
1-800-572-1028

Global Specialties. An Interplex Electronics Company.
70 Fulton Terrace. New Haven, CT 06512.
Telephone: (203) 624-3103. © Interplex Electronics 1989.
All Global Specialties breadboarding products made in USA.

CIRCLE 156 ON FREE INFORMATION CARD

A0011

JANUARY 1990

25

NEW PRODUCTS

NOISE-CANCELING HEADSETS.

The aviation headsets tested by Dick Rutan and Jeana Yeager on their around-the-world *Voyager* flight, are now directly available from Bose. Stemming from Dr. Amar G. Bose's frustration with passenger headsets on a commercial flight in 1978 (the incessant engine noise interfered with listening pleasure), and the direct result of ten years of R&D, in part with the U.S. Air Force, the *Bose Aviation Headset* features patented electronic circuitry that cancels unwanted noise while allowing desired communications to be heard.

The headset is an integrated system that combines patented physical and electronic noise-attenuation systems and offers two major improvements over conventional headsets. First, the "Clear Comfort" cushions on the earcup, which conform precisely to the contours of the head, seal out noise without uncomfortably high force. Second, the headset's electronic circuitry actively cancels much of the noise.

A sound-pressure servo (feedback) system uses microphones in the earcups to monitor the sound at the user's ear; that measured sound is compared with the



Active Noise Cancellation System
• Noise Sensor
• Driver
• Pressure Servo

Clear Comfort™ GelFoam Cushions

Electret Boom Mic with low distortion housing

Fully Articulated Boom Adjustment

Low Force Stainless Steel Headband
Soft Contoured Foam Pad for maximum comfort
Delayed Height Adjustment

Boom and Cable can be attached to either left or right earcup

On/Off Switch provides fail-safe operation

Power Input (cigarette lighter adapter supplied)

CIRCLE 25 ON FREE INFORMATION CARD

sound the user wants to hear—for example, radio communications or, if no signal is provided, silence. The difference between the existing and the desired sound is then "processed" to create a correction signal that is opposite to the unwanted noise and, when reproduced by the speaker in the earcup, cancels the noise. The process of measuring, creating a correction signal, and using it to cancel noise is rapid and continuous, allowing the *Aviation Headsets* to react to any dynamically changing noise source.

The *Aviation Headsets* offer pilots, particularly in propeller-driven aircraft and helicopters, improved communications, reduction in fatigue, and the prevention of permanent hearing loss from ambient noise. Similar headsets would be effective in police, fire, and emergency vehicles, where radio communications must be heard over the sirens.

The *Aviation Headsets* cost \$965.00 each, and are being marketed directly through a toll-free number: 800-242-9008.—**Bose Corporation**, The Mountain, Framingham, MA 01701.

flexibility. An internal voltmeter and ammeter on each model eliminates the need for an external digital multimeter, reduces overall system component costs, and can feed back information via the GPIB. Each unit also offers an automatic programmable timer mode that allows the user to program up to 200 voltage/current-limit settings and 200 time intervals (one-second minimum/ten-hour maximum).

The *PPS Series* of programmable power supplies start at \$995.00.—**Beckman Industrial Corporation**, Instrumentation Products Division, 550 South Harbor Boulevard, La Habra, CA 90631.

HIGH-SPEED COMPARATOR.

Combining a variety of features that simplify analog circuit design, the *AD790* from *Analog Devices* consumes less than one-third the power of other units in its class. It has a maximum 50-ns propagation delay when operated from a single +5-volt or dual ± 15 -volt supplies. With single-supply operation, power dissipation is a maximum 60 mW. It can handle ground-referenced signals, and offers a wide input-signal range, on-board latch, TTL and CMOS logic output, and 500- μ V input-hysteresis voltage.

The *AD790* is the first comparator that is manufactured with Analog Device's high-speed Complementary Bipolar (CB) process. By incorporating CB transistors in the IC design, the comparator can accommodate rail-to-rail input signals and deliver symmetrical output swings. In single-supply operation, the input signal can range from +5

PROGRAMMABLE POWER SUPPLIES.

GPIB capability is built into every model in *Beckman's PPS Series* of system DC-power supplies, eliminating the time-consuming process of choosing GPIB as an option, installing it, and getting it running. The series includes a 30-volt DC/3.5-A, 40-volts DC/7.5-A, 60-volts DC/10.0-A, and



CIRCLE 26 ON FREE INFORMATION CARD

60-volts DC/17.0-A models. Each offers full-rated power from 100 to 1000 watts, remote sensing to compensate for system wiring loss to the load, and a back-lit LCD with adjustable contrast and illumination. The power supplies feature multiple operating modes, such as delta V, delta T, and manual for increased system

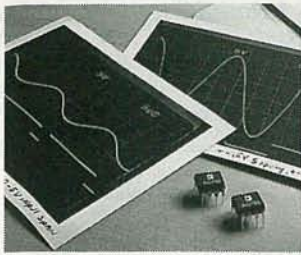

CIRCLE 27 ON FREE INFORMATION CARD

volts to ground, permitting wide dynamic range data-acquisition in +5-volt logic systems. Built-in 500- μ V hysteresis eliminates undesirable oscillations when handling fast pulses or slow low-level signals. The comparator's output also minimizes current spikes, another source of oscillation in many voltage comparators.

The TTL- and CMOS-compatible output simplifies connection to digital logic. An on-chip latch can be strobed to retain output data, making the AD790 useful in building high-speed discrete analog-to-digital converters. The out-

put voltage is highly symmetrical between V_{LOGIC} and ground, ensuring high accuracy when positive- and negative-slewing input signals cross the threshold level.

The AD790 is available in an 8-pin plastic or ceramic DIP and is specified for operation over the 0° to +70°, -40° to +85°, and -55° to +125° operating temperature ranges. Two performance grades are available, with maximum offset voltage of either 1 mV or 250 μ V. Maximum common-mode voltage is from $+V_S$ to -2 volts; the allowable input signal range is $\pm V_S$.

The AD790 comparator ranges in price from \$2.50 for the JN grade to \$7.95 for the SQ version, in lots of 100.—Analog Devices, Literature Center, 70 Shawmut Road, Canton, MA 02021.

100-MHz OSCILLOSCOPE. Three different signals can be observed at two time-base settings on B&K-PRECISION's model 2190 os-

cilloscope with triple input, six-trace operation. The high-performance scope provides excellent high-frequency triggering, even on signals well beyond its rated bandwidth. The 2190 also features 1-mV-per-division vertical sensitivity, V-mode for viewing two signals that are unrelated in frequency, dual time base, alternate sweep function, a 20-MHz bandwidth limiter, and video-sync separators.



CIRCLE 28 ON FREE INFORMATION CARD

The 100-MHz scope offers users a choice of 23 calibrated sweep-time ranges from 2 ns to 50 ns per division on the main time base and 20 calibrated ranges on the delayed-sweep time base. Each sweep time

range is fully adjustable between calibrated ranges. A $\times 10$ magnifier, which allows closer examination of waveforms while maintaining display calibration, is also provided. In delayed-sweep operation, the delayed signal can be viewed as a second trace or superimposed on the non-delayed signal.

The 2190 offers front-panel x-y operation, TTL-compatible z-axis input, signal-delay line, single-sweep operation, and channel-1 output on the rear panel for driving a frequency counter or other instruments. It comes with two 10:1 probes, a user manual, and schematic diagram.

The model 2190 100-MHz oscilloscope has a suggested retail price of \$1645.00.—B&K-PRECISION, Maxtec International Corp., 6470 West Cortland Street, Chicago, IL 60635.

ANALOG INPUT MODULE. A module designed for use with the Apple Macintosh Plus, SE, and II computers,

Get A Complete Course In

ELECTRONIC ENGINEERING

8 volumes, over 2000 pages, including all necessary math and physics. 29 examinations to help you gauge your personal progress. A truly great learning experience.

Prepare now to take advantage of the growing demand for people able to work at the engineering level.

Ask for our brochure giving complete details of content. Use your free information card number, or write us directly. **\$99.95**, Postage Included. Satisfaction guaranteed or money refunded.



**Banner
Technical
Books, Inc.**

1203 Grant Ave.
Rockford, IL 61103

CIRCLE 67 ON FREE INFORMATION CARD

M O R E T H A N

LOGIC



286 SupersPort Laptop by Heathkit®

Your logical source for quality computer and electronic product needs, the **FREE Heathkit Catalog** is your key to a fun and exciting hobby. The Heathkit Catalog contains powerful kit laptop and desktop computers, test instruments, weather equipment, and home theater components, plus self-study electronics courses. Order your **FREE Heathkit Catalog** today! It's the logical thing to do!

1-800-44-HEATH
(1-800-444-3284)

Send to: Heath Company, Dept. 020-854
Benton Harbor, Michigan 49022

Name

Address

City State Zip

A subsidiary of Zenith Electronics Corporation

CIRCLE 86 ON FREE INFORMATION CARD

R-E Engineering Admart

Rates: Ads are 2 1/4" x 2 7/8". One insertion \$950. Six insertions \$925. each. Twelve insertions \$895. each. Closing date same as regular rate card. Send order with remittance to **Engineering Admart**, Radio Electronics Magazine, 500-B Bi-County Blvd., Farmingdale, NY 11735. Direct telephone inquiries to Arline Fishman, area code-516-293-3000. *Only 100% Engineering ads are accepted for this Admart.*

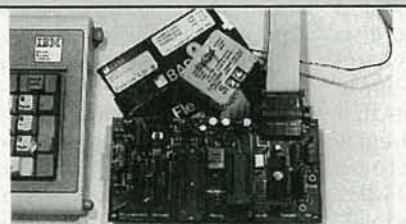

6805 MICROCOMPUTER DEVELOPMENT SYSTEM

The MCPM-1 system allows the IBM PC and compatibles to be used as a complete development system for the Motorola MC68705P3, P5, U3, U5, R3 and R5 single chip microcomputers. The system includes a cross assembler program, a simulator/debugger program and a programming board that connects to a serial port. Price—\$449.00 VISA and MASTERCARD accepted.

TECI THE ENGINEERS COLLABORATIVE, INC.

RR#3, BOX 8C Barton, Vermont 05822
Phone (802) 525-3458 FAX (802) 525-3451

CIRCLE 157 ON FREE INFORMATION CARD

FCC LICENSE PREPARATION

The FCC has revised and updated the commercial license exam. The **NEW EXAM** covers updated marine and aviation rules and regulations, transistor and digital circuitry. **THE GENERAL RADIOTELEPHONE OPERATOR LICENSE - STUDY GUIDE contains vital information. VIDEO SEMINAR KITS ARE NOW AVAILABLE.**

WPT PUBLICATION
979 Young Street, Suite A
Woodburn, Oregon 97071
Phone (503) 981-5159

CIRCLE 144 ON FREE INFORMATION CARD

MIDI PROJECTS



BP182—MIDI interfacing enables any so equipped instruments, regardless of the manufacturer, to be easily connected together and used as a system with easy computer control of these music systems. Combine a computer and some MIDI instruments and you can have what is virtually a programmable orchestra. To get your copy **send \$6.95 plus \$1.25 for shipping** in the U.S. to **Electronic Technology Today Inc., P.O. Box 240, Massapequa Park, NY 11762-0240.**

MetraByte's SCSI-8AIN performs real-time, high-speed, high-resolution, analog input tasks. The eight-channel, 12-bit analog converter is accurate to within 0.02%, with a conversion time of 14µs. With 12-bit resolution, the least-significant-bit value is 4.88 mV in the ±10-volt range. An instrumentation amplifier provides gains of 1, 10, 100, 200, or 500 corresponding to signal spans of ±10 volt, ±1 volt, ±0.1 volt, ±0.05 volt, and ±0.02 volt, respectively. The gain of the instrumentation amplifier is selected by a front-panel DIP switch.

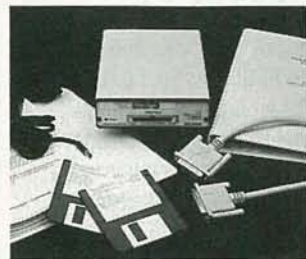

CIRCLE 29 ON FREE INFORMATION CARD

Data is transferred to or from the *SCSI-8AIN* one byte at a time at a maximum rate of 57.6 kilobytes per second and support sample rates of up to 28,800 samples per second. One waveform can be digitized at 28,000

samples per second, and eight waveforms can be digitized at 3,600 samples per second. Those rates support up to 8 analog input channels simultaneously, making it capable of providing oscilloscope, chart-recorder, and spectrum-analyzer emulations. A master clock synchronizes all *SCSI-8AIN* analog-converter activity, so that state information can be obtained at fixed intervals from multiple channels.

The included software drivers allow the module to be controlled by a variety of software packages that run on Macintosh computers, including seven high-level programming languages and five menu-driven application programs. The *SCSI-8AIN* communicates via the SCIA (Small Computer System Interface) port located on the back of the Macintosh computer. That bus accepts as many as six peripherals to be placed in daisy-chain network. Custom configurations are very easy to develop for such applications as digital signal processing, signal averaging, chromatography, spectroscopy, and more.

The module comes with a peripheral unit; calibration,

test, and I/O software; one SCSI cable; a 117-volt AC desk-top power transformer; and also comes with hardware and software manuals.

The *SCSI-8AIN* 8-channel, 12-bit analog input module is available for \$790.00 and the *SCSI-TERM* termination device costs \$50.00.—**MetraByte Corp.**, 440 Myles Standish Blvd., Taunton, MA 02780.

FUNCTION GENERATOR. Its unique front-panel design coupled with eight different waveforms, seven modulation modes, and optional arbitrary-waveform-generation capability make *Fluke's PM5138* 10-MHz function generator versatile and easy to use. Instead of the array of rotary switches, knobs, and dials usually found on function generators, the *PM 5138* has a large, backlit multifunction LCD and five pairs of keys for selecting the required parameter. The frequency, AC voltage, DC offset, and other numerically programmable parameters are set by pressing the appropriate key and adjusting the unit's one rotary knob until the correct reading appears on the screen. The required waveform and modulation



CIRCLE 30 ON FREE INFORMATION CARD

modes are selected from a menu.

The function generator also offers Arbitrary Waveform Generation (AWG), which is usually found only on specialized arbitrary generators with few waveform and modulation modes. Included with the GPIB/IEEE-488 interface option, AWG features a 20 Mega-points/second sampling rate, 1024-point horizontal resolution, and 1024-point vertical resolution. Waveforms can be programmed over the GPIB either from a computer or directly from a digital storage oscilloscope.

The *PM 5138* function generator has a suggested list price of \$3590.00, or \$3990.00 for the model with the factory-installed arbitrary waveform generation option.—**John Fluke Mfg. Co., Inc.**, P.O. Box C-9090, Everett, WA 98206; 800-443-5853, ext. 77.

EXPAND YOUR CAREER HORIZONS...

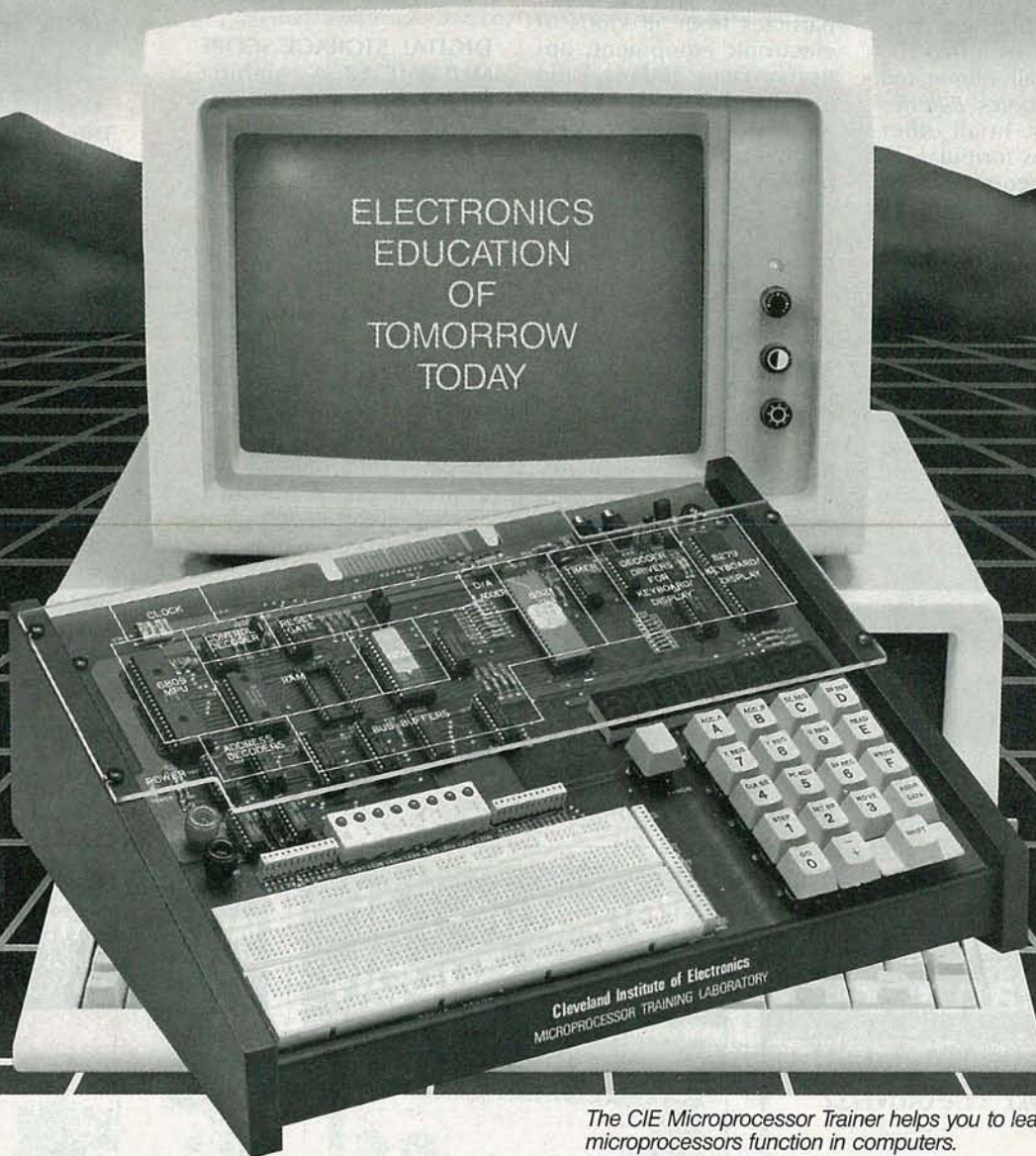

The CIE Microprocessor Trainer helps you to learn how circuits with microprocessors function in computers.

START WITH CIE.

Microprocessor Technology. Satellite Communications. Robotics. Wherever you want to go in electronics... start first with CIE.

Why CIE? Because we're the leader in teaching electronics through independent study. Consider this. We teach over 25,000 students from all over the United States and in over 70 foreign countries. And we've been doing it for over 50 years, helping thousands of men and women get started in electronics careers.

We offer flexible training to meet your needs. You can start at the beginner level or, if you already know something about electronics, you may want to start at a higher level. But wherever you start, you can go as far as you like. You can even earn your Associate in Applied Science Degree in Electronics.

Let us get you started today. Just call toll-free 1-800-321-2155 (in Ohio, 1-800-362-2105) or mail in

the handy reply coupon or card below to:
Cleveland Institute of Electronics,
1776 East 17th Street, Cleveland, Ohio 44114.

CIE World Headquarters

ARE-157

Cleveland Institute of Electronics, Inc.
1776 East 17th Street • Cleveland, Ohio 44114

Please send your independent study catalog.
For your convenience, CIE will try to have a representative contact you — there is no obligation.

Print Name _____

Address _____ Apt. _____

City _____ State _____ Zip _____

Age _____ Area Code/Phone No. _____

Check box for G.I. Bill bulletin on Educational Benefits

Veteran Active Duty **MAIL TODAY!**

Just call toll-free 1-800-321-2155 (in Ohio, 1-800-362-2105)

JANUARY 1990

OZONE-SAFE AEROSOLS. When possible, ozone-depleting CFC's (ChloroFluoro Carbons), which are typically found in aerosols, have been totally eliminated from Chemtronics' E-Series of chemicals. In all other cases, E-Series' formulas exceed the recommended 20% cut-back in regulated CFC's.

The E-Series consists of four products. *Ultrajet* is a microscopically clean, moisture-free source of "canned air" for applications where "ultra-pure" cleaning is required. It filters its compressed gas to less than 0.2 microns and



CIRCLE 31 ON FREE INFORMATION CARD

delivers a powerful 120 PSI jet action that instantly removes dust, lint, and oxide particles from all kinds of electronic equipment, optical surfaces, and precision instruments. *Freeze-It* quickly cools circuits to -96°F , leaving no residual film, to provide positive diagnosis of thermal intermittents. *Flux-Off Plus* solvent removes flux, soldering oils, and production contaminants from electronic subassemblies, PC boards, and other electronic components. It penetrates even tightly packed components and evaporates completely, leaving surfaces dry and residue free. *TF Plus* is a mild cleanser and degreaser for use on solvent-sensitive equipment and precision instruments. It removes dirt, grease, and molding compounds on contact, evaporates completely leaving no white residue, and is safe for use on delicate plastics and elastomers.

For container sizes and prices of E-Series products

contact—**HUB Material Company**, 33 Springdale Avenue, Canton, MA 02021.

DIGITAL STORAGE SCOPE/MULTIMETER. A combination 2-channel digital storage oscilloscope and digital multimeter from *Leader Instruments*, the model 200, allows two-channel comparisons, addition or subtraction of two signals, and X-Y capability. The portable 2½-pound instrument runs on batteries or AC power.

The model 200's oscilloscope section has a 3-MS/s maximum sampling rate and is completely auto-ranging. The optimal waveform is displayed by touching the auto-timebase and vertical-sensitivity buttons, and the standard printer interface allows waveforms and setting conditions to be output to an optional dedicated printer (model 710) for hard-copy documentation. Sensitivity, timebase, trigger source, slope, and display mode are displayed on screen. The memory banks



CIRCLE 32 ON FREE INFORMATION CARD

can store three waveforms per channel; in addition, the model 200 is battery-backed for long-term storage of all six waveforms.

The autoranging DMM has a manual override feature as well as audible continuity and overload indicators. It offers AC/DC voltage and current measurement functions, resistance, and a low-power ohm mode to provide a lower test voltage for in-circuit resistance measurements.

The model 200 combination digital storage oscilloscope/multimeter has a suggested price of \$1,645.00; the model 710 printer costs \$480.00.—**Leader Instruments Corporation**, 380 Oser Avenue, Hauppauge, NY 11788. **R-E**

A New AOR Scanner

100 Channels Low, Air, High, UHF & 800MHz



- Perfect for base or mobile. Includes AC and DC power cords, mobile mount hardware and 2 antennas.
- Covers 27-84MHz, 108-174MHz, 406-512MHz and 830-950MHz.
- 5 Scan Banks and 5 Search Banks
- 25 Day Satisfaction Guarantee
- No Frequencies Cut Out.
- Size: 3½"H x 5¾"W x 7¼"D. Wt.: 2 lb. 10 oz.

AR950

Total Price, Freight Prepaid (Express Shipping Optional)

\$299.00

ACE
COMMUNICATIONS

10707 E. 106th St. Indpls., IN 46256

Toll Free 800-445-7717

Visa and MasterCard (COD slightly higher)

In Indiana 317-849-2570 Collect FAX (317) 849-8794

CIRCLE 152 ON FREE INFORMATION CARD

Versatile Lab Power Supply



MODEL 3002A
Only **\$125⁰⁰**

- 0-30 VDC at 0-2A • Excellent Regulation
- Ripple & Noise - 500 μV RMS • Built-in Short-Circuit and Overload Protection

Model 3002A features continuously adjustable current limiting and precision constant voltage/constant current operation with "automatic crossover." This lab-grade unit can also be used as a current regulated power source. Options: 10-Turn Voltage and Current Controls, \$25.00 ea.

FREE SHIPPING — 48 STATES. Check, Money Order or C.O.D. (add \$3.00). No credit cards. IL residents add 7% tax. 15-Day Money Back Guarantee. Save on Quality Test Equipment & Closeouts. Free Literature.

Salen Enterprises, Ltd.
P.O. Box 915, Morton Grove, IL 60053
Area Code 312-465-1424

CIRCLE 149 ON FREE INFORMATION CARD

LEARN VCR CLEANING/MAINTENANCE/REPAIR

EARN UP TO \$1000 A WEEK, WORKING PART TIME FROM YOUR OWN HOME!



Secrets Revealed!

NO Special Tools or Equipment Needed.

EARN UP TO \$60 AN HOUR AND MORE!

THE MONEY MAKING OPPORTUNITY OF THE 1990'S

IF you are able to work with common small hand tools, and are familiar with basic electronics (i.e. able to use voltmeter, understand DC electronics)... IF you possess average mechanical ability, and have a VCR on which to practice and learn... then we can teach YOU VCR maintenance and repair!

FACT: up to 90% of ALL VCR malfunctions are due to simple MECHANICAL or ELECTRO-MECHANICAL breakdowns!

FACT: over 77 million VCRs in use today nationwide! Average VCR needs service or repair every 12 to 18 months!

Viewo's 400 PAGE TRAINING MANUAL (over 500 photos and illustrations) and AWARD-WINNING VIDEO TRAINING TAPE reveals the SECRETS of VCR maintenance and repair—"real world" information that is NOT available elsewhere!

Also includes all the info you'll need regarding the BUSINESS-SIDE of running a successful service operation!

FREE INFORMATION
CALL TOLL-FREE 1-800-537-0589

Or write to: Viewo Publications Inc.
3540 Wilshire BL, STE. 310
Los Angeles, CA 90010 Dept. RE

CIRCLE 143 ON FREE INFORMATION CARD

Radio-Electronics mini-ADS

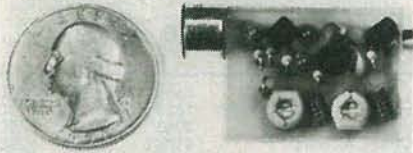

SIMPLY SNAP THE WAT-50 MINIATURE FM TRANSMITTER on top of a 9v battery and hear every sound in an entire house up to 1 mile away! Adjustable from 70-130 MHZ. Use with any FM radio. Complete kit **\$29.95 + \$1.50 S + H**. Free shipping on 2 or more! COD add \$4. Call or send VISA, MC, MO. **DECO INDUSTRIES, Box 607, Bedford Hills, NY 10507. (914) 232-3878.**

CIRCLE 127 ON FREE INFORMATION CARD



FINAL CLOSEOUT ON ZENITH SSAVI STV-2 UHF used **\$38 ea./100 lot**; Oak N-12S **\$45 ea.**; MLD-1200s **\$39 ea.**; Sylvania 4040 w/3 remotes **\$99 ea.**; converters & more. Call for list. **RADAR SPEEDS GUNS & SYSTEMS** for car, snowmobile racing, skiing, etc. Professional X & K band models. Low prices and 90-day warranty. Makes a great gift! Pre-paid cash & quantity discounts. **AIS SATELLITE, INC. 106 N. 7th St./E, Perkasi, PA 18944.** Orders & catalogs: 1-800-AIS-2001; tech. info: 215-453-1400.

CIRCLE 81 ON FREE INFORMATION CARD



FREE CATALOG OF HARD-TO-FIND TOOLS is packed with more than 2000 quality items. Your single source for precision tools used by electronic technicians, engineers, instrument mechanics, schools, laboratories and government agencies. Also contains Jensen's line of more than 40 tool kits. Send for your free copy today! **JENSEN TOOLS INC., 7815 46th St., Phoenix, AZ 85044. (602) 968-6231.**

CIRCLE 115 ON FREE INFORMATION CARD

CALL NOW AND RESERVE YOUR SPACE

- 6 x rate \$940.00 per each insertion.
- Fast reader service cycle.
- Short lead time for the placement of ads.
- We typeset and layout the ad at no additional charge.

Call **516-293-3000** to reserve space. Ask for Arline Fishman. Limited number of pages available. Mail materials to: mini-ADS, RADIO-ELECTRONICS, 500-B Bi-County Blvd., Farmingdale, NY 11735.

ACTUAL SIZE

The **REGEN-I** module maintains the volume level of amateur, business (Police, Fire, Power, Fleet, etc.), CB, marine radios and scanners. The **REGEN-I** will amplify signals and attenuate a strong audio signal keeping volume at a nearly constant level regardless of incoming signal strength and reduce un-squelched FM hiss. Simple installation. **\$49.95** phone orders OR **\$39.95** Pre-paid, mail orders only. **EMULATION ASSOCIATES, 520 GLENBROOK RD, STE 203-B, STAMFORD, CT 06906 SALES: 203-356-1632 FAX: 203-323-9044**

CIRCLE 161 ON FREE INFORMATION CARD



AMAZING POCKET REFERENCE: 480 pages of tables, formulas, constants, conversions and maps and it fits in your shirt pocket! (3.2" x 5.4" x 0.6") Chapters include Electronics, Computers, Math, Tools, Glues & Solvents, Chemistry & Physics, Construction, Carpentry, Geology, Hardware, Automotive, Air, Water, Welding, Plumbing, Pipe, 1-800 Airlines, Area Codes, Money, and much, much more. **\$9.95 + \$2.00 shipping** (Colorado inc. 56¢ tax). Check/Visa/MC. **Sequoia Publishing, Inc., Dept. 950, P.O. Box 620820, Littleton, CO 80162.**

CIRCLE 138 ON FREE INFORMATION CARD



CABLE TV CONVERTERS AND DE-SCRAMBLERS SB-3 **\$79.00** TRI-BI **\$95.00** MLD-**\$85.00** M35B **\$89.00** JRX-DIC **\$129.00** Special combos available. We ship COD. Quantity discounts. Call for pricing on other products. Dealers wanted. **FREE CATALOG.** We stand behind our products where others fail. One year warranty. **ACE PRODUCTS, P.O. Box 582, Saco, ME 04072 (207) 967-0726.**

CIRCLE 75 ON FREE INFORMATION CARD



APPLIANCE REPAIR HANDBOOKS—13 volumes by service experts; easy-to-understand diagrams, illustrations. For major appliances (air conditioners, refrigerators, washers, dryers, microwaves, etc.), elec. housewares, personal-care appliances. Basics of solid state, setting up shop, test instruments. **\$2.65 to \$7.90 each.** Free brochure. **APPLIANCE SERVICE, P.O. Box 789, Lombard, IL 60148. (312) 932-9550.**

CIRCLE 84 ON FREE INFORMATION CARD



THE MODEL WTT-20 IS ONLY THE SIZE OF A DIME, yet transmits both sides of a telephone conversation to any FM radio with crystal clarity. Telephone line powered - never needs a battery! Up to 1/4 mile range. Adjustable from 70-130 MHZ. Complete kit **\$29.95 + \$1.50 S + H**. Free Shipping on 2 or more! COD add \$4. Call or send VISA, MC, MO. **DECO INDUSTRIES, Box 607, Bedford Hills, NY 10507. (914) 232-3878.**

CIRCLE 127 ON FREE INFORMATION CARD

HITACHI SCOPES AT DISCOUNT PRICES



V-212

\$425

List \$595

Save \$170

20MHz Dual Trace Oscilloscope

All Hitachi scopes include probes, schematics and Hitachi's 3 year warranty on parts and labor. Many accessories available for all scopes.



V-425
List \$1,070 **\$849**

- DC to 40MHz
- Dual Channel
- CRT Readout
- Cursor Meas
- DC Offset
- Alt Magnifier
- Compact Size



V-1060
List \$1595 **\$1,359**

- DC to 100MHz
- Dual Channel
- Delayed Sweep
- CRT Readout
- Sweep Time
- Autoranging
- Trigger Lock
- 2mV Sensitivity

V-223 20MHz
V-422 40MHz
V-423 40MHz
V-660 60MHz
V-1065 100MHz
V-1100A 100MHz
V-1150 150MHz

D.T., 1mV sens, Delayed Sweep, DC Offset, Vert Mode Trigger
D.T., 1mV sens, DC Offset Vert Mode Trigger, Alt Mag
D.T., 1mV sens, Delayed Sweep, DC Offset, Alt Mag
D.T., 2mV sens, Delayed Sweep, CRT Readout
D.T., 2mV sens, Delayed Sweep, CRT Readout, Cursor Meas
Q.T., 1mV sens, Delayed Sweep, CRT Readout, DVM, Counter
Q.T., 1mV sens, Delayed Sweep, Cursor Meas, DVM, Counter

LIST	PRICE	SAVE
\$825	\$725	\$100
\$940	\$740	\$200
\$1,025	\$825	\$200
\$1,295	\$1,145	\$150
\$1,895	\$1,670	\$225
\$2,450	\$2,095	\$355
\$3,100	\$2,565	\$535

ELENCO PRODUCTS AT DISCOUNT PRICES

20MHz Dual Trace Oscilloscope



\$375
MO-1251

- 6" CRT
- Built in component tester
- TV Sync

FREE DMM

with purchase of
MO-1251/1252 Scope

SCOPE PROBES

P-1 65MHz, 1x, 10x **\$19.95**
P-2 100MHz, 1x, 10x **\$23.95**

35MHz Dual Trace Oscilloscope



\$495
MO-1252

- High luminance 6" CRT
- 1mV Sensitivity
- 6KV Acceleration Voltage
- 10ns Rise Time
- X-Y Operation • Z Axis
- Delayed Triggering Sweep

Top quality scopes at a very reasonable price. Contains all desired features. Two 1x, 10x probes, diagrams and manual. Two year guarantee.

PRICE BREAKTHRU on Auto Ranging DMMs



3 to choose from:
MDM-1180 \$24.95
MDM-1181 \$27.95
MDM-1182 \$29.95

- 3 1/2 LCD Display
- 27 Functions
- Auto /Manual Ranges
- Audible Continuity
- Data Hold (MDM-1182)
- .1% Accuracy (MDM-1181)



True RMS 4 1/2
Digit Multimeter
\$135 **M-7000**

.05% DC Accuracy
.1% Resistance
with Freq. Counter
and deluxe case



Multimeter with
Capacitance and
Transistor Tester
\$55 **CM-1500A**

Reads Volts, Ohms,
Current, Capacitors,
Transistors and
Diodes with case



Digital Capacitance Meter
CM-1550
\$58.95

9 Ranges
.1pf-20,000ufd
.5% basic accy
Zero control
with case



Digital LCR Meter
LC-1800
\$125

Measures
Coils 1uH-200H
Caps .1pf-200uf
Res .01-20M

Bench DMMS



M-3500 \$125 3 1/2 digit
.1% accy

M-4500 \$175 4 1/2 digit
.05% accy

SOLDERING STATION Temperature Controlled



SL-30
\$99

Digital display
Temp range:
300F-900F
Grounded tip
Overheat protect

Solderless Breadboards



9430
1,100 pins **\$15**
9434
2,170 pins **\$25**
9436
2,860 pins **\$35**
All have color
coded posts

AC Clamp-On Current Adapter



ST-265
\$25
0-1000A AC
Works with
most DMM

Wide Band Signal Generators



SG-9000 \$129
RF Freq 100K-450MHz
AM Modulation of 1KHz
Variable RF output

**SG-9500 with Digital Display
and 150MHz built-in Freq Ctr \$249**

3 1/2 Digit Probe Type DMM



M-1900
\$39

Convenient one hand operation
Measures DCV, ACV, Ohms
Audible continuity check, Data hold
with batteries
and case

Function Generator Blox

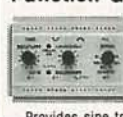

#9600
\$28.95

Provides sine, tri, squ wave
from 1Hz to 1MHz
AM or FM capability

Decade Blox



#9610 or #9620
\$18.95

#9610 Resistor Blox
47 ohm to 1M & 100K pot
#9620 Capacitor Blox
47pf to 10MFD

Digital Triple Power Supply



XP-765
\$249

0-20V at 1A
0-20V at 1A
5V at 5A

Fully Regulated, Short circuit protected with
2 Limit Cont., 3 Separate supplies
XP-660 with Analog Meters \$175

Quad Power Supply



XP-580
\$59.95

2-20V at 2A
12V at 1A
5V at 3A
-5V at 5A

Fully regulated and
short circuit protected
XP-575 without meters \$39.95

10MHz XT 100% IBM® Compatible



MODEL PC-1000
\$595

**5 Year
Warranty**

150W Power Supply
256K RAM
Expandable to 640K
Monochrome Monitor
Monographic Video Card
Parallel Printer Port

FREE spreadsheet and word processor
3.XXMS DOS and GW Basic add 75.00

Four-Function Frequency Counters



F-100 120MH
\$179

F-1000 1.2GH
\$259

Frequency, Period, Totalize,
Self Check with High Stabilized Crystal Oven
Oscillator, 8 digit LED display

GF-8016 Function Generator with Freq. Counter



\$249

Sine, Square, Triangle
Pulse, Ramp, .2 to 2MHz
Freq Counter .1 - 10MHz

GF-8015 without Freq. Meter \$179

WE WILL NOT BE UNDERSOLD!

UPS Shipping: 48 States 5%
(\$10 Max) IL Res., 7% Tax



C & S SALES INC.

1245 Rosewood, Deerfield, IL 60015
(800) 292-7711 (708) 541-0710

15 Day Money Back Guarantee
2 Year Warranty Prices subject to change

WRITE FOR FREE CATALOG

BUILD THIS

IF YOU'VE SEEN A RECENTLY PRODUCED motion picture presented in a modern theater, then you are undoubtedly aware of the stunning realism and dramatic impact created by the use of the Dolby-stereo surround-sound audio process. The system was developed by Dolby Laboratories for the motion-picture industry to literally surround viewers with sound and place them in the very midst of the action.

For anyone unfamiliar with the concept, the Dolby-stereo surround-sound process works to increase the sensation of "being there" by reproducing distinct sounds toward the front, sides, and rear of the viewer. In practice, it is accomplished by feeding the primary stereo soundtrack to speakers located behind the screen on the left, the center, and the right side of the theater.

Simultaneously, an additional audio channel, decoded from within the primary channels, is sent to a system of smaller speakers located to the sides and to the rear of the audience. That additional surround channel is used to re-create ambient sounds like wind noise or "on location" street sounds as well as special sound effects intended to travel past the audience from front to rear, or even to seem to circle overhead.

Since the mid 1970's, over 1100 motion pictures have been produced with surround-sound tracks. Because the process encodes the surround information into a 2-channel stereo signal, when the movies are transferred to video tapes and laser discs, the encoded information remains intact. However, in order to enjoy surround sound at home, at the very minimum, a stereo VCR; some type of decoder, and additional surround speakers are required.

The basic principle of all surround-sound decoders, from the simplest to the most expensive, is the same. They all reproduce the surround information by recovering the (L-R) difference signal which is encoded into the left and right channels of the movie soundtrack. The decoder presented here goes beyond the capabilities of a simple surround-sound decoder. Besides the surround decoder circuit, additional circuitry is

ACOUSTIC FIELD GENERATOR

Our AFG will turn any livingroom into a full-sized movie theater or concert hall.

TOD T. TEMPLIN

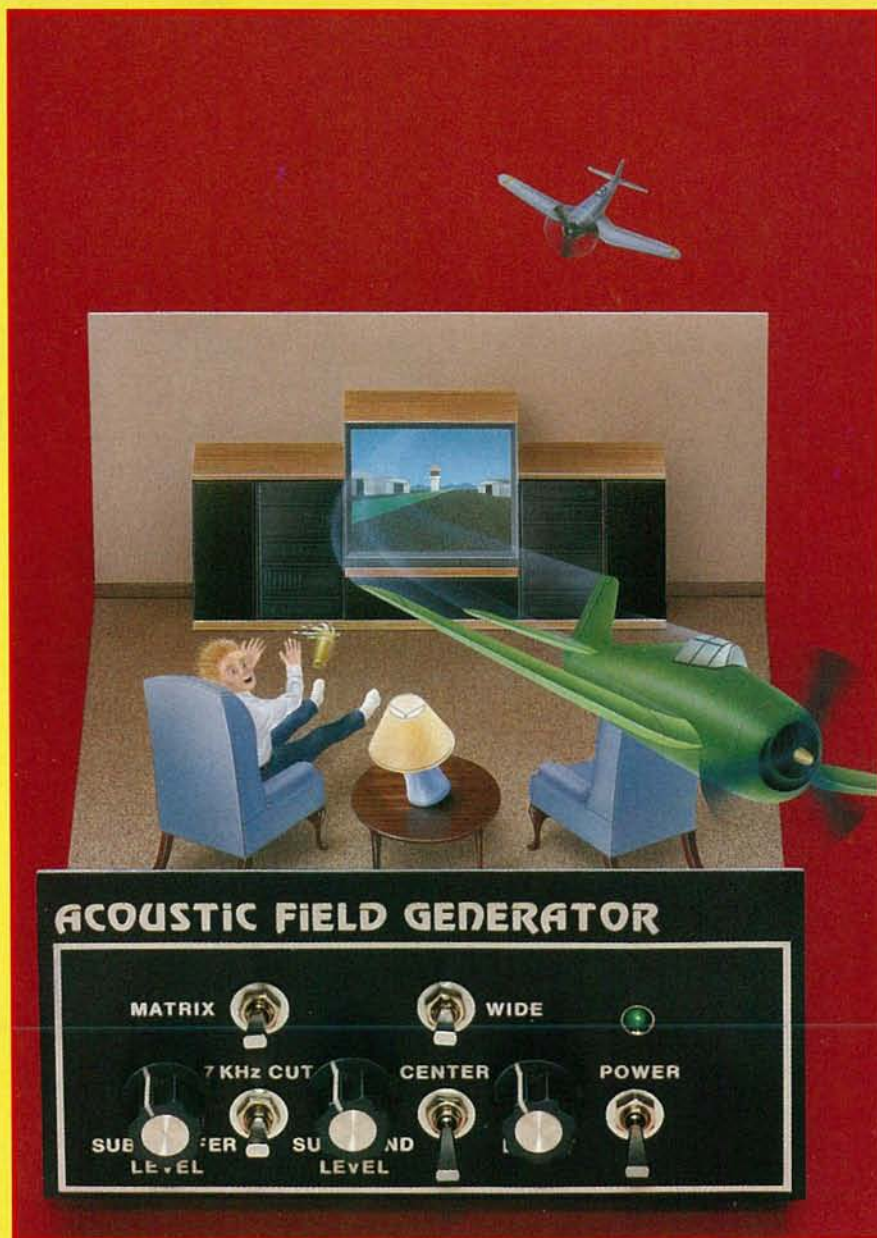

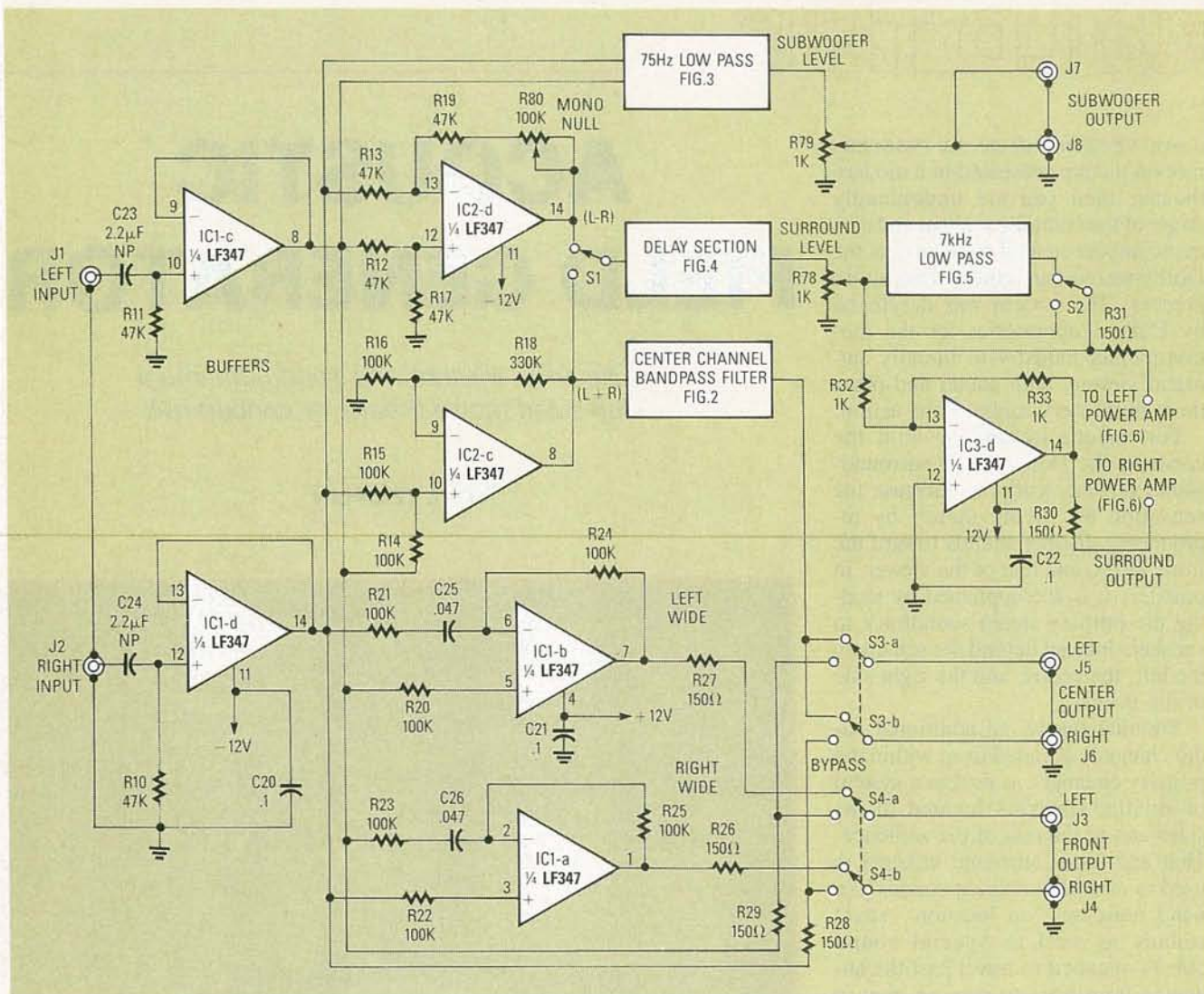

FIG. 1—THE AFG IS MADE UP OF 10 relatively simple circuit elements.

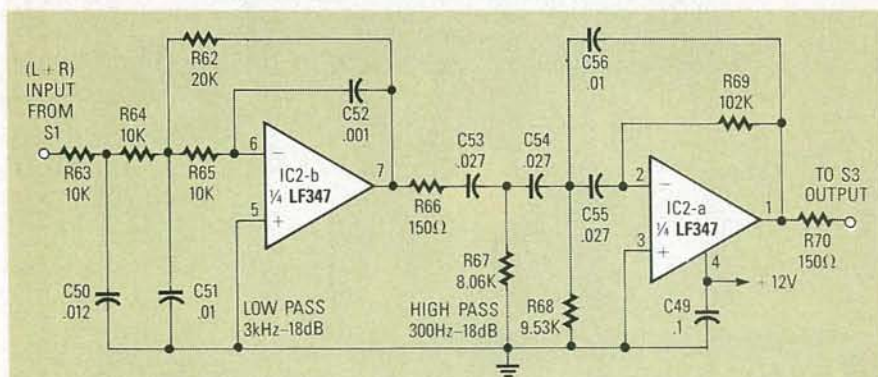

FIG. 2—THE CENTER-CHANNEL SPEECH FILTER is built by cascading a 3-kHz low-pass filter with a 300-Hz high-pass filter to form a band-pass filter.

used to create wide-left, center-dialogue, wide-right, and subwoofer signals. Presenting those signals through six properly arranged speakers results in the acoustical illusion of a large, almost boundless, three-dimensional listening environment, even in a small room; hence the name,

“Acoustic Field Generator,” but we’ll call it the AFG for short. This article is not intended to provide an in-depth tutorial or technical description of the surround-sound system. Rather, it is intended to show you how to construct and install a high-quality, multichannel sound decoder for use in

your home.

The AFG offers two different modes of operation; “matrix” and “concert.” In the matrix mode, the (L-R) difference signal is recovered from surround-encoded source material and is then passed through a 2048-stage bucket-brigade delay line. The delay is continuously adjustable from about 5 to 35 milliseconds, and has a bandpass of 50 Hz to 15 kHz. That enables the accurate decoding and presentation of the surround-channel information present within the source material. The (L+R) sum signal is also recovered to be sent through the delay section of the AFG when the concert mode is selected. That imparts the ambience and realism of a live concert-hall performance to musical material played through the AFG. In either mode, the output of the decoder/delay section is sent to a pair of 10-watt-per-channel power

amplifiers, included on the main circuit board, for driving a pair of surround-channel speakers.

The AFG also provides a means of greatly increasing the apparent separation or "width" of the stereo image presented by the front speakers. In an ordinary decoder, the left- and right-channel signals are sent to the front speakers unaltered, and the center channel, if present at all, is fed a simple sum of the left and right signals. Although that technique provides a very solid front soundstage, it severely limits the system's ability to convincingly present extreme-left or -right sound effects. And, because the screen in most home-video systems is relatively small, especially when compared to the screen in a movie theater, dialogue which should be confined to the screen, tends to appear off screen in the left and right speakers—particularly for viewers seated off center.

The AFG uses frequency-selective circuitry to cancel some of the dialogue from the left and right channels, but that creates a phantom "hole" in the center of the soundstage. So, the AFG also creates a center dialogue channel to fill that hole by summing the left and right channels and passing them through a band-pass filter with a response curve which favors the range of frequencies covered by the human voice. Feeding the voice-only "dialogue" signal directly to the speakers in the video monitor locates the dialogue firmly on the screen without destroying the spatial effects of the front soundstage.

Finally, the AFG includes a 75-Hz active low-pass filter for driving a subwoofer setup. If you are not currently using a subwoofer as part of your system, you are missing out on the dynamic impact and heightened level of excitement which is imparted by the extreme low-frequency sounds used in motion pictures, primarily as a special audio effect. The subwoofer output of the AFG has that sonic information isolated and ready to feed to a power amplifier and speaker of your choice. You may wish to consult with a local audio dealer for advice on selecting a proper subwoofer and power amplifier. Suffice it to say, that a relatively high-power amplifier and large subwoofer will be required if you intend to fill your room with earth-shaking bass that goes far beyond the capabilities of most "full-

range" speakers. It is preferable to place the subwoofer toward the front of the soundstage, although the exact position is not critical, due to the ear's inability to accurately locate very low-frequency sound. Thus, many subwoofers are designed to physically resemble an end table or other piece of furniture, so that they can aesthetically blend into the other room decor.

The AFG was designed to be connected into the pre-amp/power-amp loop of your regular home entertain-

ment system. Consequently, all the functions of the AFG may be switched to bypass and unity gain to effectively remove it from the system, if required. We believe, however, that once you experience the added sonic dimension that the AFG adds to music as well as movies, you'll never want to switch it off.

About the circuit

When viewed as a whole, the AFG circuitry is quite complex. However,

PARTS LIST

All resistors ¼-watt, 5%, except as noted.

R1—1500 ohms
R2, R3, R54—22,000 ohms
R4, R5, R32, R33—1000 ohms
R6, R7, R61, R62, R74—20,000 ohms
R8, R9—1 ohm, ½-watt, 5%
R10—R13, R19, R34, R35—47,000 ohms
R14—R17, R20—R25, R47—R49, R55, R56—100,000 ohms
R18, R57—330,000 ohms
R26—R31, R66, R70—150 ohms
R36—R43, R67—8060 ohms, 1%
R44—R46—16,000 ohms
R50, R51—5600 ohms
R52—2400 ohms
R53—8200 ohms
R58—R60, R63—R65, R71—R73—10,000 ohms
R68—9530 ohms, ¼-watt, 1%
R69—102,000 ohms, ¼-watt, 1%
R75, R80—100,000 ohms, potentiometer
R76—10,000 ohms, potentiometer
R77—50,000 ohms, PC-mount potentiometer
R78, R79—1000 ohms, PC-mount potentiometer

Capacitors

C1—C4—2200 µF, 25 volts, electrolytic
C5, C6—10 µF, 35 volts, radial electrolytic
C7—C12, C19—C22, C27, C28, C30, C31, C45, C49, C58—0.1 µF, 50 volts, metal film
C13, C14, C23, C24, C43—2.2 µF, 50 volts, bi-polar radial electrolytic
C15, C16—22 µF, 16 volts, bi-polar radial electrolytic
C17, C18—0.22 µF, metal film
C25, C26—0.047 µF, metal film
C32—C34—3300 pF, polyester
C36, C37—2700 pF, polyester
C38—C41—270 pF, 5% ceramic disc
C42, C47—0.47 µF, metal film
C44—120 pF, 5% ceramic disc
C46—0.56 µF, metal film

C48—0.039 µF, metal film
C50—0.012 µF, metal film
C51, C56—0.01 µF, metal film
C52—1000 pF, 5% polyester
C53—C55—0.027 µF, metal film
C57—5600 pF, 5% polyester
C58—4700 pF, 5% polyester
C59—470 pF, 5% ceramic disc

Semiconductors

D1, D2—1N5400 50 PIV 3-amp diode
IC1—IC4—LF347 quad JFET
IC5—MN3008 2048-stage bucket brigade device
IC6—MN3101 2-phase clock
IC7—7812T +12-volt regulator
IC8—7912T -12-volt regulator
IC9, IC10—LM1875T audio amp
LED1—light emitting diode pilot lamp

Other components

T1—Power Transformer 25.2 Volt Center Tapped 2 Amp.
F1—F3—1-amp fuse
J1—J8—8-pin RCA-style jack panel
J9—J12—4-position pushbutton speaker-terminal panel
S1, S2, S5—SPDT switch
S3, S4—DPDT switch

Miscellaneous: speakers of your choice, 5 14-pin IC sockets, 1 8-pin IC socket, 1 heat sink (2 × 2 × 5/4-inch aluminum angle stock), 2 T0-220 mica insulators with mounting hardware, silicone grease, 3 in-line fuse holders, 3 knobs, chassis, linecord, solder, etc.

Note: The following items are available from T3 Research, Inc., 5329 N. Navajo Ave., Glendale, Wisconsin 53217-5036: An etched, drilled, and plated PC board, \$15.00; a basic parts kit consisting of all semiconductors, resistors, and capacitors, \$55.00; a piece of aluminum stock for the heat sink, \$3.00. Please include \$2.50 for postage and handling with your order. Wisconsin residents please include appropriate sales tax.

referring to the simplified schematic in Fig. 1, you can see that the AFG is really made up of 10 relatively simple circuit elements. IC1-c and IC1-d are configured as unity-gain non-inverting buffer amplifiers. They transform the 47-kilohm input impedance, which is set by R10 and R11, to a low-impedance source which drives all of the AFG amplifiers, filters, and bypass outputs.

The summing (L + R) amplifier, IC2-c, combines equal amounts of the left and right signals, via R14 and R15, to develop a total composite signal. Left- and right-channel signals are applied equally through R13 and R12 to IC2-d, the difference (L - R) decoder. Any signal that's common to both channels is canceled by IC2-d, thus forming one signal which contains none of the common "mono" information present in the original stereo signal. Potentiometer R80 provides a means of exactly balancing the inverting and non-inverting gains of the amplifier for a perfect null.

The stereo width-enhancement circuit is made up from IC1-a and IC1-b. It works similarly to the (L - R) decoder, except that C25 and C26 have been added in the inverting inputs of each op-amp. Consider, for the moment, just the "right wide" circuit of IC1-a; C26 and R23 form a gently sloping high-pass filter for the left-channel signal only. Thus, the amount of signal cancellation is dependent on frequency and the relative amplitude between the two channels. In other words, the more a signal is the *same* in both channels, the more it is removed from the output of the circuit; the effect increases as the signal's frequency rises. If, however, the input signal appears only in the right channel, no matter what its frequency or amplitude, it does not cancel in the difference amplifier and appears at the output unaffected.

IC1-b functions in the same way to develop the "left wide" signal because its inverting and non-inverting inputs are connected to the left and right channels in a manner opposite that of IC1-a. The net effect of all that is to increase the apparent separation between the left and right channels by eliminating some of the material common between them. The output of the width-enhancement circuit is routed to S4, which selects either the "wide" or the bypass signal for feeding the front-channel amplifier.

The center-channel dialogue filter, or speech filter if you prefer (see Fig. 2), is built by cascading a 3-kHz low-pass filter with a 300-Hz high-pass filter to form a band-pass filter. The frequency characteristics of the human voice fall predominantly within that range. As with all of the other filters used in the AFG, those are of the 3rd order Butterworth design. That design was chosen because it offers minimum peaking within the passband. It has a sharp -18 dB/octave cutoff, a flat voltage and power frequency response, and minimum phase change within the passband. The output of the bandpass filter is routed to the high side of S3. That switch allows the center-channel output of the AFG to be switched between the dialogue filter and the bypass mode.

As shown in Fig. 3, IC3-a and IC3-b form an active crossover network for driving a subwoofer. IC3-a sums signals from the left- and right-channel buffer amps, it inverts the summed signal 180 degrees, and it provides a low driving impedance for the following filter stage. IC3-b and its associated RC network form a 75-Hz, 3rd-order low-pass filter. Because the filter inverts the signal another 180 degrees, the signal that appears across R79 (which is the output-level control) is back in phase with the original input signal.

The delay section of the AFG, shown in Fig. 4, is built around the MN3008 *Bucket Brigade Device* (BBD), made by Matsushita (Panasonic), and the MN3101 two-phase variable-frequency clock generator. The BBD is a P-channel silicon-gate MOS LSI circuit comprised of 2048 bucket-brigade stages fabricated on a single chip. Each stage consists of a small capacitor that stores an electric charge and a tetrode transistor for

switching purposes. Electrical charges corresponding to analog signals are transferred from one stage to the next by a two-phase clock drive, in the same manner that a fireman's bucket brigade transfers a pail of water from one man to the next. A signal presented at the input is transferred down the line of buckets toward the output at a speed controlled by the clock frequency. The more slowly the clock runs, the longer it takes for the signal to travel through the circuit. (See discussion of BBD theory in the October 1986 **Radio-Electronics**.)

The amount of delay required in our system varies between approximately 5 and 35 milliseconds, so our first consideration must be to select the proper range of clock frequency. The delay time of a BBD is equal to the number of stages divided by twice the clock frequency. So, based on manufacturer's data for the MN3101 clock-generator IC, values were chosen for R53, R54, R77, and C44, to produce a clock frequency, adjustable via R77, which varies from about 30 kHz to 130 kHz.

Our next consideration deals with the property of delay lines known as aliasing. If the frequency of the signal applied to the input of a delay line becomes higher than one half of the clock frequency, the time available to store the sample of that signal in the capacitor becomes too short. The amplitude of that signal's frequency has a value which changes during the time of the sample, so the charge stored in the capacitor is not an accurate representation of that instant of time. To avoid the problem and the resulting distortion, a filter is placed ahead of the BBD which limits the input frequency to one half of the lowest clock frequency used. Given that we'd like to run the clock at speeds as slow as 30 kHz, we must limit the maximum fre-

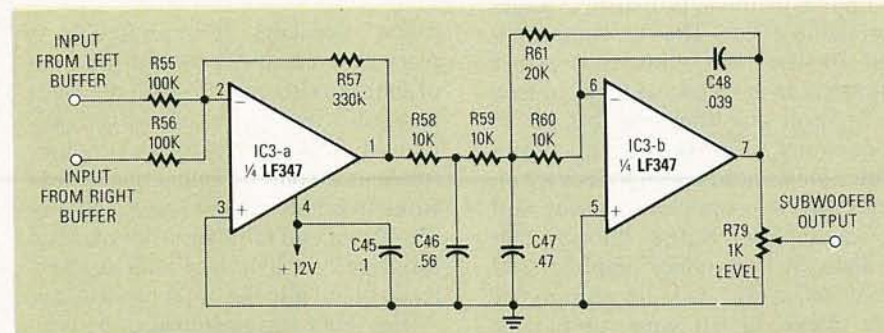

FIG. 3—AN ACTIVE CROSSOVER NETWORK for driving a high-power subwoofer system is made from IC3-a and IC3-b.

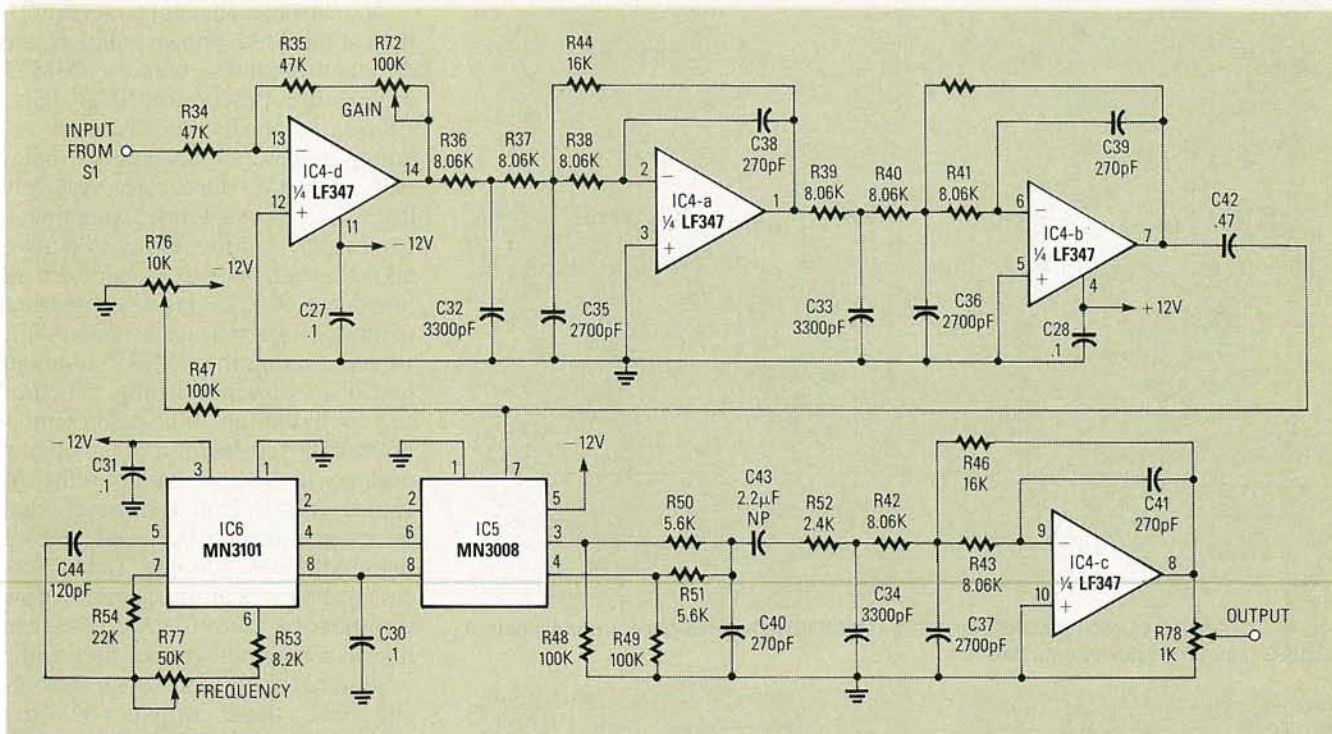

FIG. 4—THE DELAY SECTION OF THE AFG IS BUILT AROUND THE MN3008 bucket-brigade device and the MN3101 two-phase variable-frequency clock generator.

quency that we apply to the BBD to 15 kHz.

If you refer back to Fig. 1, S1 selects the signal to be delayed; either the difference signal ($L - R$) from IC2-d in the matrix mode or the sum signal ($L + R$) from IC2-c in the concert mode. The selected signal is fed from S1 to the delay section (Fig. 4) where IC4-d is configured as an inverting amplifier; R75 adjusts the gain between unity and $\times 3$. Integrated circuits IC4-a and IC4-b, along with their associated RC networks, are identical 3rd-order 15-kHz low-pass filters. Cascading two filters produces a very sharp cut off (-36 dB per octave), which is convenient, as it eliminates any problems that may arise with aliasing, while maintaining a respectable 15-kHz bandwidth for the section. Potentiometer R76 is used to adjust the bias voltage required by the BBD to exactly one half the supply voltage; a requirement of the device. Notice that both the BBD and the clock IC run off of the negative power-supply rail.

Another property of a BBD is that clock phase 1 drives all the odd-number stages of the device and clock phase 2 drives all the even stages. When the signal reaches the end of the line, the output of the last odd stage must be combined with the output of

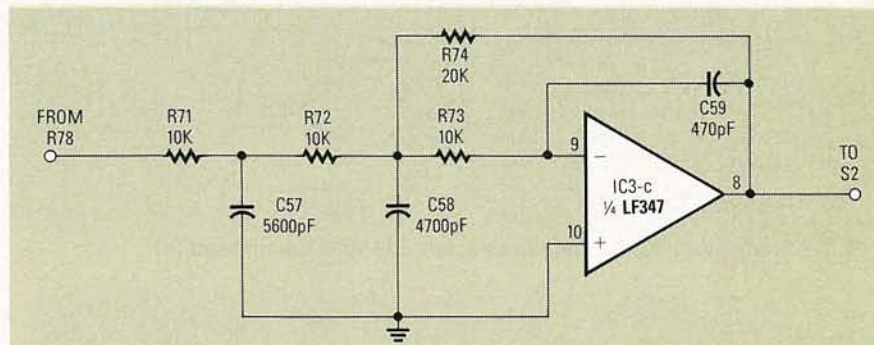

FIG. 5—A 3rd-ORDER 7-kHz LOW-PASS FILTER IS MADE FROM IC3-c AND ITS ASSOCIATED RC NETWORK.

the last even stage to reconstruct an exact replica of the input signal. The purpose for doing that is to self-cancel any of the clock signal from the output of the device; R48 and R49 are the source-load resistors for the last two BBD stages and R50 and R51 sum the two outputs. The delayed signal is next applied to another 3rd-order 15-kHz low-pass filter comprising IC4-c and its associated RC network. That last filter is required to stop any remaining clock signal from reaching the output of the circuit. Potentiometer R78 is there to serve as the volume control for the surround channels by controlling the amount of delayed signal that is applied to the power amplifiers.

To provide for increased high-fre-

quency noise reduction in the surround channel and to more closely comply with the Dolby Laboratories standards for surround sound, a 3rd-order 7-kHz low-pass filter is included in the AFG design. As shown in Fig. 5, IC3-c and its associated RC network forms the filter; S2 then selects between the output of that filter and the bypass mode. If you refer back to Fig. 1, notice that the wiper of S2 is connected to two circuits; it goes directly to the left surround power amplifier via R31, and to IC3-d, a unity-gain inverting amplifier, via R32. The output of IC3-d drives the right surround power amplifier via R30. The reason for driving the power amplifiers out of phase will be explained shortly.

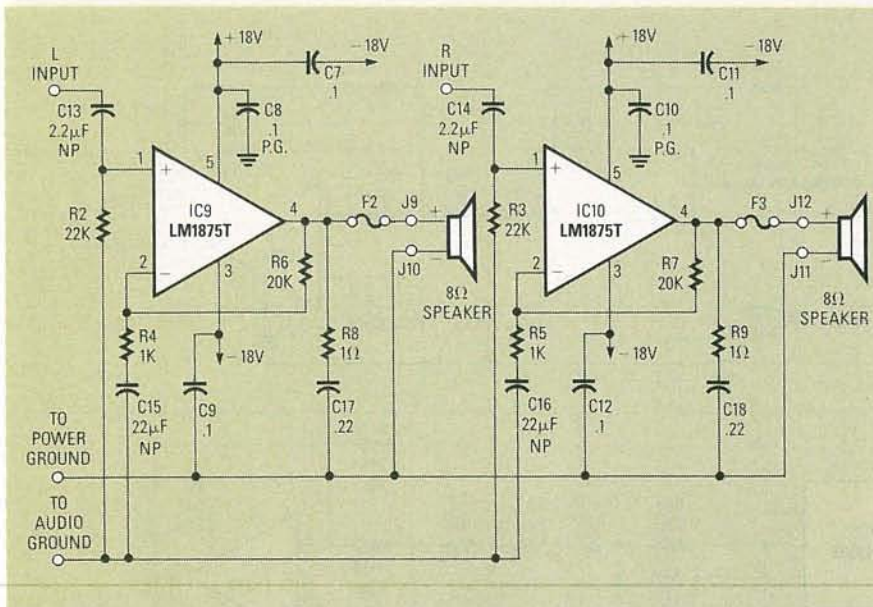

FIG. 6—THE SURROUND CHANNEL POWER AMPLIFIERS are designed around a pair of LM1875 monolithic power-amplifier IC's.

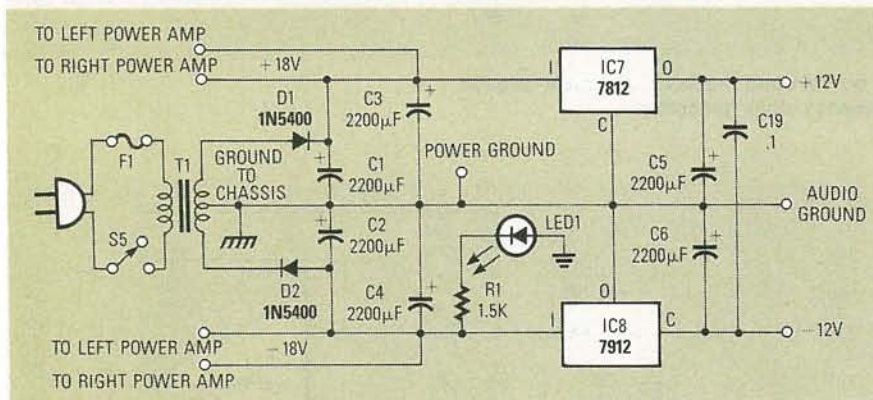

FIG. 7—THE POWER SUPPLY produces about ± 18 -volts unregulated DC.

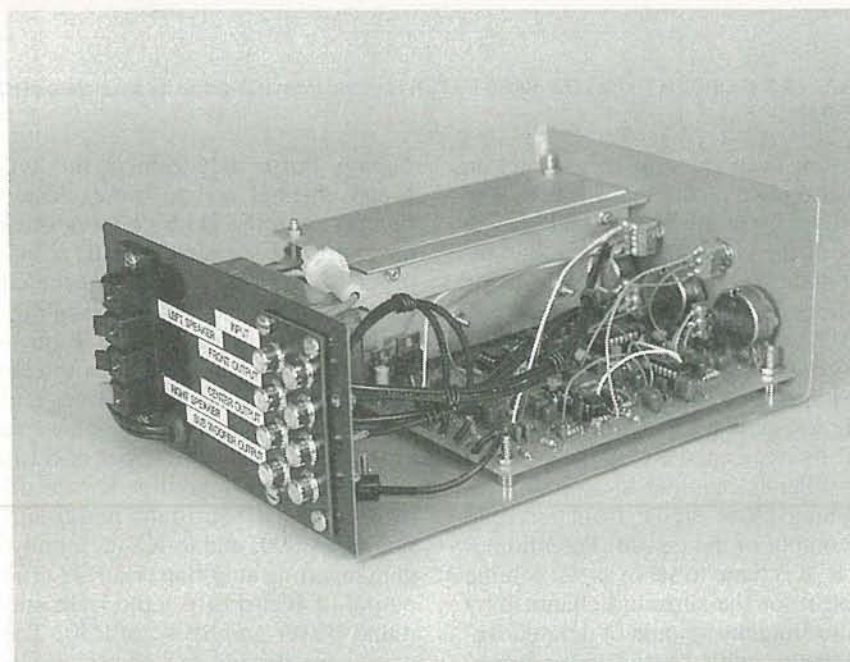

FIG. 8—THE PROTOTYPE ACOUSTIC FIELD GENERATOR. It's a tight fit in this cabinet, but it makes for a neater finished unit.

The surround channel power amplifiers of the AFG, shown in Fig. 6, are designed around a pair of LM1875 monolithic power-amplifier IC's. Chosen primarily because they require very few external parts to implement, and they also offer very low distortion, fast slew rate, wide power bandwidth, and the ability to deliver up to 20 watts into an 8-ohm load; all in a 5-pin TO-220 package. Because of limited heat-sink space in the AFG, we are running the LM1875 at about half of its power capability. The circuit configuration of the power amp is essentially the same as that of any ordinary op-amp operating in the inverting mode. Notice however, that there are two separate ground-return lines to the power supply. That is necessary because high currents flow through the output ground-return line. If a common ground-return line were used for both the input and output signal, those currents could develop enough voltage across the resistance of the return line itself to effectively act as an input signal to the amplifier, thus causing problems such as high-frequency oscillations or distortion.

The power supply of the AFG, shown in Fig. 7, is of conventional design. A 25-volt center-tapped transformer, along with diodes D1 and D2, produces about ± 18 -volts unregulated DC. Two 2200- μ F filter capacitors are used in each leg of the supply to provide ample energy storage to meet the high-current demands of the audio output amplifier IC's during high-output peaks. Integrated circuits IC7 and IC8 regulate the positive and negative supply rails to plus and minus 12 volts for use in the low signal level circuits. The plus and minus 12- and 18-volt rails are bypassed to ground by 0.1- μ F capacitors distributed throughout the entire AFG circuitry. That keeps the impedance of the supply rails at audio frequencies as low as possible, thus reducing the interaction between the various circuits.

That's all we have room for this time. We've given you the list of parts, so that you can at least gather all of them together. Next month we'll give you the foil pattern and parts-placement diagram so you'll be able to build your own AFG. You'll find that more fun than just looking at ours which, by the way, is shown in Fig. 8.

R-E

BUILD THIS

3-CHIP LOGIC ANALYZER

MICROPROCESSOR SYSTEMS OFTEN monitor several signals at once, like address or data bus contents. That's often difficult to duplicate with most logic probes, and logic analyzers are too expensive for most hobbyists. One solution is to build an eight-bit, 3-chip, word-recognition logic analyzer for about \$6. The low parts count keeps size and power demands low, so it can run directly off the Circuit-Under-Test (CUT).

Principles of operation

The schematic is shown in Fig. 1. It uses two cascaded four-bit 74LS85 digital magnitude comparators, IC1 and IC2, to monitor an eight-bit signal in any TTL-compatible environment. The digital word being sent is entered on a group of DIP switch inputs (S1-a-S1-h). If it's matched by signals from the test device inputs (TP0-TP7), the upper 74LS85 sets pin 6 high.

The 74LS00 is a quad 2-input NAND gate; IC3-a and IC3-b make up an R-S flip-flop, IC3-c is unused, and IC3-d is used as an inverter to drive one flip-flop input. The two flip-flop inputs are pin 1 on IC3-a, and pin 4 on IC3-b. Pin 1 on IC3-a is kept high by being tied back to +5V through R3-i. Pressing the RESET switch, S2, momentarily grounds pin 1 of IC1 and pin 6 of IC2, turning off Q1 and LED1.

The high from pin 6 of IC2 sets the flip-flop, driving pin 6 of the 74LS00 high, turning on Q1 and LED1 until the user presses S2. However, test points TP0-TP7 shouldn't have latched yet. A comparison ripples through a 74LS85 in about 32 microseconds (worst case), so each eight-bit word has to last about 64 nanoseconds for valid comparison. That shouldn't cause problems with 4-8 MHz microprocessor signals.

Construction

The prototype, shown in use in Fig. 2, was built on a PC board using wire-wrap IC sockets and a nine-element SIP-resistor array. The test leads should be about six inches long. The push-on connectors are single, break-apart, Molex IC sockets, covered with heat-shrink tubing; you could also use

If you have ever needed a simple logic analyzer, or wanted to know more about how they work or how to use them, then try our \$6 circuit.

J.J. ROBINSON II

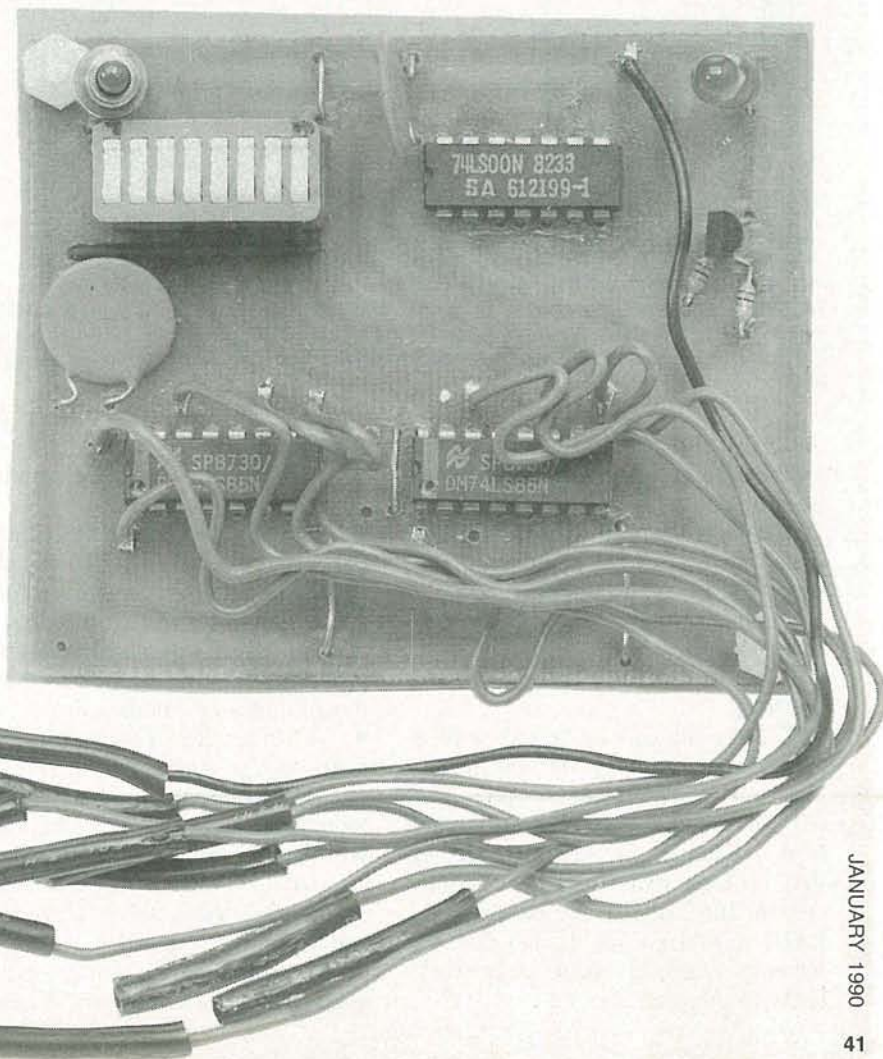

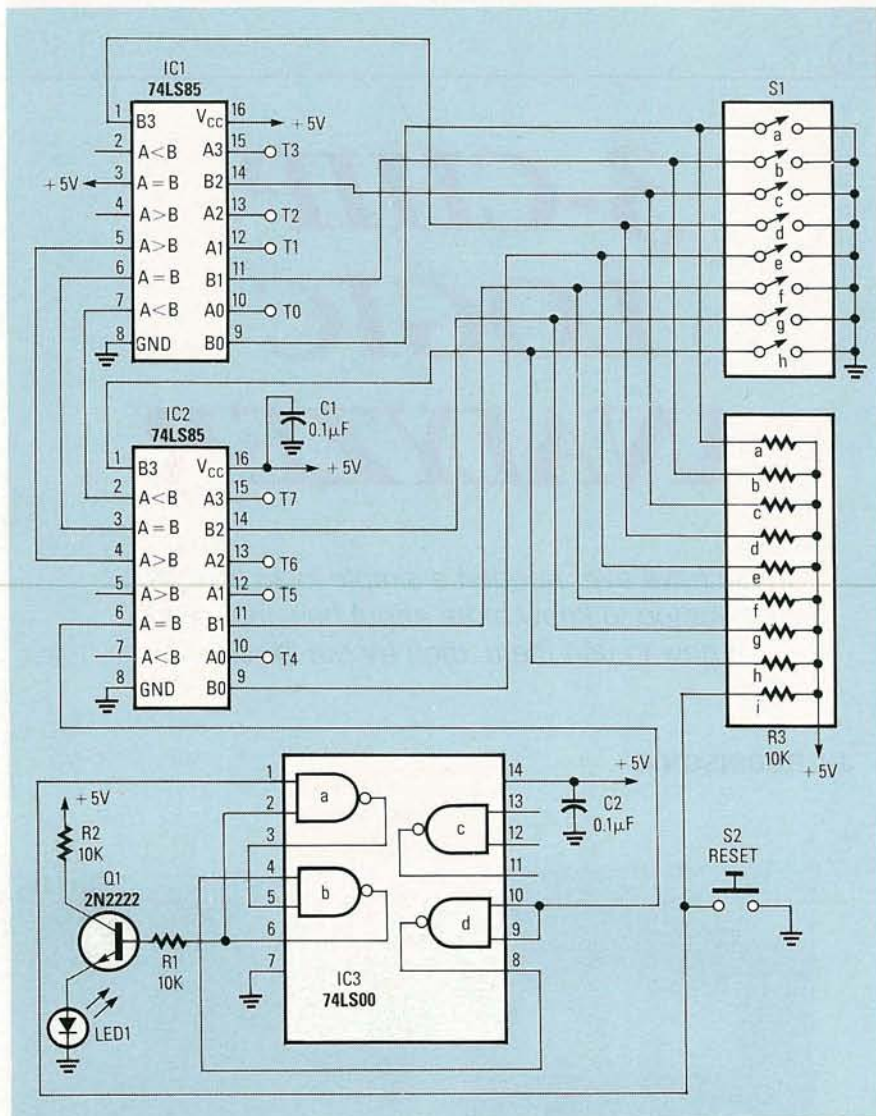

FIG. 1—SCHEMATIC OF THE 3-CHIP LOGIC ANALYZER. It's made from two cascaded 74LS85 4-bit magnitude comparators (IC1 and IC2), and uses an 8-switch SPST DIP switch S1 and 8-resistor SIP array R3 to set the bit states compared against. The output of IC2 is fed into inverter IC3-d, which feeds into RS flip-flop IC4-a and b, which drives Q1 and LED1.

an IC test clip. The space between the PC board and the tested circuit has to be insulated with a sheet of plastic or small block of wood. At high frequencies, use a shielded enclosure. The prototype PC board operated reliably when unshielded near a 16-MHz video PC board.

Testing

The circuit can be tested with a static input word on the test leads. When the analyzer's switches (S1-S8) match it, LED1 should light. If the switches are then changed so they no longer match, LED1 should stay lit. If S2 (RESET) is now pressed, LED1 should go out. If that doesn't happen, carefully check your work for wiring errors.

Applications

There are three tests for which the analyzer is quite useful:

- Data bus: Connect the test leads in the correct order to the microprocessor data bus, and check for the desired eight-bit test word. They can be elements of the machine language program, data transmitted to the microcomputer by another device, etc.
- Address bus: Connect the test leads to the address bus; since it's often 16 bits long, only half can be monitored at once. The upper half will usually be the most significant, and will show what parts of the address space the system is accessing under program control.
- Control signals: Connect the test leads to monitor a selection of control

PARTS LIST

All resistors are ¼-watt, 5%.

R1, R2—10,000 ohms

R3-a-R3-i—10,000 ohms × 9 SIP network

Capacitors

C1, C2—0.1 µF, ceramic disc

Semiconductors

IC1, IC2—74LS85 magnitude comparator

IC3—74LS00 quad NAND gate

Q1—2N2222 NPN transistor

LED1—light-emitting diode

Other components

S1-a-S1-h—8-switch DIP

S2—subminiature, momentary, push-button SPST switch

TP1-TP8—Molex break-apart IC pins

Miscellaneous: PC board, wire, solder, and heat-shrink tubing.

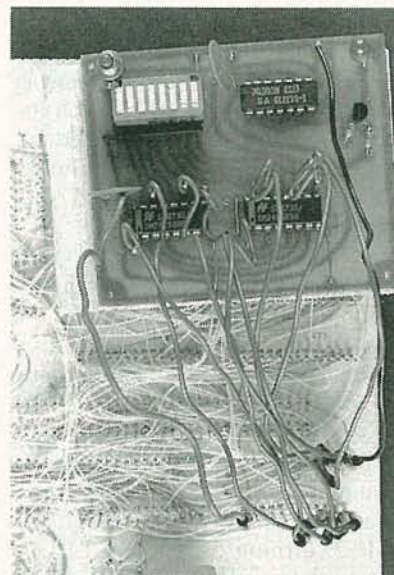

FIG. 2—PROTOTYPE OF THE 3-CHIP logic analyzer; note SPST DIP switch S1 and the SIP resistor array R3 at upper left. The eight pins covered with heatshrink tubing are made from Molex break-apart IC pins.

signals, like chip-, write-, and read-enable (CE, WE, and RE) pins of memory devices, I/O selects, etc. That can show whether the CE, WE, and/or RE are simultaneously active, whether multiple memories are simultaneously selected, and happens to be very useful in debugging address decoding algorithms.

To use the analyzer, connect the power and ground to the test circuit points, and the eight test leads to the appropriate signals. When a positive match is found, the LED glows. For the next test, enter a new search word and press S2.

R-E

between the audio.

The input stage, composed of R1, 10-volt Zener D1, and the base-emitter junction of Q1, places a high-impedance loop across the green (tip) and red (ring) phone-line wires. The current through the phone line should be:

$$I_{\text{phone}} = (V_{\text{tip}} - V_{\text{D1}} - V_{\text{BE1}}) / R1 \\ = (48 \text{ V} - 10 \text{ V} - 0.7 \text{ V}) / 100\text{K} \\ = 373 \mu\text{A}.$$

That causes about a 1-volt drop from the 48-volt level, that drives Q1 into saturation at about 200 millivolts. If the phone rings or is picked up, Q1 cuts off and the inverting input of IC2-a goes to 12 volts. Next, voltage divider R3-R5 biases the noninverting input of IC2-a and the inverting input of IC2-b at:

$$V_{\text{BIAS}} = V_{\text{CC}} \times [R3 / (R3 + R5)], \\ = 12 \text{ V} \times [20\text{K} / (20\text{K} + 10\text{K})], \\ = 8 \text{ V}.$$

At that point, the output of IC2-a goes low, discharging C3. The output of IC2-b goes high, turning Q2 on and driving it into saturation via R6, and activating relay RY1, breaking the audio path between J1 and J2, and J3 and J4. After the phone stops ringing, or is hung up, the output of IC2-a goes high, charging C3 through R4, with a time constant of:

$$\tau = R4 \times C3 \\ = 100\text{K} \times 47 \mu\text{F} \\ = 4.7 \text{ seconds}.$$

If the phone rings before C3 reaches 8 volts as set by R3 and R5, C3 discharges and the timing cycle restarts. After a certain exponential charging interval, the potential across C3 reaches 8 volts, and the output of IC2-b goes low, turning off Q2 and RY1 and reconnecting the audio. The final charging voltage in that case is $V_f = V_{\text{CC}} = 12 \text{ V}$, and the target voltage is $V_t = 8 \text{ V}$. Since τ is known, the charging interval is:

$$T = -2.303 \times \tau \times \text{Log}_{10}[1 - (V_f / V_t)], \\ = -2.303 \times 4.7 \text{ seconds} \\ \times \text{Log}_{10}[1 - (8 \text{ V} / 12 \text{ V})], \\ = 5.164 \text{ seconds}.$$

When RY1 energizes and the audio is cut off, audio output terminals J3 and J4 are shorted through C4 to prevent any hum introduced when the audio-muting circuit switches line-level audio. Here, D2 prevents reverse-bias spikes, generated by switching RY1, from destroying Q2.

PARTS LIST

All resistors are 1/4-watt, 5%, unless otherwise indicated.

R1, R2, R4—100,000 ohms
R3—20,000 ohms
R5, R6—10,000 ohms

Capacitors

C1—47 μF , 16 volts, electrolytic
C2, C4—0.1 μF , 50 volts, non-polarized (NP) ceramic disc
C3—47 μF , 10 volts, electrolytic

Semiconductors

BR1—NTE-5332 1-amp, 600-volt PIV 4-pin DIP bridge rectifier
D1—NTE-140A 10-volt Zener diode
D2—IN4004 rectifier
Q1, Q2—2N2222 NPN transistor
IC1—7812 5-volt regulator
IC2—LM393N 14-pin DIP dual voltage comparator

Other components

T1—120-volt/12.6-volt, 300-mA transformer
RY1—5-volt, DPDT, 8-pin DIP Relay
PL1—AC line cord with plug
PL2—four-conductor modular tele-

phone cord with plug
J1—J4—RCA phono jack

Miscellaneous: Case, AC line cord grommet, two straight-line TO-3 transistor sockets, an 8-pin DIP IC socket, wire, solder, and drill with bits.

NOTE: A kit of parts is available for \$29.95 from Applitron Services, 2721 Creswell Road, Bel-Air, MD 21014. It includes an etched and drilled PC board, but excludes the AC line plug and cord PL1 with grommet, modular telephone plug and cord PL2, and the case. The PC board alone is \$15.00, should you wish to obtain the parts locally. Please enclose \$1.95 postage and handling; allow 4–6 weeks for delivery. Relay RY1 can be obtained separately from All-Electronics Corp., P.O. Box 567, Van Nuys, CA 91408, (800) 826-5432, for \$2.50.

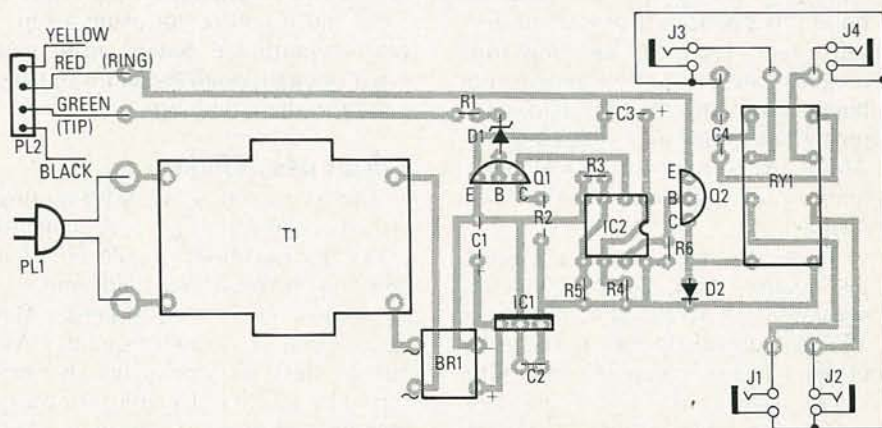

FIG. 2—PARTS-PLACEMENT DIAGRAM for the audio-muting circuit. Note the spacing of the pins of RY1, for orientation purposes.

Finally, the grounds for J1–J4 in Fig. 1 are separate from those of the rest of the circuit. The ground symbol for the main part of the audio-muting circuit is the normal downward-pointing, three-line, triangular arrow, whereas the ground symbol for J1–J4 is a downward-pointing open triangle. The reason is that the radio, stereo, or TV, shouldn't share a common ground with the rest of the audio-muting circuit.

Also, the ground terminals aren't connected J1-to-J3 and J2-to-J4, to attempt to separate the channels and avoid crosstalk. The radio, stereo, or TV will have one common ground for all four terminals within its own cabinet, so joining all four ground termi-

nals of J1–J4 shouldn't make any difference. Similarly, you wouldn't connect J1-to-J2 and J3-to-J4, since that would isolate input and output, preventing the speakers from being properly grounded, and might damage whatever audio source is connected to J1 and J2.

You can also use the audio-muting circuit with two mono sources, like two TV's, instead of one stereo source, but you have to isolate the grounds for the two channels. In that case, *don't connect all four grounds for J1–J4 together*, or you might get one really nasty shock, and/or some pretty spectacular fireworks. You can connect the grounds of J1 and J3 and

continued on page 101

TECHNOLOGY

WHAT'S NEW IN CD PLAYERS

If you're in the market for a new CD player, you should familiarize yourself with all of the new features available

JOSEF BERNARD

WHETHER YOU'RE BUYING A CD PLAYER for the first time, or upgrading your audio system with a new one, 1990 has plenty in store for you. For one thing, you'll find that, as befits today's political era, many of the new players are "kinder and gentler."

CD players have changed a lot since they were introduced jointly by Philips and Sony in 1983. For one thing, they cost a lot less than the \$900 first units, although you can still easily pay that much and more if you put your mind to it. For another, the new players are loaded with features and technology that were barely a gleam in designers' eyes just a few years ago. Here's what's new in the current crop of CD players.

Changers

It seems that the more we have, the more we want. It isn't enough to have as much as 74 minutes of superior sound recorded on an almost indestructible medium—now we don't even want to have to get up to change discs! Enter the CD changer. Changers come in two varieties—carousel and magazine. With a carousel changer (Fig. 1) you load in as many discs as it will hold, usually five, and off you go. When one disc is finished, the next swings into place. Assuming that you always play a given set of discs in the same order, you can pro-

gram carousel changers to play selections in a certain order, or even to skip some selections.

Magazine-type changers accept cartridges that can hold five, six, or as many as ten compact discs (Fig. 2). Again, the order in which discs and selections are played is programmable. Magazines, which cost between \$15 and \$30 each, from different manufacturers are *not* interchangeable, although those used by Sony can be swapped between their home and car units. Most carousel, and some magazine players include a "single-play" drawer for individual CD's. And at least one magazine model has twin drawers (Fig. 3) so you can reload one while playing the other.

Multi-disc players

There are now a number of different disc formats on the market offering a number of different types of programming. There are conventional five-inch (actually closer to 4¾-inches) CD's, the small three-inch discs that offer a shorter "pop-size" playing time, CD-V's for music videos, and 8- and 12-inch laser discs for movies and other visual material. What those formats have in common is that they all involve spinning discs that are read

by bouncing a laser beam off their surfaces. It seemed only natural that someone would eventually come up with a single player that handled all those formats, which are similar in principle, and a quite a few companies have done just that (see Fig. 4).

The devices are sometimes referred to as "multi-disc players," (also as "combi players") but the term "multi-disc" refers not to their ability to accept several discs at once, but to their ability to accommodate several different disc formats—one at a time, of course. Even some portable units can play both 5- and 3-inch CD's without the adapters that have sometimes been necessary in the past.

Programmability

One of a CD player's big selling points, after the quality of its sound, is its programmability. You can instruct



Take any one of these HANDBOOKS ELECTRONICS and CONTROL

- your one source for engineering books from over 100 different publishers
- the latest and best information in your field
- discounts of up to 40% off publishers' list prices



322/910

Publisher's Price \$114.50

ANTENNA ENGINEERING HANDBOOK, Second Edition

Edited by R. C. Johnson and H. Jasik

- 1,408 pages, 946 illustrations
- covers all types of antennas currently in use with a separate chapter devoted to each
- provides detailed data on physical fundamentals, operating principles, design techniques, and performance data
- up-to-the-minute information on antenna applications
- a must for those involved in any phase of antenna engineering

Publisher's Price \$75.00

STANDARD HANDBOOK OF ENGINEERING CALCULATIONS, Second Edition

By T. G. Hicks

- 1,468 pages, 793 illustrations, 499 tables
- puts more than 1,100 specific calculation procedures at your fingertips
- every calculation procedure gives the exact, numbered steps to follow for a quick, accurate solution
- virtually all procedures can be easily programmed on your PC or calculator
- uses USCS and SI units in all calculation procedures

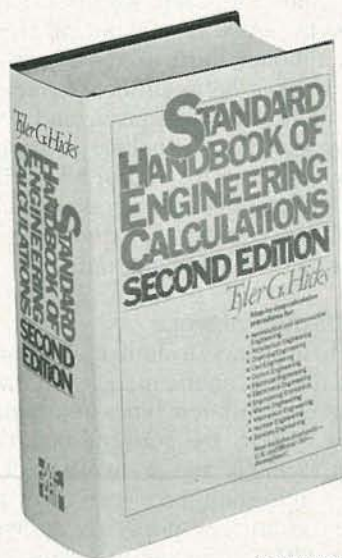

287/35X



047/790

Publisher's Price \$98.50

TELEVISION ENGINEERING HANDBOOK

Edited by K. B. Benson

- 1,478 pages, 1,091 illustrations
- packed with all the technical information today's engineer needs to design, operate, and maintain every type of television equipment
- extensive coverage of receivers, broadcast equipment, video tape recording, video disc recording, and the latest technological advances
- provides television system and industry standards for the U.S. and other countries
- the most comprehensive book on the subject of television engineering

for only \$14.95 — when you join the ENGINEERS' BOOK CLUB

values up to
\$114.50

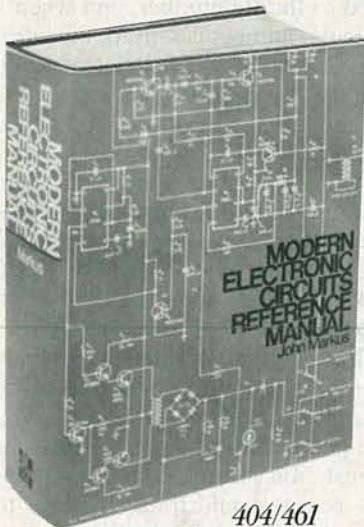

404/461

Publisher's Price \$89.95

MODERN ELECTRONIC CIRCUITS REFERENCE MANUAL

By J. T. Markus

- 1,264 pages, 3,666 circuit diagrams
- a handy, desktop reference with 103 chapters organized by "family" grouping
- filled with predesigned and use-tested circuits to save you production time and money
- includes concise summaries of all the recent applications notes, journal articles, and reports on each circuit, efficiently organized and indexed for the practicing engineer



4 reasons to join today!

- 1. Best and newest books from ALL publishers!** Books are selected from a wide range of publishers by expert editors and consultants to give you continuing access to the best and latest books in your field.
 - 2. Big savings!** Build your library and save money, too! Savings range up to 40% off publishers' list prices.
 - 3. Bonus books!** You will automatically be eligible to participate in our Bonus Book Plan that allows you savings up to 70% off the publishers' prices of many professional and general interest books!
 - 4. Convenience!** 14-16 times a year (about once every 3-4 weeks) you receive the Club Bulletin FREE. It fully describes the Main Selection and alternate selections. A dated Reply Card is included. If you want the Main Selection, you simply do nothing — it will be shipped automatically. If you want an alternate selection — or no book at all — you simply indicate it on the Reply Card and return it by the date specified. You will have at least 10 days to decide. If, because of late delivery of the Bulletin you receive a Main Selection you do not want, you may return it for credit at the Club's expense.
- As a Club member you agree only to the purchase of two additional books during your first year of membership. Membership may be discontinued by either you or the Club at any time after you have purchased the two additional books.

Publisher's Price \$89.50

ELECTRONICS ENGINEERS' HANDBOOK, Third Edition

Edited by D. G. Fink and D. Christiansen

- 2,496 pages, 1,600 illustrations
- the definitive reference to electronics engineering
- fully updated to cover all recent advances and developments
- ranges from essential principles and data to the latest design solutions and practical applications — with an all-new chapter on standards
- written and compiled by more than 170 contributors — all experts in their fields

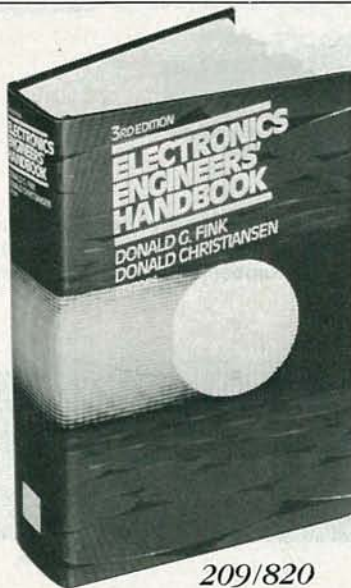

209/820

FOR FASTER SERVICE IN ENROLLING CALL TOLL FREE 1-800-2-MCGRAW

McGraw-Hill Book Clubs
Electronics and Control Engineers' Book Club®
P.O. Box 582
Hightstown, NJ 08520-9959

Please enroll me as a member of the Electronics and Control Engineers' Book Club® and send me the book I have chosen for only \$14.95 plus local tax, postage and handling. I agree to purchase a minimum of two additional books during my first year as outlined under the Club plan described in this ad. Membership in the club is cancellable by me or McGraw-Hill any time after the two book purchase requirement has been fulfilled. A shipping and handling charge is added to all shipments.

I wish to order the following book:

- ANTENNA ENGINEERING HANDBOOK (322/910)
- MODERN ELECTRONIC CIRCUITS REFERENCE MANUAL (404/461)
- ELECTRONICS ENGINEERS' HANDBOOK, 3/e (209/820)
- TELEVISION ENGINEERING HANDBOOK (047/790)
- STANDARD HANDBOOK OF ENGINEERING CALCULATIONS (287/35X)

Signature _____

Name _____

Address/Apt. # _____

City/State/Zip _____

This order subject to acceptance by McGraw-Hill. Offer good only to new members. Foreign member acceptance subject to special conditions.

ECGA-022

JANUARY 1990

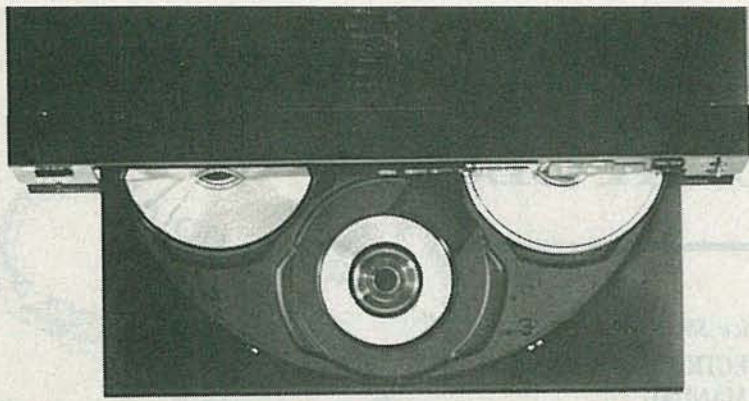

FIG. 1—A CAROUSEL CHANGER, such as Sony's *CDP-C8ESD*, can accept up to five CD's and play them in succession. It can be programmed to skip the tracks that you don't customarily listen to.



FIG. 2—WITH MAGAZINE CHANGERS you can store your CD's in sets of five, six, or ten, ready to play in pre-programmed order. The programming information is stored in the changer and called from memory in response to the ID number of the first disc in the magazine. This is JVC's *XL-M401BK* changer.



FIG. 3—IF ONE MAGAZINE ISN'T ENOUGH, changers such as the Pioneer *PD-T503* have twin drawers so you can have two on line. You can also reload one magazine while the other is playing.

a player to play some selections and skip others (and even to replay the same selections), or decide for itself in what order to play the tracks (random- or shuffle-play), and take it on its own from there. Some players can play tracks at random while remembering to ignore the ones you don't care for.

All players have a time display of some sort, which is useful in making up programs to transfer to tape. Some

models can be programmed to automatically insert a four-second pause between selections, so that you can then use the tapes on players with automatic search functions. There is at least one player on the market that can scan a disc and find the loudest passage, allowing you to set the recording levels on your tape deck to prevent distortion.

CD changers can be programmed in the same way. The programming

information is stored in nonvolatile RAM in the changer. When a magazine or, in the case of carousel players, an assortment of discs is inserted into the changer, the first disc is scanned and a manufacturer's ID number unique to it is retrieved from a sub-code (non-music) area. Programming information for a given cartridge is keyed to the ID number, and when a particular number is sensed, the information pertaining to it is retrieved from the changer's memory. If the first disc in a cartridge is exchanged for another, the program for that cartridge has to be reentered. The same also applies to disc assortments for carousels. There's one player that can keep track of 226 discs at 20 tracks per disc, for a total of 4520 tracks.

The recording format of compact discs allows for index marks to be included by the manufacturer to denote points on the disc of particular interest. You can enter the index numbers as you would track numbers to get to those points immediately, or to select certain portions of the disc during programming. Unfortunately, not many manufacturers take the trouble to include indexing, and the feature is largely unused.

A *Custom Index* feature on some Sony players, though, permits you to enter your own index point (as many as six of them) into the player's memory. When you think you've marked the proper place on the disc, you tell the player; it then replays the three-second passage preceding the marked point to allow you to review and, if necessary, edit the index point. Another touch of the button locks the index point in memory. If you want to adjust the position of the index point you can do so in increments of $\frac{1}{100}$ of a second using the player's FORWARD and BACK buttons.

Sampling, filters, and extra bits

The first stage in converting an analog signal to a digital one, such as what's used on CD's, is a process called *sampling*. The analog-to-digital converter "peeks" at the analog signal many times each second, and the result of each peek is a number in binary form, or a "sample," that represents the instantaneous amplitude of that signal—its level at the instant of the "peek." The process is illustrated in Fig. 5.

To sample a waveform accurately,

the sampling frequency must be at least twice that of the highest frequency that is sampled. If it is lower than that, the digitized signal will not be a proper representation of the analog one, and will be filled with distortion products. In the case of compact discs, the sampling frequency has been standardized at 44.1 kHz, which ensures reproduction of signals having frequencies up to (and a bit beyond) 20 kHz, the theoretical limit of human hearing.

However, while that technique may record the digitized signal with considerable accuracy, the process of playing it back (converting the stream of binary numbers back into an analog waveform that can be amplified and fed to a set of loudspeakers or headphones) introduces its own set of difficulties that must be overcome if accuracy is to be maintained.

In the sampling process used during playback to recover the data stored on a CD, there is an interaction between the frequency of the signal on the disc and that of the sampling clock (which sets the sampling frequency). The interaction, which is known as *aliasing*, gives rise to sum and difference frequencies that represent artificial (and erroneous) information that never was on the disc. That information gives rise to distortion and can also waste amplifier power.

To get rid of those unwanted harmonics, a technique known as *oversampling* is used. Oversampling takes place in a section of the player called the digital filter. In fact, as you shall see, quite a lot happens in a CD player's digital filter, and while the required IC's used to be an expensive high-end luxury, they are now found on virtually every player on the mar-

ket. As shown in Fig. 6, the filter processes the digital signal almost immediately after it has been retrieved from a disc. Oversampling simply means reading the digital information recorded on the disc at a multiple of the basic sampling rate of 44.1 kHz. That results in the frequencies of the harmonics being so high that most aliasing products disappear (they are filtered out, in effect) and those that remain are far out of the way, where they can cause little problem and

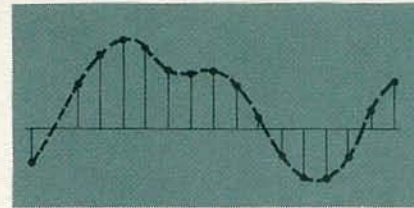

FIG. 5—SAMPLING IS THE PROCESS of recording the instantaneous values of a waveform at specified intervals. The Nyquist theorem states that, for accurate reproduction, the sampling frequency must be twice that of the highest frequency of the signal sampled.

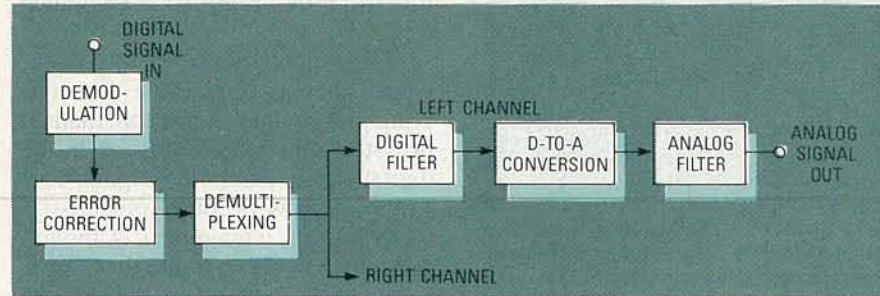

FIG. 6—SIGNAL FLOW in a typical CD player. Much of the signal processing that takes place in today's players occurs in the digital filter section.

where they can easily be removed by an analog low-pass filter.

Oversampling can also increase the accuracy of the information read from a disc to some degree. It is not uncommon to find CD players boasting $4\times$ and $8\times$ oversampling rates, representing frequencies of 176.4 and 352.8 kHz. Generally speaking, the higher the oversampling rate, the better the player.

Digital filters perform another function. An analog signal that will eventually wind up on a CD is first recorded on magnetic tape in 16-bit digital form, eventually winding up on the disc as a stream of 8-bit digital words that, in turn, represent 14-bit words. (See "Compact Discs Bit-by-

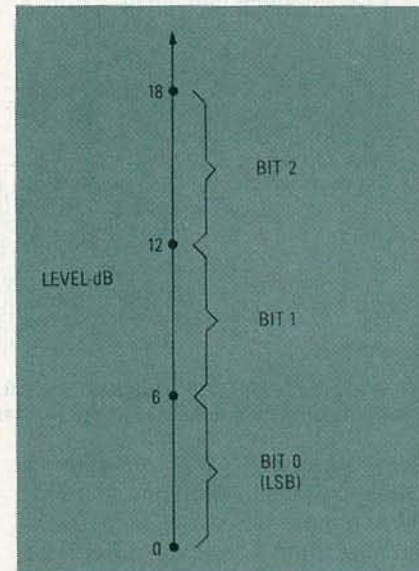

FIG. 7—THERE IS A SIX-DB DIFFERENCE in signal strength represented from bit to bit in the binary words used in digital recording for CD's. At the level of bit-0, the least-significant bit, ambiguities in recording or decoding can result in an artificial raising of a recording's noise floor. Oversampling and other digital-filter processing do much to reduce error at that level and expand a player's effective dynamic range.

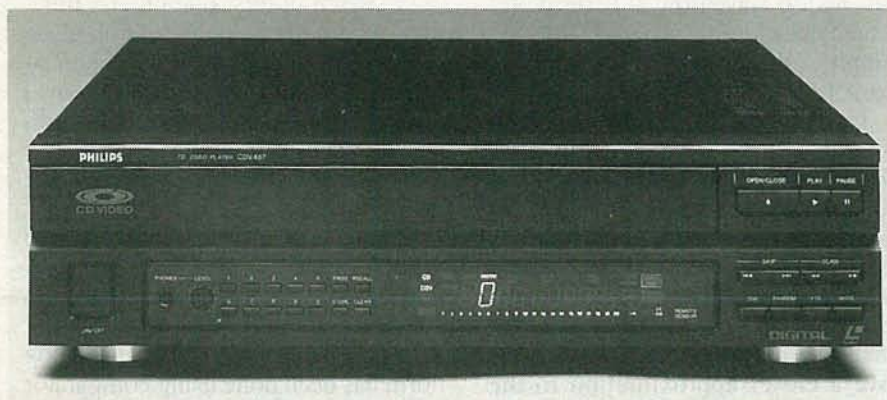

FIG. 4—MULTI-PLAY UNITS can play a variety of laser-read discs containing audio or video material. They include 3- and 5-inch CD's, CD-V's, and 8- and 12-inch laser discs. This is the Philips CDV-487.

Bit" *Radio-Electronics*, August, 1986 for details of the process and information on what else is on a CD besides music.)

In the early CD players, it was considered enough merely to decode the bit stream, convert it back to 16-bit

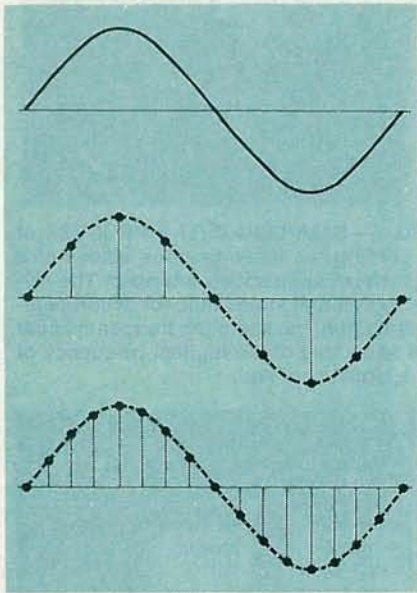

FIG. 8—OVERSAMPLING ADDS EXTRA data points to the waveform reconstructed from a CD's digital information. The process yields a waveform that more closely resembles the original one, and also requires less processing.

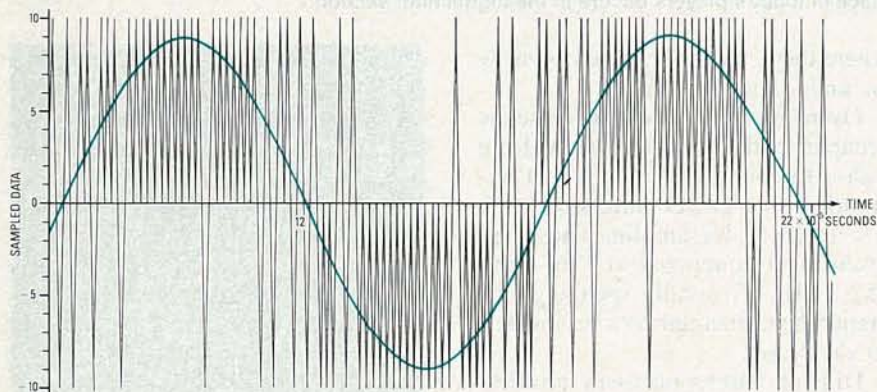

FIG. 9—THE OUTPUT OF PHILIPS' one-bit, 256x oversampling system is a string of pulses of constant amplitude. The pulse density determines the signal's amplitude.

analog form, and pass it through an analog low-pass filter to smooth it a bit and to remove the aliased signals before outputting it to an amplifier. The resulting signal, though, was far from ideal. It was not a very accurate representation of the original. Figure 7 shows how each step of the digitized waveform represents a change in level of six decibels (for a total dynamic range of 96 dB—sixteen steps multiplied by six decibels). For mid- and high-level signals that does not present much of a problem. At very low levels, though, way down at the level of the least-significant bit, the six-dB-per-bit assignment becomes *very* significant.

That first step is a lulu—there's quite a difference between the total silence of zero dB and the sound level, low as it is, at the level repre-

sented by the first bit six dB above it. What's needed is some extra bits to smooth things out and eliminate any ambiguity that may try to creep in (that is part of what manufacturers claim as "improved linearity"). Again, in early players, it was considered sufficient to restore the digital signal to its original 16-bit form. As the speed of D-to-A converter devices increased, though, it became possible for them to generate digital words of even greater length than 16 bits in real time from the information contained on a CD.

Where do those extra bits come from? They arise from the oversampling process and from mathematical operations that are performed on the digital signal within the digital filter which, as now becomes obvious, is more than just a plain filter. Although it is impractical to get into the mathematics of the matter here, the Nyquist theorem, which states that the mini-

imum sampling rate must be twice the highest frequency to be sampled, also implies that if that rule is followed, *all* the information contained in the original analog waveform will be represented in the digital samples. It's then simply a matter of knowing how to extract it.

Today's digital filters have begun to do just that, and from the 8-bit (actually 14-bit) signal stored on a CD it is now easily possible to extract a considerably more accurate 18-bit one. A few players go so far as to generate a 45-bit digital signal! The extra bits represent additional points on the reconstructed waveform (Fig. 8), and give a closer approximation to the original analog signal as well as requiring less analog filtering. The result is, as President Bush might put it, a "kinder, gentler" waveform—one

that does not require as brutal an analog filter. The additional data points also make it possible to perform (within the digital filter, again) a process called *noise shaping*, which reduces greatly the effects of a phenomenon known as quantization error, which is heard as noise.

Just prior to the analog output filter is the circuitry that performs the digital-to-analog, or D-to-A conversion. A manufacturer can choose to operate on any number of the bits generated by the digital filter, but generally restricts the number to 18. An 18-bit Digital-to-Analog Converter (DAC) is about as good as current manufacturing processes can produce at a reasonable cost. Some players advertise "dual D-to-A converters." Using two DAC's means that each has to work less and is not being pushed to the limit of its performance; according to some it also adds extra separation between channels.

One-bit, 256x oversampling

This year you will begin to see CD players that offer 256x oversampling. That's a frequency of 11.2896 MHz, for those readers without their calculators handy, with one-bit accuracy! "All right," you say, "what happened to all the other bits?" And how can just a single bit tell you anything at all about how a piece of music sounds?

The answer depends on how you understand the technique. In the MASH (multi-stage noise-shaping) system patented by Japan's NTT, and in another similar one developed by Philips, all the bits recorded on the disc are used but, rather than being reorganized as they come off the disc into 16-bit words, they are considered as a stream of bits, one bit at a time. (There is a good analogy to be made with parallel and serial communications in personal-computer systems.) The very high sampling rate ensures accuracy and smoothness, and is the equivalent of sampling each bit of the 16-bit word 16 times.

Further accuracy is claimed to be due to the use of a different D-to-A conversion system than is found on conventional players. Traditionally, conversion of digital signals to analog form has been done using comparator networks weighted with resistors to give a stepped-waveform output of the sort described earlier. As the bits come off the line (as it were) in the

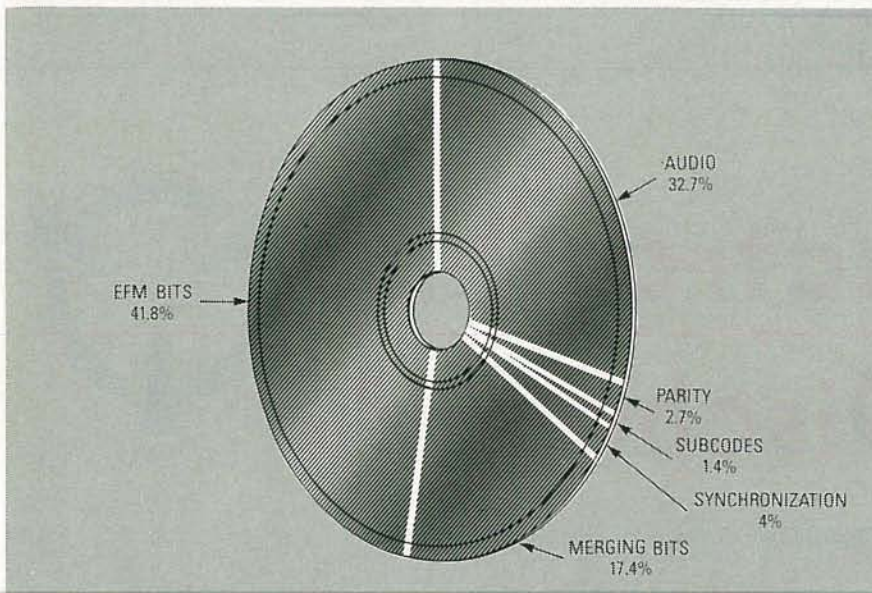

FIG. 10—ONLY ONE-THIRD of a CD's capacity is used to store digitized sound. Much of the rest contains error-correction information, and a substantial portion is devoted to the subcodes that make up a CD + G disc's visual content.



FIG. 11—THE FIRST CD+G/M PLAYER on the market is JVC's XL-G512. It decodes information contained in a CD + G disc's subcodes to output a video signal, and can also output MIDI control information for MIDI-equipped instruments and computers if that information is included on the disc.

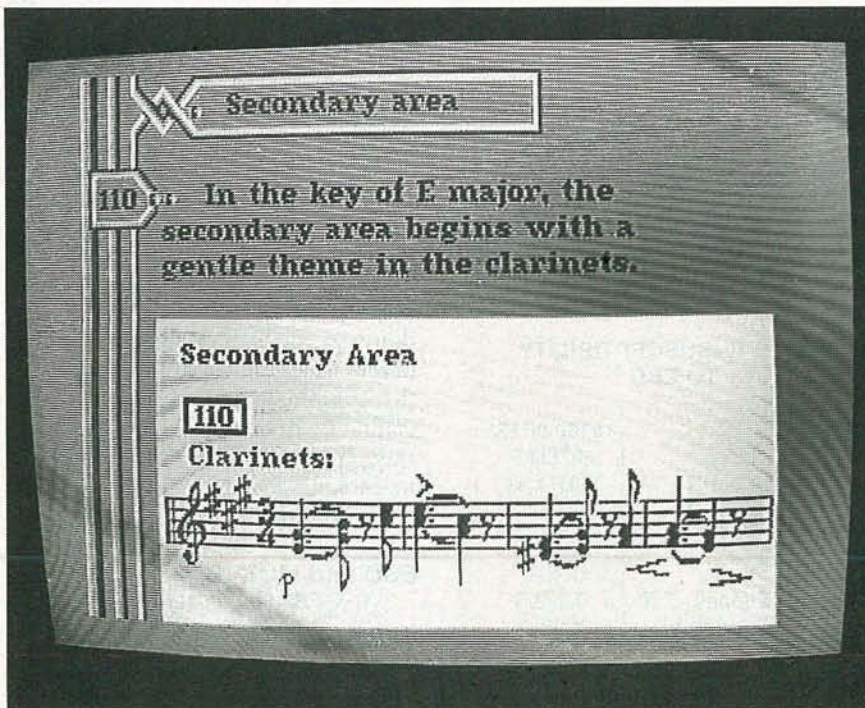

FIG. 12—A CLASSICAL CD + G DISC might contain not only the performance and a copy of the score, but a commentary on the composition as well.

Philips system, they are used to charge small capacitors. It is those charges that form the player's output waveform. An example of that PDM (Pulse Density Modulation) output is shown in Fig. 9. Philips claims greater accuracy for its system compared to the resistor-comparator method. It, too, is "kinder and gentler."

CD + G/M

There's lots more stored on the surface of a compact disc than just music. In fact, only about a third of the information there represents sound; the rest is used for error correction, indexing, and other purposes (see Fig. 10). A sizable chunk of space is reserved for the information known as subcodes. Until now, the subcode area has been pretty much ignored. Aside from a few CD players that had subcode outputs (the output of the digital subcode information, whatever it might be), there were no subcode standards to follow and, consequently, nobody did anything. However, an industry document known as the *Sony-Philips Red Book* has now set forth such standards for the industry, and the result is a new type of CD, known as the CD + G, or sometimes CD + G/M. Players for that new format are just becoming available, the first being JVC's XL-G512BK shown in Fig. 11.

The term "CD + G" stands for "Compact Disc Plus Graphics." The graphics are stored, in digital form, in the subcode area of a disc. They are decoded by a CD + G player and converted into a video signal that can be fed to a monitor or TV receiver. The video, while it cannot present anything like real-time-TV detail or animation, does have the appearance of a high-quality teletext signal.

One application of CD + G is to have the subcoded graphics information accompany popular music as a form of music video. One of the first releases in that form is Donna Summer's *Another Place and Time*. For classical music, the system can be used to display scores and librettos, and can even provide an on-screen commentary on the composition (Fig. 12). As the system becomes popularized, new uses will no doubt be found for it. In the meantime, CD + G discs can be played on ordinary CD players—you just won't see the "G" part.

continued on page 56



Electrostatic Discharge



Fight ESD and keep your components healthy.

DAVE HOLLANDER

CONSIDER THIS SCENARIO: YOU'VE RECEIVED a MOS IC, removed it from its black foam or pink foam packing, and soldered it in place. Your project might work initially, but its performance falls far below expectations. Your IC is probably a victim of electrostatic discharge (ESD), and was likely damaged by improper handling. ESD is one of the most common causes of component failure, and as the actual transistor-device geometries on board a silicon chip shrink, an IC becomes more sensitive to it.

ESD can cause component failure or performance degradation that's difficult or impossible to detect, and is a major concern in modern electronics. The problems of ESD can occur as erroneous data, incorrect instructions, or system shutdown on operating hardware. This article will attempt to explain the mechanisms behind IC failure due to ESD, how to handle sensitive IC's properly, and how to set up a safe work area.

How ESD is generated

ESD is also called triboelectric charging. When two insulators are rubbed together, charge is transferred by friction, like what occurs if you run your feet across a carpet. The charge is a function of separation, extent of contact, rate of separation, humidity, and, of course, the triboelectric material itself (see Fig. 1).

ESD current is pretty low, while potential can exceed 300 kV. When charge is built up in a human body and discharges as a perceptible arc

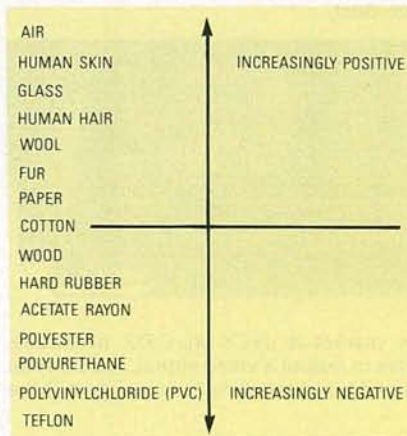

FIG. 1—THIS DEPICTION SHOWS the relative propensity of different common materials to either lose ("INCREASINGLY POSITIVE") or accumulate ("INCREASINGLY NEGATIVE") charge.

(felt as a slight tingle), no damage is done if the potential is under 2.5 kV (the "discomfort threshold"). Levels below that are barely noticeable, but

can disrupt equipment. Table 1 shows the relative susceptibility of various semiconductor devices to ESD.

You might notice that you get electrostatic shocks more often in the winter than in the summer. That's because, in the summer, the relative humidity levels are much higher, and the buildup of moisture on a surface provides a discharge path. By comparison, materials that reject moisture exhibit the highest propensity toward ESD. Above 65% relative humidity, there's no real ESD problem, while below 20%, over 300 times more static charge is generated.

How much charge a human body will accumulate is dependent upon on the individual's size and skin conductivity. Another example of reduced humidity giving rise to electrostatic charging and ESD occurs when you put nylon and polyester clothing together in a dryer. You've no doubt seen how you can often generate as much as 650 volts by doing so, since the primary object in a dryer is the removal of moisture, and the combination of nylon and polyester are prime triboelectric materials. Typical ESD voltages are given in Table 2, for a number of common configurations.

TABLE 1—SUSCEPTIBILITY TO ESD

DEVICE TYPE	RANGE OF ESD SUSCEPTIBILITY, kV
Power MOSFET	0.1-0.2
JFET	0.14-10
CMOS	0.25-2
Schottky Diodes, TTL	0.3-2.5
Bipolar Transistors	0.38-7
ECL	0.5
SCR	0.68-1

ESD and MOS IC's

All MOS devices have an insulated gate that's subject to voltage breakdown. The gates on Motorola's devices are about 800 angstroms thick, and they break down at a gate-source potential (V_{GS}) of about 100 volts.

The high-impedance gates are protected by onboard resistor-diode networks, but they don't make an IC immune to ESD. Laboratory tests indicate that devices can fail after one very high voltage discharge, or after the cumulative effect of several lower potential discharges.

ESD-damaged devices behave in various ways. The most severely damaged devices are easiest to detect because their inputs or outputs have been completely destroyed; they're either shorted to V_{DD} or V_{SS} , or are open, and the device no longer functions. In other cases, detection can be more difficult because the device is intermittent or degraded. From the data in Fig. 1 and Table 2, you can easily see why MOS IC's can be damaged by improper handling.

ESD and Power MOSFET's

Being MOS devices, TMOS™ transistors (Motorola's trade name for its power MOSFET's) can also be damaged by ESD. However, they're not as susceptible as CMOS, due to large input capacitances that let them absorb more energy before breaking down. However, at breakdown potential, there's enough energy in the C_{GS} to totally perforate the gate-oxide. With a typical V_{GS} maximum rating of ± 20 volts DC, and ESD potentials typically reaching 100 volts–25 kV,

you can see why special handling is needed.

Curve-tracer plots of a MOS device before and after ESD degradation are shown in Figs. 2-a and b. Where most power MOSFET's have the ± 20 -volt DC rating, Motorola power MOSFET's use the Bullet-Proof4™ process, resulting in more reliable devices with higher V_{GS} breakdown levels. They're guaranteed to withstand ± 40 volts DC for a single, non-repetitive pulse of 50- μ s duration or less, achieved by control of gate-oxide thickness. With improved dielectric strength comes better resistance to ESD damage.

Classification of devices

Military specifications are used to classify ESD sensitivity of semiconductor devices. Through measurements, the model of Fig. 3 closely approximates the human body. Discharge of that network directly into a device indicates that the model assumes a "hard ground" is in contact with the part. Although all pin combinations should be evaluated (six different versions for a power MOSFET), preliminary tests usually show that gate-oxide breakdown is most likely, and that reverse-bias makes a junction about an order of magnitude more sensitive than forward-bias. The damage mechanism is usually gate-oxide punch-through or junction melt-through. In other words, when a semiconductor device is subjected to unusually high voltages, the charges (holes and electrons) move apart in directions that they were never intended to go.

Static protection

The basic method for ESD protection combines prevention of static build-up and removal of existing charge. Charge-dissipation procedures differ for insulators and conductors. Since charge can't flow through an insulator, it has to be removed by contact with a conductor. If the item is an insulator (plastic box, clothing, etc.), ionized air is required. If it's a conductor (metal tray, conductive bag, person's body, etc.), complete discharge can be accomplished by grounding.

Many methods are used to inhibit

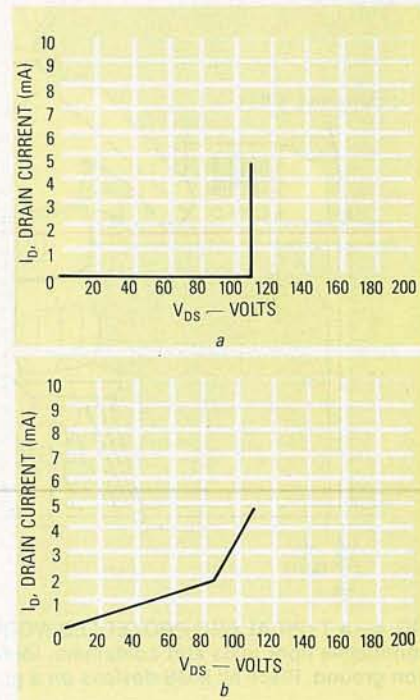

FIG.2—CURVE TRACER PLOTS OF A MOS device before (a) and after (b) being subjected to ESD degradation.

ESD; carpets are made with antistatic materials and coatings. Equipment can be sprayed with antistatic solutions, materials with low triboelectric propensity can be used, and clothing can be made of triboelectrically insensitive fabric. Static-safe work stations are also used. Components are packaged in conductive or antistatic packaging. In addition, relative humidity within the environment is maintained above 65%.

How to prevent ESD?

You might find industrial-grade precautions impractical, but if you're educated in ESD and its effects, you'll have better control of your

TABLE 2—TYPICAL ELECTROSTATIC VOLTAGES

MEANS OF STATIC GENERATION	ELECTROSTATIC VOLTAGES, kV	
	RELATIVE HUMIDITY	
	10-20%	65-90%
Walking across carpet	35	1.5
Walking across vinyl floor	12	0.25
Worker at bench	6	0.1
Vinyl envelope	7	0.6
Common polyethylene bag picked up from bench	20	1.2
Work chair padded with polyurethane foam	18	1.5

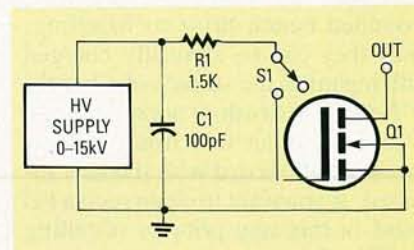

FIG. 3—THIS MODEL CLOSELY approximates the human body. Discharge of this network directly into a device indicates that the model assumes a "hard ground" is in contact with the part.

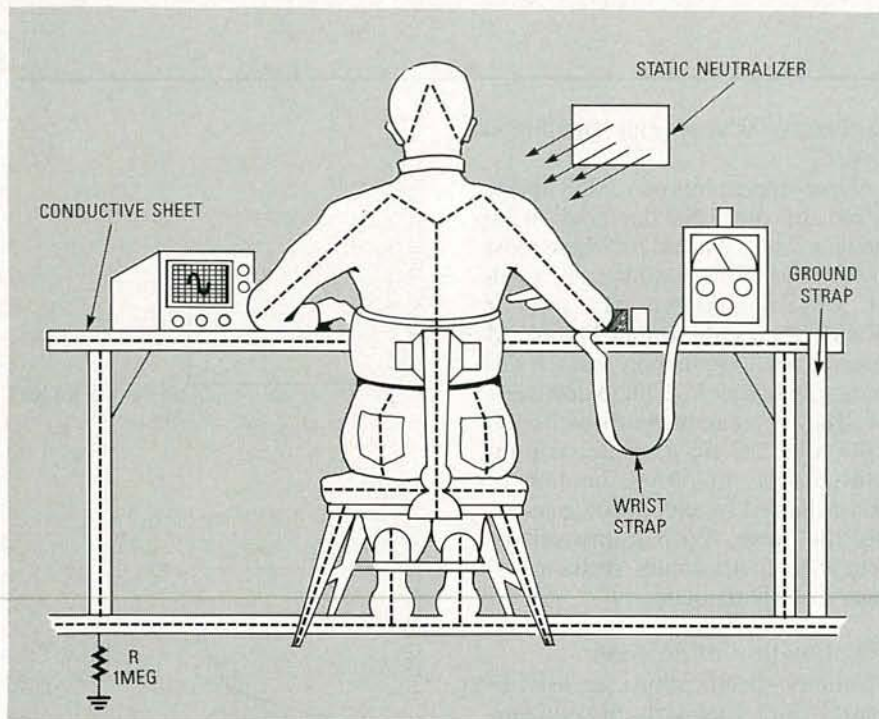

FIG. 4—A TYPICAL ESD-PROTECTED WORK STATION, with a 1/16-inch metallic bench top, conductive floor mats and containers, ionized air blowers, wrist straps, and soldering-iron ground. Place all MOS devices on a grounded bench prior to handling.

working environment. A typical work station is shown in Fig. 4. The steps to



FIG. 5—ALWAYS USE PACKAGING labels like this one to indicate ESD-sensitive parts, and that proper handling of the parts is required.

be taken are listed below:

- Never exceed maximum specified data-sheet ratings.
- Work benches should have grounded metallic tops, conductive floor mats and containers, and ionized air blowers.
- Use wrist straps in contact with the skin.
- Use a ground strap on the tip of all soldering irons.
- Place all MOS devices on a grounded bench prior to handling, since they can be statically charged with regard to the surface of a bench.
- Never use brush or spray cleaning to remove solder flux from a MOS-populated PC board with the IC's installed. If you want to clean such a PC board in this way prior to installing the IC's, fine.
- Place completed PC-board assemblies in antistatic bags if they're transported to another location.
- Keep work benches free of coffee

cups and stirrers, paper, styrofoam, tobacco ash, cellophane wrappers, and plastic.

- Never insert or remove an IC from its socket with power applied.
- Check all power supplies for voltage transients like ripple or spikes.
- All low-impedance equipment like pulse generators should be connected to MOS devices *only* after power up, and disconnected before being shut off.

MOS-device packaging is critical; components purchased for home projects should come with antistatic or conductive packaging. Static-sensitive IC's are normally packaged in either black conductive foam, specially treated pink plastic bags, or an oily antistatic styrofoam. There should also be packaging labels indicating ESD-sensitive parts, and that proper handling is required, as in Fig. 5. Never insert a MOS device into a conventional plastic tray or piece of styrofoam. Keep it in its original packaging until ready to use.

All equipment should have a good earth ground, but particularly if it's ESD-sensitive. In a dry climate, attach a small metal plate with a good ground to your desk/workbench. By touching it to discharge any static potential built up while walking across carpeting, your equipment might live longer.

R-E

CD PLAYERS

continued from page 53

The "M" in "CD + G/M" stands for "MIDI," which itself is an acronym for "Musical Instrument Digital Interface." A MIDI signal is used to store or transmit performance information, such as the output of a music synthesizer's keyboard, which might consist of duration, pressure, and (of course) which-keys-are-pressed data as well as that for other performance parameters. You could use the MIDI signal to have your MIDI-equipped instrument play along.

Gizmos, gadgets and gimmicks

As you browse (or plow, depending on the intensity of your interest) through the literature on the new CD players, you'll come across mention of lots of special features that may tickle your fancy. Many of those features are intended to appeal to the high-end audiophile, and their effect on the quality of the final product (the sound that comes out of your speakers) may be so slight as to be unnoticeable to ordinary people.

Some players use a single-beam tracking system while others boast of a three-beam one. Both use the intensity of the laser light reflected from a disc to provide control information that keeps the beam on track. Don't let the terminology confuse you. A three-beam system does not use three lasers; it just splits the output of a single laser into three beams. Indeed, all CD players contain just one laser whose beam is used both for reading the digital information from a disc and for tracking. A three-beam system can react more quickly to a "drift" situation, but you probably won't notice the difference.

One or two makes of CD players boast a speed stabilizer that supposedly makes a disc rotate at a more even speed than it otherwise would. That feature is similar in purpose to the stick-on stabilizer rings that are sold separately to be attached to the outer perimeter of CD's to add to their mass (and presumably speed stability). In either manifestation, that may not be such a great idea.

First of all, the speed of a CD is constantly changing anyway, from 500 rpm down, as the laser beam tracks farther from the center of the

continued on page 99

1989 ANNUAL INDEX

Radio Electronics Volume 60 and COMPUTER DIGEST Volume 6

Abbreviations: (AR)Antique Radio; (ARE)Ask R-E; (AUD)Audio Update; (C)Construction; (CD)ComputerDigest; (CC)Communications Corner; (D)Department; (DB)Drawing Board; (ED)Editorial; (EW)Editor's Workbench; (ER)Equipment Reports; (HH)Hardware Hacker; (HWR)Hardware Review; (LTR)Letter; (NI)New Ideas; (PCS)PC Service; (SR)Shortwave Radio; (SWR)Software Review; (VN)VideoNews

A

A/B Switch, Remote(Heil)(C) Oct 37
AC power-load interface(Lancaster)(HH) Mar 25
A/D converters
accuracy(Lancaster)(HH) Jan 34
(Lancaster)(HH) Jun 67
Ace Communications AOR AR-2515
Communications Receiver(ER) Nov 24
Active Antenna(Kreuter)(C) Feb 51,(PCS)Feb 110
(LTR)Apr 14,Jun 14,Sep 14
Alarm system
High-Tech Home Security(Friedman) Apr 33
Install a Home-Security
System(Friedman & Fenton) Apr 42
Phasor Property Guard(Iannini) (C) Dec 37,(PCS)Dec 79
Wireless Security System(Becker)(C) Apr 47
All About
Capacitors(Bernard) May 49,Aug 56
Relays (Trietley) Nov 59,Dec 59
**Alpha/Theta Meditation
Goggles(Worley)(C)** Apr 53,(PCS)Apr 69
(LTR)May 15,(LTR)Oct 14
Alternate dimming circuit(ARE) Sep 8
AM receiver
Carrier Current Receiver(Sheets & Graf)(C) Feb 55
Amateur TV Transmitter(Graf & Sheets)(C) Jun 45,Jul 45
(PCS)Jul 56,84,(LTR)Sep 14
American Reliance
AR-6400P Cable Tester(ER) Feb 22
Amplifier
damping factor: How important
is it?(Klein)(AUD) Jan 78
High-Power Hi-Fi Audio Amp
for your Home or Car(Ross & Watts)(C) Mar 51
Importance of amplifier
output current, The(Klein)(AUD) Apr 70
Antenna
Active(Kreuter)(C) Feb 51
Choosing the Right Shortwave Antenna(Carr) Jul 61
ANTIQUA RADIO(D)(Fitch) Jan 84, Feb 91, Apr 14, May 74
Condensers and tubes Jan 84,(LTR)Mar 14,(LTR)Apr 14
How television got its start May 74
Loudspeakers and things Feb 91
April Fool's
Microwave oven(Hakemachi)(C) Apr 74
Mass-teleportation card(Lancaster)(HH) Apr 25
ASK R-ED) Jan 12, Feb 12, Mar 8, Apr 8
May 12, Jun 12, (LTR)Sep 14, Jul 10
Aug 8, Sep 8, Oct 8
Nov 12, Dec 8
Alternate dimming circuit Sep 8
Broken IC pin Dec 8
Computer-monitor color remover Oct 8
Delay circuit Jul 10
Digital
Meters Feb 12
TV Aug 8
Flasher circuit Nov 12
Flashing LEDs May 12
Guitar equalizer Jun 12
LED Flasher, sequential May 12
Light-control circuit Sep 8
Linear-to-log converter Jul 10
Mike Input Attenuator Dec 8
Neon indicators Oct 8
PAL/SECAM conversions Jun 12
Parts values Oct 8,(LTR)Dec 14
Power Supplies Jan 12

Pulse shortener Jun 12
RAM increase Apr 8
RFI solutions Mar 8,(LTR)Aug 12
Re-wiring homes Nov 12
Robot, Timex Mar 8
SCR, light-activated Jan 12
Septic pump, automatic Nov 12
640K expansion Sep 8
640K rejection Sep 8
Telephone-call recorder Oct 8
Time-base corrector Feb 12
Timex robot Mar 8
Touch switch May 12
TV
Earphone jack Apr 8,(LTR)Jun 14
Interference Mar 8
Z-80 Hardware Jan 12, Mar 8
Atari ST, The(Yap)(CD) Feb 99
AUDIO(See also AUDIO UPDATE, SHORTWAVE RADIO)
Amp, High-Power Mar 51,(PCS)Mar 74
Hi-Fi(Ross & Watts)(C) Sep 51
Beyond Stereo(Feldman) Feb 55
Carrier Current Jan 55
Receiver(Sheets & Graf)(C) Oct 52
Transmitter(Sheets & Graf)(C) Oct 49
FMX: Is it Good for FM?(Feldman) Jan 82
One-Band Shortwave Dec 6
Converter(Graf & Sheets)(C) Mar 43
Tunable preselectors(Friedman)(CC) Jan 78, Feb 89, Mar 84,
Video CD's(Lachenbruch) (VN) Apr 70, May 70, Jun 87,
Wireless FM Microphone(Spiwak)(C) Jul 8, Aug 12, Sep 70,
Oct 61, Nov 74, Dec 67
AUDIO UPDATE(D)(Klein) Jan 78, Feb 89, Mar 84,
Apr 70, May 70, Jun 87,
Jul 8, Aug 12, Sep 70,
Oct 61, Nov 74, Dec 67
Amplifier damping factor:
How important is it? Jan 78
Evolution of car stereo, the Sep 70
Frequency response: What
do the numbers really mean? Aug 71
Happy 10th Anniversary, Sep 72
Sony Walkman Oct 72
History and theory of the
dynamic loudspeaker May 70,(LTR)Aug 12
How loud is real? Jul 8
HX-Pro: A "new" and improved
cassette-deck circuit Mar 84
Importance of amplifier
output current, The Apr 70
Question of reliability, the Feb 89
Slew factor, How important is it? Jun 87
Sonic Differences Between
CD Players? Dec 67
Sound of CD, Part 1 Nov 74
Automatic Test Equipment(Stover) Oct 61
AVCOM PSA-65A Spectrum Analyzer(ER) Nov 24

B

B&K-Precision
1201SR Television Frequency
Converter/Modulator(ER) Oct 17
1249 NTSC Generator(ER) Dec 18
388-HD Test Bench(ER) Mar 16
Basic Op-Amps(Marston) Mar 69
Bar-code resources(Lancaster)(HH) Jul 66
Battery Backup Mar 69
REACTS(Bybee)(C) Jul 66
Battery-charge indicator(LTR) Jan 65
Aug 12

Beckman Industrial
Model 233 Professional Digital Multimeter(ER) Aug 16
Beyond Stereo(Feldman) Sep 51
Bilateral Switches(Marston) Nov 54
Brain waves
Alpha/Theta Meditation Goggles(Worley)(C) Apr 53
Broadcaster, wireless stereo(Lancaster)(HH) Oct 65
Bug Detector(Ross)(C) Jun 42,(PCS)Jun 78
Build This (See CONSTRUCTION)
Building an OmniView Application(Toutonghi)(CD) Aug 80
Business, starting a technical(Lancaster)(HH) Jun 67

C

CD (See COMPACT DISC)
CMOS oscillators(Lancaster)(HH) Jul 66
CMOS PLL's(Marston) Dec 55
Cable
-converter "hum"(LTR) Feb 14
Tester
American Reliance AR-6400P(ER) Feb 22
for Only \$25, Build a(Barbarello)(CD)(C) Apr 77
(Rowe)(NI) Mar 73
Calibration
10-MHz Frequency Standard(Palmer)(C) Feb 63
Call progress detectors(Lancaster)(HH) May 61
Canon FAX-L920 Laser Facsimile(ER) Feb 22
Capacitance
Inductance Meter, Sencore LC102(ER) Apr 17
Meter, Digital(Lashansky)(C) Jul 38,(LTR)Oct 14
Capacitors, All About(Bernard) May 49,Aug 56
Car stereo
Evolution of(Klein)(AUD) Sep 70
High-Power Hi-Fi Audio Amp
for your Home or Car(Ross & Watts)(C) Mar 51
One-Band Shortwave
Converter(Graf & Sheets)(C) Oct 49
Carrier Current
Audio Transmitter(Sheets & Graf)(C) Jan 55
Receiver(Sheets & Graf)(C) Feb 55
CeBIT(Endrijonas)(CD) Jul 73
Character generator
Complete Circuit, A(Grossblatt)(DB) Jul 28
Custom(Grossblatt)(DB) Mar 80
Let's start programming!(Grossblatt)(DB) May 72
Choosing the
Right Shortwave Antenna(Carr) Jul 61
Video Tape That's Right
for You(Feldman) May 45
Circuitmate DM27 Digital Multimeter(ER) Oct 17
CIRCUITS(See also ASK R-E, DRAWING BOARD)
Basic Op-Amps(Marston) Mar 69
Bilateral Switches(Marston) Nov 54
CMOS PLL's(Marston) Dec 55
Compound Op-Amps(Marston) Jan 69
Down-Counter Cookbook(Marston) Feb 71
Op-Amp Oscillators(Marston) Jul 51
Op-Amps in Instrumentation(Marston) Sep 59
Relays, All About(Trietley) Nov 59,Dec 59
Working With
Counters(Marston) Apr 63
Op-Amps(Marston) May 54
Clock and doorbell chip(Lancaster) (HH) Dec 68
Cold fusion
(Lancaster)(HH) Aug 64, Sep 65
(LTR)Aug 12

more on(Lancaster)(HH)	Nov 64
Comdex, Report From(CD)(EW)	Aug 75
COMMUNICATIONS CORNER(D)(Friedman)	
Tunable preselectors	Jan 82
COMMUNICATIONS(See also COMMUNICATIONS CORNER)	
Fax-Mate(Plant)(C)	Oct 33
ISDN Prototyping Telephone (Tousignant & Sliger)(C)	May 35, Jun 61
Light Beam Communicator(Sonntag)(C)	Jul 31, Aug 52
Phonlink II(McNabb & Roseth)	Feb 44, Mar 46
Command Post, Wilson WindowWare(SWR)(EW)(CD)	Dec 81
Communications Receiver Ace Communications AR-2515(ER)	Nov 24
Communicator, Light Beam(Sonntag)(C)	Jul 31, Aug 52
Compact disc	
Audio/video (Lachenbruch)(VN)	Dec 6
Players, How to Repair(Phelps)	Nov 52
the sound of CD, Part 1(Klein)(AUD)	Nov 74
the sound of CD, Part 2(Klein)(AUD)	Dec 67
Compass	
Digi-Compass(Black)(C)	Nov 43
Complete Circuit, A(Grossblatt)(DB)	Jul 28
Compound Op-Amps(Marston)	Jan 69
COMPUTER(See also COMPUTER DIGEST, DRAWING BOARD)	
Aided Video(Morton & Scott)(CD)	Mar 93(LTR) Jun 14, Oct 14
Digi-Compass(Black)(C)	Nov 43
Interface	
Automatic Test Equipment(Stover)	Oct 61
Radiation Monitor Update(Jaffe & Sythe)	Jun 51
Monitor color remover(ARE)	Oct 8
Musical Instrument Digital Interface(Simonton)	Aug 33
Phonlink II(McNabb & Roseth)(C)	Feb 44
REACTS(Bybee)(C)	Jan 65
RFL solutions(ARE)	Mar 8(LTR) Aug 12
640K Rejection(ARE)	Sep 8
COMPUTER DIGEST	Jan 87, Feb 95, Mar 89, Apr 77
	May 77, Jun 79, Jul 73, Aug 75
	Sep 77, Oct 83, Nov 83, Dec 81
	Feb 99
Atari ST, The(Yap)	
Building an OmniView Application(Toutonghi)	Aug 80
CeBIT(Endrijonas)	Jul 73
Computer Aided Video (Morton & Scott)	Mar 93(LTR) Jun 14, Oct 14
Digital to Analog Converter(Weber)(C)	May 77
EDITOR'S WORKBENCH(D)(Holtzman)	Jan 88, Feb 96, Mar 90, Apr 77
	May 77, Jun 79, Jul 83, Aug 75
	Sep 77, Oct 83, Nov 81, Dec 81
	Feb 96, Mar 90, Apr 77
	Jul 75, Aug 75, Sep 77, Oct 83
Book reviews	
Bolt System's Multiboot(SW)	Oct 83
Borland's Turbo Pascal 5.0(SWR)	Mar 90
ButtonWare's PC-File.dB(SWR)	Aug 75
Cambridge Direct's Z88 laptop(HWR)	Feb 96
Comdex, Report From D-G Electronic Developments' DoubleCOM(HWR)	Jan 88
Datasmart Technologies' ProComm+ (SWR)	Jan 88
DG Electronic Development's DoubleCOM(SWR)	Oct 83
Dot programs	Mar 90
Hayes Microcomputer Products' SmartCom III(SWR)	Jan 88
Inset Systems' Hijack(SWR)	May 77
IQ Technologies' Smart RS-232 Data Meter(HWR)	Mar 90
Laptops	Feb 96
Laser-printer paper	Aug 75
Mace's Gold(SWR)	Jul 75
Micrografx' Designer(SWR)	Mar 90
Norton Utilities Advanced Edition Version 4.5(SWR)	Jul 75
OS/2	
Presentation Manager(SWR)	Apr 77
Standard Edition Version 1.1(SWR)	Apr 77
Prime Solution's Disk Technician(SWR)	May 77
RG Software Systems' Disk Watcher(SWR)	May 77
Tandy Model 100 laptop(HWR)	Feb 96
Teletek X-Bandit EMS 4.0 Memory Board(HWR)	Jun 79
Toshiba T1000 laptop(HWR)	Feb 96
Traveling Software's Laplink(SWR)	Sep 77
ViewLink(SWR)	Jun 79
Turbo Pascal 5.0(SWR)	May 77
Wilson WindowWare's Command Post(SWR)	Dec 81
Windows, Microsoft(SWR)	Dec 81
80386 Motherboard(McIlhany)(C)	Jun 79, Jul 81, Aug 75
Install a Tape Backup Unit, How to(Fenton)	Jun 79
Inside Intel's 80386 (Margulis)	Jan 90, Feb 103, Mar 98
Intelligent Cable Tester for Only \$25!(Barbarelli)(C)	Apr 77
OmniView and a 386(Toutonghi)	Jul 73
PC Run Circles Around a Cray?, A(Byers)	Apr 77
Programmable Architectures: The Next Breakthrough?(Reeve)	Sep 77
Put a 386SX Tiger in Your Tank(McIlhany)(C)	Jun 79, Jul 81, Aug 75
Run MS-DOS on the PT-68K(Henry)(C)	Jan 96
68705 Microcontroller(Henry)(C)	Sep 82, Oct 83
Condensers and tubes(Fitch)(AR)	Jan 84
CONSTRUCTION	
Active Antenna(Kreuter)	Feb 51

Alpha/Theta Meditation Goggles(Worley)	Apr 53
Amateur TV Transmitter (Graf & Sheets)	Jun 45, Jul 45
Bug Detector(Ross)	Jun 42
Carrier Current Audio Transmitter(Sheets & Graf)	Jan 55
Receiver(Sheets & Graf)	Feb 55
Digi-Compass(Black)	Nov 43
Digital	
Capacitance Meter(Lashansky)	Jul 38
Peak Detector(Secura)	Apr 59
-to Analog Converter(Weber)(CD)	May 77
80386 Motherboard(McIlhany)(CD)	Jun 79, Jul 81, Aug 75
Etching Tank(Lewis)	Dec 45
Fax-Mate(Plant)	Oct 33
High-Power Hi-Fi Audio Amp for your Home or Car(Ross & Watts)	Mar 51
ISDN Prototyping Telephone (Tousignant & Sliger)	May 35, Jun 61
Intelligent Cable Tester for Only \$25!(Barbarelli)(CD)	Apr 77
Light Beam Communicator(Sonntag)	Jul 31, Aug 52
Low Frequency Converter(Sheets & Graf)	Sep 47
Transmitter(Nelson)	Sep 43
Low-Capacitance Scope Probe(Friedman)	Jan 52
Macrowave Oven(Hakemachi)	Apr 74
Music-On-Hold Adapter(Sokolowski)	Aug 42
One-Band Shortwave Converter(Graf & Sheets)	Oct 49
Phasor Property Guard(Iannini)	Dec 37
Phonlink II(McNabb & Roseth)	Feb 44, Mar 46
Plasma Display Globe(Caudill)	Jan 62
Put a 386SX Tiger in Your Tank(McIlhany)(CD)	Jun 79, Jul 81, Aug 75
R-C Decade Box(Lashansky)	Nov 39
REACTS(Bybee)	Jan 65
RGB-to-NTSC Converter(Bek)(CD)	Dec 81
Remote A/B Switch(Heil)	Oct 37
Remote Control Extender(Heil)	May 41
Run MS-DOS on the PT-68K(Henry)(CD)	Jan 96
68705 Microcontroller(Henry)(CD)	Sep 82, Oct 83
Solar Power Supply(Becker)	Aug 47
Spectrum Analyzer(Baumgartner)	Sep 33
Monitor(Baumgartner)	Oct 46
10-MHz Frequency Standard(Palmer)	Feb 63
Universal Laser Power Supply(McComb)	Mar 33
Video Scene Switcher(Sheets & Graf)	Nov 33, Dec 42
Wireless FM Microphone(Spiwak)	Mar 43
Wireless Security System(Becker)	Apr 47
Contest is over, the(Grossblatt)(DB)	Sep 72
Converter	
Digital to Analog Converter(Weber)(C)	May 77
Low Frequency(Sheets & Graf)(C)	Sep 47
Coprocessor accelerator board(Byers)(CD)	Apr 77
Counters, Working With(Marston)	Apr 63
Custom-character generator, A(Grossblatt)(DB)	Mar 80
"Custom" EPROM decoders(Grossblatt)(DB)	Jan 80
D	
Data books(HH)	Jan 34
Delay circuit(ARE)	Jul 10
Designer, Micrografx'(SWR)(CD)(EW)	Mar 90
Designing PC boards(DB)	Aug 73, Oct 81
Desktop book publishing(Lancaster)(HH)	Sep 65
Detector, bug(Ross)(C)	Jun 42
Developing and Etching a PC Board(Grossblatt)(DB)	Dec 77
Dialog information service(Lancaster)(HH)	Mar 25
Digi-Compass(Black)(C)	Nov 43
Digital	
Audio(HH)	Jul 66
Audio front ends(Lancaster)(HH)	Jun 67
Capacitance Meter(Lashansky)(C)	Jul 38, (PCS) Jul 84
Compass	
Digi-Compass(Black)(C)	Nov 43
(Lancaster)(HH)	Sep 65
Meters(ARE)	Feb 12
Multimeters	
Circuitmate DM27(ER)	Oct 17
Beckman 233(ER)	Aug 16
Peak Detector(Secura)(C)	Apr 59
Sinewaves(Lancaster)(HH)	Jan 34, Apr 25
Storage oscilloscope, Tektronix 222(ER)	Jul 20
-to Analog Converter(Weber)(C)(CD)	May 77
Trainer, Elenco XK-220(ER)	Sep 22
Tuners, servicing	
New Radios, New Problems, New Solutions(McClellan)	Jul 57, Aug 60
TV(ARE)	Aug 8
"Disco" circuit, A new (Lancaster)(HH)	Mar 25
Disk	
Drive Tester, Lynx 470(ER)	May 17
Technician, Prime Solution's(SWR)(CD)(EW)	May 77
Watcher, RG Software Systems(SWR)(CD)(EW)	May 77
Dot programs(CD)(EW)	Mar 90
DoubleCOM, D-G Electronic Developments(HWR)(CD)(EW)	Jan 88, Oct 83
Down-Counter Cookbook(Marston)	Feb 71
DRAWING BOARD(D)(Grossblatt)	Jan 88, Mar 80, May 72
	Jul 28, Aug 73, Sep 72
	Oct 81, Nov 78, Dec 77

"Custom" EPROM decoders	Jan 80
Complete Circuit, A	Jul 28
Contest is over, the	Sep 72
Custom-character generator, A	Mar 80
Developing and Etching a PC Board	Dec 77
Laying out a PC Board(Grossblatt)	Oct 81
Let's start programming!(Grossblatt)	May 72
PC boards(Grossblatt)	Aug 73
PC Photography	Nov 78
Dynamic loudspeaker, history and theory of(Klein)(AUD)	May 70

E

EPROM	
Contest results(Grossblatt)(DB)	Sep 72
decoders, custom(Grossblatt)(DB)	Jan 80
Editor, video	
Computer Aided Video(Morton & Scott)(CD)	Mar 93
Video Scene Switcher(Sheets & Graf)(C)	Nov 33
EDITORIAL	
Herb Friedman(Fenton)	Jan 4
Radiation Awareness(Fenton)	Jun 4
80386 Motherboard(McIlhany)(C)(CD)	Jul 81, Aug 75
Electrolytic chemistry(HH)	Aug 64
Electronic music resources(HH)	Feb 78
Elenco XK-220 Digital Trainer(ER)	Sep 22
EQUIPMENT REPORTS(D)	Feb 22, Apr 17, May 17
	Jun 16, Jul 20, Aug 16, Sep 22
	Oct 17, Nov 24, Dec 18
Ace Communications AOR AR-2515 Communications Receiver	Nov 24
American Reliance AR-6400P Cable Tester	Feb 22
AVCOM PSA-65A Spectrum Analyzer	Nov 24
B&K-Precision 1201SR Television Frequency Converter/Modulator	Oct 17
1249 NTSC Generator	Dec 18
388-HD Test Bench	Mar 16
Beckman Industrial Model 233 Professional Digital Multimeter	Aug 16
Canon FAX-L920 Laser Facsimile	Feb 22
Circuitmate DM27 Digital Multimeter	Oct 17
Elenco XK-220 Digital Trainer	Sep 22
Global Specialties BOA Microprocessor Applications Workstation	Jun 16
Jameco Electronics JE680 IC programmer	Jun 16
Lynx 470 Disk Drive Tester	May 17
Mark-V SM-333 Surround Sound Processor	May 17
Precision Motion 20-MHz Logic Analyzer	Dec 18
Sencore LC102 Capacitance/Inductance Meter	Apr 17
Sibex FG-1 Handheld Function Generator	Sep 22
Tektronix 222 Handheld Digital Storage Oscilloscope	Jul 20
VideOsmith Spectrum Probe	Aug 16
Etching Tank, Make Your Own(Lewis)(C)	Dec 45
Evolution of car stereo, the(Klein)(AUD)	Sep 70
Extender, remote control(Heil)(C)	May 41

F

FMX: Is it Good for FM?(Feldman)	Oct 52
Facsimile	
Canon FAX-L920 Laser(ER)	Feb 22
Fax-Mate(Plant)(C)	Oct 33, (PCS) Oct 82
Filter capacitors, picking (Lancaster)(HH)	Oct 65
Filters	
infrared(Lancaster)(HH)	Jan 34
optical(Lancaster)(HH)	Jan 34
Flasher circuit(ARE)	Nov 12
Flashing LEDs(ARE)	May 12
Frequency	
Propagation, sunrise and Sunset affect(Leinwoll)(SWR)	Feb 87
Response: What do the numbers really mean?(Klein)(AUD)	Aug 71
Standard, 10-MHz(Palmer)(C)	Feb 63
Friedman, Herb(Fenton)(ED)	Jan 4
Function Generator, Sibex FG-1(ER)	Sep 22

G

Getting an oscilloscope(Lancaster)(HH)	Jul 66
"Ghosts," removing(Lachenbruch)(VN)	Nov 6
Global Specialties BOA Microcomputer Applications Workstation(ER)	Jun 16
Gold, Mace's(SWR)(CD)(EW)	Jul 75
Guitar equalizer(ARE)	Jun 12

H

HDTV	
—an alternative viewpoint(Lancaster)(HH)	Feb 78
High Definition Television(Feldman)	Feb 33
Letters	Mar 14, Jul 12, Nov 16, Dec 14
(Lachenbruch)(VN)	Jan 8, Feb 6, Apr 6, May 6, Jun 8
Happy 10th Anniversary, Sony Walkman(Klein)(AUD)	Oct 72
HARDWARE HACKER(D)(Lancaster)	Jan 34, Feb 78, Mar 25, Apr 25, May 61, Jun 67

Jul 66, Aug 64, Sep 65
Oct 65, Nov 65, Dec 68

A/D converter accuracy
Getting an oscilloscope
HDTV—An alternative viewpoint
Humidity sensors
More on cold fusion
New "disco" circuit, A
PC-Board Breakthrough
Phase-plane plots
Picking filter capacitors
Refilling SX toner cartridges
Soup cans full of chips
Try cold fusion for yourself!

HARDWARE REVIEWS(Holtzman)(CD)(EW)

Cambridge Direct's Z88 laptop Feb 96
D-G Electronic Developments' DoubleCOM Jan 88
IQ Technologies' Smart Data Meter Mar 90
Tandy Model 100 laptop Feb 96
Teletek X-Bandit EMS 4.0 Memory Board Jun 79
Toshiba T1000 laptop Feb 96

High Definition Television(Feldman) Feb 35
High-Power Hi-Fi Audio Amp for your Home or Car(Ross & Watts)(C) Mar 51, (LTR) Apr 14, (LTR) May 15, Nov 16

High-Tech Home Security(Friedman) Apr 33
Hijack, Inset Systems'(SWR)(CD)(EW) May 77

History
and theory of the dynamic loudspeaker(Klein)(AUD) May 70
Evolution of car stereo, the(Klein)(AUD) Sep 70
How television got its start(AR) May 74

Holiday Gift Guide Dec 51

Home Automation
Phonlink II(McNabb & Roseth)(C) Feb 44, Mar 46
REACTS(Bybee)(C) Jan 65

Home security System
High-Tech(Friedman) Apr 33
Install a(Friedman & Fenton) Apr 42
Phasor Property Guard(Iannini)(C) Dec 37
Wireless Security System(Becker)(C) Apr 47

How
Important is slow factor? loud is real?(Klein)(AUD) Jun 87
television got its start(Fitch)(AR) Jul 8
How to Install a Tape Backup Unit(Fenton)(CD) May 74
to Repair CD Players(Pelphs) Jun 79
Humidity sensors(Lancaster)(HH) Nov 52
HX-Pro: A "new" and improved cassette-deck circuit(Klein)(AUD) Sep 65
Mar 84

I

IC Programmer, Jameco JE680(ER) Jun 16

IDTV
Improved Definition TV(Feldman) Jan 43
(Lachenbruch)(VN) Nov 6

Importance of amplifier output current, The(Klein)(AUD) Apr 70
Improved Definition TV(Feldman) Jan 43

Install
a Home-Security System(Friedman & Fenton) Apr 42
a Tape Backup Unit(Fenton)(CD) Jun 79
Inside Intel's 80386(Margulis)(CD) Jan 90, Feb 103, Mar 98

Intelligent Cable Tester for Only \$25!(Barbarelli)(C)(CD) Apr 77

International
Frequency Coordinating Committee(Leinwoll)(SWR) Apr 72
Power standards(Lancaster)(HH) Oct 65

ISDN Prototyping Telephone (Tousignant & Sliker)(C) May 35, Jun 61, (PCS) May 59, (LTR) Sep 14

J

Jameco Electronics JE680 IC programmer(ER) Jun 16

Jamming
the end of an era?(Leinwoll)(SWR) Jun 75
the Soviet system and the future of(Leinwoll)(SWR) Oct 78

K

Keep Your VCR Healthy(Hansen) Mar 61, Sep 55

L

LCD projection TV's(Lachenbruch)(VN) May 6

LED Flasher, sequential(ARE) May 12

Laplank, Traveling Software(SWR)(CD)(EW) Sep 77

Laptops
Cambridge Direct's Z88(CD)(EW) Feb 96
Tandy Model 100(CD)(EW) Feb 96
Toshiba T1000 (CD)(EW) Feb 96
Large-size picture tubes(Lachenbruch)(VN) Aug 6

Laser
-discs(Lachenbruch)(VN) Sep 6
Hacking resources(HH) Oct 65
Power Supply, Universal (McComb)(C) Mar 33, (PCS) Mar 74
printer paper(CD)(EW) Aug 75

Solid-state visible(HH) Oct 65

Laying out a PC Board(Grossblatt)(DB) Oct 81

Let's start programming!(Grossblatt)(DB) May 72

LETTERS(D)
Jan 16, Feb 14, Mar 14, Apr 14
May 15, Jun 14, Jul 12, Aug 12
Sep 14, Oct 14, Nov 16, Dec 14
Mar 25

Libraries, on-line(HH)

Light
Beam Communicator (Sonntag)(C) Jul 31, Aug 52, (PCS) Jul 56
-control circuit(ARE) Sep 8

Linear
stepper motors(HH) Nov 64
-to-log converter(ARE) Jul 10

Logic Circuit, Programmable(Reeve)(CD) Sep 77
Logic designer
Elenco XK-220 Digital Trainer Sep 22

Logic Analyzer, 20-MHz, Precision Motion(ER) Dec 18
Loudspeakers and things(Fitch)(AR) Feb 91

Low Frequency
Converter(Sheets & Graf)(C) Sep 47, (PCS) Sep 64
resources(Lancaster)(HH) May 61
Transmitter(Nelson)(C) Sep 43, (PCS) Sep 64

Low-Capacitance Scope Probe(Friedman)(C) Jan 52

Lynx 470 Disk Drive Tester(ER) May 17

M

Macrowave oven(Hakemachi)(C) Apr 74

Make Your Own Etching Tank(Lewis)(C) Dec 45

Mark-V SM-333 Surround Sound Processor(ER) May 17

Mass-teleportation card(Lancaster)(HH) Apr 25

Meditation Goggles, Alpha Theta(Worley)(C) Apr 53, (PCS) Apr 69

Microcomputer Applications Workstation(ER) Jun 16
Global Specialties BOA Sep 82, Oct 83

Microcontroller, 68705(Henry)(CD)(C) Mar 43

Microphone, FM Wireless(Spiwak)(C) Apr 25

Micropower regulators(HH) Dec 81

Microsoft Windows(EW)(CD) Aug 33

MIDI, All About(Simonton) Nov 64

Model
-making resources(Lancaster)(HH) Nov 64
100 laptop, Tandy(HWR)(CD)(EW) Feb 96

More on cold fusion(Lancaster)(HH) Nov 64

Motherboard, Build an 80386 (McIlhany)(CD)(C) Jun 79, Jul 81, Aug 75, (EW) Sep 77

Multiboot, Bolt System's(SWR)(CD)(EW) Oct 83

Multipath distortion(Lachenbruch)(VN) Nov 6

Music-On-Hold Adapter(Sokolowski)(C) Aug 42, (PCS) Aug 70

Musical Instrument Digital Interface(Simonton) Aug 33

N

NTSC/PAL/SECAM conversions(Lachenbruch)(VN) Sep 6

NTSC Generator B&K-Precision(ER) Dec 18

Neon indicators(ARE) Oct 8

New "disco" circuit, A(Lancaster)(HH) Mar 25

NEW IDEAS(D) Mar 73

Cable Tester(Rowe) Mar 73

NEW LITERATURE(D) Jul 27, Sep 27, Oct 28, Dec 35

NEW PRODUCTS(D) Jan 28, Feb 26, Mar 22, Apr 22
May 22, Jun 22, Jul 22, Aug 22
Sep 25, Oct 24, Nov 26, Dec 28, (LTR) Dec 14

New Radios, New Problems, New Solutions(McClellan) Jul 57, Aug 60

Norton Utilities Advanced Edition Version 4.5(SWR)(CD)(EW) Jul 75

Nuclear-waste management(LTR) Nov 16

O

OS/2
Presentation Manager(SWR)(CD)(EW) Apr 77
Standard Edition Version 1.1(SWR)(CD)(EW) Apr 77

Omniview
and a 386(Toutonghi)(CD) Jul 73
Application, Building an(Toutonghi)(CD) Aug 80

One-Band Shortwave Converter(Graf & Sheets)(C) Oct 49

Optical reprint sources (Lancaster)(HH) Dec 68

Op-Amp Oscillators(Marston) Jul 51

Op-Amps, Basic(Marston) Mar 69

Compound(Marston) Jan 69

in Instrumentation(Marston) Sep 59

Working with(Marston) May 54

Optic communications
Light Beam Communicator(Sonntag)(C) Jul 31, Aug 52

Oscilloscope,
Getting an(Lancaster)(HH) Jul 66
Probes, Understanding(Gordon) Jan 46
Tektronix 222 digital storage(ER) Jul 20

P

PAL
NTSC VCR(Lachenbruch)(VN) Jul 6

SECAM conversions(ARE) Jun 12

PC boards(Grossblatt)(DB) Aug 73, Oct 81

Breakthrough(Lancaster)(HH) Dec 68

Developing and Etching(Grossblatt)(DB) Dec 77

Make Your Own Etching Tank(Lewis)(C) Dec 45

Photography(Grossblatt)(DB) Nov 78

Resource list(Lancaster)(HH) Dec 68

PC-File: dB, ButtonWare's(SWR)(CD)(EW) Aug 75

PC SERVICE(D) Feb 110, Mar 74, Apr 69, May 59
Jun 78, Jul 56, Jul 84, (LTR) Jul 12, Aug 70
Sep 64, Oct 71, Oct 82, Oct 90, Dec 79

PC Run Circles Around a Cray?, A(Byers)(CD) Apr 77

PT-68K, Run MS-DOS on(Henry)(CD)(C) Jan 96

Parts tester
R-C Decade Box(Lashansky)(C) Nov 39

Parts values(ARE) Oct 8

Peak Detector, Digital(Secura)(C) Apr 59

Personal video(Lachenbruch)(VN) Apr 6

Phase
-controlled dimming(HH) Mar 25

-locked loop IC's(Marston) Dec 55

-plane plots(Lancaster)(HH) May 61

Phasor Property Guard, Programmable(Iannini)(C) Dec 37, (PCS) Dec 79

Phonlink II(McNabb & Roseth)(C) Feb 44, Mar 46, (PCS) Feb 110

Picking filter capacitors(Lancaster)(HH) Oct 65

Picture-in-picture(Lachenbruch)(VN) Aug 6

Plasma Display Globe(Caudill)(C) Jan 62

Portable LCD TV's(Lachenbruch)(VN) Sep 6

PostScript video(HH) Nov 64

Power
Sources, future(Lancaster)(HH) Aug 64

Standards, international(Lancaster)(HH) Oct 65

Supplies(ARE) Jan 12

Supply
Laser Power, Universal(McComb)(C) Mar 33

Solar(Becker)(C) Aug 47

Precision Motion
20-MHz Logic Analyzer(ER) Dec 18

Probes
Low-Capacitance Scope(Friedman)(C) Jan 52

Understanding Oscilloscope Probes(Gordon) Jan 46

ProComm +, Datastorm Technologies(SWR)(CD)(EW) Jan 88

Programmable Architectures: The Next Breakthrough?(Reeve)(CD) Sep 77

Programmable Phasor Property Guard(Iannini)(C) Dec 37

Pseudo-random sequences(HH) Feb 7

Pulse shortener(ARE) Jun 12

Put a 386SX Tiger in Your Tank(McIlhany)(C)(CD) Jun 79, Jul 81, Aug 75, (EW) Sep 77

Q

Question of reliability, the(Klein)(AUD) Feb 89

R

RAM increase(ARE) Apr 8

R-C Decade Box(Lashansky)(C) Nov 39

RF bugging devices
Tracking Down Bugs Using a Spectrum Analyzer(Bowen) Jun 33

RGB-to-NTSC Converter(Bek)(C)(CD) Dec 81

Radalert(Sep 88) Letters(LTR) Jan 16

Radalert Update(Jaffe & Sythe) Jun 51, (LTR) Oct 14

Radiation Awareness(Fenton)(ED) Jun 4

(LTR) Feb 14, Nov 16, Dec 14

Monitor Update(Jaffe & Sythe) Jun 51

RADIO(See also ANTIQUE RADIO, SHORTWAVE RADIO, AUDIO UPDATE)

-Electronics Advanced Control System(Bybee)(C) Jan 65

FMX: is it Good for FM?(Feldman) Oct 52

International Frequency Coordinating Committee(Leinwoll) Apr 72

Low Frequency Converter(Sheets & Graf)(C) Sep 47

Transmitter(Nelson)(C) Sep 43

New Radios, New Problems, New Solutions(McClellan) Jul 57, Aug 60

One-Band Shortwave Converter(Graf & Sheets)(C) Oct 49

Radio-wave propagation (See SHORTWAVE RADIO)

REACTS(Bybee)(C) Jan 65

READER-HELP-READER(D) Jun 18

Receivers
 Carrier Current(Sheets & Graf)(C) Feb 55
 Light Beam Communicator(Sonntag)(C) Jul 31, Aug 52
 Tunable preselectors(Friedman)(CC) Jan 82
 Refilling SX toner cartridges(Lancaster)(HH) Apr 25
 Relays, All About(Trietley) Nov 59, Dec 59
Remote
 A/B Switch(Heil)(C) Oct 37, (PCS) Oct 71
 Control Extender(Heil)(C) May 41, (PCS) May 59
 Repair(See SERVICING)
 Re-wiring homes(ARE) Nov 12
 Robot, Timex(ARE) Mar 8
 Run MS-DOS on the PT-68K(Henry)(C)(CD) Jan 96

S

SAW devices(HH) May 61
 SCR, light-activated(ARE) Jan 12
 SAM 2000, IQ Technologies(HWR)(CD)(EW) Oct 83
 Scope Probe, Low-Capacitance(Friedman)(C) Jan 52
Security
 High-Tech Home Security(Friedman) Apr 33
 Install a Home Security System(Friedman & Fenton) Apr 42
 System, Wireless(Becker)(C) Apr 47
 Sencore LC102 Capacitance/Inductance Meter(ER) Apr 17
 Sensors(Lancaster)(HH) Jun 67
 Septic pump, automatic(ARE) Nov 12

SERVICING
 How to Repair CD Players(Pheips) Nov 52
 Keep Your VCR Healthy(Hansen) Mar 61, Sep 55
 New Radios, New Problems, New Solutions(McClellan) Jul 57, Aug 60
 Speed Up Your VCR Troubleshooting(Emerich) Mar 65
 1750-meter-band Low Frequency Transmitter(Nelson)(C) Sep 43

Shortwave(See also SHORTWAVE RADIO)
 Active Antenna(Kreuter)(C) Feb 51
 Antenna, Choosing the Right(Carr) Jun 61
 Converter, One-Band (Graf & Sheets)(C) Oct 49, (PCS) Oct 90

SHORTWAVE RADIO(D)(Leinwoll) Feb 87, Apr 72, Jun 75, Oct 78

International Frequency Coordinating Committee Apr 72
 Jamming: the end of an era Feb 87
 Sunrise and sunset affect frequency propagation Oct 78
 The Soviet jamming system and the future of jamming Sep 22

Sibex FG-1 Handheld Function Generator(ER) Sep 8
 640K expansion(ARE) Mar 90

Smart Data Meter, IQ Technologies(HWR)(CD)(EW) Jan 88

SmartCom III, Hayes Microcomputer Products(SWR)(CD)(EW) Oct 83

SOFTWARE REVIEWS(Holtzman)(CD)(EW)
 Bolt System's Multiboot Mar 90
 Borland's Turbo Pascal 5.0 Aug 75
 ButtonWare's PC-File:db Jan 88
 Datastorm Technologies' ProComm + DG Electronic Development's DoubleCOM Jan 88, Oct 83
 Hayes Microcomputer Products' SmartCom III Inset Systems' Hijack May 77
 Mace's Gold Jul 75
 Micrografix' Designer Mar 90
 Norton Utilities Advanced Edition Version 4.5 Jul 75

OS/2
 Presentation Manager Apr 77
 Standard Edition Version 1.1 Apr 77
 Prime Solution's Disk Technician May 77
 RG Software Systems' Disk Watcher May 77
 Traveling Software's Laplink Sep 77
 ViewLink Jun 79
 Wilson Windowware's Command Post Dec 81

Solar power (Lancaster)(HH) Aug 47, (LTR) Nov 16
 Supply(Becker)(C) Aug 47, (PCS) Aug 70

Sony Walkman, Happy 10th Anniversary(Klein)(AUD) Oct 72

Sound of CD, The Part 1(Klein)(AUD) Nov 74
 Part 2(Klein)(AUD) Dec 67
 Sound Retrieval System(Feldman) Sep 51
 Soup cans full of chips(Lancaster)(HH) Jun 67
 Soviet jamming system and the future of jamming, The(Leinwoll)(SWR) Oct 78
 Speaker-cable performance (LTR) Jun 14, Aug 12

Spectrum Analyzer
 (Baumgartner)(C) Sep 33
 AVCOM PSA-65A(ER) Nov 24
 Monitor(Baumgartner)(C) Oct 46, (PCS) Oct 90, (LTR) Dec 14

Probe, VideOsmith(ER) Aug 16
 Speech Synthesizer(Dec. 88 CD) (LTR) Feb 14
 Speed Up Your VCR Troubleshooting(Emerich) Mar 65
 Starting a technical business(HH) Jun 67
 State variable filters(Lancaster)(HH) May 61

Stereo (See also AUDIO)
 TV(Lachenbruch)(VN) Jun 8
 wireless broadcaster(Lancaster)(HH) Oct 65
 Stepper driver circuits(Lancaster)(HH) Nov 64
 Still video(Lachenbruch)(VN) Apr 6, Jun 6

Sunrise and sunset affect frequency propagation(Leinwoll)(SWR) Feb 87
 Surround Sound Processor, Mark-V SM-333(ER) May 17
 Switches, Bilateral(Marston) Nov 54

T

T1000 laptop, Toshiba(HWR)(CD)(EW) Feb 96
 Tape Backup Unit, How to Install a(Fenton)(CD) Jun 79

Technical literature(Lancaster)(HH) Feb 78, Jul 66, Aug 64
 Tektronix 222 Handheld Digital Storage Oscilloscope(ER) Jul 20

TELEPHONE

-Call recorder(ARE) Oct 8
 ISDN Prototyping(Tousignant & Sliger) (C) May 35, Jun 61
 -Line add-on

Fax-Mate(Plant)(C) Oct 33
 Music-On-Hold Adapter(Sokolowski)(C) Aug 42
 Phonlink II(McNabb & Roseth)(C) Feb 44, Mar 46

Surveillance Tracking Down Bugs Using a Spectrum Analyzer(Bowen) Jun 33

TELEVISION(See also VIDEO, VIDEO NEWS)
 Earphone jack(ARE) Apr 8, (LTR) Jun 14

Frequency Converter/Modulator B&K 1201SR(ER) Oct 17

Interference(ARE) Mar 8
 Transmitter, Amateur(Graf & Sheets)(C) Jun 45, Jul 45

10-MHz Frequency Standard(Palmer)(C) Feb 63
 Widescreen(Lachenbruch)(VN) Dec 6

TEST EQUIPMENT(See also EQUIPMENT REPORTS)

10-MHz Frequency Standard(Palmer)(C) Feb 63
 Automatic Test Equipment(Stover) Oct 61
 Cable Tester(Rowe)(NI) Mar 73

Digital Capacitance Meter(Lashansky)(C) Jul 38
 Peak Detector(Secura)(C) Apr 59

Low-Capacitance Scope Probe(Friedman)(C) Jan 52
 R-C Decade Box(Lashansky)(C) Nov 39

Spectrum Analyzer
 (Baumgartner)(C) Sep 33
 Monitor(Baumgartner)(C) Oct 46, (LTR) Dec 14

Speed Up Your VCR Troubleshooting(Emerich) Mar 65
 Understanding Oscilloscope Probes(Gordon) Jan 46

Time-base corrector(ARE) Feb 12
 Timex robot(ARE) Mar 8

Toner
 cartridges, Refilling SX(Lancaster)(HH) Apr 25
 reloading tools(HH) Jul 66

Touch switch(ARE) May 12
 Tracking Down Bugs Using a Spectrum Analyzer(Bowen) Jun 33

Transducers(Lancaster)(HH) Jun 67

Transmitter
 Amateur TV(Graf & Sheets)(C) Jun 45, Jul 45
 Carrier Current Audio(Sheets & Graf)(C) (PCS) Jul 56, 84, (LTR) Sep 14, Jan 55

Light Beam Communicator(Sonntag)(C) Jul 31, Aug 52
 Low Frequency(Nelson)(C) Sep 43
 Wireless FM Microphone(Spiwak)(C) Mar 43

Transputer, INMOS Corp.s(Byers)(CD) Apr 77

TROUBLESHOOTING(See also SERVICING)
 Automatic Test Equipment(Stover) Oct 61
 Keep Your VCR Healthy(Hansen) Mar 61, Sep 55

New Radios, New Problems, New Solutions(McClellan) Jul 57, Aug 60

Try cold fusion for yourself!(Lancaster)(HH) Aug 64
 Tunable preselectors(Friedman)(CC) Jan 82

Turbo Pascal 5.0, Borland(SWR)(CD)(EW) Mar 90, May 77
TV(See TELEVISION, VIDEO, VIDEO NEWS)

U

Understanding Oscilloscope Probes(Gordon) Jan 46
 Universal Laser Power Supply(McComb)(C) Mar 33

V

VCR
 Double-deck(Lachenbruch)(VN) Mar 6, Nov 6
 Hi8(Lachenbruch)(VN) Jun 8

Keep Yours Healthy(Hansen) Mar 61, Sep 55
 S-VHS(Lachenbruch)(VN) Jun 8

Troubleshooting, Speed Up Your(Emerich) Mar 65
 VHS(Lachenbruch)(VN) Jul 6
 VHS-C(Lachenbruch)(VN) Oct 6

VIDEO(See also VIDEO NEWS)
 Amateur TV Transmitter(Graf & Sheets)(C) Jun 45, Jul 45

Editing Computer Aided Video(Morton & Scott)(CD) Mar 93
 Video Scene Switcher (Sheets & Graf)(C) Nov 33, Dec 42, (PCS) Dec 79

High Definition Television(Feldman) Feb 35
 How television got its start(Fitch)(AR) May 74

Improved Definition TV(Feldman) Jan 43
 Keep Your VCR Healthy(Hansen) Mar 61, Sep 55

RGB-to-NTSC Converter (Bek)(C)(CD) Dec 81
 Remote A/B Switch(Heil)(C) Oct 37

Remote Control Extender(Heil)(C) May 41
 Speed Up Your VCR Troubleshooting(Emerich) Mar 65

Tapes: Choosing the One That's Right For You(Feldman) May 45

VIDEO NEWS(Lachenbruch)(D) Jan 8, Feb 6, Mar 6, Apr 6, May 6, Jun 8, Jul 6, Aug 6, Sep 6, Oct 6, Nov 6, Dec 6

Video Scene Switcher(Sheets & Graf)(C) Nov 33

Video Tapes: Choosing the One That's Right For You(Feldman) May 45

Videodisc players(Lachenbruch)(VN) Jul 6

VideOsmith Spectrum Probe(ER) Aug 16
 ViewLink, Traveling Software's(SWR)(CD)(EW) Jun 79

W

Walkman, Sony Happy 10th Anniversary(Klein)(AUD) Oct 72

WHAT'S NEWS(D) Jan 6, Feb 4, Mar 4, Apr 4, May 4, Jun 6, Jul 4, Aug 4, Sep 4, Oct 4, Nov 4, Dec 4

Widescreen TV(Lachenbruch)(VN) Oct 6, Dec 6

Windows, Microsoft(EW)(CD) Dec 81

Wireless FM Microphone(Spiwak)(C) Mar 43, (PCS) Mar 74
 Security System(Becker)(C) Apr 47, (PCS) Apr 69

Working With
 Counters(Marston) Apr 63
 Working With Op-Amps(Marston) May 54

X

X-Bandit EMS 4.0 Memory Board Teletek(HWR)(CD)(EW) Jun 79

Z

Z-80 Hardware(ARE) Jan 12, Mar 8

Z88 laptop, Cambridge Direct's(HWR)(CD)(EW) Feb 96
 Zero crossing detection(Lancaster)(HH) Mar 25



"They use them in vacuum cleaners."

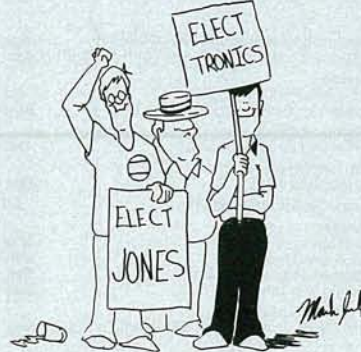

"No. There's no such thing as a tall circuit."

HARDWARE HACKER

PostScript fractal fern
Unusual cooling ideas
Thermoelectric modules
Chaos science resources
Superintelligent machines

Chaos science resources

DON LANCASTER

LET'S START OFF WITH SOME NEW UPDATE info for our previous columns. The 38.4-kilohertz crystal needed for the stereo broadcaster is available for around \$3 from *Statek*, who stocks quite a wide variety of small and cheap low-frequency crystals.

Since 38.4 kHz is a standard modem value, it seems a better choice than your usual 38.0-kHz stereo-multiplex frequency, and should work just about as well. Probably your best way to throw the project together, though, is to go to one of the kits that are offered in the **Radio-Electronics** classified section.

One interesting use for that chip is to measure the torque on a rotating shaft. A \$1.50 part can easily replace a \$1100 telemetry system here, at a lower power and smaller size.

Two additional sources for heavy water (deuterium) are the *Canadian Atomic Energy Commission* and their *Isotech* reps here in the US. Price is in the forty-cents-per-gram range.

A key cold-fusion paper appears on pages 301-308 of Volume 261 of the *Journal of Electroanalytical Chemistry*. The *EPRI Journal* (Electric Power Research Institute), August 1989, also has some interesting stuff in it.

A few of you callers on our hacker helpline have suggested faking those high-priced linear actuators we looked at two columns back. To do that, take an ordinary stepper and couple it to a piece of threaded rod by using shrink tubing. Then add two nuts and some

sort of platform to create a traveling slider. Various tricks could eliminate backlash, and you should be able to replace a \$57 list price actuator with a surplus \$2 stepper.

As per usual, all of our names and numbers have been gathered together for you into one common sidebar.

Thermoelectric coolers

There sure appears to be a lot of hacker interest in the thermoelectric cooling devices. We'll start off with the bottom line—besides their very high costs, those devices are pretty much useless, since they are so incredibly and horribly inefficient. They are only workable for very specialized and arcane applications where nothing else will do. Thermoelectric coolers will work only when you go to ridiculous extremes on insulation and heatsink efficiency, and then are capable of pumping only tiny amounts of heat. And, to further shatter some hacker dreams, no way will they make ice in the real world.

At any rate, a *thermoelectric module* is a solid-state cooling device. All you do is input a current,

and heat moves through the device, cooling one side and heating the other.

Figure 1 shows you a typical device. That one's the *Cambion* model 801-2007. A similar component is also available through *Melcor*. That dude measures some two inches square and can move up to 22 watts of heat when powered by a 12-volt car battery at 7 amps. Cost is in the \$20-\$30 range.

Solid-state cooling modules use the *Peltier effect*. Figure 2 shows you details. What you do is start off with bismuth telluride or some other semiconductor. Then you cut it up into blocks, while heavily *p* doping some of them and *n* doping others.

When a current is applied in the proper direction, the electron carriers in the *n* material and the hole carriers in the *p* material will "drag" thermal energy along with their motions. In both cases, the heat moves downward, creating a hot side and a cold side.

The amount of heat you do move depends highly upon the temperature differential you have to maintain. As Fig. 3 shows, that particular device can provide a 60°C difference between the hot and cold side, *provided that you pump no heat through it*. On the other hand, if you do maintain both sides at the same temperature, you can pump up to 22 watts of heat through the device.

In most uses, of course, you will want both to cool something and move heat, so you must use the middle of the curve. For instance,

NEED HELP?

Phone or write your **Hardware Hacker** questions to:
Don Lancaster
Synergetics
Box 809-RE
Thatcher, AZ, 85552
(602) 428-4073

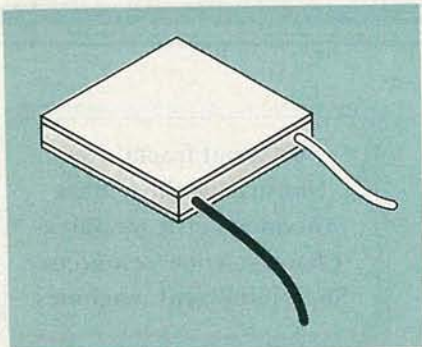

FIG. 1—THERMOELECTRIC COOLING modules are fairly cheap and easy to apply, but they are so inefficient that they are pretty much useless for any higher-power heat pumping.

you could pump eight watts with a 40°C drop. To put that in perspective, the module could, in theory, make a very small ice cube in around one hour...under ideal conditions.

The trouble is that conditions are *never* ideal for thermoelectric modules. There are a number of nasty "gotchas" that will gang up on you when you try to use them in the real world.

**NEW FROM
DON LANCASTER**

HANDS-ON BOOKS

Hardware Hacker Reprints II	24.50
Ask The Guru Reprints I or II	24.50
CMOS Cookbook	18.50
TTL Cookbook	16.50
Active Filter Cookbook	15.50
Micro Cookbook vol I or II	16.50
Enhancing your Apple I or II	17.50
AppleWriter Cookbook	19.50
Apple Assembly Cookbook	21.50
Incredible Secret Money Machine	10.50
LaserWriter Reference (Apple)	19.50
PostScript Cookbook (Adobe)	16.50
PostScript Ref. Man. (Adobe)	22.50
PostScript Prog. Design (Adobe)	22.50
Real World Postscript (Roth)	22.50

UNLOCKED SOFTWARE

LaserWriter Corner (Ile/Mac/PC)	29.50
PostScript Show & Tell	39.50
Intro to PostScript VHS Video	39.50
PostScript Perspective Draw	39.50
PostScript Beginner Stuff	39.50
PostScript Technical Illustrations	39.50
PostScript Work in Progress	39.50
PostScript BBS stuff	19.50
Absolute Reset Ile & Iic	19.50
AppleWriter/Laserwriter Utilities	49.50
Enhance I or II Companion Disk	19.50
AppleWriter CB or Assy CB Disk	24.50

FREE VOICE HELPLINE VISA/MC

SYNERGETICS
Box 809-RE
Thatcher, AZ 85552
(602) 428-4073

CIRCLE 83 ON FREE INFORMATION CARD

NAMES AND NUMBERS

Cambion
1601 N. Powerline Road
Pompano Beach, FL 33069
(800) 274-6748
Canadian AEC
34 Slater Street
Ottawa, Ont, CANADA K1A 0S4
(613) 237-3270
Computer Shopper
One Park Avenue, 11th Fl.
New York, NY 10016
(212) 503-3500
DATArx
111 E. Drake Road, Ste. 7041
Fort Collins, CO 80525
(303) 223-2120
Edmund Scientific
101 E. Gloucester Pike
Barrington, NJ 08007
(609) 573-6250

EPRI Journal
Box 10412
Palo Alto, CA 94303
(415) 855-2370
Isotech
3858 Benner Road
Miamisburg, OH 45342
(800) 448-9760
Haygean Machine
2225 South 170th Street
New Berlin, WI 53151
(414) 797-7520
Lightwave
Box 2139
Tulsa, OK 74101
(918) 835-3161
Melcor
990 Spruce Street
Trenton, NJ 08648
(609) 393-4178

Thermoelectric modules are rather expensive, mostly because they have not been improved one iota in the last two decades. Worse

yet, all of them are horribly inefficient. In a typical use, you'd have to input five watts of input power to provide just one watt of cooling.

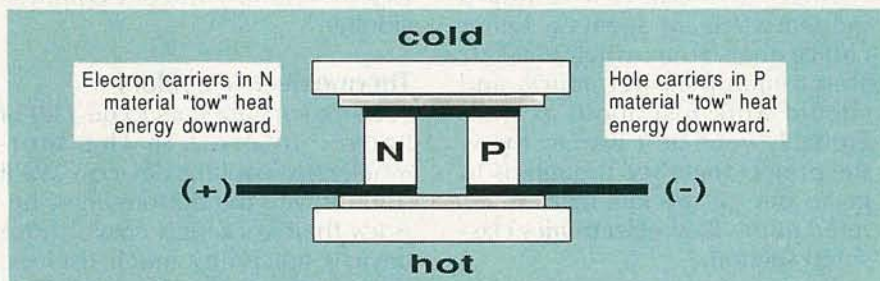

FIG. 2—A THERMOELECTRIC MODULE consists of blocks of bismuth telluride that have been alternately n- and p-doped. The blocks are placed electrically in series and thermally in parallel. When a DC current is applied, electrons in the n material and holes in the p material will tow heat along with themselves.

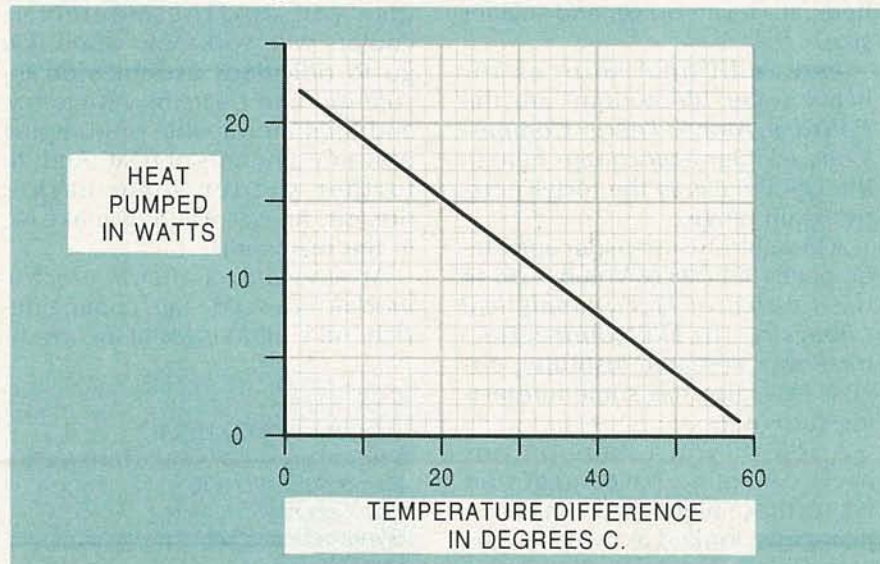

FIG. 3—THE AMOUNT OF HEAT PUMPED by a thermoelectric module depends on the temperature drop you require. Note that the heat transferred at the maximum temperature differential is zero. Note also that the heat differential is with respect to the hot end of your heat sink, and not to ambient.

NAMES AND NUMBERS

Philips/Signetics

45 George Washington Hwy.
Smithfield, RI 02917
(401) 232-0500

Sanyo

7 Pearl Court
Allendale, NJ 07401
(201) 825-8080

SGS

1000 East Bell Road
Phoenix, AZ 85022
(602) 867-6259

Sprague

70 Pembroke Road
Concord, NH 03301
(603) 224-1961

Statek

512 North Main Street
Orange, CA 92668
(714) 639-7810

Stock Drive Products

2101 Jericho Turnpike
New Hyde Park, NY 11040
(516) 328-3300

Synergetics

Box 809
Thatcher, AZ 85552
(602) 428-4073

Tektronix

Box 4600 M/S 94-860
Beaverton, OR 97076
(800) 426-2200

Texas Instruments

Box 809066
Dallas, TX 75380
(800) 232-3200

Vortec

10125 Carver Road
Cincinnati, OH 45242
(800) 441-7475

Mechanical air conditioners are almost *fifty* times more efficient than that! Worse yet, you have to apply that extra heat to exactly where you do not want it.

The heatsink you connect the hot side of the module to must be absolutely flat, and be machined to within 0.001 inch over its entire area. It must then get carefully covered with a thin layer of thermal grease. Obviously, those portions of a module not contacting the heatsink can not deliver any useful cooling.

The real killer of most thermoelectric-module applications lies in the thermal drop between the heatsink and the ambient temperature. For higher power uses, a fan or water cooling is essential.

For instance, a very large plain old heatsink will have at best a 1°C-per-watt temperature rise above the ambient. Say you want to pump the 8 watts at a 40°C drop. The heatsink will have to sink those 8 watts, plus an additional 32 watts or so of input power for a total of 40 watts. At 1°C-per-watt heatsink rise, the heatsink will warm to 40°C *above* the ambient room temperature. *And you've done nothing but break even!* The cooling module has a 40-degree *drop* across it. The heatsink has a 40-degree *rise* across it. And the net cooling is *zero*. You have nothing at all to show for all your effort.

One more time: In the previous

example, your final cooling is zero, because the hot side of the heatsink rises just as much above ambient as the amount of temperature drop you are trying to achieve! And a one-degree-per-watt heatsink is a darn good one...and large, too.

So, an extremely low thermal drop from heatsink to ambient is absolutely essential. Also essential is an incredible quantity of insulation around whatever you are cooling, for any net heat flux into your area being cooled will only make matters much worse than they already are.

The modules can get reversed by reversing the current. Because of the inefficiency, the heating mode is five times more effective than the cooling mode.

One side effect of that inefficiency is that you must run the modules off nearly pure direct current. The least amount of power-supply ripple will dramatically cut the cooling ability, since the ripple troughs will heat your load five times better than the ripple peaks will cool your load.

A car battery is often the best choice to power your thermoelectric modules. You might temporarily demonstrate a module by holding your module between your thumb and finger and then connecting the module to a single alkaline "D" cell. Do not use the "D" cell for more than a few seconds at a time.

What good are thermoelectric modules? You definitely can't buy a 4×8 foot panel of them and use them to air condition your house. But they are lots of fun to play with. They're a sure-fire topic for a winning science-fair project or student paper. Besides that, though, thermoelectric modules are limited to those specialized and low-load uses where nothing else can do the job. Important uses include coolers for infrared detectors, dew-point humidity sensors, chillers for microscope stages, and for thermal-management uses in satellites.

I have often wondered why they are not used in satellite-receiver front ends. I guess the answer is that the gain of the input amplifier drops faster with temperature than the noise figure improves.

Both *Cambion* and *Melcor* have lots of interesting tech literature on thermoelectrics, so you might want to contact both for more info.

Other coolers

There are three other approaches to unusual cooling techniques that are hacker hackable. You just might want to pick up on those instead.

First, Japanese air conditioners are ridiculously better than the American ones, and have been for the past few years. It seems that all the American manufacturers refuse to pick up the new technology, blaming the building codes, and claiming that a customer demand does not exist.

The new air conditioners have EER's (Energy Efficiency Ratings) approaching a value of 15, meaning that they use 33 percent less electrical energy than ours do. That's \$60 per month or so. They are also much quieter and far more comfortable. Four of the secrets include a new beastie called a *scroll compressor*, a motor with an infinitely variable speed blower on the air handler, and a total programmed microprocessor control.

I guess you would call the second device a solid-state cooler, although you do need a large air compressor across the room for a power source. At least the extra heat is not generated at precisely the wrong place, as is the case with thermoelectric modules.

FRactal and Chaos Science Resources

It turns out that rapidly moving air accepts heat from slowly moving air. Thermodynamics and all. So, if you build a suitable *vortex nozzle device* having one inlet for shop air and two outlets, you can arrange things so that cold air comes out one end and hot air out the other—with zero moving parts. Believe it or not, you can get as cold as the $-40^{\circ}\text{Fahrenheit}$ dry-ice temperatures, or else you can optimize the flow rates to get maximum heat pumping at lower temperature differentials.

One obvious use for those is as needle coolers for industrial sewing machines. Any heat-caused needle breakage can be almost completely eliminated by using a vortex nozzle.

The leading manufacturer of vortex cooling nozzles seems to be *Vortec*. Besides offering bunches of free data and free audio-cassette tapes on vortex cooling, they also have a number of other unusual nozzles that can do such things as air amplification.

As a third approach to effective cooling, dry-ice machines are amazingly low cost and simple. *Edmund Scientific* is one source. All you do is to connect the machine to a carbon dioxide tank (also cheap) from your local gas supplier and turn it on. Slightly over half the gas expands and boils off, while the rest of it will cool and solidify into one solid block. Presto—instant cold.

Naturally, you do that only in a well-vented area while you are wearing safety glasses. You also will want to avoid the instant frostbite caused by roughly handling the finished product, or otherwise letting it come into skin or eye contact.

Another contest

In case you have not noticed, the bottom has once again fallen out of the memory-chip market, eliminating that insane two-year pricing blip that was directly caused by some incredibly stupid and monumentally misdirected government meddling in the free-trade process. Your jellybean 1-megabyte dynamic RAM chips can now be had in quantity for as little as \$8 each. That translates to around 800 *microcents* per bit.

Beauty of Fractals, by Peitgen and Richter

Earlier text that is both a coffee table book and a source of useful algorithms. From the same publisher that did the *Science of Fractal Images*. (Springer-Verlag, 1986)
175 Fifth Avenue, New York, NY 10010 (212) 460-1500

BYTE Magazine

Occasional fractal articles and reviews. See *A Better Way to Compress Images*, January 1988, pp. 215-223 in particular.

1 Phoenix Mill Lane, Peterborough, NH 03458 (603) 924-9281

Chaos—Making of a new Science, by James Gleick

Interesting and easily read survey of the entire field of fractals and chaos science. Frustratingly shallow at times. (Viking, 1987)

40 West 23rd Street, New York, NY 10010 (212) 337-5200

Fractal Geometry of Nature, by B.B. Mandelbrot

The original "horse's whatever" book that started it all. Mind-blowing artwork in an otherwise unreadable and excessively egocentric text. (W.H. Freeman Press, 1982)

4419 West 1980 South, Salt Lake City, UT 84104 (801)973-4660

Science of Fractal Images, by M.F. Barnsley et. al.

Outstanding collection of useful hands-on fractal information. Good starting place to extend your own research. Includes algorithms and a good bibliography (Springer-Verlag, 1988)

175 Fifth Avenue, New York, NY 10010 (212)460-1500

SCIENCE Magazine

Occasional fractal and chaos science articles and reviews.
1333 H Street NW, Washington, DC 20005 (202)326-6400

SCIENTIFIC AMERICAN magazine

Occasional fractal articles and reviews. See their *Computer Recreations* column for ongoing info and comments.

415 Madison Avenue, New York, NY 10017 (212)754-0550

SIGGRAPH Proceedings

Far and away the best annual computer graphics show. Includes the latest and best of fractal and chaos science developments, on all three levels—theoretical, tutorial, and artsy-craftsy. (Siggraph-ACM Press, annually)

11 West 42nd Street, New York, NY 10036 (212)869-7440

And hackers can once again rejoice. Yea team.

Now, depending on who is doing the counting, the human brain will contain the equivalent of four billion memory bits or so. That's equal to a dozen CD-ROM platters or a small shoebox full of 1 Meg \times 8 SIMM strips. It's also equal to a mere *eight* of the 64 Meg \times 8 SIMM's just beginning to emerge from their preliminary lab research stage.

Projecting these ongoing memory trends, in around ten years or so, *machines will definitely be smarter than people*. So, for this month's contest, just write me a short essay on exactly what happens when machines will inevitably become the most intelligent life form on earth.

We'll have all the usual *Incredible Secret Money Machine* book prizes for the dozen or so best entries, with an all-expense-paid (FOB Thatcher, AZ) *tinaja quest* for two going to the top entry of all. As usual, all entries have

to be on paper, and should get sent to me here at *Synergetics*, rather than to the editorial department of **Radio-Electronics**.

Now, there's a memory effect that nobody talks about very much, and its implications for machine intelligence are genuinely scary. I like to call it the *threshold effect*. Your threshold effect goes like this: *If you double the size of a memory, the performance capabilities of that memory usually will expand by much more than a factor of two*. That happens because the arrangement and the use of your memory can now be better organized, and can more effectively perform higher-level functions.

For instance, some of your smallest microcontrollers only have room for a single hand-coded program. Add a little memory, and you can step up to a *system monitor* that gives you more power and control. More memory and you step up to some *interpreted language*. More still,

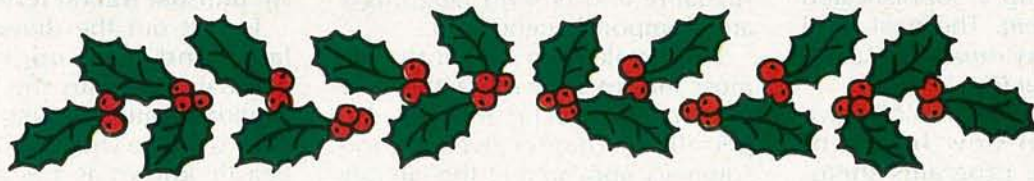

Plug a Friend into Radio-Electronics this Christmas ... and Save \$11!

This Christmas give an electrifying gift ... plug a friend into Radio-Electronics and brighten his whole new year! Whether electronics is his livelihood or his hobby, your gift will sharpen his focus and illuminate the whole spectrum of electronics throughout the coming year.

Radio-Electronics will keep him informed and up-to-date with new ideas and innovations in all areas of electronic technology ... computers, video, radio, stereo, solid state technology, satellite TV, industrial and medical electronics, communications, robotics, and much, much more.

He'll get great plans and printed circuit patterns for great electronic projects. In just the last year, Radio-Electronics has presented voice scramblers, video switchers, frequency standards, wireless audio links, radiation monitors, function generators, and much more.

In coming issues, Radio-Electronics will present practical, educational, and money-saving projects like: a helium-neon laser ... a lighting controller ... a video timebase corrector ... a video noise processor ... a light-beam communicator ... an antenna amplifier ... and many others!

PLUS ... equipment troubleshooting techniques ... circuit design ... reports on new technology and new products ... equipment test reports ... in-depth coverage on computers, video, audio, shortwave radio ... and lots more exciting features and articles.

SAVE \$11 ...OR EVEN \$22 ... For each gift of Radio-Electronics you give this Christmas, you save a full \$11.00 off the newsstand price. And as an R-E gift donor, you're entitled to start or extend your own subscription at the same Special Holiday Gift Rate — you save an additional \$11.00!

No need to send money ... if you prefer, we'll hold the bill till January, 1990. But you must rush the attached Gift Certificate to us to allow time to process your order and send a handsome gift announcement card, signed with your name, in time for Christmas.

So do it now ... take just a moment to fill in the names of a friend or two and mail the Gift Certificate to us in its attached, postage-paid reply envelope. That's all it takes to plug your friends into a whole year of exciting projects and new ideas in Radio-Electronics!

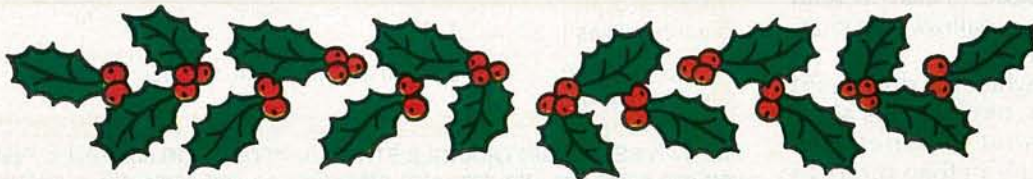

and you pick up a sophisticated *operating system*. The next level gives you fancy *toolboxes*, and *integrated programs*.

The level beyond that can give you powerful new levels of organizing the programs themselves. *HyperCard* and its mutants are an obvious example here. Beyond that lies all the *expert systems*, *massively parallel architectures*, and *artificial intelligence*.

Because of the threshold effects, going from a 4-megabit memory to a 4-gigabit one will gain you far more than a mere 1000:1 in performance abilities. I feel that something like a million to one is more like it.

It would seem to me that there are probably three or four brand new and previously unthought of thresholds that lie between where we are today and where we will be when we get up to routinely being human-brain sized a decade from now. What are the thresholds and when will they get crossed? Knowing the correct answers to that one could make you filthy rich in a real hurry.

Chaos and fractal resources

There is a new endeavor out there that is known as *Chaos Science*. Actually, it's really a loosely knit collection of all sorts of unusual old and new stuff, much of it only weakly related, if at all. As a general rule, if something can keep a math freak off the street at night and if it looks pretty in an alien sort of way, then it probably can be called chaos science. Since chaos science is futuristic, utterly and totally bizarre, and more than eminently hackable, it should be of foremost interest to most of you **Radio-Electronics** hackers.

Our *Chaos Science Resources* sidebar will give you a quick summary of a few of the main places to go for further info on this exciting new field. You'll probably want to start off with James Gleick's book *Chaos—Making a New Science*. It offers a thorough and easy-to-read but sometimes shallow introduction to the field.

The horse's whatever document on the subject, of course, is Mandelbrot's *Fractal Geometry of Nature*. While more than pretty to look at, the text is pretty nigh un-

readable and is both laughingly and pompously egocentric.

The book I am currently the most impressed with is the new *Science of Fractal Images*, especially in chapter five. A good summary appeared in the January 1988 *Byte* magazine and it was under the title *A Better Way to Compress Images*.

One of the things that struck me about that great book and the *Byte* summary article was that the sample BASIC and C programs were forever making those complicated translate-rotate-scale transformations. That's the kind of stuff that *PostScript* does free, invisibly, and automatically all of the time. Contrary to all the dire negative comments early in the red book, *PostScript* should end up *nearly ideal* for fractal-geometry uses, along with most anything else involving chaos science.

An unusual fractal fern

To test out the theory, I translated and then upgraded the original code into the *PostScript* routines found in Figs. 4 and 5. They will give you a typical chaotic beastie known as a *Serpenski* triangle, plus *the fern*, the second most popular fractal image of all time. Of course, the *Mandelbrot Set* is numero uno, and I am saving it for sometime later.

While you can run the code through any old word processor, you do need a *PostScript* speaking laser printer or a *PostScript* emulator to get your final copies. You could reverse-engineer them back into BASIC, or else use the original listings as they appeared in the *Byte* article.

Even though there's still an awful lot of slop left in the code, I was quite pleased with both the final results and their speed under

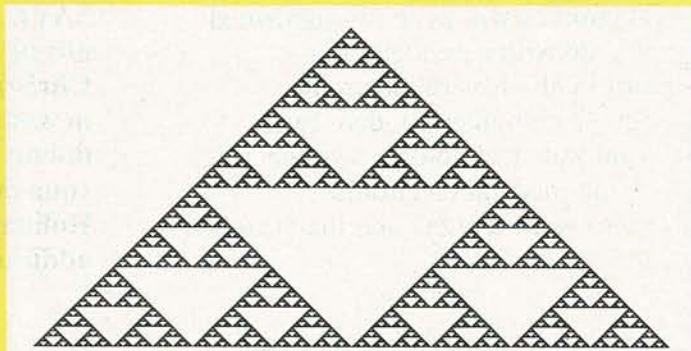

```
/problastcreate {mark /counter 0 def probabilities {128 mul round cvi  
{transforms counter get} repeat /counter counter 1 add def} forall  
counttomark 128 sub neg dup 0 gt { [1 0 0 1 0 0] repeat} {pop} ifelse} /problast  
exch def} bind def
```

```
/doit {problastcreate 1 1 20 {problast rand -24 bitshift get transform 2 copy  
moveto 0.001 10 rlineto} repeat newpath numdots {problast rand -24 bitshift  
get transform 2 copy moveto 0.001 0 rlineto stroke} repeat} bind def
```

```
% /// demo - remove before use. ///
```

```
/numdots 6000 def % increase for denser image; decrease to print faster
```

```
/transforms [  
[0.5 0 0 0.5 0 0]  
[0.5 0 0 0.5 1 0]  
[0.5 0 0 0.5 0.5 0.5]  
] def
```

```
/probabilities [ .33 .33 .34 ] def
```

```
1 setlinecap 0 setlinewidth 200 300 translate 100 dup scale doit  
showpage quit
```

FIG. 4—A SERPENSKI TRIANGLE STRANGE ATTRACTOR done using *PostScript*. While you can enter this into any word processor on any computer, a printer that accepts *PostScript* is needed for your final output.

PostScript. I elected to create a custom probability table once ahead of time, rather than making slower individual probability selections on the fly. Providing for 128 entries in the table, rather than the expected 100, gives us some further speedup and simplification. But a lot more cries to be done.

When you are experimenting with them on your own, be sure to change the numdots variable to something in the high thousands for your original fast-printing samples that will image in a few seconds to a minute or two. Later on, you could increase numdots as high as you need to for top-quality final images that might take hours to print in their larger sizes.

One other "gotcha:" The six-element matrices used by the original fractal people and PostScript differ slightly. To get from one to the other, simply *interchange the second and third numbers in the array*. Never mind why.

There are some amazingly bizarre things about the fern image of Fig. 5. First and foremost, larger sizes of the fern original are hauntingly beautiful. In fact, I've never seen *any* PostScript code image *anywhere* that comes even remotely close.

Second, the smaller pieces of the fern are definitely *not* a smaller, or *selfsimilar* copy of your whole picture. Unlike ordinary pictures, as you magnify, additional and uniquely different detail appears. But that is what fractal stuff is all about.

Third, although an apparently random process is used that picks four tasks by using random probabilities in random orders, you always end up with the *same* final image! That will happen regardless of which random numbers get used in which order.

That is a stunning example of a *strange attractor*, otherwise known as the holy grail of fractal-ism. As you might expect, others are seeking out the possible strange attractors thought to underlie the stock-market prices and weather patterns.

Despite that, a sick random-number generator will definitely not perform. You have to use a good one. Short repetition se-

quences appear to be a no-no. Many more details are in my *Apple Assembly Cookbook*.

Fourth, believe it or not, the *entire* fern is coded as only 28 numbers in a tiny data array! There's no difference whatsoever between your Serpenski triangle and the fern, except for the 28 numbers.

Nor is there any other difference between those and untold billions of other wildly different images. We thus have an absolutely incredible picture-compaction scheme going on here. For a full-page PostScript fern, the data compaction can approach 300,000:1! Unfortunately, though, your image-regeneration times do get out of hand with compaction levels that are that high. You can forget about real time. In theory, by going to just a few more numbers, we can create *any* image at all. Which gets heavy fast.

Fifth, and finally, the image really does look just like an authentic Black Spleenwort Fern. Now, Black Spleenwort Ferns have

FIX VCR's

Over 75% of VCR failures are due to mechanical problems.

If you fix or maintain VCR's, TENTEL offers fast, universal, easy to use gauges for diagnosing mechanical tape transport problems. Powerful tools for measuring torque, tape tension, spindle height, tape guide height, head protrusion, drum eccentricity and more! You can't afford to just guess when your customers and your future depends on professional service, done right the first time.

FREE CATALOG, Also Video Training Tape Now Available - \$24.95

(800)538-6894

In Calif.-(916)939-4005

Tentel® Corp.

**4475 Golden Foothill Pkwy
El Dorado Hills, CA 95630**

CIRCLE 158 ON FREE INFORMATION CARD

Try the

Radio Electronics

bulletin board system

**(RE-BBS)
516-293-2283**

The more you use it the more useful it becomes.

We support 300 and 1200 baud operation.

Parameters: 8N1 (8 data bits, no parity, 1 stop bit) or 7E1 (7 data bits, even parity, 1 stop bit).

Add yourself to our user files to increase your access.

Communicate with other R-E readers.

Leave your comments on R-E with the SYSOP.

**RE-BBS
516-293-2283**

CABLE - TV

band - stop filters

- FOR ELIMINATION OF SEVERE INTERFERENCE
- FOR "CENSORING" OF ADULT BROADCASTS

NEW ADDRESS



- ATTENUATION - 45 dB TYPICAL
- BANDWIDTH - 4 MHz AT 5 dB POINTS
- INSERTION LOSS - 2 dB

MODEL	TUNING RANGE	FOR CHANNELS	PASSBAND	PRICE	SHIPPING/HANDLING
23H	50-66 MHz	2,3 (or 6 meter ham)	50-300 MHz	\$30	FREE
46FM	66-108 MHz	4,5,6 (or any FM)	50-300 MHz	\$30	FREE
1417	120-144 MHz	14(A) 15(B) 16(C) 17(D)	50-400 MHz	\$30	FREE
1822	144-174 MHz	18(E) 19(F) 20(G) 21(H) 22(I)	50-400 MHz	\$30	FREE
713	174-216 MHz	7,8,9,10,11,12,13	50-400 MHz	\$30	FREE

3 for \$72 - 10 for \$180 - mix & match

Call Toll Free For C.O.D. or Send Check To Order

No Shipping Charges

- Shipped Within 3 Days
- 30 Day Money Back Guarantee

FACTORY DIRECT FROM

Star Circuits

P.O. Box 94917
Las Vegas, NV 89193-4917

1-800-433-6319

JANUARY 1990

been around for a rather long time, and they sure are pretty, but nobody ever accused them of being very bright. Could the exact same process be used by the real fern to teach itself how to grow?

To me, the odds are overwhelming that that does seem to be the case. We thus appear to be tampering with some heavy-duty stuff here.

What really astounds me over the fern, though, is that you do *not* really draw it. All you have to do is *let it out*, and it leaps out of its cage with a vengeance. I guess that is where the "strange" in *strange attractors* comes from in the first place.

Oh yes, if you do find the strange attractor that underlies stock-market prices and send it to me, I'll be most happy to send you *five* of my money machine books. I might even consider a free *tinaja quest* as well.

Help wanted

How about you helping me for a change? I'm having trouble finding some sources of cheap stock plastic metric gears, especially the *Module 1.0* size. Any suggestions? Yes, *Stock Drive Products* carries them, but at five times what I want to pay for them. A free book for your trouble.

New tech literature

Several manufacturers are newly turning to videotape product introductions. *Tektronix* has bunches of scope and spectrum-analyzer tapes available for you. And *Sprague* has a free new "videotech paper" on a full bridge motor driver.

Speaking of *Sprague*, they also have a unique new UGN3055U Hall-effect device. The \$1.60 parts are *addressable*, which means that up to thirty of them can share the same two-wire series query line.

From the *Philips* branch of good old *Signetics*, a fat new data handbook on *RF Power Transistors* and a very detailed ap note on all those popular 74HC4046 phase-locked loops.

The *SGS* people have a free soapbox full of EPROM samples, while *Texas Instruments* has a new free evaluation printed-circuit board for their TL7770-5 supply



```
/problastcreate {mark /counter 0 def probabilities {128 mul round cvi
{transforms counter get} repeat /counter counter 1 add def} forall
countmark 128 sub neg dup 0 gt { [1 0 0 1 0 0] repeat} {pop} ifelse /problast
exch def} bind def
```

```
/doit {problastcreate 1 1 20 {problast rand -24 bitshift get transform 2 copy
moveto 0.001 10 rlineto} repeat newpath numdots {problast rand -24 bitshift
get transform 2 copy moveto 0.001 0 rlineto stroke} repeat} bind def
```

```
% /// demo - remove before use. ///
```

```
/numdots 6000 def % increase for denser image; decrease to print faster
```

```
/transforms [
[0 0 0 .16 0 0]
[.2 .23 -.26 .22 0 1.6]
[-.15 .26 .28 .24 0 .44]
[.85 -.04 .04 .85 0 1.6]
] def
```

```
/probabilities [.01 .07 .07 .85] def
```

```
1 setlinecap 0 setlinewidth 200 300 translate 30 dup scale doit
showpage quit
```

FIG. 5—A FRACTAL FERN DONE IN POSTSCRIPT. Note that only 28 data values are needed to completely define this image. But what's really astounding is that you don't really "draw" this fern—instead, you simply let it out!

voltage supervisor chip.

Here we go again. Bright blue light-emitting diodes have been newly announced by *Sanyo*. Is that yet another false alarm? Time will tell.

Stock-market quotation decoders and support software are now available from *DATArx*. *Lightwave* is a new, free fiber-optics trade journal. And the *Quick Shooter* is a low-cost plastic injection molding machine from *Haygeman Machine*. That one uses a drill press for an injection ram.

Turning to my own products, I've recently upgraded and improved my book-on-demand printed *Hardware Hacker II* reprints, covering all of my hacking columns that have appeared in **Radio-Electronics**. I've also recently

released a similar *LaserWriter Secrets* test covering my *LaserWriter Corner* columns over in *Computer Shopper*.

As always, this is your column and you can get technical help and off-the-wall networking per that *Need Help?* box. The best calling times are weekdays 8-5, *Mountain Standard Time*. Let's hear from you. **R-E**



AUDIO UPDATE



LARRY KLEIN,
AUDIO EDITOR

The Audio Answerman strikes again!

BECAUSE THIS COLUMN IS WRITTEN FOR the casual hi-fi user, rather than the dedicated audiophile, all the column topics—including the following Q's and A's—are chosen to be helpful and/or informative. For this month's column, I've chosen two questions, one practical and the other mostly theoretical. Let me know how you feel about this format.

Recording Balance

Q. When I'm recording a disc or FM program on my cassette deck, I notice that the right- and left-channel recording-level indicators seldom read the same. Sometimes one is higher; sometimes the other. Should I try to balance the channels using the recording-level controls, or simply let things fall as they may? On some of my dubbed tapes the right-to-left balance seems just fine; on others, the sound seems to come mostly from one side or the other. Is there any way to make sure that things are adjusted correctly?

A. First of all, keep in mind that properly adjusted stereo recording-level indicators show exactly the same readings only when identical signal voltages are fed to them by the source or by the tape being played. Given the normal signal variations between the right and left channels of a wide-range stereo recording, the readings should coincide frequently, but momentarily.

Over the years, I've occasionally encountered recordings and FM programs that, for one reason or another, sounded off-center, and



I'm sure that a recorder's meters would have confirmed what I heard. But on the vast majority of recordings, the signal levels in the two stereo channels will provide a balanced sound stage and average out to about the same reading on both meters.

There's an easy way to check the internal balance of your recording circuits. With your record-level controls set similarly, feed a mono signal simultaneously into both channels and check for identical meter indications. If you can't get a mono signal at the tape-output jacks by switching your preamp to mono, and if you can't switch your tuner to mono, you will need to use a single-male/double-female Y connector. When plugged into your amplifier's right or left tape-

output jack, it will provide the same mono signal source to both tape-input channels.

Assuming that you find a balance problem within your recorder, clean and demagnetize its heads and, most important, try recalibrating its recording-bias controls—assuming that its instruction manual tells you how. (I fixed an unbalanced Nakamichi by doing just that.) If those suggestions don't help, call or drop a note to your recorder's manufacturer explaining the problem and the steps you've already taken to handle it. He may be able to assist you over the phone, or at least provide the address of the nearest authorized repair shop.

Although the question is about lack of recording balance, it

Official 1934 SHORT WAVE RADIO MANUAL

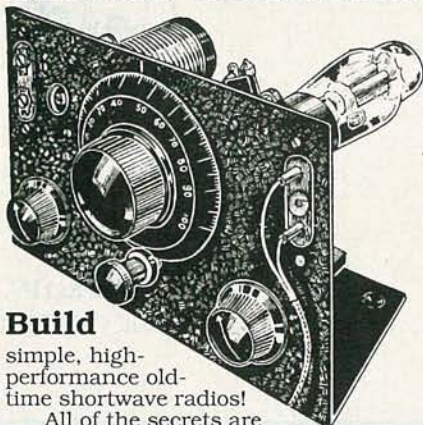

Build

simple, high-performance old-time shortwave radios!

All of the secrets are here: the circuit diagrams, parts layout, coil specifications, construction details, operation hints, and much more!

This is a compilation of shortwave construction articles from "Short Wave Craft" magazines published in the 20's & 30's. It's wall-to-wall "how-to."

Included are circuit diagrams, photographs, and design secrets of all shortwave receivers being manufactured in 1934 including some of the most famous: SW-3, the SW-5 "Thrill Box", the deForest KR-1, the Hammurand "Comet Pro", and many more.

Also included is a new chapter showing how you can use transistors to replace hard-to-find vacuum tubes. You'll even see the circuit that was lashed together on a table top one night using junk box parts, a hair curler and alligator clips. Attached to an antenna strung across the basement ceiling and a 9 volt battery, signals started popping in like crazy. In a couple of minutes an urgent message from a ship's captain off Seattle over 1500 miles away was heard asking for a navigator to help him through shallow water!

These small regenerative receivers are extremely simple, but do they ever perform! This is a must book for the experimenter, the survivalist who is concerned about basic communication, shortwave listeners, ham radio operators who collect old receivers, and just about anyone interested in old-time radio.

Great book! Fun to read! One of the best old-time radio books to turn up in years. Heavily illustrated! Order a copy today! 8 1/2 x 11 paperback 260 pages only \$15.70 postpaid!



wouldn't hurt to point out that an audible right-left system unbalance can come about through misadjustment of speaker-system midrange controls. Because the ear is most sensitive to mid frequencies (4 kHz or so), a pair of speakers whose midrange-level controls are adjusted differently will sound unbalanced. Objectively, one will be playing louder than the other despite the fact that the same signal level is fed to both.

Reflected speaker sound

Q. I've read several articles about live-end/dead-end listening rooms, in which the loudspeaker end of the room is heavily damped with acoustical absorption material and the listener's end is fairly reflective. That is said to improve a speaker's response and imaging properties. Can such a setup be used with speakers that intentionally reflect sound from the rear walls, such as electrostatics, planars, or conventional speakers with rear-firing radiators?

A. Ideally, a loudspeaker's sound-radiation pattern—which, indirectly, is what we are talking about here—should be designed with a particular recording-microphone setup in mind. Since that is impractical given the variety of recording practices, the best that the speaker designer can do is to design a system that will present a reasonable stereo image with most program material and in most of the rooms in which it is likely to find itself. In a conventional listening room, the speaker sound that reaches a listener's ears consists of the direct sound from the drivers plus a large amount of early- and late-arriving reflections bounced from the walls, floor, and furniture. If a speaker's immediate environment has sufficient acoustical absorption, most of those early reflections will be soaked up or severely attenuated. The late-arriving reflections from the more distant walls will be relatively unaffected. The advocates of such an arrangement state that its advantages include the preservation of accurate directional cues and instrumental detail.

Speakers designed to radiate multidirectionally or with strong

rear radiation obviously shouldn't be installed in a non-reflective location, since they intentionally use the adjacent walls to deliver large percentages of reflected (and, therefore, delayed) sound to the listener's ears. As noted by German acoustic researcher Helmut Haas in 1951, as long as the interval between the delayed and direct sounds doesn't exceed 40 to 50 milliseconds, the ear fuses the two into a single event. The delayed sound is heard as an echo only when the 50-millisecond delay is exceeded.

An unexpected psychoacoustic effect of delays of between 5 and 30 ms is to "expand" the perceived sound source. Not only does the sound increase in volume, but it also takes on—in Haas' words—a "pseudostereophonic quality." (That pseudo-stereo effect probably accounts for the widened sound stage provided by a popular speaker design that employs eight small rear drivers and one forward-facing one.) Incidentally, a speaker system's sound reflected from a nearby rear wall has little in common with the reflections in a concert hall from walls perhaps 50–100 feet away—despite the efforts of some manufacturers to imply that their deliberately reflective speakers mimic the acoustics of concert halls.

For good reasons, open-back dipolar and omnidirectional systems (which have included some of the best speakers on the market) and rear-radiating speaker systems are necessarily more placement-critical than conventional forward-radiating types. The problem is to arrive at a spacing from adjacent surfaces that enables the reflected energies to make a positive—rather than destructive—contribution to the sound and stereo image perceived by the listener.

Which type of speaker design is the best? My feeling is that as long as recording techniques (and room acoustics) are not standardized, most otherwise well-designed systems will sound good on most recordings. In truth, speakers that radiate substantial energy rearward have special installation constraints, but their advocates will tell you that they are more than worth it. **R-E**

Lindsay Publications

Box 12-WA6, Bradley IL 60915

Send a copy of *Short Wave Radio Manual*. Enclosed is \$15.70. Chk, MC, Visa. Send a free catalog of other books.

Name _____

Address _____

City _____ St _____ Zip _____

SHORTWAVE RADIO



STANLEY LEINWOLL

The future of shortwave broadcasting

MORE THAN 130 COUNTRIES currently operate international shortwave broadcasting services. Many of them use shortwave broadcasting as an instrument of their foreign policies. The United States, the Soviet Union, and Great Britain alone carry approximately 6,000 frequency hours daily to every continent on Earth in every major language, and also many minor languages.

In addition, a large number of countries, including Brazil, Argentina, the People's Republic of China, Mexico, the USSR, and many developing countries use shortwave for domestic broadcasts. Those national services are aimed primarily toward large rural and suburban audiences.

Because of the popularity and versatility of the shortwave spectrum, the number of frequency-hours scheduled for High-Frequency (HF) broadcasting has quadrupled since the end of World War II, from about 8,500 frequency hours to more than 35,000 today. And as technology has advanced, the standard transmitter power has increased from 50-100 kW in the late 1940's to 250-500 kW in the 1980's.

Rapidly growing demand for a limited number of frequencies, coupled with a power race, has resulted in increasing chaos in the HF broadcast bands. The 9-MHz band (9500-9770 kHz) has been monitored at four different locations in Europe. The results are summarized in Fig. 1, which shows occupancy during the period from February 13-17, 1989.

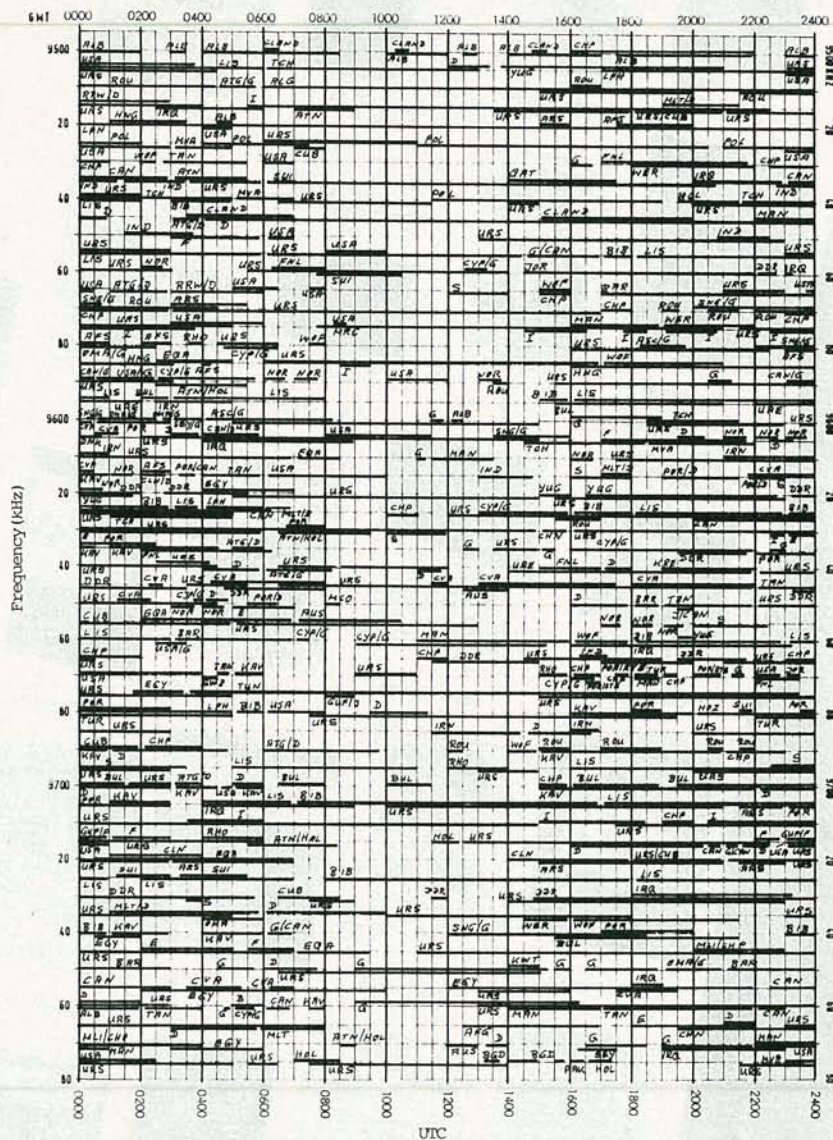

FIG. 1

The solid horizontal lines show actual users, and the frequency is shown vertically along the mar-

gins, in 5-kHz increments. It can be seen that, during prime broadcasting hours, virtually all frequen-

SELECT 5 BOOKS for only \$3⁹⁵

(values to \$138.70)
and get a **FREE Gift!**

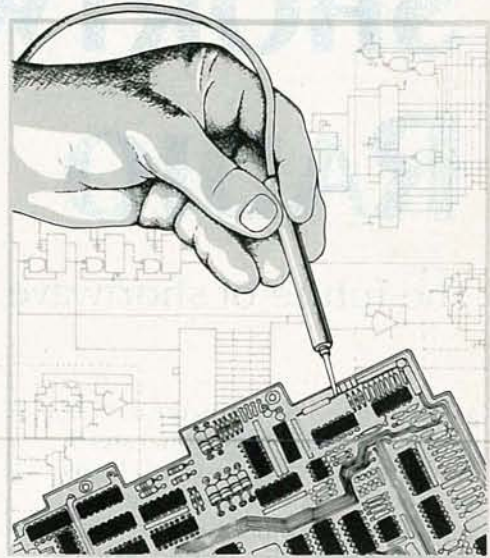

2707 \$26.95
Counts as 2



2883P \$16.95



3195 \$28.95
Counts as 2

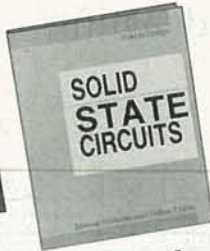

2975 \$24.95



2790 \$19.95



1964P \$12.95



3175 \$23.95



3183P \$11.95



3096 \$27.95
Counts as 2



2924P \$14.95



1367P \$18.95



1625P \$18.95

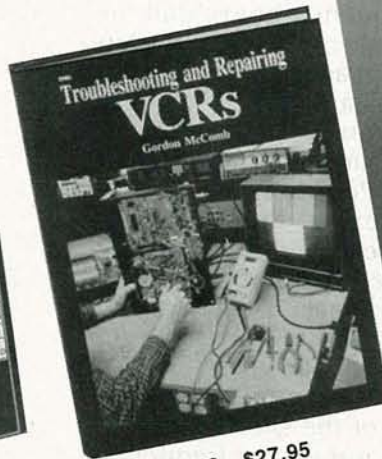

2960 \$27.95
Counts as 2

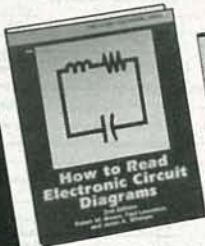

2880P \$12.95



2920P \$19.95



3205 \$24.95



2831P \$14.95



2875 \$17.95



3156 \$23.95



2800P \$14.95

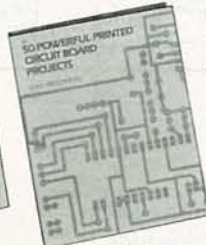

2972 \$23.95

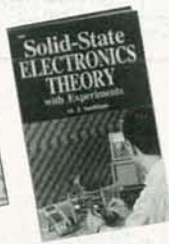

2926 \$25.95



2900P \$24.95
Counts as 2



2996P \$12.95



3107 \$26.95

For 23 years, your most complete source for electronics books.

An Absolutely No-Risk Guarantee.

2724 \$24.95

2613 \$24.95
Counts as 2

1938P \$29.95
Counts as 2

2925 \$16.95

2980P \$19.95

2809 \$27.95
Counts as 2

3133 \$15.95

3028P \$19.95

3044 \$18.95

2772 \$17.95

1536P \$9.95

1604P \$17.95

2912P \$14.95

2867P \$17.95

3017P \$9.95

2966 \$22.95

FREE when you join!

Here's 15 Easy Electronic Projects From Delton T. Horn

Projects you can build—some unique, some old favorites—from the author's vast treasury of electronics know-how.

(a \$7.95 value!)

Delton T. Horn's
All-Time Favorite
Electronic Projects

Membership Benefits • Big Savings. In addition to this introductory offer, you keep saving substantially with members' prices of up to 50% off the publishers' price. • **Bonus Books.** Starting immediately, you will be eligible for our Bonus Book Plan, with savings of up to 80% off publishers' prices. • **Club News Bulletins.** 14 times per year you will receive the Book Club News, describing all the current selections—mains, alternates, extras—plus bonus offers and special sales, with hundreds of titles to choose from. • **Automatic Order.** If you want the Main Selection, do nothing and it will be sent to you automatically. If you prefer another selection, or no book at all, simply indicate your choice on the reply form provided. As a member, you agree to purchase at least 3 books within the next 12 months and may resign at any time thereafter. • **Ironclad No-Risk Guarantee.** If not satisfied with your books, return them within 10 days without obligation! • **Exceptional Quality.** All books are quality publishers' editions especially selected by our Editorial Board.



ELECTRONICS BOOK CLUB®

Blue Ridge Summit, PA 17294-0810

Please accept my membership in the Electronics Book Club® and send the 5 volumes listed below, plus my FREE copy of Delton T. Horn's All-Time Favorite Electronic Projects (3105P), billing me \$3.95 plus shipping and handling charges. If not satisfied, I may return the books within ten days without obligation and have my membership cancelled. I agree to purchase at least 3 books at regular Club prices (plus shipping/handling) during the next 12 months and may resign any time thereafter.

Name _____

Address _____

City _____

State _____ Zip _____ Phone _____

Signature _____

Valid for new members only. Foreign applicants will receive special ordering instructions. Canada must remit in U.S. currency. This order subject to acceptance by the Electronics Book Club®. RE190

Put Professional Knowledge and a
COLLEGE DEGREE
 in your Technical Career through
HOME STUDY

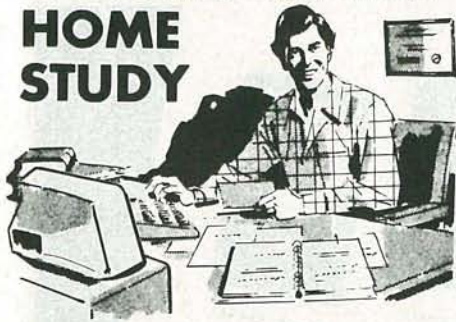

Add prestige and earning power to your technical career by earning your Associate or Bachelor degree through directed home study.

Grantham College of Engineering awards accredited degrees in **electronics and computers.**

An important part of being prepared to *move up* is holding the right college degree, and the absolutely necessary part is knowing your field. Grantham can help you both ways—to learn more and to earn your degree in the process.

Grantham offers two degree programs—one with major emphasis in **electronics**, the other with major emphasis in **computers**. Associate and bachelor degrees are awarded in each program, and both programs are available completely by correspondence.

No commuting to class. Study at your own pace, while continuing on your present job. Learn from easy-to-understand lessons, with help from your Grantham instructors when you need it.

Write for our free catalog (see address below), or phone us at toll-free 1-800-955-2527 (for catalog requests only) and ask for our "degree catalog."

Accredited by
 the Accrediting Commission of the
 National Home Study Council

GRANTHAM
 College of Engineering
 10570 Humbolt Street
 Los Alamitos, CA 90720

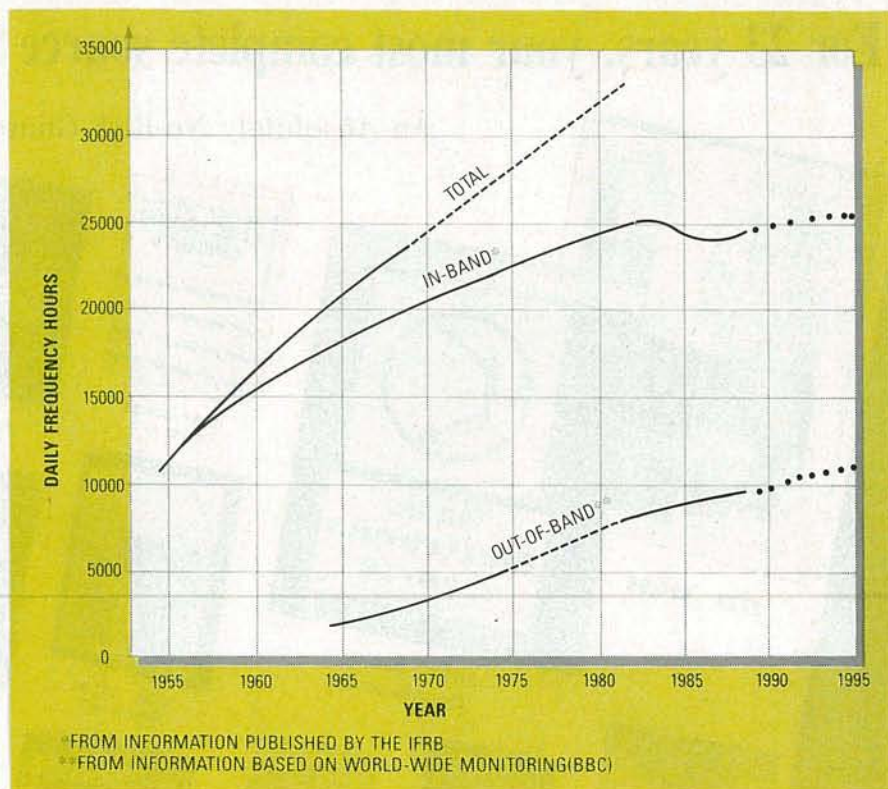

FIG. 2

TABLE I

Kilohertz Pre-1979 WARC	Bandwidth	1979 Kilohertz Spectrum	Bandwidth	Implementation Date
5950 - 6200	250	5950 - 6200	250	—
7100 - 7300	200	7100 - 7300	200	—
9500 - 9775	275	9500 - 9900	400	July 1, 1994
11700 - 11975	275	11650 - 12050	400	July 1, 1989
none	—	13600 - 13800	200	July 1, 1989
15100 - 15450	350	15100 - 15600	500	July 1, 1989
17700 - 17900	200	17550 - 17900	350	July 1, 1989
21450 - 21750	300	21450 - 21850	400	July 1, 1989
25600 - 26100	500	25670 - 26100	430	January 1, 1982
Total Spectrum	2350kHz		3130kHz	

cies are occupied by at least one broadcaster. In many cases, two or more broadcasters use the same frequency simultaneously.

For more than forty years broadcasters have been grappling with the problem of increasing congestion in a severely restricted spectrum. One method of alleviating serious overcrowding is to expand the supply of the broadcast frequencies. That can be accomplished by an appropriate radio conference with the authority to re-allocate spectrum for the broadcasting service. The last such

conference was held in 1979; the World Administrative Radio Conference (WARC-79) was convened in Geneva for approximately ten weeks.

WARC-79

The less-developed countries at WARC-79 opposed the loss of a fixed shortwave spectrum but, at the same time, wanted a high-frequency broadcast planning conference. Their position was that the developed countries had control of the high-frequency broad-
continued on page 100

DRAWING BOARD



ROBERT GROSSBLATT

The world of video

BEFORE WE GET INTO CIRCUITS AND stuff, there's a piece of follow-up business I have to take care of. If you're a regular reader, you'll remember that we ran a contest some months ago to see who could come up with a good way to use the space left empty in the EPROM character generator we designed.

There were lots of entries and lots of ideas, but the best one came from Randall Logan of British Columbia, Canada. He used the remaining space in the EPROM to build an automatic hex to decimal converter that still left enough room in the EPROM for the character codes we worked out as our circuit was being developed. The circuit details are on page 72 of the September 1989 issue of *Radio-Electronics*.

Since it's the height of tedium to generate the code for the EPROM, Randall wrote a BASIC program to create the data. He sent me a copy of it and, as promised, I'm sharing it with all of you—it's shown in Listing 1. Although the program is written for an IBM or compatible, it won't take a lot of work to convert it to the BASIC dialect used by other computers. The program is well-commented so you shouldn't have any trouble figuring out how it works and what you'd have to do to change it.

Just about the only reason for changing it would be to match the data outputs of the EPROM to your seven-segment display. The segment assignments (a, b, c, etc.) are pretty much standardized, but sometimes it's easier to lay out a PC board by switching the order of

the EPROM data pins. In any event, you've got the circuit and now you've got a program to generate the data for the EPROM.

As a last note on the subject, the program will create a file 2049 bytes long. The extra byte comes about because BASIC (at least IBM BASIC) adds an "end of file mark" (1Ah), whenever it writes a data file. It isn't a big deal since the first 2048 bytes are the ones going into the EPROM, but being aware of the extra byte (as well as knowing why it's there) means there's just one less thing to worry about.

And now for something com-

pletely different.

In going through the mail I've received recently, it's evident that video is a really popular subject. Lots of readers are fascinated by the hardware but haven't gotten their hands dirty because they're not familiar with video signals, terminology, and hardware requirements. Over the next few months we'll go through some video basics together. We'll take apart the NTSC standard and examine the individual parts of the waveform. Once we know what we're looking at, we'll see what has to be done to design video circuitry. It's

LISTING 1

```
100 REM THIS PROGRAM WILL GENERATE A 2048 BYTE BINARY FILE (EPROM.DAT)
105 REM CONTAINING THE DATA REQUIRED FOR THE EPROM IN THE
110 REM BINARY TO HEX/DECIMAL CONVERSION CIRCUIT AS SHOWN IN THE
120 REM SEPTEMBER ISSUE OF RADIO ELECTRONICS, PAGE 72
130 REM
140 REM WRITTEN BY RANDALL LOGAN, 1989
150 REM
160 REM DESCRIPTION OF VARIABLES
170 REM B=NUMBER BASE (10 OR 16)
180 REM N=NUMBER TO CONVERT (0-255)
190 REM P=SELECTED DIGIT POSITION WITHIN NUMBER (0-3)
200 REM D=DIGIT VALUE (0-9) FOR DECIMAL #'S AND (0-15) FOR HEX #'S
210 REM V=TEMPORARY WORKING VARIABLE
220 REM S( )=CHARACTER SEGMENT DATA (16 ELEMENT ARRAY)
230 REM Z=USED TO DETERMINE IF LEADING ZERO BLANKING IS REQUIRED
240 REM
250 CLS
260 DIM S(16)
270 REM READ SEGMENT DATA FOR ALL 16 CHARACTERS (0-F) INTO ARRAY
280 FOR I = 0 TO 15:READ S(I):NEXT
310 DATA 63,6,91,79,102,109,125,7,127,111,119,124,57,94,121,113
320 REM
330 REM NOW GENERATE BINARY FILE FOR EPROM PROGRAMMER (EPROM.DAT)
340 REM
350 OPEN "EPROM.DAT" FOR OUTPUT AS #1
360 FOR B = 10 TO 16 STEP 6
370 FOR N = 0 TO 255
380 V = N
390 FOR P = 3 TO 0 STEP -1
400 D = INT(V / (B ^ P)): Z = Z + D
410 V = V - D * (B ^ P)
415 REM LINE 420 BLANKS LEADING ZEROS (FOR DECIMAL VALUES ONLY)
420 IF Z = 0 AND P > 0 AND B = 10 THEN PRINT #1, CHR$(0); : GOTO 440
430 PRINT #1, CHR$(S(D));
440 NEXT P
450 Z = 0: REM RESET ZERO BLANKING TEST VALUE
460 NEXT N
470 NEXT B
480 CLOSE #1
```

complicated enough to be interesting and just hairy enough to be fun.

Who could ask for more?

Some video basics

Back in 1953, a group of relatively unknown people sat down together and made some decisions that affected the lives of every person in this country (and some other countries as well). That sounds like the beginning of a trashy spy novel, but it's not—it's the beginning of the television standard. The people who made the decision were known as the National Television System Committee, and they established the color-TV standard known as NTSC. There are lots of jokes about what the initials stand for (Never The Same Color, etc.), but whatever you might think of it, NTSC video is (in the United States) the name of the game.

All the video circuitry in a television set is designed with one job in mind—to control the movement of the electron beam that scans across the inside of the picture tube. The video signal that moves the dot on the screen and determines how bright it will be is one of the most complex signals in common use. The key to knowing how video works and making sense out of video hardware is understanding all the component parts of the video waveform.

All video, either broadcast NTSC or high-resolution computer, is made up of the same basic elements. As a simplified explanation, the electron beam in the picture tube scans across the screen from left to right and back again. When it reaches the bottom right of the screen, it moves to the upper left and starts another trip back and forth across the screen. The rate at which it travels left to right, and how often it moves back to the top right of the screen are all defined in the NTSC standard.

The video signal fed to a TV set has two basic jobs. The first is to control the beam's movement, and the second is to control the brightness of the beam. The former tells the TV where to put the picture and the latter tells the TV what picture to put there.

Even though the video circuitry

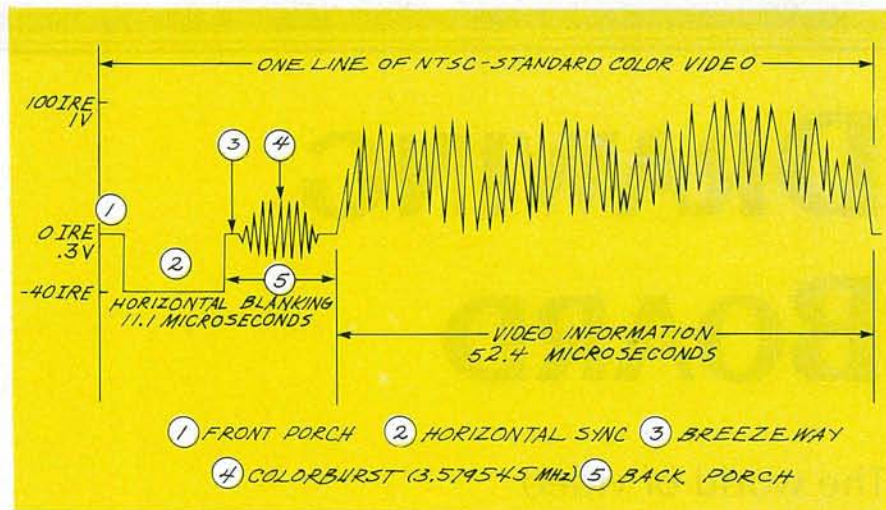

FIG. 1

in a television set is constantly moving the beam around the screen from left to right and top to bottom, there's no way to guarantee that the movement is going to be at the precise rates required by the NTSC standard. As we all know, nothing is forever; components age, values drift, and it wouldn't be long before a TV—no matter how well made—would go out of alignment.

Most television sets move the dot around the screen at rates that are close to the NTSC standard, but they have built-in slop factors. That means that there's enough latitude in the TV's control circuitry to enable it to be adjusted to strict NTSC timing. Older television sets had horizontal and vertical hold controls, but most of the newer sets do it automatically.

The horizontal and vertical control of the television image is the job of two components of the NTSC signal known, appropriately enough, as horizontal sync and vertical sync. The former tells the electron beam to move back (or flyback) to the right edge of the screen and the latter causes the beam to move back to the upper right hand corner.

Before we look at the big picture (sorry about that), let's take a look at the most basic unit of the video signal—a horizontal line. The NTSC standard calls for 525 lines of video for each *frame* (the entire picture), and there are two *fields* per frame.

The horizontal line

The whole video signal is really a

series of repeated horizontal lines of control and picture information. The NTSC standard allows a total time of about 63.5 microseconds for each line, so a bit of arithmetic tells us that the frequency is about 15.75 kHz. I'm using approximate numbers because the exact value is different for color and black and white. That rate is referred to as the "horizontal scan frequency," and during each cycle the video signal is controlling the placement of the image and carrying the image information, as well.

The illustration in Fig. 1 shows you exactly what's happening in each horizontal line. The left-hand side of the picture corresponds to the trailing edge of the horizontal sync pulse, which is labeled as "2" in the drawing. As you can see, about 20% of the line time is devoted to control signals, and each part of that section has its own name and allowable duration.

Most television sets "overscan" the image. That means that a bit of the left and right edges of each line take place outside the screen area—think of it as slightly zooming in on the line. That's done for a variety of reasons; most important, it makes sure that the only part of the image you'll see on the tube is picture information—the control data is always off screen.

If you're looking at a color image, the first important piece of information sent on each line is the colorburst signal. That is about 8 to 10 cycles of a 3.579545-MHz clock, and it's used as a standard to

continued on page 91

COMPUTER DIGEST

BUILD THE PORT-A-MATIC

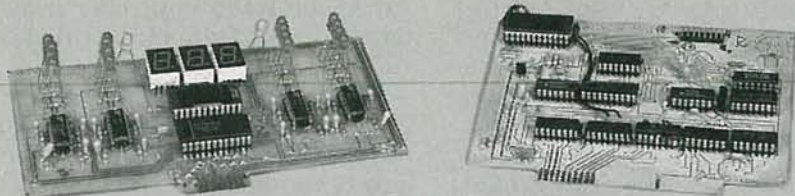

Keep tabs on your expansion bus.

ROBERT GROSSBLATT

There are lots of reasons for the PC's popularity, and if you pop open the case you'll find eight of them on the motherboard. IBM's decision to provide relatively complete details on the architecture of the machine was an invitation for designers to create add-on hardware for the PC. As things stand now, there are after-market products for the PC family that can do just about anything you can imagine—and a lot you can't.

No matter what kind of peripheral you plug into the bus, chances are that the microprocessor (8088, 80286, 80386, even the 80486) will talk to it through an I/O port. Peripherals include video adapters, serial and parallel ports, the keyboard, floppy- and hard-disk controllers, and more. Since Intel microprocessors can address many ports (even the lowly 8088 can address 65,536 different ones), you'd think that port-address conflicts would never occur.

Think again.

IBM has reserved specific ports for specific purposes, and as PC's

have evolved, additional ports were reserved. The devices using those ports make the computer more powerful, but they also make it easier to configure something incorrectly.

The Port-A-Matic makes it easy to keep track of I/O operations because it provides a real-time indication of which ports are being accessed. The Port-A-Matic provides a three-digit hex display of the port address, and it lights a discrete LED to provide a 1-of-16 indication of which device is connected to the port. Another discrete LED tells you whether the CPU is doing a read or a write to the port. You can easily customize the circuit so that the discrete LED's light up for a desired I/O port. Even though the Port-A-Matic is a fairly complex circuit, you should be able to build it for well under \$75. PC-board patterns will be published in PC Service.

The PC bus

Since the Port-A-Matic lives in one of the PC's expansion slots

continued on page 84

EDITOR'S WORK- BENCH

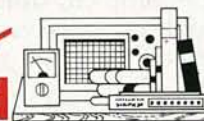

Floppy Heaven

I just found the ultimate floppy-disk controller: the newly released CompaCard IV (CC4) from MicroSolutions (see Fig. 1). I've been searching for something like it for a couple of years; MicroSolutions has really come through.

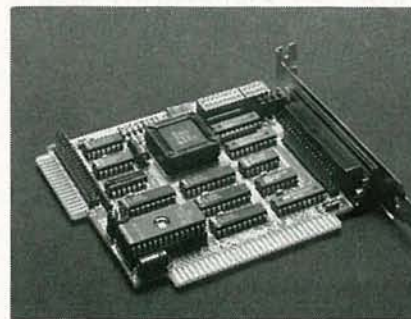

FIG. 1

What I've long been looking for is a controller that allows three internal drives and that also has a DB-37 connector for an external drive—in my case, an Irwin 785 tape-backup unit.

Why do I want three internal drives? I get review software in all four of the standard formats (360K, 720K, 1.2MB, and 1.44MB), so I need high-density versions of both 3.5-inch and 5.25-inch drives. However, for trading files with friends and business associates, I need a 360K drive, because 1.2MB drives can't reliably write to 360K diskettes. (Actually, they can write reliably enough; the problem is track mis-alignment when one

drive tries to read a disk formatted on another drive. I've had no problem trading either of the 3.5-inch disks.

Other controllers typically allow two internal drives only, or two internal and two external drives. However, the latter supply only the external DB-37 connector, so it's impossible to connect a third internal drive with a standard 34-pin edge connector. MicroSolutions sensibly solved that problem simply by wiring an additional 34-pin dual-row header connector in parallel with the DB-37.

So connecting a third (and fourth) drive internally is now as simple as connecting the first two drives; Just attach a power connector and a normal 34-conductor data cable and you're ready to roll.

If that's all there were to the CompatiCard IV, I'd be impressed, but there's more; several items will be particularly interesting for owners of older PC and XT compatibles without built-in support for high-density 5.25-inch drives or 3.5-inch drives of either density.

Advanced features

The most innovative feature is support for a new 2.8MB diskette format. No, the format is not IBM endorsed—but as of this writing (early October), there are rumors that IBM will soon introduce a 2.8MB format using the same vertical recording format as MicroSolutions'.

To handle the increased amount of data stored on a 2.8MB disk in a reasonable amount of time, the data transfer rate has been quadrupled (compared with that of a standard 360K drive) to 1 Mbit/second. The drives, however, are expensive (about \$450), as are the diskettes (about \$10).

No one knows if yet another diskette format can catch on. However, the CC4 is still a good buy because not only does it look forward to the future, it goes a long way toward maintaining compatibility with past formats.

Upgrading PC's and XT's

You can't use high-density

drives on most PC's and XT's because their floppy-disk controllers work only at a single data transfer rate (250 kHz), and high-density drives need 300- and 500-kHz rates.

Even with the right controller, there may be software problems; the BIOSes of older machines don't know how to handle the additional tracks and sectors of high-density drives. You may be able to get around the BIOS problem by installing a 360K drive as drive A, and loading a software driver via CONFIG.SYS to access a high-density drive as drive B or higher. But you wouldn't be able to install the high-density drive as drive A, unless you gave up the ability to boot from A. The reason is a classic Catch-22; you can't load the driver until you've loaded the driver to know how to load the driver.

Anyway, the CC4 solves that problem by including an on-board EPROM that occupies 2K of the address space above the video adapters; that EPROM can be viewed as a BIOS upgrade for older PC/XT models that allows them to access the newer high-density floppy-disk drives. The only limitation is that the EPROM software applies only to the first two drives; if you add a third (or fourth) drive, you'll have to load a device driver, which occupies about 4.5K of memory.

The ROM allows another neat trick, the ability to boot from any floppy drive attached to the card. For example, I have a 1.2MB drive-A, a 1.44MB drive-B, and a 360K drive-E (drives C and D are hard disks). If at any time I want to boot from the 360K drive, all I have to do is put a formatted 360K system disk into the drive and the CC4 handles the rest. At that point the 360K drive becomes drive A, and the original drive B remains as it was. To access the 1.2MB drive, I'd have to load a copy of DRIVER.SYS (which comes with DOS 3.3) when booting.

The CC4 can also function as a secondary controller. In that configuration, you'd leave your existing floppy controller alone, and move a jumper on the CC4 so that data would flow via a different set

of I/O ports. A software driver would then handle the dirty work of transferring data in the usual fashion.

Incidentally, if you've got an AT compatible with a standard Western Digital combined hard/floppy controller (model number 61-000107-00, as shown in the upper left corner of the board), you can disable the on-board controller simply by moving the shorting block from pins E2 and E3 to pins E2 and E1. What you're really doing is assigning the WD board to a different set of I/O port addresses. I do that because the Irwin controller must work off the normal address range.

MicroSolutions has bent over backward attempting to make the CC4 flexible and easy to configure. For one, the configuration DIP switches are located at the top of the card, so you don't have to remove it from your PC to change settings. Also, you can choose from six interrupt levels, three DMA channels, four I/O port ranges, two drive-speed settings, and seven EPROM address ranges. A special set of jumpers allows you to supply power to external drives, if necessary. You can even connect an 8-inch drive to the CC4!

The CC4 also comes with several useful utility programs. One allows you to format diskettes in the background (i.e., while running your word processor or another application); another allows you to format high-density disks if you're running an early version of DOS.

In short, there's no doubt that the CompatiCard IV is the most versatile floppy-disk controller on the market. Highly recommended.—Jeff Holtzman 

Slick!
**A Drawing-Management
System for AutoCAD**

If you're a regular AutoCAD user you know that it doesn't take much time at all for your hard disk to fill up with drawing files. They can be completed jobs, works in progress, or libraries of

blocks to insert in new drawings. The one thing they have in common is a that they all have to be available all the time—it's a well known fact that the more drawings you produce, the more drawings you have to have on hand.

Managing your store of drawing files gets to be a full-time job since the DOS limitation of eight-letter file names can put a real strain on anyone's imagination. And while the difference between TRANS835.DWG and TRANT835.DWG may be remembered for about two minutes after you've created the files, things get somewhat obscure six months down the line.

Although there are several third-party AutoCAD utilities around to help you manage drawings, none of them are as versatile or convenient as Slick!. Not only does it give you a painless way of dealing with drawings, but after you've used it for a while, you'll wonder how you ever managed without it.

Slick! is available in four versions ranging in price from \$95 for the most basic version to \$250 for the top of the line. But even the least-expensive package can save you lots of time and brain damage as soon as you begin using it.

When you run Slick!, you're presented with a graphic representation of your disk—directories on the left and files on the right. As you scroll through the directories, Slick! will list the DWG and SLD files on the disk. When you find the ones you're looking for, you can view as many as four files on the screen at once by moving the cursor to the file list and tagging the files you're interested in. The tagged files can be displayed in a variety of selectable windows similar to the viewports found in AutoCAD Release 10. Once you get the files on the screen, all the Slick! commands are accessed through several pull-down windows at the top of the screen.

You can zoom and pan in any of the drawings and, if you're looking at a 3D drawing, you can also change the viewpoint just as you would with AutoCAD's VPOINT command. You can also get a list

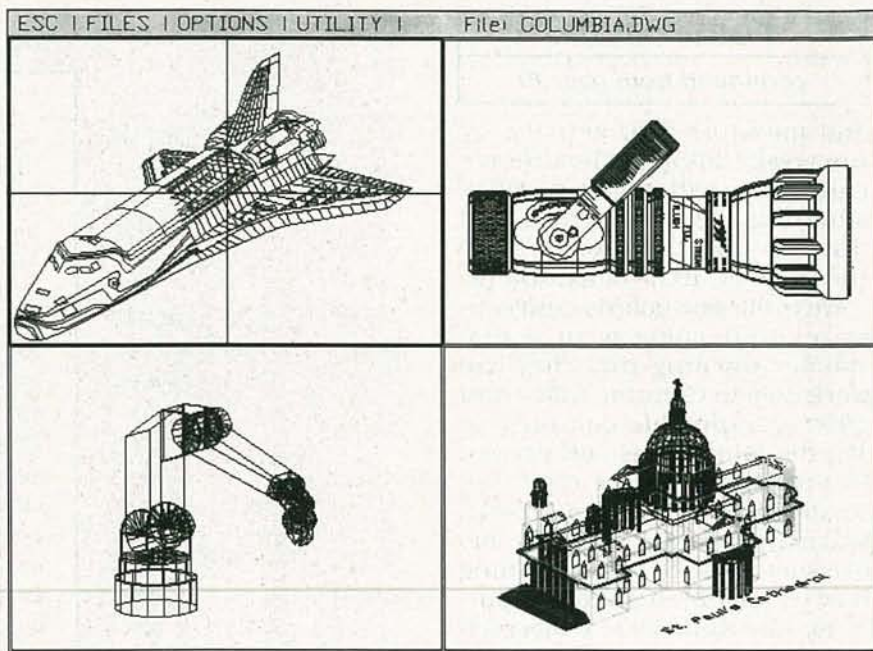

FIG. 2

of the layers and blocks in the drawing and have any of them displayed on the screen as well. Slick! also gives you the ability to copy, rename, or delete files as you're viewing them. That comes in really handy when you're doing disk housekeeping since it's nice to look at a drawing before you delete it.

One of Slick!'s neatest features is being able to scroll through drawing files on the graphics screen. Choosing the files option will give you a list of the drawings in the current directory and choosing one of them will cause it to be immediately drawn on the screen in the current window. Slick! puts drawings on the screen from three to ten times faster than AutoCAD so it doesn't take long to scroll through a di-

rectory's worth of files. And since you can select viewports while you're looking at a drawing, you can display the full drawing in one window with three different zoomed views of it in the other windows at the same time (see Fig. 2).

Don't overlook the fact that Slick! will display both AutoCAD and AutoSketch slides, as well as drawings, and you can zoom and pan around slide files with the same resolution you get with drawing files. No matter how much you zoom in on a slide file, a straight line stays straight and text stays readable—no jaggies. That's really useful for 3D drawings since we all know about the limitations of AutoCAD's HIDE command. You'll wait forever for AutoCAD to remove hidden lines, only to have the resulting image disappear as soon as you issue the next command.

If you make a slide of the drawing after AutoCAD has removed hidden lines, you can use Slick! to view the SLD file. That will let you pan and zoom to any part of the image you want to examine with no loss in resolution. Try doing that in AutoCAD!

Of course, being able to get an image like that on the screen isn't as useful as getting it on paper. That brings us to the more ad-

continued on page 90

ITEMS DISCUSSED

- CompatiCard IV (\$149), MicroSolutions, 123 W. Lincoln Highway, DeKalb, IL 60115. (815) 756-3411.
CIRCLE 48 ON FREE INFORMATION CARD

- Slick! (Level 1, \$95; Level 2, \$150; Level 3, \$195; Level 4, \$250), CAD Systems Unlimited, 5201 Great America Parkway #443, Santa Clara, California 95054.
CIRCLE 47 ON FREE INFORMATION CARD

PORT-A-MATIC

continued from page 81

and monitors CPU activity, we can't really talk about how the circuit works without first understanding the bus signals that drive it—and that brings us to the issue of "IBM compatibility."

We've all seen boards (and software) that come with a disclaimer warning that they will work only in *Genuine IBM's and 100% compatible computers*. The disclaimer is usually printed in end-of-the-world type and plastered prominently on the box and in the manual. There are lots of issues involved in determining how compatible a given computer is, but what we're concerned with is hardware-compatible expansion slots. As in BIOS-level compatibility, there are degrees of compatibility at the hardware level, as well, since signal timing is just as important a consideration as the signal itself. A line that goes active either too soon or too late might as well not go active at all.

The Port-A-Matic was designed to be tolerant of minor variations in bus timing (within limits), and has worked without problem in several XT and AT machines including those built around the 80386. The Port-A-Matic does not work in IBM PS/2 Models 50 and above (those with the micro-channel architecture ((MCA) bus).

For non-MCA machines, the 62-pin bus (shown in Fig. 1) of the original PC is IBM's standard I/O channel. When IBM introduced the AT, that bus was enlarged by adding another 36-pin edge connector to accommodate the additional lines needed by the 80286. However, the Port-A-Matic uses only the original bus. In Fig. 1, the lines that the Port-A-Matic uses are marked with an asterisk. You can plug the Port-A-Matic into either an 8- or a 16-bit slot.

Since all standard IBM I/O devices, and most peripheral cards as well, use only the first 2048 (0800h) I/O ports, the Port-A-Matic watches only address lines A0-A9, the lower 10 address

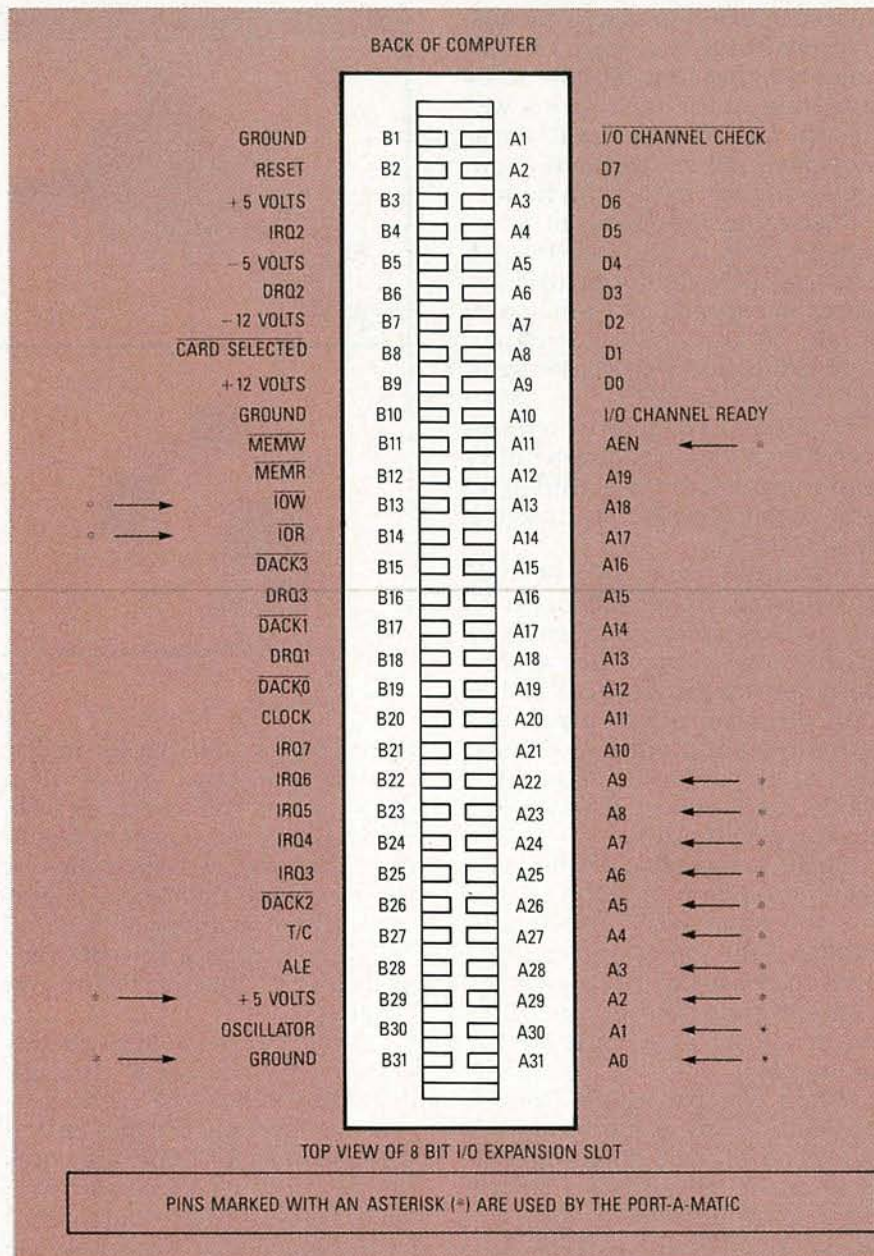

Fig. 1. THE 8-BIT BUS CONNECTOR of the original PC has 62 pins for address, data, and control lines.

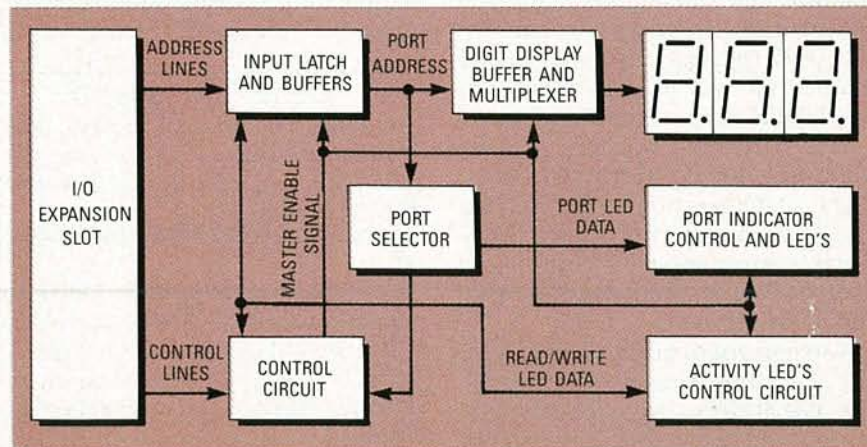
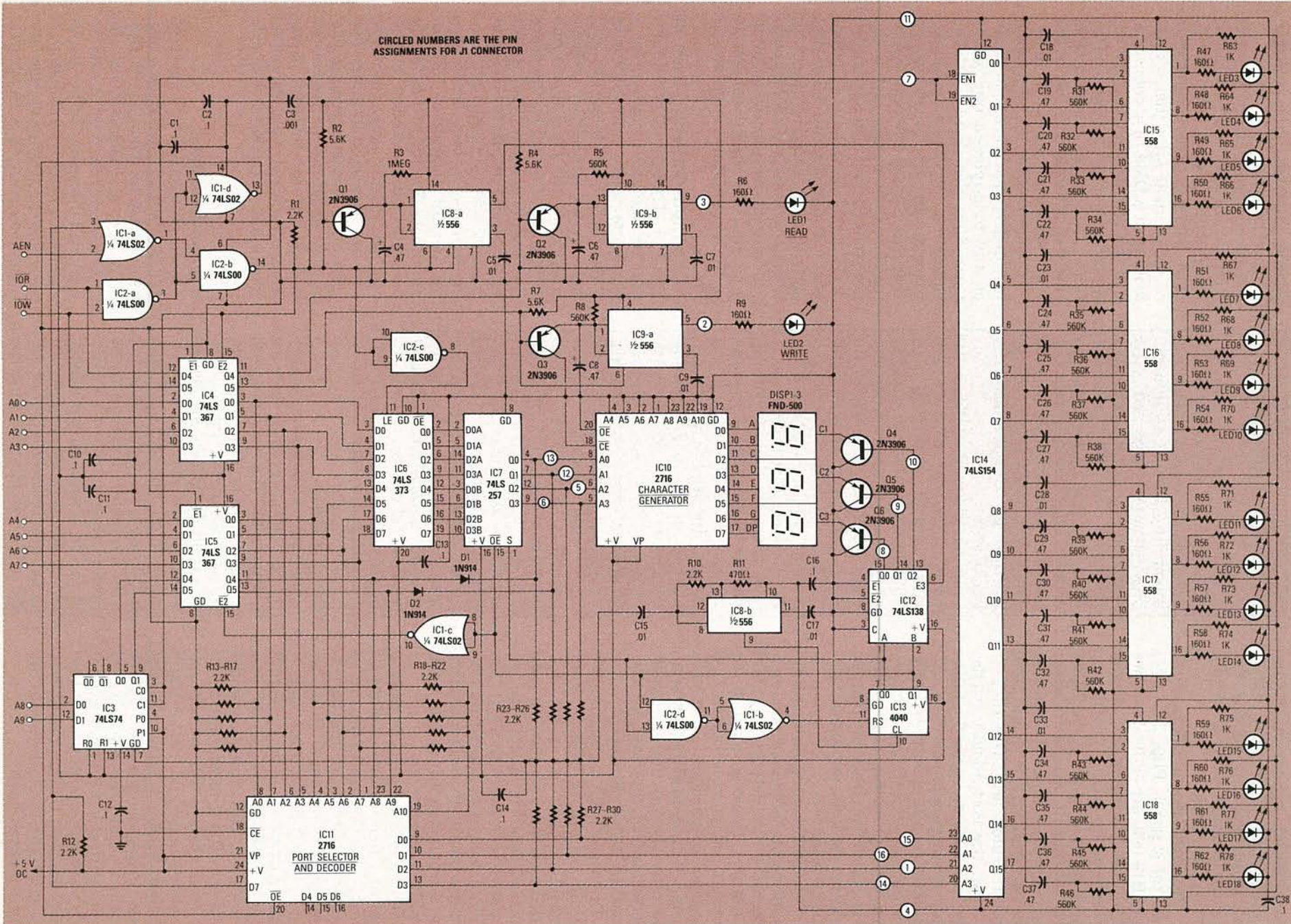

Fig. 2. BLOCK DIAGRAM of the Port-A-Matic. It is designed to be as compatible as possible with IBM-type computers.

CIRCLED NUMBERS ARE THE PIN ASSIGNMENTS FOR J1 CONNECTOR



85 Fig. 3. COMPLETE SCHEMATIC DIAGRAM of the Port-A-Matic.

lines, which appear on expansion-bus pins A22—A31. Power and ground are supplied to the board through pins B29 and B31, respectively.

The card also monitors three control signals. Pins B13 ($\overline{\text{OW}}$) and B14 ($\overline{\text{OR}}$) are active-low lines that indicate when the microprocessor is either writing or reading an I/O port, respectively. (Recall that the microprocessor has separate signals to indicate reading and writing to and from main memory and I/O ports.)

Last, the Port-A-Matic needs AEN (pin A11), an active-high line that lets expansion-card circuitry know that the computer is performing a DMA (Direct Memory Access) operation, the speedy transfer of data from one place to another without microprocessor intervention.

PC and XT compatibles (and some older AT compatibles) normally use the Intel 8237 as a DMA controller. However, most of the new AT compatibles (both 80286 and 80386 varieties), use VLSI chip sets instead of discreet components; the functions originally performed by the 8237 are carried out inside the VLSI's.

During a DMA operation, all other controlling devices must relinquish their use of the bus, otherwise bus contention and garbled data will result. The microprocessor is put to sleep by a signal that gets routed on the motherboard, and any controller on the expansion bus gets notified by a high on AEN.

The Port-A-Matic is only a monitoring circuit—it doesn't have to take control of the bus to do its job. Even so, the Port-A-Matic still has to pay attention to AEN because some DMA operations involve I/O addressing, and they happen so frequently that the Port-A-Matic's display would flicker without meaning if it decoded them. Whenever AEN becomes active, the Port-A-Matic ignores whatever appears on the bus. If that sounds like a drawback, it's not. The board would work perfectly if it didn't ignore AEN, but the display would be meaningless. So the board was designed to be selective about the ports it responds to.

PC PORT ADDRESSING

Even though IBM-compatible PC's use I/O ports for many types of operations, there's a surprising lack of standards. Most of the ports reserved by the computer for basic operations (keyboard, video, disk, etc.), use addresses that remain constant from machine to machine, but when it comes to printer and communications ports, things begin to get considerably less consistent.

The first serial and parallel ports (COM1 and LPT1) are usually located at 03F8h and 03BCh, respectively, and COM2 appears at 02F8h. However, other ports are less clearly defined. LPT2 can be at 0278h, 0378h, or other addresses. Ports COM3, COM4, and LPT3 are even less clearly defined.

In order for Port-A-Matic to decode those ports, you must find out exactly which addresses are used by your hardware. You can usually obtain those addresses from the documentation that came with your peripheral cards; alternatively, various software tools can help.

The best program of that nature is DIAGS.EXE. It was written by Joan Riff and is in the public domain, so you should be able to find it by logging onto your favorite bulletin board. It's a complex program, but the accompanying documentation (DIAGS.DOC) is well written and covers every aspect of using the program.

How it works

Now that we know what signals the Port-A-Matic uses, let's see how it works. The block diagram in Fig. 2 gives an overview of circuit operation. The ten address lines from the I/O slot are always present at the Port-A-Matic's input buffers, but the only data that the board pays any attention to is whatever happens to be there during an I/O operation. When the control circuit senses that a port is being accessed, it latches the address in the buffers, then checks the address

against the table that is stored in the port selector.

If there's a match, the control circuit is notified, but that's not the end of the story. The Port-A-Matic still has to check the state of AEN to make sure that it's not looking at a DMA operation.

If the circuit sees that there's no DMA operation going on (AEN is low), it asserts a master enable signal that causes the rest of the Port-A-Matic to process the data.

The address in the input latch is transferred to the display buffer and multiplexed out to the three-digit hex display. At the same time, the master enable signal will cause one of the two activity LED's (READ or WRITE) to light up. The data coming from the port selector will also be decoded and the LED associated with that port will also light up. All of that activity is controlled by timers, so the Port-A-Matic will display each valid port address for about a half a second. A complete schematic of the Port-A-Matic is shown in Fig. 3.

The input buffers consist of IC3—IC5. Those 74LS367's contain two groups of buffers in a single package, one four bits wide and one two bits wide, and each section has its own output-enable pin. The four-bit sections in IC4 and IC5 handle the lower eight address lines. The two-bit section in IC4 is used as the buffer for the $\overline{\text{OR}}$ and $\overline{\text{OW}}$ signals coming from the PC bus. That leaves the two-bit section of IC5; although it's devoted to the two upper address lines, A8 and A9, you can see in the schematic that they are handled differently. The reason for that will become clear after we examine the rest of the circuit; but in a nutshell, doing things the way we did simplified the design and reduced the parts count.

High address lines

Both A8 and A9 are connected to IC3, a 74LS74 set up as a two-bit data latch. When the Port-A-Matic detects a valid address, the master enable signal clocks whatever happens to be on A8 and A9 into IC3, and that data is presented to the input pins of the two-bit section of IC5. Setting up

the address buffers that way represents a design compromise, because the 74LS74 is just a pair of D flip-flops, not a true latch. The price you pay for using it in that manner is that, contrary to what everybody tells you, the data at the input doesn't show up at the output when the chip is clocked. Instead, that data actually appears one clock pulse later.

That could have serious consequences for the Port-A-Matic since it means that there's a possibility of missing a one-time-only port access by the computer. Fortunately, as we'll see, there's a relatively easy fix for that. For now, it's important just to be aware of the problem.

The control circuit is made up of a handful of gates and passive components, along with IC11, the EPROM containing the port selection look-up table. The control circuit's job is to issue the master enable signal—a low-going pulse at the output of IC2-b.

When an I/O operation takes place, it causes the output of IC2-a, a NAND gate, to go high. That signal is in turn fed to one leg of IC2-b, another NAND gate whose job it is to issue the master enable signal. It's also inverted by IC1-d, a NOR gate set up as a simple inverter, and the resulting low enables the outputs of the four-bit sections of IC4 and IC5, which thereby causes the lower

eight bits of the address bus to show up at the corresponding address inputs of IC11, the port-selector EPROM. The same signal from IC1-d also enables the outputs of the EPROM.

We'll get into the details of the look-up table later; for now it's only important to know that bit 7 of each table entry is used as the enabling toggle for port addresses. In particular, that bit will be cleared for a valid address and set for an invalid address.

The D7 line of the EPROM is fed back to IC1-a, one input of a NOR gate; the other leg of the gate is connected directly to AEN from the bus. If either input to IC1-a is high, either the EPROM says to ignore that address, or the computer is doing a DMA operation. (Actually both may be true.) In any case, the output of IC1-a will be low and, since it's connected to the other leg of IC2-b, no master enable signal will be issued.

If, however, a high is issued from IC1-a, that high is fed to IC2-b, and since the other leg will also be high (because IC2-a detected an I/O operation), the output of IC2-b will go low.

That is the master enable signal that the Port-A-Matic has been waiting for; when it's received the rest of the circuit will be activated.

Before we continue, however, let's take another look at what's happening with A8 and A9, the two high-order address lines from the bus.

If it's the first time a particular I/O address has shown up on the bus, the states of A8 and A9 won't be clocked through IC3 and then show up at the inputs of IC5. That is because the 74LS74 is clocked by the master enable signal, and that won't be generated until a valid I/O address shows up at the address pins of IC11, the port selector EPROM. In other words, we need the master enable signal in order to produce the master enable signal.

The situation, however, isn't as ridiculous as it seems. A circuit design, like most other things in life, is the product of inspiration, realization, and compromise. You begin with a list of design criteria and, once there's some

working silicon on the bench, you have to weigh real-world practicalities against breadboard idealism.

It would certainly be possible to redesign Port-A-Matic to eliminate the problem, but the price would be an increase in circuit complexity, parts count, and cost. And those considerations are just as important as circuit operation. Further, increasing the parts count increases the possibility of unforeseen circuit glitches, and raises the power requirements. And the more complex the circuit, the more complex the PC board.

For all those reasons, we decided to come up with a better solution. The solution involves making a relatively minor operational compromise in the circuit, and it involves using a bit of creative construction in building the look-up table. However, before we can get into building the look-up table, we have to know how the rest of the circuit operates. So, for now, let's just assume that an I/O address has been put on the bus, the Port-A-Matic has checked the port-selector EPROM, and the master enable signal has been generated.

The master enable signal

Once a valid address is detected, the main job of the master enable signal is to load the address data into the display buffer, activate the display timers, and turn on the display.

The master enable signal from IC2-b is inverted by IC2-c, and the resulting high triggers the latch-enable input of IC6, a 74LS373 octal latch. The data stored there is then presented to IC7, a 74LS257 quad two-input multiplexer—the electronic equivalent of a four-pole, two-position rotary switch. By putting a high or low on the select control (pin 1), one of the two sets of input lines will be routed to the output pins. You can tie the 257 directly to a bus because a low on the output-enable (pin 15) "floats" the outputs (effectively removes them from the bus). That feature is important because the display section can handle only eight inputs, but the

DATA AND STATUS PORTS

Most I/O operations actually involve the use of several sequential port addresses for data, status, control, etc. We programmed the prototype to respond only to data ports. The reason is that if you programmed the same LED number into all addresses associated with COM1 (for example), the least significant digit of the display would flicker so rapidly that it would be all but impossible to read. So unless you have a particular reason to monitor control and status ports, you'll find it's more useful for Port-A-Matic to respond only to the data port.

circuit must deal with ten lines (A0–A9).

Since we're only using three seven-segment digits for the display, one question is: Why should we bother with display multiplexing at all? Multiplexing is a good way to reduce parts count, but the break-even point is about three digits.

The reason is that we need a hex, rather than a decimal, display. That means using a character generator that can decode all the numerals from 0 to 9, as well as the hex digits A to F. Unfortunately, such character generators are hard to find. Motorola makes one, and HP has some smart, self-latching hex displays, but both solutions are expensive, and the parts are hard to come by in small quantities. So we built our own; here's how.

The Port-A-Matic divides the ten address lines into three groups: A0–A3, A4–A7, and A8–A9. The multiplexing control circuitry is composed of IC8-b (half of a 556 dual timer), IC12 (a 74LS138 decoder), IC13 (a 4040 counter), and several gates.

The basic multiplexing clock is provided by IC8-b. It drives the 4040 and the resulting binary count drives the 74LS138's select pins. That puts a series of sequential lows on the bases of the display pass transistors (Q4–Q6), and each of the digits will thus light up in turn. Gates IC2-d and IC1-b decode the binary count from the 4040 and provide a reset pulse for the counter whenever the count reaches three.

Multiplexing the display isn't much use unless the data being fed to the display is multiplexed as well. The data and the display must be synchronized so that the right data is presented to the display inputs when the right display is illuminated. The two outputs of the 4040 that drive the 74LS138 also control the order in which the address data is fed to the display circuit. As long as the Q1 output of the 4040 is low, the outputs of IC7 (the data multiplexer) will be enabled. In addition, the same line that enables IC7's outputs is inverted by IC1-c, so the outputs of the

CHOOSING EPROM'S FOR THE PORT-A-MATIC

Much of Port-A-Matic's operation depends on the proper functioning of IC11, the port-selector EPROM. Every I/O operation performed by the computer is checked by IC11 to see whether the Port-A-Matic should respond to the port address on the bus.

Not only does IC11 play a major role in the circuit, it has only a limited amount of time to do its job, and the duration of that time may be critical. The reason is that even though the 8088 takes between eight and ten clock cycles to perform an I/O operation (unless the hardware or software slows things down by adding wait states), the address remains valid on the computer's bus for even less time than that.

Even though computer timing is measured in microseconds and EPROM timing is measured in nanoseconds, using a standard 2716 (with a 450-ns access time) can cause instability in the Port-A-Matic's display. That's because the master enable signal isn't issued until IC11 has approved the port address, but the computer doesn't wait around patiently until that judgment is made.

If the EPROM is too slow and

the computer is too fast, the master enable signal could be issued just as the computer was beginning another I/O operation. That would cause the Port-A-Matic's display to change to a second address after showing the one that triggered it in the first place. The second address is usually related to something like an interrupt request, RAM refresh, and so on.

The problem can be eliminated by using a faster EPROM for IC11. There's no hard and fast formula for calculating how fast an EPROM you should use, but if the problem shows up, you can clear it up by switching to a different EPROM.

The fastest 2716 that's easily available is a 2716-1, with an access time of 350 nanoseconds. If that's still too slow, you could switch to a 2732A, since they're available with access times as low as 200 nanoseconds, which should be fast enough for even a real screamer personal computer like a 33-MHz 386 machine.

You can plug a 2732 directly into IC11's socket, but the look-up table must be burned into the top half of the EPROM, since the extra address pin is tied high on the board.

two-bit section of IC5, the buffer that handles A8 and A9, will be disabled.

When the first digit is enabled, IC7 is enabled, IC5 is disabled, and the lower four address lines are routed to the character generator and the display. When the second digit is lit, IC5 remains disabled, and IC7 sends the second group of address lines (A4–A7) to the character generator. When the last digit is lit, IC7 is disabled and IC5 is enabled, thereby causing the signals from A8 and A9 to be routed to the character generator through D1 and D2. The two diodes are needed to isolate the outputs of the two-bit section of IC5 from the outputs of IC7. That arrangement is necessary because the

4040 runs constantly, whether or not the Port-A-Matic has detected a valid I/O address.

If the diodes weren't there and the outputs of the two-bit part of IC5 were connected directly to the inputs of the character generator, the A8 and A9 inputs of the port selector EPROM would see data from both IC5 and IC7. That might also cause it to ignore a valid address and okay an invalid address.

LED selection

One really useful feature of the Port-A-Matic is its ability to assign a particular LED to a particular port address. It's a lot easier to see what your computer is doing by having the Port-A-Matic light an LED you've la-

belled COM1 than waste some brain space by remembering that COM1 is assigned to port 03F8h. The LED assignments are made in the EPROM look-up table. If a valid I/O address shows up on the bus, the EPROM enables the control circuitry and also sends the stored LED number to IC14, a 74LS154 four-to-sixteen line data selector. When the master enable signal shows up at IC14's enable inputs (pins 18 and 19), one of IC14's outputs will go low, thereby triggering a one-shot that lights the corresponding LED for half a second.

All of the one-shots are built using 558 quad timers. The 558 has open-collector outputs, so pull-up resistors (R63-R78) are used on all outputs.

Two additional LED's, LED1 and LED2, indicate I/O activity, \overline{IOR} and \overline{IOW} , respectively. The LED's are controlled by separate halves of IC9, a 556 dual timer. The I/O activity data is stored in the two-bit section of IC4 (D4 and D5); when the master enable sig-

nal appears, that data is passed to the input pins of IC9. Since \overline{IOR} and \overline{IOW} from the bus are both active low, and only one can be active during a given I/O operation, a single low will be sent to the corresponding half of IC9.

The master enable signal triggers a similar one-shot (IC8-a), whose output pulse enables IC12, the 74LS138 that multiplexes the three display digits. The Port-A-Matic sends data to the display circuit constantly, but the digits themselves are only illuminated when the master enable signal triggers IC8-a.

The three one-shots (IC8-a and both halves of IC9) are quite similar. The transistors that control their inputs let an input trigger interrupt the one-shot's internal timing.

The one-shot (IC8-a) controlling the display multiplexer is more responsive than the ones in IC9 because IC8-a's reset input (pin 4) is also controlled by the master enable signal. Every time a new I/O address is validated by

ORDERING INFORMATION

A set of two double-sided printed circuit boards is available for \$38.95 from Systems 80 Instruments Ltd., c/o CF Liebert, Inc., P.O. Box L, Blaine, WA 98230. The two programmed EPROMs (2716-1, 350 ns) as described in the article are also available from Systems 80 for \$19.95. All prices include shipping and handling.

the port selector EPROM, the master enable signal will reset the one-shot.

The look-up table

As mentioned before, the lower eight address lines are handled in a straightforward manner, so we can be sure that they will always be properly sent to the lower eight address pins of the port selector EPROM. But there's no way to tell what data will be at the EPROM's two upper address lines (A8 and A9, pins 23 and 22). But since we're dealing with digital data, it's misleading to say that the data there will be indeterminate. Actually, there are only four possibilities, zero through three. And we've already seen that confusion will exist only the first time the address shows up on the bus.

The reason that's not significant is that most I/O operations involve accessing the same port over and over. The trick to correctly decoding the upper two address lines is to make sure we take all the digital possibilities into account when we build the look-up table.

For example, suppose we want to decode port 03F8h, and that we want to assign it to LED12. If there was no problem with the address lines, we would put a 0Ch at location 03F8h in the EPROM. When the port is accessed, the low state of bit 7 will enable the rest of the control circuitry and the C in the lower half will be passed on to IC14, so LED12 will light up.

In order to make that happen, regardless of what data is present at the EPROM's A8 and A9 inputs during the first access of port 3F8h by the computer, we also

PARTS LIST

Resistors

All resistors are 1/4-watt, 5%, unless otherwise noted.

R1, R10, R12-R30	2200 ohms
R2, R4, R7	5600 ohms
R3	1 megohm
R5, R8, R31-R46	560,000 ohms
R6, R9, R47-R62	160 ohms
R11	470 ohms
R63-R78	1000 ohms

Capacitors

C1, C2, C10-C14, C16, C38	0.1 μ F, monolithic
C3	0.001 μ F, silver mylar
C4, C6, C8, C19-C22, C24-C26, C29-C32, C34-C37	0.47 μ F, 35 volts, Tantalum
C5, C7, C9, C15, C17, C18, C22, C28, C33	0.01 μ F, monolithic

Semiconductors

IC1	74LS02 quad NOR gate
IC2	74LS00 quad NAND gate
IC3	74LS74 dual D flip-flop
IC4, IC5	74LS367 hex buffer
IC6	74LS373 octal D latch
IC7	74LS257 quad 2-input multiplexer
IC8, IC9	556 dual timer
IC10	2716 EPROM 2K X 8, 450 ns
IC11	2716 EPROM 2k X 8, see text for speed
IC12	74LS138 1-of-8 decoder
IC13	4040 binary ripple counter
IC14	74LS154 4-to-16 line decoder
IC15-IC18	558 quad timer
D1, D2	1N914 small-signal diode
LED1	yellow light-emitting diode
LED2	green light-emitting diode
LED3-LED18	red light-emitting diode
DISP1-DISP3	FND500 LED display, common-cathode
Q1-Q6	2N3906 small-signal PNP transistor

R-E Computer Admart

Rates: Ads are 2 1/4" x 2 7/8". One insertion \$950. Six insertions \$925 each. Twelve insertions \$895 each. Closing date same as regular rate card. Send order with remittance to **Computer Admart**, Radio Electronics Magazine, 500-B Bi-County Blvd., Farmingdale, NY 11735. Direct telephone inquiries to Arline Fishman, area code-516-293-3000. *Only 100% Computer ads are accepted for this Admart.*



WE SERVICE AND REPAIR:

- IBM PC/XT
- AT Brands
- And Other Compatible Models

Expert Professional Service and Repair on:

- Motherboards
- Keyboards
- Adapter boards
- Power Supply
- CRT Display Monitors
- Floppy Disk Drives

For More Information, Call or Write:

BF Electronics

108 E. Main • P. O. Box 338 • Hinton, OK 73047
BOB & LEE FURROW (405) 542-3672

CIRCLE 151 ON FREE INFORMATION CARD

ICs PROMPT DELIVERY!!!

SAME DAY SHIPPING (USUALLY)
 QUANTITY ONE PRICES SHOWN FOR OCT. 22, 1989
 OUTSIDE OKLAHOMA: NO SALES TAX

DYNAMIC RAM		
SIMM	AST Prem386/33Mhz	\$300.00
SIMM	(1) 256Kx36 80 ns	300.00
SIMM	1Mx9 80 ns	122.00
SIMM	(2) 256Kx9 100 ns	35.00
1Mbit	1Mx1 100 ns	11.25
41256	256Kx1 60 ns	4.95
41256	256Kx1 80 ns	3.95
41256	256Kx1 100 ns	2.80
41256	256Kx1 120 ns	2.65
4464	64Kx4 120 ns	3.75
41264 (3)	64Kx4 100 ns	7.95
EPROM		
27C1000	128Kx8 200 ns	\$20.75
27512	64Kx8 200 ns	7.80
27256	32Kx8 150 ns	6.50
27128	16Kx8 250 ns	4.25
STATIC RAM		
62256P-10	32Kx8 100 ns	\$12.95
6264P-12	8Kx8 120 ns	4.85
6116AP-12	2Kx8 120 ns	4.50

OPEN 6 1/2 DAYS, 7:30 AM-10 PM. SHIP VIA FED-EX ON SAT.

SAT DELIVERY INCLUDED ON FED-EX ORDERS RECEIVED BY: 8:00 AM. MICROPROCESSORS UNLIMITED, INC. 24,000 S. Peoria Ave., BESSGS, OK, 74421 (918) 267-4961
 Th \$2 \$6.25+6 No minimum order. Please note: prices subject to change! Shipping, insurance extra, up to \$1 for packing materials.
 Fr \$1 \$14.25+6

CIRCLE 61 ON FREE INFORMATION CARD

GETTING THE MOST FROM YOUR PRINTER

Getting The Most From Your Printer



BP181—It is probable that 80% of dot-matrix printer users only ever use 20% of the features offered by their printers. This book will help you unlock the special features and capabilities that you probably don't even know exist. To order your copy send **\$6.95 plus \$1.50 for shipping** in the U.S. to **Electronic Technology Today Inc., P.O. Box 240, Massapequa Park, NY 11762-0240.**

have to store an 0Ch at every location in the look-up table that might be checked. And that means programming 0Ch at locations 00F8h, 01F8h, and 02F8h, as well as at 03F8h.

The practical effect of doing that will be that the Port-A-Matic will correctly decode an access to port 3F8h regardless of what states are present at the port selector's A8 and A9 pins. The consequence is that one display digit may flicker the first time a port is accessed.

You might think that that

would make it impossible for you to decode two ports whose address differs only in the upper digit—02F8h and 03F8h, for example. Not true.

Remember that the reason for putting the same data at four locations in the look-up table is to be certain that the master enable signal will be generated no matter what data is present at the EPROM's A8 and A9 lines the first time a port address is put on the computer bus. Since the control circuitry only cares about the state of the EPROM's D7 line, the

master enable signal will be produced whenever that line is low. The EPROM data in the lower four bits only determines which LED will light up.

So, for example, if you wanted any access of port 02F8h to light LED3, and any access of port 03F8h to light LED 12, you would store 03h at EPROM location 02F8h and 0Ch at EPROM location 03F8h. The values at 0F8h and 1F8h can be anything as long as the high bit is low.

Unfortunately, we're out of space. See you next time. **CD**

WORKBENCH

continued from page 83

vanced versions of Slick!. Everything described so far, (and more), is part of the basic \$95 version. The other versions do still more.

Slick! can use all the standard display cards that are supported by AutoCAD (CGA, EGA, VGA, and Hercules), and has simple command-line switches to directly support higher screen resolution with more than fifty other video cards. The Level-2 version of Slick! will also support any ADI display driver. If you run AutoCAD with an ADI driver, Slick! Level-2 will give you the same on screen resolution as AutoCAD.

The Level-3 version of Slick! (\$195) won't support ADI displays, but it will print your drawings (or slides) on either an HP Laserjet or an Epson-compatible printer. The prints aren't just screen dumps—the program does the same type of vector to raster conversion that AutoCAD does when it prints a file. Slick's printer setup screen lets you set the plot origin, size, and orientation, and can send the result to either the printer for a hard copy or a file for storage.

The top-of-the-line version of Slick! is Level-4 (\$250), and that one has both the ADI and printer options.

You can run Slick! from the DOS prompt, but the real power of the program becomes evident

by running it while you're still working in AutoCAD. The manual shows you how to modify the ACAD.PGP file so you can run SLICK directly from AutoCAD's command line, and being able to scroll through a directory of blocks means that you don't have to remember the difference between TRANS385.DWG and TRANT385.DWG—you can see it on the screen.

Slick! works extremely well, saves a lot of time, and CAD Systems Unlimited is a great company to deal with on the phone. If you only have the bucks to buy a single AutoCAD accessory, Slick! is the one that you must get. It's by far the most useful CAD utility that you can possibly own.—Robert Grossblatt **CD**

DRAWING BOARD

continued from page 80

determine both the hue and saturation of the colors displayed on the TV. The two elements, hue and saturation, are usually referred to as "chrominance" or "chroma."

A separate colorburst signal is sent for each line of video and they're all exactly in phase with each other. That's obvious if you realize that inconsistencies would result in color shifts from line to line. (That might make for some interesting pictures, but it's not the kind of stuff sponsors shell out bucks to transmit.)

The picture information immediately follows the back porch and, for the next 52 microseconds or so, the electron beam travels across the screen painting a line of varying color and brightness. The color you see depends on the relative phase difference between the video signal and the colorburst signal in the back porch. The brightness, referred to as the "luminance," is simply a function of the voltage level.

If you look at the voltage scale on Fig. 1, you can see how the voltage varies during a line of video. NTSC video calls for a peak-to-peak signal voltage of 1 volt but, instead of volts, the video signal is usually referred to in IEE (Institute of Electrical and Electronic Engineers), or IRE (Institute of Radio Engineers) units. That scale divides the 1-volt range into 140 parts with zero-IRE corresponding to about 0.3 volts. The full scale goes from -40 IRE to +100 IRE units. When you hear a person refer to 50 units of video, they're using the IRE scale.

The reason things are done like that is that there has to be some way to distinguish between control signals and picture information. The NTSC solution was to reserve the area from 0 to 0.3 volts for the control signals and the rest of the space (0.3 to 1 volt) for picture. If the luminance is at 0.3 volts or 0 IRE, the picture will be black—100 IRE will give you white. Everything in the middle will be seen as varying shades of gray or color. The area below 0 IRE is usually referred to as "blacker than black."

Once the end of the picture information is reached, the electron beam is turned off for about 1.5 microseconds (the front porch), and then a horizontal sync pulse is sent. The location and duration of the pulse (4.7 microseconds) is critical to proper placement of the horizontal line on the screen since that causes the electron to move back to the right side of the screen and start a new line.

Messing around with the horizontal sync is a popular activity with the people who dream up ways to scramble TV pictures. If the pulse isn't there at exactly the right time, the television set has no way to identify the start of a new line of video. As a result, the TV will do horizontal retraces at somewhat random intervals and instead of watching a recently released movie, you'll be looking at some images that really belong on a *variable intersitter* (and how many of you know what that is?).

When we get together next time, we'll talk about vertical sync and start to design some video hardware. It should be fun. R-E

Try the **Radio-Electronics**

bulletin board
system

(RE-BBS)
516-293-2283

The more you use it the more
useful it becomes.

We support 300 and 1200 baud
operation.

Parameters: 8N1 (8 data bits, no
parity, 1 stop bit) or 7E1 (7 data
bits, even parity, 1 stop bit).

Add yourself to our user files to
increase your access.

Communicate with other R-E
readers.

Leave your comments on R-E with
the SYSOP.

RE-BBS
516-293-2283

ZENITH

TURBOSPORT 386 PORTABLE LAPTOP COMPUTER

386
40 MB
Hard
Drive!



- 80386 32-bit processor, 12/6 MHz (switchable).
- 40 MB (28ms) hard drive.
- One 3.5" 1.4 MB floppy disk drive.
- 2 MB RAM. • 100% IBM compatible.
- "Page-White" fluorescent backlit LCD display, 10.5" viewing area. • MS-DOS 3.21 included.
- Supports: MS OS/2 version 1.0, Xenix, and also Microsoft Windows/386 environments.
- Zero wait state.
- Socket for 80387 numeric co-processor.
- Internal Hayes 2400 baud modem.
- Serial and parallel printer ports.
- Resolution: 640 x 400 pixels.
- 79-key full function detachable keyboard.
- Real time clock and calendar. • AC adapter.
- "Fast" charge NiCad battery pack included.
- Dim.: 13.25"W x 14.75"D x 4.75"H.
- Weight: 14.7 lbs. • One Year Warranty!

FACTORY NEW! FACTORY PERFECT!

Due to a special arrangement, we were able to obtain a large inventory of these portable computers. As a result, we can now offer them to you at HUGE SAVINGS!

Manufacturer's
Suggested Retail
\$8,499.00
DAMARK PRICE:
\$2999
Item No. B-1515-128686
Insured Ship/Hand.: \$19.00

FOR FASTEST
SERVICE CALL
TOLL FREE
1-800-729-9000



FEDERAL EXPRESS RUSH DELIVERIES ONLY
\$6.95 plus normal S/H. Ask an operator to "SHIP IT FED EX® Delivery Service!"

DAMARK INTERNATIONAL, INC.
6707 Shingle Creek Parkway, Minneapolis, MN 55430
Customer Service • 612-566-4940

Please rush me: _____ Zenith Laptop Computer(s)
@ \$2999 each, plus \$19.00 s/h each. Item
No. B-1515-128686. MN res. add 6% sales tax.

Name _____
Address _____
City, State, Zip _____
 Check/MO VISA MasterCard Discover
Card No. _____
Exp. Date _____ Ph. # () _____
Signature _____

DELIVERY TO 48 U.S. STATES ONLY

JANUARY 1990

MARKET CENTER

FOR SALE

PHOTOFACT folders, under #1400 \$4.00. Others \$6.00. Postpaid. **LOEB**, 414 Chestnut Lane, East Meadow, NY 11554.

GREAT buys! Surplus prices, ICs, linears, transformers, PS, stepping motors, vacuum pump, phototransistor, meters, LSASE, **FERTIK'S**, 5400 Ella, Phila., PA 19120.

DESCRAMBLERS. All brands. Special: Combo Jerrold 400 and SB3 \$165. Complete cable descrambler kit \$39. Complete satellite descrambler kit \$45. Free catalog. **MJM INDUSTRY**, Box 531, Bronx, NY 10461-0531.

CABLE-TV AT ITS BEST

SCIENTIFIC ATLANTA:

Models 8500-8550-8580 . . . \$275.00

SA-3 [Add-On Descrambler] . . . \$ 99.00

JERROLD:

SB-3 [Inband Gated Sync] . . . \$ 74.00

TRI-BI [Trimode/Bistate] . . . \$ 95.00

OAK:

M-35B [Combo W/Vari-sync] . . . \$ 99.00

N-12 [Add-On W/Vari-sync] . . . \$ 89.00

HAMLIN:

MLD-1200 [Add-On] . . . \$ 89.00

ZENITH: [Z-TAC Descrambler] . \$169.00

CONVERTERS: [80-Channels] . \$ 95.00

N.A.S. INTERNATIONAL
(800) 726-4NAS

TUBES: "oldest," "latest." Parts and schematics. SASE for lists. **STEINMETZ**, 7519 Maplewood, RE, Hammond, IN 46324.

LASER Listener II, other projects. Surveillance, descrambling, false identification, information. Plans, kits, other strange stuff. Informational package \$3.00 refundable. **DIRIJO/BOND ELECTRONICS**, Box 212, Lowell, NC 28098.

ENGINEERING software, PC/MSDOS. Hobbyists — students — engineers. Circuit design \$59.00, FFT analysis \$69.00, mathematics \$49.00, logic simulation \$49.00, circuit analysis \$29.00. Free catalog, (614) 491-0832, **BSOFT SOFTWARE**, 444 Colton Rd., Columbus, OH 43207.

RESTRICTED technical information: Electronic surveillance, schematics, locksmithing, covert sciences, hacking, etc. **Huge selection. Free brochures.** **MENTOR-Z**, Drawer 1549, Asbury Park, NJ 07712.

MICROWAVE TV RECEIVERS 1.9 to 2.7 GHz



2 CH Compact Dish System - \$77.95
5 CH Dish System - \$93.95
12 CH Yagi (Rod) System - \$123.95
30 CH Dish System - \$163.90 Yagi - \$183.90
SUN MICROWAVE INT'L. INC. Send \$1st for catalog on these and other fine video products.
P.O. BOX 34522
PHOENIX, AZ 85067
(602) 230-0640
QUANTITY DISCOUNTS LIFETIME WARRANTY

CABLE TV converters bargain headquarters: Zenith, Tocom, Scientific Atlanta, Hamlin, Jerrold 400-DRX3DIC w/remote \$135, Oak M35B \$60.00. Quantity discount. Visa-M/C-COD. Order yours today. 1 (800) 327-8544.

STEPPER motor drive & control with Commodore 64. Affordable hardware, interface, & software. Send for detailed literature & prices to: **MASE**, R.D. #2 Box 166, Mohrsville, PA 19541.

T.V. tunable notch filters. Free brochure. **D.K. VIDEO**, Box 63/6025, Margate, FL 33063. (305) 752-9202.

SURPLUS ELECTRONICS. New giant wholesale catalog. Hundreds of amazing bargains. \$2. Box 840, Champlain, NY 12919.

CLASSIFIED AD ORDER FORM

To run your own classified ad, put one word on each of the lines below and send this form along with your check to:

Radio-Electronics Classified Ads, 500-B Bi-County Boulevard, Farmingdale, NY 11735

PLEASE INDICATE in which category of classified advertising you wish your ad to appear. For special headings, there is a surcharge of **\$25.00**.

Plans/Kits Business Opportunities For Sale
 Education/Instruction Wanted Satellite Television

Special Category: \$25.00

PLEASE PRINT EACH WORD SEPARATELY, IN BLOCK LETTERS.

(No refunds or credits for typesetting errors can be made unless you clearly print or type your copy.) Rates indicated are for standard style classified ads only. See below for additional charges for special ads. **Minimum: 15 words.**

1	2	3	4	5
6	7	8	9	10
11	12	13	14	15 (\$46.50)
16 (\$49.60)	17 (\$52.70)	18 (\$55.80)	19 (\$58.90)	20 (\$62.00)
21 (\$65.10)	22 (\$68.20)	23 (\$71.30)	24 (\$74.40)	25 (\$77.50)
26 (\$80.60)	27 (\$83.70)	28 (\$86.80)	29 (\$89.90)	30 (\$93.00)
31 (\$96.10)	32 (\$99.20)	33 (\$102.30)	34 (\$105.40)	35 (\$108.50)

We accept MasterCard and Visa for payment of orders. If you wish to use your credit card to pay for your ad fill in the following additional information (Sorry, no telephone orders can be accepted.):

Card Number

Expiration Date

Please Print Name

Signature

IF YOU USE A BOX NUMBER YOU MUST INCLUDE YOUR PERMANENT ADDRESS AND PHONE NUMBER FOR OUR FILES. ADS SUBMITTED WITHOUT THIS INFORMATION WILL NOT BE ACCEPTED.

CLASSIFIED COMMERCIAL RATE: (for firms or individuals offering commercial products or services) \$3.10 per word prepaid (no charge for zip code)...**MINIMUM 15 WORDS.** 5% discount for same ad in 6 issues; 10% discount for same ad in 12 issues within one year; if prepaid. **NON-COMMERCIAL RATE:** (for individuals who want to buy or sell a personal item) \$2.50 per word, prepaid...no minimum. **ONLY FIRST WORD AND NAME** set in bold caps at no extra charge. Additional bold face (not available as all caps) **55¢ per word additional.** Entire ad in boldface, \$3.70 per word. **TINT SCREEN BEHIND ENTIRE AD: \$3.85 per word.** **TINT SCREEN BEHIND ENTIRE AD PLUS ALL BOLD FACE AD: \$4.50 per word.** **EXPANDED TYPE AD: \$4.70 per word prepaid.** Entire ad in boldface, \$5.60 per word. **TINT SCREEN BEHIND ENTIRE EXPANDED TYPE AD: \$5.90 per word.** **TINT SCREEN BEHIND ENTIRE EXPANDED TYPE AD PLUS ALL BOLD FACE AD: \$6.80 per word.** **DISPLAY ADS:** 1" x 2 1/4" — \$385.00; 2" x 2 1/4" — \$770.00; 3" x 2 1/4" — \$1155.00. **General Information:** Frequency rates and prepayment discounts are available. **ALL COPY SUBJECT TO PUBLISHERS APPROVAL. ADVERTISEMENTS USING P.O. BOX ADDRESS WILL NOT BE ACCEPTED UNTIL ADVERTISER SUPPLIES PUBLISHER WITH PERMANENT ADDRESS AND PHONE NUMBER.** Copy to be in our hands on the 10th of the third month preceding the date of the issue. (i.e., Aug. issue copy must be received by May 10th). When normal closing date falls on Saturday, Sunday or Holiday, issue closes on preceding working day. Send for the classified brochure. Circle Number 49 on the Free Information Card.

CB RADIO OWNERS!

We specialize in a wide variety of technical information, parts and services for CB radios. 10-Meter and FM conversion kits, repair books, plans, high-performance accessories. Thousands of satisfied customer since 1976! Catalog \$2.

CBC INTERNATIONAL
P.O. BOX 31500RE, PHOENIX, AZ 85046

FEB 87 Triparts \$59.00. Feb 84 SB parts \$49.00. \$3.50 shipping. OCTE, Box 276, Alburg, VT 05440. (514) 739-9328.

RENTAL movie stabilizer. Connect between VCRs or to monitor. Satisfaction guaranteed. \$69.95, \$4.00 handling. 1 (800) 367-7909.

CABLE TV descramblers, Jerrold, Scientific Atlanta, Zenith, most major brands. Dealer inquiries welcome. Visa-M/C accepted. **E & O VIDEO,** 9691 E. 265th Street, Elko, MN 55020. 1 (800) 638-6898.

TEST equipment pre-owned now at affordable prices. Signal generators from \$50.00. Oscilloscopes from \$50.00. Other equipment, including manuals available. Send for Catalog. **J.B. ELECTRONICS,** 3446 Dempster, Skokie, IL 60076. (312) 982-1973.

BEST BY MAIL

Rates: Write National, Box 5, Sarasota, FL 34230

FREE STAMPS WITH approvals. Aldinger, Box 6061(RE), Minot, N.D. 58702.

HELP WANTED

CRUISE SHIP JOBS. Hiring: Men-Women. \$300-\$900 Weekly. Plus World Travel. Hawaii, Caribbean, South Pacific. Call Now! 1(206)736-7000, Ext. 900 N.

MONEYMAKING OPPORTUNITIES

EARN \$2,000 PER 1,000 envelopes you process at home. Easy plan. Free information send self-addressed stamped envelope: Lincoln Enterprises, POB 752209, Houston, TX 77275-2209.

EARN BIG PROFITS buying seized vehicles, jewelry and homes. Examples: 1985 Porsche \$3,900, 22' boat \$1,400, 3 bedroom home \$17,000. Buyers Guide: 1-800-727-7699, Box 2000.

PERSONAL/MISCELLANEOUS

LONELY? FREE SINGLES Lists! \$1.00: Publishing, Box 24618(RE), Detroit, 48224.

CABLE TV converters: Jerrold, Oak, Scientific Atlantic, Zenith & many others. "New MTS" stereo add-on: mute & volume. Ideal for 400 and 450 owners! 1 (800) 826-7623, Amex, Visa, M/C accepted. **B & B INC.,** 4030 Beau-D-Rue Drive, Eagan, MN 55122.

DESCRAMBLERS, Oak remote \$165.00, Tri-Bi \$89.00, SA-3 \$99.00, MLD 1200 \$55.00 - 10 for \$450.00, remote Pioneer \$199.00, Pioneer add on \$129.00, M35B \$65.00, Jerrold 400 \$135.00, Magnavox converter w/r \$45.00, Tocom Remote \$199.00, same day shipping, COD ok. **MOUNT HOOD ELECTRONICS,** (206) 896-6837.

ELECTRONIC test equipment, laboratory equipment, — surplus and priced to go! Catalog \$1.00. **LEHMAN,** R.D. 1 Box 580, Wrightsville, PA 17368.

PARABOLIC reflectors. 18" spun aluminum dish focuses RF, light, sound. \$25.00; **PJC,** 2981 Tess Ave., Granger, UT 84119.

FREE CATALOG

FAMOUS "FIRESTIK" BRAND CB ANTENNAS AND ACCESSORIES. QUALITY PRODUCTS FOR THE SERIOUS CB'er. SINCE 1962
FIRESTIK ANTENNA COMPANY
2614 EAST ADAMS
PHOENIX, ARIZONA 85034

UNIVERSAL couplings to correct shaft misalignment. Insulated, available in two sizes, inexpensive. **JACKSON BROTHERS,** Box 632, Paramus, NJ 07652. (201) 967-1309.

MINIATURE electronics like James Bond. Catalog \$3.00, refundable. **F & P ENTERPRISES,** Box 51272, Palo Alto, CA 94303-L.

CABLE-TV

WE'LL MATCH OR BEAT ANYONE'S ADVERTISED RETAIL OR WHOLESALE PRICES!

BONANZA!

ITEM	1 UNIT	10 OR MORE
HAMLIN MCC 3000 36 CORDED REMOTE CONVERTER (Ch 3 only)	29 00	18 00
PANASONIC WIRELESS CONVERTER (our best buy)	98 00	79 00
STAR GATE 2000	88 00	69 00
*JERROLD 400 COMBO	169 00	119 00
JERROLD 400 HAND REMOTE CONTROL	29 00	18 00
*JERROLD 450 COMBO	199 00	139 00
*JERROLD 450 HAND REMOTE CONTROL	29 00	18 00
JERROLD SB-ADD-ON	99 00	63 00
*JERROLD SB-ADD-ON WITH TRIMODE	109 00	75 00
*M-35 B COMBO UNIT (Ch 3 output only)	99 00	70 00
*M-35 B COMBO UNIT WITH VARISYNC	109 00	75 00
*MINICODE (N-12)	99 00	62 00
*MINICODE (N-12) WITH VARISYNC	109 00	65 00
*MINICODE VARISYNC WITH AUTO ON-OFF	145 00	105 00
ECONOCODE (minicode substitute)	69 00	42 00
ECONOCODE WITH VARISYNC	79 00	46 00
*MLD-1200-3 (Ch 3 output)	99 00	62 00
*MLD-1200-2 (Ch 2 output)	99 00	62 00
*ZENITH SSAVI CABLE READY	175 00	125 00
INTERFERENCE FILTERS (Ch 3 only)	24 00	14 00
*EAGLE PD-3 DESCRAMBLER (Ch 3 output only)	119 00	65 00
*SCIENTIFIC ATLANTA ADD-ON REPLACEMENT DESCRAMBLER	119 00	85 00

*CALL FOR AVAILABILITY

Quantity	Item	Output Channel	Price Each	TOTAL PRICE
			SUBTOTAL	
			Shipping Add \$3.00 per unit	
			COD & Credit Cards — Add 5%	
			TOTAL	

California Penal Code #593-D forbids us from shipping any cable descrambling unit to anyone residing in the state of California.
Prices subject to change without notice.

PLEASE PRINT

Name _____
Address _____ City _____
State _____ Zip _____ Phone Number () _____
 Cashier's Check Money Order COD Visa Mastercard
Acct # _____ Exp. Date _____
Signature _____

FOR OUR RECORDS:

DECLARATION OF AUTHORIZED USE — I, the undersigned, do hereby declare under penalty of perjury that all products purchased, now and in the future, will only be used on cable TV systems with proper authorization from local officials or cable company officials in accordance with all applicable federal and state laws. **FEDERAL AND VARIOUS STATE LAWS PROVIDE FOR SUBSTANTIAL CRIMINAL AND CIVIL PENALTIES FOR UNAUTHORIZED USE.**

Dated: _____ Signed: _____

Pacific Cable Company, Inc.

7325½ RESEDA BLVD., DEPT. R-1 • RESEDA, CA 91335
(818) 716-5914 • No Collect Calls • (818) 716-5140

IMPORTANT: WHEN CALLING FOR INFORMATION
Please have the make and model # of the equipment used in your area. *Thank You*

© Copyright 1987 PACIFIC CABLE CO., INC.

JANUARY 1990

AMAZING SCIENTIFIC & ELECTRONIC PRODUCTS

PLANS PARTS ARE IN STOCK	GRA1 — ANTI GRAVITY GENERATOR	\$10.00
	LCT7 — 40 WATT BURNING CUTTING LASER	\$20.00
	RUB4 — HI POWER PULSED DRILLING LASER	\$20.00
	BTCS5 — 1 MILLION VOLT TESLA COIL	\$20.00
	MCPC1 — HI VELOCITY COIL GUN	\$15.00
	LLS1 — LASER LIGHT SHOW 3 METHODS	\$20.00
	EH1 — ELECTRONIC HYPNOTISM TECHNIQUES	\$8.00
	EML1 — LOWER POWERED COIL GUN LAUNCHER	\$8.00
	JL3 — JACOB LADDER 3 MODELS	\$10.00
	SD5 — SEE IN THE DARK	\$10.00
	LEV1 — LEVITATION DEVICE	\$10.00

KITS ASSISTANCE AVAILABLE	FMV1K — 3 MILE FM VOICE TRANSMITTER	\$34.50
	PFS1K — HAND CONTROLLED PLASMA FIRE SABER	\$49.50
	NIG7 — HI FLUX NEGATIVE ION GENERATOR	\$34.50
	PG5K — PLASMA LIGHTNING GLOBE	\$49.50
	LHC2K — VISIBLE SIMULATED 3 COLOR LASER	\$44.50
	HOD1K — HOMING/TRACKING BEEPER TRANSMITTER	\$44.50
	LGU6K — 2.5 MW HAND-HELD VISIBLE LASER GUN	\$249.50
	BTC3K — 250,000 VOLT TABLE TOP TESLA COIL	\$249.50
	IOG2K — ION RAY GUN, project energy without wires	\$129.95
	TKE1K — TELEKINETIC ENHANCER/ELECTRIC MAN	\$79.50
	VWPM7K — 3 MILE AUTO TELEPHONE TRANSMITTER	\$49.50

ASSEMBLED	ASSEMBLED IN OUR LABS	
	LIST10 — INFINITY XMTR Listen in via phone lines	\$199.50
	IPG70 — INVISIBLE PAIN FIELD BLAST WAVE GENERATOR	\$74.50
	ITM10 — 100,000 VOLT INTIMIDATOR UP TO 20'	\$99.50
	TAT30 — AUTOMATIC TELEPHONE RECORDING DEVICE	\$24.50
	PSP40 — PHASOR SONIC BLAST WAVE PISTOL	\$89.50
	ONE10 — ALL NEW 26" VIVID COLORED NEON STICK	\$74.50
	LGU20 — 5 TO 1MW VISIBLE RED HeNe LASER GUN	\$199.50
	BLS10 — 100,000 WATT BLASTER DEFENSE WAND	\$89.50

EASY ORDERING PROCEDURE - TOLL FREE 1-800-221-1705 or 24 HRS on 1-603-673-4730 or FAX IT TO 1-603-672-5406
 VISA, MC, CHECK, MO IN US FUNDS. INCLUDE 10% SHIPPING. ORDERS \$100.00 & UP ONLY ADD \$10.00. CATALOG \$1.00 OR FREE WITH ORDER.

INFORMATION UNLIMITED
 P.O. BOX 716, DEPT. R2, AMHERST, NH 03031

SINGERS! REMOVE VOCALS FROM RECORDS AND CDs!



SING WITH THE WORLD'S BEST BANDS!

An Unlimited supply of Backgrounds from standard stereo records! Record with your voice or perform live with the backgrounds. Used in Professional Performance yet connects easily to a home component stereo. This unique product is manufactured and sold Exclusively by LT Sound - Not sold through dealers. Call or write for a Free Brochure and Demo Record.

LT Sound, Dept. R.L-3, 7980 LT Parkway
 Lithonia, GA 30058 (404) 482-4724
 Manufactured and Sold Exclusively by LT Sound
24 HOUR PHONE DEMO LINE: (404) 482-2485

ACCEPTING new customers again for our monthly picture flyer. Lots of quality surplus electronic parts at low prices. **STAR-TRONICS**, PO Box 683, McMinnville, OR 97128.

CABLE boxes, 400 w/r \$135.00, RTC-56 \$169.95, SA-3 \$99.95, Tocom w/r \$199.00, Hamlin 1200 \$45.00, Pioneer add on with free remote converter \$199.00, M35B \$55.00, TriMode \$99.00, 90 day warranty, C.O.D. welcome. **G.D. ELECTRONICS**, (602) 829-9441.

DIAL drives for fine tuning variable capacitors and potentiometers. Reduction ratios up to 10:1 available. **JACKSON BROTHERS**, Box 632, Paramus, NJ 07652. (201) 967-1309.

INDUCTORS! Lowest prices available. Immediate delivery on all types. **ELTECH SALES, INC.**, 286 Colby Place, Paramus, NJ 07652. (201) 967-1309.

RECEIVE absolutely free 50 technical magazines! Complete details \$5.00. **BALL**, PO Box 1078-RE, Snellville, GA 30278-1078.

NEW HE NE LASER TUBES \$35

Dealer Inquiries Invited.

Free Catalog!

MEREDITH INSTRUMENTS: 6403 N. 59th Ave.
 Glendale, AZ 85301 • (602) 934-9387
"The Source for Laser Surplus"

TJ Services is serving you! Quality products, dependable service, knowledgeable sales people and low prices prove it! Not sure what you need? Call (313) 979-8356, fax: (313) 795-4329. Prices quoted are: 20/10/5/1 lot. **Jerrold** Data Reading Trimode combo wireless remote \$109/\$119/\$129/\$139. DRX-3-DIC \$69/\$79/\$89/\$99. DRZ-3 \$49/\$59/\$69/\$79. Tri-Bi-2 or 3 \$69/\$79/\$89/\$95. SB-3 \$45.00 each. **Oak** M35B starting at \$20 each. Original N-12-3VS \$65 each. Scientific Atlanta type add-on \$69/\$79/\$89/\$109. Combo's - call. **Hamlin** CRX-66003M \$89/\$99/\$109/\$125. CRX-6600-2 \$39/\$49/\$59/\$69. MLD-1200-2 or 3 \$29/\$39/\$49/\$59. **Eagle** PD-3 original \$59/\$64/\$99/\$109. **Interference Filters**, we stock all channels \$12/\$15/\$18/\$30. **Pioneer type** add-on \$79/\$89/\$109/\$129. **Replacement remotes** for most converters - call. Many accessories and parts in stock.

COMMUNICATIONS. Electronic equipment, sales, service, FCC licensed, free catalog. **RAYS**, PO Box 14862, Fort Worth, TX 76117-0862.

T.V. converters, Tocom w/r, SA3, 400 w/r, M35B, RTC-56, MLD 1200, Pioneer w/r, Pioneer add on, Z-Tac, all at wholesale prices, example — Tocom with remote \$199.00 or 5 for \$175.00 each, TriMode \$89.00. S.A.C., (702) 647-3799.

AUTO security — american made NU-1 Auto Alarm. Simple installation instructions. Complete system \$58.89 plus \$4.50 S/H. P.D. & F, Box 10281, Killeen, TX 76542.

IS it true... Jeeps for \$44.00 through the government? Call for facts! (708) 742-1142 Ext. 4673.

PRIVACY problem — need information? New electronics surveillance, debugging, protection catalog \$5.00. Assembled — kits. **TECHNOLOGY SERVICES**, 829B Ginette Street, Gretna, LA 70056.

TUBES - 2000 TYPES DISCOUNT PRICES!

Early, hard-to-find, and modern tubes. Also transformers, capacitors and parts for tube equipment. *Send \$2.00 for 24 page wholesale catalog.*

ANTIQUE ELECTRONIC SUPPLY
 688 W. First St. • Tempe, AZ 85281 • 602/894-9503

PLANS AND KITS

BUILD this five-digit panel meter and square-wave generator including an ohms, capacitance and frequency meter. Detailed instructions \$2.50. **BAGNALL ELECTRONICS**, 179 May, Fairfield, CT 06430.

DESCRAMBLING, new secret manual. Build your own descramblers for cable and subscription TV. Instructions, schematics for SSAVI, gated sync, sinewave, (HBO, Cinemax, Showtime, UHF, adult) \$8.95, \$2.00 postage. **CABLETRONICS**, Box 30502R, Bethesda, MD 20814.

450 MHz Spectrum analyzer — kit — \$459.95 or assembled & tested \$799.95. For more information, send legal size SASE to **A & A ENGINEERING**, 2521 W. LaPalma, #K, Anaheim, CA 92801.

REMOTE CONTROL KEYCHAIN

Complete w/mini-transmitter and +5 vdc RF receiver Fully assembled including plans to build your own auto alarm. Quantity discounts available.

\$19.95 Check, Visa or M/C Add \$3 shipping

VISITECT INC./Dept. R (415) 872-0128
 PO BOX 5442, SO. SAN FRAN., CA 94080

Projection TV. Convert your TV to project 7 foot picture... Easy... Results comparable to \$2,500 projectors... **Plans and 8" Lens \$24.95... Professional systems available... Illustrated catalog free... MACROCOMA**, 15GE Main Street, Washington Crossing, PA 18977. Creditcard orders 24 Hrs. (215) 736-3979.

ALARM kit for home, 12vDC, delay and instantaneous loop. Includes board and components. \$47.50 + \$3.50 S/H. For purchase or free info: **K.E.P.**, PO Box 830123, Stone Mountain, GA 30083.

RADIO Astronomy! Monthly magazine, books, components. \$3.00 brings sample package. **BOB'S ELECTRONIC SERVICE**, 7605 Deland, Ft. Pierce, FL 34951.

CATALOG: hobby/broadcasting/HAM/CB: Cable TV, transmitters, amplifiers, surveillance devices, computers, more! **PANAXIS**, Box 130-F1, Paradise, CA 95967.

SURVEILLANCE equipment design gives 58 schematics of Sheffield Electronics' surveillance devices. Circuits explained. Transmitters range from pens to one-mile VOX's including crystal, subcarrier, carrier current, infrared, firefly, automobile. Demodulators given. Cube tap and duplex mains powered transmitters presented. Eighteen telephone transmitters are leech and battery types including crystal and subcarrier. Countermeasures chapter. Much more. This 8 1/2 x 11 inch 110-page book is illustrated with photographs. Price \$30.00 + \$4.00 S & H. First class mail U.S. & Canada. Overseas Airmail S & H \$9.00. One-day processing, pay with Money Order or Cashier's Check. Send to: **WINSTON ARRINGTON**, 7223 Stony Island Ave., Chicago, IL 60649-2806.

CABLE TV DESCRAMBLERS

JERROLD™ Tri-Bi Mode	\$105.00	10 Lot \$85.00
JERROLD™ SB-3 OR 2	\$89.00	\$65.00
Hamlin MLD-1200	\$99.95	\$62.00
Oak N-12 W/V.S.	\$99.95	\$62.00
Oak-M-35-B W/V.S.	\$99.00	\$78.00
OAK E-13	\$99.95	\$58.00
Zenith SSAVI	\$185.00	\$145.00
Eagle PD-3	\$120.00	\$85.00
Scientific Atlanta	\$129.95	\$105.00
SA-Combo's	CALL	\$call
Tocom	\$350.00	\$295.00
Oak N-12 W/ Auto.	\$140.00	\$105.00
Jerrold Starcom CSV	\$139.95	Call

M.D. ELECTRONICS WILL MATCH ANY ADVERTISED PRICE IN THIS MAGAZINE

*NEW STARGATE 2000 CABLE CONVERTER



1-\$89.00 10-\$69.00 100-Call
 Last channel recall-Favorite channel select-75 channel-Channel scan-Manual fine tune-One year warranty-surge protection-HRC & Standard switchable-and much more. **Call Today!**

INFORMATION (402) 554-0417
Orders Call Toll Free 1-800-624-1150
M.D. ELECTRONICS 115 NEW YORK MALL SUITE 133E OMAHA, NE. 68114
 M.C. VISA C.O.D.
CIRCLE 53 ON FREE INFORMATION CARD



TV-SCOPE
PENN RESEARCH, Box 3543
W1111amsport, PA 17701

FINALLY!

An interesting and worthwhile project. This **EASY-TO-BUILD** circuit lets you use any regular TV set as a simple **OSCILLOSCOPE**. No modifications to TV! Tiny, 9v battery powered. Goes anywhere! Order now! Ask for our **FREE CATALOG** of other plans and kits!

STEREO FM transmitter! Transmit your VCR/CD/Walkman to any FM stereo radio. One chip does it all! Free schematic and info. Send a self addressed/stamped envelope to: **DJ INC.**, 847A Second Ave., Suite 113, New York, NY 10017.

FM transmitter 88 to 108 MHz kit \$12.95; power supply 0 to 20 V 1 AMP kit \$79.99; Flyback tester assembled \$95.99; shipping and handle 4% unit. SASE for information. SIERRA ELECTRONICS, PO Box 709, Elfers, FL 34680-0709.

ELECTRONIC kits! Transmitters! Recorders! Phone devices! Bug detectors! Surveillance items! More! Catalog \$1.00: XANDI ELECTRONICS, Box 25647, 60Y, Tempe, AZ 85285-5647.

BUILD the "Invader," common construction materials, electronic kits available, complete robot plans \$11.95, details free, ROBOT WORKS, Box 1979, Colorado Springs, CO 80901.

COMMODORE-64 RS232 interface. Plans \$5.00. PCB and components available. Details free. HITECH INDUSTRIES, P.O. Box 690925, Tulsa, OK 74169.

SECURITY schematics, transistor, ultrasonic and IC designs, \$8.00. For large list of plans, send \$2.00 (refundable) to: SELECTIONS, PO Box 08121, Detroit, MI 48208.

CB Tricks II book. Power amplifier design and theory, UHF CB tune ups. Send \$19.95 MEDICINE MAN CB, PO Box 37, Clarksville, AR 72830.

DETECTION — Surveillance, debugging, plans, kits, assembled devices. Latest high-tech catalog \$5. **DETECTION SYSTEMS**, 2515 E. Thomas, #16-864F, Phoenix, AZ 85016.

ELECTROLOCK programmable keypad door release system, complete kit including electric strike: \$129.95. Assembled and tested: \$149.95. Free brochure and orders: **SYSTEMS ASSOCIATES INC.**, 1320 Cranston Street, Cranston, RI 02920. (401) 943-2986.

INVESTIGATORS, experimenters — Quality new plans. Hard to find micro and restricted devices. Free catalog. Self addressed stamped envelope to **KELLEY SECURITY INC.**, Suite 90, 2531 Sawtelle Blvd., Los Angeles, CA 90064.

SINGERS. At last, build your own vocal filter. Remove lead vocals from standard stereo records, CDs, tapes, FM broadcasts, so you can be the lead singer of your favorite band. Theory, manual, schematics \$6.95. **WEEDER TECHNOLOGIES**, 14773 Lindsey, Mt. Orab, OH 45154.

CABLE RENTERS STOP!

If you currently renting your cable equipment it's time to look into owning your own. You can save up to \$100 plus every year. Satisfaction Guaranteed.

We carry all the major brands of Converters, Remote controls and Descramblers, **JERROLD, OAK, ZENITH, EAGLE, HAMLIN, SCIENTIFIC ATLANTA**, Many more. Fast courteous service.

Call today 512-250-8816 or write for your Free catalog.

VISA M/C Order C.O.D. Toll Free **1-800-228-7404**

Nu-Tek Electronic 5114 Balcones Woods dr. Suite#307 Dept.298R Austin, Tx 78759

THE ELECTRONIC GOLDMINE

INFRARED DETECTOR KIT

Uses sensitive sensor and electronic circuitry to respond to all types of infrared TV, VCR, etc. remote controllers and LEDs by producing sound and lighting a bright red LED. Great for testing and verification of infrared output - sees what you can not see. Small size: 2.5" x 1.4". Operates on 9V battery (not included). Kit comes with all parts and PC board.



C6441 \$5.95

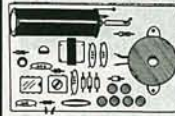

MINI GEIGER COUNTER KIT

This useful kit lets you detect the radiation that you are being exposed to! Use it to detect radium dials on old watches, camping lantern mantles, radioactive minerals, background radiation, etc. Kit detects alpha, beta, gamma and X-ray radiation and features sensitive alpha-window GM tube with IC Circuit. Firmly clicks in proportion to intensity of radiation! Size only 1.9" x 3". Operates from one 9V battery (not included). With all parts and PC board.

C6430 \$59.95

PARTIAL LISTING OF OVER 130 UNIQUE KITS

All of our kits come with an etched and drilled PC board and all parts - you provide the battery and case (if desired). Kits that operate from 120VAC should be built by knowledgeable builders only due to AC safety concerns.

Lighting Bolt Strobe Kit (120VAC)	C6431	\$34.95
3 Channel Color Organ Kit (120VAC)	C4530	\$12.98
10 Channel Light Sequencer Kit (120VAC)	C4725	\$28.95
Battery Operated Blacklight Kit (6VDC)	C6356	\$13.95
Wheel of Fortune Kit (9VDC)	C3806	\$14.98
Logic Probe Kit (3VDC)	C6384	\$12.00
Ultrasonic Pest Repeller Kit (9VDC)	C6350	\$ 9.00
Burglar Alarm Kit (6VDC)	C6280	\$ 8.75
Jungle Bird Kit (9VDC)	C6374	\$ 6.25
Electronic Intercom Kit (9VDC)	C4743	\$12.49
Micro Xenon Tube Flasher Kit (1.5VDC)	C6268	\$14.95
Simulated Laser Kit (9VDC)	C6394	\$ 8.00
Battery Tester Kit (Tests all Types)(9VDC)	C6414	\$ 6.95

Ultra-brilliant clear jumbo case red led. Output: 300MCD. **SUPER BRIGHT LED** A1012 3/\$1.00 100/\$25.00

SURFACE MOUNT CHIP COMPONENTS

CAPS		RESISTORS		YOUR CHOICE - ANY ONE VALUE OF RESISTOR OR CAPACITOR IS 20/\$1.00 or 100/\$4.00 (NO MIXING)	
2pf	10	220	.5K	22K	
3pf	39	270	1.8K	39K	
5pf	47	390	2.2K	68K	
10pf	54	470	3.3K	470K	
12pf	82	560	8.2K		
22pf	120	680	12K		
100pf	180	1.2K	15K		

INVERTER TRANSFORMER

Try 4 lead transformer for use with 555 IC to convert 120VDC to over 250V for strobes, fluorescent tubes, etc. Simple schematic included. N703 \$2.00 each 100 for \$170

4KV TRIGGER COIL

3 lead trigger coil to fire most xenon flash tubes. N7700 \$1.25 each 100 for \$80

MINIMUM ORDER \$10.00 plus 3.00 shipping and handling. We accept M/C, Visa and money orders, COD fee: 2.50 in addition to 3.00 shipping charge.
SEND ORDERS TO: The Electronic Goldmine
P.O. Box 5408 Scottsdale, AZ 85261
PHONE ORDERS: (602) 451-7454

CIRCLE 135 ON FREE INFORMATION CARD

LOOK NO FURTHER!

If you've been looking high and low for a dependable supplier of top-quality electronic parts and components... let MCM end your search. **LOOK AT OUR QUALITY** — it's tough to beat! **LOOK AT OUR SELECTION** — over 15,000 in-stock items to choose from! **LOOK AT OUR VALUE** — some of the most competitive prices in the industry! **LOOK AT OUR SERVICE** — convenient TOLL-FREE phone lines, fast order turnaround and courteous, friendly assistance when you need it!

If these are the things you've been looking for, it's time you look to MCM ELECTRONICS. The first time you do, you'll like what you see!



For a **FREE, ONE-YEAR SUBSCRIPTION** to the **MCM Electronics Catalog**,
Call **TOLL-FREE, 1-800-543-4330**



MCM ELECTRONICS
650 CONGRESS PARK DR
CENTERVILLE, OH 45459-4072
A PREMIER Company

SOURCE NO. RE-62

CIRCLE 87 ON FREE INFORMATION CARD

JANUARY 1990

95

CABLE TV CONVERTERS & EQUIPMENT



	ONE UNIT	10+ UNITS
SCIENTIFIC ATLANTA W/ TRI-BI	225.00	175.00
PANASONIC WIRELESS CONVERTER 1403N	85.00	74.00
JERROLD 400 COMBO W/ REMOTE (DRX3DIC)	134.00	100.00
JERROLD 400 OR 450 REMOTE HAND UNIT	24.00	15.00
JERROLD JR X 3DIC	84.00	65.00
JERROLD SB ADD ON	74.00	55.00
JERROLD SB ADD ON WITH TRI-BI	95.00	75.00
OAK M-35 COMBO	79.00	50.00
OAK MINICODE (N-12)	84.00	59.00
OAK ECONOCODE (E-13)	64.00	40.00
HAMLIN MLD 1200	64.00	55.00
SCIENTIFIC ATLANTA SA-3 ADD ON	109.00	80.00
INTERFERENCE FILTER (CHANNEL 3 OR 6)	24.00	14.00
SCIENTIFIC ATLANTA 83 CHANNEL CONVERTER	95.00	80.00
PIONEER CONVERTER BA 4500 SERIES	100.00	85.00
TOMCOM VIP	Call for price and availability	
ZENITH FLASHING	Call for price and availability	
ZENITH SSAVI	Call for price and availability	
EAGLE PD-3	Call for price and availability	

VIDEO-LINK Enterprises, Inc.

165 W. PUTNAM AVE.
GREENWICH, CT 06830
(203) 622-4386

MONDAY - FRIDAY 10 AM — 5:30 PM, E.S.T.

IMPORTANT: Have make and model # of the equipment used in your area.

QTY	ITEM	OUTPUT CHANNEL	PRICE EACH	TOTAL PRICE
NO CONNECTICUT SALES. It is not the intent of VIDEO-LINK to defraud any pay television operator and we will not assist any company or individual in doing so.			SUBTOT.	
			Shipping \$3/Unit	
			COD: Add 5%	
			TOTAL	

PLEASE PRINT:

CASHIER'S CHECK M.O. C.O.D.

NAME _____

ADDRESS _____

CITY/STATE/ZIP _____

PHONE _____

SIGNATURE _____

WAIVER. Since I, the undersigned, fully understand that the ownership of a cable decoder does not give the owner of the decoder the right to decode or view premium cable channels without proper authorization from their local cable company, hereby declare under penalty of perjury that all products purchased, at any time, will only be used on cable TV systems with proper authorization from local officials or cable company officers in accordance with all applicable federal and state laws. Federal and various state laws provide for substantial criminal and civil penalties for unauthorized use.

Dated: _____ Signed: _____

CIRCLE 64 ON FREE INFORMATION CARD

P-C-13
Artwork Made Easy

PC Boards Layout Software takes the Hassle out of Creating P-C-13 Artwork.

- Advanced Features • Menu Driven
- Auto-Router & Schematic Program Available

Requirements: IBM PC or compatible 384 K RAM, DOS 3.0 or later
PC Boards \$99.00 Demo \$10.00

2110 14th Ave. South, Birmingham, AL 35205 (205) 933-1122

MICROPROCESSOR alarm kit. For home, auto, RV. 8 zones. Delay, valet, continuous modes. \$31.95 plus \$2.00 S/H. Just add power supply, case, sensors. **PRECISION ELECTRONICS**, 4N306 Norris Ave., West Chicago, IL 60185.

CLOSEOUT "TV Frequency Standard" April 1988 R-E, kit/antenna coil \$55.00, finished units \$200.00, **PERSHING TECHNICAL**, Box 1951, Fort Worth, TX 76101.

CABLE TV CONVERTERS

WHY PAY A HIGH MONTHLY FEE?



All Jerrold, Oak, Hamlin, Zenith, Scientific Atlanta, Magnavox and all specialized cable equipment available for shipment within 24 hours. For fast service MC / VISA or C.O.D. telephone orders accepted **(800) 648-3030** 60 Day Guarantee (Quantity Discounts) 8 A.M. to 5 P.M. C.S.T. **CLOSED WEEKENDS.** Send self-addressed Stamped envelope (60¢ postage) for Catalog.

MIDWEST ELECTRONICS INC. P.O. Box 5000 Suite 311 (R) Carpentersville, IL 60110

No Illinois Orders Accepted.

SATELLITE TV

CABLE TV secrets — the outlaw publication the cable companies tried to ban. HBO, Movie Channel, Showtime, descramblers, converters, etc. Supplier's list included \$8.95. **CABLE FACTS**, Box 711-R, Pataskala, OH 43062.

FREE catalog — Do-it-yourself save 40-60%. Lowest prices worldwide, systems, upgrades, parts, all major brands factory fresh and warrantied. **SKYVISION**, 2009 Collegeway, Fergus Falls, MN 56537. 1 (800) 334-6455.

PAY TV AND SATELLITE DESCRAMBLING

NEW... 1990 EDITION... NEW

The newest systems, parameters, turn-ons, harassment and countermeasures being used by and against cable, wireless and satellite operators. New original information \$15.95. Pay TV Vol. 1 \$14.95. Volume 2 \$12.95. Experiences with VC \$12.95. MDS/MMDS Handbook \$9.95. Build Satellite Systems Under \$600. \$12.95. Any 3/28 or 6/42. Scrambling News Monthly \$24.95/yr. Sample \$3. Scrambling News Year 1 (200) pages \$22.95. Year 2 \$22.95. Catalog \$1 or call. **Scrambling News, 1552 Hertel Ave., Buffalo, N.Y. 14216 COD's 716-874-2088**

DESCRAMBLER: Build our low cost **video** only, satellite TV descrambler for most satellite channels. Uses easy to get, everyday parts. Boards & plans \$35.00 US funds. Board, plans & parts \$99.00 US funds. Wired & tested unit \$189.00 US funds. Send check, money order or Visa to: **VALLEY MICRO-WAVE ELECTRONICS**, Bear River, Nova Scotia, Canada B0S 1B0 or phone (902) 467-3577. 8am to 4pm eastern time. Note: educational project only. Not to be used illegally.

CABLE TV "BOXES"

Converters — Descramblers
Remote Controls — Accessories

- * Guaranteed Best Prices *
- * 1 Year Warranty — C.O.D. s *
- * Immediate Shipping *
- * FREE CATALOG *

Call or Write

TRANS-WORLD CABLE CO.
12062 Southwest 117th Court, Suite 126
Miami, Florida 33186
1-800-442-9333



VIDEOCIPHER II manuals. **Volume 1** — hardware, **Volume 2** — software. Either \$32.45. **Volume 3** — projects/software — \$42.45. **Volume 4** — repair — \$97.45. **Volume 5** documentation — \$42.45. **Cable Hacker's Bible** — \$32.45. CODs: (602) 782-2316. 0100-032 software — catalog-\$3.00. **TELECODE**, Box 6426-RE, Yuma, AZ 85366-6426.

VIDEOCIPHER II descrambling manual. Schematics, video and audio. Explains DES, EPROM, CloneMaster, 3Musketeer, pay-per-view (HBO, Cinemax, Showtime, adult, etc.) \$13.95, \$2.00 postage. **CABLETRONICS**, Box 30502R, Bethesda, MD 20814.

COMPUTER SYSTEMS

FROM \$895. US-made XT, AT, 386 in modern tower enclosure. Also Commodore service, parts. **TOPTECH INTERNATIONAL**, 1112 S. Delaware Ave., Philadelphia, PA 19147.

When
you give blood
you give
another
birthday,
another laugh,
another hug,
another
chance.



American Red Cross

Please give blood.



ANNOUNCING . . .

WORLD'S FIRST

High Performance Universal Counter Timer Module/Panel Meter

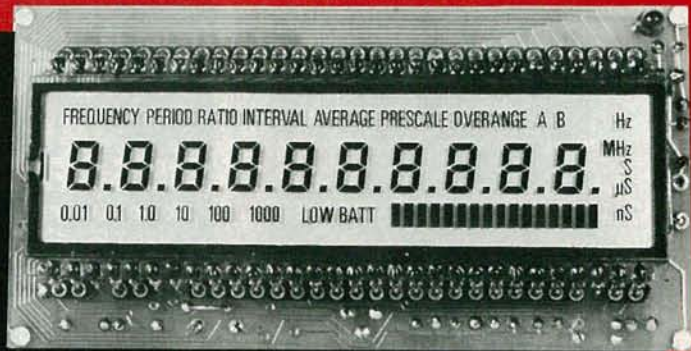

ACTUAL SIZE

- 10 Digit (120 Segment) LCD Display with Gate, Function, and Input Annunciators.
- 1 Hz to Over 150 MHz Direct Count (1 Hz resolution in 1 Sec)
- Single Shot Time Interval 100 ns, 1 ns averaged.
- Functions include: Frequency, Period, Ratio, and Time Interval and Average.
- 16 Segment Analog Input Bargraph is driven by an 8 Bit A to D and Can Be Used for Signal Level Display.
- Low Power (250 mw) with Single 5v Supply.
- High Accuracy, 1 ppm 10 MHz Crystal Time Base with Cal Adjust on Board.
- Economical to Use in Custom OEM Applications.

OPTOELECTRONICS INC.

5821 N.E. 14th Avenue • Fort Lauderdale, Florida 33334
(800) 327-5912 • FL (305) 771-2050 • FAX (305) 771-2052

CIRCLE 148 ON FREE INFORMATION CARD

EDUCATION & INSTRUCTION

MAGIC! Four illustrated lessons plus inside information shows you how. We provide almost 50 tricks including equipment for four professional effects. You get a binder to keep the materials in, and a one-year membership in the International Performing Magicians with a plastic membership card that has your name gold-embossed. You get a one-year subscription to our quarterly newsletter "IT's MAGIC!" Order now! \$29.95 for each course + \$3.50 postage and handling. (New York residents add applicable state and local sales tax). **THE MAGIC COURSE**, 500-B BiCounty Boulevard, Farmingdale, NY 11735.

LEARN IBM PC assembly language. 80 sample programs. Disk \$5. Book \$18. **ZIPFAST**, Box 12238, Lexington, KY 40581-2238.

LEARN electronics the practical way. Build your own kit or do tens of experiments with your own self trainer. For free catalog: **ARLI ELECTRONICS**, 2155 Verdugo Blvd. #22, Montrose, CA 91020.

BUSINESS OPPORTUNITIES

EASY work! Excellent pay! Assemble products at home. Call for information. (504) 641-8003 Ext. 5192.

MAKE \$50/hr working evenings or weekends in your own electronics business. Send for free facts. **INDUSTRY**, Box 531, Bronx, NY 10461.

YOUR own radio station! AM, FM, TV, cable. Licensed/unlicensed. **BROADCASTING**, Box 130-F1, Paradise, CA 95967.

INVENTIONS, ideas, technology wanted for presentation to industry/exhibition at national innovation exposition. Call 1 (800) 288-IDEA.

BYOB Begin your own business. High profits. No gimmicks. Free details. **JSR ENTERPRISES**, Box 249, Dept 2121, Orange Park, FL 32067-0249.

NUTS & VOLTS P.O. Box 1111-E
MAGAZINE Placentia, CA 92670
714-632-7721

GIVE YOURSELF A BREAK — A PRICE BREAK!
NUTS & VOLTS WILL *Save* YOU MONEY
ON ELECTRONIC PARTS & EQUIPMENT
Plus SHOW YOU WHERE TO FIND UNIQUE,
UNUSUAL AND HARD-TO-FIND ITEMS.

SUBSCRIBE TODAY!

A National Publication For The Buying And Selling Of Electronic Equipment

Subscription Rates U.S. FUNDS REQUIRED	
3rd Class Mail - USA	
One Year \$12.00	
Two Years \$21.00	
Lifetime \$60.00	
1st Class Mail	
One Year USA \$20.00	
Canada/Mexico \$22.00	
Foreign - 1 Yr. \$55.00	

Air Mail

MAKE \$75,000 to \$250,000 yearly fixing IBM monitors, no investment, start from home, (a telephone required). Information USA, Canada \$1.00, Europe, Middle East \$8.00. **RANDALL DISPLAY**, Box 2168-R, Van Nuys, CA 91404 USA.

PROJECTION TV... Make \$\$\$'s assembling projectors. Easy!... Results comparable to \$2,500 projectors... **Plans, 8" Lens & dealers information** \$22.50... Professional systems available... Illustrated catalog free. **MACROCOMA**, 15GEX Main Street, Washington Crossing, PA 18977... Credit-card orders 24 Hrs. (215) 736-2880.

LET the government finance your small business. Grants/loans to \$500,000. Free recorded message: (707) 449-8600. (KS1)

LEARN gold, silver, platinum scrap recycling business. Free information. Write: **RECYCLING**, Box 11216RT, Reno, NV 89510-1216.

WANTED

INVENTIONS/new products/ideas wanted: Call TLCI for free information 1 (800) 468-7200 24 hours/day - USA/Canada.

INVENTORS! Confused? Need help? Call IMPAC for Free information package. In US and Canada: 1 (800) 225-5800.

*****PRESENTING*****

CABLE TV DESCRAMBLERS

***** STARRING *****
JERROLD, HAMLIN, OAK
AND OTHER FAMOUS MANUFACTURERS

- FINEST WARRANTY PROGRAM AVAILABLE
- LOWEST RETAIL/WHOLESALE PRICES IN U.S.
- ORDERS SHIPPED FROM STOCK WITHIN 24 HOURS

FOR FREE CATALOG ONLY **1-800-345-8927**
FOR ALL INFORMATION 1-818-716-5914

PACIFIC CABLE CO. INC.
7325 1/2 RESEDA BLVD., DEPT. RET 89
RESEDA, CA 91335

DESCRAMBLER MODULE

LATEST technology alternative to Jerrold SB-3 or Radio-Electronics Feb. 1984 project. Featuring electronic tuning, AGC, auto-on/off, AC/DC power, mini-size, A&T, and more. For literature — **SOUTH-TECH DISTRIBUTING**, (813) 527-2190.

INVENTORS

INVENTORS! Can you patent and profit from your idea? Call **AMERICAN INVENTORS CORPORATION** for free information. Over a decade of service 1 (800) 338-5656. In Massachusetts or Canada call (413) 568-3753.

MASTERCARD AND VISA are now accepted for payment of your advertising. Simply complete the form on the first page of the Market Center and we will bill.

CONSOLIDATED ELECTRONICS

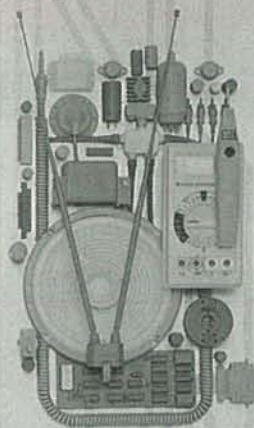

CONSUMER & INDUSTRIAL ELECTRONICS CATALOG • 17TH EDITION

THE ULTIMATE ELECTRONICS CATALOG.

Order your 260 page catalogue packed with over 10,000 money saving electronic parts and equipment. Send \$3.00 check or money order, or call 1-800-543-3568 today and use your Mastercard or Visa.

Consolidated Electronics, Incorporated
705 Watervliet Ave., Dayton, Ohio 45420-2599

NAME _____
ADDRESS _____
CITY _____
STATE _____ ZIP _____

CIRCLE 70 ON FREE INFORMATION CARD

FREE CATALOG! 1-800-648-7938

For all information 1-702-362-9026

JERROLD HAMLIN OAK ETC.

CABLE TV DESCRAMBLERS

- Compare our low Low Retail Prices!
- Guaranteed Prices & Warranties!
- Orders Shipped Immediately!

REPUBLIC CABLE PRODUCTS INC.

4080 Paradise Rd. #15 Dept. RE-90

Las Vegas, NV 89109



PROJECT CABINETS/ ENCLOSURES

RIGID 1/16 aluminum shell, hardwood trim, contemporary styling. Several sizes and styles available. \$10.99 — \$26.99, free brochures. PYRAMID ELECTRONIC PRODUCTS, 15020 LaGrange Road, Suite 2100, Orland Park, IL 60462.

MULTI CHANNEL MICROWAVE ANTENNAS

- CRYSTAL CONTROLLED MICROWAVE ANTENNAS FOR OVER THE AIR CABLE SYSTEMS (WIRELESS CABLE)
 - CAPABLE OF RECEIVING 30 CHANNELS
 - CONVERTERS AVAILABLE FOR ZENITH SYSTEMS
- CALL FOR PRICE (203) 622-4386

VIDEO-LINK ENTERPRISES

165 W. PUTNAM AVE. GREENWICH. CT 06830

DIGITAL CAR DASHBOARDS

BUILD yourself complete electronic dashboards. Information package: \$2.00 (refundable). MODERN LABS, 2900-F Ruisseau, Saint-Elizabeth, QC, J0K 2J0, Canada.

COMPUTER BOOKS

DISCOUNT computer books. All titles available, including recent releases. Please call or write for our latest catalog. BOOKWARE, 147 Campville Road, Northfield, CT 06778. 1 (800) 288-5662.

CABLE TV DESCRAMBLER LIQUIDATION!

- Major Makes & Models!
- Will match or beat anyone's prices!
- Dealer discounts at 5 units!
- Examples:
HAMLIN COMBOS . \$44 ea. (Min. 5)
OAK ADD/ON \$40 ea. (Min. 5)
OAK M35B \$60 ea. (Min. 5)

WEST COAST ELECTRONICS

For Information: 818-709-1758

Catalogs & Orders: 800-628-9656

PRESERVATION...PLAN ON IT

National Trust for Historic Preservation
Dept. PA, 1785 Massachusetts Ave., N.W.
Washington, D.C. 20036

But What Do All These Good Ideas Mean? Lower Prices!

For the past few months we have been telling you, among other things, that because we ask for a \$35 a year Membership Fee we do not force our customers to subsidize the cost of sending hundreds of thousands of Catalogs every few months to everyone on our Mailing List, and because our Catalog is actually a 2-inch three ring binder we do not waste money in sending the same old stuff to our customers over and over again. So what do all these cost saving ideas mean? Much lower prices than anywhere else on more than 10,000 items of electronic components. The following is a sample listing of some of these low prices:

- | | |
|---|--|
| ★ 1/4 Watt, 5%, Carbon Film Resistors: \$0.77/100, \$4.76/1000 | ★ 1/4 Watt, 1%, Metal Film Resistors: \$0.32/10, \$1.16/100, \$8.25/1000 |
| ★ 74HC00, 74HCT00, 74LS00 Integrated Circuits: \$0.18/1, \$144.00/1000 | ★ LM741 Operational Amplifiers: \$2.00/10, \$165.24/1000 |
| ★ 78xx Positive Voltage Regulators (TO-220): \$0.38/1, \$30.80/100 | ★ 79xx Negative Voltage Regulators (TO-220): \$0.48/1, \$39.60/100 |
| ★ Cambion Low Profile 14-Pin Solder-Tab Sockets: \$0.10/1, \$73.92/1000 | ★ Panasonic 15-Turn Rectangular Trim Pots: \$1.10/1, \$632.00/1000 |
| ★ Panasonic ECQ-V 0.1µF, 50V Bypass Capacitors: \$0.93/10, \$64.53/1000 | ★ Panasonic Dipped Tantalum 10µF, 25V Capacitors: \$5.11/10, \$354.67/1000 |
| ★ Package of 50, 3.0" Overall Length Wire-Wrap Wire: \$0.60/1 | ★ AP Products (Associated Electronics/3M): 20% Off List |
| ★ 1N4001 Rectifier Diodes: \$0.42/10, \$28.52/1000 | ★ 1N4148 Switching Diodes: \$0.28/10, \$19.44/1000 |
| ★ 2N2222A Transistors: \$0.32/1, \$22.20/100, \$185/1000 | ★ 2N3906 Transistors: \$7.20/100, \$60.00/1000 |
| ★ Howard W. Sams and Hayden Books: 34% Off Cover Price | ★ Hammond Manufacturing Cases: 20% to 30% Off List |

12 Months Saving Guarantee

We will refund the first year Membership Fee of any member who has purchased \$300 or more worth of products from Electronic Buyers Club and has not saved an amount greater than the first year Membership Fee, if buying the same items elsewhere.

These are not just a select number of items that we have chosen as 'Loss Leaders'. In fact we have been selling these items for the same (or lower) prices for the past 4 years! There are no grouping or volume purchase requirements to obtain these prices either! Become a Member today so you can start saving on all of the more than 10,000 items that we stock.

30 Days Money Back Guarantee

We will refund the full Membership Fee of any new member of Electronic Buyers Club who within 30 Days after receiving the Membership Binder, returns the Binder to EBC and asks for the cancellation of Membership.

**Electronic
Buyers
Club**

A Division of International Components Corporation

1803 N.W. Lincoln Way • Toledo, OR 97391

PHONE (All 50 States & Canada): 1-800-325-0101

FAX: (503) 336-4400 • Hours: 6:00 AM - 6:00 PM PST



CD PLAYERS

continued from page 56

disc. That reduction in speed maintains a constant linear velocity and constant rate of data flow as the disc is played. In fact, adding mass to the disc may exacerbate an imagined speed problem by making it more difficult for a player to change rotational speed when it needs to. Furthermore, since data from a CD is buffered in memory before being acted on, the effects of any speed variations, real or imaginary, disappear anyway for all practical purposes.

Quite a few players include such features as optocoupling between stages, separate power supplies, special chassis, and optical/digital outputs. The first three are intended to keep one section of a player from affecting, and interfering with, the workings of another. Optocoupling (converting an electrical signal to light, and then back to electricity again to convey it from one stage of the device to another) is said to eliminate interstage interference and to

transfer digital waveforms more accurately than more conventional hookup techniques. Separate power supplies, too, promise cleaner operation, the idea being that fluctuations arising in one power supply from the demands of one part of a player's circuitry will not affect the performance of the other parts. Some chassis are touted for their abilities to reject or absorb vibration, thus making it easier for a player to track the disc it's playing. Finally, optical/digital outputs can convey the output of the player—still in digital form—to an amplifier equipped with digital inputs, thus, in theory, presenting it with a purer signal for processing and amplification. Transferring the digital signal in the form of light rather than electricity also prevents contamination in the form of hum or other electrical noise.

The efficacy of any, or all, of those features can be demonstrated only if the rest of an audio system is capable of reproducing the supposed benefits, and appreciated only if your ears are capable of discerning them. That, in the end, will be the final proof of the pudding. R-E

ASK R-E

continued from page 14

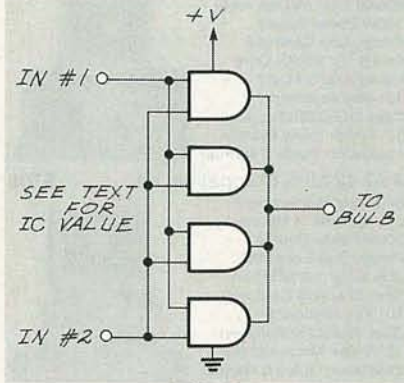













FIG. 2

A much easier way to do the job is shown in Fig. 2. I've ganged the four AND gates in a single package in parallel to provide a bit of extra drive for the output transistor (or relay). You should use CMOS parts, as they're perfectly happy working from twelve volts. Using a TTL part means having to add a 5-volt regulator to the circuit and that's a good way to make things more complicated. R-E

YOU CAN ONLY FIND A WIDE RANGE SELECTION OF ELECTRONIC KITS AT MARK V ELECTRONICS, INC.

▲ indicates the level of difficulty in the assembling of our Products. ▲ Beginner ▲▲ Intermediate ▲▲▲ Advanced ★ Fully Assembled

					
SM-328	FC-1000A	TY-45	TR-355 A / B	TA-28	SM-48A
					
TA-3600	TA-802	TA-477	SM-333	SM-666	

AMPLIFIERS			MISCELLANEOUS		
MODEL	DESCRIPTION	KIT ASSEMBLED	MODEL	DESCRIPTION	KIT ASSEMBLED
TA-001	1W Mini-Amplifier ▲	\$ 5.07	TY-1A	Battery Fluorescent Light Driver ▲	\$ 5.19
TA-006	6W Mini-Amplifier ▲	6.90	TY-7	Electronic Touch Switch ▲	7.15
TA-007	12W Mini-Amplifier ▲	11.20	TY-8	Electronic Lotto ▲	15.00
TA-10	Stereo Pre-Amp. w/magnetic mic. amp. ▲	8.20	TY-11A	Multi-Functional Control Switch ▲	5.19
TA-28MK2	Digital Voice Recorder ▲▲	30.00	TY-12A	Digital Clock w/timer ▲	16.63
TA-50A/B	Multi-Purpose Melody Generator ▲	11.84	TY-13	Color Led Audio Level Meter ▲	20.15
TA-50C	Multi-Purpose Melody Generator ▲	12.65	TY-14	Electronic Shock ▲	6.25
TA-120MK2	Class "A" Main Power Mono Amp. ▲▲	31.25	TY-18	High Precision Sound Control Switch ▲	9.22
TA-300	30W Multi-Purpose Single Channel Amp. ▲	20.00	TY-20	V Shape Color Led Level Meter ▲	21.45
TA-302	60W Stereo Power Booster ▲▲★	50.00	TY-23B	3 Channel Color Light Controller ▲▲▲★	71.50
TA-3221	50W + 50W IC Stereo Amp. w/led level display ▲	35.50	TY-25	Stereo Loudspeaker Protector ▲	12.65
TA-323A	HQ 30W + 30W Stereo Amp. ▲	29.50	TY-35	FM Wireless Microphone ▲	9.22
TA-377A	FET Stereo Pre-Amp. ▲▲▲	59.95	TY-36	AC/DC Quartz Digital Clock ▲	18.00
TA-400	40W Solid State Mono Amp. ▲	28.00	TY-38	Sound/Touch Control Switch ▲	12.00
TA-477	120W Mostet Power Mono Amp. ▲▲	68.00	TY-41 MK111	Infrared Remote Control Unit ▲▲▲	15.00
TA-800	80W + 80W DC Pre-Main & Power Amp. ▲▲	60.92	TY-41 MKV	Infrared Remote Control Unit ▲▲▲	20.00
TA-802	80W + 80W DC Stereo Main Power Amp. ▲▲	45.94	TY-42	Bar/Dot Level Meter ▲▲	24.15
TA-820A	60W + 60W OCL DC Pre-Main Stereo Amp. ▲▲	48.00	TY-43	3 1/2 Digital Panel Meter ▲	33.00
TA-1000A	100W Class "A" Main Power Mono Amp. ▲▲	59.69	TY-45	20 Steps Bar/Dot Audio Level Display ▲▲	38.45
TA-1500	100W x 2 Class "A" DC Stereo Pre-Main Amp. ▲▲▲	73.70	TY-47	Superior Electronic Roulette ▲▲▲	19.46
TA-2400A	Electronic Echo & Revelation Amp. ▲▲▲★	93.30	SM-222	7 Bands Graphic Equalizer ▲▲▲★	26.80
TA-2500	HQ Pre-Amp. w/10 band graphic equalizer ★		SM-328	4 Channel Professional Color Light Controller ★	38.80
TA-2800	Hi-Fi Bi-Fet Pre-Amp. w/3 way tone control ▲▲	48.90	SM-333	Audio/Video Surround Sound Processor ▲▲▲★	62.00
TA-3000	Stereo Simulator ▲	33.20	SM-666	Dynamic Noise Reduction ▲	26.00
TA-3600	300W HQ Hi-Fi Power Mono Amp. ▲▲▲	86.00	T-1	LCD Thermometer Clock w/in-outdoor sensor ★	34.00
			T-2	LCD Thermometer Clock w/ F & C measurement ★	22.00
			# 8501	Parrot Talking Clock ★	12.20
			# 8504	Mynah Talking Clock ★	12.20

— WE ACCEPT MAJOR CREDIT CARDS, MONEY ORDERS AND CHECKS — BUSINESS & SHOWROOM HOURS: (PACIFIC TIME) MON. - FRI.: 9:30 A.M. - 5:00 P.M., SAT.: 10:00 A.M. - 5:00 P.M. TERMS: \$10.00 MIN. ORDER * \$20 MIN. CHARGE CARD ORDER * WE SHIP UPS GROUND * ADD 10% OF TOTAL ORDER (MIN. \$3.00) FOR SHIPPING OUTSIDE USA. ADD 20% (MIN. \$5.00) * TRANSIT INSURANCE: ADD 5% OF TOTAL (OUTSIDE USA ONLY) CA RESIDENTS ADD SALES TAX * ALL MERCHANDISE SUBJECT TO PRIOR SALE * PRICES ARE SUBJECT TO CHANGE WITHOUT NOTICE * WE ARE NOT RESPONSIBLE FOR TYPOGRAPHICAL ERRORS.

CATALOG OR INFORMATION: 213-888-8988, * PHONE ORDER: 1-800-423-3483 (IN CALIF.) 1-800-521-MARK FAX: 213-888-6868

MARK V ELECTRONIC, INC. — 8019 E. Slauson Ave., Montebello, CA 90640

CIRCLE 93 ON FREE INFORMATION CARD

JANUARY 1990

ASSEMBLE YOUR OWN COMPUTER FOR LE\$\$

IBM XT 10 MHz Compatible Kit.....\$379

- 4.77/10 MHz Motherboard
- 256KB RAM (640KB max)
- 150W Power Supply
- Floppy Disk Controller
- One 5 1/4" 360KB Drive
- MonoGraphics Card w/ P
- 101 Key Keyboard
- Case (3LED,2Button,Key)
- 12" Amber Mono Monitor
- Installation Guide & Manual



IBM AT 12 MHz Compatible Kit.....\$705

- 8/12 MHz Motherboard
- 512 KB RAM (4 MB max)
- 200W Power Supply
- Floppy Disk Controller
- One 5 1/4" 1.2 MB Drive
- MonoGraphics Card w/ P
- 101 Key Keyboard
- Case (3LED,2Button,Key)
- 12" Amber Mono Monitor
- Installation Guide & Manual



Display Upgrade:

- CGA Package \$200
- EGA Package \$455
- VGA Package \$500

Hard Drive Option:

- 20MB w/CTRL XT-\$275 AT-\$315
- 30MB w/CTRL XT-\$310 AT-\$410
- 40MB w/CTRL XT-\$390 AT-\$415

MS-DOS with GWBASIC \$75

All Components Fully Tested Before Ship

VISA & M/C subject to 3% surcharge

Price & Quantity subject to change without prior notice

15% Restocking Fee on All Items

JINCO COMPUTERS INC.

5122 WALNUT GROVE AVE.

SAN GABRIEL, CA 91776

Tel: (818) 309-1108

Fax: (818) 309-1107

IBM, XT, AT are registered trademarks of International Business Machine.

CIRCLE 137 ON FREE INFORMATION CARD

SHORTWAVE RADIO

continued from page 78

casting spectrum, and formal a priori planning was their only means of obtaining a fair share of shortwave frequencies.

Ultimately, WARC-79 arrived at a solution: there would be a 33% increase in the amount of spectrum allocated to high-frequency broadcasting in exchange for the convening of a two-session high-frequency broadcast planning conference.

Table 1 indicates how the high-frequency broadcasting allocations were expanded at WARC-79. The important 6- and 7-MHz bands were not expanded at all, in spite of the protests of the United States and 21 other administrations. The little-used 26-MHz band was reduced by 70 kHz.

WARC-79 stipulated that the use of the expanded bands would be regulated by provisions agreed to at the broadcast-planning conferences, fixing the dates of availability in two stages: Frequencies above 10 MHz would become available on July 1, 1989; frequencies below 10 MHz would become available July 1, 1994. However, some movement into the 1979 expansion bands commenced immediately after WARC-79, and has continued ever since.

Broadcast-planning conferences were held in 1984 and 1987, and a third is expected to be convened in the early 1990's (see WARC-84, *Radio-Electronics*, November 1984; and HFBC-87, *Radio-Electronics*, February 1988). However, many formidable obstacles remain.

- The desires of smaller, less-developed countries to have guaranteed protected access to the HF broadcasting spectrum have yet to be satisfied.
- There is insufficient spectrum to satisfy the needs of broadcasters, large and small alike. The popularity of the medium has never been greater, and more administrations than ever before see it as an essential adjunct to their foreign-policy goals.
- During the next several years there will be preparations for another broadcasting conference. It

will be necessary for it to find a way of fitting a sufficient number of requirements into the planned portion of the spectrum. That, just by itself, will be a formidable task.

It is therefore likely that neither the broadcasters seeking equitability in the planned portion of the spectrum, nor those with a substantial number of assignments in the coordinated portion of the bands will find the next planning exercise entirely acceptable.

Figure 2 is reprinted from a European Broadcasting Union report entitled *Statistics of the Occupancy of the HF Bands for Broadcasting*. It indicates, in daily frequency hours, how HF broadcasting has grown between 1954 and 1981. More-recent data, provided by the BBC, also plotted on Fig. 2, indicates that in-band broadcasting has tapered off in recent years. However, an analysis of out-of-band broadcasting clearly indicates that it has continued to increase. Projected growth to 1995 is shown with dotted lines.

At present, more than 60 countries are operating out-of-band. The WARC-79 expansion bands are already largely occupied. Moreover, about 50 administrations are broadcasting in portions of the 6-, 7-, and 9-MHz bands allocated to other services, including the aeronautical and maritime mobile, the amateur, and the fixed services.

Figure 2 is particularly significant because it indicates that broadcasters appear to have grown impatient battling for reliable frequencies in the allocated portions of the spectrum. Instead, they are moving out-of-band, in search of clear channels in relatively non-congested areas of the spectrum. That may be the most disquieting aspect of our look at the future of HF broadcasting.

The future

Broadcasters are now operating in portions of the HF spectrum allocated to virtually every other service. It is feared that the trend toward *de facto* band expansion will continue. There are several reasons for that:

- Relatively inexpensive shortwave receivers which tune the entire shortwave spectrum continu-

3 FOR 1 SPECIAL

ON SUB-MINIATURE VOICE
FM TRANSMITTERS.
KITS CONTAIN PC BOARDS



*FMX-1 LONG RANGE (3 MI) ULTRA SENSITIVE FM VOICE XMTR with fine tune, range control plus.....\$29.50



*TELX-1 TELEPHONE FM XMTR (3 MI) automatically operates when phone is used. Crystal clear clarity with fine tune and range control. Non detectable.....\$29.50



*ATR-1 AUTOMATIC TELEPHONE RECORDING DEVICE tapes telephone conversation all automatically.....\$19.50

ALL THREE OF ABOVE FOR.....\$59.50

CALL OR SEND VISA, MASTER CHARGE, MONEY ORDER, ETC. TO AMAZING CONCEPTS, BOX 716, AMHERST, NH 03031. (603) 673-4730.

ously, from 3 to 30 MHz, have become available.

- As sophisticated communications techniques (satellite, scatter, etc.) become less costly, their use will expand into developing areas of the world. Consequently, the need for HF frequencies to carry fixed services will decrease, enabling some of the less-developed countries to make more use of out-of-band frequencies.

- Several Asian and European administrations, having little or no amateur services of their own, have found the amateur 40-meter band to be fertile ground.

- There is no prospect of legal band expansion taking place in this century. Any re-allocation of spectrum to the shortwave broadcasting service will have to await the re-accommodation of services currently using the spectrum.

The elements of a bandless HF broadcasting spectrum are therefore in place. Remedial actions taken by the next HF Broadcasting Conference will, it is hoped, effectively stem the tide in the twenty-first century.

R-E

AUDIO MUTE

continued from page 44

the grounds of J2 and J4, but leave both pairs separate.

That isolates the two channels, but make certain that there's no accidental short between the two channels, like a solder splash. Thus, only in the case of two mono sources, should there be three separate grounds; the main one for the audio-muting circuit, the one for the J1-J3 channel, and a separate one for the J2-J4 channel. (Figs. 1-3 show the two grounds that would normally be present for stereo audio.)

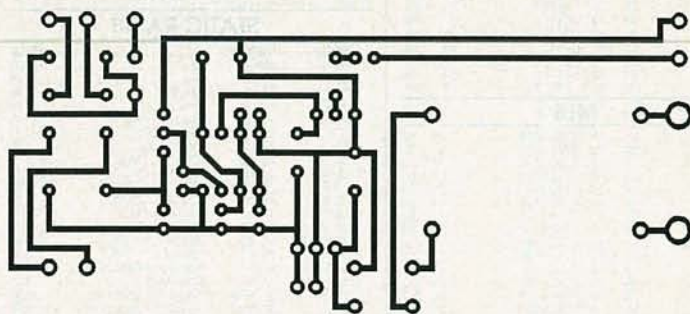

Audio-muting circuit's solder-side foil pattern

Construction

This is a very simple project to build. The parts-placement diagram is shown in Fig. 2, and the foil pattern is shown below. You might, however, want to build the circuit on either breadboard or perfboard. You can stuff the PC board in any order, and you might want to use sockets for Q1, Q2, and IC2, even though they weren't used in the prototype. When you're finished building the circuit, check for mistakes like solder splashes, or diodes, transistors, or IC's inserted backwards. The completed board can be installed in any suitable case.

R-E

Parts Express
International Inc.

EMINENCE



MOTOROLA

Polydax

1-800-338-0531

PIONEER

3-WAY 100W CROSSOVER

12 dB/octave rolloff. 800Hz, 5000Hz crossover points. 8 ohm. 100 watts RMS.



#260-210 **\$12.50** **\$9.95**
(1-9) (10-up)

SPEAKER CONTROL PANEL

Panel with 50 watt L-pads for tweeter and midrange and built-in LED power meter. 5" x 2 1/2" 100 watt version available



#260-235 **\$14.50** **\$12.90**
(1-5) (6-up)

12" POLY WOOFER

Super duty, 40 oz. magnet. 100 watts RMS, 145 watts max. 4 and 8 ohm compatible (6 ohm). 2" voice coil. fs = 25 Hz. QTS = .166. VAS = 10.8 cu. ft. Response: 25-1500 Hz. Net weight: 9 lbs. Pioneer #A30GU40-51D



#290-125 **\$36.80** **\$34.50**
(1-3) (4-up)

WALNUT SPEAKER CABINET KIT

Super quality, genuine walnut veneer cabinet. Kit includes: routed and mitred top, sides, and bottom in unfinished 3/4" walnut veneer. Cut your own custom holes in the front and rear to match your drivers. 15" x 24" x 11". Volume: 1.9 cubic feet.



#260-350 **\$22.50** **\$19.95**
(1-3) (4-up)

PIONEER HORN TWEETER

Mylar dome. 2.93 oz. barium ferrite magnet. 8 ohm. Response: 1800-20000 Hz. 35W RMS, 50W max. fs = 2000 Hz, SPL = 106 dB. Pioneer #AHE60-51F



#270-050 **\$6.50** **\$5.90**
(1-9) (10-up)

12" SUB WOOFER

Dual voice coil sub woofer. 30 oz. magnet, 2" voice coils. 100 watts RMS, 145 watts max. fs = 25 Hz. 6 ohm (4 and 8 ohm compatible). SPL = 89 dB 1W/1M. Response: 25-700 Hz. QTS = .31, VAS = 10.3 cu. ft. Pioneer #A30GU30-55D. Net weight: 6 lbs.



#290-145 **\$39.80** **\$36.80**
(1-3) (4-up)

15" THRUSTER WOOFER

Thruster by Eminence. Made in USA. Poly foam surround, 56 oz. magnet. 2-1/2", 2 layer voice coil. 150 watts RMS, 210 watts max. 4 ohm. fs = 23.5 Hz, QTS = .33, VAS = 17.9 cu. ft. SPL = 94.8 dB 1W/1M. Net weight: 15 lbs.



#290-180 **\$43.50** **\$39.80**
(1-3) (4-up)

GRILL FRAME KIT

With this kit you can make speaker grill frames up to 30" x 40". Kit includes 4 corner pieces, 2 "T" brackets, and 7 frame bars. Grill mounting kit included.

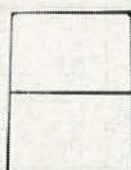

#260-333 **\$8.50** **\$7.80**
(1-9) (10-up)

18" EMINENCE WOOFER

MADE IN USA

100 oz. magnet, 3" voice coil. 250 watts RMS, 350 watts max. 8 ohm, 30 Hz resonant frequency. 22-2700 Hz response. Efficiency: 95 dB 1W/1M. Paper cone, treated accordion surround. Net weight: 29 lbs.



#290-200 **\$98.90** **\$89.50**
(1-3) (4-up)

TITANIUM COMPOSITE TWEETER

Titanium is deposited on a polymer dome to combine the advantages of both hard and soft dome technologies. 8 ohm. Ferro fluid cooled voice coil. fs = 1200 Hz, SPL = 90 dB 1W/1M. 50 watts RMS, 70 watts max. 4" round. Polydax part #DTW100T125.



#270-047 **\$27.50** **\$24.80**
(1-9) (10-up)

Parts Express

340 E. First St. Dayton, Ohio 45402
Local: 1-513-222-0173
FAX: 513-222-4644

* 15 day money back guarantee *\$15.00 minimum order *We accept Mastercard, Visa, Discover, and COD orders *24 hour shipping *Shipping charge = UPS chart rate *\$1.00 (\$3.00 minimum charge) *Hours: 8:30 am-6:00 pm EST, Monday - Friday *Mail order customers, please call for shipping estimate on orders exceeding 5 lbs.



JANUARY 1990

Now Available...Jameco's NEW 1990 Catalog with 80 pages of Computer Peripherals, Components & More!

Oscilloscope Probes

Attenuation: x1 / x10
Capacitance
180: 180pF
210: 180pF
2pF; (LF210):
2pF / 17pF



180 40MHz Oscilloscope
Probe \$19.95
210 100MHz Oscilloscope
Probe \$29.95

TEST EQUIPMENT

oldStar 20MHz Oscilloscope
and 1GHz Frequency Counter



GS7020
Large 6" rectangular display • High
sensitivity: 1 mV/div

57020 Oscilloscope.....\$399.95
Wide measuring range • Measured
true hold function

57102 Frequency Counter \$299.95

Cometheus 9600 Baud Modem



100E External 9600 Baud \$749.95
100B Internal 1200 Baud \$49.95
100B Internal 2400 Baud \$99.95

Metex Digital Multimeters

Metex General Specs:
Handheld, high accuracy
AC/DC Voltage, AC/DC
Current, Resistance, Diodes,
Continuity, Transistor hFE
Manual ranging w/overload
protection



M4650
3650, 3650B & M4650 only:
Also measure frequency and capacitance
M4650 only: • Data Hold Switch • 4.5 Digit

3610 3.5 Digit Multimeter \$49.95
3650 3.5 Digit Multimeter w/Frequency &
Capacitance \$69.95
3650B Same as M3650 w/Bargraph \$79.95
M4650 4.5 Digit w/Frequency, Capacitance and
Data Hold Switch \$99.95

PROTOTYPING PRODUCTS Jameco Solderless Breadboards

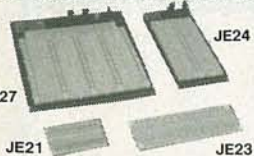

JE24
JE27
JE21
JE23

Part No.	Dim. L" x W"	Contact Points	Binding Posts	Price
E21	3.25 x 2.125	400	0	\$4.95
E23	6.5 x 2.125	830	0	\$6.95
E24	6.5 x 3.125	1,360	2	\$12.95
E25	6.5 x 4.25	1,660	3	\$17.95
E26	6.875 x 5.75	2,390	4	\$22.95
E27	7.25 x 7.5	3,220	4	\$32.95

Prototype Design Stations

WM2

WM1 & WM2 Features: • Removable solderless breadboard • Variable and fixed DC power supply • Multi-frequency signal generator • Analog multimeter • 8 bicolor LEDs (red & green) • 8 logic switches • Logic probe • Lighted power switch • Fuse overload protected • Sturdy ruggedized case

WM1 Special Features: • 4 potentiometers • Built-in speaker

WM2 Special Features: • Pulse Generator • Binary coded decimal (BCD) to 7-segment decoder/driver • DB25 connector • Frequency counter (1Hz to 1MHz)

WM1 Analog Prototype Station \$199.95

WM2 Digital Prototype Station \$249.95



IBM Compatible Cases and Power Supplies

JE2012



JE1030

JE1010 Flip-Top Standard PC/XT Case \$39.95
JE1011 Side Standard PC/XT Case \$39.95
JE1018 Side Baby AT Case \$59.95
JE1030 150 watt PC/XT Power Supply \$59.95
JE1032 200 watt Baby AT Power Supply \$89.95
JE2011 Vertical Case w/300W Pwr. Supply \$279.95
JE2012 Mini-Vertical Case w/200W Pwr. Supply \$149.95
JE2014 Flip-Top Baby XT Turbo Case \$69.95
JE2019 Flip-Top Baby AT Case \$69.95

Display Monitors and Packages

AMBER 12" Amber Monochrome \$99.95
HD55H 14" RGB 640 x 240 \$249.95
M9070S 16" Multiscan Monitor 1280 x 800 \$1099.95
TM5154 14" EGA 720 x 350 \$369.95
JE1059 TM5154 EGA Monitor & EGA Card \$459.95
TM5156 14" VGA 720 x 480 \$399.95
JE2060 TM5156 VGA Monitor & VGA Card \$529.95
TM5157 14" Multiscan 800 x 600 \$469.95
JE2057 TM5157 Multiscan Monitor & EGA Card ... \$559.95



A.R.T. EPROM Programmer



• Programs all current EPROMs in the 2716 to 27512 range plus the X2864 EEPROM • May be operated by any RS232 port w/terminal emulation • Fully intelligent • ASCII command driven • Menu driven software included
EPP \$179.95

UVP EPROM Eraser



• Erases all EPROM's • Erases 1 chip in 15 Min. and 8 chips in 21 min. • Maintains constant exposure distance of 1" • Special conductive foam liner eliminates static build-up • Built-in safety lock • UV intensity: 6800 UW/CM²
DE4 \$69.95

Jameco IBM PC/XT/AT Compatible Keyboards



JE2017

JE2015 84-Key Standard AT Style
Layout \$59.95
JE1016 101-Key Enhanced Layout
with 12 Function Keys \$69.95
JE2016 111-Key Enhanced with Solar
Powered Calculator \$79.95
JE2017 104-Key Enhanced with Trackball
(140 DPI Resolution) \$99.95

Soldering and Desoldering Stations



XY1683
XY999

60 Watt Digital Display Soldering Station • Electronic temperature control from 200° to 878°F • Temperature displayed on easy to read .560"H 3-digit LED readout • Nichrome heating element
XY960 \$99.95
60 Watt Analog Display Soldering Station • Electronic temperature control from 200° to 878°F • Cartridge heating element for a longer life of the soldering tip
XY1683 \$59.95
60 Watt Analog Display Soldering Station • Electronic temperature control from 200° to 878°F • Ceramic heating element for a steady temperature and long life
XY2660 \$89.95
30 Watt Electronic Temperature Controlled Desoldering Station • Electronic temperature control from 212° to 842°F • Self-contained high rotary vacuum pump
XY999 \$279.95

Hard & Hard/Floppy Disk Controller Cards

Computer Type	MFM Hard		RLL Hard		MFM Hard/Floppy		RLL Hard/Floppy	
	Part No. / Price	Part No. / Price	Part No. / Price	Part No. / Price	Part No. / Price	Part No. / Price		
8088 (PC/XT) @ 3:1 Interleave	XTGEN\$79.95	1004A27X\$89.95	JE1044\$109.95					
80286 (AT) 386 @ 2:1 Interleave	1003VMM1\$129.95	1003VSR1\$149.95	1003VMM2\$149.95	1003VSR2\$169.95				
80286 (AT) 386 @ 1:1 Interleave	1006VMM1\$149.95	1006VSR1\$169.95	1006VMM2\$169.95	1006VSR2\$189.95				

355 Shoreway Road
Elmont, CA 94002
4 Hour Order Hotline (415) 592-8097
AX's (415) 592-2503 or (415) 595-2664
Telex 176043 - Ans. Back: Jameco Blmt
Data Sheets - 50c each
Send \$2.00 Postage for a FREE 80-Page Catalog
© 1990 Jameco Electronics 1/90
JME is a registered trademark of
International Business Machines



Mail Order Electronics - Worldwide
Jameco
ELECTRONICS



\$25.00 Minimum Order - U.S. Funds Only
CA Residents Add 6%, 6.5% or 7% Sales Tax
Shipping - Add 5% plus \$1.50 Insurance
(May vary according to weight and shipping method)
Terms: Prices subject to change without notice.
We are not responsible for typographical errors.
We reserve the right to substitute manufacturers.
Items subject to availability and prior sale.
Products pictured may only be representative.
Complete list of terms/warranties is available upon request.

24-Hour Order Hotline (415) 592-8097 • The Following Services Are Also Available Through (415) 592-8097 From 7AM - 5PM P.S.T.:
• Customer Service • Technical Assistance • Credit Department • All Other Inquiries

★ QUALITY PARTS ★ DISCOUNT PRICES ★ FAST SHIPPING

ALL ELECTRONICS CORP.

3 to 6 Vdc MOTOR with GEARBOX

Probably designed for child's toy. Lever selects 2 forward and one reverse speed. 1st gear approx. 120 rpm/6vdc, 2nd gear approx. 300 rpm/6vdc, Reverse approx. 120 rpm/6vdc.

3.35" X 1.75" X 3.25"
CAT# DCM-10 \$6.00

4 AA BATTERY PACK (USED)

Four AA nickel cadmium batteries connected in series to make a 4.8 volt pack. Batteries are in a 2 X 2 configuration with a 2 pin connector attached. The four batteries can be separated into single AA size solder tab nickel cadmium batteries or resoldered into other configurations.

SPECIAL SALE PRICE - ~~WERE \$4.00 per pack~~ NOW \$3.00 per pack
CAT# NCB-41AAU

6 VOLT D.C. 9.5 AMP/HOUR GEL-CELL

Elpower# 695
6 volt, 9.5 amp/hour rechargeable gel-cell battery.
4.25" X 2.75" X 5.5".
Quick connect terminals.
CAT# GC-695
\$15.00 each

12 VOLT DC MINI FAN

Howard Industries# 3-15-810. Operates on 12 Vdc, 0.10 amp, 1.0 watt. Compact plastic housing, 0.35" square X 1.275" thick, 9 blade fan. Two 9" pigtail leads.
CAT# CF-121 \$9.00 each

115 VAC COOLING FAN

STANDARD SIZE COOLING FAN. Features die cast metal housing for strength and durability. IMPEDANCE PROTECTED 4 1/16" square X 1 1/2" deep.
Factory new 120 Vac fans. CF1-N \$9.50 each

WALL TRANSFORMERS

ALL PLUG DIRECTLY INTO 120 VAC OUTLET

6 Vdc @ 200 ma. CAT# DCTX-620 \$2.25
9 Vdc @ 250 ma. CAT# DCTX-925 \$2.50
18 Vac @ 1 amp. CAT# ACTX-1885 \$3.50

LED'S

STANDARD JUMBO DIFFUSED T 1-3/4 size

RED CAT# LED-1 10 for \$1.50 • 100 for \$13.00
GREEN CAT# LED-2 10 for \$2.00 • 100 for \$17.00
YELLOW CAT# LED-3 10 for \$2.00 • 100 for \$17.00

FLASHING LED

with built in flashing circuit operates on 5 volts...

RED \$1.00 each
CAT# LED-4 10 for \$9.50
GREEN \$1.00 each
CAT# LED-4G 10 for \$9.50

BI-POLAR LED
Lights RED one direction, GREEN the other. Two leads.
CAT# LED-6 2 for \$1.70

LED HOLDER

Two piece holder.
CAT# HLED 10 for 65¢

RELAYS

12 VOLT D.C. COIL S.P.D.T.
Omron# G2E-184P 4 Amp contacts 335 ohm coil. Sugar cube size. .61" X .42" X .44" high. P.C. mount with pins on DIP spacing.
CAT# RLY-787 \$1.50 each

5-6 VDC SIP REED RELAY

Electrol
"Blue Boy"
BBS1A05A10
5-6 Vdc, 500 ohm coil. S.P.S.T., normally open reed relay. 0.5 amp contacts. SIP configuration. 1" X .375" X .3".
CAT# RRLY-SIP5 \$1.10 each • 10 for \$10.00

PHOTO FLASH CAPACITOR

Rubycon# FKX
200 mfd. 330 volts.
0.79" diameter X 1.11" high
Solder loop terminals.
CAT# PPC-200 \$3.25 each
10 for \$30.00 • 100 for \$275.00

22/44 PIN CONNECTOR

.156" pin spacing, 0.200" between double rows, gold contacts, P.C. mounting.
SPECIAL. Same as AMP# 2-530655-6.
CAT# EBC-1G \$1.00 each • 10 for \$8.00

SOUND AND VIDEO MODULATOR

The UM1361-1. Designed for use with T.V. computers. Can be used with video cameras, games or other audio/video source. Built in A/B switch enables user to switch from T.V. antenna without disconnection. Operates on channel 3 or 4. Requires 12 Vdc. Hook up diagram included.
CAT# AVMOD \$5.00 each

LIGHT ACTIVATED MOTION SENSOR

This device contains a photocell which senses sudden change in ambient light. Could be used as a door annunciator or modified to trigger other devices.
5 1/2" X 4" X 1". Operates on 6 Vdc. Requires 4 AA batteries (not included)
CAT# LSMD \$5.75 per unit

1/4 WATT RESISTOR KIT

Ideal for the workshop, this 1/4 watt resistor kit contains 10 pieces each of 42 of the most popular values (420 pieces total). Includes a divided box and a parts locator.

VALUES in this kit are:
1 ohm, 10 ohm, 39 ohm, 47 ohm, 51 ohm, 68 ohm, 100 ohm, 130 ohm, 150 ohm, 180 ohm, 220 ohm, 330 ohm, 470 ohm, 560 ohm, 680 ohm, 1K, 1.2K, 1.5K, 2K, 2.2K, 2.7K, 3K, 4.7K, 5.1K, 5.6K, 10K, 15K, 22K, 30K, 33K, 39K, 47K, 56K, 68K, 100K, 120K, 150K, 220K, 470K, 1 MEG, 5.1 MEG, 10 MEG

The resistors alone would sell for \$21.00.
Complete kit • CAT# REKIT-14 \$17.00

XENON TUBE

1" long flashtube prepped with 3 1/2" red and black leads. Ideal for electronic flash or strobe projects.
CAT# FLT-3 2 for \$1.00

PIEZO WARNING DEVICE

Murata Erie # PKB8-440
High pitched audible alarm. Operates on 3 - 20 Vdc @ 20 ma. 1" high x 7/8" dia. P.C. board mount.
CAT# PBZ-84 \$1.75 each

NICKEL-CAD BATTERIES (RECHARGEABLE)

SPECIAL! AAA SIZE
Panasonic! P-18AAA
1.2 volt @ 180 MAH
CAT# NCB-AAAX \$1.50 each
10 for \$13.50 • 100 for \$125.00

AA SIZE

1.25 volts 500 mAh
CAT# NCB-AA
AA SIZE \$2.20 each WITH SOLDER TABS
CAT# NCB-SAA
C SIZE \$4.25 EACH
1.2 volts 1200 mAh
CAT# NCB-C
D SIZE \$4.50 each
1.2 volts 1200 mAh
CAT# NCB-D

TRANSISTORS

ORDER BY PART #

PN2222 NPN TO-92 5 for 75¢
PN2907 PNP TO-92 5 for 75¢
2N3055 NPN TO-3 \$1.00 each
MJ2955 PNP TO-3 \$1.50 each
MJE2955T PNP TO-220 75¢ each
MJE3055T NPN TO-220 75¢ each
TIP31 NPN TO-220 75¢ each
TIP32 PNP TO-220 75¢ each
TIP121 NPN TO-220 75¢ each
TIP126 PNP TO-220 75¢ each

TIL-99 PHOTO TRANSISTOR

TO-18 case with window. For wide-angle viewing applications. Spectrally and mechanically compatible with TIL-31B. CAT# TIL-99 \$1.00 each • 10 for \$9.00

TIL-31B PHOTO DIODE
TO-18 case with window. Infrared emitting photo diode. CAT# TIL-31B \$1.00 ea. • 10 for \$9.50

N-CHANNEL MOSFET

RF-511 TO-220 case
CAT# IRF 511
\$1.00 each • 10 for \$9.00
LARGE QUANTITY AVAILABLE

L.E.D. FLASHER KIT

Two L.E.D.'s flash in unison when a 9 volt battery is attached. This kit includes a p.c. board, all the parts and instructions to make a simple flasher circuit. A quick and easy project for anyone with basic soldering skills. CAT# LEDKIT \$1.75 per kit

TELEPHONE COUPLING TRANSFORMER

Multi Products International# A19N-HO-1D/1
Primary 600 ohm
Secondary: 600/600 ohm
.77" X .61" X .63" high.
6 p.c. pins on .187" centers.
Primary inductance: 300 mH min., at 1kHz, 1 volt.
CAT# TCTX-1 \$1.25 each • 10 for \$11.00

OPTO SENSOR

U shaped package with mounting ears. 1/8" opening. 3/4" mounting holes. CAT# OSU-6 50¢ each
10 for \$4.50 • 100 for \$40.00

OPTO ISOLATOR

Sigma# 301T1-1281. Signal applied to the input is coupled by means of light to isolated photo conductive cell. High reliability switching. 12 volt input.
CAT# OP-301 \$1.50 each

A.C. LINE CORDS

Black 6ft., 18/2, apt-2
NON POLARIZED PLUG
CAT# LCAC 2 for \$1.00 • 100 for \$45.00
POLARIZED PLUG
CAT# LCP-1 60¢ each • 100 for \$50.00

14.7 VOLT TRANSFORMER

Sprite Industries# CS-510A. 14.7 volt, 60 Hz, 8.82 Va. 1.61" high X 1.95" X 1.47". Mounting holes on 2.32" centers.
CAT# TX-147 \$3.00 each
10 for \$27.00 • 100 for \$250.00

LOOK WHAT \$1.00 WILL BUY

200 ASSORTED 1/4 WATT RESISTORS
Bent leads, carbon comp. and carbon film.
CAT# GRES \$1.00 per assortment

200 ASSORTED 1/2 WATT RESISTORS
Bent leads, carbon comp. and carbon film.
CAT# GRABE \$1.00 per assortment

50 ASSORTED DISC CAPACITORS
Most are cut (p.c. leads). Some to 500 volts
CAT# GRABDC \$1.00 per assortment

15 VALUES OF ELECTROLYTICS
Contains both axial and radial styles from 1 mfd.
CAT# GRABCP \$1.00 per assortment

10 AMP SOLID STATE RELAY

ELECTROL# S2181
CONTROL:
Rated 5.5 hp 10 Vdc (will operate on 3-32 Vdc).
LOAD: 10 amp @ 240 Vac
2 1/4" X 1 3/4" X 7/8"
CAT# SSRLY-10B \$9.50 each
QUANTITY DISCOUNT
10 for \$85.00 • 25 for \$175.00
50 for \$300.00 • 100 for \$500.00

CALL OR WRITE FOR OUR FREE CATALOG OVER 4000 PARTS!



Now 60 pages!

MAIL ORDERS TO:
ALL ELECTRONICS
P.O. BOX 567
VAN NUYS, CA 91408
TWX-5101010163 (ALL ELECTRONIC)
OUTSIDE THE U.S.A.
SEND \$2.00 POSTAGE FOR A CATALOG!!

ORDER TOLL FREE
800-826-5432
INFO: (818)904-0524
FAX: (818)781-2653
MINIMUM ORDER \$10.00
QUANTITIES LIMITED
CALIF. ADD SALES TAX
USA: \$3.00 SHIPPING
FOREIGN ORDERS INCLUDE SUFFICIENT SHIPPING. NO C.O.D.



**4800/2400 BAUD
FAX/DATA MODEM
\$119⁹⁵**

- FAX TRANSMISSION ONLY
- 4800 BAUD FAX CAPABILITY TO ANY GROUP III FAX
- 2400 BAUD V.22BIX DATA MODEM
- XT/AT COMPATIBLE HALF CARD
- MENU-DRIVEN SOFTWARE
- MULTIPLE FAX TRANSMISSIONS TO GROUPED ADDRESSES



**2400 BAUD MODEM
\$89⁹⁵**

- 2400/1200/300 BAUD
- FULL Hayes COMPATIBILITY
- CONFIGURE AS COM1, COM2, COM3 OR COM4 • BUILT-IN SPEAKER • AUTO WAIT-FOR-DIAL TONE AND AUTO-REDIAL • PROCOMM COMMUNICATIONS SOFTWARE • MADE IN THE USA



MINI UPRIGHT CASE \$249⁹⁵

- SMALL FOOTPRINT MINI-UPRIGHT FOR 8088 OR MINI 286/386 MOTHERBOARDS
- ROOM FOR 6 EXPANSION CARDS
- HOLDS 3 5-1/4" & 1 3-1/2" DRIVES (1/2 HT)
- 200 WATT POWER SUPPLY
- 2-DIGIT LED SPEED DISPLAY
- 12" H X 16" L X 8" W



UPRIGHT CASE \$299⁹⁵

- SPACE SAVING DESIGN HOLDS ALL SIZES OF MOTHERBOARDS AND INCLUDES: • 250W POWER SUPPLY
- MOUNTS FOR 3 FLOPPY & 4 HARD DRIVES
- TURBO & RESET SWITCH • LED SPEED DISPLAY • POWER & DISK LED'S
- ALL HARDWARE, FACEPLATES & SPEAKER



MODULAR PROGRAMMING SYSTEM

MODULES USE A COMMON HOST ADAPTOR CARD - 1 SLOT PROGRAMS EPROMS, PROMS, PALS, MORE!

HOST ADAPTOR CARD \$29.95

- UNIVERSAL INTERFACE FOR ALL PROGRAMMING MODULES
- SELECTABLE ADDRESSES PREVENTS CONFLICTS
- MOLDED CABLE



UNIVERSAL MODULE \$499.95

- PROGRAMS EPROMS, EEPROMS, PALS, BI-POLAR PROMS, 8748 & 8751 SERIES DEVICES; 16V8 AND 20V8 GAL'S (GENERIC ARRAY LOGIC/FROM LATTICE, NS, SGS • TESTS TTL, CMOS, DYNAMIC & STATIC RAMS • LOAD DISK; SAVE; DISK; EDIT; BLANK CHECK; PROGRAM, AUTO, READ MASTER, VERIFY AND COMPARE • TEXTOL SOCKET FOR 3" - 6" W. IC'S (8-40 PINS)

EPROM MODULE \$119.95

- PROGRAMS 24-32 PIN EPROMS, CMOS EPROMS & EEPROMS FROM 16K TO 1024K • HEX TO OBJ CONVERTER • AUTO, BLANK CHECK/PROGRAM/VERIFY • VPP 5, 12.5, 12.75, 13, 21 & 25 VOLTS • NORMAL, INTELLIGENT, INTERACTIVE & QUICK PULSE PROGRAMMING ALGORITHMS

OTHER MODULES

- MOD-MPL PAL MODULE \$249.95
- MOD-MIC DIGITAL TESTER MODULE \$129.95
- MOD-MBP BI-POLAR PROGRAMMING MODULE \$259.95
- MOD-MMP MICROPROCESSOR PROG. MODULE \$179.95
- MOD-MPL-SOFT CUPL SOFTWARE \$99.95

VGA COMPATIBLE PACKAGE \$499⁹⁵

- 720 X 540 MAX RESOLUTION, 640 X 480 IN 16 COLORS, 528 X 480 RESOLUTION IN 256 COLORS • IBM STYLE MONITOR
- VGA, EGA, CGA, AND MGA COMPATIBLE



VGA MONITOR \$359.95

- 14" ANALOG VGA • GLARE RESISTANT SCREEN • 720 X 480
- TILT/SWIVEL BASE • FRONT MOUNTED POWER SWITCH

RELISYS MULTISYNCH \$429.95

- FULL FEATURED MULTISCAN MONITOR WITH UNLIMITED COLORS • 1024 X 768 RESOLUTION, 14" NON-GLARE DISPLAY
- AUTO SWITCHING • TTL/ANALOG VIDEO INPUT

JDR-MULTI

- EGA-MONITOR 14" RGB MONITOR \$339.95
- NEC-MULTI-3D DIGITAL 1024X768 RESOLUTION \$649.95
- JDR-MONO 12" TTL MONOCHROME-GREEN \$69.95
- JDR-AMBER 12" TTL MONOCHROME-AMBER \$69.95

QUALITY KEYBOARDS

- STANDARD KEYBOARDS:**
- BTC-5060 AUTOSENSE FOR XT/AT \$59.95
- MAX-5060 WITH TACTILE FEEDBACK \$64.95

- ENHANCED KEYBOARDS:**
- BTC-5339 AUTOSENSE FOR XT/AT, AUTOREPEAT \$69.95
- K103-A AUDIBLE "CLICK" STYLE \$84.95
- MAX-5339 MAXI-SWITCH W/TACTILE FEEDBACK \$84.95

MODULAR CIRCUIT TECHNOLOGY

- DRIVE CONTROLLERS:**
- MCT-FDC FLOPPY DISK CONTROLLER \$29.95
- MCT-FDC-HD 1.44MB FLOPPY CONTROLLER \$49.95
- MCT-HDC HARD DISK CONTROLLER \$79.95
- MCT-RLL RLL CONTROLLER \$89.95
- MCT-FH FLOPPY/HARD CONTROLLER \$139.95
- MCT-AFH 286/386 FLOPPY/HARD \$149.95
- MCT-AFH-RLL 286/386 RLL CONTROLLER \$199.95

- DISPLAY ADAPTOR CARDS:**
- MCT-MGP MONOCHROME GRAPHICS \$59.95
- MCT-CG COLOR GRAPHICS ADAPTOR \$49.95
- MCT-EGA ENHANCED GRAPHICS ADAPTOR \$149.95
- MCT-VGA-8 8-BIT VGA, ANALOG OUTPUT \$169.95
- MCT-VGA-16 16-BIT VGA, ANALOG OUTPUT \$249.95
- MCT-MGM-MIO MONOGRAPHS MULTI I/O \$119.75
- MCT-MGAIO 286/386 MONOGRAPHS I/O \$99.95

- MULTIFUNCTION CARDS:**
- MCT-MIO MULTI I/O FLOPPY CONTROLLER \$79.95
- MCT-IO MULTI I/O CARD \$59.95
- MCT-AHF 286/386 MULTIFUNCTION \$139.95
- MCT-AIO 286/386 MULTI I/O CARD \$59.95

- MEMORY CARDS:**
- MCT-RAM 576K RAM CARD \$59.95
- MCT-EMS EXPANDED MEMORY CARD \$129.95
- MCT-AEMS 286/386 EMS CARD \$139.95

GeniScan 400 DPI \$199⁹⁵

- UP TO 400 DPI • 32 LEVELS OF GRAY SCALE • SPEED OVERRRUN WARNING LIGHT
- INCLUDES SCANEDIT II, PRODIGY OCR AND DR. GENIUS SOFTWARE



EPROM PROGRAMMER \$129.95

- PROGRAMS 27XX AND 27XXX EPROMS UP TO 27512
- SUPPORTS VARIOUS PROGRAMMING FORMATS & VOLTAGES
- SPLIT OR COMBINE CONTENTS OF SEVERAL EPROMS OF DIFFERENT SIZES
- READ, WRITE, COPY, BLANK CHECK & VERIFY
- SOFTWARE FOR HEX AND INTEL HEX FORMATS



HARD DISKS KITS

- 21.4 MB \$199
- 32.7 MB \$219
- 42.8 MB \$339
- 65.5 MB \$389
- 80.2 MB \$569



SIZE	MODEL	AVG. SPEED	FORM FACTOR	DRIVE ONLY	XT KIT	AT F/H KIT
21.4MB	ST-225	65 MS	5-1/4"	\$199	\$249	\$309
32.7MB RLL	ST-238	65 MS	5-1/4"	\$219	\$279	\$379
42.8MB	ST-251-1	28 MS	5-1/4"	\$339	\$389	\$449
65.5MB RLL	ST-277-1	28 MS	5-1/4"	\$369	\$449	\$549
80.2MB	ST-4095	28 MS	5-1/4"	\$569	—	\$679
122.7MB RLL	ST-4144R	28 MS	5-1/4"	\$699	\$759	\$859
21.4MB	ST-125	40 MS	3-1/2"	\$259	\$299	\$373
32.1MB RLL	ST-138	40 MS	3-1/2"	\$289	\$339	\$429

157.5MB ESDI DRIVE KIT \$1049

- 5-1/4" HARD DISK, FLOPPY/HARD CONTROLLER, CABLES, MOUNTING HARDWARE & SOFTWARE. 1355-PKG

1.44MB 3-1/2" DRIVE \$99⁹⁵

- ULTRA HIGH DENSITY
- READ/WRITE 720K DISKS, TOO
- FDD-1.44X BLACK FACEPLATE
- FDD-1.44A BEIGE FACEPLATE
- FDD-1.44 SOFT SOFTWARE DRIVER \$19.95



- 1/2 HEIGHT FLOPPY DISK DRIVES:**
- FD-55B 5-1/4" TEAC DS/DD 360K \$99.95
- FD-55G 5-1/4" TEAC DS/HD 1.2M \$129.95
- FDD-360 5-1/4" DS/DD 360K \$69.95
- FDD-1.2 5-1/4" DS/HD 1.2M \$95.95

MOTHERBOARDS 20MHZ 386 \$699

UPGRADE!

- 16/20 MHZ
- 16 MB RAM CAPACITY - 8MB ON BOARD(OK), 8 MB RAM CARD
- USES 256K OR 1MB SIP RAMS
- 8 SLOTS: 1X32-BIT RAM 2X 8-BIT & 5X 16-BIT
- MEMORY INTERLEAVING
- AMI BIOS • XT-SIZE BOARD

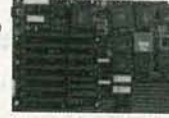

10MHZ MINI-286 \$199⁹⁵

- AT COMPATIBLE • KEYBOARD SELECTABLE 6/10MHZ
- EXPANDABLE TO 4MB ON-BOARD WITH 1MB DRAMS (OK)
- SIX 16-BIT, TWO 8-BIT SLOTS • AMI BIOS • LED SUPPORT

LOGITECH MICE

- THREE-BUTTON SERIES 9
- 320 DPI RESOLUTION
- SERIAL PS/2 COMPATIBLE.



- LOGC9 SERIAL MOUSE \$98.95
- LOGC9-C* SERIAL (NOT PS/2 COMPATIBLE) \$79.95
- LOGC9-P SERIAL MOUSE WITH PAINTSHOW \$109.95
- LOGC9-PC SERIAL MOUSE WITH PAINT/CAD \$154.95
- LOGB9 BUS MOUSE \$89.95
- LOGB9-P BUS MOUSE WITH PAINTSHOW \$104.95
- LOGB9-PC BUS MOUSE WITH PAINT/CAD \$149.95

JDR MICRODEVICES, 2233 BRANHAM LANE, SAN JOSE 95124
 LOCAL (408) 559-1200 FAX (408) 559-0250 TELEX 171-110
 RETAIL STORE: 1256 S. BASCOM AVE., SAN JOSE, CA
 (408) 947-8881 HOURS: M-F 9-7 SAT. 9-5 SUN. 12-4



ORDER TOLL FREE 800-538-5000

CUSTOMER SERVICE TOLL-FREE 800-538-5001 • TECHNICAL SUPPORT TOLL-FREE 800-538-5002

CIRCLE 113 ON FREE INFORMATION CARD
 DEALERS CIRCLE 170 ON FREE INFORMATION CARD

VALUE-PRICED TEST EQUIPMENT ALL WITH A 2 YEAR WARRANTY!

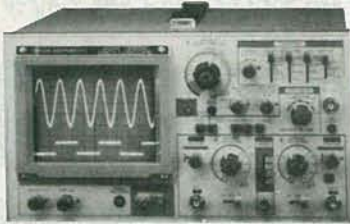

35 MHZ DUAL TRACE OSCILLOSCOPE **\$499.95**
 • WIDE BAND WIDTH • VARIABLE HOLDOFF
 MODEL-3500 (SHOWN)

20 MHZ DUAL TRACE OSCILLOSCOPE **\$389.95**
 • TV SYNC FILTER • COMPONENTS TESTER
 MODEL 2000

THE ULTIMATE 3.5 DIGIT DMM **\$79.95**
 • BASIC DC ACCURACY $\pm 0.25\%$
 • 34 RANGES
 • TEMP. TRANSISTOR & RESISTANCE FEATURES
 DMM-300 (SHOWN)



3.5 DIGIT FULL FUNCTION DMM **\$49.95**
 • BASIC DC ACCURACY $\pm 0.25\%$
 • 22 RANGES
 DMM-200 \$49.95

3.5 DIGIT POCKET SIZE DMM **\$29.95**
 • BASIC DC ACCURACY $\pm 0.5\%$ • 14 RANGES
 DMM-100

3.5 DIGIT PROBE TYPE DMM **\$54.95**
 • AUTORANGING
 • AC/DC 2V - 500V
 • RESISTANCE: 2K-2M
 DPM-1000 (SHOWN)



HIGH/LOW LOGIC PROBE **\$17.95**
 • DETECTS TTL/CMOS LOGIC STATES
 • MEMORY FUNCTION FREEZES DATA FOR LATER USE
 LP-2800

PULSER PROBE FOR QUICK DEBUGGING **\$19.95**
 • INJECTS PULSE INTO TEST CIRCUIT-VARIABLE WIDTH
 • TTL, DTL, TRL, HTL, HINIL, MOS, & CMOS COMPATIBLE
 LP-540



JIM'S BARGAIN HUNTERS CORNER

Jim Wharton
 JDR's VP Sales

SAVE UP TO 63% ON FACTORY REFURBS

MULTI-I/O WITH FLOPPY CONTROLLER **\$39.95**

IF NEW \$79.95
 SUPPORTS 2 FLOPPIES, SERIAL, PARALLEL AND GAME PORTS, PLUS CLOCK/CALENDAR.
 MCT-MIO EXPIRES 12/31/89

MONOGRAPHICS PRINTER CARD **\$29.95**

IF NEW \$79.95
 720 X348 DISPLAY, SERIAL PORT OPTIONAL.
 MCT-MG EXPIRES 12/31/89

JDR Microdevices
 2233 BRANHAM LANE, SAN JOSE, CA 95124

ORDER TOLL-FREE 800-538-5000

LOCAL (408) 559-1200 CUSTOMER SERVICE 800-538-5001
 TECH SUPPORT 800-538-5002 FAX (408) 559-0250

ADVERTISING INDEX

RADIO-ELECTRONICS does not assume any responsibility for errors that may appear in the index below.

Free Information Number	Page		
106	AMC Sales	17	138 Sequoia Pub. 33
152	Ace Communications	32	— Star Circuits 69
75	Ace Products	33	83 Synergetics 62
153	AIS Satellite	33	146 TAB Books 15
107	All Electronics	105	157 TECI 28
—	Amazing Concepts	100	145,92 Tektronix 7, 18
84	Appliance Service	33	158 Tentel 68
67	Banner Technical Books	27	123 Test Probes 3
151	B F Electronics	90	250-254 Test Probes 3
109	C & S Sales	34	64 Video-Link 96
70	CEI	98	143 Viejo Publications 32
—	CIE	5, 31	144 WPT Publications 28
—	Command Productions	17	
58	Cook's Institute	24	
127	Deco Industries	33	
82	Digi-Key	104	
135	Electronic Goldmine	95	
—	Electronic Tech Today	CV3	
—	Electronics Bookclub	74	
161	Emulation Associates	33	
121	Fluke Manufacturing	CV2	
156	Global Specialties	25	
—	Grantham College	78	
86	Heathkit	27	
—	Information Unltd.	94	
136	International Components Corp.	98	
113,170	JDR Microdevices	106, 107	
113,170	JDR Microdevices	108	
114	Jameco	102	
115	Jensen Tools	33	
137	Jinco Computers	100	
—	Lindsay Publ.	72	
—	McGraw Hill Book Club	46	
87	MCM Electronics	95	
53	MD Electronics	94	
93	Mark V. Electronics	99	
61	Microprocessors Unltd.	90	
160	Movietime	24	
—	NRI Schools	8	
147,148	Optoelectronics	14, 97	
—	Pacific Cable	93	
56	Parts Express	101	
78	Radio Shack	13	
149	Salen Enterprises	32	
155,154	Sencore	23, CV4	

Gernsback Publications, Inc.
 500-B Bi-County Blvd.
 Farmingdale, NY 11735
 1-516-293-3000
 Fax 1-516-293-3115
 President: Larry Steckler
 Vice President: Cathy Steckler

For Advertising ONLY
 1-516-293-3000
 Fax 1-516-293-3115
Larry Steckler
 publisher
Arline Fishman
 advertising director
Lisa Strassman
 credit manager
Christina Estrada
 advertising assistant

SALES OFFICES

EAST/SOUTHEAST
Stanley Levitan
 Eastern Sales Manager
 Radio-Electronics
 259-23 57th Avenue
 Little Neck, NY 11362
 1-718-428-6037, 1-516-293-3000

MIDWEST/Texas/Arkansas/Okla.
Ralph Bergen
 Midwest Sales Manager
 Radio-Electronics
 540 Frontage Road—Suite 339
 Northfield, IL 60093
 1-312-446-1444
 Fax 1-312-446-8451

PACIFIC COAST/ Mountain States
Marvin Green
 Pacific Sales Manager
 Radio-Electronics
 5430 Van Nuys Blvd. Suite 316
 Van Nuys, CA 91401
 1-818-986-2001
 Fax 1-818-986-2009

BUY BONDS

Electronics Paperback Books

GREAT PAPERBACKS AT SPECIAL PRICES



BP173—COMPUTER MUSIC PROJECTS \$6.95. Shows how to use your home computer to produce electronic music. Many circuits. Mostly jargon free.



BP233—ELECTRONIC HOBBYISTS HANDBOOK \$9.95. Single source of easily located info that the electronics hobbyist needs in his day-to-day pursuit of this fascinating hobby.



PCP103—PRACTICAL MIDI HANDBOOK \$9.95. Explains what MIDI (the Musical Digital Interface) can do and how you can put it to work. Covers Keyboards, drum machines, sequencers, mixers, guitars and computer music.



RFTD—RADIO'S FIRST TWO DECADES \$3.50. This story of radio's early days makes for fascinating reading. Spark-gap transmitters, KOKA's beginnings, and much more.



PCP102—INTRODUCING DIGITAL AUDIO \$9.95. CD, DAT, and sampling. What is involved in the digital part of audio signals. Principles and practices of digital audio techniques.



BP195—INTRODUCTION TO SATELLITE TV \$9.95. A definitive introduction to the subject written for the professional engineer, electronics enthusiast, or others who want to know more before they buy. 8 x 10 in.



TELE—THE INVENTION OF TELEVISION \$9.95. Everything you never learned about television from its start as a dream in the 1800's to the promise of tomorrow.



BP239—GETTING THE MOST FROM YOUR MULTIMETER \$5.95. Covers basics of analog and digital meters. Methods of component testing (includes transistors, thyristors, resistors, capacitors and other active and passive devices).



PCP107—DIGITAL LOGIC GATES AND FLIP-FLOPS \$10.00. What they do and how to use them. You'll probably never need another book on this subject.



BP143—INTRO TO PROGRAMMING THE ATARI 500/600 XL \$5.95. Perfect complement to the Atari user's manual. Even shows how to use animated graphics.



RADIO—100 RADIO HOOKUPS \$3.00. Wonderful reprint of this 1924 book that presents 100 schematics of radio circuits of that era. The antique radio lover will label this one a "must own" book.



BP152—INTRO TO Z-80 MACHINE CODE \$5.95. Speed up your programs. They may be harder to write, but it's worth learning how. Some demo programs are included.



BP198—AN INTRODUCTION TO ANTENNA THEORY \$6.95. Basic concepts relevant to receiving and transmitting antennas.



BP144—FURTHER PRACTICAL ELECTRONICS CALCULATIONS AND FORMULAE \$9.00. Companion volume to BP53. Book carries on with new data not found in earlier edition. 450 pages.



BP125—35 SIMPLE AMATEUR BAND ANTENNAS \$5.50. All kinds of antennas for all kinds of amateur radio reception.

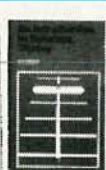

BP172—ELECTRONIC CIRCUITS FOR THE COMPUTER CONTROL OF ROBOTS \$7.50. Data and circuits for interfacing the computer to the robot's motors and sensors.



BP105—ANTENNA PROJECTS \$5.50. Practical radio antenna designs that deliver good performance and are relatively simple and inexpensive to build.



BP121—DESIGN & MAKE YOUR OWN PC BOARDS \$5.75. Everything you need to know before you make printed-circuit boards for your projects.



BP117—PRACTICAL ELECTRONIC BUILDING BLOCKS, Book 1 \$5.75. Build the blocks and then combine them to form almost any custom project of your choice.



BP118—PRACTICAL ELECTRONIC BUILDING BLOCKS, Book 2 \$5.75. Amplifiers for all kinds to add to the circuits from Book 1 of this series.

Quality Paperbacks



BP106—SYNTHESIZERS FOR MUSICIANS \$10.00. Covers principles of modern synthesis—linear, arithmetic, phase distortion, frequency modulation, sampling.



BP127—HOW TO DESIGN ELECTRONIC PROJECTS \$5.75. How to use standard circuit elements to make custom electronic projects.



BP92—CRYSTAL SET CONSTRUCTION \$5.50. A variety of crystal radio receivers for the experimenter and hobbyist.



BP110—HOW TO GET YOUR ELECTRONIC PROJECTS WORKING \$5.75. How to find the faults in your projects, repair them and get them working.



BP121—DESIGN & MAKE YOUR OWN PC BOARDS \$5.75. Everything you need to know before you make printed-circuit boards for your projects.



BP256—INTRO TO LOUDSPEAKERS AND ENCLOSURE DESIGN \$5.95. Explore all the aspects of speaker design including speakers, enclosures, and crossovers. Wind up with a description of a state-of-the-art speaker system.



BP85—INTERNATIONAL TRANSISTOR EQUIVALENTS \$7.50. Locates possible substitutes for a popular user-oriented selection of modern transistors. Japanese, European and American types.



BP117—PRACTICAL ELECTRONIC BUILDING BLOCKS, Book 1 \$5.75. Build the blocks and then combine them to form almost any custom project of your choice.



BP118—PRACTICAL ELECTRONIC BUILDING BLOCKS, Book 2 \$5.75. Amplifiers for all kinds to add to the circuits from Book 1 of this series.



BP77—MICRO-PROCESSING SYSTEMS AND CIRCUITS \$5.95. Guide to the elements of micro-processing systems. Teaches all the fundamentals.



BP77—MICRO-PROCESSING SYSTEMS AND CIRCUITS \$5.95. Have you ever written your own programs only to find that they do not work? This book shows you how to find errors.



BP77—MICRO-PROCESSING SYSTEMS AND CIRCUITS \$5.95. Have you ever written your own programs only to find that they do not work? This book shows you how to find errors.

Affordable Prices



BP248—TEST EQUIPMENT CONSTRUCTION \$5.95. Details the construction of simple, inexpensive, yet extremely useful test equipment. 10 different instruments are included.



BP106—MODERN OP-AMP PROJECTS \$5.00. Includes a Slide Timer, AF Signal Gen, Mike Pre-amp, Scratch Filter, and much more.



BP59—SECOND BOOK FOR CMOS IC PROJECTS \$5.50. Multivibrators, amplifiers; triggers & gates; special devices including reaction timer, simple electronic organ, and more.



BP185—ELECTRONIC SYNTHESIZER \$5.95. Shows how to build a monophonic synthesizer; section by section. Replaces BP61.



BP182—MIDI PROJECTS \$6.95. Details of how to interface many popular home computers with MIDI music systems.



BP65—SINGLE IC PROJECTS \$5.75. All projects in this book are based on one IC and are simple to construct. Great way to get started with IC's.



BP49—POPULAR ELECTRONIC PROJECTS \$5.95. A collection of a wide range of electronic projects and circuits for the experimenter.



BP97—IC PROJECTS FOR BEGINNERS \$5.50. Written especially for the less experienced experimenter. Complete parts layouts and wiring diagrams.



BP260—CONCISE INTRO TO OS/2 \$5.95. Learn how the OS/2 operating system is structured and how to use it effectively. Written with the non-expert busy person in mind.



BP80—POPULAR ELECTRONIC CIRCUITS, Book 1 \$5.95. More circuits for hobbyists. Audio, radio, test, music, household and more.



BP80—POPULAR ELECTRONIC CIRCUITS, Book 2 \$5.95. More useful circuits. None of these projects duplicate those in Book 1 of this series.

CHECK OFF THE BOOKS YOU WANT

ELECTRONIC TECHNOLOGY TODAY INC.
P.O. Box 240, Massapequa Park, NY 11762-0240

SHIPPING CHARGES IN USA AND CANADA

\$0.01 to \$5.00	... \$1.25
\$5.01 to 10.00	... \$2.00
\$10.01 to 20.00	... \$3.00
\$20.01 to 30.00	... \$4.00
\$30.01 to 40.00	... \$5.00
\$40.01 to 50.00	... \$6.00
\$50.01 and above	... \$7.50

SORRY, No orders accepted outside of USA and Canada Number of books ordered

Name _____
Address _____
City _____ State _____ Zip _____

Total price of merchandise \$ _____
Sales Tax (New York State Residents only) \$ _____
Shipping (see chart) \$ _____
All payments must be in U.S. funds
Total Enclosed ... \$ _____

Introducing The SG80 AM Stereo-FM Stereo Analyzer™

Now For The First Time, A High-Performance AM Stereo (C-QUAM)® - FM Stereo Analyzer Integrated Into One Unit, Allowing You To Performance Test, Troubleshoot, And Align To Manufacturers' Requirements

New

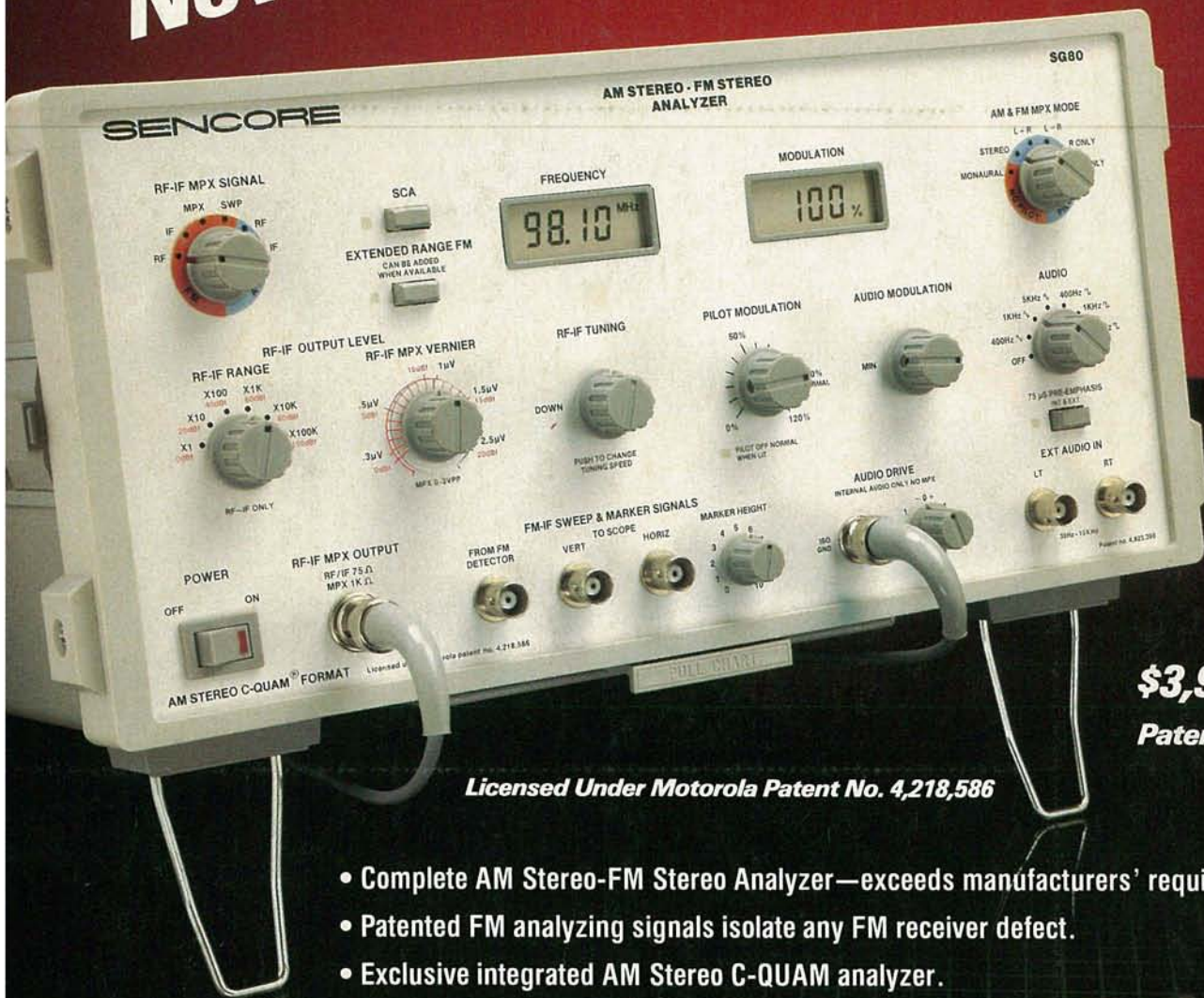

\$3,995

Patented

Licensed Under Motorola Patent No. 4,218,586

- Complete AM Stereo-FM Stereo Analyzer—exceeds manufacturers' requirements.
- Patented FM analyzing signals isolate any FM receiver defect.
- Exclusive integrated AM Stereo C-QUAM analyzer.
- Digitally accurate performance tests meet EIA/IHF requirements.
- Exclusive, tuneable FM-IF Sweep and Markers—aligns all IF stages.
- Expandable FM features for future service needs, plus SCA compatible.
- Twice the capability for less than 1/2 the cost of stand-alone instruments.

C-QUAM is a registered trademark of Motorola, Inc.

CIRCLE 154 ON FREE INFORMATION CARD

SENCORE
3200 Sencore Drive, Sioux Falls, South Dakota 57107

Call 1-800-SENCORE
(736-2673)

**Ask About
A 10 Day
Video Preview**



**RS232
Compatible**