

48783

Radio — **HI-TECH HOME SECURITY**

APRIL 1989

Electronics

TECHNOLOGY - VIDEO - STEREO - COMPUTERS - SERVICE

HOW TO INSTALL A HOME-SECURITY SYSTEM

Tips and techniques for wired and wireless systems

BUILD YOUR OWN SECURITY SYSTEM

A versatile wireless system you can build

BUILD A DIGITAL PEAK DETECTOR

Display and hold the maximum output level from any transducer.

BUILD R-E's MEDITATION GOGGLES

Put electronics to work so you can relax!

CIRCUIT COOKBOOK

More than 20 practical counter circuit recipes!

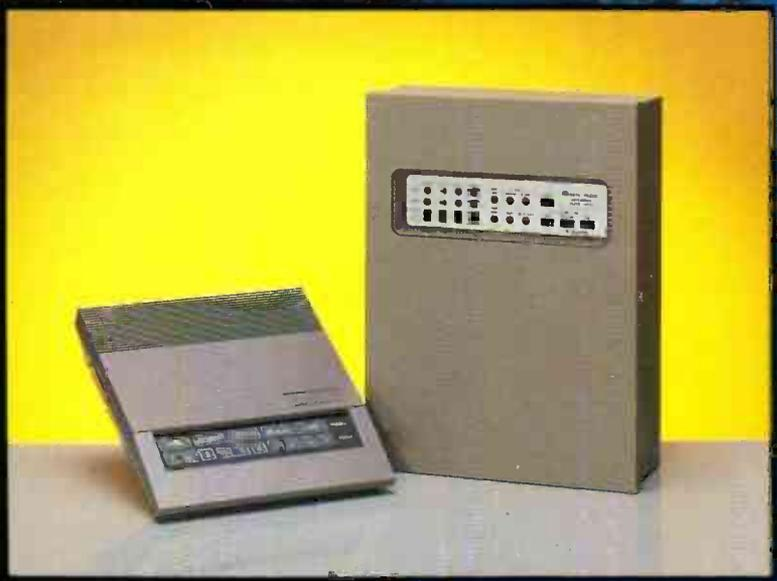

\$2.25 U.S.
\$2.75 CAN



A
GERNSBACK
PUBLICATION

29 XXXXXXXXX 5-DIGIT 60505
390736 DHM 09975093 04
MR ROBERT DAHM
997 GRAND AV
AURORA, IL 60505
JAN 90
RE

FLUKE



PHILIPS

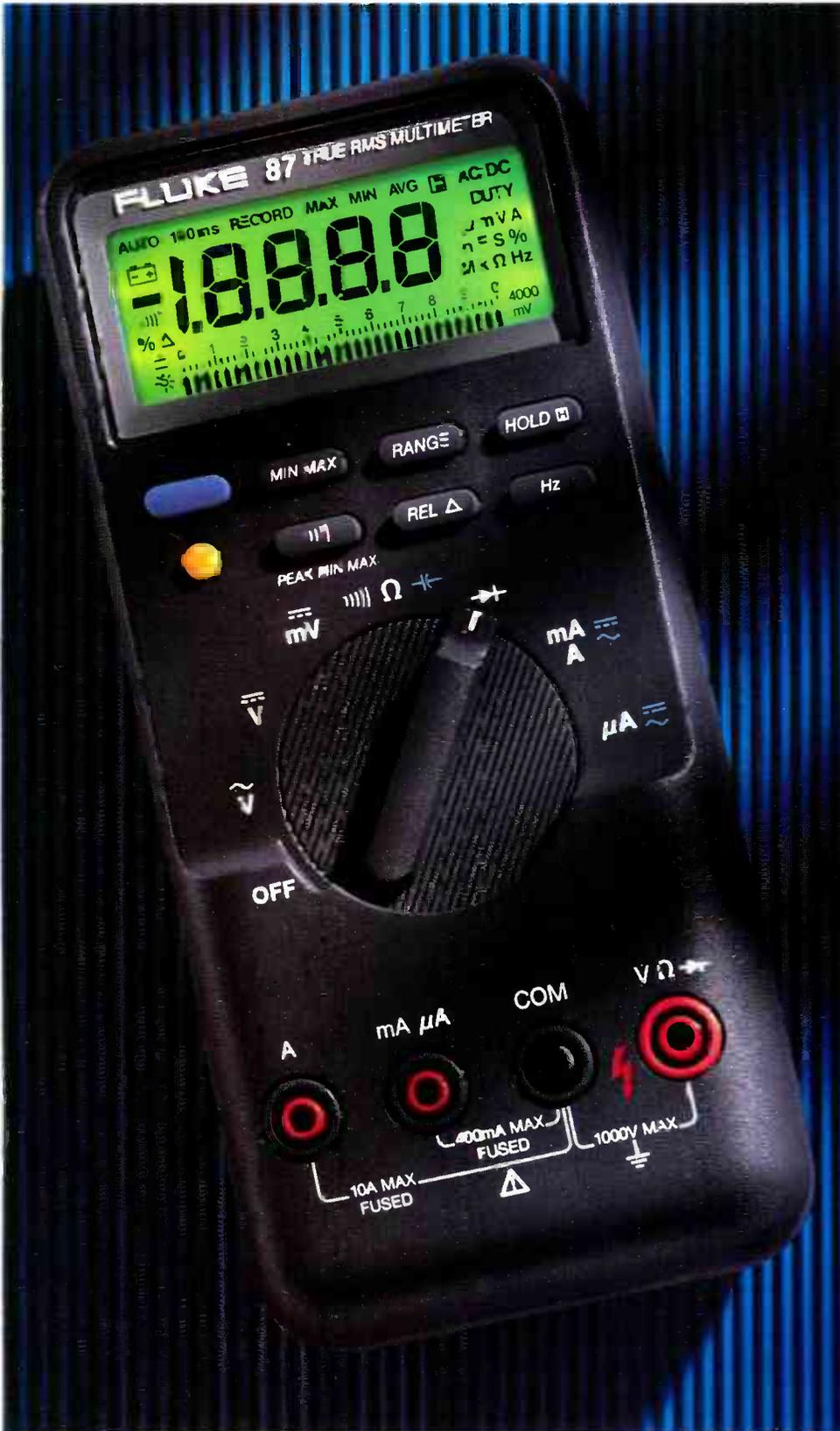

The new 80 Series is a digital meter, an analog meter, a frequency counter, a recorder, a capacitance tester, and a lot more.

It's the first multimeter that can truly be called "multi" ... not only standard features, but special functions usually limited to dedicated instruments.

Plus, innovations only Fluke can bring you. Like duty cycle measurements. Or recording the minimum, maximum and average value of a signal. Or the audible MIN MAX Alert™ that beeps for new highs or lows.

There's even Fluke's exclusive Input Alert™, that warns you of incorrect input connections. And a unique Flex-Stand™ and protective holster, so you can use the 80 Series almost anywhere.

Make sure your next multimeter is truly multi. Call today at 1-800-44-FLUKE, ext 33.

FROM THE WORLD LEADER IN DIGITAL MULTIMETERS.



FLUKE 83	FLUKE 85	FLUKE 87
\$189*	\$219*	\$259*
0.3% basic dc accuracy	0.1% basic dc accuracy	0.1% basic dc accuracy
5 kHz acV	20 kHz acV	20 kHz acV
Analog bargraph & zoom	Analog bargraph & zoom	High resolution analog pointer
Three year warranty	Three year warranty	True rms ac
		1ms PEAK MIN MAX
		4½ digit mode
		Back lit display
		Three year warranty

*Suggested U.S. list price

The new Fluke 80 Series shown actual size

John Fluke Mfg. Co., Inc., P.O. Box C9990 M/S 250C, Everett, WA 98203
 U.S.: 206-356-5400 CANADA: 416-890-7600 OTHER COUNTRIES: 206-356-5500
 © Copyright 1988 John Fluke Mfg. Co., Inc. All rights reserved. Ad No. 0581-F80

FLUKE

CIRCLE 121 ON FREE INFORMATION CARD

www.americanradiohistory.com

BUILD THIS

- 47 WIRELESS SECURITY SYSTEM**
Our easy-to-build system combines infrared and RF technologies.
Dan Becker
- 53 ALPHA/THETA MEDITATION GOGGLES**
Photic stimulation—a simple relaxation technique.
Mark Worley
- 59 DIGITAL PEAK-DETECTOR**
Display and hold the maximum output level from any transducer.
Roger D. Secura
- 74 MACROWAVE OVEN**
A special April project.
Laurence Hakemachi

TECHNOLOGY

- 33 HIGH-TECH SECURITY SYSTEMS**
An in-depth look at what's available in home security today.
Herb Friedman
- 42 INSTALL YOUR OWN BURGLAR ALARM**
Step-by-step guide to wired- and wireless-system installations.
Herb Friedman and Brian C. Fenton

CIRCUITS

- 63 WORKING WITH COUNTERS**
Recipes for more than 20 practical counter circuits.
Ray Marston

DEPARTMENTS

- 6 VIDEO NEWS**
What's new in this fast-changing field.
David Lachenbruch
- 17 EQUIPMENT REPORTS**
Sencore LC102 Capacitance/Inductance Meter.
- 25 HARDWARE HACKER**
Refilling SX toner cartridges.
Don Lancaster
- 70 AUDIO UPDATE**
The importance of amplifier output current.
Larry Klein
- 72 SHORTWAVE RADIO**
The International Frequency Coordinating Committee.
Stanley Leinwoll

COMPUTER DIGEST

A PC can circle around a C64?

Digital's latest PC-based software package, *Circle*, allows you to connect a C64 to a PC and use it as a terminal. The package includes a C64 emulator and a PC terminal emulator. The package is available for \$49.95.

Circle is a great way to use your C64 as a terminal. It allows you to use the C64's keyboard and mouse to control the PC. The package is available for \$49.95.

Build an

expensive

radio repair

for only \$25?

BY BARRANIELLO

A simple fix can save you

hundreds of dollars in repair

charges. Here's how to do it.

The first step is to check

the power supply. If it's

bad, the radio won't work.

Next, check the tuning

diode. If it's bad, the

radio won't tune.

Finally, check the

output transformer. If

it's bad, the radio won't

output any power.

By following these

steps, you can save

hundreds of dollars in

repair charges.

For more information,

see page 77.

EDITORS' WORK BENCH

BY BARRANIELLO

The first step is to

check the power supply.

If it's bad, the radio

won't work.

Next, check the tuning

diode. If it's bad, the

radio won't tune.

Finally, check the

output transformer.

If it's bad, the radio

won't output any

power.

By following these

steps, you can save

hundreds of dollars

in repair charges.

For more information,

see page 77.

BY BARRANIELLO

The first step is to

check the power supply.

If it's bad, the radio

won't work.

Next, check the tuning

diode. If it's bad, the

radio won't tune.

Finally, check the

output transformer.

If it's bad, the radio

won't output any

power.

By following these

steps, you can save

hundreds of dollars

in repair charges.

For more information,

see page 77.

BY BARRANIELLO

The first step is to

check the power supply.

If it's bad, the radio

won't work.

Next, check the tuning

diode. If it's bad, the

radio won't tune.

Finally, check the

output transformer.

If it's bad, the radio

won't output any

power.

By following these

steps, you can save

hundreds of dollars

in repair charges.

For more information,

see page 77.

PAGE 77

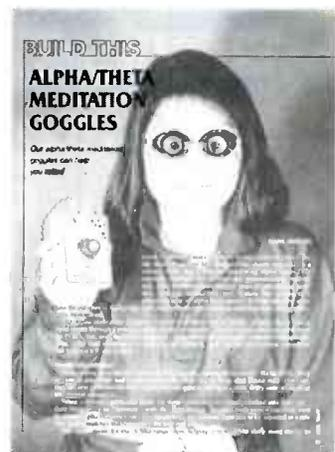

PAGE 53

AND MORE

- 104 Advertising and Sales Offices**
- 104 Advertising Index**
- 8 Ask R-E**
- 105 Free Information Card**
- 14 Letters**
- 87 Market Center**
- 22 New Products**
- 69 PC Service**
- 4 What's News**

ON THE COVER



Whether you live in a large city or a rural area crime has become a frightening fact of life. One reaction to the problem is the sometimes confusing proliferation of devices sold to protect your home, family, and possessions. How can you decide what kind of protection best suits your circumstances? In this issue, we sort out some of the home-security options that are available today. Turn to page 33 to read about how high-tech systems work and what features they offer. The devices pictured on the cover are representative of the two basic types of home-security systems—wired and wireless. Beginning on page 42, we describe how to install each kind of system. And, on page 47, there's a complete wireless home-security system that you can build yourself.

COMING NEXT MONTH

**THE MAY ISSUE
IS ON SALE
APRIL 4.**

EXPERIMENTING WITH ISDN

Build an ISDN-compatible development system for under \$500.

VIDEO TAPE

Are "high grade" tapes worth the high price?

BUILD AN I-R EXTENDER

Extend the reach of your remote control to any room in the house and get video signals where you want them.

REACTS 16-BIT A/D CONVERTER

Open the **Radio Electronics** Advanced Control system to the outside world.

As a service to readers, RADIO-ELECTRONICS publishes available plans or information relating to newsworthy products, techniques and scientific and technological developments. Because of possible variances in the quality and condition of materials and workmanship used by readers, RADIO-ELECTRONICS disclaims any responsibility for the safe and proper functioning of reader-built projects based upon or from plans or information published in this magazine.

Since some of the equipment and circuitry described in RADIO-ELECTRONICS may relate to or be covered by U.S. patents, RADIO-ELECTRONICS disclaims any liability for the infringement of such patents by the making, using, or selling of any such equipment or circuitry, and suggests that anyone interested in such projects consult a patent attorney.

RADIO-ELECTRONICS, (ISSN 0033-7862) April 1989. Published monthly by Gernsback Publications, Inc., 500-B Bi-County Boulevard, Farmingdale, NY 11735 Second-Class Postage paid at Farmingdale, NY and additional mailing offices. Second-Class mail registration No. 9242 authorized at Toronto, Canada. One-year subscription rate U.S.A. and possessions \$17.97, Canada \$23.97, all other countries \$26.97. All subscription orders payable in U.S.A. funds only, via international postal money order or check drawn on a U.S.A. bank. Single copies \$2.25. © 1989 by Gernsback Publications, Inc. All rights reserved. Printed in U.S.A.

POSTMASTER: Please send address changes to RADIO-ELECTRONICS, Subscription Dept., Box 55115, Boulder, CO 80321-5115.

A stamped self-addressed envelope must accompany all submitted manuscripts and/or artwork or photographs if their return is desired should they be rejected. We disclaim any responsibility for the loss or damage of manuscripts and/or artwork or photographs while in our possession or otherwise.

Radio Electronics®

Hugo Gernsback (1884-1967) founder
M. Harvey Gernsback,
editor-in-chief, emeritus

Larry Steckler, EHF, CET,
editor-in-chief and publisher

EDITORIAL DEPARTMENT

Art Kleiman, editorial director

Brian C. Fenton, editor

Carl Laron, WB2SLR,
editorial associate

Marc Spiwak, associate editor

Jonathan A. Gordon,
assistant technical editor

Teri Scaduto, assistant editor

Jeffrey K. Holtzman,
computer editor

Robert A. Young, assistant editor

Byron G. Wels, editorial associate

Jack Darr, CET, service editor

Robert Grossblatt, circuits editor

Larry Klein, audio editor

David Lachenbruch,
contributing editor

Don Lancaster,
contributing editor

Richard D. Fitch,
contributing editor

Kathy Campbell, editorial assistant

Andre Duzant, technical illustrator

Injae Lee, assistant illustrator

PRODUCTION DEPARTMENT

Ruby M. Yee, production director

Robert A. W. Lowndes,
editorial production

Karen Tucker, advertising production

Marcella Amoroso, production traffic

CIRCULATION DEPARTMENT

Jacqueline P. Cheeseboro,
circulation director

Wendy Alanko,
circulation analyst

Theresa Lombardo,
circulation assistant

Typography by Mates Graphics

Cover background

©The Stock Market/ Peter Garfield

Inset photo by

Diversified Photo Services

Radio-Electronics is indexed in
Applied Science & Technology Index
and *Readers Guide to Periodical Literature*.

Microfilm & Microfiche editions are available. Contact circulation department for details.

Advertising Sales Offices listed on page 104.



Now electronics technicians can get into VCR Servicing quickly and easily

Learn professional VCR servicing at home or in your shop with exclusive videotaped demonstrations

Today, there are more than 10 million VCRs in use, with people standing in line to have them serviced. You can bring this profitable business into your shop with NRI professional training in VCR servicing. This top-level training supports the industry's claim that the best technicians today are those who service VCRs.

Integrated Three-Way Self-Teaching Program

In one integrated program, NRI gives you a study guide, 9 instructional units, 2 hours of video training tapes accompanied by a 32-page workbook that pulls it all together. At home or in your shop, you'll cover all the basic concepts of video recording, mechanical and electronic systems analyses, and the latest troubleshooting techniques. Your workbook and instructional units also contain an abundance of diagrams, data, and supplementary material that makes them valuable additions to your servicing library.

The "How-To" Videotape

Your NRI Action Videocassette uses every modern communications technique to make learning fast and easy. You'll enjoy expert lectures and see animation and video graphics that make every point crystal-clear. You'll follow the camera eye into the heart of the VCR as step-by-step servicing techniques are shown. Both electronic and mechanical troubleshooting are covered . . . including everything from complete replacement and adjustment of the recording heads to diagnosing micro-processor control faults.

Plus Training On All The New Video Systems

Although your course concentrates on VCRs covering Beta, VHS, and 3/4" U-Matic commercial VCRs, NRI also brings you up to speed in other key areas. You'll get training in capacitance and optical video disc players, projection TV, and video cameras. All are included to make you the complete video technician. There's even an optional final examination for NRI's VCR Professional Certificate.

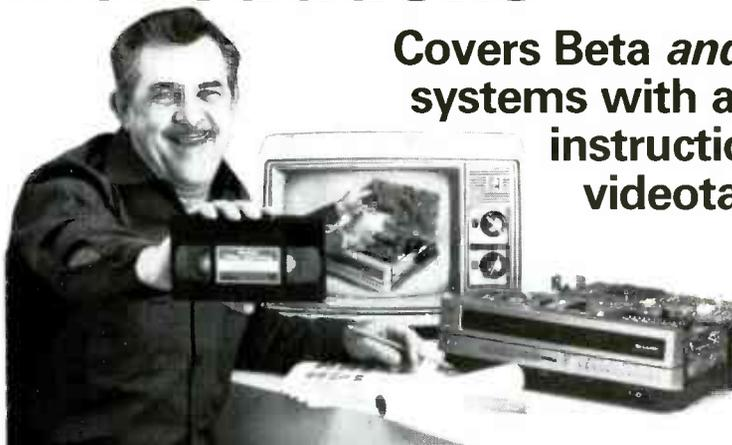

Covers Beta and VHS systems with actual instruction on videotape.

The Best Professional Training

This exclusive self-study course has been developed by the professionals at NRI. NRI has trained more television technicians than any other electronics school! In fact, NRI has consistently led the way in developing troubleshooting techniques for servicing virtually every piece of home entertainment equipment as it appears in the marketplace.

Satisfaction Guaranteed . . . 15-Day No-Risk Examination

Send today for the new NRI Self-Study Course in VCR Servicing for

Professionals. Examine it for 15 full days, look over the lessons, sample the videotape. If you're not fully satisfied that this is the kind of training you and your people need to get into the profitable VCR servicing business, return it for a prompt and full refund, including postage. Act now, and start adding new business to your business.

Special Introductory Offer

This complete VCR training course with two hour videotape is being offered for a limited time only, on orders received from this ad, at our low introductory price of \$179.95. Save \$20 by acting now!

NRI Training For Professionals
McGraw-Hill Continuing Education Center
4401 Connecticut Ave Washington, DC 20008

YES! Get me started in profitable VCR servicing. Rush me my NRI self-study course in VCR Servicing for Professionals. I understand I may return it for a full refund within 15 days if not completely satisfied.



NRI Training For Professionals
McGraw-Hill Continuing
Education Center
4401 Connecticut Avenue
Washington, DC 20008

PLEASE SPECIFY TAPE FORMAT DESIRED VHS BETA

Name (please print) _____

Company _____

Street _____

City/State/Zip _____

Enclosed is my check money order for \$179.95 (D.C. residents add 6% tax) Make check payable to NRI

Charge to VISA MasterCard _____

Card Number _____ Interbank Number _____

Card Number _____ Expiration Date _____

Signature _____

(required for credit card sales)

2600 0-98

WHAT'S NEWS

Packet proposed for shuttle



WAYNE WILSON WB8TSO OF HEATH COMPANY (in jacket) presents Gil Carmen, president of the Johnson Space Center Amateur Radio Club, with the HK-21 Pocket Packet TNC, as club members look on.

Heath Company recently donated three *HK-21* pocket packet TNC's (Terminal Niode Controller) to the NASA Johnson Space Center Amateur Radio Club in Houston. As part of the Shuttle Amateur Radio *EX*periment (SAREX), it is proposed that an *HK-21* be used on a March 1990 shuttle flight.

Packet radio allows digitized information—voice, images, and

data—to be transmitted over radio frequencies. In this experiment, amateur radio band frequencies will be used to transmit packetized data to and from the shuttle.

If the project is approved, one of the packet radios will be specially adapted for space travel. NASA will mount it into a protective SAREX casing unit and modifications will be made for use in zero gravity.

Computer controlled system uses water for cooling

Possibly the most common way of welding metals is to heat them with a mixture of oxygen and acetylene gas (oxyacetylene). That method has its weaknesses—acetylene is highly flammable and requires careful storing in metal containers. Welding must be done close to the acetylene source to keep pressure high.

As you may remember from high-school chemistry, water can

easily be broken down into its components—oxygen and hydrogen—with an electric current. Those gases give out intense heat on reuniting.

Now a French system that uses complex computer controls appears to have put an end to the difficulties—such as producing large enough quantities of properly regulated gas at a workable pressure—of working with oxygen and hydrogen. The new method is safer than oxyacetylene because it

produces only the amount of gas needed. The flame, which is hottest at the core, permits more precise work than oxyacetylene, which is hottest at the edges.

Despite the cheap fuel source, start-up expense may be a severe drawback, at least for the small operator. A complete system will cost at least \$5000, as compared to less than \$200 for an oxyacetylene system. Industrial users will find such costs insignificant in view of the lower operating costs. **R-E**

Oldest floppy disk

This floppy disk, unearthed at the site of the ancient Sumerian city of Lagash, extends the history of personal computing back to the third millennium B.C. The person-



ALTHOUGH SOMEWHAT OUTDATED, this computer disk was once on the leading edge of technology.

al computer was previously thought to have been invented at about the time Columbus was busy discovering new lands, and only in widespread use since the gold-rush years made possible gold-plated connectors at a price affordable to even low-middle-income settlers. The inscription that appears on the protective clay sleeve reads, in part, "The program on this disk is protected by (illegible)...to the lions...beheaded...Copyright Microsoft Corp., 2900 B.C." **APR-1**

HANDHELD DIGITAL IC COMPARATOR/TESTERS FEATURE 20 CHANNEL LOGIC MONITOR

B&K-PRECISION's Model 550 and 552 IC Comparator Tester/Logic Monitors test IC's by comparison to a known good reference in one simple operation. As logic monitors, they simultaneously indicate the logic states of up to 20 IC pins. They test most 14 to 20 pin, 54 and 74 Series TTL (Model 550) or 4000 and 74C Series CMOS (Model 552) devices. Both models are available from distributors at \$425. Contact your local distributor or: B&K-PRECISION, Maxtec Int., 6460 W. Cortland St., Chicago, IL 60635. (312) 889-9087. **CIRCLE 251**



LOGIC/PULSER PROBES HELP LOCATE DIGITAL FAULTS IN LAB OR IN FIELD SERVICE

B&K-PRECISION now offers logic and pulser probes to fill the needs of engineers and technicians. The DP-21 is a 20 MHz probe that also displays pulse presence and logic status. Both LED and audible logic state indicators are featured. The DP-31 pulser probe can be used alone or with a logic probe or scope. It produces a 10µs pulse at 0.5 or 400 PPS rates and features an external square wave and synchronizing terminal. Both probes are multi-family compatible. The DP-21 is \$32. The DP-31 is \$33. Contact your local distributor or: B&K-PRECISION, Maxtec Int., 6460 W. Cortland St., Chicago, IL 60635. (312) 889-9087.



CIRCLE 250 ON FREE INFORMATION CARD



NEW COMPARATOR

ADDS IC/COMPONENT TESTING TO SCOPE
Test virtually any type of passive or active component or module with B&K-PRECISION's new 541 Component Comparator. The 541 is designed for use with the 540 component tester or virtually any x-y oscilloscope. It is well suited for both in-circuit and out-of-circuit tests. It's fast and easy to use. Unlike single function testing, the 541 can be used on series, parallel or series/parallel circuits. \$395. Contact your local distributor or: B&K-PRECISION, Maxtec Int., 6460 W. Cortland St., Chicago, IL 60635. (312) 889-9087 **CIRCLE 252**



NEW COMPONENT TESTER LOCATES FAULTS ON UNPOWERED BOARDS IN FIELD OR PLANT

The new Model 540 component tester is an extremely cost effective, highly flexible trouble-shooting aid that can assist in rapidly locating faults on unpowered boards. Faults can be traced to the component level without specific circuit knowledge. Individual components can also be tested. Test results are displayed as a curve on a built-in CRT display. Curve tracing allows matching of components. Two channels allow production testing against known good boards. Ideal for field service or production testing. \$995. Contact your local distributor or: B&K-PRECISION, Maxtec Int., 6460 W. Cortland St., Chicago, IL 60635. (312) 889-9087. **CIRCLE 253**



PROGRAMMABLE IC TESTER TESTS TTL, CMOS, RAM AND ROM IC'S, IN OR OUT-OF-CIRCUIT

Called the "first cost-effective way to test IC's both in and out-of-circuit," the new B&K-PRECISION Model 560 fills the void between basic component testers and costly ATE systems. Over 1500 different 14 to 24 pin devices can be tested, including TTL and CMOS digital IC's, RAMs and ROMs. The 560 speeds testing, simplifies diagnostics and doesn't require prior test skills. Plain-English user prompts guide every step of operation. Test results are displayed as positive "pass" or "fail." Test results can be fed to a printer. Applications include incoming inspection, QC, production line testing and troubleshooting faulty products. \$3,500. Contact your local distributor or: B&K-PRECISION, Maxtec Int., 6460 W. Cortland St., Chicago, IL 60635. (312) 889-9087. **CIRCLE 254**

B&K-PRECISION has what you need for fast, cost-effective IC or board testing.

Check it out!

- Programmable in/out-of-circuit IC tester
- Portable curve-tracing component tester
- Portable IC comparator tester/logic monitors
- Benchtop IC component comparator tester
- Multi-family compact pulser probes
- Memory-mode multi-family logic probes

Whether your needs are for production board testing, incoming inspection or field service, B&K-PRECISION has you covered with time saving, accurate digital test products.

The Model 560 Programmable In/Out-of-circuit IC Tester is the first cost-effective way to rapidly test IC's both in and out-of-circuit. Punch up the number you need from a resident memory of over 1500 TTL, CMOS IC's, RAM's and ROM's.

The Model 540 Component Tester locates faults on unpowered boards, down to the component level. Curve-tracing method also allows fast comparison of components or boards.

The Model 541 Component Comparator is a companion instrument for use with your scope or the 540. It tests IC's, semiconductors, capacitors, inductors, transformers and more.

The Models 550 and 552 IC Comparator Tester/Logic Monitors are hand-held portables for TTL and CMOS applications. In-circuit dynamic tests compare a known-good IC to an on-board IC. A 20-channel logic monitor is built-in.

The B&K-PRECISION digital test line-up is rounded out by convenient and economical pulser and logic probes.

For immediate delivery or complete specifications and applications information, call your local distributor or B&K-PRECISION.



BK PRECISION

MAXTEC INTERNATIONAL CORP.
6460 West Cortland St. • Chicago, IL 60635 • 312-889-9087
International Sales, 6460 W. Cortland St., Chicago, IL 60635

Canadian Sales, Atlas Electronics, Ontario
South and Central American Sales, Empire Exporters, Plainville, NY 11303

VIDEO NEWS



DAVID LACHENBRUCH,
CONTRIBUTING EDITOR

● **Personal video.** Sony's compact *Video Walkman*, which combines an 8mm VCR and a TV set with a 3-inch LCD screen in a book-size package, seems to have opened a new product category called "personal video." Before the year is over, there probably will be at least a half-dozen competitors on the market. Most of them will sacrifice some compactness for versatility, though, using full-size VHS decks instead of 8mm. Casio already has a VHS combination with a 3.3-inch screen, and is expected to introduce new models with 4- and 5-inch pictures. Matsushita has a model with a compact Super VHS-C transport and will add one with full-size VHS, while Sharp has demonstrated a 4-inch combo and Hitachi has shown a 5-incher. Canon will join Sony in the 8mm field, but its model is reported to be even smaller and lighter than the original Sony *Video Walkman*.

● **Private Eye.** Consumer-electronics manufacturers are exploring possible personal-video uses of *Private Eye*, a tiny 2-ounce display device developed by Reflection Technology Inc., Cambridge, MA, that is expected to be used within a year for computer and calculator displays. *Private Eye* can be clipped to eyeglasses, a headphone, or a helmet so that one eye is looking through a viewing window that is less than 1-inch square. The eye sees the equivalent of a 12-inch display hanging in mid-air about 2 feet away. So far, it has been shown only as a monochrome display, but with high contrast and with resolution of 720 × 280 pixels. Its developers say that it is potentially very inexpensive and that a color-video version could be developed as "a realistic engineering activity, not a science activity." One major Japanese TV manufacturer reportedly has taken a license on the system, which could become the visual equivalent of earphones.

● **HDTV seen taking over.** HDTV will grow faster than either color TV or VCR's, according to a report by Robert R. Nathan Associates for the EIA. The report forecast that HDTV receivers

would be in 25% of American households by the end of the century, and that 10% of American homes would have HDTV sets four years after high-definition broadcasting begins. Among other findings and assumptions in the report: Initially, HDTV will find its place in sets with screens 30 inches and larger, eventually dipping down to the 20-inch size. Transmission standards should be set in time for the first significant sales of HDTV sets to start in 1993. Large-screen HDTV sets will first be sold at an average retail price of about \$2,500. Most large-screen HDTV sets will be made in the United States. HDTV sets will completely replace NTSC sets in the 30-inch-and-larger size group in the market within 6 years of adoption. Current NTSC sets won't be rendered obsolete by HDTV because the new broadcasts and cable-casts will be compatible with existing TV standards.

● **Still video.** Although video has taken over from film in consumer-movie making, it may have a much tougher road ahead before it can dispossess film in still-picture taking. At least eight manufacturers have now introduced still-video camera systems in Japan and/or the U.S.; all of those systems utilize the standard 2-inch magnetic "video floppy" that can store 50 single-field pictures or 25 full-frame images. Still video has already found a place in newspaper photography because of its immediacy and its ability to be transmitted over regular telephone wires. Its advantages in the home include that same capability of phone transport, along with the ability to view pictures over any TV set. However, its current disadvantages as a consumer product are topped by its high cost, its low definition as compared with film photography, and the high cost of making prints. In some ways, the history of consumer video and film photography have followed opposing paths: In film, still photography came first, followed much later by practical moving pictures. In video, however, just the opposite is true; motion was easy while economical still pictures pose a real problem to manufacturers.

R-E

ELECTRONICS ENGINEERS & DESIGNERS BOOK CLUB®

3 books for only \$1⁹⁵ (values to \$174.85)

Quality, Affordable Professional Books

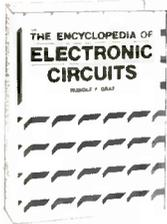

1938 \$60.00
Counts as 3



2888 \$32.95



2612 \$25.95



2631 \$22.95

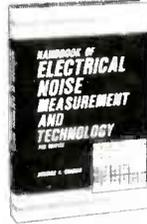

2802 \$39.95
Counts as 2



2809 \$26.95

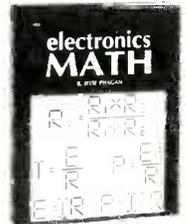

1962 \$22.95



2897 \$27.95

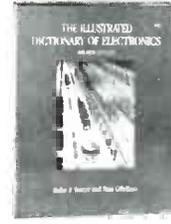

2900 \$36.95
Counts as 2



2720 \$32.50



2672 \$49.50
Counts as 2



2957 \$39.95



9781 \$68.95

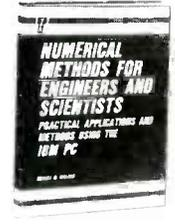

2697 \$19.95



2785 \$39.95
Counts as 2

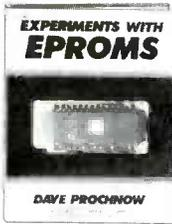

2962 \$24.95



2985 \$24.95



3002 \$49.50
Counts as 2



9762P \$21.95

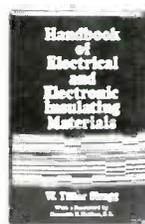

9787 \$58.95

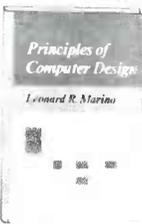

9813 \$39.95



3035P \$14.95



9820 \$46.95

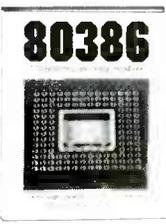

2937P \$19.95

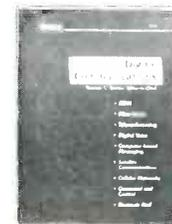

9773 \$44.95

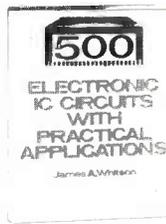

2920 \$29.95

How the Club Works

YOUR BENEFITS: You get 3 books for \$1.95 plus shipping & handling when you join. You keep on saving with discounts up to 50% as a member.

YOUR PROFESSIONAL BOOKSTORE BY MAIL: Every 3-4 weeks, you will receive the EE&D Book Club News describing the Main Selection and Alternates, as well as bonus offers and special sales, with scores of titles to choose from.

AUTOMATIC ORDER: If you want the Main selection, do nothing and it will be sent to you automatically. If you prefer another selection, or no selection at all, simply indicate your choice on the reply form provided. As a member, you agree to purchase at least 3 books within the next 2 years and may resign at any time thereafter.

BONUS BOOKS: Starting immediately you will be eligible for our *Bonus Book Plan* with savings of up to 80% off publishers' prices.

IRONCLAD NO-RISK GUARANTEE: If not satisfied with your books, return them within 10 days without obligation!

EXCEPTIONAL QUALITY: All books are quality publishers' editions especially selected by our Editorial Board.

SEND NO MONEY NOW!

INTRODUCTORY 10-DAY FREE EXAMINATION



ELECTRONICS ENGINEERS & DESIGNERS BOOK CLUB®
Blue Ridge Summit, PA 17294-0860

YES! Please accept my membership in the *Electronics Engineers & Designers Book Club®* and send me the volumes I have listed below, billing me only \$1.95 plus shipping and handling charges. I understand that the books are sent on a 10-Day Free Examination basis. If dissatisfied in any way, I may return the books within 10 days and incur no further obligation. Otherwise, I agree to pay the provided invoice promptly. To complete my membership obligation I need only purchase 3 additional books at regular members' prices during the next 2 years, and may resign at any time thereafter.

NAME _____
 ADDRESS _____
 CITY _____
 STATE _____ ZIP _____ PHONE _____
 SIGNATURE _____

Valid for new members only. Foreign applicants will receive special ordering instructions. Canada must remit in U.S. funds. This order is subject to acceptance by the *Electronics Engineers & Designers Book Club®*. DRE 489

TALK IS CHEAP.

Have you heard? For less than \$90 your AT or XT-compatible computer can talk! All it needs is the HV-2000 Computer Voice Kit from Heathkit.

Reading letters, transcriptions and computerized instruction can be easier and quicker than you ever thought possible. Computer games gain a new dimension. Your computer can even entertain children with stories and songs.

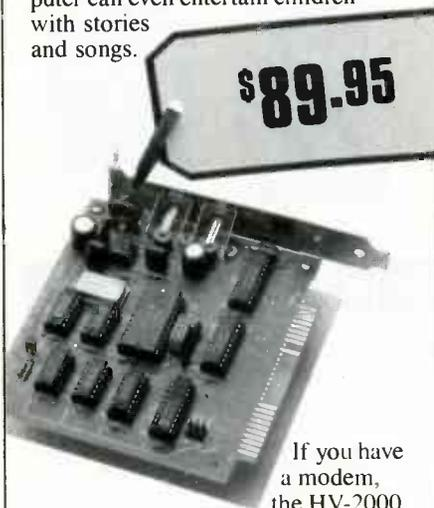

If you have a modem, the HV-2000

Computer Voice will allow your computer to recite reference and research information from time-sharing services. Or, speak radio transmitted ASCII information.

The HV-2000 Computer Voice Card, containing speech synthesizer and audio amplifier, plugs into any AT or XT-compatible computer's expansion slot. An external speaker is also included. Versatile, Heath-developed software gives you a wide variety of voices and easy interface to high and low level languages.

The HV-2000 Computer Voice. At less than \$90, talk IS cheap. To order, call toll-free 1-800-253-0570. Use your Visa, MasterCard, American Express or Heath Revolving Charge card. Or call 616-982-3614 for the nearest store location.

Heath Company

A subsidiary of Zenith Electronics Corporation

Prices, product availability and specifications are subject to change without notice.

CIRCLE 86 ON FREE INFORMATION CARD

ASK R-E

RAM INCREASE

I have a Tandy 1000SX computer and would like to increase the amount of RAM in the circuit. I don't want to use a memory expansion board because I'd like to keep as many slots available as possible. Is it possible to add more RAM by piggy-backing memory IC's on top of the existing ones and tying in chip-select, address, and data lines at appropriate points on the bus?—B.M., Oakhurst, CA.

Judging by the mail, a lot of people seem to be interested in doing something like that. It's become a bit more expensive to experiment with RAM since the price of memory has multiplied by a factor of five in the last year or so, but I can't argue with the fact that more memory is a desirable thing.

In any event, while what you want to do is probably theoretically possible, from a practical point of view you're letting yourself in for a lot of potential brain damage. Since I don't have schematics on the Tandy 1000SX, it's impossible to tell how much of a job it is to add memory to the motherboard; but there are undoubtedly several major factors that you're overlooking.

First of all, it's a safe guess that you're talking about dynamic RAM and that brings up several ugly necessities, the chief of which is refresh. Dynamic RAM has to be refreshed periodically (usually every 2 milliseconds), or the stored data will fade away into hyperspace. A reliable refresh system is one of the major components in the design of the circuit and there's probably an upper limit to the amount of RAM it can handle. Adding memory to the board without knowing exactly how refresh is done is a risky business.

You also aren't paying any attention to how the control lines are handled. Tying the select lines to the new memory without paying any attention to how the memory

is organized may lead to a situation where you're enabling two memory cells at the same bit location of the same address. At best that would be a waste of memory and at worst you'll damage some very expensive silicon.

The bottom line here is that it's not a good idea to monkey around with an existing design unless you understand the design; and that means having the paperwork. For what it's worth, I'd be willing to guess that the board isn't generating the proper control signals to deal with any additional memory. You'll have to check the circuit to see if that's true, and, if it is, your first job is to build decoding circuitry to handle the extra memory you want to add.

Remember, there's more on a memory expansion board than a bunch of RAM.

ADD A JACK

I'd like to add an earphone jack to my television set so that I can listen to it without disturbing anyone else. What's the easiest way to do that?—E. Juzumas, Seaford, NY.

Adding an earphone jack to a set is a straightforward operation but there are a couple of twists that can make it more difficult. Let's take a look at the simplest case and then talk about the problems that you might run across.

You can't deal with the audio until the TV's front end has finished demodulating the RF and separating it into audio and baseband video, as shown in Fig. 1. Once those two signals are available, the audio signal can be picked up and routed to an earphone jack. There are two places where you can do that.

The first is at the volume control and you have two options there as well. You can take it from the end of the potentiometer, in which case the TV set's volume control won't have any effect on the level at the earphones, or you can take

EXPAND YOUR CAREER HORIZONS...

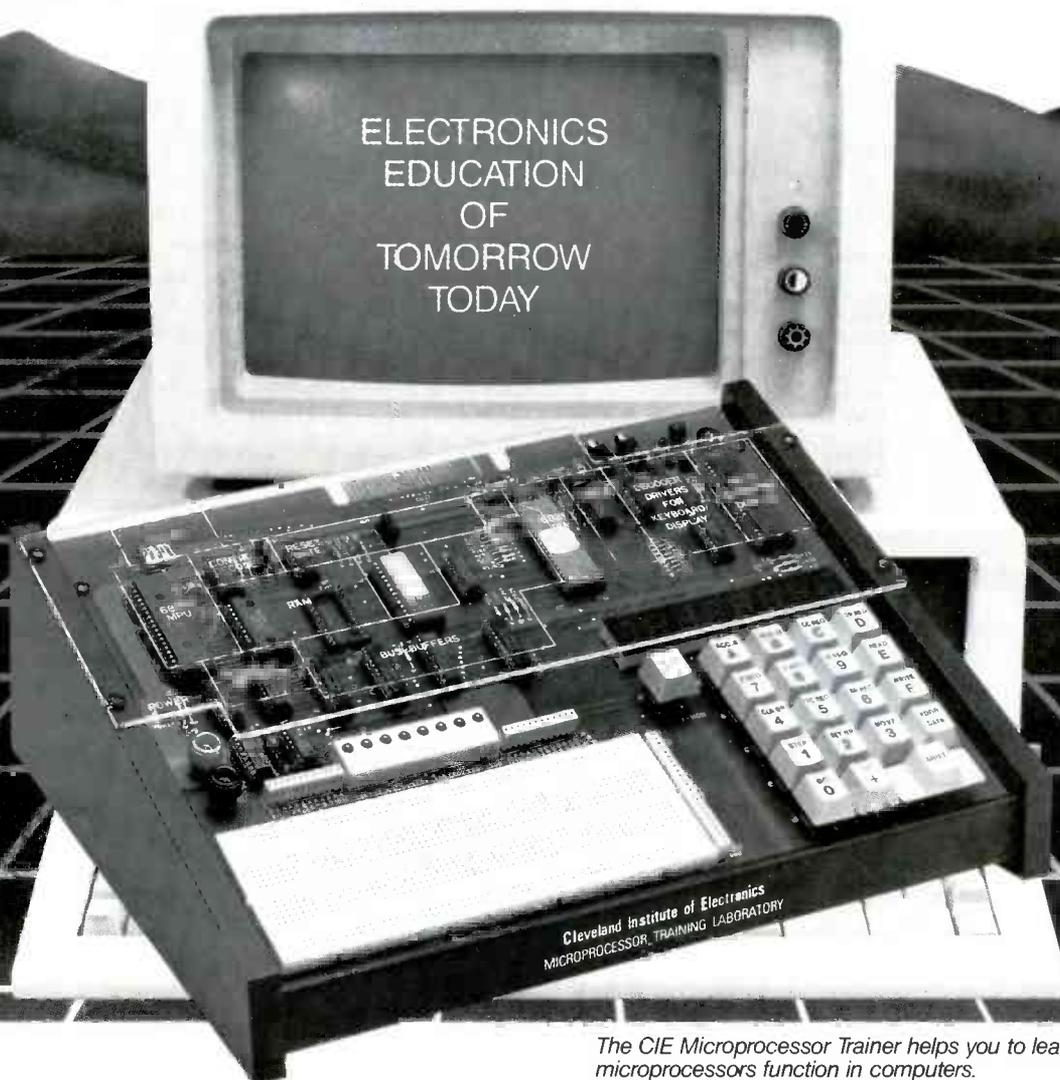

The CIE Microprocessor Trainer helps you to learn how circuits with microprocessors function in computers.

START WITH CIE.

Microprocessor Technology. Satellite Communications. Robotics. Wherever you want to go in electronics... start first with CIE.

Why CIE? Because we're the leader in teaching electronics through independent study. Consider this. We teach over 25,000 students from all over the United States and in over 70 foreign countries. And we've been doing it for over 50 years, helping thousands of men and women get started in electronics careers.

We offer flexible training to meet your needs. You can start at the beginner level or, if you already know something about electronics, you may want to start at a higher level. But wherever you start, you can go as far as you like. You can even earn your Associate in Applied Science Degree in Electronics.

Let us get you started today. Just call toll-free **1-800-321-2155** (in Ohio, 1-800-362-2105) or mail in

CIRCLE 60 ON FREE INFORMATION CARD

the handy reply coupon or card below to:
Cleveland Institute of Electronics,
1776 East 17th Street, Cleveland, Ohio 44114.

CIE World Headquarters

ARE-120

Cleveland Institute of Electronics, Inc.
1776 East 17th Street • Cleveland, Ohio 44114

Please send your independent study catalog.
For your convenience, CIE will try to have a representative contact you — there is no obligation.

Print Name _____

Address _____ Apt. _____

City _____ State _____ Zip _____

Age _____ Area Code/Phone No. _____

Check box for G.I. Bill bulletin on Educational Benefits

Veteran Active Duty **MAIL TODAY!**

Just call toll-free **1-800-321-2155** (in Ohio, 1-800-362-2105)

APRIL 1989

ATTENTION! ELECTRONICS TECHNICIANS

EARN YOUR
**B.S.E.E.
DEGREE**

THROUGH HOME STUDY

Our New and Highly Effective Advanced-Placement Program for experienced Electronic Technicians grants credit for previous Schooling and Professional Experience, and can greatly reduce the time required to complete Program and reach graduation. No residence schooling required for qualified Electronic Technicians. Through this Special Program you can pull all of the loose ends of your electronics background together and earn your B.S.E.E. Degree. Upgrade your status and pay to the Engineering Level. Advance Rapidly! Many finish in 12 months or less. Students and graduates in all 50 States and throughout the World. Established Over 40 Years! Write for free Descriptive Literature.

**COOK'S INSTITUTE
OF ELECTRONIC ENGINEERING**



4251 CYPRESS DRIVE
JACKSON, MISSISSIPPI 39212

CIRCLE 58 ON FREE INFORMATION CARD

NEW SUPER LONG PLAY TAPE RECORDERS

12 Hour Model — \$119.00*
USES D-120 TAPE

Modified Panasonic Slimline,
high quality, AC-DC
Recorders provide 6
continuous hours of quality
recording & playback on a
each side of cassette for a
total of 12 hours.
Built-in features include
• Voice level control, • Digital
counter, etc. TDK DC 120
Cassette Furnished.

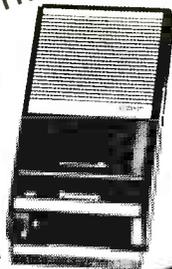

PHONE RECORDING ADAPTER

Records calls automatically. All Solid
state connects to your telephone
jack and tape recorder. Starts
recording when phone is lifted. \$24.95*
Stops when you hang up. FCC APPROVED



VOX VOICE ACTIVATED CONTROL SWITCH

Solid state. Self contained. Adjust-
able sensitivity. Voices or other
sounds automatically activate and
control recorder. Uses either re-
corder or remote mike. \$28.50*



*Add for ship & hdg. Phone Adapter & Vox \$1.50 ea.
Recorders \$4.00 ea. Cal. Res. add tax. Mail order, VISA,
M/C, COD's OK. Money Back Guarantee Qty. disc.
avail., Dealer Inquiries invited. Free data
AMC SALES INC. Dept. A9335 Lubec
St., Box 928, Downey, CA
90241 Phone (213)
869-8519

RADIO-ELECTRONICS

CIRCLE 108 ON FREE INFORMATION CARD

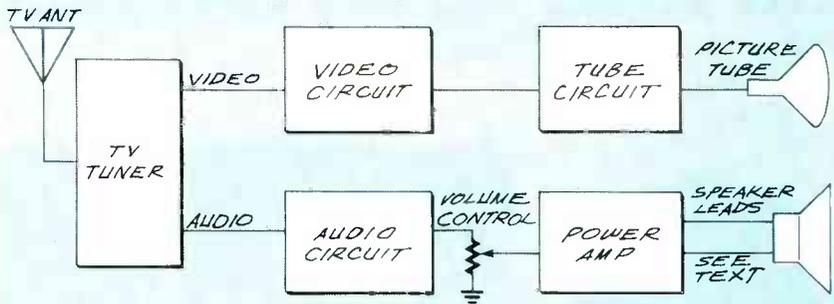

FIG. 1

the signal from the wiper of the potentiometer which will allow you to use the volume control to regulate the level at the earphones.

If you can't physically get at the volume control (or if it would require taking the entire set apart), you can also take the sound from the speaker connections. That would, of course, also allow you to set the volume with the TV set's volume control.

Most TV sets have an interlock on the power cord to make sure that the set is disconnected from the wall whenever the back is removed; but make sure that the plug is removed from the wall before you take the back off the set. Some of the voltages in a TV set are at lethal levels and, unless you know exactly what you're doing, playing around inside the cabinet with the power connected is a good way to risk getting fried.

When you decide to monkey around with a TV set, it's also a good idea to wait until the set's been off for an hour or so. There are some big capacitors inside and you want to make sure everything's been discharged before you go sticking your hands in there.

You can experiment with the three methods I've described and see which works best for you. Although it's probably easiest to take the sound from the speaker, be aware that some TV audio power amps don't have one side of their outputs tied to ground. You can check that by turning your TV off and testing for continuity between the chassis and the speaker leads.

If the amp in your set floats the outputs and the TV housing (on which you'll mount the earphone jack) is plastic, you can still pick the sound off the speaker leads. If,

however, your TV is housed in a metal case and there's no continuity between one side of the speaker and ground, you'll have to take the sound from the volume control; that's because grounding one side of the speaker may damage the output stage of the TV audio amp.

Whichever method you choose, the wiring setup will be exactly the same. You'll have to break the connection in the TV set and wire the jack so that the sound is always routed through the contact switch in the jack. You'll need the capacitor and jack as shown in Fig. 2. You

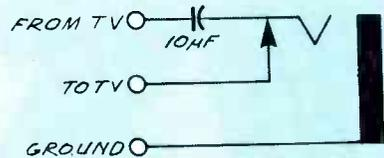

FIG. 2

can use any type of jack (it really depends on your earphone's plug), but make sure that you get the ones with a built-in switch.

That's really all there is to it. Drill a hole in the cabinet at a convenient location, mount the jack, and you'll be able to listen to the TV audio without bothering anyone else in the room. **R-E**



It's very realistic—it has a built-in 20-minute delay for takeoff.

HITACHI SCOPES AT DISCOUNT PRICES

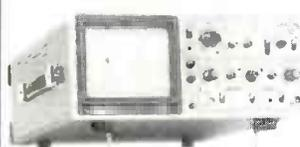

V-212

\$399

List \$560
Save \$161

20MHz Dual Trace Oscilloscope

All Hitachi scopes include probes, schematics and Hitachi's 3 year warranty on parts and labor. Many accessories available for all scopes.



V-425

List \$995

\$835

- DC to 40MHz
- Dual Channel
- CRT Readout
- Cursor Meas
- DC Offset
- Alt Magnifier
- Compact Size



V-1060

List \$1595

\$1,285

- DC to 100MHz
- Dual Channel
- Delayed Sweep
- CRT Readout
- Sweep Time
- Autoranging
- Trigger Lock
- 2mV Sensitivity

	LIST	PRICE	SAVE
V-223 20MHz	\$770	\$695	\$75
V-422 40MHz	\$875	\$695	\$180
V-423 40MHz	\$955	\$795	\$160
V-660 60MHz	\$1,195	\$990	\$205
V-1065 100MHz	\$1,895	\$1,670	\$225
V-1100A 100MHz	\$2,295	\$1,995	\$300
V-1150 150MHz	\$3,100	\$2,565	\$535

ELENCO PRODUCTS AT DISCOUNT PRICES

20MHz Dual Trace Oscilloscope

\$359

MO-1251

- 6" CRT
- Built in component tester
- TV Sync
- X-Y Operation

FREE DMM
with purchase of
MO-1251/1252 Scope

SCOPE PROBES

P-1 65MHz, 1x, 10x **\$19.95**
P-2 100MHz, 1x, 10x **\$23.95**
Fits all scopes with
BNC connector

35MHz Dual Trace Good to 50MHz

\$495

MO-1252

- High Luminance 6" CRT
- 1mV Sensitivity
- 6KV Acceleration Voltage
- 10ns Rise Time
- X-Y Operation • Z Axis
- Delayed Triggering Sweep

Top quality scopes at a very reasonable price. Contains all desired features. Two 1x, 10x probes, diagrams and manual. Two year guarantee.

Autoranging DMM

M-5000

\$45

9 Functions
Memory and
Data hold
1/2% basic acc
3 1/2% digit LCD

True RMS 4 1/2 Digit Multimeter

M-7000

\$135
.05% DC Accuracy
.1% Resistance
with Freq. Counter
and deluxe case

Multimeter with Capacitance and Transistor Tester

CM-1500

\$55
Reads Vclts, Ohms,
Current, Capacitors,
Transistors and
Diodes with case

Digital Capacitance Meter

CM-1550

\$58.95

9 Ranges
.1pf-20,000ufd
.5% basic accy
Zero control
with case

Digital LCR Meter

LC-1800

\$138

Measures
Coils 1uH-200H
Caps. 1pf-200uf
Res. .01-20M

AC Clamp-On Current Adapter

ST-265

\$22

0-1000A AC
Works with
most DMM

Bench DMMs

M-3500

\$125

3 1/2 digit
.1% accy

M-4500

\$175

4 1/2 digit
.05% accy

50MHz Logic Probe

LP-700

\$23

Logic Pulsar LP-600 **\$23**

Solderless Breadboards

9430 1,100 pins **\$15**
9434 2,170 pins **\$25**
9436 2,860 pins **\$35**
All have color
coded posts

9436 SHOWN

Low Cost Multimeter

M-1600

\$25

3 1/2 digit LCD
1% DC Accy
10A Scale
Auto zero
/polarity

Wide Band Signal Generators

SG-9000 **\$129**

RF Freq 100K-450MHz
AM Modulation of 1KHz
Variable RF output

SG-9500 with Digital Display
and 150MHz built-in Freq Ctr **\$249**

3 1/2 Digit Probe Type DMM

M-1900

\$41

Convenient one hand operation
Measures DCV, ACV, Ohms
Audible continuity check, Data Hold
with batteries
and case

Function Generator Blox

#9600

\$28.95

Provides sine, tri, squ wave
From 1Hz to 1MHz
AM or FM capability

Decade Blox

9610 or

9620

\$18.95

#9610 Resistor Blox
47 ohm to 1M & 100K pot
#9620 Capacitor Blox
47pf to 10MFD

Digital Triple Power Supply

XP-765

\$249

0-20V at 1A
0-20V at 1A
5V at 5A

Fully Regulated, Short circuit protected with
2 Limit Cont., 3 Separate supplies
XP-660 with Analog Meters **\$175**

Quad Power Supply

XP-580

\$59.95

2-20V at 2A
12V at 1A
5V at 3A
-5V at 5A

Fully regulated and
short circuit protected
XP-575 without meters **\$44.95**

10MHz XT 100% IBM® Compatible

5 Year

Warranty

\$595

MODEL

PC-1000

•5/10MHz Motherboard
•8 Expansion Slots
•Math Compressor Slots
•360K Floppy Drive
•AT Style Keyboard
•150W Power Supply
•256K RAM
•Expandable to 640K
•Monochrome Monitor
•Monographic Video Card
•Parallel Printer Port

FREE spreadsheet and word processor
3.3MS DOS and GW Basic add \$75

Four-Function Frequency Counters

F-1000 1.2GH

\$259

F-100 120MH

\$179

Frequency, Period, Totalize,
Self Check with High Stabilized Crystal Oven
Oscillator, 8 digit LED display

GF-8016 Function Generator with Freq. Counter

\$239

Sine, Square, Triangle
Pulse, Ramp, .2 to 2MHz
Freq Counter .1 - 10MHz

GF-8015 without Freq. Meter **\$179**

WE WILL NOT BE UNDERSOLD!

UPS Shipping: US 5%

(\$10 Max) IL Res., 7% Tax



C & S SALES INC.

1245 Rosewood, Deerfield, IL 60015

(800) 292-7711 (312) 541-0710

15 Day Money Back Guarantee

2 Year Warranty

WRITE FOR FREE CATALOG

CIRCLE 109 ON FREE INFORMATION CARD

Get A Complete Course In

ELECTRONIC ENGINEERING

8 volumes, over 2000 pages, including all necessary math and physics. 29 examinations to help you gauge your personal progress. A truly great learning experience.

Prepare now to take advantage of the growing demand for people able to work at the engineering level.

Ask for our brochure giving complete details of content. Use your free information card number, or write us directly. \$99.95, Postage Included. Satisfaction guaranteed or money refunded.



**Banner
Technical
Books, Inc.**

1203 Grant Ave.
Rockford, IL 61103

CIRCLE 67 ON FREE INFORMATION CARD

LETTERS

THOSE DARN DIODES

We wish we had a dollar for every diode we put in backward—because we'd be \$4 richer right now! In the article "High-Power Hi-Fi Audio Amp for Home or Car," (*Radio-Electronics*, March 1989) Fig. 5, the 12-volt power supply, on page 54 shows diodes D1 through D4 reversed. Figure 6, the photo on page 55, shows the correct orientation for those diodes. Sorry 'bout that.—*Editor*

CALIBRATION CLARIFICATION

The "TV-Derived Frequency Standard" (*Radio-Electronics*, April



LETTERS

RADIO-ELECTRONICS
500-B BI-COUNTY BOULEVARD
FARMINGDALE, NY 11735

1988) introduces three uncertainties that can be eliminated if the counter being calibrated has a 2.5-, 5-, or 10-MHz reference oscillator. The uncertainties are those in the transmitted 3.58-MHz color sub-carrier, the calibration of the standard itself, and the ± 1 count error in the counter display. Those uncertainties are additive, and may amount to 3 ppm or so. (They could be much less than 3 ppm, but you can never really be certain of that; nor is it easy to ascertain what the value might be at any point in time.)

It's a waste of time to keep a frequency counter calibrated to an unnecessarily high degree of accuracy. If 2% is good enough for you in audio-frequency work, the line-voltage frequency is a handy calibration reference. Some work may require measurements to within 1 ppm or better.

A shortwave receiver is about all that's needed to calibrate a frequency counter with a 2.5-, 5-, or 10-MHz oscillator. Let the counter warm up and stabilize, and adjust its oscillator for zero beat with WWV. If the counter's radiated oscillator signal and the receiver's sensitivity are great enough, not even a dummy antenna will be needed to couple the signals and hear the beat frequency.

With no propagation path corrections, WWV carrier frequencies are accurate to ± 0.03 ppm. The only other uncertainty introduced using this method is your ability to hear the beat, or difference frequency, and to adjust it to as close to zero as possible. Difference

When performance & price really count...



CRYSTEK CRYSTALS

The pulse of dependable communications

QUARTZ CRYSTALS FOR Industrial Equipment/Instrumentation

- Micro-processor control
- Computers/Modems
- Test/Measurement
- Medical

General Communications

- Channel element Service (VHF/UHF)
- Land Mobile 2-way
- Marine
- Aircraft
- Telemetry
- Monitors/Scanners/Pagers

Amateurs/2-Meter/General Coverage CB/Hobbyist/Experimenter

The Pulse of Dependable Communications...

Crystek Crystals offers their new 16 page **FREE** catalog of crystals and oscillators. Offering state of the art crystal components manufactured

For Optimum
Stability and
Reliability in
Frequency
Management

Custom Made Crystals Catalog

by the latest automated technology. Custom designed or "off the shelf." Crystek meets the need, worldwide. **Write or call today!**



NEW



Replacement Crystals Catalog

CRYSTEK CORPORATION
DIVISION OF WHITEHALL CORPORATION



2351/2371 Crystal Drive • Ft. Myers, FL 33907
P.O. Box 06135 • Ft. Myers, FL 33906-6135
TOLL FREE 1-800-237-3061

PH 813-936-2109/TWX 510-951-7448/FAX 813-939-4226
TOLL FREE IN THE U.S.A. EXCEPT FLORIDA, ALASKA, HAWAII

CIRCLE 69 ON FREE INFORMATION CARD

frequencies as low as 0.1 Hz are easy to detect. If you can set the beat that low at 10 MHz, that's only 0.01 ppm. Adding the WWV tolerance gives 0.04 ppm, but don't expect any but the best Temperature-Controlled Crystal Oscillators (TCXO's) to remain steady at that value. Short- and long-term drift, ambient temperature, and line-voltage changes all play a role in increasing the uncertainty of the calibration, but that's a subject unto itself.

If the counter you have, or are thinking of getting, has a reference-oscillator frequency that won't beat audibly with WWV, then **Radio-Electronics'** "TV-Derived Frequency Standard" might be the next best thing to packing the unit off to the manufacturer for periodic recalibration.

DAN A. NIEMI
Gwinn, MI

SUMMER SCHOOL

The Massachusetts Institute of Technology's special Summer Session of professional seminars includes several programs that should interest the readers of **Radio-Electronics**. The following is a brief outline of selected seminars that are being offered:

June 1989

Program 6.01s: "Structure and Interpretation of Computer Programs"; June 26-12; Professor William M. Siebert.

Program 1.23s: "Knowledge-Based Expert Systems for Engineering"; June 26-30; Prof. Duvuru Sriram.

July 1989

Program 6.84s: "Parallel Algorithms and Architecture"; July 17-21; Prof. F. Thomas Leighton.

Program 6.83s: "Parallel Computing: Dataflow Architecture and Languages"; July 24-28; Prof. Arvind.

Program 6.87s: "Robot Manipulators, Computer Vision and Artificial Intelligence"; July 24-28; Prof. Berthold K.P. Horn.

August 1989

One-Day Seminar: "Writing for the Computer Industry"; August 12; Prof. Edward Barrett.

Program 6.90s: Scientific Supercomputing with Dataflow"; August 14-18; Prof. Jack B. Dennis.

Program 6.64s: Computer-

Aided Multivariable Control System Design"; August 21-25; Prof. Michael Athans.

Anyone who is interested in attending these seminars can receive descriptive brochures by contacting MIT Summer Session Office, Room E19-356, Cambridge, MA 02139; telephone 617-253-2101.

FREDERICK J. MCGARRY
Director, Summer-Session Office of the Massachusetts Institute of Technology

CAPACITOR CONNECTIONS

In "Antique Radios" (**Radio-Electronics**, January 1989) you suggest connecting capacitors in series. Unless a voltage divider is implemented, the voltage will divide proportionally to the DC resistance of the capacitors. It is unlikely that they will be the same. If that distributed voltage exceeds the breakdown voltage of one of the capacitors, it will fail. Then the

continued on page 93

Get your hands on the standard: POMONA.

Since 1951 POMONA has grown to become the standard of the industry. And for good reason. Our test products assure honest test results because they are the best you can buy. Specify POMONA and get unsurpassed quality, the broadest product line, the greatest selection, the industry standard.



For your FREE 1989 General Catalog, circle reader service number printed below

ITT Pomona Electronics
An ITT ElectroMechanical Components Worldwide Company

APRIL 1989

CIRCLE 101 ON FREE INFORMATION CARD

15

Cable Checklist

ENJOY CABLE TV MORE THAN EVER



SNOOPER STOPPER/DATA BLOCKER

\$39⁹⁵



- Prevent cable companies from spying on you to see how many cable converters you have
 - Removes beeping sound from your FM when radio is connected to cable TV
 - Cable TV descramblers are being sold by the thousands, but few people know descramblers can be detected on most addressable systems
- Maintain your privacy with a Snooper Stopper. For more detailed information, send \$2.00 for our "Cable TV Snooper Stopper" article.

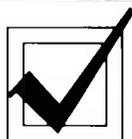

MACROVISION... NOW YOU SEE IT, NOW YOU DON'T

MS1-KIT **\$29⁹⁵**

Includes all the parts, pc board, AC adaptor, and instructions from a published construction article in *Radio Electronics* magazine.



- Remove copy-protection from video cassettes
- Digital filter type; removes only Macrovision pulses

JMAK-4 BLACK BOX **\$14⁹⁵**

Original box as shown in ad with two feet and four holes to mount pc board.

- No adjustments; crystal controlled
- Compatible with all VCRs
- Uses automatic vertical blanking level
- Assembles in less than three hours

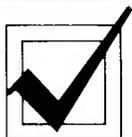

SIGNAL ELIMINATOR

\$29⁹⁵



- Works on cable or broadcast TV
- External adjustments allow precise tuning to any frequency
- #23 H-Tuneable to ch. 2 & 3 (50-66 Mhz) also 6 meter HAM TVI interference filter
- #46 FM-Tuneable to ch. 4-6 (66-108 Mhz & FM Band)
- #713-Tuneable to ch. 7-13 (174-216 Mhz)
- #1417-Tuneable to ch. 14-17 (A-D) (120-144 Mhz)
- #1822-Tuneable to ch. 18-22 (E-J) (144-174 Mhz)

ELIMINATE a Channel

that you find unsuitable for family viewing, but is poorly scrambled by your cable company. **OR**

CLEAR UP a Channel

that presently contains severe interference by ELIMINATING whatever signal is causing this.

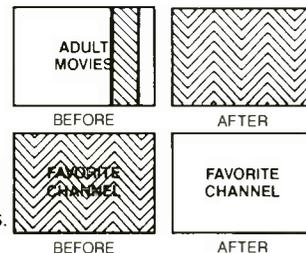

Note: If picture and sound are equally affected, this IS interference and CAN be removed by our product. If only picture is affected, this usually IS NOT interference and CANNOT be removed by our product.



72 Channel CABLE CONVERTER with Infra-Red Remote

MC-702 Converter
\$79⁹⁵



- Microprocessor controlled PLL operation
- Skip channel memory eliminates unused channels
- Parental control for all channels
- Compatible with all external descramblers
- Last channel recall
- Fine tune memory
- UL listed/FCC approved
- Simple installation with any TV
- Includes battery and 3 foot coax
- Channel output 2 or 3 switchable

Add \$3.50 shipping & handling
\$9.50 Canadian orders

ORDER TOLL FREE ANYTIME 1-800-227-8529

Inside MA: 508-695-8699 Fax: 508-695-9694
Ask for additional free information
Add \$3.00 shipping & handling on all orders unless otherwise noted. \$6.00 Canadian orders.
Visa, MasterCard, or C.O.D.



J & W ELECTRONICS, INC.

P.O. BOX 800 • MANSFIELD, MA 02048

EQUIPMENT REPORTS

Sencore LC102 Capacitance/Inductance Meter

Check capacitors and
inductors the fast and easy
way!

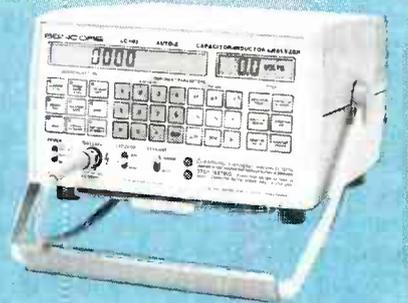

CIRCLE 14 ON FREE INFORMATION CARD

IT SEEMS THAT AS CIRCUITS GET MORE and more complicated, testing components and troubleshooting in general get that much easier. For example, take the LC102 "Auto-Z" meter from Sencore (3200 Sencore Drive, Sioux Falls, South Dakota 57107). It can give you a precise capacitance or inductance measurement displayed in common terms at the touch of a button, and even has an automatic test to tell you whether a capacitor or inductor is good or bad. Its capacitance range is from 0.1 pF to 19.99 F, and its inductance range is from 0.1 μ H to 20 H, and both can be fully auto-ranged. It can also be operated on an IEEE 488 bus. Another good feature is that it can be powered from an optional rechargeable lead-acid battery, making the LC102 well suited for field use.

Besides the obvious, such as checking a capacitor's value, the LC102 can test for such things as leakage, ESR (Equivalent Series Resistance), and dielectric absorption. ESR is the real resistive component of a capacitor's AC impedance. Dielectric absorption is the inability of a capacitor to fully discharge, and the LC102 provides an automatic test for that. It also provides an accurate "true inductance" test, as well as a "ringing test" to check coils, deflection yokes, switching power supply

transformers, and all other types of non-iron core inductors.

To determine a capacitor's value, the LC102 measures one RC time constant while charging the capacitor under test to +5 volts. That basically means that the LC102 measures the rate at which a capacitor charges under known conditions. An inductor's value is determined by applying a changing current to the inductor under test and measuring the produced EMF. In plain terms, an inductor has a tendency to resist changes in current, and the strength at which it resists those changes corresponds to the inductor's value.

The properties of an inductor are such that a current (or waveform) flowing through the inductor will continue to flow even after the current source is removed. The current continues to flow (or the waveform continuously repeats itself) until all of its energy is dissipated by the inductor in the form of heat (the waveform repeats itself as its magnitude gets increasingly smaller until the waveform "flattens," or dampens out completely—that is known as ringing). Therefore, the ringing test is done by applying a pulse to the inductor under test, and then counting the number of ring cycles before the pulse dampens to a preset point.

Good or bad?

One of the more interesting features of the LC102 is that it can store a set of component parameters for either a capacitor or an inductor in memory, and then perform an automatic go/no-go test for any of those parameters. The test reading and "good" or "bad" will be displayed on the LCD when a test button is pressed. A large number of the same components can be quickly checked by connecting them one at a time to the test leads and selecting the desired test.

The go/no-go test is performed by first pressing the appropriate component-type button on the front panel of the LC102. The numerical value of the device is entered followed by a multiplier (pF, μ F, mH, μ H, etc.). The tolerance of the device is then entered as follows: A 1- to 3-digit number from 1 to 100 is entered, followed by pressing the "+ %" button. Then a 1- or 2-digit number is entered, followed by pressing the "- %" button. The voltage rating, or working voltage (from 1 to 999.9) of the capacitor to be tested is entered, followed by pressing the "V" button. When the capacitor-leakage button is pressed, the working voltage is applied to the capacitor under test. Therefore, you do have to be careful **not** to touch the test-leads during that test.

For safety's sake, two red LED's on the front panel are there to warn you—one to indicate the presence of anything above 25 volts being applied to the test leads, and the other to indicate that the internal discharge circuit has failed. (When performing the leakage test, ultra-large capacitors may cause the test-lead fuse to blow, leaving the capacitor charged with a potentially dangerous voltage.)

Cable testing

Coaxial cables and transmission lines behave like a capacitor when open at both ends. The LC102 can therefore be used to determine the length of a cable or the distance to an open. That is done by first measuring the capacitance of one foot of the cable under test, and then measuring the capacitance of the entire length. The entire capacitance is then divided by the capacitance per foot to find the distance to the break.

Likewise, coaxial cables behave like an inductor when shorted. So the LC102 can be used to determine the approximate distance to a short. The inductance per foot of a sample cable is measured, and then the inductance of the suspected cable is measured. The total inductance is then divided by the inductance per foot to find the distance to the short.

Accessories

The LC102 is supplied with an AC power adapter/recharger, and test leads and an adapter to connect to

larger components. It also comes with a test-lead mounting clip and a test-button hold-down rod.

Optional accessories include a touch test probe, a field calibrator, a rechargeable lead-acid battery, an SCR/triac tester, a chip-component test lead, a bus interface for the IEEE 488 bus, and a 220-volt AC adapter/recharger. An easy-to-use component holder is also available that makes testing a lot quicker and, at the same time, frees up your hands for doing all sorts of other things.

We're sure that the LC102 will feel at home in your repair shop or research and development center. Its advanced features will allow you to breeze through tests that used to take a lot more time. The LC102 may end up paying for itself, by the amount of time saved. And, once you become familiar with its controls, you'll find the LC102 is very easy—maybe even fun—to use. Of course, with a suggested retail price of \$1895.00, the LC102 is an investment for serious troubleshooting, not for fun. **R-E**

Try the

**Radio
Electronics**

bulletin board
system

(RE-BBS)
516-293-2283

The more you use it the more
useful it becomes.

We support 300 and 1200 baud
operation.

Parameters: 8N1 (8 data bits, no
parity, 1 stop bit) or 7E1 (7 data
bits, even parity, 1 stop bit).

Add yourself to our user files to
increase your access.

Communicate with other R-E
readers.

Leave your comments on R-E with
the SYSOP.

RE-BBS
516-293-2283



Cut Your Video Servicing Time By 54%

With the Market Proven VA62 Universal Video Analyzing System.

Today's VCRs, TVs, and MTS Stereo TVs require a proven method to quickly isolate the defective component. New technology has made simple problem solving a time-consuming and expensive procedure.

A survey of over 1500 Video Analyzer owners has shown that the VA62's unique signal substitution method has reduced their video servicing time by an average of 54%, and increased their servicing profits.

You can join the successful service centers that have cut their video servicing time and increased their profits with the VA62 Universal Video Analyzing System. Call for a brochure on the VA62. Call **1-800-843-3338**, and increase your profits. In Canada Call **1-800-851-8866**.

SENCORE

3200 Sencore Drive, Sioux Falls, SD 57107

100% American Made

CIRCLE 180 ON FREE INFORMATION CARD

www.americanradiohistory.com

How to build a high-paying career, even a business of your own, in computer programming.



**CARL BARONE,
NRI PROGRAMMER/ANALYST**

Start with training that gives you hands-on programming experience—at home and at your own pace. Training that begins with BASIC, then continues with Pascal, C, and COBOL—today's hottest computer languages. Training that even includes a powerful IBM-compatible computer, modem, and programming software you keep.

Start with real-world training. The kind of training only NRI provides.

Now with NRI's new at-home training in Computer Programming, you can be one of today's highly paid, creative team of computer wizards who give computers the power to carry out an astonishing range of business, professional, and personal applications. Now, with NRI, you can be a computer programmer, ready to build a high-paying career—even a business of your own—making computers do anything you want them to do.

The only programming course that includes a powerful computer system and software you keep.

Unlike any other school, NRI gives you hands-on programming experience with a powerful IBM-compatible Packard Bell computer system, including 2400



Only NRI gives you an IBM-compatible computer with modem, 512K RAM, disk drive, monitor, and software—BASIC, Pascal, C, and COBOL—all yours to keep!

baud internal modem, 512K RAM, disk drive, monitor, and invaluable programming software—BASIC, Pascal, C, and COBOL—all yours to keep.

You get the experience and the know-how, the computer and the software to get to the heart of every programming problem, design imaginative solutions, then use your choice of four key computer languages to build original, working programs.

No matter what your background, NRI gives you everything you need to succeed in programming, today's top-growth computer career field.

You need no previous experience to build a successful programming career with NRI training. Indeed, your NRI lessons start by walking you step by step through the fundamentals, giving you an expert understanding of the programming design techniques used every day by successful micro and mainframe programmers. And then the fun really begins.

C, and COBOL. Then, rounding out your training, you use your modem to "talk" to your instructor, meet other NRI students, even download programs through NRI's exclusive programmers network, PRONET.

Your career in computer programming begins with your FREE catalog from NRI.

For all the details about NRI's at-home training in Computer Programming, send the coupon today. Soon you'll receive NRI's fascinating, information-packed, full-color catalog.

Open it up and you'll find vivid descriptions of every aspect of your NRI training. You'll see the computer system included in your course up close in a special, poster-sized foldout section. And, best of all, you'll find out how your NRI training will make it easy for you to build that high-paying career—even a business of your own—in computer programming.



You master today's hottest computer languages, gaining the skills you need to build programs for a wide variety of real-world applications.

With your personal NRI instructor on call and ready to help, you use your computer and software to actually design, code, run, debug, and document programs in BASIC, Pascal,

Send for your NRI catalog today. It's yours, free.

If the coupon is missing, write to us at the NRI School of Computer Programming, McGraw-Hill Continuing Education Center, 4401 Connecticut Avenue, NW, Washington, DC 20008.

IBM is a Registered Trademark of the IBM Corporation

NRI School of Computer Programming

McGraw-Hill Continuing Education Center
4401 Connecticut Avenue, NW
Washington, DC 20008



YES! Please rush me my FREE catalog describing NRI's at-home training in Computer Programming.

NAME _____ (please print) AGE _____

ADDRESS _____

CITY/STATE/ZIP _____ 5415-049

Accredited by the National Home Study Council

NEW PRODUCTS



CIRCLE 10 ON FREE INFORMATION CARD

6-DISC CD-VIDEO PLAYER.

video represents the merging of digital audio and laser video—two formats that *Philips* played a major role in developing. With CD-video gaining recognition and appreciation from both retailers and consumers, and an increase in the quantity and kinds of software being produced, Philips has introduced their model *CDV488* CD-video player. Compatible with 6 different types of discs, the *CDV488* can play virtually every type of software available today. It also offers advanced digital technology and features, a universal remote control, and such special effects as picture memory, mosaic picture effect, strobe, and freeze.

The unit plays the 3-inch CD single, the 5-inch CD, the 5-inch CD-V gold disc, and the 8- and 12-inch laser-video discs. It also plays the new 8-inch LD single—a thinner version of the standard 8-inch disc that provides 20 minutes of both audio and video.

The CD-V player offers favorite-track selection and 20 audio-track or video-chapter programming. It features Philips 16-bit, 4· oversam-

pling digital filter, and dual 16-bit digital-to-analog converter. The *CDV488* also incorporates chrominance and luminance (Y/C) processing for superior picture quality. It features an "S"-type video output connector for compatibility with the growing number of high-performance monitors that use "S" inputs.

A universal remote control, which can control up to 10 different types of components, is included. Remote functions include jog for still-picture, step-picture, and slow-motion control. The shutter dial allows fast motion and high-speed scan; the angle and direction of its rotation determine the speed (2, 5, or 10 times normal speed) and the direction of the picture sequencing. Other remote functions include next and previous track/chapter, next and previous index, still/next-still and still/previous-still, select track/chapter, and on-screen display.

The *CDV488* has a suggested retail price of \$1300.00.—**Philips Consumer Electronics Company**, One Philips Drive, P.O. Box 14810, Knoxville, TN 37914-1810.

COMPUTER WORKSTATION.

OPC's MACabinet Workstation is specifically designed for *Apple Macintosh* computers, with special compartments that accommodate the monitor, printer, disk drive, hard disk, modem, and keyboard.

The workstation provides an efficient paper-management system that allows easy loading and restacks the printed paper on the bottom shelf. All computer components can be locked safely away behind a tambour door.

For quick access to cable connections, there is a rear service door; power cable exit slots are also provided on the back of the unit. A slide-out mouse tray can be used on either the right or the left side. The workstation sits on heavy-duty, dual-wheel, steel-



CIRCLE 12 ON FREE INFORMATION CARD

bracketed casters so that it can be moved around easily.

The *MACabinet Workstation* has a suggested retail price of \$649.00.—**OPC, Inc.**, 11828 Glenoaks Blvd., San Fernando, CA 91340.

DUST REMOVER. Chemtronic's *E-Series* line of chemicals for computer and electronic field service has been formulated to be environmentally sound, meeting EPA ozone safety standards. *E-Series Ultrajet* gas duster—a second generation EPA-exempt fluorocarbon that offers low toxicity, inertness, and non-flammability—has been designated as a substitute for regulated CFC's.



CIRCLE 13 ON FREE INFORMATION CARD

E-Series Ultrajet uses high-gauge pressure (120 psi) to deliver powerful jet blasts for dust removing and cleaning electronic systems. Because it is highly filtered, the product can be safely used on optical surfaces and precision mechanisms. *Ultrajet* is non-abrasive and leaves no residue.

It is packaged in 12-ounce cans. For high-volume users, a complete reusable system is also available.

E-Series Ultrajet costs \$5.45 in individual cans; the complete system costs \$24.50 (refills are \$5.00).—Chemtronics, 681 Old Willets Path, Hauppauge, NY 11788.

FASTER ELECTRONS. *Electr-O-lube* is a spray-on liquid from *Zip-Tronix* which, its manufacturer claims, will reduce or eliminate the propagation-delay bottleneck in many of today's semiconductors. Applied in a thin film to the surface of a device or circuit board, the product penetrates to the interior through tiny cracks and crevices to lubricate the very paths traveled by the electrons within.

Speedups as great as 25% are promised, as well as a decrease in warmup times. Things also tend to turn off faster.

However, the manufacturer cautions, *Electr-O-Lube* is not intend-



CIRCLE 289 ON FREE INFORMATION CARD

ed for use in superconducting circuitry as it tends to get gummy at low temperatures and impede electron flow. For such situations, another *Zip-Tronix* product, *Kry-O-Flo*, is recommended. *Kry-O-Flo*, also available in spray cans, penetrates to cryogenic superconducting electron paths and imparts to them a soothing warmth that encourages normal electron flow to resume.—*A-Tronix Corp.*, 459-F Absolute Dr., Liberal, KS 76543. R-E

Joseph Electronics' 40th Anniversary Specials!

Special INSTRUMENT SALE!

Model 2120 Oscilloscope
DC to 20 MHz. Dual Trace, 6" CRT, 1mv Sensitivity.
Reg. \$520 **\$379.40**
40TH ANNIVERSARY PRICE

Model 2125 Oscilloscope
Same great features as 2120, except with delayed sweep
Reg. \$620 **\$519.40**
40TH ANNIVERSARY PRICE

Model 1541A Oscilloscope DC to 40 MHz, Dual Trace, 6" CRT 1mv Sensitivity
Reg. \$845 **\$739.40**
40TH ANNIVERSARY PRICE

Model 2160 Oscilloscope DC-60MHz, dual trace, delay sweep, 6" CRT, 1mv. sensitivity
Reg. \$995 **\$839.40**
40TH ANNIVERSARY PRICE

Model 2520 Digital Storage 20MHz, Dual Trace, 2mv Sens.
Reg. \$1990 **\$1795.40**
40TH ANNIVERSARY PRICE

Model 2521 Digital Storage 20MHz, Dual Trace CRT Readout, Cursors, RS232 Interface
Reg. \$3050 **\$2745.40**
40TH ANNIVERSARY PRICE

Model 1249 NTSC/RGB Color Bar Generator. Composite Video Output, RF Output
Reg. \$499 **\$419.40**
40TH ANNIVERSARY PRICE

Model 2009 MTS TV Stereo Generator Ideal for Stereo TV Receivers, VCR's and Stereo Adapter Service
Reg. \$499 **\$419.40**
40TH ANNIVERSARY PRICE

Model 2830 3 1/2 DIGIT LED BENCH Multimeter .5 DCV Accuracy, ALL 33 Ranges and Functions are Push Button Selectable
Reg. \$243 **\$209.40**
40TH ANNIVERSARY PRICE

Model 1045 Telephone Product Tester Provides Basic Operation Tests for Corded and Cordless Telephones, Answering Machines and Automatic Dialers
Reg. \$495 **\$415.40**
40TH ANNIVERSARY PRICE

Model 1803 Frequency Counter 100 MHz, 8 digit display, zero blanking AC or Battery
Reg. \$199 **\$169.40**
40TH ANNIVERSARY PRICE

Model 2005 RF Signal Generator 100 KHz to 150 MHz, in 6 fundamental bands and 450 MHz in harmonics
Reg. \$195 **\$165.40**
40TH ANNIVERSARY PRICE

Model 3011 Function Generator 2 MHz, 4 digit display, TTL & CMOS pulse outputs
Reg. \$239 **\$199.40**
40TH ANNIVERSARY PRICE

Model 1630 DC Power Supply 0-30V, 0-3A, high-low current range. Low ripple
Reg. \$251 **\$209.40**
40TH ANNIVERSARY PRICE

Model 1601 DC Power Supply isolated 0-50V, 0-2A in ranges, fully automatic shutdown, Adj. current limit
Reg. \$463 **\$389.40**
40TH ANNIVERSARY PRICE

Model 1653 Triple Output Power Supply two 0-25 VDC @ 5A and 5VDC @ 5A, fully automatic shutdown
Reg. \$489 **\$409.40**
40TH ANNIVERSARY PRICE

Model 1653 AC Power Supply variable isolated 0-150 VAC @ 2A, built-in isolation transformer
Reg. \$200 **\$169.40**
40TH ANNIVERSARY PRICE

NEW! Model 388-HD Hand-held 3 1/2 Digit LCD TEST BENCH

41 voltage ranges, frequency counter, capacitance meter, logic probe, transistor and diode tester. All packed into a drop-resistant case. **SPECIAL PRICE!**

Reg. \$139 **\$119.40**

We are celebrating our 40th Anniversary by offering you huge savings on B&K Test Equipment.

Send for FREE 528 page "Industrial Products Catalog" I understand it is FREE with any order or if requested on company letterhead. (Otherwise, \$4.95 to cover catalog and shipping costs.)

ORDER TOLL FREE
1-800-323-5925
IN CHICAGO LAND
312-297-4200
FAX: 312-297-6923

Joseph ELECTRONICS



IL Res. 7% Tax

JOSEPH ELECTRONICS, INC. Dept. R
8830 N. Milwaukee Ave., Niles, IL 60648

Rush merchandise per attached order.
I understand rated accounts are shipped open account; otherwise send per credit card
Include \$5.00 per item for shipping and handling.
 Visa Master Card Discover
 Check Money Order Rush Catalog
Card No. _____ Exp. Date _____

Name _____
Company _____
Street Address _____
City _____ State _____ Zip _____

WITH CIE, THE WORLD OF ELECTRONICS CAN BE YOUR WORLD, TOO.

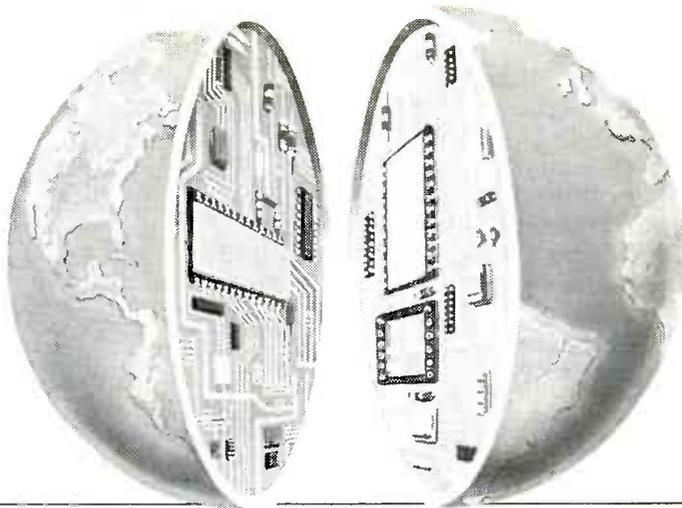

Look at the world as it was 20 years ago and as it is today. Now, try to name another field that's grown faster in those 20 years than electronics. Everywhere you look, you'll find electronics in action. In industry, aerospace, business, medicine, science, government, communications—you name it. And as high technology grows, electronics will grow. Which means few other fields, if any, offer more career opportunities, more job security, more room for advancement—if you have the right skills.

SPECIALISTS NEED SPECIALIZED TRAINING.

It stands to reason that you learn anything best from a specialist, and CIE is the largest independent home study school specializing exclusively in electronics, with a record that speaks for itself. According to a recent survey, 92% of CIE graduates are employed in electronics or a closely related field. When you're investing your time and money, you deserve results like that.

INDEPENDENT STUDY BACKED BY PERSONAL ATTENTION.

We believe in independent study because it puts you in a classroom of one. So you can study where and when you want. At your pace, no somebody else's. And with over 50 years of experience, we've developed proven programs to give you the support

such study demands. Programs that give you the theory you need backed with practical experience using some of the most sophisticated electronics tools available anywhere, including our Microprocessor Training Laboratory with 4K of random access memory. Of course, if you ever have a question or problem, our instructors are only a phone call away.



START WHERE YOU WANT, GO AS FAR AS YOU WANT.

CIE's broad range of entry, intermediate, and advanced level courses in a variety of career areas gives you many options. Start with the Career Course that best suits your talents and interests and go as far as you want—all the way, if you wish, to your Associate in Applied Science Degree in Electronics Engineering Technology. But wherever you start, the time to start is **now**. Simply use the coupon below to send for your FREE CIE catalog and complete package of career information. Or phone us, toll-free, at 1-800-321-2155 (in Ohio, 1-800-523-9109). Don't wait, ask for your free catalog now. After all, there's a whole world of electronics out there waiting for you.

CIE

Cleveland Institute of Electronics, Inc.
1776 East 17th Street, Cleveland, Ohio 44114
Member NHSC
Accredited Member National Home Study Council

CIE **Cleveland Institute of Electronics, Inc.**
1776 East 17th Street, Cleveland, Ohio 44114

ARE-121

YES... I want to learn from the specialists in electronics—CIE. Please send me my FREE CIE school catalog, including details about CIE's Associate Degree program, plus my FREE package of home study information.

Name (print): _____

Address: _____

City: _____ State: _____ Zip: _____

Age: _____ Area Code/Phone No.: _____ / _____

Check box for G.I. Bill bulletin on educational benefits:

Veteran Active Duty

**MAIL
TODAY!**

CIRCLE 60 ON FREE INFORMATION CARD

HARDWARE HACKER

Refilling SX cartridges
More digital sinewaves
Minimum order hassles
Micropower regulators
Mass teleportation card

Refilling SX toner cartridges

DON LANCASTER

BOY, THERE SURE HAS BEEN A LOT OF helpline response to the solid-state compass stuff we looked at two months ago. I guess I did mention that you can get fluxgate sensors off the shelf from *Radio Shack*. Meanwhile, the original "horse's mouth" paper about all that is *Earth's Field Magnetometry* by W.F. Stuart, appearing in *Reports on Progress in Physics*, 1972, vol. 35, pages 803-881. And you may also find *Recent Advances in Fluxgate Magnetometry* from the *IEEE Transactions on Magnetics*, MAG-8, no. 1, pages 76-82 of more than passing interest.

One helpline caller has asked why magnetoresistive sensors couldn't be used. Those are primarily to be used with very strong magnetic fields, and I don't think they are nearly sensitive enough for any compass use. Far and away the most off-the-wall winning entry in our fluxgate compass contest came from Dr. Dennis O'Leary who studies fish whose ears have built-in magnets. See his paper on "Magnets in guitarfish vestibular receptors", over in *Experientia*, v. 37 (1981), pages 86 and 87.

Several callers did give me some additional input in infrared filters. Apparently, unexposed 35-mm photo film works just fine. Years ago, I had a student learn that the hard way. He built a shaft encoder having the light transmission pattern exposed on a litho film disk. The trouble was that the infrared light whipped on through the black parts just as easily as it went through the clear portions.

Some infrared response curves on their various plastics is avail-

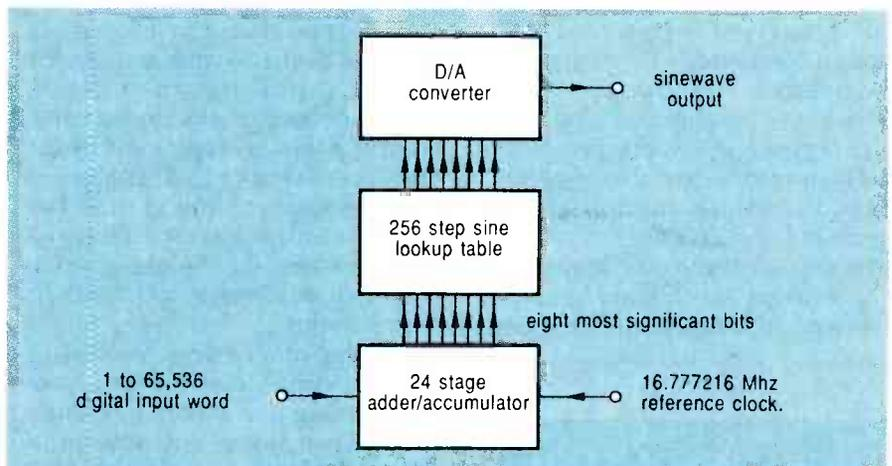

FIG. 1—DIGITAL SINE WAVES generated by phase addition. The input word sets how fast the waveform phase will advance, in turn deciding the directly synthesized output frequency. The values shown will generate 1 Hz to 65.536 kHz in 1-Hz steps.

able in a "PEL-ette" known as "Infrared Transmittance of Plexiglas Colors that are Opaque in the Visible Portion of the Spectrum," available from the folks at *Rohm and Haas*.

Every once in a while a resource comes along which is absolutely and unquestionably in that "must have" category. That is certainly true of the *Signal* from the *Whole Earth Review* people. That is a master directory of virtually all communications resources, well done up in the style of the original

Whole Earth Catalog and costing \$16.95. No hacker can ignore that book. It is far too important.

As per usual, this is your column and you can get technical help and off-the-wall networking per the *Need Help* box. As is customary, many of the products and services mentioned do appear in the *Names and Numbers* sidebar.

Let's start off with a loose end...

Digital sine waves

There was a surprising amount of interest in our recent digital sine wave stuff, and I apparently did forget to include one key technique. Thanks to Tim Green, another contest winner, for bringing that to my attention.

The idea is called *phase addition*, and its block diagram appears in Fig. 1. What you do is route a digital word to a D/A converter that is followed by a low-pass filter, just as we did before.

NEED HELP?

Phone or write your **Hardware Hacker** questions directly to:
Don Lancaster
Synergetics
Box 809
Thatcher, AZ 85552
(602) 428-4073

Only this time, your digital word consists of the top 8 bits of a 24-bit adder/accumulator. At a constant and high clock rate, a fixed phase increment is added to the accumulator. For instance a "1" input could advance the phase count so slowly that you'll get a 1-Hz sine wave, while a "2" would give you 2 Hz, on up to the much larger numbers which give you much higher frequencies.

Advantages of the method are that you are directly synthesizing the final frequency, which eliminates all the hunting and the noise bandwidth of phase-lock loops. Thus, your spectral purity can be extremely high. There is also no bad transient whenever you change frequency—just a smooth and unbroken transition.

For lower frequencies, a personal computer will work just fine, and it should be trivial to generate up to several kilohertz using an *Apple II*. You can do so in 1-Hz or even smaller resolution steps.

To work at any higher frequencies, speed limitations on those

hardware adder-accumulators can get to be a problem. One extremely expensive source of ultra-fast chips for that is *Stanford Telecommunications*, while slower and much lower-cost kits are obtainable from *A & A Engineering*. One source of additional details is the *Radio Amateur's Handbook*.

Minimum-order hassles

One of the biggest hacker help-line complaints concerns all of those steep minimum orders that many of the electronics distributors seem to be insisting upon. The problem is bad and it is getting much worse. How can you cope with it?

First, note that it just is simply not possible in this day and age for anyone to profitably offer the direct-mail sales of electronic hardware if their average mail order ends up less than \$25. Those \$15 or \$25 minimums or any \$5 to \$8 below-minimum service charges from the "new-age" good-guy distributors are all necessary for their very survival.

On the other hand, several of the "old-line" distributors have gone as high as a \$250 minimum order. Even worse yet, several of them now have an intolerable \$100 per line item minimum. Which means if you want a two-cent part, you now have to buy 5000 identical ones at once, or else forget it.

The *Bell Electronics* people have just garnered a ZZZ rating and moved to the very summit of my *Synergetics* black list for their unacceptably high line minimums and all their outright arrogance. (All I wanted were a few jelly-bean regulators.) Unfortunately, those epsilon minuses are not alone.

The sad fact is that, if you are an individual hacker, the deck gets very much stacked against you. On the other hand, that just may end up as the only game in town.

So, how can you cope with steep minimum orders? Here are a baker's dozen partial solutions...

(1) Plan ahead. If you run in panic mode, you will almost always end up wasting money. Find the best dealer with the best source and the lowest minimums. Combine what you need with what you think you may need for other upcoming projects. Try to get every-

thing from one or two suppliers, rather than a dozen.

(2) Try to always deal with a "new-age" distributor, such as *Mouser*, *Active*, *DigiKey*, or *Jameco*, instead of using those "old-line" houses such as *Schweber*, *Allied*, *Cramer*, *Newark*, *Bell*, or *Hamilton*.

(3) Fill out your minimum order with other goodies which you would someday like to play with.

(4) Rather than using a distributor, request free samples directly from Applications Engineering of the firm actually building the part. Use a laser-printed or other business letterhead. Request only as many parts as you need, and tell them exactly what you are going to do with them.

(5) Check into your local walk-in surplus stores. Often you might find reasonable substitutes at incredibly low prices, especially on unadvertised odd lots. The savings can even make a 100-mile drive worthwhile.

(6) Build up your own personal inventory of "in-stock" parts that you are likely to use in the future.

(7) Network with friends in a ham or computer club, or with engineers or techs from an aerospace company or whatever. Be able to swap parts both ways. Become a resource for the other party.

(8) Move to Silicon Valley, where all of the 24-hour convenience grocery markets also carry all the other known types of chips. No minimum. Or, if you are too far away, always be sure to try *Radio Shack*.

(9) Naturally, we would hope you would always check out our **Radio-Electronics** advertisers first for any component part. That's why we put the bingo card in the magazine. But two other great source for oddball components are the unique *Nuts and Volts* bargain shopper and all the distress merchandisers found in that classified ad section of *Electronic News*. While the latter always will have steep minimum line charges, the prices are often so ridiculously low that it may not matter.

(10) Aggressively subscribe to all the electronics trade journals, such as *EDN*, *Electronic Design*, *E.E. Times*, *Electronic Products*, and/or the *Electronic Component*

**NEW FROM
DON LANCASTER**

HANDS-ON BOOKS

Hardware Hacker Reprints II	24.50
Ask The Guru Reprints I or II	24.50
CMOS Cookbook	18.50
TTL Cookbook	16.50
Active Filter Cookbook	15.50
Micro Cookbook vol I or II	16.50
Enhancing your Apple I or II	17.50
AppleWriter Cookbook	19.50
Apple Assembly Cookbook	21.50
Incredible Secret Money Machine	10.50
LaserWriter Reference (Apple)	19.50
PostScript Cookbook (Adobe)	16.50
PostScript Ref. Man. (Adobe)	22.50
PostScript Prog. Design (Adobe)	22.50

UNLOCKED SOFTWARE

PostScript Show & Tell (Ile/Mac/PC)	39.50
Intro to PostScript VHS Video	39.50
PostScript Perspective Draw	39.50
PostScript Printed Circuits	39.50
PostScript Technical Illustrations	39.50
PostScript Work in Progress	39.50
PostScript BBS stuff	19.50
Absolute Reset Ile & Iic	19.50
AppleWriter/Laserwriter Utilities	49.50
Enhance I or II Companion Disk	19.50
AppleWriter CB or Assy CB Disk	24.50

FREE VOICE HELPLINE VISA/MC

SYNERGETICS
Box 809-RE
Thatcher, AZ 85552
(602) 428-4073

CIRCLE 83 ON FREE INFORMATION CARD

NAMES AND NUMBERS

A & A Engineering

2521 W. LaPalma Unit K
Anaheim, CA 92801
(714) 952-2114

BLH Electronics

75 Shawmut Road
Canton, MA 02021
(617) 821-2000

Colorease

100 E. Ohio Street
Chicago, IL 80611
(312) 440-1266

Electronic News

7 East 12th Street
New York, NY 10003
(215) 630-0951

Gould/AMI

1200 Buckskin Road
Pocatello, ID 83201
(800) 468-5310

ID Systems

174 Concord Street
Peterborough, NH 03458
(603) 924-9631

Lazer Products

12741 E. Caley Avenue no. 130
Englewood, CO 80111
(303) 792-5277

Maxim

120 San Gabriel Drive
Sunnyvale, CA 94086
(408) 737-7600

Mitel

2321 Morena Blvd, Suite M
San Diego, CA 92110
(619) 276-3421

Nuts & Volts

PO Box 1111
Placentia, CA 92670
(714) 632-7721

Old Colony Sound Lab

PO Box 243
Peterborough, NH 03458
(603) 924-6371

Rohm & Haas

Box 219
Bristol, PA 19007
(215) 788-5501

Sensors

174 Concord Street
Peterborough, NH 03458
(603) 924-9631

Sharp

Sharp Plaza
Mahwah, NJ 07430
(201) 529-8757

Stanford Telecomm

2421 Mission College Blvd
Santa Clara, CA 95054
(408) 748-1010

Tek Direct/Tektronix

PO Box 500 M/S 02-050
Beaverton, OR 97075
(800) 426-2200

Texas Instruments

Box 655303 M/S 8206
Dallas, TX 75265
(214) 995-3821

Whole Earth Access

2990 Seventh Street
Berkeley, CA 94710
(800) 845-2000

News. You'll find lots of free-sample offers in any of those, along with unique sources of supply. As usual, you get a complete list from *Uhrlichts Periodicals Dictionary* at your local library.

(11) Acquire an enormous junk box. Or better yet, a junk room or a junk building or two. Fill them with broken TV sets, dead VCR's, or whatever else trips your trigger. A dozen cubic yards or so should do for a bare-bones start.

(12) Hamfests, particularly the big regional ones, have outstanding parts bargains and zero minimum orders. Ask for full details at your local ham club, or, once

again, do see *Nuts and Volts* for a listing.

(13) Combine your order with that of another hardware hacker. Or start your own "buying club."

Low-power regulators

The folks at *Maxim* have added yet two more low-power regulator chips to their line. The MAX644 steps up a single alkaline cell as weak as 0.9 volts up to a fixed and regulated 5.0 volts. The MAX645 gives the same treatment to a 2.4-volt lithium cell.

Figure 2 shows you the circuit. The secret is to have two switching regulators. The first regulator gen-

erates around 12 volts or so at a very low current for internal use. That high voltage gives enough MOS transistor base drive to allow for high efficiency.

While the circuit is quite simple, careful selection of the inductors and the Schottky diode are needed for maximum efficiency.

The typical efficiency is in the 75-percent range. Currents up to 59 mils are directly available, while an external pass transistor may be added for higher current needs.

For this month's contest, just tell me what you would do with a micro-power regulator that delivers +5 volts off a nearly dead single alkaline cell. We will have all the usual *Incredible Secret Money Machine* book prizes, along with an all-expense-paid (FOB Thatcher, AZ) tinaja quest for two for the best entry of all. Send all your written entries to me and not to **Radio-Electronics**.

Refilling SX cartridges

As we have seen in past columns, a profitable business can be built up centered around refilling toner cartridges for copiers and laser printers. Many recent hacker helpline requests have been for methods to refill those *Canon SX* cartridges as used in the *LaserJet II* and the *LaserWriter II*.

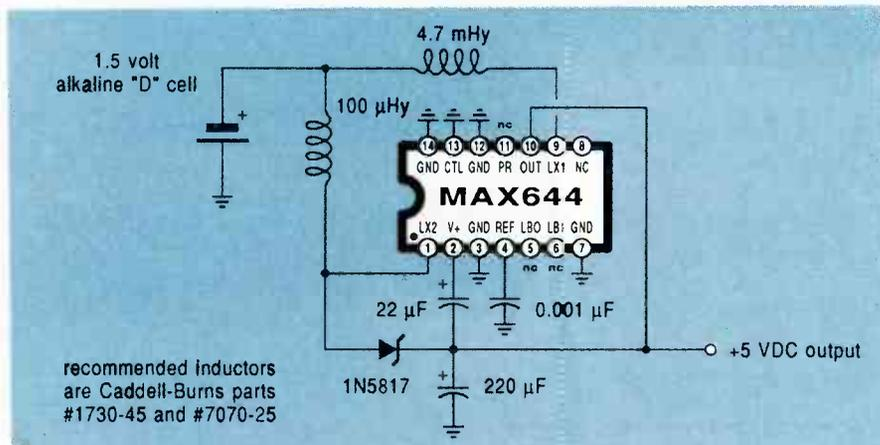

FIG. 2—THIS SIMPLE SWITCHING REGULATOR steps up a single alkaline cell to give you a fixed +5-volt output at 50 milliamps. An external pass transistor can be added for more output current.

An affordable portable i

Price/Bandwidth

\$4995 100 MHz 2230 DSO*, 20 MS/s, 4K Record Length, 100 ns Glitch Capture, Cursors, CRT Readout, GPIB or RS-232-C Option

\$3995 60 MHz 2221 DSO, 20 MS/s, 4K Record Length, 100 ns Glitch Capture, Cursors, CRT Readout, GPIB or RS-232-C Option

\$2995 60 MHz 2220 DSO, 20 MS/s, 4K Record Length, 100 ns Glitch Capture, GPIB or RS-232-C Option

\$2995 100 MHz 2236 Two Channel, Counter/Timer/DMM, Dual Time Base

NEW **\$2795** 100 MHz 2247A Four Channel, Counter/Timer, Store/Recall of 20 Front Panel Setups, Auto Setup, Smart Cursors™

\$2495 100 MHz 2246A Four Channel, Store/Recall of 20 Front Panel Setups, Auto Setup, Smart Cursors™, Dual Time Base

\$2395 50 MHz 2210 DSO, 20 MS/s Sample Rate, 4K Record Length

NEW **\$1495** 20 MHz 2201 DSO, 10 MS/s Sample Rate, 2K Record Length, Hard Copy (RS-232-C) Option

\$1895 100 MHz 2245A Four Channel, Auto Setup, Cursors, Dual Time Base

\$1695 100 MHz 2235 Two Channel, Dual Time Base

\$1095 50 MHz 2225 Two Channel, Horizontal Magnification (x5, x10, x50)

\$695 20 MHz 2205 Two Channel

*Digital Storage Oscilloscope

Check the prices and performance. You'll find the best measure of both in Tek 2200 Series Oscilloscopes. Twelve scopes with bandwidths ranging from 20 to 100 MHz. Two and four channels. Analog and digital. And prices starting at just \$695.

Select for such features as automatic setup, time and voltage cursors, built-in DMM functions, Counter/Timer and dual analog/digital capabilities at the push of a button.

These are scopes you'll appreciate for their well-proven reliability, achieved through simplified, practical internal design. They come

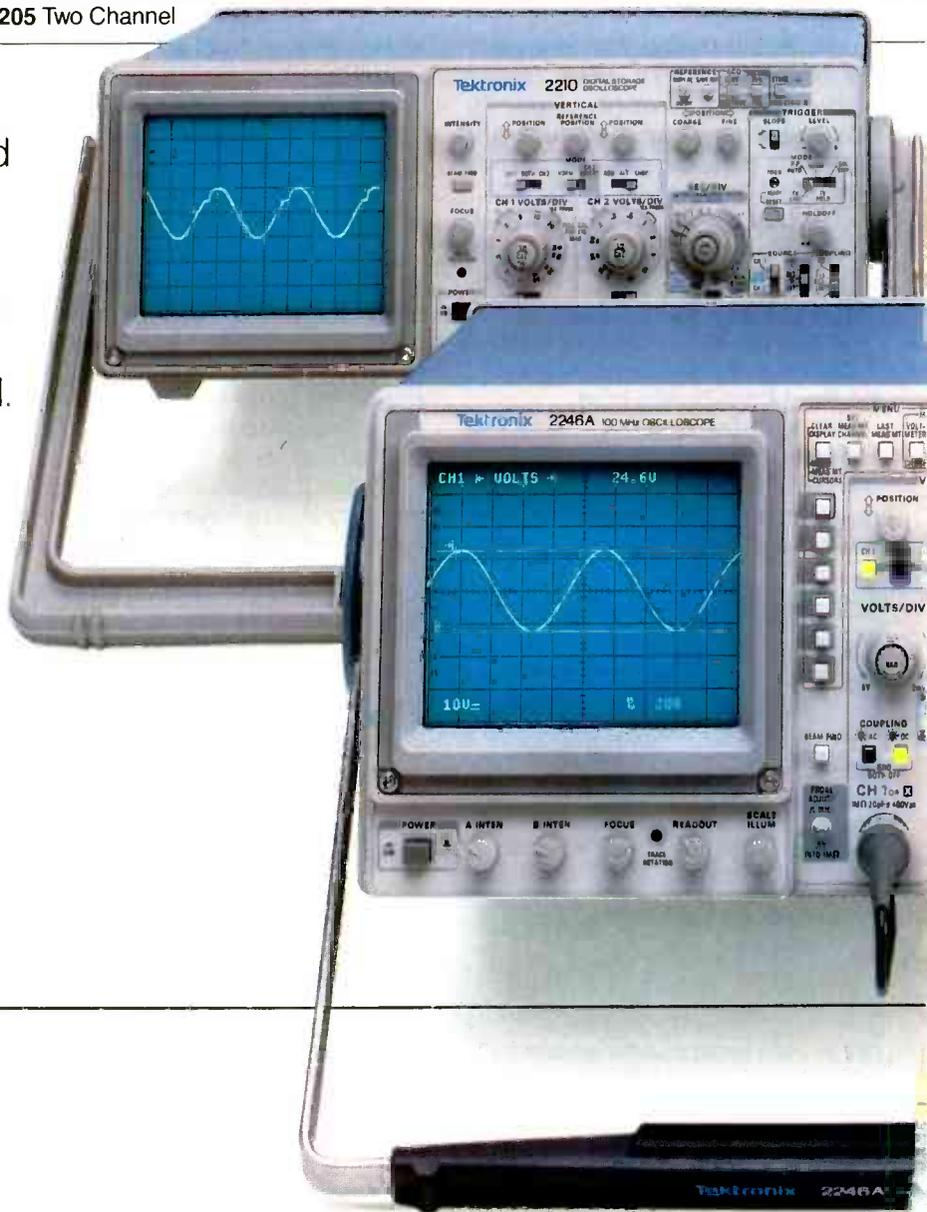

right within your range.

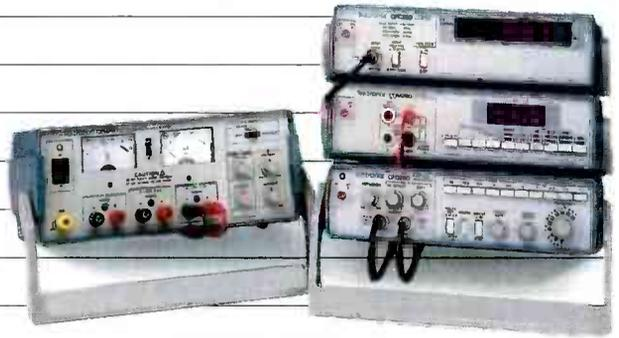

Industrial-quality test instrumentation starting at \$295.



complete with probes and comprehensive Tek warranty that includes the CRT.

Ask those who own, use and rely on one — on the bench or in the field. There's just no substitute for genuine Tek quality. At any price. And at these prices, all the better.

Order one to go. Ask your Tek representative to set up a demo. Or call Tek direct. No need to settle for less when there's a top quality Tek portable with performance and price right within your range.

LISTED



For easy ordering or more information, call Tek direct:

1-800-426-2200



Tektronix
COMMITTED TO EXCELLENCE

CIRCLE 92 ON FREE INFORMATION CARD

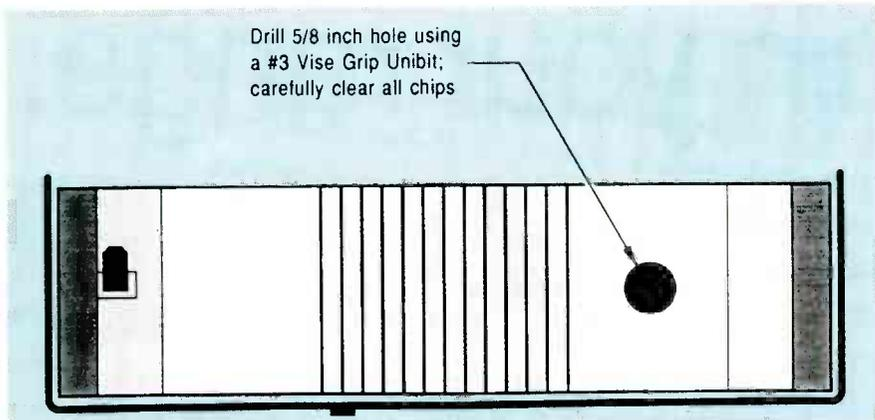

FIG. 3—ADDING A FRESH TONER filling hole to an SX cartridge. Use a no. 3 vise grip unibit and a very slow drilling speed.

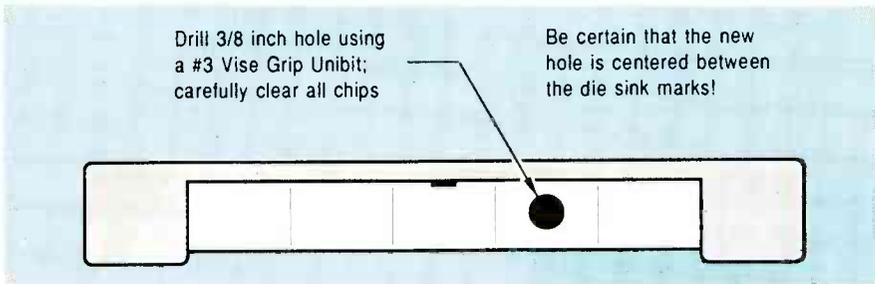

FIG. 4—ADDING THE SPENT-TONER emptying hole to a Canon SX cartridge.

Sadly, there is now as much as a 15:1 cost penalty in per-page toner costs when using those newer Canon SX laser printers over the older CX engines. On the older CX cartridges, you were able to buy cartridges for five bucks out of your Sunday paper and refill them up to seven times, bringing all your toner costs down into the 0.33-cents-a-page range that is cost competitive with jiffy offset printing services.

Unfortunately, those SX cartridges do use a highly abrasive toner, combined with drums that are intolerably scratch sensitive.

So, while you can in fact reload SX cartridges, at present, you just can not even remotely approach those CX cartridge economics. So,

do consider this a progress report where I'll bring you up to date on what can and cannot be done at the present.

While it is difficult to even get a second SX reload, you can sometimes do so with the following ricks and techniques. First, you immediately remove the factory toner and give it to your friendly neighborhood diesel mechanic or use as a valve grinding compound. Replace it with a good quality third-party refill toner.

Second, be certain to use a drum lubricant, such as *Pixie Dust* or its equivalent. Do a very light dusting after every refill.

There are two refilling methods, the *Punch and Go* and the *Total Teardown*. I very much prefer

punch and go, since that delivers far and away the lowest per-page toner cost to the end user. We charge \$22 for local SX refills. Since this is a remote rural area, I can get away with such an outrageously high price. You can do the job by yourself for as little as \$7.50 and three minutes time.

The SX cartridge needs to be modified before you can refill it. Using a Vise Grip no. 3 *Unibit* and a very slow drilling speed, you drill the two holes as shown in Figs. 3 and 4. Drill upside down and be very careful to remove the single chip that the unibit provides. The two holes are then capped with a nickel *Caplug* or else some very aggressive tape.

There are three major steps to the refilling process. You first open the holding-tank hole and carefully shake out the excess toner. Do this outside and avoid breathing any of the toner. You'll then reseal your holding-tank hole, open the fresh toner tank hole, and pour in a bottle of refill toner.

Finally, you remove the old fusion wiper wand and peel and stick a new wiper pad in place.

Another tip: keep the green toner dial advanced all the way to nine for any and all rough drafts and for all internal use documents. Note that the *higher* the number, the *less* toner you will use. Cartridge life can easily be doubled merely by using that simple technique.

I currently recommend using *Lazer Products* to supply toner, pixie dust, wiper pads, and drum recoating.

Mass teleportation

The rate at which science and technological fact is outpacing science fiction continues to utterly astound me. Nowhere is that more apparent than in the emerging field of mass teleportation.

The exciting center of all that has recently been happening is in that outstanding *International Journal of Teleportation and Mass Transfer*. In particular, do check out Barfoot and Gentry's tutorial material way back in Volume XVIII, pages 1146-1198, along with their extremely detailed bibliography.

continued on page 76

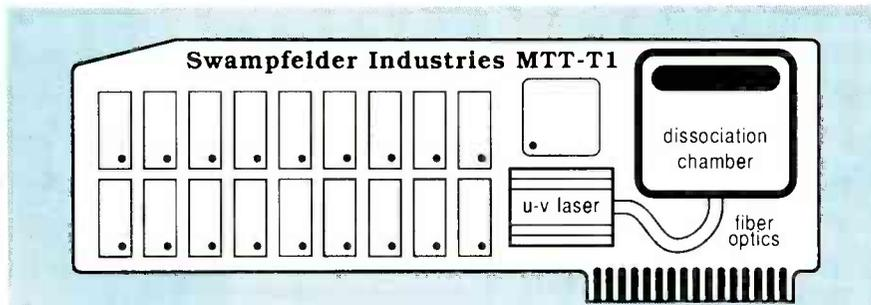

FIG. 5—PICTORIAL OF THE MTT-T1 mass-teleportation transmitter unit for the Apple II Plus. The solid-state 100 milliwatt ultra-violet laser chip is optical-fiber coupled to the dissociation chamber. The telephone connection is on the other side of the card.



EARLY MAN PROTECTED HIS HOME against marauding beasts and the things that go bump in the night by blocking the entrance to his cave with a large rock. As man's housing became more sophisticated, security was provided by a water-filled moat or a large dog. But as housing lots shrank in size there was no longer room for a moat, and a large enough dog eats too much; so security evolved into barbed wire, trip wires that rang bells, and even a flock of geese—because geese provide early warning by honking at strangers. Unfortunately, except for a mean dog, none of those security methods are very effective at protecting property when no one is around.

What was needed was an intruder alarm that could wake the dead, or, at the very least, alert a neighbor or the beat cop—the idea being that a potential intruder *knew for certain* that he was likely to be caught in the act. It was electric power—usually provided by batteries—that allowed us to use a

very loud bell as an intruder alarm.

Of course, in time the miscreants learned how to defeat a simple electric-based alarm, so today we use high-technology electronic equipment to protect our castles: microprocessors, mainframe computers, electronic nightingale-floors, infrared motion detectors, microwave sensors, wireless signalling, automatic telephone dialers, subaudible telephone signals, cellular-telephone alarms, and most important, the *central station*.

The central station

Before we go any farther, let's take time out to look at the central station—also called a *central monitor* or *central station monitor*—because that is really what is behind the effective use almost all high-tech home-security equipment.

Before it became financially necessary for the majority of women to work, one could be reasonably certain that a neighbor would be home to hear

an alarm bell, and the neighbor would notify the police if she heard clang-clang-clang. Also, in many areas, there were “beat cops,” policemen who walked by your home several times a day. Today, however, many communities are deserted during working hours: If there is anyone around it's the postman or the UPS driver, and when they have moved on, the neighborhood is as deserted as Death Valley at high noon. As for the beat cop, he vanished long ago from residential areas—you're lucky if he passes by twice a day in a patrol car.

So an alarm bell can ring for hours and there will be no one to hear it; a fact that is well-known by both amateur and professional thieves. Because of that, the central station—which was formerly used primarily by business establishments—has become the front-line defense for the homeowner.

Basically, central-station monitoring works like this: When a home's alarm goes off it also triggers an automatic telephone dialer that calls a

central monitoring facility. A computer at the central station tells the duty operator precisely what is wrong at the home: a fire, a burglary, a hold-up, an invalid needing medical attention, even freezing cold or a leaking water pipe. The central station's operator usually—not always—phones the house to find out what is wrong and to get a verbal all-clear password in the event that the alarm was accidental. If the operator does not get an *absolutely precise* password, he or she immediately notifies the proper authorities, such as the police or fire departments, an emergency rescue service, or a neighbor (if your alarm sends a "freezing temperature" or "water leak" signal).

Why an *absolutely precise* password? Well, assume that an intruder has forced you at gunpoint to silence the alarm, and then he listens in on an extension telephone—still pointing the gun—as you answer the central station's call. Assume that your password is the numbers 5678. You reply 8956. The operator will say "Thank you," and the intruder will feel safe. Meanwhile, the operator calls for the cops.

With a high-tech alarm there might be no call-back from the central station. A keypad code that is used to silence the alarm also tells the central station's computer that all is well. If an armed intruder forces you to turn off the alarm, entering an extra number tells the central station that you are being held at gunpoint. For example, if the code 5678 turns off the alarm and automatically sends an "all safe" signal to the central station, the code 56789 will turn off the alarm but send a signal to the central station that a hold-up is in progress.

Perimeter defense

The earliest home-security system was the "perimeter alarm," which is refined or "supervised" form is still the end result for many—usually the best—high-tech home alarms. Basically, it consists of a battery in series with a normally-open switch and an alarm bell. The switch might, for example, be a *mat switch*, the kind used by supermarkets to trigger a door-opening mechanism. Anything, or anyone causing the switch to close completes the electric circuit, which causes the alarm bell to sound.

As you can well figure out, there are two things wrong with that kind of

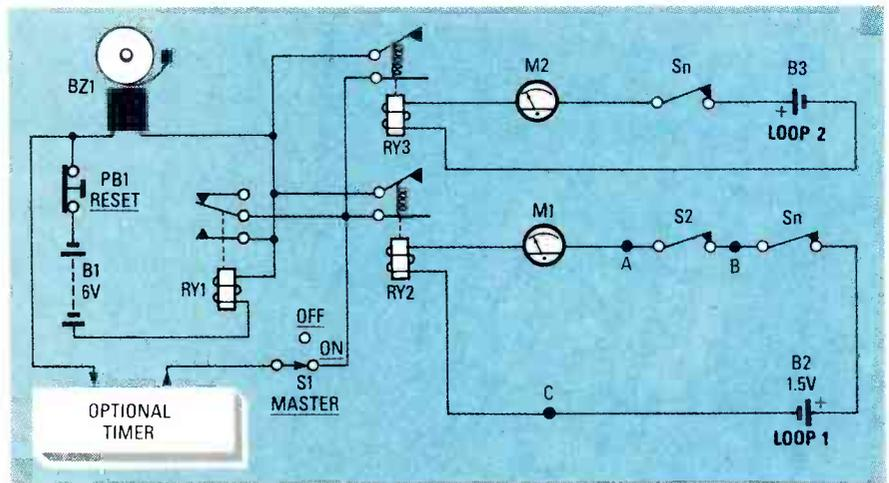

FIG. 1—IN A SIMPLE SUPERVISED SYSTEM the protective loop's power is provided by an end-of-line (EOL) battery. A meter indicates if the loop is closed.

alarm. First, the alarm stops when the switch is opened—when the person steps off the mat. But more important, it does not tell if the circuit is working. Suppose the switch becomes defective. How do you know that it's defective? An intruder can step on a defective mat-switch and the alarm will not sound.

It was to overcome those limitations that the latching alarm with a *supervised* loop was developed. Although initially designed to use commonly available relays, it remains the basic alarm circuit; we simply use high-tech components to do the same thing. Once you understand the supervised loop you can understand just about everything, including a wireless and a microprocessor-based alarm.

Supervision

Figure 1 shows a simple latching supervised alarm. It was probably designed by Methuselah, although it is still in common use today because it is reliable, and it is absolutely free from electrical disturbances—which cannot be said of solid-state alarms.

The reason Fig. 1 is called a *supervised alarm* is because the user *knows for certain* that the protective devices—normally-closed switches—are not only working, but are properly set.

Trace the series-circuit labeled LOOP 1, which consists of relay RY2, battery B2, meter M1, switch S2, and switch Sn. Sn represents any number of series-connected switch devices: fine wires, spring switches, magnetic switches—any kind of device that will open a series circuit. Relay RY2 is an extremely sensitive device, re-

quiring only 3–7 mA to pull in. The reason that the relay must be so sensitive is because it is powered by a 1.5-volt battery, B2. The battery is a special type known as a *No. 6 telephone, railroad, or protective alarm* cell. It is humongous, more than 6-inches high and 2 $\frac{3}{8}$ -inches in diameter. (You probably used one many years ago in your school's science class.) Since it supplies just a few milliamperes of current—and only when the loop circuit is closed—the battery could last for years—or at the very least, several months.

The battery is called an EOL (*End Of Line*) power source because it is literally at the end of all the wiring in the loop, usually buried somewhere out of sight.

When all switches in the loop are closed, the current flowing in the loop causes a reading on meter M1. If the user sees a meter reading he knows that the circuit is "armed": All switches are closed and operating. If there is no meter reading the user knows that either a window, a door, or some other protected entrance is open, or a switch is defective, or the battery is pooped out. In short, the current flowing in the loop *supervises* the loop.

When the loop is armed, the current flowing in the loop causes RY2's spring-loaded contacts to be pulled open. If anything stops the current flow in the loop—we'll show shortly how it's done—RY1's contacts spring back, closing the series connection of battery B1, relay RY1, momentary switch PB1, etc. RY1's contacts self-latch RY1 so that the relay remains pulled in, even if RY2's contacts are

opened. Since the alarm bell, BZ1, is connected across RY1's solenoid coil, it sounds off.

Because some towns and cities frown on alarms that sound for hours, an optional timer is often connected in series with the alarm circuit so that BZ1 is silenced after 10 or 15 minutes. Other than the timer drop-out, BZ1 can only be silenced by pressing RESET switch PBI, or by opening MASTER switch S1.

The loop's battery is placed at the end of the line to prevent easy bypassing of the system by an intruder. For example, if the intruder forces open a window that's protected by switch S1, the loop will be opened at points A and B. Current will cease flowing through RY2 and the alarm will sound. If the intruder should be able, somehow, to cut any part of the loop wiring, again the loop current ceases and the alarm will sound. Even if the intruder tries to maintain the series circuit by short-circuiting points A and C, the short will occur in front of the battery, so the current through RY2 will be interrupted and the alarm will sound. That is why EOL protection is provided in modern high-tech alarms even if a battery isn't used. We'll show later how it's done with resistors.

Notice that LOOP 2 is essentially identical to LOOP 1. In early systems, an entire house was protected by a single loop. Today, we usually use multiple loops, one reason being that it's easier to find an open switch. For example, if LOOP 1 is used to protect the basement windows while LOOP 2 is only for the front and rear doors, you don't have to run down to the basement to check all the window switches if the supervisory meter shows that LOOP 2 is open. Similarly, if the meter shows that LOOP 1 is open, you had better check the basement windows.

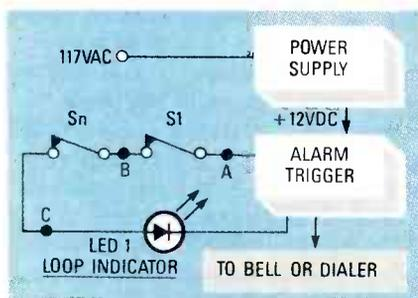

FIG. 2—IN MANY MODERN alarm systems the loop power comes from the center's power supply. An LED is used as the closed-loop indicator.

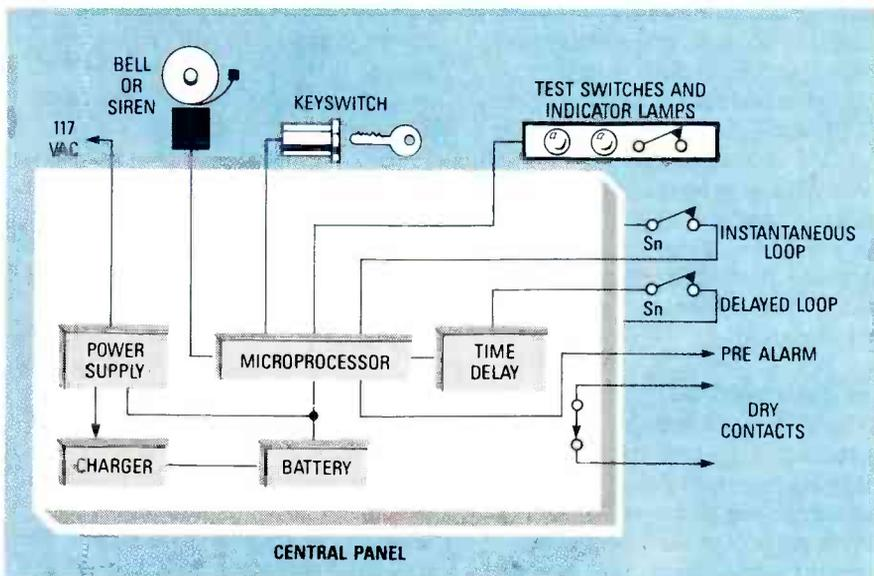

FIG. 3—A MICROPROCESSOR simplifies the operation of a basic control center that provides various time delays and signals.

Actually, with the relay-type system you know that something's wrong because an open loop will cause the bell to sound as soon as the alarm is turned on ("armed"). The modern computer-type system, however, can or will arm even if a loop is open; it simply bypasses the open loop. That means that if you have a multi-loop system, and say, for example, that a basement window has been left open, the alarm can/will automatically lock out the basement window loop. The lock-out allows you to set the alarm and leave, but your home is really unprotected against basement entry. It is precisely to avoid an unknown-lockout problem that all multi-loop alarms have individual indicators—either a meter or an LED—for each loop. And remember, each loop represents a separate protected circuit, and it doesn't matter how many protective devices are on the circuit; if they are all series-connected they are on the same supervised loop. (Take note that high-tech alarms now include normally-open switches in a loop. Although the N.O. switches are not supervised, they are considered loop switches because the term *loop* is now accepted to mean *all* the switches and detectors on the same control circuit.)

A final note before we move on to the high-tech stuff. To ensure minimum maintenance, battery B1 was replaced by a line-powered supply that automatically switched to a battery when the linepower failed—a not uncommon occurrence until recent years. Later still, the loop battery

(B2, B3, etc.) was also replaced by power from the line-powered supply, which created a reliability problem that can plague even microprocessor-based alarms.

The problem is shown in Fig. 2, a simplified supervised loop that is powered by the main power supply. Light-emitting diode LED1 lights when switches S1 and Sn are closed—showing that the loop is armed. But what if an intruder can reach through a broken window, or had previously short-circuited points A and C? The loop indicator still shows a closed supervised loop, but S1 and Sn can be opened without triggering the alarm because they are located after the short-circuit.

Several early solid-state alarms used the loop powering shown in Fig. 2. Many "home-type" alarms still use the Fig. 2 loop powering, although they often have the option of EOL (End Of Line) resistor termination, which provides the same security as the EOL battery. We'll explain the EOL resistor termination later.

The control center

The control center—which is also called a control panel, a control box, an alarm control, or whatever—usually contains everything except for the alarm bell or siren, and the protective devices. Early solid-state control centers simply replaced the relays with transistors and/or SCR's. Most were disasters because an electric disturbance or RF radiation could trigger the solid-state devices, and a light-

ning hit anywhere in the neighborhood usually wiped out the control center. Fortunately, false-triggering is no longer a problem in the newer panels, provided that they are securely grounded to the main water pipe. But if you have one of the early centers that keep sending false alarms, you now know why. Also, grounding or not, some computerized control centers still get clobbered by a nearby lightning strike.

High-tech control

The difference between basic-solid-state and high-tech control centers is that the high-tech device contains a microprocessor that usually controls everything except the loop sensors.

For example, even the simplest high-tech panel provides for a 24-hour *panic* switch and two protective loops: an instantaneous loop for everything except the entry doors, and a delayed-entry loop. Instead of having to arm and disarm the door sensor by using a bypass keyswitch for the front door, the microprocessor allows the

user a safe period of 0–45 seconds to get out of the house after the alarm is armed. Similarly, the user can take 0–45 seconds to turn off the alarm after entering through a door.

The microprocessor also provides a *delayed entry* warning so that you don't forget to turn off the alarm. The warning is usually a low-volume buzzer that will sound off as soon as the door is opened—so you don't forget to disable the alarm—or, it sounds off after 30 seconds as a warning that in another 30 seconds the main alarm siren or bell will sound off if not disabled.

The panic function is for emergencies that usually require a neighbor's attention rather than the police or fire departments. When an alarm system is connected to a central station, all alarm conditions except the panic loop are transmitted to the central station. Usually—not always—a *panic switch* sounds the alarm bell or siren to attract a neighbor: It might be used by an invalid. In both the simple and the most complex high-tech alarms, the panic loop will also arm the rest of the alarm.

Why panic-arm the alarm? Well, assume that you're home alone and you hear a noise in the yard. You don't know whether the sound is from an intruder or if you're just hearing things that go bump in the night. If your alarm sends a signal to a central station, you don't want to hit the *emergency* or *hold-up* switch because to do that will send an alarm to the central station, which might result in a false-alarm to the police. So you hit

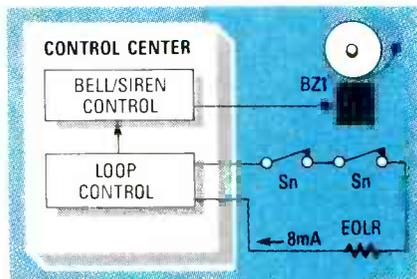

FIG. 4—AN END-OF-LINE-RESISTOR loop protects against anyone bypassing the loop by simply short-circuiting the wires.

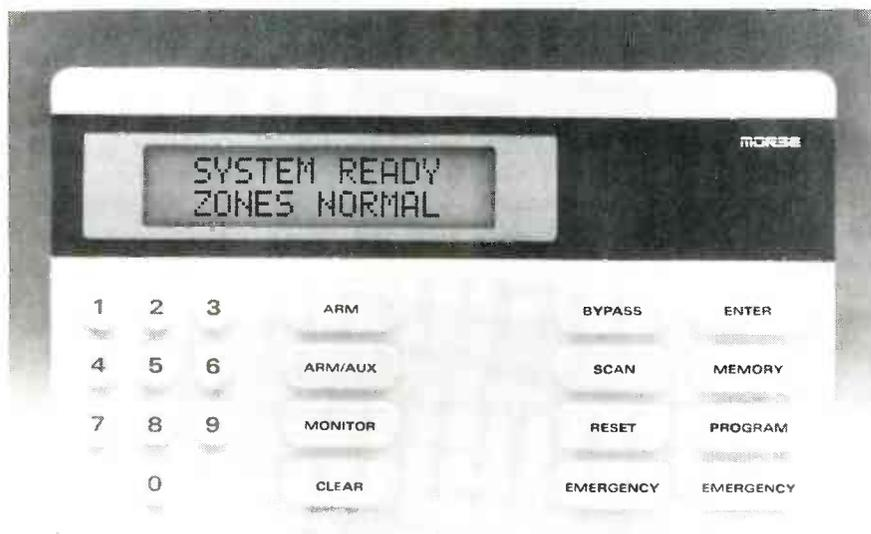

FIG. 5—THE MOST ADVANCED COMPUTERIZED home-alarm systems provide both user programming and an alpha display of all operating conditions and circuit problems.

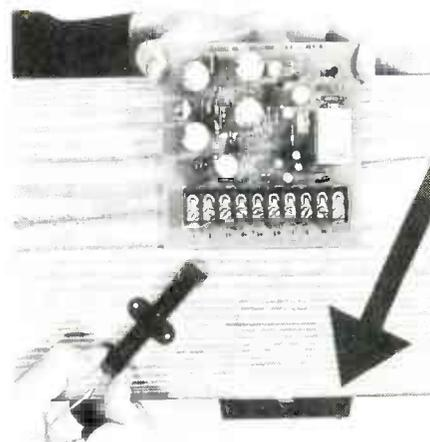

FIG. 6—A SMALL SILICON SENSOR and its control unit can distinguish between the footsteps of animals or humans.

the *panic* switch, which causes the microprocessor to turn on the yard lights, sound the alarm siren so that your neighbor will peek out his window to see what's up, and *automatically* arm your alarm system if it had been *off*.

If the sound was actually made by an intruder, and if he attempts to enter your home, he triggers the alarm to the central station.

The panic loop is similar to the 24-hour, or perimeter, protective loops of some (usually more expensive) alarm systems. The primary difference is that a 24-hour loop provides full-time 24-hour protection even if you're home with most of the alarm system turned off. If the 24-hour loop is triggered, the control center sends an alarm to the central station and arms the rest of the alarm system. (You would normally keep the non-24-hour loops *off* so that you could move about freely, without having to worry about whether opening a closet or a door would trigger the alarm.)

Figure 3 is a generic block diagram of a low-cost microprocessor-controlled control center. Note that it does not contain a central-station dialer, although there is a set of "dry contacts" that can be used to activate an accessory dialer. (*Dry contacts* means switch contacts that have no resident voltage source.) Also note that there is no EOL power supply for the loops—the loops are powered from the center's power supply.

The more advanced high-tech control centers that are used in the home, such as those in Napco's 800 and 900 series, contain from six to nine protective circuits that can be set up as intruder loops, a panic alarm, fire pro-

tection, or medical supervision. Virtually every feature—including the function and operation of the loops as well as automatic battery testing—is under full-time microprocessor control. For example, the microprocessor controls a digital telephone dialer for central-station communications; a built-in two-tone/steady siren driver for intruder, panic, and fire protection; the time delay of the protective loops; and the time delays for the entry doors. It will even flash an outdoor strobe continuously after the alarm automatically resets to warn that an intrusion had been attempted, and that the intruders might well be inside the house even though the alarm bell/siren has timed-out. Typical of the control centers offering Napco's price/function level, the center can be controlled via one or more keypads, and the user-desired functions—even the dialer's telephone number(s)—are programmed in a PROM by the installer, or manufacturer.

EOLR

The Napco 900 center, which is typical of the most recent PROM designs, provides EOL supervision through a resistor, which is called an EOLR for *End Of Line Resistor*. Figure 4 shows the basic generic circuit of a supervised EOLR loop.

The loop control provides a voltage into the loop that results in about 8-mA of current flow when the EOLR resistor is connected to the end of the loop. The loop control is triggered by anything that causes the loop current to vary substantially above or below 8 mA. As you can see, if the loop is broken at any point, or if it is short-circuited in front of the EOLR, the loop control will trigger the bell/siren control, which causes the alarm bell or siren to sound.

Super-tech

The most advanced of the high-tech home systems—with an “advanced” price to match—is represented by the Morse *MDC-16 Control Communicator System*, which includes the *MPC-32-D Personal Control*. Basically, the control center does everything that a PROM-type control center can do, only more so. There are more protective circuits, several arming modes, individual password codes for different protected areas and users, selectable transmission schemes for various central stations receivers, and

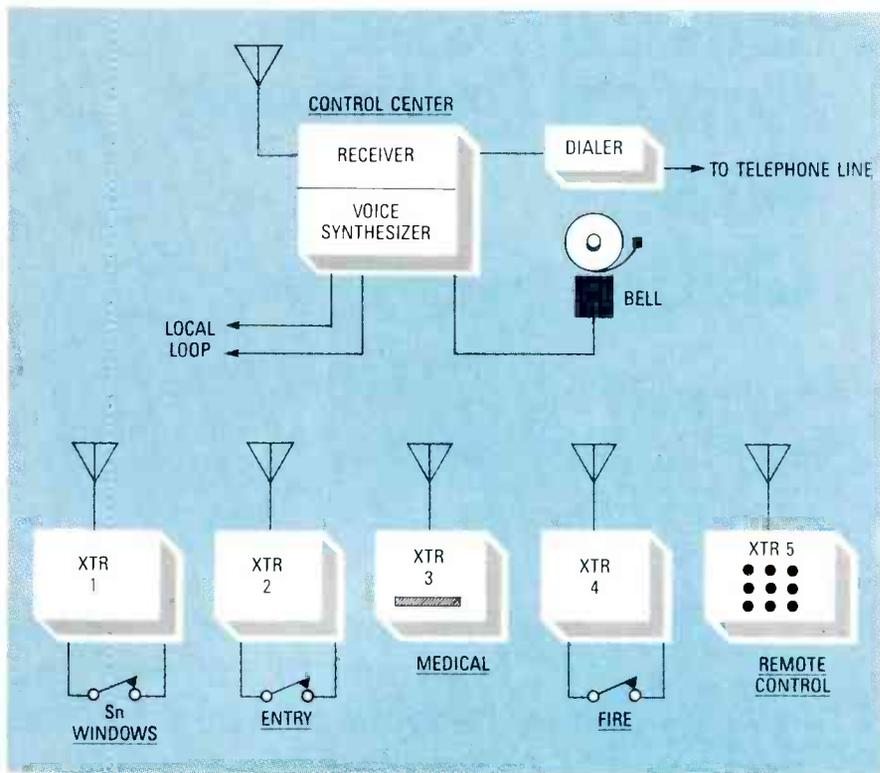

FIG. 7—IN A WIRELESS SECURITY SYSTEM the loop and emergency conditions are broadcast to a receiver in the control center. Once a day the control center automatically broadcasts a polling signal to each transmitter to check the condition of the transmitter's battery.

zone trouble reports. There's even listen-in capability through a telephone, such as for a central station to check on a “medical” signal.

But most important, unlike less expensive high-tech panels that are programmed through a PROM “burn” by the installer or the manufacturer, the Morse panel uses non-volatile EEPROM *user programming* that allows any feature to be changed at any time from the personal control, which is shown in Fig. 5.

Notice that the personal control shown in Fig. 5 has a two-line alpha display, which provides cues for user programming or indicates various operating conditions. For example, Fig. 5 shows that all zones are normal and the system is ready for arming. If the loop that protects Pop's workshop is open, the condition will be alpha-displayed as “POP'S ROOM.” The person attempting to arm the system would thereby know precisely which loop is open.

High-tech sensors

Of course, no panel will work unless there are sensors. While the most common sensors are some form of switch—even a foil strip is a normally-closed switch—we also use

some high-tech witchcraft to avoid the use of hard-wired switches. For example, there are infrared, ultrasonic, and microwave devices that flood a wide area with unseen light, unheard sound, or radio waves. Any disturbance to the light, sound, or radio field triggers the alarm. Unfortunately, many of the “flood” devices can be triggered by household pets, curtains blowing, and the like.

Simply because it's relatively low in cost and easy to install, the high-tech sensor most commonly used in the home is the PIR detector—PIR meaning *Passive InfraRed*. A PIR detector, uses either a segmented front lens, or a combination segmented lens and mirror segments behind the lens to focus sensitivity on particular areas or angles of coverage. Optional lenses for many PIR's optimize sensitivity for many different conditions, such as long side hallways, alcoves, lofts, etc.

Nightingales sing

A somewhat unusual sensor for home use is the electronic *nightingale floor*. Back in antiquity, Sultans, Passhas, and other despots protected their harems and treasuries with a specially

continued on page 69

Join the Electronics and Control Engineers' Book Club®

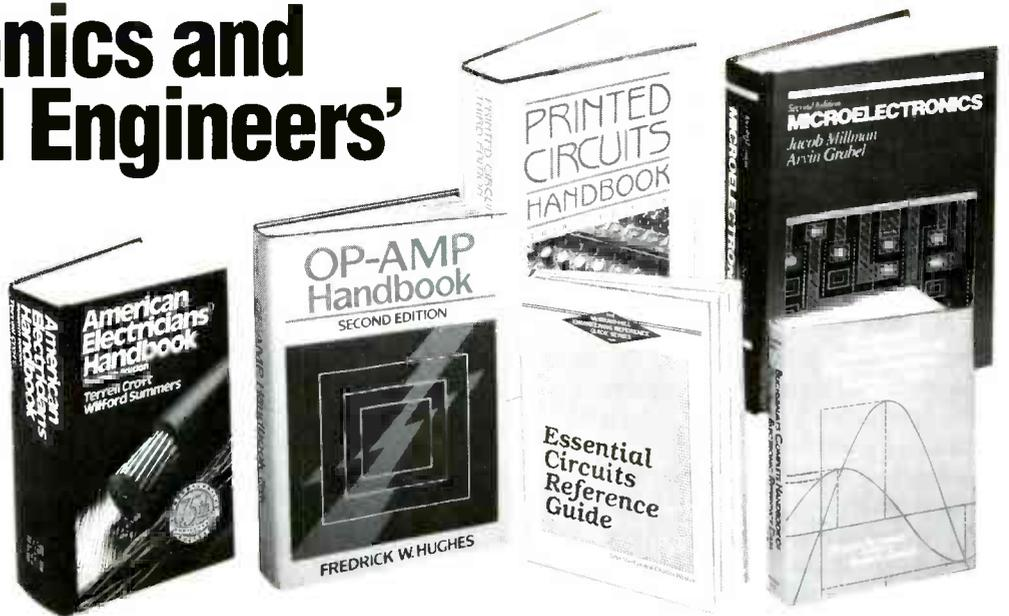

BUCHSBAUM'S COMPLETE HANDBOOK OF PRACTICAL ELECTRONIC REFERENCE DATA, Third Ed. By W.H. Buchsbaum, revised by R.C. Genn, Jr. 635 pp., 357 illus. & tables. This best-selling reference is invaluable for engineers whose work involves going outside their own area of expertise. Coverage includes digital logic; optoelectronics; antennas and transmission lines; RF and microwave fundamentals; communications systems; television systems; computers; radio; recording; and more. 583880-X Pub. Pr., \$34.95 Club Pr. \$26.50

PRINTED CIRCUITS HANDBOOK, Third Edition. By C.F. Coombs, Jr. 960 pp., 556 illus. Here in one handy volume is all the information you need to design, manufacture, test, and repair printed wiring boards and assemblies. This new edition features ten all-new chapters, including three on SMT. 126/097 Pub. Pr., \$59.50 Club Pr., \$45.50

32-BIT MICROPROCESSORS. Edited by H. J. Mitchell, 248 pp., 104 illus. and tables. A complete survey of the architecture, operation, and applications of today's most important new devices from AT&T, Immos, Intel, and Motorola. 425/85X Pub. Pr., \$45.00 Club Pr., \$35.00

MICROWAVE AMPLIFIERS AND OSCILLATORS. By C. Gentili. 150 pp., 79 illus. A thorough, practical introduction to the theory and design of microwave amplifiers and oscillators, with coverage of the scattering matrix, the gallium arsenide field-effect transistor, and microstrip technology. 229/953 Pub. Pr., \$34.95 Club Pr., \$27.95

COMMUNICATIONS RECEIVERS: Principles and Design. By Ulrich L. Rohde and T.T.N. Bucher, 608 pp., 402 illus. Everything you need to know if you design or work with communications receivers, from theory to practical design approaches. Coverage includes all types of receivers: shortwave, broadcast, radar, military, marine, aeronautical, and more. 535/701 Pub. Pr., \$59.50 Club Pr., \$44.50

- your one source for engineering books from over 100 different publishers
- the latest and best information in your field
- discounts of up to 40% off publishers' list prices

New Members!
Take any one of these great professional books **\$289** for only as a premium with your first selection!

Spectacular values up to **\$99.90**

ESSENTIAL CIRCUITS REFERENCE GUIDE. By J. Markus & C. Weston. 528 pp., illus. Collects into one convenient volume more than 1,000 ready-to-use circuit diagrams for today's electronics applications. Now you can have the circuit you need in a matter of seconds — without having to reinvent the wheel. 404/623 Pub. Pr., \$59.50 Club Pr., \$47.50

CIRCUIT DESIGN FOR ELECTRONIC INSTRUMENTATION: Analog and Digital Devices from Sensor to Display, Second Ed. By D. Wobschall. 400 pp., 365 illus. Brings you the entire process of circuit design in a comprehensive, easy-to-follow format. This new edition reflects the latest in IC technology, including CMOS and ECL devices. 712/31X Pub. Pr., \$49.50 Club Pr., \$36.95

AMERICAN ELECTRICIANS' HANDBOOK, Eleventh Ed. By T. Croft and W. Summers. 1,824 pp., 1,560 illus. This newly updated handbook shows you how to select, install, maintain, and operate all the latest electrical equipment and wiring. It includes the most recent code requirements, basic formulas, and a wealth of circuit diagrams and illustrations. 139/326 Pub. Pr., \$64.50 Club Pr., \$49.50

ENGINEERING FUNDAMENTALS FOR THE PROFESSIONAL ENGINEERS' EXAM, Third Ed. By L. M. Polentz. 432 pp., 170 illus. Features worked-out solutions and full explanations for all sample problems so you can learn how to solve them. It's a dependable way to prepare for the exam or a perfect on-the-job reference. 503/931 Pub. Pr., \$36.50 Club Pr., \$27.95

AUTOMATIC CONTROL SYSTEMS, Fifth Ed. By B. C. Kuo. 736 pp., illus. Provides an overview of automatic control systems, including in-depth coverage of classical control techniques, optimal control theory, and analog and digital control system design. This up-dated edition discusses the latest ideas on the use of computers to design control systems and as components of such systems. 583706-4 Pub. Pr., \$51.00 Club Pr., \$36.95

OP-AMP HANDBOOK, Second Ed. By F. W. Hughes. 320 pp., 231 illus. Organized for on-the-job reference, this handbook covers all facets of op-amps, from stability and protection to signal processing using op-amps. Includes a collection of over 60 practical circuits for a variety of applications, procedures, and experiments. 583651-3 Pub. Pr., \$39.00 Club Pr., \$27.50

HANDBOOK FOR SOUND ENGINEERS: The New Audio Cyclopedia. Edited by G. Ballou. 1,247 pp., over 1,200 illus. This giant handbook gives you truly comprehensive coverage of sound — and the methods of producing, reproducing, controlling, changing, reinforcing, and measuring it. 583913-X Pub. Pr., \$79.95 Club Pr., \$55.95

MICROELECTRONICS, Second Ed. By J. Millman and A. Grabel. 1,001 pp., 646 illus. Takes you from the basics of semiconductor properties to an understanding of the operation of solid-state devices, and then to more advanced topics. Its up-to-date coverage, real-life examples, and practical data make this an ideal reference for the working engineer. 423/30X Pub. Pr., \$51.95 Club Pr., \$41.50

ENGINEERING MATHEMATICS HANDBOOK, Third Ed. By J. J. Tuma. 572 pp., illus. This best-selling handbook gives you the essential mathematical tools—formulas, definitions, theorems, tables, and models for computer programming — that you need for your day-to-day engineering calculations. 654/433 Pub. Pr., \$46.50 Club Pr., \$34.50

ELECTRONICS SOURCEBOOK FOR TECHNICIANS AND ENGINEERS

592 pp., 800 illus., softbound 335/591

This condensed, paperback version of the Handbook for Electronics Engineering Technicians is the perfect on-the-job reference for all electronics professionals. From fully worked-out examples, explanations, tables, and graphs ... through up-to-date coverage of active filters, microwaves, and fiber optics ... to using the full spectrum of technical equipment, the **Sourcebook** is the single most convenient professional electronics reference available.



A \$22.95 Value — Yours ABSOLUTELY FREE when you join!

BASIC TELEVISION AND VIDEO SYSTEMS, Fifth Ed. By B. Grob. 592 pp., illus. Provides the clearest picture of how television and video systems work, and what to do when they don't. Covers television receivers, VCR's, video cameras, and cable systems — all in readable, practical detail. 249/334 Pub. Pr., \$34.95 Club Pr., \$24.95

ANALOG ELECTRONIC CIRCUITS. By G. M. Glasford. 480 pp., 350 illus. Gives you the detailed information and equations you need to create and analyze top quality circuit designs or effectively utilize the designs of others. 583768-4 Pub. Pr., \$55.00 Club Pr., \$39.50

HANDBOOK OF ELECTRONIC NOISE MEASUREMENT AND TECHNOLOGY, Second Ed. By C. A. Vergers. 440 pp., 213 illus. Provides answers to all your questions about noise origins, causes, effects. Also shows you how to predict and measure noise, and how to design low-noise circuits. 583947-4 Pub. Pr., \$39.95 Club Pr., \$29.95

SWITCHGEAR AND CONTROL HANDBOOK, Second Ed. Edited by R. W. Smeaton. 1,056 pp., 789 illus. The only handbook that treats all aspects of switchgear control, including design, applications, safety, and maintenance. Updated to reflect the changes brought about by the use of computers, solid-state devices, and programmable controls. 584/494 Pub. Pr., \$75.00 Club Pr., \$56.95

ANTENNA APPLICATIONS REFERENCE GUIDE. Edited by R. C. Johnson and H. Jasik. 496 pp., 368 illus. and tables. Covers the major applications of antenna technology in all areas of communications and their design methods. Emphasizes important new applications such as earth station, satellite, seeker, aircraft, and microwave-relay antennas. 322/848 Pub. Pr., \$53.95 Club Pr., \$42.50

MICROCOMPUTER DESIGN. By M. Hordeski. 406 pp., illus. Emphasizes the most current, cost effective methods for developing, debugging and testing all types of microprocessor products, including software and hardware. 583683-1 Pub. Pr., \$43.00 Club Pr., \$29.95

BOB MIDDLETON'S HANDBOOK OF ELECTRONIC TIME-SAVERS AND SHORTCUTS. By R.G. Middleton. 378 pp., illus., softbound. Packed with little-known tricks of the trade and brand-new techniques, this popular handbook makes it easier than ever to troubleshoot radio, TV, audio equipment, CCTV, and more. 583865-6 Pub. Pr., \$29.95 Club Pr., \$22.50

Be sure to consider these important titles as well!

INTRODUCTION TO RADAR SYSTEMS, Second Ed. By M. I. Skolnik. 579/891 Pub. Pr., \$52.95 Club Pr., \$42.50

ELECTRONIC TEST EQUIPMENT: Principles and Applications. By T.J. Byers. 095/221 Pub. Pr., \$39.95 Club Pr., \$29.95

OPERATIONAL AMPLIFIERS AND LINEAR INTEGRATED CIRCUITS, Third Ed. By R. F. Coughlin and F. F. Driscoll. 583754-4 Pub. Pr., \$40.00 Club Pr., \$25.95

McGraw-Hill's NATIONAL ELECTRICAL CODE HANDBOOK, 19th Ed. By J. F. McPartland. 457/077 Pub. Pr., \$42.50 Club Pr., \$31.95

HANDBOOK OF ELECTRONICS CALCULATIONS FOR ENGINEERS AND TECHNICIANS, Second Ed. Edited by M. Kaufman & A. H. Seidman. 352/281 Pub. Pr., \$49.50 Club Pr., \$37.50

PROBABILITY, SIGNALS, NOISE. By J. Dupraz. 183/389 Pub. Pr., \$43.95 Club Pr., \$34.95

POWER GENERATION CALCULATIONS REFERENCE GUIDE. By T. G. Hicks. 288/283 Pub. Pr., \$36.50 Club Pr., \$27.50

HUMAN FACTORS REFERENCE GUIDE FOR ELECTRONICS AND COMPUTER PROFESSIONALS. By W. E. Woodson. 717/684 Pub. Pr., \$35.95 Club Pr., \$29.50

REFERENCE DATA FOR ENGINEERS: Radio, Electronics, Computer, and Communications, Seventh Ed. Edited by E. C. Jordan. 583619-X Pub. Pr., \$39.95 Club Pr., \$49.95

THE LASER GUIDEBOOK. By J. Hecht. 277/338 Pub. Pr., \$52.95 Club Pr., \$41.50



Here's how the Club works to serve YOU:

IMPORTANT INFORMATION... WE MAKE IT EASY TO GET!
In our rapidly changing world, those who perform best are those who are best informed. Designed exclusively for the practicing engineer, the Electronics and Control Engineers' Book Club provides you with information that is relevant, reliable, and specific enough to meet your needs. Each Club bulletin comes your way 14-16 times a year and offers you more than 30 books to choose from — the finest and newest books from all publishers!

DEPENDABLE SERVICE... WE'RE HERE TO HELP!
Whether you want information about a book or have a question about your membership, our qualified staff is here to help. Just call us toll-free or write to our Customer Service. We also make sure you get only the books you want. All you do is simply tell us your choice on the Reply Card and return it to us by the specified date. If you want the Main Selection, do nothing — it will be sent to you automatically. (A small shipping and handling charge is added to each shipment.)

CONVENIENCE... WE DO THE WORK!
In addition to the benefit of timely information, Club membership offers many other benefits. For example, you get a wide choice of books that cannot be matched by any bookstore — anywhere. And all your books are conveniently delivered right to your door. You also get the luxury of 10 full days to decide whether you want the Main Selection. If you should ever receive a Main Selection you don't want because the club bulletin came late, just return it for credit at our expense.

Substantial Savings... AND A BONUS PROGRAM TOO!
Working with our goal to provide you with the best information at the greatest possible savings, you will enjoy substantial discounts — up to 40%! — on every book you buy. Plus, you're automatically eligible for our Bonus Book Plan which allows you to receive up to 70% off on a wide selection of books.

MEMBERSHIP TERMS... IT'S WORTHWHILE TO BELONG!
Your only obligation is to purchase one more book — at a handsome discount — during the next 12 months, after which you enjoy the benefits of membership with no further obligation. Either you or the Club may cancel membership anytime after.

FOR FASTER SERVICE IN ENROLLING CALL TOLL-FREE 1-800-2-MCGRAW

MAIL THIS COUPON TODAY

McGraw-Hill Book Clubs Electronics and Control Engineers' Book Club®

P.O. Box 582, Hightstown, NJ 08520-9959

Please enroll me as a member and send me the two books indicated, plus the ELECTRONICS SOURCEBOOK FOR TECHNICIANS AND ENGINEERS. I am to receive one book for just \$2.89, the other at the discounted member's price, plus local tax, shipping and handling charges. I agree to purchase a minimum of one additional book during my first year of membership as outlined under the Club plan described in this ad. I understand that a shipping and handling charge is added to all shipments.

Your FREE Sourcebook	
335/591	
Write Code No. of the \$2.89 selection here	Write Code No. for the First selection here
<input type="text"/>	<input type="text"/>

Signature _____

Name _____

Address/Apt. # _____

City _____

State _____ Zip _____

This order subject to acceptance by McGraw-Hill. All prices subject to change without notice. Offer good only to new members. Foreign member acceptance subject to special conditions.

E34050

HOW TO

INSTALL A HOME SECURITY SYSTEM



Do it yourself and save on the cost of a professional-quality home burglar alarm.

HERB FRIEDMAN and BRIAN C. FENTON

HOUSE BURGLARY IS NO LONGER A growth industry. Statistics show that for the past several years there has been a decline in the percentage of house burglaries. Is that because there are fewer thieves? No! There are fewer burglaries because there are more home alarm systems.

A burglar will move on to an unprotected house rather than take his chances with one that's obviously protected—unless he's certain that you've stashed away a fortune in cash or gems. Under those circumstances, *no* alarm system in the world will protect your valuables.

Unfortunately, if you've priced dealer-installed home protection you have most likely experienced "sticker shock," because in many localities there is a basic charge of several hundred dollars for the central control unit, plus \$50 per opening—an *opening* being anything that has a sensor: a window, a door, a skylight, an interior closet, a valuable picture, etc. Fifty dollars an opening adds up quickly, so even a small burglar-alarm installation can cost well in excess of \$1000, and even then you might not end up with every opening protected—you might get just door protection and some kind of area detector to cover the "important" parts of your home.

Do it yourself

But if you can spare from one to three days, you can install a profes-

sional-quality all-opening intruder system at a starting price of about \$250. If you want to have more of the bells and whistles of a multi-zone pro system, you can still do it for significantly less than \$1000. Here, we'll show you two basic alarm-system installations: first we'll look at a *wired* system, and second, a *wireless* system. But before we get into the nitty-gritty of drilling holes and connecting wires, a few words about the equipment used for this article.

For the wired system, we selected a Radio Shack 49-450 control center. Not because the Radio Shack control center is necessarily the best, but because it's good and it's easily available. A user can get service, and future Radio Shack accessories will probably work with all of their older equipment.

For the wireless system, we selected the *Dicon 9000* wireless security system from Dicon Systems, Inc. (631 Executive Drive, Willowbrook, IL 60521). We picked the 9000 because it gives us an excellent opportunity to point out how electronics has made super hi-tech features available on do-it-yourself home burglar-alarm systems.

Let's do it

Let's get on with installing our wired alarm. In addition to the usual hand tools—long-nose pliers, cutters, and screwdriver—you'll need an elec-

tric drill, an 18-inch long, 3/8-inch *feeler* or electrician's bit (it has a hole near the tip to help you pull wires through walls and floors), and an Arrow T-25 staple gun. The T-25 shoots round staples, which are safe for stapling wires to moldings—the round staple doesn't cut into the wire. (The T-25 staple gun can usually be rented for a day or so.)

The Radio Shack model 49-450 control center is powered by 117 volts AC or a rechargeable battery that automatically cuts in if the AC power fails. The control center provides three protective circuits that are called *loops*. There is an instantaneous loop that sounds the alarm as soon as one of its switches is opened; a door loop that provides up to 45 seconds to get out of the house after the alarm is armed (turned on), and up to 45 seconds to turn off the alarm after you enter; and a panic circuit that allows you to sound the alarm—even if the system isn't armed—by pressing a panic or an emergency switch within the house. Most important, the Radio Shack control center can be used with a \$22 *Touch-Tone*-type digital keyswitch (we'll explain its importance later). So-called *pro* control centers require almost \$200 in extra hardware to provide digital keyswitch control. The control center has LED indicators that show the protective loops are set (sensors closed), that the system is armed, that the AC power is on, and

also shows the condition of the back-up battery.

There are front-panel switches for testing the battery and the alarm siren or bell. In our system we choose to use a 2-tone siren—a “wailer”—because it is supplied in a low-cost “package” deal, and because in certain localities the houses and apartments must have a fire alarm that sounds a bell. While a bell can be either a fire or a burglar alarm, a wailing siren is always recognized as a burglar alarm, or a panic or a medical-transmitter call for assistance.

Take note that there are two versions of the control center, and both use the 49-450 stock number. The older version’s battery backup is individual alkaline or Ni-Cd cells. The new version’s backup battery is two series-connected 6-volt rechargeable gel-cells that mount in the bottom of the control center. The new version also comes with an absolutely superb operating and alarm-installation manual. You want the new version.

Mounting the center

The control center has only two knockouts in the back of the cabinet, and they are going to end up packed with wires. If a knockout is blocked by a stud within the wall you are going to have a miserable time fishing all the necessary wires through the one remaining knockout, so make certain that the center is mounted to the wall between two studs. It is easy to use an electronic stud finder to determine the position of the studs in the wall. While stud finders are available at Radio Shack, similar devices are available at Sears for under \$10—half the price of the Radio Shack model.

When you mount the control center be sure that the test switches can be used, and the LED indicators can be seen by the shortest person who will use the alarm system; but keep the control center high enough so that its switches are beyond the reach of small children.

No matter what you decide to use as the main control center, and no matter where you will place it, install a keyswitch in the control center’s front-panel knockout as shown in Fig. 1. (A keyswitch is supplied in the “package kit.”) That way, if every-



FIG. 1—REGARDLESS OF WHAT YOU use for the regular arming switch, there should be a control keyswitch on the front of the central control box.



FIG. 2—TO LEAVE A WINDOW OPEN while the alarm is armed, mount a second magnet a few inches below the magnetic sensor’s main magnet. Simply raise the window until the second magnet is opposite the switch.



FIG. 3—A PULL-APART will allow you to leave the top part of an up-down or a slider window open.

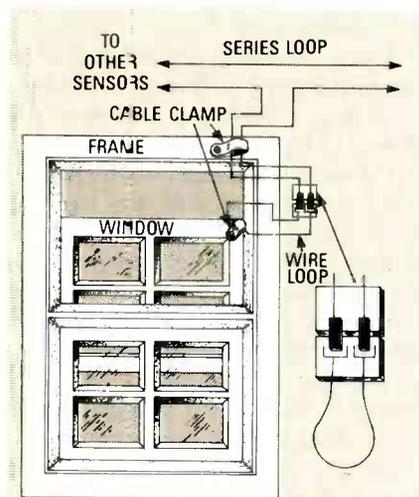

FIG. 4—THIS IS HOW A PULL-APART is connected to the loop.

thing else crashes the system can be disarmed.

The sensors

Next, install the various sensors—called *bugs*—on the windows and doors. The easiest window *bug* to install is the magnetic switch. If you want to be able to leave the bottom open for ventilation, install a second magnet about half way down, as shown in Fig. 2. You can then raise the window until the extra magnet is opposite the switch.

If you want to be able to open the top of the window, use the *pull-apart* shown in Fig. 3. If someone attempts to lower the window, the pull-apart literally pulls apart and triggers the alarm. A pull-apart is really a 300-ohm TV-line coupler whose contacts are gold-plated. If you can’t get an “alarm-type” pull-apart, use standard TV connectors. Either type is wired as shown in Fig. 4.

As shown in Fig. 5, difficult-to-protect basement windows can be *bugged* with wire lacing made from No. 24 or No. 26 enamel-insulated solid wire. Anyone attempting to push out the window will break the wire lacing and trigger the alarm. The wires themselves are held in place with round T-25 staples.

Basement windows with removable screens and storms can be protected by using the ball-type *pull-trap* shown in Fig. 6 and Fig. 7. Normally, when the metal separator between the balls is pulled out the ball contacts don’t touch and the alarm is triggered. But by using the connection shown in Fig. 7, anyone forcing the window, or trying to cut the metal pull wire, interrupts the series loop and thus triggers the alarm.

Cool it

Basement air conditioners are a favorite spot for breaking in because they are often left unconnected to the alarm. As shown in Fig. 8, you can wire the A/C into the system by placing a magnetic switch on the window frame above the A/C, and its magnet on the top of the A/C’s frame. Use *Barge* adhesive or double-sided foam tape to secure the magnet to the air conditioner’s frame.

Every splice should be soldered for



FIG. 5—WIRE LACING WILL PROTECT A screened basement window or a crawl-space opening.



FIG. 6—IF A WINDOW SCREEN must be removed and lacing will get in the way, use a pull-trap to loop through a removable trip-wire lace. Cutting the trip wire will trigger the alarm. Trying to move the trip wire will open the pull-trap.

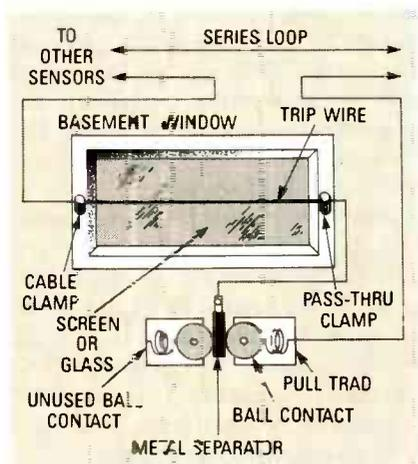

FIG. 7—THIS IS HOW the pull-trap is connected to the protective loop.

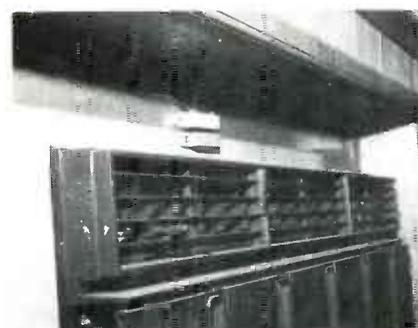

FIG. 8—AN AIR CONDITIONER can be bugged with a conventional magnetic switch.

at least a 1/2-inch, wrapped with tape, and then stapled to a beam or other wood support—even floor molding—as shown in Fig. 9. There must be no connections that are simply twisted and taped, because they can oxidize and cause false alarms.

If you use foil to bug window glass, you must cover the foil with clear varnish or thinned, clear nail-polish. Without the protective covering, the foil will peel off the glass on the first humid day. You can really make a mess of the job, so use a 3/8-inch artist's brush, span the brush across only one edge of the foil and try to "paint" each side of the tape in a single pass. Try not to go over the same foil twice except at the corners, which should get at least two, preferably three coats.

Across the hinge

If you use foil on an entry door's window—and every entry door having a window through which someone can reach should be bugged with foil—as shown in Fig. 10, you span across the hinge with a door cord. The door cord shown is an Ademco, purchased in an electrical-supply store. It is preferred to the Radio Shack door cord because of the position of the terminal screws. The screws on a Radio Shack cord are arranged so that they are almost impossible to access if the door has its hinges immediately adjacent to a wall. (When you see the cord you'll understand the problem.) Take note that a door's window foil is connected to the instantaneous protective loop, not the delayed door loop; you want the alarm to go off the instant someone smashes through the window, not 45 seconds later.

If you can manage to install it without hacking the wall, one of the best entry-door switches is the roller type shown in Fig. 11. Mounted in the top of the jamb it is almost weatherproof; and, as shown, it does not interfere with the old-time (meaning high-quality) interlocking weatherstripping. It's particularly useful when the door has sagged on its hinges, leaving a somewhat large gap between the top of the door and the frame. The roller switch is basically a plunger switch that pushes in as the door squeezes the roller wheel upward. It's a hard switch to locate, but worth the effort to search out if needed.

If you can't manage to install a

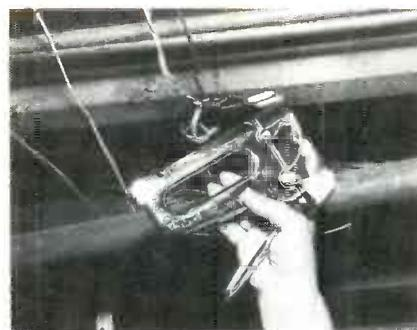

FIG. 9—SOLDER ALL SPLICES, and then staple the taped splice to a wood support—a beam, molding, etc.

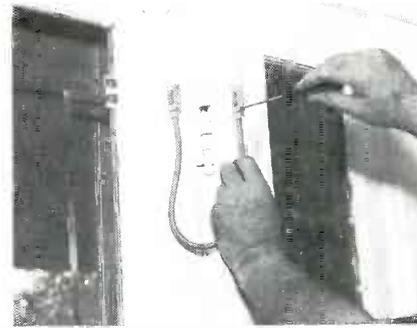

FIG. 10—USE A DOOR CORD to bridge a flexible connection across a door hinge.

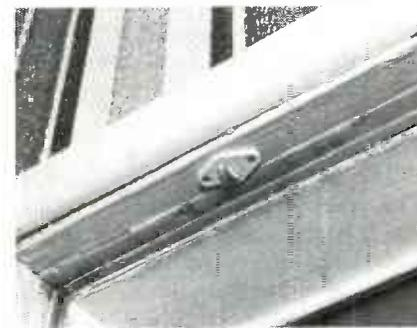

FIG. 11—A ROLLER SWITCH is among the best of the entry-door "bugs," but installation takes quite a bit of skill. If you don't think you can do it, don't.

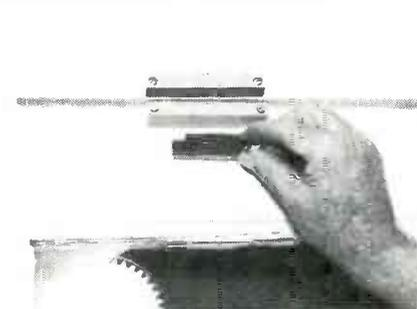

FIG. 12—A WIDE GAP between the door and its frame or molding requires an over-size magnetic switch. The standard-size magnetic switch held in the hand is for comparison.

concealed roller switch (or a plunger switch) for the entrance door, use a magnetic switch. The problem is that the most common switch, the one shown being held in Fig. 12, must be within 1/4 to 1/2 inch of its magnet. In

an older house with a thick door trim, or if the door has sagged, there might be no way to locate the switch and its magnet within their working separation distance. In that case, use the long magnetic switch shown. Although it's almost twice the cost of the smaller conventional switch, it can work within five inches of its magnet. The one from Radio Shack is supplied with several thick spacers that can resolve just about any mounting problem you may come across.

If you have included any interior doors such as closets in the alarm loop, you might want some way to bypass one or more so that you can move around the house freely, yet still have the alarm turned on. Or you might want to bypass the back door, yet keep the rest of the house protected. Either way, it's done with switch assembly which is wired as shown in Fig. 13. Just remember that the switch's *on* position means that the bypass is what's on.

A tiny 12-volt buzzer can be wired near the door as a pre-alarm to remind anyone entering that the alarm is on and must be turned off before the time-out elapses (up to 45 seconds). It is a decided asset, because it helps avoid waking the neighborhood if you come home late at night too tired to remember to turn off the alarm.

Keypad entry

As shown in Fig. 14, the pre-alarm buzzer can be mounted with two-sided foam tape directly below a Radio Shack keypad entry switch; and you should certainly consider using a keypad switch that is located adjacent to the entry door. The switch has LED's that indicate when the loop is ready (green), and when the system is armed (red). The user selects and can change the code at any time. If something goes wrong with the switch or the system, unlike other keypad switches that lock out—leaving the user frantically searching for the control center's key that will turn off the alarm—the Radio Shack unit defaults to a factory code. The combination of the * and # keys is also a panic switch.

Unfortunately, Radio Shack does not sell a surface-mounting box for the keyswitch. Their mounting box requires that you chop a relatively large mounting hole in the wall; wiring inside the wall might prove difficult, and the landlord might not be

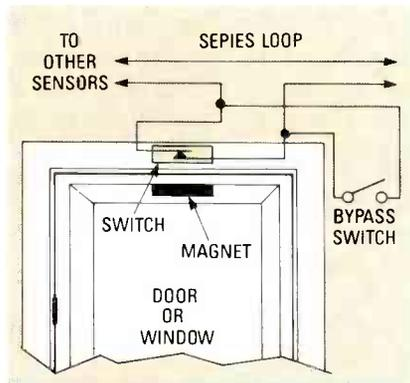

FIG. 13—THIS IS HOW a bypass switch is connected to a door "bug."

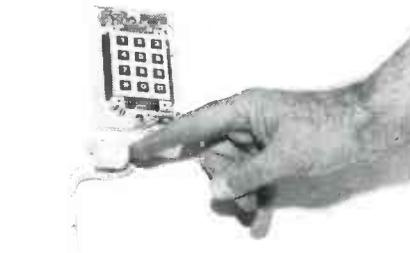

FIG. 14—IF YOU USE A KEYPAD entry switch, you can tape the pre-alarm buzzer to the bottom of the switch's surface-mounting box.



FIG. 15—A STROBE LIGHT mounted on the front of the house instantly tells the neighbors and the police that it's your alarm that's wailing.



FIG. 16—THE LAST STEP is to install the backup battery and connect the AC power. If all went well, the green loop light will turn on and the siren will sound when you press the test switch.

thrilled at the prospect of your moving and leaving a gaping hole behind. Use a surface-mounting box instead, such as a plastic or a metal *Wiremold* box

from your local electrical-parts store.

When your keypad switch is completed, you can simply enter your code, then take up to 45 seconds to get out the door. The system arms long after you have safely passed through the door. Same thing on entry. You enter, hear the buzzer, and get up to 45 seconds to punch in the code that turns off the alarm. Any attempt to tamper with the keypad triggers an internal switch that sets off the alarm.

Figure 15 shows a strobe light that is mounted on the front of the house. It answers the question "Whose alarm is ringing?" by flashing when the siren (or bell) goes off—so anyone within earshot knows instantly whose home is under attack. Put the strobe light out in the open, as conspicuous as is possible. Make certain that it's not screened by one or more tall or leafy trees.

Finally, as shown in Fig. 16, connect the AC power and install the backup batteries. If all went well, the siren should sound, and the strobe should flash when you press the TEST switch.

A wireless system

Installing a wireless system isn't all that different from a wired system, with one major exception: You don't have to drill holes for fishing wires through walls and ceilings. Because of that, installation is usually much quicker. However, the considerations for mounting sensors and the like remain very much the same.

The basic *Dicon 9000* package that we chose for our sample installation (Fig. 17) consists of a base unit, two remote door/window sensors with transmitters, and an emergency speaker/siren. The suggested retail price for the system is under \$700. Available accessories include emergency pendants, smoke detectors, temperature sensors, flood sensors, remote keypads, and motion detectors.

The *9000* is a sophisticated system with up to four security zones; it can dial up to eight telephone numbers to report an emergency, and it can dial them in any order depending on the emergency. For example, in a medical emergency, you would want your doctor to be called before the fire department, yet during a fire emergency, your doctor is the last person you'd want to call—unless he lives next door. Along with a voice-synthesized

response of "Security emergency!," "Fire emergency!," or "Medical emergency!" you can record a 15-second message in digital memory.)

While we're on the subject of dialers, we should point out that, especially in larger towns and cities, a fire or police department will not respond to a recorded message. You should have the unit call a neighbor, or a central monitoring system. Dicon has set up a central monitoring system to accept emergency responses. While the price for the service is fairly standard, it's not cheap: about \$15 per month. However, the people at the central station are trained and therefore can conceivably get help to you quicker—and they're always home. Perhaps more important, they receive the necessary information in digital form for speedier responses.

Setting up the system

The basic *Dicon 9000* is meant to cover two doors or windows. One of its most obvious features is that it is very easy to set up. A voice synthesizer guides you through the process. The first setup task is to install batteries in the remote transmitters and to plug the base unit in. As soon as power is supplied to the base unit, it will ask you to select a 3-digit security code using its very intelligible voice synthesizer. After you enter your selected code, it will repeat the code, and will then ask you to connect the first module.

Each remote transmitter is assigned a unique code by the base unit. To

program the code, a module is removed from the transmitter and plugged into the base unit. Once the base programs the module with a code, it asks for the second module to be plugged in. Since each module code is unique, any alarm can be tracked down to the exact module and reported. The *9000* can support up to 30 individual modules.

The *Dicon 9000's* voice synthesizer guides you through the entering of emergency telephone numbers and the recording of your personal message. Once you complete that task, you're ready to test the system. Assuming everything passes the tests, you can permanently install the sensors. (See Figs. 18–20).

The *9000* features 4 security zones. Zone 1, usually for your entry doors, can be selected for immediate or delayed alarm. Zones 2–4 are always immediate. Any individual sensor can be turned off or bypassed, and any zone can be on or off.

While most people contemplating their first alarm don't see the need for multiple security zones, we'll give a simple example to show why they are necessary. If you are home alone and would like your alarm on, you don't want to be made a captive of one room. If all of your motion detectors are on one zone, you can secure the premises with a perimeter zone, yet be free to move around inside. If you are expecting someone else to come home, the entry door on one zone can be left on delay, yet opening any windows—which are on another zone—

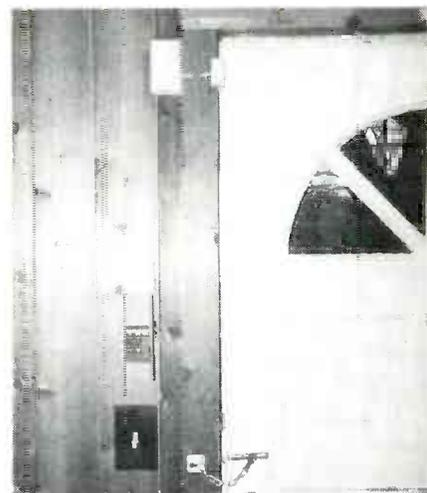

FIG. 18—THE REMOTE KEYPAD is easily installed by an exit door. Note the magnetic reed switch with transmitter at the top left of the door. Such sensors should always be installed on the outer edge, not the hinge side, of a door.



FIG. 19—THE REMOTE TRANSMITTERS can be easily be concealed behind curtains or drapes.



FIG. 20—AN INFRARED SENSOR can view a whole room if it is mounted in a corner. Be sure that it doesn't "see" windows, or radiators that can change temperature rapidly. Also, be sure that such sensors are on zones that can be easily turned off, so that you don't become a prisoner in your own home.

will immediately trigger the alarm. At all times, sensors such as smoke detectors and medical pendants will cause an alarm when triggered, even if the system is not armed.

continued on page 68



FIG. 17—THE DICON 9000 SYSTEM. Shown are the emergency speaker/siren, two magnetic switches with remote transmitters, the base unit, and the optional fire alarm, infrared sensor, and remote keypad.

BUILD THIS

WIRELESS SECURITY SYSTEM

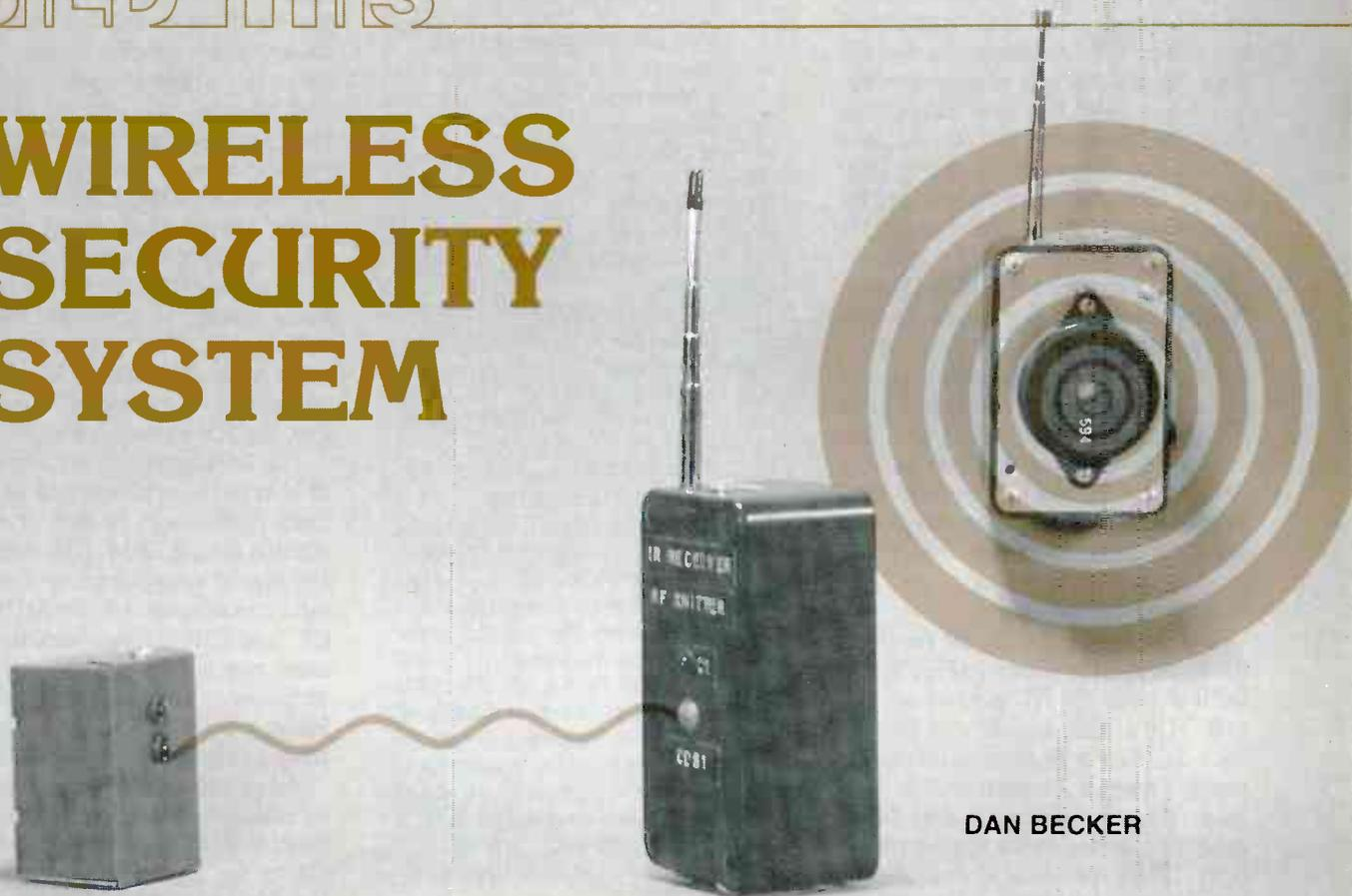

DAN BECKER

Build a wireless security system that monitors an area using an invisible infrared beam and beeps a hand-held buzzer unit when a problem is detected.

EACH YEAR THE NEED FOR A SECURITY alarm in the home increases. Fortunately, security-system technology increases, too, as does the ease of installation. Our system is a good example—it uses an unseen infrared beam which, when interrupted, activates an RF transmitter that broadcasts a signal to a hand-held beeper-like device. By making the system wireless, installation is simplified and one or more remote locations can be monitored.

How it works

Figure 1 shows a block diagram of the system, which contains an IR transmitter, an IR receiver/RF transmitter, and an RF receiver/alert beeper.

Two IR-LED's in the transmitter transmit a pulsed beam of invisible infrared light to the receiver, which contains an IR phototransistor. The

phototransistor detects and amplifies the pulse-modulated IR beam. If the receiver section senses that the IR beam is momentarily interrupted by an object blocking the beam's path, it triggers the transmitter whose output is a 49.890-MHz carrier that is amplitude modulated by a 490-Hz tone.

Upon receiving the 490-Hz amplitude-modulated carrier, the RF re-

ceiver/beeper unit sounds an alarm that alerts the user to the intrusion.

The system is not limited to just one RF transmitter. A single RF receiver/beeper can be used to monitor any number of RF transmitters (or locations). However, the receiver/beeper unit can not discriminate between different transmitter sites in multiple-transmitter systems.

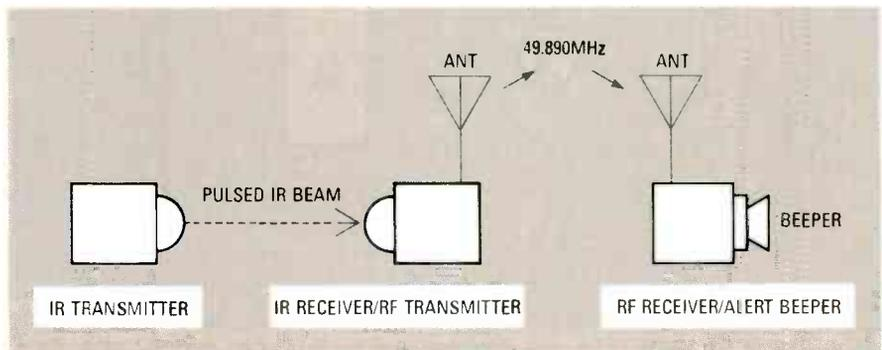

FIG. 1—BLOCK DIAGRAM of the wireless infrared security system.

IR transmitter

As shown in Fig. 2, current through IR-LED1 and IR-LED2 is switched on and off by Q2. Resistors R6 and R7 limit the peak current to approximately 1.4 amperes. IC1 is configured as an astable oscillator, and R1, R2, and C1 set the frequency to about 1500 Hz. In the astable configuration, R1 controls the length of time that pin 3 is low—approximately 43 microseconds. During that low, Q1 and Q2 are switched on, allowing current to flow through both IR-LED's. By limiting the on time to 43 microseconds, the power dissipation in the two IR-LED's is approximately 128 milliwatts. Resistors R3–R5 limit the base current of Q1 and Q2, and C2 provides low-impedance bypassing of the power supply.

Receiver/transmitter

The schematic for the IR receiver/RF transmitter is shown in Fig. 3, and we'll discuss the IR receiver section first. IC1-a, Q2, and R1, in parallel with LDR1, a light-dependent resistor, create a current source. Because phototransistor Q1 and LDR1 are both exposed to the same ambient light, LDR1 automatically adjusts the current that is feeding into Q1, in order to maximize the sensitivity of the photodetector circuit.

When Q1 faces the pulsing infrared beam from the transmitter, Q1's emitter-collector voltage fluctuates in step with the pulses. Capacitor C14 couples Q1's output to op-amp IC1-b. R4 and R5 set IC1-b's gain to about 51 dB. Resistors R2, R3, R17, R18, and capacitor C13 establish a DC voltage-offset that is approximately two-thirds

PARTS LIST

INFRARED TRANSMITTER

All resistors are ¼-watt, 5%, unless otherwise noted.

R1—3300 ohms
R2—82,000 ohms
R3—33,000 ohms
R4—1300 ohms
R5—10,000 ohms
R6, R7—2.2 ohms, ½ watt

Capacitors
C1—0.01 µF, metalized film, 16 volts
C2—100 µF, 16 volts, electrolytic

Semiconductors
IC1—7555 CMOS timer
IR-LED1, IR-LED2—VT1261 Vactec infrared light-emitting diode
Q1—2N4403 PNP transistor
Q2—TIP110 NPN transistor

Miscellaneous: SPST switch, PC board, LED mounting rings, hook-up wire, enclosure, etc.

Note: The following items are available from the source mentioned in the Sources Box. A PC board (TS5.1), \$3.95; IR-LED1 and IR-LED2 (kit IR5-1), \$7.95; All components including semiconductors, resistors, capacitors, optoelectronic devices, IC socket, LED mounting rings, and a PC board (IR5-2 kit), \$17.95.

of the power-supply voltage, V_{CC} , or about 8 volts. That allows the amplifier to operate from a single-ended power supply.

The AC signal and the 8-volt DC offset are fed to pin 2 of IC2. As long as the voltage on pin 2 is greater than two-thirds V_{CC} , IC2 operates as a monostable multivibrator whose time delay is determined by R6 and C2. IC2 and Q3 function as a missing-

pulse detector. As long as pin 2 is held above 8 volts, Q3 is biased off, and has no effect on the operation of the monostable's circuit. Once a timing cycle is completed, pin 3 goes to— and remains at—ground potential. However, with an infrared signal present, the base of Q3 and pin 2 of IC2 are repeatedly triggered by negative-going pulses from pin 7 of IC1-b. Consequently, the timing cycle of IC2 is continuously interrupted before it has a chance to complete one time-delay cycle. That causes pin 3 to remain high. With pin 3 high, the RF transmitter is turned off; with pin 3 low, the RF transmitter is turned on.

The RF-transmitter section consists of a crystal oscillator and an audio-tone modulator. In the crystal-oscillator circuit, R14–R16 establish a DC bias of approximately 7 mA. The circuit is tuned to 49.890 MHz by L1, C9, and C10. T1 provides an impedance match between the oscillator's output and the antenna. The antenna-loading coil, L2, tunes a one-meter whip to resonance at 49.890 MHz.

Amplitude modulation is achieved by connecting R16 to pin 3 of astable-timer IC3. Components R11–R13 and C6 set the astable's frequency to 490 Hz. Pin 3 of IC3 goes low once during each 490-Hz cycle, which turns on Q5, allowing it to generate and transmit an RF signal. When pin 3 of IC3 is high, Q5 is off, and RF oscillation stops. Because IC3 is set to oscillate at the audio rate of 490 Hz, a 490-Hz amplitude-modulated RF carrier is generated by the Q5 circuit.

Figure 4 shows the envelope of the transmitted RF signal as seen on a spectrum analyzer. The bandwidth is less than ± 10 kHz, as required by Part 15 of the FCC's Rules and Regulations.

The RF transmitter is turned on or off by Q4 and its associated components (see Fig. 3). To do that, Q4 turns the modulator, IC3, on or off. Q4's drain is connected through L4, a radio-frequency choke, to pins 2 and 6 of IC3. When Q4 is on, pins 2 and 6 are held below four volts (one-third of V_{CC}), causing pin 3 to go high; that stops the RF oscillation because Q5 is turned off. When Q4 is off, pins 2 and 6 of IC3 are unaffected by Q4's very high off-state impedance. Consequently, RF transmission occurs.

Transistor Q4 is switched on and off by pin 3 of IC2. C4 charges through R7 when pin 3 goes high. The

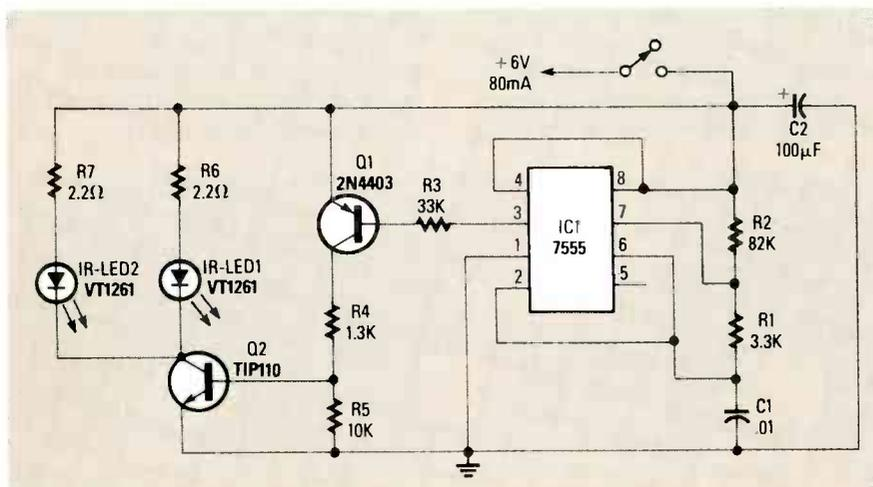

FIG. 2—THE IR TRANSMITTER, one component of the three-part system, transmits a continuous beam of infrared light to the IR receiver/RF transmitter.

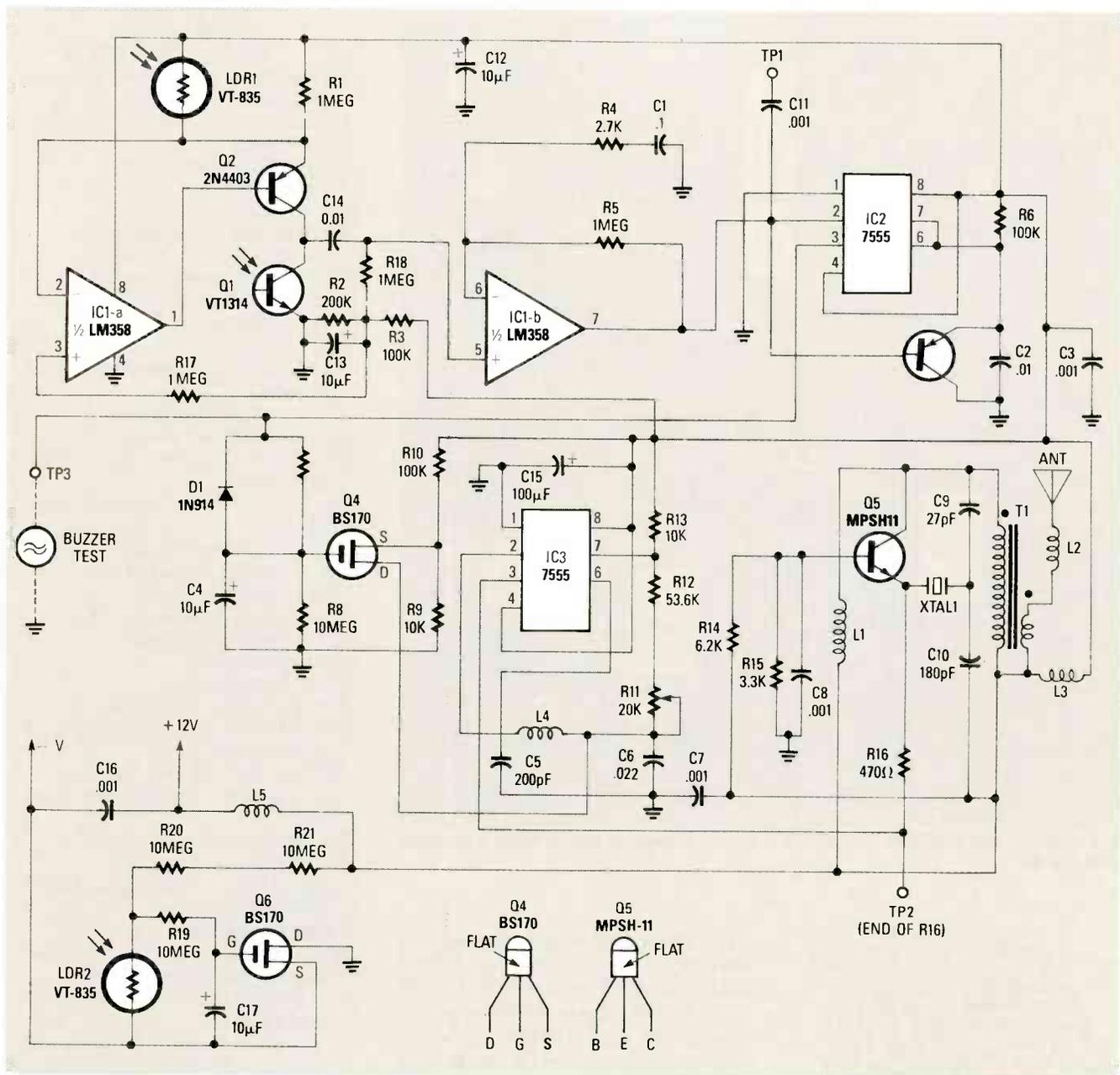

FIG. 3—THE IR RECEIVER/RF TRANSMITTER receives the IR beam and transmits an RF warning signal when the beam is interrupted.

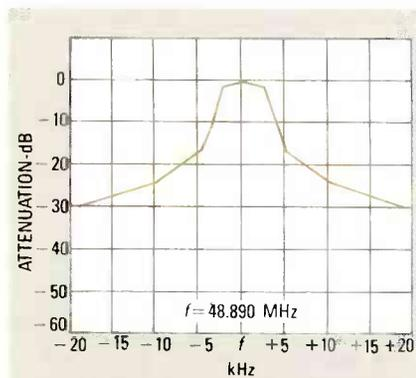

FIG. 4—THE BANDWIDTH of the transmitted RF signal.

voltage across C4 and between Q4's source and gate biases Q4 on when it reaches approximately three volts. When pin 3 goes low (to ground), C4 quickly discharges through D1, thereby biasing Q4 off.

Voltage-divider R9 and R10 bias Q4's source terminal to approximately 0.7 volts. That voltage, in conjunction with R8, provide a delay of several seconds between when Q4 turns on and when it turns off (it turns off when C4 charges to 3 volts or more). The RC time-constant circuit activates the RF transmitter for several seconds, even if pin 3 of IC2 goes low for only a fraction of a second.

Transistor Q6 and its associated components function as an on-off switch that is controlled by the intensity of the ambient light. LDR2's resistance is low when the device is exposed to light, thereby forcing Q6's V_{GS} (gate-source voltage) below the turn-on threshold. Capacitor C17 charges through resistors R19-R21 when LDR2 is not illuminated. Q6 turns on when the voltage across C17 reaches approximately 2.5 volts. With transistor Q6 on, the negative terminal of the power supply is connected to the circuit ground, thereby applying power to the IR receiver/RF transmitter.

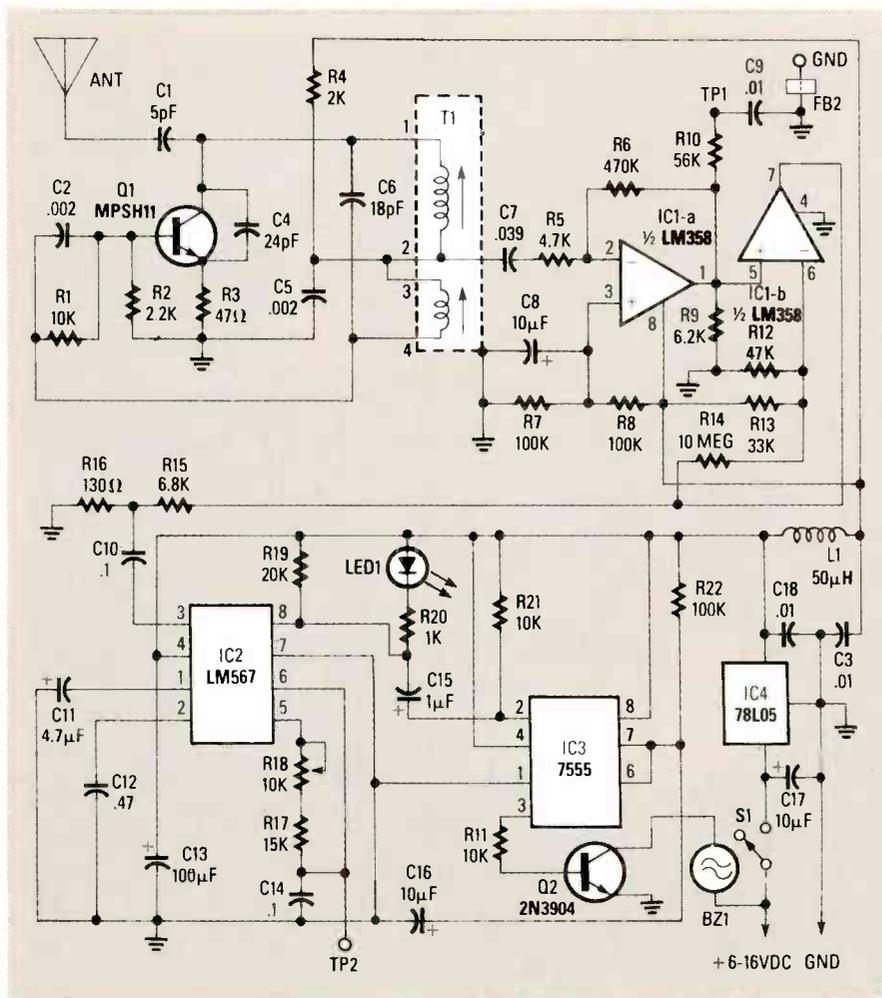

FIG. 5—THE RF RECEIVER/ALERT BEEPER sounds a warning buzzer when it receives the RF signal.

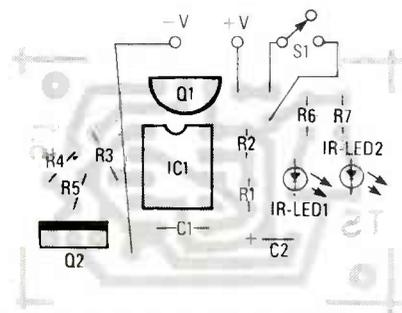

FIG. 6—PARTS PLACEMENT for the IR transmitter.

RF receiver/beeper

The RF receiver/alert beeper is shown in Fig. 5; the receiver circuit is a superregenerative receiver. An amplitude-modulated RF carrier is coupled from the antenna, through C1, into T1, and then to Q1's base. Resistors R1-R4 bias Q1 for an emitter current of approximately 1 mA. Capacitor C5 bypasses the RF signal, but not audio signals, to ground. The value of C2 is selected to cause self-oscillation, or motorboating, which is

a requirement of a superregenerative detector. In that configuration, Q1 oscillates at an RF frequency of 49.890 MHz, at a repetition rate of approximately 450 kHz. During each 450-kHz cycle, just before Q1 breaks into RF oscillation, the circuit functions as a very-high-gain RF amplifier.

Transistor Q1's average DC emitter current increases and decreases according to the amplitude of the RF signal. Because the RF signal is amplitude-modulated by a 490-Hz tone, a 490-Hz voltage appears at the junction of Q1's collector and R4. C7 couples the 490-Hz signal from the receiver to op-amp IC1-a, which provides 10-dB gain. IC1-b further amplifies and clips the signal, shaping it into square pulses. Resistors R7-R9, R12, and R13 allow IC1 to be powered by a single-ended power supply.

The square-wave pulses from IC1-b are fed to tone-decoder IC2 through R15 and C10. The decoder's input-signal voltage is reduced by R16,

PARTS LIST IR RECEIVER/ RF TRANSMITTER

All resistors are 1/4-watt, 5%, unless otherwise noted.

- R1, R5, R7, R17, R18—1 megohm
- R2—200,000 ohms
- R3, R6, R10—100,000 ohms
- R4—2700 ohms
- R9, R13—10,000 ohms
- R8, R19-R21—10 megohms
- R11—20,000 ohms, trimmer
- R12—53,600 ohms, 1/4-watt, 1%
- R14—6200 ohms
- R15—3300 ohms
- R16—470 ohms

All capacitors are rated for at least 16 volts.

- C1—0.1 μ F, metallized film
- C2, C14—0.01 μ F, metallized film
- C3, C7, C8, C11, C16—0.001 μ F, ceramic disc
- C4, C12, C13, C17—10 μ F, electrolytic
- C5—200 pF, ceramic disc
- C6—0.022 μ F, metallized film
- C9—27 pF, ceramic disc
- C10—180 pF, ceramic disc
- C15—100 μ F, electrolytic

Semiconductors

- IC1—LM358 op-amp
- IC2, IC3—7555 CMOS timer
- Q1—VT1314 Vactec NPN infrared phototransistor
- Q2, Q3—2N4403 PNP transistor
- Q4, Q6—BS170 MOS power transistor

- Q5—MPSH11 NPN transistor
- D1—1N914 switching diode
- LDR1, LDR2—VT-835 Vactec photoconductive cell

Other components

- ANT—1-meter whip, or a 1-meter length of No. 22 hookup wire
- L1—0.47- μ H RF inductor (TOKO 7KM series)
- L2—0.6- μ H antenna loading coil (Time Space Scientific TS500-34-24)
- L3-L5—50- μ H miniature RF choke
- T1—RF transformer (Time Space Scientific TS2343-18-5)
- XTAL1—49.890-MHz series-resonant crystal

Miscellaneous: SPST switch (optional), PC board, IC sockets, etc.

Note: The following items are available from the source mentioned in the Sources Box. T1 and L1-L5 (kit TR3-1), \$10.95; PC board (TS3.3), \$9.95; LDR1, LDR2, and Q1 (kit TR3-3), \$9.95; XTAL1 (49.890 MHz), \$5.35; All components including semiconductors, resistors, capacitors, dip sockets, and a PC board (kit TR3-4), \$45.95. (None of the kits include an antenna, switch, or enclosure.)

PARTS LIST

RF RECEIVER/ALERT BEEPER

All resistors are 1/4-watt, 5%, unless otherwise noted.

- R1, R11, R21—10,000 ohms
- R2—2200 ohms
- R3—47 ohms
- R4—2000 ohms
- R5—4700 ohms
- R6—470,000 ohms
- R7, R8, R22—100,000 ohms
- R9—6200 ohms
- R10—56,000 ohms
- R12—47,000 ohms
- R13—33,000 ohms
- R14—10 megohms
- R15—6800 ohms
- R16—130 ohms
- R17—15,000 ohms
- R18—10,000 ohms, 20-turn trimmer potentiometer
- R19—20,000 ohms
- R20—1000 ohms

All capacitors are rated for at least 16 volts.

- C1—5 pF, ceramic disc
- C2, C5—0.002 μF, ceramic disc
- C4—24 pF, ceramic disc
- C6—18 pF, ceramic disc
- C7—0.039 μF, metalized film
- C8, C16, C17—10 μF, electrolytic
- C3, C9, C18—0.01 μF, ceramic disc
- C10, C14—0.1 μF, metalized film
- C11—4.7 μF, tantalum
- C12—0.47 μF, tantalum
- C13—100 μF, electrolytic
- C15—1 μF, electrolytic

Semiconductors

- IC1—LM358 op-amp
- IC2—LM567 tone decoder
- IC3—7555 CMOS timer
- IC4—78L05 5-volt regulator
- LED1—Red light-emitting diode
- Q1—MPSH11 NPN transistor
- Q2—2N3904 NPN transistor

Other components

- ANT—Telescopic antenna or two feet of No. 22 hook-up wire
- BZ1—Piezo buzzer
- S1—SPST switch
- L1—50-μH RF choke
- T1—RF transformer, primary is 18 turns of no. 28 magnet wire, secondary is 5 turns of no. 24 magnet wire, on 0.23-inch diameter, no. 43 ferrite core

Miscellaneous: dip sockets, plastic enclosure, SPST switch (optional), wire, etc.

Note: The following items are available from the source mentioned in the Sources Box. A PC board (TS2.2), \$9.35; T1 (TS3310), \$7.95; All components including semiconductors, resistors, capacitors, ferrite beads, L1, T1, antenna wire, dip sockets, and a PC board (kit RC2-1), \$29.95.

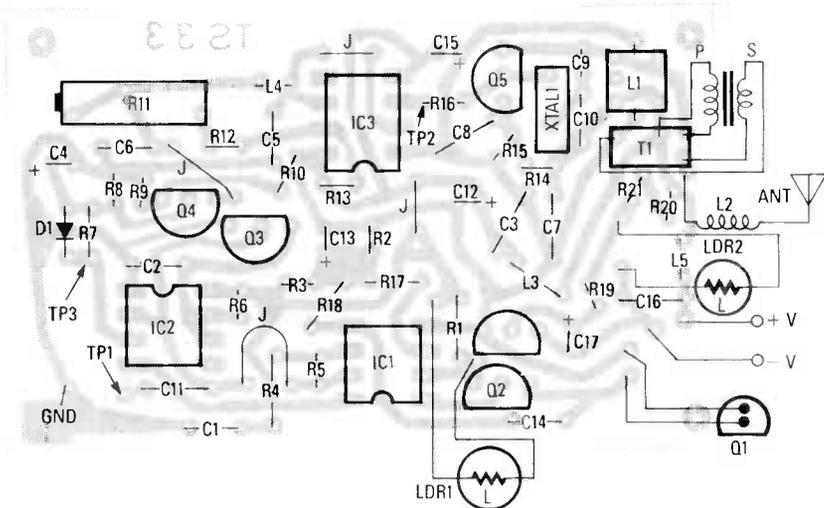

FIG. 7—PARTS PLACEMENT for the IR receiver/RF transmitter.

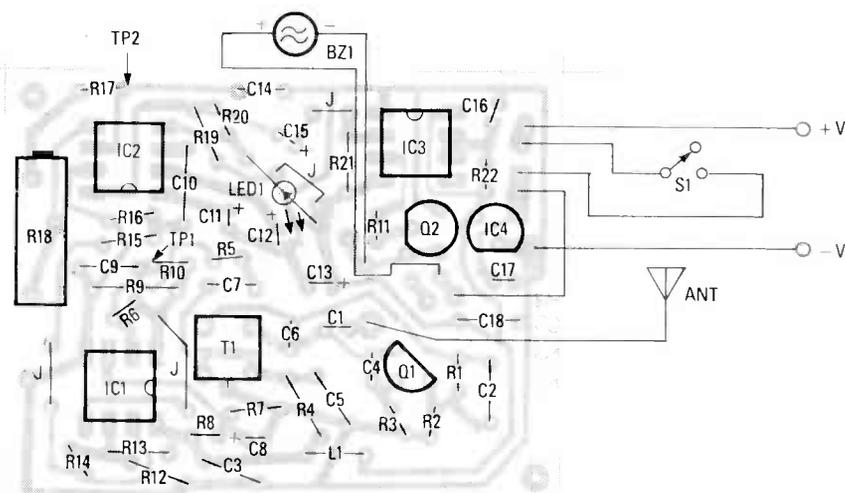

FIG. 8—PARTS PLACEMENT for the RF receiver/alert beeper.

thereby increasing the decoder's immunity to false triggering caused by other signals present in the 49-MHz band. Therefore, R16 is optional and, if installed, it will reduce the maximum range of the RF system. Capacitors C11 and C12 set the decoder's bandwidth, and R17, R18, and C14 set the frequency to which IC2 will respond (490 Hz). Pin 8 of IC2 goes low when a 490-Hz tone is applied to pin 3. At all other times, pull-up resistor R19 keeps pin 8 high. A high-to-low pulse transition at pin 8 is coupled to IC3's trigger input (pin 2) through C15. Pull-up resistor R21 keeps pin 2 high at all other times. Once triggered, IC3's output (pin 3) goes high, biasing Q2 on. (Q2 functions as a current sink for BZ1.) R22 and C16 determine the length of time that BZ1 sounds.

Construction

Each of the three circuits is as-

sembled on its own PC board and mounted in its own enclosure. Templates for the boards are provided in PC Service. Alternatively, etched and drilled boards can be purchased from the source given in the Parts List. Use a suitable enclosure for each circuit. If you intend to use rechargeable batteries as the power supply, be sure that the enclosure is large enough for both the PC board and the batteries. If you use an AC adapter for the power supply, you can use a smaller enclosure.

Before mounting components on the PC boards, use the boards as templates for any holes that have to be drilled in the enclosures. All 555 timer IC's are CMOS, so we suggest that you use dip sockets, and wear a grounded wrist strap when handling the IC's. If you don't use IC sockets, use a grounded (3-wire) soldering iron.

Figures 6, 7, and 8 show the Parts Placement diagrams for the IR trans-

mitter, the IR receiver/RF transmitter, and the RF receiver/alert beeper, respectively. All resistors are installed vertically. Capacitors mount flush against the board with *minimum* lead lengths—that is especially important in the RF and tone-decoder circuits. Install XTAL1 after C9 and C10 are installed. All transistor leads are approximately ¼-inch long. If you decide to control the IR receiver/RF transmitter manually, rather than use the automatic daytime-off circuit, omit Q6's circuit and install an SPST switch between the solder pads that were intended for Q6's source and drain.

Test points

For the RF receiver/alert beeper, make TP1 (test point 1) by placing a ferrite bead over one end of R10, and then solder the resistor onto the PC board so that it stands vertically, with the ferrite bead and the ring on top. Also, be sure that there is an easily accessible ground test point. TP2 is located at the junction of R17 and C14.

The IR receiver/RF transmitter board has three test points. TP1 is located on the free end of C11. Just temporarily solder a piece of red wire to the TP1 pad, and a piece of black wire to ground (both should be about 4 inches long). In the alignment procedure that follows, those two wires temporarily attach to an external audio amplifier/speaker. TP2 is the point where R16 and IC3 pin 3 meet, and TP3 is between R7 and the cathode of D1.

If you find that the test points are picking up interference, you may have to install a ferrite bead over the test point as was previously described.



FIG. 9—THE PROTOTYPE SYSTEM. The unit on the left is the IR transmitter, the one in the center is the IR receiver/RF transmitter, and the one on the right is the RF receiver/alert beeper.

SOURCES

All of the parts or parts kits mentioned in the Parts List are available from Time Space Scientific, 101 Highland Dr., Chapel Hill, NC 27514. Be sure to add \$4.50 to any total order for shipping and handling. For technical information, write to Time Space Scientific, and please include a self-addressed stamped envelope.

The completed system units are shown in Fig. 9.

Optics

Mount the optical components in their respective enclosures as follows: For the IR Transmitter, drill two ¼-inch holes in the cover of the case with their centers ½-inch apart. Install IR-LED1 and IR-LED2 in the holes using LED mounting rings. If necessary, connect a pair of wire leads between the PC board and the IR-LED's, but keep the leads reasonably short.

Install phototransistor Q1 into the enclosure of the IR receiver/RF transmitter, the same way you installed the IR-LED's. Also, mount LDR1 adjacent to Q1 so that both are exposed to the same intensity of ambient light. Mount LDR2 in a location that will ensure maximum exposure to ambient light.

Alignment

For test purposes, each of the three circuits can be powered from a 9-volt battery, but for continuous operation, rechargeable batteries or AC adapters are recommended. The IR transmitter, and the RF receiver/alert beeper work well from a 6-volt gel-cell battery, but a 12-volt DC supply is required for the IR receiver/RF transmitter. And, if the connecting wires to the 12-volt supply are longer than two feet, install a 50-µH RF choke in series with the negative supply lead at the PC board.

The alignment requires a frequency counter that is capable of measuring audio frequencies, and an audio amplifier/speaker that has either an auxiliary- or a microphone-input jack (a portable cassette player with a microphone-input jack can be used). All test points are referenced to the circuit ground.

Cover LDR2 with black tape or plastic to shield it from ambient light. Attach a power supply to the IR re-

ceiver/RF transmitter circuit and allow one minute for C17 to charge. Then, using a small screwdriver, turn L1's core counterclockwise until it protrudes approximately ⅓₃₂ inch. Attach a frequency counter to TP2 and adjust R11 for a reading of 490 Hz. Disconnect the frequency counter and, using the appropriate connectors, attach the audio amplifier/speaker (the portable cassette recorder) to TP1: A 490-Hz tone should be heard.

Apply power to the IR transmitter.

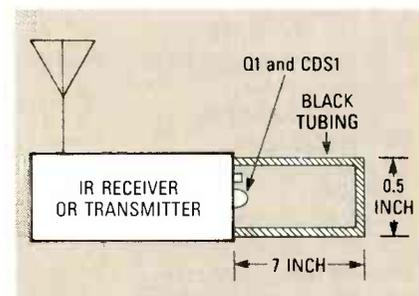

FIG. 10—A LIGHT SHIELD may be needed depending on the ambient light levels (see text).

While listening to the audio signal at TP1, place the IR transmitter in front of phototransistor Q1; a higher-pitched tone of approximately 1500 Hz should also be heard. After a few seconds, the 490-Hz tone should stop, leaving only the 1500-Hz tone. Momentarily interrupt the IR beam; the 490-Hz tone should again be heard.

Expose LDR2 to light. After a few seconds the audio tone(s) should stop, indicating that Q6 has shut off the circuit. Cover LDR2 so that the IR receiver/RF transmitter operates. Turn off the IR transmitter.

Apply power to the RF receiver/beeper (BZ1 may sound momentarily). Connect a frequency counter to TP2, and adjust R18 so that the counter measures 490 Hz. Next, connect the audio amplifier/speaker to TP1. Adjust T1's core until the top of the core is level with the top of the RF transformer. A rushing noise—and possibly the 490-Hz audio tone from the RF transmitter—should be heard. Adjust both T1 and L1 (in the receiver and the transmitter) for the loudest 490-Hz tone. Momentarily turn off the RF receiver/beeper and remove IC2. Collapse the antenna on the RF transmitter and place it about 30 feet from the receiver. Then, turn on the RF receiver and fine-tune T1 (on the

continued on page 58

BUILD THIS

ALPHA/THETA MEDITATION GOGGLES

Our alpha/theta meditation goggles can help you relax!



MARK WORLEY

MOST OF US NEED TO LEARN HOW TO RELAX FROM THE EVERY day stress of modern life. Research has shown that while in a relaxed state, our brains are generating alpha waves. For example, practitioners of yoga and transcendental meditation, after months and sometimes years of painstaking practice, can put themselves into a state that produces a preponderance of alpha brain waves. But because few of us

have the patience to learn yoga, a far simpler technique to achieve relaxation is by using alpha-wave biofeedback.

The Alpha/Meditation Goggles (A/MG) will allow you to readily produce those restful alpha waves through a process called photic stimulation. That technique has been used since the 1930's, but, until recently, it required a darkened room with bulky, expensive equipment. Now, solid-state electronics provides an inexpensive, safe, pocket-sized photic stimulator that runs on a 9-volt battery.

Photic stimulation

Alpha waves are a normal rhythm of brain signals, ranging from about 7 Hz to 14 Hz. They are low in amplitude and occur infrequently while you're in an alert awake state. However, they become pronounced when you close your eyes and fall into a cozy, drifty state of physical and mental relaxation.

When a person's particular alpha (or theta) frequency is visually flashed into their eyes, their brain tends to "resonate" with the light flashes. Because each person has their own dominant alpha frequency (or theta frequency), the flashing light has to be adjusted to a rate that nearly matches that frequency for any real effect.

The applications for the A/MG range from helping you to get to sleep more easily, to

meditate, or for self-hypnosis training. You'll find that the alpha waves occur while you're in a state of relaxed awareness, which is often called an *alpha state*.

Circuit description

As Fig. 1 shows, a 555 astable oscillator (IC1), and transistor driver (Q2) are used to flash the series-connected LED's over an adjustable range of about 6.5 pps to 14.5 pps (pulses per second), or, optionally, 3.5 pps to 7 pps.

IC1 is configured as a conventional astable oscillator having an output pulse that goes low for 10 ms at the rate set by potentiometer R1. Resistors R4, R5, and R6 allow the oscillator to be fine tuned to correct for $\pm 20\%$ tolerance error in C2 and R1. You can use a frequency counter on pin 3 of IC1 to set R1's range, so that it has about the same overlap at each end of the 7- to 14-Hz band.

Note: Resistors R4-R6 can be omitted from the project, because it may not be necessary to trim the flash rate of your instrument so precisely. If you like, R5 can be a panel-mounted potentiometer for fine-adjusting R1.

Transistor Q1 is normally kept off by R8; Q1, in turn, keeps Q3 off. A low-going pulse from IC1 turns on Q1 for 10 ms, and pulses Q2 to momentarily flash the LED's. Resistor R10 will develop 650 mV across it at 54 mA. That 650 mV will turn on Q3 and limit Q2's current to 54 mA. Having that limiter, a constant current passes through the LED's with each pulse, independent of the supply voltage.

Most LED's are rated for about 20 mA of continuous current, but at a 15% duty-cycle, they can handle over 50 mA without harm. The LED brightness is significantly increased, yet the battery drain is still kept quite low. If you find that the LED's are uncomfortably bright, increase R10 to between 15 and 27 ohms.

The specified LED's are high-efficiency versions that emit a surprisingly intense beam of 30-mcd (millicandies are a measure of light intensity) at 20 mA. Standard LED's frequently have an intensity of 1 to 5 mcd, and a scattered, diffused beam. For the best effect, use the specified LED's because they have lightly tinted lenses, higher output, and a narrow beam.

Commonly, red LED's have a forward voltage drop (V_F) of about 1.7

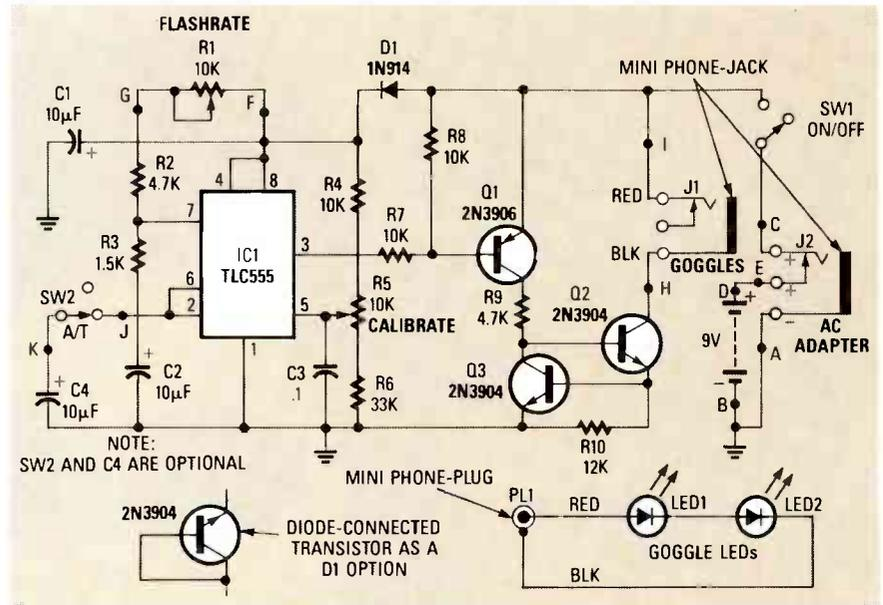

FIG. 1—THE HEART OF THE ALPHA MEDITATION circuit is a simple 555 timer whose pulse frequency is controlled by potentiometer R1. The pulse rate sets the visual flashing rate of the LED's in the goggles.

volts at 20 mA, whereas the brighter ones typically have a V_F of over 2 volts.

Therefore, up to four standard LED's can be used in the circuit. However, the V_F of the brighter LED's prevents using four of them with a 9-volt supply.

Diode D1 and capacitor C1 provide better power-supply filtering and isolation for IC1 than a conventional R/C filter. However, a 100-ohm resistor can be substituted for D1 if you desire. For a very-low voltage loss across D1, you could try using a Schottky diode or a diode-connected transistor, such as a 2N2222 or 2N3904 (see Fig. 1.). That isn't really necessary, but it may keep some purists happier. Without the filter, the high-current pulses through the LED's can adversely affect the 555's operation, particularly with a weakening battery.

A mini phone-jack, J1, provides a convenient way to disconnect the goggles from the control box for storage. Another jack, J2, allows you to power the A/MG from an AC adapter having a 6- to 12-volt DC output. Make sure that the adapter has the proper polarity (a DC output, not AC), and a rating of 50 mA or more. Remember that a 12-volt adapter will not make the LED's any brighter than a 9-volt battery because of the current limiting.

PC-board assembly

The control circuitry does not need special care in assembly or layout, so

perfboard should work just as well as the author's PC-board; the Parts Placement is shown in Fig. 2. For ease of discussion, we'll assume you're using the PC board. Note that the PC board supplied by the author is silk screened with all parts labeled, and solder-pads A through K are identified. All the holes have been drilled to their proper size. The inside of the control box is shown in Fig. 3, while the control box exterior assembly is shown in Fig. 4.

1. To keep the board oriented properly, lay the board on your work surface with the copper side down and S1's mounting holes to your right. Identify the locations of all the component mounting holes, and the mounting pads. Keep IC1 in its anti-static foam until you're ready to install it.

2. Insert the switch into its mounting holes and solder the three leads. The mounting tabs can be soldered to the board, too, but you will have to scrape the black finish from those tabs in order to do that.

3. Install C1, C2, and D1. Those parts are polarized and must be installed as indicated. (C4 should also be installed if it is going to be used.)

4. Install all resistors except R1, and also install C3. There are two ground pads for C3 to accommodate a variety of capacitor styles and sizes.

5. Use a piece of capacitor or resistor lead to jumper the two pads on the 555 (pins 4 and 8). Install the jumper flat

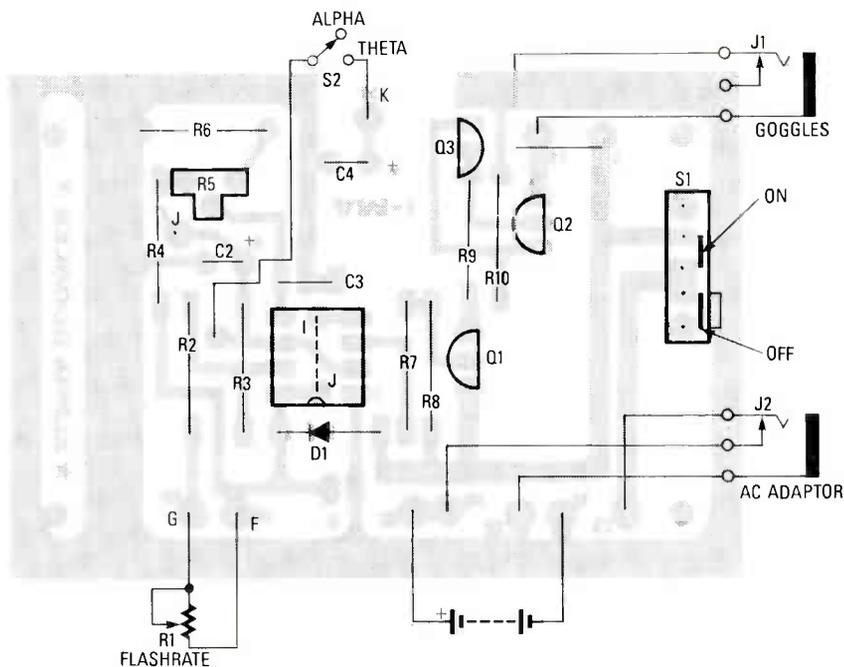

FIG. 2—THE PARTS PLACEMENT for the A/MG PC-board shows switch S1 soldered directly on the board. Notice transistor orientation, and the polarity of capacitors and diode D1.

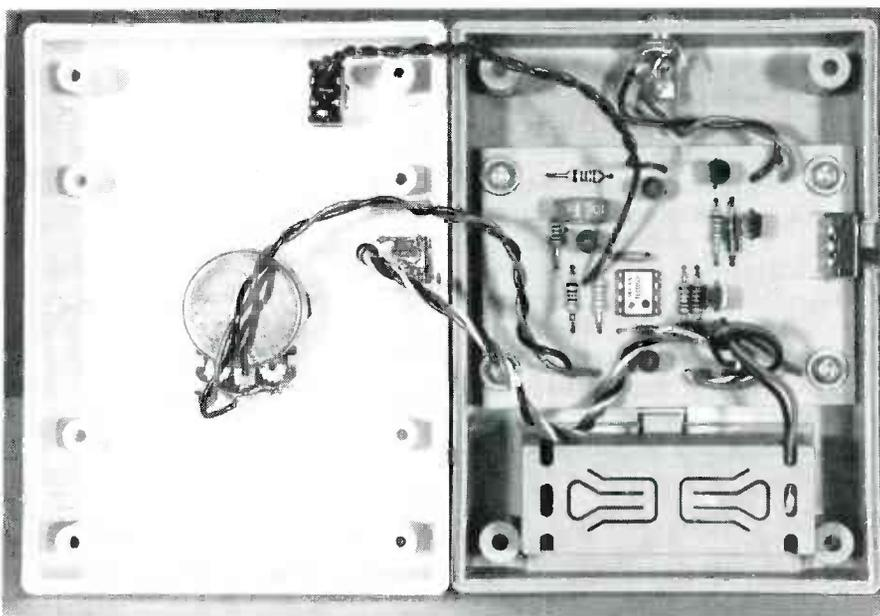

FIG. 3—THE INSIDE VIEW OF THE A/MG control box. Notice the clean layout. A 9-volt-battery compartment is just below PC board.

on the component side of the board. The 555 will be installed on top of that wire.

6. Identify the three transistors, Q1-Q3. Install them with their flat side facing the proper direction, according to the Parts-Placement diagram in Fig. 2.

7. Install IC1 with pin 1 in the lower-right corner near D1. (Pin 1 is also identified on the copper foil.) Be sure the jumper wire has been installed under IC1 before you install IC1 or a

socket. We'll continue with the remaining wires later.

8. Temporarily mount the board loosely in the bottom half of the box on top of the mounting bosses, and mark the hole for the on/off switch. Be sure to slide the switch between its two positions when marking the cut-out. The plastic is easy to cut, so a small, flat file is all that's required. The switch has a low profile, so the top half of the case does not have to be notched.

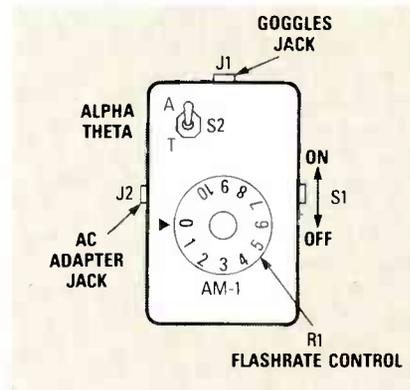

FIG. 4—EXTERIOR DIAGRAM OF THE A/MG control box showing the position of the flashrate control knob, and various jacks and switches.

9. In the bottom half of the case, mount a mini phone-jack (J1) for the goggles. Also, mount a jack for the AC adapter (J2) on the top half of the case. Make sure the jack clears any internal obstructions.

10. Insert the battery-clip leads from inside the battery holder through the slot on the right side. Tie a large knot in the leads to keep them from pulling back through the slot, while leaving 1/4 inch of lead length to solder to the PC board.

11. Solder the black battery-lead to solder pad "A" and the red lead in pad "D." (If you aren't installing an AC-adapter jack at this time, solder the red battery lead to pad "C," and the black lead to pad "A.")

12. Solder a red wire to pad "C" and a black wire to pad "B," then route them to the AC-adapter jack and solder them in place. Make sure that the polarity of the adapter matches the red (+) and black (-) wires. Also, connect a white wire between pad "E" and the switched terminal on the same jack. (That way, the battery will be disconnected when the AC adapter is plugged in.)

13. Solder a black wire between pad "H" and the outer ring terminal of the jack for the goggles, then solder a red wire between pad "I" and the "tip" terminal of the same jack.

14. Drill a hole in the center of the box's cover for the flash-rate potentiometer, R1.

15. If the theta-range option is used, connect a pair of lightly twisted 3-inch wires from pads "J" and "K" and S2, which should be mounted on the instrument's cover. Either wire can go to either pad. When S2 is closed, the A/MG will be operating in

PARTS LIST

All resistors are 1/4-watt, 5%.

R1—10,000 potentiometer
R2, R9—4700 ohms
R3—1500 ohms
R4, R7, R8—10,000 ohms
R5—10,000 trimmer potentiometer
R6—33,000 ohms
R10—12 ohms

Capacitors

C1—10 μ F, 15 volts, electrolytic
C2, C4—10 μ F, 20 volts, 10%, tantalum
C3—0.1 μ F ceramic disk

Semiconductors

IC1—Texas Instruments, TLC555CP oscillator
Q1—2N3906 transistor
Q2, Q3—2N3904, 2N2222, or equivalent transistor
D1—1N4148, 1N914, or equivalent diode
LED1, LED2—Dialight #521-9247, red LED

Other components

S1—slide switch, Mouser #10SP018
J1, J2—mini phone-jack, 2 conductor, closed circuit
PL1, PL2—mini phone-plugs, 2 conductor

Miscellaneous: 9-volt battery clip, Amerex box No. 171, 3/8-inch No. 4 screws, No. 4 washers, knob, PC board, pair of goggles, 1-inch diameter black-vinyl caps for goggles, 4 foot of 22-gauge wire (red and black).

Note: The following is available from Mark C. Worley, PO Box 261113, San Diego, CA 92126. Kit No. 1 has all the listed parts for alpha frequency only, including wire for the interconnecting cable and internal wiring, instructions, diagrams, and schematic: \$40. Kit No. 2 contains all the parts of kit No. 1 plus S2 and C4 for theta frequency: \$43. A silk-screened PC board with parts placement sheet is available for \$5, plus \$0.50 postage. An AC adapter suitable to power the A/MG is available for \$5 plus \$1 postage. Please include \$3 shipping charge per kit order. California residents must add 7% tax. Payment in U.S. funds only. Shipment will be made within 30 days of receipt of order. Please include a SASE when inquiring about individual parts or technical questions.

the theta mode, otherwise the A/MG will be in the alpha mode. (The unmarked pad between R2 and R3 can be used in place of pad "J" if you find it more convenient.)

16. Mount the PC board with four No. 4 screws and four No. 4 washers, so that S1 is fixed solidly against the inside edge of the box.

Goggle assembly

As shown in Fig. 5, the goggles are built from modified swimming goggles, which can be bought from a variety of department and sporting-goods stores for \$5 or less. Choose darkly colored goggles if you have a choice.

1. Carefully identify the center of the lenses; that's where the LED's will be mounted. That way you'll get the maximum exposure from the LED's.
2. Some goggles are made from a plastic that can shatter quite easily when drilled, so use sharp drill bits and operate your drill at the lowest practical speed possible.

3. Drill the LED mounting holes 0.2-inch in diameter, or better yet, measure your LED's with calipers and drill the holes slightly undersized. With care, you'll get a good press fit. If the hole is too large, a little epoxy or *Super glue* will fix that. Don't worry about a little glue mess because it will be covered later.

4. Drill a series of 5 holes (1/16-inch in diameter) across the top of the goggles (not the lenses) to allow them to "breathe." Remember, they are watertight, so we'll need to let any perspiration escape.

5. Use minimum heat and a heatsink when soldering wires to the LED's because they are easily destroyed by excessive heat. Solder the following wires about 1/4-inch up from the base

of the LED, then clip the LED leads just above the solder point. Tightly twist a pair of red and black 22-gauge wires to form a flexible cable about 3-feet long to connect the goggles and the control box. Solder a 3-inch wire between the cathode of LED1 to the anode of LED2; solder the red wire of the 3-foot twisted pair to the anode of LED1, then solder the black wire of the twisted pair to the cathode of LED2.

6. Finally, attach a mini phone plug to the end of the cable that matches J1, on the control box.

7. After verifying that the LED's flash properly when plugged into the control box, use epoxy, hot glue, or RTV to glue two plastic bottle caps over the exposed lead ends of the two LED's, and then anchor the twisted-pair cable to the side of the goggles to prevent straining the LED solder connections. The caps can be medicine-vial caps, bottle caps, or anything similar that's about 1 inch in diameter.

8. Complete any final assembly work, attach the two halves of the instrument case, and apply power.

Using the goggles

Seat yourself comfortably where you'll have minimal distractions. Put the goggles on and adjust the straps for a comfortable fit. Place the control box where you can easily adjust the flashrate with minimal arm movement. Now close your eyes and turn the A/MG on. Play with the flashrate control for awhile to get a feel for the instrument. At the two extreme ends of the control's rotation, you should

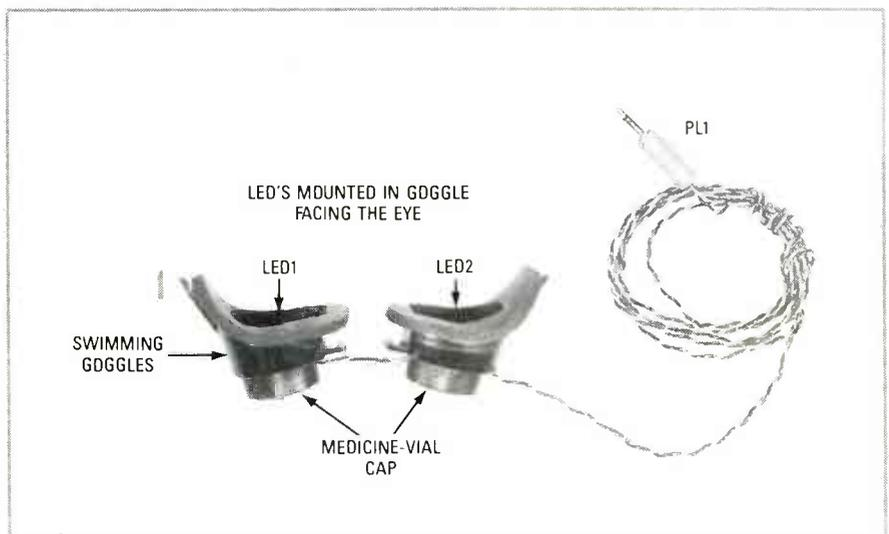

FIG. 5—THE ALPHA-MEDITATION GOGGLES are really common swimming goggles having LED's mounted inside each eye goggle. The LED's are electrically connected in series, and synchronously flash on and off.

feel that the flashrate somehow feels too fast and too slow. Somewhere in between those two extremes is a flashrate that's just right for you.

You should find that even with your eyes closed, there's still a noticeable flashing from the goggles. The LED's aren't bright enough to hurt your eyes, but the best effects are accomplished with your eyes closed. Continue to adjust the control slowly back and forth as you search for your own, personal alpha frequency.

At the correct frequency, you may find that your eyelids tend to flutter slightly in time with the flashes, or the intensity of the LED's may seem to be greater. Also, somehow, the flashrate will feel more comfortable and in tune with you. Don't force the process or worry too much about whether or not the A/MG is working at your frequency. Pick a rate that seems comfortable and try to relax under its effects.

After about 10 minutes, turn the A/MG off. You will almost assuredly find that you are feeling quite relaxed, almost languid, and that the feeling will begin to dissipate with the instrument turned off. That means that you've found the right flashrate for yourself. Make a note of the dial position for future reference. Each person that uses the A/MG will likely have a different setting.

Theta waves

For those wanting to experiment with the theta band, add a switch on the front panel, S2, that will connect a 10 μ F capacitor (C4) in parallel with C2, for the lower frequency range. (Refer to step No. 15 in the PC-board assembly instructions.) There's a space on the PC board for C4 just below the legend "AM-1." Watch the polarity of the new capacitor. Because the timing capacitance is doubled with C4 added, the pulse width of each flash has also doubled, but the duty cycle is the same because the pulse period has also doubled.

Here is a list of the more commonly documented brain frequencies, and when they usually occur. That is not to imply that these frequencies occur only during these states, or that all authorities on brain functions agree to the exact frequencies specified for each band.

- **Beta:** 14–30 Hz, predominant frequencies while awake.
- **Alpha:** 7–14 Hz, predominant when sitting or lying down quietly

with eyes closed and the mind is at ease.

- **Theta:** 3.5–7 Hz, present during problem solving, also present during sleep or deep trance.

- **Delta:** 0.5–3.5 Hz, present during sleep and, sometimes, illness.

Questions & answers

When do alpha brain waves appear? Alpha waves change under differing conditions and may disappear completely. They are most prominent when the subject is sitting or lying down quietly with the eyes closed and the mind at ease. Considerable mental effort tends to depress alpha waves, such as concentration or emotional excitement can cause their complete disappearance.

What are Alpha goggles? The meditation goggles are photic stimulators that synchronize the brain's natural alpha frequency to that of the goggles. When a close match of the flashing rate and the subject's alpha rate is accomplished, the brain naturally begins to "get in step" with the goggles and increases the amplitude of the alpha waves. Simply put, the flash rate forces the brain to generate alpha waves, resulting in relaxation.

How do you adjust for the proper flash rate? That is a difficult and subjective thing to describe. For the most part, you will notice that as you adjust the rate, it will seem too slow at one point and too fast at another. Somewhere in between those points is a frequency that feels right, somehow. Also, at that rate, you may notice that the flashing lights seem brighter and that your eyelids or other related muscles begin to twitch slightly with the

MEDICAL ALERT

If you are an epileptic, do not use the A/MG goggles. Persons suffering from epilepsy can experience a seizure when exposed to alpha-rhythm photic stimulation. For example, one commonplace photic stimulation is the "picket fence effect," which gives the sunlight a strobing effect when viewed through trees from a moving vehicle—such photic stimulation is also caused by the A/MG goggles. If you are not known to be an epileptic, but begin to perceive an odd odor, sound, or other unexpected phenomenon while using the A/MG goggles, shut it off immediately and seek professional advice from your physician.

rhythm of the lights. The rate does not have to be set precisely.

How do you know that it's working? Again, that is quite subjective, but easily proved. Lie back, set the rate for what seems right, and relax for a few minutes under the influence of the goggles. Now, leave the goggles on, but turn the switch off, using a minimum of body movement to do so. There will be a noticeable "coming down" feeling as you lose the high state of alpha that was induced by the goggles. You'll also feel quite lethargic and at ease, something you might not have noticed while the goggles were flashing. You're still producing a good level of alpha waves and are still in a meditative state with the goggles turned off, so why not continue your meditation at that time?

What dangers are there? With one exception, epilepsy, none that we know of. Photic stimulation is not a new idea. What is new is the application of solid-state circuitry and sensory-reducing goggles. The lights are low-powered solid-state devices called LED's, virtually the same as used in many digital clocks and appliances. There are no dangerous, eye-damaging light levels used.

If you are a known epileptic, do not use this instrument. Lights flashing at the alpha rate can cause a seizure: see medical alert side box. If you have undiagnosed epilepsy, you may perceive an odd smell, or other unusual effect immediately prior to a seizure. If that happens, remove the goggles immediately!

What about hypnosis? The goggles are also a useful aid in hypnosis when the subject is overly analytical, or critical of the hypnotic techniques used. Likewise, self-hypnosis is more easily achieved through the relaxation the goggles provide.

Will I lose control of myself? **Ar** emphatic **NO**. Except as noted about epilepsy, the goggles cannot control your mind; they are only a tool. You are always in control. The state that the goggles help induce is usually of heightened awareness, so you're more aware of your surroundings, but, because you're relaxed, they aren't as distracting.

Of course, there is the chance that you'll become so relaxed you'll fall asleep and miss your favorite TV program, or maybe you'll be late for supper—but those usually aren't classified as harmful side effects. **R-E**

Radio-Electronics mini-ADS

SECURITY SYSTEM

continued from page 52



THE MODEL WTT-20 IS ONLY THE SIZE OF A DIME, yet transmits both sides of a telephone conversation to any FM radio with crystal clarity. Telephone line powered - never needs a battery! Up to 1/4 mile range. Adjustable from 70-130 MHz. Complete kit **\$29.95 + \$1.50 S + H**. Free Shipping on 2 or more! COD add \$4. Call or send VISA, MC, MO. **DECO INDUSTRIES, Box 607, Bedford Hills, NY 10507. (914) 232-3878.**

CIRCLE 127 ON FREE INFORMATION CARD



CABLE TV CONVERTERS AND DE-SCRAMBLERS SB-3 \$79.00 TRI-BI \$95.00 MLD-\$85.00 M35B \$89.00 JRX-DIC \$129.00 Special combos available. We ship COD. Quantity discounts. Call for pricing on other products. Dealers wanted. FREE CATALOG. We stand behind our products where others fail. One year warranty. **ACE PRODUCTS, P.O. Box 582, Saco, ME 04072 (207) 967-0726.**

CIRCLE 183 ON FREE INFORMATION CARD

receiver) for the best reception. Finally, disconnect all the test probes and reinsert IC2.

If necessary, fine-tune L1 (on the RF transmitter) to minimize the transmission of a second harmonic, which may be heard on an FM radio tuned to approximately 100 MHz.

Installation and operation

The range of the IR beam is inversely proportional to the intensity of the ambient light, and is typically a maximum of 18 feet. The system is designed to operate under low-intensity lighting. Although strong fluorescent lighting has little effect on the system, bright daylight and bright incandescent lighting will reduce the maximum range of the IR beam. For operation under modest amounts of daylight and/or incandescent lighting, a simple light shield can be constructed from black tubing installed over phototransistor Q1 and LDR1, as shown in Fig. 10

Keeping in mind the effects of external light sources, mount the IR receiver/RF transmitter on a wall or a pole across from the intended location of the IR transmitter. With the IR receiver securely mounted, attach the audio amplifier/speaker to TP1. Apply power to both the IR receiver/RF transmitter and the IR transmitter. Holding the IR transmitter approximately where you intend to mount it, align the two devices while listening to the 1500-Hz tone from the amplifier. The IR beam is correctly aligned when the 1500-Hz tone sounds the loudest, and the IR transmitter is within range when the 490-Hz tone dies out.

An alternative alignment method is to connect a piezo buzzer to TP3. The buzzer will continuously sound until the IR transmitter and the IR receiver are properly aligned and within range, at which time the buzzer abruptly stops.

Next, decide on a location for the RF receiver. The range of the RF transmitter is approximately 100 feet. You may keep the receiver portable.

You may want to consider additional locations to be monitored, such as a driveway, a garage, or the entrance to a swimming pool. The system is adaptable to many interesting projects.

R-E



PREVENT PHONE MISUSE, selectively restrict Long Distance/Outgoing calls. Get printed record of Date, Number Dialed, Start/End timings, Durations of all Outgoing calls and Timings, Durations of incoming calls; using Telephone Activity Monitor, TAM model 88-U. Memory, 800 calls. List **\$195.00**. Introductory **\$156.00 + \$6.00 S&H**. NJ residents 6% tax. Phone orders (609) 393-7474, Visa/Mastercard. **ELECTROSALES CORP OF AMERICA, INC., 1555 Brunswick Avenue, Lawrenceville, NJ 08648.**

CIRCLE 182 ON FREE INFORMATION CARD

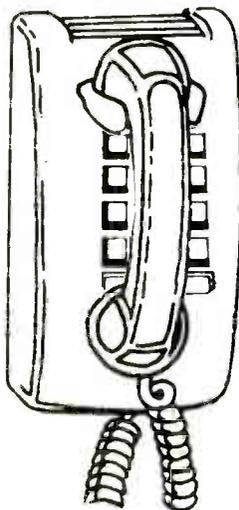

CALL NOW AND RESERVE YOUR SPACE

- 6 x rate \$890.00 per each insertion.
- Fast reader service cycle.
- Short lead time for the placement of ads.
- We typeset and layout the ad at no additional charge.

Call **516-293-3000** to reserve space. Ask for Arline Fishman. Limited number of pages available. Mail materials to: mini-ADS, RADIO-ELECTRONICS, 500-B Bi-County Blvd., Farmingdale, NY 11735. FAX: 516-293-3115.



SIMPLY SNAP THE WAT-50 MINIATURE FM TRANSMITTER on top of a 9v battery and hear every sound in an entire house up to 1 mile away! Adjustable from 70-130 MHz. Use with any FM radio. Complete kit **\$29.95 + \$1.50 S + H**. Free shipping on 2 or more! COD add \$4. Call or send VISA, MC, MO. **DECO INDUSTRIES, Box 607, Bedford Hills, NY 10507. (914) 232-3878.**

CIRCLE 127 ON FREE INFORMATION CARD

BUILD THIS

DIGITAL

ROGER D. SECURA

PEAK

DETECTOR

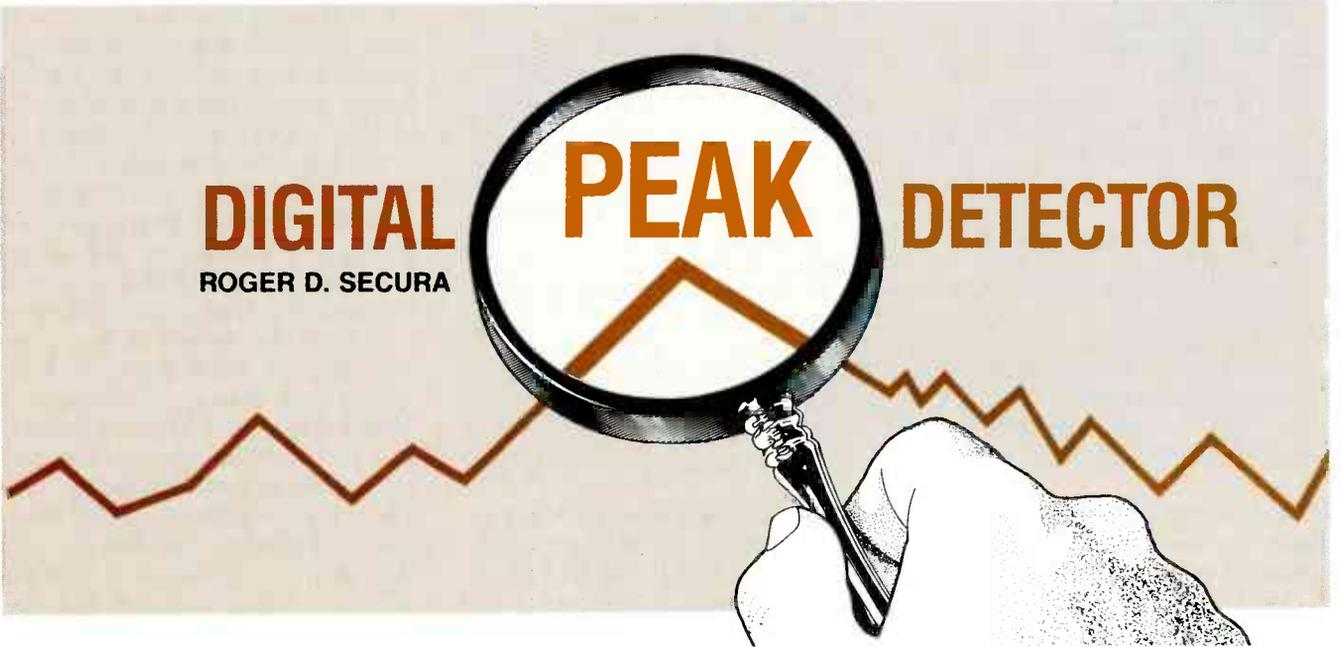

When you need to know the hottest, the fastest, the highest, or the absolute most, you need to build our peak detector.

WHAT'S THE TOP WIND SPEED DURING A hurricane? What about that jumbo jet on final approach, flying 1000-feet over your home: Is the noise pollution higher than that allowed by law? How hot does beach-sand get under a blazing summer sun?

To answer those questions, you have to measure the relevant physical parameter, store the maximum event, and then display the result. To sense the relevant parameter, you need a *transducer*. To track and hold the maximum event, you need a *peak detector*. And to record the result, you need a *digital display*. Such a peak-detecting device should continuously track, hold, and display the maximum level of any physical parameter; for example, speed, loudness, temperature, pressure, position, flow rate, force, light intensity, and so on—you name it.

Transducers

Getting the world of electronics to communicate with the physical world is like trying to mix oil with water—an almost impossible task, unless you have the right emulsifier. We know that emulsifiers work with oil and water, but what works with physical quantities and electronics? You can't shake them up in a bottle. To get them

to mix you need a transducer. And there are literally hundreds of different types of transducers; each type mixing a specific physical parameter with electricity.

A transducer outputs an electrical signal that is proportional to the magnitude of the physical event it's detecting; an output can be a series of digital pulses, an analog voltage, a varying frequency, or a change in current or resistance.

An example of a practical transducer is a *Light Dependent Resistor* or LDR, which is a resistor whose resistance changes in proportion to the

amount of light striking its surface. (Cadmium-sulfide photocells are the most common LDR's.) But our peak detector can sense only voltage within the 0 to 5-volt range; it can't sense resistance at all! What's needed is a method to convert the LDR's resistance to an equivalent voltage. A typical LDR might have a light-to-dark resistance range of 100 ohms to 500,000 ohms. A circuit must be designed that transforms that resistance range into a voltage range between 0 to 5 volts. That conversion process is called *signal conditioning*.

As shown in Fig. 1, to condition the

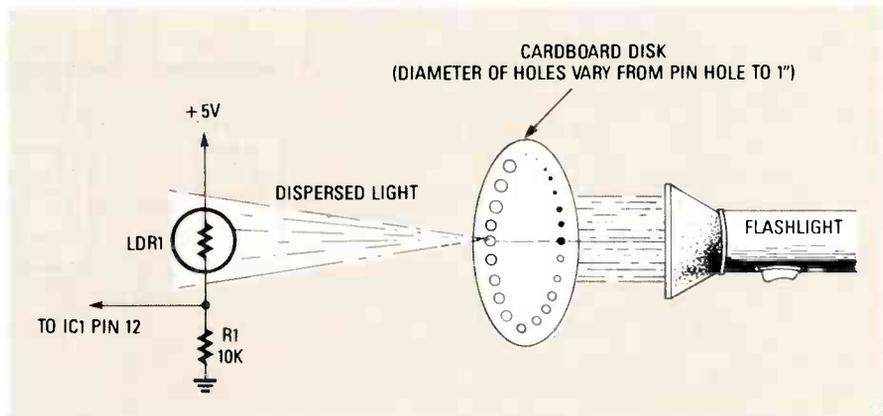

FIG. 1—THE LIGHT DEPENDENT RESISTOR (LDR1) IS A TRANSDUCER whose resistance changes in proportion to amount of light falling on its surface.

PARTS LIST

All resistors are ¼-watt, 5% unless otherwise noted)

R1, R7—1000 ohms

R2—100 ohms

R8, R9, R42—10,000 ohms

R3—R6, R10—R19—10,000 ohms, 1%

R20—R40—330 ohms

R41—250,000-ohm potentiometer

Capacitors

C1—22 μ F, 16 volts, electrolytic

C2—10 μ F, 16 volts, electrolytic

C3—.01 μ F, 50 volts, ceramic disc

Semiconductors

D1, D2—1N914 Diode

DISP1—DISP3—7 Segment LED Display (common anode)

Q1—2N3906, PNP Transistor

Q2—2N3904, NPN Transistor

IC1—LM324, Quad Op-amp

IC2—555, Timer

IC3—4066, Quad Bilateral Switch

IC4, IC5—74193, 4-bit up-down counter

IC6—IC8—74190, 4-bit up-down counter

IC9—IC11—7446, BCD-to-Seven-Segment Decoder/Driver

Other components

S1, S2—Normally-open momentary-on push button

S3—6 position rotary switch

LDR1—cadmium-sulfide (CdS) photocell

LDR, a voltage divider is formed by connecting the LDR in series with resistor R1 and a 5-volt source. When the light source is maximum, the LDR appears as a low resistance, allowing almost the entire 5 volts to be developed across R1. When the light source is minimum (dark), the LDR has its highest resistance, so almost

all the voltage is developed across it, and practically no voltage is developed across R1. So far, we've taken a light-intensity transducer, the LDR, and conditioned its changing resistance to be compatible with the our peak detector's input requirement of 0 to 5-volts. Shortly, we'll see how to calibrate our transducer.

How it works

Figure 2 shows a block diagram of our digital-readout peak-detector. The purpose of the peak detector is to track and hold (using the charge-storing ability of a capacitor) the highest output voltage from a transducer. An op-amp with a high input-impedance is used as a buffer to ensure that the stored charge on the capacitor doesn't leak off. Another op-amp is used as a comparator that has the task of enabling/disabling the Binary Coded Decimal (BCD) and binary counters.

Initially, the voltage on the inverting input of the comparator is at ground level. As a small voltage (0–5 volts) is captured by the peak detector and presented to the comparator's non-inverting input, the output will swing high, which asserts the bilateral switch; clock pulses now pass through the switch to clock both the BCD and binary counters. The outputs of the binary counters are connected to a R2R ladder network, which functions as a digital-to-analog converter. As the binary count increases, the R2R ladder voltage also

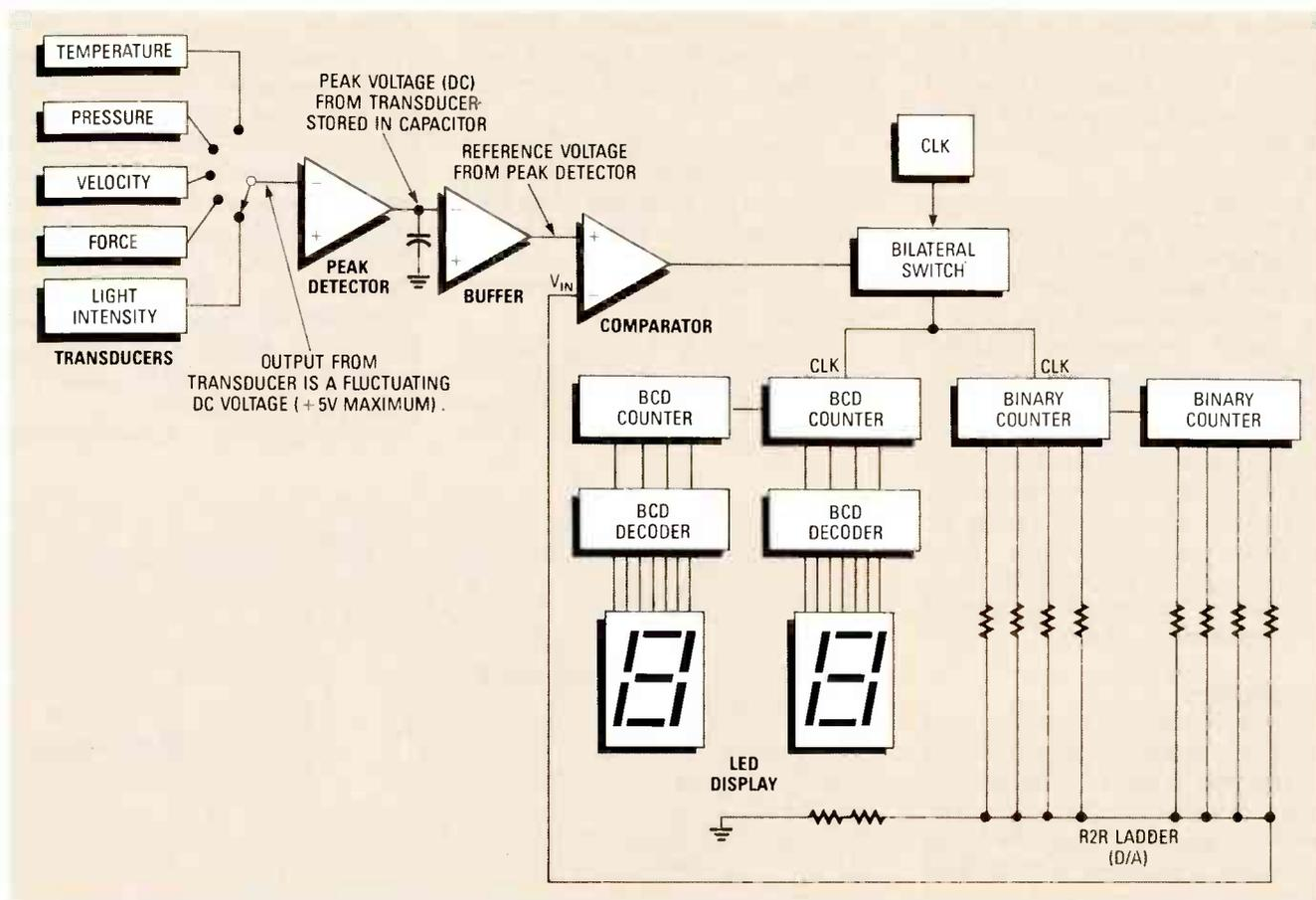

FIG. 2—THE TRANSDUCER, PEAK DETECTOR, AND DISPLAY are the main components of a digital-readout peak-detector.

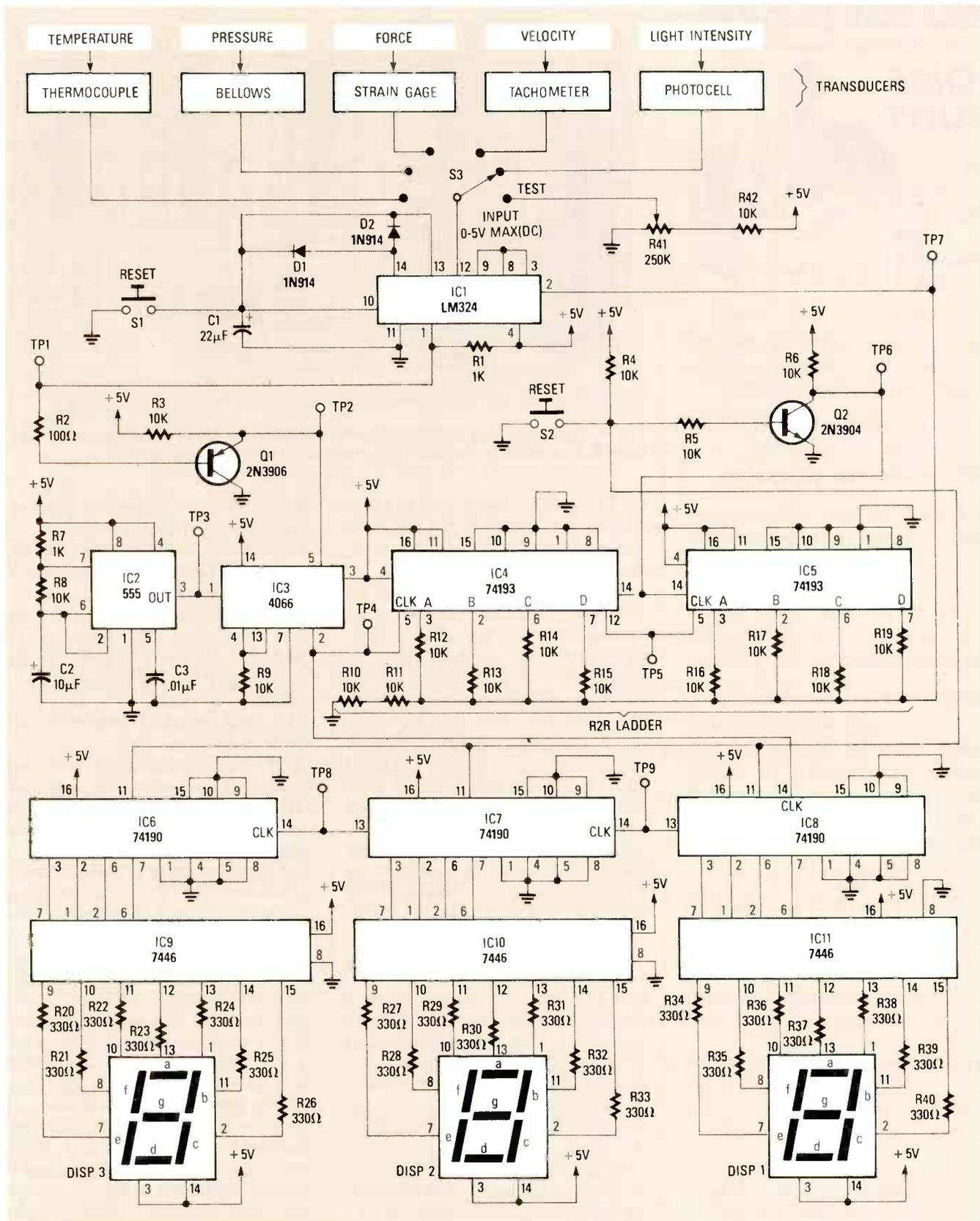

FIG. 3—THE CIRCUITRY CONSISTS OF COMMON TTL, CMOS, AND OP-AMP IC'S. When switch S3 is in the test position, varying R41 simulates a transducer's voltage output.

increases until it reaches a point slightly above the voltage of the peak detector; at that instant, the comparator output swings low, which dis-

ables the bilateral switch and stops the counters.

If everything functions properly, the number displayed on the 7-seg-

ment LED's will represent a value equivalent to the transducer's output. Note that the display's reading is not an actual voltage reading, but simply

Put Professional Knowledge and a
COLLEGE DEGREE
 in your Technical Career through
HOME STUDY

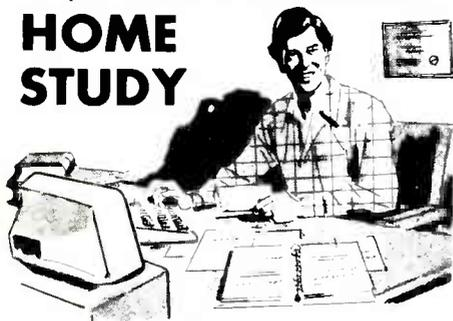

Add prestige and earning power to your technical career by earning your Associate or Bachelor degree through directed home study.

Grantham College of Engineering awards accredited degrees in **electronics and computers.**

An important part of being prepared to *move up* is holding the right college degree, and the absolutely necessary part is knowing your field. Grantham can help you both ways—to learn more and to earn your degree in the process.

Grantham offers two degree programs—one with major emphasis in **electronics**, the other with major emphasis in **computers**. Associate and bachelor degrees are awarded in each program, and both programs are available completely by correspondence.

No commuting to class. Study at your own pace, while continuing on your present job. Learn from easy-to-understand lessons, with help from your Grantham instructors when you need it.

Write for our free catalog (see address below) or telephone us at (213) 493-4421 (no collect calls) and ask for our "degree catalog."

Accredited by
 the Accrediting Commission of the
 National Home Study Council

GRANTHAM
College of Engineering
 10570 Humbolt Street
 Los Alamitos, CA 90720

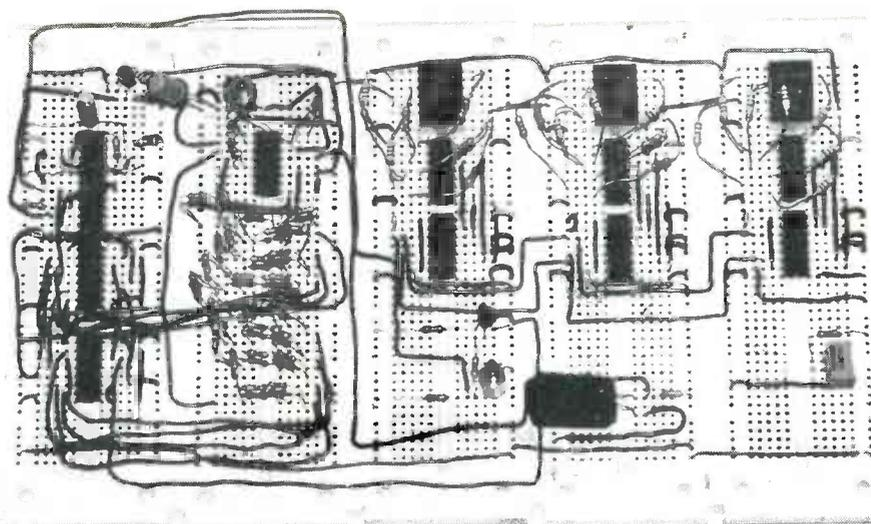

FIG. 4—THE AUTHOR'S PROTOTYPE WAS ASSEMBLED ON A SOLDERLESS BREADBOARD. Use insulated hookup wire to minimize the possibility of shorts.

the BCD count from IC9 and IC10. Any further increase in transducer voltage will be tracked, displayed, and maintained.

Of course, the transducer is not yet calibrated. Calibration implies comparison with a known standard. Getting into the mathematics of footcandles can be pretty complicated, so we'll develop our own standard—albeit crude for our light sensor. As shown in Fig. 1, simply punch holes of increasing diameter into a cardboard disk to allow extra light to pass through each successive hole; then chart the light intensity falling on the LDR, for each punched hole, by measuring the voltage across R1 and the display's reading. The more light that falls on the LDR, the lower its resistance and, consequently, the greater the voltage drop across R1. Although that method is far from scientific, it should give you a rough scale with which to compare light levels. The same technique can be used with other transducers, such as temperature-dependent resistor's. Using a thermometer for comparison can give a more meaningful calibration curve.

Figure 3 is the complete schematic of the digital-readout peak-detector. As shown in Fig. 4, the author used a proto-board for assembly, but you may just as easily use a prototype PC-board and wire-wrap all connections.

Testing

If your circuit fails to respond after construction, use the following trou-

bleshooting procedures to pinpoint the problem (refer to Fig. 3):

1. Switch S1 to the test position, and adjust the potentiometer R41 for an output of 2.5 volts.
2. Check TP3 for a 30-Hz clock signal. No clock on TP4 means there's a problem with either IC2 or IC3. The clock signal at TP5 should have a frequency of about 1 Hz. Test Point TP8 should output less than one clock cycle every 16 seconds.
3. If all checks out so far, press and release the reset button (S2) and see if TP6 goes from a low to a high, and then back to low. If there's a problem, check Q2 and associated circuitry.
4. Check the output of the R2R ladder network at TP7. To do that, press and release S2 to reset the counters, and watch TP7 (using an oscilloscope or meter) for a slow rising DC voltage (+ 5-volts maximum). Any deviation from the normal ascension indicates a problem in the R2R ladder network or binary counters IC4 and IC5. Note: The resistors in the R2R ladder, R10-R19, should be within 1% tolerance.
5. The final test is to simultaneously press and release S1 and S2, then wait for the LED's to stop counting. When they stop, the display will register a number equivalent to the 2.5 volts on R41 potentiometer. (Don't worry about the actual displayed number.) Repeat that procedure a few times. The same number should re-appear on each test. Next, turn the test potentiometer R41 up to three volts. The LED's should start counting up to some number and then stop. **R-E**

WORKING WITH COUNTERS

Count on counter circuits to keep counting.

RAY MARSTON

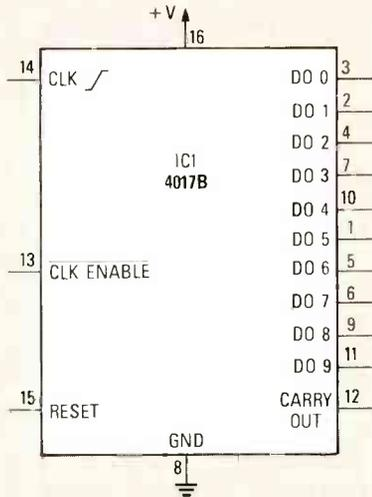

FIG. 1—THE 4017B DECADE COUNTER has 10 DECODED OUTPUTS, a CARRY OUT bit, and is triggered on the clock's rising-edge.

CMOS D AND JK FLIP-FLOPS ARE THE BUILDING blocks for all counter/dividers. Constructing your own counter/divider is fine—especially when only one or two flip-flops are required. However, for a complicated design requiring 10 or more flip-flops, it's best to use a counter/divider IC already developed in a single *Dual In-line Package* (DIP): options include binary, decade, or hexadecimal counters, up/down counting, resets, presets, LED driver outputs, and a carry-out line for cascading IC's. Let's start by examining one of the best know CMOS up-counters, the 4017B.

Decade counter

Figure 1 shows the 4017B IC pin-out; that IC is one of the best known CMOS up-counters, having a synchronous decade-counter and 10-decoded outputs. Synchronous means that all flip-flops are triggered at the same time (no ripple through clocking), and all DECODED OUTPUTS 0-9 will change states simultaneously. The 4017B works quite simply: When asserted, a single high bit is latched into the counter at DECODED OUTPUT 0. That bit will then travel to the next DECODED OUTPUT on the rising edge of each new

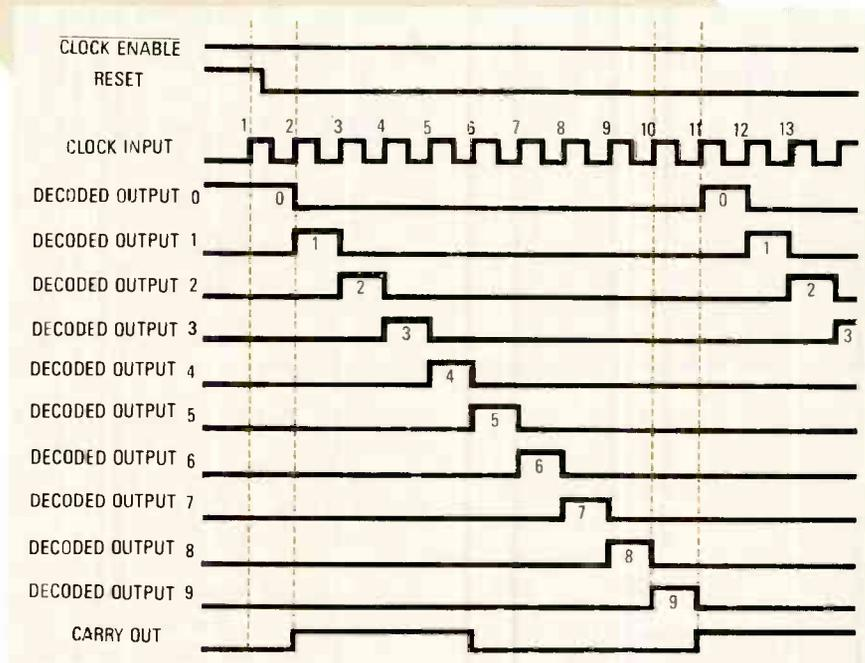

FIG. 2—TIMING DIAGRAM OF THE 4017B. Only one DECODED-OUTPUT is high at any given moment.

clock pulse. (Only one of the ten DECODED OUTPUTS will be high at any given moment.) The DECODED OUTPUTS 0-9 thereby represent a decimal (1-10) equivalent of the total number of clock cycles.

Timing diagrams

The timing diagram for any counter IC is like a road map—without it you will be lost. If you intend to do any serious design work using counter IC's, then by all means get a copy of National Semiconductor's CMOS logic data book.

Figure 2 shows the 4017B timing diagram. By placing a high on the

RESET (pin 15) and holding the CLOCK ENABLE (pin 13) low, the chip is asserted and a high bit is automatically entered into DECODED OUTPUT 0 (pin 9). To initialize the IC, the RESET line should be brought low just after the rising-edge of the first clock pulse. On the rising edge of the second clock pulse, the high bit will then advance to DECODED OUTPUT 1 (pin 2). Then, after the rising edge of the third clock pulse, the high bit will advance to DECODED OUTPUT 2 (pin 4), and so forth. At any given moment, nine of the ten DECODED OUTPUTS will be low, with the remaining DECODED OUTPUT high. The counting cycle can be

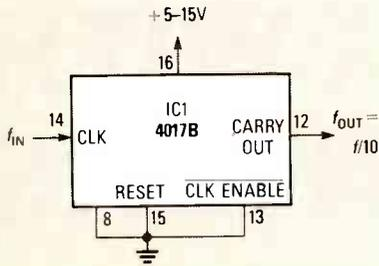

FIG. 3—A 4017B CONNECTED as a decade counter/divider.

ENABLE line, and is therefore not bothered by a trigger signal with a slow rise time. An additional CARRY OUT signal (pin 12) completes one cycle for every ten clock cycles and, as we'll see, can be used to clock additional 4017B's in a multi-decade ripple counter.

Decade circuits

Figure 3 shows the 4017B connected as a decade divider, where the output frequency is 1/10th the input

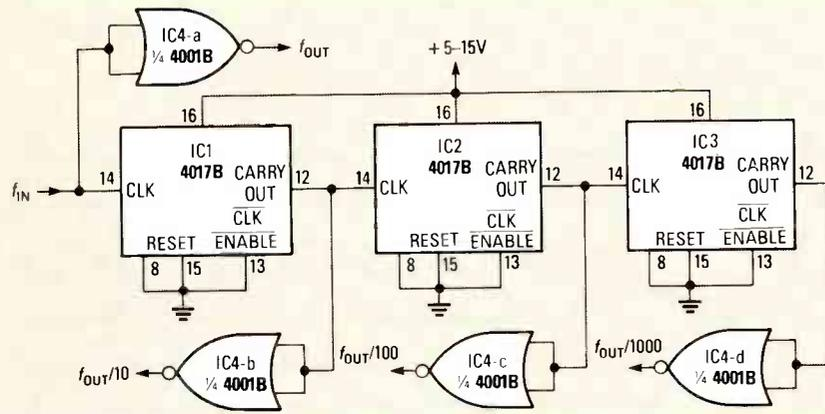

FIG. 4—ANY NUMBER OF 4017B's can be cascaded to make a multi-decade divider. Outputs should be buffered using a 4001B CMOS inverter gate.

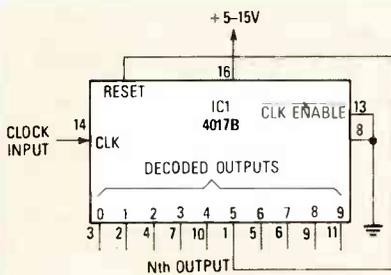

FIG. 5—THE 4017B AS A DIVIDE-BY-N COUNTER. This circuit is set for divide-by-5 operation.

frequency. The IC is always asserted because RESET and $\overline{\text{CLOCK ENABLE}}$ are grounded. The output is taken from the CARRY OUT, while the DECODED OUTPUTS are ignored.

Figure 4 shows how to cascade 4017B counters to divide the f_{IN} clock frequency by 10, 100, and 1000. The CARRY OUT of each counter is used as the clock input to the following IC. Notice that all f_{OUT} outputs are buffered via simple CMOS inverters (made from 4001B NOR gates); that ensures

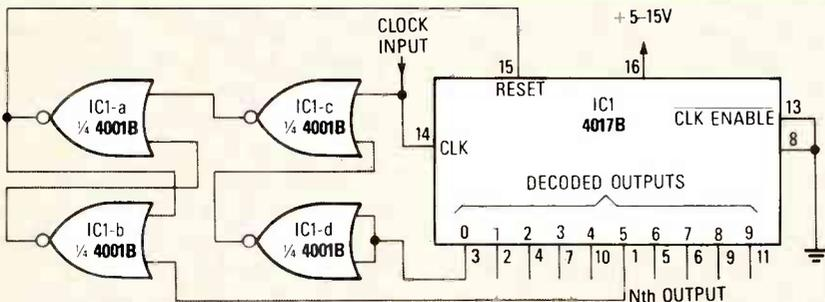

FIG. 6—A DIVIDE-BY-N COUNTER USING A 4017B. The extra logic gates ensure a minimum reset pulse-width.

stopped by setting the $\overline{\text{CLOCK ENABLE}}$ (pin 13) high. Furthermore, the IC has a built-in Schmitt trigger on its $\overline{\text{CLOCK}}$

that output loading does not degrade the pulse's rise time. For example, using a 1-MHz crystal oscillator as a

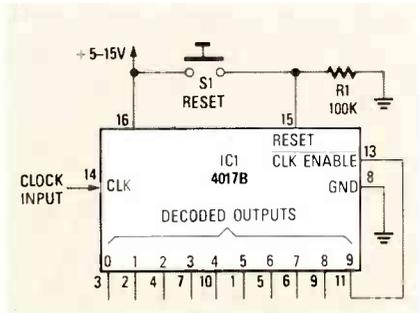

FIG. 7—THE 4017B CONNECTED for sequence-and-stop action.

clock, then a 100 kHz, 10 kHz, and 1-kHz frequency can be generated.

Figure 5 shows how to connect the 4017B as a divide-by-N counter (where N = any integer from 2 to 9). A divide-by-N counter (or Mod-N counter) has its "Nth" DECODED OUTPUT hard-wired back to the RESET. The counter is then cleared to its zero count (a high on pin DECODE OUTPUT 0) on the arrival of the "Nth" clock pulse.

What could happen if the divide-by-5 counter, in Fig. 5, used a clock signal having an extremely slow rise-time? The RESET could be triggered high and then low (by the DECODED OUTPUT 5) while the slowly rising clock is still rising. The DECODED OUTPUT 0 is reset high, but is then immediately clocked again by the remaining positive edge of the rising clock—causing the DECODED OUTPUT to shift to the next position. Now let's design a circuit to avoid that problem.

Figure 6 shows a slightly more reliable version of the divide-by-N counter. Logic gates control the RESET operation via IC1-a to IC1-d, (IC1-a and IC1-b form a NOR flip-flop). Here the RESET command is latched high on the arrival of the "Nth" clock pulse, only while the clock pulse remains high, but is removed automatically when the clock pulse goes low again. Those extra gates ensure a minimum RESET pulse width (for a given clock rise time), which stabilizes counter operation.

The 4017B is particularly useful for a whole range of "sequencer" applications, where the DECODED OUTPUTS can drive LED displays, relays, or sound generators.

Sometimes it's desirable to count up to a predetermined number and then stop. Figure 7 shows a 4017B wired for that type of operation. The counter will stop when its $\overline{\text{CLOCK ENABLE}}$ pin is driven high by DECODED OUTPUT 9; moreover, the counter can

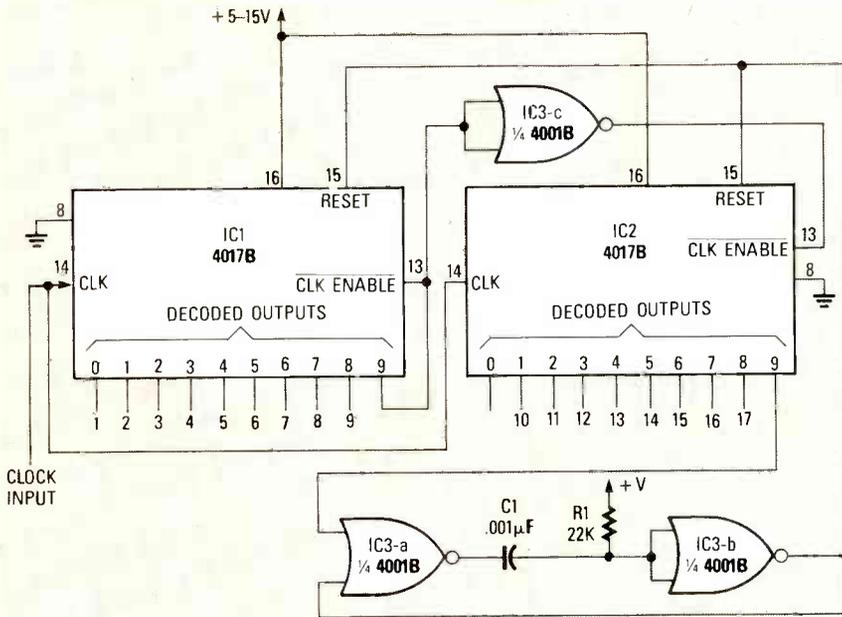

FIG. 8—THE 4017B CONNECTED for divide-by-17 operation.

be negated via any one of the 4017B's DECODED OUTPUTS. The count sequence is then re-started by pressing reset button S1.

Figure 8 shows how to connect a pair of 4017B's to provide 17 stages of fully decoded outputs. The clock signal is simultaneously fed to both IC's; however, when the count is below 10, the DECODED OUTPUT 9 of IC1 is low, which forces the $\overline{\text{CLOCK ENABLE}}$ of IC2 to be set high by INVERTER gate IC3-c. So IC2 is negated, meaning it's not influenced by the clock signals. When the 10th clock pulse arrives, the DECODED OUTPUT 9 of IC1 goes high, which negates IC1; simultaneously, the $\overline{\text{CLOCK ENABLE}}$ of IC2 is driven low by IC3-c, thereby asserting IC2; the high that is already in DECODED OUTPUT 0 is immediately toggled into DECODED OUTPUT 1 by the same 10th clock pulse. Eventually, the 17th clock pulse arrives, causing the DECODED OUTPUT 9 of IC2 to go high. That triggers the $15\mu\text{s}$ monostable made from IC3-a and IC3-b, which clears both counters to their high DECODED OUTPUT 0 states. The counting sequence then repeats itself.

Note that the DECODED OUTPUT 9 of IC1, and the DECODED OUTPUTS 0 and 9 of IC2 are lost in the counting action, so the circuit gives a maximum of 17 usable counting states. Any number of counts within the range from 10 to 17 can be designed by connecting the input of IC3-a to the appropriate DECODED OUTPUT of IC2.

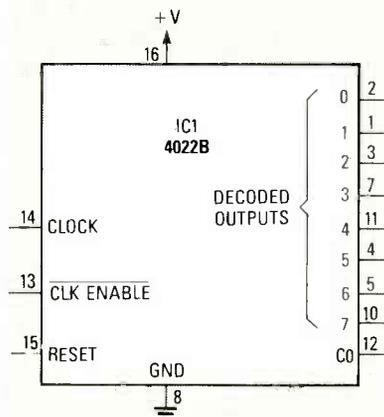

FIG. 9—PINOUT DIAGRAM OF THE 4022B Octal counter.

Counters in computers

Counters can be used in simple applications where it's necessary to merely count a number of input pulses, or divide them by a fixed ratio. Those are some of the relatively common applications. But what about more complex timing applications? For example, dividers are very often used in all kinds of computer timing circuits. A master clock first generates an overall synchronizing signal. Dividers are then used to derive other clock speeds needed in slower sections of the computer—yet still need to be synchronized with the master clock. For example, if the master clock runs at 1 MHz, then a 4017B decade counter could be used to generate a synchronous 100-kHz signal.

Octal counter

The 4022B is a synchronous octal counter (divide-by-8) having eight DECODED OUTPUTS (0 to 7) that sequentially go high as the IC is clocked. Fig. 9 shows the 4022B pinout diagram. For normal octal counting, the RESET and $\overline{\text{CLOCK ENABLE}}$ pins are tied low, which asserts the IC for counting. The high bit advances to the next DECODED OUTPUT on the rising edge of the clocking pulse. The CARRY OUT signal completes 1 cycle for every 8-clock cycles. Lastly, the IC has a built-in Schmitt trigger on its $\overline{\text{CLOCK ENABLE}}$ line, which renders it insensitive to clock signal rise and fall times.

Synchronous up-counters

The 4026B and 4033B are both synchronous up-counters that have circuitry for decoding and driving a 7-segment common-cathode LED display. The output drive currents, however, are limited to only a few mA.

Figure 10 shows the pinout diagram of the 4026B. A special feature of that IC is the DISPLAY ENABLE IN and DISPLAY ENABLE OUT pins. If the DISPLAY ENABLE IN pin is held high, the display will function normally. When the pin is pulled low, the display will be

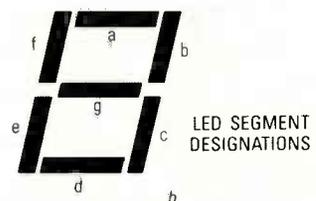
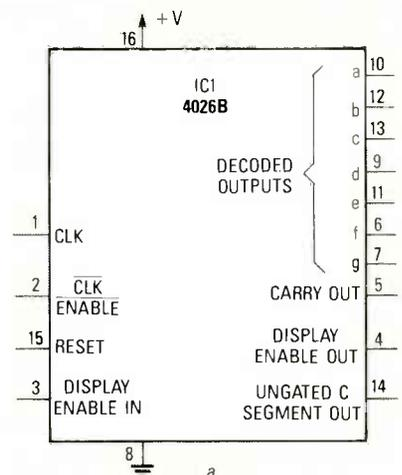

FIG. 10—PINOUT DIAGRAM OF THE 4026B decade counter with 7-segment display driver having DISPLAY ENABLE control (a), and LED-segment designations (b).

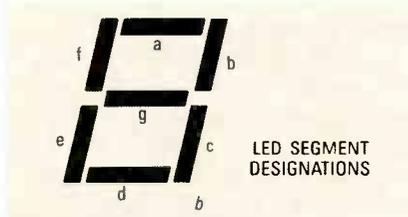
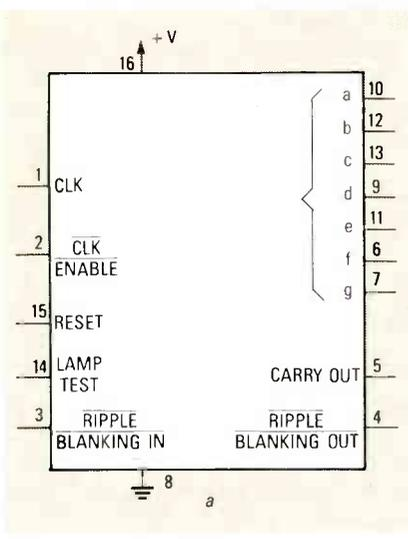

FIG. 11—PINOUT DIAGRAM OF THE 4033B decade counter with 7-segment display driver having RIPPLE BLANKING facility (a), and LED-segment designations (b).

blanked, although the counter IC continues to count. The IC also has an UNGATED C SEGMENT OUTPUT pin, which can be used in conjunction with external logic to control the display segments individually.

Figure 11 shows the pinout diagram of the 4033B. That IC features RIPPLE BLANKING input and output pin, which can be used to blank the leading and trailing zeros in multi-decade applications. The "O" display blanks automatically when the RIPPLE BLANKING INPUT pin is held low. Additionally, the IC features a LAMP TEST pin; that if pulled high, will drive all display decoded outputs high, illuminating all

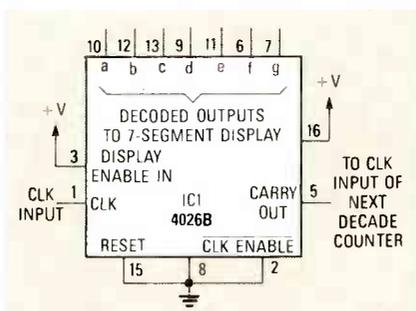

FIG. 12—THE 4026B CONNECTED for decade dividing and 7-segment display operation; DISPLAY ENABLE input must be tied high for display illumination.

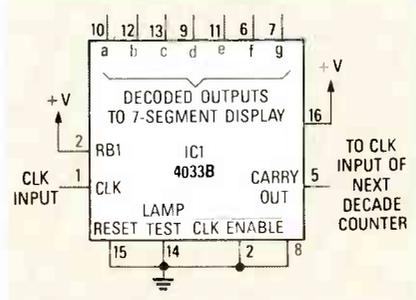

FIG. 13—THE 4033B CONNECTED for decade dividing and 7-segment display operation; RB1 (ripple blanking input) must be tied high for normal display operation, or low for zero-digit suppression.

7-segments of the display.

Figures 12 and 13 show how to connect the 4026B and 4033B, for decade 7-segment display operation. For each positive edge of the clock, the counter will illuminate the proper LED segments to display the decimal numbers from 0 to 9. When using the 4026B, the DISPLAY ENABLE INPUT pin must be tied high if the display is to be illuminated. When using the 4033B, the RB1 INPUT (ripple-blanking input) must be tied high if the display is to operate normally, or tied low to give zero-digit suppression. Notice that in both circuits if multi-decade counting

is used, the CARRY OUT of one stage becomes the clock input to the next stage.

Figure 14 shows how to interconnect several 4033B's for multi-decade counting; additionally, to give automatic suppression of leading and trailing zeros so that, for example, the count 009.90 will actually be displayed as 9.9. To get leading zero suppression on the integer side, the RBI INPUT of the Most Significant Bit' (MSB) IC must be tied low; its RBO (ripple blanking output) must be connected to the RBI of the next MSB IC, and so on down the line. To get trailing zero suppression on the fraction side of the display, the RBI pin of the

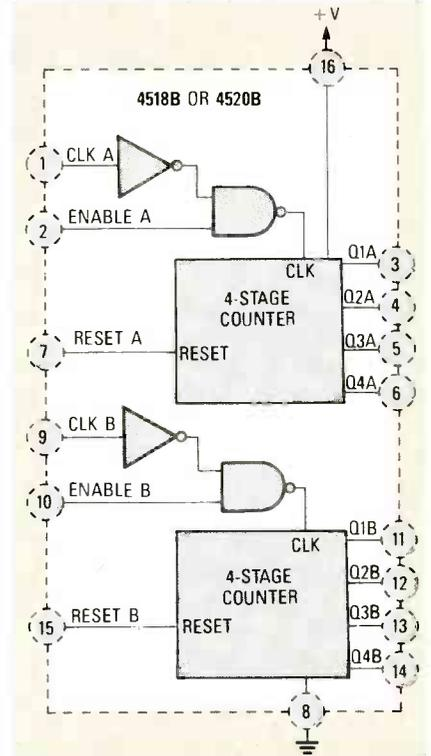

FIG. 15—PINOUT DIAGRAM OF THE 4518B dual decade-counter, and 4520B dual binary-counter.

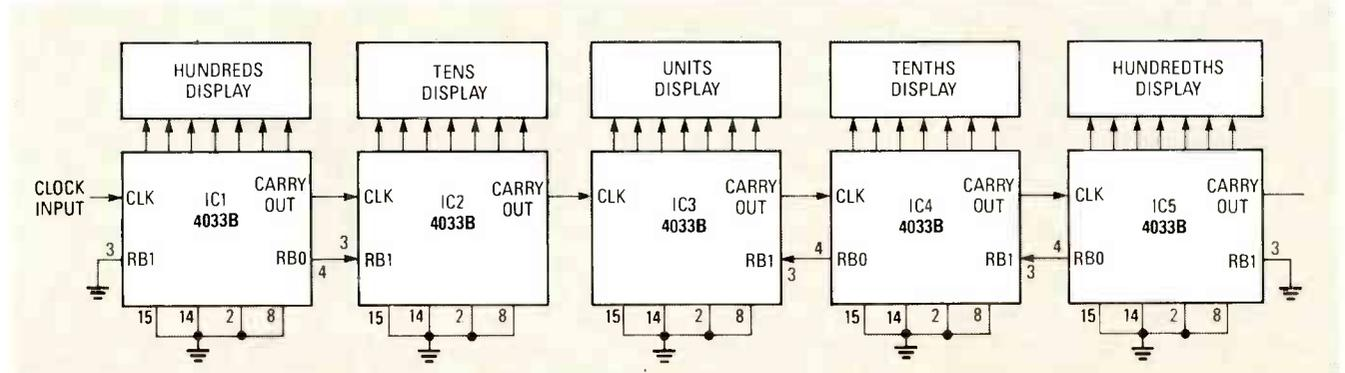

FIG. 14—THE 4033B CONNECTED so that RBI and RBO give leading and trailing zero suppression in a multi-decade display.

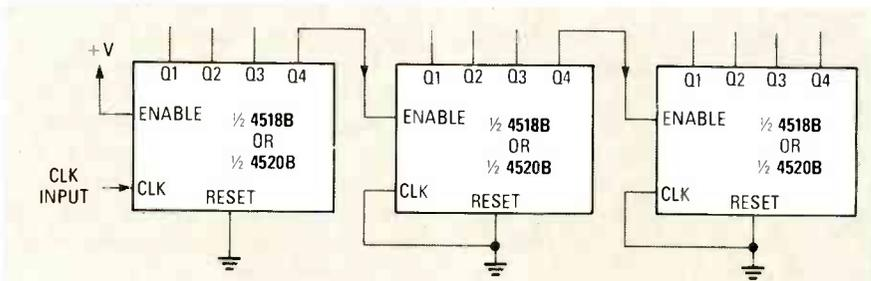

FIG. 16—THE 4518B OR 4520B counters cascaded for ripple operation.

negative-edge triggering, the feed the clock to the ENABLE pin and tie the CLOCK pin low. Each counter can be asynchronously cleared by a high level on the RESET pin. The outputs of both dual IC's must be decoded externally to drive a 7-segment display.

Notice that those counters don't have a CARRY OUTPUT. In order to cascade stages, triggering on the negative-edge of the clock is required. As

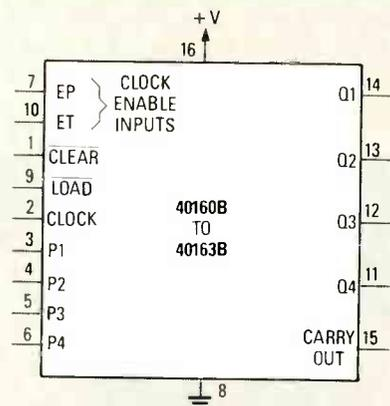

FIG. 17—PINOUT DIAGRAM OF THE 40160B TO 40163B range of programmable 4-bit counters.

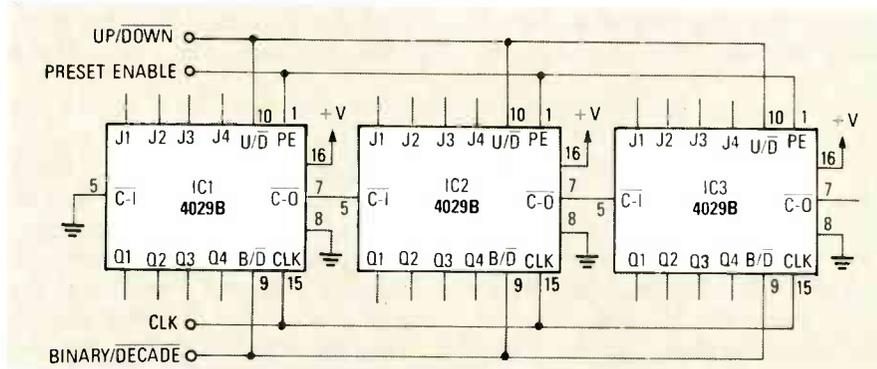

FIG. 20—HERE'S HOW TO CASCADE 4029B's for synchronous parallel-clocking.

the RBI of the next LSB counter, and so on, to the first counter in the fractions chain.

shown in figure 16, the Q4 OUTPUT of each counter is fed to the ENABLE INPUT of the following stage, which must also have its CLOCK pin tied low.

Counters that preset

As shown in Fig. 17, the 40160B to 40163B series of presettable up-counters have identical pinouts. By presettable we mean that the DECODED OUTPUTS Q1-Q4 can be preset to start counting from any number that is fed into the four PRESET P1-P4 input pins—sometimes called JAM inputs. The presetting function is not limited only to start-up, but can also be used during the counting sequence; the decoded outputs can thus be cleared back to the original preset inputs at any time.

The 40160B and 40162B are decade dividers, while the 40161B and 40163B are binary dividers. Also, the clear function for the 40162B and 40163B is synchronous with the clock. That means a low on the CLEAR sets all outputs low on the rising edge of the next clock pulse. On the other hand, the clear function for the 40160B and 40161B is asynchronous. A low level on that CLEAR sets all outputs low regardless of the clocks state.

Figure 18 shows how to connect any of the 40160 to 40163 IC's as a normal counter. All counters in that series have two clock-enable pins, EP and ET, which must be tied high for normal counting operation. Those

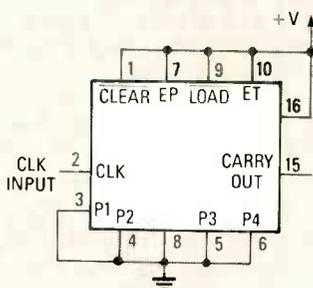

FIG. 18—THE 40160B TO 40163B connected for normal counter operation.

- NOTES:
- 40160B IS DECADE COUNTER WITH ASYNCHRONOUS CLEAR.
 - 40161B IS BINARY COUNTER WITH ASYNCHRONOUS CLEAR.
 - 40162B IS DECADE COUNTER WITH ASYNCHRONOUS CLEAR.
 - 40163B IS BINARY COUNTER WITH ASYNCHRONOUS CLEAR.

Keep in mind that neither the 4026B nor the 4033B have data latches. That basically means that the displays tend to blur while the IC's are going through a counting cycle. It is, however, no tremendous problem.

Dual up-counters

The 4518B and 4520B are IC's that house two counters in a single 16-pin package. The 4518B is a dual decade counter with BCD outputs; the 4520B is a dual hexadecimal (divide-by-16) counter with a 4-bit binary output. Figure 15 shows the identical pinout diagram of the 4518B and 4520B.

Those counters can be clocked using either positive- or negative-edge triggering. For positive-edge triggering, feed the clock to the CLOCK pin and tie the ENABLE pin high. For

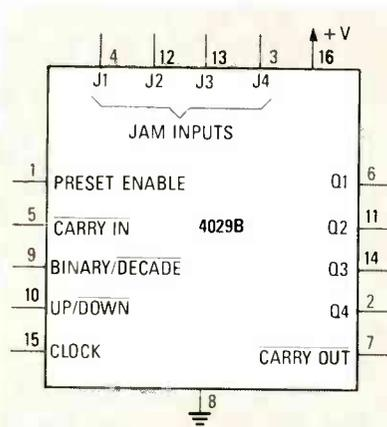

FIG. 19—PINOUT DIAGRAM OF THE 4029B presettable up/down counter.

Least Significant Bit' (LSB) must be tied low, and its RBO must be taken to

pins facilitate an internal carry look-ahead feature that is useful in fast counting applications.

Synchronous up/down counters

Synchronous up/down counters are devices that can count in either direction. Counting direction is controlled by either of two methods. The first by using a single clock in conjunction with an UP/DOWN control pin. The second by using two separate clock signals, with one controlling the up-count and the other controlling the

down-count.

All CMOS up/down counters are presettable types that output a 4-bit binary word, or BCD number, with either synchronous or asynchronous clearing functions. Because the up/down counters are presettable, the outputs can be forced to agree with the 4-JAM pins, otherwise called PRESET pins.

Figure 19 shows the 4029B counter. That device uses a single clock with count direction controlled via an UP/DOWN pin. The IC can act as either a

decade (BCD output) counter, or as a binary (4-bit) counter, depending on the logic setting of a BINARY/DECADE pin. The actions of the CARRY OUT pin facilitate fully synchronous action in multi-decade counting applications, as shown in Fig. 20. Here, all IC's are clocked in parallel, and the CARRY OUT pin of each counter is used to enable the following one.

Several 4029B's can also be cascaded and clocked in an asynchronous ripple mode but that's a subject for another article. **R-E**

SECURITY

continued from page 46

You don't need a module for each door or window: you can connect a complete, normally closed loop to each transmitter module. (The manual for the system makes no mention of that potentially valuable feature.) Although you might feel that wiring such loops defeat the whole purpose of a wireless system, it really doesn't—you still can get away without having to drill any holes to fish wires through. If you really object to having any wires visible, you can install a transmitter at each window and door. Although the Dicon unit comes with reed-type sensors, you are free to include any passive, normally closed sensors within the loop.

Mounting the base unit and emergency speaker/siren are two important considerations. The base unit, of course, must be mounted near a telephone line. It doesn't have to be mounted near an exit door, and indeed, it is preferable *not* to mount it there for two reasons. First, since the heart of the system is a telephone dialer, the last thing you want a burglar to do is to unplug the 9000 from the telephone line. Since the obvious place for the control center to be mounted is by the front door, it's the first place the burglar will look, and therefore the worst place to mount it. The second reason that makes it unnecessary to mount the unit by the exit is that remote keypads are available. The remote can be mounted by any exit door, or can be left handheld. A burglar can do very little with the remote—unless he knows your security code.

The emergency speaker/siren not

only is an attention-getter in times of emergencies, it also is used to give information to the user. For example, when you arm the system, the base unit gives a report of troubles with any of the modules. If you arm the alarm using the remote keypad, you still want to hear any of those reports. And you can, thanks to the speaker. If an intruder breaks in he will hear the report of "Security emergency!" followed by your recorded message. If that doesn't chase him off, he may use the speaker to guide him to the base unit and disconnect it from the phone line. To protect against such brazen burglars, it might be wise to conceal the speaker and base unit—or perhaps use a cellular telephone.

Anyone who has ever armed an alarm only to find himself rushing around to get out before the time delay expires will like the 9000's non-delay feature. Instead of giving you a specified time to get out the door, the 9000 looks at the door's status. Once you give your command to arm the system, it waits for you to close the door before actually arming itself.

Some professional alarm installers insist that a wireless system is not as reliable or secure as a wired system. (What if the batteries die? What about false alarms? etc.) To be honest, we had the same reservations. However, it doesn't have to be true about a wireless system. In the *Dicon 9000*, battery status is constantly monitored. All sensors report to the base unit regularly. When a battery goes low (meaning that it has about a month of life remaining), the TROUBLE LED lights, and pressing a special key gives a verbal report of the trouble. Every time the alarm is set, the trouble report is given again so that it's difficult to forget. (Any modules that

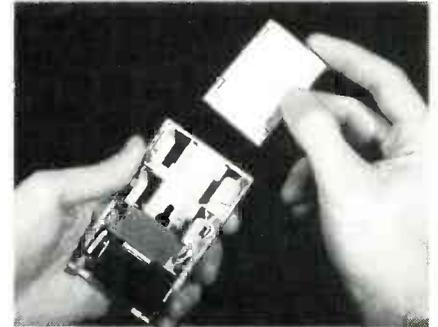

FIG. 21—THE HEART OF a Dicon remote transmitter is a small, removable module. The module is programmed by the base unit with a unique code. Therefore any emergency condition can be tracked down to the exact module.

have been turned off are also reported.) Signal strength is always monitored for level. The signal range for the system is 200 feet. That increases to 500 feet with the addition of a small whip antenna. Since the RF signals are in the 300-MHz range, you must be sure not to mount the base unit in, or too close to, such things as metal file cabinets.

To eliminate false alarms, the transmitter modules send a 16-bit digital message, which is repeated 32 times within 2 seconds. Three of four consecutive messages must be identical, or they will be considered false. Although not a scientific test, in six months of actual use, our test system never falsed.

Which system is best?

Both wired and wireless systems, as you've seen, have their advantages. Neither one can be considered the best for all instances. But we hope that this article has given you an idea of what features can be found in home-alarm systems, and has helped you make a decision as to which type is best for your home. **R-E**

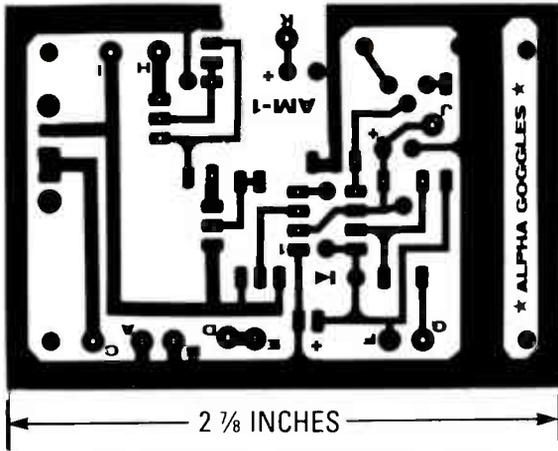

ALPHA MEDITATION GOGGLES foil pattern.

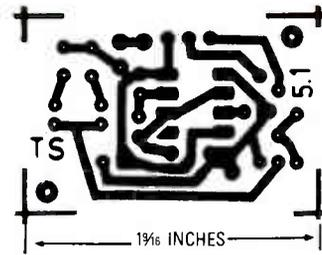

THEIR TRANSMITTER foil pattern.

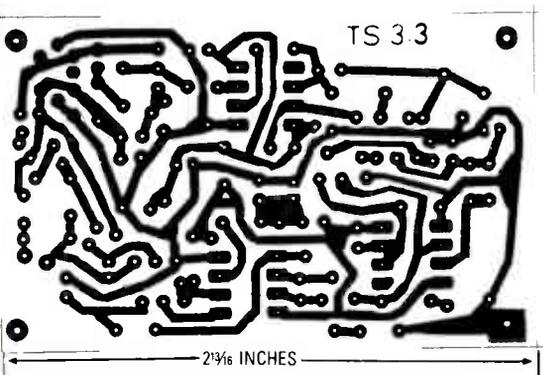

IR RECEIVER/RF TRANSMITTER foil pattern.

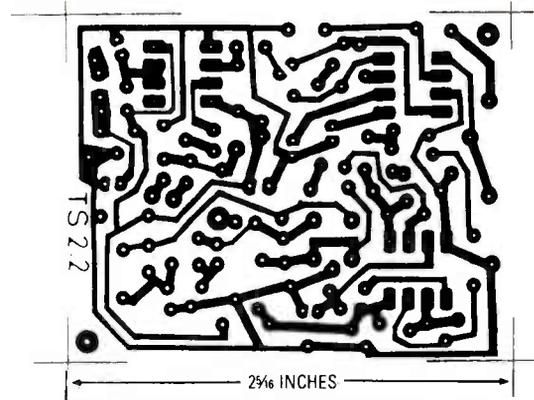

RF RECEIVER/ALERT BEEPER foil pattern.

HOME SECURITY

continued from page 37

built floor—the nightingale floor—that creaked loudly when walked on. A shrill *sque-e-e-k* in the middle of the night was certain to bring on the Sultan's personal bodyguards.

The modern *nightingale floor* is the Teiresias, Inc.'s *Pulsar Volumetric Stress Detector*, shown in Fig. 6. The sensing device is an encapsulated silicon bar that is epoxy-cemented to a floor beam. Any deformation of the beam, no matter how slight, is detected by the sensor, whose processing amplifier can tell the difference between the stresses caused by structural shifts, the patter of the multi-legged feet of household pets (or rodents), or the strides of a human. When the processor senses the stresses caused by humans, it trips a conventional alarm's protective loop.

Wireless protection

Wireless detectors and control centers are the latest development in high-tech home security. As shown in Fig. 7, a generic representation of a

full-feature wireless system such as the one offered by Dicon Systems, Inc., the control center consists of a radio receiver, a super-sophisticated computerized control system, and a voice synthesizer that can give user instructions and voice alarms. The center drives an internal digital dialer for a central station and one or more other numbers and announcements, a local alarm bell or siren, and it can be hard-wired to a local loop or detector. Its real sensing power, however, lies in individual transmitters, each having its own digital code so that the control center knows where the alarm is coming from. Although Fig. 9 shows only five transmitters, the center can accommodate more. For example, there might be two or more transmitters for the windows; one for upstairs, one for downstairs, and possibly one for the basement. (It saves wiring through floors and ceilings.) Similarly, there might be separate transmitters for the front and back doors, or multiple transmitters for fire detectors and medical or panic transmitters (pendant transmitters worn on a necklace). Best of all, the system can be controlled from one or more remote-con-

trol transmitters.

The transmitters are battery powered. They are *supervised* in that their battery levels and signal strengths are checked regularly. If the center determines that a battery is getting weak, it announces—by voice, beeper, or display—that the transmitter's battery should be replaced soon.

The operating frequency for wireless systems is usually in the 300-MHz band, so that the antenna can fit in the small transmitter cases. Where there are reception problems, the equipment might operate on 40.8 MHz, because the lower frequency passes through brick and steel doors and walls with less attenuation.

An important point to keep in mind when considering a home-security system is that many installation services are familiar only with the equipment that they are authorized to sell, or the stuff they are used to using. (Try asking a dealer if he knows of a *nightingale floor* sensor.) If you think you need a particular kind of protection, do not accept that it doesn't exist. In this era of high-tech devices, somewhere out there someone has exactly what you want. **R-E**

AUDIO UPDATE

The importance of amplifier output current.



LARRY KLEIN,
AUDIO EDITOR

MANY YEARS AGO, I WAS INVITED TO attend a record company's press conference, given to introduce a new "blockbuster" four-channel classical recording. To ensure that there would be adequate sound-pressure level in the very large recording studio where the record was being demonstrated, the engineer in charge had set up four Acoustic Research *LST* speaker systems facing inward from the corners of an imaginary 25- by 25-foot square in the middle of the studio floor. Those speakers were to be driven by a pair of Phase Linear 700 amplifiers, thus providing 350 watts per speaker channel. The engineer in charge of the setup was an old friend of mine and he invited me to come early to help balance the system.

When I arrived, my engineer friend was cursing to himself because the amplifiers, for some reason, were distorting badly on musical peaks. I was mystified, because, in my experience, the pair of *LST*'s I happened to have at home certainly didn't seem to be so low in efficiency as to cause clipping in a 350-watt amplifier. My friend subsequently solved the problem by replacing the power amps with another brand (I think they were Crowns) borrowed from a local dealer—and the press conference went on as scheduled without further technical hitches.

I forget whether I didn't get a chance to ask about the amplifier problem, or whether I simply didn't understand my friend's answer. In any case, I filed the matter

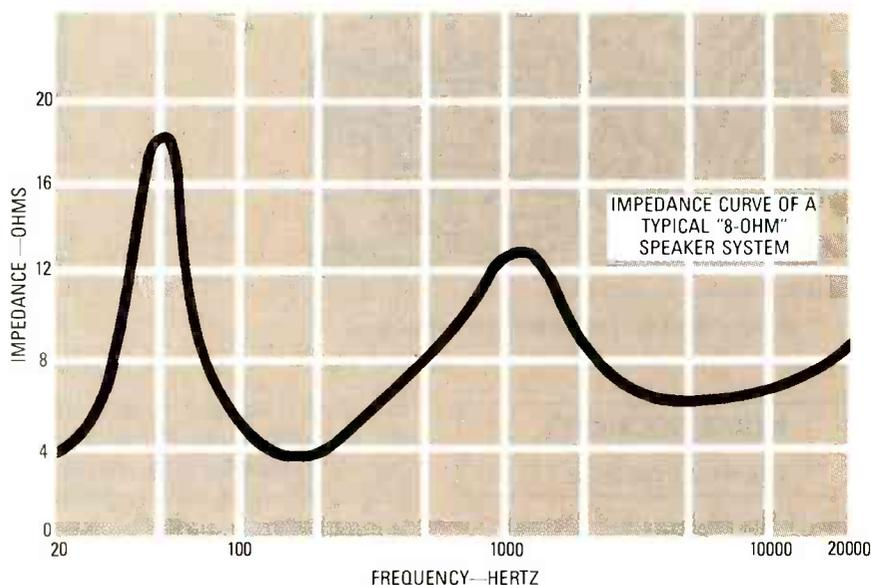

FIG. 1

away in my head in the "unsolved audio mystery" category—where it remained until many years later. It was during a discussion about the strange reactive loads presented by some speaker systems that everything suddenly fell into place. As I mentally reconstructed the problem, it wasn't that the original amplifiers weren't capable of putting out their rated power into standard 8-ohm loads; they just couldn't deliver their power into the very low impedance reactive load characteristics of the AR *LST* speaker system. (As I recall, the *LST* system had both a tapped inductor and a very large capacitor at its input terminals). As the curve in Fig. 1 shows, the impedance of a typical "8-ohm" speaker system can vary widely with frequency.

Speaker impedance and power

The best of today's better solid-state amplifiers approximate a constant-voltage source. That means that for a given input signal, the amplifier will, within reason, put out a constant voltage across the speaker terminals—*whatever the load*. If, for example, there are 20 volts at the amplifier's speaker terminals, the relevant part of Ohm's Law (watts = volts²/speaker impedance) tells us that there are 50 watts being fed to an 8-ohm speaker. Theoretically, if a 4-ohm speaker were connected, the same 20 volts across it would produce 100 watts.

However, very few amplifiers double their maximum output power when switched from an 8-ohm to a 4-ohm load. Most ampli-

fiers will deliver only about 50% more power into 4 ohms than 8 ohms, due to power-supply current limitations or the intervention of their protective circuits. Each time the load resistance is halved (causing the power output to be doubled), the amplifier's power supply is called upon to deliver *twice as much* current to the output devices at a given input signal. Obviously, that can create problems. Under conditions of excessive current drain, the power supply's voltage level sags. As the power-supply voltage falls, so does the maximum output-power capability of the amplifier. Any attempt to drive the amplifier beyond its lowered power-output capability will result in clipping distortion.

To recapitulate, the sequence goes this way: A very low value speaker impedance causes excessive current to be drawn—via the output transistors—from the amplifier's power-supply. The excessive drain, in turn, causes the power-supply voltage to fall. The drop in power-supply voltage reduces the signal level that can be handled by the amplifier. When that limit is exceeded, waveform clipping results. The audibility of clipping depends both on its severity and its duration. If only the tips of the highest peak waveforms are truncated, then the clipping may pass unnoticed. However, insofar as the music waveforms begin to resemble square waves, the problem becomes very audible.

Overloads such as I've described are likely to have additional consequences. The amplifier may run hot enough to trigger its thermal-protection circuit, it may blow fuses, or—worst case—it may burn out its output transistors or the tweeters in the connected speaker systems. Some of the early circuits that were designed to protect the output devices from excessive current tended to be complex and unreliable and, worst of all, would sometimes audibly misbehave. However, with today's improved output devices, simpler and more reliable protection circuits (sometimes consisting only of speaker-line or power-supply fuses) provide the required protection.

Current thinking

Given all the above, it's easy to see why many amplifier manufacturers have recently begun to feature "current reserve" as an important specification. Even conventional 8-ohm-rated speaker systems can fall as low as 2 to 3 ohms at some test frequencies, or on musical material containing those frequencies. If the current reserves of an amplifier are not sufficient to sustain its wattage output into low impedances, the amplifier momentarily runs out of power—and frequently right at the time when it is musically needed the most!

I'm not too embarrassed that it took me so many years to appreciate the importance of high-current capability in amplifiers; most of the Japanese manufacturers had no more insight into the matter than I did. The reason, I suspect, had to do with the impedance characteristics of Japanese speakers. In the 1970's, you still found Japanese amplifiers that overheated or shut off if you tried to drive American-made 4-ohm speakers with them. And it was only five or six years ago, if memory serves, that an engineer from a major Japanese manufacturer asked me for reference material that explained dynamic headroom and current capability.

One final note: If you check the current EIA amplifier-test standard you will find no mention of output-current capability in either the primary or secondary ratings. At the time we were working on the standard, none of us thought about output current as an important factor. Today, there still does not appear to be a universally agreed-upon method of rating amplifier-current capability. I therefore assume that output-current ratings such as 20, 30 or 50 amperes usually refer to an amplifier's short-term capability, not to its continuous rating. But in any case, I'm encouraged by the fact that output-current ratings continue to be played up in press releases and spec sheets. I believe that a large output-current capability can make a significant contribution to sound quality, given today's speakers and the way they are designed and used.

R-E



CHEMICAL SOLUTIONS

FREE CHEMTRONICS CATALOG!

Comprehensive new source for over 200 products used in electronic manufacturing and field service. Precision cleaning agents, flux removers, bulk solvents, circuit refrigerants, precision dusters, non-residual wipers, foam swabs, premoistened pads/swabs, antistatic compounds, conformal coatings, lubricants, adhesives, desoldering braids, rosin core solder and solder masking agents. Complete with technical specifications and application guide.



Chemtronics Inc.
681 Old Willets Path
Hauppauge, N.Y. 11788
516-582-3322

CIRCLE 54 ON FREE INFORMATION CARD

Be an FCC LICENSED ELECTRONIC TECHNICIAN!



No costly School. No commuting to class. The Original Home-Study course prepares you for the "FCC Commercial Radio-telephone License". This valuable license is your "ticket" to thousands of exciting jobs in Communications, Radio-TV, Microwave, Computers, Radar, Avionics and more! You don't need a college degree to qualify, but you do need an FCC License. **No Need to Quit Your Job or Go To School** This proven course is easy, fast and low cost! **GUARANTEED PASS** — You get your FCC License or money refunded. **Send for FREE facts now. MAIL COUPON TODAY!**

COMMAND PRODUCTIONS

FCC LICENSE TRAINING, Dept. 90
P.O. Box 2824, San Francisco, CA 94126
Please rush FREE details immediately!

NAME _____
ADDRESS _____
CITY _____ STATE _____ ZIP _____

APRIL 1989

71

SHORTWAVE RADIO



STANLEY LEINWOLL

International Frequency Coordinating Committee

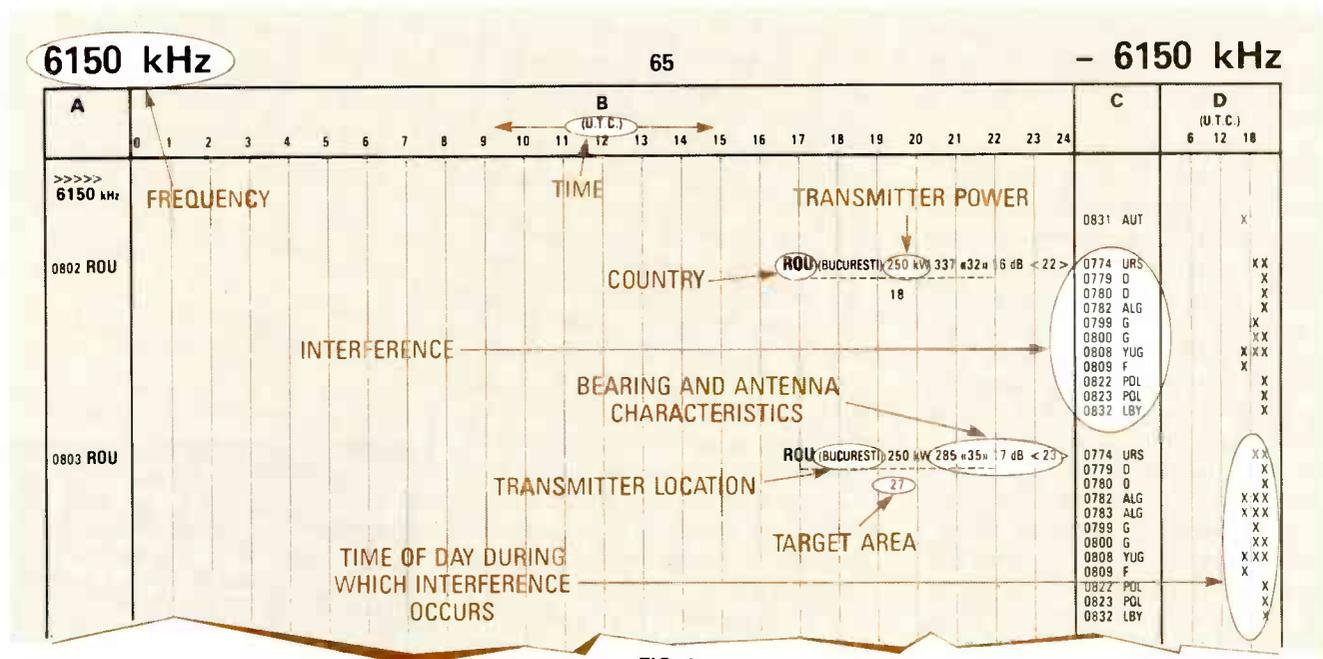

FIG. 1

ONE OF THE MOST IMPORTANT, INFLUENTIAL, yet little-known organizations in the field of shortwave broadcasting is the *International Frequency Coordinating Committee (IFCC)*, which is also known as "The Club."

The IFCC is made up of high-level technical representatives of the Voice of America (VOA), Radio Free Europe (RFE) and Radio Liberty (RL), the British Broadcasting Corp. (BBC), Radio Germany (Deutsche Welle), Radio Canada International, Radio Nederland, and the Federal Communications Commission (FCC), which represents some sixteen private U.S. broadcasting organizations, such as WYFR, KGEI, KTWR, WINB, and others. The IFCC meets six times yearly to coordinate their shortwave-broadcast schedules.

IFCC history

Roger Legge was the father of Article 17 of the *International Telecommunication Union (ITU) Radio Regulations*; that was a revolutionary coordination procedure, under which all shortwave broadcasting organizations submitted their schedules six months in advance of implementation to the *International Frequency Registration Board (IFRB)*. In force since 1960, Article 17 has had a major impact on shortwave broadcasting, enabling broadcasters to resolve conflicts before a tentative frequency schedule was implemented.

At that time, Legge noted that U.S. broadcasters were submitting schedules that were in conflict with each other. He suggested that U.S. broadcasters, VOA, RFE, RL, and the FCC meet periodically to resolve their con-

licts before submitting schedules to the IFRB. The U.S. broadcasters accepted the proposal and, in 1963, at the suggestion of Roger Legge, then frequency manager of VOA, the IFCC was born.

Tentative Schedule

The early IFCC meetings were very difficult, sometimes acrimonious; when a conflict arose, a change had to be made to resolve it. One of the broadcasters must either move to another frequency, or change characteristics such as antenna bearing or transmitter location, in order to make interference-producing conflicts technically compatible. That was not always easy, or even possible. Conflicts over a single frequency sometimes lasted a full day. However, even from the start, the group worked together to

R-E Engineering Admart

Rates: Ads are 2 1/4" x 2 1/8". One insertion \$900. Six insertions \$875. each. Twelve insertions \$845. each. Closing date same as regular rate card. Send order with remittance to Engineering Admart, Radio Electronics Magazine, 500-B Bi-County Blvd., Farmingdale, NY 11735. Direct telephone inquiries to Arline Fishman, area code-516-293-3000. Only 100% Engineering ads are accepted for this Admart.

MIDI PROJECTS



BP182—MIDI interfacing enables any so equipped instruments, regardless of the manufacturer, to be easily connected together and used as a system with easy computer control of these music systems. Combine a computer and some MIDI instruments and you can have what is virtually a programmable orchestra. To get your copy send \$6.95 plus \$1.25 for shipping in the U.S. to Electronic Technology Today Inc., P.O. Box 240, Massapequa Park, NY 11762-0240.

FCC LICENSE PREPARATION

The FCC has revised and updated the commercial license exam. The **NEW EXAM** covers updated marine and aviation rules and regulations, transistor and digital circuitry. **THE GENERAL RADIOTELEPHONE OPERATOR LICENSE - STUDY GUIDE** contains vital information. **VIDEO SEMINAR KITS ARE NOW AVAILABLE.**

WPT PUBLICATION
979 Young Street, Suite A
Woodburn, Oregon 97071
Phone (503) 981-5159

CIRCLE 178 ON FREE INFORMATION CARD

Surface Mount Chip Component Prototyping Kits—

Only \$49.95

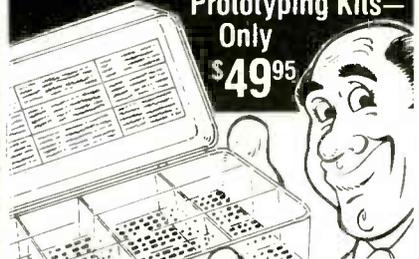

CC-1 Capacitor Kit contains 365 pieces, 5 ea. of every 10% value from 1p1 to .33μf. CR-1 Resistor Kit contains 1540 pieces: 10 ea. of every 5% value from 10Ω to 10 megΩ. Sizes are 0805 and 1206. Each kit is ONLY \$49.95 and available for Immediate One Day Delivery!

Order by toll-free phone, FAX, or mail. We accept VISA, MC, AMEX, COD, or Pre-paid orders. Company P.O.'s accepted with approved credit. Call for free detailed brochure.

COMMUNICATIONS SPECIALISTS, INC.
426 West Taft Ave. · Orange, CA 92665-4296
Local (714) 998-3021 · FAX (714) 974-3420

Entire USA 1-800-854-0547

CIRCLE 176 ON FREE INFORMATION CARD

resolve its differences, and the number of solutions to problems far outweighed those that could not be resolved immediately.

The IFRB publishes the submitted information in a book called the *Tentative Schedule*. Continuing conflicts, such as two or more broadcasters operating on the same frequency to the same target area can easily be identified, and it's then up to the broadcasters concerned to solve their problems. In some cases, the IFRB makes recommendations for resolving conflicts, but acceptance of the recommendations is not mandatory; IFRB is a part of the ITU. Figure 1 shows an annotated page from a recent *Tentative Schedule*.

It was not long before other broadcast organizations became aware of the IFCC, and requested membership. Radio Canada, Radio Nederland, and the BBC joined during the first several years, and the Deutsche Welle entered the group in 1966.

Other broadcasters soon learned of the IFCC's activities and wanted to join. One representative from a Far Eastern broadcaster traveled 6,000 miles to attend a meeting as an observer, then appealed to the group to allow his organization to participate in the meetings. By that time, however, with about 400 transmitters represented at the meetings, and conflicts becoming more and more difficult to resolve, the IFCC decided that addi-

tional participation would prejudice the effectiveness of the group.

Still other broadcasters continued trying to gain admittance to the IFCC and were also turned down. It was then that one of the European rejectees referred to the group as "The Club."

How the Club Works

The Article 17 coordination procedure divides the broadcasting year into four seasons:

- Spring: The first Sunday in March to the first Sunday in May.
- Summer: The first Sunday in May to the first Sunday in September.
- Fall: The first Sunday in September to the first Sunday in November.
- Winter: The first Sunday in November to the first Sunday in March of the following year.

Approximately six months before the start of a season, IFCC members send their schedules to a designated host, who records the schedules in a booklet, which, when complete, contains the combined schedules of all the participants. Technical representatives of the member broadcasters travel to the host city, and with all the representatives sitting around a conference table, the host then reads through all frequencies, from 5,955 kHz to 26,095 kHz. Should a conflict arise, the reading stops until a satisfactory solution can be found. A total of 375 frequencies are coordinated.

Each schedule is coordinated

twice. The first reading is made six months in advance of implementation of the schedule. The final reading is about two months before a schedule is due to go into effect; that takes into account any modifications to the schedule that must be made because of programming or propagation changes, or because of unexpected interference problems that have arisen since the original submission of the tentative schedules.

IFCC meeting schedule

With the exception of the FCC, participating organizations take turns hosting meetings. The annual meeting schedule, indicating when each schedule is coordinated, is as follows:

- January: The final Spring schedule is coordinated.
- March: The final Summer schedule, plus the preliminary Fall schedule.
- May: Preliminary Winter schedule.
- July: Final Fall schedule.
- September: Final Winter schedule, plus preliminary Spring schedule for the following year.
- November: Preliminary Summer schedule for the following year.

The IFCC is unique in the annals of shortwave broadcasting. It has met for over 25 years, and in spite of the fact that the shortwave bands are overcrowded by a factor of more than two, and that all participants are in competition for the same scarce natural re-

continued on page 93

MACROWAVE OVEN

The big chill: Build a macrowave oven.

LAURENCE HAKEMACHI

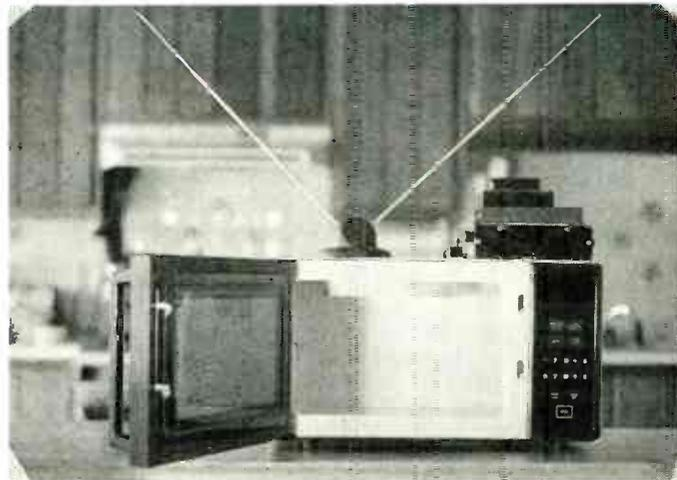

ONE OF THIS GENERATION'S MOST SIGNIFICANT electronics accomplishments, ranking alongside the solid-state whoopie cushion and the CD-player-in-a-boom-box as indicators of our society's grasp and appreciation of technology, is the microwave oven. A microwave oven liberates you from much of the tedium of food preparation and frees valuable time for such worthwhile pursuits as watching TV, staring into space, or partying.

However, there are times when what you need is not a way to heat things up faster, but a way to cool them down faster. Maybe you have leftovers to put in the freezer but don't want to wait up half the night for them to get cold enough so they won't defrost everything else in there. Or what if you need more ice cubes right away, or want to cool down a case of beer fast? Maybe you're just in a hurry to freeze-dry a cat! What you need is what will be the up-and-coming electronic glamour-gadget of the '90's—the macrowave oven!

How it works

It has long been known, although never referred to in polite company, that just as short-wavelength microwaves can generate heat in many materials, much longer electromagnetic wavelengths known as *macrowaves* can have the opposite effect. Macrowaves remove heat from objects by causing infrared radiation to be radiated faster than it can be generated, thus producing a cooling effect. Because of their great penetrating power, macrowaves cause immediate internal

as well as surface heat loss, resulting in an efficiency much greater than that of convection-type cooling devices such as refrigerators.

Oven modification

Until quite recently, the construction of a macrowave oven would have been a difficult and time-consuming affair, well beyond the abilities and budgets of most home experimenters. However, the availability of a device called a krystron, which takes the place of the magnetron found in microwave ovens, has changed all that. For the sake of this project, a ready-to-install krystron is available by mail.

(The etymology of the word "krystron," incidentally, is uncer-

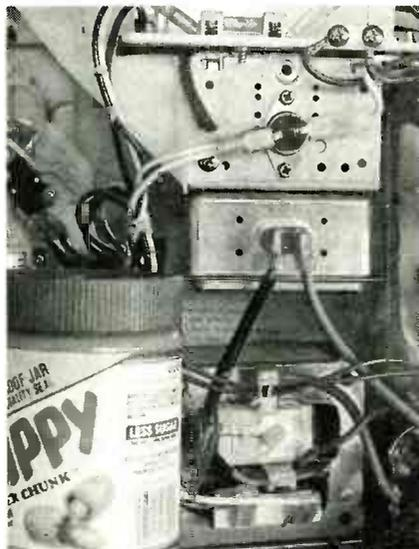

FIG. 1—MACROWAVE OVEN replaces standard magnetron with krystron. Type 18-OZ device is shown here.

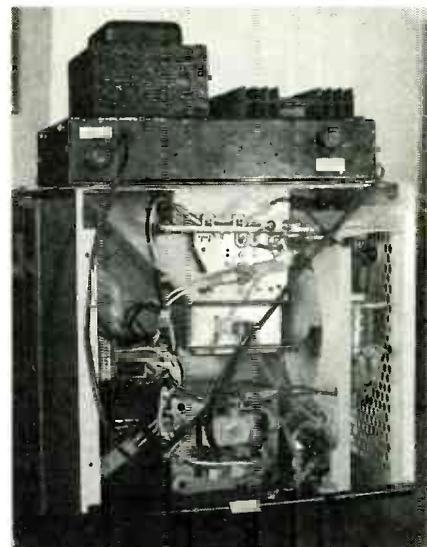

FIG. 2—THERE'S NO SUCH THING as too much power when it comes to generating macrowaves.

tain. Some claim that it is derived from the Greek *kryo*, meaning "cold." Others believe it comes from the Japanese word for a microwave-generating device.)

It is not necessary to start from scratch. An ordinary microwave oven of the kind you may already own will do. The modifications required are threefold. First, the existing magnetron must be replaced with a krystron (Fig. 1). Depending on the size of your unit, you will need a krystron designated 8-OZ, 18-OZ or 24-OZ. A 500-watt oven will be converted nicely with an 8-OZ unit; a 1000-watt or greater one will work best with a 24-OZ krystron. All that is necessary is to remove the existing magnetron (which you have probably already

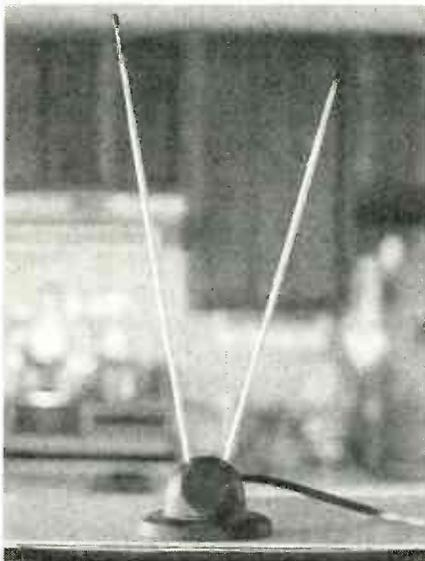

FIG. 3—HEAT REMOVED from items being cooled is down-converted to RF and harmlessly re-radiated by a high-precision dissipation device.

done, see box on this page) and replace it with the plug-compatible krystron. Make sure it is seated securely in its socket, and that all waveguides, if any, are secure.

The second step involves the power supply. Krystrons require a lot of

power, so the bigger the power supply the better your macrowave oven will perform. The exact voltage and current available are unimportant—what matters is that more is better! Figure 2 shows the author's prototype, which has been successful in inducing hypothermia in houseflies. The supply can be mounted anywhere you can fit it where it won't slide off.

The final component called an RF dissipator, shown in Fig. 3, reradiates the up-converted infrared radiation (heat) removed from the item being processed in the form of harmless radio-frequency waves which will be of little bother to anyone. **DO NOT ATTEMPT TO CONSTRUCT THE DISSIPATOR YOURSELF!** It is extremely complex with very critical dimensional tolerances. If you do not purchase the already assembled unit, there is no guarantee that your macrowave oven will work.

And that's all there is to it. Just put on your mittens and immerse the completed macrowave oven, with the stuff you want to cool inside, in a large Dewar flask containing enough liquid nitrogen or helium to cover ev-

You can save a lot of work by having your magnetron converted to a krystron. Remove it carefully from its socket, wrap it well, and mail it to:

Laurence Hakemachi
Utilities Closet
Chaco Laboratories
Josephson Junction, NM 87500

The cost for the simple conversion is as follows:

- Type 8-OZ—\$3000.85
- Type 18-OZ—\$3001.65
- Type 24-OZ—\$3002.05

Also available is the precision RF-dissipation device, type RS-15-958, mentioned in the text. Price is \$399.00. Shipping is additional, and will be billed separately. All checks should be made payable to the Chaco Advanced Superconducting H eadquarters, or simply "CASH."

everything. The efficiency of the device is largely determined by the amount of coolant used.

If we forgot to mention earlier that the krystron is a superconducting device and will not operate at ordinary temperatures, we're sorry and we apologize. Anyway, before you can say, "April Fool," your macrowave oven will be doing its job. **R-E**

Employers

Willing workers available now at as little as 1/2 your usual cost.

This is your chance to get help you've needed, but thought you couldn't afford.

No business too large or too small. Call your private industry council or write **National Alliance of Business**, P.O. Box 7207, Washington, D.C. 20044



Learn Electronics Engineering at home with proven results!

THE COMPLETE ELECTRONICS HOME-STUDY COURSE

Advance your career in the Electronics Industry. Now you can learn at your own pace with easy, "Self-Study" training lessons. No previous technical background required.

You will learn fast with our two new simplified training manuals. Hundreds of illustrations make understanding easy! Our 38 step-by-step lessons take you from basic D.C. up to Digital techniques.

Now you can get the same proven course used successfully by many schools, corporations and U.S. military to train their personnel. Order the complete course today. Only \$49.95 postpaid. Satisfaction guaranteed or money refunded.

ELECTRONICS TRAINING - Dept. 70
#107 INDUSTRIAL CENTER
Sausalito, CA 94965

CABLE - TV

band - stop filters

- FOR ELIMINATION OF SEVERE INTERFERENCE
- FOR "CENSORING" OF ADULT BROADCASTS



- ATTENUATION - 45 dB TYPICAL
- BANDWIDTH - 4 MHz AT 5 dB POINTS
- INSERTION LOSS - 2 dB

MODEL	TUNING RANGE	FOR CHANNELS	PASSBAND	PRICE	SHIPPING/HANDLING
23H	50-66 MHz	2,3 (or 6 meter ham)	50-300 MHz	\$30	FREE
46FM	66-108 MHz	4,5,6 (or any FM)	50-300 MHz	\$30	FREE
1417	120-144 MHz	14(A) 15(B) 16(C) 17(D)	50-400 MHz	\$30	FREE
1822	144-174 MHz	18(E) 19(F) 20(G) 21(H) 22(I)	50-400 MHz	\$30	FREE
713	174-216 MHz	7,8,9,10,11,12,13	50-400 MHz	\$30	FREE

3 for \$72 - 10 for \$180 - mix & match

Call Toll Free For C.O.D. or Send Check To Order
No Shipping Charges

- Shipped Within 3 Days
- 30 Day Money Back Guarantee

FACTORY DIRECT FROM

Star Circuits

P.O. Box 8067
Pembroke Pines, FL 33084
1-800-433-6319

HARDWARE HACKER

continued from page 32

Next, for plenty of the hands-on construction details, check out Chediski, Colcord, and Elden's medium-budget project on pages 1245-1277 of the same issue.

It sure is refreshing to see a very scholarly journal that always remains simple, practical, and yet quite easily understood by lay people. It looks like the technology you should be watching is the *quark-muon* dissociation and regeneration process.

So, I guess I was not too overly surprised when Marcia Swampfelder shipped me her latest two peripheral cards for the old Apple II Plus, her MTT-T1 mass-transference transmitter, along with her MTT-R1 mass-transference receiver. Marcia is a tad on the conservative side, so she insisted on using the illegal monitor entry points that precludes the use of those cards on newer Apples or other personal computers.

The pricing is rather attractive at

\$68.50 for the MTT-T1 and a mere \$43.50 for the separate MTT-R1. You can order direct from Marcia.

Anyway, you first plug your transmitter card into one Apple II Plus and as many as four receiver cards into four receiving Apple II Plus computers. Any object that gets placed in the transmitter's dissociation chamber then will appear reconstructed in the receiver's regeneration chamber.

The effective range does depend on the telephone line in use, but for your average quality voice grade line, you can teleport objects as far as 500 miles using one receiver, 200 miles using two receivers, 100 with three, and 50 miles with four receivers. The poorly understood methodology of *conjugate phase decongruence* does prevent you from reliably using more than four receivers, regardless of the distance. Even on local loops.

The Apple power-supply and baud-rate considerations both limit the size of the teleportation chambers. Those chambers found on the MTT-T1 and the MTT-R1 are slightly larger than a quarter. In the usual demo of the cards you insert a quarter into the chamber on the MTT-T1 card, and it will reappear intact approximately 12 minutes later on the MTT-R1.

For a real "Golly Gee Mr. Science" demo, you permit four regeneration cards to serve each dissociation card. The single quarter you placed in the dissociation chamber will simultaneously reappear in all four of the receiving cards, again in the twelve minute dissociation-regeneration interval. Put another way, the quad demo returns a dollar in change for every quarter that is invested.

Figure 5 shows you the MTT-T1 transmitter card. The teleportation chamber is optical fiber coupled to an *Atascotia Industries* 100-milliwatt tunable ultra-violet solid-state laser. I don't know whether the \$2.75 price or the 67-percent optical efficiency is the most outstanding feature of that new component. The rest of the card consists of RAM, ROM, CPU, and I/O stuff, all done up in Marcia's highly conservative style.

Marcia reports that virtually all of her current production is going

to all the importers of specialty herbs and spices. Her new teleportation system eliminates all of those long delays at customs, besides allowing her users to set all of their own international currency exchange rates.

New tech literature

A new *Microelectronic Data Book* just arrived today from *Mitel*. It is chock full of telecommunications chips, and includes bunches of useful ap-notes. Two other recent arrivals are the *Linear Circuits Applications* from *Texas Instruments*, and that *MOS Products Catalog*, from *Gould*, who recently bought out *AMI* and all the chips described in the book.

Some interesting new strain-gauge products are now available from *BLH Electronics*. In particular, their SR-4 should be useful for weighing scales or whatever. And *Sharp* has a new *LCD Units* booklet on liquid-crystal displays and their drivers.

Tektronix has a new *TEK Direct* catalog and several free videotapes out. Their oscilloscope prices do start at under \$700, and are much better than those of any other manufacturer.

Unusual and quite high-quality audio kits are available from the *Old Colony Sound Lab*. As a caver who exclusively uses carbide for light, I guess I've disqualified myself from commenting on the apparent stupidity of still continuing to use vacuum tubes in this day and age. Oh well.

ColorEase is an unusual and quite messy process that lets you create your own full color "real ink" instant transfers that may be applied to virtually any surface.

Two interesting new trade journals include *ID Systems* on bar codes and such, along with *Sensors*, for the robotics crowd.

Turning to my own products, if you are at all into designing active electronic filters, check out my *Active Filter Cookbook*. If you are into high-quality text or graphics of any style, be sure to look at all my PostScript stuff, especially the *PostScript Show and Tell*. Finally, remember that we now have fully updated and edited *Hardware Hacker* bound reprints available. Let's hear from you. **R-E**



SINCE
1965

**THE ONLY SOURCE
YOU'LL EVER NEED!**

SATISFACTION GUARANTEED

- QUICK SHIPMENT
- LOW COST
- RELIABILITY

FOR FREE CATALOG, CALL OR WRITE:

JAN CRYSTALS

P.O. BOX 06017
FORT MYERS, FL 33906
(813) 936-2397



TOLL-FREE:

1-800-237-3063

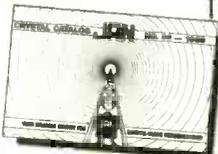

IN FLORIDA: 1-800-226-XTAL
FAX ORDERS: 1-813-936-3750

COMPUTER DIGEST

A PC run circles around a Cray?

TJ BYERS

Despite advances in micro-processor technology, the single-CPU architecture of the personal computer limits the maximum rate at which data can be processed. There is just so much data you can cram through a processor in a given amount of time.

While faster clock rates provide some relief, all other things being equal, performance only increases linearly with clock speed. A 16-MHz system, for example, would be twice as fast as an 8-MHz system. However, we are fast approaching the speed limit of our present technology.

Wider data buses provide another avenue for improvement. During the past decade, the data buses of common PC's have doubled in width twice, from the 8-bit buses of the Z80 and the 8088, to the 16-bit buses of the 80286 and 68020, to the 32-bit

buses of the 80386 and the 68030. However, those wide new buses are straining conventional hardware and software techniques to the limit.

The point is that we're reaching the attainable limit of performance improvement by increasing raw CPU speed. Fortunately, however, there is hope. To increase performance, savvy PC users are adding dedicated coprocessors and general-purpose parallel processors to their systems—processors that are designed to increase performance by assuming at least partial responsibility for the processing workload.

In fact, given enough processing help, there is no limit to what a PC can do. For about the price of a workstation, a single PC can run circles around a mighty Cray 1S supercomputer.

continued on page 83

Build an intelligent cable tester for only \$25!

JIM BARBARELLO

A single fault in a printer or modem cable can disable the device just when you need it most. A cable fault is not a problem if you're a cable manufacturer, because you can use your sophisticated (and expensive) cable tester to troubleshoot the cable. The problem is that most of us can't afford that type of equipment. There is, however, a simple and inexpensive alternative. If you own a PC and have about \$25 in spare change, you can build your own multi-line cable tester.

Our tester connects to your PC's printer port and allows you to test any cable with as many as 24 active lines. The tester works by performing a continuity check on the 576 possible interconnections; a complete test takes only about ten seconds. The tester uses inexpensive, readily available components, is built on a solderless breadboard (so no PC board is required), and is controlled by a simple BASIC program, which you're free to modify or enhance.

Multiplexing

To understand how the cable tester works, let's review the concept of multiplexing. Consider the circuit shown in Fig. 1. The two rotary switches are ganged, so both sections change simultaneously. In each position a different device glows: LED1, LED2, or LMP1. However, if we rotate the

continued on page 80

EDITOR'S WORKBENCH

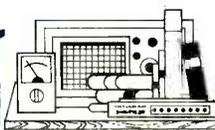

JEFF HOLTZMAN

The long-awaited graphical interface for OS/2 is:

- Big (8MB of hard disk space is required)
- Hungry (3MB RAM minimum)
- Slow on anything but a fast 286 or 386

Presentation Manager

OS/2 Standard Edition Version 1.1 (Presentation Manager, or PM for short) was released on Halloween, 1988. It's not something you want to rush out and buy, because there's not much you can do with it. But it is something you want to get a hands-on look at, because it's a harbinger of the future.

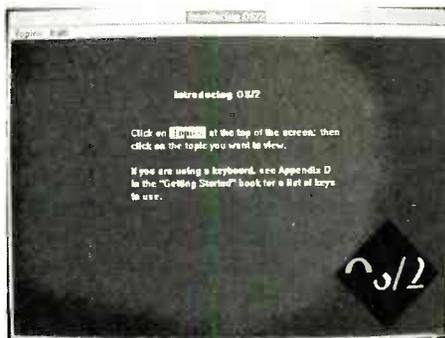

continued on page 78

Of course there's no software for it now, but Microsoft, Aldus (PageMaker), and Micrografx (Designer) are working feverishly to get new versions of their products out the door. Interestingly, however, it appears that Borland will beat them with a PM version of SideKick Plus.

In addition, like the character-based version of OS/2, special features of the 386 go sadly unused. That means there's still support for only one DOS session, and that it won't run in a window.

Hardware support is also limited. Few printers and fewer display adapters are supported (although IBM will release more drivers shortly), and PM itself is much more selective about the hardware it will run on. In fact, most of the non-IBM AT compatibles I had in the office wasn't able to get through the installation process. My AST Premium/286, which runs IBM's version of OS/2 1.0 fine, couldn't even get through the PM installation program without rebooting, and I had to trick the install program to complete installation on a Dell System 300.

In spite of those gripes, there's something about PM that's highly appealing. For one, it's like a grown-up version of Windows. It's got a new screen-oriented file manager that makes copying, moving, creating, and deleting files and subdirectories easy—better than the typical DOS shell, in fact.

For purposes of testing, I installed PM on Compaq's new SLT/286, a battery-powered 12-MHz AT-compatible that has the first VGA-compatible screen in a laptop. The machine had a 40MB hard disk and 2.6MB of RAM. I drove an NEC MultiSync monitor through the SLT/286's external VGA port.

PM comes on five 1.44MB floppy disks. You boot from one; it copies a minimal system to your hard disk. Then you boot from the hard disk; an automatic process prompts you to insert the remaining floppies one by one as it copies each to the hard disk.

After installation, PM comes up with a Start Programs menu in

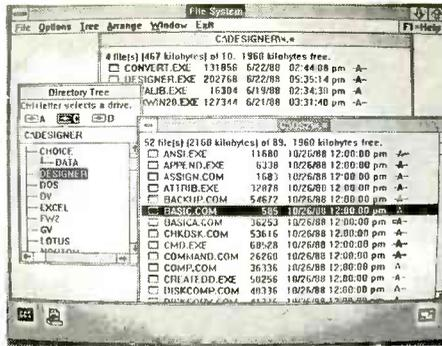

FIG. 2

the center of the screen, and three icons along the bottom. Those icons allow access to DOS, a print spooler, and PM's task manager. You make the process represented by an icon the active one by double-clicking on the icon.

As its name suggests, the Start Programs menu allows you to run a program. Programs are organized in groups; PM comes with two groups: Main and Utility. The Main group includes File System (the file manager), a tutorial called Introducing OS/2, a full-screen OS/2 command-line prompt, and a windowed OS/2 prompt. The Utility group includes the Control Panel (for setting time, date, and mouse preferences), CHKDSK, FORMAT, and the OS/2 System Editor. (Yes! OS/2 now includes a protected-mode editor! It's a full-screen editor that's better than EDLIN, but that's the best you can say about it.) Of course, you can add your own groups and programs to the Start Programs menu.

The task manager allows you to switch among active processes. In the default configuration, that allows you to switch among the DOS command prompt, the Start Programs menu, and the print spooler manager. Of course, as you start more programs, their names are added to the Task Manager's list. You can call the Task up at any time by pressing Ctrl-Esc.

The Task Manager also adds one item sorely missing from Windows: the ability to arrange the currently active processes on screen, in either cascade (overlapping) or tiled (non-overlapping) form. With Windows, by contrast, you have to size and place each window manually.

PM also includes an extensive on-line help system that does a good job of teaching you about and reminding you of the basics of using the system.

The File System displays a graphic representation of your hard disk's structure. To log into a particular subdirectory, just click on it with the mouse. A window opens that shows each file in that directory. You can list all files, programs (BAT, COM, EXE) only, or data files only; you can further qualify the list by file attribute; you can sort the list by name, extension, date and time, or by size; you can display just file names, or complete file info (size, time and date of last modification, and file attributes).

PM provides several ways of selecting one or more files or complete subdirectories; after selecting, you can copy, move, or delete any one of them with a few quick mouse motions.

What good is it?

Right now, not much. But neither was MS-DOS 1.0 in 1981. It's going to take some time, maybe even longer than it took DOS to overtake CP/M; but it will, eventually. For now, however, because of high RAM prices and lack of applications, PM is the most expensive DOS shell available. ♦CD♦

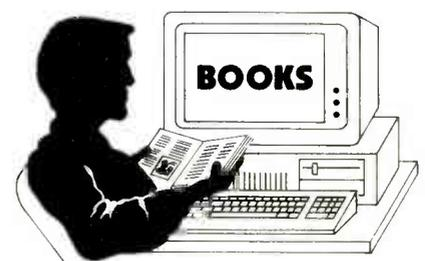

A Pair From Prentice Hall

Books that provide a balance of detailed hardware and software information are hard to come by; Jeffrey P. Royer's *Handbook of Software and Hardware Interfacing for IBM PCs* attempts to bridge the gap. The *Handbook* is well written and clearly illustrated; it includes more information on PC hardware and less on BIOS and DOS than Peter Norton's guide.

R-E Computer Admart

Rates: Ads are 2 1/4" x 2 7/8". One insertion \$900. Six insertions \$875. each. Twelve insertions \$845. each. Closing date same as regular rate card. Send order with remittance to **Computer Admart**, Radio Electronics Magazine, 500-B Bi-County Blvd., Farmingdale, NY 11735. Direct telephone inquiries to Arline Fishman, area code-516-293-3000. **Only 100% Computer ads are accepted for this Admart.**

SECRETS OF THE COMMODORE 64

BP135—A beginners guide to the Commodore 64 presents masses of useful data and programming tips, as well as describing how to get the best from the powerful sound and graphics facilities. We look at how the memory is organized, random numbers and ways of generating them, graphics-color-and simple animation, and even a chapter on machine code. Get your copy today. **Send \$5.00 plus \$1.25 for shipping** in the U.S. to **Electronic Technology Today Inc., P.O. Box 240, Massapequa Park, NY 11762-0240.**



A PRACTICAL INTRODUCTION TO MICROPROCESSORS

BP123—Introduces microprocessors by having the reader construct a very simple microprocessor circuit that he can experiment with and thus hopefully gain a clear insight into this complex subject. The completed unit is only intended as an education aid, but can be built inexpensively and many of the parts can be reused for other applications later. Get your copy for **\$5.00 plus \$1.25 for shipping** in the U.S. from **Electronic Technology Today Inc., P.O. Box 240, Massapequa Park, NY 11762-0240.**

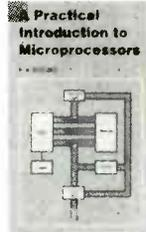

ICs PROMPT DELIVERY!!!

SAME DAY SHIPPING (USUALLY)
QUANTITY ONE PRICES SHOWN for JAN. 22, 1989

OUTSIDE OKLAHOMA: NO SALES TAX

DYNAMIC RAM				
SIMM (1) 256Kx36	100 ns	\$750.00	(2) SIMM OR 1Mbit 1Mbit (3) SIMM 256Kx1 (4) SIMM 256Kx1 (5) EPROM (6) STATIC RAM (7) EPROM (8) STATIC RAM (9) EPROM (10) STATIC RAM (11) EPROM (12) STATIC RAM	
SIMM (2) 1Mx9	80 ns	425.00		
SIMM (2) 256Kx1	60 ns	150.00		
1Mbit	1Mx1	80 ns		36.50
1Mbit	1Mx1	100 ns		27.99
41256	256Kx1	60 ns		14.95
41256	256Kx1	100 ns		12.95
51258 (3)	256Kx1	100 ns		13.25
41256	256Kx1	120 ns		12.15
41264 (4)	64Kx4	120 ns		14.50
EPROM				
27C1000	128Kx8	200 ns		\$28.50
27C512	64Kx8	200 ns	13.95	
27256	32Kx8	150 ns	8.15	
27128	16Kx8	250 ns	4.95	
STATIC RAM				
62256P-10	32Kx8	100 ns	\$22.95	
6264P-12	8Kx8	120 ns	9.75	
6116AP-12	2Kx8	120 ns	5.50	

OPEN 6 1/2 DAYS, 7:30 AM-10 PM. SHIP VIA FED-EX ON SAT.

WE EXPORT ONLY TO CANADA, GUAM, PUERTO RICO & VIRGIN ISLANDS

SAT DELIVERY INCLUDED ON FED-EX ORDERS
RECEIVED BY: BEGGS, OK, 74421
The Best At \$29.95
Pr. #1 \$10.25 1 lb

MasterCard/VISA or UPS CASH COD
MICROPROCESSORS UNLIMITED, INC.
24,000 S. Peoria Ave.
BEGGS, OK, 74421
No minimum order. Please note: prices subject to change! Shipping insurance extra, up to \$1 for packing materials

CIRCLE 61 ON FREE INFORMATION CARD

The first half of the book introduces software basics: dealing with the keyboard, disk files, COM and EXE files, etc. A strong point is the chapter on device drivers. Several short yet useful utility programs are provided as examples. One is a simple program for toggling the attribute bits of a directory entry; another lengthens the keyboard buffer from 16 to 40 bytes. A sample device driver provides screen output using normal BIOS calls; it can be used as a model for a more elaborate driver.

Later sections of the book describe fundamental microprocessor operation, and the meaning and use of the I/O bus control signals. A number of practical circuits are shown in enough detail that a moderately knowledgeable technician or engineer could build them without problem. For example, one circuit provides an 8-bit input port (for reading pushbutton switches) and a latched 8-bit output port (for driving LED's).

Later, the book provides a good introduction to wait states, ready-signal generation, and DMA operation. All topics are thoroughly covered. A sample circuit and program shows how to

connect and operate an 8-bit A/D converter.

An appendix outlines construction of a "Pedagogical Board" that contains a parallel interface, a timer IC, an A/D converter, an interrupt controller, an audio amplifier, a stepper-motor driver, LED's, and a keypad. The author sells the board as well as the example programs for modest fees.

The *Handbook* is not aimed at beginners; it assumes passing familiarity with microprocessors, DMA controllers, etc., and similar familiarity with BIOS and DOS. Experts won't find much new here, but for those aspiring to expert status, the book is a good place to start. Its circuits and discussions are limited to the 8-bit PC and XT systems, but the principles developed are applicable to 16-bit AT systems.

CIRCLE 29 ON FREE INFORMATION CARD

Troubleshooting guide

Byron W. Putnam's *Microcomputer Hardware Operation, and Troubleshooting with IBM PC Applications* starts at a more basic level. The first third of the

book discusses the elements of a computer system in elementary terms. Things pick up in Chapter 5, which discusses the LSI devices on the system board (parallel port, timer, interrupt, DMA, and video controllers, etc.). Chapter 6 continues with an overview of DRAM systems and touches briefly on the expansion slot signals.

A strong point is the discussion of floppy-disk drive operation and maintenance in Chapter 8. Several good diagrams show how the complicated electrical and mechanical systems interact with one another as a system; the book also provides detailed information on how to align floppy-disk drives.

All in all, the book provides a well-written introduction to computer systems in general and the IBM PC in particular. You'll need to understand the principles developed here (along with some digital electronics) to know what's going on in Royer's book. The chapter on disk drives is a little out of place in a book that is otherwise so basic, but the information presented is solid and a little hard to come by. **CD**

CIRCLE 30 ON FREE INFORMATION CARD

CABLE TESTER

continued from page 77

switches quickly, all three devices will appear to be on at the same time.

That process is called *multiplexing*; it lets each device share the common transmission line part of the time. Multiplexing is the basis of modern phone transmission; that's how hundreds of calls are sent over a single pair of wires.

Our cable tester reverses the standard multiplexing scheme to allow testing many wires with just a single input and a single output. The principle is shown in Fig. 2; note that the rotary switches there are not ganged.

If we place both switches in position 1, LED1 will light, indicating continuity. But if we leave S1 in position 1 and move S2 to position 2, the LED should go out. If it doesn't, there must be a connection—intentional or otherwise—between lines 1 and 2.

We accomplish that type of switching with a 4051 multiplexer/demultiplexer, shown in Fig. 3. As shown in Table 1, depending on the binary code present at inputs A, B, and C of the 4051, we can connect the common line to any of the eight transmission lines. Note that if we apply a high level to the Inhibit line, all connections are broken between the common and transmission lines, regardless of the state of the A, B, and C inputs. Like the rotary switches in Figures 1 and 2, the 4051 can accommodate AC and DC signals in both directions.

The circuit

If the PC had a standard interface with 24 input and 24 output lines, multiplexing would be unnecessary. It doesn't, so the cable tester uses the 11 output lines of the PC's parallel port to control six 4051 IC's, and one of the port's five input lines to sense transmission status. The complete circuit is shown in Fig. 4.

To select IC1, we must bring its Inhibit line low while keeping the Inhibit lines of IC2 and IC3 high. Then, depending on what we apply to the A, B, and C inputs, we

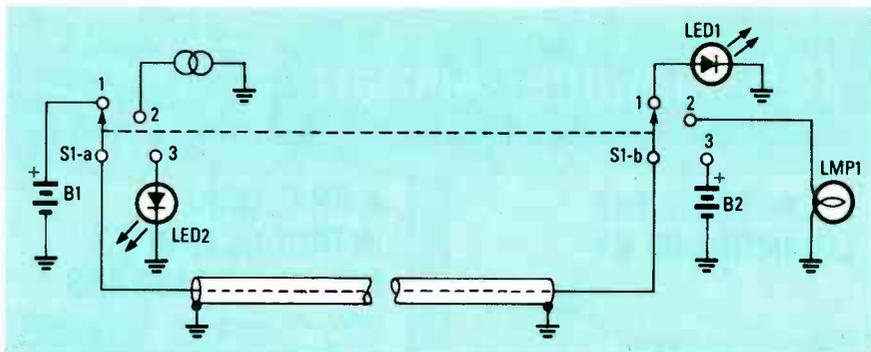

Fig. 1. A MULTIPLEXED CIRCUIT allows a single cable to carry several different circuits.

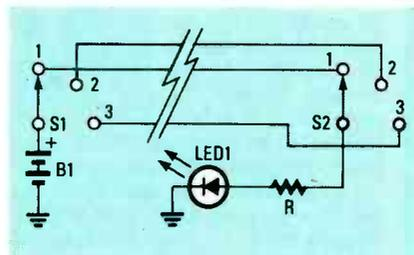

Fig. 2. BY DECOUPLING the switches and driving (B1) and sensing (LED1) the common lines, it's possible to test various combinations of connections.

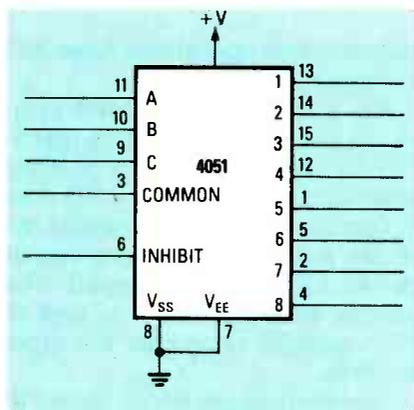

Fig. 3. THE CMOS 4051 allows a single common line to connect to one of eight input/output lines when the inhibit line is low.

can select any of the eight transmission lines. The Common line (pin 3) is connected to +V, so +5 volts will be transmitted through the selected transmission line to the cable under test via J1.

The other end of the cable is connected to J2. There, a line is selected by similar use of the Inhibit and A, B, and C lines of IC4, IC5 and IC6. The Common output line is sensed by pin 11 of the printer port. Resistor R1 serves as a pull-down to prevent false readings.

Think of the combination of IC1, IC2, and IC3 as a 24-position electronically controlled rotary switch. Similarly, the combina-

tion of IC4, IC5, and IC6 acts like a second rotary switch. Each "switch" is independently adjustable. For example, line 1 can be selected as the input to the cable, while any of lines 1 through 24 can be sensed at the output of the cable. That independent selection allows checking of all possible combinations of input and output lines. Power is provided by three 1½-volt AA batteries.

Addressing the 4051's

On the input side, lines A, B, and C are connected to printer-port pins 4, 3, and 2, respectively. Those pins correspond to the three lowest bits (D2, D1, and D0) of the 8-bit parallel data. To select transmission line 1, we connect the A, B, and C lines to ground; to select transmission line 8, we connect A, B, and C to +V.

Note that all three IC's (IC1-IC3) are addressed; we avoid contention by releasing the Inhibit line of only one IC at a time. The Inhibit line for IC1 is pin 1 (STROBE). For IC2, it is pin 14 (AUTOFD), and for IC3 it is pin 16 (INVT). To select IC1, send a decimal 5 to port 890 (OUT 890.5). A decimal 6 selects IC2, and decimal 0 selects IC3.

Addressing the output side is more complicated. Bits D7 and D6 (pins 9 and 8, respectively) are used to generate the A, B, and C signals through IC7 and IC8. To select IC4, set D7 = 1 and D6 = 1. Select IC5 with D7 = 1 and D6 = 0. Finally, select IC6 with D7 = 0 and D6 = 1. The A, B, and C lines are driven by D5, D4, and D3 (pins 7, 6, and 5, respectively). So, to select transmission line "5" in IC5, we would make D7 = 1, D6 = 0, D5 = 1, D4 = 0 and D3 = 0.

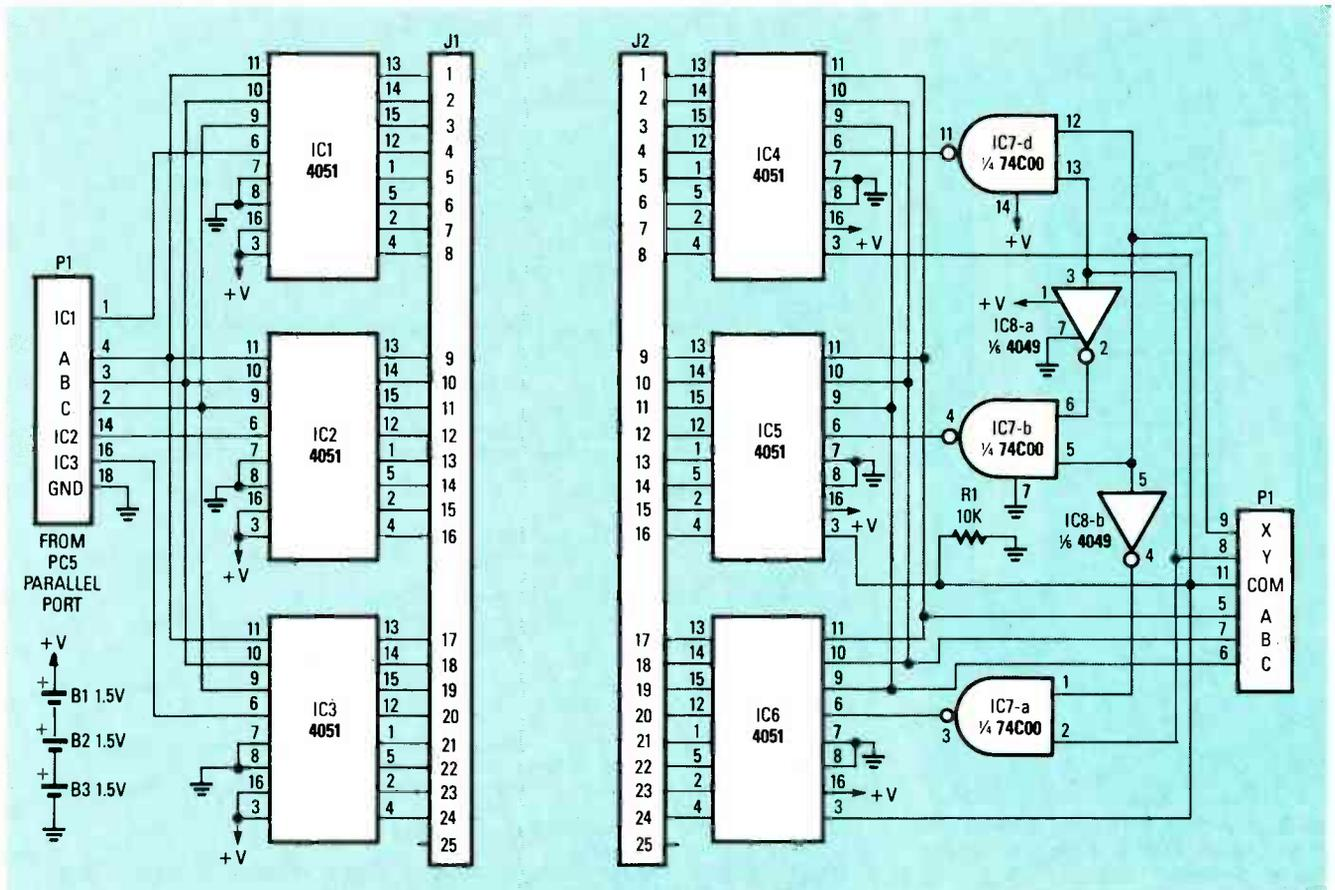

Fig. 4. COMPLETE SCHEMATIC DIAGRAM of the cable tester. The circuitry to the left of J1 is the input side; to the right is the output. Plug P1 connects to the PC's parallel port.

However, we must be careful not to disturb bits D2, D1, and D0, which were previously set. We do that by reading the status of port 888 and masking off the higher bits with the function INP(888) AND 7. That gives us a decimal value indicating the status of bits D2–D0. We can now add the decimal value from bits D7–D3 to that number and send it back out. To continue the previous example, we had D7=1, D6=0, D5=1, D4=0, and D3=0, or 10100XXX (with the X's meaning we don't care what those bits are). The decimal number for that pattern is $128 \times 1 + 64 \times 0 + 32 \times 1 + 16 \times 0 + 8 \times 0$, or 160.

If D2=1, D1=1, and D0=0, that pattern's decimal equivalent is 6. Add that to 160 and we get 166. So to select input line 15 and output line 13, we OUT 890,6 (to select IC2), and OUT 888,166 (to select transmission line 7 in IC2 and transmission line 5 in IC5).

Although the calculations seem somewhat involved, the

computer program accomplishes them quickly; in Listing 1, see lines 110 and 120 for the input side and 250–290 for the output side of the PC Cable Tester.

Construction

It's certainly possible to design a PC board for the tester, but we chose to build it on a standard 6 1/2-inch solderless breadboard, which provides just enough room for the circuit's eight IC's. Use short lengths of no. 22 solid wire to make the breadboard interconnections.

Next, obtain a four-foot length

TABLE 1—4051 TRUTH TABLE

Inhibit	A	B	C	Line Selected
0	0	0	0	1
0	0	0	1	2
0	0	1	0	3
0	0	1	1	4
0	1	0	0	5
0	1	0	1	6
0	1	1	0	7
0	1	1	1	8
1	X	X	X	NONE

PARTS LIST

- IC1–IC6—4051, 8-channel CMOS mux/demux
- IC7—74C00, quad CMOS NAND gate
- IC8—4049, quad CMOS hex inverter
- R1—10,000 ohms, 1/4 watt, 5%
- P1—25-pin D Plug and hood
- J1, J2—25-pin D socket and hood
- 6 1/2-inch x 2 1/8-inch solderless breadboard
- 5 feet of 15-conductor, 24 AWG unshielded cable
- 22 AWG solid wire
- 2-inch x 6-inch aluminum panel
- AA battery holder (3 cells)
- 5-inch x 9-inch x 1/2-inch plywood base
- 3 AA batteries

NOTE: An enhanced version of the test program, along with a detailed description of operation is available on a 5 1/4-inch disk for \$7.00 from J. J. Barbarello, RD #3, Box 241H, Tennent Road, Manalapan, NJ 07726. Both BASIC source and a compiled version of the program are included.

of 15-conductor cable; that cable connects to the PC's printer port. On the end that will attach to the

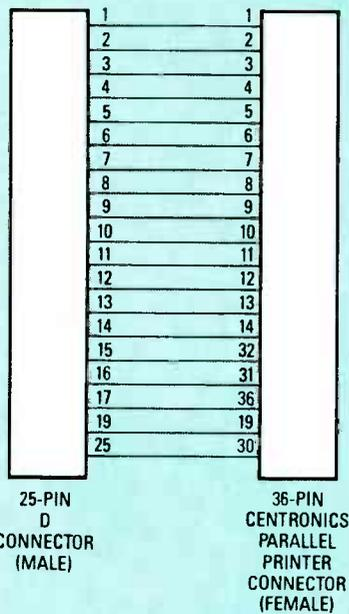

Fig. 5. ADAPTER for testing a standard printer cable with a male Centronics plug on one end.

connector, strip back the outer cable jacket about 1½ inches, exposing the 15 wires. Then strip ¼ inch of insulation from 13 of the wires, and cut off the remaining two wires. Tin each of the exposed ends. Repeat the process for the other end of the cable, but strip 4 inches of outer jacket and ⅜ of an inch of insulation from each wire. The wires on the connector end are soldered to the 13 pins of P1 as shown in Fig. 4. The wires on the other end are inserted into the appropriate points on the breadboard.

Cut forty-eight 4-inch lengths of no. 22 solid wire, stripping ⅜ of an inch of insulation from one end and ⅜ of an inch of insulation from the other. Solder the ⅜-inch stripped end of a wire to pin 1 of J1. Repeat that process for pins 2–24 of J1 and pins 1–24 of J2 (J1 and J2 are standard 25-pin “D” connectors). Make a bracket out of a piece of aluminum and then mount J1 and J2 on the bracket. Finally, insert the free end of each of the forty eight wires into the appropriate points on the breadboard.

The three AA batteries are

housed in a standard battery holder. You can use a power switch, but it's just as easy to insert or remove the +V battery wire to the breadboard. The breadboard, batteries and bracket can be mounted on a plywood base.

To test a cable without 25-pin D connectors, make a suitable adapter. One end of the adapter will be a 25 pin “D” plug. The other end will have a mating connector for the cable to be tested. These two connectors are then attached. An adapter for a 36-pin Centronics connector is shown in Fig. 5.

Operation

Type in and save the BASIC program shown in Listing 1 (or download PCCABLE. BAS from the RE-BBS—516-293-3000). Attach the cable tester to your PC's printer port and then run the program. Connect the cable to be tested to the input and output jacks of the tester. When the program asks *How many wires in the cable (1–24)?*, enter the appropriate number; if you're not

LISTING 1

```

1 REM** PC Cable Tester Program
2 REM** Name: PCCABLE
3 REM** (c) 1987 J.J. Barbarello
4 REM** V871017
10 DEF SEG=64:KEY OFF:DEFINT I,0:DIM I(576),0(576)
20 CLS:CNT=1:PRINT TAB(30);"P.C. CABLE TESTER":PRINT STRING$(79,223)
30 LOCATE 4,15:PRINT STRING$(50,32):LOCATE 4,15:LINE INPUT"How many wires in
  the cable (1-24)?...";NL$:NL=VAL(NL$)
40 IF NL<1 OR NL>24 THEN 20
50 N1=INT(NL/8):N2=NL MOD 8:IF N2=0 THEN N2=7 ELSE N2=N2-1
60 LOCATE 6,18,0:PRINT"Checking for Connections on Line:"
90 T=TIMER
100 FOR I=1 TO NL
110 IF I=1 THEN OUT 890,5 ELSE IF I=9 THEN OUT 890,6 ELSE IF I=17 THEN OUT 890,0
120 OUT 888,(I-1) AND 7:LOCATE 6,52:PRINT USING"***";I
130 GOSUB 250:NEXT I
140 CLS:PRINT TAB(30);"P.C. CABLE TESTER":PRINT STRING$(79,223)
150 LOCATE 3,22,1:PRINT USING"Test Completed in ***.## seconds.":TIMER-T
160 IF CNT=1 THEN LOCATE 5,28:PRINT"NO CONNECTIONS FOUND.":GOTO 190
170 LOCATE 5,1:PRINT"CONNECTION FOUND BETWEEN THE FOLLOWING INPUT AND OUTPUT
  LINES (IN/OUT):"
180 FOR I=0 TO CNT-2:LOCATE (I MOD 10)+7,INT(I/10)*10+1:PRINT USING"**/**";
  I(I+1);0(I+1):NEXT I
190 LOCATE 18,27:PRINT"Another Test (Y/N)?...";
200 W$=INPUT$(1):W$=CHR$(ASC(W$) AND 223):IF W$(">"Y" AND W$(">"N" THEN 200
210 PRINT W$:IF W$="Y" THEN 20
220 LOCATE 18,27:PRINT"PC CABLE TESTER OFF LINE.
230 OUT 888,0:OUT 890,238:END:REM* TURN EVERYTHING OFF BEFORE ENDING
240 REM** SUBROUTINE TO CHECK EACH INPUT LINE
250 L1=7:IF NL<8 THEN L1=N2
260 MASK=192:C=1:FOR L=0 TO L1:OUT 888,(MASK+L*8+(INP(888) AND 7)):GOSUB 310:
  NEXT L:IF NL<9 THEN RETURN
270 L1=7:IF NL<16 THEN L1=N2
280 MASK=128:C=9:FOR L=0 TO L1:OUT 888,(MASK+L*8+(INP(888) AND 7)):GOSUB 310:
  NEXT L:IF NL<17 THEN RETURN
290 MASK=64:C=17:FOR L=0 TO N2:OUT 888,(MASK+L*8+(INP(888) AND 7)):GOSUB 310:
  NEXT L:RETURN
300 REM** SUBROUTINE TO CHECK FOR CONTINUITY
310 IF (INP(889) AND 128)=128 THEN RETURN
320 IF (INP(889) AND 128)<>0 THEN LOCATE 10,1:PRINT"*** ERROR ***":STOP
330 I(CNT)=I:0(CNT)=L+C:CNT=CNT+1:RETURN

```

sure, enter 24. The program will then check all possible combinations of lines and give you a list of connections found.

Each item in the list is of the form I/I, meaning that pin 1 of the connector that is attached to the tester's input is connected to pin 1 of the other connector at the tester's output. On a standard 4.77-MHz PC, it takes about 10 seconds to test all 24 lines in all



Fig. 6. The completed cable tester. Construction is not critical, and a prototyping board should give good results.

576 combinations; testing fewer lines decreases the test time. Compiling the program reduces test time considerably. **CD**

Divide and conquer

The idea is to divide and conquer; let's illustrate with an analogy. If, for example, you find that your secretary is not getting her work done because of constant telephone interruptions, you hire a receptionist and divide the workload between the two, thereby improving productivity.

In a similar manner, a computer can divide and distribute its workload by offloading portions of it to other processors. Whereas dedicated hardware—disk controllers and video adapters, for example—improve system performance by doing some of the CPU's work, those types of controllers typically differ from general-purpose processors in that they require step-by-step instructions from the CPU about how to operate.

By contrast, a processor gets its orders directly from the software application without involving the CPU at all. That leaves the CPU free to do other things, and thereby increases overall productivity. In addition, a general-purpose processor can be adapted to a number of tasks, whereas the typical hardware controller can only do one thing, albeit very well.

Basically, there are two different types of processors: coprocessors and parallel processors, although the distinction between them is at times hazy. Strictly speaking, a coprocessor is a processor dedicated to one task and one task alone—like the receptionist in the example. Parallel processors, on the other hand, can function in different situations.

In what follows, we'll discuss several parallel and coprocessing products for the IBM family. Keep in mind, however, that comparable products for the Apple and other systems are available.

Number crunching

The most popular and best known coprocessors are the math coprocessors from Intel: the 8087, 80287, and the 80387.

Those IC's work in conjunction with the 8088/86, 80286, and 80386 CPU's, respectively, and usually plug directly into a socket on the PC's motherboard.

As the name suggests, a math coprocessor does nothing but mathematical calculations—a task that a general-purpose microprocessor is very slow at. The chip doesn't do windows and it can't read a disk—but it can multiply two numbers as much as 100 times faster than a CPU by itself.

To give you an idea of how a math coprocessor can improve performance, consider the math-intensive CAD program, AutoCAD. Without a math coprocessor, even simple AutoCAD drawings can take several minutes to compute for display using just the CPU as a number cruncher.

However, when a math coprocessor is installed, AutoCAD recognizes its presence and diverts all math routines to it rather than forcing them through the CPU. Then, while the coprocessor is busy munching mantissas, the CPU is analyzing the results and placing them on the screen. The outcome of that partnership is a tenfold increase in speed.

You want to do windows?

If it's screen performance you want, there are coprocessors for that, too. Popular IC's include Texas Instruments' 34010, Intel's 82786, and others from Hitachi, National Semiconductor, and others. Like the math coprocessors discussed above, video coprocessors are optimized for a single task: manipulating graphics on a video screen. They can't access a disk drive or read a keyboard, but they sure can move pixels around!

Unlike the simple interface between the microprocessor and the math coprocessor, video coprocessors usually require a good deal of support circuitry. Commercial products include the *Pepper 1600* from Number Nine Computer and the *Ultra 2000 CAD* from INI Computer Systems.

Unlike typical IBM-style video

controllers (Hercules, EGA, etc.), those video adapters use video coprocessor IC's that receive display instructions directly from applications software. In that situation, the CPU is relegated simply to coordinating screen operations with keyboard input, disk access, and other housekeeping system functions.

Parallel processors

Parallel processors are more versatile than dedicated coprocessors because they can be programmed to do more than one thing, be it number crunching, video graphics, or just plain system routines.

Like a coprocessor, a parallel processor works alongside the main CPU and receives its instructions from the software application rather than from the CPU. Generally, each parallel processor is an island unto itself. It is assigned a specific task, it does it, and then it waits for another assignment.

A crude analogy to parallel processing is a local-area network (LAN), in which information is accessed by an individual node from a shared data bank, and is then processed according to the user's needs. Then the results are returned to the data bank so that others may make use of it.

Parallel processors handle things on a more basic level. Whereas the LAN may have more than one application running on the network, with each user using a different piece of software, the parallel processor is driven by one all-encompassing application that takes total control of each processor.

The transputer

An increasingly popular parallel processor for PC applications is called a *transputer*, an acronym derived from TRANSistor comPUTER. The term was coined by INMOS Corp. of Bristol, England, (the same company that makes the DAC used in most VGA adapters); it basically means a computer on a chip.

In fact, INMOS makes two transputers: the T414 and the T800. As shown in Fig. 1, the T414 is a 32-bit CPU with 2K of

Pipelining

Pipelining gets its name from the fact that several processors are connected serially, like sections of pipe, with the output of the first tied to the input of the second, whose output is tied to the input of the third, and so forth. Data that enters the pipeline is acted upon by each processor as it travels through the pipeline.

Analogous to pipelining is the operation of an assembly line. An assembly line is divided into several stages, at each of which a particular operation takes place. One station might install the engine into the body, for example, while the next puts on a door. As the partially assembled car travels down the line, more and more items are added until, finally, a finished product emerges at the end. By advancing the vehicle as each step is completed and replacing it with a vehicle from the previous station, no assembly station is idle. Therefore, it is possible to turn out a steady stream of finished cars at a rate that is much faster than if each had been individually crafted.

The same strategy can be applied to many computer functions—floating-point arithmetic, for example. To see how pipelining can improve performance, let's compare the methods used by a microprocessor and a math coprocessor to multiply two numbers.

Typically, the CPU accomplishes the job (through software) by (1) splitting each number into an exponent and a mantissa, (2) adding the exponents, (3) storing the result in temporary memory, (4) multiplying the mantissas, (5) fetching the exponent, and (6) combining the two into a final answer. Only after the entire sequence has run its course can the CPU start on another calculation.

The math coprocessor, on the other hand, multiplies the two numbers using a multi-stage pipeline, as shown in Fig. 3. The two numbers enter the pipeline's first stage, where they are identified as to exponent and mantissa. The elements are then shifted to the second stage,

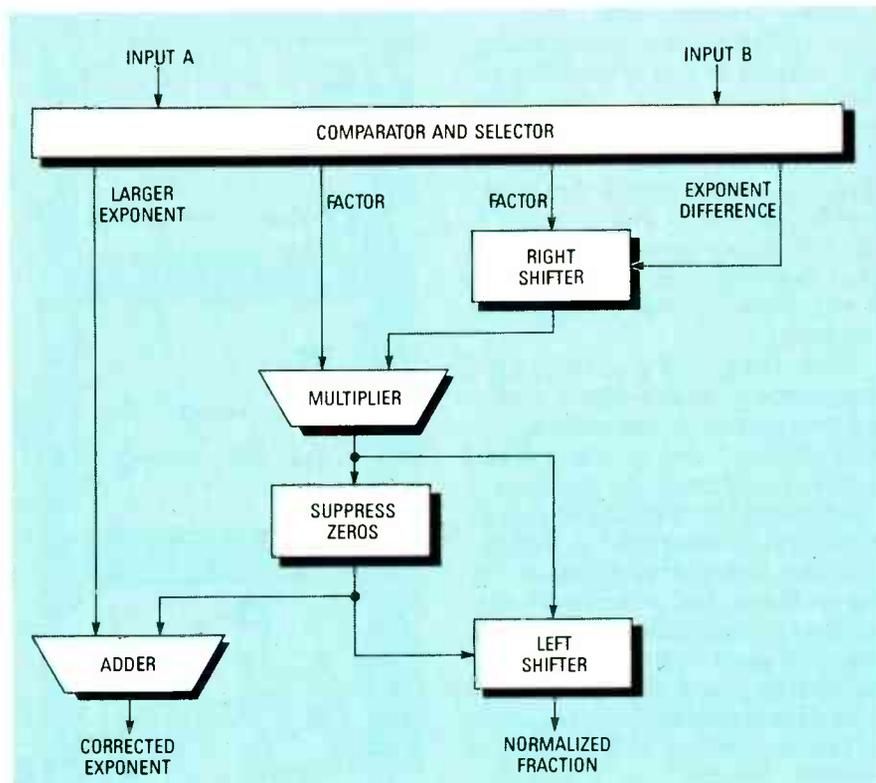

Fig. 3. BLOCK DIAGRAM of a pipelined math coprocessor.

Coprocessor Or Accelerator?

One term loosely bandied about the PC industry is the *coprocessor accelerator board*, a name generally given to adapter cards that contain high-speed CPU chips to increase system throughput. Where the term originated is anybody's guess, but most of those boards are not coprocessors; they're simply accelerators.

The difference is in the way an accelerator board operates. To install an accelerator card in most cases you must remove the system's old CPU and run a jumper cable from the accelerator card to the now-empty CPU socket.

Notice that the two processors don't work together simultaneously; at best you may switch between them to accommodate temperamental software applications. By contrast, to achieve true parallel processing, both CPU's must be accessible by software at the all times—something the typical accelerator card simply cannot do.

where the mantissas are weighted for processing. The third stage

multiplies the mantissas and the fourth strips the fraction of unnecessary zeros; the fifth and final stage adds the exponents and converts the results to conventional scientific notation.

The coprocessor really picks up speed, because after the first pair of numbers is shifted from the first stage to the second, another pair can enter the now-empty first stage. In fact, with each successive movement of data between stages, another pair of numbers can enter the pipeline, causing it to fill. After the fifth shift, results begin pouring out of the pipeline.

Of course, pipelining is not limited to Intel's math coprocessors; a pipeline can also be created using several transputers. However, pipelining is only efficient when the number of similar computations to be performed is large, as in floating-point arithmetic. Instructions are still executed one step at a time, and problems that rely on the results of one operation before invoking another are at a disadvantage. For that reason, designers developed a number of other architectures for increasing performance.

Parallel architectures

In conventional processing, the system is fed a problem serially, one chunk at a time: do A, then B, and then C. An advanced architecture, called a *concurrent system*, might attack the problem by accepting instructions A, B, and C simultaneously, and then routing each instruction to a separate processor that acts upon it.

Planning and publishing a magazine provides a good analogy. A magazine is basically an anthology of related articles placed under one cover. To produce a magazine, the publisher draws from many sources, including authors, news services, public relation firms, and advertisers. Because the information is generated by each contributor independently, much of it can be done simultaneously without the work of one depending on the result of another. In effect, work proceeds concurrently until the results are collected and assembled into print.

Similarly, a concurrent system works on more than one aspect of

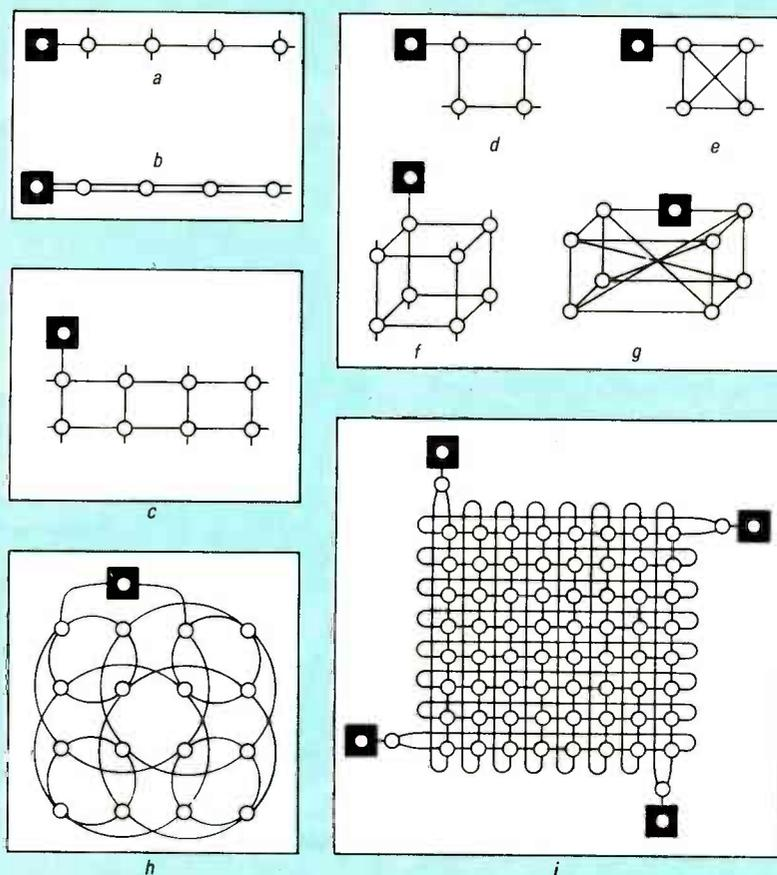

Fig. 4. SEVERAL WAYS TO INTERCONNECT TRANSPUTERS: (a) linear, (b) fast linear, (c) 2D array, (d) cube, (e), cross-connected cube, (f) 3D cube, (g) cross-connected 3D cube, (h) hypercube, and (i) 64-node torus.

Companies Mentioned

- Intel Corporation, 3065 Bowers, Santa Clara, CA 95051. (408) 987-8080.
- Number Nine Computer Corporation, 725 Concord Ave., Cambridge, MA 02138. (617) 492-0999.
- INI Computer Systems, 6915 Hightech Dr., Midvale, UT 84047. (801) 561-1100.
- MicroWay, Inc., P.O. Box 79, Kingston, MA 02364. (617) 746-7341.
- Computer System Architects, 950 N. University Ave., Provo, UT 84604. (801) 374-2300
- Definicon, 1100 Business Center Circle, Newbury Park, CA 91320. (805) 499-3559.
- Intel Scientific Computers, 15201 N.W. Greenbrier Pkwy., Beaverton, OR 97006. (503) 629-7631.
- Autodesk, Inc., 2320 Marinship Way, Sausalito, CA 94965. (408) 332-2344.

a problem at once. First the problem is broken down into as many parallel elements as possible; then each processor in the system is given an assignment. When all processors have reported in, the results are assembled and analyzed. Based on those results, the software then initiates another round of processing. That winnowing process continues until a solution to the overall problem is found; the number of steps required depends on the number of parallel processors the software supports and the magnitude or complexity of the problem.

There are many ways to assemble a concurrent system, some of which are shown in Fig. 4.

Parallel programming

Because conventional programming languages are not designed to deal with parallel processors, alternative parallel-speaking languages have been developed. Some are esoteric lan-

guages written for a specific machine in a specific configuration, but many are adaptations of more familiar languages.

Transputer boards are generally programmed in modified versions of standard languages, such as Pascal, C, and Fortran. One of the more popular transputer languages, Occam, is akin to Pascal. Except for the parallelism commands, working with that type of language is similar to working with a standard dialect.

For each parallel system, however, a different software application that recognizes the number of transputer chips and their configuration must be written. You place that information in a header library that precedes the run library (the program itself). After compilation, the program will only run on that system or an identically configured system. Not one change can be made to the transputer hardware without going back to the original pro-

(Continued on page 94)

MARKET CENTER

FOR SALE

TUBES, new, unused. Send self-addressed, stamped envelope for list. **FALA ELECTRONICS**, Box 1376-2, Milwaukee, WI 53201.

RESTRICTED technical information: Electronic surveillance, schematics, locksmithing, covert sciences, hacking, etc. **Huge selection. Free brochures. MENTOR-Z**, Drawer 1549, Asbury Park, NJ 07712.

PHOTOFACT folders, under #1400 \$4.00. Others \$6.00. Postpaid. **LOEB**, 414 Chestnut Lane, East Meadow, NY 11554.

TUBES, name brands, new, 80% off list. **KIRBY**, 298 West Carmel Drive, Carmel, IN 46032.

CLASSIFIED AD ORDER FORM

To run your own classified ad, put one word on each of the lines below and send this form along with your check to:

Radio-Electronics Classified Ads, 500-B Bi-County Boulevard, Farmingdale, NY 11735

PLEASE INDICATE in which category of classified advertising you wish your ad to appear. For special headings, there is a surcharge of **\$25.00**.

Plans/Kits Business Opportunities For Sale
 Education/Instruction Wanted Satellite Television

Special Category: \$25.00

PLEASE PRINT EACH WORD SEPARATELY, IN BLOCK LETTERS.

(No refunds or credits for typesetting errors can be made unless you clearly print or type your copy.) Rates indicated are for standard style classified ads only. See below for additional charges for special ads. **Minimum: 15 words.**

1	2	3	4	5
6	7	8	9	10
11	12	13	14	15 (\$46.50)
16 (\$49.60)	17 (\$52.70)	18 (\$55.80)	19 (\$58.90)	20 (\$62.00)
21 (\$65.10)	22 (\$68.20)	23 (\$71.30)	24 (\$74.40)	25 (\$77.50)
26 (\$80.60)	27 (\$83.70)	28 (\$86.80)	29 (\$89.90)	30 (\$93.00)
31 (\$96.10)	32 (\$99.20)	33 (\$102.30)	34 (\$105.40)	35 (\$108.50)

We accept MasterCard and Visa for payment of orders. If you wish to use your credit card to pay for your ad fill in the following additional information (Sorry, no telephone orders can be accepted.):

Card Number

Expiration Date

Please Print Name

Signature

IF YOU USE A BOX NUMBER YOU MUST INCLUDE YOUR PERMANENT ADDRESS AND PHONE NUMBER FOR OUR FILES. ADS SUBMITTED WITHOUT THIS INFORMATION WILL NOT BE ACCEPTED.

CLASSIFIED COMMERCIAL RATE: (for firms or individuals offering commercial products or services) \$3.10 per word prepaid (no charge for zip code). **MINIMUM 15 WORDS.** 5% discount for same ad in 6 issues; 10% discount for same ad in 12 issues within one year; if prepaid. **NON-COMMERCIAL RATE:** (for individuals who want to buy or sell a personal item) \$2.50 per word, prepaid....no minimum. **ONLY FIRST WORD AND NAME** set in bold caps at no extra charge. Additional bold face (not available as all caps) **55¢ per word additional.** Entire ad in boldface, \$3.70 per word. **TINT SCREEN BEHIND ENTIRE AD: \$3.85 per word. TINT SCREEN BEHIND ENTIRE AD PLUS ALL BOLD FACE AD: \$4.50 per word. EXPANDED TYPE AD: \$4.70 per word prepaid.** Entire ad in boldface, \$5.60 per word. **TINT SCREEN BEHIND ENTIRE EXPANDED TYPE AD: \$5.90 per word. TINT SCREEN BEHIND ENTIRE EXPANDED TYPE AD PLUS ALL BOLD FACE AD: \$6.80 per word. DISPLAY ADS:** 1" x 2 1/4"—\$385.00; 2" x 2 1/4"—\$770.00; 3" x 2 1/4"—\$1155.00. **General Information:** Frequency rates and prepayment discounts are available. **ALL COPY SUBJECT TO PUBLISHERS APPROVAL. ADVERTISEMENTS USING P.O. BOX ADDRESS WILL NOT BE ACCEPTED UNTIL ADVERTISER SUPPLIES PUBLISHER WITH PERMANENT ADDRESS AND PHONE NUMBER.** Copy to be in our hands on the 12th of the third month preceding the date of the issue. (i.e., Aug. issue copy must be received by May 12th). When normal closing date falls on Saturday, Sunday or Holiday, issue closes on preceding working day. Send for the classified brochure. Circle Number 49 on the Free Information Card.

CABLE TV converters and descramblers. We sell only the best. Low prices. SB-3 \$79.00, we ship COD. Free catalog. ACE PRODUCTS, PO box 582 Dep't. E, Saco, ME 04072. (207) 967-0726.

TWO-WAY-RADIO, PC COMPUTERS, UNIDEN SERVICE. General Radiotelephone licensed technician. Catalog-**RAYS**, 2025 Moline, Ft. Worth, TX 76117. (817) 831-7717.

GREAT buys! Surplus prices, ICs, linears, transformers, PS, stepping motors, vacuum pump, phototransistor, meters, Isase, **FERTIK'S**, 5400 Ella, Phila., PA 19120.

CB RADIO OWNERS!

We specialize in a wide variety of technical information, parts and services for CB radios. 10-Meter and FM conversion kits, repair books, plans, high-performance accessories. Over 12 years of satisfied customers! Catalog \$2.

CBC INTERNATIONAL
P.O. BOX 31500RE, PHOENIX, AZ 85046

DESCRAMBLERS. All brands. Special combo Jerrold 400 and SB3 \$165. Complete cable descrambler kit \$39. Complete satellite descrambler kit \$45.00. Free catalog. **MJM INDUSTRY**, Box 531, Bronx, NY 10461-0531.

BANDSTOP Filters—Clear up channels affected by interfering signals. Channels 2, 3, 4, 8, 14, 15, 16, 17, 18, 19, 20, 21 and 22 available. \$20 each—10 for \$130. dB ELECTRONICS, P.O. Box 8644, Pembroke Pines, FL 33084.

ENGINEERING software. IBM/compatibles. CompDes Circuit Design. Basic electricity through circuit designs. CompMath. General mathematics through statistics. CompView. Digital Analysis, waveforms and filters. \$49. (614) 491-0832. **BSOFT SOFTWARE** 444 Colton Road, Columbus, OH 43207.

Multi-Channel Microwave T.V. Receivers



1.9-2.7 GHz Parabolic Dish 40+ dB Gain
LIFETIME WARRANTY
 Complete System \$99.95 (Shipping Incl.)
 Replacement Components
 & Expert Repairs Available

K & S ELECTRONICS Call now for same
 P.O. BOX 34522 day shipping!
 PHOENIX, AZ 85067 (602) 230-0640
\$2 CREDIT ON PHONE ORDERS

CABLE TV DESCRAMBLERS. Jerrold, Scientific Atlanta, Zenith, most major brands. Dealer Inquiries Welcome. Visa—M/C Accepted. **E & O VIDEO**, 9691 E. 265th Street, Elko, MN 55020. 1 (800) 638-6898.

GATED Pulse Decoder as described in December '88 Radio-Electronics article. Partial kit \$25.00. Works on in-band, out-band. AM or FM reference and pilotless systems. Canadian orders add \$2.00 shipping. Cannot accept A.R.Z. orders. Allow 4 to 6 weeks for delivery. **CYBERNETWORKS**, Box 41850, Phoenix, AZ 85080.

TUBES. New, old stock from Radio-TV stores. Send \$1.00 (refundable) for extensive lists. **DIERS**, 4276-E 4 North 50 Street, Milwaukee, WI 53216-1313.

CABLE Descramblers. Five piece specials, Hamlin \$50.00, Oak \$45.00, Jerrold DRX-3-DIC \$100.00, Zenith-call, units for all Tocom systems (714) 974-5688.

TEKTRONIX Oscilloscopes and other surplus equipment. Free Catalog. **MACTRONICS**, 19625 S.W. 269 Street, Homestead, FL 33031.

CONSOLIDATED ELECTRONICS

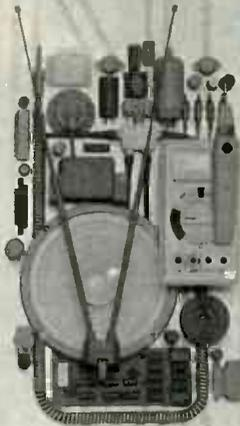

CONSUMER & INDUSTRIAL ELECTRONICS CATALOG • 17TH EDITION

THE ULTIMATE ELECTRONICS CATALOG.

Order your 260 page catalogue packed with over 10,000 money saving electronic parts and equipment. Send \$3.00 check or money order, or call **1-800-543-3568** today and use your Mastercard or Visa.
Consolidated Electronics, Incorporated
705 Watervliet Ave., Dayton, Ohio 45420-2599

NAME _____
ADDRESS _____
CITY _____
STATE _____ ZIP _____

CIRCLE 70 ON FREE INFORMATION CARD

FREE CATALOG

FAMOUS "FIRESTIK" BRAND CB ANTENNAS AND ACCESSORIES. QUALITY PRODUCTS FOR THE SERIOUS CB'er. SINCE 1962
FIRESTIK ANTENNA COMPANY
2614 EAST ADAMS
PHOENIX, ARIZONA 85034

CABLE TV CONVERTERS/DESCRAMBLERS. Free Catalog! VIDEO MART 3938 E. Grant #241-C, Tucson, AZ 85712. (602) 721-6557.

T.V. Tunable notch filters. Free Brochure. **D.K. VIDEO,** Box 63/6025, Margate, FL 33063. (305) 752-9202.

Fair Pricing (313) 979-8356. Lots 5 and 10; 65 SB 55; 65 MLD 1200 55; 85 TriBi 75; 90 SA 80; 105 SSAVI 95; 295 Pioneer 275; 180 Z-Tac 170; 180 Tocom 170; 18 Filters any channel-15; No Michigan sales.

MICROWAVE TV RECEIVERS 1.9 to 2.7 GHz



2 CH Compact Dish System - \$77.95
5 CH Dish System - \$93.95
12 CH Yagi (Rood) System - \$123.95
30 CH Dish System-\$163.90 Yagi-\$183.90
SUN MICROWAVE INTL. INC. Send \$1.00 for catalog on these and other fine video products.
P.O. BOX 34522
PHOENIX, AZ 85067
(602) 230-0640
QUANTITY DISCOUNTS LIFETIME WARRANTY

The **DECODER.** Satellite and Cable Descrambling Newsletter. News-Schematics-Modifications-Reviews. \$24.00/year. Complementary sample. **TELECODE,** Box 6426, Yuma, AZ 85366-6426.

LOW prices - ICs, transistors, capacitors, switches. Special 27128 - \$3. 7805 - \$.24. Flyer SASE. **SAN-TECH** 11 Revere Place, Tappan, NY 10983. (914) 359-1130.

SENIOR PROM - For all your Eprom needs! Duplication, Programming, Supplies. Great Prices! Write for details. **SENIOR PROM,** 11 Manor Ridge Drive, Princeton Junction, NJ 08550.

REDUCED 75% Diehl Mark V-Scanner \$249. Diehl Mark III \$99. **NEW, WEEC** 2805 University Ave., Madison, WI 53705. (608) 233-9741, (608) 238-4629.

RADIO Amateur (HAM) Education. Learn at home or in your car. VHS Video or Audio Cassettes. Easy to obtain License. Free information. **AMATEUR RADIO SCHOOL** 2350 Rosalia Drive, Fullerton, CA 92635.

ALUMINUM image transfer process, your artwork to aluminum. Write: **J & E ENTERPRISES,** 2457 N. Marmora, Chicago, IL 60639.



TUBES - 2000 TYPES DISCOUNT PRICES!

Early, hard-to-find, and modern tubes. Also transformers, capacitors and parts for tube equipment. Send \$2.00 for 24 page wholesale catalog.

ANTIQUE ELECTRONIC SUPPLY
688 W. First St. • Tempe, AZ 85281 • 602/894-9503

FAIR prices SB-3, Z-TAC, SA3, TRI-BI, MLD-1200-3. Pioneer, any notch filters. Small dealer only. No Michigan sales (313) 979-8356.

COMMODORE /Amiga chips, Diagnostics, parts or low cost repairs (eg. C-64 - \$49.95 + UPS). Catalog and Dealer pricing available. **VISA/MC. KASARA MICROSYSTEMS, INC.,** (Division of QEP) Route 9W/Kay Fries Drive, Stony Point, NY 10980. 1 (800) 248-2983 or (914) 942-2252.

TEST Equipment pre-owned now at affordable prices. Signal generators from \$50. Oscilloscopes from \$50, other equipment, including manuals available. Send for catalog **J.B. ELECTRONICS,** 9518 Grand Ave., Franklin Park, IL 60131. (312) 451-1750.

LASERS, from \$40, for brochure write **MWK INDUSTRIES,** 9852 W. Katella, Suite 340R, Anaheim, CA 92804. Or call (714) 956-8497.

CATV Converters & Descramblers. Quality Products. Professional Service. Call 1 (800) 541-5487. Visa/MC accepted. **MOUNTAINTECH. INC.** Box 5074, Mt. Crested Butte, CO 81225.

RENTAL MOVIE STABILIZER Connect between VCRs or to monitor. Satisfaction Guaranteed. \$59.95, \$4 handling. 1 (800) 367-7907.

Hi-TECH Chip Kit will read data stream for Z-TAC or any SSAVI. Experimenters Chip Kit = 39.00 with pre wired tuner = 49.00, ready to go SSAVI = \$149.00, ready to go Z-TAC = \$249.00. Other Hi-Tech units available. **HI-TECH ELECTRONICS,** P.O. Box 42423, Detroit, MI 48242. (313) 722-9381.

CABLE TV converters - free catalog - Zenith, Tocom, Scientific Atlanta, Jerrold, Pioneer, Oak, Panasonic - Remotes, Video Accessories. Best Buys/Service, Monthly Specials. **ARIZONA VIDEO,** 3661 N. Campbell, #310-A, Tucson, AZ, 85719. (602) 323-3330.

CABLE DESCRAMBLER LIQUIDATION. Major makes and models available. Industry pricing! (Example: Hamlin Combo's, \$44 each...minimum 10 orders). **DEALERS ONLY! Call WEST COAST ELECTRONICS,** (818) 709-1758.

TOCOM 5503 VIP. Circuit to automatically "TURN-ON" descrambler. All modes. \$35.00 **MIKE** Box 743, Oldsmar FL 34677, COD's.

EXTRA strength Apex® screwdriving bits. Popular and hard-to-find sizes. Free information. **SHOCKEY'S** 5841 Longford Road, Dayton, OH 45424-2940. (513) 236-2983.

HOTTEST European C64 games for only \$5/DS disk! Free catalog: **T.G.S.,** Box 491, New York, NY 11375.

PLANS AND KITS

BUILD this five-digit panel meter and square-wave generator including an ohms, capacitance and frequency meter. Detailed instructions \$2.50. **BAG-NALL ELECTRONICS,** 179 May, Fairfield, CT 06430.

Scientific Atlanta & Pioneer Cable Descramblers in Stock

AC/DC - The New Leader in Low Prices

• We will match or beat anyone's advertised price •

ITEM	ONE UNIT	10+ UNITS
PIONEER ADD ON PD-2 DECODER FOR ALL PIONEER SYSTEMS	250.00	200.00
PANASONIC WIRELESS CONVERTER 1403N	79.95	69.00
JERROLD JSX3-DIC 36 CHANNEL CONVERTER	84.95	65.00
JERROLD 400 WITH REMOTE (MANUAL FINE TUNING)	64.95	55.00
JERROLD 400 COMBO W/ REMOTE (DRX3DIC)	134.95	100.00
JERROLD 450 COMBO W/ REMOTE (DRZ3DIC)	169.95	125.00
JERROLD 400 OR 450 REMOTE HAND UNIT	24.95	15.00
JERROLD SB ADD ON	74.95	55.00
JERROLD SB ADD ON WITH TRI-BI	95.00	75.00
OAK M-35 COMBO	94.95	65.00
OAK MINICODE (N-12)	84.95	59.00
OAK ECONOCODE (E-13)	64.95	40.00
HAMLIN MLD-1200	64.95	55.00
EAGLE PD-3	99.95	60.00
ZENITH SSAVI CABLE READY	149.95	100.00
SCIENTIFIC ATLANTA SA-3 ADD ON	109.95	80.00
INTERFERENCE FILTER (CHANNEL 3 OR 6)	24.95	14.00
TOCAM REPLACEMENT	250.00	200.00
PANASONIC CONVERTOR W/ VOLUME CONTROL (170 3PB)	109.95	95.00
SCIENTIFIC ATLANTA 8580	299.95	249.00
SCIENTIFIC ATLANTA 83 CHANNEL CONVERTER	94.95	79.00
SCIENTIFIC ATLANTA 8535	210.00	175.00
PIONEER CONVERTOR (4535)	89.95	75.00

QUANTITY	ITEM	OUTPUT CHANNEL	PRICE EACH	TOTAL PRICE
			SUBTOTAL	
			Shipping Add	\$3.00 per Unit
			COD	Add 5%
			TOTAL	

It is not the intent of AC-DC to defraud any pay television operator and we will not assist any company or individual in doing so.

PLEASE PRINT: Cashier's Check Money Order COD

Name _____
Address _____
City / State / Zip _____
Signature _____ Phone Number () _____

WAIVER. Since I, the undersigned, fully understand that the ownership of a cable decoder does not give the owner of the decoder the right to decode or view premium cable channels without proper authorization from their local cable company, hereby declare under penalty of perjury that all products purchased, at any time, will only be used on cable TV systems with proper authorization from local officials or cable company officers in accordance with all applicable federal and state laws. Federal and various state laws provide for substantial criminal and civil penalties for unauthorized use.

Dated: _____ Signed: _____

ATLANTIC CABLE DISTRIBUTING CENTER INC.
366 N. BROADWAY, SUITE 310, JERICHO, NY 11759.
516 - 625-3550 IMPORTANT: Have make and model of the equipment used in your area **516 - 625-3532**

CIRCLE 64 ON FREE INFORMATION CARD

One tree can make
3,000,000 matches.

One match can burn
3,000,000 trees.

A Public Service of This Magazine
& The Advertising Council

SINGERS! REMOVE VOCALS FROM RECORDS AND CDs!

SING WITH THE WORLD'S BEST BANDS!

An Unlimited supply of Backgrounds from standard stereo records! Record with your voice or perform live with the backgrounds. Used in Professional Performance yet connects easily to a home component stereo. This unique product is manufactured and sold Exclusively by LT Sound - Not sold through dealers. Call or write for a Free Brochure and Demo Record.

LT Sound, Dept. R.L-3, 7980 LT Parkway
Lithonia, GA 30058 (404) 482-4724
Manufactured and Sold Exclusively by LT Sound
24 HOUR PHONE DEMO LINE: (404) 482-2485

INVESTIGATORS, Experimenters. Quality new plans hard to find. Micro and restricted devices. Free catalog. **SASE KELLEY SECURITY, INC.**, Suite 90, 2531 Sawtelle Blvd., Los Angeles, CA 90064.

SNOOPER stopper kit of parts, educational manual prevents cable company spys discovering descramblers, extra hookups. \$19.95. **WORLD MARKET IMPORTS**, MPO-476, Saint John, Canada, E2L-3Z8.

FIBER, Optic Development Kit: Contains all the components to complete a digital communication link. Send \$16.95 to **INDUSTRIAL FIBER OPTICS** Box 3576, Scottsdale, AZ 85257.

SURVEILLANCE equipment design gives 58 schematics of Sheffield Electronics' surveillance devices. Circuits explained. Transmitters range from pens to one-mile VOX's including crystal, subcarrier, carrier current, infrared, firefly, automobile. Demodulators given. Cube tap and duplex mains powered transmitters presented. Eighteen telephone transmitters are leech and battery types including crystal and subcarrier. Countermeasures chapter. Much more. This 8 1/2 x 11-inch 110 page book is illustrated with photographs. Price \$30.00 + \$4.00 S & H. First class mail U.S. & Canada. One-day processing, pay with Money Order or Cashier's Check. Send to: **WINSTON ARRINGTON**, 7223 Stony Island Ave., Chicago, IL 60649-2806.

"**CB Trick of the Trade** book" learn CB repair tricks and tuning tricks. Send \$19.95 to **MEDICINE MAN**, CB P.O. Box 37, Clarksville, AR 72830.

FM transmitter 88 to 108 MHz Kit \$12.95 **Sierra Electronics**. Box 709, Elfers, FL 34680-0709.

ELECTRONIC Kits! Transmitters! Recorders! Phone devices! Bug detectors! Surveillance items! More! Catalog \$1.00: **XANDI ELECTRONICS**, Box 25647, 60M, Tempe, AZ 85285-5647.

HOTTEST European C64 games for only \$5/DS disk! Free catalog; **T.G.S.**, Box 491, New York, NY 11375.

FINALLY!
An interesting and worthwhile project. This **EASY-TO-BUILD** circuit lets you use any regular TV set as a simple **OSCILLOSCOPE**. Build for less than \$10. **NO MODIFICATIONS TO TV!** Single or dual trace. Send for **FREE CATALOG** of other plans and kits.

DETAILED PLANS: \$4.95
TV-SCOPE
PENN RESEARCH,
Box 3543
Williamsport, PA 17701

FINALLY!
An interesting and worthwhile project. This **EASY-TO-BUILD** circuit lets you use any regular TV set as a simple **OSCILLOSCOPE**. Build for less than \$10. **NO MODIFICATIONS TO TV!** Single or dual trace. Send for **FREE CATALOG** of other plans and kits.

EDUCATION & INSTRUCTION

BE a recording engineer; Train at home for high paying-exciting careers. Free information. **AUDIO INSTITUTE** 2174 Union St., Suite 22K, San Francisco, CA 94123.

COMPUTER/satellite video tapes: Make \$50,000 or more per year! Step by Step instructions. How to build IBM PC-XT compatible computers. \$69.95. How to repair Videocipher II descramblers. \$69.95. **COMPUTER BOARDS UNLIMITED** 1317 West North Ave., Baltimore, MD 21217. (301) 728-3690.

MAGIC! Four illustrated lessons plus inside information shows you how. We provide almost 50 tricks including equipment for four professional effects. You get a binder to keep the materials in, and a one-year membership in the International Performing Magicians with a plastic membership card that has your name gold-embossed. You get a one-year subscription to our quarterly newsletter "IT'S MAGIC!" Order now! \$29.95 for each course + \$3.50 postage and handling. (New York residents add applicable state and local sales tax). **THE MAGIC COURSE**, 500-B BiCounty Boulevard, Farmingdale, NY 11735.

F.C.C. Commercial General Radiotelephone license. Electronics home study. Fast, inexpensive! "Free" details. **COMMAND**, D-176, Box 2223, San Francisco, CA 94126.

HAM licenses supereasy. **Bahr** 2535-E2 Marietta, Palmbay, FL 32905.

SCRAMBLE FACTS

718-343-0130

PHONE TODAY for 3 minutes of satellite TV industry news, technical tips, and new product information.

WALNUT SPEAKER CABINET KIT

Super quality, genuine walnut veneer cabinet. Kit includes: routed and mitred top, sides, and bottom in unfinished 3/4" walnut veneer. Cut your own custom holes in the front and rear to match your drivers. 15" x 24" x 11". Volume: 1.9 cu. ft.

#260-350 \$22.50 \$19.95
(1-3) (4-up)

15" THRUSTER WOOFER

Thruster by Eminence. Made in U.S.A. Forward poly roll foam surround, 96 oz. magnet. 2-1/2", 2 layer voice coil. 150 watts RMS, 210 watts max. 4 ohm. fs = 23.5 Hz, QMS = 9.86, QES = .34, QTS = .33, VAS = 17.9 cu. ft. SPL = 94.8 dB 1W/1M. Net weight: 15 lbs.

#290-180 \$43.50 \$39.80
(1-3) (4-up)

SUBWOOFER CROSSOVER

200 watts RMS. 12 dB per octave, 150 Hz at 8 ohm crossover point.

#260-220 \$28.80 \$24.40
(1-5) (6-up)

SPEAKERS AND COMPONENTS

PIONEER
MG ELECTRONICS

EMINENCE

MOTOROLA
Polydax

12" POLY WOOFER

Super duty, 40 oz. magnet. Polypropylene cone. 100 watts RMS, 145 watts max. 4 and 8 ohm compatible (6 ohm). 2" voice coil. fs = 25 Hz. VAS = 10.8 cu. ft., QTS = .166. Response: 25-1,500 Hz. Net weight: 9 lbs.

#290-125 \$36.80 \$34.50
(1-3) (4-up)

12" PIONEER SUB WOOFER

Dual voice coil sub woofer. 30 oz. magnet, 2" voice coil. 100 watts RMS, 145 watts max. fs = 25 Hz. 6 ohm (4 and 8 ohm compatible). SPL = 89 dB 1W/1M. Response: 25-700 Hz. QTS = .31, VAS = 10.3 cu. ft. Pioneer #A30GU30-55D. Net weight: 6 lbs.

#290-145 \$39.80 \$36.80
(1-3) (4-up)

15" 3-WAY, 125 WATT SYSTEM

Our "Top-of the Line" system. The system features elements specifically selected to produce a balanced output throughout the full frequency bandwidth of the system. System includes: (1) #290-155 15" polypropylene woofer rated at 145 watts max, (2) #280-020 cup midranges, (1) #270-035 4" soft dome tweeter, (1) #260-215 200 watt 3-way crossover, (2) #260-265 100 watt mid, tweeter "L" pad attenuators, (1) #260-300 speaker terminal, and (1) #260-340 grille cloth.

#15-125 \$99.95
Each

18" EMINENCE WOOFER

100 oz. magnet, 3" voice coil. 250 watts RMS, 350 watts max. 8 ohm, 30 Hz resonant frequency. 22-2700 Hz response. Efficiency: 95 dB 1W/1M. Paper cone treated accordin surround. Net weight: 29 lbs.

#290-200 \$98.80 \$89.50
(1-3) (4-up)

PIONEER HORN TWEETER

Mylar dome, 2.93 oz. barium ferrite magnet. 8 ohm. Response: 1,800-20,000 Hz. 35W RMS, 50W max. fs = 2,000 Hz, SPL = 106 dB. Pioneer #AHE60-51F.

#270-050 \$6.50 \$5.90
(1-9) (10-up)

3-WAY 100W CROSS-OVER

12 dB / octave rolloff. 800 Hz, 5000 Hz. 8 ohm. 100 watts RMS.

#260-210 \$12.50 \$9.95
(1-9) (10-up)

Parts Express
International Inc

340 E. First St., Dayton, OH 45402
Local 1-513-222-0173
FAX: 513/222-4644

CALL TOLL FREE

1-800-338-0531

* 15 day money back guarantee. * \$10.00 minimum order. * We accept Mastercard, Visa, Discover, and C.O.D. orders. * 24 hour shipping. * Shipping charge = UPS chart rate (\$2.50 minimum charge). * Hours: 8:30 am - 6:00 pm EST, Monday - Friday. * Mail order customers, please call for shipping estimate on orders exceeding 5 lbs.

FREE CATALOG

HIGH TECH ELECTRONICS

SCRAMBLER PHONES! Phone bug detectors! Electronic countermeasures equipment! Executive and personal protection products! And much more!!! Catalog \$3.00 (Refundable with first order) **DIVERSIFIED WHOLESALE PRODUCTS**, P.O. Box 1275-RE, Redondo Beach, CA 90278.

BIG PROFITS! ELECTRONIC ASSEMBLY BUSINESS

Start home, spare time. Investment knowledge or experience unnecessary. **BIG DEMAND** assembling electronic devices. Sales handled by professionals. Unusual business opportunity.

FREE: Complete illustrated literature
BARTA, RE-O Box 248
Walnut Creek, Calif. 94597

BUSINESS OPPORTUNITIES

EARN thousands with your own part time electronics business. I do. Free proof, information. **INDUSTRY**, Box 531, Bronx, NY 10461-0531.

PROJECTION TV... Make \$\$\$'s assembling Projectors. Easy!... Results comparable to \$2,500 projectors... **Plans, 8" Lens & Dealers** information \$22.50... Professional Systems available... Illustrated catalog free. **MACROCOMA 15GHX** Main Street, Washington Crossing, PA 18977... Credit-card Orders 24 hrs. (215) 736-2880.

GOVERNMENT jobs \$15,400-\$72,500. Now hiring. Excellent benefits. Call (312) 742-1142. Ext. J-4673.

BIG PROFITS!

Learn VCR cleaning/repair! Prior experience unnecessary. Need only small hand tools, average mechanical ability. **Big demand** performing VCR cleanings and repairs! Viejo's 400 page **TRAINING MANUAL** (over 500 photos and illustrations!) and companion **VIDEO TRAINING TAPE** contains hundreds of REAL-WORLD examples of VCR malfunctions and their repair solutions. Secrets revealed! Also: business tips for your new service business!

Free INFO: call (toll free) 1-800-537-0589 or write to:
Viejo Publications, Dept. R-E 3540 Wilshire Blvd., Suite 310, Los Angeles, CA. 90010

EASY work! Excellent pay! Assemble products at home. Call for information. (504) 641-8003 Ext. 5192.

MANUFACTURE electronic equipment at home for the Army, Navy, Air Force, and NASA. Will supply plan. Inexpensive easy to build equipment. Government pays \$4,000. Cost you \$900. Profit \$3,100. Send \$35.00 to: **SUBCONTRACT R & D**, 136-31 222nd Laurelton, NY 11413 (REE)

P.C. board design and plotting services. Insertion and surface mount technology. Call for artwork samples. (509) 586-4469.

Scrambling News

Scrambling systems apply the latest in electronic technology. Interesting News, technical feature articles, new patents, turn-ons, feedback. Monthly \$24.95/yr Sample \$3. Scrambling News: Year 1 \$22.95. With current subscription \$45. Advanced Cable and Satellite Descrambling (New) Not a rehash \$19.95. MDS/MMDS Wireless Cable Hacking (New) \$12.95. Experiences with Videocypher \$14.95 (New). All new Spring product catalog \$1.

Scrambling News, 1552 Hertel Ave., Buffalo, N.Y. 14216 COD's 716-874-2088

SATELLITE TV

CABLE TV Secrets—the outlaw publication the cable companies tried to ban. HBO, Movie Channel, Showtime, descramblers, converters, etc. Supplier's list included \$8.95. **CABLE FACTS**, Box 711-R, Pataskala, OH 43062.

SATELLITE TV receiver kits! Instruction manuals! Boards! Semiconductor parts! 59 deg LNA's! LNB's! Ku-Band LNB's! Catalog \$1.00 **XANDI ELECTRONICS**, Box 25647, Dept. 21SS, Tempe, AZ 85285-5647.

VIDEOCYpher II descrambling manual, schematics, video and audio. Explains DES, EPROM, Wizardplus, KeysRuS, Clonemaster, 3Musketeer. Pay-per-view (HBO, Cinemax, Showtime, adult, etc.) \$13.95, \$2 postage. **CABLETRONICS**, Box 30502/R, Bethesda, MD 20814.

AMAZING SCIENTIFIC & ELECTRONIC PRODUCTS

PLANS

Build Yourself! — All Parts Available in Stock

LC7— BURNING CUTTING CO ₂ LASER	\$20.00
RUB4— PORTABLE LASER RAY PISTOL	\$20.00
TCC1— 3 SEPARATE TESLA COIL PLANS TO 1.5 MEV	\$25.00
IOG1— ION RAY GUN	\$10.00
GRA1— GRAVITY GENERATOR	\$10.00
EML1— ELECTRO MAGNET COIL GUN LAUNCHER	\$8.00

KITS

With All Necessary Plans

MFT3K— FM VOICE TRANSMITTER 3 MI RANGE	\$49.50
VWPM7K— TELEPHONE TRANSMITTER 3 MI RANGE	\$39.50
BTC3K— 250,000 VOLT 10-14" SPARK TESLA COIL	\$249.50
LHC2K— SIMULATED MULTICOLOR LASER	\$44.50
BLSK— 100,000 WATT BLASTER DEFENSE DEVICE	\$69.50
ITMK— 100,000 VOLT 20' AFFECTIVE RANGE INTIMIDATOR	\$69.50
PSP4K— TIME VARIANT SHOCK WAVE PISTOL	\$59.50
STAIK— ALL NEW SPACE AGE ACTIVE PLASMA SABER	\$59.50
MVPIK— SEE IN DARK KIT	\$199.50
PTGIK— SPECTACULAR PLASMA TORNADO GENERATOR	\$149.50

ASSEMBLED

With All Necessary Instructions

BTCL0— 50,000 VOLT-WORLD'S SMALLEST TESLA COIL	\$54.50
LGU40— 1MW HeNe VISIBLE RED LASER GUN	\$249.50
TAT30— AUTO TELEPHONE RECORDING DEVICE	\$24.50
GVPI0— SEE IN TOTAL DARKNESS IR VIEWER	\$349.50
LIST0— SNOOPER PHONE INFINITY TRANSMITTER	\$169.50
IPG70— INVISIBLE PAIN FIELD GENERATOR MULTI MODE	\$74.50

● **CATALOG** CONTAINING DESCRIPTIONS OF ABOVE PLUS HUNDREDS MORE AVAILABLE FOR \$1.00 OR USE OUR PHONE FOR "ORDERS ONLY" 603-673-4730.

PLEASE INCLUDE \$3.00 PH ON ALL KITS AND PRODUCTS PLANS ARE POSTAGE PAID. SEND CHECK, MO. VISA, MC IN US FUNDS.

INFORMATION UNLIMITED
P.O. BOX 716 DEPT. RE. AMHERST, NH 03031

CATALOG OR INFORMATION: (213) 888-8988
TOLL FREE 1-800-423-3483 OR
1-800-521-MARK (IN CAL) FOR ORDERS

PAID BY ONLY

ORDER BY FAX (213) 888-6868

VIDEO/AUDIO SURROUND SOUND PROCESSOR
SM-333



It creates high quality simulated stereo Surround "Music Field" for most video types CD, LD, Surround Sound Encoded VHS, Laser, etc. This processor employs the most updated IC in its heart. It is also equipped with a DNR DYNAMIC NOISE REDUCTION SYSTEM IC made by NATIONAL SEMICONDUCTOR to particularly filter out the annoying noise that is commonly found on tapes or CD disc. In addition, there is an NOISE OP. AMPS and all in one board design no other external connections connect to the main board.

Other features include:
• Continuous Variable Audio Time Delay
• Surround Effect & Level Control
• Dynamic Noise Reduction System
• High output signal (6V MAX) can match with any kind of Main Power Amp
• All metal construction for reliability & durability!

SPECIFICATIONS:
Frequency Response: 20Hz - 20KHz ± 2.5dB • Total Harmonic Distortion: 0.05% 20Hz - 20KHz (front channel) < 0.25% (surround channel) • Input Signal Voltage: 0.1V - 3.5V • Output Voltage: 0.1V - 3.5V (front channel), 6V MAX (surround channel) • Delay Time: 5ms - 50ms • Input Impedance: 47K Ohms Power AC 110V 60Hz • Dimensions: 4 3/16" (W) X 4 13/16" (D) X 2 1/16" (H)
KIT/ASM. AND TESTED. \$72/93

STEREO SIMULATOR TA-3000



UPGRADE YOUR TV & VCR
This simulator is special designed to give the most accurate stereo impression to L.S. It reproduces and enhances an original stereo effect since the L.S. is required for the best of stereo sound. SET & TRANSDUCER The simulator can even help you to provide your television with an amplifier to a stereo one with a built in STEREO function. Our simulator is also applicable to any other stereo systems. In coloring it is an ANALOG STEREO. Subsequently it is the most economical entertainment for every family. While in standard condition it gives interesting pleasure.
KIT \$43.38
ASM. AND TESTED

100W + 100W NEW CLASS 'A' DC STEREO PRE-MAIN AMP
TA-1500



200W POWERFUL AMP W/MIC MIXER!
KIT \$73.70
METAL CABINET/XFORMER \$26/\$168.00

MARK V ELECTRONICS, INC.
8019, E. SLAUSON AVE.
MONTEBELLO, CA 90640

SHOWROOM HOURS: (PACIFIC TIME)
MON. - FRI. 9:30 TO 5:00 SAT. 10:00 - 5:00

0-15V 2A REGULATED DC POWER SUPPLY
MW-200/TR200

This regulated DC Power Supply is designed for both precision and amateurs. It features Short Circuit Protection System, Overload Indicator, Output Cut-off Switch, and Adjustable Overload Protection System. So it is a must for every laboratory and production line.



SPECIFICATIONS & FEATURES

Output Voltage: Continuous adjustable from 0 to 15V DC
Output Current: Continuous adjustable from 0.2A to 2A
Method of Protection: Current Limited (in case of overload, output voltage will automatically decrease to the minimum)
Overload Indicator: LED (lit up)
Ripple & Noise: Less than 1 mV (no-load loading)
Stability of Output Voltage: Less than 10 mV
Power Requirements: 100-120V/200-220V AC/10A
Dimensions: 125mm (H) x 187mm (W) x 125mm (D)
ASSEMBLED AND TESTED \$80.00

HIGH QUALITY PRE-AMPLIFIER WITH 10 BAND EQUALIZER
TA-2500



ELECTRONIC ECHO AND REVERBERATION AMPLIFIER
TA-2400A



MULTIFUNCTIONAL LED D.P.M.



MEASUREMENT RANGE
D.C. VOLTAGE 1mV - 1000V
A.C. VOLTAGE 1mV - 1000V
DIGITAL THERMOMETER 0°C - 100°C
D.C. CURRENT 1µA - 2A
CAPACITOR METER 1pF - 2µF
DIMENSIONS: 3 3/4" x 1 7/8" x 4 1/16"
KIT \$34.50
ASM. AND TESTED & CAL. \$43

DIGITAL VOICE MEMO TA-28 MKII



NEW

FEATURES

- SOLID STATE RECORD/PLAY BACK.
- POWER/RECORD LED INDICATOR.
- 4 BIT ADPCM ALGORITHM.
- 8 BIT A/D/D/A CONVERTER.
- 256K MEMORY CAPACITOR.
- 8 SEC OR 16 SEC RECORD TIME.
- SAMPLING FREQUENCY 8KHz OR 4 KHz.
- INCLUDED CONDENSOR MIC & SPEAKER.
- BUILT IN LOW PASS FILTER.
- MORE REALISTIC & CLEARLY.
- LOW POWER CONSUMPTION.
- SUPPLY VOLTAGE: 5V DC
- DIMENSIONS: 3 3/4" x 2 1/4" x 1"
- FREE 256K TQY GRADE D-RAM

KIT/ASM & TESTED \$30/40

8 Digit 1GHz Multifunctional Counter FC-1000A



A small laboratory bench digital counter with 8 1/2 FUNCTION push buttons. FREQUENCY PERIOD UNIT (Hz/SEC) DATA HOLD & 8 1/2 DIGIT. The panel controls make the instrument outstanding for home use (recorder, a display, tone, etc.). Bright LED display shows frequency, Hz, kHz, MHz, GHz, etc. The digital display can be used to enable the accuracy of measurement. Data is stored in a 1000000 word memory. Comes complete in kit, assembled and tested.

FEATURES:

- Frequency range: 10Hz - 10GHz. GUARANTEED 1% accuracy.
- Resolution: 10Hz, 100Hz, 10KHz, 100KHz, 1MHz, 10MHz, 100MHz, 1GHz, 10GHz.
- Period range: 0.5µs - 100s.
- Unit changing capacity: 99999999.
- Accuracy: Absolute Error: 0.001% or better.
- Hold function: Hold time: more than 1000 hrs. 8 digits.
- Operating temp.: 0°C - 50°C (32°F - 122°F).
- Dimensions: 2 1/2" (W) x 7 1/2" (D) x 3 1/2" (H).
- KIT/ASM AND TESTED & CAL. \$192.00

TA-477 120W MOSFET POWER AMPLIFIER

BUILD A PROFESSIONAL AMP BY YOURSELF

This amplifier consists of three super low TIV differential stages and Hitachi 2S149 75K 134 match pair MOSFET at output component whose frequency response and transient response is superior to the other power transistor. Therefore this amplifier has high fidelity and superior analytic power over the entire Audio Spectrum. It is suitable for reproducing classic and modern music. Heavy Duty Heat Sink with 28 radial fins is included.
KIT \$86.00
Metal Cabinet/X Former (Optional) \$33.00/24.00

TERMS: \$10.00 min order • \$20.00 min charge card order • Check, money order or phone order accepted • We ship UPS Ground • Add 10% of total order (min \$2.5) for shipping, outside USA add 20% (min \$5.00) • Transit Insurance: add 5% of total (outside USA only) • CA residents add sales tax • All merchandise subject to prior sale • Prices are subject to change without notice • Any goods proved to be defective MUST BE RETURNED IN ORIGINAL FORM WITH A COPY OF YOUR INVOICE WITHIN 30 DAYS FOR REPLACEMENT.

CIRCLE 93 ON FREE INFORMATION CARD

www.americanradiohistory.com

SHORTWAVE RADIO

continued from page 73

source—frequencies, it has continued to solve problems. Although disputes have sometimes been heated and bitter, the participants have realized that failure to compromise could lead to the collapse of the organization, which would be detrimental to all the members.

It's surprising that similar groups, operating regionally, have not yet emerged. For example, a Far Eastern IFCC, coordinating frequencies around the Pacific rim, would certainly improve the situation in that area of the world.

Anyone wanting a free copy of a recent coordinated schedule, which consists of 32 pages of material, should write to Shirley Sandler, RFE/RL Inc., 1775 Broadway, New York, NY 10019.

Shortwave conditions

As the days lengthen in March and April, the higher frequencies will remain open for DX longer than during the winter months. During the day in the east, 15 MHz, 17 MHz, 21 MHz, and 26 MHz will be possible from early morning until several hours after sunset. The amateur 100-meter band will open to Europe, and openings to South America and Africa will also occur regularly; in the late afternoon, trans-Pacific 10-meter openings will occur.

During the evening and nighttime hours, good to excellent DX will be possible in all bands from 6 MHz to 15 MHz, depending upon the location of the transmitting station; moreover, 17 MHz will be open, especially from Africa and Latin America.

Due to approaching summer conditions, noise levels in the broadcast band will begin to increase, making DX more difficult than it has been.

During years of high sunspot activity the number of severe ionospheric storms increases. As a result, radio conditions periodically become very poor. Disturbed conditions tend to peak during the equinox months of March and September. Major storms can black out virtually the entire shortwave spectrum for a day or two at a time. In the early days of radio, many listeners and radio amateurs dismantled their radios looking for bugs that weren't there. R-E

LETTERS

continued from page 15

full voltage will be dumped across the remaining capacitor(s), which will also fail.

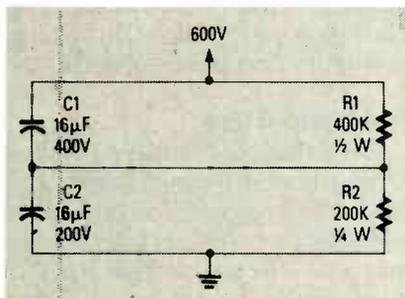

FIG. 1

Usually a resistive divider of suitable wattage, with resistance proportional to the WVDC of the capacitors, and whose total value will allow a current flow of approximately 1 mA, will protect the capacitors from that mode of failure. (See Fig. 1.) The nominal values would be 1 KΩ per volt and $0.001 \times$ the resistance in KΩ wattage.

I enjoy your magazine a great deal. It is always full of all kinds of interesting stories, projects, and technology updates.
VIC SCHMIDTMANN
Newark, CA

ACTIVE ANTENNA

In the article "Active Antenna" (Radio-Electronics, February 1989), Fig. 2, which shows Q1-FET, MPF102, would lead you to believe that the middle lead is the gate. Of

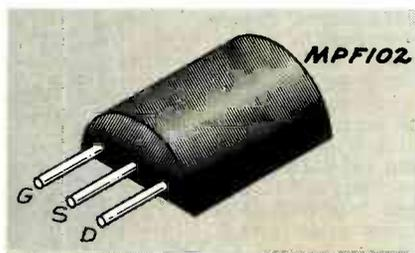

FIG. 2

course, it isn't; it is the source (or "S"). The photograph, Fig. 3 of the article, bears that out. It shows MPF102 to be twisted—if you look very closely.

My drawing (Fig. 2) is correct.
JOHN L. KURSCHNER
Toms River, NJ

R-E

Active keeps you active!



Whether you are in an "after-hour emergency" or are a dedicated "do-it-yourselfer", **Active** can help you! Visit one of our conveniently located stores, or refer to our catalogue. Call toll-free to access North America's largest and best selection of electronic components and accessories! **Active**, an affiliate of **Future Electronics** has over 12,000 first grade, industrial items in stock ready for **immediate delivery**.

You can count on us!

Locations Nearest You

Westborough, MA 508-366-8899	Chicago, IL 312-593-6655
Woburn, MA 617-932-4616	Seattle, WA 206-881-8191
Long Island, NY 516-471-5400	Santa Clara, CA 408-727-4550
Mt. Laurel, N.J. 609-273-2700	Baltimore, MD 301-536-5400
Detroit, MI 313-689-8000	BY PHONE 1-800-ACTIVE-4



TOLL-FREE 1-800-ACTIVE-4

CIRCLE 52 ON FREE INFORMATION CARD

NUTS & VOLTS P.O. Box 1111-E
MAGAZINE Placentia, CA 92670
714-832-7724

GIVE YOURSELF A BREAK — A PRICE BREAK!
NUTS & VOLTS WILL *Save* YOU MONEY
ON ELECTRONIC PARTS & EQUIPMENT
Plus SHOW YOU WHERE TO FIND UNIQUE,
UNUSUAL AND HARD-TO-FIND ITEMS.

SUBSCRIBE TODAY!

A National Publication For The Buying And Selling Of Electronic Equipment

Subscription Rates	
US FUNDS REQUIRED	
3rd Class Mail-USA	
One Year	\$12.00
Two Years	\$23.00
Life Time	\$60.00
1st Class Mail	
One Year USA	\$20.00
Canada Mexico	\$22.00
Air Mail	
Foreign 1 Yr	\$55.00

DESCRAMBLER MODULE

LATEST technology alternative to Jerrold SB-3 or Radio-Electronics Feb. 1984 project. Featuring electronic tuning, AGC, auto-on/off, AC/DC power, mini-size, A&T, and more. For literature—SOUTHTECH DISTRIBUTING, (813) 527-2190.

CABLE-TV AT IT'S BEST

SCIENTIFIC Atlanta models 8500—8550—8580 remote included... \$275.00. SB-3's... \$74.00. TRI-BI's... \$95.00. SA-3's... \$99.00. Zenith (Z-Tac) descramblers... \$169.00. N-12 (Vari-sync)... \$89.00. M-35 B (Vari-sync)... \$99.00. Hamlin MLD-1200's... \$89.00. 80-Channel converters... \$95.00. Dealer discount on (5) units. Call—N.A.S. INTERNATIONAL, (213) 631-3552.

MODEMS

SMARTONE Internal Hayes compatible 1200bps Autoanswer/Autodial. Free Bitcom Software. \$15.00 Free CompuServe, 2 yr warranty. No shipping charges. \$65.95. GTECH TECHNOLOGIES, 11221 Interstate-10, New Orleans, LA 70128.

BUY BONDS

TRANSPUTERS

continued from page 86

gram (source code) and recompiling it using the new hardware parameters. By using a hardware header, the time it takes to change a program to fit another configuration is minimized.

The bottom line

Even though common PC's run ten and twenty times faster than their counterparts of only a decade ago, we still can't seem to get enough speed—which is why coprocessors and parallel processing are so attractive. In fact, it is predicted that by 1991, 48% of all PC's sold will contain parallel processing hardware. The drawback is that parallel processing requires special software.

But that's like what we experienced with the first PC's in the early 1980's, and many good programs and applications programs came from that era. ♦♦♦

Try the

Radio-Electronics

bulletin board system

(RE-BBS)
516-293-2283

The more you use it the more useful it becomes.

We support 300 and 1200 baud operation.

Parameters: 8N1 (8 data bits, no parity, 1 stop bit) or 7E1 (7 data bits, even parity, 1 stop bit).

Add yourself to our user files to increase your access.

Communicate with other R-E readers.

Leave your comments on R-E with the SYSOP.

RE-BBS
516-293-2283

Dr. Frankenstein couldn't find the parts he needed either! You won't have that problem with MCM ELECTRONICS!

Whether you're working on small jobs or real "monsters," chances are you've had to make do from time to time with parts or components that were *almost* right! Often, finding a substitute that works takes extra time...and renders disappointing results. So stop turning your customers' beauties into ghouls. Order your FREE subscription of MCM's 172-page catalog today. You'll find a huge inventory of nearly 11,000 in-stock items that can be shipped to you in

record time under some of the most flexible payment terms in the industry. If Dr. Frankenstein could have ordered from MCM, "Frankie" might have looked — and acted — a whole lot different!

For your FREE Subscription to our Catalogs, call TOLL-FREE! 1-800-543-4330

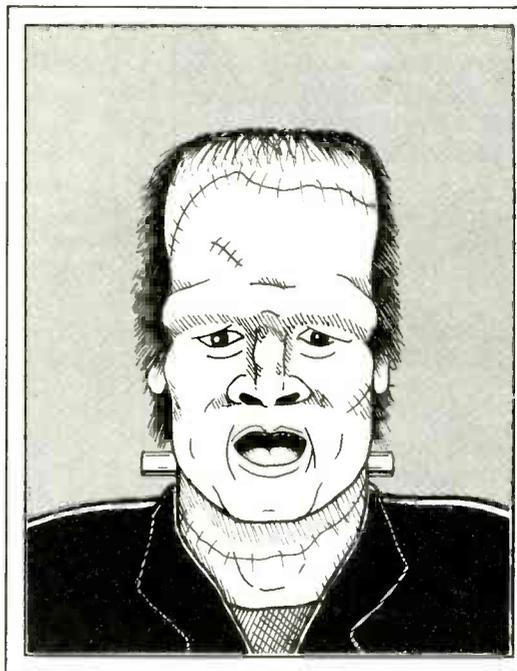

MCM ELECTRONICS
650 CONGRESS PARK DR.
CENTERVILLE, OH 45459-4072
A PREMIER Company

SOURCE NO. RE-55

★ QUALITY PARTS ★ DISCOUNT PRICES ★ FAST SHIPPING

ALL ELECTRONICS CORP.

10 AMP SOLID STATE RELAYS

ELECTROL# S2181
CONTROL:
Rated 5.5 to 10 Vdc
(will operate on 3-32 Vdc).
LOAD: 10 amp @ 240 Vac
2 1/4" X 1 3/4" X 7/8"

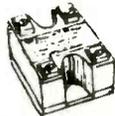

CAT# SSRLY-10B \$9.50 each
QUANTITY DISCOUNT
10 for \$85.00 • 25 for \$175.00
50 for \$300.00 • 100 for \$500.00

STROBE KIT

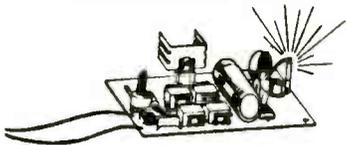

Variable rate strobe kit, flashes between 60 to 120 times per minute. Will operate on either 6 or 12 Vdc depending upon how you wire the circuit. Comes complete with P.C. board and instructions for easy assembly.
CAT# STROBE-1 \$7.50 each

CASSETTE MECHANISM

Alpine cassette transport mechanism. Includes stereo tape head,

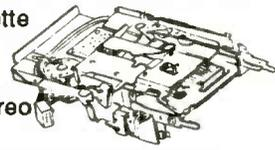

Mitsubishi # MET-3RF2B 13.2 Vdc motor, belt, pulleys, capstan, fast forward, rewind and eject actuator. Does not include amplifier section.
6 1/2" X 5 1/4" X 1 3/4".

CAT# CMEC-5 \$7.50 each
10 for \$65.00

PIEZO WARNING DEVICE



Murata Erie # PKB8-4A0
High pitched audible alarm. Operates on 3 - 20 Vdc @ 20 ma. 1" high x 7/8" dia. P.C. board mount.
CAT# PBZ-84 \$1.75 each

XENON TUBE



1" long flashtube with 3 1/2" red and black leads. Ideal for electronic flash or strobe projects.
CAT# FLT-3 2 for \$1.00

NICKEL-CAD BATTERIES (RECHARGEABLE)

SPECIAL!! AAA SIZE
Panasonic# P-18AAA
1.2 volt @ 180 MAH
CAT# NCB-AAAX \$1.50 each
10 for \$13.50 • 100 for \$125.00



AA SIZE \$2.00 each
1.25 volts 500 mAh
CAT# NCB-AA
AA SIZE \$2.20 each
WITH SOLDER TABS
CAT# NCB-SAA
C SIZE \$4.25 EACH
1.2 volts 1200 mAh
CAT# NCB-C
D SIZE \$4.50 each
1.2 volts 1200 mAh
CAT# NCB-D

TRANSISTORS

CAT#	TYPE	CASE	PRICE
PN2222	NPN	TO-92	5 for 75¢
2N2904	PNP	TO-5	3 for \$1.00
2N2906	PNP	TO-18	3 for \$1.00
PN2907	PNP	TO-92	5 for 75¢
2N3055	NPN	TO-3	\$1.00 each
PN3569	NPN	TO-92	5 for 50¢
2N3904	NPN	TO-92	5 for 75¢
2N3906	PNP	TO-92	5 for 75¢
2N4400	NPN	TO-92	5 for 75¢
2N4402	PNP	TO-92	5 for 75¢
2N5400	PNP	TO-92	4 for \$1.00
2N5880	PNP	TO-3	\$2.00 each
2N5882	NPN	TO-3	\$2.00 each
MJ2955	PNP	TO-3	\$1.50 each
MJE2955T	PNP	TO-220	75¢ each
MJE3055T	NPN	TO-220	75¢ each
TIP30	PNP	TO-220	75¢ each
TIP31	NPN	TO-220	75¢ each
TIP32	PNP	TO-220	75¢ each
TIP41	NPN	TO-220	75¢ each
TIP42	PNP	TO-220	75¢ each
TIP121	NPN	TO-220	75¢ each
TIP126	PNP	TO-220	75¢ each

WIDE BAND AMPLIFIER

NEC# UPC1651G. 1200 Mhz @ 3 db.
Gain: 19db @ f=500 hz. 5 volt operation.
Small package 4mm dia. X 2.5 mm thick.
CAT# UPC-1651 2 for \$1.00
10 for \$4.50 • 100 for \$35.00

N-CHANNEL MOSFET

IRF-511 TO-220 case
CAT# IRF 511
\$1.00 each • 10 for \$9.00
LARGE QUANTITY AVAILABLE

OPTO SENSOR

U shaped package with mounting ears. 1/8" opening. 3/4" mounting holes. CAT# OSU-6 50¢ each
10 for \$4.50 • 100 for \$40.00

WALL TRANSFORMERS



ALL PLUG DIRECTLY INTO 120 VAC OUTLET
6 Vdc @ 200 ma. CAT# DCTX-620 \$2.25
6 Vdc @ 750 ma. CAT# DCTX-675 \$3.50
9 Vdc @ 250 ma. CAT# DCTX-925 \$2.50
12 Vac @ 930 ma. CAT# ACTX-1293 \$3.50
18 Vac @ 1 amp. CAT# ACTX-1885 \$3.50

SWITCHES

ITT PUSH BUTTON

ITT MDPL series. 3/4" X 1/2" gray rectangular key cap. S.P.S.T. N.O.
Push to close. RATED: 0.1 amp switching, 0.25 amp carry current. P.C. mount. CAT# PB-8 65¢ each • 10 for \$6.00 • 100 for \$50.00



10 POSITION MINI-ROTARY

Grayhill# 56P36-01-1-10N-C
Mini rotary switch. Non-shorting. 1 deck, 10 positions. .125" dia. shaft X .375" long. .377" behind the panel depth. P.C. pins.
CAT# MRS-10 \$2.50 each



HALL EFFECT SWITCH

MICROSWITCH# 4BE3
Slanted keyboard switch with hall effect sensor. Snaps into 5/8" square chassis hole. Hall effect sensor slides easily from switch and can be used in other applications.
CAT# HESW 4 for \$1.00
10 for \$2.00 • 100 for \$15.00



SPDT PUSHBUTTON

Marquard# 1843
Rated 6 amps @ 125/250 Vac.
Black plastic pushbutton.
Switch body: .92" X .94" X .65".
CAT# PB-18 \$1.65 each • 10 for \$1.50 each



LED'S

STANDARD JUMBO DIFFUSED T 1-3/4 size

RED CAT# LED-1 10 for \$1.50 • 100 for \$13.00
GREEN CAT# LED-2 10 for \$2.00 • 100 for \$17.00
YELLOW CAT# LED-3 10 for \$2.00 • 100 for \$17.00

FLASHING LED

with built in flashing circuit operates on 5 volts...
RED \$1.00 each
CAT# LED-4 10 for \$9.50
GREEN \$1.00 each
CAT# LED-4G 10 for \$9.50

BI-POLAR LED

Lights RED one direction, GREEN the other. Two leads.
CAT# LED-6 2 for \$1.70

LED HOLDER

Two piece holder.
CAT# HLED 10 for 65¢

RELAYS

12 VOLT D.C. COIL S.P.D.T.

Omron# G2E-184P
4 Amp contacts
335 ohm coil.
Sugar cube size.
.61" X .42" X .44" high.
P.C. mount with pins on DIP spacing.
CAT# RLY-787 \$1.50 each



120 VOLT A.C. - D.P.D.T.

GUARDIAN# 1220U-04
10 Amp contacts.
1,100 ohm coil
1.703" X 1.578" X 1.687". Clear polycarbonate cover. Gold plated solder or socket mount terminals.
CAT# RLY-228 \$3.50 each



CALL OR WRITE FOR OUR FREE CATALOG OVER 4000 PARTS!



MAIL ORDERS TO:
ALL ELECTRONICS
P.O. BOX 567
VAN NUYS, CA 91408

TWX-5101010163 (ALL ELECTRONIC)

OUTSIDE THE U.S.A.
SEND \$2.00 POSTAGE FOR A CATALOG!!

ORDER TOLL FREE
800-826-5432

INFO: (818)904-0524
FAX: (818)781-2653
MINIMUM ORDER \$10.00
QUANTITIES LIMITED
CALIF. ADD SALES TAX
USA: \$3.00 SHIPPING
FOREIGN ORDERS
INCLUDE SUFFICIENT SHIPPING. NO C.O.D.



Mail Order Electronics - Worldwide

ameco ELECTRONICS

Mail-Order Electronics 24 HOUR ORDER HOTLINE 415-592-8097 IC Clearance Sale! Expires 5/31/89

NEC V20 & V30 CHIPS

Table with 3 columns: Part No., Description, Price. Includes items like UPD70108-5 (5MHz) V20 Chip, UPD70108-8 (8MHz) V20 Chip, etc.

7400

Table with 4 columns: Part No., Description, Price. Lists various 7400 series logic chips like 7400, 7402, 7404, etc.

74LS

Table with 4 columns: Part No., Description, Price. Lists various 74LS series logic chips like 74LS00, 74LS02, 74LS04, etc.

74S/PROMS*

Table with 4 columns: Part No., Description, Price. Lists various 74S and PROM chips like 74S00, 74S02, etc.

CD-CMOS

Table with 4 columns: Part No., Description, Price. Lists various CD-CMOS chips like CD4001, CD4008, etc.

EEPROMS

Table with 4 columns: Part No., Description, Price. Lists various EEPROM chips like 2816A, 2816A-25, etc.

MICROPROCESSOR COMPONENTS

MISCELLANEOUS CHIPS

Table with 3 columns: Part No., Description, Price. Lists miscellaneous chips like D765AC, W09216, Z80, etc.

8000 SERIES

Table with 3 columns: Part No., Description, Price. Lists 8000 series chips like 8031, 80C31, 8033, etc.

DYNAMIC RAMS

Table with 4 columns: Part No., Function, Price. Lists various dynamic RAM chips like 2016-12, 2018-45, etc.

8000 SERIES Continued

Table with 3 columns: Part No., Description, Price. Continuation of 8000 series chips like 8087(15MHz), 8087-1(10MHz), etc.

EPROMS

Table with 4 columns: Part No., Description, Price. Lists various EPROM chips like TMS2516, TMS2532, etc.

8000 SERIES Continued

Table with 3 columns: Part No., Description, Price. Continuation of 8000 series chips like 80286-10 LDC, 80287(8MHz), etc.

DATA ACQUISITION

Table with 3 columns: Part No., Description, Price. Lists data acquisition chips like ADC0804CLN, ADC0808CCN, etc.

6500/6800 68000 Series

Table with 3 columns: Part No., Description, Price. Lists 6500/6800 and 68000 series chips like 6502, 65C02(CMOS), etc.

Commodore

Table with 3 columns: Part No., Description, Price. Lists Commodore chips like LAG570, WD1770, etc.

74C/CMOS

Table with 3 columns: Part No., Description, Price. Lists 74C/CMOS chips like 74C00 Sale, 74C02 Sale, etc.

MISC. COMPONENTS

TANTALUM CAPACITORS

Table with 3 columns: Part No., Description, Price. Lists tantalum capacitors like TM1/35, TM2/35, etc.

POTENTIOMETERS

Table with 3 columns: Part No., Description, Price. Lists potentiometers like 43PXX, 63PXX, etc.

TRANSISTORS AND DIODES

Table with 3 columns: Part No., Description, Price. Lists transistors and diodes like PN2222, 2N2222A, etc.

SWITCHES

Table with 3 columns: Part No., Description, Price. Lists switches like JMT123 SPDT, MPC121 SPDT, etc.

D-SUB CONNECTORS

Table with 3 columns: Part No., Description, Price. Lists D-sub connectors like DB25P Male, DB25S Female, etc.

LEDS

Table with 3 columns: Part No., Description, Price. Lists LEDs like XC5569 T14, XC5567 T14, etc.

IC SOCKETS

Table with 3 columns: Part No., Description, Price. Lists IC sockets like 8LP, 14LP, 16LP, etc.

74HC HI-SPEED CMOS

Table with 4 columns: Part No., Description, Price. Lists 74HC HI-speed CMOS chips like 74HC00, 74HC02, etc.

74HCT - CMOS TTL

Table with 4 columns: Part No., Description, Price. Lists 74HCT CMOS TTL chips like 74HCT00, 74HCT02, etc.

LINEAR

Table with 3 columns: Part No., Description, Price. Lists linear chips like DS0026CN, LM1458N, etc.

PARTIAL LISTING • OVER 4000 COMPONENTS AND ACCESSORIES IN STOCK! • CALL FOR QUANTITY DISCOUNTS RAM'S SUBJECT TO FREQUENT PRICE CHANGES

CIRCLE 114 ON FREE INFORMATION CARD

www.americanradiohistory.com

Worldwide • Since 1974

• QUALITY COMPONENTS • COMPETITIVE PRICING
• PROMPT DELIVERY



COMPUTER PRODUCTS

Jameco IBM AT Compatible 16MHz 80286 NEAT Motherboard

- Expandable to 8MB RAM (Zero-K included)
- 8/16MHz switchable
- Supports all NEAT functions including shadow RAM, EMS 4.0, RAM remapping and selectable wait states • 80287-10 Coprocessor capability
- Norton SI rating of 15.6
- AMI BIOS ROMs included
- One-year warranty



JE3010 8/16MHz NEAT (AT) . . . \$469.95

— Additional Motherboards —

JE1001 4.77/8MHz (PC/XT) . . . \$ 89.95
JE1002 4.77/10MHz (PC/XT) . . . \$109.95
JE3005 8/12MHz (AT) . . . \$329.95

Jameco IBM PC/XT/AT Compatible Computer Cases



JE1010 Standard PC/XT Flip-Top Case . . . \$34.95
JE1011 Standard PC/XT Slide Case . . . \$39.95
JE1014 Baby XT Turbo Flip-Top Case . . . \$69.95
JE1017 Baby AT Flip-Top Case . . . \$54.95
JE1018 Baby AT Slide Case . . . \$69.95
JE1019 Baby AT Flip-Top Case . . . \$69.95

TEST EQUIPMENT

Metex M4650:

- Handheld, high accuracy
- 4 1/2 Digit LCD
- Manual ranging with Overload Protection
- Audible continuity tester
- Tests: AC/DC Voltage, Resistance, Continuity, Capacitance, Frequency
- One Year Warranty
- Size: 7" L x 3.5" W x 1.5" H

M4650 . . . \$99.95

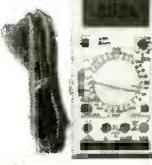

JAMECO SOLDERLESS BREADBOARD SOCKETS

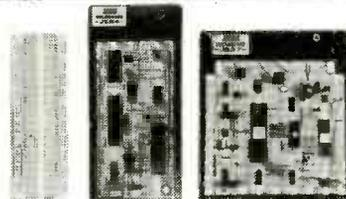

Part No.	Dim. L" x W"	Contact Points	Binding Posts	Price
JE20	6 1/2 x 3/4	200	0	\$ 1.95
JE21	3 1/4 x 2 1/8	400	0	\$ 4.95
JE22	6 1/2 x 1 3/8	630	0	\$ 5.95
JE23	6 1/2 x 2 1/8	830	0	\$ 7.95
JE24	6 1/2 x 3 1/8	1,360	2	\$12.95
JE25	6 1/2 x 4 1/8	1,660	3	\$19.95
JE26	6 7/8 x 5 3/8	2,390	4	\$24.95
JE27	7 1/4 x 7 1/2	3,220	4	\$34.95

DATA BOOKS

400041 NSC Linear Data Book-Vol. I (88) . . . \$14.95
400042 NSC Linear Data Book-Vol. II (88) . . . \$ 9.95
400043 NSC Linear Data Book-Vol. III (88) . . . \$ 9.95
210830 Intel Memory Handbook (88) . . . \$17.95
230843 Intel Microsystem Hndbk. Set (88) . . . \$24.95

Jameco IBM PC/XT 8MHz Turbo Compatible Kit With 256K RAM

- Free! QAPLUS Diagnostic Software Included!
- Free! PC Write Word Processing Software included!
- 256K RAM Included, Expandable to 640K
- 4.77 or 8MHz Switchable
- AMI BIOS ROM Included
- Save \$128.06



Build Your Own And LEARN!

Part No.	Description	Price
JE1001	4.77/8MHz Turbo Motherboard . . . (Zero-K RAM — includes AMI BIOS ROM)	\$89.95
JE1010	Flip-Top Case . . .	34.95
JE1015	XT/AT Compatible Keyboard . . .	59.95
JE1020	5.25" DSDD Disk Drive (Black Bezel) . . .	89.95
JE1030	150 Watt Power Supply . . .	59.95
JE1040	360K Floppy Controller . . .	29.95
JE1050	Mono/Graphics Card with Printer Port . . .	59.95
AMBER	12" Monochrome Amber Monitor . . .	99.95
41256-150	256K RAM (9 chips) . . .	103.41

Save \$128.06 Regular List \$628.01
JE3002 IBM Compatible PC/XT 8MHz Turbo Kit. . . \$499.95

IBM COMPATIBLE DISPLAY MONITORS

AMBER 12" Amber Monochrome . . . \$99.95
CTX2410 14" RGB Color . . . \$279.95

14" EGA Color — EGA/CGA Compatible, 720 x 350 Max. Resolution (PC/XT/AT)
TM5154 . . . \$399.95

14" EGA Monitor and EGA Card — EGA compatible, 720 x 350 Max. Resolution — displays up to 16 colors (PC/XT/AT)
JE1059 SAVE \$40.00 . . . \$519.95

TM5155 14" Multiscan Color . . . \$549.95 \$499.95

QC1478 14" VGA Monitor . . . \$449.95
14" VGA Monitor and VGA Card — QC1478 VGA Monitor and Orchid VGA Card (PC/XT/AT)

JE2055 SAVE \$70.00 . . . \$649.95

JAMECO IBM PC/XT/AT COMPATIBLE CARDS

Graphic Display Cards

JE1050 Mono Graphics Card w/Printer Port (PC/XT/AT) . . . \$59.95
JE1052 Color Graphics Card w/Printer Port (PC/XT/AT) . . . \$49.95
JE1055 EGA Card with 256K Video RAM (PC/XT/AT) . . . \$159.95
JE1071 Multi I/O with Drive Controller and Mono Graphics (PC/XT) . . . \$119.95

Multifunction, I/O and Expansion Cards

JE1060 I/O Card with Serial, Game, Parallel Printer Port and Real Time Clock (PC/XT) . . . \$59.95
JE1061 RS232 Serial Half Card (PC/XT) . . . \$29.95
JE1062 RS232 Serial Half Card (AT) . . . \$34.95
JE1065 I/O Card w/Serial, Game & Parallel Printer Port (AT) . . . \$59.95
JE1081 2MB of expanded or extended memory (zero-K on-board) (AT) . . . \$119.95
JE1082 3MB of expanded or extended memory, parallel printer port, serial port and game port (zero-K on-board) (AT) . . . \$169.95 \$149.95

Floppy and Hard Disk Controller Cards

JE1041 20/40MB Hard Disk Controller Card (PC/XT) . . . \$79.95
JE1043 360K/720K/1.2MB/1.44MB Floppy Disk Cont. (PC/XT/AT) \$49.95
JE1044 360K Floppy/Hard Disk Controller Card (PC/XT) . . . \$129.95
JE1045 360K/720K/1.2MB/1.44MB Floppy/Hard Disk Controller Card (AT) . . . \$149.95

COMPUTER PERIPHERALS

AMI 80386 Motherboards

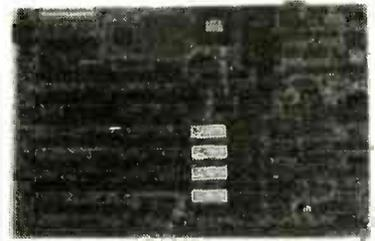

- Expandable to 2MB (Zero-K incl.) of 32-bit RAM with expansion board (included) • Expand an additional 8MB using the JE3030 (below Zero-K incl.)
- XT footprint-AT compatible • 80387-16/20 capability • Built-in set-up and diagnostics • Includes AMI BIOS ROMs • One-year warranty

JE3020 16MHz 80386 (AT) . . . \$1199.95
JE3025 20MHz 80386 (AT) . . . \$1499.95
JE3030 8MB (Zero-K) Daughterboard . . . \$249.95

Seagate 20,30 40 and 60MB Half Height Hard Disk Drives

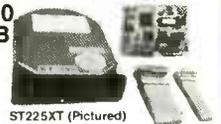

ST225 20MB Drive only (PC/XT/AT) . . . \$224.95
ST225XT 20MB w/Controller (PC/XT) . . . \$269.95
ST225AT 20MB w/Controller (AT) . . . \$339.95
ST238 30MB Drive only (PC/XT/AT) . . . \$249.95
ST238XT 30MB w/Controller (PC/XT) . . . \$299.95
ST238AT 30MB w/Controller (AT) . . . \$389.95
ST251 40MB Drive only (PC/XT/AT) . . . \$379.95
ST251XT 40MB w/Cont. Card (PC/XT) . . . \$419.95
ST251AT 40MB w/Controller Card (AT) . . . \$489.95
ST251-1 40MB Fast 28ms (Drive only) . . . \$469.95
ST277 60MB Drive only (PC/XT/AT) . . . \$449.95
ST277XT 60MB w/Controller (PC/XT) . . . \$499.95
ST277AT 60MB w/Controller Card (AT) . . . \$589.95

40MB Tape Back-Up for IBM PC/XT/AT
DJ10 40MB Back-Up and Tape . . . \$349.95
TB40 40MB Tape Cartridge . . . \$24.95

Jameco 5.25" PC/XT & AT Compatible Disk Drives

JE1020 360K Black Bzl. (PC/XT/AT) . . . \$89.95
JE1021 360K Beige Bzl. (PC/XT/AT) . . . \$89.95
JE1022 1.2MB Beige Bzl. (PC/XT/AT) . . . \$99.95

3.5" PC/XT/AT Compatible Disk Drives

352KU 3.5" 720KB (Mounting Frame Included) (PC/XT/AT) . . . \$109.95
356KU 3.5" 1.44MB (Mounting Frame Included) (PC/XT/AT) . . . \$129.95

Datronics

2400/1200/300 Modems

NEW, Pocket Version!
• Hayes command compatible • Bell 103/1212A compatible • Auto-dial/auto-answer • FCC approved • 1-year warranty • Includes MaxiMite Communication Software (except 1200P)

1200P 1200/300 Baud Pocket Modem . . . \$ 99.95
1200H 1200/300 Baud Internal Modem . . . \$ 69.95
2400H 2400/1200/300 Internal Modem . . . \$129.95
1200C 1200/300 Baud External Modem . . . \$ 99.95
2400C 2400/1200/300 External Modem . . . \$169.95

Data Sheets — 50¢ each
Prices Subject to Change

Send \$2.00 Postage for a FREE 1989 CATALOG

FAX Numbers: 415-592-2503 or 415-595-2664

Telex: 176043

U.S. Funds Only
Shipping: Add 5% plus \$1.50 Insurance
(May vary according to weight)

California Residents:
Add 6%, 6 1/2% or 7%
Sales Tax

©1989 Jameco Electronics 4/89



1355 Shoreway Road, Belmont, California 94002

24 HOUR ORDER HOTLINE (415) 592-8097 • The Following Phone Lines Are Available From 7AM-5PM PS.T:

• Customer Service (415) 592-8121 • Technical Assistance (415) 592-9990 • Credit Department (415) 592-9983 • All Other Inquiries (415) 592-7108

CIRCLE 114 ON FREE INFORMATION CARD

POWER SUPPLIES



- 135 WATT POWER SUPPLY**
 - UL APPROVED
 - +5V @ 15A, +12V @ 4.2A, -5V @ 5A, -12V @ .5A
 - PS-135 \$59.95
 - PS-150 150W SUPPLY \$69.95
- 200 WATT POWER SUPPLY**
 - UL APPROVED
 - +5V @ 20A, +12V @ 7A, -5V @ 5A, -12V @ .5A
 - PS-200 \$89.95
- APPLE TYPE SUPPLY**
 - WITH APPLE CONNECTOR
 - +5V @ 6A, +12V @ 3A, -5V @ 1A, -12V @ 1A
 - PS-A \$49.95
- 36 WATT POWER SUPPLY**
 - +5V @ 2.5A, +12V @ 1.5A
 - 3 PIN INPUT, 6 PIN OUTPUT
 - SELECTABLE 110V-220V
 - PS-3045 \$12.95

SOLDER STATIONS



- SOLDER/DESOLDER STATION**
 - OIL-FREE VACUUM PUMP
 - TEMP ADJUSTS (212° F-900° F) & VACUUM (0-60 CMHG)
 - WITH GUN-REST, COOLING TRAY, WIRE BRUSH & TIP CLEANER ROD
 - XY999SD \$399.95
 - XY999D DESOLDER ONLY \$349.99
- DELUXE SOLDER STATION**
 - ROTARY SWITCH TEMP CONTROL (200° F-878° F RANGE)
 - LED TEMPERATURE READOUTS
 - INCLUDES COOLING TRAY
 - XY9-60L \$79.95
- SOLDER STATION**
 - UL APPROVED
 - HEAT SETTING ADJUSTS
 - TIP TEMPERATURE READOUT
 - REPLACEMENT TIPS @ \$2.95
 - 168-3C \$59.95

WIREWRAP PROTOTYPE CARDS

FR-4 EPOXY GLASS LAMINATE WITH GOLD PLATED EDGE CARD FINGERS AND SILK SCREENED LEGENDS

FOR XT

- JDR-PR1 WITH +5V AND GROUND PLANE \$27.95
- JDR-PR2 ABOVE WITH I/O DECODING LAYOUT \$29.95

FOR AT

- JDR-PR10 16 BIT WITH I/O DECODING LAYOUT \$34.95
- JDR-PR10PK PARTS KIT FOR JDR-PR10 ABOVE \$12.95

FOR PS/2

- JDR-PR32 32 BIT PROTOTYPE CARD \$69.95
- JDR-PR16 16 BIT WITH I/O DECODING LAYOUT \$49.95
- JDR-PR16PK PARTS KIT FOR JDR-PR16 ABOVE \$15.95
- JDR-PR16V 16 BIT FOR VIDEO APPLICATIONS \$39.95

JDR INSTRUMENTS—2 YEAR WARRANTY!

- 35 MHZ DUAL TRACE OSCILLOSCOPE**
 - WIDE BAND WIDTH
 - VARIABLE HOLD-OFF
 - MODEL-3500 (SHOWN) \$499.95
- 20 MHZ DUAL TRACE OSCILLOSCOPE**
 - TV SYNC FILTER
 - COMPONENTS TESTER
 - MODEL 2000 \$389.95
- 3.5 DIGIT PROBE TYPE DMM**
 - AUTORANGING
 - AC/DC 2V - 500V, RESIS, 2K-2M
 - DPM-1000 (SHOWN) \$54.95
- 3.5 DIGIT POCKET SIZE DMM**
 - BASIC DC ACCURACY ±0.5%
 - 14 RANGES
 - DMM-100 \$29.95
- 3.5 DIGIT FULL FUNCTION DMM**
 - BASIC DC ACCURACY ±0.25%
 - 22 RANGES
 - DMM-200 \$49.95
- THE ULTIMATE 3.5 DIGIT DMM**
 - BASIC DC ACCURACY ±0.25%
 - 34 RANGES
 - TEMP, TRANSISTOR & RESISTANCE FEATURES
 - DMM-300 (SHOWN) \$79.95

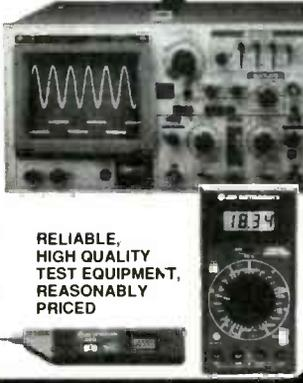

RELIABLE, HIGH QUALITY TEST EQUIPMENT, REASONABLY PRICED

DATA SWITCH BOXES

TYPE	# OF POS	PARALL.	SERIAL	PRICE
PUSHBTN	2-WAY	AB-P	AB-S	39.95
ROTARY	2-WAY	RSP-2	RSS-2	24.95
ROTARY	3-WAY	RSP-3	RSS-3	27.95
ROTARY	4-WAY	RSP-4	RSS-4	29.95

EXTENDER CARDS

- FOR PROTOTYPE DEBUGGING, TESTING AND TROUBLESHOOTING
- EXT-8088 XT COMPATIBLE \$29.95
 - EXT-80286 AT COMPATIBLE \$39.95
 - EXT-16 MICROCHANNEL 16-BIT \$69.95
 - EXT-32 MICROCHANNEL 32-BIT \$99.95

COMPUTER CABLES

- GOLD-PLATED CONTACTS; 100% SHIELDED
- CBL-PRINTER PC PRINTER CABLE 9.95
 - CBL-PRINTER-25 AS ABOVE 25 FT. 15.95
 - CBL-PRINTER-RA RT. ANGL. PRINTER 15.95
 - CBL-DB25-MM DB25 MALE-MALE 9.95
 - CBL-DB25-MF DB25 MALE-FEMALE 9.95
 - CBL-9-SERIAL 9 PIN-25 PIN SERIAL 6.95
 - CBL-KBD-EXT KEYBOARD EXTEN. 7.95
 - CBL-CNT-MM 36 PIN CENTRON-M/M 14.95
 - CBL-HD-20 20 PIN HARD DISK 3.95
 - CBL-HD-34D 34 PIN DUAL HARD DISK 6.95
 - CBL-FDC-EXT 37 PIN EXT. FLOPPY 9.95
 - CBL-MNT-9 9 PIN MONITOR EXTEN. 6.95
 - CBL-MODEM DB25-DB25 FEMALE 7.95

NEW LOW PRICES! SOLDERLESS BREADBOARDS

- WBU-204-3 1360 TIE PTS \$12.95
- WBU-204 1660 TIE PTS \$19.95
- WBU-206 2390 TIE PTS \$24.95
- WBU-208 3220 TIE PTS \$34.95

IDC CONNECTORS/RIBBON CABLE

DESCRIPTION	ORDER BY	CONTACTS					
		10	20	2E	34	40	50
SOLDER HEADER	IDHxxS	.82	1.29	1.69	2.20	2.58	3.24
RIGHT ANGLE SOLDER HEADER	IDHxxSR	.85	1.35	1.75	2.31	2.72	3.39
WIREWRAP HEADER	IDHxxW	1.86	2.98	3.94	4.50	5.28	6.63
RIGHT ANGLE WIREWRAP HEADER	IDHxxWR	2.05	3.28	4.22	4.45	4.80	7.30
RIBBON HEADER SOCKET	IDSxx	.63	.89	.95	1.29	1.49	1.69
RIBBON HEADER	IDMxx	—	5.50	6.25	7.00	7.50	8.50
RIBBON EDGE CARD	IDExx	.85	1.25	1.35	1.75	2.05	2.45
10' RIBBON CABLE	RCxx	1.60	3.20	4.13	5.40	6.40	7.50

FOR ORDERING INSTRUCTIONS, SEE D-SUBMINIATURE CONNECTORS BELOW

RS-232 BREAKOUT BOX

- FOR TROUBLESHOOTING SERIAL COMMUNICATIONS
- OPEN/CLOSE INDIVIDUAL CIRCUITS
 - 20 JUMPERS CROSS-CONNECT ANY TWO CIRCUITS
 - 10 CIRCUIT ACTIVITY LEDS
 - GENDER-BO \$34.95

SURGE SUPPRESSOR

- PROTECTS YOUR EQUIPMENT!
- SIX 3-PRONG AC OUTLETS
 - 15 AMP CIRCUIT BREAKER
 - 6' HEAVY DUTY CORD
 - 15 AMP MAX LOAD, 1875 WATTS
 - UL APPROVED
 - POWER-SURGE \$12.95
 - POWER-STRIP W/OSURGE \$9.95

LITHIUM BATTERY

- 6V FOR 286 AND 386 PCS
- MOTHERBOARD CONNECTOR
- ADHESIVE VELCRO MOUNTING STRIP
- LITHIUM 6.8V \$11.95
- COIN TYPE BATTERY
- LONG-LASTING 3V LITHIUM
- 3V-MHW \$1.95
- HOLDER \$1.49

PC BREADBOARD

- 62 CLEARLY LABELLED BUS LINES
- ACCEPTS UP TO 24 14-PIN ICs
- 1940 TIE POINTS
- EXT FEMALE DB25 D-SUB CONNECT UP-604 \$49.95

GENDER CHANGERS

- GENDER-FF FEMALE-FEMALE \$7.95
- GENDER-MM MALE-MALE \$7.95
- GENDER-MM MALE-FEMALE \$7.95
- GENDER-MF MALE-MALE \$8.95
- GENDER-JB JUMPER BOX \$8.95
- GENDER-MT MINITESTER \$14.95
- GENDER-VGA DB9-DB15 \$19.95
- GENDER-9-25 DB9-DB25 \$4.95

D-SUBMINIATURE CONNECTORS

DESCRIPTION	ORDER BY	CONTACTS						
		9	15	19	25	37	50	
SOLDER CUP	MALE	DBxxP	.45	.59	.69	.69	1.35	1.85
	FEMALE	DBxxS	.49	.69	.75	.75	1.39	2.29
RIGHT ANGLE PC SOLDER	MALE	DBxxPR	.49	.69	—	.79	2.27	—
	FEMALE	DBxxSR	.55	.75	—	.85	2.49	—
WIREWRAP	MALE	DBxxPWW	1.69	2.56	—	3.89	5.60	—
	FEMALE	DBxxSww	2.76	4.27	—	6.84	9.95	—
IDC RIBBON CABLE	MALE	IDBxxP	1.39	1.99	—	2.25	4.25	—
	FEMALE	IDBxxS	1.45	2.05	—	2.35	4.49	—
HOODS	METAL	MHOODxx	1.05	1.15	—	1.25	—	—
	PLASTIC	HOODxx	.39	.39	—	.39	.69	.75

ORDERING INSTRUCTIONS: INSERT THE NUMBER OF CONTACTS IN THE POSITION MARKED "xx" OF THE "ORDER BY" PART NUMBER LISTED. EXAMPLE: A 15 PIN FIGHT ANGLE MALE PC SOLDER WOULD BE DB15PR MOUNTING HARDWARE .59

IC SOCKETS/DIP CONNECTORS

DESCRIPTION	ORDER BY	CONTACTS									
		8	14	16	18	20	22	24	28	40	
SOLDERTAIL SOCKETS	xxST	.11	.11	.12	.15	.18	.15	.20	.22	.30	
WIREWRAP SOCKETS	xxWW	.59	.69	.69	.99	1.09	1.39	1.49	1.69	1.99	
ZIF SOCKETS	ZIFxx	—	4.95	4.95	—	5.95	—	5.95	6.95	9.95	
TOOLED SOCKETS	AUGATxxST	.62	.79	.89	1.09	1.29	1.39	1.49	1.69	2.49	
TOOLED VW SOCKETS	AUGATxxWW	1.30	1.80	2.10	2.40	2.50	2.90	3.15	3.70	5.40	
COMPONENT CARRIERS	ICCxx	.49	.59	.69	.99	.99	.99	1.09	1.49	1.49	
DIP PLUGS (IDC)	IDPxx	.95	.49	.59	1.29	1.49	—	.85	1.49	1.59	

FOR ORDERING INSTRUCTIONS SEE D-SUBMINIATURE CONNECTORS ABOVE

APPLE-COMPATIBLE PRODUCTS

- FLOPPY DRIVE FOR APPLE II SERIES AP-150 (W/CABLE, CONNECTOR) \$99.95
- REPLACEMENT KEYBOARD FOR APPLE II & II+ KEYBOARD-AP \$59.95
- EPROM PROGRAMMER, NOT REC. FOR CMOS, RP-525 (NO POWER SUPPLY REQ.) \$89.95
- 16K RAM CARD BOOSTS 48K APPLE TO 64K RAM-CARD (2 YEAR WARRANTY) \$39.95

"SNAPABLE HEADERS"

- SNAP APART TO MAKE ANY SIZE HEADER, WITH .1" CENTERS
- 1 X 40 STRAIGHT LEAD .99
 - 1 X 40 RIGHT ANGLE LEAD \$1.49
 - 2 X 40 STRAIGHT LEAD \$2.49
 - 2 X 40 RIGHT ANGLE LEAD \$2.99



JDR MICRODEVICES, 110 KNOWLES DRIVE, LOS GATOS, CA 95030
 LOCAL (408) 866-6200 FAX (408) 378-8927 TELE 171-110
 RETAIL STORE: 1256 SOUTH BASCOM AVE., SAN JOSE, CA
 (408) 947-8881 HOURS: M-F 9-7 SAT. 9-5 SUN. 12-4

ORDER TOLL FREE 800-538-5000

COPYRIGHT 1989 JDR MICRODEVICES

CONTINENTAL U.S.

CIRCLE 171 ON FREE INFORMATION CARD

www.americanradiohistory.com

2400 BAUD MODEM
\$129.95



- ALL HAVE ■ HAYES COMPATIBILITY ■ AUTO DIAL ANSWER
- SELF TEST ON POWER UP ■ FULL AND HALF DUPLEX
- TOUCHTONE OR PULSE DIALING ■ 2ND PHONE JACK
- CALL PROGRESS MONITORING ■ ADJUSTABLE VOLUME

INTERNAL MODEMS (MIRROR II SOFTWARE INCLUDED)

- PRO-241 2400 BAUD \$129.95
- PRO-12H 1200 BAUD 1/2 CARD \$69.95
- PRO-24M 2400 BAUD FOR PS/2 \$249.95

EXTERNAL MODEMS (REQ. SERIAL PT. CABLE, SOFTWARE)

- PRO-24E 2400 BAUD \$169.95
- PRO-12E 1200 BAUD \$99.95

DFI HANDY SCANNER

400 DPI \$249.95

- INSTANTLY SCANS UP TO 4.1" WIDE IMAGES ■ 100, 200, 300, 400 DPI BOTH DIRECTIONS ■ B&W & 3 HALF-TONE MODES ■ 32 LEVELS OF GRAY SCALE ■ HERCULES, CGA AND EGA COMPATIBLE
- INCLUDES HALO DPE AND IMAGE EDITOR SOFTWARE
- HS-3000 OCR-SOFT OCR SOFTWARE \$99.95

UPRIGHT CASE \$249.95

- SPACESAVING DESIGN HOLDS ALL SIZES OF MOTHERBOARDS, INCLUDES:
 - 250W POWER SUPPLY ■ MOUNTS FOR 3 FLOPPY & 4 HARD DRIVES
 - TURBO & RESET SWITCH ■ LED SPEED DISPLAY ■ POWER & DISK LED'S
 - ALL HARDWARE, FACEPLATES & SPEAKER CASE-100
- CASE-FLIP FOR 8088 BOARDS \$39.95
- CASE-SLIDE FOR 8088 BOARDS \$39.95
- CASE-70 FOR 286 BOARDS \$89.95
- CASE-50 FOR 8088/286 BOARDS \$59.95
- CASE-JR MINI-286 W/150W PS \$149.95

LOGITECH HIREZ MOUSE \$99.95

- HIGH RESOLUTION BUS MOUSE, IDEAL FOR CAD WORK ■ 320 DPI ■ WITH DRIVER, TEXT EDITOR & POP-UP MENUS
- NO PAD, POWER SUPPLY OR PORT REQ
- LMOUSE-BH

- LOGITECH 3 BUTTON MOUSE
- PC MAGAZINE EDITORS CHOICE! ALL MODELS HAVE SERIAL SUPPORT (COM1/COM2), 200 D.P.I. RESOLUTION, LOTUS 1-2-3 SHELL, SELF-INSTALLING SOFTWARE AND "POINT EDITOR"

- LMOUSE SERIAL MOUSE W/LOGIPAIN \$79.95
- LMOUSE-IP BUS MOUSE W/LOGIPAIN \$99.95
- LMOUSE-BP BUS MOUSE W/PUBLISHER PKG \$129.95
- LMOUSE-BPC BUS MOUSE W/LOGIPAIN/CAD \$149.95

MODULAR PROGRAMMING SYSTEM

INTEGRATED MODULAR SYSTEM EASILY EXPANDS! ALL MODULES USE A COMMON HOST ADAPTOR CARD—USE JUST ONE SLOT TO PROGRAM EPROMS, PROMS, PALS & MORE

HOST ADAPTOR CARD \$29.95

- UNIVERSAL INTERFACE FOR ALL THE PROGRAMMING MODULES!
- SELECTABLE PROGRAMMABLE ADDRESSES PREVENTS CONFLICTS
- MOLDED CABLE
- MCT-MAC

UNIVERSAL MODULE \$499.95

- PROGRAMS EPROMS, EEPROMS, PALS, BI-POLAR PROMS, 8748 & 8751 SERIES DEVICES ■ PROGRAMS 16V8 20V8 GALS (GALLIUM ARSENIDE) FROM LATTICE, NS, SGS ■ TESTS TTL, CMOS, DYNAMIC & STATIC RAMS ■ LOAD DISK, SAVE DISK, EDIT, BLANK CHECK, PROGRAM, AUTO, READ MASTER, VERIFY & COMPARE
- TEXTLOOP SOCKET FOR 3" TO 6"W. IC'S (8-40 PINS)
- MCT-MUP

VGA COMPATIBLE PACKAGE \$649

- 800 X 560 MAX RESOLUTION ■ 640 X 480 IN 16 COLORS
- 320 X 200 IN 256 COLORS ■ IBM STYLE MONITOR
- VGA, EGA, CGA, HERCULES, MONOCHROME COMPATIBLE
- VGA-PKG (INCLUDES CARD & MONITOR)

NEC MULTISYNC II \$599.95

- AUTO FREQ ADJUSTMENT ■ RESOLUTION TO 800 X560
- IDEAL FOR CAD, CAM, WINDOWS ■ 9-15 PIN ADAPTER
- NEC-MULTI

JDR MULTI \$499.95

- FULL FEATURED MULTISCAN MONITOR WITH UNLIMITED COLORS ■ HIGH RESOLUTION, 14" NON-GLARE DISPLAY
- AUTO SWITCHING ■ TTL/ANALOG VIDEO INPUT
- JDR-MULTI

MONO-MONITOR (12" MONOCHROME MONITOR) \$69.95

EGA MONITOR \$399.95

- 640 X 200/350 RESOLUTION ■ .31 MM DOT PITCH ■ 14" BLACK MATRIX SCREEN ■ 16 COLOR DISPLAY ■ 9-PIN CABLE
- EGA-MONITOR

SAVE \$50! EGA CARD & MONITOR—JUST \$499

KEYBOARDS

- 101 KEY ENHANCED, W/SEPARATE CURSOR PAD:
 - BTC-5339 AUTOSENSE FOR XT/AT, AUTOREPEAT \$79.95
 - K103-A AUDIBLE "CLICK" STYLE \$84.95
 - MAX-5339 MAXI-SWITCH W/TACTILE FEEDBACK \$84.95

- 84 KEY STYLES:
 - BTC-5060 AUTOSENSE FOR XT/AT \$59.95
 - MAX-5060 MAXI-SWITCH W/TACTILE FEEDBACK \$64.95

MODULAR CIRCUIT TECHNOLOGY

NEW LOW PRICES!

- MOTHERBOARDS:
 - MCT-XMB STANDARD 8088 MOTHERBOARD \$87.95
 - MCT-TURBO 4.77/8 MHZ 8088 MOTHERBOARD \$95.95
 - MCT-TURBO-10 4.77/10 MHZ SINGLE CHIP 8088 \$99.95
 - MCT-M286 6/10 MHZ MINI-286 \$299.95
 - MCT-M286-12 6/12 MHZ MINI-286 \$339.95

- DRIVE CONTROLLERS:
 - MCT-FDC FLOPPY DISK CONTROLLER \$29.95
 - MCT-FDC-1.2 1.2 MB FLOPPY CONTROLLER \$69.95
 - MCT-HDC HARD DISK CONTROLLER \$79.95
 - MCT-RLL RLL CONTROLLER \$119.95
 - MCT-FH FLOPPY/HARD CONTROLLER \$139.95
 - MCT-AFH 286/386 FLOPPY/HARD \$149.95
 - MCT-AFH-RLL 286/386 RLL CONTROLLER \$199.95

- DISPLAY ADAPTOR CARDS:
 - MCT-MGP MONOCHROME GRAPHICS \$59.95
 - MCT-CG COLOR GRAPHICS ADAPTOR \$49.95
 - MCT-EGA ENHANCED GRAPHICS ADAPTOR \$149.95
 - MCT-MGMIO MONOGRAPHICS MULTI I/O \$119.75
 - MCT-MGAIO 286/386 MONOGRAPHICS I/O \$99.95

- MULTIFUNCTION CARDS:
 - MCT-MIO MULTI I/O FLOPPY CONTROLLER 79.95
 - MCT-IO MULTI I/O CARD \$59.95
 - MCT-AMF 286/386 MULTIFUNCTION \$139.95
 - MCT-AIO 286/386 MULTI I/O CARD \$59.95

- MEMORY CARDS:
 - MCT-RAM 576K RAM CARD \$59.95
 - MCT-EMS 128K EMS CARD \$129.95
 - MCT-AEMS 286/386 EMS CARD \$139.95

EPROM MODULE \$119.95

- PROGRAMS 24-32 PIN EPROMS, CMOS EPROMS & EEPROMS FROM 16K TO 1024K ■ HEX TO OBJ CONVERTER ■ AUTO, BLANK CHECK/PROGRAM/VERIFY ■ VPP 5, 12.5, 12.75, 13, 21 & 25 VOLTS
- NORMAL, INTELLIGENT, INTERACTIVE, & QUICK PULSE PROGRAMMING ALGORITHMS
- MCT-MEP
- MCT-MEP-4 4-EPROM PROGRAMMER \$169.95
- MCT-MEP-8 8-EPROM PROGRAMMER \$259.95
- MCT-MEP-16 16-EPROM PROGRAMMER \$499.95

DIGITAL IC MODULE \$129.95

- TESTS TTL, CMOS, DYNAMIC & STATIC RAM
- AUTO SEARCH FOR UNKNOWN PART NUMBERS
- USER-PROGRAMMABLE TEST PROCEDURES
- MCT-MIC

PAL MODULE \$249.95

- PROGRAMS MMI, NS, TI 20 & TI 24 PIN DEVICES
- BLANK CHECK, PROGRAM, AUTO, READMASTER, VERIFY & SECURITY FUSE BLOW
- MCT-MPL
- PAL PROGRAMMING DEVELOPMENT SOFTWARE
- MCT-MPL-SOFT \$99.95

20 Mb \$289

30 Mb \$329

KITS INCLUDE A SEAGATE HARD DISK DRIVE, DRIVE CONTROLLER, CABLES AND INSTRUCTIONS

- HDKIT20 20 MB SYSTEM KIT
- HDKIT30 30 MB SYSTEM KIT

FAST, RELIABLE SEAGATE HARD DISKS:

DISK SIZE	MODEL	AVG. SPD.	SIZE	PRICE
20MB	ST-125	65 MS	3-1/2"	\$259
20MB	ST-225	65 MS	5-1/4"	\$225
30MB RLL	ST-238	65 MS	5-1/4"	\$249
40MB	ST-251	40 MS	5-1/4"	\$379
40MB	ST-251-1	28 MS	5-1/4"	\$469
60MB RLL	ST-277	40 MS	5-1/4"	\$449
80MB	ST-4096	28 MS	5-1/4"	\$629

1 Mb 3 1/2" DRIVE \$99.95

- ULTRA HIGH DENSITY
- FOR 720K DISKS, TOO
- FDD-1.44X BLACK FACEPLATE
- FDD-1.44A BEIGE FACEPLATE
- FDD-1.44 SOFT SOFTWARE DRIVER \$19.95

1/2 HEIGHT FLOPPY DISK DRIVES:

- FD-55B 5-1/4" TEAC DS/DD 360K \$99.95
- FD-55G 5-1/4" TEAC DS/HD 1.2M \$129.95
- FDD-360 5-1/4" DS/DD 360K \$69.95
- FDD-1.2 5-1/4" DS/HD 1.2M \$109.95
- FDD-3.5A 3-1/2" 720K (BEIGE) \$97.95
- FDD-3.5X 3-1/2" 720K (BLACK) \$97.95

NASHUA DISKETTES (BOXES OF 10):

- N-MD2D 360K DS/DD \$6.95
- N-MD2D BULK (MIN. ORDER 50 DISKS) EACH .49
- N-MD2H 1.2 MB DS/HD \$13.95
- N-3.5HD 1.44 MB 3-1/2" DS/HD \$49.95
- N-3.5DS 720K 3-1/2" DD/DS \$16.95

BUILD YOUR OWN SYSTEM!

OVER 25,000 JDR SYSTEMS HAVE BEEN BUILT. OUR DETAILED INSTRUCTIONS MAKE IT VERY EASY—ALL YOU NEED IS ABOUT 2 HOURS AND A SCREWDRIVER!

VIDEO INSTRUCTIONS \$4.95 WITH SYSTEM

OUR 20 MINUTE VIDEO SHOWS YOU STEP-BY-STEP HOW TO BUILD AN XT-COMPATIBLE SYSTEM. SPECIFY VHS OR BETA. VIDEO WITH SYSTEM KIT, \$4.95 VIDEO ALONE, 19.95

10 MHz TURBO 8088 SYSTEM \$636.20

- SERIAL PARALLEL PORTS, CLOCK/CALENDAR & GAME ADAPTOR ■ RUNS COLOR GRAPHICS ON ITS MONOCHROME MONITOR ■ MOTHERBOARD ■ 256K RAM MEMORY ■ 135W POWER SUPPLY ■ FLIPTOP CASE
- 84 KEY KEY-BOARD ■ 360K FLOPPY DRIVE
- MONOGRAPHICS I/O CARD

12 MHz MINI-286 SYSTEM \$1152.70

- 12 MHZ MINI-286 MOTHERBOARD ■ 512K RAM MEMORY
- MINI-AT CASE WITH POWER SUPPLY ■ 84 KEY KEYBOARD ■ MONOCHROME MONITOR ■ 1.2 MB FLOPPY DRIVE ■ FLOPPY/HARD CONTROL ■ GRAPHICS ADAPTOR

EPROM PROGRAMMER \$129

- PROGRAMS 27XX AND 27XX EPROMS UP TO 27512
- SUPPORTS VARIOUS PROGRAMMING FORMATS & VOLTAGES ■ SPLIT OR COMBINE CONTENTS OF SEVERAL EPROMS OF DIFFERENT SIZES
- READ, WRITE, COPY, ERASE, CHECK & VERIFY
- SOFTWARE FOR HEX AND INTEL HEX FORMATS
- MCT-EPROM

JDR MICRODEVICES, 110 KNOWLES DRIVE, LOS GATOS, CA 95030

LOCAL (408) 866-6200 FAX (408) 378-8927 TELE 171-110

RETAIL STORE: 1256 S. BASCOM AVE., SAN JOSE, CA

(408) 947-8881 HOURS: M-F, 9-7 SAT. 9-5 SUN. 12-4

Terms: Minimum order \$10.00. For shipping & handling include \$3.50 for ground and \$4.50 air. Orders over 1 lb and foreign orders may require additional shipping charges—please contact the sales department for the amount. CA residents must include applicable sales tax. Prices subject to change without notice. We are not responsible for typographical errors. We reserve the right to limit quantities and to substitute manufacturer. All merchandise subject to prior sales. A full copy of our terms is available upon request. Items pictured may only be representative.

ORDER TOLL FREE 800-538-5000

COPYRIGHT 1989 JDR MICRODEVICES

CONTINENTAL US





Quality Name Brand Electronic Components

Computerized Order Processing & Inventory Control

Volume Discounts - OEM Pricing - Toll Free Wats Line

701 Brooks Ave. South

P.O. Box 677

Thief River Falls, MN 56701-0677

95%* OF THE TOP 100 ELECTRONIC MANUFACTURERS IN THE UNITED STATES ARE DIGI-KEY CUSTOMERS

*Source: Electronic Business 200, "Electronic Business" Magazine, July 15, 1988

This might seem incredible until you realize that . . .

- **95%** OF THE ITEMS IN DIGI-KEY'S CATALOG ARE AVAILABLE FOR "OFF-THE-SHELF" DELIVERY — AND THE OTHER 5% ARE ON THE WAY!!
- **99%** OF ORDERS ARE SHIPPED TO DIGI-KEY CUSTOMERS WITHIN 24 HOURS!!
- **100%** COMMITMENT TO CUSTOMER SATISFACTION!!

To receive your complimentary copy of the current Digi-Key Catalog or for pricing and Availability on your current or future needs — Contact Digi-Key today

1-800-344-4539

Easy To Remember: 1-800-DIGI-KEY

AK, PR: 218-681-6674; Easylink: 62827914; Telex II: 9103508982 "DIGI-KEY CORP; FAX: 218-681-3380

Serving A National Market With Quality Electronic Components Since 1972



• Panasonic • Amp • 3M/Associated Electronics • Omron • Texas Instruments • International Rectifier

CW Industries • Tex-Techs, Inc. • Vector • Hirose • Toko America • Diodes Inc. • Aavid • Comair Rotron • OK Industries

American Power Devices • Littelfuse • Keystone • Euro-Dip • Teccor • Saxton • ITT Canon • JW Miller • Baron • Diamond • Optrex

CIRCLE 82 ON FREE INFORMATION CARD

Radio Shack—The Technology Store®

SUPER VALUES IN PARTS AND ACCESSORIES!

"Hotline" Special-Order Service



One-Week Delivery Time on Most Items

Your Radio Shack store manager can special-order a wide variety of parts and accessories not shown in our catalog—tubes, ICs, phono cartridges and styli, microprocessor, scanner and CB crystals, even SAMS Photofacts®. There's no minimum order or handling charges.

Novice Ham Course

Prepared by
Gordon West,
WB6NOA

19⁹⁵



Everything you need to earn the new Novice Amateur Radio license with voice and digital privileges. Includes two self-paced code cassettes, a study guide with sample exam questions and answers, FCC Form 610, and binder. #62-2402

RS-232 Plugs and Accessories

(1)



(2)



(3)



(1) Solder RS-232 Connectors.

Positions	Type	Cat. No.	Each
9	Male	276-1537	1.49
9	Female	276-1538	2.49
9	Hood	276-1539	1.19
25	Male	276-1547	1.99
25	Female	276-1548	2.99
25	Hood	276-1549	1.29

(2) Inline RS-232 Tester. Dual-color LEDs help you spot line problems fast. #276-1401 14.95

(3) Inline RS-232 Spike Protector. Guard computer, peripherals. #276-1402 16.95

(1) Solar Cell and Project Kit

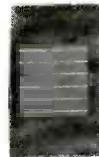

Put Your Sun to Work



(1) Flexible Solar Cell. This 3 1/4 x 1 7/8" cell produces about 1.2VDC, 65 mA. #276-138 5.95

(2) Solar Project Kit. Mini panel, motor, propeller, educational booklet. #277-1201 9.95

Project Tools

(1)



(2)



(3)



(1) Mini Vise. #64-2094 3.99
 (2) Adjustable Project Holder. For easier soldering, gluing, painting and assembly. #64-2093 7.99
 (3) Mini Drill. #64-2097 3.49

Power Buys!

(1)



(2)



(3)



(1) RFI-Busting Toroid Choke Cores. Easy to install on AC power cords, coax, phone lines. #273-104, Pkg. of 2/6.95
 (2) 0.1 mH RF Choke. #273-102, 99¢
 (3) Heavy-Duty MOV. #276-568, 1.99

R & C Bargains

(1)



(2)



(3)



(1) Pkg. of 50 Low-pF Capacitors. 50 WVDC. 2 to 33 pF. #272-806 2.99
 (2) Pkg. of 500 1/4-W, 5% Resistors. 54 popular values. #271-312 7.95
 (3) 12 Trimmer Pots. #271-1605, 1.98

Unusual Items

(1)



(2)



(3)



(1) PC-Mount Mini Speaker. 29/32" diameter! 8 ohms. #273-090 4.99
 (2) Trimmer Capacitor. 95-420 pF. Compression type. #272-1336, 1.69
 (3) Thermistor. #271-110 1.99

FM Receiver

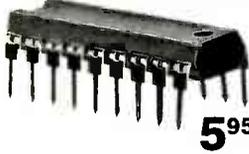

5⁹⁵

TDA7000. RF amplifier, mixer, IF and demod stages on one 18-pin DIP. Perfect for a small FM broadcast or public-service band receiver—requires a minimum of support parts. 70 kHz IF eliminates IF transformers. With circuit data. #276-1304

Mini Audio Amp

11⁹⁵

- Built-In Speaker
- High-Gain IC Design



Ideal test amplifier, it's also great for computer voice and music synthesis, circuit tracing, and line testing. Has 1/8" headphone jack, 1/8" input jack and volume control. Battery extra. #277-1008

Switch Values

(1)



(2)



(3)



(1) SPST Rocker Switch. Rated 6 amps at 125VAC. #275-690 1.99
 DPDT Rocker. #275-691 2.59
 (2) DPDT Knife. #275-1537 1.29
 (3) Mercury Bulb. #275-027 1.29

LED Indicators

(1)



(2)



(3)



(1) Super-Bright Red LED. 2000 mcd output! #276-087 1.69
 (2) Blinking Red LED. Built-in flasher IC. #276-036 1.29
 (3) Blinking Green LED. Flash rate: 1 Hz. #276-030 1.29

More Project Parts

(1)



(2)



(3)



(1) PC-Mount Electret Mike Element. Hi-fi response. 2-10VDC. #270-090 1.49
 Element With Leads. #270-092 2.99
 (2) 0-15 VDC Voltmeter. #270-1754 7.95
 (3) Transmitter Case. Perfect for a pocket-size IR or RF controller. #270-293 3.99
 Many other styles and sizes of project housings available at our store near you—at low prices!

Board, Project Book



Our Best Breadboard

Universal Breadboard. Molded socket accepts DIPs, discretes and 22-gauge wires. Mounted on a heavy metal base with rubber feet. #276-169 19.95



Getting Started in Electronics. By Forrest Mims III. The perfect introduction to electronics project building. 128 pages. #276-5003 2.49

Bench Instrument

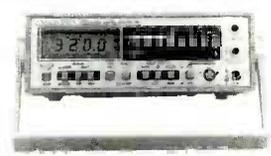

99⁹⁵

Incredible Value!

Precise LCD digital display plus 31-segment analog bargraph. Displays transistor gain directly. Diode-check, memory and continuity functions. Measures to 1000VDC, 750VAC, 10 amps AC as well as DC, and resistance. With leads and manual. #22-195 99.95

Over 1000 items in stock! Binding Posts, Books, Breadboards, Buzzers, Capacitors, Chokes, Clips, Coax, Connectors, Fuses, Hardware, ICs, Jacks, Knobs, Lamps, Multitesters, PC Boards, Plugs, Rectifiers, Resistors, Switches, Tools, Transformers, Transistors, Wire, Zeners, More!

Prices apply at participating Radio Shack stores and dealers

Radio Shack

A DIVISION OF TANDY CORPORATION

CIRCLE 78 ON FREE INFORMATION CARD

3 FOR 1 SPECIAL

ON SUB-MINIATURE VOICE FM TRANSMITTERS. KITS CONTAIN PC BOARDS



***FMX-1 LONG RANGE (3 MI) ULTRA SENSITIVE FM VOICE XMTR** with fine tune, range control plus.....\$24.50



***TELX-1 TELEPHONE FM XMTR (3 MI)** automatically operates when phone is used. Crystal clear clarity with fine tune and range control. Non detectable.....\$24.50



***ATR-1 AUTOMATIC TELEPHONE RECORDING DEVICE** tapes telephone conversation all automatically.....\$19.50

ALL THREE OF ABOVE FOR.....\$49.50

CALL OR SEND VISA, MASTER CHARGE, MONEY ORDER, ETC. TO **AMAZING CONCEPTS**, BOX 716, AMHERST, NH 03031. (603) 673-4730.

ADVERTISING INDEX

RADIO-ELECTRONICS does not assume any responsibility for errors that may appear in the index below.

Free Information Number	Page		Page
108	AMC Sales	12	— Pacific Cable
183	Ace Products	58	56 Parts Express
52	Active Electronics	93	101 Pomona Electronics
107	All Electronics	95	78 Radio Shack
—	Amazing Concepts	91, 104	— Scope Electronics
106	American Design Components ..	101	179, 180 Sencore
64	Atlantic Cable Distribution	88	74 Solid State Sales
77	B&K Precision	5	— Star Circuits
77	B&K Precision	200-254	83 Synergetics
67	Banner Technical Books	14	92 Tektronix
109	C & S Sales	13	178 WPT Publications
70	CEI	88	
60	CIE	11, 24	
54	Chemtronics	71	
—	Command Productions	71	
176	Communications Specialists	73	
58	Cook's Institute	12	
69	Crystek	14	
127	Deco Industries	58	
82	Digi-Key	102	
181	Electronics Book Club	7	
—	Electronics Training	75	
182	Electrosales	58	
121	Fluke Manufacturing	CV2	
—	Grantham College	62	
86	Heathkit	8	
65	J & W	16	
113	JDR Instruments	97, 98, 100	
114	Jameco	96, 97	
104	Jan Crystals	76	
—	Joseph Electronics	23	
87	MCM Electronics	94	
53	MD Electronics	104	
93	Mark V. Electronics	91	
—	McGraw Hill Book Club	38	
61	Microprocessors Unltd.	79	
—	NRI	21	

Gernsback Publications, Inc.
500-B Bi-County Blvd.
Farmingdale, NY 11735
1-516-293-3000
Fax 1-516-293-3115
President: **Larry Steckler**
Vice President: **Cathy Steckler**

For Advertising ONLY
1-516-293-3000
Fax 1-516-293-3115
Larry Steckler
publisher

Arline Fishman
advertising director
Shelli Weinman
advertising associate
Lisa Strassman
credit manager
Christina Estrada
advertising assistant

SALES OFFICES

EAST/SOUTHEAST
Stanley Levitan
Eastern Sales Manager
Radio-Electronics
259-23 57th Avenue
Little Neck, NY 11362
1-718-428-6037, 1-516-293-3000

MIDWEST/Texas/Arkansas/Okla.
Ralph Bergen
Midwest Sales Manager
Radio-Electronics
540 Frontage Road—Suite 339
Northfield, IL 60093
1-312-446-1444
Fax 1-312-446-8451

PACIFIC COAST/ Mountain States
Marvin Green
Pacific Sales Manager
Radio-Electronics
5430 Van Nuys Blvd. Suite 316
Van Nuys, CA 91401
1-818-986-2001
Fax 1-818-986-2009

CABLE TV DESCRAMBLERS

	10 Lot	
JERROLD™ Tri-Bi Mode.	\$105.00	\$85.00
JERROLD™ SB-3 OR 2	\$89.00	\$65.00
Hamlin MLD-1200.....	\$99.95	\$62.00
Oak N-12 W/V.S.....	\$99.95	\$62.00
Oak M-35-B W/V.S.....	\$99.00	\$78.00
OAK E-13.....	\$99.95	\$58.00
Zenith SSAVI.....	\$185.00	\$145.00
Eagle PD-3.....	\$120.00	\$85.00
Scientific Atlanta.....	\$129.95	\$105.00
SA-Combo's.....	CALL	\$Call
Tocom.....	\$350.00	\$295.00
Oak N-12 W/ Auto.....	\$140.00	\$105.00
Jerrold Starcom CSV....	\$139.95	Call

M.D. ELECTRONICS
WILL MATCH ANY
ADVERTISED PRICE
IN THIS MAGAZINE

*NEW STARGATE 2000 CABLE CONVERTER



1-\$89.00 10-\$69.00 100-Call
Last channel recall-Favorite channel select-
75 channel-Channel scan-Manual fine tune-
One year warranty-surge protection-HRC & Stand-
ard switchable- and much more. **Call Today!**

INFORMATION(402)554-0417

Orders Call Toll Free
1-800-624-1150

M.D. ELECTRONICS
115 NEW YORK MALL
SUITE 133E
OMAHA, NE. 68114

M.C.
VISA
C.O.D.

Find The Defective Capacitors, Coils, Resistors, SCRs And Triacs That All Other Testers Miss . . .

Presenting a new, improved dynamic and mistake proof LC Analyzer that finds defective components all other testers miss.

- Dynamically tests capacitors for value from 1 pF to 20F, leakage with up to 1000 volts applied, dielectric absorption and equivalent series resistance (ESR).

- Dynamically tests inductors, in-or-out of circuit, from 1 uH to 20 Henrys for opens, shorts, value, and detects even one shorted turn.

- Dynamically tests SCRs, Triacs, High Value Resistors, and locates the distance to within feet of an open or short in a transmission line for an added bonus.

- Automatically makes all of the tests, compares them to EIA (Electronic Industries Association) standards and reads the results as Good or Bad. Enter all information right from the component without look-up charts, calculations, or errors.

- Extends your testing capability to places where an AC cord won't reach, with rechargeable 9 hour battery or AC operations.

- An added feature alerts you that the fuse has opened, and that there may be residual high voltage on the component under test.

New!
And Improved!



It's like having your own Standards Engineer with you at all times.

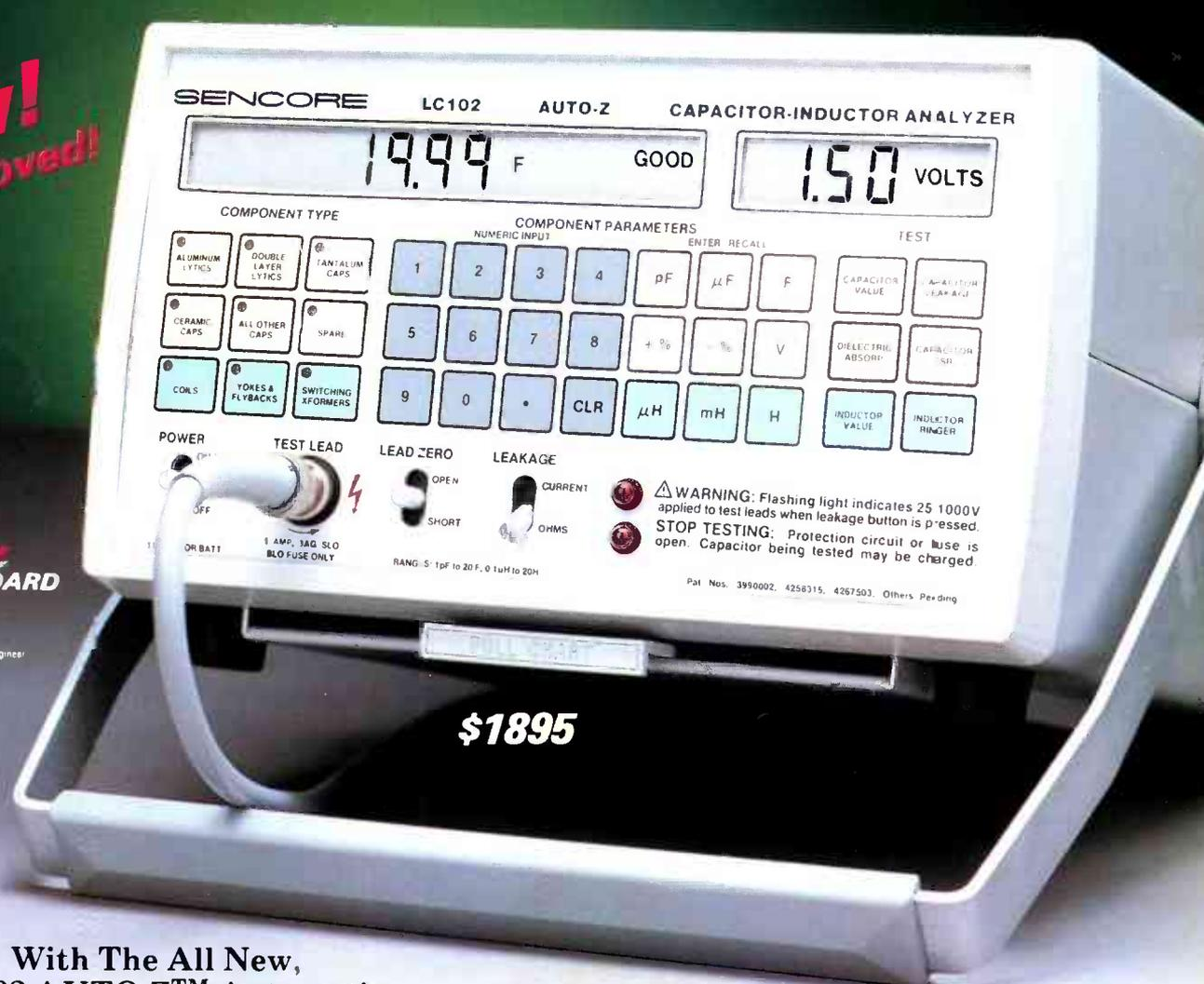

\$1895

With The All New,
**LC102 AUTO-Z™ Automatic
Capacitor-Inductor Analyzer.**
Four Patents

Call 1-800-843-3338
In Canada Call 1-800-851-8866

CIRCLE 179 ON FREE INFORMATION CARD

www.americanradiohistory.com

SUPER VALUES!



B&K 40 MHZ OSCILLOSCOPE

SAVE \$250 ■ 20 Calibrated sweeps ■ 6" CRT with internal graticule and scale illumination ■ Video sync separator ■ Single sweep ■ X-Y operation ■ Z axis output ■ V mode displays 2 unrelated frequency signals ■ Two 10:1 direct probes

Reg. \$848.00

Our Price \$598⁰⁰
Model 1541A

COBRA® RADAR DETECTOR Trapshooter®

SAVE \$60 ■ Mounts on dash, visor — even windshield ■ Graduated signal strength meter ■ 2 power cords for permanent or detachable installation ■ City/highway switch ■ X and K band indicators ■ 3 anti-falsing circuits

Reg. \$199.95

Our Price \$139⁹⁵
Model RD-3168

ALL PURPOSE 92-Pc. TOOL CASE

SAVE \$40 ■ Complete with everything you need for home, shop, auto ■ Includes 52-pc. socket set with ratchets and extenders ■ 2 tool pallets with roomy rear storage compartments ■ Rugged, handsome carry case

Reg. \$169.95

Our Price \$129⁹⁵
Model FTK-28

ASK FOR FREE CATALOG.

FREE BONUS

VM-520 20K OHM/volt Multi-tester with purchase of any item on this page. Sale Prices and BONUS Offer expire 4/30/89.



SCOPE ELECTRONICS

260 Motor Pkwy., Hauppauge, NY 11788

TOLL FREE 800-648-2626

(In NY State 800-832-1446 Ext. 242)

TELEPHONE ORDERS NOW!



Money orders, checks accepted.

C.O.D.'s require 25% deposit.

Service & Shipping Charges Continental U.S.A.

FOR ORDERS	ADD
\$0-50	\$ 4.50
\$51-100	\$ 5.50
\$101-200	\$ 7.00
\$201-300	\$ 8.00
\$301-400	\$ 9.00
\$401-500	\$10.00
\$501-750	\$12.50
\$751-1,000	\$15.00
\$1,001-1,250	\$17.50
\$1,251-1,500	\$20.00
\$1,501-2,000	\$25.00
\$2,001 & Up	\$30.00