

48783

**Radio** — **KEEP YOUR VCR OUT OF THE REPAIR SHOP**

MARCH 1989

# Electronics®

TECHNOLOGY - VIDEO - STEREO - COMPUTERS - SERVICE

## LASERS

Build our universal power supply and put any laser tube to work

GERNSBACK PUBLICATION

## BUILD A WIRELESS MICROPHONE

A simple 2-transistor circuit

## COMPUTER DIGEST

Using the Amiga 2000 for professional-looking home videos

## BUILD A HI-FI HIGH-POWER AMPLIFIER

For your home or car

## VCR SERVICING

New scopes cut troubleshooting time!



\$2.25 U.S.  
\$2.75 CAN



## WORKING WITH OP-AMPS

A Circuit Cookbook

\*\*\*\*\* CAR-RT SORT \*\* CRD3  
750456 HRR 5165MD93 67  
AUG 89





PHILIPS

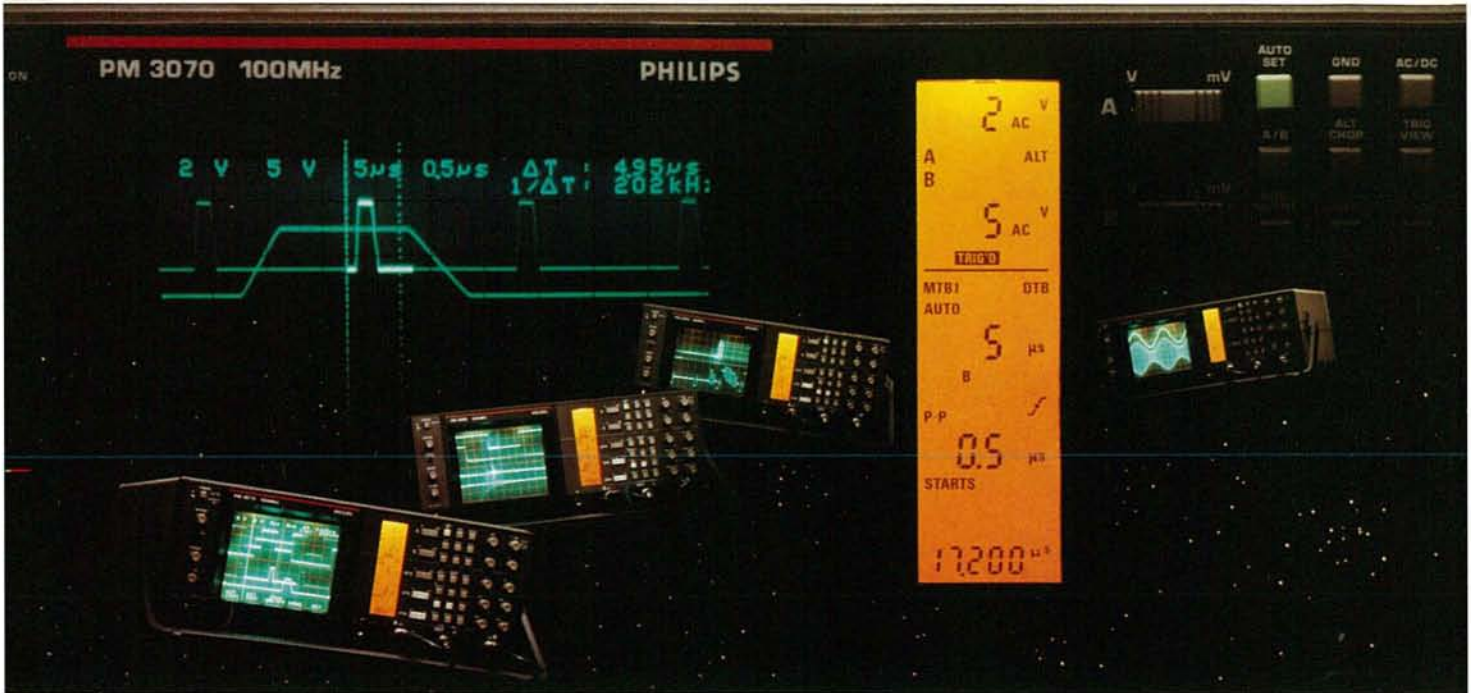

# Introducing a whole new way to look at oscilloscopes.

**Operation that's instinctively, unbelievably clear. Information that's detailed, yet free of errors. And intelligence that will speed your work. Philips' micro-computer controlled medium-frequency Smart Series. They could change forever the way you look at oscilloscopes.**

## HIGH PERFORMANCE WITH A VIEW

- **LCD window.** Large digital indications note all selected functions, instrument settings and parameter values. Instantly. Precisely. With no mistakes. And right where you need them—next to the CRT. Not hidden in crowded frontpanels. Not wasting critical waveform display area. It's a revolutionary idea that facilitates the use of an oscilloscope like nothing else. And it's only from Philips. Once again.
- **16kV CRT.** Higher acceleration voltage and advanced electron optics assure brilliance and spot quality that outshines anything else in this class.
- **Pushbutton simplicity.** Quick, one-function buttons have replaced knobs for faster, surer, more reliable operation.

- **Instant-action AUTOSET.** Philips' intelligent beamfinder automatically selects channel, amplitude, timebase and triggering for error-free display of any input signal. Great for troubleshooting!
- **"Clever" cursors and delayed sweep.** Standard on the PM 3070, "clever" cursors supply immediate amplitude and timing measurements with direct CRT readout. And an exclusive cursor-operated ZOOM function offers the most efficient use of delayed sweep available in analog scopes.
- **Auto-Triggering intelligence.** Provides fast, stable triggering up to 150 MHz.
- **Probefactor compensation in LCD.** It automatically adjusts all readouts for the probe you're using.
- **IEEE compatibility.** For fast computer hook-up and automated production test and calibration.

- **Choice of four models:** Single and dual timebase; 60 or 100 MHz bandwidths.

## SUPPORTING VIEW

Philips' medium-frequency instruments come with a 3-year warranty, a 30-day money-back guarantee and all the tech-

nical and service assistance you need. From Fluke—the people who believe that extraordinary technology deserves extraordinary support.

## POINT OF VIEW

Call Fluke today at **800-44-FLUKE ext. 77**. And find out how easy it is to change the way you look at oscilloscopes.

*Ask for your free copy of our new guidebook, Basic Principles of Oscilloscopes.*

John Fluke Mfg. Co., Inc., P.O. Box C9090, MIS 250C, Everett, WA 98206  
U.S.: 206-356-5400 CANADA: 416-890-7600  
OTHER COUNTRIES: 206-356-5500

© Copyright 1988 John Fluke Mfg. Co., Inc. All rights reserved. Ad No. 0481-P3065/70



SMART SERIES OSCILLOSCOPES • 60 & 100 MHz



CIRCLE 121 ON FREE INFORMATION CARD

## BUILD THIS

- 33 UNIVERSAL POWER SUPPLY**  
This power supply works with any laser tube!  
**Gordon McComb**
- 43 WIRELESS FM MICROPHONE**  
Transmit an audio signal to any frequency in the standard FM band.  
**Marc Spiwak**
- 46 PHONLINK II**  
Control your home appliances from any touch-tone phone.  
**Janet McNabb and Gene Roseth**
- 51 HIGH-POWER HI-FI AUDIO AMP FOR HOME OR CAR**  
Build a versatile audio powerhouse!  
**L.K. Ross and Amp Watts**

## TECHNOLOGY

- 61 KEEP YOUR VCR HEALTHY**  
Simple maintenance will keep your VCR out of the repair shop.  
**Peter M. Hansen**
- 65 SPEED UP VCR TROUBLESHOOTING**  
Advanced oscilloscope features simplify VCR and camcorder repair.  
**Jim Emerich**

## CIRCUITS

- 69 BASIC OP-AMPS**  
A look at fundamental principles and circuits.  
**Ray Marston**

## DEPARTMENTS

- |  |  |
|--|--|
| <ul style="list-style-type: none"><li><b>6 VIDEO NEWS</b><br/>What's new in this fast-changing field.<br/><b>David Lachenbruch</b></li><li><b>16 EQUIPMENT REPORTS</b><br/>B&amp;K Precision's 388-HD Test Bench multimeter.</li><li><b>25 HARDWARE HACKER</b><br/>A new "disco" circuit.<br/><b>Don Lancaster</b></li></ul> | <ul style="list-style-type: none"><li><b>73 NEW IDEAS</b><br/>A quick cable tester.</li><li><b>80 DRAWING BOARD</b><br/>A custom-character generator.<br/><b>Robert Grossblatt</b></li><li><b>84 AUDIO UPDATE</b><br/>HX:Pro: A "new" and improved cassette-deck circuit.<br/><b>Larry Klein</b></li></ul> |
|--|--|

## COMPUTER DIGEST

(A NEW KIND OF MAGAZINE FOR ELECTRONICS PROFESSIONALS)  
SPICE UP YOUR HOME VIDEOS  
Using the Amiga for video post production Page 93



DIGGING DEEPER INTO THE '386  
Bus timing and Peripheral devices Page 98

PAGE 89

**NEW! TO**  
**SPEED-UP VCR TROUBLESHOOTING**

Modern equipment can turn hours of troubleshooting into a few minutes and give you a better understanding of VCR operation.

**Jim Emerich**

Modern equipment can turn hours of troubleshooting into a few minutes and give you a better understanding of VCR operation. This article provides a comprehensive guide to VCR troubleshooting, covering common problems and their solutions. It includes detailed diagrams and step-by-step instructions for diagnosing and repairing VCRs. The author, Jim Emerich, is an experienced technician and provides valuable insights into the inner workings of VCRs.

PAGE 65

## AND MORE

- 124 Advertising and Sales Offices**
- 124 Advertising Index**
- 8 Ask R-E**
- 125 Free Information Card**
- 14 Letters**
- 105 Market Center**
- 74 PC Service**
- 4 What's News**

## ON THE COVER

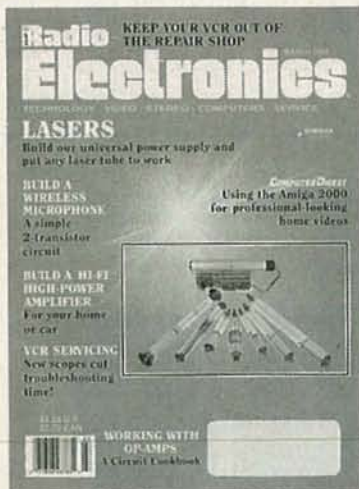

Lasers can be a lot of fun to experiment with, learn from, and, as Forrest Mims proves with the cover background, they can be fun to photograph, too. The only problem is that laser tubes require special high-voltage power supplies in order to operate. And, to further complicate things, different laser tubes have specific voltage and current requirements. Therefore, you usually need a "custom" power supply for every laser tube you come across. However, a few simple adjustments on our laser power supply make it compatible with *any* helium-neon laser tube. See page 33.

## COMING NEXT MONTH

### THE APRIL ISSUE IS ON SALE MARCH 2.

#### SPECIAL SECTION: HOME SECURITY

An in-depth look at security-system technology, how to install security systems—including wireless ones—in your home, and a complete home-security system that you can build.

#### DIGITAL PEAK DETECTOR

Display and hold the maximum output level from any transducer.

#### ALL ABOUT CAPACITORS

Match the right capacitor to the job.

#### CIRCUIT COOKBOOK

Recipes for more than 20 practical counter circuits.

As a service to readers, RADIO-ELECTRONICS publishes available plans or information relating to newsworthy products, techniques and scientific and technological developments. Because of possible variances in the quality and condition of materials and workmanship used by readers, RADIO-ELECTRONICS disclaims any responsibility for the safe and proper functioning of reader-built projects based upon or from plans or information published in this magazine.

Since some of the equipment and circuitry described in RADIO-ELECTRONICS may relate to or be covered by U.S. patents, RADIO-ELECTRONICS disclaims any liability for the infringement of such patents by the making, using, or selling of any such equipment or circuitry, and suggests that anyone interested in such projects consult a patent attorney.

RADIO-ELECTRONICS, (ISSN 0033-7862) March 1989. Published monthly by Gernsback Publications, Inc., 500-B Bi-County Boulevard, Farmingdale, NY 11735 Second-Class Postage paid at Farmingdale, NY and additional mailing offices. Second-Class mail registration No. 9242 authorized at Toronto, Canada. One-year subscription rate U.S.A. and possessions \$17.97, Canada \$23.97, all other countries \$26.97. All subscription orders payable in U.S.A. funds only, via international postal money order or check drawn on a U.S.A. bank. Single copies \$2.25. © 1989 by Gernsback Publications, Inc. All rights reserved. Printed in U.S.A.

**POSTMASTER:** Please send address changes to RADIO-ELECTRONICS, Subscription Dept., Box 55115, Boulder, CO 80321-5115.

A stamped self-addressed envelope must accompany all submitted manuscripts and/or artwork or photographs if their return is desired should they be rejected. We disclaim any responsibility for the loss or damage of manuscripts and/or artwork or photographs while in our possession or otherwise.

## Radio Electronics®

Hugo Gernsback (1884-1967) founder  
M. Harvey Gernsback,  
editor-in-chief, emeritus

Larry Steckler, EHF, CET,  
editor-in-chief and publisher

#### EDITORIAL DEPARTMENT

Art Kleiman, editorial director  
Brian C. Fenton, editor  
Carl Laron, WB2SLR,  
editorial associate  
Marc Spiwak, associate editor  
Jonathan A. Gordon,  
assistant technical editor  
Teri Scaduto, assistant editor  
Jeffrey K. Holtzman,  
computer editor  
Robert A. Young, assistant editor  
Byron G. Wels, editorial associate  
Jack Darr, CET, service editor  
Robert Grossblatt, circuits editor  
Larry Klein, audio editor  
David Lachenbruch,  
contributing editor  
Don Lancaster,  
contributing editor  
Richard D. Fitch,  
contributing editor  
Kathy Campbell, editorial assistant  
Andre Duzant, technical illustrator  
Injae Lee, assistant illustrator

#### PRODUCTION DEPARTMENT

Ruby M. Yee, production director  
Robert A. W. Lowndes,  
editorial production  
Karen Tucker, advertising production  
Marcella Amoroso, production traffic

#### CIRCULATION DEPARTMENT

Jacqueline P. Cheeseboro,  
circulation director  
Wendy Alanko,  
circulation analyst  
Theresa Lombardo,  
circulation assistant

Typography by Mates Graphics

Cover photo by  
Diversified Photo Services  
and Forrest Mims III.

Radio-Electronics is indexed in  
*Applied Science & Technology Index*  
and *Readers Guide to Periodical Literature*.

Microfilm & microfiche editions are  
available. Contact circulation depart-  
ment for details.

Advertising Sales Offices listed  
on page 124.



# Intermittents. We Hear You.

*Introducing The Heavy-Duty DMM With An Audible Readout That Lets You Keep Both Eyes On The Job.*

**Intelligent design and solid construction make the new HD 150 Series the best DMMs in their class.**

They're the latest in a distinguished line that began when Beckman Industrial pioneered heavy-duty DMMs with their distinctive yellow color. Many competitors have since imitated that color. As for imitating their performance, no one comes close.

The HD 150 Series attains new levels of excellence with a range of advanced features. They're waterproof. Drop proof.

Auto-ranging. Slim-styled for one-hand comfort and convenience. With auto-off to prolong battery life. Plus 2 fuses, PTC resistor and MOV for unsurpassed overload protection.

**Audible readout.** A "sound" reason to go with the HD 150 Series. With this unique feature on the HD 153, you measure parameters by listening to a continuous variable tone. As the parameter you measure rises or falls, the tone's frequency increases or decreases, accordingly. Use it for volts, amps, or ohms. It's ideal for peaking and nulling, too.

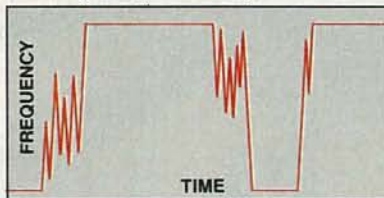

**Intermittent alert.** A key application of audible readout. The HD 153 pinpoints intermittents by emitting a "crackling" sound when they're detected. The response sounds in about 1 msec—far faster than the information appears on any DMM display.

**Logic function.**

The HD 153 detects TTL or CMOS logic pulses using standard test leads.

**Easy to use.**

The HD 150 Series lets you read the LCD even at wide angles. With the large rotary dial you select functions with one-handed (right or left) convenience. Auto-ranging speeds you to the right range. A tilt-stand and Skyhook let you set or hang the DMM almost anywhere.

**Built tough to work hard.** The HD 150 Series DMMs are so tightly sealed against water and grime that they're *guaranteed for five years* against contamination. And, because they're built so tough, they're guaranteed for two years against *any* damage (except abuse). Crashes, overloads, moisture, dust... you name it. The HD 150 Series can handle it all!

**Listening is believing.** For a hands-on demo, see your distributor now. Learn why the HD 150 Series is the soundest DMM value you'll see. Or hear.

**Key Specifications**

	HD 151	HD 152	HD 153
Auto-ranging	✓	✓	✓
Range Lock		✓	✓
Audible readout			✓
Tilt Stand and Skyhook™	Optional	Optional	Included
Logic pulse detector			✓
DC voltage accuracy	0.7%	0.5%	0.25%
10A range		✓	✓
Suggested list price	\$149.00	\$169.00	\$199.00

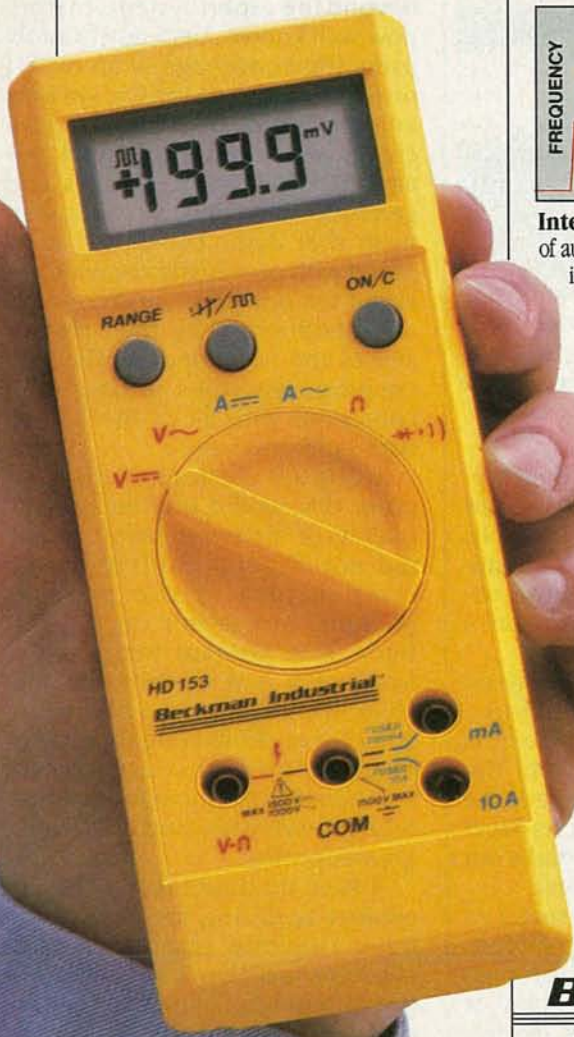

**Beckman Industrial™**

Beckman Industrial Corporation  
Instrumentation Products Division  
A Subsidiary of Emerson Electric Company  
3883 Ruffin Road, San Diego, California 92123-1898  
(619) 495-3200 • FAX: (619) 268-0172 • TLX: 249031

*In Service Instruments,  
We're The One.*

© 1988 Beckman Industrial Corporation  
Specifications subject to change without notice.  
Valox is a registered trademark of General Electric Corporation.

# WHAT'S NEWS

Motors 100 times smaller than any known today

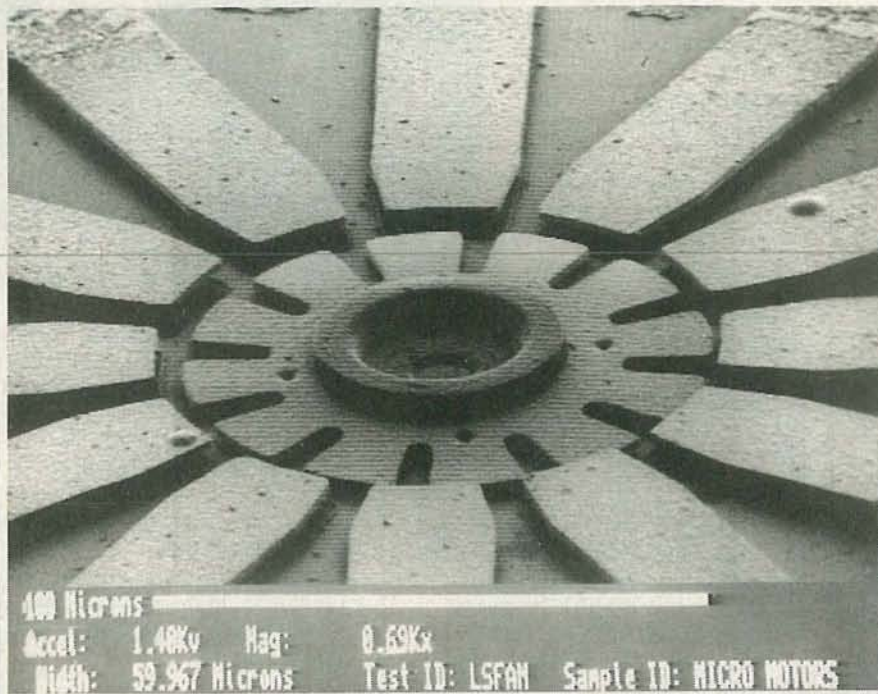

THE NEW MICROMOTOR, as photographed with an electron microscope. The rotor (center) is approximately two-thousandths of an inch across. The teeth, or rotor poles, are about the size of red blood cells.

Electric motors no larger than the width of a human hair are reported by researchers at the University of California at Berkeley, CA. The motors are about three-thousandths of an inch in diameter, with notched teeth "about the size of red blood cells." They were developed by Richard S. Muller, professor of engineering and computer science at Berkeley, and his graduate students, Long-Shen Fan and Yu-Chong Tai.

The new motors are constructed with the same lithographic and etching techniques that are used in fabricating microelectronic components on a chip. The mechanical elements are made of polysilicon that is deposited and patterned in layers, sandwiched between layers of silicon dioxide. The silicon dioxide provides a framework that holds the assem-

bly together while it is built up.

After enough layers have been added to complete the assembly, the silicon diode matrix is chemically dissolved, leaving the assembled micromechanism on a chip.

The prototype motors are driven by electrostatic force—the force that exists between two objects with opposite voltages. Until the micromotors were developed, the distance between mechanical parts was too great to make an electrostatic motor practical.

Electrostatic drive interfaces efficiently with microchip circuitry, Muller said—another promising feature for the development of micro-mechanical devices. He and his colleagues expect that micromotors that are useful for practical applications will be produced within the next few years.

## "Discovery" opens new path for computer applications

In what may be the first practical application of an advanced form of artificial intelligence, Drs. Neil Pessall and Jan Schreuers of the Westinghouse Research and Development Center have successfully asked a computer to figure out a way to make better metal tubes, making it unnecessary to have a team of experts.

The method used, called a "discovery system," goes a step beyond the expert systems that are now well known. Instead of simply using the knowledge of an expert or experts, the discovery systems analyze their own thinking to create *new* knowledge. They examine the data from a process, and generate new rules of operation from that data. Those are compared with previously known rules about the operation, and conflicts are identified. They then resolve any of the identified conflicts by creating new rules of operation consistent with all of the known data—old and new.

In one test application, the computer discovered that the surface quality of zirconium-alloy tubing did not depend entirely on the temperature of the process coolant, but rather on the difference in coolant temperature from what it was when the machine was adjusted for operation. The cost of eliminating those temperature differences was small compared to the increased yield of tubing produced—and, as a result, greater profits.

"I have no doubt that a team of experts analyzing the data would have reached the same conclusions," said Dr. Schreuers. "But it was much quicker and less expensive to use a discovery system." The technology has the potential for broad application in industrial processes of all kinds, including electronics. **R-E**

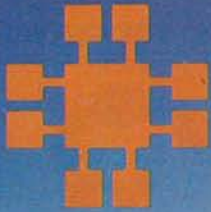

# JDR INSTRUMENTS™

Complete customer satisfaction... superior service... friendly, knowledgeable personnel... quality merchandise... providing the best values in leading edge technology.

## 35 MHz OSCILLOSCOPE

A remarkable value

# \$499<sup>95</sup>

Wide bandwidth and exceptional 1mV/DIV sensitivity make the Model 3500 a powerful diagnostic tool for engineers or technicians at a remarkable price. Delayed triggering allows any portion of a waveform to be isolated and expanded for closer inspection. Variable Holdoff allows stable viewing of complex waveforms.

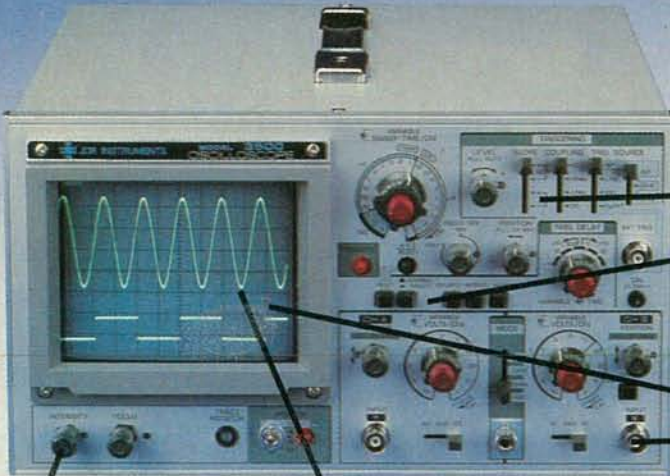

TV SYNC FILTER

DELAYED AND SINGLE SWEEP MODES

EXCEPTIONALLY BRIGHT 5" CRT

X-Y OPERATION

Z AXIS INTENSITY MODULATION

FAST 10NS RISE TIME

### DMM-300

### \$79.95

3.5 DIGIT DMM/MULTITESTER

This full function 3.5 digit DMM offers highly accurate performance and a host of added features like audible continuity, capacitance, transistor, temperature, and conductance to help you do the job—fast. Temperature probe, test leads and battery included.

- \* Basic DC accuracy: plus/minus 0.25%
- \* DC voltage: 200mv–1000V, 5 ranges
- \* AC voltage: 200mv–750V, 5 ranges
- \* Resistance: 200 ohms–20M ohms, 6 ranges
- \* Capacitance: 2000pf–20 µf, 3 ranges
- \* Transistor Tester: 0°–2000°F
- \* Conductance: 200ns
- \* Fully overload protected
- \* Input impedance: 10M ohm.

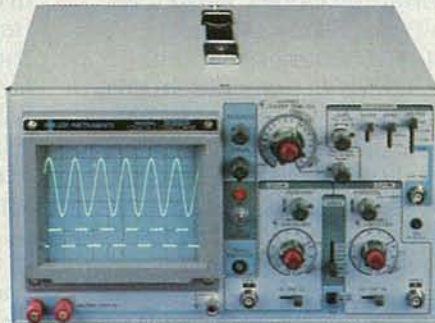

### MODEL 2000

### \$389.95

20 MHz DUAL TRACE OSCILLOSCOPE

Model 2000 makes frequency calculation and phase measurement quick and easy. The component tester aids in fast troubleshooting. Service technicians appreciate the TV Sync circuits for viewing TV-V and TV-H and accurate synchronization of the video signal, Blanking, VITS, and V/H sync pulses.

- \* Exceptionally bright 5" CRT
- \* Built-in component tester
- \* TV Sync filter
- \* X-Y operation \*110/220 volts

### DMM-100

### \$29.95

3.5 DIGIT POCKET SIZE DMM

Perfect for the field service technician. Shirt pocket size without compromising features or accuracy. Large, easy to read 1/2" LCD display. Fully overload protected for safety. 2000 hour battery life with standard 9v cell. Probes and battery included.

- \* Basic DC accuracy: plus/minus 0.5%
- \* DC voltage: 2v–1000v, 4 ranges
- \* AC voltage: 200v–750v, 2 ranges
- \* Resistance: 2k ohms–2M ohms, 4 ranges
- \* DC current: 2mA–2A, 4 ranges
- \* Input impedance: 10M ohm
- \* Fully overload protected
- \* Approx. 5" x 3" x 1". Under 7 ozs.

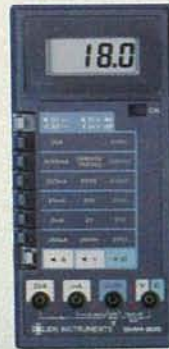

### DMM-200

### \$49.95

3.5 DIGIT FULL FUNCTION DMM

Get highly accurate performance at a very affordable price. Rugged construction, 20 amp current capability and 22 ranges make it a perfect choice for serious field or bench work. Low battery indicator and tilt-stand. Probes and 2000 hour battery included.

- \* Basic DC accuracy: plus or minus 0.25%
- \* DC voltage: 200mv–1000V, 5 ranges
- \* AC voltage: 200mv–750V, 5 ranges
- \* Resistance: 200 ohms–20M ohms, 6 ranges
- \* AC/DC current: 200µA–20A, 6 ranges
- \* Input impedance: 10M ohm
- \* Fully overload protected
- \* Approx. 7" x 3 1/2" x 1 1/2". Wt. 11 ozs.

### DPM-1000

### \$54.95

3.5 DIGIT PROBE TYPE DMM

Custom 80 pin LSI chip provides accuracy and reliability in such a compact size. Autoranging, audible continuity and data hold feature help you pinpoint the problem quickly. Case and batteries included.

- \* Basic DC accuracy: plus/minus 1%
- \* DC voltage: 2v–500v, autoranging
- \* AC voltage: 2v–500v, autoranging
- \* Resistance: 2k ohms–2M ohms, autoranging
- \* Fully overload protected
- \* Input impedance: 11M ohm
- \* Approx 6 1/2" x 1" x 3/4". Under 3 ozs.



- ★ 2 YEAR REPLACEMENT WARRANTY
- ★ 30 DAY MONEY BACK GUARANTEE
- ★ TOLL FREE TECHNICAL SUPPORT
- ★ NEXT DAY AIR SHIP AVAILABLE

COPYRIGHT 1987 JDR MICRODEVICES



JDR INSTRUMENTS, 110 KNOWLES DRIVE, LOS GATOS, CA 95030  
RETAIL STORE: 1256 SOUTH BASCOM AVE, SAN JOSE, CA (408) 947-8881

# ORDER TOLL FREE 800-538-5000

CIRCLE 59 ON FREE INFORMATION CARD

# VIDEO NEWS



**DAVID LACHENBRUCH,**  
CONTRIBUTING EDITOR

• **TV from China.** Color and black-and-white TV's are now coming into the United States from the People's Republic of China in limited quantities. The Chinese are anxious to become a major supplier of TV's—and, eventually, VCR's—to the outside world.

On a recent visit to China, I toured several major TV plants and talked with officials of China National Electronics Import and Export Corporation (CEIEC), which produces, as well as exports, electronics products. China is now manufacturing about 14,000,000 monochrome sets annually—which makes it the world's largest producer of black-and-white television sets—plus up to 7,000,000 color sets. China is already exporting a large number of color sets to the U.K., and is beginning shipments to the U.S., mainly of low-end 13-inch sets (although on our visit we saw such sophisticated products as digital picture-in-picture receivers).

China has an extreme shortage of color picture tubes—it imports more than half of its requirements—but new plants that are being built in joint ventures with overseas manufacturers could eliminate the shortage in the next couple of years. VCR's are extremely popular in China, but currently very few are being built there. However, joint ventures and know-how pacts with Philips and several Japanese manufacturers are expected to result in the production of perhaps 500,000 units in 1990. Another product for which China has high hopes is the TV receive-only (TVRO) home-satellite terminal. We saw them come off the production line in Nanjing, for shipment to the U.S.

• **Dual-deck VCR's.** Most audio-cassette recorders now have dual decks to simplify tape duplication, or to play to cassettes consecutively. So why not double-deck VCR's? That idea has been proposed from time to time, and Sharp even marketed one at one time in the Middle East.

Go-Video, of Scottsdale, AZ, says that it has a basic patent on the idea, but claims that the Japanese and Korean VCR manufacturers are conspiring to prevent its manufacture, and has filed an anti-trust lawsuit against them. Several

of the defendants had settled at press time, and agreed to cooperate with Go-Video's efforts to market a two-headed video deck. The Motion Picture Association of America (MPAA) has blocked all previous efforts to sell double-deckers in the United States on the grounds that they could be used to violate copyrights by making it easy to copy recorded cassettes. Originally a defendant in Go-Video's suit, the MPAA was dropped from the complaint after it agreed to end its opposition—when Go-Video said it would include electronic anti-copy safeguards on its two-deck machines. Now, presumably, Go-Video is free to market the double-deckers here—but without the ability to duplicate copyrighted cassettes. The big question is whether a device with such limited utility can succeed.

• **Multiple systems.** There are currently at least 18 different HDTV systems that are claimed to meet the FCC's criteria. Most of them use a 1,050-line non-interlaced picture, and many require at least a portion of a second channel to provide the enhancements needed for HDTV—the wider aspect ratio and the additional lines.

The goal of the FCC and the industry is to agree on an all-American HDTV system as soon as possible—ideally, within the next couple of years—so that work can proceed on broadcasting, cable-origination, and receiving equipment. Although there is some confusion on the subject, there is also considerable agreement that any standards for terrestrial broadcasting, cable transmission, and such new systems as direct-satellite broadcasting and telephone-company distribution via fiber optics should be mutually compatible. That will ensure that viewers will not have to buy two or three different TV sets—or expensive multi-standard sets—to be able to watch all modes of transmission standards.

Although some estimate that HDTV standards can be developed in the next two or three years, others believe such a schedule optimistic in view of the number of systems to be considered. While some work can be done on receiving systems, most work will have to await the selection of a transmission system.



# Cable Checklist

## ENJOY CABLE TV MORE THAN EVER



### SNOOPER STOPPER/DATA BLOCKER ..... \$39<sup>95</sup>



- Prevent cable companies from spying on you to see how many cable converters you have
  - Removes beeping sound from your FM when radio is connected to cable TV
  - Cable TV descramblers are being sold by the thousands, but few people know descramblers can be detected on most addressable systems
- Maintain your privacy with a Snooper Stopper. For more detailed information, send \$2.00 for our "Cable TV Snooper Stopper" article.



### MACROVISION... NOW YOU SEE IT, NOW YOU DON'T

#### MS1-KIT ..... \$29<sup>95</sup>

Includes all the parts, pc board, AC adaptor, and instructions from a published construction article in *Radio Electronics* magazine.



- Remove copy-protection from video cassettes
- Digital filter type; removes only Macrovision pulses

#### JMAK-4 BLACK BOX ..... \$14<sup>95</sup>

Original box as shown in ad with two feet and four holes to mount pc board.

- No adjustments; crystal controlled
- Compatible with all VCRs
- Uses automatic vertical blanking level
- Assembles in less than three hours



### SIGNAL ELIMINATOR ..... \$29<sup>95</sup>



- Works on cable or broadcast TV
- External adjustments allow precise tuning to any frequency
- #23H-Tuneable to ch. 2 & 3 (50-66 Mhz) also 6 meter HAM TVI interference filter
- #46FM-Tuneable to ch. 4-6 (66-108 Mhz & FM Band)
- #713-Tuneable to ch. 7-13 (174-216 Mhz)
- #1417-Tuneable to ch. 14-17 [A-D] (120-144 Mhz)
- #1822-Tuneable to ch. 18-22 [E-J] (144-174 Mhz)

#### ELIMINATE a Channel

that you find unsuitable for family viewing, but is poorly scrambled by your cable company. OR

**CLEAR UP a Channel** that presently contains severe interference by ELIMINATING whatever signal is causing this.

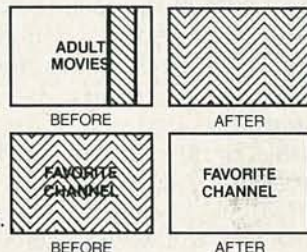

Note: If picture and sound are equally affected, this IS interference and CAN be removed by our product. If only picture is affected, this usually IS NOT interference and CANNOT be removed by our product.



### 72 Channel CABLE CONVERTER with Infra-Red Remote ..... MC-702 Converter \$79<sup>95</sup>

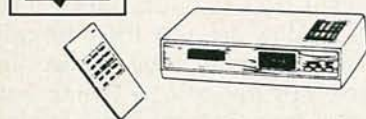

- Microprocessor controlled PLL operation
- Skip channel memory eliminates unused channels
- Parental control for all channels
- Compatible with all external descramblers
- Last channel recall
- Fine tune memory
- UL listed/FCC approved
- Simple installation with any TV
- Includes battery and 3 foot coax
- Channel output 2 or 3 switchable

Add \$3.50 shipping & handling  
\$9.50 Canadian orders

**ORDER TOLL FREE ANYTIME**  
**1-800-227-8529**

Inside MA: 508-695-8699 Fax: 508-695-9694  
Ask for additional free information  
Add \$3.00 shipping & handling on all orders unless otherwise noted. \$6.00 Canadian orders.  
Visa, MasterCard, or C.O.D.



**J & W**  
**ELECTRONICS, INC.**

P.O. BOX 800 • MANSFIELD, MA 02048

CIRCLE 65 ON FREE INFORMATION CARD

# ASK R-E

WRITE TO:

ASK R-E  
Radio-Electronics  
500-B Bi-County Blvd.  
Farmingdale, NY 11735

## HARDWARE AND A Z-80

I'm interested in developing hardware around the Z-80 but a lot of the software I've been looking at requires RAM at 0000h. The problem is that that is also the Z-80's power-up location. Is there some way to either change the power-up location or store a permanent jump there to some other location in RAM? Also, can anything be done about the Z-80's built-in jump to 0066h for an NMI?—C. Long Baltimore, MD

The first thing to realize is that there's absolutely no way, short of surgery, to change the Z-80's internal jump locations. They're an inherent part of the microcode and there's not one thing you can do about it. Given that, let's see what the options are for working around it.

Most small systems, including home-built Z-80 circuits such as a controller, development system, or the like, follow the path of least resistance and draw up a memory map with ROM at the bottom and RAM at the top—and that is still the best way to go about it.

If you insist on sticking ROM up at the top, you need some way of getting power-up instructions down at 0000h. Most systems doing that sort of thing load 0000h with a jump to the ROM starting location that contains all the initialization code. That means you have to load three bytes at the bottom of memory since the jump uses three bytes of code.

There's no way you can have ROM and RAM occupying the same memory space, so you need some way of switching between them—automatically. Simply stated, you want the ROM active

only at power up and reset, and the RAM active the rest of the time.

That can often be a real decoding nightmare but, since we know when the ROM has to be selected, the problem is a bit easier to solve. In actual fact we don't have to do any address decoding at all. There's not enough room here to go through the design of the circuit but the subject is interesting enough to cover in detail later on.

First of all, the jump instruction has to be put in some type of permanent storage device. A small bipolar PROM like a 74S288 makes sense because it's easy to program, can be tristated, and we only need three bytes of code. The circuit's core is a decade counter, such as the 4017. Why a decade counter? Well, once you realize that a jump instruction takes ten clock cycles you should understand what's going to happen.

At power up, the final output of the counter keeps the ROM enabled and the RAM disabled. The Z-80 goes to location 0000h and takes ten clock cycles to fetch the jump instruction. Meanwhile, the counter is advancing once for each clock cycle. At the end of the opcode fetch the counter has reached ten. That disables the counter, tristates the ROM, and enables the RAM that's mapped to the bottom of the memory map.

The parts count for the circuit is minimal. You'll need a PROM, a counter, and maybe a gate or two to make it all happen. If you want more than just the one instruction to execute automatically whenever the system is reset—initialize ports, test memory, etc.—you only need a larger PROM (an EPROM is

ideal), and a longer counter to do the job. The rest of the circuit is the same.

## TV INTERFERENCE

Every time I turn on my computer, my television reception gets really noisy. I've tried reorienting the antenna, electrically isolating the AC outlets, and a host of other things, but nothing seems to help. I see some improvement when I move the two farther apart, but there are practical limitations to that. What can I do?—J. Ootmar, Somerville, NJ

Not much. You might write to the Federal Communications Commission and have them send you a copy of their booklet "How to Identify and Resolve Radio-TV Interference Problems." The address is: The U.S. Government Printing Office, Washington, DC 20402, and the stock number is 004-000-00345-4.

I can save you the price of postage by telling you that while the booklet will go into great depth about what causes the problem, it won't give you any solutions that you haven't already tried.

Face it! Computers move TTL-level signals around their boards and through their cables at furious rates of speed—at least 1 MHz, and science says that currents moving through a wire will create electric fields. The faster the signals move, the stronger the induced field. That has become a real problem as computer speeds move further into the world of double-digit clocks. A 386 machine running at 20 MHz is going to radiate a lot of electrical energy and those fields are going to be carried by every

Discover—Explore—Experience  
Today's Electronics With ...

# McGraw-Hill's Contemporary Electronics Series

Now you can meet the challenges of today's electronics quickly and easily. This professional level learning series is as innovative as the circuitry it explains and as fascinating as the experiments you build and explore! And it's for anyone who has an interest in electronics... from the hobbyist to the professional.

## Thousands Have Already Experienced the Excitement!

Today's high-tech world demands an entirely new and innovative approach to understanding electronics. That's why McGraw-Hill has developed this unique "hands-on" learning method that brings to life the dynamics of the new electronics. It's a unique combination of interactive materials that gets you involved as you build and experiment with today's latest electronic circuitry.

Just how well this innovative learning approach meets the challenge of the new electronics is confirmed by those who have already completed the Series... "You have put me right into the middle of an extraordinary learning experience. With each lab exercise I have gained a new understanding of the intricacies of today's electronics." Or... "For me, the Series was just the answer. I felt confident within my specialty, but my grasp of other areas of electronics was slipping away. Your Series helped me upgrade my knowledge of the latest electronics concepts." Or this from a company director of training... "We manufacture sophisticated electronic products, with a lot of people in sales, assembly and purchasing. McGraw-Hill has answered a real need in helping our employees see the total picture. They now communicate with customers and each other more effectively."

## Your Involvement in the New Electronics Begins Immediately.

You master one subject at a time with 15 McGraw-Hill *Concept Modules*, sent to you one

every 4 to 6 weeks. You waste no time on extraneous materials or outdated history. It's an entertaining, lively, nontraditional approach to the most modern of subject matter.

Your very first module takes you right to the heart of basic circuit concepts and gets you ready to use integrated circuits to build a digital oscillator. Then, you'll verify the operation of different electronic circuits using a light emitting diode (LED).

And each successive module brings you up to speed quickly, clarifying the latest advances in today's electronics... from digital logic and microprocessors to data communications, robotics, lasers, fiber optics, and more.

## Unique Combination of Interactive Instruction Materials Makes Learning Easy.

Laboratory experiments, vividly illustrated text and interactive cassette tapes all blend together to give you a clear, simplified understanding of contemporary electronics.

With each module, you receive a McGraw-Hill *Action-Audio Cassette* that brings to life the facts and makes you feel as if you're participating in a lively dialogue with experts.

Your ability to quickly make this knowledge your own is further aided by strikingly *illustrated* texts that use diagrams, explanations, illustrations, and schematics to drive home and rein-

force the meaning of each important point. Carefully indexed binders conveniently house all this material, as well as the instructions that will guide you through your "hands-on" lab experiments.

Throughout your Series, *laboratory experiments* reinforce every significant concept. With this essential "hands-on" experience using actual electronic components, you master principles that apply all the way up to tomorrow's VLSI (Very Large Scale Integrated) circuitry.

## Discover, Explore, Experience for Yourself—15-Day Trial.

In all ways, the Contemporary Electronics Series is an exciting learning experience that offers you the quickest and least expensive method available to master today's electronics... and the only one with "hands-on" experience.

To order your first module for a 15-day

trial examination, simply complete the card and send today! If the card is missing, write to us for ordering information.



McGraw-Hill  
Continuing  
Education Center

3939 Wisconsin Avenue, NW  
Washington, DC 20016



With your first module, you'll build this solderless breadboarding system. As you add additional boards, you create increasingly complex circuits easily and quickly, bringing today's electronics concepts to life.

piece of metal on the computer.

With a 25-MHz clock, a lot of the radiated frequencies are going to be high enough to fall in the range of standard receivers. AM radio, for instance, is roughly between 0.5 MHz and 1.5 MHz, and even a five-year-old computer will generate frequencies in that range. It's further complicated by the fact that modern receivers (including TV tuners) are much more sensitive than they used to be.

Making the receiver more sensitive means that you'll be able to get better reception—but it also means that it's more likely to pick up RFI noise from your computer. Since the difference between music and noise is often in the ears of the listener, I can't imagine how to do it electronically.

As far as eliminating RFI is concerned, forget it. Power companies have been pumping AC voltage over electrical lines for many years, and the last time I looked there was still an enormous 60-Hz field on my bench.

### TIMEX ROBOT

**I'm planning to build a robot around my old Timex 1000 computer and I want to include the Timex printer as well. I want to power the whole thing from one 12-volt DC supply, but the printer needs 24 volts at 1.5 amps for the thermal print head. Is there a simple way to get the 24 volts I need for the print head from the 12-volt supply?—E.O., Roosevelt, MN**

There are several things to consider. I don't know what kind of 12-volt supply you were planning to use, but it had better be pretty chunky if you want to power a robot. That is especially true if you're going to have a mobile robot, because motors take a lot of juice. Given that as being the case, it's a reasonably fair assumption that you'll be using something like a car battery as the basis of the 12-volt supply.

It's a lot easier to get 12 volts from a 24-volt battery than the other way around. It's possible to build charge pumps and other cir-

cuits to get 24 volts, but needing to draw 1.5 amperes complicates things considerably. Let me tell you that if it was my project, I'd run the thing off two 12-volt batteries in series. A 12-volt supply could be tapped from one and the printer could run off both.

You might want to examine the printer and see if it can be tricked into running off 12 volts. I'm not familiar with your printer but I do have a Sinclair Thermal Printer that I got in England. It was sold by Sinclair to work with the ZX-81 and it runs off 9 volts.

I don't have any specs on it but it was the original model sold to work with the Sinclair Computer. Since Timex did little more than change the name when they marketed the computer in this country, I would expect that the same is true of the printer. Consequently, it might be a good idea to really eyeball the innards of the printer and see whether or not the 24 volts is stepped down somewhere beneath its plastic cover. **R-E**



## Prototyping Made Easy. In The Quantities You Require.

**Your Electronic Specialty Products distributor has a wide selection of 3M breadboards and prototyping labs in the quantities and styles you desire.**

We invented solderless breadboarding with one thought in mind: "make it fast and easy!" And we build these products with American made reliability.

Whether your requirements demand 3M's A•C•E 100 Series solderless breadboards or Powerace prototyping labs with self-contained power supplies, or our newest Powerace labs

with removable boards, you'll find what you need at your authorized 3M Electronic Specialty Products distributor.

For educators, students, hobbyists and even professional designers, 3M prototyping products make circuit building and testing fun and easy. And whether you need one breadboard or a hundred, we've got them packaged as you need them.

Your Electronic Specialty Products distributor also has all the prototyping tools you'll need. Tools such as jumper wires, adaptor pins and patch cords.

For the name of your nearest 3M A•C•E Board and Powerace distributor, call toll free 800-321-9668 or (216) 354-2101 in Ohio.

**Electronic Specialty Products  
3M Electronic Products Division**

9325 Progress Parkway  
Mentor, Ohio 44060

**We've Packaged Our Solutions.**



# Where's Your **ELECTRONICS** Career Headed?

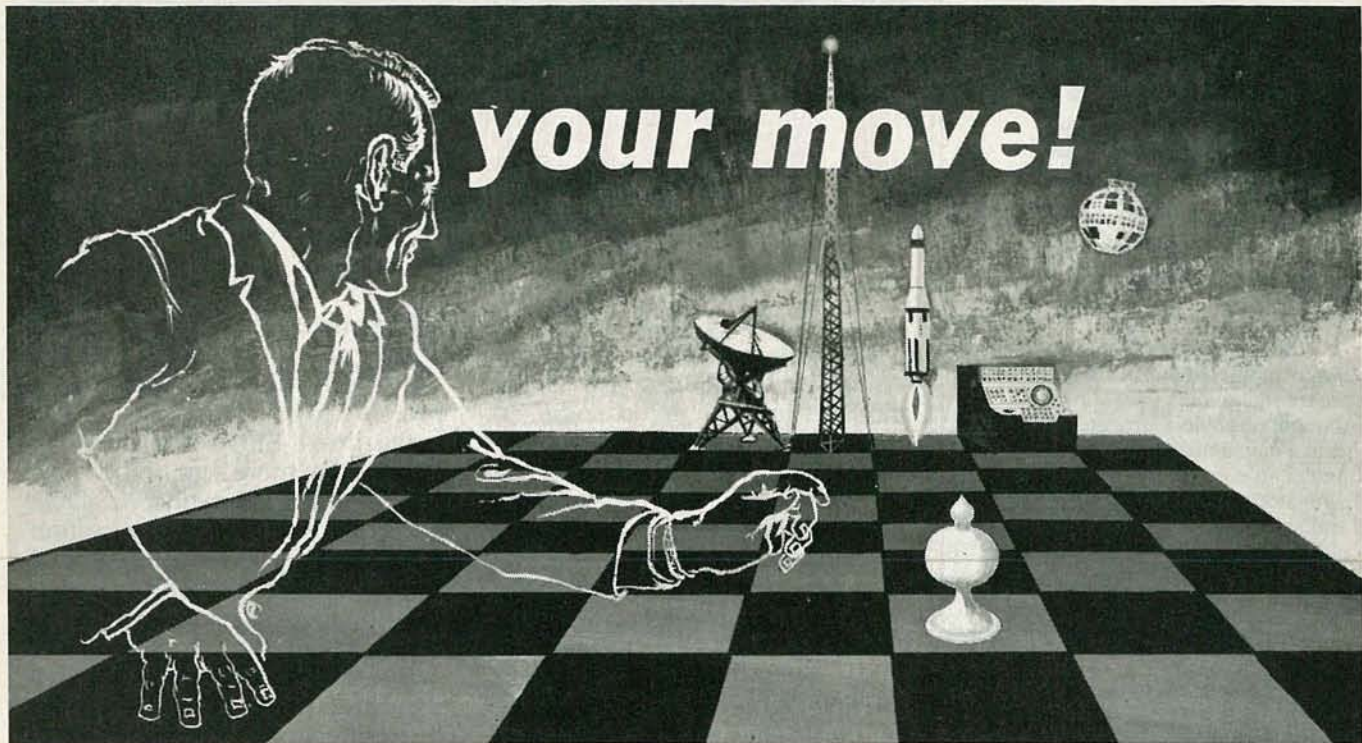

## The Move You Make Today Can Shape Your Future

Yes it's your move. Whether on a chess board or in your career, you should plan each move carefully. In **electronics**, you can *move ahead* faster and further with a

## **B. S. DEGREE**

Put professional knowledge and a COLLEGE DEGREE in your electronics career. Earn your degree through independent study at home, with Grantham College of Engineering. No commuting to class. Study at your own pace, while continuing your present job.

The accredited Grantham non-traditional degree program is intended for mature, fully employed workers who want to upgrade their careers . . . and who can successfully study electronics and supporting subjects through

### **INDEPENDENT STUDY, AT HOME**

Free Details Available from:

**Grantham College of Engineering**  
10570 Humbolt Street  
Los Alamitos, California 90720

### **Independent Home Study Can Prepare You**

Study materials, carefully written by the Grantham staff for independent study at home, are supplied by the College, and your technical questions related to those materials and the lesson tests are promptly answered by the Grantham teaching staff.

### **Recognition and Quality Assurance**

Grantham College of Engineering is accredited by the Accrediting Commission of the National Home Study Council.

All lessons and other study materials, as well as communications between the college and students, are in the English language. However, we have students in many foreign countries; about 80% of our students live in the United States of America.

**Grantham College of Engineering** R-389  
10570 Humbolt Street, Los Alamitos, CA 90720

Please mail me your free catalog which explains your B.S. Degree independent-study program.

Name \_\_\_\_\_ Age \_\_\_\_\_

Address \_\_\_\_\_

City \_\_\_\_\_ State \_\_\_\_\_ Zip \_\_\_\_\_

# TALK IS CHEAP.

Have you heard? For less than \$90 your AT or XT-compatible computer can talk! All it needs is the HV-2000 Computer Voice Kit from Heathkit.

Reading letters, transcriptions and computerized instruction can be easier and quicker than you ever thought possible. Computer games gain a new dimension. Your computer can even entertain children with stories and songs.



If you have a modem, the HV-2000

Computer Voice will allow your computer to recite reference and research information from time-sharing services. Or, speak radio transmitted ASCII information.

The HV-2000 Computer Voice Card, containing speech synthesizer and audio amplifier, plugs into any AT or XT-compatible computer's expansion slot. An external speaker is also included. Versatile, Heath-developed software gives you a wide variety of voices and easy interface to high and low level languages.

The HV-2000 Computer Voice. At less than \$90, talk IS cheap. To order, call toll-free 1-800-253-0570. Use your Visa, MasterCard, American Express or Heath Revolving Charge card. Or call 616-982-3614 for the nearest store location.

## Heath Company

A subsidiary of Zenith Electronics Corporation

Prices, product availability and specifications are subject to change without notice.

# LETTERS

## TUBE TALK

Reading the "Antique Radio" column in the January issue of **Radio-Electronics**, I noted some errors that beg correction.

First, the 201A and the 01A are the same type tube. Various manufacturers had designated the type as 201A, 301A, and 401A. The first digit was dropped in 1930 to resolve the confusion. For the same reason, other tube types with three-digit numbers also dropped the first digit—the 227 became the 27, the 280 became the 80, and, as noted in the article, the 112A became the 12A.

Also, when the 201A was used as a detector, it was usually used as a triode—not as a diode connected as described in the article. The grid-leak detection method was used in most cases. The next most popular method for using the 201A as a detector was the grid-bias method, again as a triode.

I haven't had any problem getting 201A tubes for my radio collection at the swap meets of the Southern California Antique Radio Society (SCARS). Some of the dealers that advertise in various periodicals (such as *Antique Electronic Supply* in Tempe, AZ) also have some 201A's available. Unfortunately, some day they will all be gone, and we will probably have to resort to embedding FET's in the bases of duds to keep the 1920's radios operational.

LARRY KENAN

## A HAPPY HACKER

Back when Byron G. Wels was making all those disparaging remarks about hackers in **Computer-Digest**, I was seriously considering not renewing my subscription to **Radio-Electronics**. I'm glad I did renew anyway. Although I have not purchased the PT-68K, and may never do so, I consider all the

space devoted to it to be well used.

Should you ever feel under pressure to emulate those "other" magazines—those that seem to believe that there's no home-brew market, no life beyond MS-DOS and OS/2, and belittle publication of schematics and hard details—I hope you will stick to your present course. This is one hacker who is very appreciative of what you've done, and is looking for more in the future. Perhaps you can cover the National 32XXX series or one of the RISC IC's next time around.

VICTOR R. FRANK, EDITOR  
*Sanyo PC Hacker's Newsletter*  
Woodside, CA  
Westlake Village, CA

## WE WANT OUR HDTV!

Enough already! There can be no high-definition television so long as the FCC decrees compatibility with the present NTSC specifications. Remember, those specifications are over 50 years old—at that time, it was a battle to get a 6-MHz-wide modulation envelope!

What we desperately need is a far-reaching FCC-type organization that sees where we can go, and opens all the standards needed for us to get there. The following are a few possibilities that deserve consideration.

A world-wide standard is needed, as satellite distribution is, or will be, taking over, regardless of what the networks might want. The main disagreement that prevents a world standard seems to be tying the vertical sweep to power-line frequency. However, that shouldn't be a problem, as color-television sets no longer use the power-line frequency as a standard. Another world standard exists that could be used and, at the same time, could ease the transfer

of that format to the TV world—the 24-frames-per-minute format currently used in movie production. If that is too slow to allow interlace (which may no longer be needed with a modern modulation system), perhaps 48-frames-per-second, would work.

What system of color is best? Are there any color systems that are better than NTSC's? My understanding is that SECAM is the least troublesome—as it has no consumer-adjustable controls, the number of false adjustments made possible by NTSC is reduced.

Aspect ratio: yes, make it wider! Stereo sound, by all means—but make the channels discrete. That is done on satellites, so why not for broadcast channels? Maybe a third channel should be established, to allow for whatever might be needed in the future.

Stereoscopic presentation is the main reason for this letter. That isn't mentioned in any of the HDTV proposals. (Will we have to go through all this again a few years down the road?) There are a few stereoscopic systems available; most require that the viewer wear special glasses. There is one (mostly forgotten) system, however, that was demonstrated on national-network television during a newscast. That test gave a feeling of depth that I still remember. It had a flicker problem that, as I see it, was probably due to the field rates present. That's why 48 frames, or some other multiple, should work. As I recall, the system was developed by some professors at Stanford; other than the demo I described, nothing more has been reported.

Why not make the entire TV signal some form of FM? That would allow noise reduction never available to our present system. (Have you ever seen a noisy, distorted, bad satellite signal?)

Again, who needs a standard for our most widely used entertainment system that can't grow as the technology expands?

I am sending a copy of this letter to my representative in Congress; I ask those who agree to do the same.

ORVAL NEMITZ  
Tucson, AZ

#### MORE ON SPEAKER LEADS

I would like to put my two bits in, concerning your answer to the question "Speaker Leads Too Small?" in "Ask R-E" in the February 1988 issue of *Radio-Electronics*. I feel you stopped short of the complete answer.

Back in 1973, I was asked to evaluate *Monster Cable* for its inherent characteristics pertaining to audio use. I installed a purely resistive 8-ohm load on one end of 50 feet of *Monster Cable*, and fed the open end with a McIntosh 2020 power amp fed by a Hewlett Packard motor-driven sine-wave generator. I used that to establish a calibrated response curve for the cable itself.

That little exercise proved enlightening. Throughout the audio spectrum (20 Hz to 20 kHz) the *Monster Cable* exhibited a reasonably flat response— $\pm 3$  dB. That would create no audible difference in either audio quality or response.

Out of curiosity, I connected the small wire usually shipped with speaker systems and found that as the frequency increased, the impedance of the wire increased. As the old saying goes, "As the impedance grows, the wattage goes." The load was not getting the same power at the higher frequencies as at the lower frequencies. Then I tried "zip" cord, house wiring, and anything else I could get my hands on. Although I got various response curves, none of them was anywhere within 9 to 10 dB's at the upper end.

Next came real-life testing with real-life speakers, with the same results: The upper end lacked brightness, crispness and volume. In fact, it sounded mushy unless the connections were made with *Monster Cable*. The real-time response curves showed the identical results obtained earlier with the resistive load: The impedance of the cables was killing the high end. Unless the speaker manufacturer compensated by making his speakers overly bright, the results would be a mushy, low high-end response and a loose-sounding bottom end.

LELAND R. FABER CET  
Santa Rosa, CA

R-E

When performance & price really count...

# CRYTEK CRYSTALS

The pulse of dependable communications



Reliability & Quality  
From Start To Finished Product

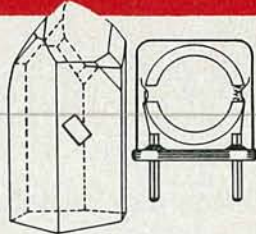

### QUARTZ CRYSTALS/OSCILLATORS FOR ELECTRONIC — INDUSTRIAL

- Micro-Processor Control
- Computers/Modems
- Test/Measurement
- Medical



### COMMUNICATIONS — REPLACEMENT

- Mobile/2-way/Channel Elements
- Pagers
- Marine
- Aircraft
- Telemetry
- Monitors/Scanners

### AMATEURS

- CB
- Hobbies
- Experimenter

COST EFFECTIVE  
MODERATE PRICING  
FAST DELIVERY



Replacement Crystals Catalog

Custom Made Crystals Catalog

### The Pulse of Dependable Communications

Crytek Crystals offers their new 16 page FREE catalog of crystals and oscillators. Offering state-of-the-art crystal components manufactured by the latest automated technology. Custom designed or "off the shelf." Crytek meets the need, worldwide. Write or call today!

### CRYTEK CORPORATION

DIVISION OF WHITEHALL CORPORATION

2351/2371 Crystal Dr. • Ft. Myers, FL 33907  
P.O. Box 06135 • Ft. Myers, FL 33906-6135  
TOLL FREE 1-800-237-3061  
(813) 936-2109 — TWX 510-951-7448



CIRCLE 185 ON FREE INFORMATION CARD

MARCH 1989

# EQUIPMENT REPORTS

## B + K Precision Model 388-HD Test Bench

A test bench you can fit in your pocket!

CIRCLE 14 ON FREE INFORMATION CARD



IF YOU DO ANY AMOUNT OF FIELD SERVICE, you know how frustrating it can be to find that you left a piece

of needed test gear behind. On the other hand, lugging equipment that you probably won't need can get frustrating, too. We've recently examined a new test instrument that should make life a little easier for many technicians: the model 388-HD from B + K Precision (6470 West Cortland Street, Chicago, IL 60635).

B + K Precision calls their 388-HD the *Test Bench*. It's a name that fits. The multimeter not only measures resistance, AC and DC voltage, and AC and DC current; it is also a capacitance meter, a frequency counter, a diode tester, a logic probe, a continuity checker, and a transistor tester. Even with all of those functions, you can still fit the *Test Bench* in your hip pocket; its case is smaller than  $1\frac{1}{2} \times 3\frac{3}{4} \times 7\frac{1}{2}$  inches, and weighs less than a pound.

The test bench is as easy to use as any other multimeter. Its front panel features only two controls: an AC/DC slide switch, and a large rotary function selector. The display is an easy-to-read  $3\frac{1}{2}$  digit LCD with 0.7-inch digits. Four test-probe input jacks, a transistor socket, and capacitor socket complete the front panel.

### Specifications

Five DC voltage ranges (200 mV

to 1000 V) and 5 AC voltage ranges (200 mV to 750 volts) are featured on the *Test Bench*. With an input impedance of 10 megohms, you won't have to worry about loading down the circuit under test.

Six ranges, from 200  $\mu$ A to 20 A, are offered for current measurements. To make current measurements, you must use separate input jacks. One jack is good for measurements to 2 amps, while a second is good for up to 20 amps. The 20-amp input is not fused, so you must be very careful to switch test leads when switching from current to voltage measurements. Otherwise, you will create a short circuit when you make your next voltage measurement.

The *Test Bench* features seven resistance ranges, from 200 ohms to 2000 megohms. An audible continuity test is also featured, which sounds a tone when the probed resistance is below about 200 ohms. The related diode-test mode can be used to check the forward and reverse voltages of semiconductor junctions.

The capacitance-measuring portion of the meter features 5 ranges from .002  $\mu$ F to 20  $\mu$ F. The capacitor is simply plugged into the slotted test jacks for measurement. No input protection is provided on those inputs, so it is essential that you short the leads of the capacitor together to discharge it before measuring it.

The *Test Bench* can measure frequencies to 200 kHz in three ranges, with a minimum input frequency of 20 Hz, and a sensitivity of 200 mV. The meter also serves as a logic probe. Annunciators on the LCD, in the shape of upward- and downward-pointing arrows, indicate high and low TTL levels. A high level is considered to be over 2.4 volts, and a low, under 0.8 volts. No pulse indication is available.

Both NPN and PNP transistors

## DIGITAL VIDEO STABILIZER ELIMINATES ALL VIDEO COPY PROTECTIONS



While watching rental movies, you will notice annoying periodic color darkening, color shift, unwanted lines, flashing or jagged edges. This is caused by the copy protection jamming signals embedded in the video tape, such as Macrovision copy protection. Digital Video Stabilizer: RXII completely eliminates all copy protections and jamming signals and brings you crystal clear pictures.

### FEATURES:

- Easy to use and a snap to install
- State-of-the-art integrated circuit technology
- 100% automatic - no need for any troublesome adjustments
- Compatible to all types of VCRs and TVs
- The best and most exciting Video Stabilizer in the market
- Light weight (8 ounces) and Compact (1x3.5x5")
- Beautiful deluxe gift box
- Uses a standard 9 Volt battery which will last 1-2 years.

**WARNING :**  
SCO Electronics and RXII dealers do not encourage people to use the Digital Video Stabilizer to duplicate rental movies or copyrighted video tapes. RXII is intended to stabilize and restore crystal clear picture quality for private home use only.

(Dealers Welcome)

To Order: \$49 ea + \$3 for FAST UPS SHIPPING

1-800-445-9285 or 516-694-1240

Visa, M/C, COD M-F: 9-6 (battery not included)

SCO ELECTRONICS INC.

Dept. CA6 581 W. Merrick Rd. Valley Stream NY 11580

Unconditional 30 days Money Back Guarantee

CIRCLE 191 ON FREE INFORMATION CARD



can be tested for  $h_{FE}$  or DC gain. The transistor is simply inserted into the test socket, and the selector is turned to either NPN or PNP. The DC gain can be read directly from the display.

### Using the Test Bench

Despite its 11 functions and 41 ranges, the *Test Bench* is very easy to use. DC and AC annunciators make it difficult to make measurements in the incorrect mode. In the capacitance mode, a *CX* annunciator appears, and in the logic mode, a *LOGIC* annunciator appears. In the frequency mode, a *kHz* annunciator is used. Unfortunately, the resistance, voltage, current,  $h_{FE}$ , and continuity modes have no LCD annunciators. The only time that could present a problem is when you must switch between voltage and current readings. If you make a measurement with the meter in the wrong mode, you run the risk of short-circuiting a voltage source.

Of course, that mistake will more likely be the result of forgetting to switch the "hot" probe between the  $v-\Omega$ -Hz input jack and one of the current input jacks to make the appropriate measurements. Fortunately the function selector, which dominates the front panel, is clearly marked with the modes and the input jacks are clearly labeled.

Of course, the *Test Bench* cannot take the place of a full-featured frequency counter, capacitance meter, and transistor tester. But then again, it doesn't try to. Of course, compromises had to be made to get so many instruments crammed into such a small case. We feel that the people at B+K Precision made the right compromises. For a technician who must commonly make a wide range of measurements, this meter might be a perfect alternative to carrying a trunk full of test gear.

It is rare that an instrument that is good for an electronics professional makes sense for a hobbyist—even a beginning hobbyist. The *Test Bench* packs many features in its modest size—at a price that would be impossible to beat buying separate units. At \$139, we feel that the *Test Bench* makes sense for everyone.

R-E

## Try the **Radio-Electronics** bulletin board system (RE-BBS) 516-293-2283

The more you use it the more useful it becomes.

We support 300 and 1200 baud operation.

Parameters: 8N1 (8 data bits, no parity, 1 stop bit) or 7E1 (7 data bits, even parity, 1 stop bit).

Add yourself to our user files to increase your access.

Communicate with other R-E readers.

Leave your comments on R-E with the SYSOP.

RE-BBS  
516-293-2283

# Up to 50% Savings on Probes



Model SP100  
Switchable 1X-10X . . . . .

\$ **43.**

Performance  
Guaranteed

**TEST PROBES, INC.** **TPI**

9178 Brown Deer Road  
San Diego, CA 92121

Call toll free for information and free catalog:

1-800-368-5719

1-800-643-8382 in CA

### ORDER FROM THESE DISTRIBUTORS

Or Phone Toll Free for the Distributor Nearest You



1-800-535-9593  
1-800-462-9520 LA

**contact east** **Metermaster**

1-800-225-5370  
(508) 682-2000 MA

1-800-962-8128  
(213) 685-4340 CA

**Specialized**  
PRODUCTS COMPANY

1-800-527-5018  
(214) 550-1923 TX

**Active** 

1-800-363-6592 Canada  
1-800-363-7601 QUE

**CALCOTRON**

(617) 879-7650



**JENSEN TOOLS INC.**

(602) 968-6231

**BCS ELECTRONICS LIMITED**

(416) 661-5585

**ALLIED ELECTRONICS INC.**  
A SUBSIDIARY OF HALL MARK ELECTRONICS CORP.

1-800-433-5700, (817) 336-5401 TX

**WESTCON INC.**

(503) 283-0132 OR, (206) 223-1133 WA

CIRCLE 123 ON FREE INFORMATION CARD

MARCH 1989

# An affordable portable

## Price/Bandwidth

**\$4995** 100 MHz 2230 DSO\*, 20 MS/s, 4K Record Length, 100 ns Glitch Capture, Cursors, CRT Readout, GPIB or RS-232-C Option

**\$3995** 60 MHz 2221 DSO, 20 MS/s, 4K Record Length, 100 ns Glitch Capture, Cursors, CRT Readout, GPIB or RS-232-C Option

**\$2995** 60 MHz 2220 DSO, 20 MS/s, 4K Record Length, 100 ns Glitch Capture, GPIB or RS-232-C Option

**\$2995** 100 MHz 2236 Two Channel, Counter/Timer/DMM, Dual Time Base

**NEW** **\$2795** 100 MHz 2247A Four Channel, Counter/Timer, Store/Recall of 20 Front Panel Setups, Auto Setup, Smart Cursors™

**\$2495** 100 MHz 2246A Four Channel, Store/Recall of 20 Front Panel Setups, Auto Setup, Smart Cursors™, Dual Time Base

**\$2395** 50 MHz 2210 DSO, 20 MS/s Sample Rate, 4K Record Length

**NEW** **\$1495** 20 MHz 2201 DSO, 10 MS/s Sample Rate, 2K Record Length, Hard Copy (RS-232-C) Option

**\$1895** 100 MHz 2245A Four Channel, Auto Setup, Cursors, Dual Time Base

**\$1695** 100 MHz 2235 Two Channel, Dual Time Base

**\$1095** 50 MHz 2225 Two Channel, Horizontal Magnification (x5, x10, x50)

**\$695** 20 MHz 2205 Two Channel

\*Digital Storage Oscilloscope

**Check the prices and performance.** You'll find the best measure of both in Tek 2200 Series Oscilloscopes. Twelve scopes with bandwidths ranging from 20 to 100 MHz. Two and four channels. Analog and digital. And prices starting at just \$695.

Select for such features as automatic setup, time and voltage cursors, built-in DMM functions, Counter/Timer and dual analog/digital capabilities at the push of a button.

These are scopes you'll appreciate for their well-proven reliability, achieved through simplified, practical internal design. They come

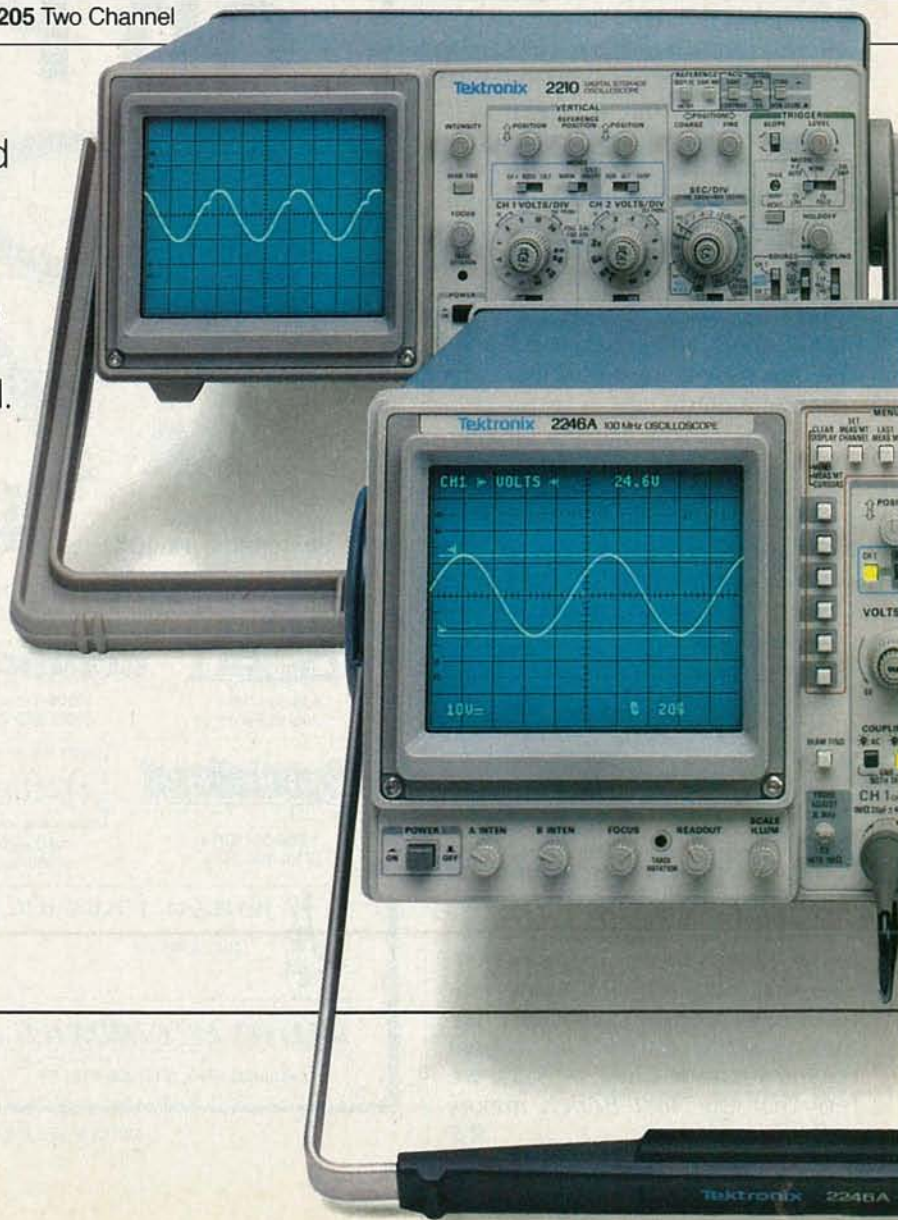

# right within your range.



Industrial-quality test instrumentation starting at \$295.

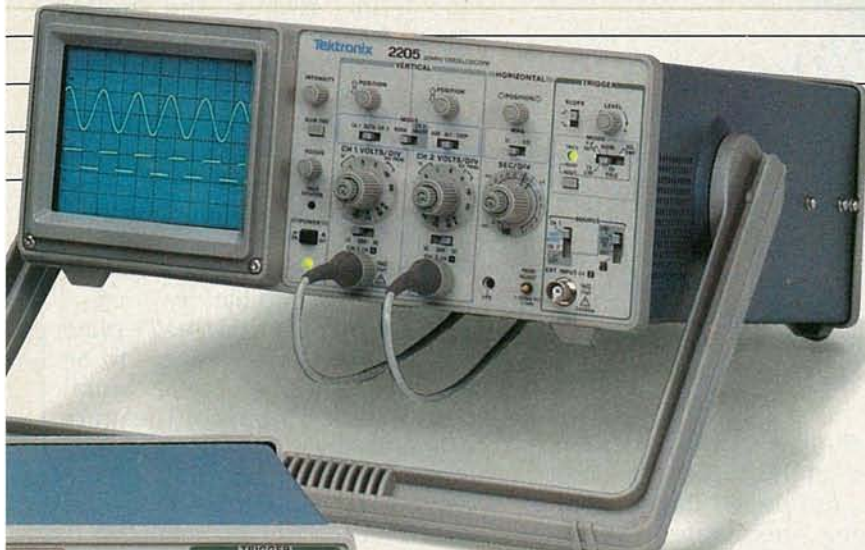

complete with probes and comprehensive Tek warranty that includes the CRT.

Ask those who own, use and rely on one—on the bench or in the field. There's just no substitute for genuine Tek quality. At any price. And at these prices, all the better.

**Order one to go.** Ask your Tek representative to set up a demo. Or call Tek direct. No need to settle for less when there's a top quality Tek portable with performance and price right within your range.

LISTED



For easy ordering or more information, call Tek direct:

## 1-800-426-2200



**Tektronix**  
COMMITTED TO EXCELLENCE

CIRCLE 92 ON FREE INFORMATION CARD



# NEW PRODUCTS



CIRCLE 10 ON FREE INFORMATION CARD

## STILL IMAGE VIDEO CAMERA.

Sony has added a new dimension to photographic instant gratification with the *Consumer Mavica* (model MVC-C1), a compact still image video camera, and the *MAP-T1* playback adaptor. The camera "captures the moment" in color images, much like a standard 35mm camera. But instead of waiting for photographic film processing, you can instantly play back images, electronically, on any television or monitor, using the playback adaptor.

The *Mavica* system uses magnetic recording of a still image video signal, allowing a quality image (up to 300 lines of horizontal resolution) to be viewed immediately. As many as 50 images can be recorded on an erasable and reusable 2-inch disk (similar to a computer floppy disk), and played back through an adaptor. Since the data is stored digitally, interfacing the *Mavica* to computers, word processors, etc., is certainly possi-

ble, although Sony offers no way to do so at this time.

Sony developed the concept of electronic photography over a decade ago; in 1981 they introduced the world's first electronic still imaging system, *MAGnetic Video CAmera* or *Mavica*. Since then, they've improved the picture quality, and reduced the size and weight, resulting in the *Consumer Mavica*. (A professional *Mavica* system has been available for some time now.)

The *Consumer Mavica* offers features that you'd expect on a good snapshot camera. For ease of use, it offers "point and shoot" simplicity, with a 15mm f/2.8 fixed-focus lens, an automatic iris and shutter speed system, a built-in strobe that is automatically activated in low-light conditions, and a built-in electronic image-sensing shutter. A 10-second timer allows the photographer to get in the picture.

Designed to fit in the palm of the

hand, the *Mavica* weighs just over a pound and measures 5¾- by 2¼- 4¼-inches.

The camera also offers continuous, high-speed still image recording at 4 to 9 pictures per second, allowing for the precise recording of such motions as golf and tennis swings. The shutter speed is automatically set according to available light and can range from 1/60 to 1/500 seconds. A "blank search" function automatically advances the disk to a blank frame. Information, such as battery condition, recording mode, and disk status, is provided at a glance. Power is provided by a 6-volt rechargeable ni-cad battery.

The lightweight *MAP-T1* playback adaptor allows images to be viewed one at a time, or at continuous 5-second intervals. The unit's single/all erase function permits unwanted single pictures, or the entire disk, to be erased. A wireless remote control (*RM-C1K*) is available optionally. It comes with a rechargeable 6-volt ni-cad battery pack, and a 9-volt AC power adaptor.

Sony envisions applications in business, for note-taking and as a presentation tool; in real estate and retail sales; for analyzing sports performances; and for consumers. According to Sony, with the advent of VCR's and camcorders "consumers have begun to look at television not only as a passive receiver of broadcast signals, but also as a video monitor for interactive purposes."

The *Consumer Mavica*, with soft carrying case and a 2-inch *Mavipak* still video floppy disk, costs \$650.00. The *MAP-1* adaptor costs \$249.00. Both units will be available in this spring.—**Sony Corporation of America**, 9 West 57th Street, New York, NY 10019.

**SMT SERVICE KIT.** Surface-mounted components are being used on circuit boards with ever-increasing frequency. The high cost of replacing those boards makes repairing them a more attractive and economical solution. Fluke's *Surface-Mount Technology Service Kit* provides service and test engineers with the specialized tools and supplies that are needed for component-level repair of surface-mount assembly. In-depth instructional information is also provided, in the form of videotapes and workbooks, to help technicians become more proficient in SMT servicing. The kit is intended to eliminate the costly replacement of SMT circuit boards in many cases. It is particularly effective when used in conjunction with such board testers as the Fluke 9100, 9010, 900, and 90 series, which have component-level fault-isolation capabilities.



CIRCLE 11 ON FREE INFORMATION CARD

The SMT service kit contains a handheld, temperature-regulated, hot-air solder tool that can quickly solder and de-solder any size or type of surface-mount component. Three nozzles are included; other nozzle configurations, to match virtually any SMC outline, are available separately.

All the specific tools needed to perform repair and service tasks are included in the kit, along with a training video and workbook.

The Surface-Mount Technology Service Kit has as suggested list price of \$1995.00.—**John Fluke Mfg. Co., Inc.**, P.O. Box C-9090, Everett, WA 98206; (800)-443-5853, ext. 73.

**CONTACT ENHANCER.** Not just another contact cleaner, *Stabilant 22*—billed as “the world’s first liquid semiconductor”—is an electrically active material that enhances conductivity within a contact without causing electrical leakage between adjacent contacts. Manufactured by D.W. Electrochemicals, the product is an initially non-conductive block polymer that, when used in contacts, acts under the effect of the electrical field and switches to a

conductive state. Thus, *Stabilant 22* provides the connection reliability of a soldered joint without bonding the contacting surfaces.

Poor connector conductivity in highly sensitive electronic systems can cause these irksome problems—static, noise, intermittents, erratic electrical behavior, and signal distortion—that service and maintenance technicians spend so much of their time solving. *Stabilant 22* coats the mating surfaces of the contacts and fills the

**Joseph Electronics' 40th Anniversary Specials!**

# Special INSTRUMENT SALE!



**Model 2120 Oscilloscope**  
DC to 20 MHz. Dual Trace, 6" CRT, 1mv Sensitivity.  
Reg. \$520 **\$379.40**  
40TH ANNIVERSARY PRICE

**Model 2125 Oscilloscope**  
Same great features as 2120, except with delayed sweep  
Reg. \$620 **\$519.40**  
40TH ANNIVERSARY PRICE

**Model 1541A Oscilloscope** DC to 40 MHz, Dual Trace, 6" CRT 1mv Sensitivity  
Reg. \$845 **\$739.40**  
40TH ANNIVERSARY PRICE

**Model 2160 Oscilloscope** DC-60MHz, dual trace, delay sweep, 6" CRT, 1mv. sensitivity  
Reg. \$995 **\$839.40**  
40TH ANNIVERSARY PRICE

**Model 2520 Digital Storage** 20MHz, Dual Trace, 2mv Sens.  
Reg. \$1990 **\$1795.40**  
40TH ANNIVERSARY PRICE

**Model 2521 Digital Storage** 20MHz, Dual Trace CRT Readout, Cursors, RS232 Interface  
Reg. \$3050 **\$2745.40**  
40TH ANNIVERSARY PRICE

**Model 1249 NTSC/RGB Color Bar Generator.** Composite Video Output, RF Output  
Reg. \$499 **\$419.40**  
40TH ANNIVERSARY PRICE

**Model 2009 MTS TV Stereo Generator** Ideal for Stereo TV, Receivers, VCR's and Stereo Adapter Service  
Reg. \$499 **\$419.40**  
40TH ANNIVERSARY PRICE

**Model 2830 3 1/2 DIGIT LED BENCH Multimeter.** 5 DCV Accuracy, ALL 33 Ranges and Functions are Push Button Selectable  
Reg. \$243 **\$209.40**  
40TH ANNIVERSARY PRICE

**Model 1045 Telephone Product Tester** Provides Basic Operation Tests for Corded and Cordless Telephones, Answering Machines and Automatic Dialers  
Reg. \$495 **\$415.40**  
40TH ANNIVERSARY PRICE

**Model 1803 Frequency Counter** 100 MHz, 8 digit display, zero blanking AC or Battery  
Reg. \$199 **\$169.40**  
40TH ANNIVERSARY PRICE

**Model 2005 RF Signal Generator** 100 KHz to 150 MHz, in 6 fundamental bands and 450 MHz in harmonics  
Reg. \$195 **\$165.40**  
40TH ANNIVERSARY PRICE

**Model 3011 Function Generator** 2 MHz, 4 digit display, TTL & CMOS pulse outputs  
Reg. \$239 **\$199.40**  
40TH ANNIVERSARY PRICE

**Model 1630 DC Power Supply** 0-30V, 0-3A, high-low current range, Low ripple  
Reg. \$251 **\$209.40**  
40TH ANNIVERSARY PRICE

**Model 1601 DC Power Supply** isolated 0-50V, 0-2A in ranges, fully automatic shutdown, Adj. current limit  
Reg. \$463 **\$389.40**  
40TH ANNIVERSARY PRICE

**Model 1650 Triple Output Power Supply** two 0-25 VDC @ .5A and 5VDC @ 5A, fully automatic shutdown  
Reg. \$489 **\$409.40**  
40TH ANNIVERSARY PRICE

**Model 1653 AC Power Supply** variable isolated 0-150 VAC @ 2A, built-in isolation transformer  
Reg. \$200 **\$169.40**  
40TH ANNIVERSARY PRICE

**NEW! Model 388-HD Hand-held 3 1/2 Digit LCD TEST BENCH**

41 voltage ranges, frequency counter, capacitance meter, logic probe, transistor and diode tester. All packed into a drop-resistant case. **SPECIAL PRICE!**  
Reg. \$139 **\$119.40**



We are celebrating our 40th Anniversary by offering you huge savings on B&K Test Equipment.

Send for FREE 480 page "Industrial Products Catalog." I understand it is FREE with any order or if requested on company letterhead. (Otherwise, \$4.95 to cover catalog and shipping costs.)

ORDER TOLL FREE  
**1-800-323-5925**  
IN ILLINOIS  
**312-297-4200**  
FAX: 312-297-6923

**Joseph ELECTRONICS**



IL Res. 7% Tax

**JOSEPH ELECTRONICS, INC.** Dept. R  
8830 N. Milwaukee Ave., Niles, IL 60648

Rush merchandise per attached order. I understand rated accounts are shipped open account; otherwise send per credit card.  
Include \$5.00 per item for shipping and handling.  
 Visa  Master Card  Discover  
 Check  Money Order  Rush Catalog  
Card No. \_\_\_\_\_ Exp. Date \_\_\_\_\_

Name \_\_\_\_\_  
Company \_\_\_\_\_  
Street Address \_\_\_\_\_  
City \_\_\_\_\_ State \_\_\_\_\_ Zip \_\_\_\_\_

MARCH 1989

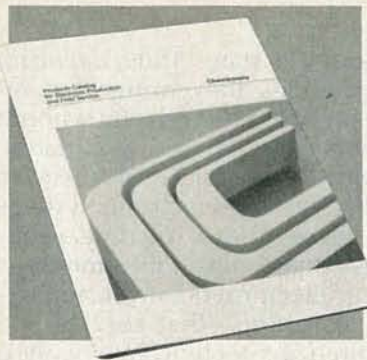

## CHEMICAL SOLUTIONS

### FREE CHEMTRONICS CATALOG!

Comprehensive new source for over 200 products used in electronic manufacturing and field service. Precision cleaning agents, flux removers, bulk solvents, circuit refrigerants, precision dusters, non-residual wipers, foam swabs, premoistened pads/swabs, antistatic compounds, conformal coatings, lubricants, adhesives, desoldering braids, rosin core solder and solder masking agents. Complete with technical specifications and application guide.



CIRCLE 54 ON FREE INFORMATION CARD

gaps between the original, scattered point-contacts. It substantially improves signal integrity and, at the same time, seals the connection against dirt, grit, and contaminants that can cause tarnish and corrosion.



CIRCLE 12 ON FREE INFORMATION CARD

A drop of *Stabilant 22* is applied with the dab of a finger, or a quick brush stroke, to the contact area. Socketed IC's can be treated with *Stabilant 22a*, a diluted version of the original that will penetrate the smallest crevice. Applications include computer, telecommunication, broadcasting, transportation, and medical equipment; as well as relays, BNC connectors, switches, and the like. The manufacturer reports reliability improvements ranging from 10-fold to 100-fold, and claims that a single treatment of *Stabilant 22* will often outlast the useful life of the equipment it's applied to.

*Stabilant 22* and *Stabilant 22a* are each available in sizes from 1/2 milliliter to 1 liter. The 15-ml *Stabilant 22* concentrate retails at \$102.00 U.S.; a 15-ml *Stabilant 22a* service kit (the most popular form) costs \$36.00 U.S.—**D.W. Electrochemicals Ltd.**, 9005 Leslie Street, Unit 106, Richmond Hill, Ontario, Canada, L4B 1G7.

**CURRENT PROBE.** The *ST-265* is a clamp-on AC-current adapter. With it, users can make AC-current measurements of up to 1000 amps with a conventional digital multimeter.

Weighing only 7 ounces and compact in size, the unit is ideal for field-service as well as in-house technicians. It features 1-amp AC resolution and 2.5% accuracy. It has a 2.1-inch jaw open-

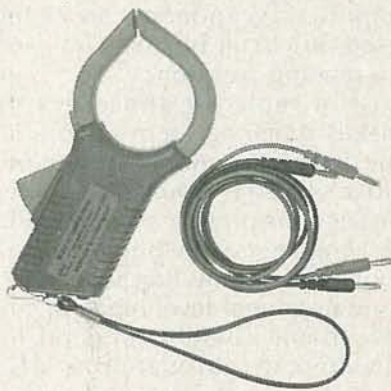

CIRCLE 13 ON FREE INFORMATION CARD

ing, and comes complete with test leads, a wrist strap, and a durable high-impact case.

The *ST-265* AC current probe costs \$29.95.—**Elenco Electronics, Inc.**, 150 West Carpenter Avenue, Wheeling, IL 60090.

### DIGITAL INPUT/OUTPUT CARD.

The *R725* is a relay actuator and digital input card for PC's, XT's, AT's, or compatible computers. It offers 8 relay-actuator outputs and 8 digital-input channels. The card also features 8 LED indicators to monitor active relays, on-board relay-driver and signal-conditioning circuits, and jumper-selectable input modes (isolated or non-isolated).

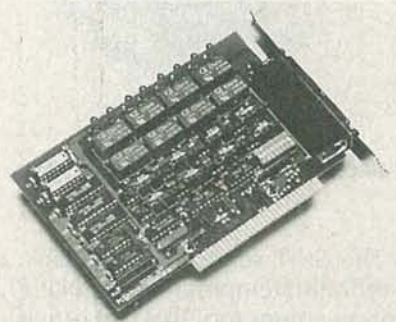

CIRCLE 14 ON FREE INFORMATION CARD

Fully programmable from any PC, XT, AT, or compatible with the source code in the user's manual, the card has a relay switching time of 10 msec, and is opto-isolated to 1500-volts DC. Applications include digital signal sensing, valve control, high-power relay driving, and switch-contact sensing.

The *R725* relay actuator and digital input card costs \$495.00—**Rapid Systems**, 433 North 34th Street, Seattle, WA 98103. **R-E**

## Be an FCC LICENSED ELECTRONIC TECHNICIAN!



No costly School. No commuting to class. The Original Home-Study course prepares you for the "FCC Commercial Radiotelephone License". This valuable license is your "ticket" to thousands of exciting jobs in Communications, Radio-TV, Microwave, Computers, Radar, Avionics and more! You don't need a college degree to qualify, but you do need an FCC License.

**No Need to Quit Your Job or Go To School** This proven course is easy, fast and low cost! **GUARANTEED PASS**— You get your FCC License or money refunded. **Send for FREE facts now. MAIL COUPON TODAY!**

### COMMAND PRODUCTIONS

FCC LICENSE TRAINING, Dept. 90  
P.O. Box 2824, San Francisco, CA 94126

Please rush FREE details immediately!

NAME \_\_\_\_\_  
ADDRESS \_\_\_\_\_  
CITY \_\_\_\_\_ STATE \_\_\_\_\_ ZIP \_\_\_\_\_

# HARDWARE HACKER

## A new "disco" circuit.

SEVERAL HELPLINE CALLERS HAVE NOW asked what the main difference is between the BSEE "engineering" and the BSEET "supertech" degrees. The quick answer is "around a million dollars or so."

That is roughly how much extra lifetime income the BSEE degree will garner on the average, including the benefits, perks, retirement plans, investments, other amenities, and also allowing for inflation.

It is no secret that the technicians and supertechs will often do all the work and the engineers get all the credit, all of the pay, and all of the promotions. Not to mention both an office and a real desk.

Many of the larger and "old line" electronics outfits tend to treat their techs and supertechs as second-class citizens, severely limiting their advancement and salary opportunities. Those problems are especially acute in aerospace and defense.

So, if you can handle all of the math and can pass all of those required non-engineering courses, then a BSEE will offer something around a 26.5 decibel better cost/benefit ratio over the BSEET.

The helpline response over the fluxgate magnetometer compass we looked at back in December has been utterly astounding, and I do thank you. A new source for the fluxgate magnetometer compass kits is *Rusty Circuits*.

*Radio Shack* also now has a low-cost solid-state fluxgate automotive compass. It does appear to be a two-piece unit having the fluxgate sensor windshield mounted via a short length of 5-

conductor cable. The display itself is a servo-like pair of coils that activate a magnetized compass rose disk. The accuracy does seem very limited, but it costs only \$49.95. That should hack beautifully. More on that whenever.

*Radio Shack* also has a new and "intelligent" power strip that turns on all your computer peripherals or home-video accessories whenever a main load is switched on or off. Some helpline callers have been asking for circuits to do that.

Several of your Canadian readers have been wondering why very few of those smaller electronics outfits will even give them the time of day. The answer is that there are just enough hassles involved that it is almost always a net loss of energy and time and money to do so.

My personal horror stories here include your Canadian post office refusing to accept my first-class mail, and waiting three hours in a bank for them to decide to use the Canadian exchange rate for a Nova Scotia bank. Honest. They couldn't find any country that was named Nova Scotia, so they had to call up the head office four times. Those epsilon minuses were just

### NEED HELP?

Phone or write your **Hardware Hacker** questions directly to:  
Don Lancaster  
**Synergetics**  
Box 809  
Thatcher, AZ 85552  
(602) 428-4073

A new "disco" circuit  
Zero crossing detection  
AC power load interface  
Phase controlled dimming  
Dialog information service

DON LANCASTER

about as sharp as five pounds of raw liver.

Finally, they ended up giving me \$7.65 for a \$24.50 check. Life is too short for that sort of thing.

Our focus this month is on the electronic lighting controls for rock concerts, discos, theater lighting, color organs, and whatever. But first, let's get up to date on...

### Library research

Some exciting things have been happening at the library lately. First and foremost, lots of libraries are now putting their card catalogs and public serials lists onto new on-line electronic BBS bulletin boards, so you can now find out what's available without leaving home.

One example of that would be the *Arizona State University* library BBS, reachable at (602) 965-7003.

The second really big news item for all of you hackers is that many libraries are now offering the great *Dialog Information Service*. Dialog is a "supergroup" electronic search service covering many hundreds of electronic data bases. If the topic that you are researching is even remotely popular or scholarly, you will definitely find it on Dialog.

While the \$2 per minute typical Dialog charges may seem a tad on the steep side at first glance, (A) that is ridiculously and insanely cheaper than getting the information by any other means; (B) the searches are far more thorough and complete than you could possibly hope to do by yourself; and (C) with practice and help from the

trained librarian, you can make your searches extremely time and cost efficient.

As an example of one tiny nook over in one obscure Dialog corner, there is the *INSPEC* data base. That holds four million abstracts of just about everything that's been done recently in the fields of physics, electronics, and computer science. *INSPEC* will often be a hacker's first and last stop.

Usually, you will use Dialog to get the abstracts of the key papers of whatever it is you are after. From there, you can go to the *Engineering Societies Library* or else *UMI* for the full text reprints.

*UMI* is the usual place that a hacker or researcher would normally go to get low-cost reprints on most any topic, as long as you know the exact publication title and all of the page numbers.

Naturally, there's also the good old *Interlibrary loan* service that all libraries provide, as well as digging out the papers by yourself.

Yes, you can subscribe to Dialog

on your own for a fairly reasonable annual fee. Sadly, the hidden costs of all the needed manuals and all the time needed learning them and keeping them current will eat you alive. Use the library instead.

As a quick reminder of some of the other obscure interesting stuff in a good library, there is the *Thomas Registry of Manufacturers* which lists nearly everybody who makes or resells anything anywhere, and *Uhrichts Periodicals Dictionary*, which shows you who publishes all of those many tens of thousands of magazines, scholarly publications, and trade journals (many are free to "qualified" subscribers), and the *Science Citations Index*, which, miraculously, will let you search forward through time, picking up newer references.

Additional details on much of that appear in my *Incredible Secret Money Machine* book.

displays. For an ancient history course, check my *Solid State Color Organ* back in the March 1963 *Electronics World*, or the *Colorgan* project in the October 1965 issue of *Radio-Electronics*.

Or perhaps the good old *Musette* (July 1966) and that *Psychedelia I* (September 1969) that also appeared later on in *Popular Electronics*.

At any rate, what I would like to do here is review the fundamentals of modern and personal-computer-based solid-state AC power control.

Obviously, you cannot just hang a 100-watt light bulb on a computer output port. The digital logic signal must first become safety-isolated to eliminate a serious shock hazard and then somehow get "amplified" big enough to control the lamp.

Figure 1 shows you a typical computer power-interface circuit.

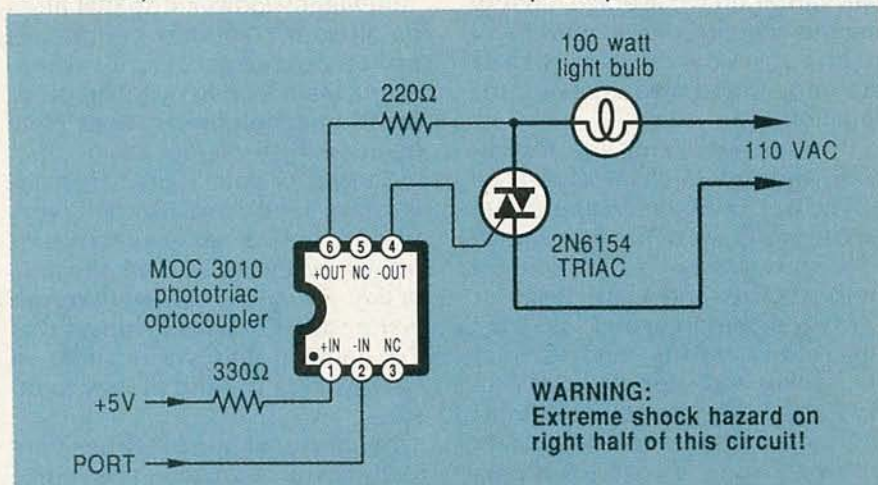

FIG. 1—THIS AC POWER-OUTPUT INTERFACE lets you directly control 100-watt lamps and other high-power loads from your microcontroller or your personal computer. The special phototriac optocoupler provides safety isolation. Note that a low-logic input will light the lamp.

### AC lighting controls

There's lots of interest these days in controlling large 120-volt AC light bulbs directly from your personal computer. Important uses include psychedelic lighting shows, advertising signs, rock concerts, theater and disco lighting, laseriums, new-age relaxation techniques, casinos, traffic displays, scoreboards, store windows, etc., etc.

I guess I kind of pioneered at least part of that field. Way back then, we were interested in *color organs*—circuits that converted music into home-audio lighting

The two key parts are a very special form of optocoupler called a phototriac isolator, and an AC power-control switch called a triac.

The triac is basically an efficient bilateral latching AC power switch. Applying a small amount of current in either direction into its gate terminal turns on an electronic switch between the triac's T1 and T2 terminals. The switch then stays on until the load current drops to zero during the next AC half cycle.

The phototriac isolator consists of an internal light-emitting diode that shines on an internal miniature light-sensitive triac. When

## NEW FROM DON LANCASTER

### HANDS-ON BOOKS

Hardware Hacker Reprints II	24.50
Ask The Guru Reprints I or II	24.50
CMOS Cookbook	18.50
TTL Cookbook	16.50
Active Filter Cookbook	15.50
Micro Cookbook vol I or II	16.50
Enhancing your Apple I or II	15.50
AppleWriter Cookbook	19.50
Apple Assembly Cookbook	21.50
Incredible Secret Money Machine	10.50
LaserWriter Reference (Apple)	19.50
PostScript Cookbook (Adobe)	16.50
PostScript Ref. Man. (Adobe)	22.50
PostScript Prog. Design (Adobe)	22.50

### UNLOCKED SOFTWARE

PostScript Show & Tell (Ile/Mac/PC)	39.50
Intro to PostScript VHS Video	39.50
PostScript Perspective Draw	39.50
PostScript Printed Circuits	39.50
PostScript Technical Illustrations	39.50
PostScript Work in Progress	39.50
PostScript BBS stuff	19.50
Absolute Reset Ile & Ilc	19.50
AppleWriter/Laserwriter Utilities	49.50
Enhance I or II Companion Disk	19.50
AppleWriter CB or Assy CB Disk	24.50

FREE VOICE HELPLINE

VISA/MC

## SYNERGETICS

Box 809-RE  
Thatcher, AZ 85552  
(602) 428-4073

CIRCLE 83 ON FREE INFORMATION CARD



## NAMES AND NUMBERS

### Advanced Micro Devices

PO Box 3453  
Sunnyvale, CA 94088  
(800) 538-8450

### ALX Digital

12265 S Dixie Hwy. #922  
Miami, FL 33156  
(305) 553-3380

### Apple Computer, Inc

20525 Mariani Avenue  
Cupertino, CA 95014  
(408) 996-1010

### University Libraries BBS

Arizona State University  
Tempe, AZ 85287  
(602) 965-7001

### Caplugs

2150 Elmwood Avenue  
Buffalo, NY 14207  
(716) 876-9855

### Circuit Cellar, Inc

4 Park Street, Suite 20  
Vernon, CT 06066  
(203) 875-2751

### Dialog

3460 Hillview Avenue  
Palo Alto, CA 94304  
(415) 858-2700

### Engineering Societies Library

345 East 47th Street

New York, NY 10017

(212) 705-7611

### Ferranti Interdesign Inc

1500 Green Hills Road  
Scotts Valley, CA 95066  
(408) 438-2900

### GE Solid State

724 Rt 202  
Somerville, NJ 08876  
(201) 685-6000

### Hamamatsu

360 Foothill Road  
Bridgewater, NJ 08807  
(201) 231-0960

### Inspec/IEEE

445 Hoes Lane  
Piscataway, NJ 08855  
(201) 981-0060

### Intersil

2450 Walsh Avenue  
Santa Clara, CA 95051  
(408) 996-5000

### International Rectifier

233 Kansas Street  
El Segundo, CA 90245  
(213) 772-2000

### Mitsubishi

1050 E Arques Avenue  
Sunnyvale, CA 94086  
(408) 730-5900

### Motorola

5005 E McDowell Road  
Phoenix, AZ 85008  
(602) 244-6900

### RFL Industries

Powerville Road  
Boonton, NJ 07005  
(201) 334-3100

### Rusty Circuits

Rt 1 Box 16 Road 220  
Angleton, TX 77515  
(409) 2997-8923

### SGS-Thompson

1000 East Bell Road  
Phoenix, AZ 85022  
(602) 867-6100

### Synergetics

Box 809  
Thatcher, AZ 85552  
(602) 428-4073

### Texas Instruments

Box 655303 M/S 8206  
Dallas, TX 75265  
(214) 995-3821

### UMI

300 North Zeeb Road  
Ann Arbor, MI 48106  
(800) 521-3044

you apply an input current to the optocoupler, the internal LED shines on the little internal phototriac turning it on, which then turns on the main power triac.

You get safety isolation because there is nothing but a light beam between the input and output. Once again, there are several different types of optocouplers. It is most important to use a phototriac style that can withstand at least a 200-volt AC output waveform.

Note that the circuit is shown slightly differently than would be intuitively obvious. Most TTL and NMOS computer ports are much better at sinking current to ground than they are at sourcing it, so it makes sense to have a low logic-level light both the optoisolator and the power lamps.

Thus, for the most reliable user circuit, you connect the positive terminal of the optoisolator to +5 volts by way of a current-limiting resistor, and the negative terminal to your computer port or pe-

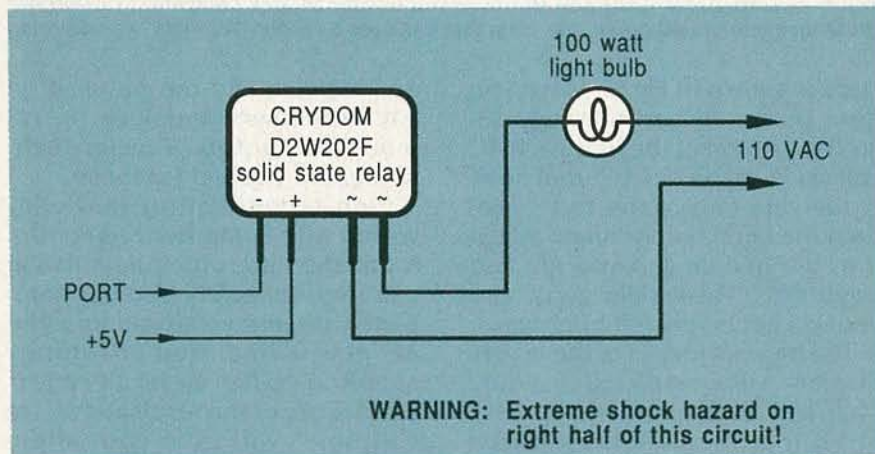

FIG. 2—THIS SIMPLER BUT MORE COSTLY AC power-output computer interface needs only one part. Once again, a low-logic input will light the lamp.

ripheral chip. A low-logic output lights the lamp, so be sure to adjust your software accordingly.

Yes, you could replace that four-piece power-interface circuit with a simpler and smaller single-piece one. Figure 2 shows you one possibility. The only trouble is that it costs around \$8 or more, compared to considerably less for the

Fig. 1 circuit. The Crydom D2W202F shown is an International Rectifier product. Those folks have data books and application notes available on those. No heatsinking is needed for 100-watt lamp loads.

### Phase-control dimming

The trick to your controlling the brightness of an incandescent

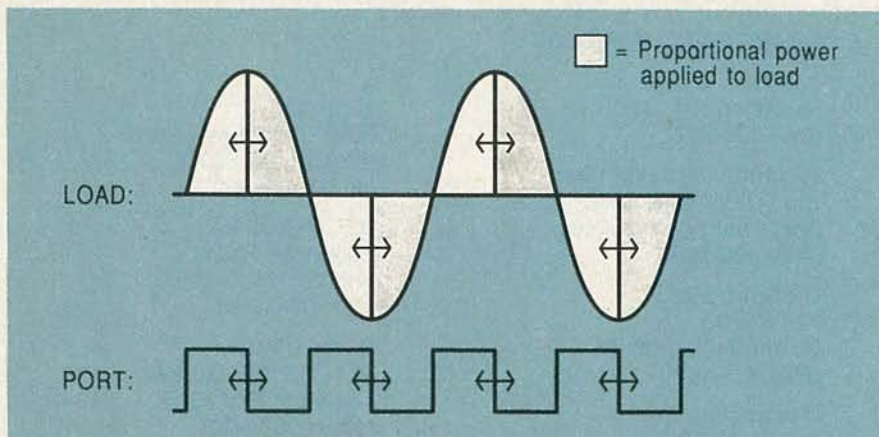

FIG. 3—THE KEY TO BRIGHTNESS CONTROL is to use a duty cycle or a “phase” modulation. Apply power early in each half cycle for maximum brightness; later for less. Use incandescent lamps only.

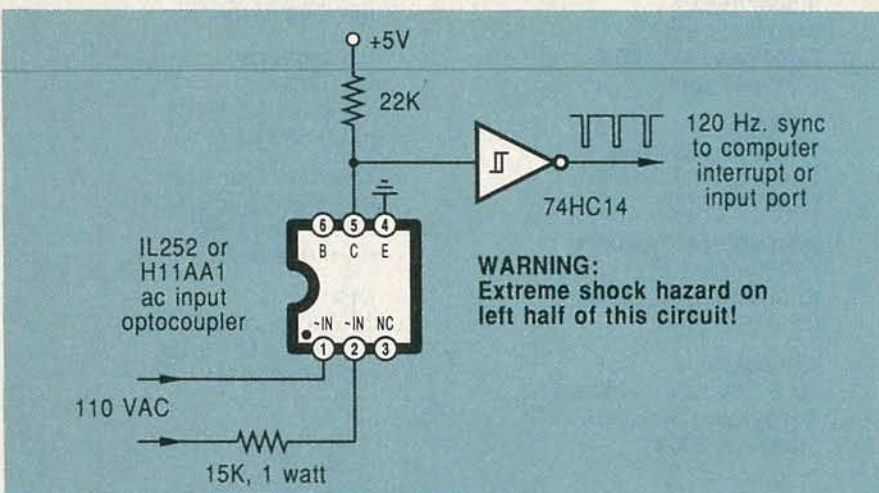

FIG. 4—A LINE-SYNCHRONIZER INPUT circuit is used to lock computer or controller phase timing to the AC power line. Note that this uses a special “AC input” optocoupler.

lamp is shown in Fig. 3. What you do is purposely and precisely delay the turn-on of the triac each AC half cycle. If you delay it until nearly the very end of the half cycle, then the lamp barely lights. Whap it in the middle and you get half brightness. Hit it right away, and you will get nearly full brightness.

The thermal inertia of the lamp's filament will average out that duty cycle and the lamp appears to light to an intermediate brightness. Since the triac is acting as a switch, it is very efficient.

Wall-mounted dimmers are one obvious and low-cost example of AC phase control, as are those BSR-type X-10 dimmer modules.

That type of phase control works quite well for most incandescent lamps and for soldering irons and other heaters. It works sort of OK for universal motors that have brushes.

But note that phase dimming

definitely should not be used on any fluorescent lamps or on AC induction motors. Fancier techniques are needed for those.

One complication that's involved with computerized control is that the same optotriac isolation you used for safety also has completely disconnected you from the AC power line. You absolutely must know when each half cycle is coming up, or the resultant “phase slipping” will give you wildly wrong results.

So, your computer circuit will need an interrupt or some other reference that happens 120 times per second, precisely locked to each zero crossing of the AC power line. You might rig that up with a small transformer driving a set-reset flip-flop, or else a pair of back-to-back optoisolators.

Figure 4 shows us a simple 120-Hz sync reference that uses another special type of optocoupler

called an AC input optoisolator.

Those will have two input LED's in parallel, one that “points” in each direction. One or the other diode conducts except briefly during the zero crossings. The Schmitt trigger inverter may or may not be needed, depending on whether you want a positive or negative sync signal.

Additional details on high-power computer interface appear in my *Micro Cookbook, volume II*.

### Some suggestions

Many of the attempts at music-controlled lighting usually turn out anywhere from disappointing to downright awful. The usual culprits include threshold effects, “muddy” results, non-linearity, and a limited dynamic range. Here are a few tips I've gleaned over the years on what it takes to do the job right.

First, you always will want to keep any supposedly “off” lamps just barely lit. Besides the bulbs and the surge-sensitive triacs lasting longer, that might give you better sensitivity to any low-level music inputs. The background level is critical here, so watch out for any temperature-drift effects.

Second, lamps and human vision perception are both non-linear. A process called *gamma correction* is used with video cameras and CRT displays to convert any linear input signal into perceived linear brightness changes.

You similarly ought to “gamma correct” a visual music display. To do that, start off with the minimum brightness and record the firing phase angle needed for the minimum perceptible lighting change. Repeat that for each successive perceptible change.

You convert that list into a linear brightness-versus-phase-angle table, stored in software or in an EPROM. Note that the correction will vary with the size of the lamp and the color of the output. The goal is to have a linear input voltage or else a binary word change create a *perceived* linear output change.

Third, the dynamic range of most music is ridiculously greater than that of a visual display. So, for the best results, grab all your mu-

*continued on page 86*

# EXPAND YOUR CAREER HORIZONS...

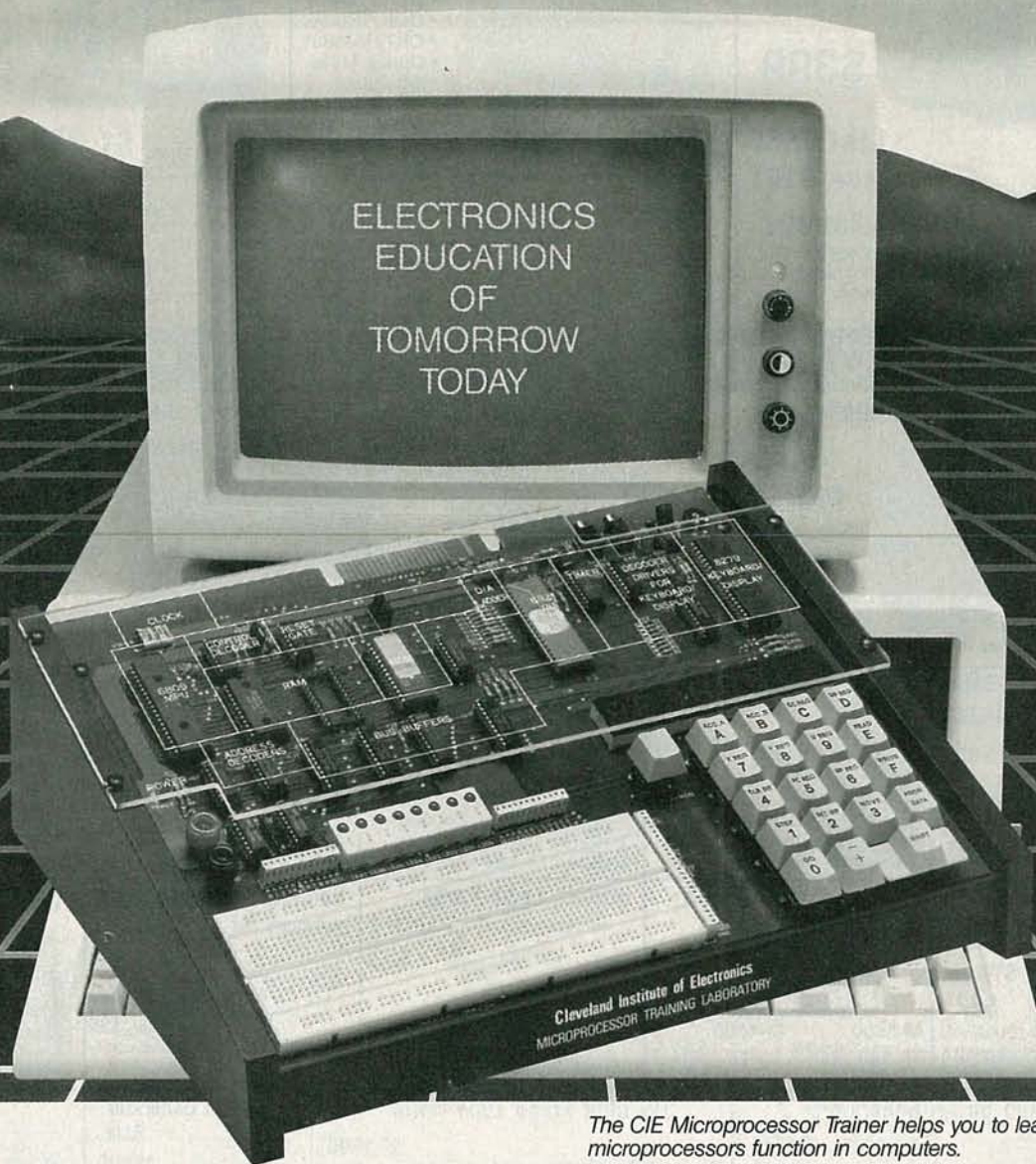

The CIE Microprocessor Trainer helps you to learn how circuits with microprocessors function in computers.

## START WITH CIE.

Microprocessor Technology. Satellite Communications. Robotics. Wherever you want to go in electronics... start first with CIE.

Why CIE? Because we're the leader in teaching electronics through independent study. Consider this. We teach over 25,000 students from all over the United States and in over 70 foreign countries. And we've been doing it for over 50 years, helping thousands of men and women get started in electronics careers.

We offer flexible training to meet your needs. You can start at the beginner level or, if you already know something about electronics, you may want to start at a higher level. But wherever you start, you can go as far as you like. You can even earn your Associate in Applied Science Degree in Electronics.

Let us get you started today. Just call toll-free **1-800-321-2155** (in Ohio, 1-800-362-2105) or mail in

CIRCLE 60 ON FREE INFORMATION CARD

the handy reply coupon or card below to:  
Cleveland Institute of Electronics,  
1776 East 17th Street, Cleveland, Ohio 44114.

## CIE World Headquarters

Cleveland Institute of Electronics, Inc.  
1776 East 17th Street • Cleveland, Ohio 44114

Please send your independent study catalog.  
For your convenience, CIE will try to have a representative contact you — there is no obligation.

Print Name \_\_\_\_\_

Address \_\_\_\_\_ Apt. \_\_\_\_\_

City \_\_\_\_\_ State \_\_\_\_\_ Zip \_\_\_\_\_

Age \_\_\_\_\_ Area Code/Phone No. \_\_\_\_\_

Check box for G.I. Bill bulletin on Educational Benefits

Veteran  Active Duty **MAIL TODAY!**

Just call toll-free **1-800-321-2155** (in Ohio, 1-800-362-2105)

ARE-116

MARCH 1989

# HITACHI SCOPES AT DISCOUNT PRICES



V-212

**\$399**

List \$560  
Save \$161

## 20MHz Dual Trace Oscilloscope

All Hitachi scopes include probes, schematics and Hitachi's 3 year warranty on parts and labor. Many accessories available for all scopes.



V-425  
List \$995 **\$835**

- DC to 40MHz
- Dual Channel
- CRT Readout
- Cursor Meas
- DC Offset
- Alt Magnifier
- Compact Size



V-1060  
List \$1595 **\$1,285**

- DC to 100MHz
- Dual Channel
- Delayed Sweep
- CRT Readout
- Sweep Time
- Autoranging
- Trigger Lock
- 2mV Sensitivity

	LIST	PRICE	SAVE
V-223 20MHz	\$770	\$695	\$75
V-422 40MHz	\$875	\$695	\$180
V-423 40MHz	\$955	\$795	\$160
V-660 60MHz	\$1,195	\$990	\$205
V-1065 100MHz	\$1,895	\$1,670	\$225
V-1100A 100MHz	\$2,295	\$1,995	\$300
V-1150 150MHz	\$3,100	\$2,565	\$535

# ELENCO PRODUCTS AT DISCOUNT PRICES

## 20MHz Dual Trace Oscilloscope

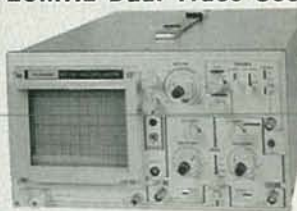

**\$359**  
MO-1251

- 6" CRT
- Built in component tester
- TV Sync
- X-Y Operation

**FREE DMM**  
with purchase of  
MO-1251/1252 Scope

### SCOPE PROBES

P-1 65MHz, 1x, 10x **\$19.95**  
P-2 100MHz, 1x, 10x **\$23.95**  
Fits all scopes with  
BNC connector

## 35MHz Dual Trace Good to 50MHz



**\$495**  
MO-1252

- High luminance 6" CRT
- 1mV Sensitivity
- 6KV Acceleration Voltage
- 10ns Rise Time
- X-Y Operation • Z Axis
- Delayed Triggering Sweep

Top quality scopes at a very reasonable price. Contains all desired features. Two 1x, 10x probes, diagrams and manual. Two year guarantee.

## Autoranging DMM



M-5000

**\$45**

- 9 Functions
- Memory and Data hold
- 1/2% basic acc
- 3 1/2 digit LCD

## True RMS 4 1/2 Digit Multimeter



M-7000

**\$135**

- .05% DC Accuracy
- .1% Resistance with Freq. Counter and deluxe case

## Multimeter with Capacitance and Transistor Tester



CM-1500

**\$55**

- Reads Volts, Ohms, Current, Capacitors, Transistors and Diodes with case

## Digital Capacitance Meter

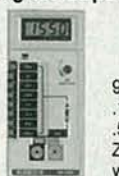

CM-1550

**\$58.95**

- 9 Ranges
- .1pf-20,000ufd
- .5% basic acc
- Zero control with case

## Digital LCR Meter



LC-1800

**\$138**

- Measures Coils 1uH-200H
- Caps .1pf-200uf
- Res .01-20M

## AC Clamp-On Current Adapter



ST-265

**\$22**

- 0-1000A AC
- Works with most DMM

## Bench DMMS



M-3500

**\$125**

3 1/2 digit .1% accy

M-4500

**\$175**

4 1/2 digit .05% accy

## 50MHz Logic Probe



LP-700

**\$23**

Logic Pulsar LP-600 \$23

## Solderless Breadboards



9430

1,100 pins **\$15**

9434

2,170 pins **\$25**

9436

2,860 pins **\$35**

All have color coded posts

9436 SHOWN

## Low Cost Multimeter



M-1600

**\$25**

- 3 1/2 digit LCD
- 1% DC Accy
- 10A Scale
- Auto zero /polarity

## Wide Band Signal Generators



SG-9000

**\$129**

- RF Freq 100K-450MHz
- AM Modulation of 1KHz
- Variable RF output

SG-9500 with Digital Display and 150MHz built-in Freq Ctr \$249

## 3 1/2 Digit Probe Type DMM



M-1900

**\$41**

- Convenient one hand operation with batteries and case
- Measures DCV, ACV, Ohms
- Audible continuity check, Data hold

## Function Generator Blox



#9600

**\$28.95**

- Provides sine, tri, squ wave
- From 1Hz to 1MHz
- AM or FM capability

## Decade Blox



9610 or 9620

**\$18.95**

- #9610 Resistor Blox
- 47 ohm to 1M & 100K pot
- #9620 Capacitor Blox
- 47pf to 10MFD

## Digital Triple Power Supply



XP-765

**\$249**

- 0-20V at 1A
- 0-20V at 1A
- 5V at 5A

Fully Regulated, Short circuit protected with 2 Limit Cont., 3 Separate supplies  
XP-660 with Analog Meters \$175

## Quad Power Supply



XP-580

**\$59.95**

- 2-20V at 2A
- 12V at 1A
- 5V at 3A
- 5V at 5A

Fully regulated and short circuit protected  
XP-575 without meters \$44.95

## 10MHz XT 100% IBM® Compatible

5 Year Warranty



**\$595**

MODEL PC-1000

- 5/10MHz Motherboard
- 8 Expansion Slots
- Math Compressor Slots
- 360K Floppy Drive
- AT Style Keyboard
- 150W Power Supply
- 256K RAM
- Expandable to 640K
- Monochrome Monitor
- Monographic Video Card
- Parallel Printer Port

**FREE spreadsheet and word processor**  
3.3MS DOS and GW Basic add \$75

## Four-Function Frequency Counters

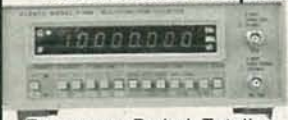

F-1000 1.2GH

**\$259**

F-100 120MH

**\$179**

- Frequency, Period, Totalize, Self Check with High Stabilized Crystal Oven Oscillator, 8 digit LED display

## GF-8016 Function Generator with Freq. Counter



GF-8016

**\$239**

- Sine, Square, Triangle Pulse, Ramp, .2 to 2MHz
- Freq Counter .1 - 10MHz

GF-8015 without Freq. Meter \$179

**WE WILL NOT BE UNDERSOLD!**

UPS Shipping: US 5%  
(\$10 Max) IL Res., 7% Tax



**C & S SALES INC.**  
1245 Rosewood, Deerfield, IL 60015  
(800) 292-7711 (312) 541-0710

**15 Day Money Back Guarantee**  
**2 Year Warranty**

**WRITE FOR FREE CATALOG**

# BUILD THIS

## UNIVERSAL **LASER** POWER SUPPLY



*Here's a power supply that can easily be adapted for use with various kinds of hobbyist and experimenter laser tubes.*

**GORDON McCOMB**

IT'S EASY TO GET STARTED EXPERIMENTING WITH LASERS. ALL YOU NEED IS A LASER TUBE, A power supply, and a protective enclosure of some kind. Getting a tube is usually no problem, because "surplus" and even used helium-neon (He-Ne) tubes are commonly available. But since the characteristics of He-Ne lasers vary considerably from model to model, a hobbyist's laser power supply should be able to work with all of them, which is exactly the case with our pulse-modulated He-Ne power supply.

### **Caution!**

Before building the power supply, let's take time out for a few words of caution. All gas lasers—including the popular helium-neon variety—require a high-voltage power supply that boosts the main voltage, from 12-volts DC or 117-volts AC, up to 1200–3000 volts. Although the supply's output voltage is relatively high, the circuit-current, or the *laser current* is low.

Because of the low laser current, some laser experimenters tend to disregard the high voltage, possibly because they believe that as long as the current is low, a high voltage can't do more than give a nasty shock. Not so! The byproduct of a nasty shock can result in severe injury, so take extra care to prevent your coming in contact with any "live" power-supply circuits or connections. To that end, all components and wires of a laser

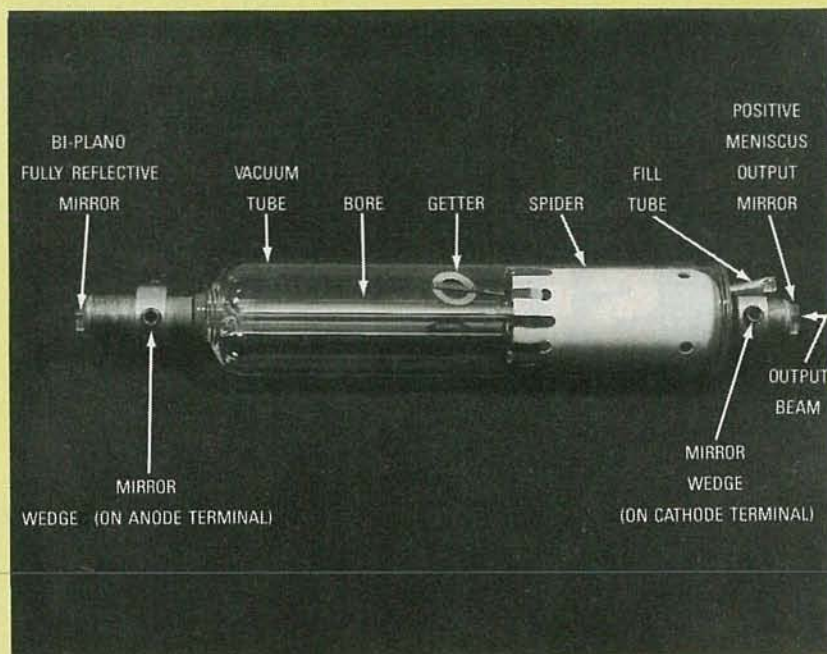

**ANATOMY OF A LASER TUBE**

The helium-neon tube is the staple of the laser experimenter. He-Ne tubes are in plentiful supply, especially in the surplus market. They emit a bright, deep-red glow that can be seen for miles around. Although the power output of He-Ne tubes is relatively small compared to other laser systems, it is perfectly suited for many homebrew and school experiments in diffraction, reflection, etc.

The helium-neon laser is a glass vessel filled with 10 parts helium and one part neon, pressurized to about 1 mm Hg. (The exact gas pressure and ratios vary between laser manufacturers.) Electrodes placed at the ends of the tube provide a means to ionize the gas, thereby exciting the helium and neon atoms. Mirrors mounted at either end form an optical resonator, or *Fabry-Perot* resonator. In most He-Ne tubes, one mirror is totally reflective and the other is partially reflective. The partially reflective mirror is the output of the tube.

Modern He-Ne lasers are composed of few parts, all fused together during manufacturing. Only the very old He-Ne tubes, or those used for special laboratory experiments, use external mirrors. The all-in-one design costs less and the mirrors are not as prone to mis-alignment.

Helium-neon lasers are actually composed of two tubes: an outer plasma tube that contains the gas and a shorter and smaller inner bore or capillary, where the lasing action takes place. The bore is attached to only one end of the tube. The loose end is the output and faces the par-

tially reflective output mirror. The bore is held concentric by a metal element called the spider. The inner diameter of the bore largely determines the diameter of the laser beam.

The ends, where the mirrors are mounted, typically serve as the anode (positive) and cathode (negative) terminals. On some lasers, the terminals are mounted on the same end. A strip of metal or wire extends to the cathode on the other end. The output mirror can be on either the anode or cathode end, but on most tubes, it is the cathode. Many manufacturers prefer that arrangement, claiming it is safer and more flexible.

Metal rings with hex screws are often placed on the mirror mounts as a means to tweak the alignment of the mirrors. Unless you suspect that the mirrors are out of alignment, you should NOT attempt to adjust the rings. They have been adjusted at the factory for maximum beam output. Tweaking them may degrade the performance of the laser.

He-Ne lasers are available in two general forms: bare and cylindrical head. Bare tubes are just that—the tube is not shielded by any type of housing and should be placed inside a tube or box during operation for protection. Cylindrical-head lasers (or just “laser heads”) are housed inside an aluminum sheath. Leads for power come out of the back end of the laser. The opposite end may have a hole for the output beam, or may be equipped with a safety shutter. The shutter prevents accidental exposure to the beam.

power supply must be properly insulated and covered. In particular, you must avoid operating a laser's power supply in the open. Play it safe, and you won't be sorry.

Most laser power supplies use high-voltage capacitors at the output stage. Like all capacitors, they can retain a charge even after the power supply has been turned off. So when working with a laser, make sure the power supply is off and disconnected from its power source, then temporarily short the output leads of the power supply together, or simply touch the supply's positive output connection to ground. Like the capacitors, the laser tube itself can retain an electric charge after power has been removed. That current should be drained by shorting the tube's terminals or leads together, or to ground.

### How it works

Regardless of their size or output power, the operating conditions of helium-neon laser tubes vary widely. A new tube starts easily and runs very efficiently; an older or used tube is harder to start and needs more current to lase continuously.

The pulse-modulated laser power supply shown in Fig. 1 was designed to accommodate a wide variety of helium neon tubes—both old and new—up to a maximum laser power output of about five milliwatts. Using pulse-width modulation (that is, varying the duty cycle of the square wave), the power supply individually controls the laser's start and run currents.

Potentiometers R12 and R13 determine the pulse width of the square wave applied to the inverting transformer, T1. In the start mode, R12 varies the pulse width until there is sufficient voltage to start the laser tube—typically 3–4 kV. Potentiometer R13 is switched into the circuit by relay RY1's contacts as current starts to flow through the laser. R13 is adjusted for the minimum current possible while still allowing the tube to lase.

The power supply operates from a 12-volt, 750-mA source; either a battery or an AC-to-DC converter. Timer IC1 operates as a 16-kHz astable multivibrator. Relay RY1 is initially not energized, so R13 and R8 are disconnected from the circuit. The setting of R12 determines the duty cycle, and thus the pulse width of the square wave at pin 3 of IC1. That signal driv-

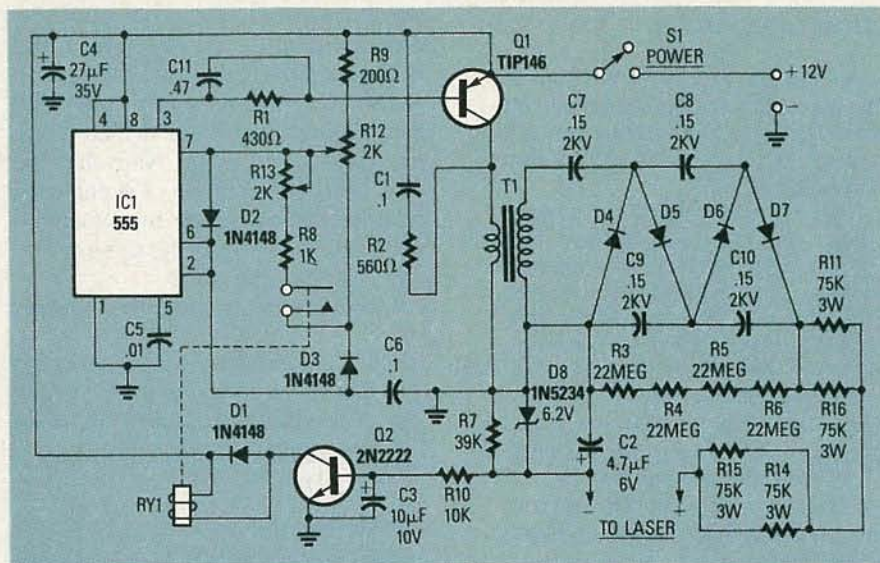

FIG. 1—THE COMPLETE POWER SUPPLY. Resistors R14–R16 are used only for laser tubes rated more than 1 mW.

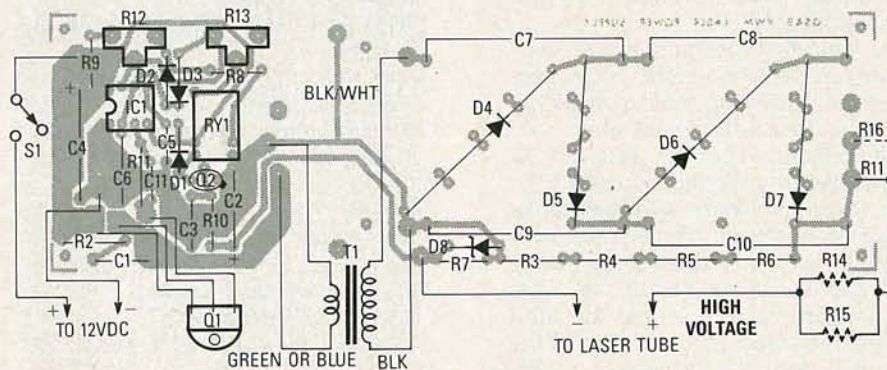

FIG. 2—THE PARTS LAYOUT. Although R16 mounts on the PC board, R15 and R16 are spliced into the laser tube's anode wire.

es the base of power transistor Q1 through current-limiting resistor R1.

Transistor Q1, which operates as a high-current/low-voltage chopper, delivers a series of square waves to the primary winding of step-up transformer T1.

With a 12-volt square wave at T1's primary, the output voltage at the secondary is between 800 and 2000 volts AC, the precise value depending on the setting of R12. Capacitors C7–C10, along with diodes D4–D7, form a standard voltage doubler ladder. The unloaded DC output of the voltage doubler is about 3–5 kV.

As the laser tube begins to conduct, current flows through R7, which causes a voltage to appear at the junction of R7 and R10. That voltage turns on Q2, which activates relay RY1, thereby switching resistors R8 and R13 into IC1's timing circuit, changing the square wave's duty cycle.

Potentiometer R13 must be readjusted to control the laser tube's current. The best position is determined

by adjusting R13 clockwise until the relay chatters, then turning it counter clockwise until the relay remains latched in the energized position.

Resistors R3–R6 provide safety when handling the supply (with the power source disconnected) by draining the charge from the voltage doubler's capacitors, as well as the electrostatic charge from the laser tube. Note that the very high resistance of R3 through R6 prohibit them from quickly draining the excess charge, so you should still manually short the power supply's output terminals together before handling the laser or its power supply.

Resistors R11 and R14–R16 depend on the laser tube. For 1-mW tubes, only R11 is used. R16 is eliminated, while R15 and R15 are replaced by a wire.

### Construction

The laser power supply is assembled on a printed-circuit board for which a template is provided in PC

## LASERS AND SAFETY

Lasers emit electromagnetic radiation, usually either visible light or infrared. The level of "radiation" is generally quite small in hobby lasers, having about the same effect on external body tissues as sunning yourself with the livingroom lamp.

Skin is fairly resilient, even to exposure up to several tens or hundreds of watts of laser energy. But the eye is much more susceptible to damage, and it is the effects of laser light on the retina that is of the greatest concern. Even as little as 20–50 milliwatts of focused visible or infrared radiation can cause immediate eye damage.

The longer the eye is exposed to radiation, and the more focused the laser beam, the greater the chance that the laser will cause a lesion on the surface of the retina. Retinal lesions can heal, but many leave blind spots. Retinal damage when using hobby lasers—those having outputs of less than five or ten milliwatts—is rare, but can occur if you stare directly at the beam for extended periods of time. Therefore, NEVER look directly at the beam, or its reflection from a mirror or a metallic surface.

Keep these points in mind when working with laser:

- Any laser power supply delivers high voltages that, under certain circumstances, can injure or kill you. Use extreme caution when building, testing, and using lasers and high-voltage power supplies.
- Do not attempt to build your own power supply unless you have at least some knowledge of electronics and electronics construction.
- Although the power-supply project is not difficult, it should be considered suitable only for intermediate to advanced hobbyists.
- Power supplies and laser tubes retain a charge even after electricity has been removed. Be sure to short out the output of the power supply as well as the terminals of the laser tube before touching the laser or high-voltage leads.

Service. Alternatively, an etched and drilled PC-board can be ordered from the source given in the Parts List.

Install the parts on the PC board as shown in Fig. 2. First mount R1 through R11. If you intend to use a laser tube rated for more than 1 mW, install R16 in the extra hole that is adjacent to R11. All resistors are installed flush on the board except for R11 and R16, which are mounted on end—and only one lead of each re-

## BUYING AND TESTING HE-NE TUBES

Apart from size and output power, tubes vary by their construction, reliability, and beam quality. After buying a He-Ne tube, you should always test it; return the tube if it doesn't work or if its quality is inferior.

Should you need a laser for a specific application that requires precision or a great deal of reliability, you may be better off buying a new and certified tube rather than one from surplus; it will come with a warranty and certification of power output.

He-Ne's emit a deep red beam at 632.8 nanometers because it is the strongest wavelength produced within the tube. Although other colors are produced, they are weak or may not be sufficiently coherent or monochromatic. Yet there are some special helium-neon lasers that are made to operate at different wavelengths, namely 1.523 micrometers (infrared) and 543.5 nanometers (green). Green and infrared He-Ne lasers are exceptionally expensive and rare in the surplus market.

The first step in establishing the quality of the tube is to inspect it visually. If the tube is used, be on the lookout for scratched, broken, or marred mirrors. After inspection, connect the tube to a suitable power supply, point the laser toward a wall, and apply power. If the laser is working properly, the beam will come out of one end only and the beam spot will be solid and well-defined.

Occasionally, the totally reflective mirror allows a small amount of light to pass through and you see a weak beam coming out the back end (that is especially true if the mirror is not precisely aligned). Usually, that poses no serious problem unless the coating on the mirror is excessively weak or damaged, or if the mirrors are seriously out of alignment.

All lasers exhibit satellite beams—small, low-powered spots caused by internal reflections that appear off to the side of the main spot. In most cases, the main beam and satellites are centered within one another, so you see just one spot. But slight varia-

tions and adjustment of the mirrors can cause the satellites to wander off axis. That can be unsightly and if it matters to you, choose a tube that has a solid beam.

Should the tube start but no beam comes out, check to be sure that nothing is blocking the exit mirror. If the beam still isn't visible, the mirrors may be out of alignment and the laser should be returned for a replacement.

If the tube doesn't ignite at all, check the power supply and connections. Try a known good tube if you have one. The tube still doesn't light? The problem may be caused by:

- Bad tube. The tube is "gassed out," has a hairline crack, or is just plain busted.
- Power supply too weak. The tube may require more current or voltage than the levels produced by the power supply.
- Insulating coating or broken connection. New and stored tubes may have an insulating coating on the terminals. Be sure to clean the terminals thoroughly. A broken lead can be mended by soldering on a new wire.

Some "problems" with laser tubes are really caused by the power supply. In fact, if your laser doesn't work, expect the power supply first. One common problem is that the tube sputters when you turn it on. That fault is most often caused by a tube that isn't receiving enough current, either because the connections from the power supply are loose or broken, the power supply is not producing enough current for the tube, or the ballast resistor is too high or too low.

Hard-to-start tubes flick on but quickly go out. If the power supply incorporates a trigger transformer, the tube may "click" on and off once every 2–3 seconds (correlating to the time delay between each high-voltage trigger pulse). Tubes that haven't been used in a while can be hard to start, so once you get it going, keep it on for a day or two. In most cases, the tube will start normally. Hard starting may also be caused by age and degassing, two factors you can't fix.

### One support

As shown in Fig. 3, the PC board is mounted on a metal plate—along with Q1, S1, and T1. The plate is 2 $\frac{3}{8}$ -inches wide  $\times$  5 $\frac{5}{8}$ -inches long. S1 and Q1 are mounted at one end on a  $\frac{7}{8}$ -inch fold. You can't see it in Fig. 3, but there is a  $\frac{1}{4}$ -inch fold along the entire length of the bracket that provides overall rigidity. If you decide to

attach the laser to the power supply as shown in Fig. 3, use the  $\frac{1}{4}$ -inch fold as the support, and secure the laser to the bracket with plastic tie-wraps that pass through two holes drilled along the long folded edge. Note that the laser tube shown in Fig. 3 is enclosed in a metal tube. It was manufactured that way, but it works the same as any other He-Ne laser tube.

Using a suitable insulating washer,

## PARTS LIST

**All resistors are  $\frac{1}{4}$ -watt, 5%, unless noted otherwise.**

- R1—430 ohms
- R2—560 ohms
- R3—R6—22 megohms
- R7—39,000 ohms
- R8—1000 ohms
- R9—200 ohms
- R10—10,000 ohms
- R11, R14—R16—75,000 ohms, 3 watts
- R12, R13—2000 ohms, miniature potentiometer

**All capacitors rated at least 12-volts DC unless noted otherwise**

- C1—0.1  $\mu$ F
- C2—4.7  $\mu$ F
- C3—10  $\mu$ F, 10 volts, radial tantalum
- C4—27  $\mu$ F, 35 volts, axial electrolytic
- C5—0.01  $\mu$ F, ceramic disc
- C6—0.1  $\mu$ F, polystyrene
- C7—C10—0.15  $\mu$ F, 2–3 kV, ceramic or Mylar
- C11—0.47  $\mu$ F, polystyrene

### Semiconductors

- IC1—555 timer
- Q1—TIP146 NPN power transistor
- Q2—2N2222 NPN transistor
- D1—D3—1N4148 diode
- D4—D7—High voltage (8–10 kV, 20-mA) diode
- D8—1N5234, 6.2-volt Zener diode

### Other Components

- RY1—6-volt SPST printed-circuit relay
- T1—High-voltage step-up/step-down transformer, 12 to approximately 280 volts.

**Miscellaneous:** wire, tubing, metal bracket, insulator, spacers, cabinet, etc.

**Note:** The following items are available from General Science and Engineering, PO Box 447, Rochester, NY 14603 (716) 338-7001: Etched and drilled PC board, \$9; transformer T1, \$15; complete kit of parts, including PCB and T1 (excluding project box), \$39. For each order add \$3 for shipping and handling. COD's accepted. New York residents must include applicable sales tax.

sistor is connected; the other leads remain free for now. Then mount D1 through D8; C1 through C11; finally, IC1 and Q2. Q1 will be mounted on a heat sink, but its connections to the PC board should be made now. Simply solder insulated wires about 2 $\frac{1}{2}$ -inches long to Q1's terminals, and connect the free ends to the printed-circuit board.



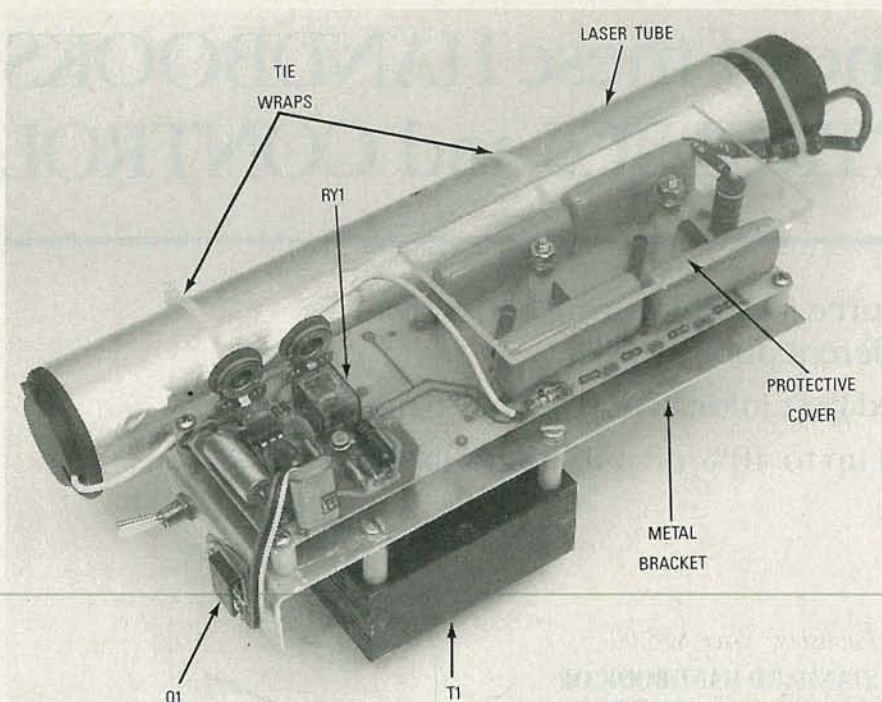

FIG. 3—FULLY ASSEMBLED, the tube is held to the bracket with plastic straps.

an insulator, and heat-transfer paste, mount Q1 on the folded end of the metal bracket. Use an ohmmeter to check for a short between the metal tab of Q1 (which serves as an alternate connection to Q1's collector) and the metal bracket. Remount Q1 if your meter indicates a short.

Transformer T1 is mounted on the bottom of the metal bracket. A  $\frac{3}{8}$ -inch hole drilled in the bracket opposite T1 is used to pass the wires through to the underside of the PC board. The wires from T1's secondary are soldered to the pads labeled A and B on the foil side of the PC board. (The leads will protrude through the board to the component side.) In a similar way, the wires from T1's primary are soldered to the pads labeled C and D.

### Connections

Make two 8-inch high-voltage leads from high-dielectric wire. Strip and tin  $\frac{1}{2}$ -inch of each end and slip a 6-inch length of clear neoprene (aquarium) tubing over both wires. Solder one wire into the NEGATIVE OUTPUT hole near R7. Solder the remaining wire to the top of R11. If you use R14 and R15, cut the wire connected to R11/R16—and its tubing—in half and splice in R14 and R15; then cover the resistors with plastic or heat-shrinkable tubing.

If your laser tube has flying leads (wire leads already installed), then just connect them to the power-supply output leads later on. If your tube has its power terminals on its ends, then an electrical contact can be made by wrapping a length of wire around them.

Before using the power supply, inspect it carefully for solder bridges, loose connections, and improperly installed components.

### Using the supply

Operating the power supply is straightforward. Secure the power leads to the tube and, if necessary, wrap high-voltage putty or electrical tape around the leads to hold them in place, but be sure that you don't block the laser's output mirror. Position the power supply so that you are facing R12's and R13's adjustment "dial" and set each potentiometer to its center position.

Apply power and observe the laser tube. Slowly adjust R12 clockwise until the tube triggers: You will hear the relay click in, and possibly a high-pitched whine. Both effects are normal. If the relay chatters and the tube sputters, keep turning R12 until the relay locks in and the tube stays on. If even a full clockwise adjustment fails to get the tube to ignite, adjust R13 slightly counter-clockwise.

### THE PROPERTIES OF LASER LIGHT

- Laser light is monochromatic. Laser light coming from the output mirror consists of one wavelength or, in some instances, two or more specific wavelengths. The individual wavelengths can be separated.
- Laser light is spatially coherent. The term spatial coherence means that all the waves are in tandem. That is, the crests and the troughs of the waves that make up the beam are in lock-step.
- Laser light is temporally coherent. Temporal coherence is when the waves from the laser (which can be considered as one large wave, thanks to spatial coherence) are emitted in even, accurately-spaced intervals. Temporal coherence is similar to the precise clicks of the metronome, timing the beat of music.
- Laser light is collimated. Because of monochromaticity and coherence, laser light does not spread (diverge) as much as ordinary light. The design of the laser itself, or simple optics, can collimate the laser light into a parallel beam.

The four main properties of laser light combine to produce a shaft of illumination that is many times more brilliant than the light of equal area from the sun. Because of their coherence, monochromaticity, and low beam divergence, lasers are ideally suited for a number of important applications. For example, the monochromatic and coherent light from a laser is necessary to form the intricate swirling patterns of a hologram. Without the laser, optical holograms would be more difficult to produce.

Coherence plays a leading role in the minimum size of a focused spot. With the right optics, it's possible to focus a laser beam to an area equal to the wavelength of the light. With the typical infrared-emitting laser diode, for instance, the beam can be focused to a tiny spot measuring just 0.8 micrometers wide. Such intricate focusing is the backbone of compact audio discs and laser discs.

Minimum divergence (owing to the coherent nature of laser light) means that the beam can travel a longer distance before spreading out. The average helium-neon laser, without optics, can form a beam spot measuring only a few inches in diameter from a distance several hundred feet away. With additional optics, beam divergence can be reduced, making it possible to transmit sound, pictures, and computer code many miles on a shaft of light. The signal is intercepted by a receiving station in the light path.

# Take any one of these HANDBOOKS ELECTRONICS and CONTROL

- your one source for engineering books from over 100 different publishers
- the latest and best information in your field
- discounts of up to 40% off publishers' list prices



322/910

*Publisher's Price \$110.00*

## ANTENNA ENGINEERING HANDBOOK, Second Edition

Edited by R. C. Johnson and H. Jasik

- 1,408 pages, 946 illustrations
- covers all types of antennas currently in use with a separate chapter devoted to each
- provides detailed data on physical fundamentals, operating principles, design techniques, and performance data
- up-to-the-minute information on antenna applications
- a must for those involved in any phase of antenna engineering

*Publisher's Price \$68.00*

## STANDARD HANDBOOK OF ENGINEERING CALCULATIONS, Second Edition

By T. G. Hicks

- 1,468 pages, 793 illustrations, 499 tables
- puts more than 1,100 specific calculation procedures at your fingertips
- every calculation procedure gives the exact, numbered steps to follow for a quick, accurate solution
- virtually all procedures can be easily programmed on your PC or calculator
- uses USCS and SI units in all calculation procedures

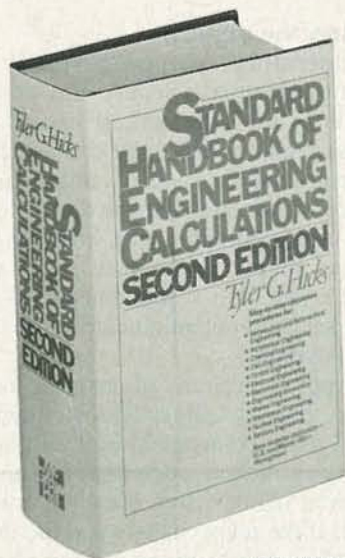

287/35X



047/790

*Publisher's Price \$95.50*

## TELEVISION ENGINEERING HANDBOOK

Edited by K. B. Benson

- 1,478 pages, 1,091 illustrations
- packed with all the technical information today's engineer needs to design, operate, and maintain every type of television equipment
- extensive coverage of receivers, broadcast equipment, video tape recording, video disc recording, and the latest technological advances
- provides television system and industry standards for the U.S. and other countries
- the most comprehensive book on the subject of television engineering

# for only \$14.95 – when you join the ENGINEERS' BOOK CLUB®

values up to \$110.00

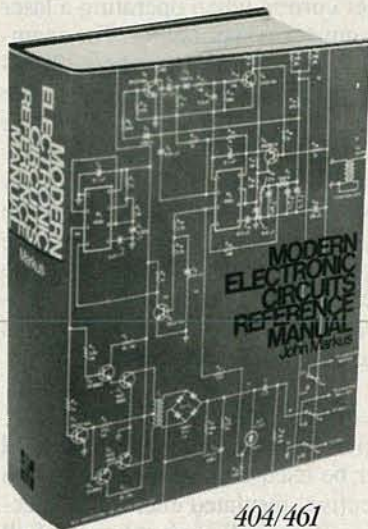

404/461

Publisher's Price \$85.50

## MODERN ELECTRONIC CIRCUITS REFERENCE MANUAL

By J. T. Markus

- 1,264 pages, 3,666 circuit diagrams
- a handy, desktop reference with 103 chapters organized by "family" grouping
- filled with predesigned and use-tested circuits to save you production time and money
- includes concise summaries of all the recent applications notes, journal articles, and reports on each circuit, efficiently organized and indexed for the practicing engineer



### 4 reasons to join today!

**1. Best and newest books from ALL publishers!** Books are selected from a wide range of publishers by expert editors and consultants to give you continuing access to the best and latest books in your field.

**2. Big savings!** Build your library and save money, too! Savings range up to 40% off publishers' list prices.

**3. Bonus books!** You will automatically be eligible to participate in our Bonus Book Plan that allows you savings up to 70% off the publishers' prices of many professional and general interest books!

**4. Convenience!** 14-16 times a year (about once every 3-4 weeks) you receive the Club Bulletin FREE. It fully describes the Main Selection and alternate selections. A dated Reply Card is included. If you want the Main Selection, you simply do nothing – it will be shipped automatically. If you want an alternate selection – or no book at all – you simply indicate it on the Reply Card and return it by the date specified. You will have at least 10 days to decide. If, because of late delivery of the Bulletin you receive a Main Selection you do not want, you may return it for credit at the Club's expense.

As a Club member you agree only to the purchase of two additional books during your first year of membership. Membership may be discontinued by either you or the Club at any time after you have purchased the two additional books.

## New!

Publisher's Price \$89.50

## ELECTRONICS ENGINEERS' HANDBOOK, Third Edition

Edited by D. G. Fink and D. Christiansen

- 2,496 pages, 1,600 illustrations
- the definitive reference to electronics engineering
- fully updated to cover all recent advances and developments
- ranges from essential principles and data to the latest design solutions and practical applications – with an all-new chapter on standards
- written and compiled by more than 170 contributors – all experts in their fields



209/820

FOR FASTER SERVICE IN ENROLLING CALL TOLL FREE 1-800-2-MCGRAW

**McGraw-Hill Book Clubs**  
**Electronics and Control Engineers' Book Club®**  
 P.O. Box 582  
 Hightstown, NJ 08520-9959

Please enroll me as a member of the Electronics and Control Engineers' Book Club® and send me the book I have chosen for only \$14.95 plus local tax, postage and handling. I agree to purchase a minimum of two additional books during my first year as outlined under the Club plan described in this ad. Membership in the club is cancellable by me or McGraw-Hill any time after the two book purchase requirement has been fulfilled. A shipping and handling charge is added to all shipments.

I wish to order the following book:

- ANTENNA ENGINEERING HANDBOOK (322/910)
- MODERN ELECTRONIC CIRCUITS REFERENCE MANUAL (404/461)
- ELECTRONICS ENGINEERS' HANDBOOK, 3/e (209/820)
- TELEVISION ENGINEERING HANDBOOK (047/790)
- STANDARD HANDBOOK OF ENGINEERING CALCULATIONS (287/35X)

Signature \_\_\_\_\_

Name \_\_\_\_\_

Address/Apt. # \_\_\_\_\_

City/State/Zip \_\_\_\_\_

This order subject to acceptance by McGraw-Hill. Offer good only to new members. Foreign member acceptance subject to special conditions.

E34022

MARCH 1989

## LASER OPERATION

Some basics first. Albert Einstein was responsible for first proposing the idea of the laser in about 1916. Einstein knew that light was a series of particles, called photons, traveling in a continuous wave. These photons could be collected, using an apparatus not yet developed, and focused into a narrow beam. To be useful, all the photons would be emitted from the apparatus at specific intervals. Much of the light energy would be concentrated in a specific wavelength, or color, making the light even more intense and powerful.

Photons can be created by a variety of means, including the ionization of gas within a sealed tube, the burning of some organic material, or the heating of a filament in a light bulb. In all cases, the atoms that make up the light source change from their usual stable or ground state to a higher excited state by the introduction of some form of energy, typically electricity. The atom can't stay at the excited state for long, and when it drops back to the ground state, it gives off a photon of light.

The release of photons by natural methods results in spontaneous emission. The photons leave the source in a random and unpredictable manner, and once a photon is emitted, it marks the end of the energy-transfer cycle. The number of excited atoms is low, so the majority of photons leave the source without meeting another excited atom.

Einstein was most interested in what would happen if a photon hit an atom that happened to be at the excited, high-energy state. He reasoned that the atom would release a photon of light that would be an identical twin to the first. If enough atoms could be excited, the chance of photons hitting them would be increased. That would lead to a chain reaction where photons would hit excited atoms and make new photons—the process continuing until the energy source was removed. Einstein had a name for that phenomenon and called it the stimulated emission of radiation.

Once the tube lights, adjust R13 clockwise until the tube begins to stutter and the relay chatters. That marks the tube's *threshold*. Turn R13 just a *smidgen* counter-clockwise until the tube turns back on and remains steady. Every tube, even those of the same size and having the same output, has slightly different current re-

Raising atoms to a high-energy state is referred to as pumping. In common neon light, for example, the neon atoms are pumped to their high-energy state by means of a high-voltage charge applied to a pair of electrodes. The gas within the tube ionizes, emitting photons. If the electrical charge is high enough, a majority of the neon atoms will be pumped to the high-energy state. A so-called population inversion occurs when there are more high-energy atoms than low-energy ones. A laser cannot work unless that population inversion is present.

Photons scatter all over the place and, on their own, they simply escape the tube and don't strike many excited atoms. But assume that a pair of mirrors are mounted on either end of the tube, and that some photons may bounce back and forth between the two mirrors.

At each bounce, the photons collide with more atoms. If many of those atoms are in their excited state, they too release photons. Remember: The new photons are twins of the original, and share many of their characteristics, including wavelength, frequency, polarity, and phase. The process of photons bouncing from one mirror to the next, each time striking atoms in the path, constitutes light amplification.

In theory, if both mirrors are completely reflective, the photons would bounce back and forth indefinitely. Rub a little of the reflective coating off one mirror, however, and it passes some light. Now, a beam of photons passes through the partially reflective mirror after the light has been sufficiently amplified. In addition, because the mirror is partially reflective, it holds back some of the light energy. That reserve continues the chain reaction inside the tube.

The combination of light amplification and stimulated emission of radiation makes the laser operate. As you probably already know, the word "LASER" is an acronym for its theory of operation—*Light Amplification by Stimulated Emission of Radiation*.

quirements. You might have to readjust R12 and R13 for every tube you own.

Resistors R11 and R14–R16 form the ballast for the laser tube. With the components shown in Fig. 1, the total resistance is about 75,000 ohms. You can safely use ballast values from 60K to 120K; use R13 to adjust for tube-

current variations. If the laser doesn't trigger or run after adjusting R12 and R13, try reducing the value of the ballast resistance, but avoid going below 60K. If the tube begins to flicker after warming up, readjust R13.

Most 1-mW tubes draw between 750-mA to 1-amp from the 12-volt DC source. You will find that you need higher current when operating a laser with greater power output. For example, a typical 5-mW laser draws 2.5–3 amperes from the 12-volt DC power source. However, take note that the power source *must* be able to deliver an initial surge of 3–5 amps. If your 12-volt power supply cannot handle that requirement, try powering the laser supply with a 12-volt alkaline lantern battery. Also, two 6-volt lead-acid, or gel-cell batteries in series make a good 12-volt source.

### The enclosure

Your laser power supply should never be used without placing it in a protective, insulated enclosure. Electronics stores sell project boxes of all sizes. If you plan on using the supply to power a number of tubes, use heavy-duty (25-amp) banana jacks to provide easy access to the anode and cathode leads. Keep the jacks separated by at least one inch and apply high voltage putty around all of the terminals to prevent arcing. Avoid using power leads longer than 6–9 inches especially for the anode connection. If, for some reason, you intend to test the supply outside of its cover, we suggest you cover the high-voltage section with a piece of plastic, as shown in Fig. 3.

### Experiments

With your power supply working, it's time to experiment with laser light. Try doing some simple experiments with optics, mirrors, and lenses. At night, aim the laser at the wall of a distant building to see how far the beam travels before spreading out. Try to measure the width of the beam and calculate its divergence. Then, insert a small telescope or rifle scope backward in the path of the beam (the beam goes in the objective and exits the eyepiece). With some adjustment the beam's divergence should be drastically reduced.

There are many other projects you can try, including holography, metrology (the study of measurement), or a light show.

R-E

# BUILD THIS

OUR BATTERY-POWERED WIRELESS FM transmitter that can transmit an audio signal over a short distance (about a hundred feet), to any frequency in the standard FM band. The transmitter itself is assembled on a PC board that measures less than 4 square inches ( $34 \times 46$  millimeters). The fully assembled unit is shown in Fig. 1.

The transmitter conforms to the FCC's regulations regarding wireless microphones. Its emissions stay within a band of 200-kHz, and its output is between 88 and 108 MHz. The field strength of the radiated emissions do not exceed  $50 \mu\text{V}/\text{m}$  at a distance of 15 meters from the device.

The small size of the transmitter is what gives it its versatility. The transmitter can be used as a wireless microphone, it can be concealed in a room and used as a "bug" for a good practical joke, or perhaps placed near a baby's crib and used as a child monitor. The wireless microphone in Fig. 2 used the case of an old microphone that was found in a junkbox. A small on/off switch was added to the circuit. It can be used to talk to someone in another car on a long road trip, or to anyone wearing a walkman-type radio.

## The circuit

The schematic for the transmitter circuit is shown in Fig. 3. Adjustable-capacitor, C10, and the coil, L1, form

# WIRELESS FM MICROPHONE

*Here's a wireless FM transmitter that's so versatile, we shouldn't even have to tell you what you can do with it!*

**MARC SPIWAK,**  
ASSOCIATE EDITOR

a tank circuit that, in combination with Q1, C2, and R1, oscillates at a frequency on the FM band. The center frequency is set by adjusting C10. An electret microphone, M1, picks up an

audio signal that is amplified by transistor Q2. The audio signal is coupled via C9 to Q1, which frequency-modulates the tank circuit. The signal is then radiated from the antenna. (A piece of solid wire can be used as an antenna if you don't want to use a telescopic one.)

The circuit can operate from 9–12 volts DC. It's easiest to use an ordinary 9-volt transistor battery, but if you have to conserve space in a small case, you may prefer to use small 12-volt batteries that are about half the size of a AA cell. If you are going to use the transmitter as a child monitor or for some other similar application, you may want to use an AC adapter as a power source.

## Parts

All of the parts, including an etched, drilled, and silk-screened PC

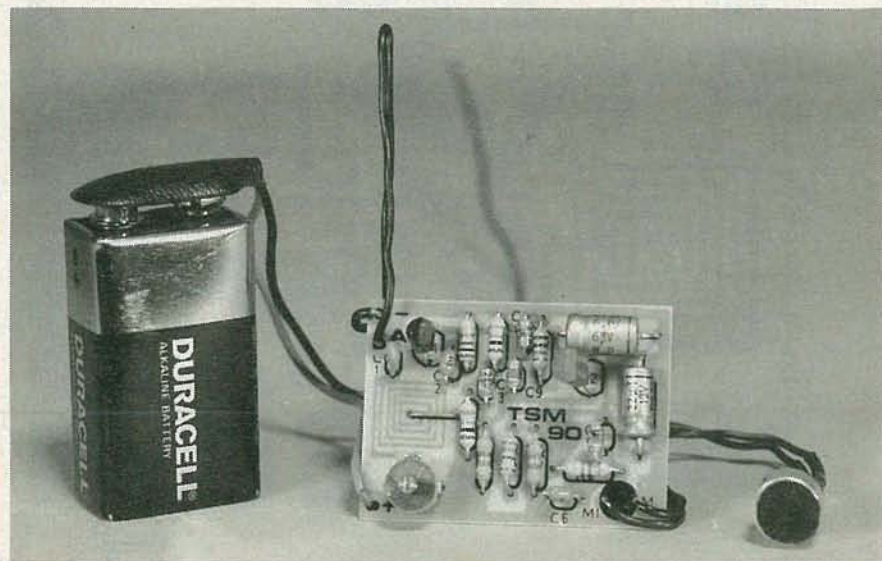
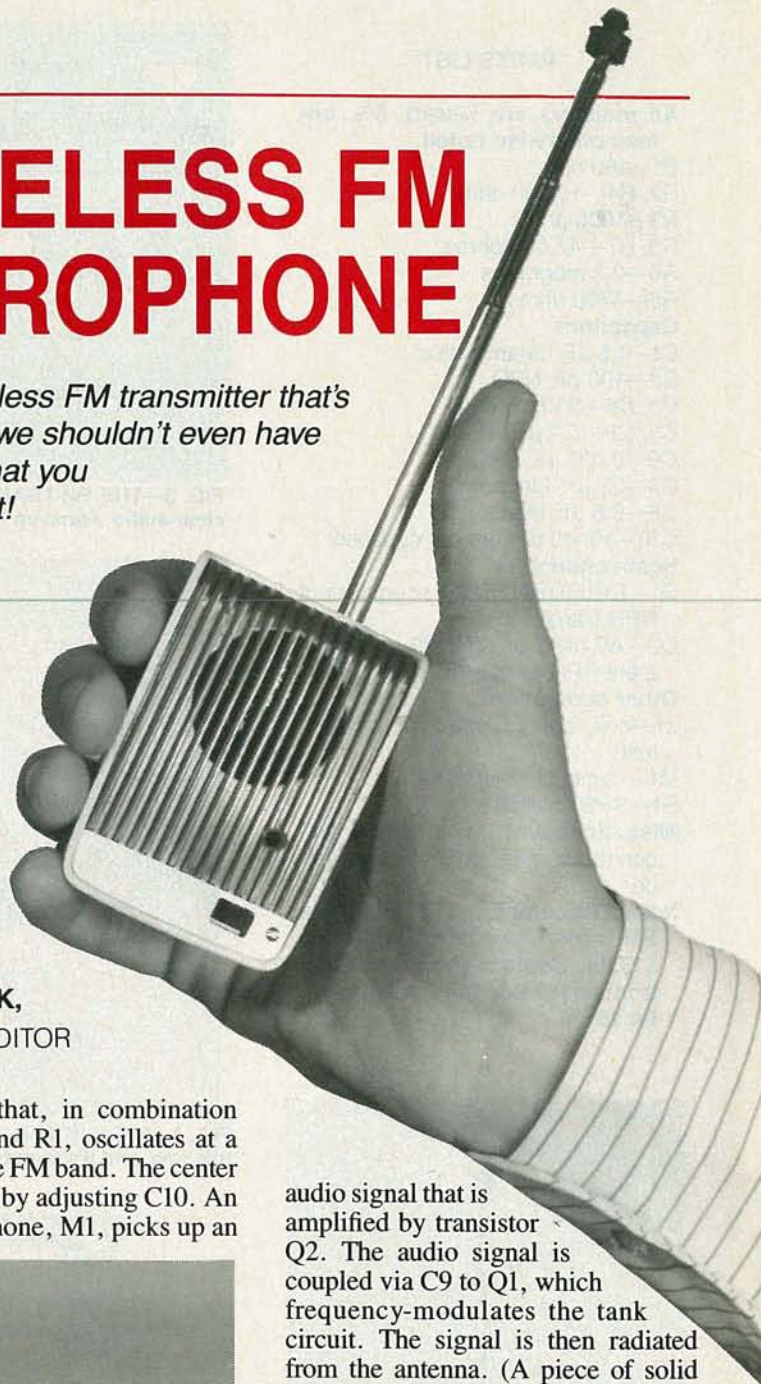

**FIG. 1—THE FULLY ASSEMBLED PC BOARD.** This FM transmitter board is so small, measuring  $1\frac{1}{8} \times 1\frac{1}{8}$  inches, that it will fit inside almost anything.

## PARTS LIST

All resistors are 1/4-watt, 5%, unless otherwise noted.

R1—100 ohms  
R2, R4—10,000 ohms  
R3—1000 ohms  
R5, R7—47,000 ohms  
R6—2.2 megohms  
R8—4700 ohms

### Capacitors

C1—1.5 pF, ceramic disc  
C2—100 pF, NPO  
C3, C4—330 pF, NPO  
C5, C9—0.1  $\mu$ F, NPO  
C6—0.001  $\mu$ F, NPO  
C7—22  $\mu$ F, electrolytic  
C8—6.8  $\mu$ F, electrolytic  
C10—10–40 pF trimmer capacitor

### Semiconductors

Q1—BF199 or NTE229, or equivalent NPN transistor  
Q2—BC183C or NTE199, or equivalent NPN transistor

### Other components

L1—coil, approximately 1  $\mu$ H (see text)

M1—electret microphone

S1—SPST switch

**Miscellaneous:** 9-volt battery and connector, wire, project case, solder, etc.

**Note:** The complete TSM kit for the FM transmitter is available for \$13.85. Contact Prospect Electronics, PO Box 9144, Allentown, PA 18105.

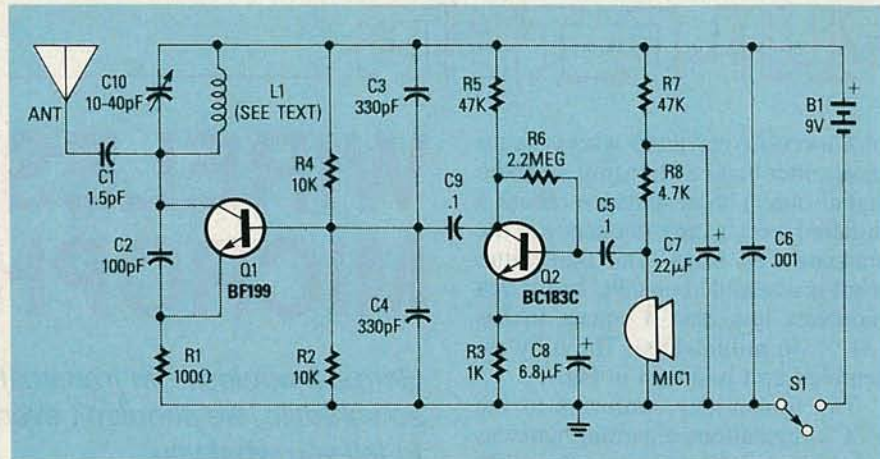

FIG. 3—THE FM-TRANSMITTER circuit has few components, but it can still transmit a clear audio signal up to a hundred feet.

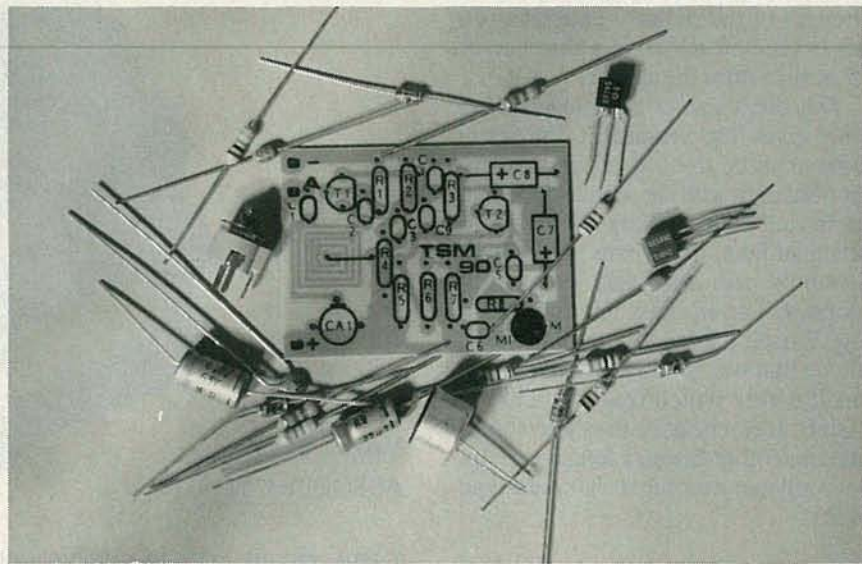

FIG. 4—HERE IS THE COMPLETE PARTS KIT. You shouldn't have any trouble building this one, and it's sure to work when finished.

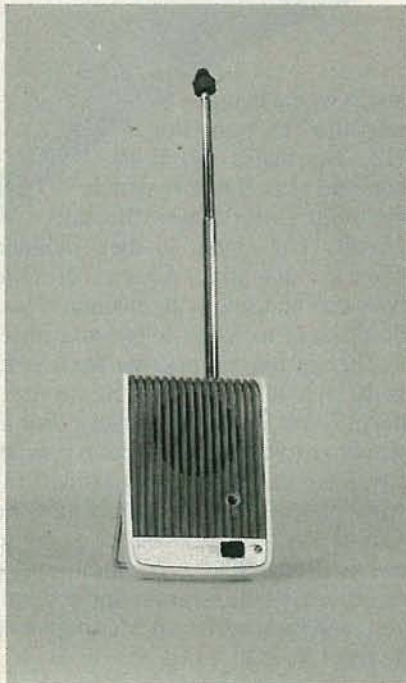

FIG. 2—THIS WIRELESS MICROPHONE was made out of an old, gutted microphone. A transmitter and a 9-volt battery fit inside.

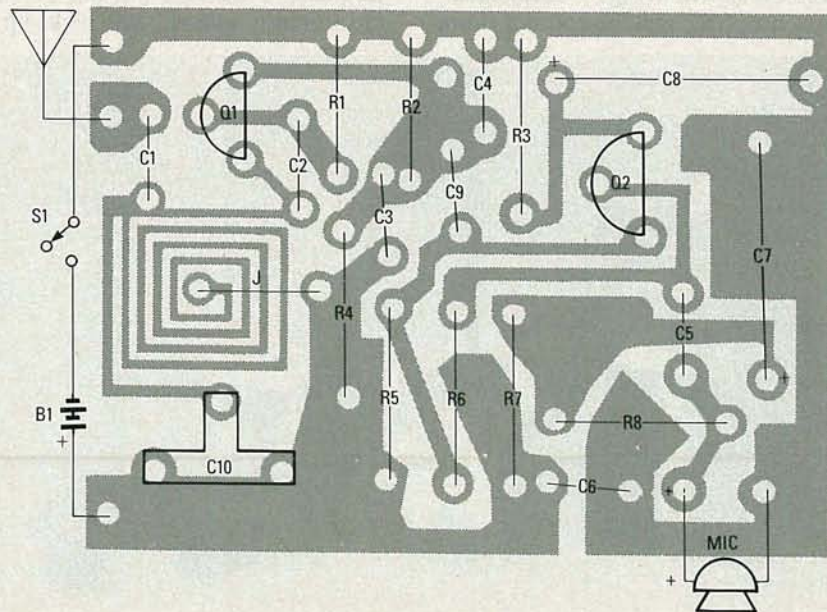

FIG. 5—PARTS-PLACEMENT DIAGRAM. Solder the components to the board in the order of the Parts List.

board are available as a kit from TSM (see Fig. 4). If you look at the PC board's foil pattern in PC Service, you'll notice that there's a small square-shaped spiral-like trace on the board. That is actually the coil, L1. So, whether you buy the kit, or if you can find all the parts in your junkbox and make your own PC board, you'll already have L1. But if you want to build the circuit on a breadboard, you might be able to get away with an adjustable coil centered around 1  $\mu$ H. The only other things you'll need is a battery and battery clip, a small case, and a piece of wire for the antenna.

### Construction

Building this kit is no different than building any other, once you have the PC board. A Parts-Placement diagram is shown in Fig. 5. The components should be soldered to the board in the order that they're listed in the Parts List. To avoid damaging the electret microphone, make sure that the lead connected to the microphone's case is the one that you connect to ground on the PC board. And of course, as always, make sure that



**FIG. 6—AN EMPTY CIGARETTE PACK makes a good home for the FM transmitter.**

there are no bad solder joints or bridges before connecting power.

### Get it working

After you apply power to the board, all you have to do is set an ordinary FM radio on an unused station on the lower portion of the dial—around 88 MHz. Then just speak into the electret microphone while adjusting C10 using a plastic trimmer tool. At some point you should hear your voice on the radio. Once you find the approximate setting of C10, fine tuning it

should be no problem. It might be easier to receive a clear signal on a dial-tuned radio, rather than a digitally tuned one.

### The case

You can really go wild on the case for this one. You can install the board and battery in practically anything. The microphone is very sensitive, so it will pick up an audio signal from inside an empty cigarette pack, as shown in Fig. 6. You can put the transmitter in any small box that will blend into the particular surroundings—it can be from cough drops, paper clips, sugar, or inside an empty vitamin jar! There's probably enough room inside most portable radios to install a transmitter, and you might be able to tap power from the existing batteries. Then you'll have a portable radio/transmitter, that can easily be moved to any room in your home.

Another idea is to hollow out the center of an old book and put a transmitter and battery in there. The wireless transmitter is so versatile, that you'll surely want to build one—or two!

**R-E**

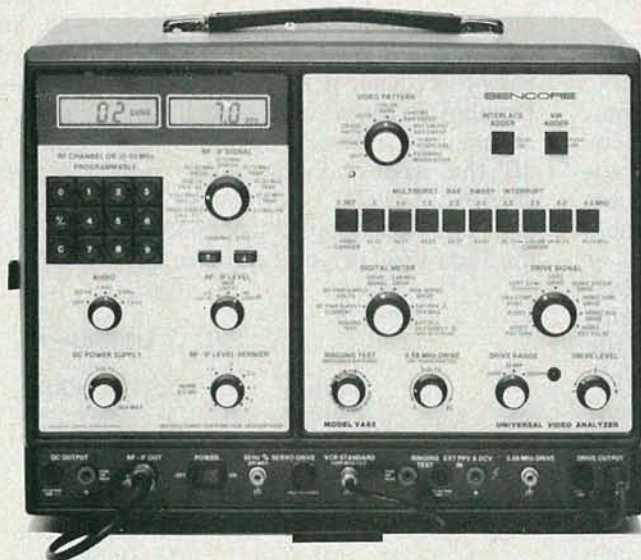

## Cut Your Video Servicing Time By 54%

**With the Market Proven VA62 Universal Video Analyzing System.**

Today's VCRs, TVs, and MTS Stereo TVs require a proven method to quickly isolate the defective component. New technology has made simple problem solving a time-consuming and expensive procedure.

A survey of over 1500 Video Analyzer owners has shown that the VA62's unique signal substitution method has reduced their video servicing time by an average of 54%, and increased their servicing profits.

You can join the successful service centers that have cut their video servicing time and increased their profits with the VA62 Universal Video Analyzing System. Call for a brochure on the VA62. Call **1-800-843-3338**, and increase your profits. In Canada Call **1-800-851-8866**.

**SENCORE**

3200 Sencore Drive, Sioux Falls, SD 57107

100% American Made

CIRCLE 181 ON FREE INFORMATION CARD.

MARCH 1989

# BUILD THIS

## PHONLINK II

*Now you can telephone home, listen to household voices, and control your lights and appliances—using any Touch-Tone phone.*

JANET McNABB and GENE ROSETH

LAST MONTH WE LEFT OFF WITH A DISCUSSION on the Phonlink II's circuitry. Now we continue with the software and circuit modifications, *and* we'll get the thing running!

### Software

Space restrictions prohibit a complete discussion of the software; however, a short excerpt from the modified Z80 source code is shown in Listing 1. A complete listing is available from the supplier in the parts list, or from the RE-BBS, (516-293-2283, 300/1200 baud, 8 data bits, no parity, 1 stop bit); just download the file PHONLNK2.ARC. The sample portion here illustrates the process of sending the house code. Notice that lines 1920, 1960, 2000, and 2040 test successive bits of register B, which contains the bit pattern corresponding to the house code. Those tests then jump to one of two routines (either genzro or genone). The two routines output modulation patterns corresponding to a logic "1" or "0." The procedure for sending out the function and number codes is similar.

The updated Phonlink II software will hang up the phone when it detects a caller disconnect, or after five minutes, whichever comes first. The automatic hang-up feature is useful if you want to listen to sounds picked up by the microphone and just hang up

when you're through, without having to deactivate the function and then hang up.

### Modifications

Figure 8 shows the Phonlink II Parts Placement. If you're building a Phonlink II system from scratch, you should use the new PC board that has all the necessary updates and changes. That PC board can be obtained from the supplier mentioned in the Parts List, or you can make one

yourself from the pattern provided in PC Service. On the other hand, if you're updating the original Phonelink to Phonlink II, then there are three things you must do. First, the software must be changed (which simply means the EPROM has to be replaced). Next, the CPU clock rate must be increased; and last, a PLI module must be connected to the system. We will now discuss each of those changes.

If you had the foresight and good

### LISTING—1

	01870 ;	OUTPUT HOUSE CODE
	01880 ;	
CAB DD21FF8F	01890	LD IX,HSCDAD ;IX GETS HOUSE CODE ADDR
CAF DD4600	01900	LD B,(IX) ;B GETS HOUSE CODE
CB2 21BC8C	01910	LD HL,PLRTNA ;SET UP
CB5 CB40	01920	BIT 0,B ;TEST LSB
CB7 2064	01930	JR NZ,GENONE ;OUTPUT A ONE OR
CB9 C35C8D	01940	JP GENZRO ;A ZERO
CBC 21C68C	01950 PLRTNA	LD HL,PLRTNB
CBF CB48	01960	BIT 1,B ;SIMILAR TO ABOVE
CC1 205A	01970	JR NZ,GENONE
CC3 C35C8D	01980	JP GENZRO
CC6 21D08C	01990 PLRTNB	LD HL,PLRTNC
CC9 CB50	02000	BIT 2,B
CCB 2050	02010	JR NZ,GENONE
CCDC35C8D	02020	JP GENZRO
CD0 21DA8C	02030 PLRTNC	LD HL,PLRTND
CD3 CB58	02040	BIT 3,B
CD5 2046	02050	JR NZ,GENONE
CD7 C35C8D	02060	JP GENZRO
	02070 ;	





fortune to mount the original EPROM in a DIP socket, then changing the software is as simple as replacing the EPROM. Otherwise, to remove the EPROM, the following procedure should be followed: Make sure that all power is disconnected from your Phonelink unit. Observe static-discharge precautions. Using a pair of sharp-pointed cutters, cut each of the pins on the EPROM (IC6), close to the plastic body of the IC. Discard the IC. Now, use a small fine-point soldering iron and needle-nose pliers to remove all the EPROM pins still soldered to the board. Using desoldering braid might be a good idea. Be careful not to damage the foil on the PC board during IC-pin removal. You should now solder in a 28-pin DIP socket, observing the proper orientation, and insert the new EPROM.

In order for the software to output the control signals on the 120-volt AC line with proper timing, it is necessary to increase the 447.5-kHz CPU clock rate. Fortunately, there is a 1.79-MHz unused clock signal available at IC3 pin 26, which does the job nicely. There is a slight complication, however, because the A/D converter (IC8) also gets its clock from the same 447.5-kHz source as the CPU. So the task is to change the CPU clock, but *not* the A/D converter clock (pin because IC8 just won't run that fast).

During the following procedure, when you are asked to *break* a path on the foil of the PC board, you should make two cuts across the path approximately 1/4 inch apart, and then remove the foil between the two cuts. The best tool to use is a small *X-acto* knife. On the top (pin component) side of the PC board, break the line from IC8 (pin 10) to IC7 (pin 11). On the bottom side of the PC board, break the line from IC10 (pin 17) to IC7 (pin 12).

Now you must add the new connections using jumper wires on the solder side of the board. Use AWG (American Wire Gage) numbers 28 or 30 gage insulated wire (wire-wrap wire works fine) to make jumper-wire connections from IC3 (pin 26) to IC7 (pin 12), and from IC10 (pin 17) to IC8 (pin 10). After you solder the jumpers in place, check for solder bridges between adjacent pads.

Let's shift our attention to the PLI module. The PLI has a 4-pin modular telephone jack. Adjacent to the PLI phone jack are pin numbers 1, 2, 3, and 4. Use a standard four-wire telephone cable with mating plug and connect the black wire to pin 1, red to 2, green to 3, and yellow to 4. The 4-wire cable should be four or five feet long, and strip the wire ends. Plug the telephone modular plug into the PLI telephone-type jack.

Now we're ready to wire the other end of the PLI cable to the Phonelink II. To do that, first install a small 2N2222A driver transistor. Solder the collector to IC1 (pin 25) and the base to IC2 (pin 12). Also, connect R58 from the base to the collector. Be **VERY CAREFUL** not to blob solder onto adjacent pins or foil paths—scrutinize your work closely with a magnifying glass! Connect the emitter to PLI-4 (yellow) wire. Connect the PLI-1 (black) wire to IC2 (pin 37). You must now connect a R57 from IC2 (pin 37) to +5V, and remove any jumpers you have for the Watch Dog (WD) selector that are next to IC2. Now, connect PLI-2,3 (red, green) wires to  $-V_D$ . It's a good idea to anchor the PLI cable, either with a strain relief mounted in the back panel, or by tying it to the other cable that goes to the telephone jack.

If you want Phonelink II to answer after 3 rings, connect a jumper from IC2 (pin 38) to  $-V_D$ ; alternatively, if you want Phonelink II to answer after 10 rings, connect a jumper from IC2 (pin 38) to  $+V_D$ .

You may use any method to solder jumper wires to the printed-circuit board, including soldering them directly into the feed-through holes, or directly onto the IC pin. In some instances, the author used individual IC-pin sockets that were soldered into

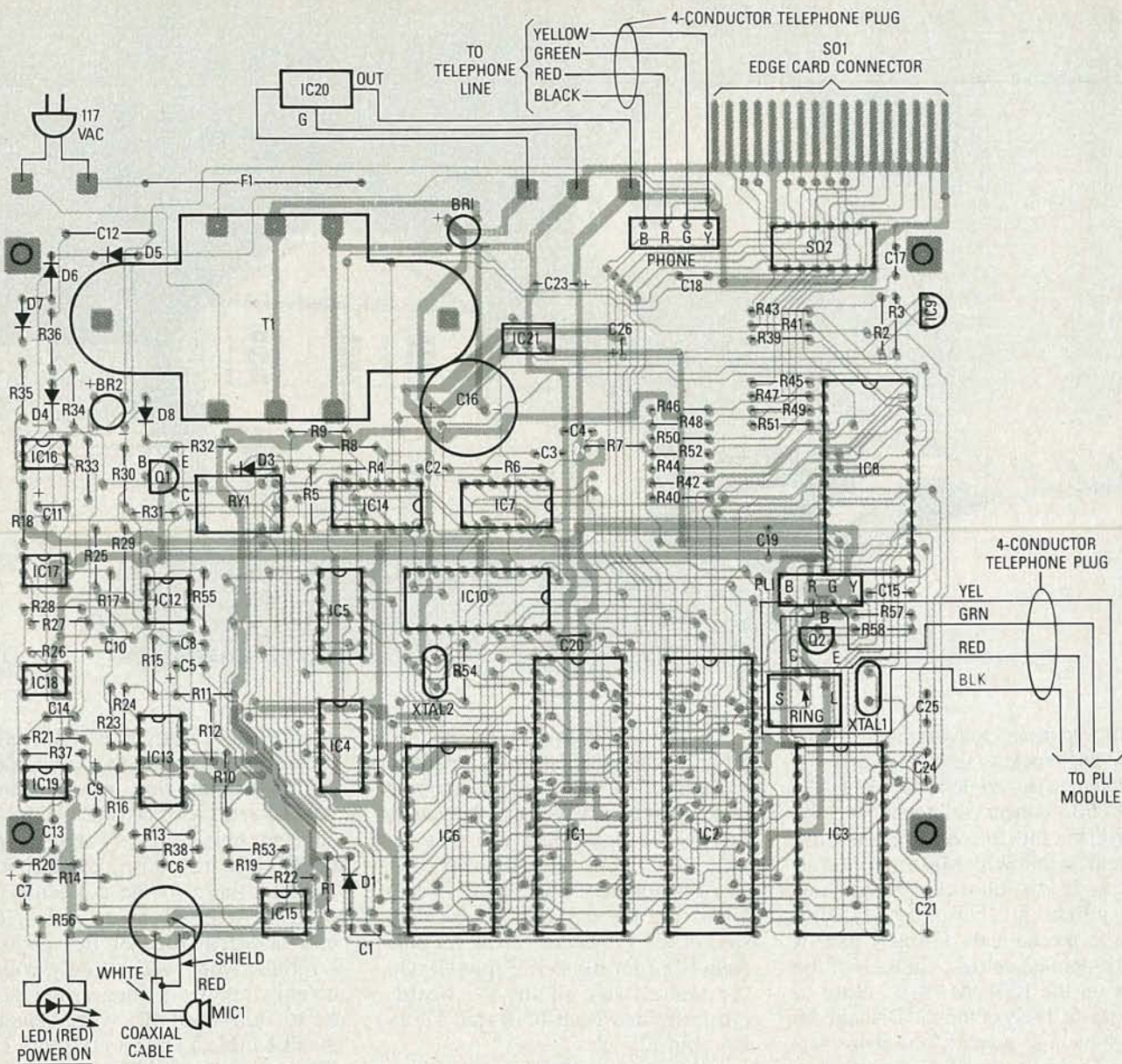

FIG. 8—PARTS PLACEMENT FOR THE PC BOARD is shown here. Mount all electrolytic capacitors, IC's, diodes, and transistors in the correct orientation.

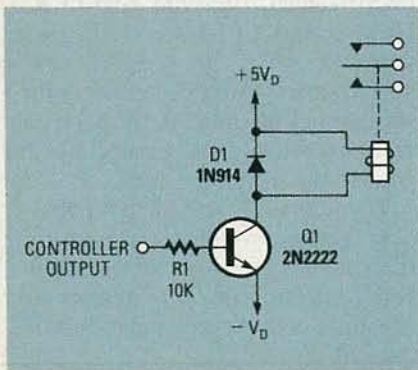

FIG. 9—RELAY CONTROL OF EXTERNAL loads is possible using the digital-output port.

feed-through holes. Jumper wires and components were then soldered directly into the pin socket.

### Interfacing

The Phonlink II comes complete with a 34-pin card-edge connector (SO1) for interfacing the 5 digital outputs and 7 analog inputs to the real

### WARNING

While Phonlink II has been designed to meet the interface requirements of the telephone system, it is not FCC type-approved. Therefore, connection of such a device to your operating company's line is subject to the regulations of that company. It is *your* responsibility to inquire about and comply with pertinent requirements.

world. The internal Phonlink II DIP socket, SO2, is an alternative connector for some of the I/O's. That connector is most useful when the interfacing I/O circuitry is simple, compact, and can fit inside Phonelink's II enclosure; possibly I/O circuitry that's constructed on perforated board, which can plug right into the SO2 DIP socket itself. For example, as shown in Fig. 9, a simple digital interface might include a driver transistor, Q1, and a relay, RY1, to control an external device. A high output on a digital line will forward-bias the transistor, which then energizes the relay. That small circuit could be mounted inside the Phonlink II with the relay contact wires strung to a remote location.

## PARTS LIST

### All resistors are 1/4-watt, 5% unless otherwise noted.

R1—100,000 ohms  
 R2—250 ohms, 1%  
 R3—10,000 ohms, 1%  
 R4, R17, R24, R27, R32, R34, R35—10,000 ohms  
 R5—R9, R19, R36, R40, R42, R44, R46, R48, R50, R52—33,000 ohms  
 R10, R15, R38—47,000 ohms  
 R11, R12, R14—1000 ohms  
 R13, R20, R21—220,000 ohms  
 R16, R28, R54, R55—1 megohm  
 R18, R25—22,000 ohms  
 R22—330,000 ohms  
 R23, R30, R31, R33—100,000 ohms  
 R26—100 ohms  
 R29—100 ohms, 1/2-watt  
 R37—470 ohms  
 R39, R41, R43, R45, R47, R49, R51—51,000 ohms  
 R53—39,000 ohms  
 R56—150 ohms

### Capacitors

C1, C6, C13—C15, C17—C22—.1  $\mu$ F, ceramic disc  
 C2, C8, C10—1  $\mu$ , molded monolithic ceramic  
 C3, C4—0.022  $\mu$ F, dipped-polyester film  
 C5, C11—10  $\mu$ F, 16 volts, dipped tantalum  
 C7—2.2  $\mu$ F, 35 volts, dipped tantalum  
 C9, C26—33  $\mu$ F, 16 volts, solid tantalum  
 C12—0.1  $\mu$ F, 200 volts, orange-drop polyester film

C16—4700  $\mu$ F, 16 volts, electrolytic  
 C23—470  $\mu$ F, 16 volts, electrolytic  
 C24, C25—22 pF, ceramic disc

### Semiconductors

IC1—TMPZ84COOP, CMOS Z80 (Toshiba)  
 IC2—8255A, PIO  
 IC3—SPO256-AL2, speech synthesizer  
 IC4—74C04, hex CMOS INVERTER  
 IC5—74C02, quad CMOS NOR  
 IC6—27C64, 8K CMOS EPROM  
 IC7—74C32, quad CMOS OR gate  
 IC8—ADC0809CCN, A/D converter  
 IC9—LM324Z, precision current reference  
 IC10—M-956, DTMF decoder (Teltona)  
 IC11, IC22—unused  
 IC12, IC15—TLC271, programmable op-amp  
 IC13—LM324, quad op-amp  
 IC14—4066, quad analog switch  
 IC16—IC19—4N32A, opto-isolator  
 IC20—LM7805CK, 5-volt regulator, TO3 case  
 IC21—LM7805CT, 5-volt regulator, TO220 case  
 BR1—200 volts, bridge rectifier, 1/2 amp  
 BR2—50 volts, bridge rectifier, 1/2 amp  
 LED1—(Light Emitting Diode) red  
 D1, D3—D5—1N914, switching diode  
 D2—unused  
 D6—D8—1N5245B, 15 volt, 1/2-watt Zener diode  
 Q1—2N2222, NPN small-signal transistor

### Other components

F1—125 volts, 1/2 amp, pigtail leads  
 MIC1—electret microphone (Radio Shack 270-092B or equivalent)  
 RY1—relay, 5 volts, 70 mA, (Radio Shack 275-243 or equivalent)  
 SO1—32-pin edge-card connector  
 SO2—16-pin DIP socket  
 T1—12.6 volts, 0.6 amp (Tria F-158XP)  
 XTAL1, XTAL2—3.58 MHz

### Modification parts

Q2—2N2222A transistor  
 R57—5600 ohms, 1/4-watt resistor  
 R58—3300 ohms, 1/4-watt resistor  
 IC6—27C64 EPROM (KPL-3A)  
 PLI—(Power Line Interface) X-10 (USA) Model PL513

**Note:** The following items are available from STG ASSOCIATES, 2705-B Juan Tabo Blvd., N.E. # 117, Albuquerque, NM 87112: modification kit to update PHONLINK to PHONLINK II (MKPL-1), \$30; PHONLINK II complete updated kit, all parts, cabinet and documentation (KPL-1A), \$220; updated PC board only (KPL-2A), \$36; programmed EPROM (KPL-3A), \$19; source code print out (KPL-4A), \$10; Please add 5% for postage and handling (10% Foreign). New Mexico residents add appropriate sales tax.

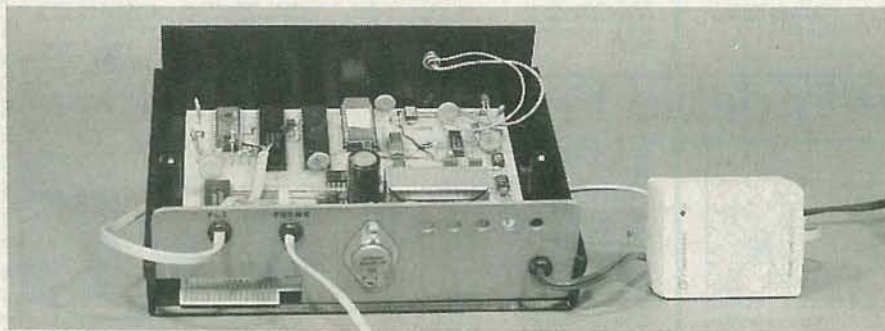

THE COMPLETED PROJECT. Note the edge connector for external circuits.

The Phonlink's II power supply can provide a maximum of about 200 mA to your I/O circuitry. However, if your application requires either power-hungry I/O circuitry, or circuitry that demands its own enclosure, then use the edge connector, SO1, and a separate power supply.

### Start-up Operation

Be sure that you have the timing jumper selected for either the long or

short ring control on the PC board. Plug in the new EPROM which has your access code written on it. Plug the power cord and the PLI into a household wall outlet. Then, plug the phone cord into a phone jack. You have to be very careful not to interchange the two telephone-type cords as they both have modular phone plugs.) If you're using Radio Shack equipment, you should set your 120-volt AC plug-in module to house-

code F, and select a number code (Radio Shack calls it a unit code instead of a number code) from 1 through 5. All that's needed now is to plug any light or appliance you wish to control into the module. The system is now ready for use.

R-E



"While you were working on that device to control the house by phone, you forgot to pay the bill, so the company cut us off."

# Electronics Paperback Books

GREAT PAPERBACKS AT SPECIAL PRICES



BP173—COMPUTER MUSIC PROJECTS ..... \$6.95. Shows how to use your home computer to produce electronic music. Many circuits. Mostly jargon-free.

BP176—TV DXING FOR THE ENTHUSIAST..... \$7.95. Practical, authoritative intro to this unusual aspect of electronics. 812 x 11 in, 144 pp.

PCP103—PRACTICAL MIDI HANDBOOK..... \$9.95. Explains what MIDI (the Musical Digital Interface) can do and how you can put it to work. Covers Keyboards, drum machines, sequencers, mixers, guitars and computer music.

RFTD—RADIO'S FIRST TWO DECADES ..... \$3.50. This story of radio's early days makes for fascinating reading. Spark-gap transmitters, KDKA's beginnings, and much more.

PCP102—INTRODUCING DIGITAL AUDIO ..... \$9.95. CD, DAT, and sampling. What is involved in the digital part of audio signals. Principles and practices of digital audio techniques.

BP195—INTRODUCTION TO SATELLITE TV..... \$9.95. A definitive introduction to the subject written for the professional engineer, electronics enthusiast, or others who want to know more before they buy. 8 x 10 in.

BP146—THE PRE-BASIC BOOK ..... \$6.95. A book on the BASIC programming for those who have not yet bought a computer as well as those who have trouble learning how to program.

BP230—GETTING THE MOST FROM YOUR MULTIMETER..... \$5.95. Covers basics of analog and digital meters. Methods of component testing (includes transistors, thyristors, resistors, capacitors and other active and passive devices).



BP135—SECRETS OF THE COMMODORE 64 ..... \$5.75. Masses of useful info and programming tips not found in any user's manual.

BP143—INTRO TO PROGRAMMING THE ATARI 600/800 XL..... \$5.95. Perfect complement to the Atari user's manual. Even shows how to use animated graphics.

BP148—COMPUTER TECHNOLOGY EXPLAINED..... \$5.50. Explanations for computer terms often encountered. A dictionary for computer lingo.

BP152—INTRO TO Z-80 MACHINE CODE..... \$5.95. Speed up your programs. They may be harder to write, but it's worth learning how. Some demo programs are included.

BP130—MICRO INTERFACING CIRCUITS—BOOK 1..... \$5.75. Practical add-ons transform your computer into control or measurement equipment.

BP131—MICRO INTERFACING CIRCUITS—BOOK 2..... \$5.75. Interfacing sound and speech generators, temperature and optical sensors, motor controllers, and more.

BP148—COMPUTER TECHNOLOGY EXPLAINED..... \$5.50. Explanations for computer terms often encountered. A dictionary for computer lingo.

BP152—INTRO TO Z-80 MACHINE CODE..... \$5.95. Speed up your programs. They may be harder to write, but it's worth learning how. Some demo programs are included.



BP105—ANTENNA PROJECTS ..... \$5.50. Practical radio antenna designs that deliver good performance and are relatively simple and inexpensive to build.

BP198—AN INTRODUCTION TO ANTENNA THEORY..... \$6.95. Basic concepts relevant to receiving and transmitting antennas.

BP144—FURTHER PRACTICAL ELECTRONICS CALCULATIONS AND FORMULAE..... \$9.00. Companion volume to BP53. Book carries on with new data not found in earlier edition. 450 pages.

BP179—ELECTRONIC CIRCUITS FOR THE COMPUTER CONTROL OF ROBOTS..... \$7.50. Data and circuits for interfacing the computer to the robot's motors and sensors. BP134—EASY ADD-ON PROJECTS FOR COMMODORE 64, VIC-20, BBC MICRO & ACORN ELECTRON..... \$6.95. Picture digitizer, light pen, model controller and more.

## Quality Paperbacks



BP183—AN INTRODUCTION TO CP/M..... \$9.95. To run and use programs operations under CP/M you need this book.

BP127—HOW TO DESIGN ELECTRONIC PROJECTS..... \$5.75. How to use standard circuit elements to make custom electronic projects.

BP110—HOW TO GET YOUR ELECTRONIC PROJECTS WORKING..... \$5.75. How to find the faults in your projects, repair them and get them working.

BP121—DESIGN & MAKE YOUR OWN PC BOARDS..... \$5.75. Everything you need to know before you make printed-circuit boards for your projects.

BP104—ELECTRONIC SCIENCE PROJECTS..... \$5.75. Simple to complex, a group of projects with a strongly scientific flavor.

BP92—CRYSTAL SET CONSTRUCTION..... \$5.50. A variety of crystal radio receivers for the experimenter and hobbyist.



BP56—ELECTRONIC SECURITY DEVICES..... \$5.50. Three basic sections. Switch activated alarms, infrared & ultrasonic systems, smoke, gas, water detection.

BP85—INTERNATIONAL TRANSISTOR EQUIVALENTS..... \$7.50. Locates possible substitutes for a popular user-oriented selection of modern transistors. Japanese, European and American types.

BP117—PRACTICAL ELECTRONIC BUILDING BLOCKS. Book 1..... \$5.75. Build the blocks and then combine them to form almost any custom project of your choice.

BP118—PRACTICAL ELECTRONIC BUILDING BLOCKS. Book 2..... \$5.75. Amplifiers for all kinds to add to the circuits from Book 1 of this series.

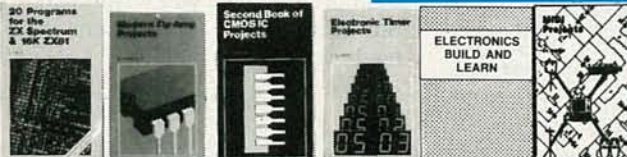

BP128—20 PROGRAMS FOR THE ZX SPECTRUM & 16K ZX81..... \$5.75. All programs run on both machines. Include flow charts and info on how to modify to run on other computers.

BP106—MODERN OP-AMP PROJECTS..... \$5.00. Includes a Slide Timer, AF Signal Gen, Mike Pre-amp, Scratch Filter, and much more.

BP58—SECOND BOOK FOR CMOS IC PROJECTS..... \$5.50. Multivibrators, amplifiers, Triggers & gates; special devices including reaction timer, simple electronic organ, and more.

BP182—MIDI PROJECTS..... \$6.95. Details of how to interface many popular home computers with MIDI music systems.



BP65—SINGLE IC PROJECTS..... \$5.75. All projects in this book are based on one IC and are simple to construct. Great way to get started with IC's.

BP49—POPULAR ELECTRONIC PROJECTS..... \$5.95. A collection of a wide range of electronic projects and circuits for the experimenter.

BP97—IC PROJECTS FOR BEGINNERS..... \$5.50. Written especially for the less experienced experimenter. Complete parts layouts and wiring diagrams.

BP80—POPULAR ELECTRONIC CIRCUITS. Book 1..... \$5.95. More circuits for hobbyists. Audio, radio, test, music, household and more.



PCP104—ELECTRONICS BUILD AND LEARN..... \$9.95. Starts off with construction details of a circuit demonstrator and shows a variety of circuits for experimenters.

BP185—ELECTRONIC SYNTHESIZER CONSTRUCTION..... \$5.95. Shows how to build a monophonic synthesizer; section by section. Replaces BP81.

BP185—ELECTRONIC SYNTHESIZER CONSTRUCTION..... \$5.95. Shows how to build a monophonic synthesizer; section by section. Replaces BP81.

BP185—ELECTRONIC SYNTHESIZER CONSTRUCTION..... \$5.95. Shows how to build a monophonic synthesizer; section by section. Replaces BP81.

## CHECK OFF THE BOOKS YOU WANT

ELECTRONIC TECHNOLOGY TODAY INC.  
P.O. Box 240, Massapequa Park, NY 11762-0240

Name \_\_\_\_\_  
Address \_\_\_\_\_  
City \_\_\_\_\_ State \_\_\_\_\_ Zip \_\_\_\_\_

SHIPPING CHARGES IN USA AND CANADA

\$0.01 to \$5.00	.. \$1.25
\$5.01 to 10.00	.. \$2.00
\$10.01 to \$20.00	.. \$3.00
\$20.01 to \$30.00	.. \$4.00
\$30.01 to \$40.00	.. \$5.00
\$40.01 to \$50.00	.. \$6.00
\$50.01 and above	.. \$7.50

SORRY, No orders accepted outside of USA and Canada

Total price of merchandise ..... \$ \_\_\_\_\_  
Sales Tax (New York State Residents only) ..... \$ \_\_\_\_\_  
Shipping (see chart) ..... \$ \_\_\_\_\_

All payments must be in U.S. funds  
Total Enclosed .. \$ \_\_\_\_\_

# BUILD THIS

## HIGH-POWER HI-FI AUDIO AMP



## FOR YOUR HOME OR CAR

*With rock-n-roll power, here's a stereo amplifier that you can build.*

### L.K. ROSS and AMP WATTS

EVERY SO OFTEN A NEW IC COMES ONTO the market that excites the experimenter's imagination with all sorts of possibilities. One such IC is National Semiconductor's LM12 power op-amp: And when we say power, we mean power. That single IC can pump out 100-watts RMS of audio into 4-ohms; twice that amount of power is available if you use two LM12 IC's in a bridge configuration.

Today,—especially with compact-disc audio, and its wide dynamic range—even moderate levels of sound reproduction require a power amplifier that won't clip the peak inputs. The LM12 can supply those peak-power demands—and so the *Opto-Amp* idea took shape from that beginning. Two separate power supplies were also designed: one for 110-volt AC home operation, and another for 12-volt DC car operation.

The LM12 power-amp has many features that make it ideal as an audio amplifier. You'll first notice the extremely low parts count that permits compact size, reliability, and ease of assembly. All kinds of circuitry are built right into the LM12 IC: controlled turn-on, thermal limiting, over-voltage shutdown, output-current limiting, and complete protection against overloads including shorts to the supplies!

Table 1 shows the complete *Opto-Amp* specifications. Notice the excellent distortion specification (THD less than .01%, slew rate as high as 9V/ $\mu$ s), which should appeal to serious audio buffs and sound professionals. Possible applications of our amplifier include just about whatever your imagination dreams up: car-stereo booster amp, sub-woofer amp, PA system, yacht-stereo amp, stage-

monitor amp, or guitar-practice amp.

### How it works

The *Opto-Amp* has two identical channels (for stereo), so we'll analyze in detail the right channel only. The LM381 (IC3) pre-amplifier has an input-voltage range of 0.75 to 1 volt, with a voltage gain of about 10; the LM12 (IC1 and IC2) power-amps will provide a voltage gain of about 4 each. In keeping with the design goal of low parts count, the LM381 is an ideal choice. It's easy to operate, and requires only a single positive supply with simple filtering provided by R9 and C9. Audio goes to the inverting input, while the non-inverting input is at AC ground through C10. Resistors R6 and R3 determine the gain, and R5 provides bias. Coupling-capacitor C11 isolates the audio input from the amplifier biasing.

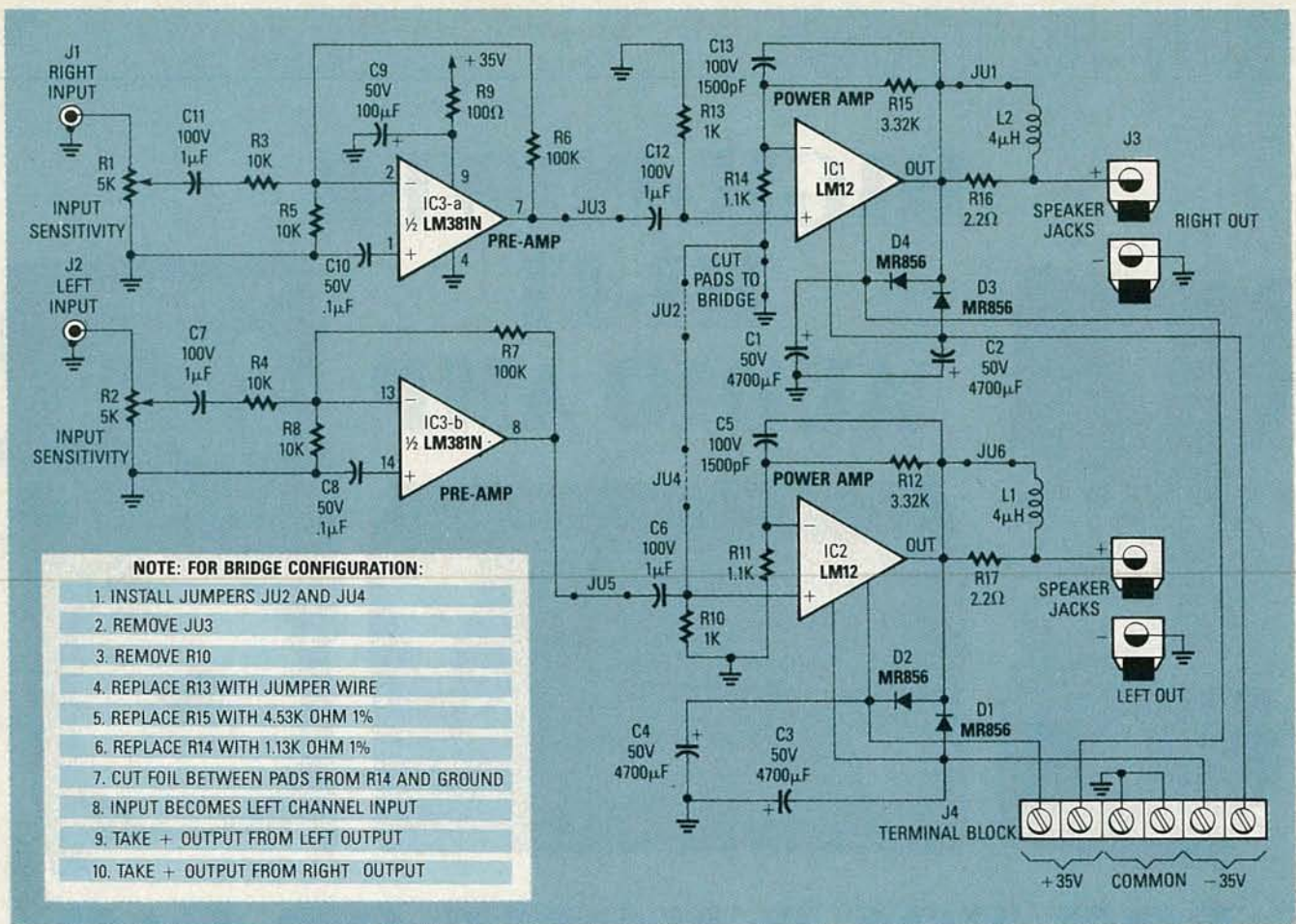

FIG. 1—THE OPTO-AMP IS NORMALLY SET UP FOR STEREO, but can be re-configured for monaural—with twice the output power.

TABLE 1: OPTO-AMP SPECIFICATIONS

**POWER RATING: CONTINUOUS**

**STEREO:** 60 WATTS RMS PER CHANNEL CONTINUOUS INTO 8 OHMS  
100 WATTS RMS PER CHANNEL CONTINUOUS INTO 4 OHMS

**BRIDGED:** 120 WATTS RMS INTO 8 OHMS  
200 WATTS RMS INTO 4 OHMS  
WILL DRIVE 2 OHM LOAD LIMITED TO 150 WATTS PER CHANNEL  
TOTAL POWER DISSIPATION IS 150 WATTS MAX EACH CHANNEL.

**DISTORTION:** THD IS LESS THAN .01%

**SLEW RATE:** 9V/ $\mu$ s

**SIZE:** 10.2" x 2.6" x 5"

**INPUT:** LINE LEVEL WITH INPUT SENSITIVITY ADJUSTMENTS

The pre-amp output is AC-coupled through C12 to IC2, which is set up as a non-inverting amplifier. The gain is equal to  $(R14 + R15)/R14$ . Diodes D3 and D4 are necessary to clamp the output to the supply rails in case the speakers (which are inductive loads) kick back. Inductor L2 and resistor R16 provide output isolation enabling

the amplifier to drive capacitive loads, which audio power amplifiers must be able to do. Capacitor C13 is in the feed-back loop for frequency stability. Large supply-capacitors C1 and C2 are located close to the IC to prevent changes in load current from returning to the amplifier's input—a precaution that also reduces the

power-supply filtering requirement.

Examine the PC-board layout and note some of the design features that are not seen in the schematic. For example, all grounds are returned to a single point for each amplifier, and the +V and -V supplies are kept separate for each IC amplifier.

**Bridging to mono**

The *Opto-Amp* is capable of being bridged for twice the power, namely, for monaural applications. To convert the *opto-amp* from a stereo to monaural (bridge) operation, you'll have to perform some PC-board surgery like moving jumpers around and cutting copper lands. That's because IC2 stays in the non-inverting configuration, while IC3 is changed to an inverting amplifier. Both amplifier outputs are then equal in magnitude, but opposite in phase. Any speaker connected between the two outputs will have twice the signal amplitude of either amplifier referenced to ground. (When two amplifiers are bridged across a speaker, the output ground of

each amplifier is no longer used for the audio's return path through the speaker.)

But there's more: The values of the gain-setting resistors in IC2 must be changed, because the gain for an inverting amplifier is R15/R14 with R14 no longer connected to ground at one end. The right input pre-amplifier is no longer needed, so remove JU3. The input to IC2 is from the left input pre-amplifier, so install JU4 and JU2. The positive input of IC2 is connected to ground by replacing R13 with a jumper wire. Refer to the note in Fig. 1 for bridge conversion.

### Power supplies

There are two different power-supplies depending on where you want to use the *opto-amp*: one for 110-volt AC home operation, and another for 12-volt DC car or boat operation.

Figure 2 shows a 12-volt power supply that you can use to operate the *Opto-Amp* in your car or boat. The 12-volt to 70-volt ( $\pm 35$  volt) converter uses a toroidal-core transformer (T1)

that has two center-tapped primary windings. Transistors Q1 and Q2 are hefty 30-amp transistors that switch 12 volts through the primary-windings No.1 and No.3. The center-tapped winding No.2 is connected to 12 volts, while windings No.4, No.5, and No.6 are the base-drive windings for Q1 and Q2. Power-resistors R1 and R2 provide bias. The base-drive windings are connected out of phase with the main primary windings, so Q1 and Q2 switch on and off to alternate the current into the transformer primary. The secondary winding has a turns ratio of approximately 5 times the primary, which yields after rectification and filtering an output voltage of  $\pm 35$  volts for a 12-volt input.

The 12-volt supply is ultra simple and ultra reliable. The tape-wound toroidal-core transformer is custom-made and available from the source in the Parts List. Other types of cores will not work; this is one of those times when the exact part must be used. The supply will pull about 2 amps under no load, and can supply 5

### PARTS LIST OPTO-AMP

All resistors are 1/4-watt, 5%, unless otherwise noted.

R1, R2—5000-ohms trimmer potentiometer

R3, R4, R5, R8—10,000 ohms

R6, R7—100,000 ohms

R10, R13—1000 ohms, 1%

R11, R14—1100 ohms, 1%

R12, R15—3320 ohms 1%

R16, R17—2.2 ohms, 2-watt

#### Capacitors

C1—C4—4700 $\mu$ F, 50 volts, axial electrolytic

C5, C13—1500 pF, 100 volts, polyester foil

C6, C7, C11, C12—1 $\mu$ F, 100 volts, ceramic monolithic

C8, C10—0.1 $\mu$ F, 50 volts, axial ceramic monolithic

#### Semiconductors

IC1, IC2—LM12CL, 150-watt power op-amp

IC3—LM381N, audio pre-amp

D1—D4—MR856, rectifier diode, 3-amp, 300-volts

#### Inductors

L1, L2—Inductor, 4 $\mu$ H

**Miscellaneous:** Thermalloy 6421B heat-sink, AW-12 PC board, enclosure, hardware, phono jacks, speaker terminals, power terminal strip, rubber feet, hookup wire, magnetic wire, 14-pin DIP socket.

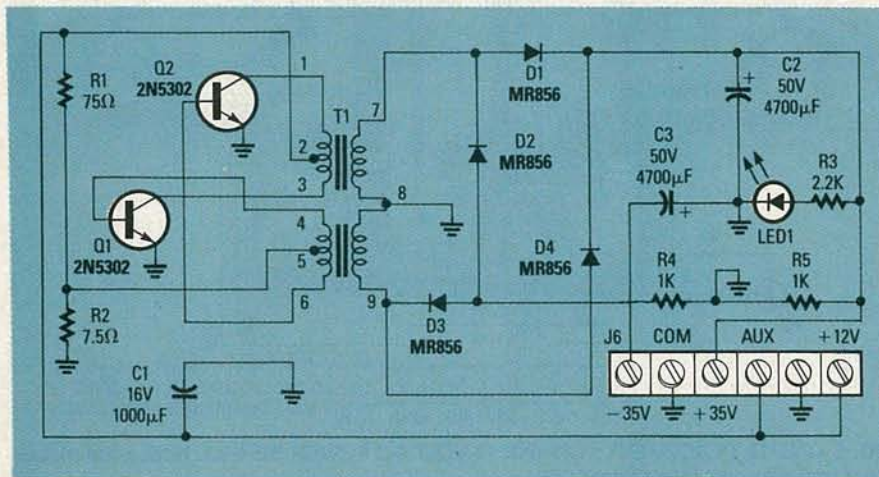

FIG. 2—THE 12-VOLT DC POWER SUPPLY is perfect for operating the *opto-amp* from a car or boat battery.

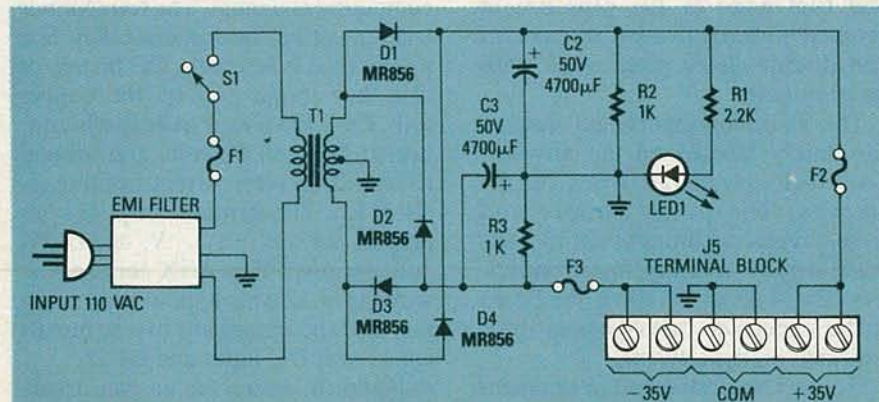

FIG. 3—THE 110-VOLT AC POWER SUPPLY is perfect for operating the *opto-amp* from your household AC current.

amps with the output voltage dropping down to  $\pm 30$  volts when heavily loaded.

Figure 3 shows the 110-volt AC power supply that uses a toroidal power transformer to supply 70 volts ( $\pm 35$  volts) at 5 amps; traditional laminated-core transformers can be used as well. The advantage of the toroid transformer is that it's self-shielding because the flux lines stay inside the core. The AC-line input uses an RFI/EMI filter, a power on/off switch, and line fuse. (A nice feature is the detachable AC line cord with standard plug that mates to the EMI-filter module.) The transformer secondary is rectified by diodes D1—D4 and filtered by C2 and C3 to provide two output voltages ( $\pm 35$  volts) with a common ground. Each output is fused for 5-amps.

Notice that the supply outputs are unregulated. Bleeder resistors R2 and R3 serve two functions. First, the bleeders maintain a minimum load to prevent a large increase in output voltage when the amplifier is disconnected. Second, when the power is

turned off, the resistors bleed the current off the filter capacitors, thereby eliminating the possibility of a shock hazard from a charged capacitor. LED1 functions as an on/off indicator that operates from secondary voltage.

The PC board for each power supply is single-sided and available from the source in the Parts List, or you can etch your own using the PC Service layout. Component polarity is critical for the electrolytic capacitors and the diodes, so make sure that you double-check them prior to soldering.

### Construction tips

As shown in Fig. 4, inductors L1 and L2 are simple to wind by hand with 10 turns of magnet wire on a ferrite core. The core type is not critical; indeed, any 1"-diameter ferrite-core will work just fine. Use 4" tie-wraps to secure the wound inductors to the PC board. Before you solder magnet wire to the PC board, scrape off the varnish and tin the bare copper with a hot soldering iron.

Take extra care when installing the IC amps on the large heat sinks. Modify the IC insulator with a knife to accommodate the two extra pins on the LM12, and remove any burrs from the heat-sink. Make sure that you use tubing on the four IC leads to prevent shorts to the heat-sink. Apply heat-sink compound on both sides of the insulator to facilitate heat transfer. When you install the LM12 on the heat sink, tighten the mounting screws before soldering the IC pins to the PC board. **CAUTION: Note that the heat-sink will ultimately be at ground potential, that the case of**

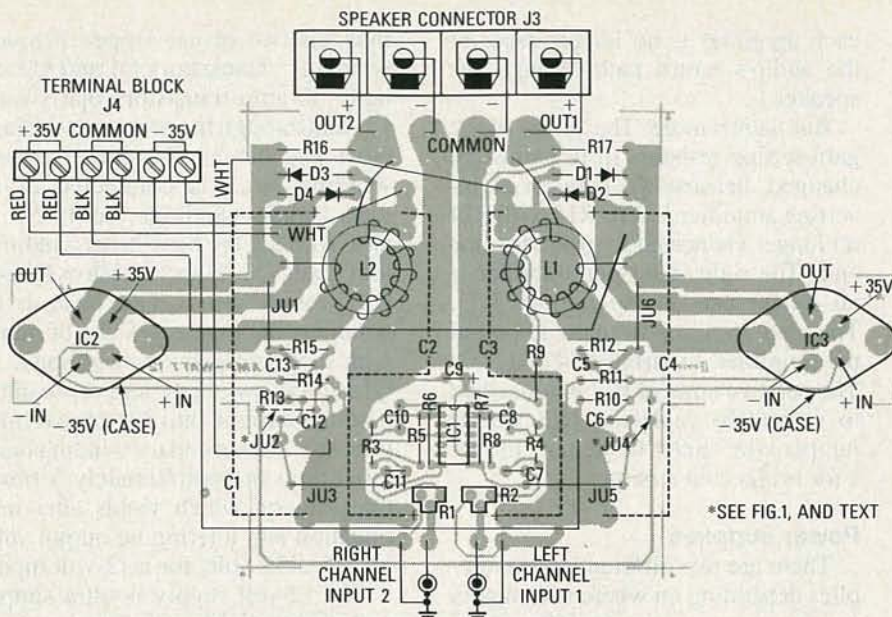

FIG. 4—PARTS PLACEMENT FOR THE OPTO-AMP. The inductors should be wound exactly as shown.

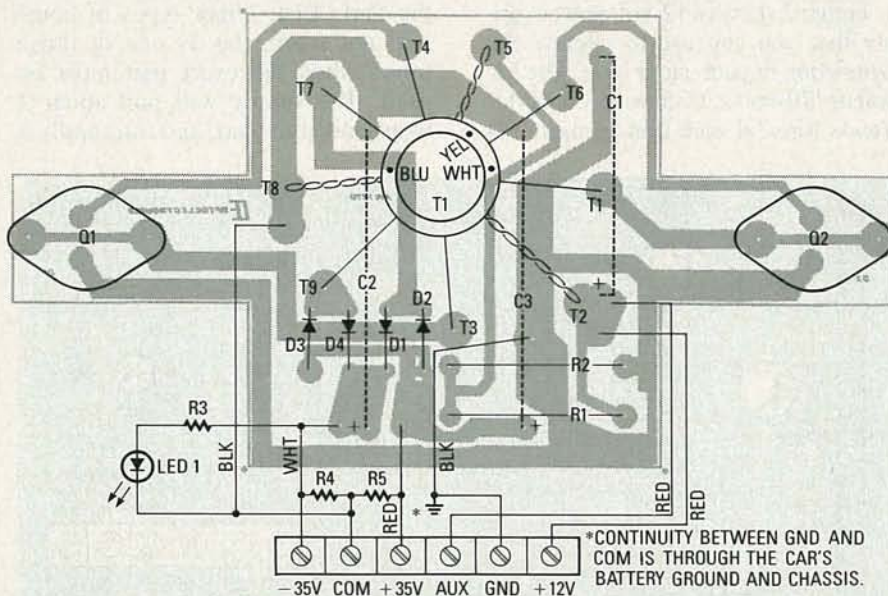

FIG. 5—PARTS PLACEMENT FOR THE 12-VOLT DC POWER SUPPLY. Notice the placement of the toroidal transformer T1.

the LM12 is the -35-volt supply, and that none of the pins are at ground potential—so be careful and double-check your work with an ohmmeter.

The amplifier inputs and outputs are clearly labeled on the artwork. Use No.16-gauge bus wires on the outputs. The power supply and ground wires are brought out to a terminal strip JU4. Lastly, install capacitors C1-C4 about 1/4" above the board on the solder side, with the polarity as indicated on the artwork.

Figure 5 shows the Parts Placement for the 12-volt DC supply. Mounting the 2N5301 power transistors using

insulated heat sinks, and heat-sink compound is a must. The transformer leads must be formed until they line up with the holes in the PC board, or else they might pull up the copper foil. The LED power indicator is connected between 12 volts and ground using a 2000-ohm current-limiting resistor R3. The terminal strip JU4 has outputs for the +V, -V, and COM connections. The AUX terminal is wired to +12 volts to power a cooling fan, and the remaining two terminals are 12-volt DC input and GND.

Figure 6 shows the custom transformer (T1) for the 12-volt DC power supply. Anyone wishing to build it

### PARTS LIST—12-VOLT POWER-SUPPLY

- Q1, Q2—2N5301, NPN transistor
- LED1—(Light Emitting Diode) green with panel mount
- D1-4—MR856, rectifier diode, fast, 3-amp, 300 volts.
- R1—75 ohms, 10-watt, 5%
- R2—7.5 ohms 5-watt, 5%
- R3—2000 ohms, 1/4-watt, 5%
- R4—1000 ohms, 1/4-watt, 5%
- R5—1000 ohms, 1/4-watt, 5%
- C1—1000 $\mu$ F, 16 volts, axial electrolytic
- C2, C3—4700 $\mu$ f, 50 volts, axial electrolytic
- T1—T1270, custom transformer

### Miscellaneous

- PS-1270 PC board, chassis assembly, hardware, 6-terminal power strip, hookup wire.



## PARTS LIST—AC POWER-SUPPLY

D1-D4—MR856, rectifier diode, fast, 3-amp, 300 volts

LED1—(Light Emitting Diode) green with panel mount

C1-C4—4700 $\mu$ F, 500 volts, radial electrolytic

R1—2200 ohms, 1/4-watt, 5%

R2, R3—1000 ohms, 1/4-watt, 5%

T1—Toroidal transformer, 110-volts primary, 70-volts, center-tapped secondary

**Miscellaneous:** EMI line-filter (Standex, LR57454, 3-amp 250-volt), 3-prong AC line-cord, SPDT switch, PS110/70 PC-board, PC-mount fuse clips, 5-amp fuses, chassis-mount fuse-holder with 3-amp 250-volt fuse, chassis assembly, hardware, 6-terminal strip, and hookup wire.

will want detailed information about the transformer that uses a standard tape-wound core. As you might have already guessed, tape-wound cores are not very common, and it is unlikely that you will find an equivalent core—except from the manufacturer, Magnetics, Inc., and their minimum order is \$100. In addition to that hurdle, the transformer is somewhat difficult to wind because of the large-wire sizes involved; therefore, Optoelectronics, Inc. will supply the complete T1270 custom-wound transformer. (For ordering information, refer to the Parts List.) Should you want

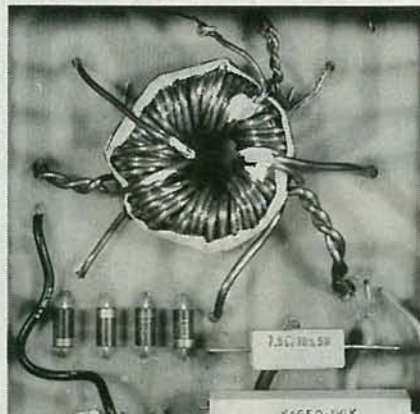

FIG. 6—HERE'S THE TOROIDAL transformer used in the 12-VOLT DC to  $\pm$ 35-VOLT DC power supply.

to build your own transformer, here are the specifications you'll need:

- Description: 12-volt input, 64-volt center-tap output, with 6.8-volt center-tap base-drive winding.

- Core: 1 mil tape-wound with case dimension of 1.460"  $\times$  0.915"  $\times$  0.345". Magnetics, Inc. part number 50029-ID.

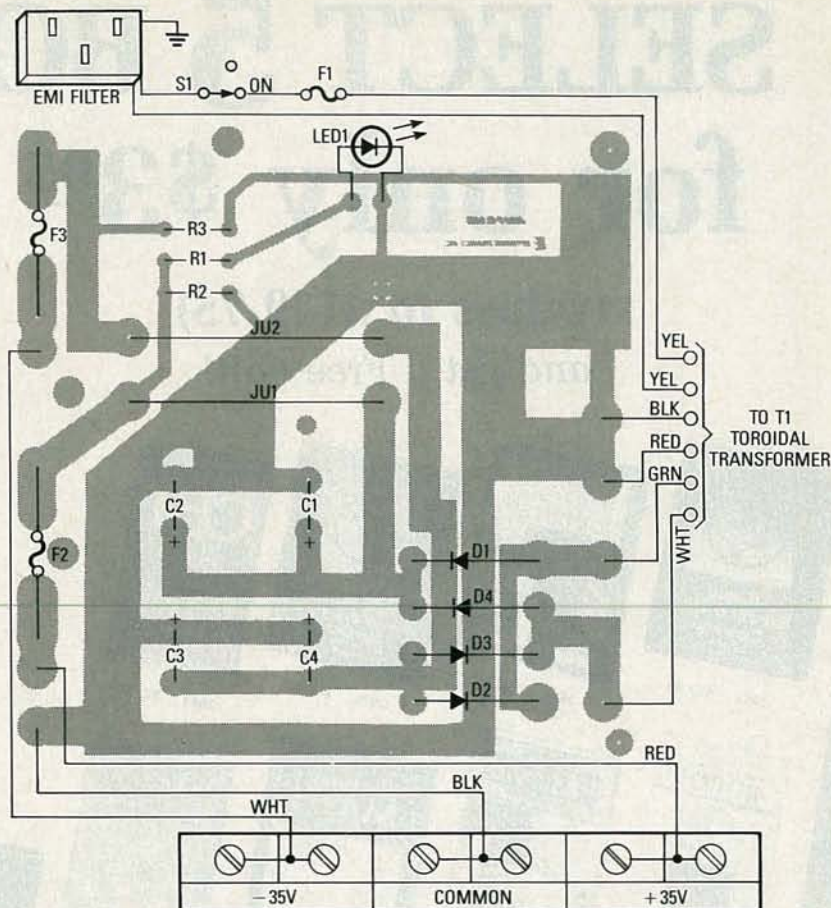

FIG. 7—PARTS PLACEMENT FOR THE 110-VOLT AC power supply.

- Windings: Primary 14-turns center-tapped, base-drive 7-turns center-tapped, secondary 19-turns center-tapped.

- Wire: Primary and secondary uses 12-gauge, base-drive uses 18-gauge.

Mount the transformer to the chassis using plastic ties with the transformer resting on plastic tie downs. Mount the PC board to the chassis on 1/4" spacers and No.4 hardware.

### ORDERING INFORMATION

The following are available from Optoelectronics, Inc. 58821 N.E. 14th Ave., Ft. Lauderdale, FL 33334; phone (800) 327-5912, FL residents phone (305) 771-2050; include 5% shipping and handling; FL residents add 6% sales tax. Master Card and Visa OK for orders over \$200. *Opto-Amp amplifier complete kit* \$149; *12-volts power supply model 1270* for \$99.95; *AC power supply model 110/70* for \$119. Individual parts: any PC board \$25; LM12CLK \$29 each; heat-sinks \$9.95 each; T1270 tape-wound power transformer for 12-volt DC supply \$30; send self addressed stamped envelope for a complete price list of all parts.

Check to make sure that nothing is shorted to the chassis under the PC board. The output terminal strip is wired as indicated on the chassis artwork with two terminals for +V, two for -V, and two for ground. Again, use 16-gauge wires for output wiring. Use a 3-amp 250-volt rated fuse in the line-fuse holder, and 5-amp fuses in the outputs.

Figure 7 shows the 110-volt to  $\pm$ 35-volt power supply. Assemble the PC board and make sure that the polarity of the diodes and filter capacitors is correct. Install all hardware in the chassis and wire the transformer secondary to the PC board as indicated in the schematic. Solder one transformer-primary lead directly to one of the insulated terminals on the EMI filter. (Use heat shrink tubing over all primary connections to prevent electrical shock when servicing.) Connect the other transformer-primary lead to the center terminal of the toggle switch. The bottom terminal of the toggle switch gets wired to the chassis-mount fuse holder, while the fuse holder's center terminal gets wired to the other insulated terminal on the EMI filter.

# SELECT 5 BOOKS for only \$3<sup>95</sup>

(values to \$129.75)  
and get a Free Gift!

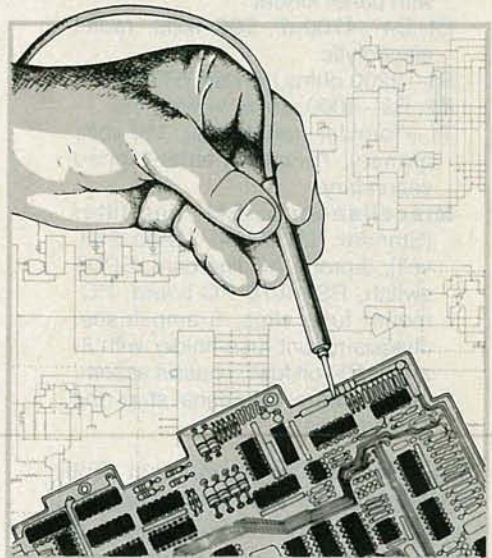

2613 \$23.95



2809 \$26.95  
Counts as 2



2925 \$16.95

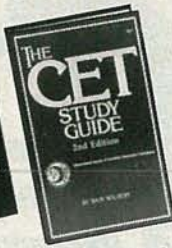

2941 \$21.95



2781 \$18.95



1925P \$16.95

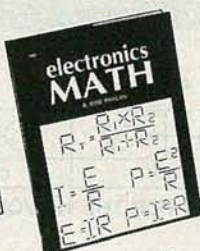

1962 \$22.95

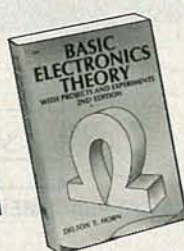

1775P \$18.95

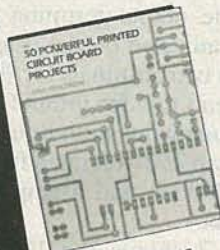

2972 \$23.95



1536P \$9.95



2707 \$26.95  
Counts as 2



2885 \$16.95

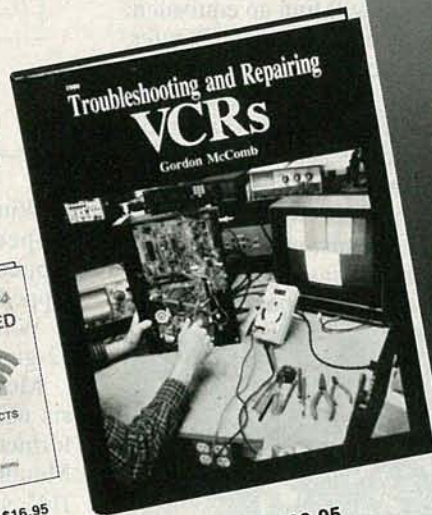

2960 \$26.95



2660P \$19.95



2995 \$25.95



2865 \$21.95



2750P \$17.95



3002 \$49.50  
Counts as 2

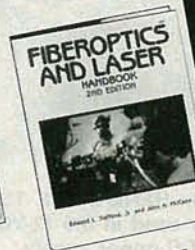

2981 \$24.95

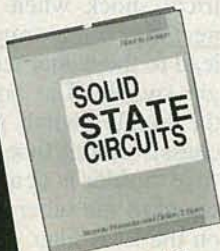

2975 \$24.95



2675 \$22.95



2831 \$22.95



2735P \$13.95



1793 \$9.95



2947 \$21.95

# Compare this offer with any other book club for Price • Quality • Benefits • Selection!

An Absolutely No-Risk Guarantee.

2900 \$36.95  
Counts as 2

3033 \$14.95

1625P \$16.95

2996 \$19.95

3034 \$19.95

2980 \$28.95  
Counts as 2

2724 \$24.95

2867 \$25.95

2883 \$25.95

2985 \$24.95

2958 \$34.95  
Counts as 2

2992 \$24.95

3017 \$15.95

2912 \$23.95

2987 \$24.95

1199P \$18.95

**FREE when you join!**

**Here's 15 Easy Electronic Projects From Delton T. Horn**

Projects you can build—some unique, some old favorites—from the author's vast treasury of electronics know-how.

(a \$7.95 value!)

Delton T. Horn's  
All-Time Favorite  
Electronic Projects

**Membership Benefits • Big Savings.** In addition to this introductory offer, you keep saving substantially with members' prices of up to 50% off the publishers' price. • **Bonus Books.** Starting immediately, you will be eligible for our Bonus Book Plan, with savings of up to 80% off publishers' prices. • **Club News Bulletins.** 14 times per year you will receive the Book Club News, describing all the current selections—mains, alternates, extras—plus bonus offers and special sales, with hundreds of titles to choose from. • **Automatic Order.** If you want the Main Selection, do nothing and it will be sent to you automatically. If you prefer another selection, or no book at all, simply indicate your choice on the reply form provided. As a member, you agree to purchase at least 3 books within the next 12 months and may resign at any time thereafter. • **Ironclad No-Risk Guarantee.** If not satisfied with your books, return them within 10 days without obligation! • **Exceptional Quality.** All books are quality publishers' editions especially selected by our Editorial Board.

## ELECTRONICS BOOK CLUB®

Blue Ridge Summit, PA 17294-0810

Please accept my membership in the Electronics Book Club® and send the 5 volumes listed below, plus my FREE copy of *Delton T. Horn's All-Time Favorite Electronic Projects* (3105P), billing me \$3.95 plus shipping and handling charges. If not satisfied, I may return the books within ten days without obligation and have my membership canceled. I agree to purchase at least 3 books at regular Club prices (plus shipping and handling) during the next 12 months and may resign any time thereafter.

Name \_\_\_\_\_  
 Address \_\_\_\_\_  
 City \_\_\_\_\_  
 State/Zip \_\_\_\_\_ Phone \_\_\_\_\_  
 Signature \_\_\_\_\_

Valid for new members only. Foreign applicants will receive special ordering instructions. Canada must remit in U.S. currency. This order subject to acceptance by the Electronics Book Club®. RE389  
 Signature of parent or guardian required for all new members under 18 years of age.

MARCH 1989

## Checkout

Use an ohmmeter to check for shorts from the LM12 to the heat-sink. Check all diodes, capacitors, and IC's for correct polarity. Stuffing components in backwards is the most frequent mistake in construction, and can be a fatal error—so check thoroughly. The next step is to check the power supply for correct output voltages. Keep in mind that, unloaded, the voltage can be 100–150% higher than the nominal voltage.

Now let's connect the *Opto-Amp* to the power supply, but with no output speakers or audio inputs connected. Nothing should get very hot and fuses should not blow. Center the sensitivity potentiometers (R1 and R2) on the PC board and then connect the speakers. Use a source input with a volume control to prevent damaging your speakers and ears.

For 12-volt operation, the wire size going to the battery must be a minimum of 12-gauge for up to 8-foot

lengths, and larger gauge for longer distances. A 30-amp in-line fuse must be placed near the source of the power (battery); after all, we're dealing with significant amounts of power that could cause severe damage to the car's electrical system, the *Opto-Amp* power supply, or worse. Even a fire could occur if the 12-volt supply line is not properly fused.

Use a 30-amp relay to switch the power off and on. You can mount a switch under the dash, or use the power antenna output from the car radio to enable the *Opto-Amp*. You will want to make sure that the relay can not be energized unless the key is turned on to prevent draining your car battery to death. At full power, the load on the car electrical system is the same as leaving the headlights on.

Both the *Opto-Amp* and power supply are compact enough to mount wherever space is available. If there is no air flow—such as in the vehicle's trunk—then use a 12-volt fan to move air over the heat-sink fins in the power supply and *Opto-Amp*. One final note about bridging: If you are planning to bridge two amps in your car then you'll need at least two power supplies.

The 110-volt AC power-supply operation is straight forward. Keep in mind that there should be nothing to hinder air movement over the *Opto-Amp*. If there is any question about overheating, then add a quiet fan. The *Opto-Amp* can be mounted apart from its power supply or right next to it. Several *Opto-Amps* can be bolted and stacked into a rack mount. You can operate the *Opto-Amp* bridged from one power supply, but the fuses will blow if the 5-amp limit is exceeded; to prevent that from happening, use two power supplies for extra power. **R-E**

# Radio-Electronics® REPRINT BOOKSTORE

- |  |  |
|--|--|
| <input type="checkbox"/> <b>SP1</b> Special Projects #1 (Winter 1980) . . . \$6.00   | <input type="checkbox"/> <b>106</b> Radio-Electronics back issues (1986) . . \$3.75<br>Write in issues desired   |
| <input type="checkbox"/> <b>SP4</b> Special Projects #4 (Summer 1982) . . \$6.00   | <input type="checkbox"/> <b>105</b> Radio-Electronics back issues (1985) . . \$4.25<br>(Jan. 85 not available)<br>Write in issues desired                |
| <input type="checkbox"/> <b>SP5</b> Special Projects #5 (Winter 1983) . . \$6.00   | <input type="checkbox"/> <b>104</b> Radio-Electronics back issues (1984) . . \$5.25<br>(December 1984 issue is not available)<br>Write in issues desired |
| <input type="checkbox"/> <b>SP6</b> Special Projects #6 (Spring 1983) . . \$6.00   | <input type="checkbox"/> <b>103</b> Radio-Electronics back issues (1983) . . \$5.50<br>(Jan., Feb., May are not available)<br>Write in issues desired    |
| <input type="checkbox"/> <b>SP7</b> Special Projects #7 (Summer 1983) . . \$6.00   | <input type="checkbox"/> <b>102</b> Radio-Electronics back issues (1982) . . \$5.75<br>(Jan., Feb.) is not available<br>Write in issues desired          |
| <input type="checkbox"/> <b>SP8</b> Special Projects #8 (Fall 1983) . . . \$6.00   | <input type="checkbox"/> <b>153</b> Etch your own PC boards . . . . . \$3.00   |
| <input type="checkbox"/> <b>SP9</b> Special Projects #9 (Winter 1984) . . \$6.00   | <input type="checkbox"/> <b>154</b> How to Repair VCR's . . . . . \$3.50   |
| <input type="checkbox"/> <b>SP10</b> Special Projects #10 (Spring 1984) . . \$6.00   | <input type="checkbox"/> <b>155</b> IBM Typewriter to Computer . . . . . \$3.00  |
| <input type="checkbox"/> <b>111</b> Hands-On Electronics #1 . . . . . \$5.00   | <input type="checkbox"/> <b>125</b> Radio-Electronics Annual 1985 . . . . \$5.95   |
| <input type="checkbox"/> <b>112</b> Hands-On Electronics #2 . . . . . \$5.00   | <input type="checkbox"/> <b>126</b> Radio-Electronics Annual 1986 . . . . \$4.95   |
| <input type="checkbox"/> <b>113</b> Hands-On Electronics #3 . . . . . \$5.00   | <input type="checkbox"/> <b>156</b> How to Make PC Boards . . . . . \$2.00   |
| <input type="checkbox"/> <b>114</b> Hands-On Electronics #4 . . . . . \$5.00   | <input type="checkbox"/> <b>157</b> All About Kits . . . . . \$2.00  |
| <input type="checkbox"/> <b>115</b> Hands-On Electronics #5 . . . . . \$5.00   | <input type="checkbox"/> <b>158</b> Electro Importing Co. Catalog (1918) . \$5.95  |
| <input type="checkbox"/> <b>115A</b> Hands-On Electronics #6 . . . . . \$4.50  | <input type="checkbox"/> <b>159</b> Low Frequency Receiving Techniques<br>Building and using VLF Antennas . . . . \$6.00                                 |
| <input type="checkbox"/> <b>116A</b> Hands-On Electronics (Jan-Feb '86) . \$4.50   | <input type="checkbox"/> <b>160</b> New Ideas - 42 Circuits . . . . . \$3.50   |
| <input type="checkbox"/> <b>116B</b> Hands-On Electronics (Mar/Apr '86) \$4.50   | <input type="checkbox"/> <b>161</b> Descrambling (Feb., 1984) . . . . . \$3.00   |
| <input type="checkbox"/> <b>116C</b> Hands-On Electronics (May/Jun '86) \$4.50   | <input type="checkbox"/> <b>162</b> Build Your Own Satellite TV Receiver \$7.00  |
| <input type="checkbox"/> <b>116D</b> Hands-On Electronics (Jul/Aug '86) . \$4.50   | <input type="checkbox"/> <b>163</b> Receiving Satellite TV . . . . . \$7.00  |
| <input type="checkbox"/> <b>116E</b> Hands-On Electronics (Sep/Oct '86) . \$4.50   | <input type="checkbox"/> <b>164</b> Modern Electrics (April, 1908) . . . . \$3.00  |
| <input type="checkbox"/> <b>116K</b> Hands-On Electronics (Nov '86) . . . \$4.00   | <input type="checkbox"/> <b>165</b> How to Repair CD Disc Players . . . . \$5.00   |
| <input type="checkbox"/> <b>116L</b> Hands-On Electronics (Dec '86) . . . \$4.00   | <input type="checkbox"/> <b>166</b> Collected Works of Mohammed Ulyses Fips<br>(62 pages, April Fools Collection) . . . \$7.50                           |
| <input type="checkbox"/> <b>117</b> Hands-On Electronics<br>(1987 back issues) . . . . . \$3.75<br>Write in issues desired | <input type="checkbox"/> <b>167</b> Designing With IC's . . . . . \$4.00   |
| <input type="checkbox"/> <b>118</b> Hands-On Electronics<br>(1988 back issues) . . . . . \$3.50<br>Write in issues desired |  |
| <input type="checkbox"/> <b>150</b> TV Descrambler . . . . . \$3.00  |  |
| <input type="checkbox"/> <b>EH87</b> Experimenters Handbook . . . . . \$3.95   |  |
| <input type="checkbox"/> <b>152</b> 8-Ball Satellite TV Antenna . . . . . \$5.00   |  |
| <input type="checkbox"/> <b>108</b> Radio-Electronics (1988 back issues) . \$3.00<br>Write in issues desired               |  |
| <input type="checkbox"/> <b>107</b> Radio-Electronics back issues (1987) \$3.25  |  |

To order any of the items indicated above, check off the ones you want. Complete the order form below. **Include your payment**, check or money order (DO NOT SEND CASH), and mail to **Radio-Electronics**, Reprint Department, P.O. Box 4079, Farmingdale, NY 11735. Please allow 4-6 weeks for delivery.

If you need a copy of an article that is in an issue we indicate is unavailable you can order it directly from us. We charge 50¢ per page. Indicate the issue (month & year), pages and article desired. Include payment in full, plus shipping and handling charge. Make checks payable to Gernsback Publications, Inc.

ARTICLE _____		
PAGES _____	MONTH _____	YEAR _____
TOTAL PAGES _____	@50¢ each	TOTAL PRICE _____

MAIL TO: **Radio-Electronics**  
Reprint Bookstore, P.O. Box 4079, Farmingdale NY 11735

All payments must be in U.S. funds

SHIPPING CHARGES IN USA & CANADA	
\$0.01 to \$5.00 . . . . . \$1.25	\$30.01 to \$40.00 . . . \$5.00
\$5.01 to 10.00 . . . . . \$2.00	\$40.01 to \$50.00 . . \$6.00
\$10.01 to \$20.00 . . . . \$3.00	\$50.01 and above . . . \$7.50
\$20.01 to \$30.00 . . . . \$4.00	

Total price of merchandise . . . . . \$ \_\_\_\_\_  
Sales Tax (New York State Residents only) . . . . . \$ \_\_\_\_\_  
Shipping Charge (see chart) . . . . . \$ \_\_\_\_\_

Name \_\_\_\_\_ Total Enclosed . . . . . \$ \_\_\_\_\_  
Address \_\_\_\_\_  
City \_\_\_\_\_ State \_\_\_\_\_ Zip \_\_\_\_\_



"We're having a little problem, but they tell me you're good with electronic stuff. . . could you give us a hand?"

# HOW TO

Your VCR can provide you with years and years of trouble-free operation, with only a minimum of simple maintenance work on your part.

PETER M. HANSEN

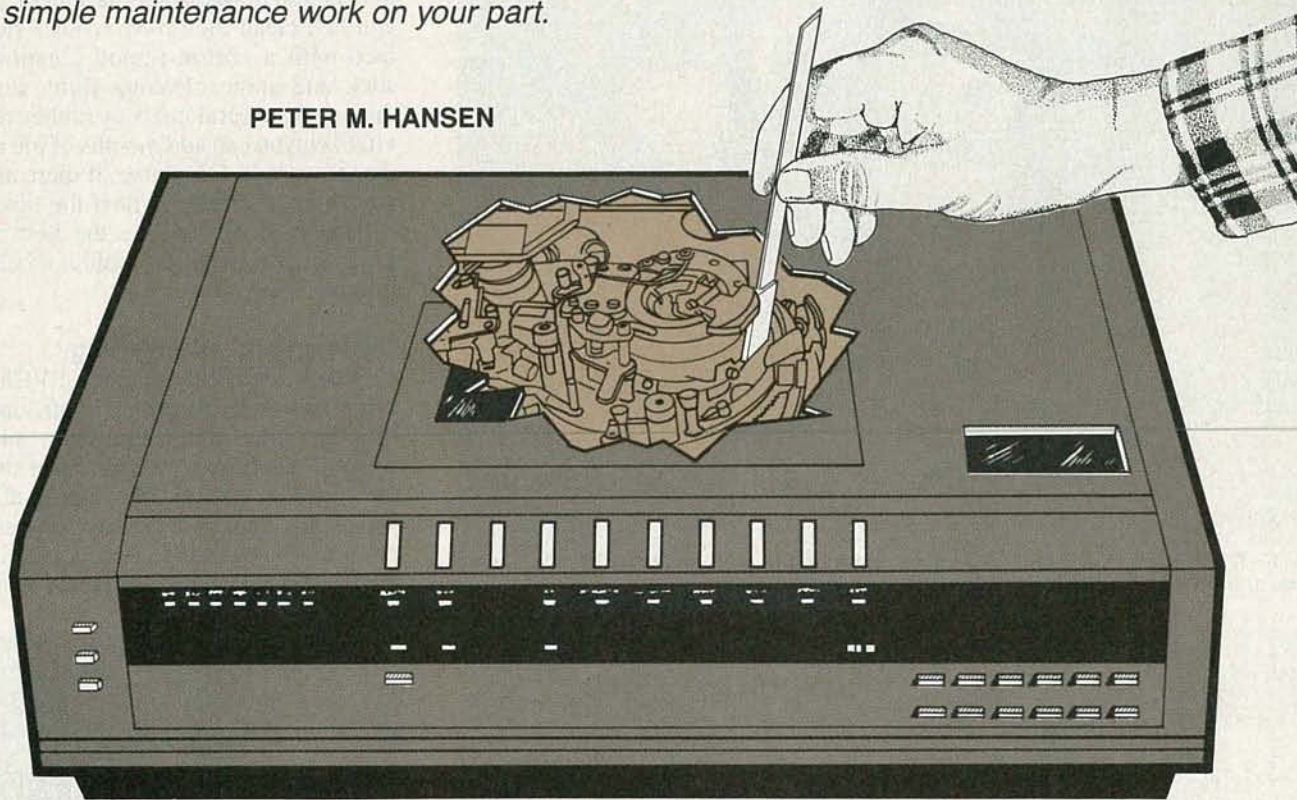

## KEEP YOUR VCR HEALTHY

IF YOU HAVE EVER TAKEN YOUR VCR IN FOR service only to be shocked when presented with a bill that was close to (or exceeded) \$100 for the simple changing of a belt or other inexpensive part, then you are certainly not alone. With tens of millions of VCR's currently in use, each one a highly complex electrical and mechanical device with hundreds of moving parts, it is no surprise that most VCR's will need some type of maintenance or repair work on the average of every 12 to 28 months.

In this article we will reveal the most common types of VCR malfunctions—the ones you are most likely to encounter—and the simple step-by-step repair procedures. Note that most of the repair work will require average mechanical ability, with little or no electronics troubleshooting, due to the fact that up to 85% of all VCR malfunctions are due to mechanical or electro-mechanical breakdowns.

We will discuss the tools and materials needed to perform most VCR service work, identify the major components used in all VHS VCR's, and instruct you on some basic video-head and tape-path cleaning techniques. (Note that even though we will only discuss VHS VCR's, much of the material given here will also be applicable to Beta VCR's, with some differences in the general mechanism configuration.)

### Cleaning materials and tools

Referring to Fig. 1, the following list of cleaning materials can be found at your local electronics supply store, or from a mail-order electronics-supplies distributor:

- Magnetic head/disk cleaner, used in cleaning the video-head drum, and tape path.
- *Dust-Off*. You should use it before and after a VCR cleaning. Spray the inside of the mechanism thoroughly

to remove all dust and contaminants.

- Chamois cleaning sticks. Those leather-tipped cleaning sticks are very good for cleaning dirty video heads. Later on in this article we will show you how to use head cleaner and chamois cleaning sticks.

- Foam-tipped cleaning sticks. They are used in cleaning the tape path, rubber belts, idlers, pinch roller, and the take-up and supply reels. Note that when we say "clean with a foam-tipped cleaning stick," that the stick's tip must be soaked with cleaning fluid first, and that "stick" and "swab" are interchangeable.

- Cotton cleaning sticks. Used to clean small, hard-to-access parts in the VCR, such as the small play idlers used in some models (sometimes located under the take-up reel), capstan shaft assembly, and for removing the old dried-up lubricant on the rails of the loading posts and at the base of the guide-post assembly.



FIG. 1—THESE CLEANING MATERIALS can be found at your local electronics supply store, or from a mail-order electronics-supplies distributor.

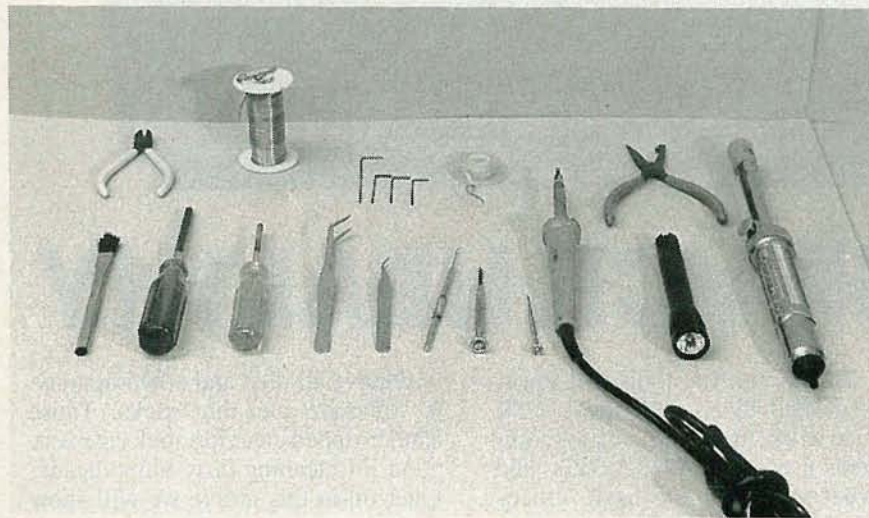

FIG. 2—BESIDES A DVM OR VOM, you'll need these common hand tools for doing any kind of VCR maintenance work.



FIG. 3—RUBBER REVITALIZER, such as Non-Slip or Re-Grip, can rejuvenate rubber tires, belts, etc., that are not worn enough to warrant replacement.

Figure 2 shows the common hand tools you'll need, besides, of course, a DVM or VOM to check fuses,

power-supply voltages, motor-winding continuity, and switch continuity. A good pair of curved- or straight-pronged tweezers and a couple of dental picks are very handy for removing small belts, plastic retaining washers (very common in VCR's and very easy to loose if you're not careful removing them!), and other tight mechanical work.

#### Rubber revitalizer

It is almost essential that you have a supply of chemical rubber revitalizer for belts and tires that won't grab—*Non-Slip* or *Re-Grip*, usually avail-

able at electronics supply shops, are two very effective brands (see Fig. 3). In many cases, you will run across rubber tires, belts, etc., where the rubber is showing signs of wear, but not enough to warrant replacement. If you first clean the rubber's outer surface with a cotton-tipped cleaning stick and some cleaning fluid, and then apply several coats of rubber revitalizer, you can add months of life to the tire or belt. Of course, if there are any signs of cracking, or if the outer surface is shiny, replace the belt or tire; rubber revitalizer would not help in those cases.

#### Cleaning and refurbishing

Before attempting to clean a VCR, make sure that the power is off, and that the unit is unplugged from wall socket. When you want to clean the the video heads and the tape path, you'll only have to remove the chassis cover as shown in Fig. 4, and usually the head shield that covers the video-

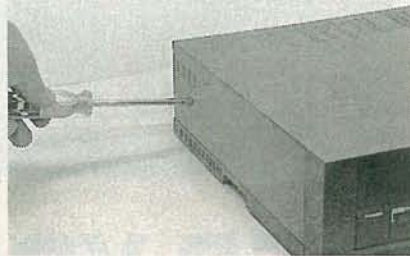

FIG. 4—YOU'LL HAVE TO REMOVE the chassis cover by unscrewing the retaining screws on the back and sides, and sometimes underneath the VCR.

Peter Hansen is the author of the *Viejo Method of VCR Maintenance and Repair* and president of Viejo Publications. The manual is available with or without the VCR-maintenance kit and training video. The kit contains VCR cleaning materials and an assortment of replacement belts, tires, idlers, etc. Contact Viejo Publications, 217 E. 86th St., Ste. 272, NY, NY 10028. 1-800-537-0589.



head drum assembly shown in Fig. 5. Typically, the top cover is removed by unscrewing the retaining screws on the back and sides, and sometimes underneath the VCR. Sometimes you will be able to clean the video-head drum without removing the head shield, but most of the time a thorough cleaning requires its removal. Note that it is more difficult to remove the cover and head shield from portable VCR's, and you should not attempt to clean one of those models until you have experience cleaning regular VCR's.

Figure 6 will help you identify the parts that you will be cleaning. The video-head drum assembly contains the video heads. Clean the video heads with a leather-tipped chamois stick, and the drum assembly with a foam-tipped cleaning swab. The full-erase head erases the tape when recording. It can be cleaned with a foam-tipped cleaning swab. The impedance roller assembly provides vertical stabilization of the tape during playback and recording. Clean it with a foam-tipped cleaning swab.

The guide rollers and guide slant poles extract the tape via the tape-load motor from the "home" position to the fully loaded position (when the tape is wrapped across the video-head drum). They also provide the needed "slant" angle for the tape as it travels across the drum. Clean those items with a foam-tipped cleaning swab. The outer base of the take-up and supply reels should also be cleaned with a foam-tipped cleaning swab. In some models, if the outer surface of the reels is rubber, it may have to be chemically revitalized.

The audio/control/erase head assembly, abbreviated as "A.C.E.," contains the audio head used for audio reproduction and recording, the control head used in generating (and reading back) the control pulses for the servo circuits, and the audio erase head, which erases the audio track during recording. Clean those thoroughly with foam-tipped cleaning sticks.

A VCR may contain one or more idlers—the fast forward/rewind idler, the play idler, etc. An idler is usually a plastic wheel with a rubber tire-like ring around its edge. However, some VCR's do not have a rubber idler, and instead use plastic gears. On the models that do use idlers, though, they will usually be located between the

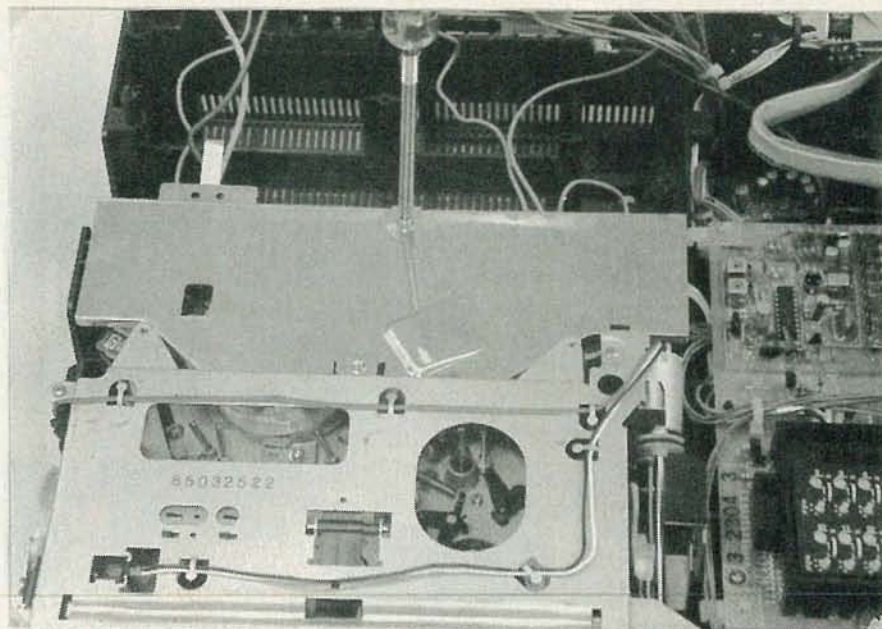

**FIG. 5—TO CLEAN THE VIDEO HEADS and tape path, you must remove the head shield that covers the video-head drum assembly.**

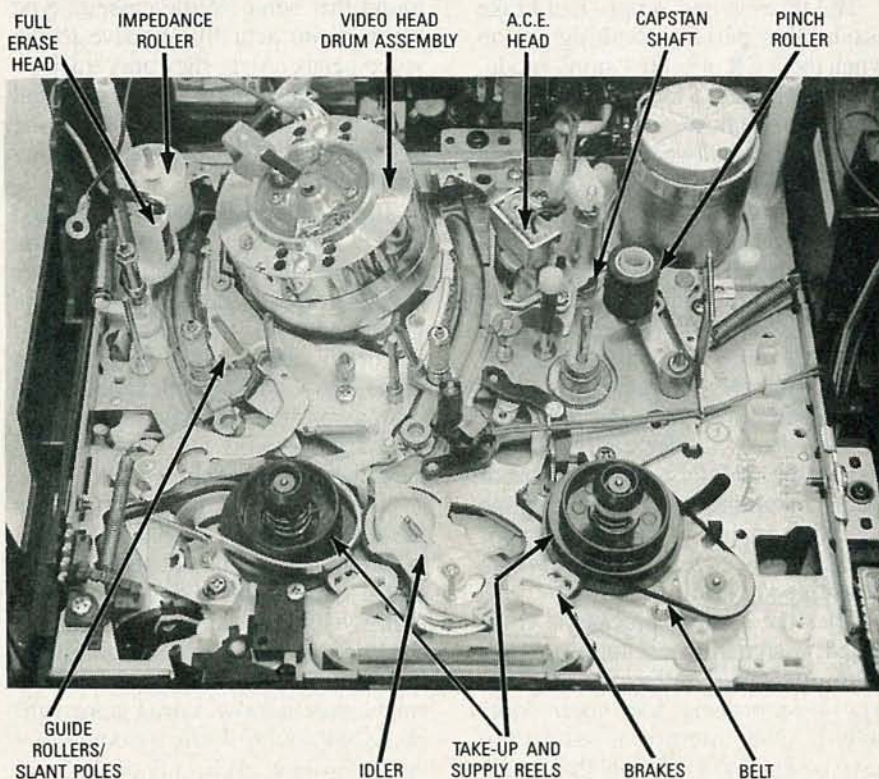
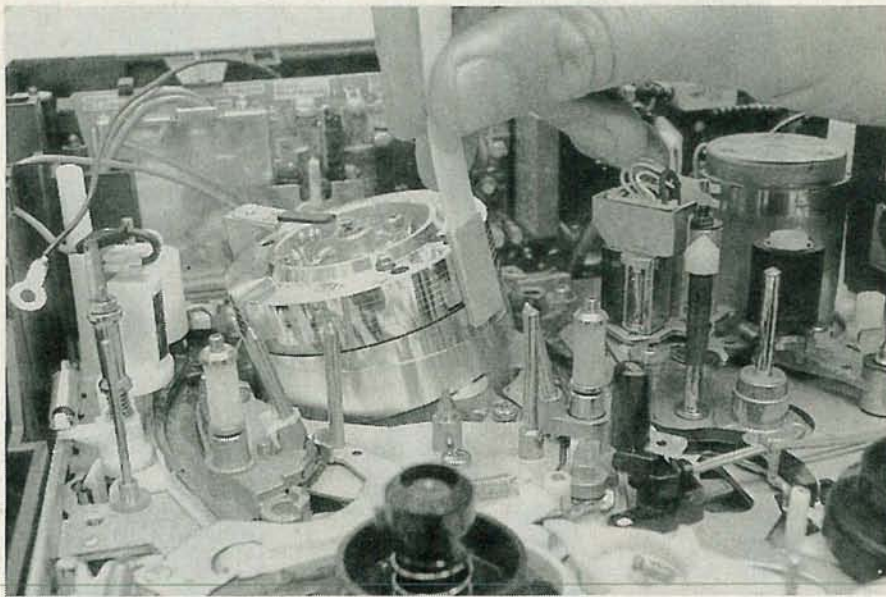

**FIG. 6—YOU MUST BE ABLE TO IDENTIFY the parts that you will be cleaning.**

take-up and supply reels and/or just above the take-up reel. In some models, Fishers in particular, the play idler will be located underneath the unit, necessitating the removal of the bottom-cover assembly.

The symptoms of a worn or cracked idler is very sluggish fast forward/rewind action, and sometimes, the "eating" of tapes—after the tape is

ejected from the VCR, a portion of it will be left dangling from the cassette shell. It is a lot cheaper to just replace the rubber tire, rather than replacing the whole idler; therefore it is a good idea to stock up on idler tires, rather than idler assemblies. If an idler looks to be in good condition, though, just clean it with a foam-tipped cleaning stick and apply Re-Grip if necessary.



**FIG. 7—THE VIDEO HEADS** should be cleaned by moving a Chamois cleaning stick back and forth across the video head in a horizontal movement.

The take-up and supply-reel brake assemblies perform braking action when the VCR is in the "stop" mode. Clean them with a foam-tipped cleaning stick. Remove any belts and inspect for signs of wear, cracking, or a shiny surface. Any belts that are worn or cracked must be replaced. Otherwise, clean with a cotton-tipped swab, and apply Re-Grip if necessary.

The capstan shaft is connected to the capstan motor assembly, and moves the tape through the machine when in the play or record mode, but only when the pinch-roller assembly is in contact with the capstan shaft. Inspect the shaft for build-up of dirt or oxide contaminants. Carefully scrape off any contaminants with a razor blade, and then clean the shaft with a foam-tipped cleaning swab.

After the loading process is completed, a signal is sent to the VCR's microprocessor, telling it that the tape-load process has been completed. The microprocessor then sends a signal to a solenoid that presses the pinch roller against the capstan shaft. The tape then starts moving through the machine and onto the take-up reel. The pinch roller may require several applications of Re-Grip to fully revitalize the rubber.

### Video heads

Dirty video heads usually result in a snowy picture, but the audio may be satisfactory. We definitely do not recommend the use of any type of video-head cleaning cassette. It has been

found that some of the cassette-type cleaners are actually abrasive to the video heads. Also, they only track an area that is the same width as an actual VHS tape, so they can't remove the dirt that accumulates above and below the tape path.

The video heads should be cleaned with a Chamois cleaning stick and some cleaning fluid. Figure 7 shows how the stick is pressed against the video head. It's a good idea to hold the drum steady with one hand and move the Chamois stick back and forth across the video head in a horizontal movement. Do not press too hard, as you can damage the heads.

Never rub the cleaning stick across the heads vertically, as that could easily break the heads loose from the drum. On extremely dirty heads, try using a chamois stick and some acetone. Most of the time a good picture will come back. Acetone, which can be purchased at a drug store, will eat right through plastic, so don't let it drip anywhere, especially on the front panel.

After cleaning the video heads, discard the used Chamois stick, and use a foam-tipped cleaning stick; hold the drum with one hand while cleaning the whole surface of the drum. You may have to use two or three cleaning sticks to do the job right.

If the picture quality is still poor after a thorough cleaning of the video heads, you will probably have to replace the video heads. When applying the leather-tipped chamois stick to the

video head, you should be able to feel some protrusion of the head—it will be slight; but with some experience, you will learn to recognize the feel of a good head, and one that needs replacing. If you can't feel any protrusion of the video head, and it seems to be completely recessed into the drum, the head is probably bad.

If you find that the video heads need replacement, you will probably need the service manual to obtain the part number for the video heads, and for other reference purposes. Replacing the heads is not as hard as it may sound—many times you can get away with just desoldering the wires on top of the head assembly, removing the old head, and inserting the new one. Do not attempt to replace the heads unless you have some experience with soldering. Also, video heads usually cost between \$50 and \$90, so be very careful—if you make a mistake, it'll be an expensive one!

### Dew sensor

Most VCR's have a device called a dew sensor. That is actually a transducer that detects the presence of dew or humidity in the atmosphere. In the event that it senses humidity, a signal is sent to the microprocessor then shuts down all of the circuits in the VCR. The dew sensor is there for the protection of the VCR and should never be tampered with, except in the case of replacement.

After cleaning the VCR, spray "dust-off" on all major components. Do not make any adjustments or alignments to any component in the tape path unless you are sure of what you are doing—and if you do make any adjustments, you should have the service manual on hand. If you feel that any adjustments are necessary, and you don't know how to do them, it is wise to have a professional serviceman do the job. **R-E**



"The instructions on how to fix the VCR came on videotape!"



# HOW TO

# SPEED-UP VCR TROUBLESHOOTING

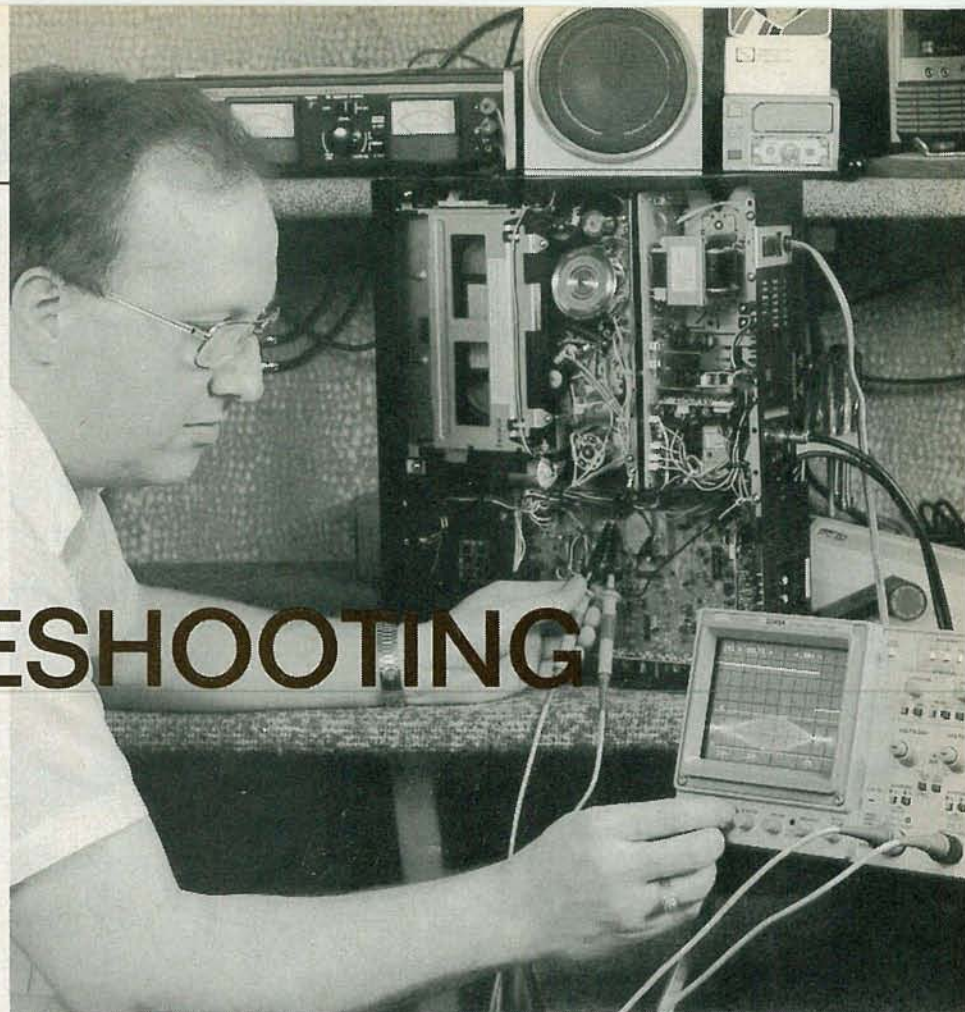

*Modern oscilloscopes can turn hours of troubleshooting into a two-minute analysis!*

## JIM EMERICH\*

TODAY'S FAST-CHANGING TECHNOLOGIES present a strong challenge to you and to the tools you use in performing your job. Nowadays, VCR's, camcorders, and compact-disc players are demanding more accurate measurements, so new tools are needed that can minimize test time and maximize productivity.

Unquestionably one of the most practical and versatile tools in a serviceman's tool kit is the oscilloscope. Recently, new low-cost portable oscilloscopes have been introduced that will help you meet the challenge of servicing today's sophisticated electronic products. Those new oscilloscopes have advanced features that will make your job a lot easier. Some of their features are auto setup, store/recall, tracking cursors, and on-screen readout.

Auto setup, for example, automatically sets each front-panel control for optimal display of the input waveform. Parameters such as volts/divi-

sion, time/division, triggering, and intensity are all set with the touch of a single button. Once you have the front panel set, you can then use the store/recall feature. In some scopes, up to 20 front-panel setups can be stored in memory, and can then be recalled at any time in the future.

Cursors are another useful feature. Some of the newer oscilloscopes offer time and voltage cursors, which allow you to accurately read measurements on-screen. You can manually adjust the cursors to measure specific segments of a waveform or, on some scopes, you can program the tracking cursors to automatically track measurements including DC, positive or negative peak voltages, and peak-to-peak voltages in a gated or non-gated mode. They can also be set to track ground and trigger levels. Those helpful features shorten setup time and also increase your confidence in the measurements.

To illustrate the capabilities of the new scopes, let's see how they can ease typical VCR troubleshooting tasks and repairs, and also drastically decrease the time they take.

### Head-switching frequency

In a VCR, the "clock" of the system is the 30-Hz head-switching pulse. That pulse can be used as a frequency reference for many VCR-alignment procedures. To confirm the head-switching pulse, you would connect the scope probe to the head-switch test point on the VCR and push the auto-setup button. The scope will automatically range the volts-per-division and the time-per-division controls. Then just position the waveform on the screen and adjust the cursors to measure and confirm a proper head-switching frequency of 30 Hz. Figure 1 shows the results you'll obtain in just a matter of moments. If the scope has a store/recall feature, you can store the front-panel setup and the cursor positions for 30 Hz. You can then recall the stored setups by pressing the recall button. In Fig. 1, the front-panel settings are stored as setup number 16, as indicated on the right-hand side of the screen. Some oscilloscopes can even store the name of the setup (upper-left portion of Fig. 1) for quick identification of what the setup is used for later on.

\*Jim Emerich is a sales engineer for Tektronix. Thanks to Mr. Frank Weihrauch, Weihrauch Electronics, and Mr. Nelson Diffendarfer, Diffendarfer Video Services, for their input to this article.

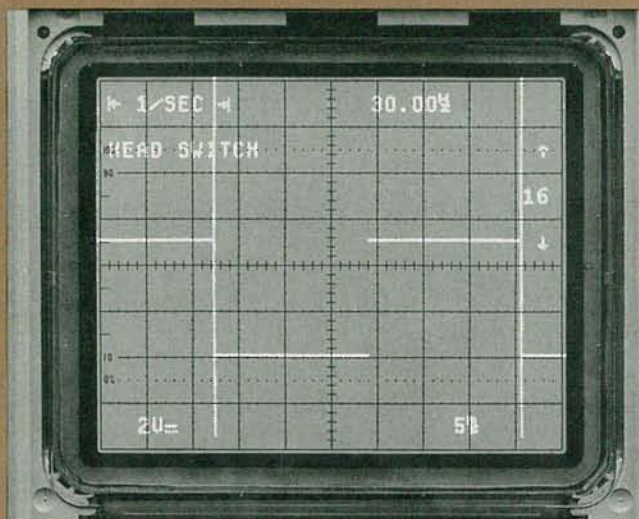

FIG. 1—YOU CAN STORE the front-panel setups in the scope's memory and recall them with the touch of a button. Note the setup's name in the upper-left corner of the display.

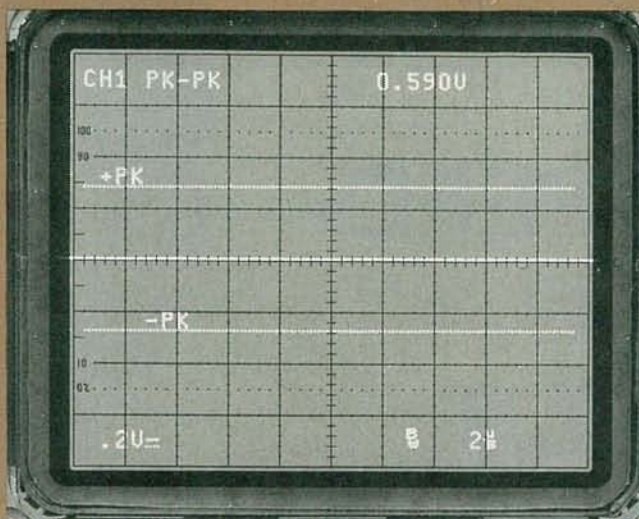

FIG. 3—TRACKING CURSORS INDICATE that there are high-frequency spikes in what appeared at first glance to be a clean DC voltage.

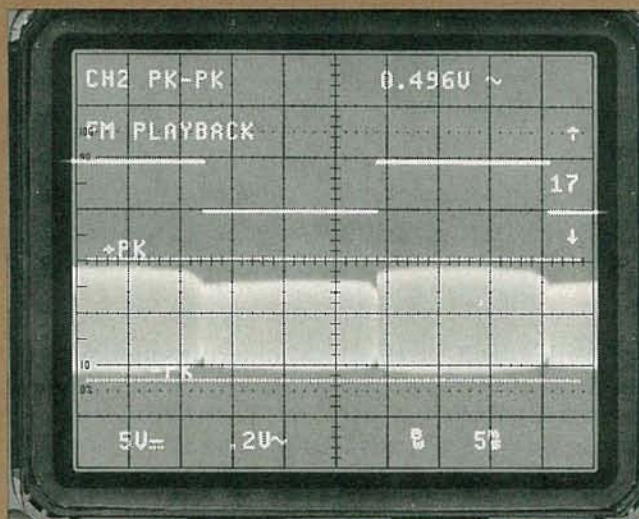

FIG. 2—PROPER HEAD ALIGNMENT can be verified using FM playback and record envelopes in just one simple step. The voltage reading of the peak-to-peak envelope is indicated in upper-right corner.

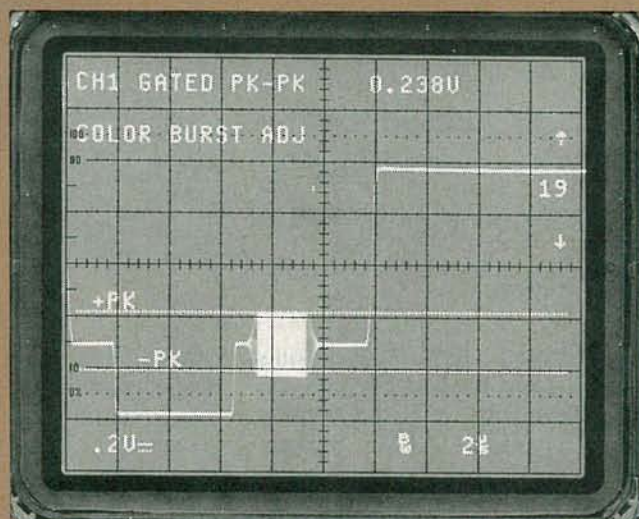

FIG. 4—GATED PEAK-TO-PEAK VOLTMETER allows you to select a portion of the waveform and measure its peak-to-peak voltage. In this example, just the color burst is being measured.

## Head alignment

Several VCR adjustments require verification of proper head alignment using the FM playback and record envelopes. (Using an oscilloscope with multiple independent channels can greatly simplify that task.) To verify proper timing of the envelope to the head-switching pulse, connect the head-switching pulse to channel one and observe the envelope on channel two.

Make sure that you trigger on channel one. As shown in Fig. 2, you can verify that there is minimal "pinching" on head A, and that the FM envelope is correct relative to the

positive head-switch edge. Notice the peak-to-peak voltage reading of the envelope, indicated in the upper-right. That illustrates on-screen readout, which is the ability to precisely measure voltages, automatically and without counting graticules. That two-channel setup can also be stored in memory for future use.

## E-to-E adjustments

Electronic-to-Electronic (E-to-E) adjustments offer their own challenges. Frequently, particular portions of the video must be adjusted to exacting video levels. At such times you may wish that you had three

hands; one to make the adjustments, one to retrigger the scope, and a third to hold the probe. An oscilloscope with auto-level triggering helps solve that problem—the scope retriggers itself automatically, even as the amplitude and frequency of the incoming video signal changes.

When making those measurements, tracking on-screen cursors will indicate where the scope is reading its voltages from. For example, in Fig. 3, notice how the peak-to-peak cursors appear to be floating above and below the DC voltage line from a VCR's power supply. The tracking cursors indicate that there are high-

frequency spikes present in what was assumed to be a clean DC voltage. Of course, that's not the main purpose of tracking cursors, but it's an added benefit that we're sure to keep in our troubleshooting bag of tricks. Although you can't see the spikes in the photo, the oscilloscope can, and it indicates the high and low peaks of them. Discovering that kind of information up front can save you considerable time and troubleshooting effort down the road.

A tracking cursor can also be used

right cursor set at the start of the vertical-sync pulse. The head-switching pulse should occur at the left cursor as seen in Fig. 5. That setup can also be stored and recalled for easy verification of the timing measurement.

#### Trigger versatility

There are oscilloscopes available that provide special triggers for use on video waveforms. The special triggers have two unique capabilities: the line mode, which triggers the scope on the individual horizontal lines of a com-

#### The right tool

By taking advantage of the advanced capabilities in today's oscilloscopes, a technician can significantly reduce the service time for products such as VCR's and camcorders. With practical features such as tracking cursors, auto setup, built-in voltmeters, and stored setups, measurements that used to take minutes can now be made in seconds.

To illustrate that point, a series of tests, including the verification of head-switching, FM playback for

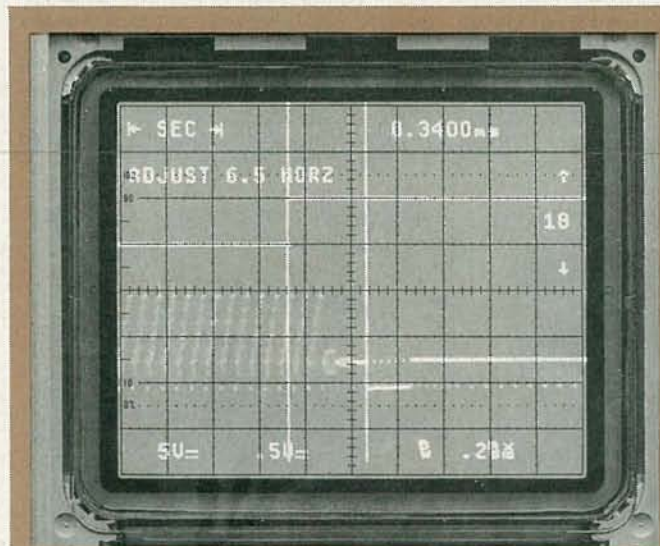

FIG. 5—DELTA-TIME CURSORS aid in making playback switching-point adjustments and provide fast time and frequency measurements without having to count graticules.

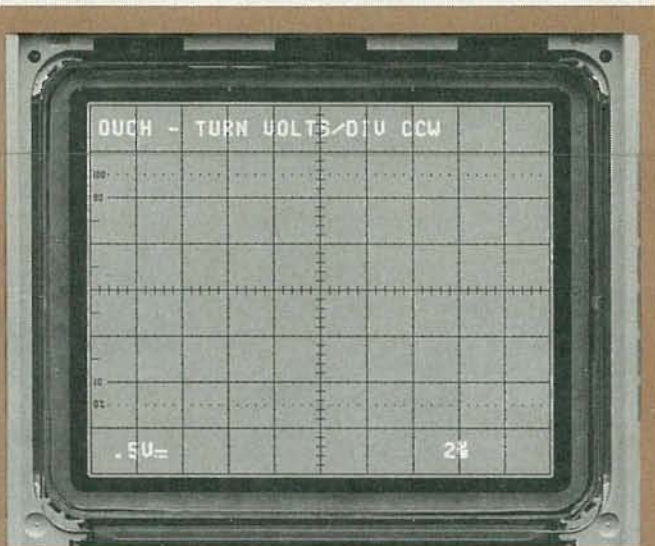

FIG. 6—BUILT-IN VOLTAGE-SENSING features and operator prompts alert the user that the signal being measured is out of range.

as a built-in gated peak-to-peak voltmeter that allows you to select any portion of the waveform and measure its peak-to-peak voltage. As an example, note the color burst from the output of the VCR in Fig. 4. The oscilloscope is measuring just the color burst and ignoring the rest of the video. Notice that the cursors show where the oscilloscope is making the measurement.

#### Playback switching

Another important E-to-E adjustment is the timing between the output video signal and the head-switching pulse. For proper tracking, the head-switching pulse should occur 6.5 horizontal-sync pulses before the vertical-sync pulse. Delta-time cursors can provide a quick means to make that time measurement without tedious graticule counting or time-consuming calculations. The left cursor can be set 6.5 horizontal-sync pulses before the vertical-sync pulse and the

posite video signal, and the field mode, which triggers the scope on the vertical interval of the composite signal. Both triggers are for use on any signal that contains sync pulses. With those capabilities, you can troubleshoot the video portions of VCR's, as well as the audio portions.

#### Operator prompts

Another oscilloscope feature that makes troubleshooting a lot easier is operator prompts. They can help you out when you exceed measurements in certain settings. For example, when you probe a voltage that is excessive for the volts/division setting that you have selected and the trace goes off the screen, operator prompts will alert you as shown in Fig. 6. All you need to do is to adjust the volts/division setting as indicated, and the trace will reappear. Operator prompts are generally considered a standard feature in the new generation of portable oscilloscopes.

both heads A and B, head alignment, video level, color level, and DC power supply voltages, were conducted on a VCR. Excluding probing time, when using a conventional oscilloscope, the tests took a total of 12 minutes. However, when the scope with cursors, automatic and stored setups, and the other features we've discussed was used (in this case, the Tektronix 2246A, the scope shown in the photographs), the identical set of tests took less than 30 seconds! Now admittedly, those tests were set up specifically to prove just how much troubleshooting time can be saved by using a scope with advanced features. Also, the tests were conducted by an experienced professional who had performed those tests dozens of times.

While advanced scope features cannot speed up *all* troubleshooting situations, they still remain an improvement sure to be welcomed by any service technician.

R-E

# Radio-Electronics mini-ADS

## contact east



**TEST INSTRUMENTS, TOOLS AND SUPPLIES.** Contact East's new 132 page, 1989 General Catalog is a source book of products for testing, assembling and repairing electronic equipment. With color photos, specifications and discounted pricing, this free catalog features test instruments, precision hand tool, tool kits (with a new Lifetime Guarantee), soldering supplies, static control products plus much more. "Same Day" shipment available. **CONTACT EAST, 335 Willow St. So., PO Box 786, North Andover, MA 01845, (508) 682-2000.**

CIRCLE 55 ON FREE INFORMATION CARD



**M-BREAKOUT SOLVES RS-232 COMPATIBILITY PROBLEMS FAST!!!** • Breaks/re-directs all 25 signals • 52 LED's give 4-state indication on all signals • Current loop test • No batteries required • Gold plated contacts • 8 jumper cables • Durable ABS plastic case • Manual and carrying pouch • We ship UPS 2nd day within 24 hours of order • Regularly \$150, R&E Special \$135, **M-TEST EQUIPMENT, P.O. Box 146008, San Francisco, CA 94114-6008, (415) 861-2382 FAX (415) 864-1076**

CIRCLE 178 ON FREE INFORMATION CARD



**THE MODEL WTT-20 IS ONLY THE SIZE OF A DIME,** yet transmits both sides of a telephone conversation to any FM radio with crystal clarity. Telephone line powered - never needs a battery! Up to ¼ mile range. Adjustable from 70-130 MHZ. Complete kit **\$29.95 + \$1.50 S+H.** Free Shipping on 2 or more! COD add \$4. Call or send VISA, MC, MO. **DECO INDUSTRIES, Box 607, Bedford Hills, NY 10507. (914) 232-3878.**

CIRCLE 127 ON FREE INFORMATION CARD



**THE CHALLENGER 100 SERIES** of digital panel meters are new high quality, low cost 3½ digit meters and come in LCD and LED versions. They are direct replacements for Modutec's "Big Little™" 100 series. The Model 130 includes a bezel. High linearity analog-digital converters provide 35 PPM reference stability. Linearity is ± ½ count across the entire range. Price: **\$39.50-49.50** (depending on model). VISA, M/C welcome. **DIGIMETER, INC., 512 Valley Way, Milpitas, CA 95035. (408) 946-9090, ext. 730, FAX: (408) 946-9190.**

CIRCLE 177 ON FREE INFORMATION CARD



**CABLE TV CONVERTERS AND DE-SCRAMBLERS SB-3 \$79.00 TRI-BI \$95.00 MLD-\$85.00 M35B \$89.00 JRX-DIC \$129.00** Special combos available. We ship COD. Quantity discounts. Call for pricing on other products. Dealers wanted. **FREE CATALOG.** We stand behind our products where others fail. One year warranty. **ACE PRODUCTS, P.O. Box 582, Saco, ME 04072 (207) 967-0726.**

CIRCLE 189 ON FREE INFORMATION CARD



**APPLIANCE REPAIR HANDBOOKS—13** volumes by service experts; easy-to-understand diagrams, illustrations. For major appliances (air conditioners, refrigerators, washers, dryers, microwaves, etc.), elec. housewares, personal-care appliances. Basics of solid state, setting up shop, test instruments. **\$2.65 to \$7.90 each.** Free brochure. **APPLIANCE SERVICE, P.O. Box 789, Lombard, IL 60148. (312) 932-9550.**

CIRCLE 84 ON FREE INFORMATION CARD

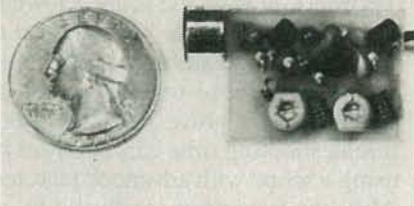

**SIMPLY SNAP THE WAT-50 MINIATURE FM TRANSMITTER** on top of a 9v battery and hear every sound in an entire house up to 1 mile away! Adjustable from 70-130 MHZ. Use with any FM radio. Complete kit **\$29.95 + \$1.50 S+H.** Free shipping on 2 or more! COD add \$4. Call or send VISA, MC, MO. **DECO INDUSTRIES, Box 607, Bedford Hills, NY 10507. (914) 232-3878.**

CIRCLE 127 ON FREE INFORMATION CARD



**FREE CATALOG OF HARD-TO-FIND TOOLS** is packed with more than 2000 quality items. Your single source for precision tools used by electronic technicians, engineers, instrument mechanics, schools, laboratories and government agencies. Also contains Jensen's line of more than 40 tool kits. Send for your free copy today! **JENSEN TOOLS INC., 7815 46th St., Phoenix, AZ 85044. (602) 968-6231.**

CIRCLE 115 ON FREE INFORMATION CARD

## CALL NOW AND RESERVE YOUR SPACE

- 6 × rate \$890.00 per each insertion.
- Fast reader service cycle.
- Short lead time for the placement of ads.
- We typeset and layout the ad at no additional charge.

Call **516-293-3000** to reserve space. Ask for Arline Fishman. Limited number of pages available. Mail materials to: mini-ADS, RADIO-ELECTRONICS, 500-B Bi-County Blvd., Farmingdale, NY 11735.

## BASIC OP-AMPS

*This month we concentrate on basic op-amp principles and circuits.*

RAY MARSTON

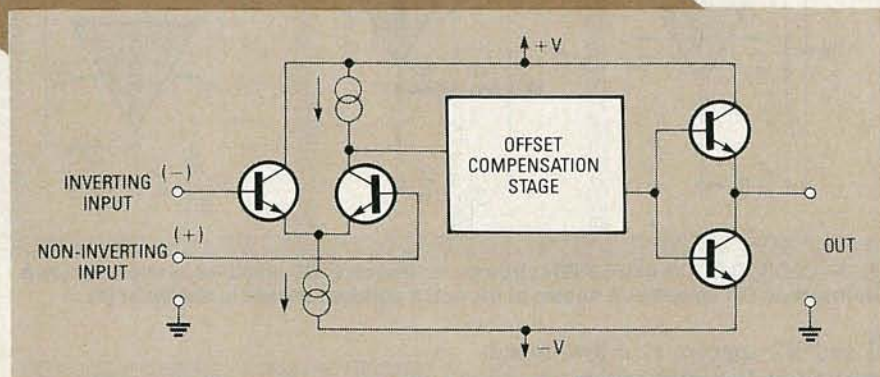

FIG. 1—SIMPLIFIED OP-AMP EQUIVALENT CIRCUIT. The basic operation of an op-amp can be simulated using discrete components as shown.

A CONVENTIONAL OPERATIONAL AMPLIFIER (op-amp) can be simply described as a high-gain direct-coupled voltage amplifier that has a single output terminal, and because it has both inverting and non-inverting input terminals, the device can function as an inverting, non-inverting, or differential amplifier. When coupled to suitable feedback networks, op-amps can be used to make precision amplifiers, filters, oscillators, level switches, comparators, etc.

In this article, we will only go into the basic op-amp applications and circuit configurations. We will not go into any specific details, such as component values, frequencies, types of power supplies, etc. The circuits shown are only to give you a starting point, and the exact details are left up to you to experiment with.

Three basic types of operational amplifiers are currently available. We are going to take an in-depth look at the operating principles and practical applications of the most common type, the conventional "voltage-in voltage-out" op-amp (typified by the LM741 and CA3140). The other two basic types of op-amps are the current-differencing or Norton op-amp, and the operational transconductance amplifier or OTA.

### Op-amp basics

In its simplest form, a conventional op-amp consists of a differential amplifier (bipolar or FET) followed by offset compensation and output stages, as shown in Fig. 1. All of those elements are integrated on a single chip and housed in an IC package.

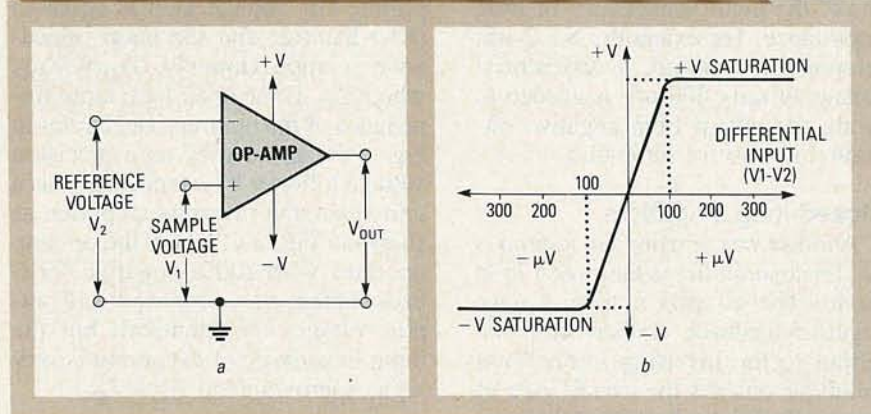

FIG. 2—A SIMPLE VOLTAGE COMPARATOR (a) has transfer characteristics shown in (b).

The differential amplifier has a high-impedance (constant-current) "tail" to give it a high input impedance and a high degree of common-mode signal rejection. It also has a high-impedance collector (or drain) load, to give it a large amount of signal-voltage gain (typically about 100 dB).

The output of the differential amplifier is fed to the circuit's output stage via an offset-compensation network, which causes the op-amp's output to center at zero volts. The output stage takes the form of a complementary emitter follower, and provides a low-impedance output.

Op-amps are normally powered from a split supply, providing +V, -V, and a common ground, enabling the op-amp's output to swing to either side of ground and take on a value of zero volts when the differential input voltage is zero.

### Basic configurations

We have seen that the op-amp is a high-gain direct-coupled voltage am-

plifier with a high input impedance and a low output impedance. In practice, the output voltage of an op-amp is proportional to the differential voltage between its two inputs, and is equal to:

$$V_{OUT} = A_O(V_1 - V_2)$$

where  $A_O$  is equal to the open-loop voltage gain of the op-amp (typically 100,000),  $V_1$  is the voltage at the non-inverting input, and  $V_2$  is the voltage at the inverting input.

Therefore, an op-amp can be used as an inverting amplifier by grounding the non-inverting terminal and feeding the input signal to the inverting terminal, or as a non-inverting amplifier by transposing the two input connections. It can also be used as a differential amplifier by feeding a separate input signal to each input, in which case the op-amp will amplify voltage difference between the two inputs. Note that if identical signals are fed to both inputs of the op-amp, ideally the output should be zero.

One useful application for an op-amp is as a differential voltage comparator, such as the one shown in Fig. 2-a. In that circuit, a fixed reference voltage is applied to the inverting terminal and a variable or sample voltage is fed to the non-inverting terminal. Because of the very high open-loop voltage gain of the op-amp, the output is driven into positive saturation (close to +V) when the sample voltage goes slightly above the reference voltage, and driven into negative saturation (close to -V) when the sample voltage goes slightly below the reference voltage.

Figure 2-b shows the circuit's transfer characteristics. Notice that it is the magnitude of the differential voltage at the inputs that determines the output voltage, and that the absolute values of the input voltages are of little importance. For example, if a 2-volt reference is applied, a differential voltage of only 200  $\mu$ V is needed to swing the output from negative saturation to positive saturation.

### Closed-loop amplifiers

Another way of using an op-amp is as a linear amplifier in the closed-loop mode. The circuits in Fig. 3 have negative feedback applied from the output to the inverting input. That technique enables the overall gain of those circuits to be precisely controlled by the values of the external-feedback components, regardless of the open-loop characteristics of the particular op-amps that are used.

Figure 3-a shows how to use an op-amp as a fixed-gain inverting DC amplifier. The gain (A) of the circuit is controlled by the ratios of R1 and R2, and is equal to  $R2/R1$ . The input impedance of the circuit is equal to the value of R1, so both the gain and the input impedance of the circuit are easily controlled.

Note in Fig. 3-a, that although R1 and R2 control the gain of the entire circuit, they have no effect on the parameters of the actual op-amp. Therefore, the inverting terminal still has a very high input impedance, so the current flowing into that terminal is negligible. Consequently, virtually all of the current that flows through R1 also flows through R2. That's why currents  $I_1$  and  $I_2$  can be regarded as being equal, as shown in the diagram. Also note that R2 has an apparent value of  $R2/A$  when seen from the inverting terminal, so the junction of

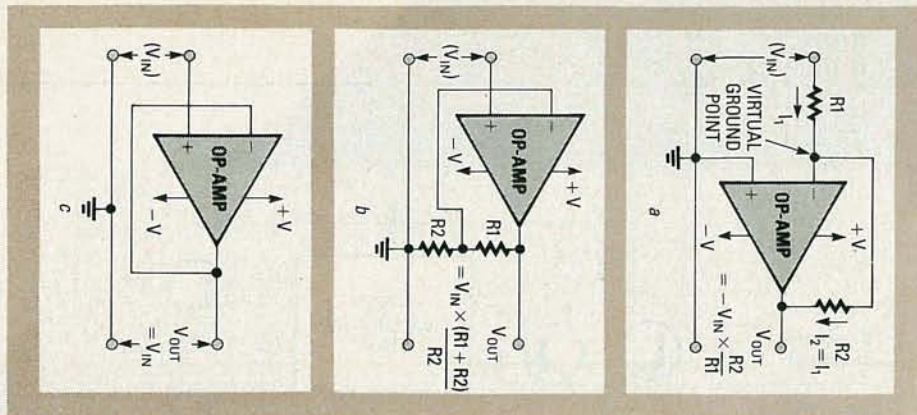

FIG. 3—CLOSED-LOOP AMPLIFIER circuits. An inverting DC amplifier is shown in (a), a non-inverting DC amplifier is shown in (b), and a voltage follower is shown in (c).

R1 and R2 appears as a low-impedance "virtual ground" point.

Figure 3-b shows how to use an op-amp as a fixed-gain non-inverting amplifier. The voltage gain is equal to  $(R1 + R2)/R2$ , and the input impedance is approximately  $(A_0/A)Z_{IN}$ , where  $Z_{IN}$  is the open-loop input impedance of the op-amp. The circuit in Fig. 3-b can be used as a precision voltage follower by connecting it as a unity-gain non-inverting amplifier, as shown in Fig. 3-c, where the op-amp operates with 100% negative feedback. In that circuit the input and output voltages are identical, but the input impedance of the circuit is very high, approximating  $A_0 \times Z_{IN}$ .

### Op-amp parameters

An ideal op-amp would have infinite input impedance, gain, and bandwidth, and would have zero output impedance and have perfect tracking between the input and output. Practical op-amps fall short of all those ideals. Consequently, various performance parameters are usually detailed in the data sheets that

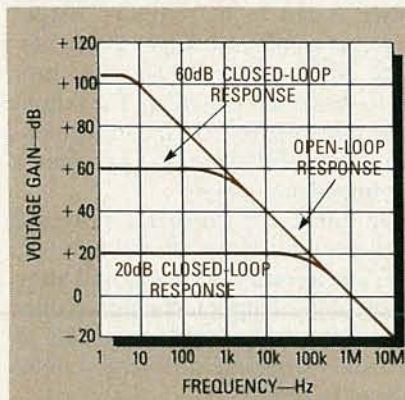

FIG. 4—TYPICAL FREQUENCY-response curve of the 741 op-amp. Notice how the bandwidth changes depending on how the circuit is configured.

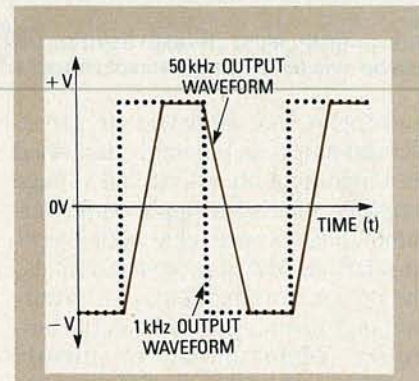

FIG. 5—EFFECT OF SLEW-RATE limiting on the output of an op-amp fed with a square-wave input.

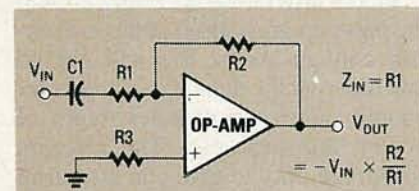

FIG. 6—THE CIRCUIT SHOWN HERE IS AN inverting AC amplifier, which has an output that is 180 degrees out of phase with the input signal.

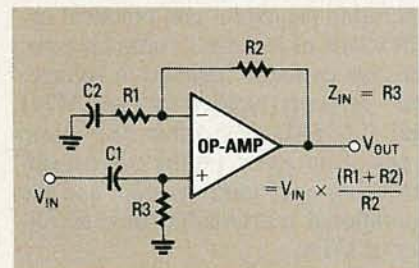

FIG. 7—A NON-INVERTING AC amplifier has an output that is in phase with the input signal.

accompany each device. The most important of those parameters are discussed in detail as follows.

- $A_0$  (open-loop voltage gain)—The low-frequency voltage gain between

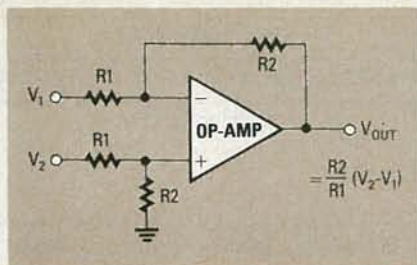

FIG. 8—A DIFFERENTIAL AMPLIFIER amplifies the difference between the two input signals.

the input and output terminals of the op-amp. It can be expressed as an actual number in terms of dB. Typical figures are 100,000, or 100dB.

●  $Z_{IN}$  (input impedance)—The resistive impedance looking directly into the input terminals of the op-amp when used in an open loop. Typical values are 1 megohm for op-amps with bipolar input stages, and a million megohms for op-amps with FET inputs.

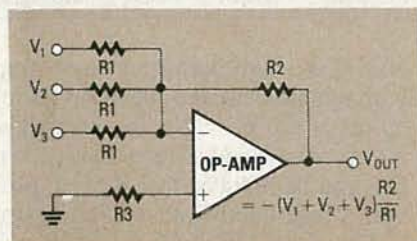

FIG. 9—AN INVERTING ADDER or audio mixer. This circuit can be used to combine three input signals.

●  $Z_O$  (output impedance)—The resistive output impedance of a basic op-amp when used in an open loop. Values of a few hundred ohms are typical of most op-amps.

●  $I_B$  (input bias current)—The input terminals of all op-amps sink or source finite amounts of current when biased for linear operation. The magnitude of that current ( $I_B$ ) is typically a fraction of a microamp in bipolar op-amps, and a few picoamps in FET-type op-amps.

●  $V_S$  (supply voltage range)—Op-amps are usually powered from a split supply (+V and -V), which must fall within maximum and minimum limits. If the voltage is too high, the op-amp may be damaged, and if it's too low, the op-amp will not function correctly. Typical limits are  $\pm 3$  volts to  $\pm 15$  volts.

●  $V_I$  (max) (input voltage range)—Most op-amps will only operate correctly if their input-terminal voltages are less than the supply voltages. Typ-

ically,  $V_I$  (max) is one or two volts less than  $V_S$ .

●  $V_{IO}$  (input-offset voltage)—In an ideal op-amp, perfect tracking would exist between the input and output terminals, and the output would register zero volts with both inputs grounded. In practice, slight imbalances within the op-amp itself cause the device to act as though a small offset or bias voltage exists between its inputs. Typically, the input-

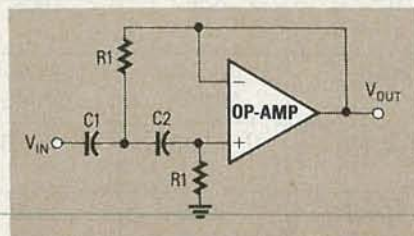

FIG. 10—A HIGH-PASS 2nd-ORDER active filter has a narrow bandwidth, controlled by the surrounding components.

offset voltage is only a few mV, but when that voltage is amplified by the circuit containing the op-amp, it may be sufficient to drive the output well away from the "zero" value. Because of that, most op-amps have some way of externally nulling out the effects of the offset voltage.

● CMRR (Common-Mode Rejection Ratio)—An op-amp produces an output that is proportional to the difference between the signals at its two

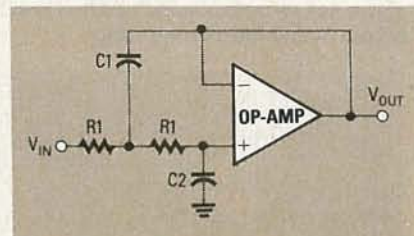

FIG. 11—A LOW-PASS 2nd-ORDER active filter also has a narrow bandwidth, but it only allows low-frequency signals to pass.

input terminals. Ideally, it should have zero output if identical signals are applied to both inputs simultaneously (the common mode). In practice, such signals do not entirely cancel out within the op-amp, and produce a small output signal. The ability of an op-amp to reject common-mode signals is usually expressed in terms of its "common mode rejection ratio" (the ratio of the op-amp's gain with a differential input versus the gain with common

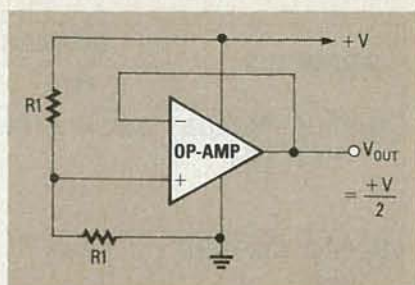

FIG. 12—A SUPPLY-LINE SPLITTER can be used to create a split supply from a single one.

mode signals). CMRR values of 90 dB are typical for most op-amps.

●  $f_T$  (transition frequency)—An op-amp typically has a low-frequency voltage gain of about 100 dB, and for the sake of stability, its open-loop frequency response is internally tailored so that the gain falls off as the input frequency rises, and falls to unity at a transition frequency denoted  $f_T$ . Usually, the response falls off at a rate of 6 dB per octave or 20 dB per decade.

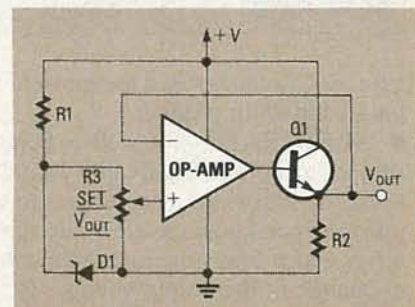

FIG. 13—ADJUSTABLE-VOLTAGE power supply.

Figure 4 shows the typical response curve of a 741-type op-amp, which has an  $f_T$  of 1 MHz, and a low-frequency gain of 106 dB.

**Note:** when the op-amp is used in a closed-loop amplifier circuit, the bandwidth of the circuit depends on the closed-loop gain. Therefore, as shown in Fig. 4, if the amplifier circuit has a gain of 60 dB, its bandwidth is only 1 kHz, but if the circuit has a gain of 20 dB, its bandwidth is 100

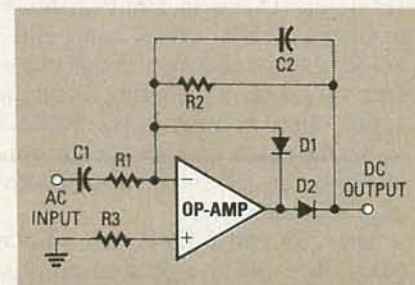

FIG. 14—A PRECISION HALF-WAVE AC/DC converter also acts as a buffer for the input signal.

TABLE 1-OP-AMP CHARACTERISTICS

PARAMETER	BIPOLAR OP-AMPS		MOSFET OP-AMPS		JFET OP-AMPS			
	741	NE531	CA3130E	CA3140E	LF351	LF411	LF441	LF13741
SUPPLY VOLTAGE RANGE ( $V_S$ )	$\pm 3V$ to $\pm 18V$	$\pm 5V$ to $\pm 22V$	$\pm 2.5V$ to $\pm 8V$ or $5V$ to $16V$	$\pm 2V$ to $\pm 18V$ or $4V$ to $36V$	$\pm 5V$ to $\pm 18V$			
SUPPLY CURRENT ( $I_S$ )	1.7mA	5.5mA	1.8mA	3.6mA	800 $\mu$ A	1.8mA	150 $\mu$ A	2mA
INPUT OFFSET VOLTAGE ( $V_{IO}$ )	1mV	2mV	8mV	5mV	5mV	0.8mV	1mV	5mV
INPUT BIAS CURRENT ( $I_B$ )	200nA	400nA	5pA	10pA	50pA	50pA	10pA	50pA
INPUT IMPEDANCE ( $Z_{IN}$ )	1MEG	20MEG	$1.5 \times 10^{12}$ OHMS	$1.5 \times 10^{12}$ OHMS	$10^{12}$ OHMS	$10^{12}$ OHMS	$10^{12}$ OHMS	$0.5 \times 10^{12}$ OHMS
VOLTAGE GAIN ( $A_O$ )	106dB	96dB	110dB	100dB	88dB	106dB	100dB	100dB
COMMON MODE REJECTION RATIO (CMRR)	90dB	100dB	90dB	90dB	100dB	100dB	95dB	90dB
TRANSITION FREQUENCY ( $f_T$ )	1 MHz	1 MHz	15 MHz	4.5 MHz	4 MHz	4 MHz	1 MHz	1 MHz
SLEW RATE	0.5V/ $\mu$ s	35V/ $\mu$ s	10V/ $\mu$ s	9V/ $\mu$ s	13V/ $\mu$ s	15V/ $\mu$ s	1V/ $\mu$ s	0.5V/ $\mu$ s

kHz. So,  $f_T$  can be used to represent a gain-bandwidth product.

● **SLEW RATE**—As well as being subject to normal bandwidth limitations, op-amps are also subject to a phenomenon known as slew-rate limiting, which limits the maximum rate of change of the output voltage. Figure 5 shows the effect that slew-rate limiting has on the output of an op-amp that is being fed with a square-wave input. Slew rate is normally specified in terms of volts per microsecond, and values in the range from 1V/ $\mu$ s to 10V/ $\mu$ s are typical for most types of op-amps. One effect of slew-rate limiting is that a greater bandwidth is available to small output signals than for large output signals.

**Practical op-amps**

Practical op-amps are available in a variety of types (bipolar, MOSFET, JFET, etc.), and in many different packages (DIP, metal-can, etc.). Some of those packages house two or four op-amps, all sharing common supply-line connections. Table 1 shows the characteristics of eight popular op-amps, all of which are in an 8-pin DIP package.

The 741 and NE531 are bipolar types. The 741 is a general-purpose op-amp featuring internal frequency compensation and overload protection on the inputs and output. The

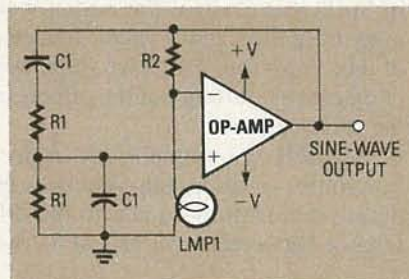

FIG. 15—WIEN-BRIDGE SINE-WAVE generator has an output amplitude that is stabilized by the low-current lamp.

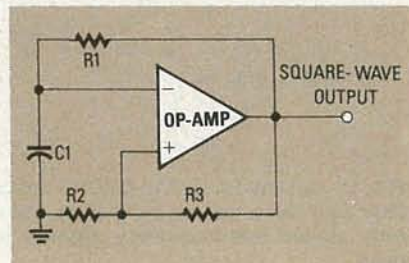

FIG. 16—A FREE-RUNNING multivibrator produces a clean square-wave output.

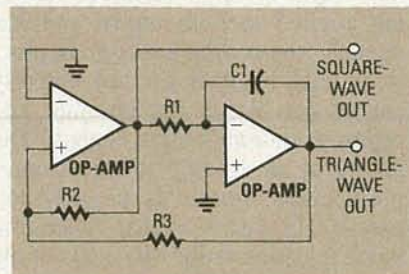

FIG. 17—THIS CIRCUIT generates both square waves and triangular waves.

NE531 is a high-performance op-amp with a high-slew-rate capability. It requires a 100-pF capacitor wired between pins 6 and 8 for stability, but that can be reduced to 1.8 pF to provide a wide bandwidth and high gain.

The CA3130 and CA3140 are MOSFET-input type op-amps that can operate from single or dual power supplies, can sense inputs down to the negative-supply value, have very high input impedances (1.5 million megohms), and have outputs that can be strobed. The CA3130 has a CMOS output stage, and an external compensation capacitor (typically 47 pF) that is wired between pins 1 and 8, thus permitting the adjustment of bandwidth characteristics.

The LF351, LF411, LF441, and LF13741, are JFET-type op-amps with very high input impedances. The LF351 and LF411 are high-performance types, while the LF441 and LF13741 are general-purpose types that can be used as direct replacements for the popular 741. Note that the LF441 current consumption is less than one tenth of the 741.

**Offset nulling**

All of the op-amps mentioned have an offset-nulling facility, to set the output at precisely zero with zero input. In most cases, offset nulling is

*continued on page 83*



# NEW IDEAS

## Cable tester

RECENTLY I WAS ASKED TO RUN CABLE throughout a four-story building. Once the eight-conductor cable was installed and all of the connectors were mounted, the next job was to check each cable. The circuit shown in Fig. 1 made that task much easier.

### How it works

In that circuit, IC1 is an LM555 timer set up as an astable multivibrator. Its output is used as the clock input for IC2, a 4017 decade counter. The counter's outputs go high sequentially with the positive edge of each clock pulse. The first seven outputs (output 0 through output 6) and ground are connected to PL1, a connector selected to mate with the ones used in the installation. In our case, a male DB-25 was used. The eighth output (output 6) was tied to LED2, used as a visual indicator. The other outputs are unused.

The display is hooked to the

other end of the cable under test. It consists of a 10-segment LED bargraph array. Only seven of the segments are needed. The anodes of those segments are connected to the appropriate pins of a second connector, PL2; the cathodes are all tied to the ground line, pin 20.

To test a cable, connect the circuit to one end and the display to the other. Turn the circuit on and observe LED1 to verify that the multivibrator is working and LED2 to verify that the counter is counting. Proceed to the other end of the cable and monitor the display. If all cable connections are correct, the display LED's will light in sequence. If the display LED's light out-of-sequence, the cable is miswired. Unlit LED's indicate poor connections or a broken cable.

The circuit can be mounted within a small aluminum box, powered by a standard 9-volt battery. In our application, the display was mounted in the plastic hood

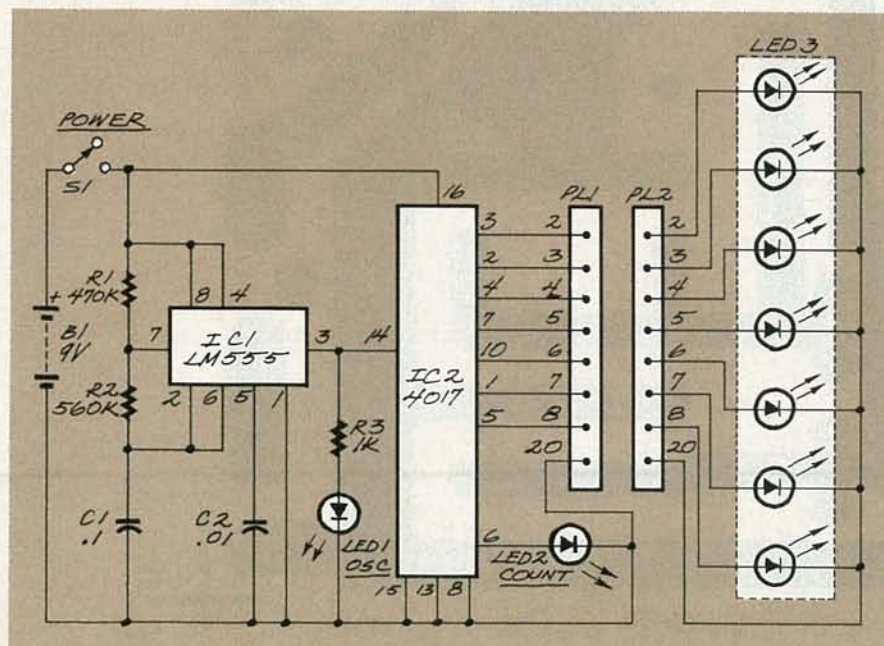
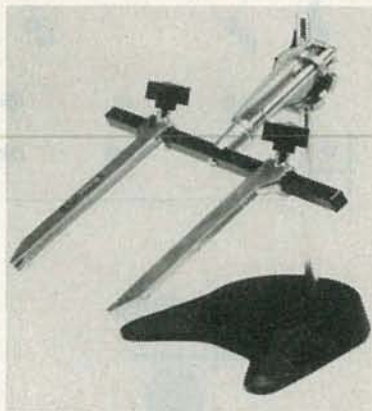

FIG. 1

### NEW IDEAS

This column is devoted to new ideas, circuits, device applications, construction techniques, helpful hints, etc.

All published entries, upon publication, will earn \$25. In addition, for U.S. residents only, Panavise will donate their *model 333*—The Rapid Assembly Circuit Board Holder, having a retail price of \$39.95. It features an eight-position rotating adjustment, indexing at 45-degree increments, and six positive lock positions in the vertical plane, giving you a full ten-inch height adjustment for comfortable working.



I agree to the above terms, and grant **Radio-Electronics Magazine** the right to publish my idea and to subsequently republish my idea in collections or compilations of reprints of similar articles. I declare that the attached idea is my own original material and that its publication does not violate any other copyright. I also declare that this material has not been previously published.

Title of Idea

Signature

Print name

Date

Street

City

State

Zip

Mail your idea along with this coupon to: **New Ideas Radio-Electronics, 500-B Bi-County Blvd., Farmingdale, NY 11735**

of the DB-25 connector, where the cable would normally go. By using other connectors, the circuit can be used to test a wide variety of multiconductor-cable installations.—*Charles L. Rowe*

# PC SERVICE

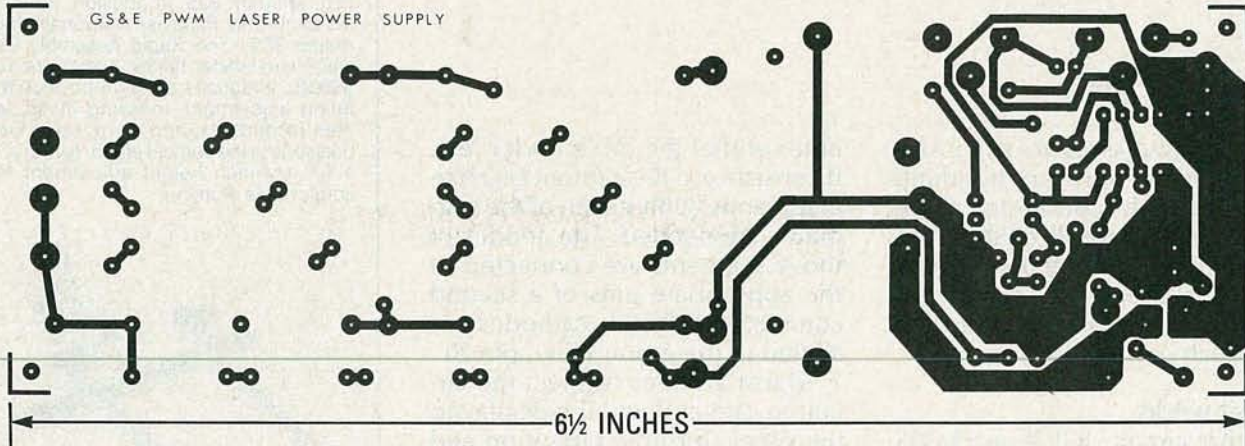

USE THIS FOIL PATTERN for the laser power supply.

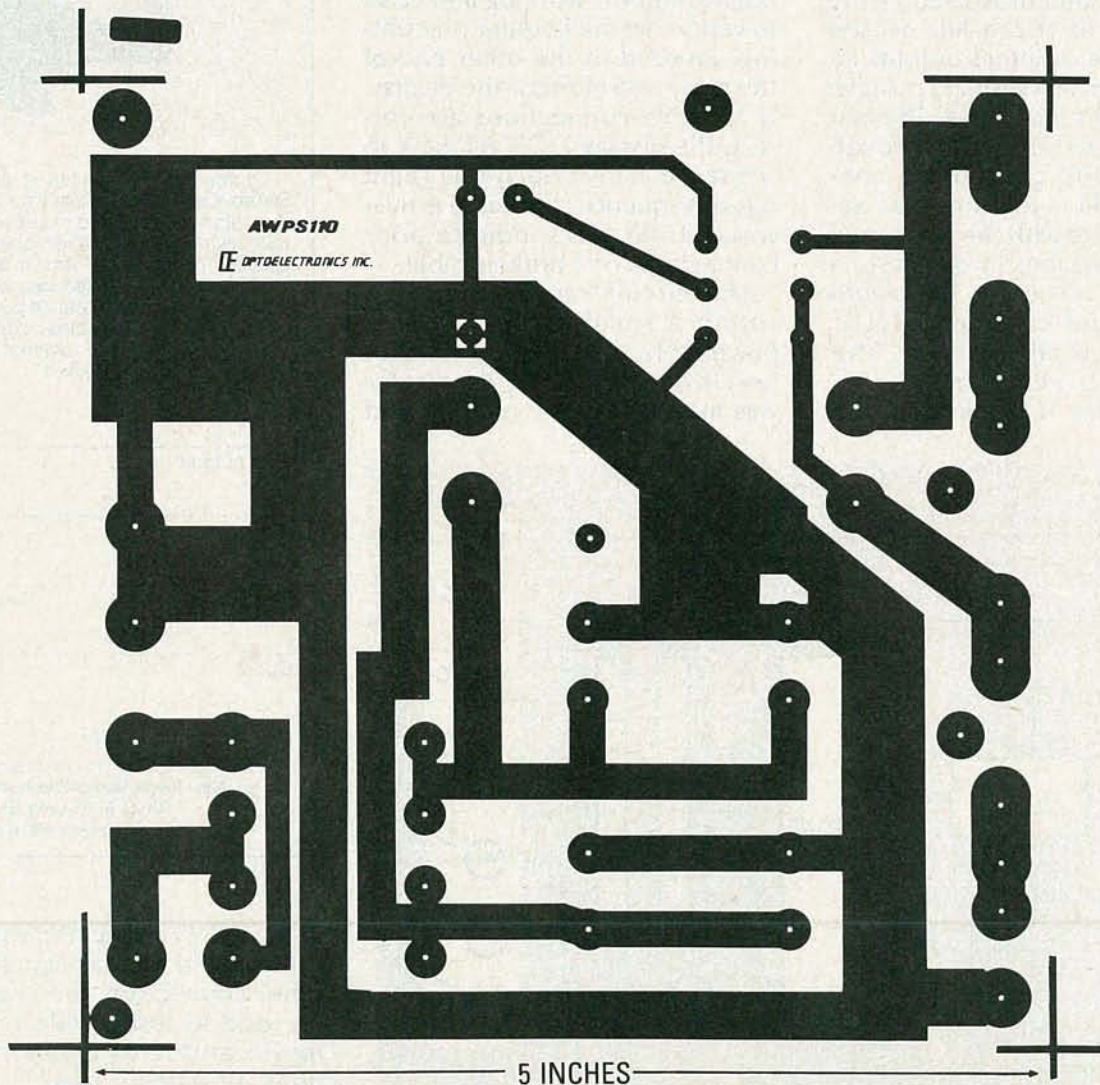

THE AC POWER SUPPLY for the high-power audio amplifier.

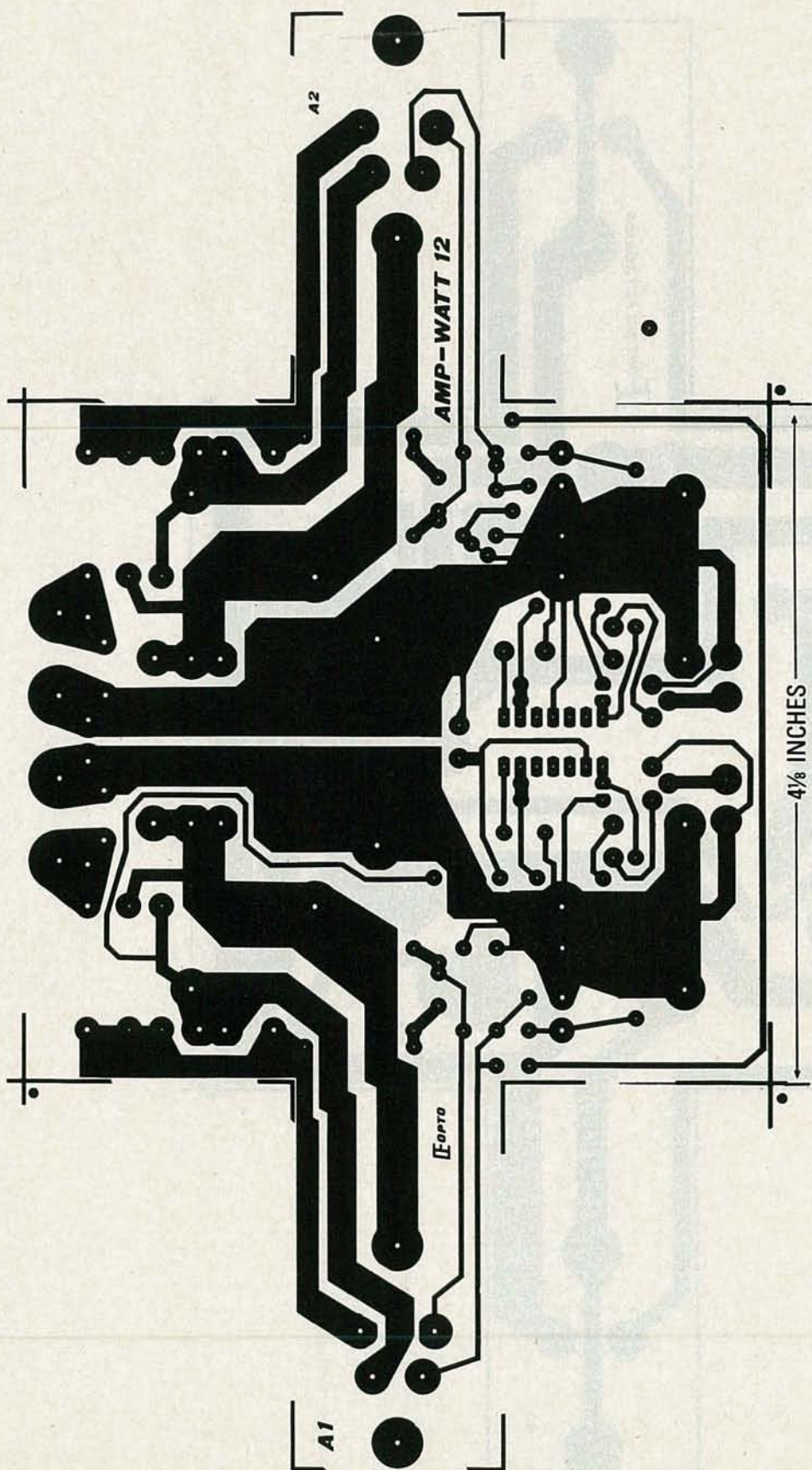

12-VOLT DC power supply for the audio amplifier.

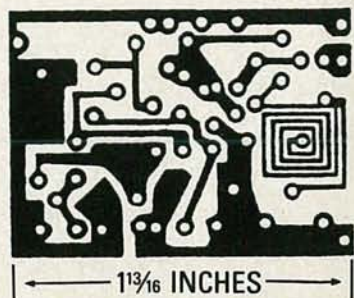

WIRELESS FM transmitter.

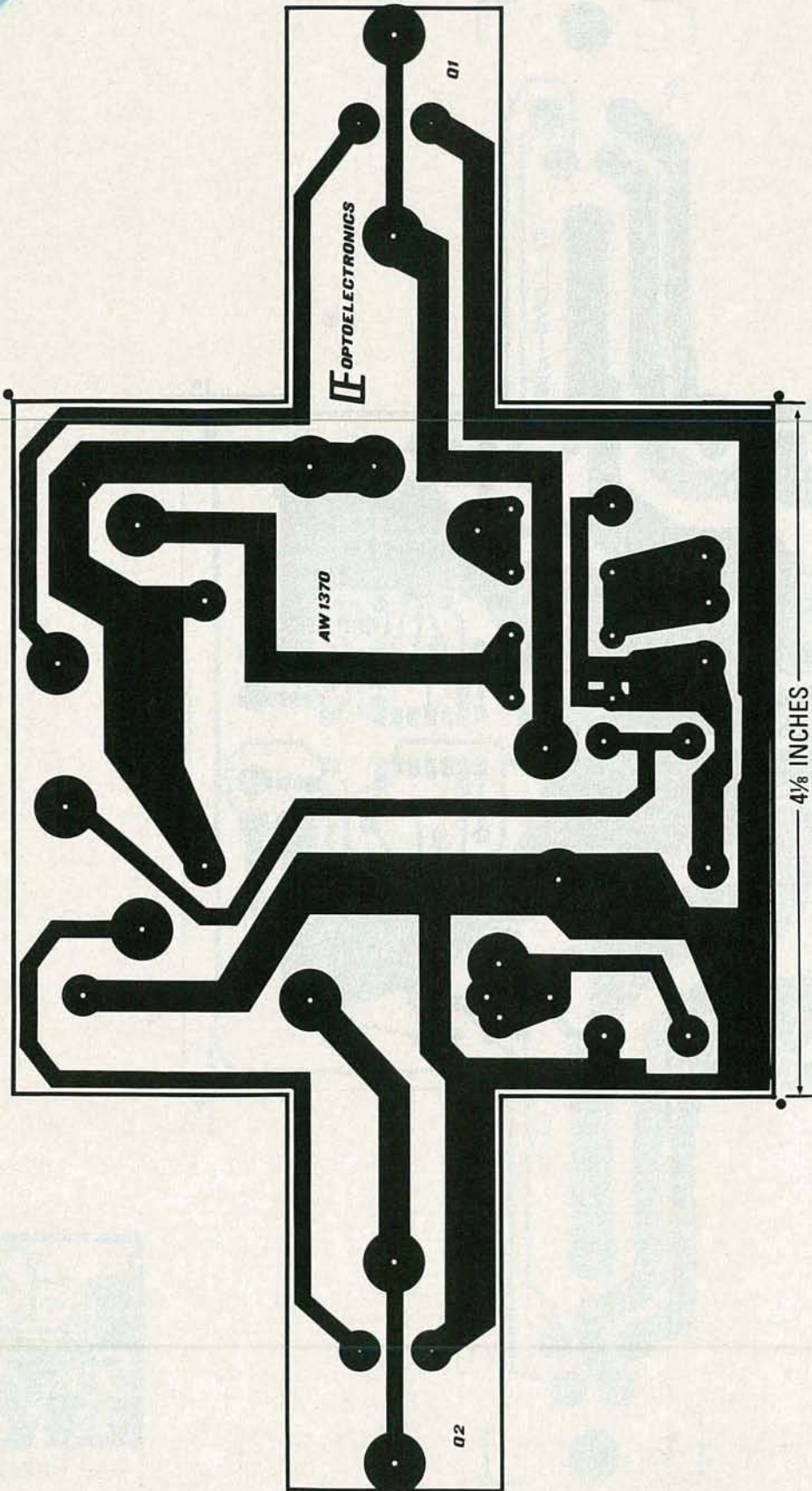

THE HIGH-POWER audio amplifier's foil pattern.

# WITH CIE, THE WORLD OF ELECTRONICS CAN BE YOUR WORLD, TOO.

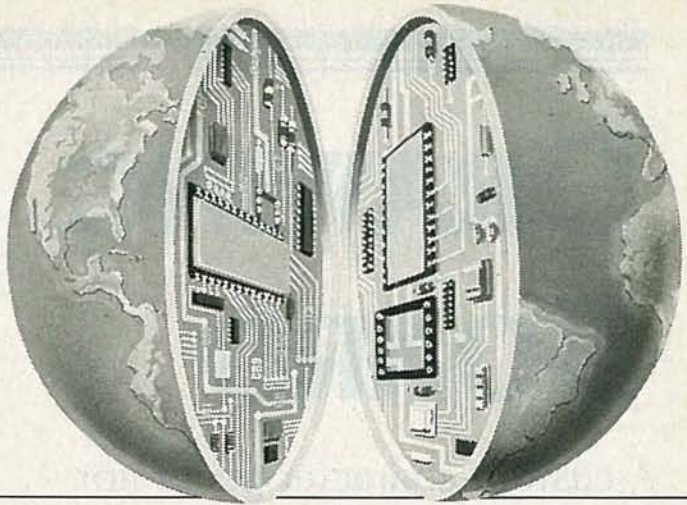

**L**ook at the world as it was 20 years ago and as it is today. Now, try to name another field that's grown faster in those 20 years than electronics. Everywhere you look, you'll find electronics in action. In industry, aerospace, business, medicine, science, government, communications—you name it. And as high technology grows, electronics will grow. Which means few other fields, if any, offer more career opportunities, more job security, more room for advancement—if you have the right skills.

## SPECIALISTS NEED SPECIALIZED TRAINING.

It stands to reason that you learn anything best from a specialist, and CIE is the largest independent home study school specializing exclusively in electronics, with a record that speaks for itself. According to a recent survey, 92% of CIE graduates are employed in electronics or a closely related field. When you're investing your time and money, you deserve results like that.

## INDEPENDENT STUDY BACKED BY PERSONAL ATTENTION.

We believe in independent study because it puts you in a classroom of one. So you can study where and when you want. At your pace, no somebody else's. And with over 50 years of experience, we've developed proven programs to give you the support

such study demands. Programs that give you the theory you need backed with practical experience using some of the most sophisticated electronics tools available anywhere, including our Microprocessor Training Laboratory with 4K of random access memory. Of course, if you ever have a question or problem, our instructors are only a phone call away.

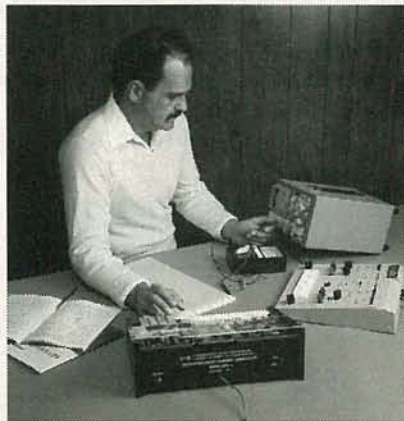

## START WHERE YOU WANT, GO AS FAR AS YOU WANT.

CIE's broad range of entry, intermediate, and advanced level courses in a variety of career areas gives you many options. Start with the Career Course that best suits your talents and interests and go as far as you want—all the way, if you wish, to your Associate in Applied Science Degree in Electronics Engineering Technology. But wherever you start, the time to start is **now**. Simply use the coupon below to send for your FREE CIE catalog and complete package of career information. Or phone us, toll-free, at **1-800-321-2155** (in Ohio, 1-800-523-9109). Don't wait, ask for your free catalog now. After all, there's a whole world of electronics out there waiting for you.

# CIE

**Cleveland Institute of Electronics, Inc.**  
1776 East 17th Street, Cleveland, Ohio 44114

Member NHSC  
Accredited Member National Home Study Council

**CIE** **Cleveland Institute of Electronics, Inc.**  
1776 East 17th Street, Cleveland, Ohio 44114

ARE-117

**YES...** I want to learn from the specialists in electronics—CIE. Please send me my FREE CIE school catalog, including details about CIE's Associate Degree program, plus my FREE package of home study information.

Name (print): \_\_\_\_\_

Address: \_\_\_\_\_

City: \_\_\_\_\_ State: \_\_\_\_\_ Zip: \_\_\_\_\_

Age: \_\_\_\_\_ Area Code/Phone No.: \_\_\_\_\_ / \_\_\_\_\_

Check box for G.I. Bill bulletin on educational benefits:

Veteran  Active Duty

**MAIL  
TODAY!**

# DRAWING BOARD



ROBERT GROSSBLATT,  
CIRCUITS EDITOR

## A custom-character generator

WE SEEM TO HAVE GOTTEN A BIT OUT OF order. Let's pick up where we left off in December, when I said that there were two advantages to the more-complex circuit in that month's Fig. 3.

The first one is that by picking the output off the base of the transistors, we can use the same chip with common-anode displays. The second advantage is that by isolating the display we can sink a lot more current.

Now we have to connect the common-cathode terminal of each display (point X in Fig. 2 in the December issue) to a collector of one of the transistors in Fig. 3.

Then connect the "stolen" clock signal.

There's also a trick that can be used to change the brightness of the display when you're stealing clocks from the circuit. Just connect the emitters of the transistors to the clock rather than ground. If we do that, the transistors will only be on for the low part of the clock's duty cycle. Therefore, we can have the brightness either at 100% (with the emitters connected to ground) or 50% (with the emitters connected to the clock). All we need is a SPDT switch (S1) to make it happen. That is a neat way around the brightness problem and as

Grossblatt's sixteenth law states: Being slick is a good thing.

If there's no convenient clock to steal from the circuit, there's no alternative but to provide one yourself. The clock circuit we've already put together is a good one to use because it gives us control over both the frequency and duty cycle...and we've already put the thing together. Just remember that the duty cycle will control the display's brightness only when the emitters are connected to the clock signal. That's because the 4017 is triggered by a transition of the clock signal, but it doesn't care about the clock signal's duty cycle. The duty cycle of the 4017's outputs is always the same; it is its strobing rate that changes.

The clock output can drive the 4017, and probably the transistors as well. However, there's one more thing to consider: The amount of current that we can safely expect the clock output to handle. It's also something to consider when you're stealing a clock. You may have to buffer the clock output before you use it.

### A contest

Although I mentioned an ongoing contest in January, the rules were never spelled out (another little mixup). So anyway, here's what I want you to think about, as well as the contest rules. I needed a binary-to-seven-segment decoder—not BCD, but binary. There are some decoders around that do the job—Motorola makes one—but they're not easy to find.

So, I built one using a 2716 (2K × 8) EPROM. Everything worked out

EPROM CHARACTER SET

0		A		K		U	
1		B		L		V	
2		C		M		W	
3		D		N		X	
4		E		O		Y	
5		F		P		Z	
6		G		Q			
7		H		R			
8		I		S			
9		J		T			

FIG. 1

well and I'll get into the details in another column. But when I was finished, it struck me that I was using only 16 bytes of space in the EPROM—there was a lot of wasted empty space.

So here's the deal.

I want all of you to stretch your brains and figure out a good use for the rest of the room in the EPROM—some 2036 bytes. Remember that the EPROM is being used only as a character generator and it's driving a standard seven-segment display with a right-hand decimal point. To make the contest a bit easier let's say that it's also permissible to use a display with a left-hand decimal point. If you come up with a good idea, write it down and send it in. The top three winners will get a year's freebie subscription to **Radio-Electronics** and I'll print your entries in this column.

Don't forget the rules. The EPROM drives a seven-segment, common-cathode display. When we get together next month, I'll go into the details and talk about using EPROM's to build customized character generators, keyboard translators, and other things.

### Character generator

Unless you're building a kit put together by somebody else, a good deal of your circuit's complexity is due to the fact that you're using standard components to do a custom job.

Think about it.

If you're making something out of wood, you can buy lumber and cut it down to size. Electronics stuff is very different. Anyone who has spent time going through schematics knows that there are often lots of unused gates, counters, and other parts on the board. The reason is simply because the design called for an OR gate—just one single OR gate—and they come four in a package.

Now, I'm the first to admit that you can solve this problem with a piece of custom silicon, but we're talking big bucks. That's the way a lot of major electronics manufacturers are going these days. More and more products show up on the market with ninety percent of their electronics in an ASIC (Ap-

# Popular Electronics IS BACK

## Exciting Features, Projects, Reports, & Columns

- **BUILD A HOT SOCKET**

A shocking little box that's fun to build, and even more fun to use.

- **LUCKY LOTTO SELECTOR**

Do those lucky numbers keep escaping you? Build our electronic selector and change your luck.

- **DICE-ROULETTE GAME**

As much fun as a trip to Vegas, use it instead of dice in any game or on its own for exciting gambling fun.

- **CORD BUSTER**

The listening is easier than ever when you cut your headphone's umbilical cord.



## And there is more!

**SCANNER SCENE**—The readers write, and we answer.

**COMPUTER BITS**—Navigating through the video jungle.

**CIRCUIT CIRCUS**—Circuits just for the fun of it.

**ANTIQUE RADIO**—A mystery is solved with the help of our readers.

**HAM RADIO**—Just how long is a long-wire antenna?

**DX LISTENING**—Learn about one of the world's SW broadcasters.

PICK UP **Popular Electronics** AT YOUR FAVORITE NEWSSTAND, CONVENIENCE STORE, OR SUPERMARKET.

# R-E Engineering Admart

Rates: Ads are 2 1/4" x 2 7/8". One insertion \$900. Six insertions \$875. each. Twelve insertions \$845. each. Closing date same as regular rate card. Send order with remittance to Engineering Admart, Radio Electronics Magazine, 500-B Bi-County Blvd., Farmingdale, NY 11735. Direct telephone inquiries to Arline Fishman, area code-516-293-3000. Only 100% Engineering ads are accepted for this Admart.

## FCC LICENSE PREPARATION

The FCC has revised and updated the commercial license exam. The NEW EXAM covers updated marine and aviation rules and regulations, transistor and digital circuitry. THE GENERAL RADIOTELEPHONE OPERATOR LICENSE - STUDY GUIDE contains vital information. VIDEO SEMINAR KITS ARE NOW AVAILABLE.

WPT PUBLICATION  
979 Young Street, Suite A  
Woodburn, Oregon 97071  
Phone (503) 981-5159

CIRCLE 182 ON FREE INFORMATION CARD

## 1989 CATALOG AVAILABLE!

The Dick Smith Electronics Catalog is the fun way to find the electronic things you need. And now the 1989 Catalog is bigger - 160 pages crammed full of the things the other guys don't offer - and better - with more of our exclusive data pages including the new "feed back" section that invites your participation. And now the 1989 Catalog is as dynamic as Dick himself with a new issue each quarter to keep you up-to-date. Join the fun! Send us your name, address, and \$2 for your 1989 Catalog subscription today!

GERTIE DREW, Catalog Subscriptions  
P.O. BOX 468, GREENWOOD, IN 46142



CIRCLE 190 ON FREE INFORMATION CARD

## Surface Mount Chip Component Prototyping Kits—

Only \$49<sup>95</sup>



CC-1 Capacitor Kit contains 365 pieces, 5 ea. of every 10% value from 1pF to .33µF. CR-1 Resistor Kit contains 1540 pieces; 10 ea. of every 5% value from 10Ω to 10 megΩ. Sizes are 0805 and 1206. Each kit is ONLY \$49.95 and available for Immediate One Day Delivery!

Order by toll-free phone, FAX, or mail. We accept VISA, MC, AMEX, COD, or Pre-paid orders. Company P.O.'s accepted with approved credit. Call for free detailed brochure.

COMMUNICATIONS SPECIALISTS, INC.  
426 West Taft Ave. • Orange, CA 92665-4296  
Local (714) 998-3021 • FAX (714) 974-3420

Entire USA 1-800-854-0547

CIRCLE 176 ON FREE INFORMATION CARD

plication Specific Integrated Circuit).

That kind of stuff is pretty much out of the reach of people like us, but the idea of custom silicon isn't totally out the window. I'm not, of course, talking about ASIC's, but things like PAL's and PROM's are easily within the grasp of someone with even a modestly equipped bench.

PAL's can go a long way to solving problems in logic, but they're aimed at handling complex gating. PROM's can do a bit of that and, unlike PAL programmers, PROM burners meet the two basic requirements of the hobbyist: they're reasonably priced and widely available.

E PROM's can easily be burned at home and used to provide a simple answer to what would otherwise be an impossibly complex solution. A perfect example of that

is in designing a custom-character generator for standard seven-segment displays. We'll go through all the steps involved and, once we've laid out the whole procedure, we'll see how it can be applied to a much wider range of circuit-design problems.

Designing a character generator means figuring out what combination of input signals produces the desired combination of output signals. The first step in the design, therefore, is exactly the same as it is in every other design—Grossblatt's golden rule: Know what you want to do before you sit down to do it. You can't make decisions with nothing in mind.

The most popular EPROM's are 2716's. They're cheap, available, and every EPROM burner I've ever seen can handle them. While it's true that there's no telling what characters you may want to dis-

play, it's also true that 2048 bytes should be plenty of room for you to satisfy even your wildest creative inspirations.

Seven-segment displays don't easily lend themselves to well-formed letters, but a good part of the alphabet can be displayed if you're willing to make some allowances. In line with Grossblatt's golden rule, the very first thing we have to do is decide what letters we can display.

I've listed the letters to display in Fig. 1, and you should feel free to make any changes you want. If you're particularly artistic or have a better imagination, you can add the letters I've left out. It seems to me, however, that there's no way to clearly represent them. If you do work something out, you might consider using the decimal point. It doesn't have to be part of the character but it might be a good idea to have it light up when you're displaying a character whose representation is, to be generous, slightly unclear.

Make sure that all the characters you design are uniquely identifiable. You'll see that some characters are in upper case and some are in lower case. The reason for that is, as you'll see when you design your own character set, that

(Continued on page 104)

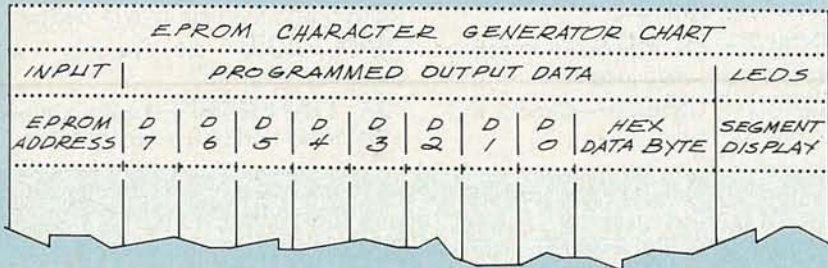

FIG. 2



## BASIC OP-AMPS

continued from page 72

achieved by wiring a 10K potentiometer between pins 1 and 5 and connecting the wiper (either directly or via a 4.7K "range-limiting" resistor) to the negative supply. In the case of the CA3130, A 100K offset-nulling potentiometer must be used.

### Applications roundup

Figures 6 and 7 show how op-amps can be used as fixed-gain inverting and non-inverting AC amplifiers. In both cases, the gain and the input impedance can be precisely controlled by carefully selecting resistor values.

Figure 8 shows how to make a differential amplifier with a gain equal to  $R2/R1$ ; if  $R1$  and  $R2$  have equal values, the exact value of the difference between the two input signals appears at the output. Figure 9 shows the circuit of an inverting "adder" or audio mixer; if  $R1$  and  $R2$  have equal values, the inverted output is equal to the sum of the input voltages.

Op-amps can be made to act as precision active filters by wiring suitable filters into their feedback networks. Figures 10 and 11 show the basic connections for making 2nd-order (narrow bandwidth) high-pass and low-pass filters respectively. The circuits shown provide roll-offs of 12 dB/octave.

The circuit in Fig. 12 is a supply-line splitter, which is useful for generating a split supply from a single-ended one. Figure 13 has a boosted output current, so the circuit can be used as a variable-voltage power supply by adjusting  $R3$ .

Figure 14 is a precision half-wave AC/DC converter. The circuit allows an AC signal to be converted to DC, and also serves as a buffer for the input signal.

Finally, the circuit in Fig. 15 uses a Wien Bridge network to generate a sine wave. The amplitude is stabilized via a low-current lamp. Figure 16 is a square-wave generator, in which the frequency can be controlled by any one of the passive component values. The circuit Fig. 17 is a function-generator that can generate both square and triangular waveforms.

R-E

## Choose from 31 Career Opportunities

### Get Your Specialized Associate Degree or Career Diploma at Home in Spare Time

Without attending college and with no previous experience, you can train for a money-making career. Send for free facts and color brochure on employment opportunities in the field that interests you most. See how easy it is to train at home for a great new career or advancement on your present job.



**CALL TOLL FREE 1-800-228-5300** Dept. DES29  
CALL ANYTIME—Operators to take your call 24 hours a day, 7 days a week. No cost. No obligation. No salesman will visit you.

OR MAIL COUPON TODAY! 495ZB

**ICS** International Correspondence Schools  
SINCE 1891 Dept. DES29 Scranton, PA 18515

Please send me free facts, color brochure and full-information on how I can study at home for the career I have chosen.

**CHECK ONE BOX ONLY!**

**ASSOCIATE IN SPECIALIZED BUSINESS DEGREE PROGRAMS**

Business Management  
 Accounting  
 Business Management with option in Finance  
 Business Management with option in Marketing

**ASSOCIATE IN SPECIALIZED TECHNOLOGY DEGREE PROGRAMS**

Civil Engineering Technology  
 Mechanical Engineering Tech.  
 Electrical Engineering Tech.  
 Electronics Technology

**CAREER DIPLOMA PROGRAMS**

High School  
 Auto Mechanics  
 Surveying & Mapping  
 Drafting  
 Air Conditioning & Refrigeration  
 Wildlife/Forestry Conservation  
 Police Sciences  
 Diesel Mechanics  
 Electrician  
 Small Business Management  
 Gun Repair  
 Electronics

Microcomputer Repair  
 Bookkeeping  
 Art  
 Motorcycle Repair  
 Catering/Gourmet Cooking  
 Computer Programming  
 Fitness & Nutrition  
 TV/VCR Repair  
 Photography  
 Journalism/Short Story Writing  
 Commercial Art

Name \_\_\_\_\_ Age \_\_\_\_\_  
Address \_\_\_\_\_ Apt. # \_\_\_\_\_  
City/State \_\_\_\_\_ Zip \_\_\_\_\_  
Phone ( ) \_\_\_\_\_

A Subsidiary of National Education Corporation

CIRCLE 187 ON FREE INFORMATION CARD

## NEW DO IT YOURSELF

NOW, you can easily make yourself your own PCB. Using CIF photo positive boards epoxy 1 side or 2 side, thickness 1/16". 5 year guarantee. Made in France. Very simple Process!



Standard sizes (inches)

3 x 5  
4 x 6  
6 x 9  
9 x 12  
9 x 14

Photo positive boards

1 side	2 side
\$ 2.00	\$ 2.70
\$ 3.30	\$ 4.40
\$ 6.60	\$ 8.80
\$ 13.20	\$ 17.70
\$ 15.40	\$ 20.60

end user prices

Military specifications MIL. P. 13949 F — UL 94 VO

# TSM

GENERAL DISTRIBUTOR  
PROSPECT ELECTRONICS  
PO BOX 9144 ALLENTOWN, PA 18105  
TEL.: (215) 770-9029  
RETAILERS WELCOME!

## CABLE - TV band - stop filters

- FOR ELIMINATION OF SEVERE INTERFERENCE
- FOR "CENSORING" OF ADULT BROADCASTS



- ATTENUATION - 45 dB TYPICAL
- BANDWIDTH - 4 MHz AT 5 dB POINTS
- INSERTION LOSS - 2 dB

MODEL	TUNING RANGE	FOR CHANNELS	PASSBAND	PRICE	SHIPPING/HANDLING
23H	50-66 MHz	2,3 (or 6 meter ham)	50-300 MHz	\$30	FREE
46FM	66-108 MHz	4,5,6 (or any FM)	50-300 MHz	\$30	FREE
1417	120-144 MHz	14(A) 15(B) 16(C) 17(D)	50-400 MHz	\$30	FREE
1822	144-174 MHz	18(E) 19(F) 20(G) 21(H) 22(I)	50-400 MHz	\$30	FREE
713	174-216 MHz	7,8,9,10,11,12,13	50-400 MHz	\$30	FREE

CALL FOR C.O.D. OR SEND CHECK TO ORDER.

SORRY, NO CREDIT CARDS

- SHIPPED WITHIN 3 DAYS
- 30 DAY MONEY BACK GUARANTEE
- QUANTITY PRICING AS LOW AS \$15 EACH

**Star Circuits**  
P.O. Box 8067  
Pembroke Pines, FL 33084  
(305) 572-2913

MARCH 1989

83

# AUDIO UPDATE

HX-Pro: A "new" and improved cassette-deck circuit.



LARRY KLEIN,  
AUDIO EDITOR

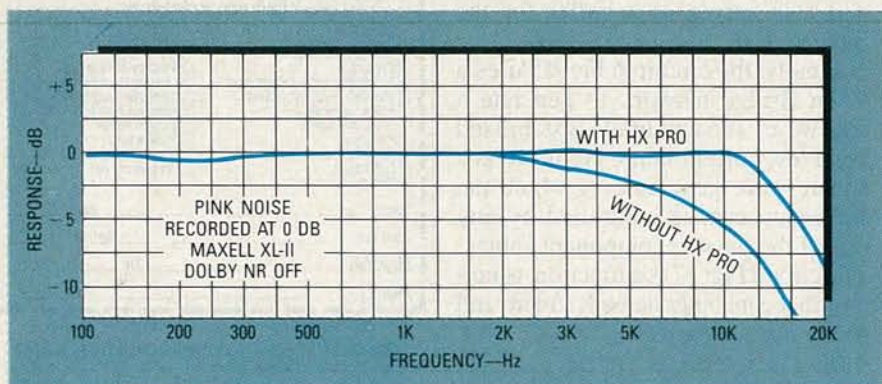

FIG. 1

IT'S BEEN 26 YEARS SINCE THE COMPACT Cassette—to use its full name—was introduced, and its evolution makes a fascinating story. I can remember the introduction of the first Norelco (Philips) unit. The book-size portable was originally promoted as a "sound camera"—the audio equivalent of the Kodak *Brownie*—that would make a handy way to record, for example, a baby's first gurgles as a sonic accompaniment for the pictures in a photo album. It was only later that Philips realized that they had a viable competitor to the increasingly popular prerecorded 8-track music format.

Considering the close connection between Dolby noise reduction and cassettes, readers may be surprised to learn that Philips initially was reluctant to permit Dolby-B noise reduction as part of the compact-cassette format. Philips felt that Dolby encoding conflicted with their goal of total compatibility—meaning the ability to play any Philips-licensed cassette

on any Philips-licensed cassette machine. However, in 1973 Philips finally saw the light—or heard the hiss—and signed an agreement with Dolby. Philips was actually Dolby's 39th licensee.

During the cassette's early days, no one, including Philips, dreamed that it would ever rival the performance of open-reel tape, the standard at that time. I include Philips in the group because the cassette machine itself would undoubtedly have had a somewhat different physical design if the original intention had been to maximize its fidelity potential.

Despite the built-in obstacles to high-fidelity performance, the designers of cassette decks and tapes have obviously worked miracles. I'm sure that some audiophiles will disagree, but it's been my experience that the better decks can copy most CD's well enough to confuse even careful listeners during an A-B comparison. (That being the case, I find the current recording industry uproar over

DAT dubbing very strange. Perhaps, as has been suggested, the DAT-dubbing battle is only the opening gun in a larger scheme to copyguard *all* tape machines. But I digress...)

When a new format or feature appears, it usually goes through a standard evolutionary process. Novel and/or beneficial technologies appear first in high-end units and then gradually trickle down to the bottom end of the line—of *everybody's* lines. Things happen that way because the new technology is usually developed with the help of an IC manufacturer, who grants no more than a year's exclusive to the original user. The next generation of equipment, from a wide variety of manufacturers, is likely to have the special IC or other component, assuming that it provides a worthwhile feature or performance improvement.

## The HX-Pro Story

For a variety of reasons, the sequence of events isn't always as I've just described. The circuit known as HX-Pro provides a good case in point. HX was originally developed by Dolby Labs and then improved by the Danish audio company, Bang & Olufsen (B&O), and called HX-Pro. It is essentially a high-frequency headroom-extension circuit that operates *only* during recording and does *not* require decoding in playback.

The operating theory of the HX-Pro circuit can be explained rather simply, although its implementa-

tion is somewhat complex. We are all aware that tape recorders employ a very-high-frequency bias signal to "condition" the tape in use for optimum recording performance. If the bias signal is set too low, distortion and over-emphasized highs result; if set too high, high-frequency audio signals aren't recorded properly. Other important parameters such as sensitivity, distortion, and maximum output are also affected—positively or negatively—by the bias level. The correct bias values in each machine are set internally by the manufacturer, and can be adjusted externally with the recorder's ferric/chrome/metal tape-type switch (plus a bias trim adjustment on some machines).

At some point, it was discovered that an audio signal with strong high frequencies actually reinforces the bias signal and results in a bias level that is higher than optimum for best performance. Although there are other unwanted effects, the most obvious audible result of the over-bias is a roll-off of

the high-frequency response. It won't help to lower the overall bias level to compensate for that effect, because then the tape will be under-biased most of the time.

The HX-Pro solution to the over/under-bias problem is to constantly monitor the level and frequency content of the input signal during recording. Then it automatically adjusts the internal bias level so that the total *effective* bias (which includes the contribution of the high audio frequencies) is optimized at all times.

Just as you don't have to be Jewish to appreciate Levy's rye bread, you don't have to understand bias theory to hear the improvement that HX-Pro provides. As illustrated in Fig. 1, HX-Pro makes it possible to record high-level high frequencies cleanly and accurately. In fact, to my ears, HX-Pro achieves a high-frequency performance with ferric- and chrome-equivalent tapes that many machines can barely manage with expensive metal tapes.

Why, then, hasn't HX-Pro be-

come as popular as Dolby B and C? Aside from the royalties that must be paid for its use, I suspect that: (1) At the time of HX-Pro's appearance, the Japanese already had a tremendous investment in metal tape, and hoped to sell a whole new generation of "metal-ready" machines; and (2) Why not save the HX-Pro feature until the sales of metal-ready machines have run their course? HX-Pro can then be introduced as the important new feature that will induce consumers to trade up.

This past year there have been several new cassette decks—all using a newly developed HX-Pro IC—from manufacturers who haven't been in the HX-Pro camp previously. I wish them luck with their products, because I find HX-Pro to be an elegant solution to a previously unrecognized—hence, unsolved—problem. HX-Pro does not require that the consumer buy premium tapes or set additional knobs, and it produces tapes that can be played back with appreciable benefit on *any* machine. R-E



# FIX VCR's

**Three out of four VCR repairs are due to a mechanical problem**

Tentel's universal gauges allow you to quickly and easily diagnose these mechanical problems. Fix machines faster, better and easier. Prevent costly customer returns and dissatisfaction. Tentel's four test instruments will accurately analyze various torques, tensions, head wear, guide height, spindle height and many checks that factory gauges can't do.

VCR repair is the eighth fastest growing business in the U.S. If you're going to be competitive in this dynamic field, these gauges are essential. Current users tell us these are the only mechanical gauges they use or need!

**(800) 538-6894**

1506 Dell Avenue  
Campbell, CA 95008 In Calif-(408) 379-1881



CIRCLE 186 ON FREE INFORMATION CARD

## NOISE REDUCTION FOR UNDER \$10.

MIXING CONSOLES

SWITCHES

MICROPHONE CONNECTORS

SNAKE CABLES

BATTERY CONTACTS



**GRAMOLIN®**

PLUGS & JACKS

PATCHBAYS

FADERS, POTS

TERMINAL STRIPS

SPEAKER TERMINALS

**CRAMOLIN®**

Even the finest equipment in the world cannot guarantee noise-free operation. One "dirty" connection anywhere in the electrical path can cause unwanted noise or signal loss.

**"MORE THAN A CONTACT CLEANER"**

**CRAMOLIN®** is a fast-acting, anti-oxidizing lubricant that cleans and preserves all metal surfaces, including gold.

When applied to metal contacts and connectors, **CRAMOLIN®** removes resistive oxides as it forms a protective molecular layer that adheres to the metal surfaces and maintains maximum electrical conductivity.

**CRAMOLIN® - USED BY THOSE WHO DEMAND THE BEST:**

Bell & Howell	Hewlett Packard	MCI(Sony)	Nakamichi
Boeing	John Fluke Mfg.	Motorola	RCA
Capitol Records	McIntosh Labs	NASA	Switchcraft

SINCE 1956

**CAIG LABORATORIES INC.**

1175-O Industrial Ave., (P.O. Box J) - Escondido, CA 92025-0051 U.S.A. • (619) 743-7143

CIRCLE 50 ON FREE INFORMATION CARD

MARCH 1989

Get A Complete Course In

# ELECTRONIC ENGINEERING

8 volumes, over 2000 pages, including all necessary math and physics. 29 examinations to help you gauge your personal progress. A truly great learning experience.

Prepare now to take advantage of the growing demand for people able to work at the engineering level.

Ask for our brochure giving complete details of content. Use your free information card number, or write us directly. **\$99.95**, Postage Included. Satisfaction guaranteed or money refunded.



**Banner Technical Books, Inc.**  
1203 Grant Ave.  
Rockford, IL 61103

CIRCLE 179 ON FREE INFORMATION CARD

## NEW SUPER LONG PLAY TAPE RECORDERS

12 Hour Model — \$119.00\*

Modified Panasonic Slimline, high quality, AC-DC Recorders provide 6 continuous hours of quality recording & playback on each side of cassette for a total of 12 hours. Built-in features include:  
• Voice level control. • Digital counter, etc. TDK DC 120 Cassette Furnished.



### PHONE RECORDING ADAPTER

Records calls automatically. All Solid state connects to your telephone jack and tape recorder. Starts recording when phone is lifted. Stops when you hang up. **\$24.95\*** FCC APPROVED



### VOX VOICE ACTIVATED CONTROL SWITCH

Solid state. Self contained. Adjustable sensitivity. Voices or other sounds automatically activate and control recorder. Uses either recorder or remote mike. **\$28.50\***



\*Add for ship & hdig. Phone Adapter & Vox \$1.50 ea. Recorders \$4.00 ea. Cal. Res. add tax. Mail order, VISA, M/C, COD's OK. Money Back Guarantee. Qty. disc. avail.. Dealer Inquiries Invited. Free data. ©  
**AMC SALES INC.** Dept A9335 Lubec St., Box 928, Downey, CA 90241 Phone (213) 869-8519

CIRCLE 108 ON FREE INFORMATION CARD

## HARDWARE HACKER

continued from page 28

sic or whatever well ahead of any volume controls and then further squash it with a log amplifier, an automatic gain-control circuit, or some sort of compressor or compander. Those compressor chips used by citizens-band radio will often work just fine, as should those companding "telephone" style A/D converters.

to handle on a real-time basis, although comb filtering or real-time digital signal processing spectral analysis surely could give spectacular results.

For live music, having a separate pickup for every instrument can work out well. In general, the more channels and the better their separation, the better your final results. Use stereo at the very least.

Sixth, and finally, a static lighting display is a no-no. Either the lamps themselves or their mirrors, their

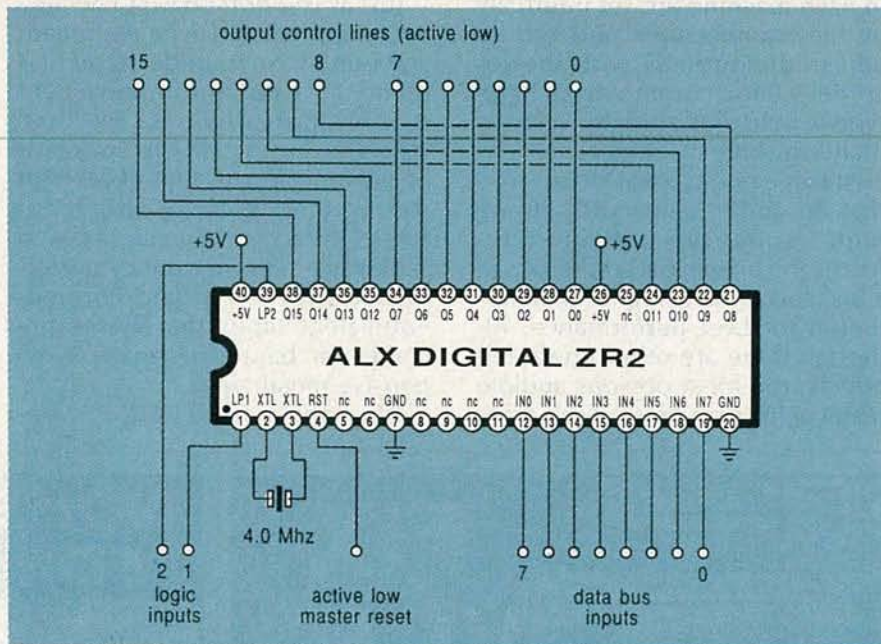

FIG. 5—THE ZR2 "DISCO CHIP" is programmable to handle many light chasers, zoners, and AC/DC dimmers, along with various other counting and control tasks. It is based on a programmable peripheral interface.

Fourth, most lamps get yellow and yellow as they are dimmed. For the best results, only absolutely outstanding color filters should be used. Good choices are dichroic filters built into the lamp, or else theater-quality acetates that are doubled or tripled up. Laser light, of course, provides the ultimate in pure color effects. Let me know if you find a cheap blue laser.

Fifth, your filters that separate the audio spectrum should have large "black holes" or guard bands in them, so the lights tend to respond to certain instruments, rather than responding to the total audio level. Ideally, you would like to include some sort of a multi-voice phase-lock audio tracker that would link one particular color to one certain instrument. That can get nasty and expensive

diffusers, or their reflectors, should slowly and continuously reposition themselves.

Let me hear from you if you've done anything in this area or have any similar ideas.

### A new disco chip

There's several obvious ways to go about building your computer-controlled lighting system. One would be to model what you want on the Commodore 64. Another would be to use an Apple II Plus, which should be able to completely control even the most complex lighting system that you could possibly dream up, given some simple and easily changed machine-language EPROM driver modules.

Another route would be to go with the BSR-type X-10 modules,

but they are rather slow-acting in their dimming modes, and the costs will get out of hand if lots of lamps are involved. Multiple commands at once could also create hassles.

I'll leave details on this to Steve Ciarcia, who gave you all the BSR fundamentals way back in the September 1980 issue of **Radio-Electronics**, and to his ongoing X-10 projects in his new *Circuit Cellar Inc* hacker magazine.

Or, you could use the fantastic *Mitsubishi M50734* controller chip. That jewel does have bunches of on-board I/O all ready to go and is one incredible piece of silicon. It should also be possible to work up custom dimmer/controller chips out of various PLA, PAL, or PLD chips whose costs are now down in the \$3 range. Any of those alternatives would make a really great **Radio-Electronics** construction project.

There is also a brand-new *ZR2 Disco Chip* integrated circuit now available from *Alx Digital*. That is based on a programmable peripheral controller circuit and costs around \$30 in singles. It may be used singly or in groups, with or without a personal computer.

Figure 5 shows you some of the details. There are twelve main operating modes, which get chosen by inputting a binary word on the input lines and then resetting.

Modes one through four are for chasers or zoners with controllable speed that may be run manually or automatically, on either a one-shot or a continuous basis.

Mode five sets up a master/slave situation where a master ZR2 can serially control many others. Mode six lets you turn groups of lights on or off under command of an input control byte. Mode seven is similar, except that it accepts a wire-saving one-line serial input.

Modes eight and nine are used to give UART-like features to the ZR2 with mode eight being the transmitter and nine the receiver.

Mode ten is just a simple pulse counter, while mode eleven acts as a "DC" light dimmer, based upon pulse-position modulation.

Mode twelve is a full "AC" phase dimmer that can dim and brighten an incandescent lamp, all at variable speeds. The mode requires a

120-Hz power line reference input for synchronization.

While this disco chip is certainly innovative and can do interesting things, it does seem to have a few rough edges here and there. I guess I would personally opt for machine-language software or else firmware instead of a dedicated peripheral-circuit to do many of the tasks. The EPROM-based firmware would often be far cheaper, more powerful, and more flexible.

### New tech lit

A lot of new technical "literature" is now coming out on floppy disk, rather than printed in some catalog. *Motorola* is a major innovator here with their new and free *Specs in Secs* data disks and selector guides. Other examples include that free *Introduction to Programmable Gate Arrays* by *Advanced Micro Devices* and the also free *MacroChip Demo* from *Ferranti Interdesign*.

The future, of course, lies in the CD-ROM distribution of data and tech info. Apple Computer has an unbelievably good offer. For \$15 each and one-week delivery, they will line you up with firms that manufacture custom CD-ROM disks especially for you. The only minor gotchas are that you are limited to a trifling 80 megabytes maximum, that you have to buy one hundred identical disks at a time, and that you can only do that once.

Turning to traditional data books, the "heavies" attacked in force this month. Do check out *Texas Instruments* for their new and must-have *1988 TTL Logic Data Book*, and for their *1988 Programmable Logic Data Book*. And that new *Intersil Component Data Catalog*, along with *Integrated Circuits for Linear Applications* from *GE Solid State*.

The *SGS-Thomson* folks have a free new *Shortform Products in Production* catalog out. Included between the covers are an incredible variety of offbeat and oddball integrated circuits having outstanding hacker potential.

Ten different free sample *idea kits* are available from the *Caplugs* people, who make all types of low-cost plastic caps and plugs, netting, edge liners, and such. There

# STRANGE Electrical Books

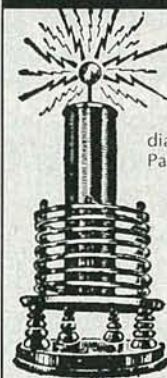

## TESLA COIL SECRETS!

Page through the private notebooks of a builder of lightning bolt generators! Incredible diagrams and secrets! Rare info! Paperback book. Only \$6.95

## HAMMARLUND Shortwave Manual!

Build 12 different hot shortwave receivers from this 1937 construction manual. Photos, diagrams, text! Wall-to-wall how to! Only \$4.95

## MUCH MORE!

Other great books on getting high power from auto alternators, run three phase motors on single phase, high voltage projects, perpetual motion, Tesla's lost inventions, magnets, unusual electrical instruments, lightning bolt generators, and much more!

## Experimental Science

Incredible two volume set from 1906. Build cameras, phonograph, hydraulic ram, Geissler tube, microscope, batteries, lenses, much, much more. Classic how-to reference. Over 1000 pages. Two volume set only \$34.95!

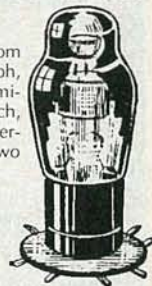

## OFFICIAL 1934 Shortwave Manual

Build simple but powerful shortwave radios from plans in this 1934 handbook. Includes new chapter showing how to use transistors to replace tubes! Heavily illustrated paperback! Excellent! Only \$14.95

## MANY OTHERS:

Static Electricity \$5.95, Electrical Designs \$11.50, Experimental Physics \$23.95, Storage Batteries \$8.95, Power Inverter Technology \$4.00, Armature Winding & Motor Repair \$16.95, 50 Perpetual Motion Mechanisms \$3.75, more! See Catalog!



## ORDER FROM THIS AD TODAY!

Check, MO, Visa, MC. Handling: 75¢ first book, 25¢ each additional. Money-back guarantee.

## OR WRITE FOR A CATALOG!

Write for your copy of Lindsay's unusual Electrical Books catalog and see for yourself what you've been missing! Send \$1.00 (US & Canada) or \$3.00 foreign airmail. We'll send your catalog immediately! Write today!



## Lindsay's Electrical Books

PO Box 12-WA5, Bradley IL 60915

Send the books marked and a free catalog!

Send just a catalog! \$1.00 enclosed...

Name \_\_\_\_\_

Address \_\_\_\_\_

City \_\_\_\_\_ St \_\_\_\_\_ Zip \_\_\_\_\_

# HAMEG® Instruments

## Top equipment for top engineering

Our line of high quality measuring instruments offers a full range of outstanding features and unbeatable price/performance standards.

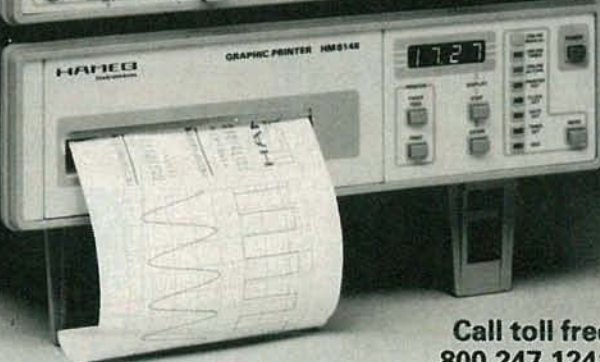
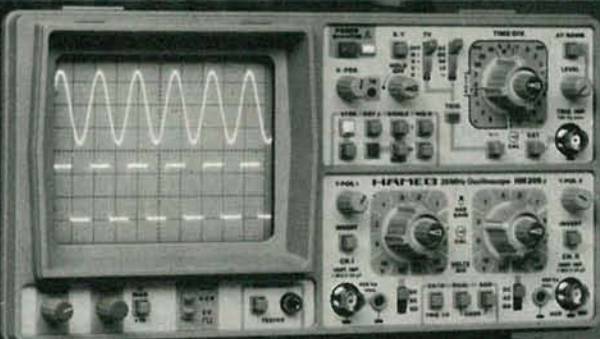

Call toll free  
800.247.1241

## HAMEG INC.

88-90 Harbor Road  
Port Washington NY 11050  
Phone (516) 883-3837  
Telex (023) 497.4606  
Telefax (516) 883-3894

4790 Wesley Drive  
Anaheim CA 92807  
Phone (714) 970-9575  
Telefax (714) 970-0328

## HARDWARE HACKER

continued from page 87

are oodles of off-the-wall hacker uses for them. Start with idea kit number 12, and see what kind of ideas you can come up with.

A *Power Measurement Handbook* has been issued by RFL, while data sheets on low-cost ultra-violet flame-detector sensors are available from *Hamamatsu*.

Turning to my own products, if you are at all into setting up your own small-scale technical or craft business, do check out my classic *Incredible Secret Money Machine* book. Plus our usual reminder that we are now shipping autographed copies of all our *Hardware Hacker* reprints volume II, and my *Ask the Guru*, volume I and II.

As always, this is your column and you can get technical help and off-the-wall networking per the usual help box. Be sure to see the *Names and Numbers* sidebar for further info on any of the products or services mentioned. R-E

Try the

**Radio  
Electronics**  
bulletin board  
system

(RE-BBS)  
516-293-2283

The more you use it the more useful it becomes.

We support 300 and 1200 baud operation.

Parameters: 8N1 (8 data bits, no parity, 1 stop bit) or 7E1 (7 data bits, even parity, 1 stop bit).

Add yourself to our user files to increase your access.

Communicate with other R-E readers.

Leave your comments on R-E with the SYSOP.

RE-BBS  
516-293-2283

# ATTENTION! ELECTRONICS TECHNICIANS

EARN YOUR  
**B.S.E.E.  
DEGREE**

THROUGH HOME STUDY

Our New and Highly Effective Advanced-Placement Program for experienced Electronic Technicians grants credit for previous Schooling and Professional Experience, and can greatly reduce the time required to complete Program and reach graduation. No residence schooling required for qualified Electronic Technicians. Through this Special Program you can pull all of the loose ends of your electronics background together and earn your B.S.E.E. Degree. Upgrade your status and pay to the Engineering Level. Advance Rapidly! Many finish in 12 months or less. Students and graduates in all 50 States and throughout the World. Established Over 40 Years! Write for free Descriptive Literature.

**COOK'S INSTITUTE**  
OF ELECTRONICS ENGINEERING



4251 CYPRESS DRIVE  
JACKSON, MISSISSIPPI 39212

CIRCLE 58 ON FREE INFORMATION CARD

## Employers

Willing workers available now at as little as 1/2 your usual cost.

This is your chance to get help you've needed, but thought you couldn't afford.

No business too large or too small. Call your private industry council or write **National Alliance of Business**, P.O. Box 7207, Washington, D.C. 20044

A Public Service of  
This Publication  
**Ad  
Council**

# COMPUTER DIGEST

VOL. 6 NO. 3 MAR. 1989

A NEW KIND OF MAGAZINE FOR ELECTRONICS PROFESSIONALS

## SPICE UP YOUR HOME VIDEOS

Using the Amiga for video post production Page 93

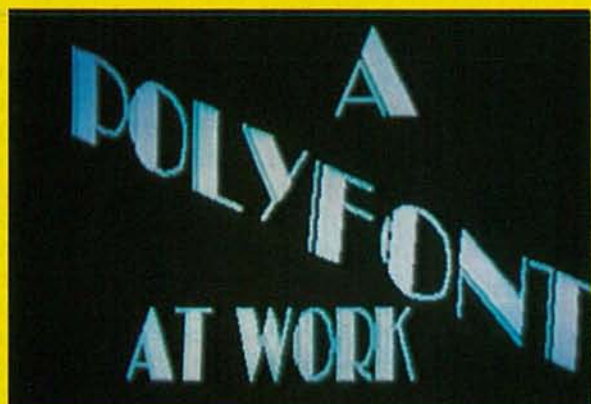

## DIGGING DEEPER INTO THE '386

Bus timing and Peripheral devices

Page 98

# EDITOR'S WORK- BENCH

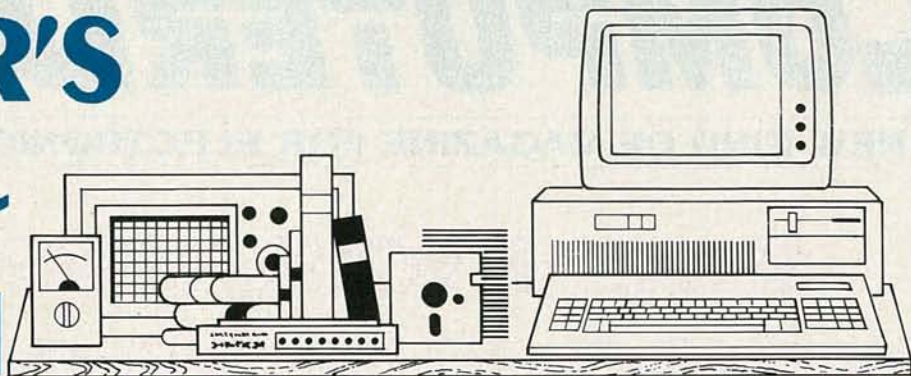

## Smart RS-232 Data Meter

**R**S-232 interfaces are the bugaboos of systems installers and maintainers. Add a new PC, printer, or modem to your system, and you'll have a lot of fun as you try to get various devices talking together via the supposed "standard."

The Smart Data Meter (Fig. 1) from IQ technologies can go a long way toward reducing serial-interface headaches. It contains built-in intelligence that helps you figure out how devices without documentation are set up (baud rate, number of data, start, and stop bits), verify the setup of a supposed "known" device, determine whether a device is DTE (Data Terminal Equipment such as a serial terminal or the serial port of a PC) or DCE (Data Communications Equipment such as a printer or modem), etc.

The Smart Data Meter is a light, hand-held device not much larger than a pocket calculator. It contains a microprocessor and a 40-character LCD display, and runs off a single nine-volt battery, good for 30 hours of use. The

meter turns itself off after about a minute of disuse, thereby showing one of the ways in which it lives up to the name *Smart*.

To use it, you plug one end of an interface cable into the meter. For connection to your computer, modem, etc., the other end has a 25-pin male D connector, and a switch that changes the device between DTE and DCE. A female-to-female gender changer is also included.

A single switch to the left of the LCD display controls all operations. After plugging in the interface cable, press the switch once, and a menu appears. Press and release the switch to move from item to item in the menu; press

and hold the switch to select an item.

The menu allows four types of operations: Read, Scan, Parm, and Print. The Read function allows you to connect the meter to an unknown output device and determine its operational parameters (baud rate, etc.). Just connect the meter and send something out of the serial port. In a few seconds the meter will show a sample of the data you sent along with the baud rate and other parameters. If nothing shows up, flip the DTE/DCE switch and try again.

In the Scan mode, the meter sends strings of characters to a receiving device at all common

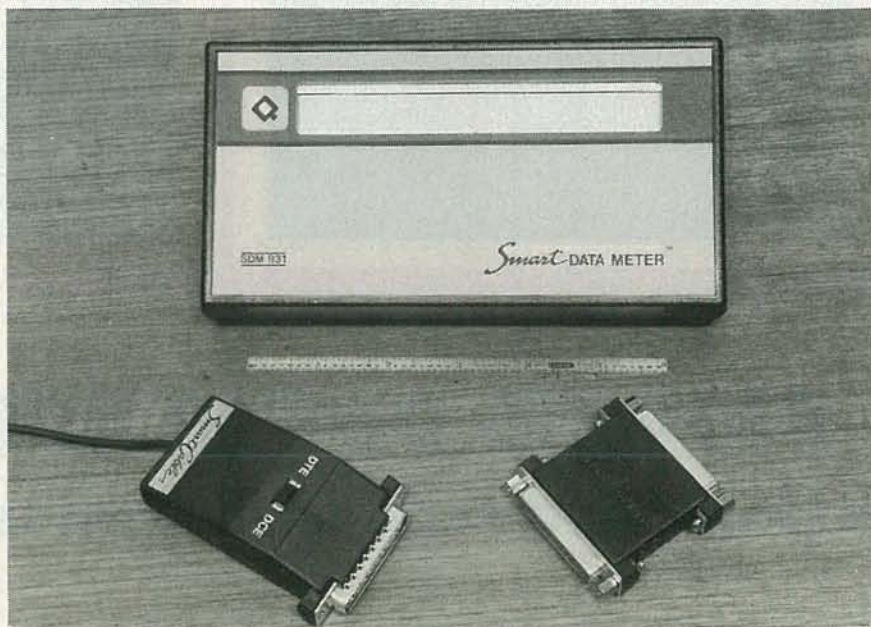

FIG. 1



baud rates from 75 to 19,200, and with various numbers of data bits, etc. This mode is particularly useful with a printer, because when the correct combination is hit upon, the printer will actually print the setup information for you.

The Parm mode allows you to set the operating parameters for the Print mode. In the Print mode, a reference string of characters is sent according to the parameters that are set in Parm mode. Depending on how a device handles the eighth data bit and the stop bit(s), more than one setting may display correctly in the Scan mode. You can use the Parm and Print modes to zero in on the correct setup.

I used the Smart Data Meter to help solve an interface problem. I was trying to connect several computers to a multi-port printer buffer. The parallel input and output worked fine, but (naturally) I couldn't get the serial input to work. But where was the problem? In the printer buffer? In the PC driving it? The meter helped me discover the problem quickly, potentially saving several hours of time.

At about \$400, the Smart Data Meter is too expensive for hobbyist or occasional use. But for technicians and systems integrators, it should quickly pay for itself.

The meter comes with a padded carrying case with a belt loop, and a miniature 12-page manual. The manual won't win any awards for clarity of writing, but the meter is so easy to operate that it really doesn't matter.

My main complaint is that the Smart Meter should have an LED or two to indicate line activity. It's a bit disconcerting to connect the meter and see no indication whatsoever that the device under test is alive.

Also, the Print mode would be more useful if the Smart Meter sent a more complete set of characters. It should send at least the 96-character ASCII set (32-127), and provide options for sending the IBM extended characters, or even all 256 possible values.

Further, a monitor mode in

which each received character was displayed in hex and ASCII would be very useful for debugging things such as printer and dumb-terminal drivers.

If you do much serial interfacing, check out the Smart Data Meter—you won't be disappointed.



### Dots and Vectors

**I**t used to be that there were two types of graphics programs for PC's: those that generate dots and those that generate vectors.

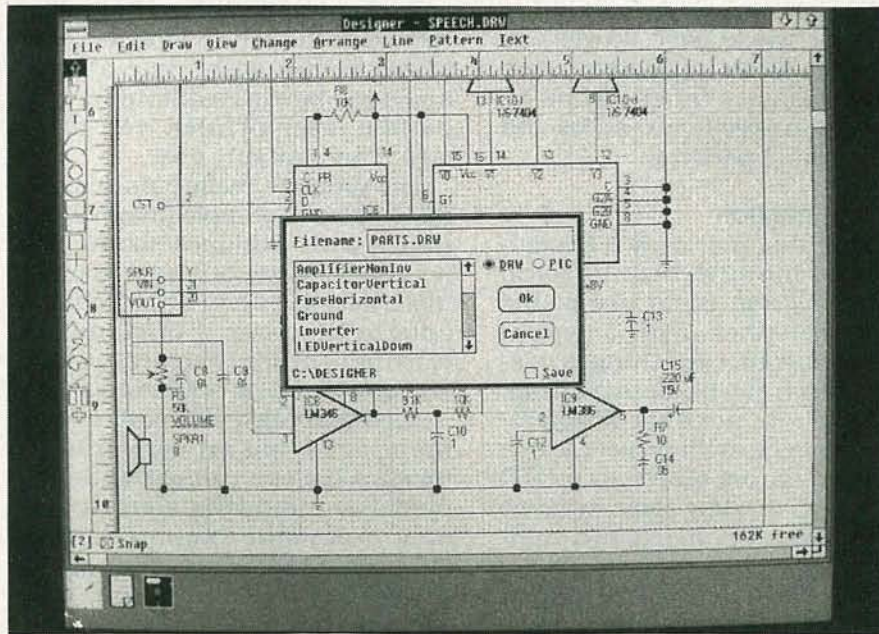

FIG. 2

Dot programs include Dr. Halo, the paint program that comes with Windows, etc. Vector programs include most CAD packages (AutoCAD, for example).

Dot programs differ from vector programs in that the images created in a dot program are not modifiable in the way in which they were created. For example, when you create a circle in a dot

program, each point along the circumference becomes a dot on the screen that has no particular relation to any other dot on the screen. So you can't change the diameter of the circle simply by specifying a new diameter; instead, you must delete the old circle dot by dot and draw a new one.

In a vector program, by contrast, a circle is a circle is a circle. You can modify that circle at any time by selecting it and stretching it.

At the user level, paint programs tend to sport spiffier, more intuitive, icon-based interfaces, whereas CAD programs tend to rely on text-based menu systems that are much harder to learn and operate.

In the past few years, however, several programs have appeared that attempt to combine the best features of both. Adobe Illustrator (for the Macintosh) is probably the best-known pro-

gram of its type; a relatively new entry for the IBM family is called Designer, seen in Fig. 2.

Designer runs under Windows, so right away you know it needs a fast 286 or 386 with megabytes of memory, a speedy hard disk, and a mouse or other pointing device. The program can run in lesser configurations, but you'll need lots of patience to do so. Designer

comes with a run-time version of Windows, but to take maximum advantage of the Windows environment, you'll probably want the full retail version.

Designer provides a dot-style user interface with vector-style drawing elements. Like a paint program, Designer presents a menu of icons along the left side of the screen. By clicking on an icon, you can select various drawing tools: line, circle, ellipse, square, rectangle, polyline, parabola, pie chart, as well as special tools for selecting objects in various ways, rotating them, inserting objects from the clipboard, and zooming.

In addition, Designer has nine CAD-like drop-down menus that function according to the Windows standard. The Draw menu duplicates the tools in the icon menus. Other icon equivalents appear in the Edit and View menus. The File menu allows you load, save and print files; the View menu allows you to view the current drawing at actual size, to view the whole page, to view all pages, to zoom, to change rulers and grids, etc. Other menus allow you to specify text styles and background patterns.

### A little intuition

One thing that makes Designer more intuitive than a typical CAD program is its use of the page metaphor. With a typical CAD program, everything is relative, which can be disconcerting. Although it's not difficult to proportion items with respect to one another on the screen in a CAD program, it takes some practice to get things proportioned right on paper.

With Designer, you specify a page size before starting a drawing, and are constantly aware of it while working. A single drawing file can contain numerous pages; conversely, a single drawing can extend across several pages. An item in the View menu allows you to see a grid of thumbnail views of several pages, depending on your video system (54 pages shown on a VGA system).

The page metaphor helps you conceptualize how a drawing will fit on a page. And drawings that

spill over onto other pages can be printed separately, and then pasted together manually. The size of the page depends on your printer.

A nice feature of Designer is the way it allows you to create libraries of symbols—electronics symbols, for example. Other CAD and drawing packages have the same basic capability, but creating a symbol library and providing a clean way of getting at the symbols can be extremely time consuming, unless you buy a commercial add-on product.

In Designer, any drawing can function as a "library." Just group a set of drawing primitives (a circle, some lines, and an arrowhead for a transistor, for example), and give the collection a name. Later, when you need a symbol, you can call it up by name using either a Windows dialog box, or visually by opening an on-screen window and copying it with the pointing device. Both methods work well.

Most CAD packages come with only a few text fonts, and typically they're not much to look at. Designer comes with quite a few, and if you have a PostScript-compatible laser printer, you can create high-quality text.

The program really cuts across disciplines. A sample image that comes with Designer shows its potential for creating advertising materials, but I had little trouble (after getting over a brief initial learning "hump") creating several good-looking schematics.

Micrografx also sells quite a few libraries of clip art (pre-drawn images that you can use as-is or modify), including electrical, electronics and computer symbols, as well as 3-D renderings of devices like resistors, tuning capacitors, IC's, etc.

The program has its faults. For example, in most CAD programs, you can zoom up or down by entering a percentage (50%, 200%), by boxing in the desired area, etc. Designer only allows the box method, and often allows only two zooms before you must return to the full-page view and start over.

Some operations are cumbersome. Changing layers, for example, entails opening a menu,

opening a dialog box, specifying the desired layer, and then clicking an OK button. That can easily add up to half a dozen clicks and seconds of time. There should be a faster way.

Overall, though, the program works well. In an engineering firm, Designer would be equally at home in the marketing department and in the engineering department. It runs under Windows, so integrating technical drawings with desktop-published material is a snap. With PageMaker and Designer, technical manuals and catalogs would be child's play.

In short, it's nice to find a product that can do so much, that really is fun to use.

### New from Borland

**T**urbo Pascal created a revolution in the programming world when it was introduced in 1983. An in-memory editor/linker/compiler that ran in a 64K CP/M machine was not only unbelievable, but impossible!

It took a while, but Borland eventually made believers out of thousands of programmers.

Version 5.0 of the now-venerable Turbo has just been introduced, and it finally has what we've been clamoring for for years: an integrated debugger. No more awkward or inconvenient add-ons; now Turbo does it all. Borland is also introducing a new version of Turbo C (2.0) that has an integrated debugger.

Further, the company is introducing a stand-alone Turbo Assembler & Debugger that provides source and assembly-level debugging, virtual-mode support on 80386-based PC's, remote debugging via an RS-232 line, and numerous other features. Turbo Assembler & Debugger can be purchased separately or discounted in combination with Turbo Pascal or C.

Lack of a debugger has long given Microsoft's Quick products a leg up on Borland's Turbo products. Now the software Goliath had better watch out for this pesky David.



# COMPUTER AIDED VIDEO

*Add pizzazz to your home videos! Here's how to assemble and use a video post-production system on the Amiga 2000.*



**KAREN D. MORTON &  
WALTER M. SCOTT III**

**I**n this IBM-dominated world, not everyone knows that an Amiga computer is a powerful tool for video production. However, with the right tools, you can:

- Create special effects. For example, you can superimpose a computer-generated spaceship over a picture of your house.
- Add titles to your home videos.
- Transfer "then" and "now" photos of your high school class onto videotape, superimposing names over photos.
- Create your own MTV-like music videos.

The process of creating those types of videos is fairly simple, but you need the right equipment and techniques. Unlike editing film and audio tape, editing videotape involves no cutting and splicing. Instead, you copy only those portions you want from raw footage onto a master tape. Adding an Amiga 2000 computer allows titles, graphics, and even animation to be superimposed on your videos.

In this article, we will introduce you to a video post-production system that can be used by either the advanced hobbyist or the low-end professional.

## System components

The post-production system described in this article requires these twelve components:

- Camera
- VHS editing system (two VCR's and a controller)
- Special-effects switcher
- Computer genlock
- Amiga 2000 computer
- RGB/NTSC computer monitor
- TV set
- Audio cassette deck
- Microphone
- Audio mixer

The camera can be a camcorder or video camera; it must produce NTSC video and line-level audio outputs. You use the camera to shoot live video and for transferring photos and slides to videotape.

Our editing system consists of the two VHS editing VCR's and a controller. The two Panasonic AG-1950 VCR's are shown in Fig. 1, but any pair of editing VCR's should do. The Panasonic AG-A95 controller is shown in the bottom of Fig. 2. One VCR serves as the source (player) and the other serves as the destination (recorder). The Panasonic system allows precise edits with a resolution of +4 and -7 frames. It also uses flying erase heads to generate clean edits without a rainbow effect. In addition, a large "jog/shuttle" knob allows precise positioning of the tape during editing. Once the beginning (inset) and ending (outset) edit points are selected, the controller auto-



matically queues the VCR's and performs the edit (copies from the player to the recorder). Alternatively, you can perform edits manually using the controls provided on each VCR.

One limitation is that the Panasonic AG-1950 has a mono (not stereo) soundtrack. However, a TV set connected to the destination VCR's RF output delivers only mono sound anyway.

The special-effects switcher (the middle of Fig. 2) performs fades and wipes to black in addition to switching between the camera and the source VCR.

To transfer titles and graphics from the Amiga to videotape, a device called a genlock is required. A genlock converts the computer's RGB video output into NTSC-standard video suitable for recording. The genlock also adjusts the computer's sync pulses to coincide with those from an external video source, either your source VCR or your video camera.

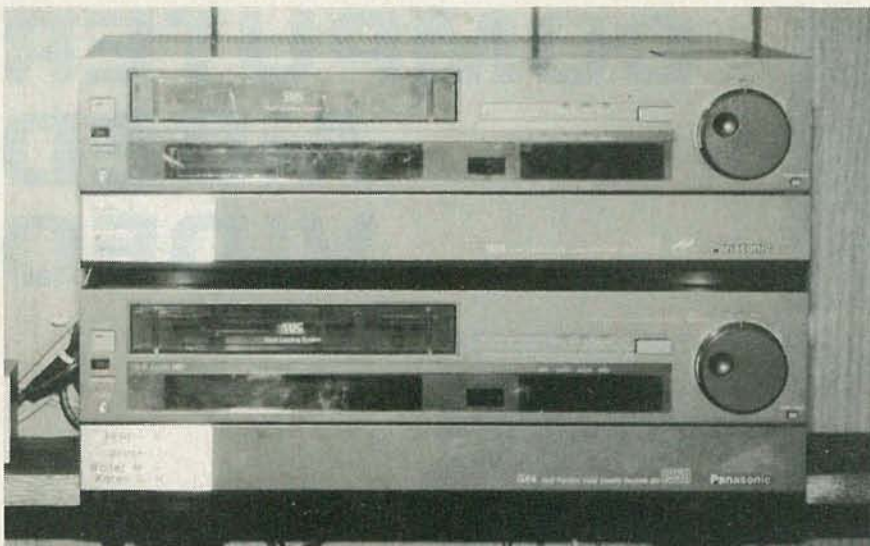

**Fig. 1** THE TWO EDITING VCR's have special features that make editing videotapes a lot easier.



**Fig. 2** THE SUPERGEN GENLOCK (top) has manual sliders for graphic fades. The Radio Shack special effects generator (middle) does fades and wipes to black, in addition to switching between two sources. The Panasonic controller (bottom) queues the VCR's for automatic edits.

We use the *Supergen* genlock by Digital Creations, because, in addition to producing a broadcast-quality signal, it has sliders for the manual control of foreground and background graphics and video dissolves. It is shown in the top of Fig. 2. The *Supergen* also comes with software to allow the Amiga to control the sliders.

We use a Commodore 1084 RGB/NTSC computer monitor to view the RGB output of the com-

puter as well as the NTSC video from the source VCR. Switching between the two is accomplished via a front-panel button.

The television set monitors the signal from the destination VCR.

An audio mixer controls sound from three sources. First is source audio (camera or VCR, as determined by the special-effects switcher). Second is the audio cassette deck, which is used for dubbing music from an audio cassette onto videotape. Third is

the microphone, which can be used for live narration and sound effects. We use a home-built mixer, but numerous mixers are available commercially.

We use two software packages to generate graphics and titles. First is *DeluxePaint II*, which we use to create static (non-moving) graphic images. With "color cycling," you can simulate simple animation.

We use *Aegis Videotitler*. That program uses both built-in Amiga fonts and its own "poly fonts," which can be skewed, enlarged, shrunk, or distorted. *Videotitler* can use its own backdrop

### Product Information

#### Hardware

Panasonic AG-1950 editing deck

Panasonic AG-A95 controller  
Panasonic Industrial Company,  
One Panasonic Way, Secaucus,  
NJ 07094, (201) 348-7000

Amiga 2000 computer  
Commodore 1084 RGB/NTSC  
Monitor  
Commodore Business Machines,  
1200 Wilson Drive, West  
Chester, PA 19380, (215)  
431-9100

Supergen genlock  
Digital Creations, 1333 Howe  
Avenue, Suite 208, Sacramento,  
CA 95825

Radio Shack model 15-1274  
Special Effects Switcher  
Radio Shack, 500 One Tandy  
Center, Ft. Worth, TX 76102

#### Software

*Aegis Videotitler/Video SEG*  
Aegis Development, 2210  
Wilshire Blvd., Suite 277, Santa  
Monica, CA 90403, (213)  
392-9972

*DeluxePaint II*  
Electronic Arts, 1820 Gateway  
Drive, San Mateo, CA 94404,  
(415) 571-7171.

*DeluxeHelp*  
RGB Video Creations, 2574  
PGA Blvd., Suite 104, Palm  
Beach Gardens, FL 33410,  
(305) 622-0138.

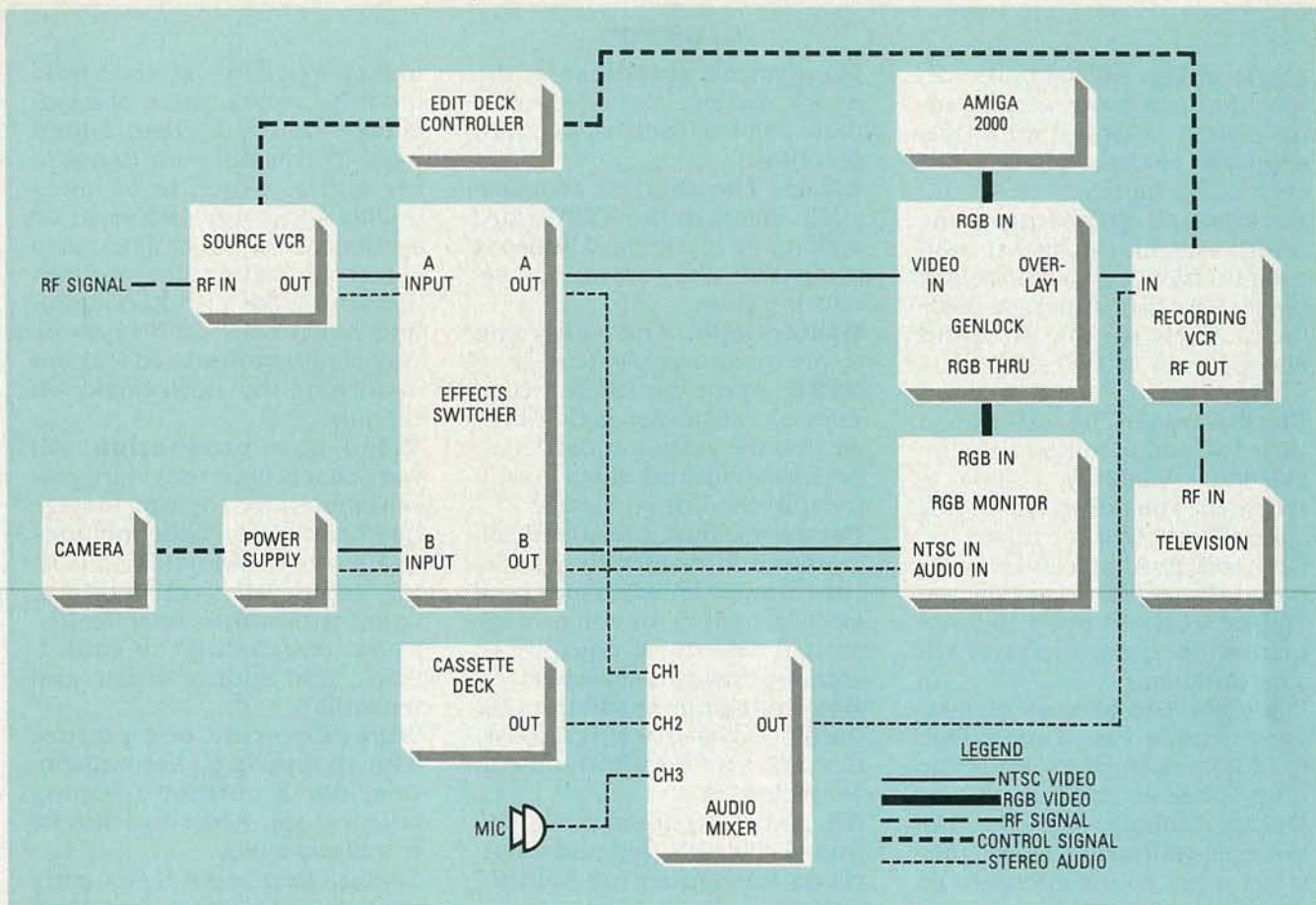

**Fig. 3** A COMPLETE VIDEO POST-PRODUCTION system can be set up for home use at reasonable cost.

(a graphic screen placed "behind" the titles), or it can use a backdrop created in another program—DeluxePaint II, for example.

We also use Aegis Video SEG (Special Effects Generator), which comes with the Videotitler, to arrange a series of graphic screens into a slide show. Each screen can be linked to the next by a variety of transitions, including dissolves, collapses, wipes, and scrolls.

### Hooking it all up

Figure 3 shows how the equipment connects together. Before making any connections, thoroughly familiarize yourself with the Panasonic editing system and with the Amiga/genlock setup. Also, consider the physical layout of the equipment. The controls you'll use most often should be easy to reach. Of course, you have to be sure to switch off all equipment while making connections.

Except for the RF connections, which use 75-ohm coax with F-connectors, the system interconnections use shielded patch cords with RCA phono plugs on each end. You'll also need some BNC to RCA adapters, because both the Panasonic VCR's and the genlock use the BNC types.

Although the genlock is supposed to lock out non-NTSC signals, we've found that snow and other garbage tend to scramble the image on the computer monitor's screen. To cancel that noise, connect an RF signal (a cable-TV feed, for example), to the RF input on the source VCR. That gives the genlock an NTSC signal to lock onto when the source VCR is on but not playing a tape. To avoid the external RF source, you could also play a tape in the source VCR at all times, or simply turn the source VCR off whenever you stop the tape. The RF signal also solves a similar problem with the special-effects switcher.

We use a Radio Shack model 15-1274 for the special-effects switcher. It has A and B inputs; A is the default (the input that the unit switches to when power is first applied). Video and audio from the source VCR should feed the A input, and video and audio from the camera should feed the B input.

The device also has A and B outputs, which are simply wired in parallel. Connect the A video output to the video input on the genlock, and connect the B video output to the monitor's CVBS (NTSC) video input.

Push the VCR button on the rear of the monitor, connect the switcher's A audio output to channel 1 on the audio mixer and the B audio output to the audio input on the monitor. Next, using a Y adapter, combine the left and right audio channels and connect that signal to the monitor's mono audio input. The RGB input on the monitor should have been connected

## GLOSSARY

**Audio mixer:** An electronic device that combines several audio signals. A typical mixer has separate volume controls for each audio input.

**Background graphics:** In the Amiga system, the background color is Color 0, which is usually black. On the Supergen genlock, when the background slider is set at 0%, color 0 is transparent.

**Control track:** The VCR puts a series of timing pulses onto the videotape whenever a signal is recorded. The pulses reside in a special section of the tape.

**Controller:** A microprocessor-based device that controls two editing VCR's in order to automatically perform a series of editing functions.

**Dissolve:** The process of double-exposing two scenes. One gradually disappears while the other takes its place.

**Dub or dubbing:** Accessing the linear soundtrack to record music or other sound effects to be used with video. Also copying a tape without edits.

**Edit point:** The beginning or end of a section of tape that will be included in the edited master tape.

**Fade in:** The gradual appearance of a picture.

**Fade out:** The gradual disappearance of a picture.

**Fade to black:** The gradual disappearance of a picture into a black screen.

**Font:** Type in a particular size and style.

**Foreground graphics:** In the Amiga system, all colors other than Color 0. (See background graphics.)

**Frame:** The shortest complete static image in the NTSC video system,  $\frac{1}{30}$  of a second. Video is composed of a continuous series of frames.

**Master tape:** The video you create by editing raw footage.

**NTSC:** Acronym for National Television Standards Committee. It is the video standard used by television and video equipment in the United States.

**Rainbow effect:** Unwanted coloration and distortion that occurs around an edit point on a videotape when the edit is made with inexpensive equipment without flying erase heads.

**Raw footage:** A movie term for the film exposed during a scene. In video, that means an un-edited recording.

**RF:** Radio Frequency. Signals from a cable-TV feed and a television transmitter are both RF signals.

**RGB:** Acronym for Red Green Blue. A video system used by graphics-oriented computers such as the Amiga.

**Special-effects switcher:** An electronic device that performs various types of transitions between two video signals or between a video signal and a black screen. (See Fade, Wipe). It is the video equivalent of an audio mixer.

**VHS hi-fi:** A method of recording low-distortion, wide-fre-

quency-response stereo audio onto the same portion of a videotape that the video signal uses. This is different than linear audio, which is of lower quality and placed on a separate section of the tape. The video signal cannot be edited without disturbing the VHS hi-fi audio; however, linear audio can be very easily manipulated without disturbing the video tracks on the tape.

**Video post-production:** All work that is done on a video presentation after the raw footage has been shot. That includes any kind of work such as editing, adding titles and graphics, using wipes and other transitions, equalizing the soundtrack, and adding music and narration.

**Wipe:** Covering one picture with another in a sweeping motion, like a curtain dropping onto a stage. Wipes can also be to a black screen.

**Zoom:** The process of changing the focal length of a lens. Most video cameras have zoom lenses. They allow the user to change the size of the picture without changing position of the camera.

**Zoom microphone:** A microphone with two selectable pickup patterns. "Normal" uses an omnidirectional pattern for short-distance sound pickup. "Tele" uses a cardioid pattern for picking up sounds at a greater distance, so as not to interfere with the subject.

when you installed the genlock.

The mixer has three stereo inputs and one stereo output. The first input comes from the effects switcher, the second from the audio cassette deck, and the third from the microphone. Connect the mixer's output to the audio input on the recording VCR.

Now connect Overlay 1 (the NTSC video output of the genlock) to the video input of the recording VCR, and connect its RF output to the TV. Set the VCR's output to channel 3 or 4, and set the TV to the same channel.

Last, if you haven't done so already, connect the editing controller to the two VCR's, connect the Amiga to the genlock, and the genlock to the monitor.

### System checkout

Before proceeding, check your wiring carefully. After confirming all connections, turn on the equipment. Set the VTR/TV switch on the destination VCR to VTR and set the input selector to Line 1. If you have connected an RF signal to the source VCR, make sure that its input selector

is set to tuner. As you change channels on the source VCR, the picture on the television set should change.

Now set the genlock. The Power/Lock LED should be green. Push the RGB/CVBS switch on the front panel of the monitor, and you should see the same signal as on the television set. Push the RGB/CVBS again to see the computer output.

Advance the sliders on the genlock. The picture on the television should gradually dissolve into whatever the computer is

displaying. Don't forget to return the sliders to their original positions.

Now push the bottom fade button on the effects switcher. The images on both the TV and the monitor (with the CVBS button pushed in) should fade to black. Fading video should not affect the graphics from the genlock. Confirm that by advancing the sliders again.

Now, press the source button on the switcher. The green LED should go out and the red LED should light up. Both the TV and the monitor should display the picture from the camera.

That confirms that the video portion of the system is functional; now check the audio. Advance the slider for channel 1. You should hear audio from the camera. (Note: Some camcorders, such as the Panasonic AG-155, will not power the microphone unless you have a tape in the camera, and it is set to record pause). Now, press the source button on the switcher. You should hear audio from the source VCR. Return the slider to its former position. Advance the slider for channel 2 while a tape is playing in the audio cassette deck. Finally, advance the slider for channel 3 and speak into the microphone. You can monitor the left and right stereo channels by watching the indicators on the destination VCR.

If something doesn't work right, switch off power and check your wiring against the block diagram. If everything looks OK, disconnect the suspected piece of equipment from the system and check its operation.

When everything is working, create a short video to test the system. When the source VCR is playing, the Power/Lock LED on the genlock should be green. Increasing the sliders on the genlock should superimpose the computer's video over the source tape's video.

Take plenty of time to get acquainted with the equipment and software before attempting a real serious project. The more time you spend playing with the system, the better your edited videos will be.

## Graphics

One thing you'll have to consider is whether to use interlace. Basically, in an interlaced system, alternate scan lines of a video image are displayed in alternate fields. For example, first all the even lines might be displayed, then all the odd lines. Each field is displayed in  $\frac{1}{2}$  of a second; two fields together comprise a frame, or a complete image.

On a TV set, an interlaced image yields smooth-looking pictures. However, the Amiga's video output flickers in interlace mode, so when the signals are mixed, the resultant video will flicker, both on the computer monitor and on a television set.

With the equipment described in this article, you can operate the Amiga in non-interlaced mode; the tradeoff is that computer-generated image have lower resolution. However, the image will be flicker-free.

Be aware that if you use a different editing system, you may have to use interlace mode. In addition, the programs that allow software control of the *Super-gen* genlock's sliders require graphics to be interlaced. However, you can still fade the genlock in and out by hand in non-interlaced mode to obtain a stable image.

## Synchronizing edits

Even if you use interlace, you only get software control of the video portion of the system; you must control the computer's video manually. Doing so takes practice; you don't want a long pause before your graphics begin, nor do you want to miss the first image in a slide show. Here are some ideas for synchronizing things.

For example, the destination VCR begins recording when its counter starts moving. This is a useful indication of when to start your graphics fade-in. A static image, such as a superimposed spider sitting beside Miss Muffet, is simple: genlock the graphic onto the video and set the Panasonic to edit as usual.

If you want to fade in a title at the end of an edit, add extra time to your outset point. Add extra

time to your inset point for a title or graphic to appear at the beginning of an edit. You'll have to try it a few times, watching the counter, to get it right.

A slide show of multiple graphics screens and transitions can be timed almost as easily as a single graphic. Video SEG has options to Load Buffer and Pause. When Load Buffer is used, the Amiga accesses its disk only at the beginning of the script—before any graphics appear. With Pause, the show waits for you to click the mouse button before displaying the next image. Using those techniques can help you create smooth presentations.

With SEG you create script files that contain information on which images are displayed, their order, and for how long. The latter capability allows you to define automatic edit points; it's useful for dissolving a slide show into video. Just be sure to allow enough time for SEG to finish its presentation when setting the source inset point.

Not only must you manipulate computer graphics manually, you must also manipulate the effects switcher manually. Again, allow extra time at the inset and/or outset for fades. Use a stopwatch to time the fades for adjustment of the edit points.

Here's a technique to trick the Panasonic controller into giving you precise timing for inserting video from the camera. Put a tape in the source VCR and set an inset point. (The tape can contain anything as long as it has a control track.) Set the inset and outset points on the destination VCR, depending on where you want the camera video to be recorded. Now, select input B on the effects switcher. When the controller makes the insert, it will insert camera video instead of video from the source tape.

## Production techniques

To tape a live event, find out what the participants are going to do and how they'll be situated. Arrive early to set up your equipment, make sure that you have sufficient lighting, and don't forget the sound. A zoom micro-

*continued on page 103*

# INSIDE INTEL's 80386

*The 386's buses, bus timing, and peripheral devices.*

JIM KARDACH AND NEAL MARGULIS, INTEL CORP.

From a hardware perspective, designing with the 386 is a little different than designing with the 376 and the 386SX. The 386 has 32-bit address and data buses; it also features bus-sizing (forcing a single 32-bit data cycle into two 16-bit data cycles) on a cycle-by-cycle basis. By contrast, the 386SX has a 24-bit address bus and a 16-bit data bus, as does the 376. All three support pipelining on a per-cycle basis; however, the 386 cannot operate in a pipelined mode when using bus-sizing.

All three processors use the same bus-control signals. That allows properly designed peripheral interfaces for one processor to be used with the others. In addition, the bus timings of the 376 and the 386SX are identical, so a system designed using a 376 can also use the 386SX.

## Off the bus

The 386 has three separate buses: the address bus, the data bus, and the control bus. The address bus is used to select a device to transmit or receive data. The data bus is used to transfer data from the device to the CPU or from the CPU to the device. The control bus consists of all the control signals that indicate when a bus cycle starts, when it ends, and in which direction data will travel.

The 386's data bus consists of 32 floatable bi-directional signals, which are known as D31–D0. The least significant bit (LSB) of the data bus is D0, and the most significant bit (MSB) of the data bus is D31.

The address bus of the 386 consists of 34 floatable output signals: A31–A2 and  $\overline{\text{BE}}_3$ – $\overline{\text{BE}}_0$ . The address signals indicate which four-byte double word in the four-gigabyte address range is being addressed. The four byte-enable signals ( $\overline{\text{BE}}_3$ – $\overline{\text{BE}}_0$ ) indicate which eight-bit group (or groups) data is being transferred on. The correspondence between byte-enable signals and the data bus is shown in Table 1.

The control bus consists of 10 signals, as shown in Table 2. Four of the control-bus signals are additionally defined as bus-definition signals that indicate to an external device what type of bus cycle the microprocessor is executing. The microprocessor can execute eight different types of bus cycles, as shown in Table 3.

TABLE 1—BYTE-ENABLE SIGNALS

Signal	Data lines
BE3	D31–D24
BE2	D23–D16
BE1	D15–D8
BE0	D7–D0

## Clock and reset

The 386 is driven by an external double-frequency clock (CLK2) that the microprocessor divides by two and phase-synchronizes to its internal clock, PCLK. Each PCLK period is referred to as a T-state. The low portion is called Phase 1; the high portion is called Phase 2.

As shown in Fig. 1, PCLK is synchronized to the falling edge of the RESET signal. Note that setup and hold times,  $t_{25}$  and  $t_{26}$ , must be met in order to guarantee the phase relation of the internal processor clock to the falling edge of the RESET signal.

The processor's CLK2 input has certain characteristics that must be met in order to guarantee proper operation. Those characteristics are summarized in Table 4. In addition to meeting those timing constraints, the clock oscillator should also be able to drive 120 pF.

To synchronize external circuitry to the internal processor clock (PCLK), an external PCLK signal should also be generated. PCLK runs at half the frequency of CLK2 and is phase synchronized to the internal processor clock during the falling edge of RESET, as shown in Fig. 1.

Figure 2 shows a synchronous circuit that can generate RESET and phase-synchronize the internal and external clocks. Note that

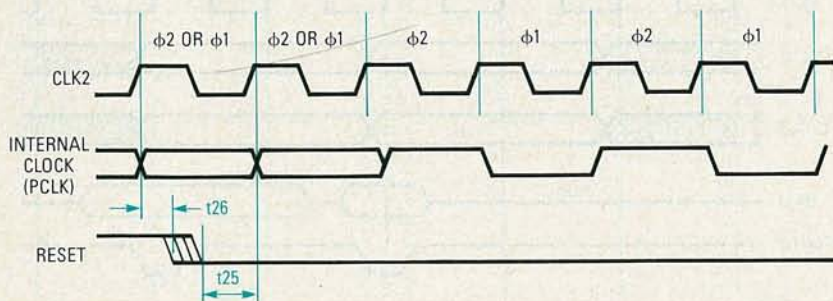

**TABLE 2—386 CONTROL SIGNALS**

Symbol	Name and Function
$\overline{W/R}$	Write/Read is a bus cycle definition signal that distinguishes write cycles from read cycles.
$\overline{D/C}$	Data/Control is a bus cycle definition signal that distinguishes data cycles, either memory or I/O, from control cycles which are: interrupt acknowledge, halt, and instruction fetching.
$\overline{M/IO}$	Memory/IO is a bus cycle definition signal that distinguishes memory cycles from input/output cycles.
$\overline{LOCK}$	Bus Lock is a bus cycle definition signal that indicates that other system bus masters are denied access to the system bus while it is active.
$\overline{ADS}$	Address Status indicates that a valid bus cycle definition and address ( $\overline{W/R}$ , $\overline{D/C}$ , $\overline{M/IO}$ , BHE, BLE and A23-A1) are being driven at the processor pins.
$\overline{NA}$	Next Address is used to request address pipelining.
$\overline{BS16}$	Bus Size 16 is used to request a 16-bit bus cycle.
$\overline{READY}$	Bus Ready terminates the bus cycle.
HOLD	Bus Hold Request input allows another bus master to request control of the local bus.
HLDA	Bus Hold Acknowledge output indicates that the processor surrendered control of its local bus to another bus master.

**TABLE 3—BUS CYCLE DEFINITIONS**

$\overline{M/IO}$	$\overline{D/C}$	$\overline{W/R}$	$\overline{LOCK}$	Bus Cycle Type
0	0	0	0	Interrupt Ack.
0	1	0	1	I/O read cycle
0	1	1	1	I/O write cycle
1	0	0	1	Memory code read
1	0	1	1	Halt or Shutdown
1	1	0	X	Memory data read
1	1	1	X	Memory data write



**Fig. 1. PCLK IS SYNCHRONIZED** to the falling edge of the reset signal.

that circuit generates a clock signal even while RESET is high; doing so allows devices that require an active clock during reset to initialize properly.

RESET is used to place the processor in a known state. When the processor detects a low-to-high transition on RESET, it termi-

nates all activities. When RESET goes low again, the processor is initialized to a known state and begins fetching instructions from the reset address, 0FFFFFF0 (i.e., 16 bytes below the top of physical memory).

The RESET input of the processor must remain high for at

least 15 CLK2 periods in order to ensure proper initialization of the processor.

**Bus cycles**

The 386 has a feature called pipelining; pipelining allows bus cycles to overlap, thereby allowing the processor to start one cycle before it has completed the previous one. The 386 operates differently depending on whether pipelining is being used or not; let's discuss non-pipelined bus cycles first.

Each bus cycle comprises at least two bus states, T1 and T2. Each bus state in turn consists of two CLK2 cycles, which can be thought of as Phase 1 and Phase 2 of the bus state. Figure 3 shows bus states for typical read and write cycles. During T1, the address and control buses are asserted. During T2, external devices respond.

If the processor's  $\overline{READY}$  input is low at the end of T2, the bus cycle terminates (cycle 1). But if  $\overline{READY}$  is high, the bus cycle continues for an additional T2 state (cycle 2), called a wait state. Wait states are added in that manner until  $\overline{READY}$  goes low.

When no bus cycles are needed (i.e., no bus requests are pending), the microprocessor remains in the idle state, T1.

**Pipelined bus cycles**

The  $\overline{NA}$  (next address) input of the 386 controls pipelining.  $\overline{NA}$  is generated by logic in the system to indicate that the address and status bus are no longer needed by the system. If the system is designed so that  $\overline{NA}$  goes active before the end of the cycle, pipelining may occur. Of course, a bus cycle must be pending for a pipelined cycle to occur.

During any particular bus cycle,  $\overline{NA}$  is not sampled until the address and status lines have been valid for one T-state.  $\overline{NA}$  is sampled at the rising CLK2 edge before Phase 2. When  $\overline{NA}$  is active, one of two states occur: 1—If a bus cycle is pending, the address bus, byte enables, and bus-status signals for the next bus cycle are output and the processor enters a T2P state. T2P states are repeated until the bus cycle is

**TABLE 4—CLK2 CHARACTERISTICS**

Symbol	Parameter	Min	Max	Unit
	Operating Frequency	4	16	MHz
t1	CLK2 Period	31	125	ns
t2a	CLK2 High time	9		ns
t2b	CLK2 High time	5		ns
t3a	CLK2 Low time	9		ns
t3b	CLK2 Low time	7		ns
t4	CLK2 Fall time		8	ns
t5	CLK2 Rise time		8	ns

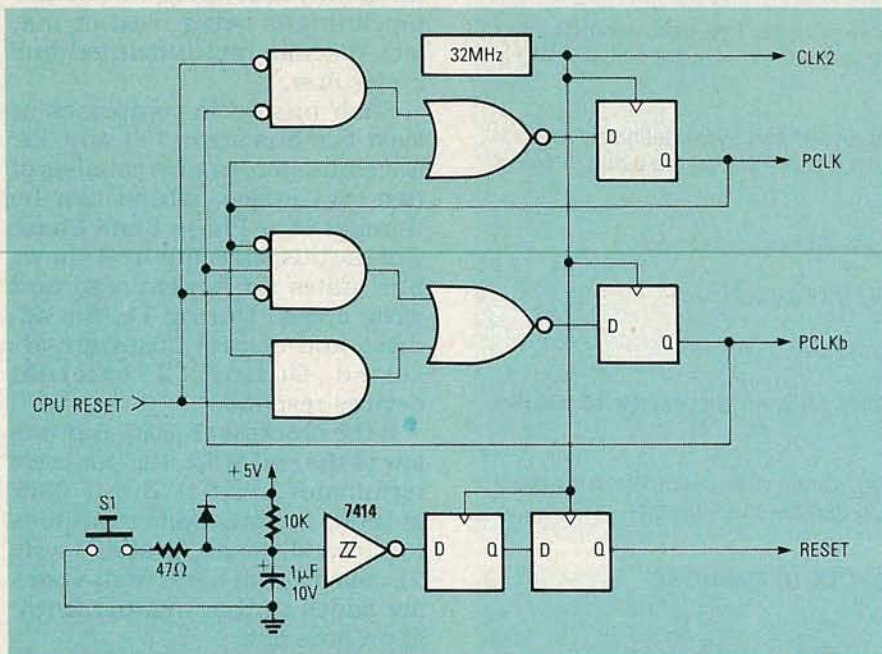

**Fig. 2.** SYNCHRONIZED RESET/CLOCK circuit is shown here. It can be implemented with discrete logic or a PLD.

complete. 2—If a bus cycle is not pending, the address bus and byte enables enter an unknown state, the bus-status signals go inactive, and the processor's bus unit enters a T2i state. If the bus cycle is not terminated, then the next state will either be a T2P state or another T2i state, depending on whether a bus cycle is now pending.

**Bus sizing**

Interfacing to a 16-bit bus is a major difficulty for many 32-bit microprocessors. The 386 provides on-chip support for connecting to either 16- or 32-bit peripheral devices through dynamic data-bus sizing.

Normally, the bus operates in a 32-bit mode: a four-byte transfer occurs in a single bus cycle with data passing on data lines D31–D0. However, before the end of any bus cycle, 32-bit operation can be forced by asserting  $\overline{BS16}$ .

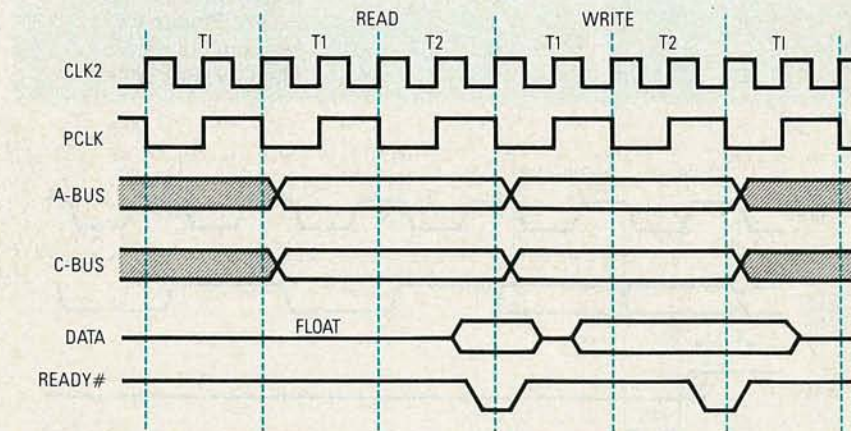

**Fig. 3.** BUS STATES for typical read and write cycles are shown here.

Doing so can have a number of effects, depending on what kind of bus cycle is occurring. If the bus cycle was a 32-bit write, a second bus cycle will be created to write out the upper word of data. If the bus cycle was a 32-bit read, a second bus cycle will be created to read in the upper word of data.

Whether read or write, the second half of the transfer takes place on the lower word of the data bus.

**Tracking bus cycles**

The Bus Cycle Tracker (BCT) is a state machine that tracks the 386 bus and provides useful information to other circuits or state machines. Using the BCT simplifies the design of synchronous control logic to interface to other devices.

The bus is capable of executing different types of bus timings. In order to determine where the first bus state in a bus cycle occurs, it's necessary to know whether the previous bus cycle was pipelined. The BCT provides that historical information.

Any type of system that has at least one pipelined device in it will require a BCT. Because the processor pipelines the next bus cycle's address and status information, which can be to a second device, that device must be able to recognize when its bus cycle starts.

**The 82380**

The 82380 is a multi-function support peripheral that inte-

grates system functions necessary for most embedded systems. The 82380 was specifically designed to work with the 80386 microprocessor. It contains eight 32-bit DMA channels, interrupt control, timers, wait-state generation, DRAM-refresh control, and system-reset logic.

With all that, however, the IC requires little or no TTL "glue" logic. It has the same AC timings as the 386, and may be connected directly to the address and data buses.

The 82380's DMA controller supports eight DMA channels, each capable of transfer rates as high as 16 megabytes per second in a 16-MHz system. Each channel can transfer data between devices of different data-path widths, and each can operate independently in any of several modes.

The 82380 also contains four 16-bit programmable interval timers. Those timers are identical to the timers in the 82C54 programmable interval timer. All four timers share a common clock input; each has a separate output pin.

Timer 1 has a dual-purpose output that can be programmed to generate normal 82C54 timer outputs, or to generate a refresh signal for DRAM subsystems. Timers 2, 3 and 4 have outputs that are internally connected to interrupt request lines. Each timer is capable of operating in one of six different modes. In each mode, the current count can be latched and read by the processor at any time.

The 82380 also has the equivalent of three enhanced 82C59A programmable interrupt controllers. Fifteen external interrupt request inputs are provided for the user, all of which can be outputs from external slave interrupt controllers. Cascading 8259A's to those inputs allows a maximum of 120 external interrupt requests. Interrupt-request lines internal to the 82380 allow the generation of interrupts in a variety of ways including: timer-generated interrupts, DMA chaining-request interrupts, and there's also DMA terminal-count interrupts.

The wait-state generator is a programmable  $\overline{\text{READY}}$  generation circuit for the processor bus. An external device can request the 82380 to generate a predetermined number of wait states. Seven different wait-state counts can be programmed into the wait-state generator by software:

three for memory accesses, three for I/O accesses, and one for refresh cycles. The wait state generator can be disabled.

The 82380's DRAM-refresh controller consists of a 24-bit refresh-address counter and bus-arbitration logic. When the controller is activated by Timer 1, it requests access to the system bus through the  $\text{HOLD}$  signal. When bus control is granted by the processor or current bus master, the refresh controller executes a memory-read cycle at the address currently in the refresh address register.

### The 80387 math coprocessor

The 387 provides floating-point support that adheres to the ANSI/IEEE floating-point standard. The 387 provides eight 80-bit numeric registers, and more than 70 instructions (including *sine*, *cosine*, *tangent*, *arctangent*, and *logarithm*). The 387 supports seven data types: 32-bit short real, 64-bit long real, 80-bit extended real, 16-bit word integer, 32-bit short integer, 64-bit long integer and 18-digit packed BCD integer.

The 387 holds all numbers in extended real format internally. *LOAD* instructions automatically convert operands represented in memory as 16-, 32-, or 64-bit integers (or 18-digit packed BCD numbers) into extended-real format. *STORE* instructions automatically perform the reverse conversion. Those capabilities allow numerically oriented applications to view data in the most appropriate format without concern for type conversions.

The 387 also contains a program-accessible control word that allows specification of rounding (round to nearest, round down, round up and chop), precision control, and handling of other special situations, all according to the IEEE 754 standard.

The only external hardware that is needed to connect the 387 to the 386 is an *AND* gate that combines the system's  $\overline{\text{READY}}$  signal with the 387's  $\overline{\text{READY0}}$  signal. The 386 talks to the 387 through I/O cycles, and it also provides an automatic chip-select. That is done

by driving its most-significant address pin (A31) high during access.

### The 82385 cache controller

The main function of a cache memory system is to provide fast local storage for frequently accessed code and data. The 82385 cache controller allows the microprocessor to run at full potential by reducing the average number of CPU wait states to nearly zero.

It does so by intercepting 386 memory references to see whether the required data resides in the cache. If the data does reside in the cache (a hit), it is returned to the microprocessor without incurring wait states. On the other hand, if the data does not reside in the cache (a miss), data is retrieved from main memory. An efficient cache yields a high hit rate (the ratio of cache hits to total memory accesses), so that the majority of memory accesses are serviced with zero wait states.

The 82385 integrates a cache directory and all cache management logic required to support an external 32K-byte cache. The structure of the cache directory is such that the entire physical address range of the 386 (4 gigabytes) is mapped into the cache. Provision is made to allow areas of memory to be set aside as non-cacheable. Physically, the 82385 ties directly to the microprocessor's bus with little external logic. Also, the 82385 has a dual-bus architecture that allows other masters to access system resources while the 386 operates locally from the cache.

### Conclusions

In this series of articles, we have tried to outline some of the important design and operational features of the 80386 family. Unfortunately, in the brief space allotted us, we have only been able to examine a few of the many facets of the 386 family. However, we hope that your appetite has been whetted, and that you'll continue your research. Part 1 of this article (January 1989) contains a list of books that you can consult for further information.  $\blacklozenge$ CD $\blacklozenge$

# TV, RADIO COMMUNICATIONS



□ **BP91—INTRO TO RADIO DXING...** \$5.50. Everything you need to know about radio DXing and how you can get into this fascinating hobby area.

□ **BP155—INTL RADIO STATIONS GUIDE...** \$6.95. New edition lists station site, country, frequency, ERP provides for thousands of short wave radio stations. Nine sections cover a variety of broadcast services.



□ **BP105—ANTENNA PROJECTS...** \$5.50. Practical antenna designs including active, loop, and ferrite types that are simple and inexpensive to build, yet perform well. Also included are antenna accessories.

... \$5.50. Shows how to build 25 antennas starting with a simple dipole and working on up to beam, triangle and even a mini rhombic.



□ **BP132—25 SHORT-WAVE BROADCAST ANTENNAS...** \$5.50. Good antennas can be inexpensive. Here's 25 different ones ranging from a simple dipole, through helical designs to a multi-band umbrella.

□ **BP136—25 INDOOR AND WINDOW ANTENNAS...** \$5.50. If you can't put up a conventional antenna because of where you live, one of these 25 designs is likely to solve your problem and deliver great reception.



MAIL TO: **Electronic Technology Today Inc.**  
P.O. Box 240  
Massapequa Park, NY 11762-0240

### SHIPPING CHARGES IN USA AND CANADA

\$0.01 to \$5.00	... \$1.25	\$30.01 to \$40.00	... \$5.00
\$5.01 to 10.00	... \$2.00	\$40.01 to \$90.00	... \$6.00
\$10.01 to \$20.00	... \$3.00	\$50.01 and above	... \$7.50
\$20.01 to \$30.00	... \$4.00		

**SORRY, No orders accepted outside of USA and Canada**

Total price of merchandise	..... \$	_____
Shipping (see chart)	..... \$	_____
Subtotal	..... \$	_____
Sales Tax (NYS only)	..... \$	_____
Total Enclosed	..... \$	_____

Name \_\_\_\_\_  
Address \_\_\_\_\_  
City \_\_\_\_\_ State \_\_\_\_\_ Zip \_\_\_\_\_



## PC and PS/2 video systems

Information on IBM video systems has been hard to come by; in fact, IBM's *Technical Reference* manuals have been just about the only detailed source. With Richard Wilton's *Programmer's Guide to PC and PS/2 Video Systems*, however, that has changed.

That book is a compendium of hardware and software details of all major IBM video adapters, including MDA, C/GA, MCGA, EGA, and VGA, as well as the Hercules Graphics Card, Hercules Graphics Card Plus, and the Hercules InColor Card.

After a brief overview of the major standards, the book jumps into a discussion of display refresh, horizontal and vertical timing, and then moves into programming the CRT controllers of the various systems. The book is laced with example programs in C and assembler; the source code is available separately on disk from Microsoft Press.

Later chapters are devoted to alphanumeric and graphics programming, and discuss information about low-level bit twiddling, as well as advanced topics like drawing circles and ellipses, area filling, displaying text in graphics mode, and even an introduction to animation techniques.

You won't find any schematic diagrams in the book; even so, you can learn a great deal about how the hardware works, and about how to program it for pleasure and profit. The book includes much hard-to-come-by information that formerly was available only from the programming "underground."

If you're seriously interested in IBM video systems, you won't find a better place to start.

## Old, New, Everything Blue

Here is a book begging for HyperText. In fact, there is so much information that the biggest problem is finding it. In 500 large-format (8.5- × 11-inch) pages it attempts to document *everything* about the IBM PC family. There are connector pinouts (for serial, parallel, keyboard, disk, mouse, bus and power-supply connectors, among others), BIOS-interrupt summaries, DOS-command summaries, ASCII character-set tables, number-conversion charts, listings of Windows data-file formats and low-level programming functions, Mouse and EMS function summaries, IC pinouts...

*The Programmer's PC Sourcebook* is a big book, but it could replace half a dozen or more reference guides from IBM and other sources. Even better would be a Hypertext version on CD-ROM with illustrations. That would make it a version of Bookshelf for the technically oriented. **CD**

### PRODUCTS REVIEWED

● Smart Data Meter (\$399), IQ Technologies, 11811 N.E. First Street, Suite 201, Bellevue, WA 98005. (800) 227-2817 or (206) 451-0232.

#### CIRCLE 15 ON FREE INFO CARD

● Laserdek 1000 (\$895), Amdek, 1901 Zanker Road, San Jose, CA 95112. (408) 436-8570.

#### CIRCLE 16 ON FREE INFO CARD

● Designer (\$695), Micrografx, 1820 N. Greenville Ave., Richardson, TX 75081. (800) 272-3729 or (214) 234-1769.

#### CIRCLE 17 ON FREE INFO CARD

● Programmer's Guide to PC and PS/2 Video Systems (\$24.95), Richard Wilton, 1987. *The Programmer's PC Sourcebook* (\$24.95), Thom Hogan, 1988. Microsoft Press, Microsoft Corp., 16011 NE 36th Way, Box 97017, Redmond, WA 98073-9717. (206) 882-8080.

#### CIRCLE 18 ON FREE INFO CARD

● Turbo Pascal 5.0 (\$150), Turbo C 2.0 (\$150), Turbo Assembler & Debugger (\$150), Borland International, 1800 Green Hills Road, Scotts Valley, CA 95066. (408) 438-8400.

#### CIRCLE 19 ON FREE INFO CARD

# R-E Computer Admart

Rates: Ads are 2 1/4" x 2 7/8". One insertion \$900. Six insertions \$875. each. Twelve insertions \$845. each. Closing date same as regular rate card. Send order with remittance to Computer Admart, Radio Electronics Magazine, 500-B Bi-County Blvd., Farmingdale, NY 11735. Direct telephone inquiries to Arline Fishman, area code-516-293-3000. Only 100% Computer ads are accepted for this Admart.

## SECRETS OF THE COMMODORE 64

Secrets of the COMMODORE 64



**BP135**—A beginners guide to the Commodore 64 presents masses of useful data and programming tips, as well as describing how to get the best from the powerful sound and graphics facilities. We look at how the memory is organized, random numbers and ways of generating them, graphics-color-and simple animation, and even a chapter on machine code. Get your copy today. **Send \$5.00 plus \$1.25 for shipping** in the U.S. to **Electronic Technology Today Inc., P.O. Box 240, Massapequa Park, NY 11762-0240.**

## A PRACTICAL INTRODUCTION TO MICROPROCESSORS

A Practical Introduction to Microprocessors

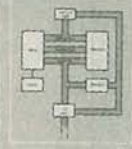

**BP123**—Introduces microprocessors by having the reader construct a very simple microprocessor circuit that he can experiment with and thus hopefully gain a clear insight into this complex subject. The completed unit is only intended as an education aid, but can be built inexpensively and many of the parts can be reused for other applications later. Get your copy for **\$5.00 plus \$1.25 for shipping** in the U.S. from **Electronic Technology Today Inc., P.O. Box 240, Massapequa Park, NY 11762-0240.**

## ICs PROMPT DELIVERY!!!

SAME DAY SHIPPING (USUALLY)

QUANTITY ONE PRICES SHOWN FOR DEC. 13, 1988

OUTSIDE OKLAHOMA: NO SALES TAX

DYNAMIC RAM			
SIMM	1Mx9	80 ns	\$450.00
SIMM	** 1Mx9	85 ns	390.00
SIMM	256Kx9	60 ns	150.00
1Mbit	1Mx1	100 ns	33.00
41256	256Kx1	60 ns	14.95
41256	256Kx1	100 ns	12.95
51258	*256Kx1	100 ns	13.50
41256	256Kx1	120 ns	12.25
41264	+ 64Kx4	120 ns	17.50
EPROM			
27C1000	128Kx8	200 ns	\$29.50
27C512	64Kx8	200 ns	13.95
27256	32Kx8	150 ns	8.15
27128	16Kx8	250 ns	4.95
STATIC RAM			
62256P-10	32Kx8	100 ns	\$22.95
6264P-12	8Kx8	120 ns	10.80

OPEN 6 1/2 DAYS, 7:30 AM-10 PM. SHIP VIA FED-EX ON SAT.

WE EXPORT ONLY TO CANADA, GUAM, PUERTO RICO & VIRGIN ISLANDS

SAT DELIVERY INCLUDED ON FED-EX ORDERS RECEIVED BY: Th: 9:00 AM, Sa: 9:00 AM, Su: 9:00 AM

MasterCard/VISA or UPS CASH COD

Factory New, Prime Parts

MICROPROCESSORS UNLIMITED, INC.

24,000 S. Phoenix Ave., BEIGGS, OK 74421 (918) 267-4961

No minimum order. Please note that prices are subject to change. Shipping & insurance extra. & up to \$1 for packing materials. Orders received by 9 PM CST can usually be delivered the next morning, via Federal Express Standard Air @ \$6.00, or guaranteed next day Priority One @ \$10.25!

CIRCLE 61 ON FREE INFORMATION CARD

## AMIGA VIDEO

continued from page 97

phone captures sound without encumbering the participants.

For a family event, such as a picnic or birthday party, make a list of the shots you want to capture. However, always be ready for the unexpected. Before the event, take shots of the surroundings and of people arriving. You can mix those with music and titles as an introduction to your video. Interesting backdrops for titles can be created from closeups of running water, textured surfaces, etc.

While shooting an event, don't be afraid to move in for closeups. On the other hand, don't zoom in and out constantly; that will make editing difficult. Try to get more than one camera angle. Vary long shots (a whole person or group), medium shots (a person from the waist up or part of a group), and closeups.

Don't fall into the trap of attempting to fix bad video in the editing room. If you have poor footage, the best post-production editing won't save it. If you want

something to appear in your video, make sure that you get it on film the way you want it. You may also want to read up on directing; try *How to Shoot a Movie and Video Story* by Arthur L. Gaskill and David A. Englander (Morgan & Morgan, Inc., Publishers, 145 Palisade Street, Dobbs Ferry, NY 10522); it's available in camera stores.

When you're editing, remember the KISS principal: Keep It Short and Simple. Don't bore your audience with long passages of conversation. Video is action oriented. Present the interesting and leave the uninteresting out. Otherwise, why bother editing?

Before beginning post-production work, we always make up a Video/Audio sheet to plan titles, graphics, and music to go with the video. Draw a line down the middle of a sheet of paper. On the top-left line, write Video. On the top-right line, write Audio. Then, to keep track of everything, write in the video and audio you plan to use for each scene.

If you've always wanted to be a movie director, how about making an original short? First,

you'll need to write a script. The script should have a story line, and should also plan for camera angles, closeups, audio effects, etc.

Be forewarned, however, that a short (10 minutes or so) takes a long time to produce. You must locate scenes, props, and actors. You must write a story that will translate to a visual medium. After you're done shooting, you'll probably spend one or two hours in production for every minute of finished video.

Another time-consuming yet rewarding endeavor is transferring still photographs onto videotape. Stills can be presented alone or with other video. Attaching closeup filters to the video camera will allow you to add life to these static shots with pans and zooms.

## System enhancements

We used a three-input audio mixer, but a four-input unit would also allow us to combine the Amiga's digital sound output. An audio equalizer can boost a weak soundtrack. Video-effects generators can add a host of interesting effects too. **CD**

## DRAWING BOARD

continued from page 94

it's often the only way you can represent the character at all.

Once the letters are designed, you have to translate them into bit patterns for the EPROM, and here is where we have to make the first of several decisions. If you plan on driving common-cathode displays, a "1" will represent a lit segment and a "0" will represent a blank. A common-anode driver will be exactly the opposite.

One nice thing about having so much room in a 2716 is that you can have both drivers in the same chip. All you have to do is split the chip in half by using the high-bit address line as a toggle and then burning mirror images of the bytes in each half of the EPROM. You can take that idea a step further by having several character sets in each EPROM and using the appropriate address lines to select the one you want.

Before we get into that however, let's continue with the overall design of the character generator.

Now that we know what the letters are going to look like, we have to work out the pin assignments for the EPROM and the display. That isn't hard to do but we're dealing with so many variables that it's a good idea to be systematic. Figure 2 shows the top half of a form that's handy for you to redraw neatly (make it as long as you need) and photocopy. It makes the process of assigning pins, translating characters into bit patterns, and getting the needed bytes as painless as possible.

For no reason other than a firm belief in symmetry and order, I've assigned the EPROM output lines to the display segments in a logical order. If you're planning on using this character generator on a hand-wired board, it really doesn't make any difference how the pins are assigned, but if you'll be doing it frequently, it's much better to establish some sort of standard for yourself.

Everyday life forces you to keep enough stuff permanently burned in your brain, so it's helpful to make as many things as possible adhere to a standard. Just about

the only reason I can think of to alter a set of pin assignments is to simplify a PC-board layout and even that shouldn't be a trivial decision since there are enormous advantages in paying attention to the order the manufacturer lists for EPROM address and output lines.

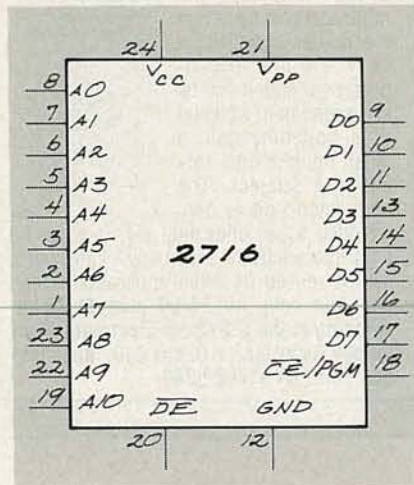

FIG. 3

While it's true that an EPROM is a random-access memory, there is a conventional way of ordering the pins. The drawing in Fig. 3 shows you the industry-accepted standard for the pinouts of a 2716. The IC will work perfectly well if you decide, for whatever reason, that you want to use A5 as A0, A9 as A3, and treat D3 as D6. The price you'll pay for convenience in a board layout is an increase in brain damage when you buy a programmer. Remember that an EPROM programmer knows what the standard EPROM pin assignments are and it assumes that you're going to follow them.

That isn't such a big deal when you're working on the design of a character generator because the bytes being programmed are only bit patterns and not code. But if you want to use EPROM's for programs, it's extremely important to follow the industry conventions because a burner will treat A0 as the low-order bit, A10, as the high order bit, and will order the output pins according to the standard as well.

The hex digits "0" through "F" have standard binary values, but things get somewhat vague when you start talking about the rest of

the alphabet. The only widely accepted standard for alphabetic characters is their ASCII code; but using that means that there will be lots of holes in your code. Since we want to make the character generator as useful as possible, it makes sense to treat the hex digits differently than the alphabetic characters. That means we'll list them twice and use an indicator to distinguish between the display of a hex digit and an alphabetic character.

And, as we've seen, the decimal point is a perfect choice.

The last character we should define is needed for those times when an illegal value is being sent to the display. Remember that there's a difference between a blank display and the display of an illegal character. We can use the "A" or "D" segment for that. We can use the "G" segment as well, but it would be nice to reserve that for the display of a dash.

What we're really talking about doing now is expanding our original idea from a simple hex display driver to a much more useful product. Rather than limiting the character generator to hex digits, it makes a lot more sense (and doesn't take a lot more work) to create a display driver that can produce more meaningful displays for many applications.

When we get together next month, we'll lay out the bit pattern, blow the EPROM, and then see what sort of handy dandy stuff we can do with it. And don't forget about the contest. Some early entries are drifting in and you've only got a month left to stick in your two cents.

R-E



"He was so surprised that the computer he built actually worked that he keeled over!"

# MARKET CENTER

## FOR SALE

**TUBES**, new, unused. Send self-addressed, stamped envelope for list. **FALA ELECTRONICS**, Box 1376-2, Milwaukee, WI 53201.

**PHOTOFACT** folders, under #1400 \$4.00. Others \$6.00. Postpaid. **LOEB**, 414 Chestnut Lane, East Meadow, NY 11554.

**TUBES**. "Oldest," "latest." Parts and schematics. SASE for list. **STEINMETZ**, 7519 Maplewood Ave., R.E., Hammond, IN 46324.

**GREAT buys!** Surplus prices, ICs, linears, transformers, PS, stepping motors, vacuum pump, phototransistor, meters, Isase, **FERTIK'S**, 5400 Ella, Phila., PA 19120.

**TWO-WAY-RADIO, PC COMPUTERS, UNIDEN SERVICE**. General Radiotelephone licensed technician. Catalog-**RAYS**, 2025 Moline, Ft. Worth, TX 76117. (817) 831-7717.

**RESTRICTED technical information:** Electronic surveillance, schematics, locksmithing, covert sciences, hacking, etc. **Huge selection. Free brochures.** **MENTOR-Z**, Drawer 1549, Asbury Park, NJ 07712.

**FAIR Pricing 1 (313) 979-8356.** Lots 5 and 10; 65 SB 55; 65 MLD 1200 55; 85 TriBi 75; 90 SA 80; 105 SSAVI 95; 295 Pioneer 275; 180 Z-Tac 170; 180 Tocom 170; 18 Filters Any Channel 15; No Michigan Sales.

## FREE CATALOG

**FAMOUS "FIRESTIK" BRAND CB ANTENNAS AND ACCESSORIES. QUALITY PRODUCTS FOR THE SERIOUS CB'er. SINCE 1962**  
**FIRESTIK ANTENNA COMPANY**  
2614 EAST ADAMS  
PHOENIX, ARIZONA 85034

**DESCRAMBLERS.** All brands. Special combo Jerrold 400 and SB3 \$165. Complete cable descrambler kit \$39. Complete satellite descrambler kit \$45.00. Free catalog. **MJM INDUSTRY**, Box 531, Bronx, NY 10461-0531.

**TRS-80** color computer software. Low prices! Huge selection! Free catalog. **T&D**, P.O. Box 1256, Holland, MI 49422.

**SOLAR** electric systems. Discount prices. **SUN POWER-TEXAS**, Dept. 01C, P.O.B. 2788A, Freeport, TX 77541. 1 (409) 233-8350.

**BANDSTOP** Filters-Remove interfering signals on Cable T.V. Channels 2, 3, 4, 14, 15, 16, 17, 18, 19, 20, 21 or 22 available. \$20 each - Money Back Guarantee, **dB ELECTRONICS**, P.O. Box 8644, Pembroke Pines, FL 33084.

## Multi-Channel Microwave T.V. Receivers

1.9-2.7 GHz Parabolic Dish 40+ dB Gain  
**LIFETIME WARRANTY**  
Complete System \$99.95 (Shipping Incl.)  
Replacement Components  
& Expert Repairs Available  
**K & S ELECTRONICS** Call now for same  
P.O. BOX 34522 day shipping!  
PHOENIX, AZ 85067 (602) 230-0640  
VISA/MC/COD \$2 CREDIT ON PHONE ORDERS

**CABLE TV DESCRAMBLERS**, Jerrold, Scientific Atlanta, Zenith, most major brands. Dealer Inquiries Welcome. Visa-M/C Accepted. **E & O VIDEO**, 9691 E. 265th Street, Elko, MN 55020. 1 (800) 638-6898.

**CABLE TV CONVERTERS/DESCRAMBLERS** Tocom 5503VIP, PZ-1, Oak Sigma- Free Catalog. **VIDEO MART** 3938 E. Grant #241-C, Tucson, AZ 85712. (602) 721-6557.

**T.V.** Tunable notch filters. Free Brochure. **D.K. VIDEO**, Box 63/6025, Margate, FL 33063. 1 (305) 752-9202.

**TUBES**, name brands, new, 80% off list. **KIRBY**, 298 West Carmel Drive, Carmel, IN 46032.

**ALUMINUM** image transfer process, your artwork to aluminum. Write: **J & E ENTERPRISES**, 2457 N. Marmora, Chicago, IL 60639.

**FAIR** prices SB-3, Z-TAC, SA3, TRI-BI, MLD-1200-3. Pioneer, any notch filters. Small dealer only. No Michigan sales (313) 979-8356.



## SING WITH THE WORLD'S BEST BANDS!

An Unlimited supply of Backgrounds from standard stereo records! Record with your voice or perform live with the backgrounds. Used in Professional Performance yet connects easily to a home component stereo. This unique product is manufactured and sold Exclusively by LT Sound - Not sold through dealers. Call or write for a Free Brochure and Demo Record.

**LT Sound**, Dept. R.L-3, 7980 LT Parkway Lithonia, GA 30058 (404) 482-4724  
Manufactured and Sold Exclusively by **LT Sound**  
**24 HOUR PHONE DEMO LINE: (404) 482-2485**

**OPENING** Special. Super Duper Kits. Send \$1.00 U.S. \$ for booklet to **3C TECHNOLOGY** Box 306, S. Lafeteche, St. Hubert, Quebec, J4T-3J6.

**HI-TECH** Chip kit will read data stream for Z-TAC or any SSAVI. Experimenters chip kit = 39.00 with pre wired tuner = 49.00, ready to go SSAVI = \$149.00, ready to go Z-TAC = \$249.00 **HI-TECH ELECTRONICS**, P.O. Box 42423, Detroit, MI 48242. (313) 722-9381.

**IC's** digital and linear, transistors, sockets, led's for sale. Very low prices. No minimum order. For free parts list write to: **ARLI ELECTRONICS**, 1052 Eilinita Ave., Glendale, CA 91208.

## CB RADIO OWNERS!

We specialize in a wide variety of technical information, parts and services for CB radios. 10-Meter and FM conversion kits, repair books, plans, high-performance accessories. Over 12 years of satisfied customers! Catalog \$2.

**CBC INTERNATIONAL**  
P.O. BOX 31500RE, PHOENIX, AZ 85046

**LASERS**, from \$40, for brochure write **MWK INDUSTRIES**, 9852 W. Katella, Suite 340R, Anaheim, CA 92804 or call (714) 956-8497.

**PLAY** guitar over any FM stereo! Tunable 9V unit Velcros to any electric guitar! 40 ft. range-3" antenna! \$29.50 complete. **C.P. Hall**, 3485 Buchanan Road, Cleveland, TN 37311.

**CATV converters & descramblers.** Quality Products. Professional Service. Call 1 (800) 541-5487. Visa/MC accepted. **MOUNTAINTECH, INC.** Box 5074, Mt. Crested Butte, CO 81225.

**COMMODORE/Amiga** chips, Diagnostics, parts or low cost repairs (eg. \$49.95 + UPS). Catalog and dealer pricing available. **VISA/MC. KASARA MICROSYSTEMS, INC.**, 24 West Street, Spring Valley, NY 10977. 1 (800) 248-2983 or (914) 362-3131.

**IS** it true...Jeeps for \$44 through the government? Call for facts! 1 (312) 742-1142, ext. 4673.

**The DECODER.** Satellite and Cable Descrambling Newsletter. News-Schematics-Modifications-Reviews. \$24.00/year. Complementary sample. **TELECODE**, Box 6426, Yuma, AZ 85366-6426.

**LOW** prices capacitors, ICs, transistors, switches. Special 27128-25 \$3.25. Flyer SASE. **SANTECH ELECTRONICS** 11 Revere Place, Tappan, NY 10983. (914) 359-1130.

**SENIOR PROM**-For all your Eprom needs! Duplication, Programming, Supplies. Great Prices! Write for details. **SENIOR PROM**, 11 Manor Ridge Drive, Princeton Junction, NJ 08550.

**TOCOMS** and more TOCOMS. Outstanding Zenith units. Quality cable products at discount prices. (714) 974-5688.

**REDUCED 75%** Diehl Mark V-Scanner \$249. Diehl Mark III \$99. **NEW WEEC** 2805 University Ave., Madison, WI 53705. (608) 233-9741, (608) 238-4629.

**Quality Microwave TV Antennas**

- Multi-Channel 1.9 to 2.7 GHz. 40dB Gain
- 30-Channel System complete \$149.95
- 12-Channel System complete \$104.95
- 2-Channel System complete \$79.95

**Phillips-Tech Electronics**  
P.O. Box 8533 • Scottsdale, AZ 85262  
(602) 947-7700 (\$3.00 Credit all phone orders!)

**LIFETIME WARRANTY** MasterCard • Visa • C.O.D.'s Quantity Pricing

**RADIO** amateur (HAM) education. Learn at home or in your car. VHS Video or Audio Cassettes. Easy to obtain License. Free information. **AMATEUR RADIO SCHOOL** 2350 Rosalia Drive, Fullerton, CA 92635.

**DESCRAMBLERS** Oak, Zenith, Tocom, Jerrold, Hamlin, S.A. All at new year wholesale prices. Example 5-loc special - Jerrold 400 W/R \$99 ea. MLD 1200 \$45 ea. Call now C.O.D. O.K. **S.A.C.** (702) 647-3799.

## CABLE T.V. "BOXES"

**Converters—Descramblers**  
**Remote Controls—Accessories**

- ★ Guaranteed Best Prices ★
- ★ 1 Year Warranty—C.O.D.'s ★
- ★ Immediate Shipping ★
- ★ FREE CATALOG ★

Call or Write  
**TRANS-WORLD CABLE CO.**  
12062 Southwest 117th Court, Suite 126  
Miami, Florida 33186  
800-442-9333

**RENTAL MOVIE STABILIZER** Connect between VCRs or to monitor. Satisfaction Guaranteed. \$59.95, \$4 handling. 1 (800) 367-7907.

**CABLE TV converters and descramblers.** We sell only the best. Low prices. SB-3 \$79.00. We ship C.O.D. Free catalog. **ACE PRODUCTS**, PO Box 582 Dep't. E, Saco, ME 04072. (207) 967-0726.

**TEST** Equipment pre-owned now at affordable prices. Signal generators from \$50. Oscilloscopes from \$50, other equipment, including manuals available. Send for catalog **J.B. ELECTRONICS**, 9518 Grand Ave., Franklin Park, IL 60131. (312) 451-1750.

**CABLE DESCRAMBLER LIQUIDATION** Major makes and models available. Industry pricing! (Example: Hamlin Combo's, \$44 each...minimum 10 orders). **DEALERS ONLY!** Call **WEST COAST ELECTRONICS** (818) 709-1758.

**FREE power supply, connectors (\$8.95 value)** with **TV Project Assortment #103** (February 1984 G. Sync article) contains **PCB TOKO** coils, transistors (BFQ85), IC's, diodes, article reprint. \$25.00. Five/\$112.50. Assortment #104, contains all other parts \$10.00. Shipping \$3.00. **MC/VISA, COD accepted.** **JIM RHODES, INC.** P.O. Box 3421, Bristol, TN 37625.

**ENGINEERING** software. IBM/compatibles. CompDes Circuit Design. Basic electricity through circuit designs. CompMath—General mathematics through statistics. CompView—Digital Analysis, waveforms and filters. \$49. (614) 491-0832. **BSOFT SOFTWARE** 444 Colton Road, Columbus, OH 43207.

### REMOTE CONTROL KEYCHAIN



Complete w/mini-transmitter and +5 vdc RF receiver. Fully assembled including plans to build your own auto alarm. Quantity discounts available.

Check, Visa or M/C \$19.95  
30 days refund

VISITECT INC. (415) 872-0128  
PO BOX 5442, SO. SAN FRAN., CA 94080

### PLANS AND KITS

**BUILD** this five-digit panel meter and square-wave generator including an ohms, capacitance and frequency meter. Detailed instructions \$2.50. **BAGNALL ELECTRONICS**, 179 May, Fairfield, CT 06430.

"CB Trick of the Trade book" learn CB repair tricks and tuning tricks. Send \$19.95 to **MEDICINE MAN**, CB, P.O. Box 37, Clarksville, AR 72830.

**FM transmitter 88 to 108 MHz kit \$12.95 SIERRA ELECTRONICS.** Box 709, Elfers, FL 34680-0709.

**CIRCUIT** boards from this and past issues PC-Service about half price. **KLAY-CORP.** 106 Mark Drive, Syracuse, NY 13209-1808, phone (315) 635-5862.

**DESCRAMBLING**, new secret manual. Build your own descramblers for **Cable** and **Subscription TV**. Instructions, schematics, for SSAVI, gated sync, sinewave. Jerrold, Hamlin, Oak, Zenith, Sylvania (HBO, Cinemax, Showtime, UHF, adult) \$8.95, \$2 postage. **CABLETRONICS**, Box 30502R, Bethesda, MD 20814.



DETAILED PLANS: \$4.95

### TV-SCOPE

PENN RESEARCH,  
Box 3543  
Williamsport, PA 17701

### FINALLY!

An interesting and worthwhile project. This **EASY-TO-BUILD** circuit lets you use any regular TV set as a simple **OSCILLOSCOPE**. Build for less than \$10. **NO MODIFICATIONS TO TV!** Single or dual trace. Send for **FREE CATALOG** of other plans and kits.

**CATALOG: Hobby/broadcasting/HAM/CB: Cable TV**, transmitters, amplifiers, buging devices, computers, **more! PANAXIS**, Box 130-F3 Paradise, CA 95967.

**MICRO-link FM stereo audio transmitter.** One chip does it all! Transmit your CD/VCR/Walkman in stereo to any FM radio. Free schematic and info. Send a self addressed/stamped envelope to: **DJ INC.**, 217 E. 85th St., Suite 108, New York, NY 10028.

**INVESTIGATORS**, experimenter's quality new plans hard to find. Micro and restricted devices. Free catalog. **SASE KELLEY SECURITY, INC.**, Suite 90, 2531 Sawtelle Blvd., Los Angeles, CA 90064.

**NUTS & VOLTS** MAGAZINE P.O. Box 1111-E, Pleasanton, CA 94566, 714-632-7721

**GIVE YOURSELF A BREAK — A PRICE BREAK! NUTS & VOLTS WILL SAVE YOU MONEY ON ELECTRONIC PARTS & EQUIPMENT. Plus SHOW YOU WHERE TO FIND UNIQUE, UNUSUAL AND HARD-TO-FIND ITEMS. SUBSCRIBE TODAY!**

Subscription Rates	U.S. Funds Required
3rd Class Mail - USA	
One Year	\$12.00
Two Years	\$21.00
Lifetime	\$60.00
1st Class Mail	
One Year USA	\$20.00
Canada/Mexico	\$22.00
Air Mail	
Foreign 1 Yr	\$55.00

*A National Publication For The Buying And Selling Of Electronic Equipment*

**SPEAKER** plans. Build your own and save! \$2.98 Bass subwoofer amp plans \$2.98. Both \$4.98. Complete plans. Satisfaction guaranteed! **C & C ENTERPRISES**, Box 15585, Alexandria, VA 22309.

**ELECTRONIC Kits!** Transmitters! Recorders! Phone Devices! Bug detectors! Surveillance items! More! Catalog \$1.00: **XANDI ELECTRONICS**, Box 25647, 60L, Tempe, AZ 85285-5647.

**PROJECTION TV** Convert your TV to project 7 foot picture... Easy... Results comparable to \$2,500 projectors... **Plans and 8" Lens** \$24.95... Professional Systems available... Illustrated Catalog **FREE**... **MACROMA** 15GG Main Street, Washington Crossing, PA 18977. Creditcard orders 24 Hrs. (215) 736-3979.

**FREE** microprocessors, free electronic magazines, free education in computers. For info write **MICRO-SAT CORPORATION**, 2401 N.E. Cornell Hillsboro, OR 97124.

**SNOOPER** Stopper Kit of parts, educational manual prevents cable company spys discovering descramblers, extra hookups. \$19.95. **WORLD MARKET IMPORTS**, MPO-476, Saint John, Canada, E2L-3Z8.

### SHORTWAVE ANTENNAS

**SWL ANTENNAS** All bands, Super performance. Direct from manufacturer. Free information. **SPI-RO**, Box 1538, Dept. R. Hendersonville, NC 28793.



## Let MCM Be Your Guide!

Your 172-Page Guide to the parts, accessories and equipment you need!



- Unbeatable Selection
- Competitive Prices
- Many New Items
- Convenient Ordering

You can always depend on MCM to keep you headed in the right direction! We back our catalog with courteous sales people, free technical advice; plus fast, efficient delivery.

To receive a **FREE** subscription to our catalogs, call **TOLL-FREE!**

**FREE CATALOG 1-800-543-4330**



**MCM ELECTRONICS**  
650 CONGRESS PARK DR.  
CENTERVILLE, OH 45459-4072

A **PREMIER** Company

**SOURCE NO. RE-54**

CIRCLE 87 ON FREE INFORMATION CARD





# AMAZING SCIENTIFIC & ELECTRONIC PRODUCTS

## PLANS

Build Yourself—All Parts Available in Stock

LC7—BURNING CUTTING CO. LASER	\$20.00
RUB4—PORTABLE LASER RAY PISTOL	\$20.00
TCCL—3 SEPARATE TESLA COIL PLANS TO 1.5 MEV	\$25.00
IOGI—ION RAY GUN	\$10.00
GRAT—GRAVITY GENERATOR	\$10.00
EML1—ELECTRO MAGNET COIL GUN/LAUNCHER	\$8.00

## KITS

With All Necessary Plans

MFT3K—FM VOICE TRANSMITTER 3 MI RANGE	\$49.50
WVPM7K—TELEPHONE TRANSMITTER 3 MI RANGE	\$39.50
BTCSK—250,000 VOLT 10-14" SPARK TESLA COIL	\$249.50
LHC2K—SIMULATED MULTICOLOR LASER	\$44.50
BLSTK—100,000 WATT BLASTER DEFENSE DEVICE	\$69.50
ITMIK—100,000 VOLT 20" AFFECTIVE RANGE INTIMIDATOR	\$69.50
PSPAK—TIME VARIANT SHOCK WAVE PISTOL	\$59.50
STAIK—ALL NEW SPACE AGE ACTIVE PLASMA SABER	\$59.50
MVPIK—SEE IN DARK KIT	\$199.50
PTGIK—SPECTACULAR PLASMA TORNADO GENERATOR	\$149.50

## ASSEMBLED

With All Necessary Instructions

BTCL—50,000 VOLT-WORLD'S SMALLEST TESLA COIL	\$54.50
LGU40—1MW HeNe VISIBLE RED LASER GUN	\$249.50
TAT30—AUTO TELEPHONE RECORDING DEVICE	\$24.50
GVPI0—SEE IN TOTAL DARKNESS IR VIEWER	\$349.50
LST10—SNOOPER PHONE INFINITY TRANSMITTER	\$169.50
IPG70—INVISIBLE PAIN FIELD GENERATOR MULTI MODE	\$74.50

● CATALOG CONTAINING DESCRIPTIONS OF ABOVE PLUS HUNDREDS MORE AVAILABLE FOR \$1.00 OR USE OUR PHONE FOR "ORDERS ONLY" 603-873-4730.

PLEASE INCLUDE \$3.00 PH ON ALL KITS AND PRODUCTS PLANS ARE POSTAGE PAID. SEND CHECK, MO, VISA, MC IN US FUNDS.

**INFORMATION UNLIMITED**  
P.O. BOX 716 DEPT. RE, AMHERST, NH 03031

## Cable TV Converters Why Pay A High Monthly Fee?

Jerrold Products include "New Jerrold Tri-Mode," SB-3. Hamlin, Oak VN-12, M-35-B, Zenith, Magnavox, Scientific Atlanta, and more. (Quantity discounts) 60 day warranty. For fast service C.O.D. orders accepted. Send SASE (60 cents postage) or call for info 1-800-648-3030. **MIDWEST ELECTRONICS, INC.**, 5143-R W. Diversey, Chicago, IL 60639. MC/Visa orders accepted. No Illinois orders accepted. Mon.-Fri. 8 A.M.-5 P.M. CST

## SATELLITE TV

**CABLE TV Secrets**—the outlaw publication the cable companies tried to ban. HBO, Movie Channel, Showtime, descramblers, converters, etc. Supplier's list included \$8.95. **CABLE FACTS**, Box 711-R, Pataskala, OH 43062.

**SATELLITE TV receiver kits!** Instruction manual, boards, semiconductor parts! 59" LNA's! LNB's! Ku-Band LNB's! Catalog \$1.00 **XANDI ELECTRONICS**, Box 25647, Dept. 21RR, Tempe, AZ 85285-5647.

**VIDEOCYpher II descrambling manual**, schematics, video and audio. Explains DES, EPROM, Wizardplus, KeysRus, Clonmaster, 3Musketeer. Pay-per-view (HBO, Cinemax, Showtime, adult, etc.) \$13.95, \$2 postage. **CABLETRONICS**, Box 30502R, Bethesda, MD 20814.

**FREE catalog systems, Upgrades**, Houston, Uden, Chaparral, etc. **Save, \$\$\$\$ SKYVISION**, 2009 Collegeway, Fergus Falls, MN 56537, (218) 739-5231.

SEND Stamp For Catalog. **COMMUNICATIONS ENGINEERING**, 76 Boulevard, Hudson Falls, NY 12839.

## Scrambling News

Scrambling systems apply the latest in electronic technology. Interesting News, technical feature articles, new patents, turn-ons, feedback. Monthly, \$24.95/yr. Sample \$3. Scrambling News: Year 1 \$22.95. With current subscription \$45. Advanced Cable and Satellite Descrambling (New). Not a rehash \$19.95. MDS/MMDS Wireless Cable Hacking (New) \$12.95. Experiences with Videocypher \$14.95 (New). All new Spring product catalog \$1.

**Scrambling News, 1552 Hertel Ave., Buffalo, N.Y. 14216 COD's 716-874-2088**

**VIDEOCYpher II Manuals**. Volume 1 - hardware, Volume 2 - software. Either \$32.45. Both \$54.95. Volume 3-Projects/software - \$42.45. **NEW! Volume 4- Repair** - \$89.95. **COD's 1** (602) 782-2316. Catalog \$3.00 **TELECODE Box** 6426-R, Yuma, AZ 85366-6426.

## CABLE EQUIPMENT BROKERS

**CABLE TV surplus inventory unmodified descramblers and plain converters at wholesale prices.** All makes. Example: OAK M35B \$30. (415) 495-3056.

## SCRAMBLE FACTS

718-343-0130

PHONE TODAY for 3 minutes of satellite TV industry news, technical tips, and new product information.

**MARK V ELECTRONICS, INC.**  
8019, E. SLAUSON AVE.  
MONTEBELLO, CA 90640

SHOWROOM HOURS: (PACIFIC TIME)  
MON.—FRI. 9:30 to 5:00 SAT. 10:00—5:00

CALL OR INFORMATION: (213) 888-8988  
TOLL FREE 1-800-423-3483 OR  
1-800-521-MARK (IN CAL) FOR ORDERS

PAID BY ONLY  
ORDER BY FAX (213) 888-6868

### VIDEO/AUDIO SURROUND SOUND PROCESSOR

SM-333

It creates high quality simulated stereo Surround "Music Field" for most video types CD, LD, Surround Sound Encoding Disk, tapes, etc. This processor employs the most updated IC at its heart. It is also equipped with a "DNR" DYNAMIC NOISE REDUCTION SYSTEM IC made by NATIONAL SEMICONDUCTOR. It particularly filters out the annoying noise that is commonly found on tapes or CD disk. In addition, there is six LOW NOISE OP-AMPS and all in one board design, no other external connections connect to the main board.

Other features include:  
• Continuous Variable Audio Time Delay • Surround Effect & Level Control • Dynamic Noise Reduction System • High output signal (8.5V MAX) can match with any kind of Main Power Amp. • All metal construction for reliability & durability!

**SPECIFICATIONS:**  
Frequency Response: 20Hz - 20KHz (± 5dB) • Total Harmonic Distortion: 0.05% (20Hz - 20KHz) (front channel), < 0.25% (surround channel) • Input Signal Voltage: 0.1V - 3.5V • Output Voltage: 0.1V - 3.5V (front channel), 8.5V Max. (surround channel) • Delay Time: 5ms - 50ms • Input Impedance: 47K Ohms • Power: AC 110V 60Hz • Dimensions: 4 3/16" (W) x 13 1/8" (D) x 2 1/8" (H) • KIT/ASM. AND TESTED

*It's a must for every modern family!*

**SUPER SALE** \$62/183

### MULTIFUNCTIONAL LED D.P.M.

**MEASUREMENT RANGE:**  
D.C. VOLTAGE: 1mV - 1000V  
A.C. VOLTAGE: 1mV - 1000V  
DIGITAL THERMOMETER: 0°C - 100°C  
D.C. CURRENT: 1 uA - 2A  
CAPACITOR METER: 1 pF - 2 uF  
DIMENSIONS: 3 3/4" x 1 7/8" x 4 1/16"

**FREE GOLD-PLATED EDGE CONNECTOR**  
SM-A3 \$32  
KIT/ASM. AND TESTED & CAL. \$43

### ELECTRONIC LOTTO

TY-8

WAS \$15 NOW \$12

• 0-49 DIGITS DISPLAY, SUITABLE FOR LOTTERY GAME.  
• AUTO-SHUT OFF POWER, SO POWER CONSUMPTION IS VERY LOW.  
• 0.5" GREEN LED DISPLAY WITH FANCY PLASTIC PANEL.  
• OPERATION VOLTAGE: 9V DC (BATTERY NOT INCLUDED).  
• DIMENSIONS: 3 1/4" x 2" x 0.5"

KIT ONLY

### 4 1/2 HI-PRECISION D.P.M.

SM-48A

**SPECIFICATIONS:**

\* 4 1/2 digit 14mm red large display with overload flash.  
\* Multi-functions including BCD, BUSY, STROBE output, very suitable for micro computer.  
\* MEMORY SYSTEM CAN HOLD the input reading for comparison and monitor.  
\* Range: DC voltage DC: 1mV - +2000A  
DC current DC: 1uA - +20A  
DC-DC 0.05% x 2 digit  
\* Accuracy: DC: 0.5% at 200mA  
\* Power: DC: 5V at 200mA  
DIMENSIONS: 3 3/4" (W) x 1 7/8" (H) x 4 1/16" (D)  
(MEET WITH DIN. STANDARD OF W. GERMANY.)  
KIT/ASM. AND TESTED & CAL. \$36/48

### 300W HQ HI-FI POWER AMPLIFIER (MONO)

TA-3600

QUASI-COMPLEMENTARY SYMMETRY WITH PARALLEL HIGH OUTPUT TRANSISTORS

**SPECIFICATIONS:**

\* POWER OUTPUT: 300W (RMS) INTO 8 OHMS - 245W (P.M.P.O.) INTO 8 OHMS  
540W (MUSIC POWER) INTO 8 OHMS  
\* LOAD IMPEDANCE: 4 OHMS OR 8 OHMS  
\* FREQUENCY RESPONSE: 10Hz - 200,000Hz  
\* TOTAL HARMONIC DISTORTION LESS THAN 0.05%  
\* INPUT SENSITIVITY AND IMPEDANCE AT 1KHz: 1V - 14V 47K OHMS  
\* SUPPLY VOLTAGE: DC ± 75V OR AC 53V x 2 BA  
\$88/110  
KIT/ASM. AND TESTED \$38/20

*SALE*

*SALE*

*NEW with 4 pos THOMSON HUGE 250 W POWER TR!*

## FREE CATALOG

TERMS: \$10 min. order • \$20 min. charge card order • Check, money order or phone order accepted • We ship UPS Ground • Add 10% of total order (min. \$2.50) for shipping, outside USA add 20% (min. \$5.00) • Transit Insurance: add 5% of total (outside USA only) • CA residents add sales tax • All merchandise subject to prior sale • Prices are subject to change without notice • Any goods proved to be defective MUST BE RETURNED IN ORIGINAL FORM WITH A COPY OF YOUR INVOICE WITHIN 30 DAYS FOR REPLACEMENT.

**CLEARANCE SALE**

TALKING CLOCK Clocks that really tell time!

**SPECIAL VALUE**  
No. 8501  
No. 8504

1. Talk push button for voice announcement of time.
  2. Read out twelve hours system display for hour, minute second by color flash, AM & PM.
  3. Display three display modes of time, alarm time & date.
  4. Alarm on off switch with thirty seconds voice alarm.
  5. Snooze: reminder voice alarm of thirty seconds after 4 minutes of first voice alarm.
  6. Volume: two level of voice output.
  7. Language available: English
- PARROT 8501 WAS \$18.95 NOW \$15.50  
MYNAH 8504 WAS \$18.95 NOW \$15.50  
NOT A KIT!

### 120W VERSATILE STEREO POWER BOOSTER

TA-302

**MATCH WITH OUR SURROUND SOUND PROCESSOR**

- OTL full transistorize and low distortion of SEPP circuit design, high output power and sound fidelity.
- With high and low input impedances for selection, so it can match with all preamplifiers, low power of portable sound equipment, and all types of stereo receiver deck to use. It can boost "walkman" type of tape and tape player, too.
- With 10 band colour LED power meter, output power can be easily defined.

TA - 302 is a versatile amplifier for both visual and listening enjoyment. 600x2 MUSIC POWER, 30 Wx2 RMS

KIT/ASM AND TESTED \$70

### DIGITAL VOICE MEMO

**SUPER VALUE** TA-28 MKII

**NEW**

- FEATURES:**
- SOLID STATE RECORD/PLAY BACK.
  - POWER/RECORD LED INDICATOR.
  - 8 BIT ADPCM ALGORITHM.
  - 8 BIT AD/DA CONVERTER.
  - 256K MEMORY CAPACITOR.
  - 8 SEC OR 16 SEC RECORD TIME.
  - SAMPLING FREQUENCY 8KHz OR 4 KHz.
  - INCLUDED CONDENSER MIC & SPEAKER.
  - BUILT IN LOW PASS FILTER.
  - MORE REALISTIC & CLEARLY.
  - LOW POWER CONSUMPTION.
  - SUPPLY VOLTAGE: 5.6V DC

\*\* FREE 256K TOY GRADE D-RAM  
KIT/ASM & TESTED \$30/40

*Second Generation*

\*\*\*\*\*PRESENTING\*\*\*\*\*  
**CABLE TV  
DESCRAMBLERS**  
\*\*\*\*\* STARRING \*\*\*\*\*  
**JERROLD, HAMLIN, OAK**  
AND OTHER FAMOUS MANUFACTURERS

- FINEST WARRANTY PROGRAM AVAILABLE
- LOWEST RETAIL/WHOLESALE PRICES IN U.S.
- ORDERS SHIPPED FROM STOCK WITHIN 24 HOURS

FOR FREE CATALOG ONLY **1-800-345-8927**  
FOR ALL INFORMATION 1-818-716-5914

**PACIFIC CABLE CO. INC.**  
73251 RESEDA BLVD. DEPT. RE1 89  
RESEDA, CA 91335



**CABLE-TV AT IT'S BEST**

SCIENTIFIC Atlanta models 8500-8550-8580 remote included... \$275.00. SB-3's...\$74.00. TRI-BI's...\$95.00. SA-3's...\$99.00. Zenith (Z-Tac) descramblers... \$169.00. N-12 (Vari-sync)... \$89.00. M-35 B (Vari-sync)... \$99.00. Hamlin MLD-1200's... \$89.00. 80-Channel converters... \$95.00. Dealer discount on (5) units. Call—N.A.S. INTERNATIONAL, (213) 631-3552.

**MINI POWER SUPPLY**

**POCKET SIZE.** Operates on 9v battery or DC adaptor with female plug. Continuously variable zero to adaptor voltage. Switching efficiency: 80% at 300ma max. Regulated, 50mv ripple. Extra pulse output. Dark plastic enclosure. \$39 postpaid. 30 day refundable. **PARAWING** P. O. Box 93, Menlo Park, CA 94026.

**CABLE TV CONVERTERS**

**CABLE TV converters.** Scientific Atlanta, Jerrold, Oak, Zenith, Hamlin. Many others. "New" Video Hopper "The Copy Killer." Visa, M/C & Amex. 1 (800) 826-7623. **B&B INC.,** P. O. Box 21-327, St. Paul, MN 55121.

**EDUCATION & INSTRUCTION**

**MAGIC!** Four illustrated lessons plus inside information shows you how. We provide almost 50 tricks including equipment for four professional effects. You get a binder to keep the materials in, and a one-year membership in the International Performing Magicians with a plastic membership card that has your name gold-embossed. You get a one-year subscription to our quarterly newsletter "IT'S MAGIC!" Order now! \$29.95 for each course + \$3.50 postage and handling. (New York residents add applicable state and local sales tax). **THE MAGIC COURSE,** 500-B BiCounty Boulevard, Farmingdale, NY 11735.

**F.C.C. Commercial General Radiotelephone license.** Electronics home study. Fast, inexpensive! "Free" details. **COMMAND,** D-176, Box 2223, San Francisco, CA 94126.

**BE a recording engineer;** Train at home for high paying-exciting careers. **FREE** information. **AUDIO INSTITUTE** 2174 Union St., Suite 22K, San Francisco, CA 94123.

**Do it yourself guide on how to maintain & clean your VCR.** Hookup diagrams. Basic problems & solutions. Illustrations included. Send \$7.95 **AMERICAN GIFTS** 1445 N. Morse, Chicago, IL 60676.

**THIS IS A BOLDFACE EXPANDED AD.** If you like this format, request it. Your cost is \$6.25 per word, plus 45% for the boldface and tint background.

**CABLE TV  
DESCRAMBLERS**

JERROLD™ Tri-Bi Mode.....	\$105.00	10 Lot	\$85.00
JERROLD™ SB-3 OR 2.....	\$89.00		\$65.00
Hamlin MLD-1200.....	\$99.95		\$62.00
Oak N-12 W/V.S.....	\$99.95		\$62.00
Oak M-35-B W/V.S.....	\$99.00		\$78.00
OAK E-13.....	\$99.95		\$58.00
Zenith SSAVI.....	\$185.00		\$145.00
Eagle PD-3.....	\$120.00		\$85.00
Scientific Atlanta.....	\$129.95		\$105.00
SA-Combo's.....	CALL		\$Call
Tocom.....	\$350.00		\$295.00
Oak N-12 W/ Auto.....	\$140.00		\$105.00
Jerrold Starcom CSV.....	\$139.95		Call

M.D. ELECTRONICS  
WILL MATCH ANY  
ADVERTISED PRICE  
IN THIS MAGAZINE

**\*NEW STARGATE 2000  
CABLE CONVERTER**



1-\$89.00 10-\$69.00 100-Call

Last channel recall-Favorite channel select-75 channel-Channel scan-Manual fine tune-One year warranty-surge protection-HRC & Standard switchable- and much more. **Call Today!**

**INFORMATION(402)554-0417**  
Orders Call Toll Free  
**1-800-624-1150**  
**M.D. ELECTRONICS**  
**115 NEW YORK MALL**  
**SUITE 133E**  
**OMAHA, NE. 68114**

M.C.  
VISA  
C.O.D.

**CIRCLE 53 ON FREE INFORMATION CARD**

**WALNUT SPEAKER  
CABINET KIT**

Super quality, genuine walnut veneer cabinet. Kit includes: routed and mitred top, sides, and bottom in unfinished 3/4" walnut veneer. Cut your own custom holes in the front and rear to match your drivers. 15" x 24" x 11". Volume: 1.9 cu. ft.



#260-350 **\$22.50** **\$19.95**  
(1-3) (4-up)

**15" THRUSTER  
WOOFER**

Thruster by Eminence. Made in U.S.A. Forward poly roll foam surround, 56 oz. magnet. 2-1/2", 2 layer voice coil. 150 watts RMS, 210 watts max. 4 ohm. fs = 23.5 Hz. QMS = 9.86, QES = .34, QTS = .33, VAS = 17.9 cu. ft. SPL = 94.8 dB 1W/1M. Net weight: 15 lbs.



#290-180 **\$43.50** **\$39.80**  
(1-3) (4-up)

**SUBWOOFER CROSSOVER**

200 watts RMS. 12 dB per octave. 150 Hz at 8 ohm crossover point.



#260-220 **\$28.80** **\$24.40**  
(1-5) (6-up)

**SPEAKERS AND COMPONENTS**

**PIONEER** **EMINENCE** **MOTOROLA** **Polydax**

**12" POLY WOOFER**

Super duty, 40 oz. magnet. Polypropylene cone. 100 watts RMS, 145 watts max. 4 and 8 ohm compatible (6 ohm). 2" voice coil. fs = 25 Hz. VAS = 10.8 cu. ft., QTS = .166. Response: 25-1,500 Hz. Net weight: 9 lbs.



#290-125 **\$36.80** **\$34.50**  
(1-3) (4-up)

**12" PIONEER  
SUB WOOFER**

Dual voice coil sub woofer. 30 oz. magnet, 2" voice coil. 100 watts RMS, 145 watts max. fs = 25 Hz. 6 ohm (4 and 8 ohm compatible). SPL = 89 dB 1W/1M. Response: 25-700 Hz. QTS = .31, VAS = 10.3 cu. ft. Pioneer #A30GU30-55D. Net weight: 6 lbs.



#290-145 **\$39.80** **\$36.80**  
(1-3) (4-up)

**15" 3-WAY, 125 WATT SYSTEM**

Our "Top-of-the-Line" system. The system features elements specifically selected to produce a balanced output throughout the full frequency bandwidth of the system. System includes: (1) #290-155 15" polypropylene woofer rated at 145 watts max, (2) #280-020 cup midranges, (1) #270-035 4" soft dome tweeter, (1) #260-215 200 watt 3-way crossover, (2) #260-265 100 watt mid, tweeter 'L' pad attenuators, (1) #260-300 speaker terminal, and (1) #260-340 grille cloth.



#15-125 **\$99.95**  
Each

**18" EMINENCE  
WOOFER**

**EMINENCE**

MADE IN U.S.A.

100 oz. magnet, 3" voice coil. 250 watts RMS, 350 watts max. 8 ohm, 30 Hz resonant frequency. 22-2700 Hz response. Efficiency: 95 dB 1W/1M. Paper cone treated accordion surround. Net weight: 29 lbs.



#290-200 **\$98.80** **\$89.50**  
(1-3) (4-up)

**PIONEER HORN  
TWEETER**

Mylar dome, 2.93 oz. barium ferrite magnet. 8 ohm. Response: 1,800-20,000 Hz. 35W RMS, 50W max. fs = 2,000 Hz, SPL = 106 dB. Pioneer #AHE60-51F.



#270-050 **\$6.50** **\$5.90**  
(1-9) (10-up)

**3-WAY 100W CROSS-  
OVER**

12 dB / octave rolloff. 800 Hz, 5000 Hz. 8 ohm. 100 watts RMS.



#260-210 **\$12.50** **\$9.95**  
(1-9) (10-up)

**Parts  
Express**  
International Inc.

340 E. First St., Dayton, OH 45402  
Local 1-513-222-0173  
FAX: 513 222-4644

**CALL  
TOLL FREE  
1-800-338-0531**

\* 15 day money back guarantee. \* \$10.00 minimum order. \* We accept Mastercard, Visa, Discover, and C.O.D. orders. \* 24 hour shipping. \* Shipping charge = UPS chart rate (\$2.50 minimum charge). \* Hours: 8:30 am - 6:00 pm EST, Monday - Friday. \* Mail order customers, please call for shipping estimate on orders exceeding 5 lbs.

**FREE  
CATALOG**



MARCH 1989

## LEARN TV/VCR REPAIR

Now you can train at home in spare time for a money-making career as a TV/VCR Repair Specialist. No previous experience necessary. No need to quit your job or school. Everything is explained in easy-to-understand language with plenty of drawings, diagrams and photos. We show you how to troubleshoot and repair video-cassette recorders and TV sets, how to handle house calls and shop repairs for almost any make of television or VCR. Tools are included with your course so you can get "hands-on" practice as you follow your lessons step by step. Send for free facts about the exciting opportunities in TV/VCR Repair and find out how you can start making money in this great career.

**MAIL COUPON TODAY** K04A  
**ICS SCHOOL OF TV/VCR REPAIR, Dept. DE029**  
SINCE 1981 Scranton, Pennsylvania 18515

Please send me full information and color brochure on how I can learn TV/VCR Repair at home in my spare time. I understand there is no obligation and no salesman will visit me.

Name \_\_\_\_\_ Age \_\_\_\_\_  
 Address \_\_\_\_\_ Apt. # \_\_\_\_\_  
 City/State \_\_\_\_\_ Zip \_\_\_\_\_  
 Phone ( ) \_\_\_\_\_

## DESCRAMBLER MODULE

**LATEST** technology alternative to Jerrold SB-3 or Radio-Electronics Feb. 1984 project. Featuring electronic tuning, AGC, auto-on/off, AC/DC power, mini-size, A&T, and more. For literature—**SOUTH-TECH DISTRIBUTING**, (813) 527-2190.

**THIS A REGULAR TYPE BOLDFACE AD with a tint screen. To have your ad appear like this one, the cost is \$4.15 per word.**

## BUY BONDS

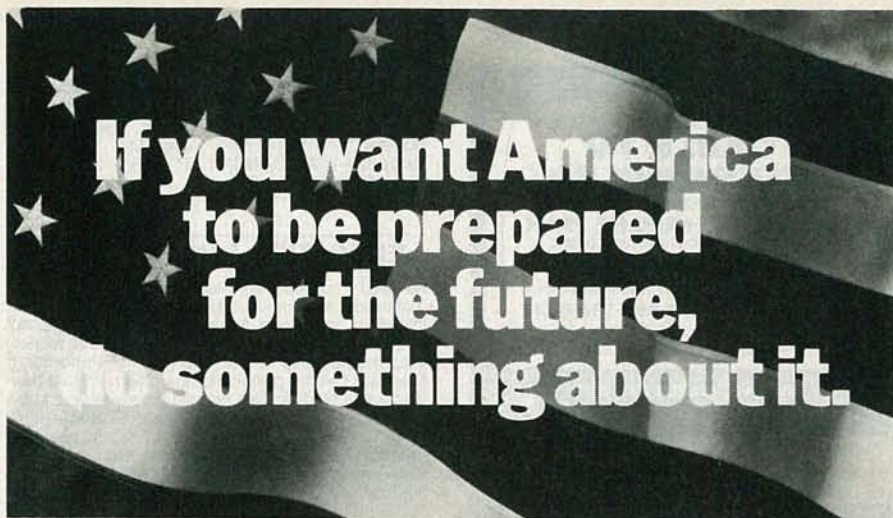

Support America's colleges. Because college is more than a place where young people are preparing for their future. It's where *America* is preparing for *its* future.

If our country's going to get smarter, stronger—and more competitive—our colleges and universities simply must become a national priority.

It's an investment we all share in. Government. Private citizens. And the business community. After all, the future of American business depends on it.

So help America prepare for the future with a corporate gift to the college of your choice—and you'll know your company has done its part.

## Give to the college of your choice.



COUNCIL FOR AID TO EDUCATION **CFAE**

## Scientific Atlanta & Pioneer Cable Descramblers in Stock AC/DC — The New Leader in Low Prices

• We will match or beat anyone's advertised price •

ITEM	ONE UNIT	10+ UNITS
PIONEER ADD ON PD-2 DECODER FOR ALL PIONEER SYSTEMS	250.00	200.00
PANASONIC WIRELESS CONVERTER 1403N	79.95	69.00
JERROLD JSX3-DIC 36 CHANNEL CONVERTER	84.95	65.00
JERROLD 400 WITH REMOTE (MANUAL FINE TUNING)	64.95	55.00
JERROLD 400 COMBO W/ REMOTE (DRX3D/C)	134.95	100.00
JERROLD 450 COMBO W/ REMOTE (DRZ3D/C)	169.95	125.00
JERROLD 400 OR 450 REMOTE HAND UNIT	24.95	15.00
JERROLD SB ADD ON	74.95	55.00
JERROLD SB ADD ON WITH TRI-BI	95.00	75.00
OAK M-35 COMBO	94.95	65.00
OAK MINICODE (N-12)	84.95	59.00
OAK ECONOCODE (E-13)	64.95	40.00
HAMLIN MLD-1200	64.95	55.00
EAGLE PD-3	99.95	60.00
ZENITH SSAVI CABLE READY	149.95	100.00
SCIENTIFIC ATLANTA SA-3 ADD ON	109.95	80.00
INTERFERENCE FILTER (CHANNEL 3 OR 6)	24.95	14.00
VIDEO TAPE COPY STABILIZER	69.95	45.00
PANASONIC CONVERTOR W/ VOLUME CONTROL (170 3PB)	109.95	95.00
SCIENTIFIC ATLANTA B580	299.95	249.00
SCIENTIFIC ATLANTA B3 CHANNEL CONVERTER	94.95	79.00
SCIENTIFIC ATLANTA B535	210.00	175.00
PIONEER CONVERTOR (4535)	89.95	75.00

QUANTITY	ITEM	OUTPUT CHANNEL	PRICE EACH	TOTAL PRICE
It is not the intent of AC/DC to defraud any pay television operator and we will not assist any company or individual in doing so.			SUBTOTAL	
PLEASE PRINT: <input type="checkbox"/> Cashier's Check <input type="checkbox"/> Money Order <input type="checkbox"/> COD			Shipping Add \$3.00 per Unit	
Name _____			COD Add 5%	
Address _____			TOTAL	
City / State / Zip _____				
Signature _____			Phone Number ( ) _____	

**WAIVER.** Since I, the undersigned, fully understand that the ownership of a cable decoder does not give the owner of the decoder the right to decode or view premium cable channels without proper authorization from their local cable company, hereby declare under penalty of perjury that all products purchased, at any time, will only be used on cable TV systems with proper authorization from local officials or cable company officers in accordance with all applicable federal and state laws. Federal and various state laws provide for substantial criminal and civil penalties for unauthorized use.

Dated: \_\_\_\_\_ Signed: \_\_\_\_\_

**ATLANTIC CABLE DISTRIBUTING CENTER INC.**  
 366 N. BROADWAY, SUITE 310, JERICHO, NY 11759.  
 516 - 625-3550 **IMPORTANT: Have make and model of the equipment used in your area.** 516 - 625-3532

CIRCLE 188 ON FREE INFORMATION CARD

**AMCOM.....** *AMCOM SAYS "We're glad we have competition. It keeps us on our toe's, so you get better products and service."*

**800-85-AMCOM (For Orders) 804-456-5505 (Tech Line)**

## CABLE TV EQUIPMENT

Standard SSAVI ADD ON UNIT.....\$159.00ea

Filters 2,3,5,6,8,9,14,15,16,17,18,19,20,21,22.....\$15.00ea

Bi-State Trimode ADD ON UNIT.....\$119.00ea

TC-VIP ADD-ON.....\$169.00

TC-VIP Kit.....\$109.00

LM318---1.00	LM319---1.00	LM324---.30	LM393---.50
LM555---.35	LM565---.75	NE592---.75	MC1330---.55
MC1350---1.00	CA1398---4.00	MC1458---.25	LM1496---.75
TLO82---1.00	TLO84---1.50	CD4002---.25	CD4011---.25
CD4012---.25	CD4013---.25	CD4016---.25	CD4018---.50
CD4024---.50	CD4027---.35	CD4053---.60	CD4066---.40
CD4069---.25	CD4071---.25	CD4081---.25	CD4082---.25
7490---.35	74ls04---.35	74ls74---.35	74ls123---.50

**"BLASTER UHF Preamp.....\$25.00**

25 db gain with only 5nf loss when mounted at your antenna mast. Uses the new PHANTOM TYPE POWER line. With stripline circuitry. ALL PARTS FOR ASSEMBLY, includes power supply.

**RARE IC CHIP MM5321**

Camera sync chip supplies all color information and sync.\$8.50

**DEALERS WANTED!!!! QUANTITY PRICES**

**Call us !!! We buy excess inventory.....**

**95%\*** OF THE TOP 100 ELECTRONIC  
MANUFACTURERS IN THE UNITED  
STATES ARE DIGI-KEY CUSTOMERS

\*Source: Electronic Business 200, "Electronic Business" Magazine, July 15, 1988

This might seem incredible until you realize that . . .

- **95%** OF THE ITEMS IN DIGI-KEY'S CATALOG ARE AVAILABLE FOR "OFF-THE-SHELF" DELIVERY — AND THE OTHER 5% ARE ON THE WAY!!
- **99%** OF ORDERS ARE SHIPPED TO DIGI-KEY CUSTOMERS WITHIN 24 HOURS!!
- **100%** COMMITMENT TO CUSTOMER SATISFACTION!!

To receive your complimentary copy of the current Digi-Key Catalog or for pricing and Availability on your current or future needs — Contact Digi-Key today

## 1-800-344-4539

Easy To Remember: 1-800-DIGI-KEY

AK, PR: 218-681-6674; Easylink: 62827914; Telex II: 9103508982 "DIGI-KEY CORP"; FAX: 218-681-3380

*Serving A National Market With Quality Electronic Components Since 1972*



# ALL ELECTRONICS CORP.

## 10 AMP SOLID STATE RELAYS

ELECTROL# S2181  
CONTROL:

Rated 5.5 to 10 Vdc  
(will operate on 3-32 Vdc).  
LOAD: 10 amp @ 240 Vac  
2 1/4" X 1 3/4" X 7/8"



CAT# SSRLY-10B \$9.50 each  
**QUANTITY DISCOUNT**  
10 for \$85.00 • 25 for \$175.00  
50 for \$300.00 • 100 for \$500.00

## STROBE KIT



Variable rate strobe kit, flashes between 60 to 120 times per minute. Will operate on either 6 or 12 Vdc depending upon how you wire the circuit. Comes complete with P.C. board and instructions for easy assembly.  
CAT# STROBE-1 \$7.50 each

## CASSETTE MECHANISM

Alpine cassette transport mechanism. Includes stereo tape head,



Mitsubishi # MET-3RF2B 13.2 Vdc motor, belt, pulleys, capstan, fast forward, rewind and eject actuator. Does not include amplifier section. 6 1/2" X 5 1/4" X 1 3/4".

CAT# CMEC-5 \$7.50 each  
10 for \$65.00

## PIEZO WARNING DEVICE



Murata Erie # PKB8-4A0  
High pitched audible alarm. Operates on 3 - 20 Vdc @ 20 ma. 1" high x 7/8" dia. P.C. board mount.  
CAT# PBZ-84 \$1.75 each

## XENON TUBE



1" long flashtube with 3 1/2" red and black leads. Ideal for electronic flash or strobe projects.  
CAT# FLT-3 2 for \$1.00

## NICKEL-CAD BATTERIES (RECHARGEABLE)

**SPECIAL!! AAA SIZE**  
Panasonic# P-18AAA  
1.2 volt @ 180 MAh  
CAT# NCB-AAAX \$1.50 each  
10 for \$13.50 • 100 for \$125.00



AA SIZE \$2.00 each  
1.25 volts 500 mAh  
CAT# NCB-AA  
AA SIZE \$2.20 each  
WITH SOLDER TABS  
CAT# NCB-SAA  
C SIZE \$4.25 EACH  
1.2 volts 1200 mAh  
CAT# NCB-C  
D SIZE \$4.50 each  
1.2 volts 1200 mAh  
CAT# NCB-D

## TRANSISTORS

CAT#	TYPE	CASE	PRICE
PN2222	NPN	TO-92	5 for 75¢
2N2904	PNP	TO-5	3 for \$1.00
2N2906	PNP	TO-18	3 for \$1.00
PN2907	PNP	TO-92	5 for 75¢
2N3055	NPN	TO-3	\$1.00 each
PN3569	NPN	TO-92	5 for 50¢
2N3904	NPN	TO-92	5 for 75¢
2N3906	PNP	TO-92	5 for 75¢
2N4400	NPN	TO-92	5 for 75¢
2N4402	PNP	TO-92	5 for 75¢
2N5400	PNP	TO-92	4 for \$1.00
2N5880	PNP	TO-3	\$2.00 each
2N5882	NPN	TO-3	\$2.00 each
MJ2955	PNP	TO-3	\$1.50 each
MJE2955T	PNP	TO-220	75¢ each
MJE3055T	NPN	TO-220	75¢ each
TIP30	PNP	TO-220	75¢ each
TIP31	NPN	TO-220	75¢ each
TIP32	PNP	TO-220	75¢ each
TIP41	NPN	TO-220	75¢ each
TIP42	PNP	TO-220	75¢ each
TIP121	NPN	TO-220	75¢ each
TIP126	PNP	TO-220	75¢ each

## WIDE BAND AMPLIFIER

NEC# UPC1651G. 1200 Mhz @ 3 db.  
Gain: 19db @ 1-500 hz. 5 volt operation.  
Small package 4mm dia. X 2.5 mm thick.  
CAT# UPC-1651 2 for \$1.00  
10 for \$4.50 • 100 for \$35.00

## N-CHANNEL MOSFET

IRF-511 TO-220 case  
CAT# IRF 511  
\$1.00 each • 10 for \$9.00  
LARGE QUANTITY AVAILABLE

## OPTO SENSOR

U shaped package with mounting ears. 1/8" opening. 3/4" mounting holes. CAT# OSU-6 50¢ each  
10 for \$4.50 • 100 for \$40.00

## WALL TRANSFORMERS



ALL PLUG DIRECTLY INTO 120 VAC OUTLET  
6 Vdc @ 200 ma. CAT# DCTX-620 \$2.25  
6 Vdc @ 750 ma. CAT# DCTX-675 \$3.50  
9 Vdc @ 250 ma. CAT# DCTX-925 \$2.50  
12 Vac @ 930 ma. CAT# ACTX-1293 \$3.50  
18 Vac @ 1 amp. CAT# ACTX-1885 \$3.50

## SWITCHES

**ITT PUSH BUTTON**  
ITT MDPL series. 3/4" X 1/2" gray rectangular key cap. S.P.S.T. N.O.  
Push to close. RATED: 0.1 amp switching, 0.25 amp carry current. P.C. mount. CAT# PB-8 65¢ each • 10 for \$6.00 • 100 for \$50.00  
**10 POSITION MINI-ROTARY**  
Grayhill# 56P36-01-1-10N-C  
Mini rotary switch. Non-shorting. 1 deck, 10 positions. .125" dia. shaft X .375" long. .377" behind the panel depth. P.C. pins.  
CAT# MRS-10 \$2.50 each

## HALL EFFECT SWITCH

MICROSWITCH# 4BE3  
Slanted keyboard switch with hall effect sensor. Snaps into 5/8" square chassis hole. Hall effect sensor slides easily from switch and can be used in other applications.  
CAT# HESW 4 for \$1.00  
10 for \$2.00 • 100 for \$15.00

## SPDT PUSHBUTTON

Marquard# 1843  
Rated 6 amps @ 125/250 Vac.  
Black plastic pushbutton.  
Switch body: .92" X .94" X .65".  
CAT# PB-18 \$1.65 each • 10 for \$1.50 each

## LED'S

**STANDARD JUMBO**  
DIFFUSED T 1-3/4 size  
**RED CAT# LED-1**  
10 for \$1.50 • 100 for \$13.00  
**GREEN CAT# LED-2**  
10 for \$2.00 • 100 for \$17.00  
**YELLOW CAT# LED-3**  
10 for \$2.00 • 100 for \$17.00

**FLASHING LED**  
with built in flashing circuit operates on 5 volts...  
**RED** \$1.00 each  
CAT# LED-4 10 for \$9.50  
**GREEN** \$1.00 each  
CAT# LED-4G 10 for \$9.50

**BI-POLAR LED**  
Lights RED one direction, GREEN the other. Two leads.  
CAT# LED-6 2 for \$1.70  
**LED HOLDER**  
Two piece holder.  
CAT# HLED 10 for 65¢

## RELAYS

**12 VOLT D.C. COIL S.P.D.T.**  
Omron# G2E-184P  
4 Amp contacts  
335 ohm coil.  
Sugar cube size.  
.61" X .42" X .44" high.  
P.C. mount with pins on DIP spacing.  
CAT# RLY-787 \$1.50 each  
**120 VOLT A.C. - D.P.D.T.**  
GUARDIAN# 1220U-04  
10 Amp contacts.  
1,100 ohm coil  
1.703" X 1.578" X 1.687". Clear polycarbonate cover. Gold plated solder or socket mount terminals.  
CAT# RLY-228 \$3.50 each

CALL OR WRITE FOR OUR FREE CATALOG OVER 4000 PARTS!



MAIL ORDERS TO:  
**ALL ELECTRONICS**  
P.O. BOX 567  
VAN NUYS, CA 91408

TWX-5101010163 (ALL ELECTRONIC)

OUTSIDE THE U.S.A.  
SEND \$2.00 POSTAGE FOR A CATALOG!!

ORDER TOLL FREE  
**800-826-5432**  
INFO: (818)904-0524  
FAX: (818)781-2653  
MINIMUM ORDER \$10.00  
QUANTITIES LIMITED  
CALIF. ADD SALES TAX  
USA: \$3.00 SHIPPING  
FOREIGN ORDERS  
INCLUDE SUFFICIENT SHIPPING. NO C.O.D.

DISCOVER

VISA

MasterCard

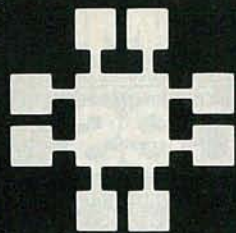

# JDR Microdevices

## 10 years of commitment to you!

As we celebrate our 10th year in business, we'd like to give a **special thanks to all our loyal customers!** Our business is built upon your trust and confidence in us, things we take very seriously.

To those of you who have never ordered from us, here are 10 reasons to give us a try:



### 1. **30 day money back guarantee on every item\***

You can buy with confidence from JDR because you can return any purchase within 30 days for a complete refund.

### 2. **One year limited warranty on every item\***

We warranty all our products to be free of defects in materials or workmanship for one year from date of purchase.

### 3. **Toll-free ordering: call 800-538-5000**

Monday-Friday 7 AM-5 PM, Saturday 10 AM-3 PM (PST).

### 4. **Toll-free customer service**

We're here to help--just give us a call.

### 5. **Toll-free, top-notch technical support**

Our 24-person support staff provides technical help before or after you make your purchase!

### 6. **Extensive product testing**

Every new product is put through extensive testing in our own labs before we add it to our selection.

### 7. **Wholesale prices on volume orders**

Just ask for our Wholesale Department.

### 8. **Fast shipping**

Most orders are processed and shipped within 48 hours. Need it tomorrow? Ask about our Overnight rates.

### 9. **Shareware by Buttonware**

Complimentary software with every purchase over \$100.

### 10. **Electronic BBS: (408) 374-2171**

For 24-hr. ordering, technical support, tips and more!

\*A full copy of our terms is available upon receipt.

"We wish to thank you and your staff for the great service you extended to our department with our orders. We really appreciate it when a company expedites our order in such a timely manner, with quality merchandise and competitive prices."

—Sally A. Callaway, Kalispell, MT

We...really appreciate JDR Microdevices, a vendor which provides products and service that can be relied upon for excellence."

Diane M. DuBois, San Jose CA

"I have your MCT-XTMB and MCT-FDC and was very pleased to find the instructions were the best by far for any circuit board I have seen. A compliment should be in order."

—C.C., Marstons Mills, MA

"THANKS! The response to my letter about the problem I was having was GREAT! Robert called me and assured me that he was going to find a solution. HE DID! Please give him my thanks for his help."

—Clyde Hussey, Sylva, NC

"I found JDR's tech support to be responsive, helpful and honest—appreciably more so than other companies I have dealt with. I would certainly use JDR for other purchases and will recommend the company to associates with confidence."

—N.G., Melville, NY

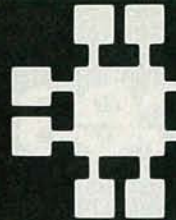

# JDR Microdevices®

**MMC**  
MICROCOMPUTER  
MARKETING COUNCIL  
of the Direct Marketing Association, Inc.

• 30 DAY MONEY BACK GUARANTEE • 1 YEAR WARRANTY ON ALL PRODUCTS • TOLL-FREE TECHNICAL SUPPORT  
• COMPLETE CUSTOMER SATISFACTION • SUPERIOR SERVICE • FRIENDLY, KNOWLEDGEABLE SALES STAFF

### STATIC RAMS

PART	SIZE	SPEED	PRICE
2112	256x4	450ns	2.99
2114	1024x4	450ns	.99
2114L-2	1024x4	200ns	1.49
TC5516	2048x8	250ns	3.95
TMM2016-200	2048x8	200ns	3.25
TMM2016-150	2048x8	150ns	3.29
TMM2016-100	2048x8	100ns	4.29
HM6116-4	2048x8	200ns	4.95
HM6116-3	2048x8	150ns	5.95
HM6116-2	2048x8	120ns	6.45
HM6116LP-4	2048x8	200ns	5.95
HM6116LP-3	2048x8	150ns	6.45
HM6116LP-2	2048x8	120ns	6.95
HM6264LP-15	8192x8	150ns	9.95
HM6264LP-12	8192x8	120ns	10.95
HM43256LP-15	32768x8	150ns	12.95
HM43256LP-12	32768x8	120ns	14.95
HM43256LP-10	32768x8	100ns	19.95

CALL TO CONFIRM CURRENT PRICES

### DYNAMIC RAMS

PART	SIZE	SPEED	PRICE
4116-200	16384x1	200ns	.89
4116-150	16384x1	150ns	.99
MK4332	32768x1	200ns	6.95
4164-130	65536x1	150ns	2.89
4164-120	65536x1	120ns	3.19
4164-100	65536x1	100ns	3.95
TMS4164	65536x1	150ns	2.89
TMS4416	16384x4	150ns	8.95
41128-150	131072x1	150ns	5.95
TMS4464-15	65536x4	150ns	10.95
TMS4464-12	65536x4	120ns	11.95
41256-150	262144x1	150ns	12.45
41256-120	262144x1	120ns	12.95
41256-100	262144x1	100ns	13.45
41256-80	262144x1	80ns	13.95
HMS1258-100	262144x1	100ns	13.95
1 MB-120	1048576x1	120ns	34.95
1 MB-100	1048576x1	100ns	37.95

CALL TO CONFIRM CURRENT PRICES

### EPROMS

PART	SIZE	SPEED	Vpp	PRICE
2708	1024x8	450ns	25V	4.95
2716	2048x8	450ns	25V	3.49
2716-1	2048x8	350ns	25V	3.95
2732	4096x8	450ns	25V	3.95
2732A	4096x8	250ns	21V	3.95
27C64	8192x8	250ns	12.5V	4.95
2764	8192x8	450ns	12.5V	3.49
2764-250	8192x8	250ns	12.5V	3.69
2764-200	8192x8	200ns	12.5V	4.25
MCM68766	8192x8	350ns	21V	15.95
27128	16384x8	250ns	12.5V	4.95
27128A-200	16384x8	200ns	12.5V	5.95
27C256	32768x8	250ns	12.5V	7.95
27256	32768x8	250ns	12.5V	5.95
27256-200	32768x8	200ns	12.5V	7.95
27512	65536x8	250ns	12.5V	11.95
27C512	65536x8	250ns	12.5V	12.95
27C101-20	131072x8	200ns	12.5V	34.95

CALL TO CONFIRM CURRENT PRICES

### CO-PROCESSORS

PART	SPEED	PRICE
8087	5 MHz	99.95
8087-2	8 MHz	139.95
8087-1	10 MHz	194.95
80287	6 MHz	159.95
80287-8	8 MHz	229.95
80287-10	10 MHz	289.95
80387-16	16 MHz	449.95
80387-20	20 MHz	599.95
80387-25	25 MHz	699.95



intel  
5  
YEAR  
WARRANTY

INCLUDES MANUAL & SOFTWARE GUIDE

CALL OUR WHOLESALE DEPT.  
FOR VOLUME QUOTES

## HIGH-TECH SPOTLIGHT

### SIMMS SINGLE IN-LINE MEMORY MODULES

PART NO.	ORGANIZATION	SPEED	PRICE
41256A8B-15	256K X 8-BIT	150NS	89.00
41256A8B-12	256K X 8-BIT	120NS	99.00
41256A8B-10	256K X 8-BIT	100NS	129.00
42100A8B-10	1MB X 8-BIT	100NS	429.00
42100A9B-10	1MB X 9-BIT	100NS	529.00
42100A9B-80	1MB X 9-BIT	80NS	599.00

### V-20 SERIES

SPEED UP YOUR PC BY 10 TO 40%!

- HIGH SPEED ADDRESS CALCULATION IN HARDWARE
- PIN COMPATIBLE WITH 8088
- SUPERSET OF 8088 INSTRUCTION SET
- LOW POWER CMOS

V20*	5 MHz	8.95	V20*	8 MHz	10.95
	10 MHz	12.95	V30	8 MHz <td>13.95</td>	13.95

### VOLTAGE REGULATORS

7805T	.49	7812K	1.39
7808T	.49	7905K	1.69
7812T	.49	7912K	1.49
7815T	.49	78L05	.49
7905T	.59	78L12	.49
7908T	.59	79L05	.69
7912T	.59	79L12	1.49
7915T	.59	LM332K	3.49
7805K	1.59	LM338K	4.49

### PALS

16L8	2.95
16R8	2.95
16R6	2.95
16R4	2.95

### UARTS

AY5-1013	3.95
AY5-1015	4.95
TR1602	3.95
2651	4.95
IM6402	3.95
IM6403	9.95
INS8250	6.95
NS16450	10.95

### INTERSIL

ICL7107	10.95
ICL7660	1.99
ICL8038	3.85
ICM7207A	5.95
ICM7208	15.95

### MISCELLANEOUS

ADC0804	2.99	9334	1.75
ADC0809	3.85	9368	2.85
DAC0800	3.29	9602	.69
DAC0808	1.95	ULN2003	.79
DAC1022	5.95	MAX232	7.95
MC1408L8	1.95	MC3470	1.95
8T28	1.29	MC3487	2.95
8T97	.59	AY5-3600	
DP8304	2.29	PRO	11.95

### 74LS00 TTL LOGIC

74LS00	.16	74LS112	.29	74LS241	.69
74LS01	.18	74LS122	.45	74LS242	.69
74LS02	.17	74LS123	.49	74LS243	.69
74LS03	.18	74LS124	2.75	74LS244	.79
74LS04	.16	74LS125	.39	74LS245	.69
74LS05	.18	74LS126	.39	74LS251	.45
74LS08	.18	74LS132	.39	74LS253	.49
74LS09	.18	74LS133	.49	74LS257	.39
74LS10	.16	74LS136	.39	74LS258	.49
74LS11	.22	74LS138	.39	74LS259	1.29
74LS12	.22	74LS139	.39	74LS260	.49
74LS13	.26	74LS145	.99	74LS266	.39
74LS14	.39	74LS147	.99	74LS273	.79
74LS15	.26	74LS148	.99	74LS279	.39
74LS20	.17	74LS151	.39	74LS280	1.98
74LS21	.22	74LS153	.39	74LS283	.59
74LS22	.22	74LS154	1.49	74LS290	.89
74LS27	.22	74LS155	.59	74LS293	.89
74LS28	.26	74LS156	.49	74LS299	1.49
74LS30	.17	74LS157	.35	74LS322	3.95
74LS32	.18	74LS158	.29	74LS323	2.49
74LS33	.28	74LS160	.29	74LS365	.39
74LS37	.26	74LS161	.39	74LS367	.39
74LS38	.26	74LS162	.49	74LS368	.39
74LS42	.39	74LS163	.39	74LS373	.79
74LS47	.75	74LS164	.49	74LS374	.79
74LS48	.85	74LS165	.65	74LS375	.95
74LS51	.17	74LS166	.95	74LS377	.79
74LS73	.29	74LS169	.95	74LS390	1.19
74LS74	.24	74LS173	.49	74LS393	.79
74LS75	.29	74LS174	.39	74LS541	1.49
74LS76	.29	74LS175	.39	74LS624	1.95
74LS83	.49	74LS191	.49	74LS640	.99
74LS85	.49	74LS192	.69	74LS645	.99
74LS86	.22	74LS193	.69	74LS670	.89
74LS90	.39	74LS194	.69	74LS682	3.20
74LS92	.49	74LS195	.69	74LS688	2.40
74LS93	.39	74LS196	.59	74LS783	22.95
74LS95	.49	74LS197	.59	26LS2521	2.80
74LS107	.34	74LS221	.59	26LS31	1.95
74LS109	.36	74LS240	.69	26LS32	1.95

### LINEAR COMPONENTS

TL071	.69	LM380	.89	XR2206	3.95
TL072	1.09	LM383	1.95	XR2211	2.95
TL074	1.95	LM386	.89	LM2917	1.95
TL081	.59	LM393	.45	CA3046	.89
TL082	.99	LM394H	5.95	CA3146	1.29
TL084	1.49	LM399H	5.95	MC3373	1.29
LM301	.34	TL494	4.20	MC3470	1.95
LM309K	1.25	TL497	3.25	MC3480	8.95
LM310	1.75	NE555	.29	MC3487	2.95
LM311	.59	NE556	.49	LM3900	.49
LM311H	.89	NE558	.79	LM3909	.98
LM311K	3.49	NE564	1.95	LM3911	2.25
LM312H	1.75	LM565	.95	LM3914	1.89
LM317T	.69	LM566	1.49	LM3915	1.89
LM318	1.49	LM567	.79	MC4024	3.49
LM319	1.25	NE570	2.95	MC4044	3.99
LM322K	3.49	NE590	2.50	RC4136	1.25
LM324	.34	NE592	.98	RC4558	.69
LM331	3.95	LM723	.49	LM1360	1.49
LM334	1.19	LM753	.98	75107	1.49
LM335	1.79	LM741	.29	75108	1.49
LM336	1.75	LM747	.69	75110	1.95
LM338K	4.49	MC1330	1.69	75150	1.95
LM339	.59	MC1350	1.19	75154	1.95
LF347	2.19	LM1458	.35	75188	1.25
LF353	.59	LM1488	.49	75189	1.25
LF356	.99	LM1489	.49	75451	.39
LF357	.99	LM1496	.85	75452	.39
LM358	.59	ULN2003	.79	75477	1.29

### HIGH SPEED CMOS LOGIC

74HC00	.21	74HC244	.85	74HCT138	.35
74HC04	.25	74HC245	.85	74HCT139	.55
74HC08	.25	74HC273	.69	74HCT157	.59
74HC14	.35	74HC367	.69	74HCT161	.79
74HC32	.35	74HC373	.69	74HCT240	.89
74HC74	.35	74HC390	.79	74HCT244	.89
74HC138	.45	74HC374	.69	74HCT245	.99
74HC139	.45	74HC4040	.89	74HCT273	.95
74HC154	1.09	74HC700	.25	74HCT373	.99
74HC157	.55	74HC704	.27	74HCT374	.99
74HC161	.55	74HC708	.25	74HCT393	.99
74HC164	.65	74HC732	.27	74HCT4040	.99
74HC175	.59	74HC774	.45	74HCT4060	1.49

### STANDARD CMOS LOGIC

4001	.19	4028	.65	4069	.19
4011	.19	4040	.69	4070	.29
4013	.35	4042	.59	4081	.26
4015	.29	4044	.69	4093	.49
4016	.29	4046	.69	14411	9.95
4017	.49	4047	.69	14433	14.95
4018	.69	4049	.29	14497	6.95
4020	.59	4050	.29	4503	4.49
4021	.69	4051	.69	4511	.69
4023	.25	4052	.69	4518	.85
4024	.49	4053	.69	4528	.79
4025	.25	4060	.69	4538	.95
4					



### CRYSTALS

32.768 KHz	.95
1.0 MHz	2.95
1.8432	2.95
2.0	1.95
2.4576	1.95
3.579545	1.95
4.0	1.95
5.0	1.95
5.0688	1.95
6.0	1.95
6.144	1.95
8.0	1.95
10.0	1.95
10.738635	1.95
12.0	1.95
14.31818	1.95
16.0	1.95
18.0	1.95
18.432	1.95
20.0	1.95
22.1184	1.95

### OSCILLATORS

1.0MHz	5.95
1.8432	5.95
2.0	5.95
2.4576	5.95
2.5	5.95
4.0	4.95
5.0	4.95
5.0688	4.95
6.0	4.95
6.144	4.95
8.0	4.95
10.0	4.95
12.0	4.95
14.31818	1.95
16.0	4.95
18.432	4.95
20.0	4.95
24.0	4.95

### DISCRETE

1N751	.49	2N4403	.25
1N5402	.25	2N6045	1.75
1N4004	10/1.00	MPS-A13	.40
1N4148	25/1.00	TIP31	.49
KB902	.55	4N25	.59
PN2222	.10	4N27	.69
2N2222	.10	4N28	.69
2N2907	.25	4N33	.89
2N3055	.79	4N37	1.19
2N3904	.10	MCT-2	.59
2N3906	.10	MCT-6	1.29
2N4401	.25	TIL-111	.99

### CAPACITORS

TANTALUM		ELECTROLYTIC	
1.0µf	15V .12	RADIAL	
6.8	15V .42	1µf	50V .14
10	15V .45	4.7	50V .11
22	15V .99	10	50V .11
1.0µf	35V .45	47	35V .13
2.2	35V .19	100	16V .15
4.7	35V .39	100	50V .23
10	35V .69	220	35V .20
		470	25V .30
		2200	16V .70
		4700	25V 1.45

DISC		AXIAL	
10pf	50V .05	1µf	50V .14
22	50V .05	10	16V .14
33	50V .05	10	50V .16
47	50V .05	22	16V .14
100	50V .05	47	50V .19
220	50V .05	100	35V .19
.001µf	50V .05	470	50V .29
.005	50V .07	1000	16V .29
.01	50V .07	2200	16V .70
.05	50V .07	4700	16V 1.25
.1	12V .10		
.1	50V .12		

### SOLDER STATION

- UL APPROVED
- ADJUSTABLE HEAT SETTING
- TIP TEMPERATURE READOUT
- REPLACEMENT TIPS AVAILABLE \$2.95

**\$49<sup>95</sup>**



### WIREWRAP PROTOTYPE CARDS

FR-4 EPOXY GLASS LAMINATE WITH GOLD PLATED EDGE-CARD FINGERS AND SILK SCREENED LEGENDS.



#### FOR PS/2

JDR-PR32	32 BIT PROTOTYPE CARD	69.95
JDR-PR16	16 BIT WITH I/O DECODING LAYOUT	49.95
JDR-PR16PK	PARTS KIT FOR JDR-PR16 ABOVE	15.95
JDR-PR16V	16 BIT FOR VIDEO APPLICATIONS	39.95

FOR AT		
JDR-PR10	16BIT WITH I/O DECODING LAYOUT	34.95
JDR-PR10PK	PARTS KIT FOR JDR-PR10 ABOVE	12.95

FOR XT		
JDR-PR1	WITH +5V AND GROUND PLANE	27.95
JDR-PR2	AS ABOVE WITH I/O DECODING LAYOUT	29.95

**FULL 1 YEAR WARRANTY ON EVERY PRODUCT!**

### POWER SUPPLIES

#### APPLE TYPE SUPPLY

- APPLE CONNECTOR
- +5V @ 6A, +12V @ 3A, -5V @ 1A, -12V @ 1A

PS-A \$49.95



#### FLOPPY DRIVE SUPPLY

- +5V @ 2.5A, +12V @ 2A, -12V @ 1A
- +5V @ 5A, IF +12 NOT USED

PS-ASTEC \$24.95



#### 36 WATT SUPPLY

- +5V @ 2.5A, +12V @ 1.5A
- 3 PIN INPUT, 6 PIN OUTPUT
- SELECTABLE 110V-220V

PS-3045 \$12.95

#### MICRO SUPPLY

- UL APPROVED, 144 WATTS
- +5V @ 18A, +12V @ 4A, -12V @ 500MA

PS-1554 \$29.95

### BIT RATE GENERATORS

MC14411	9.95
BR1941	4.95
4702	9.95
COM5016	16.95
COM8116	8.95
MM5307	4.95

### BYPASS CAPACITORS

.01xx	CERAMIC DISC	100/5.00
.01xx	MONOLITHIC	100/10.00
.1xx	CERAMIC DISC	100/6.50
.1xx	MONOLITHIC	100/12.50

### CLOCK CIRCUITS

MC146818	5.95	MMS58174	9.95
MM58167	9.95	MSM5832	2.95

### DISK CONTROLLERS

1771	4.95	2797	29.95
1791	9.95	8272	4.39
1793	9.95	UPD765	4.39
1795	12.95	MB8876	12.95
1797	12.95	MB8877	12.95
2791	19.95	1691	6.95
2793	19.95	2143	6.95

### "SNAPABLE" HEADERS

CAN BE SNAPPED APART TO MAKE ANY SIZE HEADER, ALL WITH .1" CENTERS

1x40	STRAIGHT LEAD	.99
1x40	RIGHT ANGLE LEAD	.49
2x40	2 STRAIGHT LEADS	2.49
2x40	2 RIGHT ANGLE LEADS	2.99

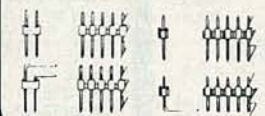

### NEW LOW PRICES! SOLDERLESS BREADBOARDS

WBU-204-3	1360 TIE PTS	12.95
WBU-204	1660 TIE PTS	19.95
WBU-206	2390 TIE PTS	24.95
WBU-208	3220 TIE PTS	34.95

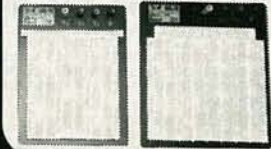

### GENDER CHANGERS

GENDER-FF	FEMALE-FEMALE	7.95
GENDER-MM	MALE-MALE	7.95
GENDER-MF	MALE-FEMALE	7.95
GENDER-NM	NULL MODEM	8.95
GENDER-JB	JUMPER BOX	8.95
GENDER-MT	MINITESTER	14.95



### EPROM ERASERS

#### SPECTRONICS CORPORATION

Model	Timer	# of Chips	Intensity (uW/Cm²)	Unit Cost
PE-140	NO	9	8,000	\$89
PE-140T	YES	9	8,000	\$139
PE-240T	YES	12	9,600	\$189



### DATARASE II \$39.95

- SHIRT POCKET SIZE!
- ERASES MOST EPROMS/EPLD'S IN 3 MINUTES
- ALL SIZES UP TO 4 AT A TIME



### RS-232 BREAKOUT BOX

FOR TROUBLESHOOTING SERIAL COMMUNICATIONS

- OPEN/CLOSE INDIVIDUAL CIRCUITS
- 20 JUMPERS CROSS-CONNECT ANY TWO CIRCUITS
- 10 LEDS SHOW CIRCUIT ACTIVITY

GENDER-BO 34.95



### IDC CONNECTORS/RIBBON CABLE

DESCRIPTION	ORDER BY	CONTACTS					
		10	20	26	34	40	50
SOLDER HEADER	IDHxxS	.82	1.29	1.68	2.20	2.58	3.24
RIGHT ANGLE SOLDER HEADER	IDHxxSR	.85	1.35	1.76	2.31	2.72	3.39
WIREWAP HEADER	IDHxxW	1.86	2.98	3.84	4.50	5.28	6.63
RIGHT ANGLE WIREWAP HEADER	IDHxxWR	2.05	3.28	4.22	4.45	4.80	7.30
RIBBON HEADER SOCKET	IDSxx	.63	.89	.95	1.29	1.49	1.69
RIBBON HEADER	IDMxx	--	5.50	6.25	7.00	7.50	8.50
RIBBON EDGE CARD	IDExx	.85	1.25	1.35	1.75	2.05	2.45
10' PLASTIC RIBBON CABLE	RCxx	1.60	3.20	4.10	5.40	6.40	7.50

FOR ORDERING INSTRUCTIONS, SEE D-SUBMINIATURE CONNECTORS BELOW

### D-SUBMINIATURE CONNECTORS

DESCRIPTION	ORDER BY	CONTACTS						
		9	15	19	25	37	50	
SOLDER CUP	MALE	DBxxP	.45	.59	.69	.69	1.35	1.85
	FEMALE	DBxxS	.49	.69	.75	.75	1.39	2.29
RIGHT ANGLE PC SOLDER	MALE	DBxxPR	.49	.69	--	.79	2.27	--
	FEMALE	DBxxSR	.55	.75	--	.85	2.49	--
WIREWAP	MALE	DBxxPWW	1.69	2.56	--	3.89	5.60	--
	FEMALE	DBxxSWW	2.76	4.27	--	6.84	9.95	--
IDC RIBBON CABLE	MALE	IDBxxP	1.39	1.99	--	2.25	4.25	--
	FEMALE	IDBxxS	1.45	2.05	--	2.35	4.49	--
HOODS	METAL	MHOODxx	1.05	1.15	1.25	1.25	--	--
	PLASTIC	HOODxx	.39	.39	--	.39	.69	.75

ORDERING INSTRUCTIONS: INSERT THE NUMBER OF CONTACTS IN THE POSITION MARKED "xx" OF THE "ORDER BY" PART NUMBER LISTED. EXAMPLE: A 15 PIN RIGHT ANGLE MALE PC SOLDER WOULD BE DB15PR

MOUNTING HARDWARE 59¢

### IC SOCKETS/DIP CONNECTORS

DESCRIPTION	ORDER BY	CONTACTS								
		8	14	16	18	20	22	24	28	40
SOLDERTAIL SOCKETS	xxST	.11	.11	.12	.15	.18	.15	.20	.22	.30
WIREWAP SOCKETS	xxWW	.59	.69	.69	.99	1.09	1.39	1.49	1.69	1.99
ZIF SOCKETS	ZIFxx	--	4.95	4.95	--	5.95	--	5.95	6.95	9.95
TOOLED SOCKETS	AUGATxxST	.62	.79	.89	1.09	1.29	1.39	1.49	1.69	2.49
TOOLED WW SOCKETS	AUGATxxWW	1.30	1.80	2.10	2.40	2.50	2.90	3.15	3.70	5.40
COMPONENT CARRIERS	ICCx	.49	.59	.69	.99	.99	.99	.99	1.09	1.49
DIP PLUGS (IDC)	IDPxx	.95	.49	.59	1.29	1.49	--	.85	1.49	1.59

FOR ORDERING INSTRUCTIONS SEE D-SUBMINIATURE CONNECTORS ABOVE

### SHORTING BLOCKS

5/\$1.00



### LITHIUM BATTERIES

- 6.8V FOR 286/386 COMPUTERS
- MOTHERBOARD CONNECTOR
- ADHESIVE VELCRO STRIP FOR EASY MOUNTING

LITHIUM 6.8V \$11.95

LITHIUM-3V 3V COIN TYPE LITHIUM BATTERY \$1.95  
3V-MHW BATTERY HOLDER \$1.49



JDR MICRODEVICES, 110 KNOWLES DRIVE, LOS GATOS, CA 95030  
LOCAL (408) 866-6200 FAX (408) 378-8927 TELEX 171-110

RETAIL STORE: 1256 SOUTH BASCOM AVE., SAN JOSE, CA  
HOURS: MON.-FRI. 9-7, SAT. 9-5, SUN. 12-4 (408) 947-8881

**ORDER TOLL FREE 800-538-5000**

COPYRIGHT 1989 JDR MICRODEVICES

CONTINENTAL U.S.



# JDR Microdevices®

• 30 DAY MONEY BACK GUARANTEE • 1 YEAR WARRANTY ON ALL PRODUCTS • TOLL-FREE TECHNICAL SUPPORT  
• COMPLETE CUSTOMER SATISFACTION • SUPERIOR SERVICE • FRIENDLY, KNOWLEDGEABLE SALES STAFF

**MMC**  
MICROCOMPUTER  
MARKETING COUNCIL  
of the Direct Marketing Association, Inc.

**PROMETHEUS**  
**2400 BAUD MODEM**



**\$129.95**

### INTERNAL 2400 BAUD

- AUTO DIAL ANSWER
  - SELF TEST ON POWER-UP
  - FULL OR HALF DUPLEX
  - TOUCHTONE OR PULSE DIALING
  - HAYES & BELL SYSTEMS COMPATIBLE
  - MIRROR II COMMUNICATIONS SOFTWARE INCLUDED
- PRO-24I 1200 BAUD 1/2 CARD **\$129.95**  
PRO-12I 1200 BAUD 1/2 CARD **\$69.95**  
PRO-24M 2400 BAUD FOR PS/2 **\$249.95**

### EXTERNAL 2400 BAUD

- 2400/1200/300 HAYES COMPATIBLE
  - 8 EASY-TO-READ STATUS LED'S
  - CALL PROGRESS MONITORING & ADJUSTABLE VOLUME
  - 2ND PHONE JACK FOR VOICE COMMUNICATIONS
  - REQUIRES SERIAL PORT & CABLE (OPTIONAL)
- PRO-24E **\$169.95**  
PRO-12E 1200 BAUD EXTERNAL **\$99.95**

### APPLE/MACINTOSH MODEMS

- MACINTOSH 2400 BAUD EXTERNAL AS ABOVE WITH C.B.L.E. AND PROCOM-M SOFTWARE.
- PRO-24EM **\$199.95**  
PRO-24A APPLE II 2400 BAUD MODEM **\$179.95**  
PRO-12A APPLE II 1200 BAUD MODEM **\$139.95**

### POCKET MODEM

**\$99.95**



- YOU'LL NEVER BE FAR FROM YOUR DATA WITH THIS 6 OUNCE HAND-HELD POCKET MODEM
- 1200/300 BAUD ■ BATTERY & AC POWER
  - SERIAL INTERFACE (DB25) ■ 4 STATUS INDICATORS
- GVC-12P  
GVC-24P 2400 BAUD VERSION **\$249.95**

### DFI HANDY SCANNER 400 DPI

**\$249.95**

- NOT ALL HANDY SCANNERS ARE THE SAME!
- INSTANTLY SCANS UP TO 4" WIDE IMAGES
  - 100, 200, 300, 400 DPI BOTH DIRECTIONS
  - B&W AND 3 HALF-TONE MODES
  - 32 LEVELS OF GRAY SCALE
  - HERCULES, CGA AND EGA COMPATIBLE
  - INCLUDES HALO DPE AND IMAGE EDITOR SOFTWARE HS-3000
- 

### LOGITECH HIREZ MOUSE

**\$99.95**

- HIGH RESOLUTION BUS MOUSE FOR BETTER RESPONSE AND LESS HAND MOVEMENT. IDEAL FOR CAD WORK
- 320 DPI ■ INCLUDES DRIVER, TEXT EDITOR & POP-UP MENUS ■ NO PAD, POWER SUPPLY OR PORT REQUIRED
- 

### LOGITECH 3-BUTTON MOUSE

- PC MAGAZINE EDITORS CHOICE! ALL MODELS HAVE SERIAL SUPPORT (COM1/COM2), 200 D.P.I., RESOLUTION, LOTUS 1-2-3 SHELL, SELF-INSTALLING SOFTWARE AND "POINT EDITOR"
- LMOUSE **\$79.95**  
LMOUSE-P SERIAL MOUSE W/LOGIPAIN **\$99.95**  
LMOUSE-BP BUS MOUSE W/LOGIPAIN **\$99.95**  
LMOUSE-BPBL BUS MOUSE W/PUBLISHER PKG **\$139.95**  
LMOUSE-BPC BUS MOUSE W/LOGIPAIN/CAD **\$149.95**

### 24-HR. ON-LINE ORDERING! (408) 374-2171

JDR'S ELECTRONIC BULLETIN BOARD OFFERS TECHNICAL SUPPORT, CONFERENCING AND MORE

### DATA SWITCH BOXES

TYPE	# OF POS.	PARALLEL	SERIAL	PRICE
PUSHBUTTON	2-WAY	AB-P	AB-5	39.95
ROTARY	2-WAY	RSP-2P	RSS-2S	24.95
ROTARY	3-WAY	RSP-3P	RSS-3S	27.95
ROTARY	4-WAY	RSP-4P	RSS-4S	29.95



### MOLDED COMPUTER CABLES

- HIGH QUALITY GOLD-PLATED CONTACTS; CABLE AND CONNECTORS ARE 100% SHIELDED. MOLDED ASSEMBLY.
- CBL-PRINTER PC PRINTER CABLE **\$9.95**  
CBL-PRINTER-25 AS ABOVE - 25 FOOT **\$15.95**  
CBL-PRINTER-RA RIGHT ANGLE PRINTER **\$15.95**  
CBL-DB25-MM DB25 MALE TO DB25 MALE **\$9.95**  
CBL-DB25-MF DB25 MALE TO DB25 FEMALE **\$9.95**  
CBL-9-SERIAL 9 PIN TO 25 PIN SERIAL **\$6.95**  
CBL-KBD-EXT KEYBOARD EXTENSION **\$7.95**  
CBL-CNT-MM 36 PIN CENTRONICS-M/M **\$14.95**  
CBL-HD-20 20 PIN HARD DISK CABLE **\$3.95**  
CBL-HD-34 34 PIN HARD DISK CABLE **\$4.95**  
CBL-HD-34D 34 PIN DUAL HARD DISK **\$6.95**  
CBL-FDC-EXT 37 PIN EXTERNAL FLOPPY **\$9.95**  
CBL-MNT-9 9 PIN MONITOR EXTENSION **\$6.95**  
CBL-MODEM DB25 TO DB25 FEMALE **\$7.95**
- 

### VGA COMPATIBLE PACKAGE

**\$649.00**

- 800 X 560 MAXIMUM RESOLUTION
  - 640 X 480 IN 16 COLORS
  - 320 X 200 IN 256 COLORS
  - IBM STYLE ANALOG MONITOR
  - FULLY VGA, EGA, CGA, HERCULES & MONOCHROME COMPATIBLE
- VGA-PKG
- 

### NEC MULTISYNC II **\$599.95**

- AUTO FREQ ADJUSTMENT ■ RESOLUTION AS HIGH AS 800 X560 ■ TEXT MODE & TEXT COLOR ■ INCL. ADAPTOR NEC-MULTI

### JDR MULTI **\$499.95**

- FULL FEATURED MULTISCAN MONITOR WITH UNLIMITED COLORS ■ HIGH RESOLUTION, 14" NON-GLARE DISPLAY ■ AUTO SWITCHING ■ TTL/ANALOG VIDEO INPUT
- JDR-MULTI

### RELISYS EGA **\$399.95**

- 800X560 MAXIMUM RESOLUTION ■ .31 MM DOT PITCH ■ 14" BLACK MATRIX SCREEN ■ 16 COLORS SWIVEL BASE
- EGA-MONITOR

### EGA SPECIAL - SAVE \$60!

BUY THE RELISYS EGA AND THE MCT EGA CARD TOGETHER AND SAVE \$60.00 JUST \$489.00

### RGB MONITOR **\$279.95**

- COLOR/GREEN/AMBER SWITCH ■ .41MM DOT PITCH ■ 640 X 240 RESOLUTION ■ 14" NON-GLARE SCREEN ■ TILT AND SWIVEL BASE
- RGB-MONITOR

### FLAT SCREEN **\$139.95**

- LOW DISTORTION 14" GLARE-RESISTANT AMBER SCREEN ■ 720 X 350 MAXIMUM RESOLUTION ■ IBM COMPATIBLE TTL INPUT ■ SWIVEL BASE

GM-1488 MONO-SAMSUNG WITH 12" SCREEN **\$129.95**

### TILT & SWIVEL MONITOR STANDS

- MS-100 **\$12.95**  
MS-200 5 OUTLETS AND SURGE SUPPRESSOR **\$39.95**

### UPRIGHT CASE

**\$299.95**

SLEEK UPRIGHT DESIGN SAVES SPACE, ADDS STYLE!

- ACCOMMODATES ALL SIZES OF MOTHERBOARDS
- 250 W POWER SUPPLY INCLUDED
- MOUNTS FOR 3 FLOPPY & 4 HARD DRIVES
- TURBO & RESET SWITCH
- SPEED DISPLAY, POWER & DISK LED'S
- INCL. MOUNTING HARDWARE, FACEPLATES & SPEAKER

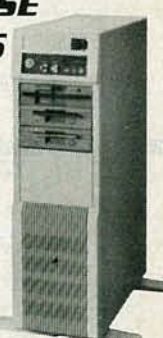
- CASE-100 **\$149.95**  
CASE-FLIP FOR 8088 MOTHERBOARDS **\$34.95**  
CASE-SLIDE FOR 8088 MOTHERBOARDS **\$39.95**  
CASE-70 FOR 286 MOTHERBOARDS **\$89.95**  
CASE-JR MINI-286 W/POWER SUPPLY **\$149.95**
- 

### POWER SUPPLIES

- ALL OUR POWER SUPPLIES ARE UL APPROVED, 110/220V
- PS-135 IBM XT COMPATIBLE, 135 WATTS **\$59.95**  
PS-150 IBM XT COMPATIBLE, 150 WATTS **\$69.95**  
PS-200 IBM AT COMPATIBLE, 200 WATTS **\$89.95**  
PS-250 IBM AT COMPATIBLE, 250 WATTS **\$129.95**

## 1.44 MB 3 1/2" DRIVE \$99.95



- ULTRA HIGH DENSITY
- ALSO WORKS WITH 720K DISKS
- FDD-1.44X BLACK FACEPLATE
- FDD-1.44A BEIGE FACEPLATE
- FDD-SOFT SOFTWARE DRIVER \$19.95

### 1/2 HEIGHT FLOPPY DISK DRIVES

FD-55B	5-1/4" TEAC DS/DD 360K	\$99.95
FD-55G	5-1/4" TEAC DS/HD 1.2M	\$129.95
M2551A	5-1/4" FUJITSU DS/DD 360K	\$89.95
M2553K	5-1/4" FUJITSU DS/HD 1.2M	\$119.95
FDD-360	5-1/4" DS/DD 360K	\$69.95
FDD-1.2	5-1/4" DS/HD 1.2M	\$109.95
MF355X	3-1/2" MITSUBISHI 1.44MB (BLACK)	\$129.95
MF355A	3-1/2" MITSUBISHI 1.44MB (BEIGE)	\$129.95
FDD-3.5X	3-1/2" DS/DD 720K (BLACK)	\$97.95
FDD-3.5A	3-1/2" DS/DD 720K (BEIGE)	\$97.95

### TAPE BACK-UP DRIVES

AR5240X	ARCHIVE TAPE DRIVE -XT'S & AT'S	\$369.95
AR5540A	FASTER TAPE DRIVE -AT'S ONLY	\$369.95
AR340	40 MB TAPE CARTRIDGES	\$24.95

### DISKETTES

N-MD2D	BOX OF 10 5-1/4" 360K DS/DD	\$6.95
N-MD2H	BOX OF 10 5-1/4" 1.2 MB DS/HD	\$13.95
N-3.5DS	BOX OF 10 3-1/2" 720K DS/DD	\$16.95
N-3.5HD	BOX OF 10 3-1/2" 1.44 MB DS/HD	\$49.95
N-MD2D BULK	360K DS/DD (MIN. 50 DISKS)	EA. 49¢

### DRIVE ACCESSORIES

FD-ARAIL	MTG. RAILS FOR COMPATIBLE	\$2.95
FD-55MHW	HALF-HEIGHT MOUNTING HARDWARE	\$2.95
FD-5Y	Y-POWER ADAPTOR FOR DRIVES	\$2.95
FD55P	BEIGE FACEPLATE FOR TEAC DRIVES	\$2.95



Kits include a Seagate hard disk drive, drive controller, cables and instructions.  
HDKIT20 20 Mb System Kit  
HDKIT30 30 Mb System Kit

20 Mb kit \$269

30 Mb kit \$299



SIZE	MODEL	AVG. SPEED	HT.	DRIVE ALONE	WITH MCT CONTROLLER			
					HDC	RLL	AFH	AFH-RLL
20MB	ST-225	65 ms	Half	\$225	\$269	-	\$339	-
30MB RLL	ST-238	65 ms	Half	\$249	-	\$299	-	\$389
40MB	ST-251	40 ms	Half	\$379	\$419	-	\$489	-
40MB	ST-251-1	28 ms	Half	\$469	\$449	-	\$519	-
60MB RLL	ST-277	40 ms	Half	\$449	-	\$499	-	\$589
30MB	ST-4038	40 ms	Full	\$559	\$603	-	\$659	-
80MB	ST-4096	28 ms	Full	\$629	-	-	\$729	-

## INBOARD 386/PC

\$895.00



UPGRADE YOUR XT TO A 386 FOR LESS THAN \$900  
■ 16 MHZ PROCESSOR REPLACES 8088

- 1 MB MEMORY INSTALLED
- EXPAND TO 3 MB WITH PIGGYBACK CARD
- 5 YEAR WARRANTY

### PCIB 1200

### PIGGYBACK MEMORY BOARDS

PCIB1210	1 MB INSTALLED	\$649.00
PCIB1220	2 MB INSTALLED	\$1195.00

"Your products and prices have kept us coming back now for two years...keep up the good work."  
--P.S., Sterling Heights, MI

"We'll continue to do business with you whenever we can."  
--James Hillegass, Minneapolis, MN

"...I will not hesitate to order anything from JDR --because I know your policy is to stand behind your products 100%."  
--Robert Rindy, Grand Forks, NB

"A note thanking your technical support staff in helping me with my computer problem....(They are) very thorough and knowledgeable. Thanks!"  
--J.F., Troy, MI

# INTERFACE CARDS BY MODULAR CIRCUIT TECHNOLOGY

## DRIVE CONTROLLERS

### FLOPPY DISK CONTROLLER \$29.95

- SINGLE SLOT CONTROL OF 4 FLOPPIES
- INTERFACES UP TO 4 FDD'S TO AN IBM PC OR COMPATIBLE
- SUPPORTS DS/HD AND DS/QD W/ DOS 3.2
- MCT-FDC

### 1.2 MB FLOPPY CONTROLLER \$69.95

- ADD VERSATILITY AND CAPACITY TO YOUR XT
- SUPPORTS 2 DRIVES, CAN MIX 360K AND 1.2 MB
- ALLOWS DATA TO FLOW FREELY FROM XT'S TO AT'S
- MCT-FDC-1.2

### FLOPPY/HARD CONTROLLER \$139.95

- XT SYSTEM SHORT OF SLOTS? THIS CARD FREES ONE UP!
- INTERFACES UP TO 2 FDD'S & 2 HDD'S, CABLING FOR 2 FDD/HDD
- SUPPORTS BOTH DS/DD & DS/QD W/DOS 3.2
- MCT-FH

### 286/386 FLOPPY/HARD \$149.95

- FLOPPY/HARD DISK CONTROL IN A TRUE AT DESIGN
- SUPPORTS UP TO 2 360K/720K/1.2 MB FDD'S
- SUPPORTS 2 HDD'S USING STANDARD TABLES
- MCT-AFH

### HARD DISK CONTROLLER \$79.95

- HARD DISK CONTROL AT AN ECONOMIC PRICE
- SUPPORTS 16 DRIVE SIZES INCLUDING 10,20,30 & 40 MB
- DIVIDE 1 LARGE DRIVE INTO 2 LOGICAL DRIVES
- MCT-HDC

### RLL CONTROLLER \$119.95

- TRANSFER DATA 50% FASTER
- SUPPORTS UP TO 2 RLL HARD DRIVES
- DESIGNED FOR XT COMPATIBLES
- MCT-RLL

### 286/386 FLOPPY/HARD RLL \$199.95

- IMPROVE SPEED AND STORAGE OF YOUR AT COMPATIBLE
- SUPPORTS UP TO 2 RLL HARD DISCS AND 2 FLOPPIES
- SUPPORTS 360/720/1.2 MB FLOPPIES IN 5.25" & 3.5"
- MCT-AFH-RLL

## MULTIFUNCTION CARDS

### MULTI I/O FLOPPY CONTROLLER \$79.95

- A PERFECT COMPANION FOR OUR MOTHERBOARDS
- SUPPORTS UP TO TWO 360K FLOPPIES, 720K W/ DOS 3.2
- SERIAL, PARALLEL, GAME PORT, CLOCK/CALENDAR
- MCT-MIO
- MIO-SERIAL—2ND SERIAL PORT \$15.95

### MULTI I/O CARD \$59.95

- USE WITH MCT-FH FOR MINIMUM OF SLOTS USED
- SERIAL PORT, CLOCK/CALENDAR WITH BATTERY
- PARALLEL PORT ADDRESSABLE AS LPT1 OR LPT2
- MCT-IO

### 286/386 MULTIFUNCTION \$139.95

- ADDS UP TO 3 MB OF RAM TO YOUR AT
- USER EXPANDABLE TO 1.5 MB OR 3 MB WITH OPTIONAL PIGGYBACK BOARD (OK INSTALLED)
- INCLUDES SERIAL AND PARALLEL PORT
- MCT-AMF
- MCT-AMF-MC PIGGYBACK BOARD \$29.95
- AIO-SERIAL 2ND SERIAL PORT \$24.95

### 286/386 MULTI I/O CARD \$59.95

- USE WITH MCT-AFH MINIMUM OF SLOTS USED
- SERIAL, PARALLEL AND GAME PORTS
- USES 16450 SERIAL SUPPORT CHIPS FOR HIGH SPEED OPS
- MCT-AIO
- AIO-SERIAL 2ND SERIAL PORT \$24.95

## MEMORY CARDS

### 576K RAM CARD \$59.95

- A CONTIGUOUS MEMORY SOLUTION IN A SHORT SLOT
- USER SELECTABLE CONFIGURATION UP TO 576K
- USES 64K & 256K RAM CHIPS (OK INSTALLED)
- MCT-RAM

### EXPANDED MEMORY CARD \$129.95

- 2MB OF LOTUS INTEL MICROSOFT MEMORY FOR AN XT
- CONFORMS TO LOTUS INTEL EMS
- USER EXPANDABLE TO 2 MB
- CAN BE USED AS EXPANDED OR CONVENTIONAL MEMORY, RAMDISK AND SPOOLER
- MCT-EMS
- MCT-AEMS 286/386 VERSION \$139.95

## DISPLAY ADAPTORS

### MONOCHROME GRAPHICS \$59.95

- TRUE HERCULES COMPATIBILITY SUPPORTS LOTUS 1-2-3
- PARALLEL PRINTER PORT CONFIGURES AS LPT1 OR LPT2
- USES VLSI CHIPS TO ENSURE RELIABILITY
- MCT-MGP

### EGA ADAPTOR \$149.95

- 100% IBM COMPATIBLE PASSES IBM EGA DIAGNOSTICS
- 256K OF VIDEO RAM ALLOWS 640 X 350 IN 16 OF 64 COLORS
- COMPATIBLE WITH COLOR AND MONOCHROME ADAPTORS
- HERCULES COMPATIBLE
- MCT-EGA

### COLOR GRAPHICS ADAPTOR \$49.95

- COMPATIBLE WITH IBM GRAPHICS STANDARDS
- SUPPORTS RGB, COLOR, & COMPOSITE MONOCHROME
- 640/320 X 200 RESOLUTION, LIGHT PEN INTERFACE
- MCT-CG

### MONOGRAPHICS MULTI I/O \$119.75

- TOTAL SYSTEM CONTROL FROM A SINGLE SLOT!
- CTRL 2 FLOPPIES, SERIAL, PARALLEL, GAME PORT, CLOCK/CAL
- RUN COLOR GRAPHICS SOFTWARE ON A MONOCHROME MONITOR
- MCT-MGMIO

### 286/386 MONOGRAPHICS I/O \$99.95

- USE THIS "DO EVERYTHING" CARD TO HOOK UP YOUR MONOCHROME MONITOR, PARALLEL PRINTER, MODEM AND JOYSTICK AT THE SAME TIME. THE ONLY OTHER CARD YOUR SYSTEM NEEDS IS A FLOPPY/HARD CONTROLLER.
- AT COMPATIBLE
- 720 X 348 RESOLUTION, 80 & 132 COLUMN TEXT
- PARALLEL, SERIAL & GAME PORTS
- HERCULES COMPATIBLE MONOGRAPHICS
- INCLUDES SOFTWARE FOR RUNNING COLOR GRAPHICS PROGRAMS ON A MONOCHROME MONITOR.
- MCT-MGAIO



JDR MICRODEVICES, 110 KNOWLES DRIVE, LOS GATOS, CA 95030  
LOCAL (408) 866-6200 FAX (408) 378-8927 TELEX 171-110

RETAIL STORE: 1256 SOUTH BASCOM AVE., SAN JOSE, CA  
HOURS: MON.-FRI. 9-7, SAT. 9-5, SUN. 12-4 (408) 947-8881

**ORDER TOLL FREE 800-538-5000**

COPYRIGHT 1989 JDR MICRODEVICES

CONTINENTAL U.S.

TERMS: MINIMUM ORDER \$10.00 FOR SHIPPING AND HANDLING INCLUDE \$2.50 FOR UPS GROUND AND \$3.50 UPS AIR. ORDERS OVER 1 LB. AND FOREIGN ORDERS MAY REQUIRE ADDITIONAL SHIPPING CHARGES—PLEASE CONTACT THE SALES DEPARTMENT FOR THE AMOUNT. CA RESIDENTS MUST INCLUDE APPLICABLE SALES TAX. PRICES ARE SUBJECT TO CHANGE WITHOUT NOTICE. WE ARE NOT RESPONSIBLE FOR TYPOGRAPHICAL ERRORS. WE RESERVE THE RIGHT TO LIMIT QUANTITIES AND TO SUBSTITUTE MANUFACTURER. ALL MERCHANDISE SUBJECT TO PRIOR SALE. A FULL COPY OF OUR TERMS IS AVAILABLE UPON REQUEST. ITEMS PICTURED MAY ONLY BE REPRESENTATIVE.

## BUILD YOUR OWN SYSTEM



OVER 20,000 JDR SYSTEMS HAVE ALREADY BEEN BUILT. EASY TO ASSEMBLE IN JUST 2 HOURS WITH A SCREWDRIVER.

### 12 MHz MINI-286 \$1232.75

- 12 MHz MINI-286 MOTHERBOARD
- 512K RAM MEMORY
- MINI-AT CASE WITH POWER SUPPLY
- 84 KEY KEYBOARD
- MONOCHROME MONITOR
- 1.2 MB FLOPPY DRIVE
- FLOPPY / HARD CONTROL GRAPHICS ADAPTOR

### 10 MHz TURBO 8088 \$661.00

- INCLUDES SERIAL PORT, 2 PARALLEL PORTS, CLOCK/CALENDAR AND GAME ADAPTOR
- RUNS COLOR GRAPHICS ON A MONOCHROME MONITOR.
- MOTHERBOARD
- 256K RAM MEMORY
- 135 WATT POWER SUPPLY
- FLIP-TOP CASE
- 84 KEY KEYBOARD
- 360K FLOPPY DRIVE
- MONOGRAPHICS I/O CARD
- MONOCHROME MONITOR

## MOTHERBOARDS

### TURBO 4.77/8 MHz \$99.95

- XT COMPATIBLE
- NORTON SI 1.7
- 4.77 OR 8 MHz OPERATION WITH 8088-2 AND OPTIONAL 8087-2 CO-PROCESSOR
- FRONT PANEL LED SPEED INDICATOR AND RESET SWITCH SET SUPPORTED
- CHOOSE NORMAL/TURBO MODE OR SOFTWARE SELECT PROCESSOR SPEED

#### MCT-TURBO

MCT-XMB STANDARD MOTHERBOARD \$87.95

### 10 MHz SINGLE CHIP \$129.95

- XT COMPATIBLE
- NORTON SI 2.1
- USES LESS POWER, IMPROVES RELIABILITY
- KEY SELECTABLE SPEED, 4.77 MHz OR 10 MHz
- 2.3 TIMES FASTER THAN A STANDARD
- RESET SWITCH, KEYLOCK, & SPEED / POWER INDICATORS SUPPORTED

#### MCT-TURBO-10

### 80286 6/10 MHz \$379.95

- AT COMPATIBLE
- LANDMARK AT SPEED 10 MHz
- NORTON SI 10.3
- 8 SLOTS (TWO 8-BIT, SIX 16-BIT)
- HARDWARE SELECTION OF 6 OR 10 MHz
- FRONT PANEL LED INDICATOR
- SOCKETS FOR 1MB OF RAM AND 80287
- ONE WAIT STATE
- BATTERY BACKED CLOCK
- KEYLOCK SUPPORTED
- RESET SWITCH

#### MCT-286

### 12 MHz MINI-286 \$399.95

- AT COMPATIBLE
- LANDMARK AT SPEED 13.2 MHz
- NORTON SI 11.6
- 6 MHz, 10 MHz (0.1 WAIT STATE), 12 MHz (1 WAIT STATE)
- ZYMOS ASICS FOR FEWER CHIPS, GREATER RELIABILITY
- SUPPORTS 512K-1024K MEMORY
- RECHARGEABLE HIGH CAPACITY NI-CAD BATTERY
- SIX 16-BIT SLOTS, TWO 8-BIT SLOTS
- MOUNTS IN STANDARD XT CASE

#### MCT-M286-12

MCT-M286 6/10 MHz MINI 80286 BOARD \$389.95

## NEW! MODULAR PROGRAMMING SYSTEM

### MODULAR CIRCUIT TECHNOLOGY

THE IDEAL SYSTEM FOR DEVELOPERS; AN INTEGRATED MODULAR SYSTEM THAT EXPANDS AS YOUR NEEDS GROW. ALL THE MODULES USE A COMMON HOST ADAPTOR CARD SO YOU NEED JUST ONE SLOT TO PROGRAM EPROMS, PROMS, PALS AND MORE.

### HOST ADAPTOR CARD \$29.95

- A UNIVERSAL INTERFACE FOR ALL THE PROGRAMMING MODULES
- USER SELECTABLE PROGRAMMABLE ADDRESSES PREVENT ADDRESSING CONFLICTS
- INCLUDES MENU-DRIVEN SOFTWARE PACKAGE
- INCLUDES MOLDED CABLE

#### MCT-MAC

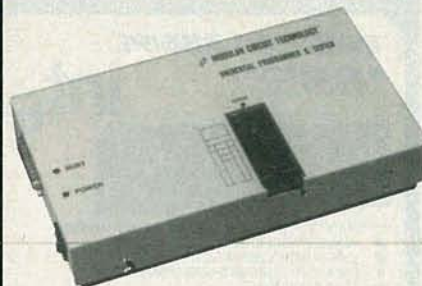
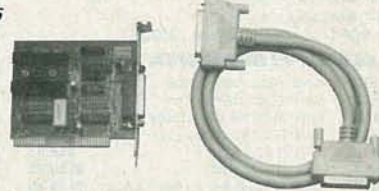

### UNIVERSAL MODULE \$499.99

- PROGRAMS EPROMS, EEPROMS, PALS, BI-POLAR PROMS, 8748 & 8751 SERIES DEVICES
- PROGRAMS 16V8 & 20V8 GALs (GALLIUM ARSENIDE) FROM LATTICE, NS, SGS
- TESTS TTL, CMOS, DYNAMIC & STATIC RAMS
- LOAD DISK, SAVE DISK, EDIT, BLANK CHECK, PROGRAM, AUTO, READ MASTER, VERIFY & COMPARE
- TEXTTOOL SOCKET ACCEPTS .3 TO .6" WIDE IC'S FROM 8-40 PINS

#### MCT-MUP



### EPROM MODULE \$119.95

- PROGRAMS 24-32 PIN EPROMS, CMOS EPROMS AND EEPROMS FROM 16K TO 1024K
- HEX TO OBU CONVERTER
- AUTO, BLANK CHECK/PROGRAM/VERIFY
- VPP 5, 12.5, 12.75, 13, 21 & 25 VOLTS
- NORMAL, INTELLIGENT, INTERACTIVE, & QUICK PULSE PROGRAMMING ALGORITHMS

#### MCT-MEP

MCT-MEP-4 FOUR-EPROM PROGRAMMER \$169.95

MCT-MEP-8 EIGHT-EPROM PROGRAMMER \$259.95

MCT-MEP-16 SIXTEEN-EPROM PROGRAMMER \$499.95

### DIGITAL IC MODULE \$129.95

- TESTS TTL, CMOS, DYNAMIC & STATIC RAM
- AUTO SEARCH FOR UNKNOWN PART NUMBERS
- USER-PROGRAMMABLE TEST PROCEDURES

#### MCT-MIC

### PAL MODULE \$249.95

- PROGRAMS MMI, NS, TI 20 & TI 24 PIN DEVICES
- BLANK CHECK, PROGRAM, AUTO, READ MASTER, VERIFY & SECURITY FUSE BLOW

#### MCT-MPL

PAL PROGRAMMING DEVELOPMENT SOFTWARE

MCT-MPL-SOFT \$99.95

### 8748 MODULE \$179.95

- PROG. 8741, 8742, 8748, 8749 & 8750 EPROMS & PROMS.
- LOAD DISK, SAVE DISK, EDIT, BLANK CHECK, PROGRAM, AUTO, READ MASTER, VERIFY & COMPARE
- NORMAL & INTELLIGENT PROGRAMMING ALGORITHMS

#### MCT-MMP

### BI-POLAR MODULE \$259.95

- PROG. AMD, MMI, NS, TI & SIGNED BI-POLAR PROMS
- LOAD DISK, SAVE DISK, EDIT, BLANK CHECK, PROGRAM, AUTO, READ MASTER, VERIFY

#### MCT-MBP

## EPROM PROGRAMMER

\$129.95

- PROGRAMS 27XX AND 27XXX EPROMS UP TO 27512
- SUPPORTS VARIOUS PROGRAMMING FORMATS & VOLTAGES
- SPLIT OR COMBINE CONTENTS OF SEVERAL EPROMS OF DIFFERENT SIZES
- READ, WRITE, COPY, ERASE CHECK & VERIFY
- SOFTWARE FOR HEX AND INTEL HEX FORMATS

#### MCT-EPROM

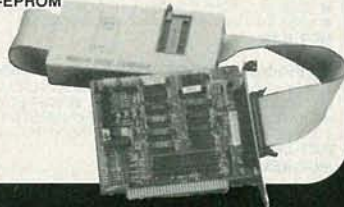

## BARGAIN HUNTER'S CORNER

CITIZEN PRINTER \$169.95

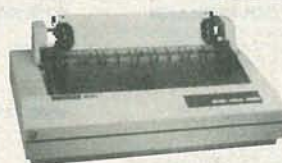

- 9 PIN DOT MATRIX PRINT HEAD
- 180 CPS DRAFT MODE, 29 CPS NLO MODE
- CENTRONICS PARALLEL INTERFACE, SERIAL OPTIONAL
- DUAL PITCH, DOUBLESTRIKE, ITALICS & SUPERSCRIP
- DOT ADDRESSABLE GRAPHICS IN SIX DENSITIES
- COMPRESSED, EXPANDED AND EMPHASIZES PRINT

SPECIAL ENDS 3/31/89



JDR MICRODEVICES, 110 KNOWLES DRIVE, LOS GATOS, CA 95030  
LOCAL (408) 866-6200 FAX (408) 378-8927 TELEX 171-110

RETAIL STORE: 1256 SOUTH BASCOM AVE., SAN JOSE, CA  
HOURS: MON.-FRI. 9-7, SAT. 9-5, SUN. 12-4 (408) 947-8881

**ORDER TOLL FREE 800-538-5000**

COPYRIGHT 1989 JDR MICRODEVICES

CONTINENTAL U.S.

TERMS: MINIMUM ORDER \$10.00 FOR SHIPPING AND HANDLING INCLUDE \$2.50 FOR UPS GROUND AND \$3.50 UPS AIR. ORDERS OVER 1 LB. AND FOREIGN ORDERS MAY REQUIRE ADDITIONAL SHIPPING CHARGES—PLEASE CONTACT THE SALES DEPARTMENT FOR THE AMOUNT. CA RESIDENTS MUST INCLUDE APPLICABLE SALES TAX. PRICES ARE SUBJECT TO CHANGE WITHOUT NOTICE. WE ARE NOT RESPONSIBLE FOR TYPOGRAPHICAL ERRORS. WE RESERVE THE RIGHT TO LIMIT QUANTITIES AND TO SUBSTITUTE MANUFACTURER. ALL MERCHANDISE SUBJECT TO PRIOR SALE. A FULL COPY OF OUR TERMS IS AVAILABLE UPON REQUEST. ITEMS PICTURED MAY ONLY BE REPRESENTATIVE.

# Radio Shack Parts Place™

## CHECK OUR BIG SELECTION—COME IN TODAY!

### "Hotline" Special-Order Service



**One-Week  
Delivery  
Time**

(most items)



Your Radio Shack store manager can special-order a wide variety of parts and accessories not shown in our catalog—tubes, ICs, phono cartridges and styli, microprocessor, scanner and CB crystals, even SAMS Photo-facts®. No minimum order, no postage or handling charge. Give us a try!

### General Class Ham Study Pack

Prepared by  
Gordon West,  
WB6NOA

**1995**



Here's everything you need to upgrade from Novice to General class in minimum time. Includes code review and speed building cassettes, test questions and answers, full explanations of correct answers, helpful hints, FCC form 610, and a sturdy molded binder. #62-2404

### Switch and Relay Bargains

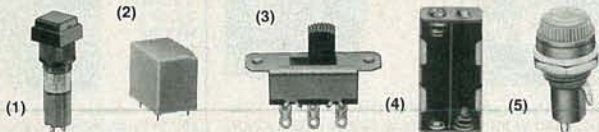

- (1) Lighted Push Switch. 3A at 125VAC. 12V lamp. #276-676 ..... 6.49
- (2) Mini 5-Amp SPDT Relay. 5A at 125VAC. 12VDC coil. #275-219 ..... 2.49
- (3) Submini Slide Switches. SPST, #275-406 ... 2/79¢. DPDT, #275-407 ... 2/89¢
- (4) Battery Holder. For 4 "AA" cells. 14 other styles in stock! #270-383 ..... 99¢
- (5) Panel-Mount Fuse Holder. For 5 x 20mm fuse. #270-362 ..... 1.49

### Fast Fixes for RS-232 Problems

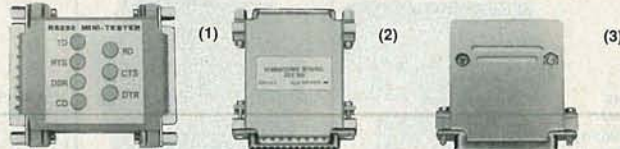

- (1) Inline RS-232 Mini Tester. Dual-color LEDs indicate status of TD, RTS, DSR, CD, RD, CTS and DTR lines. #276-1401 ..... 14.95
- (2) Inline RS-232 Spike Protector. #276-1402 ..... 16.95
- (3) Male D-Sub 25 to Modular Jack Adapter Kit. #276-1405 ..... 2.99

### High-Tech ICs for Experimenters

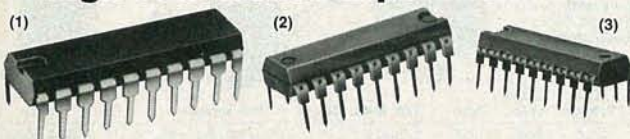

- (1) VCP200 Speech Recognition IC. Speaker independent! Understands seven commands. Easy to use. 20 pin. #276-1308 ..... 9.95
- (2) TDA7000 FM Receiver On-a-Chip. Ideal for a small FM or public service band receiver. 70 kHz IF. 18-pin. #276-1304 ..... 5.95
- (3) SSI202 Touch-Tone Decoder. 18-pin. #276-1303 ..... 12.95

### TNC Connectors and Mike Cable



- (1) Solderless Male TNC Plug. #278-140 ..... 1.99
- (2) TNC 90° Adapter. Female-to-male. #278-141 ..... 2.99
- (3) Female-to-Female TNC Coupler. #278-142 ..... 1.99
- (4) Coiled Ham/CB Mike Cable. Extends to 5 feet. #278-355 ..... 6.49
- (5) Speaker MEGACABLE™. 12-gauge. #278-1268 ..... Per Foot 99¢

### Gold-Plate Plugs

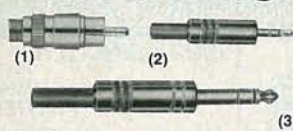

- (1) Phono Plug. #274-850 ... 2.49
- (2) 3-Conductor (Stereo) 1/8" Phone Plug. #274-858 ..... 2.49
- (3) 3-Conductor (Stereo) 1/4" Phone Plug. #274-856 ..... 3.99

### Lighting Buys

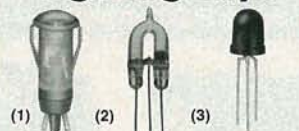

- (1) Super-Bright Red LED With Holder. #276-088 ..... 1.79
- (2) Strobe Tube. #272-1145 ... 3.29
- (3) Jumbo Red LED. Two elements in a 10mm housing. #276-065 ... 1.19

### Sounder Values



- (1) PC-Mount Micro Speaker. 700-3000 Hz. 8 ohms. #273-090 ... 4.99
- (2) Pulsing Piezo. #273-066 ... 3.99
- (3) Pulsing Electronic Buzzer. For 12VDC. #273-058 ..... 3.49

### Test Lead Sets

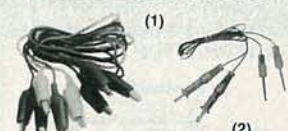

- (1) Set of 4 Jumper Cables. 30" long. #278-001 ..... Set 2.99
- (2) Micro-Hook Test Leads. 18 1/2" long. Banana plug to "grabber" hook. #278-018 ..... Pair 3.49

### Bench Test Instrument



Precise LCD digital display plus 31-segment analog bargraph. Displays transistor gain directly. Diode-check, memory and continuity functions. Measures to 1000VDC, 750VAC, 10 amps AC and DC, resistance. #22-195 ..... 99.95

### AC Power Strips



**Six-Outlet.** Perfect for workbench. Has six grounded outlets, heavy-duty 6-foot cord with grounded plug, on/off switch with indicator light and push-to-reset circuit breaker. Handles 15 amps. UL listed AC. #61-2619 ..... 21.95

**Four-Outlet.** As above, but without switch. UL listed AC. #61-2620 ..... 15.95

### Universal Breadboard

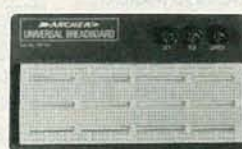

Our finest! Molded 2 1/4 x 6 1/2" breadboard is mounted on a 7 x 4" "stay put" metal base with rubber feet. 640 plug-in points. Accepts DIPs, discretes, and up to 22-gauge wires. Three binding posts. #276-169 ..... 19.95

Over 1000 items in stock! Binding Posts, Books, Breadboards, Buzzers, Capacitors, Chokes, Clips, Coax, Connectors, Fuses, Hardware, ICs, Jacks, Knobs, Lamps, Multitesters, PC Boards, Plugs, Rectifiers, Resistors, Switches, Tools, Transformers, Transistors, Wire, Zeners, More!

# Radio Shack®

A DIVISION OF TANDY CORPORATION

Prices apply at participating Radio Shack stores and dealers

CIRCLE 78 ON FREE INFORMATION CARD

MARCH 1989

# What's New at AMERICAN DESIGN COMPONENTS?

We warehouse 60,000 items at American Design Components—expensive, often hard-to-find components for sale at a fraction of their original cost!

You'll find every part you need—either brand new or removed from equipment (RFE) in excellent condition. But quantities are limited. Order from this ad, or visit our retail showroom and find exactly what you need from the thousands of items on display.

Call Toll Free: (800) 524-0809

## THERE'S NO RISK!

With our 90-day warranty, any purchase can be returned for any reason for full credit or refund.

## "THE ADAM IS BACK!"



(Less Printer)

No wiring neces. (just plugs together). Incl: hook-up diagram; Keyboard, 1 cassette digital data drive, 2 game controllers, power supply & 1 cassette. Capable of running CP/M, has built-in word processor.

Item #7410 Complete — \$99.00

## ADAM 5 1/4" DISK DRIVE

Gives your Adam fast, reliable data storage & retrieval. Can hold up to 160Kb of information. Uses industry-standard SS/DD disks. Connects directly to your Adam memory console. Comes w/disk drive power supply, Disk Manager disk & owner's manual. Mfr — Coleco, model 7817.

Item #12830 New — \$199.00

## 5 1/4" FULL-HEIGHT HARD DISK DRIVES

40Mb (AT/XT Compat.)

High speed, 40 ms. access time. Quantum #Q540

Item #17765 New — \$379.00

10Mb (ST412 Compat.)

Major manufacturers — Get them while they last!

Item #17199 \$99.00 ea.

## 5 1/4" HALF-HT. HARD DISK DRIVES

10Mb (ST212 Compatible)

Mfr — Tandon #TM252

Item #19704 New — \$99.00

20Mb (ST225 Compatible)

Mfr — Olivetti #EM5520/2

Tested—Like New! Item #20060 \$159.00

## 5 1/4" FULL-HEIGHT DISK DRIVE (IBM® Compat.)

48 TPI, 40 Track, Double Side/Double Density Tandon #TM100-2 or equiv.

Item #7928 \$79.00 New

2 for \$150.00 New

## 3 1/2" MICROFLOPPY DISK DRIVE

1 Mb (unformatted), 135 TPI, 3 ms. access time. Power requirements: +12, +5 volts. Removed from operational computers—

TESTED — LIKE NEW!

Mfr — NEC, model FD1035

Item #17171 \$79.00 ea.

2 for \$150.00

## 9" MONITORS... (Open Frame)



★ TTL — High Res... Green Phosphor

Input: 12VDC. Audiotronics #900964-04

Item #17198 New — \$19.95



★ Composite — Black & White...

Input: 12VDC. (Mtd. in metal chassis.) Motorola #XM226-21

Item #19694 New — \$22.95

## 115 CFM MUFFIN®-TYPE FANS



115VAC; 60Hz.; 21W; 28A.; 3100 RPM; 5-blade model; aluminum housing. Can be mtd for blowing or exhaust.

Dimen.: 4 1/8" sq. x 1 1/2" D.

Mfr: Howard Industries or equiv.

Item #1864 New — \$9.95

W/Adjustable Speed Control

Item #20611 \$12.95

## 27 CFM MINI FANS



115VAC/60Hz., 12W., low noise-level fans. Can be mtd. for blowing or exhaust. Fits standard 3 1/2" relay rack. Impedance protected.

7 metal blades. Dim.: 3 1/8" sq. x 1 1/2" D. Mfr — Rotron or equiv.

NEW — Item #13210 \$7.95

RFE — Item #1873 \$5.95

## VOICE-ACTIVATED SWITCH



"Activate 'on' or 'off' with the sound of your voice, a whistle or clap..."

Ideal for robotics, lights, etc. Turns on w/the first sound & off w/the second. Solid-state units w/adjust. sens. control & pick-up microphone attached to PC board.

Dim.: 2 3/4" x 3 1/8" x 7/8". VOX input: 6-9VDC; can be used w/any standard battery. Item #16440.

3 switches / \$9.95

## STEPPING MOTORS for ROBOTICS...

Precision steppers with increments from 1 to 7.5°. Speeds up to 5,000 steps.

Item No.	Step Angle	DC Voltage	Torque oz./in.	Type	Mfr. & Part No.	Dimensions	Fig.	Price
7630	1.8°	3.0	200	PM	Superior MO92-FT-402	2" L x 2 1/4" dia. x 2 1/4" H	1	\$34.50 ea. 2 for \$59.50
16410	1.8°	12.0	700*	PM	Applied Motion 4017-839	1 1/2" sq. x 1 1/4" D	2	\$9.95 ea. 2 for \$14.95
16406	3.6°	12.0	700*	PM	Applied Motion 4017-838	1 1/2" sq. x 1 1/4" D	2	\$9.95 ea. 2 for \$14.95
7014	7.5°	12.0	900*	PM	Mitsubishi 55SI-25DAYA	2 1/8" sq. x 1" D	3	\$10.95 ea. 2 for \$19.95

\*Grams per Cm.

DISK DRIVES — MONITORS — COMPUTER COMPONENTS — INTEGRATED CIRCUITS — CAPACITORS — POWER SUPPLIES — VOLTAGE REGULATORS — OPTO ELECTRONICS — SEMICONDUCTORS —

## ADAM PRINTER

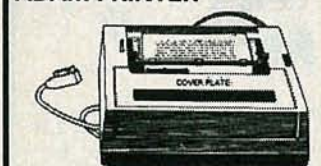

Friction feed, Takes standard paper 8 1/2 x 11".

Item #8839 New — \$69.50

## ADAM ACCESSORIES...

COLECOVISION to ADAM EXPANSION KIT...

Item #9918 \$59.50

DATA DRIVE... Item #6641 \$19.95

PRINTER POWER SUPPLY... Item #6642 \$14.95

ASCII KEYBOARD... Item #6643 \$19.95

CONTROLLERS Set of 4)... Item #7013 \$9.95 RFE

ADAM CASSETTES... Incl. Smart Basic, Buck Rogers & blank cassette. Item #7786

Baker's Dozen — \$19.95

DISK DRIVE POWER SUPPLY... Item #14603 \$14.95

ADAM DAISY PRINT WHEEL... Item #13305 \$3.95

ADAM RIBBON CARTRIDGE... Item #13306 \$3.95

## SWITCHING POWER SUPPLIES...

Input Voltage: 115/230VAC, 50/60Hz.

Item No.	+5V	Output Voltages (DC)		Mfr. & Part No.	Dimensions (L x W x H)	Price
		+12V	-12V +24V			
17210	18.0	2.5	2.5	Sola #39-139	13" x 4 1/2" x 1 1/2"	\$29.95
17897*	8.0	2.0	1.5	Power Systems #11627AY52021	8 1/2" x 5" x 2 1/2"	24.95
17223	4.0	.8	.2	Power Systems #1556	8 5/8" x 5 1/2" x 2"	19.95
5353	3.0	.17		Astec #AA11101	7 3/8" x 6 1/2" x 2"	19.95

\*Mounted on base

## COLECOVISION Accessories...

EXPANSION MODULE #2 Play arcade quality driving & racing games on your ColecoVision. Incl. Turbo cartridge.

Item #13146 New — \$39.95

ROLLER CONTROLLER Gives full 360° game control. Hi-speed action of an arcade. Can be used w/the Adam. Incl. Slither cartridge.

Item #13147 New — \$39.95

SUPER ACTION CONTROLLER SET Gives you indiv. control of 4+ on-screen players. Includes Baseball cartridge.

Item #13148 New — \$39.95

## NICAD BATTERY PACKS (Rechargeable)

"AA" Cells

4.8V @ 450ma

4 AA cells connected in series.

Item #1264...5 packs/ \$9.95

"C Cells"

6V @ 1.25Ah.

Consists of 5 "C" cells connected in series & shrink wrapped.

Item #19675 \$7.95

## RECORDING TAPE

7 1/2" Reel, 2400 ft.



1/4 Mil. Bulk erased. Major mfrs.: Ampex, Scotch, etc. Item #6711.

15 reels for \$9.95

## TIMEX-SINCLAIR...

2040 PRINTER



32-column — compatible with any of the Timex-Sinclair computers, as well as our PC8300 Computer. Uses standard 4 1/2" thermal paper.

Item #15851 New — \$39.95

## COPPER-CLAD PRINTED CIRCUIT BOARD (Double-Sided)

Glass coated, epoxy laminated. 1 oz. Double sided, .022" thick.

Dimensions: 24" L x 18.5" H

Item #13606

3 sheets / \$9.95







# Worldwide • Since 1974

## QUALITY COMPONENTS • COMPETITIVE PRICING

### PROMPT DELIVERY



### COMPUTER PRODUCTS

#### Jameco IBM AT Compatible 16MHz 80286 NEAT Motherboard

- Expandable to 8MB RAM (Zero-K included)
- 8/12 or 8/16MHz switchable
- Supports all NEAT functions including shadow RAM, EMS 4.0, RAM re-mapping and selectable wait states
- 80287-10 Coprocessor capability
- Norton SI rating of 15.6
- AMI BIOS ROMs included
- One-year warranty



**JE3010** 8/12/16MHz NEAT (AT) . . . \$469.95

#### — Additional Motherboards —

**JE1001** 4.77/8MHz (PC/XT) . . . \$ 89.95  
**JE1002** 4.77/10MHz (PC/XT) . . . \$109.95  
**JE3005** 8/12MHz (AT) . . . \$329.95

#### Jameco IBM PC/XT/AT Compatible Computer Cases

**JE1010** Standard PC/XT Flip-Top Case . . . \$34.95  
**JE1011** Standard PC/XT Slide Case . . . \$39.95  
**JE1014** Baby XT Turbo Flip-Top Case . . . \$69.95  
**JE1017** Baby AT Flip-Top Case . . . \$54.95  
**JE1018** Baby AT Slide Case . . . \$69.95  
**JE1019** Baby AT Flip-Top Case . . . \$69.95

### TEST EQUIPMENT

#### Metex M4650:

- Handheld, high accuracy
- 4 1/2 Digit LCD
- Manual ranging with Overload Protection
- Audible continuity tester
- Tests: AC/DC Voltage, Resistance, Continuity, Capacitance, Frequency
- One Year Warranty
- Size: 7" L x 3.5" W x 1.5" H

**M4650** . . . \$99.95



### JAMECO SOLDERLESS BREADBOARD SOCKETS

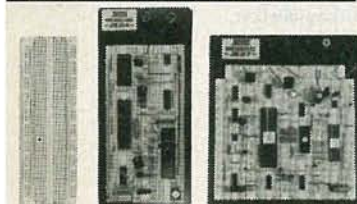

Part No.	Dim. L" x W"	Contact Points	Binding Posts	Price
<b>JE23</b>	6 1/2 x 3/4	200	0	\$ 1.95
<b>JE21</b>	3 1/4 x 2 1/2	400	0	\$ 4.95
<b>JE22</b>	6 1/2 x 1 3/8	630	0	\$ 5.95
<b>JE23</b>	6 1/2 x 2 1/8	830	0	\$ 7.95
<b>JE24</b>	6 1/2 x 3 1/8	1,360	2	\$14.95
<b>JE25</b>	6 1/2 x 4 1/4	1,660	3	\$22.95
<b>JE26</b>	6 7/8 x 5 3/8	2,390	4	\$27.95
<b>JE27</b>	7 1/4 x 7 1/2	3,220	4	\$37.95

### DATA BOOKS

**400041** NSC Linear Data Book-Vol. I (88) . . . \$14.95  
**400042** NSC Linear Data Book-Vol. II (88) . . . \$ 9.95  
**400043** NSC Linear Data Book-Vol. III (88) . . . \$ 9.95  
**210830** Intel Memory Handbook (88) . . . \$17.95  
**230843** Intel Microsystem Hndbk. Set (88) . . . \$24.95

### Jameco IBM PC/XT 8MHz Turbo Compatible Kit With 256K RAM

- Free! QAPLUS Diagnostic Software Included!
- Free! PC Write Word Processing Software Included!
- 256K RAM Included, Expandable to 640K
- 4.77 or 8MHz Switchable
- AMI BIOS ROM Included
- Save \$128.06



Build Your Own And LEARN!

Part No.	Description	Price
<b>JE1001</b>	4.77/8MHz Turbo Motherboard . . . . .	\$89.95
	(Zero-K RAM — includes AMI BIOS ROM)	
<b>JE1010</b>	Flip-Top Case . . . . .	34.95
<b>JE1015</b>	XT/AT Compatible Keyboard . . . . .	59.95
<b>JE1020</b>	5.25" DSDD Disk Drive (Black Bezel) . . . . .	89.95
<b>JE1030</b>	150 Watt Power Supply . . . . .	59.95
<b>JE1040</b>	360K Floppy Controller . . . . .	29.95
<b>JE1050</b>	Mono/Graphics Card with Printer Port . . . . .	59.95
<b>AMBER</b>	12" Monochrome Amber Monitor . . . . .	99.95
<b>41256-150</b>	256K RAM (9 chips) . . . . .	103.41

Save \$128.06 Regular List \$628.01  
**JE3002** IBM Compatible PC/XT 8MHz Turbo Kit. . . . \$499.95

### IBM COMPATIBLE DISPLAY MONITORS

**AMBER** 12" Amber Monochrome . . . \$99.95  
**CTX2410** 14" RGB Color . . . . . \$279.95



**14" EGA Color** - EGA/CGA Compatible, 720 x 350 Max. Resolution (PC/XT/AT)  
**TM5154** . . . . . \$399.95

**14" EGA Monitor and EGA Card** - EGA compatible, 720 x 350 Max. Resolution — displays up to 16 colors (PC/XT/AT)  
**JE1059** SAVE \$40.00 . . . . . \$519.95

**14" Multiscan Color** -VGA/PGC/EGA compat., 800 x 600 Max. Res. (PC/XT/AT)  
**TM5155** . . . . . \$549.95

**13" VGA Monitor and VGA Card** - VGA compatible, 800 x 560 Max. Resolution — displays up to 256 colors (PC/XT/AT)  
**JEVGA** . . . . . \$649.95

### JAMECO IBM PC/XT/AT COMPATIBLE CARDS

**Graphic Display Cards**  
**JE1050** Mono Graphics Card w/Printer Port (PC/XT/AT) . . . . \$59.95  
**JE1052** Color Graphics Card w/Printer Port (PC/XT/AT) . . . . \$49.95  
**JE1055** EGA Card with 256K Video RAM (PC/XT/AT) . . . . \$159.95  
**JE1071** Multi I/O with Drive Controller and Mono Graphics (PC/XT) . . . . \$119.95

**Multifunction, I/O and Expansion Cards**  
**JE1060** I/O Card with Serial, Game, Parallel Printer Port and Real Time Clock (PC/XT) . . . . . \$59.95  
**JE1061** RS232 Serial Half Card (PC/XT) . . . . . \$29.95  
**JE1062** RS232 Serial Half Card (AT) . . . . . \$34.95  
**JE1065** I/O Card w/Serail, Game & Parallel Printer Port (AT) . . . \$59.95  
**JE1081** 2MB of expanded or extended memory (zero-K on-board) (AT) . . . . . \$119.95  
**JE1082** 3MB of expanded or extended memory, parallel printer port, serial port and game port (zero-K on-board) (AT) . . . . . \$169.95

**Floppy and Hard Disk Controller Cards**  
**JE1041** 20/40MB Hard Disk Controller Card (PC/XT) . . . . . \$79.95  
**JE1043** 360K/720K/1.2MB/1.44MB Floppy Disk Cont. (PC/XT/AT) \$49.95  
**JE1044** 360K Floppy/Hard Disk Controller Card (PC/XT) . . . \$129.95  
**JE1045** 360K/720K/1.2MB/1.44MB Floppy/Hard Disk Controller Card (AT) . . . . . \$149.95

### COMPUTER PERIPHERALS

#### AMI 80386 Motherboards

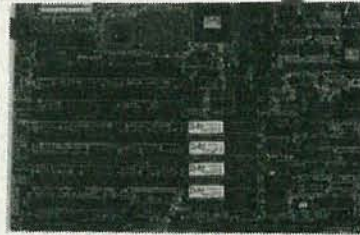

- Expandable to 2MB (Zero-K incl.) of 32-bit RAM with expansion board (included)
- Expand an additional 8MB using the JE3030 (below, Zero-K incl.)
- XT footprint-AT compatible
- 80387-16/20 capability
- Built-in set-up and diagnostics
- Includes AMI BIOS ROMs
- One-year warranty

**JE3020** 16MHz 80386 (AT) . . . \$1199.95  
**JE3025** 20MHz 80386 (AT) . . . \$1499.95  
**JE3030** 8MB (Zero-K) Daughterboard . . . \$249.95

#### Seagate 20,30 40 and 60MB Half Height Hard Disk Drives



**ST225** 20MB Drive only (PC/XT/AT) . . . . \$224.95  
**ST225XT** 20MB w/Controller (PC/XT) . . . . \$269.95  
**ST225AT** 20MB w/Controller (AT) . . . . \$339.95  
**ST238** 30MB Drive only (PC/XT/AT) . . . . \$249.95  
**ST238XT** 30MB w/Controller (PC/XT) . . . . \$299.95  
**ST238AT** 30MB w/Controller (AT) . . . . \$389.95  
**ST251** 40MB Drive only (PC/XT/AT) . . . . \$379.95  
**ST251XT** 40MB w/Cont. Card (PC/XT) . . . . \$419.95  
**ST251AT** 40MB w/Controller Card (AT) . . . . \$489.95  
**ST251-1** 40MB Fast 28ms (Drive only) . . . . \$469.95  
**ST277** 60MB Drive only (PC/XT/AT) . . . . \$449.95  
**ST277XT** 60MB w/Controller (PC/XT) . . . . \$499.95  
**ST277AT** 60MB w/Controller Card (AT) . . . . \$589.95

**40MB Tape Back-Up for IBM PC/XT/AT**  
**DJ10** 40MB Back-Up and Tape . . . \$349.95  
**TB40** 40MB Tape Cartridge . . . . \$24.95

#### Jameco 5.25" PC/XT & AT Compatible Disk Drives



**JE1020** 360K Black Bzl. (PC/XT/AT) . . . \$ 89.95  
**JE1021** 360K Beige Bzl. (PC/XT/AT) . . . \$ 89.95  
**JE1022** 1.2MB Beige Bzl. (PC/XT/AT) . . \$109.95

**3.5" PC/XT/AT Compatible Disk Drives**  
**MF353B** (PC/XT/AT) . . . . \$129.95 \$109.95  
**MF355B** (PC/XT/AT) . . . . \$149.95 \$129.95

### Datatronics

#### 2400/1200/300 Modems

##### NEW, Pocket Version!

- Hayes command compatible
- Bell 103/212A compatible
- Auto-dial/auto-answer
- FCC approved
- 1-year warranty
- Includes MaxiMite Communication Software (except 1200P)

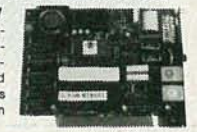

**1200P** 1200/300 Baud Pocket Modem . . . \$ 99.95  
**1200H** 1200/300 Baud Internal Modem . . . \$ 69.95  
**2400H** 2400/1200/300 Internal Modem . . . \$129.95  
**1200C** 1200/300 Baud External Modem . . . \$ 99.95  
**2400C** 2400/1200/300 External Modem . . . \$169.95

U.S. Funds Only  
 Shipping: Add 5% plus \$1.50 Insurance  
 (May vary according to weight)

\$20 Minimum Order

IBM is a registered trademark of International Business Machines

California Residents:  
 Add 6%, 6 1/2% or 7%  
 Sales Tax



1355 Shoreway Road, Belmont, California 94002

24 HOUR ORDER HOTLINE (415) 592-8097 • The Following Phone Lines Are Available From 7AM-5PM P.S.T.:

• Customer Service (415) 592-8121 • Technical Assistance (415) 592-9990 • Credit Department (415) 592-9983 • All Other Inquiries (415) 592-7108

Data Sheets — 50¢ each  
 Prices Subject to Change

Send \$2.00 Postage for a  
 FREE 1989 CATALOG

FAX Numbers: 415-592-2503  
 or 415-595-2664

Telex: 176043

# 3 FOR 1 SPECIAL

**ON SUB-MINIATURE VOICE FM TRANSMITTERS. KITS CONTAIN PC BOARDS**



\***FMX-1 LONG RANGE (3 MI) ULTRA SENSITIVE FM VOICE XMTR** with fine tune, range control plus.....\$24.50



\***TELX-1 TELEPHONE FM XMTR (3 MI)** automatically operates when phone is used. Crystal clear clarity with fine tune and range control. Non detectable.....\$24.50



\***ATR-1 AUTOMATIC TELEPHONE RECORDING DEVICE** tapes telephone conversation all automatically.....\$19.50

**ALL THREE OF ABOVE FOR.....\$49.50**

CALL OR SEND VISA, MASTER CHARGE, MONEY ORDER, ETC. TO **AMAZING CONCEPTS**, BOX 716, AMHERST, NH 03031. (603) 673-4730.

## CONSOLIDATED ELECTRONICS

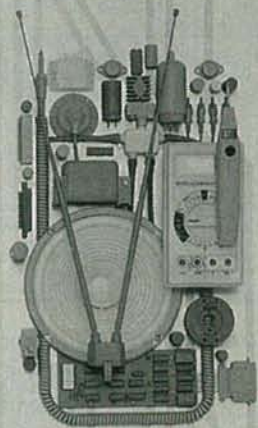

CONSUMER & INDUSTRIAL ELECTRONICS CATALOG • 17TH EDITION

## THE ULTIMATE ELECTRONICS CATALOG.

Order your 260 page catalogue packed with over 10,000 money saving electronic parts and equipment. Send \$3.00 check or money order, or call **1-800-543-3568** today and use your Mastercard or Visa. Consolidated Electronics, Incorporated 705 Watervliet Ave., Dayton, Ohio 45420-2599

NAME \_\_\_\_\_  
 ADDRESS \_\_\_\_\_  
 CITY \_\_\_\_\_  
 STATE \_\_\_\_\_ ZIP \_\_\_\_\_

## ADVERTISING INDEX

RADIO-ELECTRONICS does not assume any responsibility for errors that may appear in the index below.

Free Information Number	Page		Page
108	AMC Sales .....	86	— Pacific Cable .....
—	AMCOM .....	110	56 Parts Express .....
189	Ace Products .....	68	78 Radio Shack .....
107	All Electronics .....	112	— RE Bookstore .....
—	Amazing Concepts .....	108, 124	191 SCO Electronics .....
106	American Design Components .....	120	— Scope Electronics .....
84	Appliance Service .....	68	180, 181 Sencore .....
76	Associated Electronics/3M .....	12	— Star Circuits .....
188	Atlantic Cable Distribution .....	110	83 Synergetics .....
179	Banner Technical Books .....	86	183 TSM .....
98	Beckman Industrial .....	3	92 Tektronix .....
109	C & S Sales .....	32	186 Tentel .....
184	CEI .....	124	123 Test Probes .....
60	CIE .....	31, 79	182 WPT Publications .....
50	Caig Laboratories .....	85	
54	Chemtronics .....	24	
—	Command Productions .....	24	
176	Communications Specialists .....	82	
55	Contact East .....	68	
58	Cook's Institute .....	88	
185	Crystek .....	15	
127	Deco Industries .....	68	
190	Dick Smith .....	82	
82	Digi-Key .....	111	
177	Digimeter .....	68	
—	Electronic Technology Today .....	50, 102	
—	Electronics Book Club .....	56	
121	Fluke Manufacturing .....	CV2	
—	Grantham College of Engineering .....	13	
62	Hameg .....	88	
86	Heathkit .....	14	
187	ICS Computer Training .....	83	
65	J & W .....	7	
59	JDR Instruments .....	5	
174, 170	JDR Microdevices .....	113, 114	
171, 172	JDR Microdevices .....	115, 116	
173, 113	JDR Microdevices .....	117, 118	
114	Jameco .....	122-123	
115	Jensen Tools .....	68	
—	Joseph Electronics .....	23	
—	Lindsay Publications .....	87	
178	M Test Equipment .....	68	
87	MCM Electronics .....	106	
53	MD Electronics .....	109	
93	Mark V. Electronics .....	108	
—	McGraw Hill Book Club .....	38	
—	McGraw Hill (cont. Ed. Series) .....	11	
61	Microprocessors Unltd. ....	103	
—	NRI .....	75	

**Gernsback Publications, Inc.**  
 500-B Bi-County Blvd.  
 Farmingdale, NY 11735  
 1-516-293-3000  
 Fax 1-516-293-3115  
 President: **Larry Steckler**  
 Vice President: **Cathy Steckler**

**For Advertising ONLY**  
 1-516-293-3000  
 Fax 1-516-293-3115  
**Larry Steckler**  
 publisher  
**Arlene Fishman**  
 advertising director  
**Shelli Weinman**  
 advertising associate  
**Lisa Strassman**  
 credit manager  
**Christina Estrada**  
 advertising assistant

### SALES OFFICES

**EAST/SOUTHEAST**  
**Stanley Levitan**  
 Eastern Sales Manager  
 Radio-Electronics  
 259-23 57th Avenue  
 Little Neck, NY 11362  
 1-718-428-6037, 1-516-293-3000

**MIDWEST/Texas/Arkansas/Okla.**  
**Ralph Bergen**  
 Midwest Sales Manager  
 Radio-Electronics  
 540 Frontage Road—Suite 339  
 Northfield, IL 60093  
 1-312-446-1444  
 Fax 1-312-446-8451

**PACIFIC COAST/ Mountain States**  
**Marvin Green**  
 Pacific Sales Manager  
 Radio-Electronics  
 5430 Van Nuys Blvd. Suite 316  
 Van Nuys, CA 91401  
 1-818-986-2001  
 Fax 1-818-986-2009

# Find The Defective Capacitors, Coils, Resistors, SCRs And Triacs That All Other Testers Miss . . .

Presenting a new, improved, dynamic and mistake proof LC Analyzer that finds defective components all other testers miss.

- Dynamically tests capacitors for value from 1 pF to 20F, leakage with up to 1000 volts applied, dielectric absorption and equivalent series resistance (ESR).

- Dynamically tests inductors, in-or-out of circuit, from 1 uH to 20 Henrys for opens, shorts, value, and detects even one shorted turn.

- Dynamically tests SCRs, Triacs, High Value Resistors, and locates the distance to within feet of an open or short in a transmission line for an added bonus.

- Automatically makes all of the tests, compares them to EIA (Electronic Industries Association) standards and reads the results as Good or Bad. Enter all information right from the component without look-up charts, calculations, or errors.

- Extends your testing capability to places where an AC cord won't reach, with rechargeable 9 hour battery or AC operations.

- An added feature alerts you that the fuse has opened, and that there may be residual high voltage on the component under test.

**New!**  
**And Improved!**

**THE Z STANDARD**  
It's like having your own Standards Engineer with you at all times.



**\$1895**

With The All New,  
LC102 AUTO-Z™ Automatic  
Capacitor-Inductor Analyzer.  
Four Patents

**Call 1-800-843-3338**  
**In Canada Call 1-800-851-8866**

CIRCLE 180 ON FREE INFORMATION CARD

# SUPER VALUES!



## B&K 40 MHZ OSCILLOSCOPE

**SAVE \$250** ■ 20 Calibrated sweeps ■ 6" CRT with internal graticule and scale illumination ■ Video sync separator ■ Single sweep ■ XY operation ■ Z axis output ■ V mode displays 2 unrelated frequency signals ■ Two 10:1 direct probes

Reg. \$848.00  
**Our Price \$598<sup>00</sup>**  
Model 1541A

## COBRA® RADAR DETECTOR Trapshooter®

**SAVE \$60** ■ Mounts on dash, visor — even windshield ■ Graduated signal strength meter ■ 2 power cords for permanent or detachable installation ■ City/highway switch ■ X and K band indicators ■ 3 anti-falsing circuits

Reg. \$199.95  
**Our Price \$139<sup>95</sup>**  
Model RD-3168

## ALL PURPOSE 92-Pc. TOOL CASE

**SAVE \$40** ■ Complete with everything you need for home, shop, auto ■ Includes 52-pc. socket set with ratchets and extenders ■ 2 tool pallets with roomy rear storage compartments ■ Rugged, handsome carry case

Reg. \$169.95  
**Our Price \$129<sup>95</sup>**  
Model FTK-28

ASK FOR FREE CATALOG.

## FREE BONUS

VM-520 20K OHM/Volt Multi-tester with purchase of any item on this page. Sale Prices and BONUS Offer expire 3/31/89.



# SCOPE ELECTRONICS

260 Motor Pkwy., Hauppauge, NY 11788

**TOLL FREE 800-648-2626**  
(In NY State 800-832-1446 Ext. 242)

## TELEPHONE ORDERS NOW!



Money orders, checks accepted. C.O.D.'s require 25% deposit.

Service & Shipping Charges Continental U.S.A.	
FOR ORDERS	ADD
\$0-50	\$ 4.50
\$51-100	\$ 5.50
\$101-200	\$ 7.00
\$201-300	\$ 8.00
\$301-400	\$ 9.00
\$401-500	\$10.00
\$501-750	\$12.50
\$751-1,000	\$15.00
\$1,001-1,250	\$17.50
\$1,251-1,500	\$20.00
\$1,501-2,000	\$25.00
\$2,001 & Up	\$30.00