

40783

Radio - BUILD A HI-TECH X-MAS TREE

\$2.25 DEC. 1987
IN CANADA \$2.75

Electronics®

TECHNOLOGY - VIDEO - STEREO - COMPUTERS - SERVICE

BUILD A DIGITAL IC TESTER

COMPUTERIZED TESTER WORKS
IN OR OUT OF CIRCUIT

THE EARLY DAYS OF RADIO

A NOSTALGIC LOOK AT
IMPROVEMENTS IN AUDIO

ANALYZING WAVEFORMS

THE RIGHT WAY TO USE
AN OSCILLOSCOPE

STRAIN-GAGE TRANSDUCERS

THE THEORY YOU NEED TO
PUT THEM TO WORK

COMPUTERDIGEST

FLOPPY-DISK DATA STORAGE
BUILD A 68000-BASED COMPUTER

CLEAN UP THE MACROVISION MESS

REMOVE COPY PROTECTION FROM VIDEO CASSETTES FOR A BETTER PICTURE

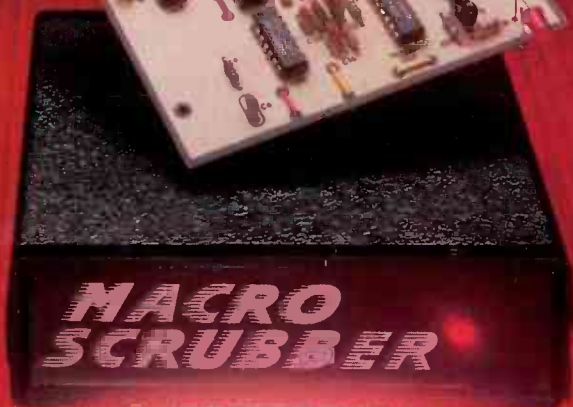
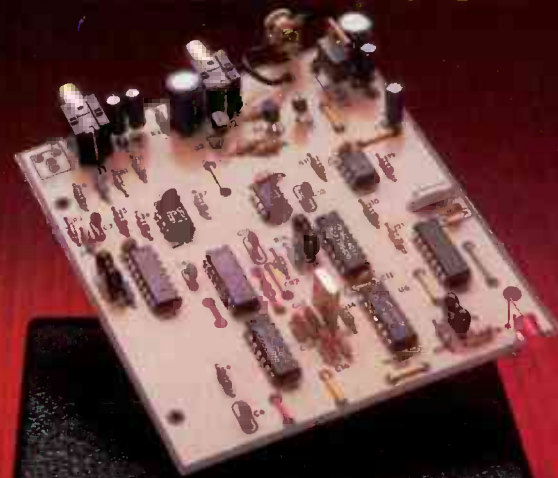

A
GERNSBACK
PUBLICATION

NEW FROM TEK AT JUST \$995!

Light weight makes the 2225 easy to carry even to remote servicing sites.

Fully segmented graticule lines ease the way for quick, accurate voltage and time measurements.

Bright, full-size CRT with minimal geometric distortion and crisp, small spot size delivers sharp trace definition.

One-button beam finder locates off-screen signals, even when intensity is turned down.

Proven design and rugged construction offer reliability at its best. And the Tek reputation for meeting rigid environmental requirements means confidence in your measurements—and in knowing that his scope is built to last.

Sweep speeds to 5 ns/div are fast enough for making accurate pulse and timing measurements on most digital logic families, with good resolution.

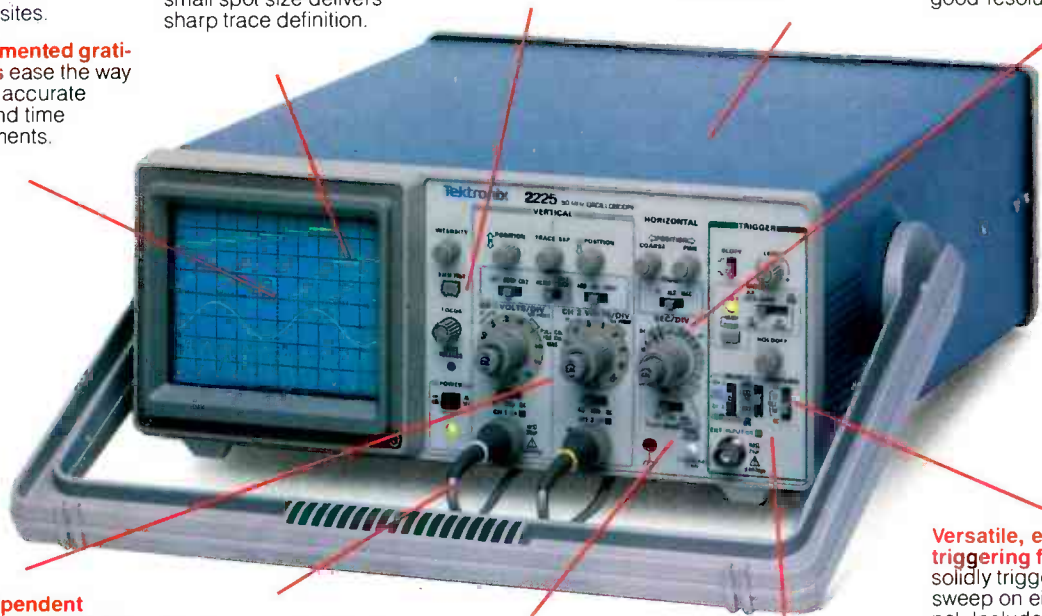

Two independent channels with 50 MHz bandwidth and independent bandwidth limiting on each channel to 5 MHz, 500 μ V/div sensitivity for low-level signal measurements and differential applications.

New low-cost probes (with nearly unbreakable tips) complement the rugged scope design. Compensation adjustments in the probe body itself eliminate the bulky compensation box at the front panel. Scope and probes are a perfect match!

Fast, accurate alternate horizontal magnification lets you choose any of three expansion levels to magnify any part of the normal waveform display—including the trigger point and end of sweep.

Now for the first time! Two vertical-channel inputs and an external Z-axis input all on the front panel. An excellent combination for manufacturing test stations and rackmount applications. And at the simple flip of a switch you can trigger on the Z-axis signal.

Versatile, easy-to-use triggering functions solidly trigger the sweep on either channel. Included are asynchronous triggering capability; flexible coupling via DC, AC, HF and LF reject filtering; hands-free triggering from virtually any signal; plus independent selection of either TV line or TV field triggering regardless of time-base setting.

Now, the professional quality and performance you expect from Tektronix... at an unexpected price: \$995 for scope, probes, 3-year warranty and 30-day free trial on approved credit. No portable in its class can match the Tek 2225 for features, versatility, convenience and value. It's the easy, economical answer to scope needs at bench and field sites, on the manufacturing floor and in the classroom. Call Tek to order, for application assistance or to get the name of your nearest Tek representative or distributor.



Call Tek direct: 1-800-426-2200



Tektronix
COMMITTED TO EXCELLENCE

December 1987 **Radio Electronics**

Vol. 58 No. 12

BUILD THIS

- 47 ELECTRONIC CHRISTMAS TREE**
Blinking LED's make this a unique holiday decoration.
Thomas L. Jozwiak
- 49 MACROVISION STABILIZER**
Clean up your VCR's picture.
D. Dupre
- 55 IN-CIRCUIT DIGITAL-IC TESTER**
Part 2. Build the tester and put it to work.
Bill Green
- 67 R-E ROBOT**
Part 12. An electronic eye.
Steven E. Sarns
- 69 PC SERVICE**
Foil patterns for Macro-Scrubber, Christmas Tree, and IC Tester.

TECHNOLOGY

- 59 HOW TO ANALYZE WAVEFORMS**
Digital readouts make waveform analysis a snap.
Gregory D. Carey, CET

CIRCUITS AND COMPONENTS

- 61 STRAIN-GAGE TRANSDUCERS**
A look at how they work and how you can use them.
Clinton M. Wood
- 64 THE EARLY DAYS OF RADIO**
Part 5. More nostalgia.
Martin Clifford

DEPARTMENTS

- | | |
|---|--|
| 12 VIDEO NEWS
What's new in video.
David Lachenbruch | 42 STATE OF SOLID STATE
An electronic potentiometer.
Robert F. Scott |
| 35 EQUIPMENT REPORTS
Mark V Professional Color
Light Controller. | 74 SATELLITE IV
What's next?
Bob Cooper, Jr. |
| 40 AUDIO UPDATE
Can you believe your ears?
Larry Klein | 77 DRAWING BOARD
Designer RAM
Robert Grossblatt |

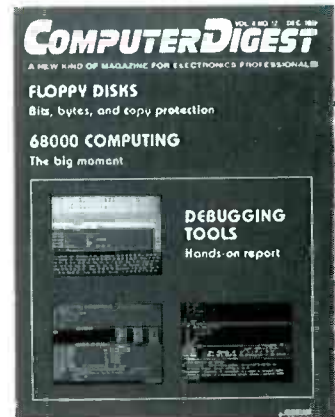

PAGE 85



PAGE 47

AND MORE

- 126 Advertising and Sales Offices**
- 126 Advertising Index**
- 101 Annual Index**
- 15 Ask R-E**
- 4 Editorial**
- 127 Free Information Card**
- 24 Letters**
- 105 Market Center**
- 32 New Products**
- 6 What's News**

DECEMBER 1987

ON THE COVER



Copy protection is commonplace in today's movie industry. The *Macrovision* encoding process is used on many new video tape releases, and some cable companies have expressed interest in it as well. Its advocates claim that *Macrovision* affords unimpaired viewing of the original tape while making it impossible to copy it. However, many sets are unable to process the encoded signal correctly—resulting in a clouded picture that might also roll or flash. If your TV is one of those that can't handle the encoded picture, our Macro-Scrubber can help. It eliminates only the *Macrovision* encoding, with no effect on normal video signals. For a clean picture all the time, build the Macro-Scrubber. The story begins on page 49.

COMING NEXT MONTH

THE JANUARY ISSUE IS ON SALE DECEMBER 3

NATIONWIDE PAGING SYSTEM

Wherever you are, you'll get your message.

BUILD AN UNINTERRUPTABLE POWER SUPPLY

A 40-watt unit keeps going when your power company quits.

SEMICONDUCTOR TESTING

How to test TTL devices.

COMPUTER DIGEST

Get your PT-68K up and running.

As a service to readers, RADIO-ELECTRONICS publishes available plans or information relating to newsworthy products, techniques and scientific and technological developments. Because of possible variances in the quality and condition of materials and workmanship used by readers, RADIO-ELECTRONICS disclaims any responsibility for the safe and proper functioning of reader-built projects based upon or from plans or information published in this magazine.

Since some of the equipment and circuitry described in RADIO-ELECTRONICS may relate to or be covered by U.S. patents, RADIO-ELECTRONICS disclaims any liability for the infringement of such patents by the making, using, or selling of any such equipment or circuitry, and suggests that anyone interested in such projects consult a patent attorney.

RADIO-ELECTRONICS, (ISSN 0033-7862) December 1987. Published monthly by Gernsback Publications, Inc., 500-B Bi-County Boulevard, Farmingdale, NY 11735 Second-Class Postage paid at Farmingdale, NY and additional mailing offices. Second-Class mail registration No. 9242 authorized at Toronto, Canada. One-year subscription rate U.S.A. and possessions \$16.97, Canada \$22.97, all other countries \$25.97. All subscription orders payable in U.S.A. funds only, via international postal money order or check drawn on a U.S.A. bank. Single copies \$1.95. © 1987 by Gernsback Publications, Inc. All rights reserved. Printed in U.S.A.

POSTMASTER: Please send address changes to RADIO-ELECTRONICS, Subscription Dept., Box 55115, Boulder, CO 80321-5115.

A stamped self-addressed envelope must accompany all submitted manuscripts and/or artwork or photographs if their return is desired should they be rejected. We disclaim any responsibility for the loss or damage of manuscripts and/or artwork or photographs while in our possession or otherwise.

Radio-Electronics®

Hugo Gernsback (1884-1967) founder
M. Harvey Gernsback,
editor-in-chief, emeritus

Larry Steckler, EHF, CET,
editor-in-chief and publisher

EDITORIAL DEPARTMENT

Art Kleiman, editorial director
Brian C. Fenton, managing editor
Carl Laron, WB2SLR, associate editor
Jeffrey K. Holtzman,
assistant technical editor
Marc Spiwak, associate editor
Robert A. Young, assistant editor
Julian S. Martin, editorial associate
Byron G. Wels, editorial associate
M. Harvey Gernsback,
contributing editor
Jack Darr, CET, service editor
Robert F. Scott,
semiconductor editor
Herb Friedman,
communications editor
Bob Cooper, Jr., satellite-TV editor
Robert Grossblatt, circuits editor
Larry Klein, audio editor
David Lachenbruch,
contributing editor
Richard D. Fitch,
contributing editor
Teri Scaduto, editorial assistant

PRODUCTION DEPARTMENT

Ruby M. Yee, production director
Robert A. W. Lowndes,
editorial production
Andre Duzant, technical illustrator
Ronald Dee, assistant technical
illustrator
Karen Tucker, advertising production
Marcella Amoroso, production traffic

CIRCULATION DEPARTMENT

Jacqueline P. Cheeseboro,
circulation director
Wendy Alanko,
circulation analyst
Theresa Lombardo,
circulation assistant

Typography by Mates Graphics
Cover photos by Nick Koudis

Radio-Electronics is indexed in
Applied Science & Technology Index
and *Readers Guide to Periodical Literature*.

Microfilm & Microfiche editions are
available. Contact circulation department
for details.

**Advertising Sales Offices listed
on page 126.**



CIRCLE 205 ON FREE INFORMATION CARD

HANDHELD DIGITAL IC COMPARATOR/TESTERS FEATURE 20 CHANNEL LOGIC MONITOR

B&K-PRECISION's Model 550 and 552 IC Comparator Tester/Logic Monitors test IC's by comparison to a known good reference in one simple operation. As logic monitors, they simultaneously indicate the logic states of up to 20 IC pins. They test most 14 to 20 pin, 54 and 74 Series TTL (Model 550) or 4000 and 74C Series CMOS (Model 552) devices. Both models are available from distributors at \$395. Contact your local distributor or: B&K-PRECISION, Dynascan Corp., 6460 W. Cortland St., Chicago, IL 60635. (312) 889-9087.



LOGIC/PULSER PROBES HELP LOCATE DIGITAL FAULTS IN LAB OR IN FIELD SERVICE

B&K-PRECISION now offers logic and pulser probes to fill the needs of engineers and technicians. The DP-21 is a 20 MHz probe that also displays pulse presence and logic status. Both LED and audible logic state indicators are featured. The DP-31 pulser probe can be used alone or with a logic probe or scope. It produces a 10µs pulse at 0.5 or 400 PPS rates and features an external square wave and synchronizing terminal. Both probes are multi-family compatible. The DP-21 is \$32. The DP-31 is \$33. Contact your local distributor or: B&K-PRECISION, Dynascan Corp., 6460 W. Cortland St., Chicago, IL 60635. (312) 889-9087.



CIRCLE 77 ON FREE INFORMATION CARD

CIRCLE 206 ON FREE INFORMATION CARD



NEW COMPARATOR ADDS IC/COMPONENT TESTING TO SCOPE

Test virtually any type of passive or active component or module with B&K-PRECISION's new 541 Component Comparator. The 541 is designed for use with the 540 component tester or virtually any x-y oscilloscope. It is well suited for both in-circuit and out-of-circuit tests. It's fast and easy to use. Unlike single function testing, the 541 can be used on series, parallel or series/parallel circuits. \$395. Contact your local distributor or: B&K-PRECISION, Dynascan Corp., 6460 W. Cortland St., Chicago, IL 60635. (312) 889-9087.

CIRCLE 207 ON FREE INFORMATION CARD



NEW COMPONENT TESTER LOCATES FAULTS ON UNPOWERED BOARDS IN FIELD OR PLANT

The new Model 540 component tester is an extremely cost effective, highly flexible trouble-shooting aid that can assist in rapidly locating faults on unpowered boards. Faults can be traced to the component level without specific circuit knowledge. Individual components can also be tested. Test results are displayed as a curve on a built-in CRT display. Curve tracing allows matching of components. Two channels allow production testing against known good boards. Ideal for field service or production testing. \$995. Contact your local distributor or: B&K-PRECISION, Dynascan Corp., 6460 W. Cortland St., Chicago, IL 60635. (312) 889-9087.

CIRCLE 208 ON FREE INFORMATION CARD



PROGRAMMABLE IC TESTER TESTS TTL, CMOS, RAM AND ROM IC'S, IN OR OUT-OF-CIRCUIT

Called the "first cost-effective way to test IC's both in and out-of-circuit," the new B&K-PRECISION Model 560 fills the void between basic component testers and costly ATE systems. Over 1500 different 14 to 24 pin devices can be tested, including TTL and CMOS digital IC's, RAMs and ROMs. The 560 speeds testing, simplifies diagnostics and doesn't require prior test skills. Plain-English user prompts guide every step of operation. Test results are displayed as positive "pass" or "fail." Test results can be fed to a printer. Applications include incoming inspection, QC, production line testing and troubleshooting faulty products. \$3,500. Contact your local distributor or: B&K-PRECISION, Dynascan Corp., 6460 W. Cortland St., Chicago, IL 60635. (312) 889-9087.

B&K-PRECISION has what you need for fast, cost-effective IC or board testing.

Check it out!

- Programmable in/out-of-circuit IC tester
- Portable curve tracing component tester
- Portable IC comparator tester/logic monitors
- Benchtop IC component comparator tester
- Multi-family compact pulser probes
- Memory-mode multi-family logic probes

Whether your needs are for production board testing, incoming inspection or field service, B&K-PRECISION has you covered with time saving, accurate digital test products.

The Model 560 Programmable In/Out-of-circuit IC Tester is the first cost-effective way to rapidly test IC's both in and out-of-circuit. Punch up the number you need from a resident memory of over 1500 TTL, CMOS IC's, RAM's and ROM's.

The Model 540 Component Tester locates faults on unpowered boards, down to the component level. Curve-tracing method also allows fast comparison of components or boards.

The Model 541 Component Comparator is a comparison instrument for use with your scope or the 540. It tests IC's, semiconductors, capacitors, inductors, transformers and more.

The Models 550 and 552 IC Comparator Tester/Logic Monitors are hand-held portables for TTL and CMOS applications. In-circuit dynamic tests compare a known-good IC to an on-board IC. A 20-channel logic monitor is built-in.

The B&K-PRECISION digital test line-up is rounded out by convenient and economical pulser and logic probes.

For immediate delivery or complete specifications and applications information, call your local distributor or B&K-PRECISION.



BK PRECISION
DYNASCAN CORPORATION

6460 West Cortland St. • Chicago, IL 60635 • 312-889-9087

International Sales, 5460 W. Cortland St., Chicago, IL 60635

Canadian Sales, Atlas Electronics, Ontario
South and Central American Sales, Empire Exporters, Plainville, NY 11303

EDITORIAL



Where is ComputerDigest going?

It's been almost four years since the first issue of **ComputerDigest** appeared inside **Radio-Electronics**. We have proven wrong the thousands of readers who felt that we would soon become "just another computer magazine." We have proven that Radio-Electronics is dedicated to covering the entire scope of electronics from satellite TV to antique radio, from digital audio tape to computers.

We hope you've noticed that **ComputerDigest** has changed during the last year. We've been taking our coverage of computers more seriously, and we've been covering more serious computers.

We've seen how computers can be used to design printed-circuit boards, and we've seen how graphics coprocessors work to make CAD programs faster and more powerful. We've looked at the computers of tomorrow with reports on IBM's PS/2. And, although we got off to a false start, we've begun to show you how to build a computer based on Motorola's powerful 68000 microprocessor.

Our hands-on reviews have kept you on top of the latest hardware and software. And we hope that our in-depth product comparisons have helped make your buying decisions easier by keeping you informed.

The construction projects have ranged from a clock board for your PC to a complete, powerful, yet low-cost 68000-based machine. We have also shown you how to install a 3-1/2-inch disk drive, and how you can dramatically increase the performance of your PC.

But that's enough talk about 1987. As we prepare our first issue for next year, we wonder how we can make **ComputerDigest** better. What type of articles do you want to see in 1988? More reviews? More construction? More industry news? Only *you* know how **ComputerDigest** can serve you better. Please don't keep it to yourself—we need to know. Write to us at 500-B Bi-County Blvd., Farmingdale, NY 11735. Let us know what computers you use and how you use them, and share your views with us..

Thanks for making 1987 a successful year for Radio-Electronics. We hope your holiday season is happy, and we wish you all the best for the new year.

A handwritten signature in black ink, which appears to read "Brian C. Fenton". The signature is stylized and written in a cursive-like font.

BRIAN C. FENTON
Managing Editor

Your Best Source for Banana Plugs and Adapters is POMONA ELECTRONICS

**STANDARD DOUBLE BANANA
PLUG: MODEL MDP**



**BNC FEMALE TO STANDARD
DOUBLE BANANA PLUG:
MODEL 1259**



**STANDARD DOUBLE BINDING
POSTS TO BNC MALE:
MODEL 1296**



**DOUBLE BANANA JACK:
MODEL 2269**



FREE 1987 GENERAL CATALOG



ITT Pomona Electronics
1500 E. Ninth St., Pomona, CA 91766
Te: (714) 623-3463

**SINGLE BINDING POST TO BNC
MALE: MODEL 3430**



**STANDARD BINDING POST:
MODEL 3760**



**CONNECTOR TEST ADAPTERS:
SOCKET TYPE (LEFT) MODEL
4690; PIN TYPE (RIGHT)
MODEL 4631**



**BNC FEMALE TO PHONO PLUG:
MODEL 2357**



Our Products are available through your favorite electronics parts distributor.
CIRCLE 101 ON FREE INFORMATION CARD

WHAT'S NEWS

Novel developments in artificial intelligence

In spite of fantastic advances, computers remain remarkably stupid about certain things. In particular, their language level is below that of a two-year-old child. And they are notoriously poor at finding things only slightly different from those asked for. Another weakness of computers is overprecision—without the exact information the computer cannot reach a conclusion. (An officer on the battlefield, on the other hand, must make instant decisions based on incomplete—and sometimes conflicting—information.)

Scientists at the General Electric Research and Development Center recently presented eight papers aimed at those problems at the Tenth International Conference on Artificial Intelligence,

held in Milan, Italy. Possibly the most topical were two papers by Dr. Urik Zernik of the Center. Both of them were based on attempts to answer two questions: How do human beings learn language?" and "How can the process be taught to computers?"

Past computer-language programs have followed academic models—the computer is "taught" a vocabulary (or fitted with a "dictionary") and given a set of grammatical rules. But humans don't learn a language that way, says Dr. Zernik. They learn with everyday experience with new words, phrases, and idioms.

His solution is to equip his program (called RINA) with a "dynamic lexicon" containing entire phrases (including idioms). RINA

is also equipped with a set of mathematical instructions that tell the computer how to work with the lexicon and how to use it to gain new knowledge.

As an example, the computer was given the statement: "Israel and Egypt buried the hatchet." The computer interpreted that as "The nations buried a knife", but it rejected the phrase; in its experience, nations do not bury physical objects. The user helped out: "Israel and Egypt were in a long conflict, they signed a peace agreement." The computer, correctly deducing the meaning of the idiom, then replied: "They buried the hatchet; they terminated the conflict." Later, given the idiom in a totally different context, it responded correctly by applying what it had learned.

A system that is designed to enable a computer to make decisions based on incomplete information was described by Dr. Piero Bonissone, in a paper detailing RUM (*Reasoning with Uncertainty Module*). The system helps the computer to make sense out of fuzzy terms, like "almost" or "probably" and to weigh the similarities and differences of the current situation against a previous one.

Another paper, by GE scientist Van-Duc Nguyen, describes advances in image understanding—a computer's ability to recognize objects shown by the lines and angles of their outlines. (See "What's News" *Radio-Electronics*, April 1987). That process of "line labeling", or identification, is improved by adding information showing all lines as either concave, convex, or occluding.

R-E



DR. URI ZERNIK, General Electric scientist, with a few of the idioms that his language, RINA, helps the computer to figure out.

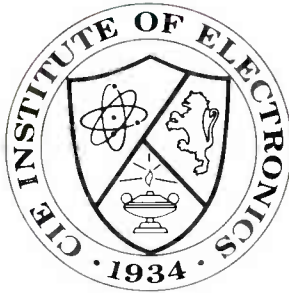

“If you’re going to learn electronics, you might as well learn it right!”

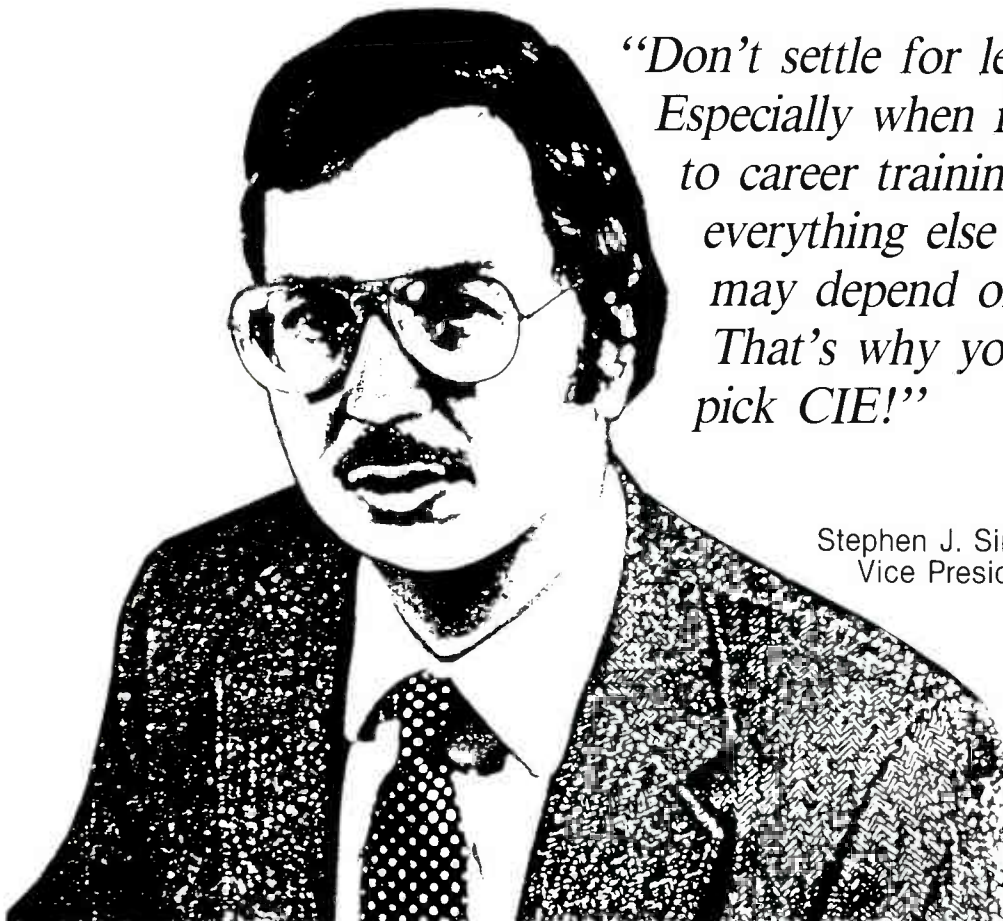

*“Don’t settle for less.
Especially when it comes
to career training...because
everything else in your life
may depend on it.
That’s why you ought to
pick CIE!”*

Stephen J. Simcic
Vice President, Academic Affairs

You've probably seen advertisements from other electronic schools. Maybe you think they're all the same. They're not! CIE is the largest independent home study school in the world that specializes exclusively in electronics.

Meet the Electronics Specialists.

When you pick an electronics school, you're getting ready to invest some time and money. And your whole future depends on the education you get in return.

That's why it makes so much sense to go with number one . . . with the specialists . . . with CIE!

There's no such thing as bargain education.

If you talk with some of our graduates, chances are you'd find a lot of them shopped around for their training. Not for the lowest priced but for the best. They pretty much knew what was available when they picked CIE as number one.

We don't promise you the moon. We do promise you a proven way to build valuable career skills. The CIE faculty and staff are dedicated to that. When you graduate, your diploma shows employers you know what you're about. Today, it's pretty hard to put a price on that.

Because we're specialists we have to stay ahead.

At CIE, we've got a position of leadership to maintain. Here are some of the ways we hang onto it . . .

Programmed Learning

That's exactly what happens with CIE's Auto-Programmed Lessons. Each lesson uses famous "programmed learning" methods to teach you important principles. You explore them, master them completely, before you start to apply them. You thoroughly understand each step before you go on to the next. You learn at your own pace.

And, beyond theory, some courses come fully equipped with electronics gear (the things you see in technical magazines) to actually let you perform hundreds of "hands-on" experiments.

Experienced specialists work closely with you.

Even though you study at home, you are not alone! Each time you return a completed lesson, you can be sure it will be reviewed, graded, and returned with appropriate instructional help. When you need additional individual help, you get it fast and in writing from the faculty technical specialist best qualified to answer your question in terms you can understand.

Pick the pace that's right for you.

CIE understands people need to learn at their own pace. There's no pressure to keep up . . . no slow learners hold you back. If you're a beginner, you start with the basics. If you already know some electronics, you move ahead to your own level.

Enjoy the promptness of CIE's "same day" grading cycle.

When we receive your lesson before noon Monday through Saturday, we grade it and mail it back the same day. You find out quickly how well you're doing!

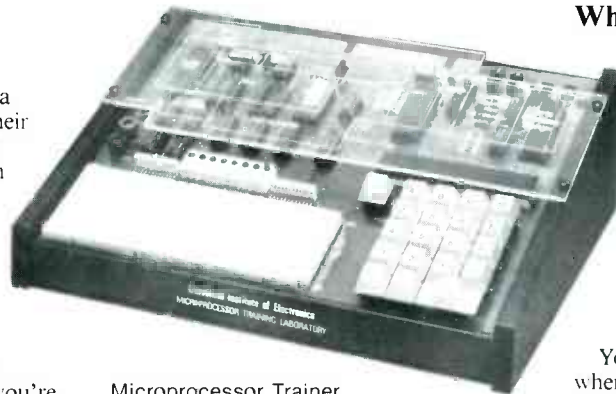

Microprocessor Trainer

State-of-the-art Laboratory Equipment

Some courses feature the CIE Microprocessor Training Laboratory. An integral part of computers, microprocessor technology is used in many phases of business, including service and manufacturing industries.

The MTL gives you the opportunity to program it and interface it with LED displays, memory devices, and switches. You'll gain all the practical experience needed to work with state-of-the-art equipment of today and tomorrow.

CIE offers you an Associate Degree.

One of the best credentials you can have in electronics — or any other career field — is a college degree. That's why CIE gives you the opportunity to earn an Associate in Applied Science in Electronics Engineering Technology. Any CIE career course can offer you credit toward the degree — more than half of the number needed in some cases.

"Cleveland Institute of Electronics is the only accredited institution of higher learning offering an Associate Degree program with tuition based on actual study time used. The faster you complete your degree assignments, the less your overall tuition."

Steve Simcic
Vice-President Academic Affairs

Which CIE Training fits you?

Beginner? Intermediate? Advanced? CIE home study courses are designed for ambitious people at all entry levels. People who may have:

1. No previous electronics knowledge, but do have an interest in it;
2. Some basic knowledge or experience in electronics;
3. In-depth working experience or prior training in electronics.

You can start where you fit and fit where you start, then go on from there to your Diploma, Associate Degree, and career.

Today is the day. Send now.

Fill in and return the postage-free card attached. If some ambitious person has removed it, cut out and mail the coupon. You'll get a FREE school catalog plus complete information on independent home study. For your convenience, we'll try to have a CIE representative contact you to answer any questions you may have.

Mail in the coupon below or, if you prefer, call toll-free 1-800-321-2155 (in Ohio, 1-800-523-9109).

ARE-74

CIE

Cleveland Institute of Electronics, Inc.

1776 East 17th Street, Cleveland, Ohio 44114

Accredited Member National Home Study Council

YES...I want to learn from the specialists in electronics — CIE. Send me my FREE CIE school catalog...including details about the Associate Degree program... plus my FREE package of home study information.

Print Name _____

Address _____ Apt. _____

City _____ State _____ Zip _____

Age _____ Area Code/Phone No. _____/_____

Check box for G.I. Bill bulletin on Educational Benefits: Veteran Active Duty

MAIL TODAY!

CIRCLE 60 ON FREE INFORMATION CARD

VIDEO NEWS



DAVID LACHENBRUCH,
CONTRIBUTING EDITOR

• **What's in a name?** Not much, evidently. Take RCA, for example: In 1986, it was sold to General Electric, which was one of the original founders of RCA. General Electric then sold off RCA Records to German publisher Bertelsmann, which not only continues to use the RCA name but has restored the old RCA "meatball" trademark—R, C, and A in a circle, with a lightning bolt at the bottom of the A. Then GE proceeded to sell both GE and RCA consumer electronics to France's giant Thomson combine. Now the RCA initials will be used on records by a German company and on TV's by a French one. The David Sarnoff Research Center (once called RCA Laboratories) was donated to SRI International, which still calls it by the name of RCA's guiding genius.

Or take Philips, the worldwide tradename of the Dutch electronics giant. In the early days of electronics, the company reached an agreement to keep the Philips name out of the United States because it might be confused with Philco, which was here first. Philco was sold to Ford, Ford sold it to GTE, and GTE sold it to North American Philips, which in turn was absorbed by Dutch Philips. So Philips ended up owning Philco, which, not surprisingly, no longer had any objection to the use of the Philips name. Thus, the Philips name finally has come to America on lightbulbs and appliances, and soon on electronics, including TV sets.

Good old names never seem to die; but sometimes they go to sleep for a while. That's what's now happening to Pilot, a historic name. It was Pilot Radio that introduced the first big-selling component FM tuner, the *Pilotuner*. Then in 1948 Pilot brought out the first portable TV (it was in a large suitcase and had a 3-inch picture); that was also the first TV set with a list price under \$100. Pilot went through a number of permutations, and eventually when audio marketer Morse sold out to Curtis Mathes, Pilot was one of the names that went with it. Curtis Mathes tried selling Pilot audio equipment for a while, but phased out the line this year. So Pilot is now in limbo, but the brand will probably make a comeback sometime soon, like oldtimers such as

Capehart, Emerson, Symphonic, and DuMont; all of those are still around, but the equipment is being manufactured by companies that have no connection to the brand's originator.

• **Zenith goes digital.** Apparently encouraged by the success of its original digital offerings last year, Zenith has introduced 15 new TV sets with all-digital signal processing, in 20- and 27-inch sizes, all with built-in TV stereo and teletext reception. That's far more digital models than any other TV manufacturer will be selling in the U.S. In other introductions, Zenith became the first American manufacturer to offer a TV set with a 35-inch tube (the tube is Japanese). Also, Zenith has introduced a new vertical VCR about six-inches wide by 12-inches tall, designed for bookshelves and other tight places. One 27-inch TV set has a removable panel that conceals a compartment just the right shape to hold Zenith's vertical VCR—and nobody else's. For its lower-priced sets, Zenith has introduced the new highly automated *Duratech* chassis, which contains 46% surface-mount parts, 80% machine-inserted components, 20% fewer connectors, and is 100% computer tested and aligned.

• **Compact disc-video postponed.** If you've been looking for those Compact Disc-Video (CD-V) records and players (**Radio-Electronics**, August 1987), you'll have to wait a little longer. Although they were formally "introduced" last summer, nothing has come on the market, and they're now scheduled for a new launch early in 1988. The CD-V format is an overall name given to the old Laservision videodisc, as well as the new five-inch discs that play five minutes of analog video and 20 minutes of digital audio. Pioneer has introduced combination players that will play the 5-inch discs as well as 8- and 12-inch ones, and others are due soon. CD-V's sponsors want to go through the hoopla of a launch after they have about 200 music-video titles in the 5-inch size. At press time, fewer than 100 selections had been committed to the short audio-video singles.

R-E

TEST EQUIPMENT THAT MEASURES UP TO YOUR SPECIFICATIONS



DMM-300 \$79.95

3.5 DIGIT DMM MULTITESTER

Our best model. A highly accurate, full function DMM loaded with many extra features. Audible continuity, capacitance, transistor temperature and conductance all in one head-head meter. Temperature probe, test leads and battery included.

- Basic DC accuracy: plus or minus 0.25%
- DC voltage: 200mv — 1000v, 5 ranges
- AC voltage: 200mv — 750v, 5 ranges
- Resistance: 200 ohms — 20M ohms, 6 ranges
- AC/DC current: 200uA — 10A, 6 ranges
- Capacitance: 2000pF — 20uF, 3 ranges
- Transistor tester: hFE test, NPN, PNP
- Temperature tester: C° — 2000° F
- Conductance: 200ns
- Fully over-load protected
- Input impedance: 10M ohm

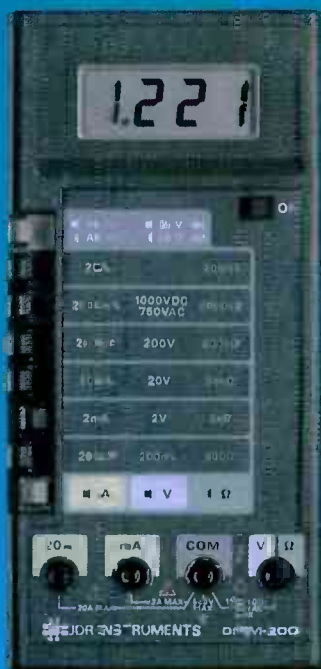

DMM-200 \$49.95

3.5 DIGIT FULL FUNCTION DMM

High accuracy, 200mA current capability and many range settings make this model ideal for serious bench or field work. Tilt stand for hands-free operator. 2000 hour battery life with standard 9v cell. Probes and battery included.

- Basic DC accuracy: plus or minus 0.25%
- DC voltage: 200mv — 1000v, 5 ranges
- AC voltage: 200mv — 750v, 5 ranges
- Resistance: 200 ohms — 20M ohms, 6 ranges
- AC/DC current: 200uA — 20A, 6 ranges
- Fully over-load protected
- Input impedance: 10M ohm
- 180 x 86 x 37mm, weighs 320 grams



DMM-700 \$49.95

3.5 DIGIT AUTO-RANGING DMM

Autorange convenience or fully manual operation. Selectable LC OHM mode permits accurate in-circuit resistance measurements involving semi-conductor junctions. MEM mode for measurement relative to a specific loading. Probes and battery included.

- Basic DC accuracy: plus or minus 0.25%
- DC voltage: 200mv — 1000v, autoranging or 5 manual ranges
- AC voltage: 2v — 750v, autoranging or 4 manual ranges
- Resistance: 200 ohms — 20M ohms, autoranging
- AC/DC current: 20mA — 10A, 2 ranges
- Fully over-load protected
- Audible continuity tester
- Input impedance: 10M ohm
- 150 x 75 x 34mm, weighs 230 grams



DMM-100 \$29.95

3.5 DIGIT POCKET SIZE DMM

Shirt-pocket portability with no compromise in features or accuracy. Large, easy to read 5" LCD display. 2000 hour battery life with standard 9v cell provides over two years of average use. Probes and battery included.

- Basic DC accuracy: plus or minus 0.5%
- DC voltage: 2v — 1000v, 4 ranges
- AC voltage: 200v — 750v, 2 ranges
- Resistance: 2k ohms — 2M ohms, 4 ranges
- DC current: 2mA — 2A, 4 ranges
- Fully over-load protected
- Input impedance: 10M ohms
- 130 x 75 x 28mm, weighs 135 grams

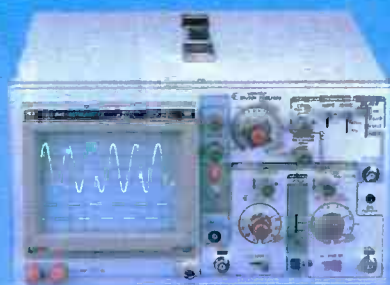

MODEL 2000 \$349.95

20 MHz DUAL TRACE OSCILLOSCOPE

Model 2000 combines useful features and exacting quality. Frequency calculation and phase measurement are quick and easy in the X-Y Mode. Service technicians will appreciate the TV Sync circuitry for viewing TV V and TV-H as well as accurate synchronization of the Video Signal, Blanking Pedestals, VITS and Vertical/Horizontal sync pulses.

- Lab quality compensated 10X probes included
- Built-in component tester
- 110/220 Volt operation
- X-Y operation
- Bright 5" CRT
- TV Sync filter



MODEL 3500 \$499.95

35 MHz DUAL TRACE OSCILLOSCOPE

Wide bandwidth and exceptional 1mV/DIV sensitivity make the Model 3500 a powerful diagnostic tool for engineers or technicians. Delayed triggering allows any portion of a waveform to be isolated and expanded for closer inspection. Variable Holdoff makes possible the stable viewing of complex waveforms.

- Lab quality compensated 10X probes included
- Delayed and single sweep modes
- Z Axis intensity modulation
- X-Y operation
- Bright 5" CRT
- TV Sync filter



DPM-1000 \$54.95

3.5 DIGIT PROBE TYPE DMM

Autorangeing, pen style design for the ultimate in portability and ease of use. Custom 80 pin LSI chip increases reliability. Audible continuity tester and data hold feature for added convenience. Case, test leads and batteries included.

- Basic DC accuracy: plus or minus 1%
- DC voltage: 2v — 500v, autoranging
- AC voltage: 2v — 500v, autoranging
- Resistance: 2k ohms — 2M ohms, autoranging
- Fully over-load protected
- Input impedance: 11M ohm
- 162 x 28 x 17mm, weighs 75 grams

2 YEAR WARRANTY ON ALL MODELS



JDR INSTRUMENTS

110 Knowles Drive, Los Gatos, CA 95030
(408) 866-6200 • FAX (408) 378-8927 • Telex 171-110

COPYRIGHT 1986 JDR MICRODEVICES
THE JDR INSTRUMENTS LOGO IS A REGISTERED TRADEMARK OF JDR MICRODEVICES.
JDR INSTRUMENTS IS A TRADEMARK OF JDR MICRODEVICES

ORDER TOLL FREE 800-538-5000

OR VISIT OUR RETAIL STORE
1256 SOUTH BASCOM AVE.
SAN JOSE, CA. (408) 947-8881
CIRCLE 59 ON FREE INFORMATION CARD

IF YOU WANT A BETTER COMPUTER BUILD IT YOURSELF.

Heath makes building the powerful 386 computer quick, fun, easy... and a great value.

Now you can own the fastest, most powerful home computer available today—at an affordable cost. Just by building it yourself.

Introducing the Heathkit H-386 Desktop Computer. With its powerful 32-bit processor, 16 MHz computing speed and “zero wait” technology,



the H-386 can breeze through complex calculations in seconds.

Every INTEL 80386 micro-processor used in our H-386 is 100% tested for all functions. And you get superb graphics because one video port provides dazzling 640-by-480 color on Zenith's new flat



screen monitor and another port drives EGA, CGA and TTL monochrome monitors. Both ports automatically emulate common video formats for easy system configuration.

Designed for people using large spreadsheets, CAD/CAM or other computation-intensive applications, or anyone who simply wants to own the newest, most powerful hardware on the market, the Heathkit H-386 can be assembled easily and quickly. One or two evenings is all it takes, and no special tools or equipment are required.

In the bargain, you get the satisfaction of having built a powerful computer system all by yourself, and the confidence that this exciting product will deliver all

the performance and dependability you expect. At a significant savings over comparable off-the-shelf brands.

What's more, all Heathkit products are backed by a newly extended, limited one-year warranty, highly respected manuals and technical consultation service.

So if you want a better computer, build it yourself. Impress your friends. And save money at the same time.



To order the new Heathkit H-386 Desktop Computer, simply call toll-free **1-800-253-0570**. Ask for operator 312. Use your Visa, MasterCard or Heath Revolving Charge. Or call **616-982-3614** for the Heath/Zenith Computers and Electronics store location nearest you.

For more information on all our quality kits, send now for your free four-color Heathkit catalog. Write Heath Company, Dept. 020-604, Benton Harbor, MI 49022.

Prices, product availability and specifications are subject to change without notice.

Heathkit®
Heath
Company

Heathkit is a registered trademark of Heath Company, a subsidiary of Zenith Electronics Corporation.

©1987, Heath Company.

CIRCLE 86 ON FREE INFORMATION CARD

ASK R-E

WRITE TO:

ASK R-E
Radio-Electronics
500-B Bi-County Blvd.
Farmingdale, NY 11735

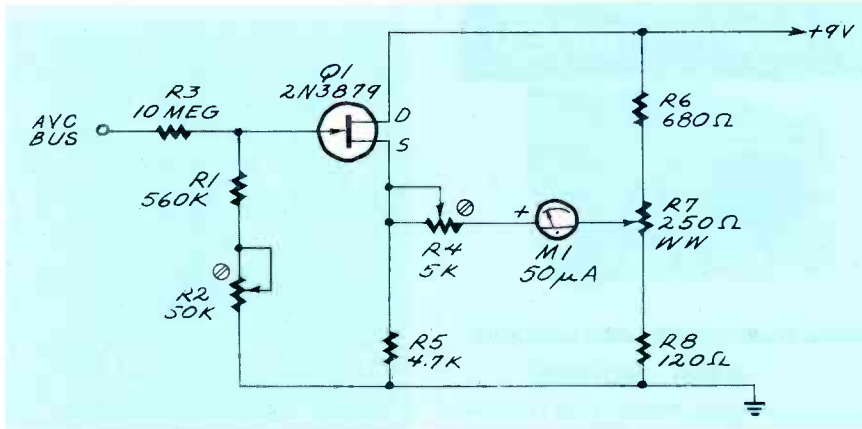

FIG. 1

S-METER AND HEADPHONE JACK

Please show the circuit of a signal-strength meter for an AM radio. Also describe how I can add a headphone jack that will automatically silence the speaker when the phones are plugged in.—J.D., Turnersville, NJ.

I don't know anything about the radio you're modifying, so the best bet for a signal-strength indicator is an FET DC voltmeter (Fig. 1) connected to the set's AGC bus. As shown, the meter reads upward when connected to a positive-going AGC. If the radio uses tubes or has a negative-going AGC, completely isolate the voltmeter's positive and negative leads from

the receiver and then reverse the meter movement's connections so it responds to a negative voltage input. Or, do as was often done on communications receivers: Turn the meter upside down so a declining voltage input will cause the meter to appear to read up-scale.

Figure 2 shows how low-impedance headphones can be connected into the audio output circuit of the radio. Inserting the phone plug connects the phones across the audio output while disconnecting the speaker.

PRECEDENCE DETECTOR

We are planning to update the indicator system used in our "Scholastic Bowl" events. The present system uses relays and we want to use solid-state circuitry.

The moderator or quiz-master asks a question and the first contestant to believe that he has the answer presses a pushbutton switch that causes his indicator lamp to light, and, at the same time, locks out the indicators of the other contestants. The judge determines the winner and then resets the system.—J.R., Cuba, IL.

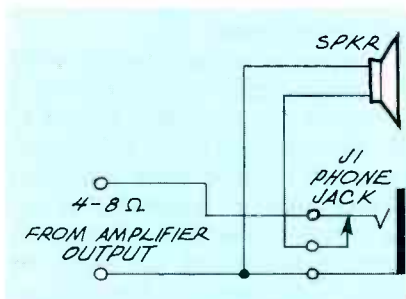

FIG. 2

TALK IS CHEAP.

Have you heard? For less than \$90 your AT or XT-compatible computer can talk! All it needs is the HV-2000 Computer Voice Kit from Heathkit.

Reading letters, transcriptions and computerized instruction can be easier and quicker than you ever thought possible. Computer games gain a new dimension. Your computer can even entertain children with stories and songs.

\$89.95

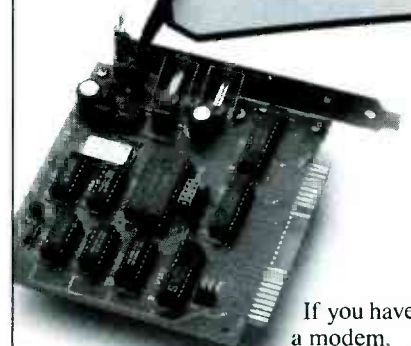

If you have a modem, the HV-2000

Computer Voice will allow your computer to recite reference and research information from time-sharing services. Or, speak radio transmitted ASCII information.

The HV-2000 Computer Voice Card, containing speech synthesizer and audio amplifier, plugs into any AT or XT-compatible computer's expansion slot. An external speaker is also included. Versatile, Heath-developed software gives you a wide variety of voices and easy interface to high and low level languages.

The HV-2000 Computer Voice. At less than \$90, talk IS cheap. To order, call toll-free 1-800-253-0570. Ask for operator 312. Use your Visa, MasterCard or Heath Revolving Charge card. Or call 616-982-3614 for the nearest store location.

Heathkit®

Heath

Company

Benton Harbor, MI 49022

Prices, product availability and specifications are subject to change without notice.

© 1987, Heath Company.

CIRCLE 86 ON FREE INFORMATION CARD

DECEMBER 1987

15

HITACHI SCOPES AT DISCOUNT PRICES!

20MHZ



Model V-212 \$475

Model V-212 20MHZ Dual Channel (1mV Sens.) \$475
 Model V-422 40MHZ Dual Channel (1mV Sens.) \$699
 Model V-425 40MHZ Dual Channel (with cursor) \$795
 Model V-660 60MHZ Dual Channel (Delayed Sweep) \$999
 Model V-1060 100MHZ Dual Channel (Delayed Sweep) \$1,375
 All above scopes have a 3 year warranty on parts and labor

100MHZ

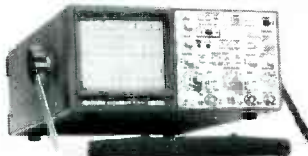

Model V1060 \$1,375

15-25%
OFF LIST
PRICE

ELENCO PRODUCTS AT DISCOUNT PRICES!

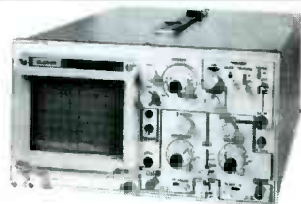

40MHZ
DELAYED
SWEEP
MO-1253
\$550



20MHZ DUAL TRACE OSCILLOSCOPE

\$359 MO-1251

35MHZ DUAL TRACE OSCILLOSCOPE

\$498 MO-1252

Top quality scopes at a very reasonable price. Contains all the desired features. Elenco's 2 year guarantee assures you of continuous service. Two 1X, 10X probes, diagrams and manual included. Write for specs.
 100 MHz Test Probes, 1X, 10X, Ref. (Complete with 5 accessories) Fits Most Scopes - \$22

MULTIMETER with CAPACITANCE AND TRANSISTOR TESTER
 Model CM-1500A \$58
 Reads Volts, Ohms, Current, Capacitors, Transistors & Diodes W/Case

TRUE RMS 4 1/2 DIGIT MULTIMETER
 Model M-7000 \$135
 .05% DC Accuracy
 1% Resistance with Freq. Counter & Deluxe Case

Auto Ranging plus Manual Ranging
 3 1/2 Digit Meter
 28 Functions Fully protected
 M-1180 .7% Acy \$36.95
 M-1182 .25% Acy \$39.95
 M-1181 .1% Acy \$42.95

GF-8016 FUNCTION GENERATOR with Freq. Counter
 \$239
 • Sine, Square, Triangle
 • Pulse, Ramp, 2 to 2MHz
 • Frequency .1 thru 10MHz
 GF-8015 without Freq. Meter \$179

10MHZ OSCILLOSCOPE \$239
 Model S-3000
 • 10MHz DC or AC
 • Triggered Sweep
 • Calibrated Vert & Hor
 • Reads Volts & Freq

BREADBOARD
 Model 9436 Shown
 9430 1,100 pins \$15
 9434 2,170 pins \$25
 9436 2,860 pins \$35

DIGITAL TRIPLE POWER SUPPLY
 Model XP-765 \$239
 0-20V @ 1A
 0-20V @ 1A
 5V @ 5A
 Fully Regulated, Short Circuit Protected with 2 Limit Cont. 3 Separate Supplies
 XP-660 with Analog Meters \$169.50

DIGITAL LCR METER \$148
 Model LC-1800
 Measures: Inductors, Capacitors, Resistors

50MHZ LOGIC PROBE 20 nsec with memory LP-700
 Logic Pulsar LP-800 \$23

DIGITAL 3 AMP POWER SUPPLY
 Model XP-750 \$175
 0-40V @ 1.5A
 0-20V @ 3A
 Fully regulated, short circuit protected current limit control
 XP-650 with Analog Meters \$129.50

MULTI-FUNCTION COUNTERS
 F-1000 1.2GH \$259
 F-100 120MH \$179
 Frequency, Period, Totalize, Self Check with High-Stabilized Crystal Oven Oscillator, 8 Digit LED Display

Our files contain a number of precedence-detector circuits that indicate which of two pushbuttons is pressed first. One circuit, which uses incandescent lamps for high visibility, is shown in Fig. 3.

The circuit, which was described by M. Jennings in the English magazine *Radio & Electronics Constructor*, is designed for SCR switching. The SCR's, of which there is one per "player," remain off until one of them is turned on when a player momentarily closes his pushbutton switch. The switch

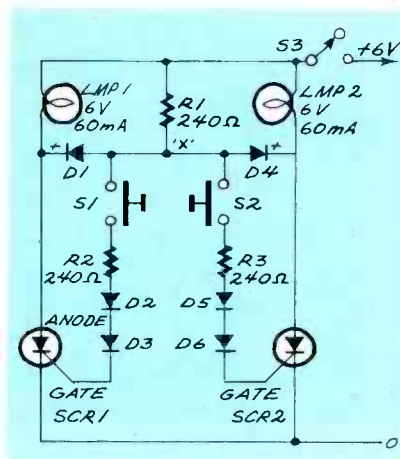



FIG. 3

closure produces a positive trigger pulse on the gate of the corresponding SCR, turning it on. As soon as one SCR turns on, its corresponding indicator lamp lights and the other SCR is locked out so that it cannot fire.

Any number of switching circuits can be added to the detector by duplicating the circuitry to the right of point "X". The SCR's are low-power types such as the Radio Shack 276-1020 and the diodes are silicon rectifiers such as the 1N4002. Switches S1 and S2 are normally-open pushbuttons. Switch S3 is used by the judge or referee to apply power and to reset the precedence detector. That switch may be a single-pole push-on/push-off type.

The precedence detector works this way: Even with S3 closed to energize the detector, the SCR's do not conduct because their gates are isolated from a positive voltage source. Assume that two (or more) players hit their push-buttons at almost the same instant, but contestant No. 1 closes his switch (S1) a fraction of a sec-



Nine Test Probes with only one difference between them and your scope's original equipment

Manufacturers Scope	Original Probe	Price	Coline/TPI Equivalent	Price	Manufacturers Scope	Original Probe	Price	Coline/TPI Equivalent	Price
TEKTRONIX 2300 Series 2200 Series 2400 Series 400 Series	P6101A	\$53	M12X1	\$38	PHILIPS PM3267 & PM3256 PM3264	PM8294	\$60	M12X1	\$38
	P6108A	\$75	M12X10	\$62		PM8926	\$70	P100	\$38
	P6121	\$100	M12X10AP	\$68		PM8928	\$95	M12X10	\$62
	P6122	\$58	P100	\$38		HITACHI V-1100A V-670 V-509	AT-10AL1.5	\$64	SP100
	P6131	\$140	M15X10HFAF	\$87					
	P6133	\$115	M12X10AP	\$68					
	P6105A	\$93	M12X10AP	\$68					
	P6106A	\$140	M15X10HFAF	\$87					
	P6130	\$130	M12X10AP	\$68					
	IWATSU SS-5321 SS-5711	SS-0014	\$92	M12X10	\$62	HEWLETT PACKARD 1715A 1722B 1725A 1740 Series	10018A	\$135	M20X10
SS-0012		\$77	M12X10	\$62	10017A		\$130	M15X10HF	\$79
LEADER LBO-315 LBO-518	LP-060X	\$60	SP100	\$43	10017A		\$130	M15X10HF	\$79
	LP-100X	\$76	SP100	\$43	10041A		\$135	P100	\$38
					10021A		\$85	IP20	\$29

Take up the Coline TPI challenge and compare our prices with the probes you currently use. In many cases you can replace both probes on your dual trace scope at the cost of one probe from the scope manufacturer. Plus, bandwidth and overall performance of the TPI probe typically exceed that of the original equipment. Satisfaction is guaranteed with a ten day return privilege. Coline TPI - Specialists in probes for over 15 years.

Available from your local distributor.

TOLL FREE INFORMATION LINE
1-800-368-5719, 1-800-643-8382 in California

Coline TPI
TEST PROBES INC.

9178 Brown Deer Road, San Diego CA, 92121 Phone: (619) 535 9292
CIRCLE 123 ON FREE INFORMATION CARD

www.americanradiohistory.com

Sent to: 9178 Brown Deer Road, San Diego CA, 92121
 Please send full size catalog
Name _____
Company _____
Address _____
Phone: _____

Train with NRI for a servicing

NEW!

Train with the newest Sanyo 880 Series Computer—it's fully IBM-compatible and runs almost twice as fast as the IBM PC!

Get started now by building this fully IBM PC compatible computer

Now you get it all... training for America's fastest growing career opportunity... training to service all computers... training on the newest total computer system, the Sanyo 880. Only NRI can give you the well-rounded training you need, because only NRI gives you a complete computer system... computer, monitor, disk drive, software, even test instruments like a digital multimeter and logic probe to work with and keep. It all adds up to training that builds the knowledge, competence, and ability you need to succeed as a computer service specialist.

Get inside the newest, fully IBM PC compatible Sanyo Microcomputer

As an NRI student, you'll get total hands-on training



SANYO COMPUTER—8088 CPU double-sided disk drive, 256K RAM, 4.77 MHz and 8 MHz turbo speed.

DIGITAL MULTIMETER—Professional test instrument for quick and easy measurements.

LESSONS—Clear, well illustrated texts build your understanding of computers step-by-step.

DISK SOFTWARE—including MS-DOS, GW BASIC, WordStar, and CalcStar.

Your NRI total systems training includes: • NRI Discovery Lab® to design and modify circuits • Your four-function digital multimeter with walk-you-through instructions on audio tape • Digital logic probe for visual examination of keyboard circuits • The newest Sanyo 880 Series Computer with "intelligent" keyboard and 360K double-density, double-sided disk drive • High resolution monochrome monitor • 8K ROM, 256K RAM • Bundled software including GW BASIC, MS-DOS, WordStar, CalcStar • Reference manuals, schematics, and bite-size lessons.

as you actually build your own latest model Sanyo 880 Series computer from the keyboard up. It's fully IBM PC-compatible and, best of all, it runs programs almost twice as fast as an IBM PC. As you assemble the Sanyo 880, you'll perform

demonstrations and experiments that will give you a total mastery of computer operation and servicing techniques. You'll do programming in BASIC language—even run and interpret essential diagnostic software.

high paying career computers

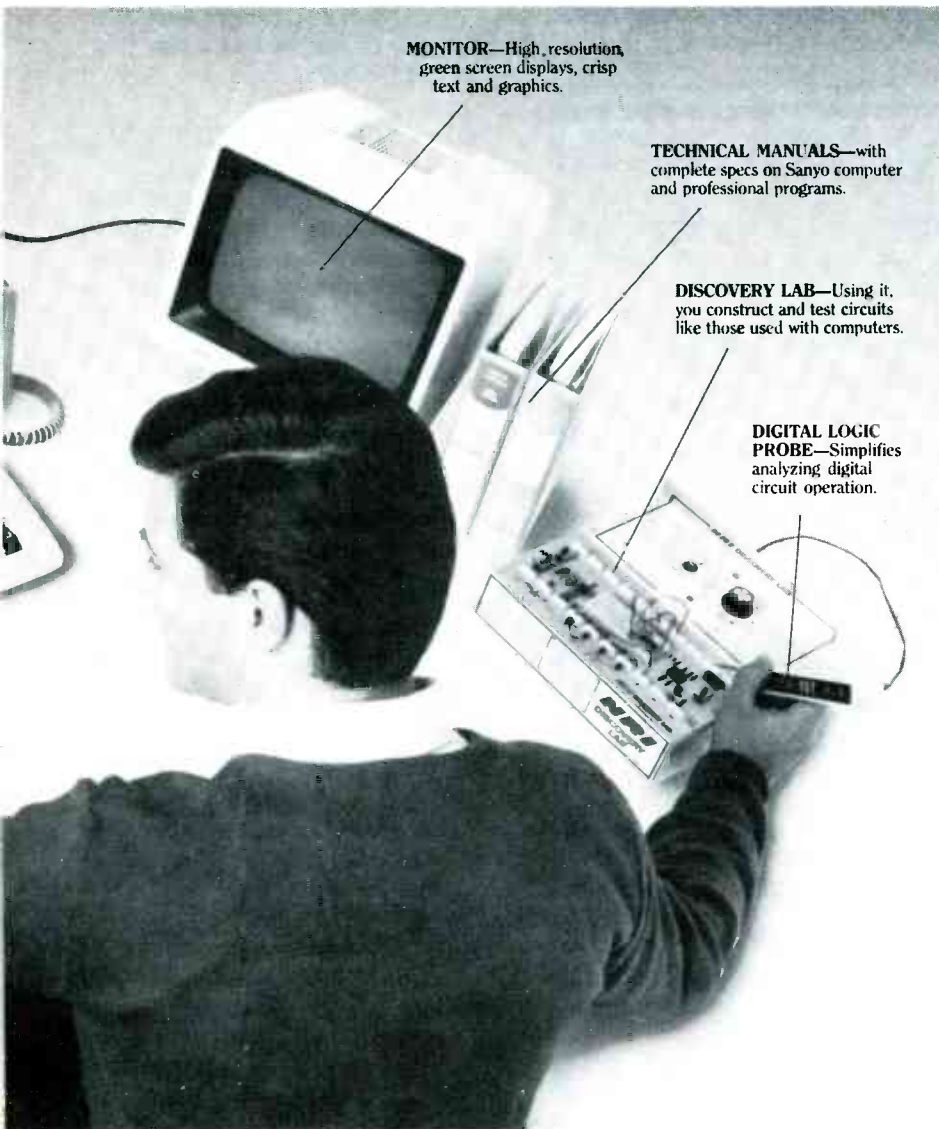

MONITOR—High resolution, green screen displays, crisp text and graphics.

TECHNICAL MANUALS—with complete specs on Sanyo computer and professional programs.

DISCOVERY LAB—Using it, you construct and test circuits like those used with computers.

DIGITAL LOGIC PROBE—Simplifies analyzing digital circuit operation.

at your own convenience, backed at all times by your own NRI instructor and the entire NRI staff of educators and student service support people. They're always ready to give you guidance, follow your progress, and help you over the rough spots to keep you moving toward your goal.

100 page free catalog tells more... send today

Send the postage-paid reply card today for NRI's 100 page catalog that gives all the facts about computer training, plus career training in robotics, data communications, TV/audio/video servicing, and many other fields. If the card is missing, write to NRI at the address below.



Understanding you get only through experience

You need no previous knowledge to succeed with NRI. You start with the basics, rapidly building on the fundamentals of electronics with bite-size lessons. You perform hands-on experiments

with your NRI Discovery Lab and then move on to master advanced concepts like digital logic, microprocessors, and computer memories.

Learn at home in your spare time

You train in your own home

NRI SCHOOLS

McGraw-Hill Continuing Education Center
3939 Wisconsin Avenue
Washington, DC 20016
We'll give you tomorrow



ond before any of the others. At the instant S1 closes, gate current flows through R1, S1, and diodes D2 and D3, so SCR1 conducts. Its anode current flows through indicator lamp LMP1, and the anode voltage falls to around 0.6 volt—the anode-cathode voltage drop across SCR1. That causes D1 to be forward-biased, so it also conducts, dropping point X to 1.2 volts—the sum of the diode-voltage drops across SCR1 and D1.

With point X at 1.2 volts, all the

other circuits are locked out, because when any other pushbutton is pressed, the two series-connected silicon diodes (D5, D6, etc.) are not sufficiently forward-biased to pass the gate current needed to fire the associated SCR. After determining the winning contestant, the umpire resets the board by pushing S3 once to turn off the conducting SCR, and again to restore power.

The indicator lamps should be low-current types—drawing ap-

proximately 60 mA or so. If you use higher current types make sure that their cold resistance (as measured with an ohmmeter) is high enough to limit the initial inrush of lamp current to the maximum surge-current rating of the SCR.

If you need something more elaborate, consider building the "Electronic Umpire" described in the December 1970 issue of **Radio-Electronics**. It handles two teams of three players each, and indicates the order of response for the first four contestants.

★ CABLE TV SPECIALS ★

CONVERTERS

	JRX-3 DIC—6 Channel Corded Remote	\$139. ⁹⁵
	JSX-3 DIC—36 Channel Set Top	\$129. ⁹⁵
	SB-3 — 'The Real Thing'	\$109. ⁹⁵
	SB-M-Refurbished	\$89. ⁹⁵
	DRZ-3D1C—68 Channel Wireless with Decoder	\$199. ⁹⁵
ZENITH:	Z-TAC Cable Add-On.	\$199. ⁹⁵
VIEW STAR:	EVSC-2010—60 Channel Wireless— with Parental Lockout.	\$ 99. ⁹⁵
	EVSC-2010 A-B—Same as above with A-B Switch	\$109. ⁹⁵
	View Star 2501—60 Channel Wireless with Volume	\$119. ⁹⁵
	Unika MR-702—72 Channel Wireless with Parental Lockout.	\$89. ⁹⁵

MISCELLANEOUS

OAK:	N-12 Mini-Code	\$ 89. ⁹⁵
	N-12 Mini-Code Vari-Sync	\$99. ⁹⁵
	N-12 Mini-Code Vari-Sync Plus Auto On-Off . .	\$159. ⁹⁵
JERROLD:	400 & 450 Handheld Transmitters.	\$ 29. ⁹⁵
HAMLIN:	MLD-1200	\$ 99. ⁹⁵
NEW ITEMS:	Ripco Tape Copy Stabilizer	\$109. ⁹⁵
	Scientific Atlanta SA-3.	\$139. ⁹⁵
OAK:	E-13 Mini-Code Substitute	\$ 79. ⁹⁵
	E-13 Mini-Code W/Vari-Syn.	\$ 89. ⁹⁵

ALL UNITS GUARANTEED. QUANTITY PRICES AVAILABLE.

UNITED ELECTRONIC SUPPLY

P.O. BOX 1206 • ELGIN, ILLINOIS 60121 • 312-697-0600

USING AN OPTOELECTRONIC COUPLER

I am trying to design a circuit that uses a Motorola MOC7811 slotted opto-coupler as a sensor, but I can't locate any applications data. Can you help?—B.J.D., Peoria, AZ .

Slotted couplers in that series consist of an infrared-emitting diode and a photodetector facing each other across a slot in the housing, as shown in Fig. 4. The slot provides a means of interrupting the path between the infrared source and its detector.

We don't have any idea as to

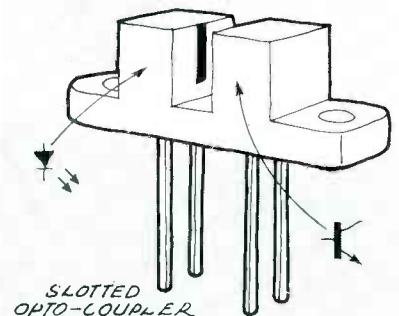

FIG. 4

what you want to accomplish, so your best bet is to seek applications data from Motorola Semiconductors, 616 West 24th St., Phoenix, AZ 85282. For typical circuits and additional applications information, see one or more of the following: *General Electric Optoelectronics Manual*, the *Motorola Optoelectronics Device Data book*, or *The Optoelectronics Data Book for Design Engineers* from Texas Instruments.

WHAT KIND OF RESISTORS

I'm interested in resistors and want information on the differences

between a thermistor, thermister, thyristor, and varistar. I have found some definitions, but they are conflicting. I'm particularly interested in the thermistor because one is used in my oscilloscope's power supply.—B.C., San Diego, CA.

The word "thermistor" is an acronym for Thermally-Sensitive Resistor. A thermistor is a ceramic semiconductor whose resistance varies greatly with changes in its temperature. The change in temperature may be due to internal heating due to current flow, or to heat from an external source. Thermistors are available with either positive or negative temperature coefficients. The NTC (Negative Temperature Coefficient) device is one that exhibits a decrease in resistance with increases in body temperature. A PTC device is one that develops an increase in resistance with an increase in temperature.

"Thermister" is a misspelling or corruption of the correct spelling.

I never heard of a "varistar." Perhaps the word you are looking for

is "varistor"—meaning a two-terminal voltage-sensitive semiconductor whose resistance decreases rapidly as the applied voltage is increased.

A thyristor is a stable (two-state) semiconductor device having three or more junctions. It can be rapidly switched between its *off* and *on* states. The term "thyristor" is often used to include SCR's and gate-controlled switches.

UNLOADED VACUUM-TUBE AMPLIFIERS

I've serviced car stereo and home hi-fi equipment for more than ten years. Occasionally, an old tube-type amplifier is brought in for service. Recently, a new service manager "hit the roof" when he found me working on a vacuum-tube power amplifier when I had not connected a load to its outputs. He says that I could have destroyed the amplifier, but won't explain how or why. What's the problem?—B.F., Mamaroneck, NY.

Solid-state power amplifiers can be run without a load on their out-

puts but can be damaged if a short circuit is inadvertently connected across the output terminals. Conversely, a vacuum-tube power amplifier can be damaged if you "crank up the power" before connecting a speaker or resistor load across the secondary of the output transformer.

Here's what happens: Without a load on the secondary winding, the primary winding appears as a very-high impedance and the audio voltages across it can rise to very-high values. The peak voltages can be high enough to cause arcing in the output tubes or cause a breakdown in the insulation between turns in the primary winding.

Whether the voltage peaks do or don't cause catastrophic tube or transformer failure depends on such factors as the transformer's design and the amplifier's output power. You have been lucky thus far, so follow the service manager's instructions and always keep a load on the output of a vacuum-tube power amplifier. R-E

NEW RUGGEDIZED SCOPE PROBES

Just a phone call away.

\$35 P6103

50 MHz 10x
Compensation Range
15 to 35 pF

\$58 P6109

150 MHz 10x
Compensation Range
18 to 22 pF

These new passive voltage probes can be used with any oscilloscopes having matching compensation ranges.

Screw in tips mean easy repair, no downtime.

To order call toll free **1-800-426-2200**

In Oregon, call collect (503) 627-9000.

VISA and MasterCharge accepted.

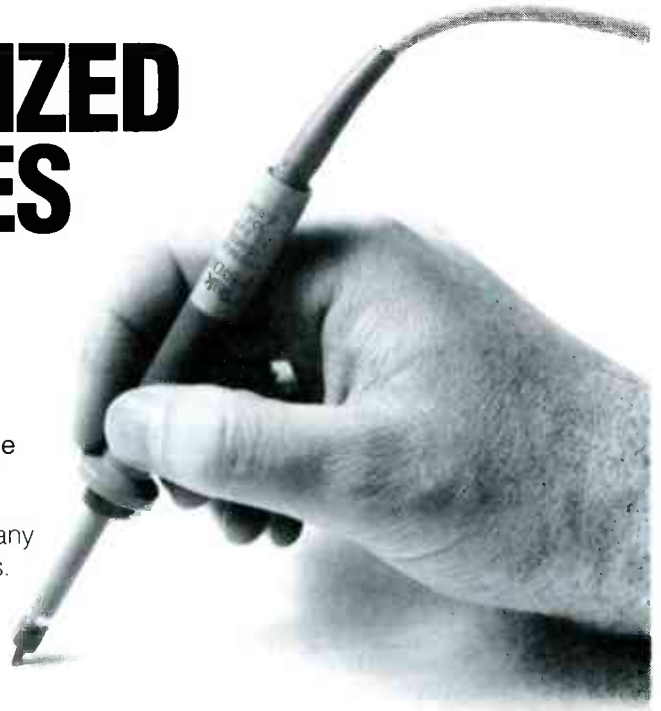

Tektronix
COMMITTED TO EXCELLENCE

LETTERS



ON ARTIFICIAL INTELLIGENCE

I read your article, "Artificial Intelligence," in the May 1987 issue of *Radio-Electronics*, and I was amazed that nothing was mentioned about the following:

Democratic electronic circuits or systems would consist of not only series/serial circuits, but parallel as well. That type of system would also include analog chips and circuits, which convey data based on the degree that a circuit is on—in short, waveforms—and not just based on electronic

switching chips or circuits. Those analog chips would simulate how the neurons work in the brain. They would probably be called *almost* and *almost* chips, or *maybe on* and *not maybe on* chips. Chips and circuits such as those would make it possible for a computer to learn, memorize, and understand, and to relate or think—to *know*.

Interface data bridges would allow the thousands of neuron microprocessors in the computer to have the same data stored in each

one as the entire computer has stored in its memory bank overall. Those would make it possible for the computer to have a holographic memory bank, just as the brain has.

A circuit that performs like an electronic mirror, composed of a simulated *data-constructed model* of reality, would enable a computer to compare incoming data with that data model for analysis and interpretation. Within that index memory bank should be a form of self-consciousness, so that the

Send Purchase Order
 Check, Money Order, or C.O.D.
 or Call Toll Free
800-223-0826
 in N.Y. State (212) 865-5580

#1 IN CABLE BOXES SPECIAL!

JERROLD CORDLESS CABLE TV CONVERTER
 MODEL DRX3-105/400

\$59.95 / 10 UP

\$69.95/1-9

- 58 channels
- Remote channel changing
- Remote on/off switch
- Remote fine tuning
- Compatible with descramblers

JERROLD CORDLESS CABLE TV CONVERTERS
 MODEL STARCOM-460

\$99.95 / 3 UP

\$109.95/1-2

- Volume control
- 68 channels
- Mute control
- Automatic fine tuning
- Instant channel recall
- Programmable to go on at a particular channel and off automatically
- Compatible with descramblers

VOLUME CONTROL

*ADD 5% FOR VISA OR MASTER CARD

JERROLD CORDLESS CABLE TV CONVERTER
 MODEL JRX3-105

\$29.95 / 10 UP

\$39.95/6-9
 \$49.95/1-5

SCIENTIFIC ATLANTA CORDLESS CABLE TV CONVERTER
 MODEL SA-550

\$79.95 / 10 UP

\$89.95/1-9

- 83 channels
- Automatic fine tuning
- parental control
- programable channeling
- compatible with descramblers

NEW!

OMNITRON ELECTRONICS

770 Amsterdam Ave., New York, NY 10025

SHIPPING CHARGES

For Orders	Add
\$25-100	\$6.50
\$100-500	\$8.50
\$500-750	\$10.50
\$750 and up	\$20.00

Write for **FREE CATALOG** 136 page

MASTER CARD VISA

RADIO-ELECTRONICS

Your Career in *ELECTRONICS* or *COMPUTERS*

Add prestige and earning power to your technical career by earning your Associate or Bachelor's Degree in electronics or computers—through independent home study.

No commuting to class. Study at your own pace, while continuing on your present job. Learn from easy-to-understand lessons, with help from your Grantham instructors when you need it.

Grantham College of Engineering is a specialized institution catering to adults who are employed in electronics and allied fields such as computers. These fields are so enormous that opportunity for advancement is always present. Promotions and natural turn-over make desirable positions available to those who are *prepared to move up!*

Put Professional Knowledge and a
COLLEGE DEGREE
in your Technical Career through
HOME STUDY

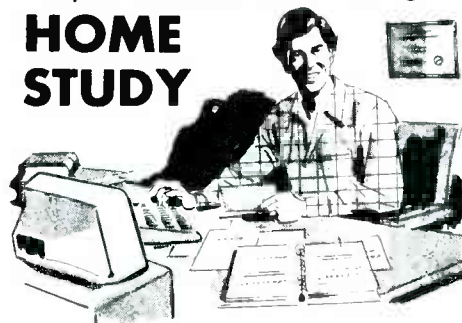

NHSC Accredited

Grantham College of Engineering
10570 Humbolt Street
Los Alamitos, California 90720

Write for our free catalog
(see coupon below) or phone
(213) 493-4423 (no collect calls)
and ask for our "degree catalog."

Grantham offers two B.S. degree programs — one with major emphasis in *ELECTRONICS* and the other with major emphasis in *COMPUTERS*. Either program can be completed by correspondence (also known as "distance education.") An A.S. degree is awarded along the way in each B.S. program, but the B.S. program is not complete without the A.S. part. Our catalog gives complete details.

Now in Our
37th Year

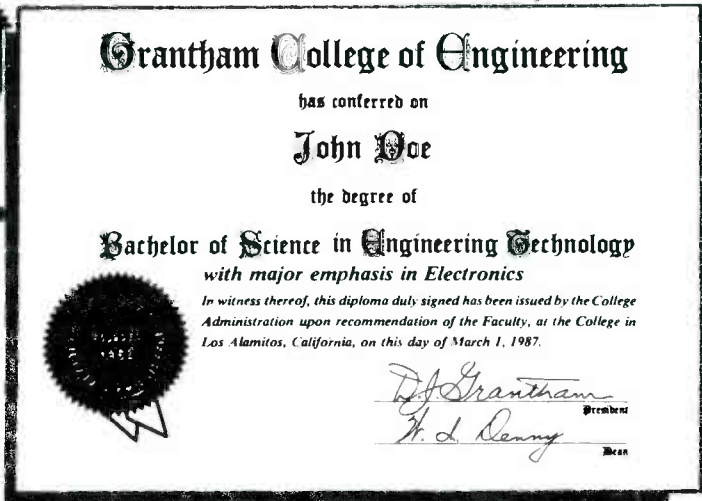
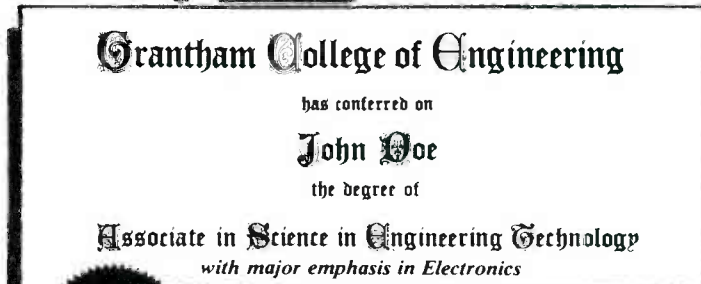
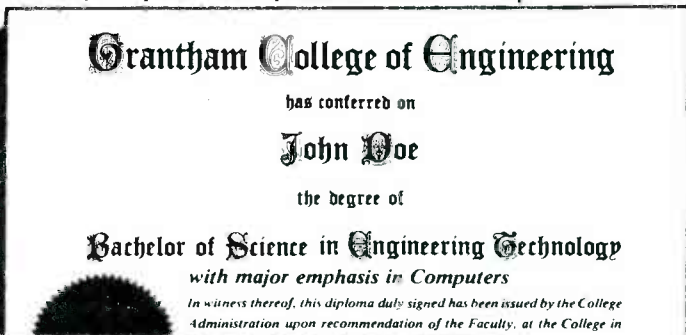
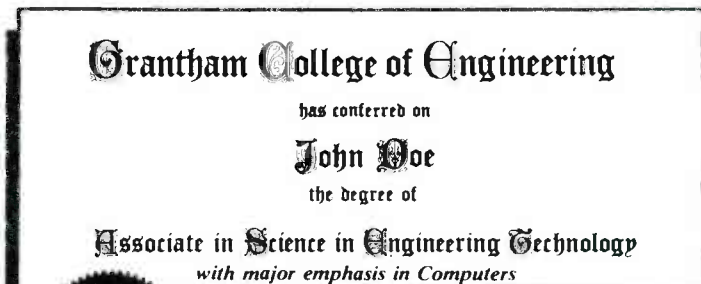

Grantham College of Engineering
P.O. Box 539, Los Alamitos, CA 90720

Please mail me your free catalog which explains your distance-education degree programs.

NAME _____

ADDRESS _____

CITY _____ STATE _____ ZIP _____

R-12-87

Test RS232C In A Zip.

Test RS232C data communications interfaces—like computers to printers, computers to modems, and computers to computers—fast and easy in the palm of your hand with Beckman Industrial's low cost, easy-to-use line of testers. Each is self contained in a Toughpak case, including five models in a durable zippered pouch, and a 10 year warranty on every model. Prices start as low as \$49.95.

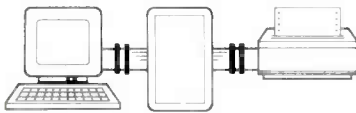

See your nearest Beckman Industrial distributor today, or send for free brochure. We'll send it to you in a zip.

Quick Cable Customizing

Fast RS232C Interfacing and Testing

LED Identification of Cable Configurations

Pocket and Hand-held Compactness

Speeds Up Trouble Shooting

10 Standard, Low-Cost Models



EasyPATCH™ 704

Easy BOB™ 750

**In Service
Instruments,
We're The One.**

Beckman Industrial™

Beckman Industrial Corporation Instrumentation Products Division
A Subsidiary of Emerson Electric Company
3883 Ruffin Rd., San Diego, California 92123-1898
(619) 565-4415 • FAX: (619) 268-0172 • TEL: 249031

© 1987 Beckman Industrial Corporation

computer can know itself better and have an identity. That would allow it to relate itself better to the outside world.

Circuits such as those would enable a computer to mimic the brain realistically. They would be able to modify and re-program themselves relative to outside circumstances and basic built-in programming, for survival and the expansion or evolution of consciousness. The circuits would be flexible and therefore capable of change and growth.

Today's computers are nothing more than inert slave mechanisms—like electronic slide rules, card catalogs, or books. We need computers that have more feedback in them.

HERBERT D. STAFFIERI
Bridgeport, CT

MICRO-FLOPPY RETROFIT

Before I read the article, "Micro-floppy Retrofit," in the August 1987 *Computer Digest*, I converted my XT B: drive to 3½ inch, using the

Toshiba ND-354A with their "Universal Kit." The kit is very inexpensive and complete, with accessories for the PC, XT, AT, Compaq2, AT&T PC6300, and compatibles. Besides costing less than the IBM kit, the Toshiba kit has the advantage of not requiring the IBM's 37-pin D-connector.

My original configuration was one half high 5¼ FDD and one half-height 20-megabyte hard disk. The half height 3½-inch disk drive fits very nicely on top of my A: drive.

I am using PC DOS 3.2, and to format 3½ inch disks at 720K I used the undocumented DOS command called DRIVPARM in my CONFIG.SYS file. The complete command is DRIVEPARM=/D:1/F:2, where /D:1 is the drive number (B:) and /F:2 indicates the 3½-inch drive type.

Having a 3½ inch drive is necessary for me to maintain compatibility with the new IBM computers at work—and it is nice to have 720K floppy storage.

RICHARD F. PELLY
Huntington Beach, CA

AMPLIFIER DESIGN

I enjoy *Radio-Electronics* very much—in fact, I can barely wait for the next issue. I want to thank you for including computer program listings with some of your articles. I find them almost as much fun as the projects.

The article, "Transistor Amplifier Design," by Jack Cunkelman in the August 1987 issue was a great source of information on common emitter amplifiers. Maybe he could do more on common-base and common-collector amps.

Line 280 in the program listing reads:

$$R2 = IZ * RE * 100 / ((RE * 100) - IZ)$$

Two problems were solved when I changed line 280 to read:

$$R2 = INT(IZ * RE * B / ((RE * B) - IZ))$$

First, the formula now considers the "input" value for beta. And I no longer get a negative result for R2 with certain "input" data.

I hope that is useful to other readers, and thanks again.

MICHAEL H. PERKINS
Louisville, KY

continued on page 37

No costly school. No commuting to class. The Original Home-Study course prepares you for the "FCC Commercial Radio-telephone License". This valuable license is your "ticket" to thousands of exciting jobs in Communications, Radio-TV, Microwave, Computers, Radar, Avionics and more! You don't need a college degree to qualify, but you do need an FCC License.

No Need to Quit Your Job or Go To School
This proven course is easy, fast and low cost! **GUARANTEED PASS** - You get your FCC License or money refunded. **Send for FREE facts now. MAIL COUPON TODAY!**

COMMAND PRODUCTIONS
FCC LICENSE TRAINING, Dept 90
P.O. Box 2223, San Francisco, CA 94126
Please rush **FREE** details immediately!

NAME _____
ADDRESS _____
CITY _____ STATE _____ ZIP _____

ONE FOR ALL,



AND ALL FROM ONE.

An extensive line of capacitors for both standard and high voltage applications from NTE Electronics.

NTE, the name you've come to trust for all your replacement semiconductor needs, now has a line of subminiature aluminum electrolytic capacitors.

These quality capacitors are available with both radial and axial leads and are dependable over a broad temperature range. Ratings include capacitance of 0.1 μF to 10000 μF , tolerance of $\pm 20\%$ (-10% to $+50\%$ for the high voltage line), and voltage range of 6.3 to 100 volts (160 to 450 for the high voltage line), making them ideal for the most demanding applications.



LOOK FOR THE FULL LINE OF QUALITY NTE REPLACEMENT PARTS AND PRODUCTS:

- Transistors
- Thyristors
- Integrated Circuits
- Rectifiers and Diodes
- High Voltage Multipliers and Dividers
- Optoelectronic Devices
- Zeners
- Microprocessors and Support Chips
- Memory ICs
- Thermal Cut-Offs
- Bridge Rectifiers
- Unijunctions
- RF Transistors
- Microwave Oven Rectifiers
- Selenium Rectifiers
- Flameproof Resistors
- Wire Ties
- Electrolytic Capacitors
- Static Control Products

For more information or the name of your local distributor, call or write NTE.



NTE ELECTRONICS, INC.

44 Farrand Street, Bloomfield, New Jersey 07003 (Outside N.J.) 1-800-631-1250 • (N.J. only) 1-800-624-2624

CIRCLE 71 ON FREE INFORMATION CARD

Please note: some books count as 2 selections

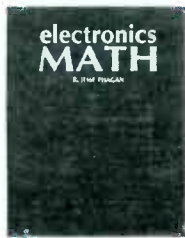

Electronics Math
Pub. Price \$22.95
Club Price \$18.95
Book #7205

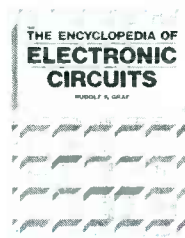

The Encyclopedia of Electronic Circuits
Pub. Price \$50.00
Club Price \$39.95
Book #7014
COUNTS AS 2 SELECTIONS

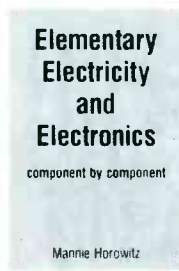

Elementary Electricity and Electronics
component by component
Mannie Horowitz
Pub. Price \$23.95
Club Price \$19.15
Book #7285



Handbook of Computers and Computing
Pub. Price \$77.50
Club Price \$62.35
Book #7072
COUNTS AS 2 SELECTIONS



The Illustrated Dictionary of Microcomputers
Pub. Price \$24.95
Club Price \$19.95
Book #7246

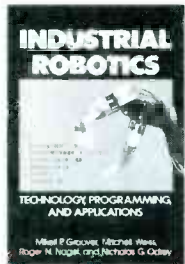

Industrial Robotics
Pub. Price \$43.95
Club Price \$35.15
Book #7211
COUNTS AS 2 SELECTIONS

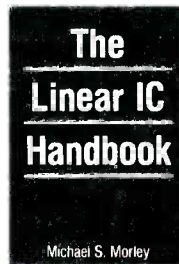

The Linear IC Handbook
Michael S. Morley
Pub. Price \$49.95
Club Price \$39.95
Book #7214
COUNTS AS 2 SELECTIONS



Cost Estimating with Microcomputers
Pub. Price \$29.95
Club Price \$23.95
Book #7037



Digital Telephony and Network Integration
Pub. Price \$44.50
Club Price \$35.95
Book #7204
COUNTS AS 2 SELECTIONS



The Paradox Companion
Pub. Price \$24.95
Club Price \$19.95
Book #7245

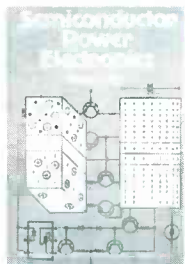

Semiconductor Power Electronics
Pub. Price \$46.95
Club Price \$37.55
Book #7267
COUNTS AS 2 SELECTIONS



Software Engineering Environments
Pub. Price \$38.95
Club Price \$31.15
Book #7247

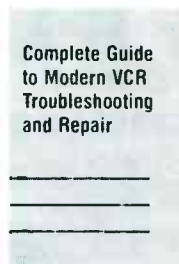

Complete Guide to Modern VCR Troubleshooting and Repair
Pub. Price \$38.33
Club Price \$31.15
Book #2126



Discovering Electronics With Useful Projects and Applications
Pub. Price \$29.95
Club Price \$23.95
Book #4560



Complete TV Servicing Handbook
Pub. Price \$33.00
Club Price \$26.35
Book #7385



The Complete Compact Disc Player
Pub. Price \$33.00
Club Price \$26.35
Book #7389



Troubleshooting Techniques for Microprocessor Controlled Video Equipment
Pub. Price \$24.95
Club Price \$19.95
Book #7599



Electronic Connections
Pub. Price \$28.67
Club Price \$23.15
Book #2808



Handbook of Video Camera Servicing and Troubleshooting Techniques
Pub. Price \$29.95
Club Price \$23.95
Book #4213

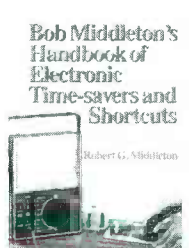

Bob Middleton's Handbook of Electronic Time-savers and Shortcuts
Pub. Price \$29.95
Club Price \$23.95
Book #4595

Until you write them yourself, you won't find better books than these...or a better deal!

Take any 3 books for just \$1.00 each.

Take 1 more at our special Club Price.

Not only will you save as much as \$120.63 off publishers' list prices on 4 of the most popular — and indispensable — technical books in print today... but also fulfill half the usual 2-book purchase obligation — automatically!

Examine your 4 books FREE for 15 days!

EBS is the professional service designed specifically to keep you on top of everything new in electronic theory and application. Every book is reviewed and approved by our Technical Advisory Board. And every month we bring you the kind of information you want — and need — to know in the field of advanced electronics... access to new thoughts on systems design, op amps, TTL, bit-slice microprocessors, circuits, LSI/VLSI, optoelectronics, satellite communications, LANs, linear control, feedback, instrumentation, A/D crossovers and more. Everything it takes to keep you going *and successful* throughout your career!

6 Unbeatable Reasons for Joining Electronics Book Service

1. Our Introductory Offer — 3 books for just \$1.00 each... a 4th at our special Club Price — a savings of as much as \$120.63 off publishers' list prices.

2. Automatic Fulfillment of half the usual 2-book purchase obligation — Once you have selected and paid for your 4 introductory selections, you *automatically* fulfill half of EBS's usual 2-book purchase obligation. Your only obligation is to then purchase 1 additional book — at Member discounts — during the first year of your Membership. You may cancel any time after that.

3. Original publishers' editions — Never cheaply-made reprints.

4. A complete book store by mail — Choose from the best, most popular books in your field — by mail and from the comfort and convenience of your home or office. Here's how it works: Every 3-4 weeks (15 times a year) you'll receive the *Bulletin* describing a new Main Selection and several Alternates. If you want the Main Selection, do nothing. It will be shipped automatically. If you prefer an Alternate — or no

book at all — simply indicate your choice on the order card always provided and return it by the date indicated. You'll always have 10 days to decide whether or not you want a Main Selection.

5. Special Member Discounts — 20% to 30% — and more — off regular list prices. A small shipping and handling charge is added to all orders.

6. The Electronics Book Service Guarantee — You never buy books you don't want. If you ever receive a book that does not live up to your expectations, return it for full credit.



Say YES and
become an electronics
know it all!

Send this coupon today!

Electronics Book Service

A Prentice Hall Book Club

P.O. Box 10621, Des Moines, IA 50380-0621

YES! Please enroll me as a trial Member of Electronic Book Service and send me the 3 books listed below for just \$1.00 each and 1 more book for the special Club Price plus postage and handling and applicable state sales tax. I understand the Membership Plan as described in this ad and that by accepting your offer, I automatically fulfill half the usual 2-book purchase obligation. I agree to then purchase 1 additional book — at Member discounts — during the first year of my Membership. If not completely satisfied with my introductory selections I may return them within 15 days and owe nothing.

Send me these 3 books for
\$1.00 each:

Book # _____

Book # _____

Book # _____

PLUS... Send me this book at
the special Club Price

Book # _____

(Please note that some books count
as 2 selections)

Name _____

Address _____

City/State/Zip _____

Signature _____

(not valid without signature)

Offer good for new Members only in the continental US and Canada.

All applications subject to credit approval.

87T51

ELECTRONIC COMPONENTS CATALOG

... yours **FREE**
by dialing

1-800-992-9943

In Texas: 817/483-4422

Call Today for your **FREE** subscription to the 1988 Mouser Electronics Catalog. Contains 176 pages featuring over 16,000 in-stock, quality electronic components.

..PLUS..Mouser's proven service and prompt delivery.
(Outside U.S.A., Send \$2.)

MOUSER ELECTRONICS



MOUSER ELECTRONICS

2401 Hwy 287 North
Mansfield, Texas 76063

DISTRIBUTION CENTERS NATIONWIDE

CIRCLE 117 ON FREE INFORMATION CARD

CABLE-TV



signal remover
50dB NOTCH FILTER

Any* signal coming in on your cable can be completely "removed" with this powerful filter. Particularly useful on "pay" channels. Also can be used to eliminate any* over-the-air signal which prevents normal reception. The filter's external adjustments allow precise tuning to any frequency required.

*AVAILABLE FOR THE FOLLOWING CHANNELS:

- MODEL 26 - For any channel between 2 and 6 (Tuning range 54 - 108 Mhz)
- MODEL 713 - For any channel between 7 and 13 (Tuning range 174 - 216 Mhz)
- MODEL 1422 -For any channel between 14(A) and 22(I) (Tuning range 120 - 174 Mhz)

★★ ONLY \$30 EACH ★★ 30 DAY FREE TRIAL ★★
To order, send \$30 check or money order. Specify Model. If not completely satisfied, simply return within 30 days for a full and speedy refund.

- ★ All models in stock
- ★ One year warranty
- ★ Fast, free delivery
- ★ Quantity discounts to 50%

STAR CIRCUITS/DEPT. 1-R
P.O. BOX 8332, PEMBROKE PINES, FL 33084

NEW PRODUCTS



CIRCLE 10 ON FREE INFORMATION CARD

FM DUAL-BAND TRANSCEIVER. The Kenwood *TW-4100A* is rated for 45 watts on 2 meters and 35 watts on 70 cm. It features selectable full-duplex cross-band ("telephone-style") operation. Cross-band repeater operation is also possible. (A control operator is needed for repeater operation.) In addition, there are programmable band scan and memory scan with

memory-channel lock-out features.

The model *TW-4100A* is 5.9 x 1.97 x 7.87" and weighs less than four pounds. Frequency coverage is 142-149 MHz (allows operation on certain MARS and CAP frequencies), and 440-449.995 MHz. The suggested price is \$649.95. —Kenwood, 2201 E. Dominguez Street, Long Beach, CA 90810.

DIGITAL MULTIMETER. The Beckman *DM71* is a handheld pen-type meter that features a 3½-digit display with 0.7% accuracy (2-mV DC range) and auto-ranging; it fits easily into a shirt pocket.

The meter has been designed for ease of use, having a rotary function dial instead of the usual combination-pushbutton operation. A DATA HOLD function allows

the user to manually freeze the display so that it can be read without rushing, or under better lighting conditions. The unit features a 90-hour battery life.

The model *DM71* has a suggested retail price of \$49.94.—Beckman Industrial Corporation, 3883 Ruffin Road, San Diego, CA 92123-1898.



CIRCLE 11 ON FREE INFORMATION CARD

SWITCH MODULE. The Tec *SNAP-TEC* is a new approach to mounting data-entry switches directly onto a printed-circuit board without the need for soldering.

Designed for low- to medium-speed switching applications, the *SNAP-TEC* uses a stainless-steel snap-dome mounted in a plastic housing along with a plastic key-cap/actuator. The switch module snaps into two holes in a .062-inch

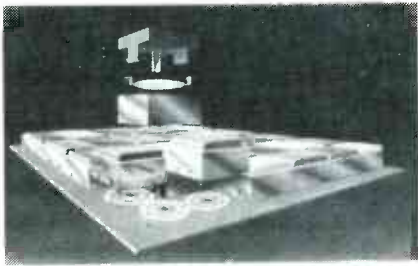

CIRCLE 12 ON FREE INFORMATION CARD

PC board directly over mating contact circuitry.

Available in a variety of colors and keycap styles, the *SNAP-TEC* can be mounted on .500-inch centers. Custom-designed keycaps are also available. Actuation force is 220 grams with a 0.015-inch nominal travel. The price per unit is under \$0.30 each when purchased in quantities of 1000.—**Tec, Incorporated**, 2727 North Fairview Avenue, P.O. Box 5646, Tucson, AZ 85703.

CABLE TIES. Two new cable ties from Panduit, the *PAN-TY* (shown) and the *STA-STRAP*, are double-loop ties whose bent tips provide faster orientation.

Both types are made of natural 6/6 nylon (white), which is U.L. 94-V2 self-extinguishable. They are also available in heat-stabilized nylon (black) and weather resistant outdoor nylon (black). Temperature ranges are -40°F to $+221^{\circ}\text{F}$ for heat-stabilized materials and -40°F to $+185^{\circ}\text{F}$ for the other two materials.

PAN-TY double-loop cable ties are one-piece construction; two sizes are available for up to a maximum combined bundle diameter of 3.8". They have a minimum loop tensile strength of 50 pounds. Prices, which depend on size, start at \$10 per 100.

STA-STRAP double-loop cable ties have a two-piece design, which allows the first loop to be

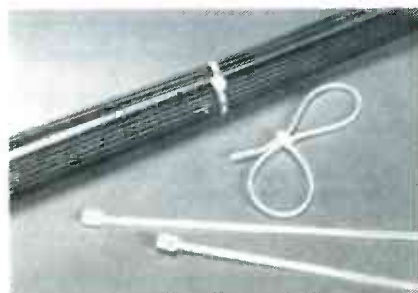

CIRCLE 13 ON FREE INFORMATION CARD

released prior to final tensioning. That design has zero insertion force and can be hand-installed only. Maximum combined bundle diameter is 1.25"; minimum loop tensile strength is 30 pounds. Pricing depends on size. —**Panduit Corp.**, 17301 Ridgeland Avenue, Tinley Park, IL 60477-0981.

DEDICATED ADAPTER. The Program Automation *Surface Mount Adapter*, for Data I/O's 120/121A programmers, can program 10 de-

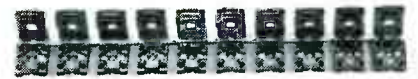

CIRCLE 14 ON FREE INFORMATION CARD

vices at a time on the upper and/or lower 10 sockets of the programmer, and uses all standard programmer instructions and readouts. For added throughput, two adapters can be used to program 20 devices at a time:

Immediate Delivery

FLUKE

DMM's at SALE PRICES!

3 1/2 DIGIT 3200 COUNT ANALOG/DIGITAL MULTIMETERS

Model 73
Value Leader-World's Most Popular DMM-Autoranging
\$69 reg. \$79

Model 75
Autoranging + Range Hold Audible Continuity Function
\$95 reg. \$109

Model 77
Touch-Hold Feature + Features of Model 75
\$125 reg. \$145

Model 37
Bench/Portable, 0.1 VDC Accuracy 10 A, Range 2 yr. Warranty
\$199 reg. \$229

4 1/2 DIGIT TRUE RMS HAND HELD

Model 8060A
Measures True RMS AC Volts & Amps, dB + Frequency From 12 Hz to 200 kHz, Resistance to 300 M
\$315 reg. \$359

Model 8062A
Same as 8060A, but Less Frequency & dB
\$265 reg. \$295

40th Year Anniversary Sale



3 YEAR WARRANTY

Model 77

Model 8021B

Model 8060A
1 YEAR WARRANTY

3 1/2 DIGIT HIGH-ACCURACY HAND HELD

Model 8021B
0.25% DC Accuracy, Audible Continuity Function
\$149 reg. \$169

Model 8020B
0.1% DC Accuracy, Audible Continuity & Conductance Function
\$175 reg. \$199

Model 8024B
0.1% DC Accuracy, 11 Functions Peak Hold, Temperature
\$219 reg. \$249

Model 8026B
0.1% DC Accuracy True RMS AC Volts & Current
\$195 reg. \$219

TRUE RMS BENCH DMMs 1 YEAR WARRANTY

Model 8010A
3 1/2 Digit 10 AMP Range
\$255 reg. \$289

Model 8010A-01
With Rechargeable Battery
\$295 reg. \$329

Model 8012A
3 1/2 Digit Two Low Ranges
\$319 reg. \$359

Model 8012A-01
With Rechargeable Battery
\$355 reg. \$399

Model 8050A
4 1/2 Digit Relative Ref. Function 0.03% DC Accuracy
\$355 reg. \$399

Model 8050A-01
With Rechargeable Battery
\$389 reg. \$439

*True RMS AC TO 50/ kHz
*Conductance Function Checks High Resistance

FREE SHIPPING!
FREE SHIPPING ON FLUKE TO UPS SHIPPABLE DESTINATION.

Send for FREE 480 page "Industrial Products Catalog". I understand it is FREE with any order or if requested on company letterhead. (Otherwise, \$4.95 to cover catalog and shipping costs.)

ORDER TOLL FREE
1-800-323-5925
IN ILLINOIS
312-297-4200
SINCE 1947

Joseph Electronics



JOSEPH ELECTRONICS, INC.
8830 N. Milwaukee Ave. Dept. R
Niles, IL 60648

Rush merchandise per attached order. I understand rated accounts are shipped open account; otherwise send per credit card.
 Visa Master Card Discover
 Check Money Order Rush Catalog
Card No. _____ Exp. Date _____

Name _____
Company _____
Street Address _____
City _____ State _____ Zip _____

IL Res. 7% Tax

CONNECTION PROTECTION

SWITCHES & RELAYS
EDGE CONNECTORS
PLUGS & SOCKETS
POTENTIOMETERS
CONNECTING CABLES
TERMINAL STRIPS
GOLD PLATED CONNECTORS
BATTERY CONTACTS



CRAMOLIN®

Even the finest equipment in the world cannot guarantee noise-free operation. One "dirty" connection anywhere in the electrical path can cause unwanted noise or signal loss.

"MORE THAN A CONTACT CLEANER"

CRAMOLIN® is a fast-acting, anti-oxidizing lubricant that cleans and preserves all metal surfaces, including gold.

When applied to metal contacts and connectors, **CRAMOLIN®** removes resistive oxides as it forms a protective molecular layer that adheres to the metal surfaces and maintains maximum electrical conductivity.

CRAMOLIN® - USED BY THOSE WHO DEMAND THE BEST:

Bell & Howell	Hewlett Packard	MCI(Sony)	Nakamichi
Boeing	John Fluke Mfg.	Motorola	RCA
Capitol Records	McIntosh Labs	NASA	Switchcraft

SINCE 1956

CAIG LABORATORIES INC

1175-O Industrial Ave., (P.O. Box J) - Escondido, CA 92025-0051 U.S.A. • (619) 743-7143

CIRCLE 50 ON FREE INFORMATION CARD

Features include: easy drop-in lock-in adapter; pop-out ejector after programming; vertical sockets for ease of handling and insertion; sockets designed to meet manufacturer's specs and ensure coplanarity; small footprint for ease of handling.

The *Surface Mount Adapter* can be used for production planning of OTP PLCC EPROMs, for incoming inspection of preprogrammed parts, and in a maintenance environment for checking questionable parts. It is priced at \$2000.00—**Program Automation, Inc.**, 22706 Aspan, Suite 308, El Toro, CA 92630.

PRECISION ALIGNMENT KIT. The Jensen Y23B840 kit contains a selection of precision tools that are manufactured to extremely fine tolerances and are designed for adjustments of VHS and Beta video-cassette recorders.

The kit includes a base-plate reference jig and a height gauge (used for precision height adjustment of the reel discs, guide posts, *continued on page 38*

NRI's At-Home Training in Electronic Design Technology Can Put You in a High-Paying Career as an In-Demand Design Technician

The best jobs in electronics today go to the people who have the skills to think and work creatively. Conceive and design circuits and equipment. Initiate ideas and carry them through. Now NRI can help you be one of these people—design technicians who command up to \$22,000 as starting salaries, earn \$35,000 or more with experience.

NRI's Electronic Design Technology course starts you with the fundamentals and builds from there to prepare you for an electronics career with real growth potential!

No Previous Experience Necessary

Even if you've never had any previous training in

electronics, you can succeed with NRI training. You start with the basics, then rapidly build on them to master advanced electronics concepts.

NRI Circuit Designer Gives You Invaluable Hands-On Experience

The heart of your lab training is the exclusive NRI Circuit Designer you build. It's a totally unique instrument with full breadboarding capability, built-in multiple power supplies, and a multifunction signal generator for circuit testing. Fast, simple connections let you create prototype circuits, immediately check them out for function or faults. Your Circuit Designer will handle both linear and digital integrated circuits as well as discrete components such as transistors and diodes.

Send for FREE Catalog

Send the coupon today for NRI's free catalog that gives you all the details about the Electronic Design Technology course. If the coupon is missing, please write to



NRI School of Electronics, 3939 Wisconsin Avenue, Washington, DC 20016.

Send coupon today for free NRI catalog.

NRI SCHOOL OF ELECTRONICS

McGraw-Hill Continuing Education Center
3939 Wisconsin Ave. Washington, D.C. 20016

Please send information about NRI training in Electronic Design Technology.

Name _____ (Please Print) _____ Age _____

Address _____

City/State/Zip _____ 10-127

Your hands on training includes all this: the unique NRI Circuit Designer, a solderless breadboarding system you build and use for circuit design, prototype construction, component evaluation, and testing... the NRI Model 2500 10 MHz triggered sweep oscilloscope, invaluable in electronic trouble shooting... a TI-30 calculator for fast, accurate computations... and 3 1/2 digit, hand-held digital multimeter you learn to use as professionals do to perform electronic tests and measurements.



EQUIPMENT REPORTS

Mark V SM-328 Professional Color Light Controller

*Control your lights for
excitement*

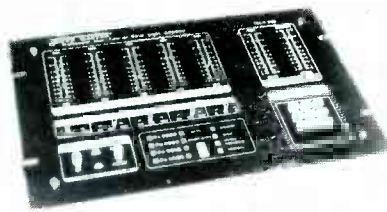

CIRCLE 20 ON FREE INFORMATION CARD

IF YOU ARE A PROFESSIONAL DJ—OR IF you just want to pretend you are—you'll be interested in the SM-328 professional light controller from Mark V Electronics, Inc. (248 E. Main Street, Suite 100, Alhambra, CA 91801). The SM-328 can be used for dance-hall lighting, to add chasing lights to advertising dis-

plays, or just to add a new dimension to your parties. The 4-channel controller is a distant relative of the color organs you might remember from the 1960's. It has a power output of better than 1000 watts per channel, so it can be used to control more than forty 100-watt spotlights or more

than 800 5-watt bulbs! But whatever lighting array you choose, there are three main ways that the SM-328 can control it: It can run its own chaser programs, it can control the lights based on an external audio signal, or it can use a combination of the input signal and the chaser program.

Chaser programs

The SM-328 can run four chaser programs, which can be used for dramatic displays of chasing lights. The first program lights each channel in sequence, with one channel active at a time. The second program does the opposite. It darkens each channel in sequence, while the other three channels appear lighted. The third

HAMEG

Instruments

HM 205-2
the new Digital Storage Oscilloscope
with 5 MHz sampling rate and 2 x 1024 / 8 bit storage
realtime bandwidth DC-20 MHz **\$888.00**

HM 8148
the new intelligent Graphic Printer
firmware for time, date, interval, linear interpolation
zooming function **\$788.00**

DSO Software
with 13 programs
incl. IEEE BUS card **\$480.00**

call toll free
(800) 247-1241
HAMEG, Inc.
88-90 Harbor Road · Port Washington, N.Y. 11050
Phone (516) 883-3837 · Telex (023) 497.4606

CIRCLE 62 ON FREE INFORMATION CARD

Test VCR Mechanics Fast and Easy!

Take the guesswork and hassles out of VCR
mechanical problem diagnosis!

Four Universal, Powerful Tools for VCR Service

Tape Tension Gauge: The Tentelometer® is the world's most universal method of measuring hold back tension. Calibration can easily be checked in the "field". Merely slide the probes over tape to measure tape tension directly in grams. Illustrated instruction manual included. This is the back tension gauge referenced by many of the VCR service manuals, and it will work on all VCRs.

T2-H7-UM \$295



Video Head Protrusion Gauge: Universal, fast, safe method of measuring the amount of video head tip wear. Measures in microns and ten-thousandths of an inch. Allows accurate predictions of remaining head life. Head wear provides useful information regarding VCR condition and wear on other components. Stop guessing about head wear. Accessory "S1" stand allows use on any VCR.

HPG-1 \$479 S1 \$95



Spindle/Elevator Gauge: The TSH gauge inserts into the VCR just like a cassette. The new TSH-V5 performs 6 critical measurements to eliminate tape binding and edge damage. This gauge quickly locates problems that can't even be detected by other methods. Fully illustrated instruction manual is included.

TSH-V5 for VHS: \$395

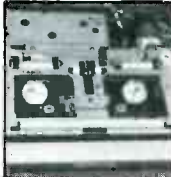

Torque Gauge: A universal, inexpensive, accurate torque gauge for VHS and Beta VCRs. Calibrated in Gram-Centimeters both clockwise and counterclockwise. Complete with easy-to-follow, detailed instruction manual for VHS recorders. Includes a modified VHS cassette for ease-of-use.

Complete System
TQ-600 \$139



Tentel® provides the most powerful, easy-to-use, field calibrateable, universal VCR test equipment available for various mechanical tests. Call our application engineers today for answers to your questions. Ask about the combination discount when ordering all 4 gauges.

Tentel Corp.

1506 Dell Avenue
Campbell, CA 95008

(800) 538-6894
(408) 379-1881
in California

CIRCLE 198 ON FREE INFORMATION CARD

program lights two channels at a time and alternates back and forth between them. Finally, the fourth program also lights two channels at a time, but in a sequence of 1-2, 2-3, 3-4, 4-1. The speed of the chasing is controlled by a lighted slide potentiometer.

The chaser program and its operating modes are selected via a 9-button keypad. For example, an AUTO control mode can be selected to automatically vary the time that each channel remains lighted; or, a slide potentiometer can be used to manually control the on-off timing. The direction of the chase is also controlled from the keypad.

Music control

By connecting the SM-328 in parallel with one of your loudspeakers, you can use the audio signal fed to the speaker as the controlling source for the lights. The actual audio level is unimportant because the SM-328 will accept signals ranging from 100 millivolts to 28 volts (or a maximum of 100 watts of audio power). Since the SM-328 has a high impedance (bridging) input it has no effect on either the speaker or its associated amplifier.

A MASTER LEVEL control allows the user to adjust the overall brightness of the lamps in proportion to the volume of the music input. Alternately, the user can create unusual or customized lighting effects, even "ride gain" on the effects, because each channel has its own level control—a lighted slide control.

The output of each channel's level control feeds an op-amp filter that determines the channel's frequency response. One channel responds to treble frequencies, one to midrange frequencies, and two channels respond equally to bass frequencies. The op-amps, in turn, control optically-coupled Triacs. In addition to a level control, each channel features a three-position slide switch that can be used to instantaneously dim or cut the light.

Some of the most interesting and eye-catching lighting displays can be obtained by using a music signal to control the execution of the light-chaser programs.

SUPER LONG PLAY TAPE RECORDERS

10 Hour Model — \$95.00*
14 Hour Model — \$159.00*

Modified Panasonic Slimline. high quality, AC-DC Recorders provide 5 or 7 continuous hours of quality recording & playback on each side of cassette for a total of 10 or 14 hours depending on model. Built-in features include • Voice level control. • Digital counter, etc. TDK DC 180 Cassette Furnished.

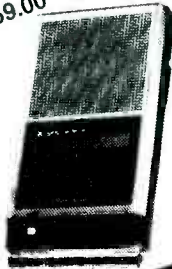

PHONE RECORDING ADAPTER

Records calls automatically. All Solid state connects to your telephone jack and tape recorder. Starts recording when phone is lifted. Stops when you hang up.

\$24.50*
FCC APPROVED

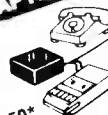

VOX VOICE ACTIVATED CONTROL SWITCH

Solid state. Self contained. Adjustable sensitivity. Voices or other sounds automatically activate and control recorder. Uses either recorder or remote mike.

\$24.95*



*Add for ship & hdig. Phone Adapter & Vox \$1.50 ea. Recorders \$4.00 ea. Cal. Res. add tax. Mail order. VISA, M/C, COD'S OK. Money Back Guarantee. Qty. disc. avail., Dealer Inquiries invited. Free data. ©
AMC SALES, Dept. A, 9335 Lubec St., Box 928, Downey, CA (213) 90241 Phone 869-8519

CIRCLE 108 ON FREE INFORMATION CARD

ATTENTION! ELECTRONICS TECHNICIANS

EARN YOUR
**B.S.E.E.
DEGREE**



THROUGH HOME STUDY

Our New and Highly Effective Advanced-Placement Program for experienced Electronic Technicians grants credit for previous Schooling and Professional Experience, and can greatly reduce the time required to complete Program and reach graduation. No residence schooling required for qualified Electronic Technicians. Through this Special Program you can pull all of the loose ends of your electronics background together and earn your B.S.E.E. Degree. Upgrade your status and pay to the Engineering Level. Advance Rapidly! Many finish in 12 months or less. Students and graduates in all 50 States and throughout the World. Established Over 40 Years! Write for free Descriptive Literature.

COOK'S INSTITUTE OF ELECTRONICS ENGINEERING



347 RAYMOND ROAD
P.O. BOX 20345
JACKSON, MISSISSIPPI 39209

CIRCLE 189 ON FREE INFORMATION CARD

Good layout

The front panel is specifically designed to be used in dim lighting—even in virtual darkness. For example, only those potentiometers that can be used in a given mode are lighted in that mode. Also, the brightness of the level-control potentiometers changes with the music signal in its channel. But while the LED's that illuminate the potentiometers can be used for quick set-up adjustments, they aren't adequate for use as an overall lighting guide; for *precise* lighting control it's still necessary to view the actual lights.

We found the keypad switches difficult to use. Their tactile feedback was very poor, and the keys did not always do what they were supposed to. However, we were able to clear up the problem by disassembling the case and cleaning the switch contacts. Other than the keypad, the SM-238 is solidly constructed, and its solid metal 14-inch rack-mount case can take a good amount of abuse. The controller carries a suggested list price of \$150. **R-E**

etc.).

Fortunately, there is a simple solution to the wide-bandwidth-noise problem in advanced SCA receivers: reduce the lock range by connecting a 25K potentiometer between pins 6 and 7 of the 565. While some people will enjoy having direct control of the bandwidth from the "front panel," it turns out that simply shorting pins 6 and 7 (minimum lock range) gives acceptable results.

I have one more suggestion: substituting a 470-pF capacitor for C43 and a 4.7K resistor for R55 will give the 10K potentiometer (R72) sufficient range to tune both the 92-kHz and the 67-kHz SCA sub-carriers.

The above discussion notwithstanding, designing an SCA receiver with the Signetics 565 is much more straightforward than with Exar's XR2211. But I did find the reward—a portable receiver that works from a single supply of 4.7-6 Volts—to be worth the effort of using Exar's model.

GIL ROBERTS
Duarte, CA

LETTERS

continued from page 26

SCA RECEIVER

I'm glad to see that **Radio-Electronics** is showing an interest in FM subcarriers, with "Build This SCA Receiver" in the August 1987 issue. The authors mention that SCA is inherently "noisy." However, with the Signetics' 565 PLL (whose basic design the authors follow) most of the noise is due to the unnecessarily wide bandwidth inherent in the SCA receiver design published in the Signetics' application notes.

Ironically, that wide-bandwidth noise shows up mostly in more advanced SCA receivers, such as the one featured in **Radio-Electronics**, that amplify the signal before input to the PLL. Below 100 mV, the lock range (thus, the capture range as well) decreases with decreasing input voltage. Therefore, a simple receiver accepting a weak SCA signal of 10-20 mV has build-in bandwidth limiting. In general, however, increased input voltage will improve the 565's demodulation characteristics (AM reception,

Need Quick Turnaround on CRYSTALS?

Try Our E.O.D.
(Emergency Order Dept.)

and get

JAN QUALITY
and STABILITY
PLUS Low Prices!

You benefit from 21 years of manufacturing quality crystals for industry, military services, radio amateurs, citizen band and experimenters.

To Get Free Catalog
Call or Write

JAN CRYSTALS
P.O. Box 06017
Ft. Myers, FL 33906
(813) 936-2397

CALL 1-800-237-3063
FREE (Except Florida)

CIRCLE 104 ON FREE INFORMATION CARD

Performance Tools.

Our AR-130A is always ready—thanks to intelligent Auto-Power-Off circuitry.

- Ideal multi-purpose meter.
- 20 Amp AC/DC capability
- Transistor hFE measurement
- Gold plated PC board reliability



AR-130A

Our AR-170 NL sets new standards—

- in telecommunications & audio equipment testing.
- Direct dBm reading (600 ohms) of systems noise level measurement
- True RMS AC measurement
- High accuracy: 20 mV, 20 μ A and 20 ohm range
- .1% DC accuracy



AR-170 NL

Our AR-460 D is an advanced LCR meter

rivaling bench instruments in both accuracy and cost—

- Directly measures "dissipation"...leakage in a capacitor and Q in an inductor
- Ideal for QA and engineering labs
- Inductance to 2H, capacitance to 200 μ F, resistance to 20 Mega Ohms



AR-460D

THE American Reliance line of Test and Measurement Equipment has been getting the job done all over the world for nearly a decade. For the location of a distributor in your area, call us for more information.

800-654-9838

American Reliance Inc., 9241 E. Valley Blvd.
Rosemead, CA 91770 • FAX: (818) 287-8855

ARI/VALUE BEYOND MEASURE



CIRCLE 195 ON FREE INFORMATION CARD

AMERICAN RELIANCE INC.

87" HI-TECH SALE

Cobra Stun Gun generates 45,000 volts of stopping power, the Cobra also delivers a burst of high intensity light directly into an attacker's eyes. Chances are that his optic nerves will be so overloaded with excess light energy that he will not be able to see you let alone continue the attack. If he does, the Cobra delivers its painful bite, leaving him dazed and confused. \$49.95. With NiCad battery & charging kit \$59.95 + \$3.74 shp.

Centron Security Light

The Centron security light puts unwelcome visitors in the spotlight... instantly! This smart lighting system's infrared sensors guard your yard or driveway when you're away or home alone. It senses the presence of people or cars by changes in temperature patterns and instantly floods the area with bright light. It guides your guest to your door and scares away would-be prowlers \$55.00 plus \$4.99 shipping.



Remote Control Pen.

Not only is it a hand-some high quality ball point writing pen, but a powerful remote-control device. Effective at distances up to 75 yds, the Remote Control Pen is perfect for turning on or off any 120 volt appliance or alarm system. Think of the possibilities. \$39.00 shipping \$3.74.



The Private Eye Motion Detector.

Alarm warns you to the presence of an intruder but the intruder doesn't know he has been detected. No wires just plug it in and it works. Information travels from the detector to the receiver via the electrical system. \$63.00 shipping \$5.40



World's smallest dialer \$49.95 Alcohol Breath Analyzer \$59.00
Levigator \$79.95 Telemonitor 2000 \$175.00
Pistol Cross Bow \$59.95 Remote Car starter..... \$225.00

****All products ready to use and Guaranteed****
ORDERS CALL TOLL FREE 1-800-624-1150 For information or free catalog call 402-554-0383 or write. Order by December 16th and we guarantee delivery by the 24th
United Imports & U.S. Mfg. M.C. VISA A.X.
6846 Pacific St. Omaha, Nebraska 68106

CIRCLE 53 ON FREE INFORMATION CARD

NEW PRODUCTS

continued from page 34

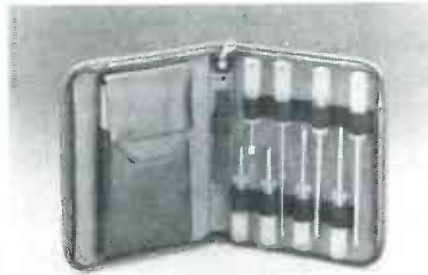

CIRCLE 15 ON FREE INFORMATION CARD

tape transport, pinch wheel audio, synchronization, and erase heads), and an eight-piece driver/wrench set with precisely configured bits for adjusting the tape-feed guide, tape-tension heads, tape transport, audio, and control heads.

The tools are furnished in a padded, vinyl zipper case having elastic straps to hold the drivers and the height gauge. A velcro-closure pouch holds the base-plate reference jig. Case size is 10 × 8 × 1½".

The kit is priced at \$169.00—Jensen Tools, Inc., 7815 S. 46th St., Phoenix, AZ 85044.

PORTABLE OSCILLOSCOPE. The Tektronix 2225 is a 50-MHz scope, and comes with a library of support material that includes a demonstration video tape, a full-color



CIRCLE 16 ON FREE INFORMATION CARD

brochure, a 36-page primer (*The XYZ's of Using a Scope*) and five technical briefs on oscilloscope measurements.

Viewers of the video tape will see demonstrations of the model 2225's dual-channel operation, alternate horizontal magnification, 500-microvolt sensitivity, and extensive triggering features. The

Fluke breaks the old mold.



Dollar for dollar the Fluke 37 breaks into the market with more features for the money than any other bench DMM. It's bold new design includes built-in handle and storage compartment, and it has all the high performance features of the world's best, most reliable 3½-digit DMMs.

Autorangeing, to eliminate guesswork. Audible Continuity, so you don't have to look at the display. An exclusive analog and digital display. Superior EMI shielding. Plus a two-year warranty.

And, how many other bench/portable meters give you these features? Min-Max recording, for monitoring signals. 38 components dedicated exclusively to input protection. Relative mode, to help you calculate changes in readings. And Fluke's patented Touch Hold, to give you an extra set of hands when you're taking critical measurements.

None. Only the Fluke 37.

For more information call 1-800-426-0361.



© 1986, Fluke

CIRCLE 121 ON FREE INFORMATION CARD

primer provides a study guide that expands on all aspects of the scope's operation and use. The technical briefs provide further details on specific measurement methods—period, frequency, phase, risetime, amplitude, etc.

The model 2225 is priced at \$995.00.—Tektronix, P.O. Box 500, Beaverton, OR 97077.

RATCHET TOOL SET. Electronic Technology Today's Cuecraft 716 consists of a reversing and locking ratchet handle having an integral 1/4-inch socket wrench/driver-holder and a fingertip shaft-spinner, number 1 and 2 Phillips-head drivers, 1/16" and 1/4" flat-blade drivers,



CIRCLE 18 ON FREE INFORMATION CARD

and two Torx drivers in sizes that are commonly used in automobiles and appliances. A 2 3/8-inch handle extension is also provided for the times when you need a little extra reach or torque.

The set also includes 1/16" and 3/32" flat-blade screwdrivers for miniature screws, and a fingertip slide-knife. All parts fit inside a form-fitted, foam-lined 4 5/8" x 3 5/16" x 1 7/16" hard-plastic travel case.

Price is \$12 postpaid. New York residents must add appropriate sales tax.—Electronic Technology Today, Inc., P.O. Box 240, Massapequa Park, NY 11762-0240



Walk "Tough Dog" Troubles Out Of Any TV & VCR In Half The Time . . . Guaranteed!



with the exclusive, patented
VA62 Universal Video Analyzer™ . . . \$3,495

Would you like to . . .

Reduce your analyzing time? Isolate any problem to one stage in any TV or VCR in minutes, without breaking a circuit connection, using the tried and proven signal substitution method of troubleshooting.

Cut costly callbacks and increase customer referrals by completely performance testing TVs and VCRs before they leave your shop? Own the only analyzer that equips you to check all standard and cable channels with digital accuracy. Check complete, RF, IF, video and chroma response of any chassis in minutes without taking the back off the receiver or removing chassis, plus set traps dynamically and easily right on the CRT.

Reduce costly inventory from stocking yokes, flybacks, and other coils and transformers for substitution only, with the patented Ringing Test? Run dynamic proof positive test on any yoke, flyback, and integrated high voltage transformer.

Protect your future by servicing VCRs for your customers before they go to your competition? Walk out "tough dog" troubles in any VCR chrominance or luminance circuit to isolate problems in minutes. Have proof positive tests of the video record/play heads before you replace the entire mechanism.

Have one piece of test equipment that doesn't need replacing every time technology changes? Be able to service Stereo TVs & VCRs profitably, and get in on the ground floor of this growing market with exclusive phase-locked accessories.

Find out how the VA62 Universal Video analyzer will make servicing easier and more profitable in your shop? Call WATS Free 1-800-843-3338 and ask your area Sales Engineer for a "Try before you buy" 10 Day Self Demo or a full color brochure and join the many servicers already on the road to more profitable servicing with the VA62.

Universal Video Analyzer is a trademark of Sencore, Inc.



WATS Free 1-800-843-3338 In Canada WATS Free 1-800-851-8866

SENCORE

Means Success In Electronic Servicing

3200 Sencore Drive, Sioux Falls, South Dakota 57107

Call Collect 605-339-0100 In SD & AK

CIRCLE 176 ON FREE INFORMATION CARD

AUDIO UPDATE

Can you believe your ears?



LARRY KLEIN,
AUDIO EDITOR

THE TERM "PSYCHOACOUSTICS" HAS recently become a prominent part of the audio vocabulary. But despite the fact that its use seems mostly reserved for those devices that are designed, electrically or acoustically, to enhance stereo imaging, as we've discussed in previous columns, the term covers much more than that. The study of psychoacoustics specifically involves the relationship of the *subjective* sensations of the human ear/brain mechanism to *objective* acoustical events.

The significant differences between the subjective and objective worlds of sound are illustrated nicely by the inconsistent ways in which the ear responds to frequency and intensity—or in psychoacoustic terms, *pitch* and *loudness*. Three examples: (1) More than fifty years ago Harvey Fletcher demonstrated that the subjective judgment of the pitch of a pure tone can be shifted as much as 10% by simply varying the intensity of the sound. (2) Aside from the pitch shift, as shown in Fig. 1, the human ear's sensitivity to low- and high-frequency ranges diminishes disproportionately as the volume (intensity) of the sound is reduced. The loudness controls found on most amplifiers and receivers are meant to compensate for that fact. (3) Most of us are aware that the ear does not respond linearly to increases in the intensity of the stimulus. For example, the measured acoustic power of a sound has to be raised about *ten times* before the average person hears it as merely *twice* as loud.

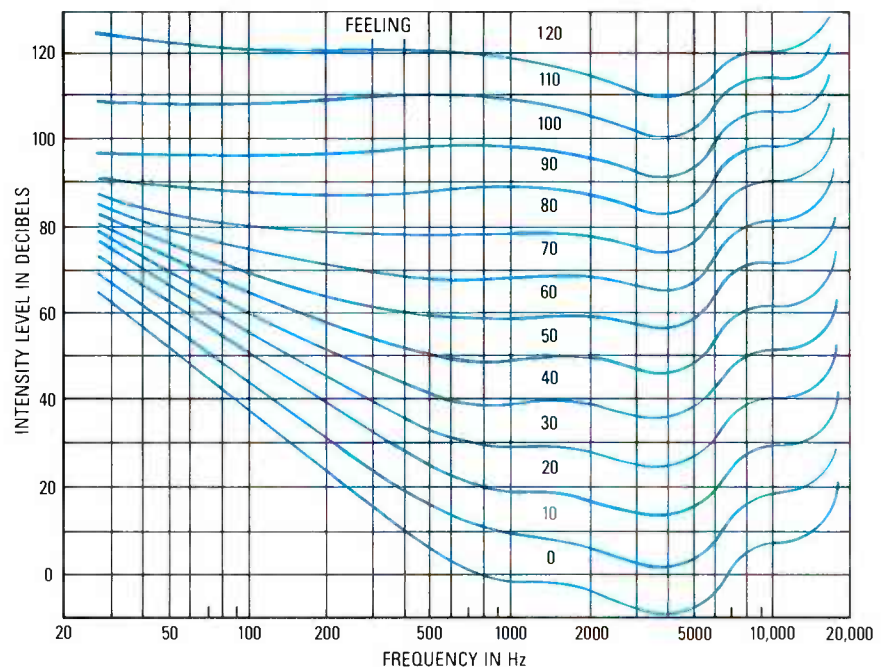

FIG. 1

Those are only three of the psychoacoustic peculiarities of human hearing, and I'm sure that most of you have read discussions of such matters before. But what is not generally appreciated is that the stereo-reproduction process itself is a totally artificial phenomena dedicated to deceiving the ear's psychoacoustic sound-localization process. Think about it—where in nature do you encounter two widely spaced, discrete sound sources each producing a portion of the sound that is heard as coming from *between* them?

Localization

Two main differences between the sounds reaching each ear are

used for localization: time-of-arrival differences, and sound-pressure-level (SPL) differences. In general, differences in arrival times are used to localize the lower-frequency sound sources, SPL differences are used for the higher frequencies; the crossover point between the two is about 1,200 Hz.

There's a good reason why the ear/brain uses (actually, needs) at least two different sound cues for localization. For high- to mid-frequency audio wavelengths, your head is an acoustic barrier that partially blocks the sound reaching the ear most distant from the sound source. The measured difference at the ears is something like 16 dB at 5,000 Hz, falling to

Discover How The World's Only 100% Automatic, Dynamic, & Portable LC Analyzer Gives You Total Confidence In Your Cap/Coil Testing ... Call 1-800-843-3338 Today!

about 7 dB at 1,000 Hz. When the frequency is low enough (the wavelengths long enough), the head is no longer an adequate baffle and approximately the same signal level is heard by both ears. However, your brain is still sensitive to the relative *timing* of the signals reaching each ear, even though there's only about a 0.6-millisecond difference when the source is located fully on one side of your head. That fraction of a millisecond difference provides the brain with the data needed for localization. When the audio wavelengths get very long—below 200 Hz or so—arrival time differences also disappear and localization is completely lost. That, by the way, explains why subwoofers operating below 200 Hz can be installed almost anywhere in the room without confusing the directional information.

Sonic masking

Most noise-reduction techniques rely on psychoacoustic *masking* to help achieve their ends. Masking describes the ear's loss in sensitivity to sounds in one frequency area when there are louder sounds within the same, or adjacent octaves. Hiss is not heard when there is a lot of music going on in the octaves at or adjacent to the hiss frequencies. Only when the musical frequencies are low (a drum or cello solo), intermittent (a solo piano or guitar), or absent, does hiss become obtrusive. Obviously, the task of a noise-reduction circuit is eased if it has to cope with hiss only in the absence of masking musical sounds.

Masking can be a severe problem in a car because the music gets obscured by wideband wind and tire noises, rather than vice versa. The soft passages in a wide-dynamic-range compact disc will inevitably be masked unless player volume is turned up high enough to override the road noise. But with the volume turned up that high, the louder passages are likely to be unbearably loud! I've not seen any indication that the manufacturers of CD car units recognize the problem and are about to install switchable dynamic-range attenuator (compression) circuits

continued on page 45



LC77 AUTO-Z™
Automatic Capacitor and Inductor Analyzer
Double Patented \$1,895

IEEE - 488

The first cap/coil analyzer guaranteed to reliably test anywhere, without calculations, look-up tables, or error — 100% automatically so you're confident of your accuracy.

Do you want to eliminate doubt from your cap/coil testing? The LC77 AUTO-Z tests all key parameters with results *anyone* can understand. Automatic good/bad results eliminate the guesswork for error-free analysis. Touch-sensitive keypad and one-two-three setup makes your AUTO-Z the easiest and fastest LC analyzer on the market.

Are you frustrated trying to test the new high-tech caps/coils used in modern electronics? Only the LC77 AUTO-Z allows you to test them all. Test capacitors from 1 pf to 20 farads, with leakage tests to 1000 V and ESR to 2000 ohms for locating failures other testers miss. Inductor value from 1 uh to 20 H and a patented ringing test for dependable, error-free coil testing every time.

Do you need the freedom of a battery-operated portable LC meter? The LC77 is 100% battery portable for use in the field or factory. The full power and potential of the LC77 AUTO-Z is packed into a light-weight, portable package. The AUTO-Z puts the complicated electronics on the inside for ease of operation on the outside.

Do you want maximum efficiency with a bus compatible LC testing system? Your LC77 AUTO-Z is IEEE 488 compatible for automated cap/coil analysis for data collection, incoming inspection, and quality assurance tests.

Be satisfied that you can meet all the challenges new technology brings. Call WATS Free 1-800-843-3338 today and tell your Area Sales Engineer you want to "try before you buy" with Sencore's exclusive 10 Day Self Demo.

AUTO-Z is a trademark of Sencore, Inc.



WATS Free 1-800-843-3338 In Canada WATS Free 1-800-851-8866

SENCORE

Means Success In Electronic Servicing

3200 Sencore Drive, Sioux Falls, South Dakota 57107
Call Collect 605-339-0100 In SD & AK

CIRCLE 177 ON FREE INFORMATION CARD

STATE OF SOLID STATE

An electronic potentiometer



ROBERT F. SCOTT,
SEMICONDUCTOR EDITOR

UPON HEARING OR READING THE words potentiometer or *pot*, we immediately think of a variable resistor having a rotary control shaft. But this is the age of electronics, and a potentiometer need no longer be a mechanical device adjusted by turning a shaft; it can be an electronic device that uses small voltages to emulate a potentiometer. One kind of device that can do that is Xicor's *E²POT* Digitally Controlled Potentiometer, which is available in several different versions as the X9MME 8-pin miniDIP series of solid-state non-volatile potentiometers. Basically, the device functions as a digitally-controlled trimmer resistor.

A digitally-controlled potentiometer can be adapted to many applications where mechanical potentiometers or digital-to-analog circuits cannot be used, or would be inconvenient to use. For example:

- It provides for automatic potentiometer calibration or adjustment on an assembly line.
- It eliminates the need for manual adjustments of mechanical potentiometers.
- It makes possible remote control via a keyboard of variable adjustments, such as volume and brightness.
- It simplifies adjustment or control of a remote device via a radio, LAN, or modem link.

99 resistors

The device is essentially an array composed of 99 resistive elements with 100 tap points that are accessible to the "wiper" element. (100

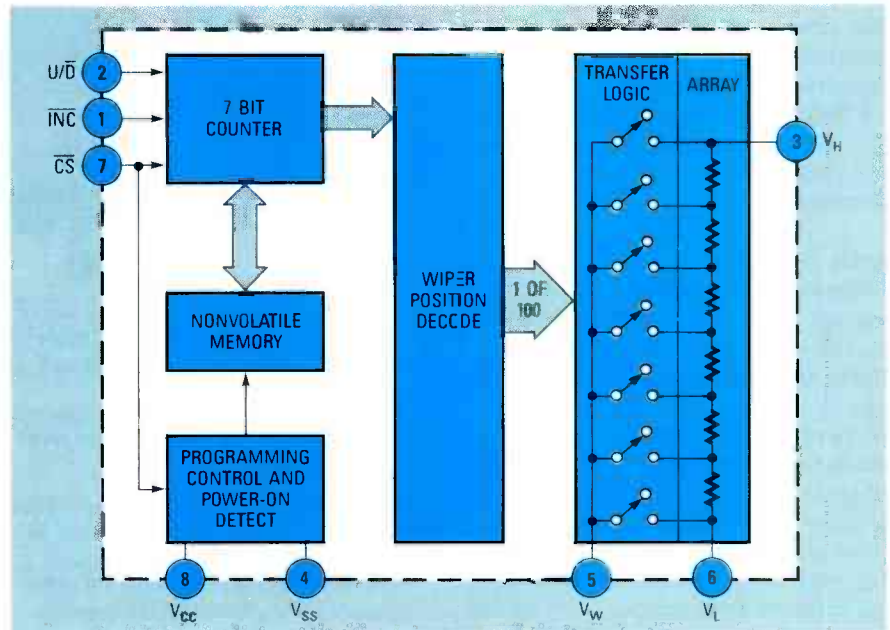

FIG. 1

TABLE 1

Mode Selection			Mode	Power
CS	INC	U/D		
L	↘	H	Wiper Up	Active
L	↙	L	Wiper Down	Active
↗	H	*	Store Wiper Position	Active

* equals high or low

points because the taps are located between adjacent resistor elements and at each end of the resistor string.) The X9MME's functional diagram and pinout are shown in Fig. 1. The wiper's position is digitally controlled by TTL-Level voltages on the \overline{CS} , U/D , and

\overline{INC} inputs. Table 1 shows the mode selection. The position data is stored in a non-volatile memory and is automatically recalled on power-up. The memory is capable of retaining the wiper position data for 100 years.

The X9MME *E²POT* is available in three versions, each having different value ranges. The X9103P is 10K, the X9503P is 50K, and the X9104P is 100K. The resolution—the value between tap points—equals the maximum end-to-end resistance divided by 99, or 101, 505, and 1010 ohms for the X9103P, X9503P, and X9104P, respectively.

Other *E²POT*'s features include:

- Single-chip MOS implementation
- Three-wire TTL control

- Operation from a 5-volt supply
- Analog voltage range of ± 5 volts
- Temperature compensation for $\pm 20\%$ of end-to-end resistance range
- Wiper current of 1-mA maximum
- Typical wiper resistance 40 ohms at 1 mA
- Resolution 1% of resistance

For information on pricing and availability of the E²POTS's, write to **XICOR INC.**, 851 Buckeye Court, Milpitas, CA 95035.

New 8-bit D/A converter

The ZN438 is a new low-cost monolithic D/A converter that requires only two external passive components for full 8-bit conversion. Features include a trimmable 2.5-volt bandgap reference, which is also available externally for use as a system reference. A trim pin can be left floating to provide the nominal 2.5 volts, or it can be connected to a 10K potentiometer to provide a $\pm 5\%$ trim range. The ZN438 has a settling time to ± 0.5 LSB of 1.25 μ sec.

The ZN348E device is available for commercial applications in a 16-lead plastic DIP package, and is priced at \$5.44, in 1000-piece lots. The ZN348J is ceramic packaged and operates in the military temperature range. Price is \$10.37 each, in 1000-piece lots. For additional information, contact **Ferranti Semiconductors**, 87 Modular Avenue, Commack, NY 11725.

CMOS megabit memory

In the Mega-Project, in conjunction with Philips, Siemens is producing the first laboratory samples of a CMOS memory chip with more than 4-million bits of storage capacity. The project's 1-Megabit DRAM will be mass-produced at Siemens' Regensburg facility this year; followed by the 4-Megabit DRAM in 1989. The 4-Megabit chip stores 4,194,304 bits on a surface of 91 mm² (6.5 mm \times 14 mm). It features the novel "trench cell"—a trench not wider than 1 μ m (1/1000 mm) etched 4 μ m deep into the silicon.

1987 data book

The 320-page *1987 Data Converters and Voltage References* data book features information on 27 A/

**Call 1-800-843-3338 today
to start thoroughly analyzing
and pinpointing any trouble in any
TV-RF distribution system,
automatically to FCC specifications . . .**



with the All New
FS74 CHANNELIZER SR.™ TV-RF Signal Analyzer
Patents Pending \$3495

IEEE - 488

Does your success in servicing RF distribution systems depend on locating problems quickly and accurately? If so, here's why your all new Sencore FS74 CHANNELIZER SR. will mean success for you . . .

Quickly tune in all TV/FM channels from 5 MHz to 890 MHz. Exclusive all channel, microprocessor-controlled digital tuner checks every standard and cable channel with better than FCC accuracy to fully analyze any system.

Exclusive 5 microvolt sensitivity to bring in even weak signals. Autoranged attenuator automatically selects the best sensitivity for simplifying your VHF, UHF, or FM signal measurements like never before possible.

Automatic hassle-free S/N ratio, A/V ratio, and hum level tests. Exclusive on-channel signal-to-noise ratio test eliminates time-consuming signal comparison and chart reading. Exclusive audio-to-video ratio test measures directly in dB for easy comparison to specifications.

Exclusive checks for ghosts, co-channel interference, line reflections, and other signal quality checks. Portable 4 MHz wideband battery-operated monitor lets you finally check the quality of your cable or MATV system and stop annoying callbacks.

Built-in autoranging AC/DC volt/ohmmeter makes troubleshooting a snap. Exclusive all-weather design holds tighter than FCC specifications from -4° F to $+104^{\circ}$ F. Truly portable, field-tested tough for dependable ease of use.

Begin successfully locating TV-RF signal problems more quickly and accurately than ever before possible, with the new FS74 CHANNELIZER SR. Call WATS Free 1-800-843-3338 today for a free Product Guide or an industry exclusive "Try before you buy" 15 Day Self Demo.

"CHANNELIZER SR." is a trademark of Sencore, Inc.



WATS Free 1-800-843-3338 In Canada WATS Free 1-800-851-8866

SENCORE

Means Success In Electronic Servicing

3200 Sencore Drive, Sioux Falls, South Dakota 57107

Call Collect 605-339-0100 In SD & AK

CIRCLE 178 ON FREE INFORMATION CARD

Crystek Crystals

FOR OPTIMUM STABILITY
AND RELIABILITY IN
FREQUENCY MANAGEMENT

QUARTZ CRYSTALS FOR

Industrial Equipment/Instrumentation

- * Micro-processor control
- * Computers/Modems
- * Test/Measurement
- * Medical



General Communications

- * Channel element Service (VHF/UHF)
- * Land Mobile 2-way
- * Marine
- * Aircraft
- * Telemetry
- * Monitors/Scanners/Pagers



Amateurs/2-Meter/General Coverage CB/Hobblest/Experimenter

NEW

The Pulse of Dependable Communications

Crystek Crystals offers their new 16 page **FREE** catalog of crystals an oscillators. Offering state of the art crystal components manufactured by the latest automated technology. Custom designed or "off the shelf." Crystek meets the need, worldwide. Write or call today!



CRYTEK CORPORATION

DIVISION OF WHITEHALL CORPORATION

2351/2371 Crystal Drive • Ft. Myers, FL 33907
P.O. Box 06135 • Ft. Myers, FL 33906-6135

TOLL FREE 1-800-237-3061

PH 813-936-2109/TWX 510-951-7448/FAX 813-939-4226

TOLL FREE IN THE U.S.A. EXCEPT FLORIDA, ALASKA, HAWAII

CIRCLE 187 ON FREE INFORMATION CARD

MOVIE TIME



V-7200



CABLE CONVERTERS

72 Channel Wireless Remote Cable Converter

Remote Fine Tuning... Fine Tune Centering... Last Channel Recall
Favorite Channel Memory... HRC/Standard Switch... 2/3 Switchable
90 Minute Sleep Timer... Switchable AC Outlet... 12 Mo. Warranty
Compatible with all CABLE DECODERS... ONLY \$79.95

V-430 Video Control Center wireless
Remote Switcher, with 4 Inputs and 3
Outputs... \$79.95

MOVIETIME, V-7800

78 Channel Remote Converter (same
features as the V-7200) + Parental Control
and built in 10 DB Amplifier. 24 Mo.
Warranty... \$89.95

Replacement Hand Units for the
JERROLD 400 or 450... \$24.95

Shipping Charge \$5.50 per order. We accept
AMERICAN EXPRESS, COD or Personal
Checks. Checks must clear prior to shipping.

Dealer Inquiries Welcome
Call 1-305-652-3971

MOVIETIME

1-305-652-1981 20203 NE 15 Ct.
1-800-843-9845 Miami, FL 33179

30 DAY MONEY BACK GUARANTEE

CIRCLE 199 ON FREE INFORMATION CARD

D converters (including 16 new devices), 20 new D/A converters, and 11 voltage references from Maxim Integrated Products. A complete product listing, converter selector guides, and package information sections are also included.

For a free copy of the 1987 *Data Converters and Voltage References* data book, contact a Maxim sales representative or distributor, or call Customer Service direct at 408/737-7600. *Maxim Integrated Products* 510 N. Pastoria Avenue, Sunnydale, CA 94086.

New Hall-effect switches

Sprague has developed a new sensor chip that makes possible the new UGN/UGS-3119, UGN/UGS-3120, and UGN/UGS-3140 monolithic Hall-effect switches that are less susceptible to mechanical stress and have better stability over their operating temperature ranges than earlier Hall-effect devices.

The 3119 is recommended for applications that provide steep magnetic slopes and low residual levels of magnetic flux density. The 3120 is for applications that require precise switch points. The 3140 is for use with small inexpensive magnets or for applications where there are relatively large distances between the magnet and the Hall cell.

The UGN types are rated for operation over the -20°C to $+85^{\circ}\text{C}$ temperature range. The UGS series has an operating range of -40°C to $+125^{\circ}\text{C}$. All types are offered in two 3-pin plastic SIPS—a 60-mil thick (1.54 mm) "U" package and a 80-mil-thick (2.03 mm) "T" package. They also come in SOT 89 (TO-24AA) packages and in hermetically sealed 3-pin ceramic packages.

The UGN-3119, -3120, and -3140 are priced at \$0.47, \$0.50, and \$0.81, respectively in lots of 100. The UGS-3119; -3120, and -3140 are priced at \$0.79, \$0.90, \$1.20 each, respectively.

For detailed technical information, request Data Sheets 26621, 27622, and 27627 from Technical Literature Service, *Sprague Electric Co.*, P.O. Box 9120, Mansfield, MA 02048-9120. **R-E**

AUDIO UPDATE

continued from page 41

in their players; but it seems to me that they are a necessity. The compression circuit could even be controlled by the brake system and arranged so that compression would be *off* when the car is stopped and *on* when it is moving. Or better yet, let's stay with cassettes—which to my mind are far more sensible for car use. At least one manufacturer (NAD) is producing a cassette deck with a novel car-tape recording feature. When the circuit is switched in, cassettes are recorded with both compression and equalization to compensate for both the noise and the special acoustics of the automotive environment.

As might be surmised, I'm all for psychoacoustic manipulation of the stereo signal if greater realism can be achieved. I've long since given up any hope of being able to provide facsimile reproduction in my home of an original acoustical event. I would be content with a reproduced musical performance that sounded *plausible*. In other words, it might have been heard that way live in some other acoustic space and time. Plausible reproduction, in my use of the term, is not easy to achieve. Perhaps half a dozen times in my 30 years of audio involvement have I experienced the acoustic illusion "I am there" or "they are here." And in almost every case, for it to succeed, the illusion required multiple channels or binaural headphone reproduction.

I hope this brief guided tour through some of the mysteries of psychoacoustics has been interesting, instructive, and has provoked some appreciation of what it takes to delude your ears into believing that they are hearing music freshly produced without artificial preservatives. Psychoacousticians are well aware that they do not as yet have all the answers as to how to hear. However, I'm convinced that there's an R&D *Twilight Zone* inhabited by a few special psychoacoustically-oriented equipment designers from whose joint efforts the audio millennium will one day emerge. R-E

Analyze defective waveforms faster, more accurately, and more confidently — every time or your money back

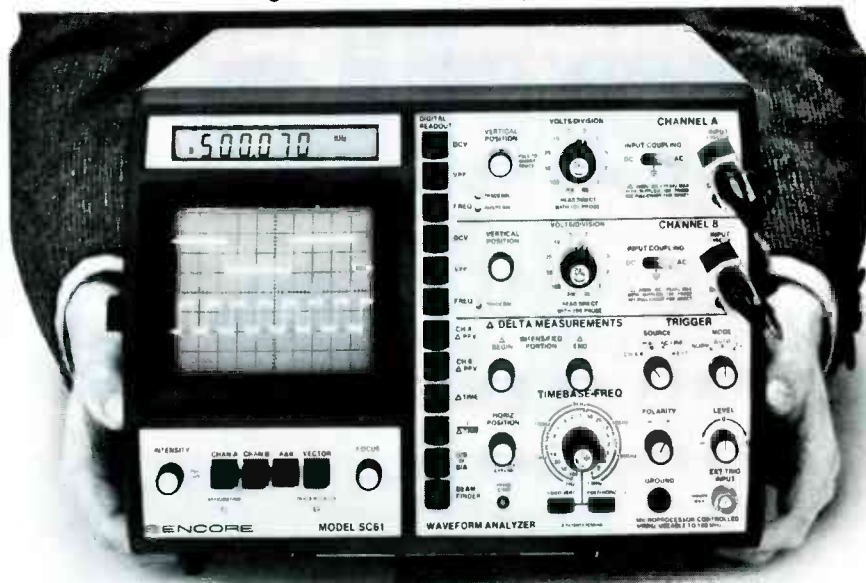

with the SC61 Waveform Analyzer
Patented \$2,995

If you value your precious time, you will really want to check out what the exclusively patented SC61 Waveform Analyzer can do for you. 10 times faster, 10 times more accurate, with zero chance of error.

End frustrating fiddling with confusing controls. Exclusive ultra solid ECL balanced noise cancelling sync amplifiers, simplified controls, and bright blue dual trace CRT help you measure signals to 100 MHz easier than ever.

Accurately and confidently measure waveforms from a tiny 5 mV all the way to a whopping 3,000 V without hesitation with patented 3,000 VPP input protection — eliminates expensive "front end" repairs and costly equipment downtime.

Make only one circuit connection and push one button for each circuit parameter test: You can instantly read out DC volts, peak-to-peak volts and frequency 100% automatically with digital speed and accuracy. It's a real troubleshooting confidence builder.

Confidently analyze complex waveforms fast and easily. Exclusive Delta measurements let you intensify any waveform portion. Analyze glitches, interference signals, rise or fall times or voltage equivalents between levels; direct in frequency or microseconds.

Speed your digital logic circuit testing. Analyzing troublesome divide and multiply stages is quicker and error free — no time-consuming graticule counting or calculations. Simply connect one test lead to any test point, push a button, for test of your choice, for ERROR FREE results.

To see what the SC61 can do for your troubleshooting personal productivity and analyzing confidence, CALL TODAY, WATS FREE, 1-800-843-3338, for a FREE 15 day Self Demo.



Call Today Wats Free 1-800-843-3338

SENCORE

3200 Sencore Drive
Sioux Falls, SD 57107
605-339-0100 In SD Only

*innovatively designed
with your time in mind.*

CIRCLE 179 ON FREE INFORMATION CARD

Information radio is on the air.



Before you hear about it on your old radio, hear it live on your new Informant Information Radio. Whether its an all-points-bulletin from the State Police, the dispatcher for the city's Fire Department, an ambulance racing to the hospital or a National Weather Service report, the new Informant from Regency makes you a part of all the action... instantly.

Breakthrough Technology. Instant Information.

Informant Information Radio uses a revolutionary new technology that allows you to constantly monitor your police, fire and



emergency frequencies, as well as NOAA weather information channels in all 50 states. All pre-programmed. This new Information Radio utilizes a principle similar to the seek and scan feature found on expensive AM/FM radios. Your information radio scans the public service channels in the area, locates the active signals, locks in and broadcasts all the information right to you. With revolutionary TURBO-SCAN speed!

Hear Your Hometown Like You've Never Heard it Before.

Just turn it on. As easy to use as your AM/FM radio. Instantly, you're tuned into real life adventures. One touch control lets you select and hold police, fire and emergency broadcasts so you don't miss a single minute of the action.

Hear the amazing Information Radio today. Take it home and be a part of the action tonight!!



Information Radio for Real Life Adventure



CIRCLE 196 ON FREE INFORMATION CARD

ELECTRONIC XMAS TREE

THOMAS L. JOZWIAK



This pocket-size electronic Christmas tree will give your holiday lighting a new and festive look.

FOR ABOUT \$10 YOU CAN BUILD A UNIQUE high-tech Christmas tree that will add a new and festive look to both your home and office holiday decorations. And because it's powered by two AA batteries, if you can't be home for the holidays you can pack one along in a suitcase to remind you of your loved ones.

The electronic Christmas tree is really a 6 1/2-inch high tree-shaped printed-circuit board that's outlined by what appears to be randomly-blinking red, green, and yellow LED's. The tree's trimming is the components for the electronic circuit that makes the LED's wink and blink. The Christmas tree's base consists of two AA-size battery holders cemented together with the tree's PC board sandwiched between the two. A little imaginative spray painting before the components are installed puts a realistic finishing touch to the Christmas-tree project.

Because the LED's are continuously cycled *on* and *off*, two alkaline batteries provide more than 300 hours of continuous operation: that's enough to provide almost two full weeks of window display or entertainment before the batteries need to be replaced.



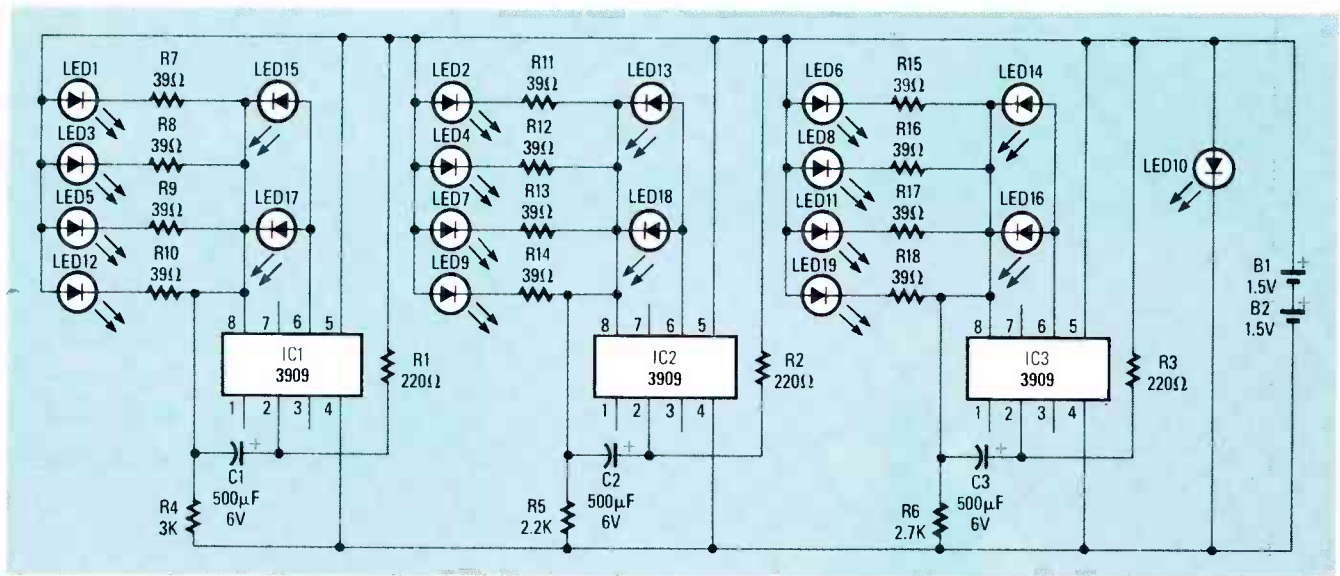

FIG. 1—THREE INDIVIDUAL FLASHER CIRCUITS having unrelated flash rates create a pseudo-random blinking of the LED's because the LED's from each individual circuit are intermixed around the edges of the tree.

How it works

As shown in Fig. 1, three individual flashing circuits that use an LM3909 LED flasher/oscillator IC create the appearance of a pseudo-random firing order. The combination of C1/R4, C2/R5, and C3/R6 control the blink rate, which is between .3 and .8 second, while the inherent wide

tolerance range (-20% to +80%) of standard electrolytic capacitors add to the irregularity of the blink cycles. The continuous current drain is about 10 mA; however, if you decrease the values of R4-6 or C1-3 in order to increase the blink rate, the current will then increase proportionately.

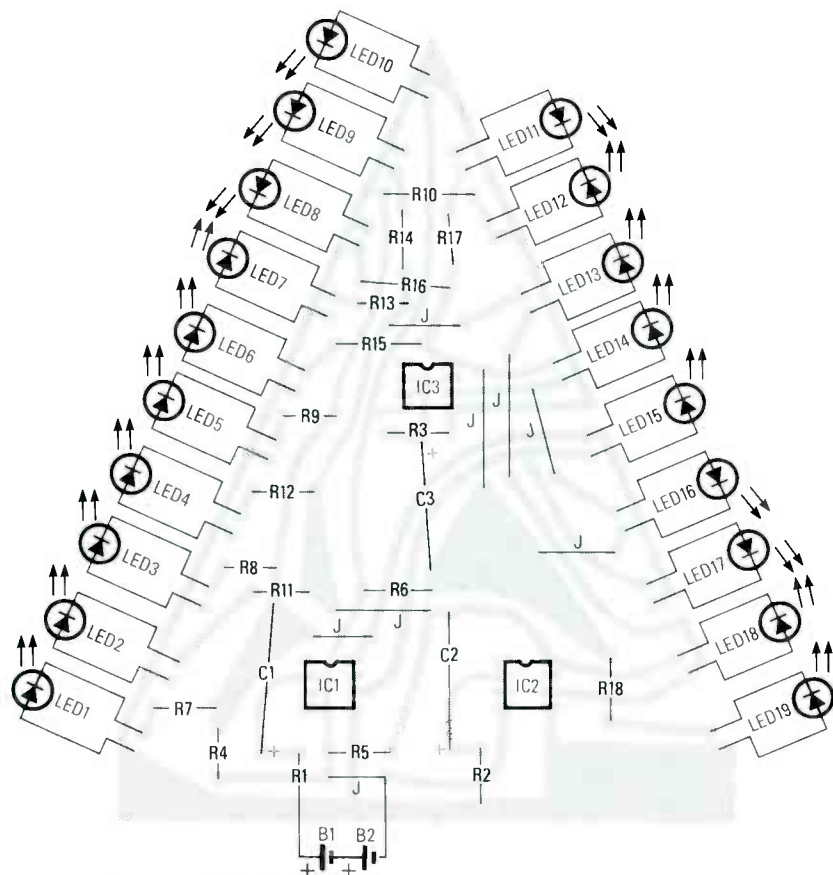

FIG. 2—TAKE EXTRA CARE THAT THE LED'S are installed with the correct polarities. If you want to decorate the "tree", do it before drilling the mounting holes for the components.

PARTS LIST

All resistors are 1/4-watt, 5%.

R1-R3—200 ohms

R4—3000 ohms

R5—2200 ohms

R6—2700 ohms

R7-R18—39 ohms

Capacitors

1-C3—500 µF, 6 volts, electrolytic

Semiconductors

IC1-IC3—LM3909, LED flasher

LED1, LED4, LED7, LED13, LED16, LED

19—Red, diffused 5-mm LED

LED2, LED5, LED6, LED11, LED14,

LED17—Yellow, diffused 5-mm LED

LED3, LED6, LED9, LED12, LED15,

LED18—Green, diffused 5-mm LED

LED10—Red flasher LED (Radio Shack 270-401 or equivalent)

Other Components

B1, B2—1.5-volt AA alkaline battery

Miscellaneous: battery holders, PC board, wire, solder, etc.

Note: An etched and drilled PC board is available for \$10 postpaid from Fen-Tek P.O. Box 5012, Babylon, NY 11707-0012. NY residents must add appropriate sales tax.

Note in particular that external current-limiting resistors aren't needed for LED13 through LED18; the resistors are built into the IC's. LED10, which serves as the tree's "star," is a special kind of flashing LED that blinks continuously at a fixed rate.

Power can be turned off by simply removing either battery, or by slipping a small piece of paper between any battery and either of its battery-holder terminals. Of course, a switch can also be added.

continued on page 82

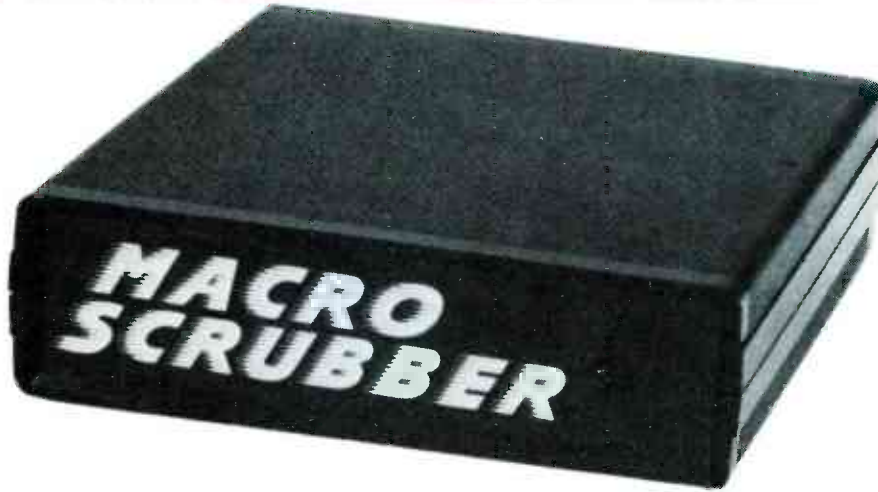

MACROVISION STABILIZER

Are copy-protected video tapes also mucking-up normal viewing on your TV? Then use a Macro-Scrubber to make the picture squeaky-clean.

D. DUPRE

YOU ARE PROBABLY ALREADY AWARE that the movie industry has launched a new front against video tape copying with a new "encoding" scheme called *Macrovision*. Although many new releases from Embassy, CBS/Fox, MGM/UA, HBO/Cannon, MCA, and Disney have been protected with it, its use is generally not advertised on the label. However, you can easily identify a *Macrovision*-processed tape by turning the vertical hold control on your TV (if your set has one) so that the black bar across the top of the picture becomes visible. If the signal contains *Macrovision* encoding, you will see five or six gray or white pulsating "boxes" on the left side of the black bar.

According to a top *Macrovision* executive, plans are already in the works to transmit *Macrovision*-encoded signals through cable systems.

The basic idea behind the *Macrovision* process is to render the program material uncopyable to a VCR while allowing the unimpaired viewing of the original tape (a goal not achieved by the original *CopyGuard* system, which has since passed away). Although some proponents of the *Macrovision* process claim that the system meets those goals, numerous consumers who have either purchased or rented a number of *Macrovision*-encoded tapes can attest to the contrary. That is evidenced by the large influx of letters to

magazines predominant in the video field, and by continuous complaints to video rental and retail stores.

Both the users and developers of the *Macrovision* process admit that some TV's and VCR's are adversely affected in the PLAY mode, but that that percentage is very small. So, if you are one of the "small percentage" you probably have a significant sum of money invested in the best features that state-of-the-art video has to offer; yet with it you wind up watching a dark, murky picture that may be flashing, rolling or streaking as well.

If you're among the users who have discovered that your VCR or TV equipment simply can't handle the so-called

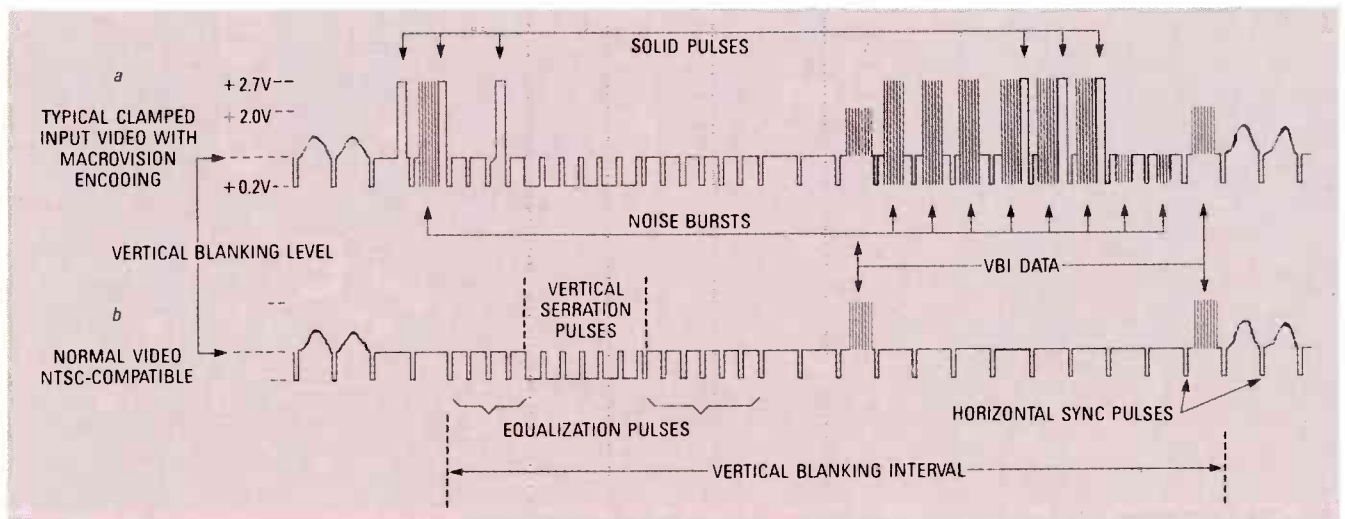

FIG. 1—MACROVISION DELIBERATELY injects interference during the vertical-blanking interval (a). The Macro-Scrubber restores the signal to standard NTSC (b).

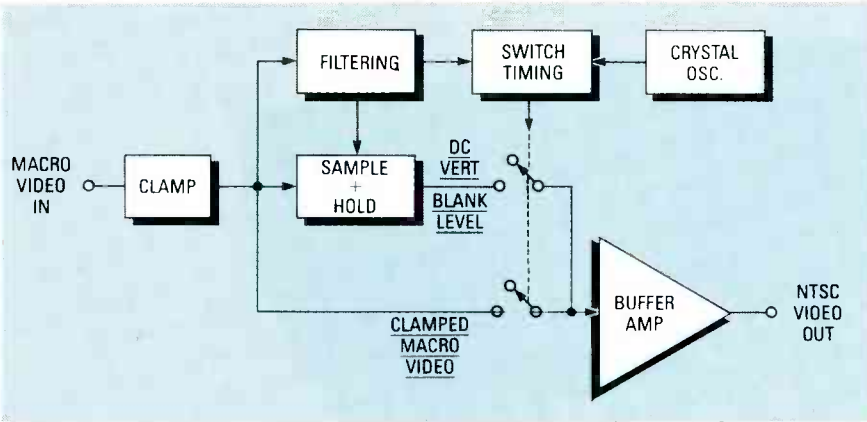

FIG. 2—AN ELECTRONIC DPDT SWITCH is used to restore the video signal to the conventional NTSC format.

“invisible” *Macrovision* encoding, then you need the Macro-Scrubber, a device that simply eliminates the encoding. Plug the device between your VCR and its TV or monitor and you won’t know that *Macrovision* even exists.

Macrovision encoding

Macrovision is not an encoding process at all. If it were, then an appropriate decoder would have to be made available to the consumer just so he could view a *Macrovision*-encoded tape. In fact, the video information remains intact and unmodified in the signal, as does the audio. The encoding is really a disturbance in the TV signal’s vertical-blanking interval that is supposed to affect only a VCR attempt-

ing to copy the tape. Unfortunately, the encoding also affects some TV’s. By simply eliminating the disturbance and returning the offending signal to normal NTSC standards you can view a completely normal picture while playing a *Macrovision*-processed tape.

As shown in Fig. 1, the *Macrovision* process merely injects noise bursts and solid pulses into the signal during selected line times within the vertical blanking interval. One possible form of *Macrovision* encoding is shown in Fig. 1-a; the same signal in conventional NTSC form is shown in Fig. 1-b. The peak level of the bursts is randomly varied from black to white. Sometimes the bursts are pumped between two or three different levels: at

WARNING

Duplication of copyright material is prohibited by law. The Macro-Scrubber is recommended for use only between a VCR and its TV or monitor as a solution to viewing problems that are generated within the TV or the monitor by *Macrovision* encoding.

other times the burst level is ramped slowly up and down. The location of the injected noise is also randomly alternated between the available line times; however, the location and level of solid pulses usually remains constant for the duration of a particular title—thus all copies of a particular title have the same encoding.

The *Macrovision* irregularities created during the vertical retrace time are intended to upset a VCR’s RECORD-mode AGC circuit so that it records an unviewable picture. Since a VCR is designed to record only the NTSC video signal—which contains no noise transitions during the vertical blanking interval—any fast irregularities in the vertical blanking interval cannot be tracked by the AGC.

The effectiveness of the *Macrovision* anti-copying system varies with the type of VCR used, but in general, synchronization is lost, leaving an unviewable picture on the attempted copy. At best, the resulting dubbed copy will exhibit erratic brightness changes. Sometimes the picture will roll vertically due to a noise burst injected just before vertical sync.

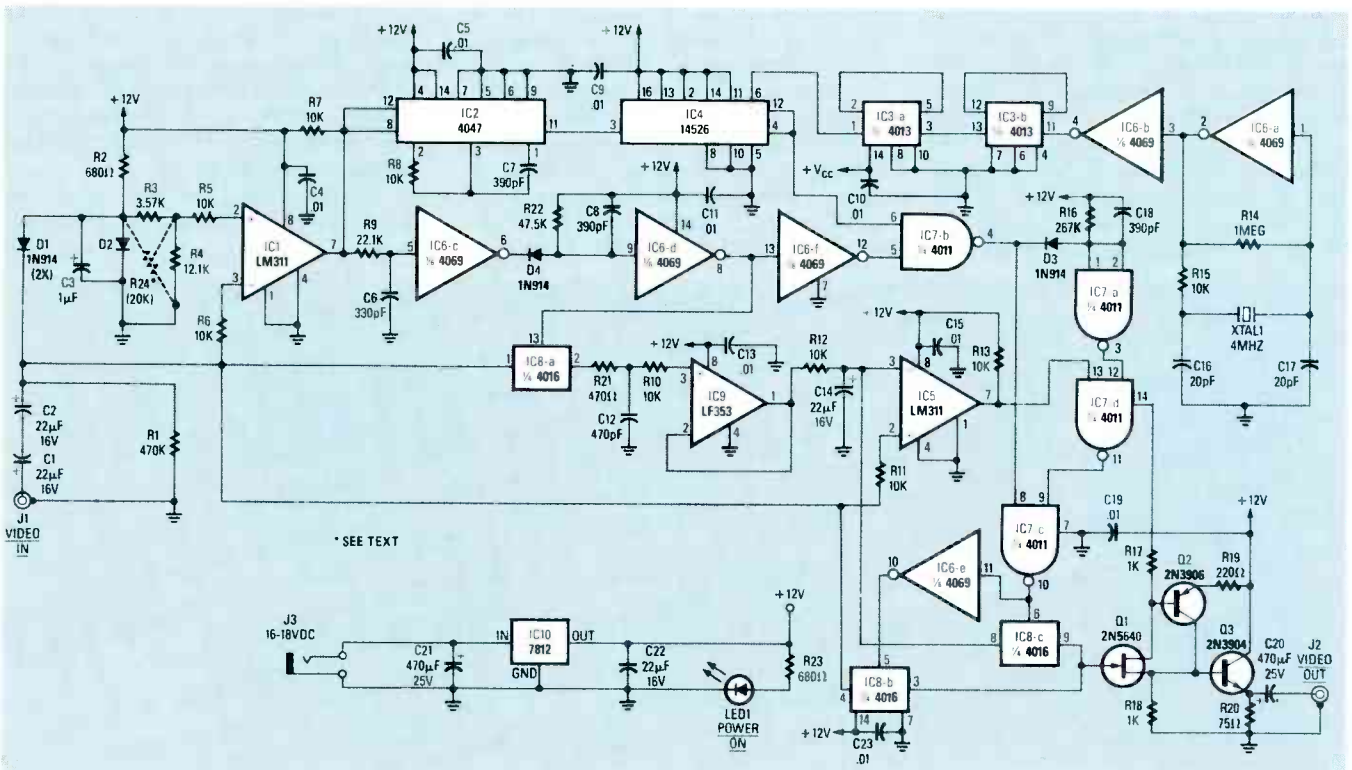

FIG. 3—THE INPUT-SIGNAL LEVEL must be within a specified range for the Macro-Scrubber to work properly. If there is some problem with the input-signal level it is suggested that R24—shown with dashed lines—be substituted for R3 and R4.

COMPLEX IS REALLY BETTER

The majority of devices sold with a purpose similar to that of the Macro-Scrubber either blank or clip the entire vertical-blanking interval, which also removes any other VBI data (color correction signals, closed captions, teletext, etc.). They then attempt to economically reconstruct the entire vertical-blanking interval, including horizontal sync, equalization, and serration pulses. From a technical viewpoint, that is often not very successful because the characteristics of the reconstructed pulses are usually set to some form of "standard" value, and as such do not really match the actual input signal. Since those units do not actually detect and selectively remove the *Macrovision* noise, they also strip the vertical-blanking interval of a normal TV signal if not bypassed or removed from the system.

Many models also require factory-type calibrations of numerous timing potentiometers. Their new blanking level is either preset to some kind of standard value or an external adjustment is provided to compensate for signals from different video tapes or sources.

What makes the Macro-Scrubber unique, when compared to the restoration devices, is that there are no precision adjustments; digital filters remove only the *Macrovision* pulses and pass the original vertical-blanking interval data and sync pulses, while sample-and-hold circuits reproduce the correct vertical-blanking level, which is switched into the output signal in place of *Macrovision* pulses. Also, the use of a crystal oscillator eliminates the need for timing adjustments. And since the Macro-Scrubber has no effect on normal video signals, there is no need to switch the Macro-Scrubber out of the system for normal viewing.

Unfortunately, similar symptoms sometimes are experienced when merely playing the original tapes on some VCR/TV combinations.

A logical solution

In comparing Figs. 1-a and 1-b, you can

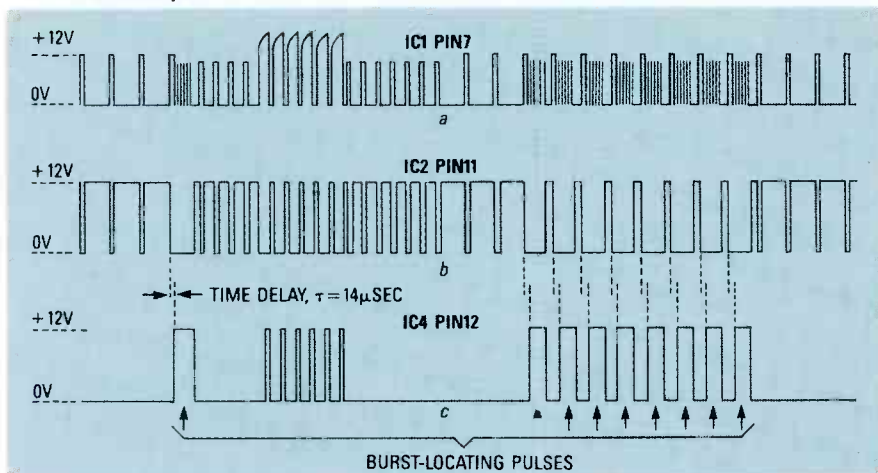

FIG. 4—THE MACRO-SCRUBBER GENERATES noise pulses which are used to locate and suppress the *Macrovision* noise-burst interference.

see that a normal NTSC video waveform is held at the vertical blanking level during times when injected noise exists in the *Macrovision*-encoded waveform. By locating the individual noise bursts and solid pulses, and by connecting the output to a DC voltage that is equivalent to the vertical blanking level at those times, we can essentially recreate the NTSC version of the waveform. When no encoding signals are present, we connect the output to the clamped video input.

Figure 2 shows a block-diagram of how the encoding can be removed. First, the incoming video signal is clamped to hold the negative sync tips at the same level, thereby removing any AC hum or other time-varying offset from the signal; that step is critical for detecting signal transitions against a fixed reference level. The clamped video is then sent to a filtering circuit to accurately locate the noise bursts and the solid pulses from which the switch-timing and the control signal are created. (A crystal oscillator is used so that timing adjustments aren't necessary.)

The sample-and-hold circuit continuously samples the video waveform to generate a DC voltage equivalent to the vertical blanking level of the incoming signal. That assures that the switched-in blanking level is always correct for the actual input signal applied and eliminates the need for any manual adjustment. Finally, an electronic double-pole, single-throw switch that is controlled by the noise-locating signal connects either the clamped input video or the reproduced blanking level to the output buffer amplifier. In so doing, *Macrovision* noise is eliminated and the signal is restored to normal NTSC video.

Circuit description

Figure 3 shows Macro-Scrubber's circuit. The *Macrovision*-encoded video signal is applied to jack J1 and is fed through back-to-back capacitors C1 and C2 to a resistor/diode network that clamps the negative sync tips close to ground poten-

PARTS LIST

All resistors are 1/4-watt, 5% unless otherwise noted.

R1—470,000 ohms
R2, R23—680 ohms
R3—3,570 ohms, 1%
R4—12,100 ohms, 1%
R5—R7, R10—R13, R15—10,000 ohms
R8—10,000 ohms, 1%
R9—22,100 ohms, 1%
R14—1 Megohm
R16—267,000 ohms, 1%
R17, R18—1,000 ohms
R19—220 ohms
R20—75 ohms
R21—470 ohms
R22—47,500 ohms, 1%
R24—20,000 ohms, trimmer potentiometer

Capacitors

C1, C2, C14, C22—22 μ F, 16 volts, electrolytic
C3—1 μ F, 35 volts, electrolytic
C4, C5, C9—C11, C13, C15, C19, C23—0.01 μ F, ceramic disk
C6—330 pF, NPO
C7, C8, C18—390 pF, silver mica
C12—470 pF, polypropylene
C16, C17—20 pF, NPO
C20, C21—470 μ F, 25 volts, electrolytic

Semiconductors

IC1, IC5—LM311 comparator
IC2—4047B multivibrator
IC3—4013B dual D flip-flop
IC4—4526B binary counter
IC6—4069B hex inverter
IC7—4011B quad NAND gate
IC8—4016B quad analog switch
IC9—LF353 dual JFET op-amp
IC10—7812, 12-volt regulator
Q1—2N5640, JFET transistor
Q2—2N3906, PNP transistor
Q3—2N3904, NPN transistor
D1—D4—1N914, switching diode
LED1—Light-emitting diode

Other components

XTAL1—4-MHz crystal, AT cut (parallel), HC-18 package

J1, J2—RCA-type phono jacks

Miscellaneous: PC board materials, 16-18-volt, 200-mA AC adapter, etc.

Note: A complete Macro-Scrubber kit, model MAK-1, which includes the PC board, cabinet, all components, and an AC adapter, is available for \$52.95 plus \$3.00 shipping and handling from: The Hobby Helper, P.O. Box 308, Bridgewater, MA. 02324. (617) 339-1026. Massachusetts residents must add appropriate sales tax.

tial (approximately 0.2 volt). The clamped video input applied to IC1's inverting input (pin 3) resembles the waveform shown in Fig. 1-a. A DC reference voltage derived from diode D2 is fed to IC1's non-inverting input (pin 2). Since the DC reference is slightly higher than the clamped voltage, IC1's output goes positive whenever the input signal is lower than the reference signal. As shown in Fig. 4-a, IC1 outputs a waveform that is normally low (0 volts) with high-going pulses con-

current with negative-going pulses below the vertical-blanking level (i.e. horizontal-sync pulses, equalization pulses, vertical-serration pulses, and *Macrovision* noise bursts).

The clamped video signal is also delivered to the input of a sample-and-hold circuit, which consists primarily of analog switch IC8-a, hold capacitor C12, and op-amp IC9. The switch is driven in such a way that it samples the level of the video signal only during vertical-sync time at the peaks of the vertical-serration pulses. The output of IC9 is a DC voltage equal to the vertical-blanking level, which will be switched into the output waveform in place of the *Macrovision* noise bursts and solid pulses.

Clamped input video is fed to the input of analog switch IC8-b, and the DC output voltage from IC9 is fed to the input of analog switch IC8-c. Notice that the outputs of analog switches IC8-b and IC8-c are connected together, and that because of inverter IC6-e, their control inputs at pins 5 and 6 respectively are driven 180° out of phase. That arrangement creates the electric equivalent of a single-pole, double-throw switch, with either the clamped input video or a DC voltage that is equal to the vertical-blanking level being fed to buffer amplifier Q1 at any one time.

It is through control of the electronic DPDT switch shown in Fig. 2 that the encoded video is restored to a normal NTSC signal. All that is needed is a proper signal to pin 6 of IC8.

The signal from IC1 pin 7 (Fig. 4-a), which contains pulses that correspond to the sync and the *Macrovision* noise pulses, is fed to IC2 pins 8 and 12. IC2 is a multivibrator that is configured as a digital low-pass filter. The time constant determined by R8 and C7 causes frequencies greater than twice the horizontal frequency to be filtered out. IC2's output at pin 11 looks like a squared-up and inverted version of its input, except that the high-frequency pulses corresponding to the *Macrovision* noise bursts have been filtered out, leaving a low level for each burst duration. (See Fig. 4-b).

The filtered signal is fed to pin 3 (ENABLE) of binary counter IC4. A 4-MHz crystal-oscillator circuit feeds dual flip-flop IC3, which divides the crystal frequency by four, yielding a 1-MHz clock input to IC4 pin 6. When the input at IC4 pin 3 goes high, that counter is asynchronously preset to the binary value determined by preset lines P3, P2, P1, and P0 (pins 2, 14, 11, and 5 respectively). With the connections shown in Fig. 3, the preset count is 14 decimal (1110 binary). Whenever the count is not zero, the counter output at pin 12 is low. The counter decrements once for each clock pulse it sees on pin 6 while pin 3 remains low. Thus, 14 μ s after the leading, negative-going edge of the input signal on pin 3 goes low, the count reaches 0 and the counter's output switches high. The high output is fed back to pin 4, the INHIBIT line, which prevents any further counting.

When the input signal at pin 3 returns high, the counter is again preset to a 14 count and the output returns to its low preset state. Low input pulses having a duration less than 14 μ sec are ignored because the counter is preset before the count ever reaches zero.

The resulting output signal at IC4 pin 12 is normally low, with high-going pulses that start 14 μ s after the beginning of each horizontal-sync pulse that precedes a *Macrovision* noise burst. The 14 μ sec delay forces the horizontal sync pulses (and color-bursts) to be switched into the output waveform. Each of the noise-burst locating pulses returns to a low at the end of the corresponding *Macrovision* burst. Those pulses, as shown in Fig. 4-c, define the points in time when the bursts occur, with one exception. Concurrent with the vertical-serration pulses, there are a string of pulses that must be removed in order to create a signal that will totally isolate the *Macrovision* noise. In order to remove those pulses we must create a gating signal with a single pulse that lasts only for the duration of the vertical sync pulse in each frame. To do that, sync and noise pulses from IC1 pin 7 (Fig. 4-a) are fed to a low-pass filter consisting of R9 and C6.

Narrow, positive-going pulses are attenuated because C6 never gets a chance to charge to a logic-high level unless the pulses are long compared to the time constant determined by R9 and C6. The only pulses wide enough to allow C6 to charge

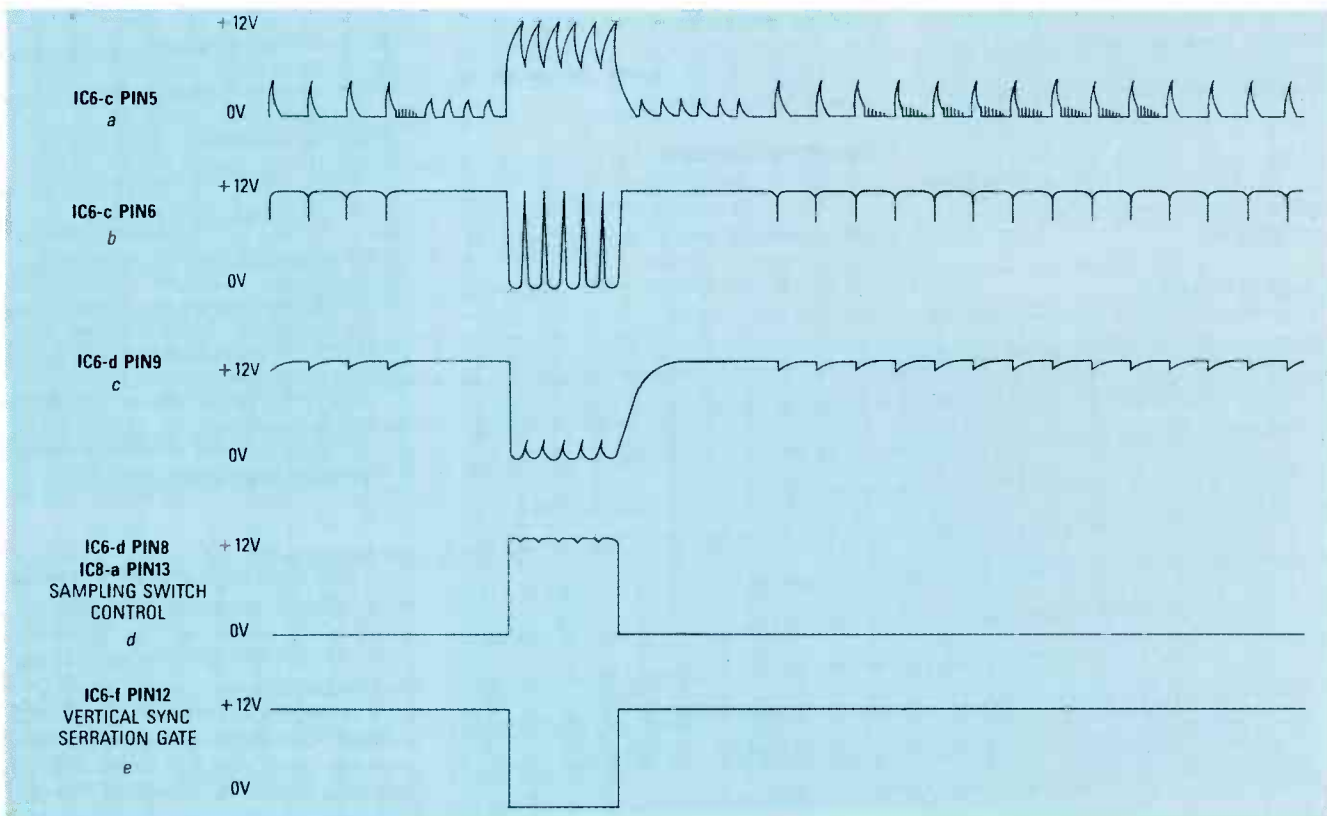

FIG. 5—VERTICAL SYNC AND BLANKING level sampling pulses are derived from the *Macrovision*-induced noise bursts.

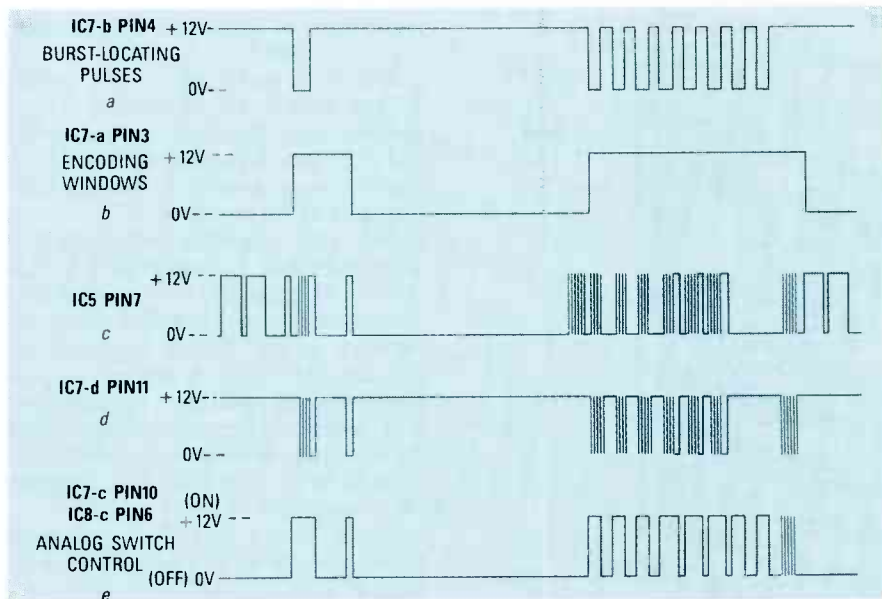

FIG. 6—WINDOWS DERIVED FROM the burst-location pulses provide the switch control signals that eliminate the *Macrovision* interference from the output signal.

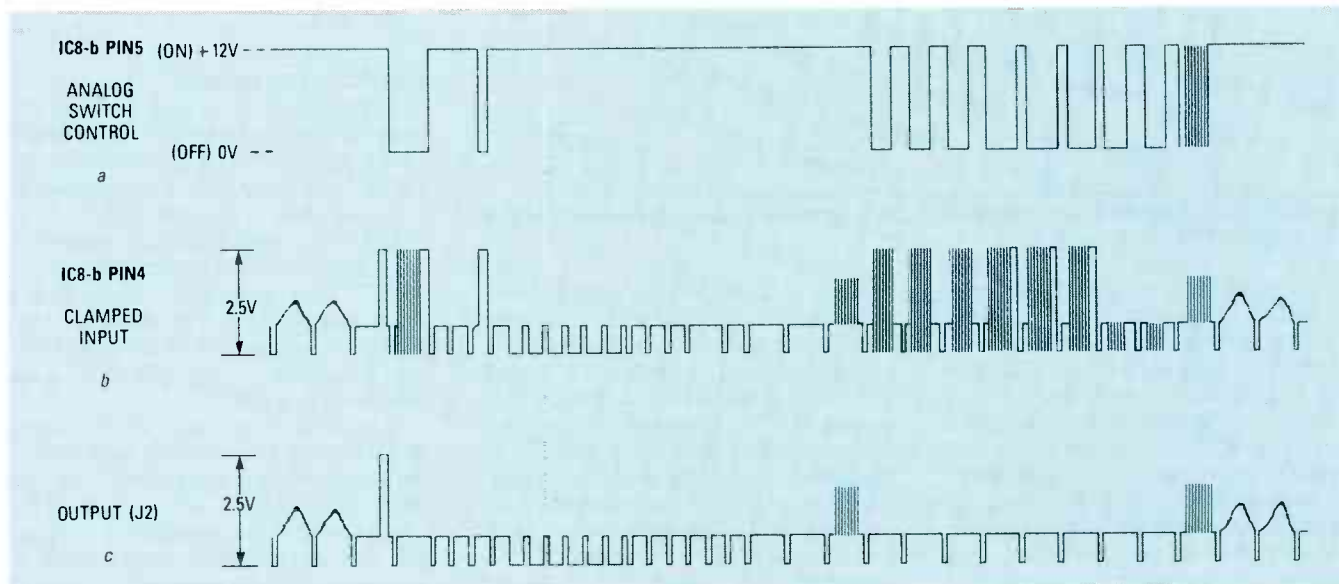

FIG. 7—THE NTSC SIGNAL IS CREATED by selectively switching the encoded input and the sampled vertical-blanking level into the output.

to a logic-high value are those corresponding to the vertical serration pulses.

Therefore, as shown in Fig. 5-a, at IC6-c pin 5 we have a signal that has +5-volt pulses corresponding to the horizontal sync pulses, and +12-volt pulses concurrent with the serration pulses during vertical-sync time.

Inverter IC6-c discriminates farther, since input pulses lower than a logic high (approximately +7V for a +12V supply) will not trigger output pulses. Therefore, as shown in Fig. 5-b, at inverter IC6-c pin 6 we have a normally high signal with low-going pulses occurring only during the vertical sync period. When that signal goes low, diode D4 becomes forward-biased and inverter IC6-d pin 9 is immediately pulled low as well. When IC6-c pin 6 goes high, D4 is reverse-biased, so

that pin 9 charges to a logic-high level at a rate determined by R22 and C8. (See Fig. 5-c.) Again, narrow pulses are ignored and, as shown in Fig. 5-d, the inverter's output (IC6-d pin 8) is normally low with logic-high sync pulses.

The inverter's output signal turns on sampling-switch IC8-a during the vertical-serration time, and C12 charges to the vertical blanking level. The high input impedance of op-amp IC9, and IC8-a in its OFF state, prevent the charged voltage on C12 from leaking off between samples. Unity-gain amplifier IC9 feeds C12's DC-voltage level to analog switch IC8-c, where it will be switched into the output waveform in place of the *Macrovision* noise.

As shown in Fig. 5-e, the vertical-sync signal at IC6-d pin 8 is inverted by IC6-f,

and is then fed to NAND gate IC7-b to gate the burst-locating signal from IC4 pin 12 (Fig. 4-c). The output signal at IC7-b pin 4 (Fig. 6-a), is normally high, with logic-low pulses that last for the duration of the corresponding *Macrovision* noise burst.

Notice, from Fig. 1-a, that some *Macrovision* bursts are followed by a solid pulse that doesn't have a negative transition. Since the *Macrovision* noise-locating pulses shown in Fig. 6-a were created by detecting high-frequency bursts below the blanking level, they do not locate the solid pulses. In order to remove the solid pulses without affecting any non-*Macrovision* pulses we must: 1) detect positive transitions above the vertical blanking level that occur during the *Macrovision*-encoded areas of vertical blanking, and 2) combine the new signal that locates the *Macrovision* solid pulses with the signal that locates the *Macrovision* noise bursts at IC7-b pin 4.

Macrovision-encoded areas of the sig-

nal are defined by feeding the signal at IC7-b pin 4 (Fig. 6-a) to a low-pass filter consisting of D3, R16, C18, and IC7-a. The resulting waveform at IC7-a pin 3 contains wide pulses, or *windows*, that define the time periods in which the *Macrovision* encoding is present. That signal is shown in Fig. 6-b.

The DC output voltage from the sample-and-hold circuit is fed to the inverting input of comparator IC5, while the clamped video input signal is fed to IC5's non-inverting input. A train of high-going pulses appears at IC5 pin 7 that corresponds to all transitions above the blanking level; including video, vertical-blanking interval data and *Macrovision* pulses. See Fig. 6-c.

The signal from IC5 pin 7 (Fig. 6-c) is gated by the window pulses from IC7-a

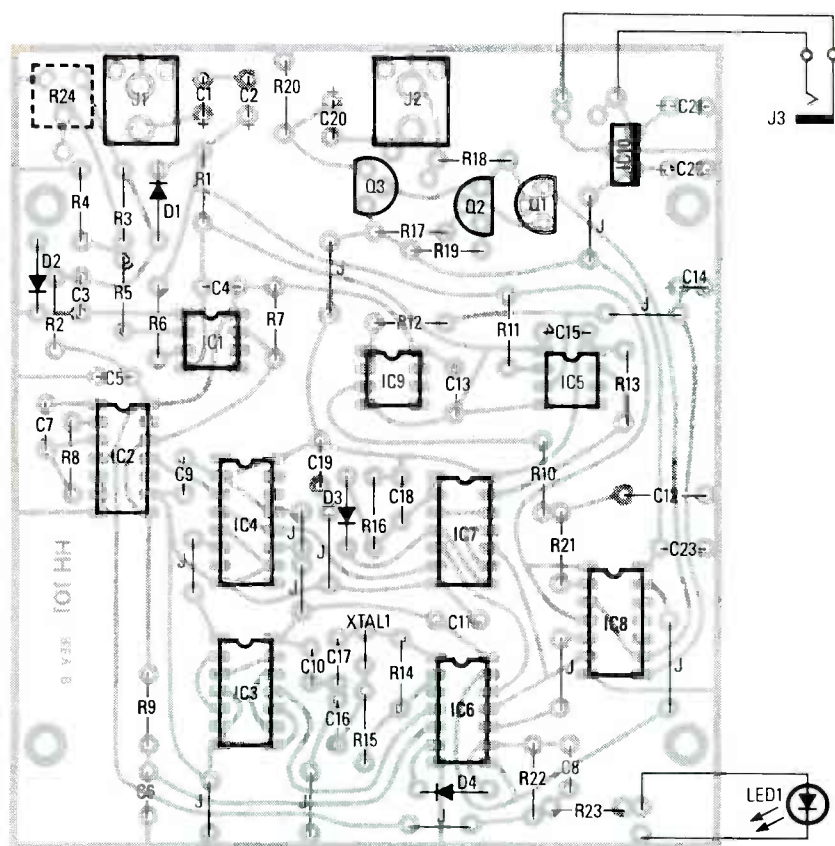

FIG. 8—RESISTOR R24, SHOWN BY THE DOTTED LINES, isn't usually used. If it is needed, you must remove resistors R3 and R4.

pin 3 (Fig. 6-b) at NAND gate IC7-d, yielding the waveform shown in Fig. 6-d at IC7-d pin 11. That signal is combined with the burst-locating signal from IC7 pin 4 (Fig. 6-a) by NAND gate IC7-c.

The final *Macrovision*-locating signal appears at IC8-c pin 6 and looks very similar to an inverted version of the original burst-locating signal (Fig. 6-a), but the pulses have been stretched to include both the bursts and the solid pulses. (See Fig. 6-e.) Notice that no locating pulse exists to remove the single solid pulse occurring at the start of the vertical blanking shown in the sample input waveform (Fig. 1-a). That is because there is no preceding negative noise burst that can be used to locate the solid pulse. As a result, that pulse will remain in the output waveform (Fig. 7-c), but it doesn't cause a problem because it is narrow and is not pumped.

The signal shown in Fig. 6-e directly feeds the control input, IC8-c pin 6, and an inverted form of the signal (Fig. 7-a) feeds analog switch IC8-b via inverter IC6-e.

The removal of the *Macrovision* encoding signal works as follows: During video time, horizontal-sync time, vertical-serialization time, and all non-*Macrovision*-encoded vertical-line times, the control input of analog switch IC8-c is low—the switch is open. At the same time, the control input of analog switch IC8-b is

high—it is closed, connecting the clamped-video video (Fig. 7-b) to Q1's gate. During *Macrovision* noise times, the situation is reversed. Switch IC8-b is open and switch IC8-c is closed, thereby connecting the DC blanking voltage from sample-and-hold amplifier IC9 to Q1. An impedance-matching amplifier stage, consisting of Q1, Q2, and Q3, provides a match for the 75-ohm video output. Thus, as shown in Fig. 7-c, a "normal" NTSC-compatible video signal is reconstructed at the output, eliminating only the *Macrovision* noise.

Construction

The circuit is assembled on a printed-circuit board. The foil pattern for that board is provided in PC Service. The parts-placement diagram for that PC board is shown in Fig. 8.

Begin stuffing the printed-circuit board by first installing all resistors, diodes, and capacitors. Make sure that all of the electrolytic capacitors and the diodes are installed with the proper polarity. Save the clipped component leads for use as jumpers.

Capacitor C12 must be a "polypropylene" type because the extremely low-leakage characteristic of the material prevents the vertical-blanking hold voltage from sagging between samples. As correct R-C time constants are critical to the proper operation of the circuit, use of

the component values shown in the schematic is essential.

The PC board's spacing for crystal XTAL1 is for an HC-18 package. Values specified in the Parts List for resistors R14 and R15, and capacitors C16 and C17, must be used in order to insure proper operation of the oscillator.

Mount the transistors and voltage regulator IC10 next. Transistor Q1 is an FET and should be handled with proper regard for static charges. A heatsink should be mounted on the voltage regulator, especially if the circuit is housed in a case that has limited ventilation. Potentiometer R24, which is indicated by dashed lines in the schematic, is not normally used, so its holes in the PC board will remain empty. (We'll explain R24 later.)

Finally, mount the IC's, using proper precautions for static electricity because most of them are CMOS. Sockets aren't necessary, but using them would make any troubleshooting or repair easier. The project will fit nicely into a PAC-TEC CM5-125 case.

Checkout and hookup

Apply power and check that the AC adapter's output voltage is between 14–24-volts DC when it is powering the circuit, and that IC10's output voltage is +12-volts DC, ± 0.6 volt.

Connect an input signal and monitor or a TV to the Macro-scrubber. Connect the VCR's video output to J1. If you have a video monitor or a TV having a video input, connect the Macro-scrubber's output, J2, directly to that piece of equipment's video input.

If your equipment lacks a video input, you'll need an RF modulator for the channel you normally use when watching your VCR (channel 2, 3, or 4). Connect the video output to the modulator's video input. Connect the VCR's audio output to the RF modulator's audio input. Connect the modulator's RF output to the TV's antenna-input jack or terminals.

Play a video tape that you have already identified as containing *Macrovision* pulses. The picture you see should now be free of interference.

If the *Macrovision*-related viewing problems still exist, or if part of the picture is blanked out, the input-signal level from your VCR may be excessively high or low. In that case, a pattern of holes has been provided in the PC pattern so that fixed resistors R3 and R4 can be replaced with a 20,000-ohm potentiometer. The potentiometer is shown in the schematic by dashed lines, and is identified in the schematic and on the PC placement diagram as R24. (Remember, if you install R24 you must remove R3 and R4.)

To adjust R24, play a *Macrovision* tape, and while observing the TV picture, adjust R24 until the picture appears to be normal—interference-free. **R-E**

In-Circuit Digital IC Tester

BILL GREEN

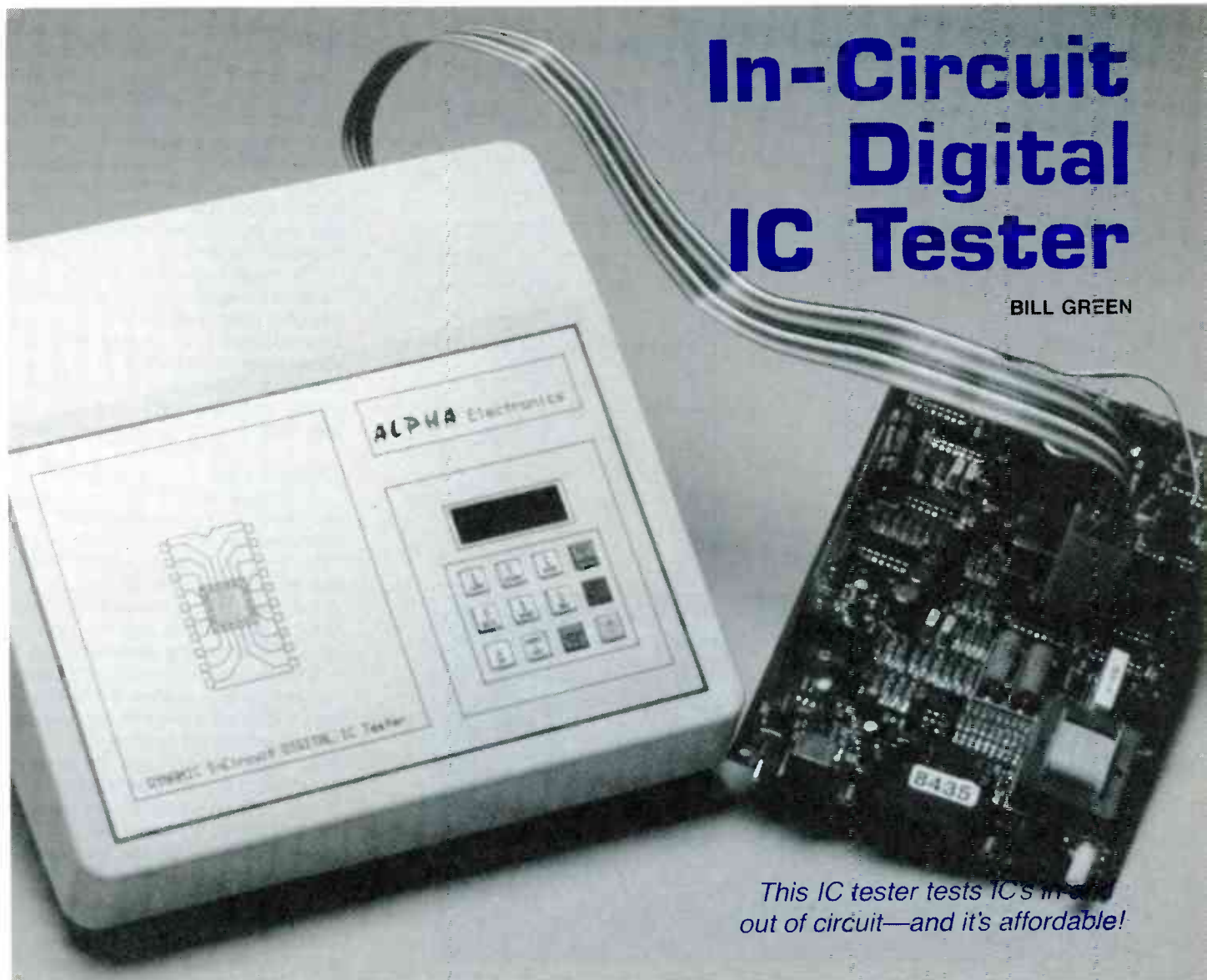

This IC tester tests IC's in-circuit—out of circuit—and it's affordable!

Part 2 LAST MONTH WE BUILT the tester and discussed basic test methodology. Now we'll go on and provide specific examples showing how to set up your own test routines on paper and by computer, and how to send those files to and from your desktop computer.

Before we get started, let's correct a few errors from last month. The schematic of the driver board incorrectly identified P2 and P4. Also, the ordering information should have noted that IC16 and IC17 are not included in the partial kit.

7404 test data

Here is how to generate test data. This procedure applies whether data is entered via external computer using the data-entry routine discussed later, or is entered via the tester's keyboard.

Our first example illustrates the process for a 7404 hex inverter. First, obtain the pin numbers for inputs, outputs, V_{CC} , and

ground, and the functional description (or truth table) from the device's data sheet.

To ease the process of generating the test data, make a copy of the template shown in Fig. 7; then fill in the blanks for the part number, number of pins, and group number. You must make a template for each test group if you need more than one. You may also sketch the part's logic diagram in the box on the template.

Next fill in the data blanks, leaving room to write eight binary digits at each pin that must be tested. If we put a 1 into an inverter, we should get a 0 out of it. So put a 1 in the blank for pin 1, and a 0 by pin 2. Repeat the procedure with the remaining five inverters. Then put an X at pins 7 and 14 to indicate that they will be ignored. Now we have all data for the first test cycle.

There is a total of eight test cycles, so now place a 0 at each input and a 1 at each output. (The X's should remain by pins 7 and 14.) That accounts for two of the eight

bits in this test group's byte, so duplicate the bit pairs four times. Then convert the eight-bit data, four bits at a time, to two hexadecimal digits using the binary/hexadecimal chart at the bottom of the template. The completed test form is shown in Fig. 8.

The test information, along with the part number and the number of pins, is then stored in the tester's memory using the procedure outlined last time. There is no need for more than one test group to test a 7404 completely.

In-circuit example

The data for an in-circuit IC depends on how the IC is connected. For example, input pins may be tied to V_{CC} or to ground, so we tell the tester to ignore those pins. Or, if the IC's input is connected to one of its outputs, ignore the input, because its data will be supplied by the output it's connected to. A sample chart is shown in Fig. 9.

TEST ROUTINE TEMPLATE

PART NUMBER (8 Alphanumeric Digits Maximum): _____
 NUMBER OF PINS (2 Digits Maximum, Even Numbers 4 to 24): _____
 GROUP NUMBER (1 to 5): _____
 REMARKS: _____

Binary Data	Hex	Funct	Pin#		Pin#	Binary Data	Hex	Funct
_____	_____	_____	_____		_____	_____	_____	_____
_____	_____	_____	_____		_____	_____	_____	_____
_____	_____	_____	_____		_____	_____	_____	_____
_____	_____	_____	_____		_____	_____	_____	_____
_____	_____	_____	_____		_____	_____	_____	_____
_____	_____	_____	_____		_____	_____	_____	_____
_____	_____	_____	_____		_____	_____	_____	_____
_____	_____	_____	_____		_____	_____	_____	_____
_____	_____	_____	_____		_____	_____	_____	_____
_____	_____	_____	_____		_____	_____	_____	_____
_____	_____	_____	_____		_____	_____	_____	_____
_____	_____	_____	_____		_____	_____	_____	_____
_____	_____	_____	_____		_____	_____	_____	_____
_____	_____	_____	_____		_____	_____	_____	_____
_____	_____	_____	_____		_____	_____	_____	_____

BINARY TO HEXADECIMAL CONVERSION TABLE

BINARY	HEX	BINARY	HEX
0000	0	1000	8
0001	1	1001	9
0010	2	1010	A
0011	3	1011	B
0100	4	1100	C
0101	5	1101	D
0110	6	1110	E
0111	7	1111	F

FIG. 7—COPY THIS TEMPLATE to simplify generating your own test routines.

Multiple test groups

IC's with pins that can function as both inputs and outputs can be tested as follows. We'll use a 74LS245 octal bus transceiver for illustration. That IC is commonly used to buffer data into and out of a microprocessor; direction of data flow is controlled by a single DIR input (pin 1).

The data for testing the IC in send mode is shown in Fig 10; the data for testing it in receive mode is shown in Fig. 11. Notice that the data in both cases is identical except for the setting of the direction line.

The enable line of a registered (latched) IC must be toggled to ensure that the IC responds when it is enabled, and does not respond when it is not enabled. Fig. 12 shows the test pattern for a 74LS373 octal data latch. The outputs should follow the inputs when the enable line (pin 11) is high, and shouldn't change otherwise.

Clocked logic

A clocked IC that has no means of setting or clearing its outputs will have an indeterminate state before it is clocked. Therefore, all outputs must be listed as indeterminate (D). The first state of a pin defined as indeterminate will be cleared to zero. (Only outputs can be indeterminate.) The remaining 7 states of the group will be processed normally. If more than one test group is needed, the first state of each additional group will not be indeterminate and should be defined as Output. Note in the test data that the clock line goes high in the odd-number cycles (1, 3, 5, and 7). The outputs will only change on those cycles, because the 74LS374 changes state during the leading clock edge. Test data is shown in Fig. 13.

Multiple-output-state devices

An IC with many inputs or outputs may require more than one test group. (Remember that there is a maximum of five test groups per part number). For exam-

PART NUMBER (8 Alphanumeric Digits Maximum): 7404
 NUMBER OF PINS (2 Digits Maximum, Even Numbers 4 to 24): 14
 GROUP NUMBER (1 to 5): 1
 REMARKS: HEX INVERTER

Binary Data	Hex	Funct	Pin#		Pin#	Binary Data	Hex	Funct
_____	_____	_____	_____		_____	_____	_____	_____
_____	_____	_____	_____		_____	_____	_____	_____
_____	_____	_____	_____		_____	_____	_____	_____
_____	_____	_____	_____		_____	_____	_____	_____
0101 0101	55	I	1		14			X
1010 1010	AA	O	2		13	0101 0101	55	I
0101 0101	55	I	3		12	1010 1010	AA	O
1010 0101	AA	O	4		11	0101 0101	55	I
0101 1010	55	I	5		10	1010 1010	AA	O
1010 1010	AA	O	6		9	0101 0101	55	I
_____	X	_____	7		8	1010 1010	AA	O

FIG. 8—TEST DATA FOR A 7404 hex inverter. All states are redundantly checked four times.

PART NUMBER (8 Alphanumeric Digits Maximum): 7404
 NUMBER OF PINS (2 Digits Maximum, Even Numbers 4 to 24): 14
 GROUP NUMBER (1 to 5): 1
 REMARKS: IN-CIRCUIT

Binary Data	Hex	Funct	Pin#		Pin#	Binary Data	Hex	Funct
_____	_____	_____	_____		_____	_____	_____	_____
_____	_____	_____	_____		_____	_____	_____	_____
_____	_____	_____	_____		_____	_____	_____	_____
_____	_____	_____	_____		_____	_____	_____	_____
0101 0101	55	I	1		14			X
1010 1010	AA	O	2		17			X
_____	X	_____	3		12	0000 0000	00	O
0101 0101	55	O	4		11	0101 0101	55	I
_____	X	_____	5		10	1010 1010	AA	O
1010 1010	AA	O	6		9	0101 0101	55	I
_____	X	_____	7		8	1010 1010	AA	O

FIG. 9—TEST DATA FOR AN IN-CIRCUIT 7404. Input pins 3, 5, and 13 are marked X, for "ignore." Those pins might be hard-wired to ground, Vcc, or elsewhere in an actual circuit.

RADIO-ELECTRONICS

PART NUMBER (8 Alphanumeric Digits Maximum): 74LS245
 NUMBER OF PINS (2 Digits Maximum, Even Numbers 4 to 24): 20
 GROUP NUMBER (1 to 5): 1
 REMARKS: SEND MODE

Binary Data	Hex	Funct	Pin#	Pin#	Binary Data	Hex	Funct
				5/R	V _{CC}	20	X
0101 0101	55	I	2	1A	E	19	0000 0000 00 I
0101 0101	55	I	3	2A	1B	18	0101 0101 55 0
0101 0101	55	I	4	3A	2B	17	0101 0101 55 0
0101 0101	55	I	5	4A	3B	16	0101 0101 55 0
0101 0101	55	I	6	5A	4B	15	0101 0101 55 0
0101 0101	55	I	7	6A	5B	14	0101 0101 55 0
0101 0101	55	I	8	7A	6B	13	0101 0101 55 0
0101 0101	55	I	9	8A	7B	12	0101 0101 55 0
	X		10	GND	8B	11	0101 0101 55 0

PART NUMBER (8 Alphanumeric Digits Maximum): 74LS245
 NUMBER OF PINS (2 Digits Maximum, Even Numbers 4 to 24): 20
 GROUP NUMBER (1 to 5): 2
 REMARKS: RECEIVE MODE

Binary Data	Hex	Funct	Pin#	Pin#	Binary Data	Hex	Funct
				5/R	V _{CC}	20	X
0000 0000	00	I	1	1A	E	19	5000 0000 00 I
0101 0101	55	0	2	2A	B	18	0101 0101 55 I
0101 0101	55	0	3	3A	2B	17	0101 0101 55 I
0101 0101	55	0	4	4A	3B	16	0101 0101 55 I
0101 0101	55	0	5	5A	4B	15	0101 0101 55 I
0101 0101	55	0	6	6A	5B	14	0101 0101 55 I
0101 0101	55	0	7	7A	6B	13	0101 0101 55 I
0101 0101	55	0	8	8A	7B	12	0101 0101 55 I
	X		10	GND	8B	11	0101 0101 55 I

FIG. 10—TEST SETUP FOR A 74LS245 octal bus transceiver in send mode.

FIG. 11—TEST SETUP FOR A 74LS245 octal bus transceiver in receive mode.

ple, the 74154 4-to-16 line decoder has four address inputs (pins 20–23), two active-low gate inputs (pins 18 and 19), and 16 outputs, one of which goes low when both gate inputs are low, depending on the state of the four address inputs. Figures 14, 15, and 16 show the data required to test the IC completely.

Advanced commands

After generating test data you'll probably want to store it in your desktop computer. The tester provides storage for as many as 105 test routines, which you may upload to and download from the tester's internal memory.

After entering test data, if you wish to store it, press the Store key, and the data will be stored in memory for future use under the part number that is entered with the data.

To load a test routine from the tester's local memory, press Load and then enter

the part number. If a corresponding routine is in memory, *CLEAR OR ENTER?* will appear on the display. Press Clr to erase the entry from memory, or press Enter to leave the data in the test buffer for testing or transfer to the external computer. To upload the data, press Send. To download it, press Recv. If you wish to retain a received file, press Store. Use the BASIC programs shown in Listings 1 and 2 to send and receive programs.

Remote data generation

The BASIC program shown in listing 3 can be used to create test patterns somewhat more conveniently than on the tester itself. It is important to note that when using the program to generate test files, only hex characters (0–9, A–F) may be used in the part number (TF\$) if the file is to be stored in the Tester's memory. The reason for this is that the Tester's keyboard has no other characters to access the test

routine in its memory. Therefore you would not be able to load or delete the test routine. For example, a part entered as 74LS138 would be inaccessible because there is no L or S on the Tester's keyboard.

Usage hints

First a few words of caution. Never connect the test clip to an IC that has power on it unless the tester is on and *COMMAND?* is scrolling in the display. Conversely, never shut the tester off when the clip is connected to a powered IC. And always make sure when testing in-circuit IC's that the tester and the DUT (*Device Under Test*) share a common ground. Connect the black test hook clip to a ground on the board near the IC's to be tested.

The test drivers (IC7–IC15) are rated at 7 volts maximum, so be careful what you connect the test clip to. A powered RS-232 driver might have ±12 volts, or even more, and voltages at those levels

PART NUMBER (8 Alphanumeric Digits Maximum): 74LS373
 NUMBER OF PINS (2 Digits Maximum, Even Numbers 4 to 24): 20
 GROUP NUMBER (1 to 5): 1
 REMARKS: OCTAL TRANSPARENT LATCH

Binary Data	Hex	Funct	Pin#	Pin#	Binary Data	Hex	Funct
				OE	V _{CC}	20	X
0000 0000	00	I	1	1Q	00	14	1001 0001 91 0
1001 0001	91	0	2	1B	00	18	1001 1001 99 I
1001 1001	99	I	3	2B	70	17	1001 1001 99 I
1001 1001	99	I	4	3B	70	17	1001 1001 99 I
1001 0001	91	0	5	2Q	70	17	1001 0001 91 0
1001 0001	91	0	6	3Q	60	15	1001 0001 91 0
1001 1001	99	I	7	3D	60	15	1001 1001 99 I
1001 1001	99	I	8	4D	50	11	1001 1001 99 I
1001 0001	91	0	9	4Q	50	11	1001 0001 91 0
	X		10	GND	E	11	1011 0011 B2 I

FIG. 12—TEST SETUP FOR A 74LS373 octal transparent data latch. Whenever the enable line (pin 11) is high, each output follows the corresponding input.

PART NUMBER (8 Alphanumeric Digits Maximum): 74LS374
 NUMBER OF PINS (2 Digits Maximum, Even Numbers 4 to 24): 20
 GROUP NUMBER (1 to 5): 1
 REMARKS: OCTAL D EDGE-TRIGGERED FF

Binary Data	Hex	Funct	Pin#	Pin#	Binary Data	Hex	Funct
				OE	V _{CC}	20	X
0000 0000	00	I	1	1Q	00	14	1001 1000 9B 0
1001 1000	9B	D	2	1B	00	18	1100 1100 CC I
1100 1100	CC	I	3	2B	70	17	1100 1100 CC I
1100 1100	CC	I	4	3B	70	17	1100 1100 CC I
1001 1000	9B	D	5	2Q	70	17	1001 1000 9B 0
1001 1000	9B	D	6	3Q	60	15	1001 1000 9B 0
1100 1100	CC	I	7	3D	60	15	1100 1100 CC I
1100 1100	CC	I	8	4D	50	11	1100 1100 CC I
1001 1000	9B	D	9	4Q	50	11	1001 1000 9B 0
	X		10	GND	CLK	11	1010 1010 AA I

FIG. 13—TEST SETUP FOR A 74LS374 octal D flip-flop. Data on each input is clocked into the corresponding output on the leading edge of each clock pulse. Clock pulses are applied to pin 11.

PART NUMBER (8 Alphanumeric Digits Maximum): 74154
 NUMBER OF PINS (2 Digits Maximum, Even Numbers 4 to 24): 24
 GROUP NUMBER (1 to 5): 1
 REMARKS: 4-70-16 LINE DECODER

Binary Data	Hex	Funct	Pin#	Pin#	Binary Data	Hex	Funct
000 000 = 00	0	1	Q0	V _{CC}	24		X
000 001 = 01	1	2	Q1	A	23	0101 0111 = 57	I
000 010 = 02	2	3	Q2	B	22	0110 0111 = 67	I
000 011 = 03	3	4	Q3	C	21	1000 0111 = 87	I
000 100 = 04	4	5	Q4	D	20	0000 0111 = 07	I
000 101 = 05	5	6	Q5	G2	19	0000 0011 = 03	I
000 110 = 06	6	7	Q6	G1	18	0000 0101 = 05	I
000 111 = 07	7	8	Q7	Q15	17	1111 1111 = FF	0
001 000 = 08	8	9	Q8	Q14	16	1111 1111 = FF	0
001 001 = 09	9	10	Q9	Q13	15	1111 1111 = FF	0
001 010 = 0A	A	11	Q10	Q12	14	1111 1111 = FF	0
001 011 = 0B	B	12	GND	Q11	13	1111 1111 = FF	0
	X						

FIG. 14—A 74154 demultiplexer has six inputs and 16 outputs, so it requires three test groups to test all combinations. Group 1 is shown here.

PART NUMBER (8 Alphanumeric Digits Maximum): 74154
 NUMBER OF PINS (2 Digits Maximum, Even Numbers 4 to 24): 24
 GROUP NUMBER (1 to 5): 2
 REMARKS: 4-70-16 LINE DECODER

Binary Data	Hex	Funct	Pin#	Pin#	Binary Data	Hex	Funct
000 000 = 00	0	1	Q0	V _{CC}	24		X
000 001 = 01	1	2	Q1	A	23	0101 0101 = 55	I
000 010 = 02	2	3	Q2	B	22	0110 0110 = 66	I
000 011 = 03	3	4	Q3	C	21	1000 0111 = 87	I
000 100 = 04	4	5	Q4	D	20	1111 1000 = FB	I
000 101 = 05	5	6	Q5	G2	19	0000 0000 = 00	I
000 110 = 06	6	7	Q6	G1	18	0000 0000 = 00	I
000 111 = 07	7	8	Q7	Q15	17	1111 1111 = FF	0
001 000 = 08	8	9	Q8	Q14	16	1111 1111 = FF	0
001 001 = 09	9	10	Q9	Q13	15	1111 1111 = FF	0
001 010 = 0A	A	11	Q10	Q12	14	0111 1111 = 7F	0
001 011 = 0B	B	12	GND	Q11	13	1011 1111 = 8F	0
	X						

FIG. 15—GROUP TWO OF THE 74154 TEST set is shown here.

PART NUMBER (8 Alphanumeric Digits Maximum): 74154
 NUMBER OF PINS (2 Digits Maximum, Even Numbers 4 to 24): 24
 GROUP NUMBER (1 to 5): 3
 REMARKS: 4-70-16 LINE DECODER

Binary Data	Hex	Funct	Pin#	Pin#	Binary Data	Hex	Funct
000 000 = 00	0	1	Q0	V _{CC}	24		X
000 001 = 01	1	2	Q1	A	23	1111 1101 = FD	I
000 010 = 02	2	3	Q2	B	22	1111 1110 = FE	I
000 011 = 03	3	4	Q3	C	21	1111 1111 = FF	I
000 100 = 04	4	5	Q4	D	20	1111 1111 = FF	I
000 101 = 05	5	6	Q5	G2	19	1111 1000 = FB	I
000 110 = 06	6	7	Q6	G1	18	1111 1000 = FB	I
000 111 = 07	7	8	Q7	Q15	17	1111 1011 = FB	0
001 000 = 08	8	9	Q8	Q14	16	1111 1101 = FD	0
001 001 = 09	9	10	Q9	Q13	15	1111 1110 = FE	0
001 010 = 0A	A	11	Q10	Q12	14	1111 1111 = FF	0
001 011 = 0B	B	12	GND	Q11	13	1111 1111 = FF	0
	X						

FIG. 16—GROUP THREE OF THE 74154 TEST set is shown here.

could damage the drivers easily. The display will probably dim if you inadvertently connect the test clip to an IC incorrectly, or if you have entered test data incorrectly. If the display does become

PARTS LIST

All resistors are 1/4-watt, 5% unless otherwise noted.

- R1—22,000 ohms
- R2—330 ohms
- R3—R6—1000 ohms

Capacitors

- C1, C8—1000 μF, 16 volts, electrolytic
- C2, C4—C7, C9—C17—0.1 μF, 10 volts, ceramic disc

- C3—10 μF, 16 volts, electrolytic

Semiconductors

- IC1—Z80 microprocessor
- IC2—DS1230-104 32K nonvolatile RAM
- IC3—MAX233 RS-232 interface
- IC4—75499 custom decoder
- IC5—75498 custom decoder
- IC6—75500 custom decoder
- IC7, IC10, IC13—NE591 open-emitter octal driver
- IC8, IC11, IC14—NE590 open-collector octal driver
- IC9, IC12, IC15—74LS373 octal latch
- IC16—7805 5-volt regulator
- IC17—2-Mhz crystal oscillator
- D1—1N4001 rectifier
- DISP1—DL1414 16-segment decoder/driver/display

Other components

- F1—1-amp pigtail fuse
- J1—9-pin D connector
- P1, P2—right-angle double-row 20-pin male header strips
- P3—right-angle double-row 26-pin male header strips
- S1—miniature SPDT toggle switch
- S2—momentary SPST pushbutton
- S3—S14—momentary SPST keyboard switches
- T1—Transformer, 9.5-12-volts, 1-amp, wall-mount

Miscellaneous: One 10-pin, two 20-pin and one 26-pin double-row female IDC header connectors. Two 12-pin single-row female IDC header connectors. Flat ribbon cable and test clips.

Note: The following are available from: ALPHA Electronics Corporation, P.O. Box 1005, Merritt Island, Florida 32952-1005, (305) 453-3534: Kit of parts for \$299.00 + \$6.00 P&H. Includes all parts, punched and screened panel, case, and labeled keys. Test cable and clips not included. Completely assembled tester for \$399.00 + \$6.00 P&H. Includes test cable with 16-, 20-, and 24-pin IC test clips. Partial kit, including all IC's (except IC16 and IC17), display, and PC boards for \$199.00 + \$5.00 P&H. Three custom IC's (75498, 75499 and 75500) for \$60.00 + \$4.00 P&H. Florida customers please add 5% State sales tax. Canadian customers please add \$3.00 additional postage to all orders. All foreign orders add appropriate postage for Air shipping and insurance.

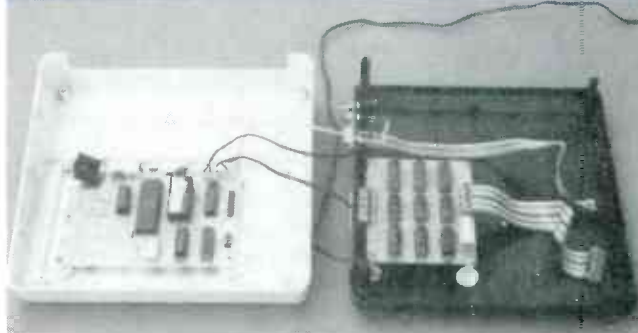

INSIDE THE IC TESTER. Last time we showed you how to build the project; this month we show you how to use it.

dim, disconnect the test clip and remove power immediately.

In addition to testing IC's both in and out of circuit, the tester can also be used as a simple logic analyzer to test as many as twenty four points in a digital circuit. Simply replace the DIP clip with individual test-hook clips. Some lines would be used as outputs to stimulate the circuit, and others would be used as inputs to read the results.

R-E

An oscilloscope is an indispensable troubleshooting tool. Adding a digital readout makes it ideal.

How to Analyze Waveforms

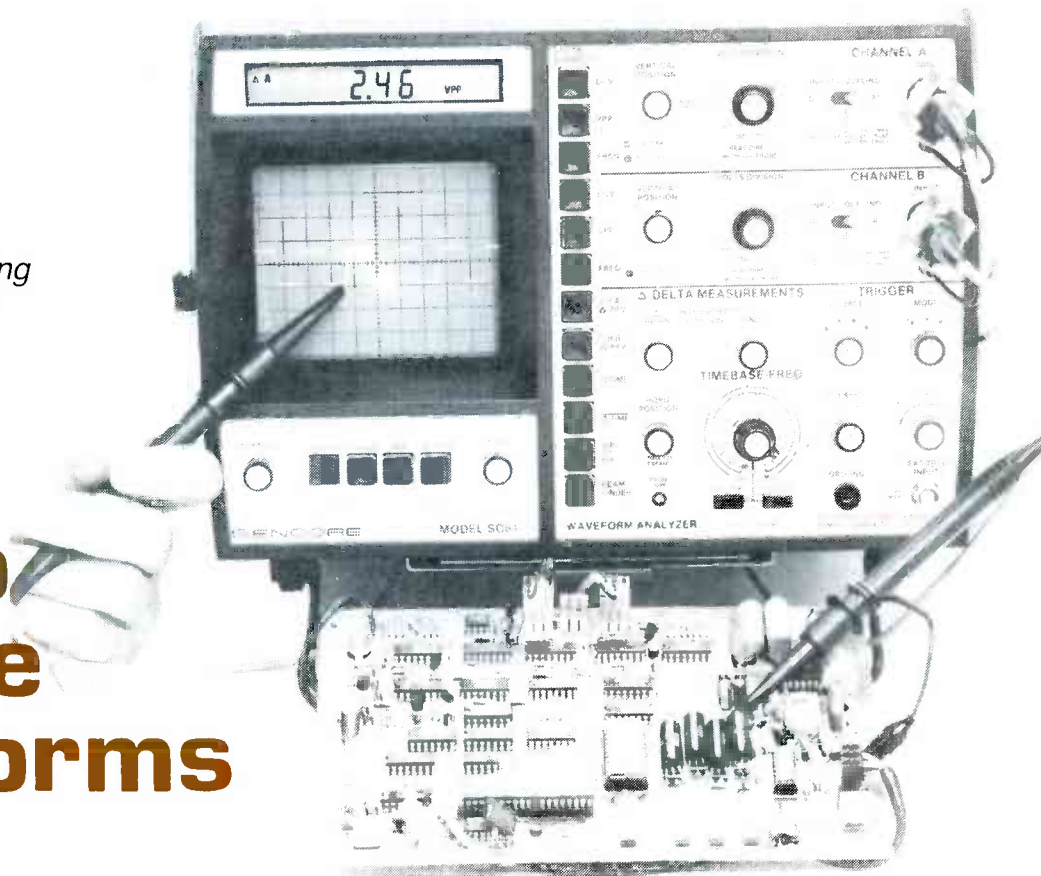

GREGORY D. CAREY, CET

AN OSCILLOSCOPE IS LIKE AN ELECTRONIC stethoscope—it allows you to confirm a circuit's "health" by examining the signals flowing through it. Whether you are designing a circuit, building a project from a magazine, or repairing circuits for a living, the ability to analyze waveforms quickly, accurately, and without mistakes can let you make the most of your technical skills. Unfortunately, many technicians only use their scopes when absolutely necessary. Because of that, they often are unfamiliar with the unit's operation, making waveform interpretation seem difficult. Combining a digital readout with the scope's graphic display, eliminates most of the problems of waveform interpretation.

What is a waveform?

Before we go on, let's be certain that you understand what the waveform on an oscilloscope's CRT screen represents. The CRT graphically displays the relationship between the voltage and time at the test point you're measuring. The vertical movement (deflection) indicates the signal's voltage, with more deflection representing larger voltages. Simultaneously, the beam is moving horizontally at a constant rate, so that each horizontal division on the CRT represents a constant time interval.

Analyzing the signal helps identify

which components are responsible for circuit problems. Let's look at how each part of the waveform helps find different component problems.

The seven waveform parameters

The seven parameters shown in Fig. 1 fully define any signal. Four of those parameters apply to any signal, and the other three apply to complex signals. We will explain how to interpret each parameter and which components are most likely to affect each one.

(1) **Waveshape:** The signal's waveshape confirms the general operation of a circuit. Waveform distortion is often caused by a problem in a reactive compo-

nent, such as a coil or a capacitor. Waveform clipping ("flat-topping") may be caused by saturation of a stage or a power supply with low output. After discovering a waveshape problem, other parameters can be used to provide additional clues about the circuit's operation.

(2) **DC level:** The DC bias at a test point is such an important troubleshooting parameter that many people use their voltmeters as their main piece of test equipment. DC problems may be responsible for problems with any of the other parameters, including distorted waveshape, or incorrect amplitude or frequency. DC problems may be caused by power-supply problems or an open or shorted

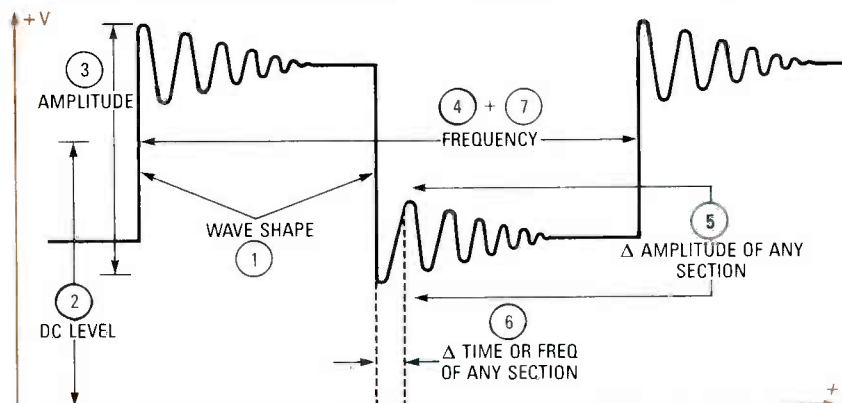

FIG. 1—TO FULLY ANALYZE A WAVEFORM, these seven parameters must be measured or observed.

component somewhere in the circuit. A DC-coupled scope, especially one with a digital readout, allows you to measure DC bias directly, while simultaneously observing the signal's waveshape. The DC and waveform readings also work together when a power supply has excessive ripple, even though its DC output is correct.

(3) Amplitude: The next test is to confirm that the signal has the correct peak-to-peak voltage. Low signal amplitude may be caused by low stage gain or by excessive loading. Poor gain often results from a defective transistor or IC, low power-supply voltage, or a defective emitter-bypass capacitor. Excessive loading may be the result of a component that has shorted or has changed value.

(4) Frequency: Some circuits, such as oscillators, generate signals for use by later stages. Other stages may be referenced to an external source, such as in VCR servo circuits, phase-locked loops, digital counter stages, or television sweep circuits. Testing the frequency of those circuits confirms whether they are working correctly.

Delta measurements

The previous four tests will fully analyze a signal if you are testing a simple waveshape, such as a sinewave or square-wave. If, on the other hand, you are testing a complex signal, you may need to know the details of the secondary parts of the signal to complete the analysis. Those added tests are called *delta* measurements. There are three types of delta measurements as follows:

(5) Delta amplitude: The peak-to-peak voltage test covered earlier measured the total amplitude from the signal's lowest to its highest points. But many signals have additional signals buried within them. For example, an incorrect color-burst level on a composite video waveform (see Fig. 2) may cause color

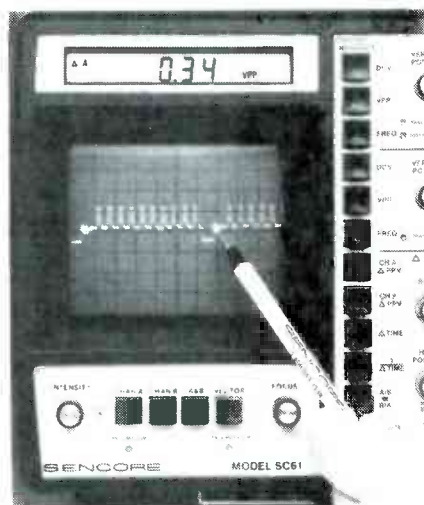

FIG. 2—PERFORMING A DELTA PEAK-TO-PEAK measurement confirms that the color burst of a composite video signal has the correct amplitude.

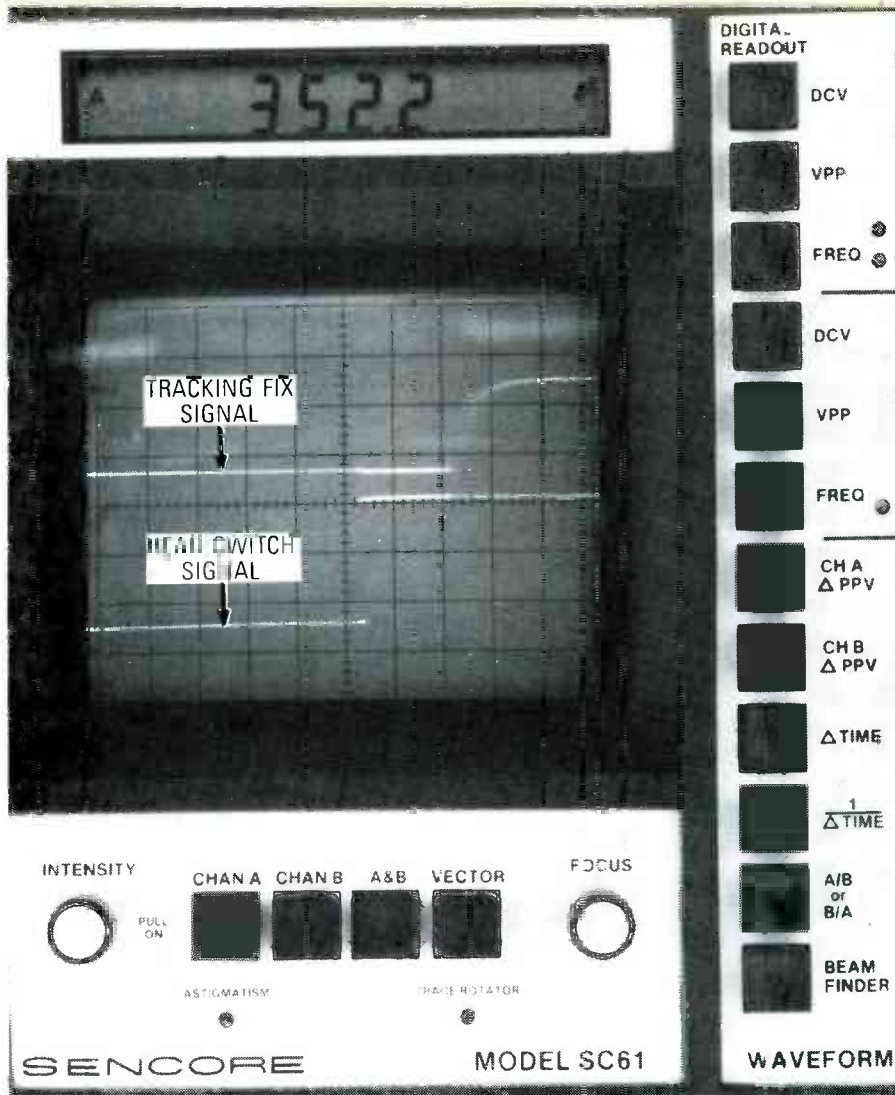

FIG. 3—MAKING A DELTA-TIME MEASUREMENT shows that the difference between a tracking fix and a head-switch signal to be 352 μ s; factory specifications call for a 400 μ s delay.

problems. An incorrect sync-pulse level on the same composite signal may cause sync instability. Ripples or glitches, riding along the top of digital squarewaves may cause later circuits to operate incorrectly. Those conditions can be detected by using delta peak-to-peak voltage measurements, which allow the level of secondary signals to be measured independently of the main signal level.

(6) Delta time: Time measurements fall into two categories: those that are part of one signal, and those involving the time difference between two signals. An example of time within one signal would be the duty cycle of a switching power supply, where the "on-time" compared to the "off-time" determines the power delivered to the load. The time delay between two signals is important in many VCR servo adjustments. See Fig. 3. Either of those applications uses a point on the waveform as a reference for a delta-time measurement.

(7) Reciprocal time measurements: You can determine the approximate frequency of a signal by measuring the time for a single cycle and then inverting the time measurement mathematically. You can use that method to determine the time constant of circuits responsible for ring-

ing, or the frequency of an interfering signal to determine its source.

Digital measurements

You make all seven of those measurements every time you fully analyze a signal with an oscilloscope. Conventional scopes require you to make every parameter reading by measuring beam displacement on the CRT, and multiplying that by the settings of the vertical or horizontal circuit controls. Some scopes with micro-processor-controlled measuring circuits, such as the Sencore SC61 shown in the opening of this article, allow every parameter to be converted to a direct digital reading. The CRT is then only used to display the overall shape of the signal.

A digital readout offers three advantages over using the CRT for measurements: Speed, accuracy, and freedom from errors. Let's look at each of those advantages in a little more detail.

Speed: You may begin to appreciate the time that direct digital readings save when you look at the number of steps needed to make a single measurement on a conventional CRT. Those steps are outlined in Table I. If you use an oscilloscope often, you perform those steps without even

continued on page 82

Strain-Gage Transducers

CLINTON M. WOOD

Strain gages can be used to measure virtually any force-related physical property. In this article we'll see how those versatile devices work.

STRAIN-GAGE TRANSDUCERS, USED IN EVERYTHING from automobiles to zinc plants, have found their way into our homes, our supermarkets, our factories, and our hospitals. They're commonly used in nearly every branch of science and technology, including research, space flight, product development, robotics, automation, energy production, agriculture, and consumer products. They can be used to measure a wide range of force-related physical properties like weight, acceleration, pressure, volume, liquid level, flow rate, and velocity. Further, they are accurate, durable, inexpensive, linear, and inherently simple to use.

Since strain-gage transducers are linear, it's easy to determine the value of a force-related input. All that's required is to divide the output voltage by the transducer sensitivity as shown in Fig. 1. That's because the input and output are related by a simple linear equation. In this article we'll see where that equation comes from, and, in the process, learn something about the underlying principles that are common to all strain-gage transducers. Toward that end, we have divided the strain-gage transducer into three components: 1) the spring element, 2) the strain gage, and 3) the bridge circuit. We'll take a look at each of those compo-

nents to see what they contribute to the operation of the transducer. Then we'll put them back together to see how the complete transducer works.

The spring element

The principle of elasticity, that is the tendency of solids to deform or change dimensions when subjected to an external force, is central to the operation of the strain-gage transducer. It makes no difference whether the force is from a weight, a fluid pressure, or even mechanical inertia; the result is the same.

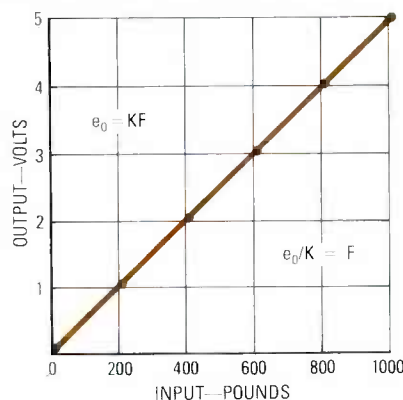

FIG. 1—IN A STRAIN-GAGE TRANSDUCER the relationship between the applied force and the output voltage is linear.

As an example, Fig. 2 shows a steel bar subjected to a force in the form of a weight. In Fig. 2-a the bar is unloaded and has a length of L . In Fig. 2-b, the bar is anchored at the top, and the weight is attached to the bottom. In that case, the resulting deformation will appear as an increase in length. In Fig. 2-c, the weight is placed on top of the bar. That will result in a decrease in length. Note that no matter how the bar is loaded, it will return to its original length when the weight is removed, provided that the applied force was not so large as to cause the bar to permanently stretch or break. The change in length resulting from an applied force is known as strain. For metallic solids like steel or aluminum, the maximum allowable strain before deformation is in the range of a few thousandths of an inch.

The property of elasticity is widely used in the manufacture of instruments because there is a linear relationship between strain and the applied force. This relationship can be expressed as

$$S = kF \quad (1)$$

where F is the applied force, S is the resulting strain, and k is the spring-element constant; the value of k depends on a number of things like the geometry and type of material, and the direction of the

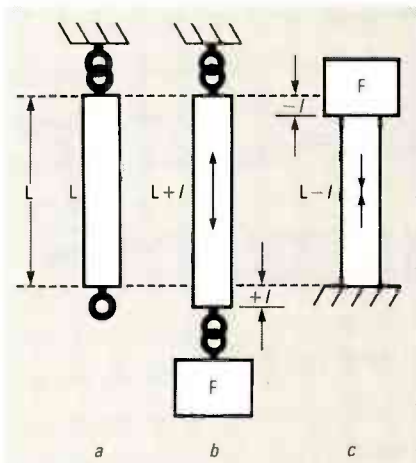

FIG. 2—IF A STEEL BAR (a) is loaded, its length will change. Depending on the placement of the load, the bar will either expand (b) or contract (c).

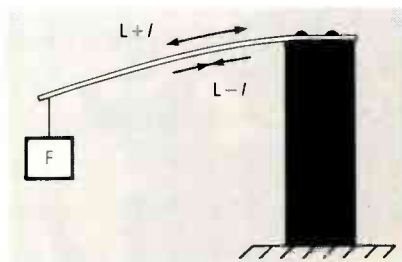

FIG. 3—WHEN FORCE IS APPLIED to the free end of the arm, the upper surface will expand and the bottom surface will contract.

applied force. That relationship, known as Hooke's Law, was originally applied to coil springs for use as a measure of weight. But we have since recognized that, within limits, it is essentially true for all solids.

The spring element is the foundation of the strain-gage transducer. It is an elastic solid (usually metallic) designed to linearly translate an applied force into an equivalent strain. Its size and shape depend on the magnitude and type of force that the transducer is to sense. A spring element could be as simple as the steel bar in Fig. 2, but a design of that type provides only one direction of strain in response to an applied force. If the applied force can produce two equal strains that are opposite in direction, the resulting transducer will be more accurate. That is often done by applying a force to the spring element in a way that will make it bend.

Figure 3 shows one way that can be done. A rectangular steel bar is anchored at one end in a cantilever configuration. The force is applied to the free end of the bar, perpendicular to the axis, rather than along the axis as in Fig. 2. As a result, the upper surface of the bar will stretch, and the bottom surface will compress. The surface strain will vary along the bar, from a maximum near the end that is anchored, to zero at the other end. But at any given position along the bar, the strain of the

upper and lower surfaces will be equal in magnitude and opposite in direction. Later we will see that those opposing strains can help stabilize the transducer against varying environmental conditions that may occur.

Some commercial transducers use spring elements that are similar to the cantilever configuration, but there are a great many other designs that are used as well—in fact, too many to discuss here realistically. Fortunately, a study of the design variations is unnecessary as long as you remember that a spring element is a structural component designed to provide a linear deformation in response to an applied force.

The strain gage

The purpose of the strain gage is to convert the strain of the spring element into an equivalent change in resistance. A strain gage is just a metallic conductor that is bonded to the spring element, stretching and compressing in the same way as the spring element. We know from basic electricity that the resistance of a conductor depends on its length. And, we know that if we place it in tension its length will increase as the steel bar did in Fig. 2. Since resistance is proportional to length, that stretching will result in an increase in resistance. If we turn that around and put the conductor into compression, its resistance will decrease.

Figure 4 shows a typical commercial strain gage. It consists of a thin foil conductor bonded to a plastic backing material. The backing, which serves as a carrier for the metal foil and provides insulation from the spring element, must be flexible enough to follow the spring element, yet tough enough to transfer the strain to the metal foil. The foil conductor is usually made of an alloy having a low temperature coefficient, like constantan. To keep the strain gage reasonably short, the foil has been laid out in a criss-cross pattern over the surface of the backing material. At one end, the foil expands to form two solder tabs which are used to attach lead wires to the strain gage. Although the design shown in Fig. 4 is typical, a number of other designs are available, including multiple gages on a single backing and circular gages for use with diaphragm-type pressure transducers. A number of designs from one supplier, Transducers Inc. (14030 Bolsa

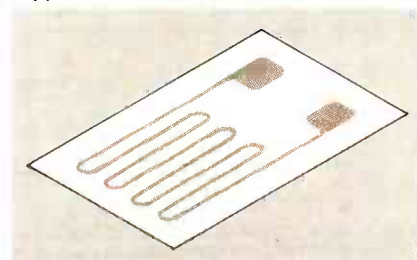

FIG. 4—A TYPICAL strain-gage design.

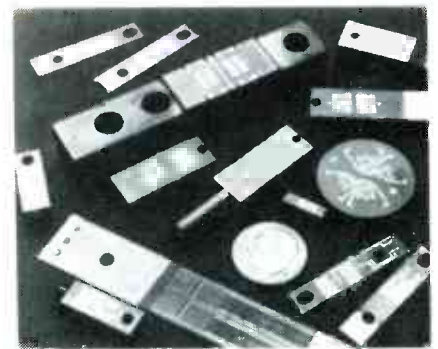

FIG. 5—STRAIN GAGES are made in a number of configurations and designs for different applications.

Ln., Cerritos, CA 90701), are shown in Fig. 5.

The strain gage is usually bonded to the spring element with an adhesive like epoxy. The quality of the bond is critical since the adhesive must accurately transfer any spring-element deformation to the strain gage. A poor bond will result in "creep"—a slippage between the strain gage and the spring element. That will make it look as if the input is slowly changing when, in fact, it is not.

The change in strain-gage resistance is related to strain by the gage factor, that is defined as the ratio of the unit change in resistance to the strain, or:

$$G = (r/R)/S \quad (2)$$

where G is the gage factor, R is the initial (unstrained) resistance of the gage, S is the strain, and r is the change in resistance resulting from a change in length. Most strain gages have an initial resistance of 120 or 350 ohms. For most metal-foil strain gages, the gage factor is usually between 2 and 3; the precise value depends on the composition of the alloy used for the foil conductor.

The last equation can be rewritten in terms of r , or:

$$r = GRS \quad (3)$$

That shows that, since both R and G are constants of the strain gage, the change in resistance is proportional to the strain.

Most strain-gage transducers use metal-foil strain gages. However, transducers using semiconductor strain gages are gaining popularity. Instead of a metal alloy, they are built using a semiconductor material. Functionally, they are similar to metal-foil gages, but they have a higher initial resistance and a larger gage factor. Since they can be made very small, they are often used in miniature transducers.

The bridge circuit

So far, we've seen that the change in strain-gage resistance is proportional to the change in the length of the spring element. And we've seen that the change in the length of the spring element is proportional to the applied force. Since both of those relationships are linear, we can

say that the change in resistance is proportional to the applied force. But a resistance change itself is not always a convenient parameter to measure because data loggers, computers, and process controllers usually require a voltage or current signal.

We could convert the resistance change into a voltage change by connecting a resistor in series with the strain gage and applying a DC voltage across the pair. If we used a series resistor of the same value as the strain gage and applied 5-volts DC, the voltage at the junction of the strain gage and the resistor would be 2.5 volts. A change made in the strain-gage resistance would then produce a change in that voltage.

Notice that it is the change in voltage that we want, because it is the change in voltage that is proportional to the change in resistance. But the change will be very small compared to the initial value of 2.5 volts. It's as if the desired signal voltage has been summed with a large, unwanted DC bias voltage. We can't amplify the small change until we eliminate the initial 2.5 volts. In transistor amplifiers, DC bias is often removed with a coupling capacitor, but we can't use that technique here because we want the steady-state voltage change as well as the dynamic change. What we need is some way to null out the initial voltage level.

One approach would be to configure the strain gage in a resistance bridge, as shown in Fig. 6. If the three resistors and the strain gage were all of the same resistance, the voltage at the junction of each pair would be the same. As a consequence, the voltage difference from one junction to the other would be zero. If we consider that voltage difference to be the output, (e_o) then we have effectively nulled out the initial voltage but preserved the DC response of the strain gage. We have also re-invented the Wheatstone bridge.

Unlike the Wheatstone bridge, though, balancing serves only to null out the initial voltage level. To make a measurement with that type of circuit, the bridge must

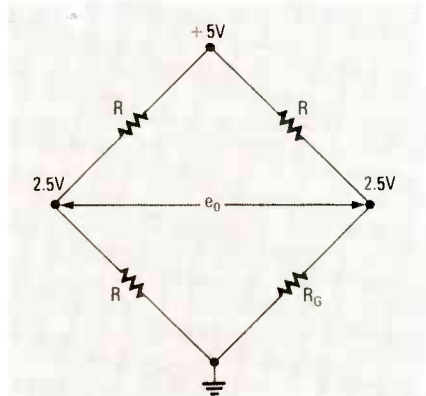

FIG. 6—USING A BRIDGE CIRCUIT allows us to null out the bridge supply voltage and only see the DC response of the strain gage.

be unbalanced by a change in the strain-gage resistance. That will cause a change in voltage difference across the bridge. We can use that change as an indication of the change in strain-gage resistance.

In the circuit of Fig. 6, you will find that for very small resistance changes, the output voltage appears to be a linear function of the change in resistance. But, as the change becomes larger it is no longer linear. We could limit the non-linearity to an acceptable level by limiting the change in resistance. But there is a better way.

Non-linearity can be eliminated entirely by building the bridge from four identical strain gages, instead of just one. The resulting circuit, which is known as a four-arm, fully-active bridge, is shown in Fig. 7.

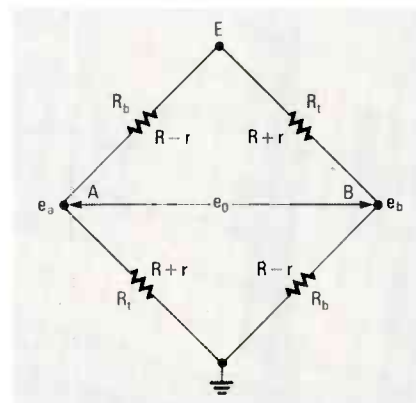

FIG. 7—A FOUR-ARM, FULLY-ACTIVE BRIDGE is made up of four identical strain gages.

The output of that bridge is a linear function of the change in strain-gage resistance, provided that the change in each strain gage is identical and that the change in two of the gages will result in an increase in resistance while the change in the other two will result in an identical decrease. In addition to being linear, the output of the circuit is higher and less sensitive to environmental changes than that of the single-gage bridge configuration. That type of circuit is used almost exclusively in strain-gage transducers.

To see how it works, let's use the spring element again as shown in Fig. 8. At some point near the fixed end of the bar, we will bond two of the strain gages to the upper surface, and the other two directly below them on the lower surface. In Fig. 8, R_t refers to the gages on top of the spring element and R_b refers to those on the bottom. When no force is applied to the bar, the top and bottom surfaces will be the same length. Since all four of the strain gages have the same initial resistance, the bridge will be balanced and the potential difference across the bridge will be zero. If we now apply a force to the end of the bar, the upper strain gages will increase in length and the lower gages will decrease. That is shown in Fig. 8 as $R+r$

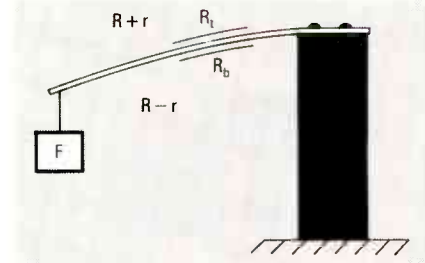

FIG. 8—WHEN FORCE IS APPLIED to the end of the spring arm, the resistance of the strain gages on its upper and lower surfaces change by equal but opposite amounts.

and $R-r$. Note that since the upper and lower strains are equal, r is the same for all four gages. But, since they are opposite in direction, r is then added to the gages on top and subtracted from the gages on the bottom.

We can show that the relationship between the voltage difference across the bridge and the change in resistance is linear. The first step is to find an expression for the voltage at point A (e_a) of the bridge (as shown in Fig. 7) as a function of the change in resistance. If we look at the bridge circuit as the parallel combination of two series resistances, we can see that the voltage at point A is given by:

$$e_a = I(R+r) \quad (4)$$

where I is the current in the left leg of the bridge. But I can be expressed as:

$$E/[(R-r) + (R+r)] = E/(2R) \quad (5)$$

where E is the bridge supply voltage. Combining those equations yields:

$$e_a = E(R+r)/(2R) \quad (6)$$

We can find an expression for the voltage at point B of the bridge in the same way, which yields:

$$e_b = E(R-r)/(2R) \quad (7)$$

Since e_a and e_b are both referred to ground, the difference in potential (e_o) between point A and point B is just the difference between e_a and e_b , or:

$$e_o = e_a - e_b = E[(R+r)/(2R)] - E[(R-r)/(2R)] \quad (8)$$

That can be further reduced to:

$$e_o = Er/R \quad (9)$$

The last equation shows that the bridge output voltage is directly proportional to the change in strain-gage resistance.

The four-arm fully-active bridge has another advantage over the single strain-gage bridge. While the single strain gage is mounted on the spring element, the other three resistors must be mounted in a strain-free location. That means that the strain gage could be subjected to temperature changes that are different from those seen by the other three resistors. Since a temperature change will cause a

continued on page 83

The Early Days of RADIO

*More nostalgia
from radio's
pioneer days.*

Part 5 AS IMPORTANT AS AMPLIFICATION was during radio's early days, an even more important receiver criterion was selectivity. Selectivity is a measure of the ability to receive closely spaced signals without interference from each other. Improved selectivity was usually attained by using taps on the antenna coil to increase its Q through better impedance matching on both sides of the antenna coil. Figure 1 shows two "selective" circuits used by the early radio experimenters. In Fig. 1-a the taps on both the primary and the secondary of antenna coil L1 are adjusted for best reception or minimum interference. In Fig. 1-b a separate tapped antenna loading coil (L2) is used to peak the antenna itself for a particular range of frequencies, and a tapped inductor (L3) increases the



impedance that L1 "sees" when looking into the rectifier.

But better selectivity created an unforeseen problem: insufficient receiver sensitivity. Being able to tune between the local powerhouse signals allowed the listener to partially hear much weaker signals from far-away places, and so was born "DX'ing"—DX'ing meaning the reception of distant signals. Unfortunately, crystal detectors could not provide sufficient volume from the weak DX stations. The need for more volume, coupled with a sharp decrease in the price of vacuum tubes, sounded the death knell for the crystal receiver. At first, only one tube was used for amplification; then, two; and finally three or more as designers learned how to build multi-stage amplifiers that didn't break into self-oscillation if the canary chirped.

Audio coupling

As shown in Fig. 2, early audio amplifiers used transformer coupling between

stages, starting at the crystal detector. The transformers provided an amplifier's plate load, DC blocking, and AC coupling into the following stage. Though the transformer simplified interstage connections, the DC current flowing in the primary winding of the amplifier-output transformers caused core saturation, which reduced the effective inductance of the transformer—thereby producing a distorted sound. Known as *hysteresis* distortion, it marked the beginning of awareness of the need for better sound quality.

Various attempts were made to get around core saturation. The most effective, of course, was to use a transformer with "more iron," but this led to transformers that weighed more than a small boat anchor. The next attempts at reducing core saturation were the circuits shown in Fig. 3, where the transformer was isolated from the DC circuit. The tube got its plate voltage either through an adjustable power resistor (R in Fig. 3-a) or through

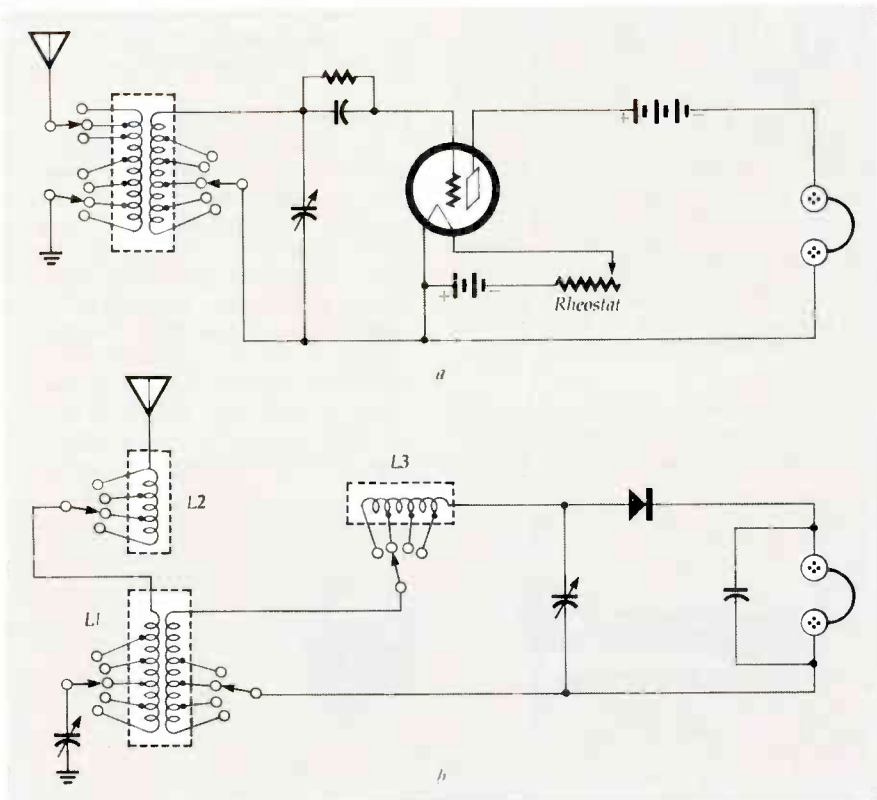

FIG. 1—SIMILAR TUNING METHODS were used for both single-tube and crystal receivers.

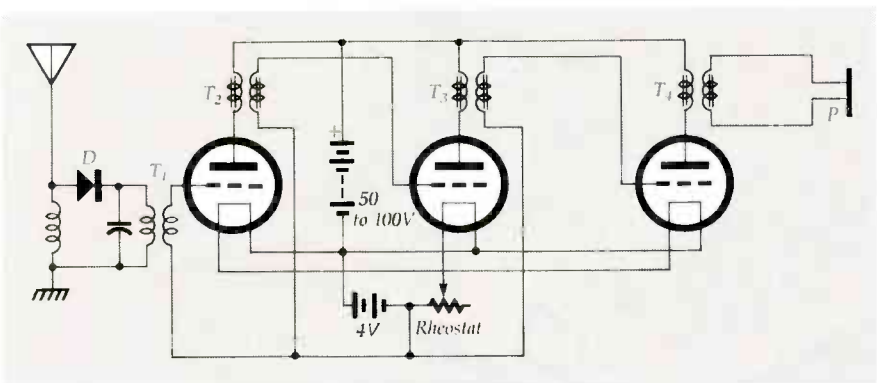

FIG. 2—INITIALLY, A CRYSTAL receiver's multistage audio amplifier was transformer coupled.

an inductor (L in Fig. 3-b). In both instances, capacitor C effectively isolates interstage transformer T from the DC plate voltage/current.

Neither circuit became popular because resistor R required a larger-than-usual battery voltage, while inductor L was frequency-selective.

One of the first attempts to eliminate the interstage transformer completely was the impedance-coupling circuit you'll find shown in Fig. 4. Unlike the interstage transformer, it did not supply voltage step-up. Also, as with other attempts to use an inductor as the plate feed, coil L was frequency-selective.

Resistance coupling

The really big breakthrough in both performance and production cost was the re-

sistance-coupled circuit shown in Fig. 5. It was inexpensive to build, had no inductors or transformers to saturate, and was not frequency-selective. Hence, it resulted in better sound quality. The disadvantage of resistance coupling was that the voltage drop across plate load-resistor R necessitated a higher battery voltage to make up for the voltage drop.

The disadvantages of resistance, transformer, and impedance coupling were overcome in 1931 by the invention of the first practical direct-coupling system by E.H. Loftin and S.Y. White. As shown in Fig. 6, in the direct-coupled amplifier the plate of one stage was directly connected to the grid of the following stage. Its advantages were its low manufacturing cost, and the possibility of greater fidelity, because it contained no frequency-discrimi-

nating components. Early units had a flat frequency-response capability of 30 Hz to 7,000 Hz, with the possibility of extending the upper limit to 10,000 Hz, which was an upper limit for those days.

Electron flow

Prior to the invention of the diode and

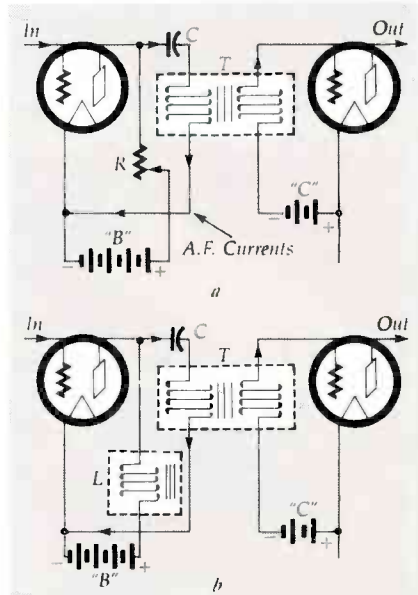

FIG. 3—THESE ARE TWO WAYS by which DC was kept out of the interstage transformer.

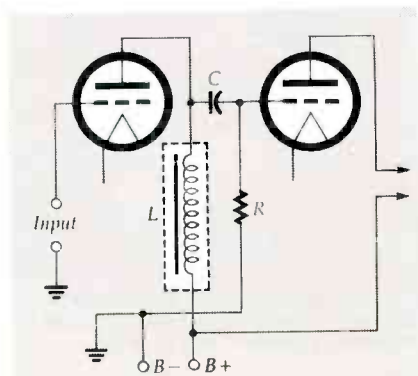

FIG. 4—IMPEDANCE COUPLING eliminated the interstage transformer, but still used an inductor (L) for the plate load.

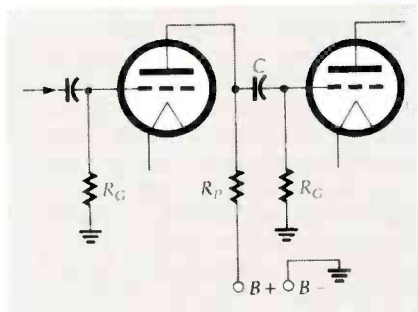

FIG. 5—IN RESISTANCE COUPLING there is neither a transformer nor an inductor. Resistors R_p and R_g and capacitor C3 provide the interstage coupling.

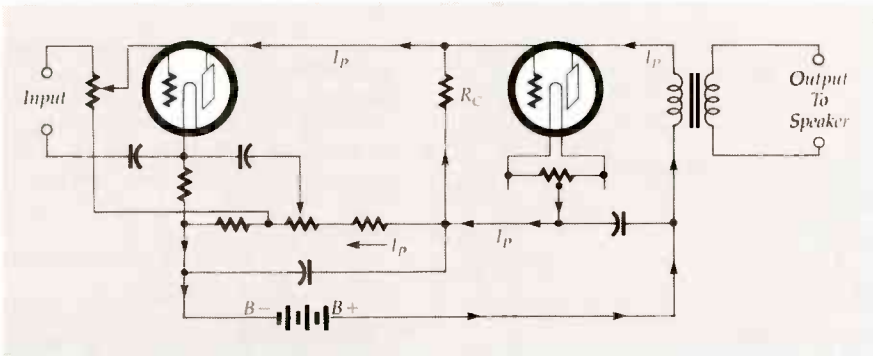

FIG. 6—DIRECT INTERSTAGE COUPLING provided the best fidelity. Note that the direction of the arrows indicates what is called "conventional current flow"; something that never really existed.

were held together with string or a rubber band (Fig. 7-b). The value of the capacitance thus achieved was unknown, but it didn't matter because it was usually used for a non-critical receiver circuit.

Headphones and speakers

As shown in Fig. 8, headphones evolved from the telephone industry; in fact, the first earphone was the "roaring twenties" standard telephone receiver, and its spin-off watchcase receiver (Fig. 8-a)—which was specifically designed for use with a radio. Although both types worked with radio receivers, they had two problems: (A) they were fatiguing because they had to be supported by hand, as shown by the complete radio in Fig. 8-b; (B) they had a very low impedance of approximately 75 ohms. Eventually, their

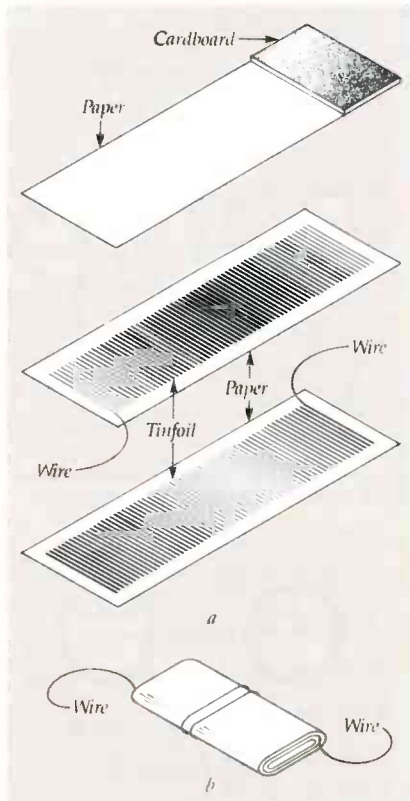

FIG. 7—EXPERIMENTERS MADE CAPACITORS from interleaved strips of tin foil and paper held together by a rubber band or string.

rows shown in Fig. 6, an original drawing of the Loftin-White direct-coupled amplifier, indicates conventional current flow.

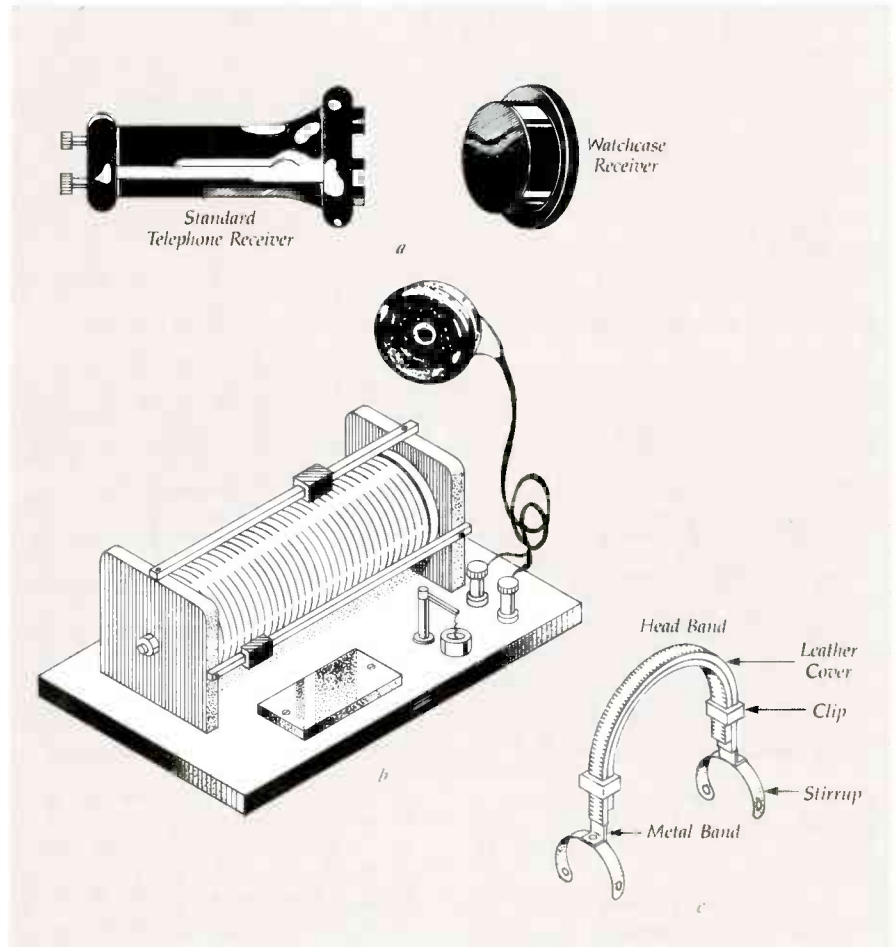

FIG. 8—THE DEVELOPMENT OF HEADPHONES: It started with a conventional telephone receiver, and ended in a headband.

triode tubes, the movement of an electron current was thought to be from positive to negative, a concept based on the ideas of Benjamin Franklin, who, having a 50-50 chance of guessing right, guessed wrong. Current flow in a vacuum tube clearly showed that current moved from a negative filament (cathode) to a plate (anode) that carried a positive charge. Although correct, the electron concept confused many experimenters, technicians, and engineers who had adopted the positive-to-negative concept and were most unwilling to give it up. Consequently, the electric and electronic industries compromised, and positive-to-negative current flow was called *conventional current flow*, while negative-to-positive current flow was called *electron flow*. For example, the ar-

Capacitors

In the early days of radio, to avoid the relatively high cost of capacitors, many experimenters and hobbyists "rolled their own" using the tin foil from a pack of cigarettes and small sheets of paper. As shown in Fig. 7-a, alternate layers of foil formed the plates of the capacitor, whereas the paper was used for the dielectric. The interleaved sheets of tin foil and paper

impedance was increased to about 100 ohms, and finally to about 1000-3000 ohms. Fatigue was mitigated when the headband shown in Fig. 8-c was invented. It allowed the user to literally "wear" the receiver. When one or two receivers were mounted in a headband the entire assembly was called a "headphone," "headphones," or "headset."

continued on page 76

R-E ROBOT

This month, we add the first of the R-E Robot's sensors—an electronic eye.

Part 12 AT THIS POINT, OUR robot is an efficient tractor unit, moderately intelligent, with plenty of pulling power. He can carry items from place to place, and can understand complex instructions. However, he is also as blind as a bat. To make the unit as useful as possible, we must give it a way to see.

You can fully appreciate the severity of the problem by imagining the following example: You are at the end of a hallway. Several doors can be chosen. Look carefully, close your eyes and, without touching or peeking, walk forward and turn into a doorway.

That is what we were asking the robot to do when we programmed the MAILBOT example in Part 9 of this series (**Radio-Electronics**, August 1987). Instructions like "Go forward 10 steps, turn right, and then go forward again 10 steps" seem clear enough on paper, but what if you did not turn exactly 90 degrees? What if your steps were short for some reason? Worst of all, what if you lost your bearing and had to start over, all without peeking?

To make it easier for the robot to get around, we will give it the ability to detect and track light sources. That capability will allow the robot to follow a light beam or an optical stripe on the floor.

Ideally, we also would like to provide the robot with the capacity to determine the distance to a light source and to triangulate its position using several light sources. Unfortunately, the software required to perform those last two tasks is quite formidable, and at this time is far from being fully developed. For now, we will discuss the problems involved in giving

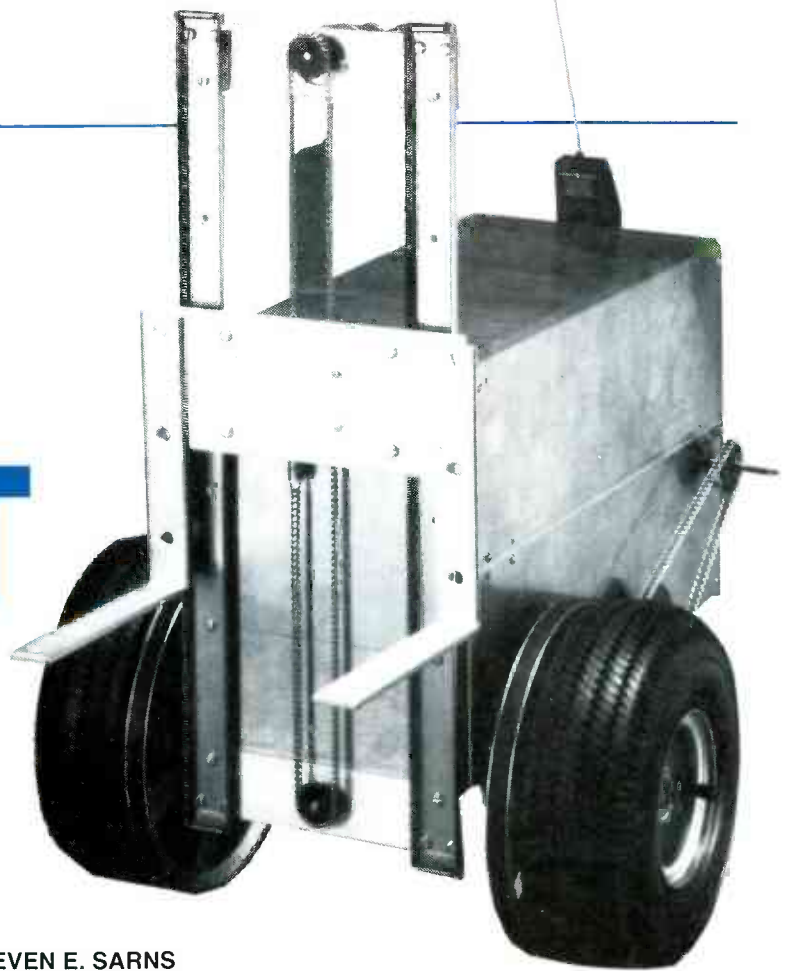

STEVEN E. SARNIS

ing the robot those capabilities, and the hardware needed to input the data that future software will require.

The robot eye will eventually be mounted on a rotating platform, or "head." The head will contain the electronics for a number of the robot's sensors and will be discussed in more detail in the next installment of this series. The head will move the eye through a few degrees, mapping light intensities at several points. The data collected in that way will be used by all of our navigation schemes.

Navigation schemes

The navigation scheme that we will implement now permits the robot to track a light beam. The robot will rotate the eye until a light-intensity maxima is determined. The robot will then angle toward that maxima.

For the future, position-finding is merely an extension of that navigation technique. By mapping the maxima of several known light sources, the robot can determine its position fairly accurately using triangulation.

For range-finding, we will need to add a second eye to the head. Then, the robot can use parallax to determine the distance between it and an unknown light source. The parallax principal, in which the difference in viewing angle at two points that are equidistant from the third are used to determine the distance to that point, is

what provides humans with depth perception: the two equidistant viewing points are our two eyes. See Fig. 1. Note that the technique is only good at relatively close ranges. But remember that even humans lose their depth perception at distances beyond 30 feet.

The human eye

In terms of design, the human eye is difficult to match. The spectral response is not too wide, ranging from 360 to 780 nanometers, but color is of secondary importance to other factors. The eye is capable of resolving details as small as one minute of arc ($1/60$ of a degree). And most importantly, the eye can operate in a very wide range of light intensities, ranging from star-lit night to bright sunlight. If those light levels are quantized, you will find that the range is on the order of 180 dB, or a billion to one.

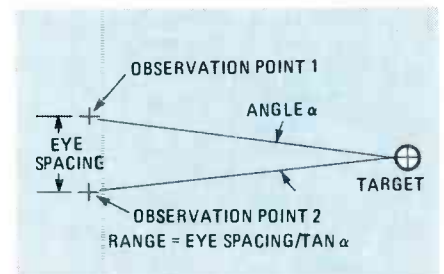

FIG. 1—USING PARALLAX to determine the distance to an object.

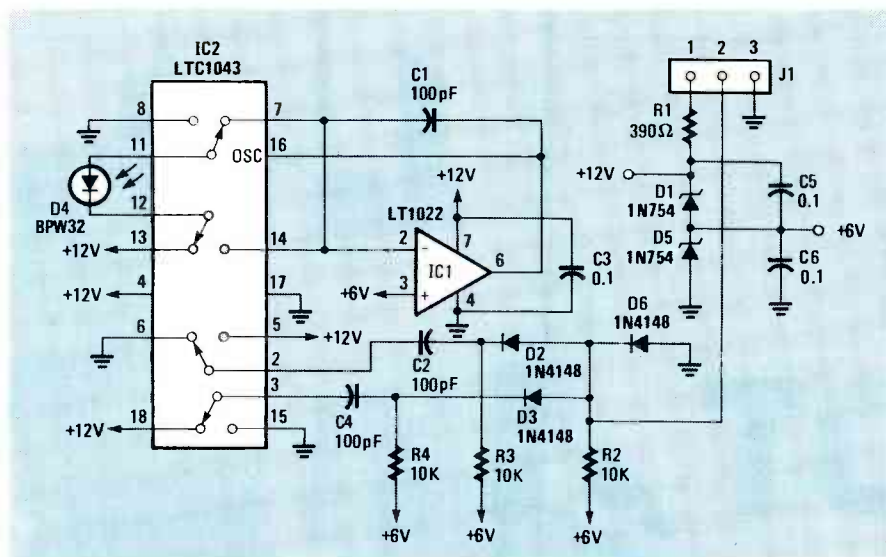

FIG.2—THE ROBOT'S EYE. The photodiode, D4, can be configured to source or sink current by IC2.

The robot eye

Our design goal was to make the robot's eye useful over as wide a range of light conditions as possible. While it is unlikely that you will need to have the robot navigate by starlight, giving the robot low-light capabilities will increase its distance range. Since light follows the inverse square law, that is, the illumination is inversely proportional to the square of the distance, light levels fall rapidly as you move away from the source. At the same time, operation at conventional ambient light-levels must be possible, and the robot should be able to deal with most common light sources.

Therefore, we feel that the minimum acceptable range should span at least 4 orders of magnitude (10,000:1 or 80 dB); that corresponds (using the inverse square law) to tracking an ideal light source over a 100:1 distance range. The maximum possible dynamic range using readily available components is about 120 dB. That corresponds to a light range of 1,000,000:1, or a distance range of 1000:1.

We choose .01 lux as the lowest light level that we wish the sensor to respond to. A lux is the amount of light falling on

one square meter from a candle located one meter away. That is at the extreme low-end of most detectors so to improve performance we will enhance the unit's light-gathering power with a Fresnel lens. Focusing a 4-square-inch Fresnel lens will amplify the light level by a factor of 100. If we were to focus such a lens on the sensor, a light level of .01 lux at the lens will result in a light level of 1 lux at the sensor. Most detectors can work with such a light level.

As we mentioned earlier, future range-finding requires that the robot be equipped with two eyes. Those will be mounted 10-inches apart on the head. If the robot can locate a light source to within 5 degrees of arc, that spacing will allow range finding at distances of up to 30 feet.

Selecting a sensor

Many different sensors for measuring illumination are available. Phototransistors, photodiodes, and PIN photodiodes are all common and well understood.

If our prime design criteria is dynamic range, then we must choose the device with the largest sensitivity range. The key parameter in determining a unit's sensitivity is its *dark current*; that is the leakage current that flows when no light reaches the device. In general, photodiodes have the greatest ratio between dark current and high-illumination output. One, the Siemens BPW32 has a rated dark current of less than 10 pA and a high-level output at 10,000 lux of 100 μA. Those figures represent a dynamic range of 140 dB. Typical output currents of that photodiode for various light levels are shown in Table 1.

Note that the photodiode's output current becomes non-linear above 1,000 lux and below .001 lux. Also, remember that linearity can also be affected by the supporting circuitry. If you can not locate the

PARTS LIST

All resistors are 1/4-watt, 5%

R1—390 ohms
R2—R4—10,000 ohms

Capacitors

C1, C2, C4—100 pF, ceramic disc
C3, C5, C6—0.1 μF, ceramic disc

Semiconductors

IC1—LT1022 op amp (Linear Technology)
IC2—LTC1043 IC switch (Linear Technology)

D1, D6—1N754 Zener diode
D2, D3, D5—1N4148 diode
D4—BPW32 photodiode (Siemens)

Other components

J1—male header

Miscellaneous: Fresnel lens, PC board, wire, solder, etc.

The 2.3-inch Fresnel lens can be ordered for \$10.00 each, plus \$6 postage and handling, from Edmund Scientific Company, 101 East Gloucester Pike, Barrington, N.J. 08007, (609) 573-6250. The part number is E32,589. NJ residents must add appropriate sales tax.

A bare printed-circuit board for the eye can be obtained from Vesta Technology Inc., 7100 W. 44th St., Wheatridge, CO 80033, (303) 422-8088, for \$19 each. An assembled and tested eye PC board, Fresnel lens not included, is available for \$59. CO residents must add appropriate sales tax.

Siemens component, a suitable substitute is NEC's PH201A photodiode.

The circuit

A schematic diagram of the eye circuit is shown in Fig. 2. The BPW32 photodiode, D4, provides an output current that is proportional to the illumination level. That small current will span a range of 10 million to one. If we were to convert the current into a voltage and the voltage into a binary number with an analog-to-digital converter, we would need a 23-bit unit! For example, if the full-scale voltage was 5, then the least significant bit would be 5 microwolts. Such a unit, if you could find one, would cost thousands of dollars.

Instead, we will convert our current into a frequency and use the RPC (Robotic Personal Computer) to determine the period of the frequency. That will give us the dynamic range that we need, since a 140-dB range can be accommodated using a frequency band of 0.1 Hz to 1 MHz. The circuit will output approximately 200 kHz when held 3 inches away from a 60-watt light bulb in a reflective lamp. The circuit will output 0.5 Hz when illuminated by the trace of an oscilloscope 2 feet away.

The frequency range used is critical. The eye must rotate a small amount, take a reading and repeat the process continu-

continued on page 84

TABLE 1

Light Level	Photodiode Current
10,000 lux	100 μA
1,000 lux	10 μA
100 lux	1 μA
10 lux	100 nA
1 lux	10 nA
0.1 lux	1 nA
0.01 lux	100 pA
0.001 lux	10 pA
0.0001 lux	1 pA

PC SERVICE

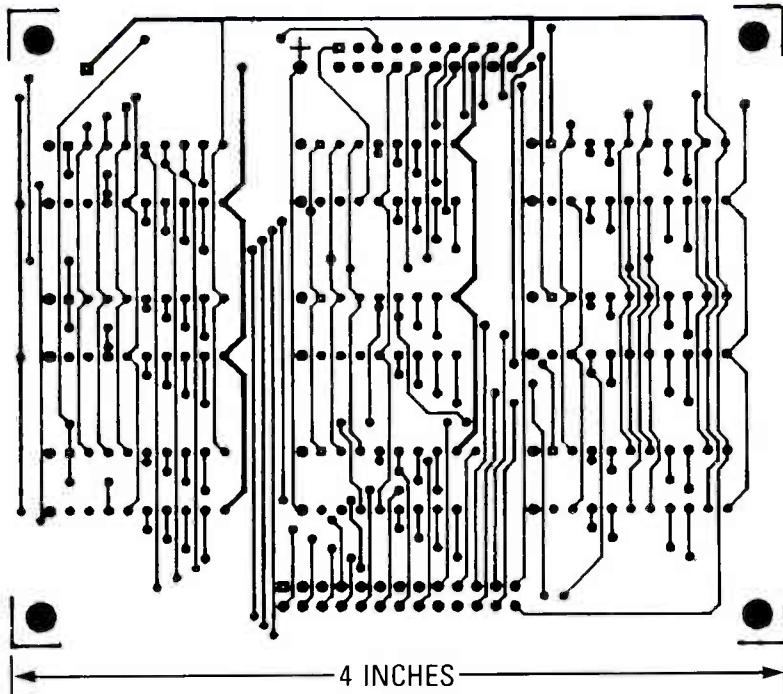

THE IC TESTER'S DRIVER BOARD. The foil side is shown here.

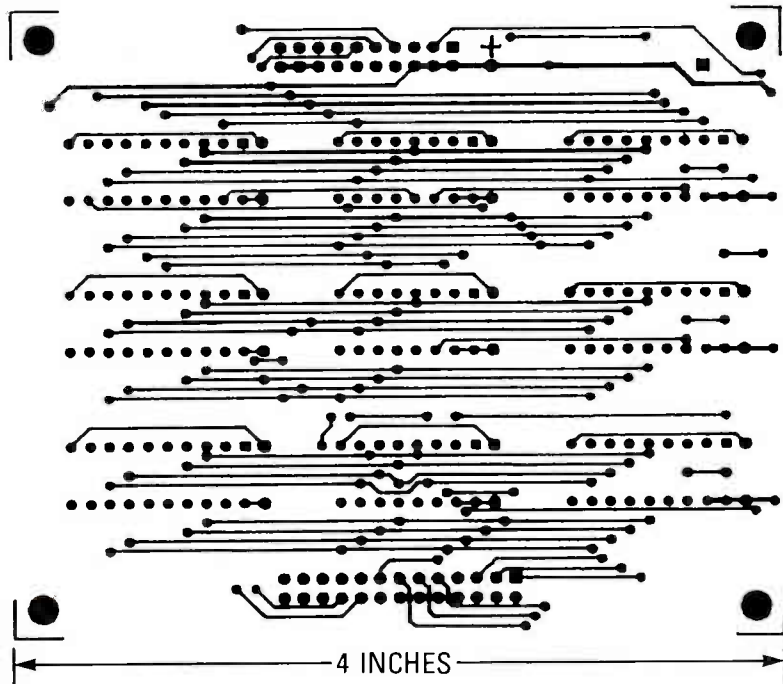

MOUNT THE COMPONENTS ON THIS SIDE of the IC Tester's driver board. The PC pattern for the main board will be shown next time.

One of the most difficult tasks in building any construction project featured in **Radio-Electronics** is making the PC board using just the foil pattern provided with the article. Well, we're doing something about it.

We've moved all the foil patterns to this new section where they're printed by themselves, full sized, with nothing on the back side of the page. What that means for you is that the printed page can be used directly to produce PC boards!

Note: The patterns provided can be used directly only for *direct positive photoresist methods*.

In order to produce a board directly from the magazine page, remove the page and carefully inspect it under a strong light and/or on a light table. Look for breaks in the traces, bridges between traces, and in general, all the kinds of things you look for in the final etched board. You can clean up the published artwork the same way you clean up your own artwork. Drafting tape and graphic aids can fix incomplete traces and doughnuts, and you can use a hobby knife to get rid of bridges and dirt.

An optional step, once you're satisfied that the artwork is clean, is to take a little bit of mineral oil and carefully wipe it across the back of the artwork. That helps make the paper translucent. Don't get any on the front side of the paper (the side with the pattern) because you'll contaminate the sensitized surface of the copper blank. After the oil has "dried" a bit—patting with a paper towel will help speed up the process—place the pattern front side down on the sensitized copper blank, and make the exposure. You'll probably have to use a longer exposure time than you are used to.

We can't tell you exactly how long an exposure time you will need as it depends on many factors but, as a starting point, figure that there's a 50 percent increase in exposure time over lithographic film. But you'll have to experiment to find the best method for you. And once you find it, stick with it.

Finally, we would like to hear how you make out using our method. Write and tell us of your successes, and failures, and what techniques work best for you. Address your letters to:

Radio-Electronics
Department PCB
500-B Bi-County Blvd.
Farmingdale, NY 11735

PC SERVICE

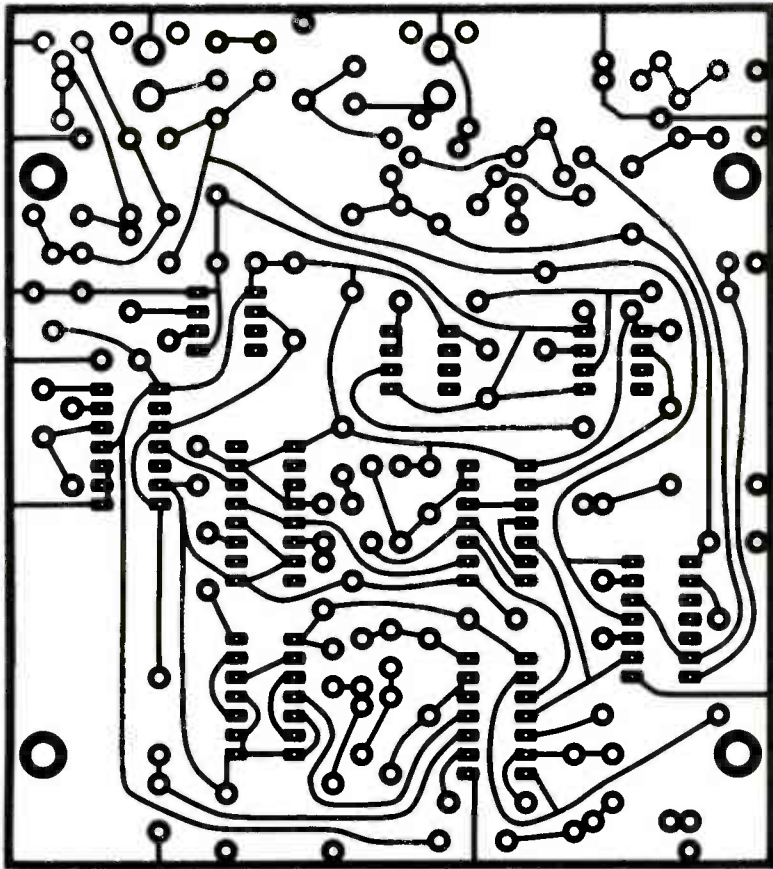

4 INCHES

BUILD THE MACROSCRUBBER using this board.

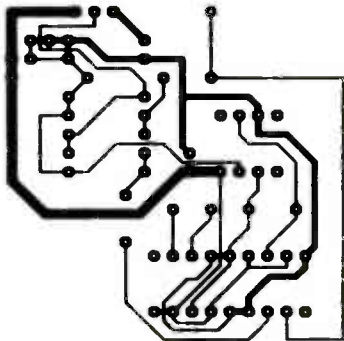

2.3 INCHES

THE ROBOT EYE'S PC board is shown here. Remember that the components mount on the foil side.

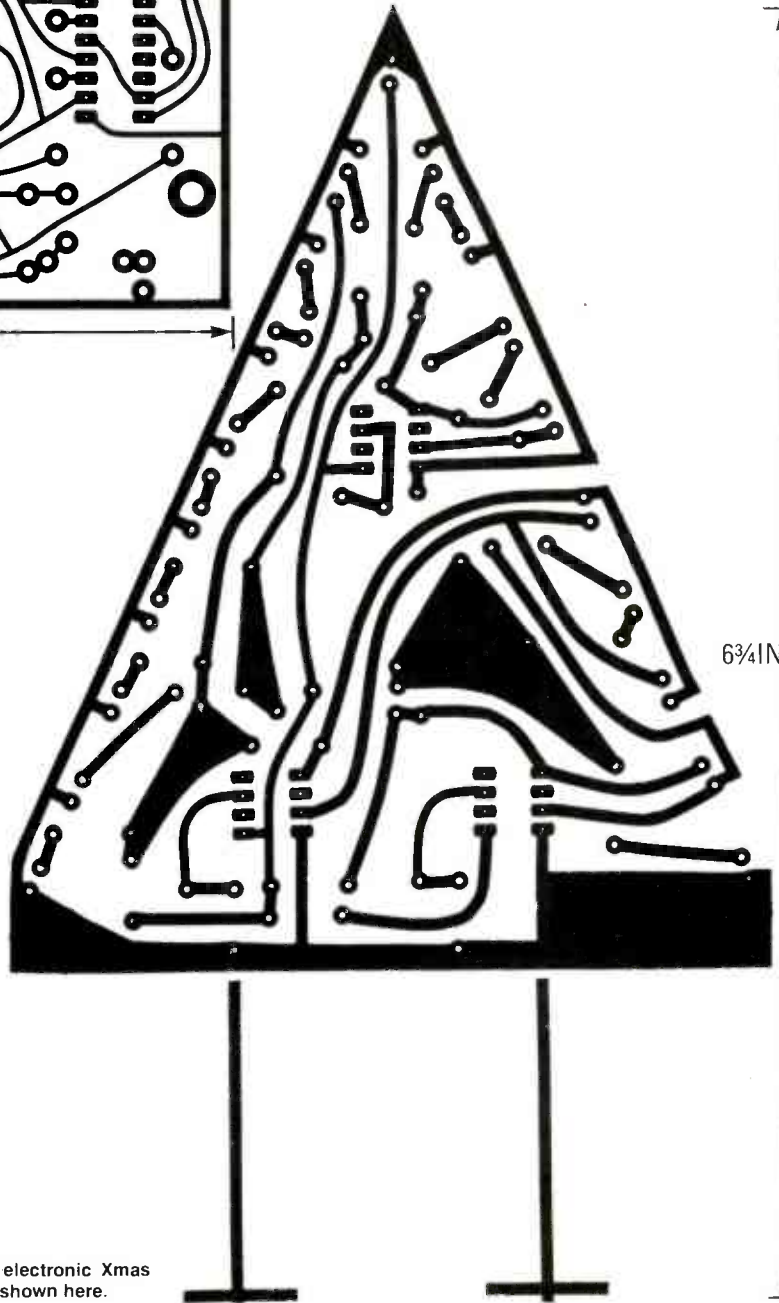

6 3/4 INCHES

LIGHT UP THE HOLIDAYS with the electronic Xmas tree. The PC board for that project is shown here.

**PC
SERVICE**

EIA/CEG AUGMENTS DIGITAL AND MICROPROCESSOR COURSE HIGH TECH PARTS KITS NOW AVAILABLE

The members of the Electronic Industries Association Consumer Electronics Group (EIA/CEG) through the Product Services Committee, has marketed the illustrated parts kit for vocational schools, educators and technicians. This is the same material used in the Digital and Microprocessor Course during EIA's summer workshop programs. These workshops are organized by the Consumer Electronics Group and co-sponsored by national service organizations and state departments of vocational education.

Parts and components are contained in a lightweight tool box with individual compartments. It includes a breadboard, power supply, pre-dressed jumpers, resistors,

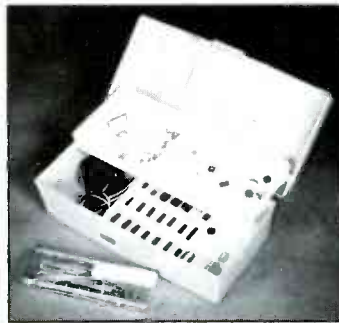
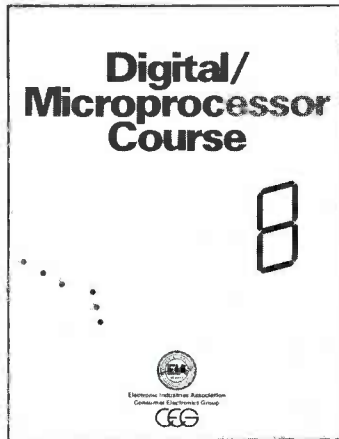

capacitors, and integrated circuits to perform all digital exercises 1 through 25 of the Digital/Microprocessor course book listed in the table of contents. Some parts have been included for the microprocessor section but other components will have to be acquired (as listed in the Introduction to Exercises 26-31).

Individual and classroom size quantities are available at the following cost: quantities 1-9, \$69.95 each, quantities 10-19, \$67.95 each, and for quantities 20 or more, \$64.95 each (cost includes shipping and handling). The kits will also include the Digital and Microprocessor Course book. Additional books are available at the cost of \$2.00 per copy.

PLEASE COMPLETE ORDER FORM FOR PARTS KITS AND BOOKS

Send to: EIA/CEG, Department PS, P.O. Box 19100, Washington, D.C. 20036

Parts Kit	Quantity	Amount	Total
1-9	_____	\$69.95 each	_____
10-19	_____	\$67.95 each	_____
20 or more	_____	\$64.95 each	_____
Additional Digital/Microprocessor Course Books	_____	\$2.00 per copy	_____
Total Amount Enclosed			_____

Name																		
Title																		
Firm																		
Address																		
City											State			Zip				

ORDER FORM

SATELLITE TV



BOB COOPER, Jr.
SATELLITE-TV EDITOR

What's next?

BY THE MOST ACCURATE COUNT, THE home-dish industry was producing, selling, and installing as many as 70,000 home-dish systems per month in the fall of 1985. Now, the most accurate figures suggest that fewer than 12,000 home-dish systems are being sold per month at the present time.

Those numbers mean different things to different groups. The cable-television industry sees a "thriving low-power satellite broadcasting business". The home-satellite industry, the people who manufacture, distribute, and install such systems "sees a business on the verge of collapse". Both of the preceding quotes appeared in the July 20, 1987 issue of *Broadcasting Magazine*, which contained a full report on the status of the home-dish industry.

Death of an industry

Which view is correct? One only has to peruse the few remaining trade publications serving the TVRO market, or to attend an electronic flea market to witness the depth of the industry's doldrums. Complete home systems with 10-foot dishes are wholesaling for under \$400; individual parts, such as 70° Kelvin LNB's are selling for as little as \$40. Much of the merchandise warehoused in the spring of 1986 for the anticipated 1986 is still there.

Several pieces of legislation have been introduced to provide some form of assistance to an ailing industry and a stunted communications medium. Hearings in support of that legislation were

held, but the legislation was never enacted. And even if it were, at best it would have made it *slightly* more difficult for satellite programmers and cable-television-system operators to maintain their present monopolistic control over programming access.

Control over programming—how it is distributed to home-dish owners and what it costs per service per month—is the central issue. Some say it is the *only* issue. Cable programmers and cable operators have married one another at the corporate level. TCI, the largest cable-system owner in the world, has bought substantial stock in services such as WTBS/CNN and others. Virtually every programmer making a profit has some or all of its stock owned by its customers, the cable system owners.

Home-dish proponents believe that such cross ownership has worked against the development of a "competitive delivery system". As David Wolford, a publisher in the home-dish industry told Congress: "Programmers such as HBO and Showtime/Viacom derive the vast majority of their revenue from cable operators. Are they really going to undercut the prices of their primary customers? The market is moving into a dangerous situation. If present conditions are allowed to continue, satellite TV will (end up being) controlled by its one and only natural competitor, cable TV."

Programmers such as HBO and Showtime have refused to date to allow anyone but themselves or their cable affiliates to market pro-

gramming to home-dish owners. Cable operators are further controlled by specified geographical territories outside of which they cannot sell to home-dish owners. That has resulted in a form of price control because there are no competitive forces at work. If you live within a cable franchise area and want HBO, you *must* buy from the local-cable HBO affiliate. If you live outside a cable franchise area, you *must* buy from HBO directly.

Cable trade-association head James Mooney told Congress: "Cable programming is readily available to home-dish owners at prices less than those paid by the average cable subscriber for the same service."

Others, such as Bob Phillips of the National Rural Telecommunications Corporation testified that his firm has not been able to buy cable programming for resale to home-dish owners at all, or in the best case they are paying 500% to 700% more per home than cable systems are paying for the identical programming service.

Stephen Shulte of Viacom/Showtime has his own pet theory as to why the home dish industry suddenly dried up and quit functioning. He told Congress: "The infrastructure of the (TVRO) industry grew up during a time when the basic selling argument (to would-be consumers) was erroneous...that cable programming was available at no charge (with a dish). When services started to scramble (their programming), the sales were simply no longer great enough to support the industry that had been created."

Charles Rule, acting assistant attorney general for the antitrust division of the Department of Justice seemed to agree with that assessment when he told Congress "(our) investigation has not uncovered the existence of any illegal concerted activity among cable operators (or programmers)."

The next generation

Is this to be the end of direct broadcasting satellites for North America, an industry that did too well, too fast, and then was ill-equipped to face its adversaries? Probably not, but a significant period of readjustment is certainly ahead. Even the most optimistic cable-system operators admit that when the cable-television industry has completed the "wiring of America" between ten million and twenty million homes will still be without the magical cable interface. Would those homes be sufficient to support a direct-to-home satellite industry?

The answer of course is yes. But not using the present C-band satellites or frequencies. All planning for the future centers on the use of the 11-12 GHz band, generally called the K or Ku band. Several large firms, such as Comsat, have planned satellites to operate in those frequency bands. Most of those firms have suspended work on the project. Hubbard Broadcasting, a Minnesota-based television and radio station owner has plans to make use of that band. Hughes, the same people who pushed C-band satellite technology to new limits, plans a 1991 launch of a pair of satellites for Ku band as well; those satellites are intended specifically for direct-to-home broadcasting. RCA(GE)-Americom, in conjunction with HBO/Time-Life, also plans to launch Ku-band satellites sometime between 1989 and 1990.

But none of those would-be satellite operators has yet been successful in attracting programming to their satellites. Americom might have a slight advantage here; they have an investment in programming through their association with HBO and could at least fill up some channels from their own stock. But Hubbard and Hughes are offering some attractive finan-

cial deals to cable programmers such as Showtime, Turner, or ESPN.

For now, the route to the next generation of home-satellite broadcasting is not clearly marked. Nor is there any certainty that it will happen unless programmers such as Showtime feel comfortable that an offering on the Ku band will not in any way anger their existing cable-TV clients. HBO is even now trying to head off future problems by offering their

present cable customers exclusive rights to the sale of Ku-band programming within their cable-franchise territories. That of course translates to monopolistic control of programming rates and terms; the very thing that has stifled C-band sales and growth. **R-E**

SCRAMBLE FACTS 718-343-0130

3 minutes of industry news, technical tips, and new product information.

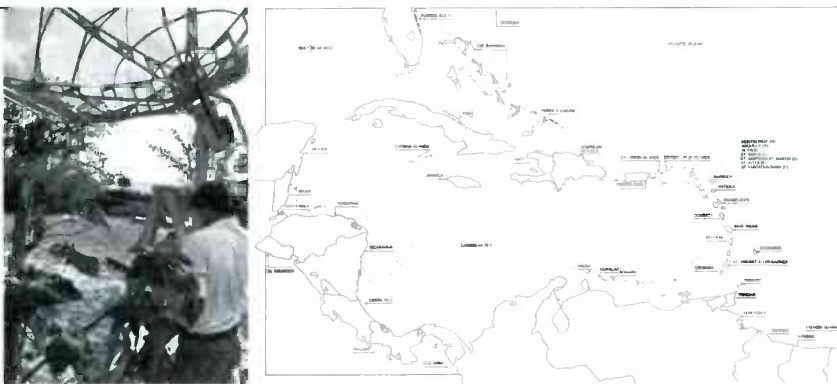

IF YOU LIVE IN THE CARIBBEAN, CENTRAL AMERICA, NORTHERN S. AMERICA or FLORIDA . . .

WIN A PARACLIPSE HOME DISH SYSTEM!

Bob Cooper's **CARIBBEAN ELECTRONICS MAGAZINE** is giving away 12 complete Paracclipse 12' home dish systems between September 1, 1987 and August 31, 1988. **FREE.** No obligation of any kind! If you are an amateur radio operator in the 'qualifying area' (see map), simply send us your Ham radio QSL card. If you are in electronics but not a licensed amateur, send your business card. You may enter once per month for each of the 12 months but no more than once per month. The home dish system winners are announced in 'CEM' monthly starting with the November 1987 issue.

PLUS - when we receive your QSL card or business card, we will send you a **FREE** sample copy of the most exciting electronics magazine in the Caribbean; Caribbean Electronics. CEM covers every aspect of communications and broadcasting, just for those who live in the Caribbean and countries surrounding the Caribbean. And we do it in English and Spanish with special Spanish summaries for all feature articles.

OUR twelve **FREE** home dish systems feature the highly acclaimed Paracclipse 12 foot dish with tuned feed, state-of-the-art solid state actuator/controller, and the top-rated by test AVCOM 2 series receiver system with remote control. This is the best, quality system for home or commercial use in the Caribbean. Find out how our CEM Lab rates everything from power line filters to VCRs, shortwave radios to home computers for Caribbean use in Caribbean Electronics Magazine. Send us your QSL card or business card today!

CARIBBEAN ELECTRONICS MAGAZINE
P.O. Box 100858, Ft. Lauderdale, FL 33310 USA
Telephone: 305/733-9955; in Florida 800-367-8150

R-E Engineering Admart

Rates: Ads are 2 1/4" x 2 7/8". One insertion \$825. Six insertions \$800 each. Twelve insertions \$775 each. Closing date same as regular rate card. Send order with remittance to **Engineering Admart**, Radio Electronics Magazine, 500-B Bi-County Blvd., Farmingdale, NY 11735. Direct telephone inquiries to Arline Fishman, area code-516-293-3000. **Only 100% Engineering ads are accepted for this Admart.**

117 PRACTICAL IC PROJECTS BUILD YOU CAN

2645T—117 PRACTICAL IC PROJECTS YOU CAN BUILD.....

\$10.95. Dozens of fully-tested, ready-to-build circuits you can put together from readily-available, low cost IC's! There are a total of 117 IC circuits ranging from an audio mixer and a signal splitter to a tape-deck amplifier and a top-octave generator organ! From TAB Books. To order your copy send **\$10.95 plus \$2.75 shipping to Electronic Technology Today Inc., P.O. Box 240, Massapequa Park, NY 11762-0240**



FCC LICENSE PREPARATION

The FCC has revised and updated the commercial license exam. The **NEW EXAM** covers updated marine and aviation rules and regulations, transistor and digital circuitry. **THE GENERAL RADIOTELEPHONE OPERATOR LICENSE - STUDY GUIDE** contains the necessary preparation for **ONLY \$25.00.**

WPT PUBLICATIONS
979 Young Street, Suite E
Woodburn, Oregon 97071
Phone (503) 981-6122

CIRCLE 186 ON FREE INFORMATION CARD

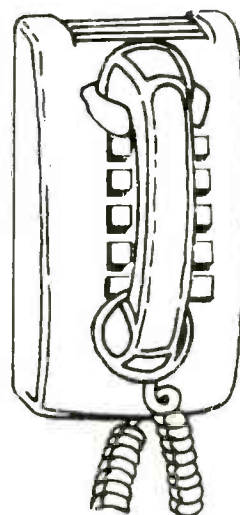

CALL NOW AND RESERVE YOUR SPACE

- 6 x rate \$800.00 per each insertion.
- Reaches 245,824 readers.
- Fast reader service cycle.
- Short lead time for the placement of ads.

Call **516-293-3000** to reserve space. Ask for Arline Fishman. Limited number of pages available. Mail materials to: Engineering Admart, RADIO-ELECTRONICS, 500-B Bi-County Blvd., Farmingdale, NY 11735.

LINEAR IC EQUIVALENTS & PIN CONNECTIONS

Linear IC Equivalents and Pin Connections



BP141—Shows equivalents & pin connections of a popular user-oriented selection of European, American and Japanese linear IC's. 320 pages, 8 x 10 inches. **\$12.50 Plus \$2.75 shipping. ELECTRONIC TECHNOLOGY TODAY INC., PO Box 240, Massapequa Park, New York 11762-0240.**

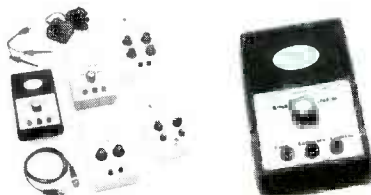

HANDHELD GENERATOR/TESTER KITS • Function Gen. 1HZ to 300KHZ **\$79.95** • Audio Gen. 8 steps 40HZ to 20KHZ **\$69.95** • IF Gen. 455KHZ & 10.7MHZ, internal modulation **\$59.95** • Transistor Tester, Tests PNP, NPN **\$34.95** • FM Gen. 80 to 120MHZ, internal modulation **\$59.95** • All kits include test leads. Any kit assembled & tested add 25%. Send \$1 for complete catalog & coupon. **SEL LABS, 22848 LEADWELL ST., CANOGA PARK, CA 91307. (818) 347-1960.**

CIRCLE 184 ON FREE INFORMATION CARD

EARLY RADIO

continued from page 66

There were two types of headphones used in the early 20's. One type had an iron armature that was mechanically connected to a mica or composition diaphragm. In the other, an electromagnet was used to attract an iron diaphragm that was supported around its circumference. An unusual design, called a "Baldwin receiver," used a fiber diaphragm; a later model had a diaphragm made of aluminum. Compared to speakers that were used during the early 1920's, a Baldwin-type headphone rendered superior sound.

The earliest speaker was a headphone put into a resonant chamber such as a glass bowl or a wood box. Subsequently, an enterprising experimenter developed a horn with tubular extension arms to ac-

commodate a headset (Fig. 9).

Commercial horn speakers were soon manufactured. Some were little more than oversized headphone units attached to curved metal or paper-mache funnels (or even to brass automobile horns). Others, like the Magnavox (first to introduce the voice coil) with a 6-volt, 1-ampere field coil, and the Western Electric, produced very good sound.

Later in the 20's cones came into use. Most of the early ones were "balanced-armature" types like a Baldwin headphone. A stylus from the armature connected to the center of the cone.

These were superseded by the "dynamic speaker," still in use. A voice coil in a strong magnetic field is connected across a low-impedance winding on the receiver's output transformer. The coil and the cone moves in and out of the field in accordance with the signal.

R-E



FIG. 9—ONE OF THE EARLIEST ATTEMPTS to get more volume was a small horn that fitted over an earphone.

DRAWING BOARD

Designer RAM



ROBERT GROSSBLATT,
CIRCUITS EDITOR

EVER SINCE CP/M BEGAN TO DECLINE, people have been saying that the days of the Z80 were numbered—don't you believe it. It's true that you won't see many new computer designs done around a Z80, but it's also true that the Z80 has too much muscle to wind up on the silicon scrap heap. It's still one of the microprocessors of choice to use as a dedicated controller.

Building our dynamic-RAM system around a Z80 makes sense because the chip's built-in features relieve us of the burden of implementing much of the design in external hardware. We'll still need glue to put all the pieces together,

but not anywhere as much if we were building the whole circuit from gates alone.

There are four Z80 control signals that are critically important in the construction of our circuit. Understanding what they are, how they work, and what their timing relationships are, is the first step in the design. The four signals, all of which are active low, are:

- Memory Request (\overline{MREQ}), pin 19
- Read (\overline{RD}), pin 21
- Write (\overline{WR}), pin 22
- Refresh (\overline{RFSH}), pin 28

Let's discuss them one at a time.

\overline{MREQ} is a control signal that is active whenever the Z80 has been

instructed to perform an operation that involves external memory. As soon as the Z80 has an address ready to put out on the bus it brings this line low. That happens for *all* memory operations: read, write, and refresh.

\overline{RD} goes low when the Z80 wants data from the outside world, which can be from either a memory location or an I/O port. Therefore a request for a read from memory must be sensed by watching \overline{MREQ} as well as \overline{RD} .

\overline{WR} is the opposite of \overline{RD} . When it goes low, the Z80 has data that it wants to send to either memory or an I/O device. Just as with \overline{RD} , the destination is determined by watching the \overline{MREQ} line.

\overline{RFSH} is the signal that keeps the Z80 popular. When it goes low it signals that the microprocessor has incremented its internal refresh counter and has put the new refresh address on the lower seven bits of the address bus (A0-A6). By combining \overline{RFSH} signal with \overline{MREQ} , you can determine exactly when a refresh operation must take place in your system.

All memory operations require two Z80 control signals, so it's important that we have a good understanding of the timing relationships between them. And any discussion of timing must start with a look at the basic heartbeat of the Z80: the instruction cycle.

M and T cycles

Figure 1 is a representation of the two fundamental parts of all Z80 instruction cycles: the M (machine) cycle, and the T (time, or clock) cycle. Every instruction that

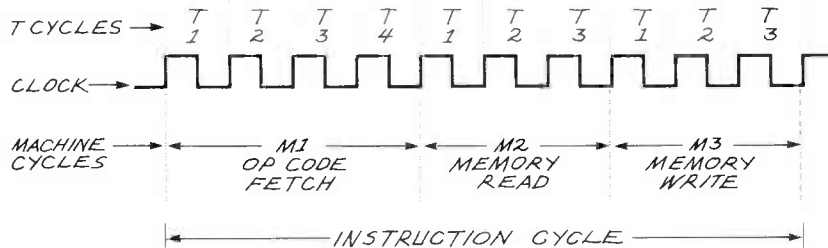

FIG. 1

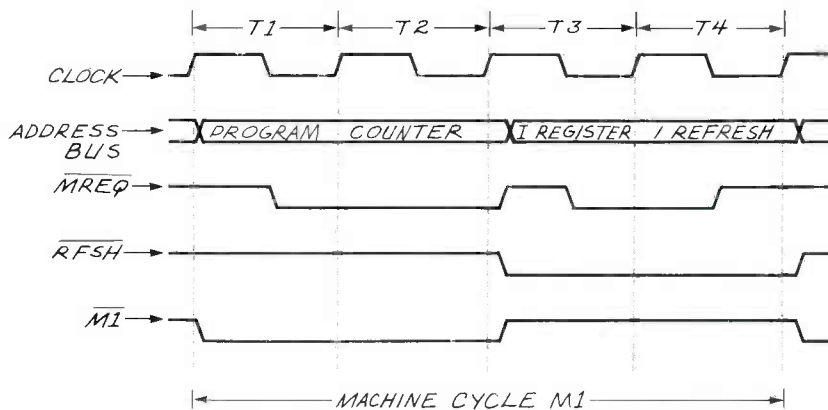

FIG. 2



**THE MOST POPULAR
WIRE-WOUND CB ANTENNAS
IN THE WORLD**

Because...they perform!

FACT

"When CB was legalized in England, 'Firestik' antennas were barred from sale because the emitted signal was too strong. Fortunately, no other country, including the U.S., limits antenna efficiency."

**YOU CAN HAVE SECOND
BEST OR, 'Firestik'!**

Call or Write for **FREE Catalog**
'Firestik' Antenna Company
2614 East Adams
Phoenix, Arizona 85034
(602) 273-7151

MILLIONS OF SATISFIED OWNERS

CIRCLE 100 ON FREE INFORMATION CARD

You Can Be
One Of The
20,000 Technicians
Certified BY ISCET



The International Society Of Certified Electronics Technicians offers permanent certification by administering the CET exam with the FCC recognized communications option for \$20. A second exam on FCC regulations for a \$10 fee is required for a Radiotelephone License. Upon passing, technicians receive both a permanent Radiotelephone Operator Certificate and a CET Certificate issued by ISCET.

ISCET Offers License Renewal

ISCET has developed a program for registration of those who currently hold a valid Radiotelephone Operator License. By sending a completed application, a photocopy of your FCC License, and \$10 your license will be renewed with the assurance of a recognized national technicians association behind it.

For More Information Contact:

ISCET 2708 W. Berry, Ft. Worth, TX
76109. (817) 921 - 9101

the Z80 executes requires from one to six machine cycles, M1-M6. During M1 the Z80 fetches the op-code of the next instruction. If the op-code is more than one byte long there will be more than one M1 cycle. In addition, it's during M1 that the Z80 handles refresh addressing. By the way, as shown in the figure, M2 and M3 are used for reads and writes.

Figure 2 is an expanded look at the M1 cycle. During T1 and T2, the Z80 places the contents of the program counter on the the address bus to get the next op-code. The microprocessor uses the next two T cycles, T3 and T4, to decode the op-code; it doesn't need the bus during that time. So, during T3 and T4, the address bus is divided in half to provide two kinds of data. The upper eight bits, A7-A15, have the contents of the I (index) register, and the lower seven bits, A0-A6, have the contents of the R, or refresh, register.

When the refresh address stabilizes, both \overline{MREQ} and \overline{RFSH} go low. That combination of signals is therefore a guaranteed-stable refresh address that can be used to systematically refresh dynamic memory.

In case you missed it, what the Z80 is doing for us is to eliminate the need for the external counters and logical glue that used to be necessary to ensure that dynamic memory would be refreshed at the right time and in the right order.

Now that you understand how much work the Z80 is ready to do for us, let's see what we have to do to take advantage of it.

Putting it to work

In using dynamic RAM with a Z80, the most important design task is to ensure that the memory is fast enough to work in the amount of time available for refresh. In our circuit we'll use a Z80B and run it at a maximum speed of 2.5 MHz, which translates into 400 nanoseconds ($1/(2.5 \times 10^6)$) per T cycle, or 800 ns to complete one refresh. In fact, however, we can't count on having the full 800 nanoseconds. Some time is eaten by delays internal to the Z80; more is needed to allow for propagation delays in our support circuitry; and all dynamic RAM

needs a refresh "precharge" time. Keeping that in mind, let's see how much of the 800 nanoseconds we actually have for refresh.

Even though Fig. 2 is only a representation of actual timing, it's clear that there are delays associated with the memory-control signals generated by the Z80. It takes about three quarters of a T cycle for the Z80 to put the program counter on the address bus and then guarantee that the memory control signals (\overline{MREQ} and \overline{RD}) are stable. And after the op-code appears on the data bus, we also must allow for settling time on the data bus.

Assuming the maximum clock speed of 2.5 MHz, we can expect to see the following timing for the whole op-code fetch cycle, (T1-T2):

$$\begin{aligned} T(OP-CODE) &= (T1+T2) - T(ADDRESS/SIGNAL) - T(DATA) \\ &= 800 - 300 - 50 \\ &= 450 \text{ nanoseconds} \end{aligned}$$

The amount of time needed for a memory read is also an important consideration, but it is usually longer than the time needed for an op-code fetch. For our 2.5 MHz system, a memory read requires about 650 nanoseconds. Not only is that longer than an op-code fetch, but both numbers are well within the bounds of the modern 150-nanosecond (and faster) RAM.

The logic that we'll need to make our system work also has built-in delays. Each of the buffers and gates that comprise the circuit contributes to the total amount of time the circuit needs to operate. TTL and fast CMOS parts have very small propagation delays, but if you add enough of them together you can wind up with a circuit that is too slow. A worst-case analysis might look like this:

- 40 ns for memory buffer delays
- 40 ns for data buffer delays
- 30 ns for gating delays
- 40 ns for Z80 buffer delays

That's a total circuit-propagation delay of 150 ns.

Those figures are not exact, but if you look through a TTL or CMOS data book, you'll see that I've overestimated the maximum possible times by a large margin.

Now that we have all the numbers worked out, we also have the maximum access time for the RAM

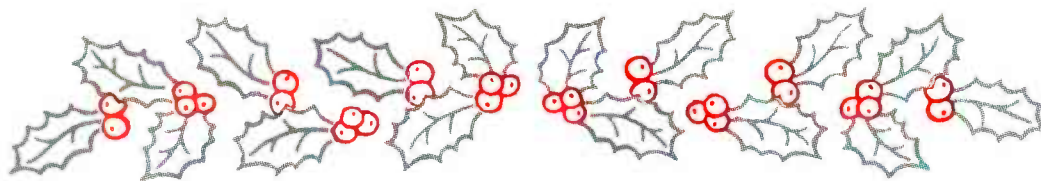

Plug a Friend into Radio-Electronics this Christmas ... and Save \$12!

This Christmas give an electrifying gift ... plug a friend into Radio-Electronics and brighten his whole new year! Whether electronics is his livelihood or his hobby, your gift will sharpen his focus and illuminate the whole spectrum of electronics throughout the coming year.

Radio-Electronics will keep him informed and up-to-date with new ideas and innovations in all areas of electronic technology ... computers, video, radio, stereo, solid state technology, satellite TV, industrial and medical electronics, communications, robotics, and much, much more.

He'll get complete plans and printed circuit patterns for building valuable test equipment and electronic devices for home and car — practical money-savers like these ... a TV signal descrambler ... a video test generator ... an auto exhaust analyzer ... a clockboard for his PC ... a radio commercial zapper ... a solid state barometer ... a working robot ... and many others!

PLUS ... equipment repair and troubleshooting ... circuit design ... new

product news and buyer's guides ... service clinics ... equipment test reports ... a special "Computer Digest" section ... regular columns on video, stereo, radio, circuits, solid state, satellite TV and robotics ... and lots more exciting features and articles.

SAVE \$12 ... OR EVEN \$24 ... For each gift of Radio-Electronics you give this Christmas, you save a full \$12.00 off the newsstand price. And as an R-E gift donor, you're entitled to start or extend your own subscription at the same Special Holiday Gift Rate — you save an additional \$12.00!

No need to send money ... if you prefer, we'll hold the bill till January, 1988. But you must rush the attached Gift Certificate to us to allow time to process your order and send a handsome gift announcement card, signed with your name, in time for Christmas.

So do it now ... take just a moment to fill in the names of a friend or two and mail the Gift Certificate to us in its attached, postage-paid reply envelope. That's all it takes to plug your friends into a whole year of exciting projects and new ideas in Radio-Electronics!

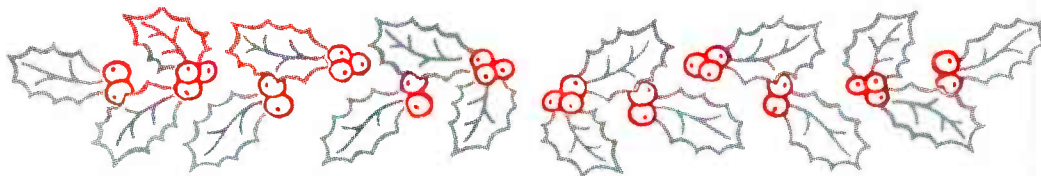

Radio-Electronics mini-ADS

we'll need. You don't need a lot of equipment to see that even if we used some slow 250-nanosecond RAM, the total circuit delay time would only be 400 (150 plus 250) ns. Most mail-order houses don't even stock 250-ns parts. The bottom line is that by using 150-ns RAM we can eliminate all the potential problems that would be caused by timing restrictions.

System design

There are a couple of things to keep in mind when using a Z80 to control a RAM system. All of them come from one general principle: *If the Z80 stops running, all our memory data will be history.*

That principle is of critical importance and it's also really easy to forget. As long as the Z80 is executing instructions it will continue putting out new refresh addresses during each M1 cycle. However, anything that puts the Z80 to sleep will also trash the memory. Fortunately, there are only a few circumstances in which that can happen:

- A reset pulse longer than 1 millisecond.
- A wait state longer than 1 millisecond.
- A DMA operation longer than 1 millisecond.

In our system, all memory access will be done through the Z80, we don't have to worry about the last two on the list. DMA simply won't be used in our system; any external request to store or retrieve data will be done by loading latches and then asking the Z80 to perform a read or a write. Similarly, we simply don't have any wait states.

Any slow I/O device using our memory system will talk to buffers and latches, not directly to memory. Some memory systems (like that of the IBM PC) must place wait states into every memory request because there isn't enough time for the "precharge time" required by the dynamic RAM. As we've seen from the mathematical analysis above, we surely don't have that problem.

Next month we'll start building the circuit. If you haven't done so already, you should get good data sheets on the Z80 and dynamic RAM. **R-E**



THE MODEL WTT-20 IS ONLY THE SIZE OF A DIME, yet transmits both sides of a telephone conversation to any FM radio with crystal clarity. Telephone line powered - never needs a battery! Up to 1/4 mile range. Adjustable from 70-130 MHz. Complete kit \$29.95 + \$1.50 S + H. Free Shipping on 2 or more! COD add \$4. Call or send VISA, MC, MO. **DECO INDUSTRIES, Box 607, Bedford Hills, NY 10507. (914) 232-3878.**

CIRCLE 127 ON FREE INFORMATION CARD



ZENITH SSAV1 from \$169, UHF INPUT, re-conditioned. Level II modules available for SSAV1s. UHF SSAV1 project handbook \$6.50 ppd. Sylvania 4040 \$169. Z-TAC, N-12, MLD-1200s. Converters, amplifiers and accessories. Satellite components. Radar speed guns for car/boat racing, bowling, skiing; baseball, etc, from \$275 used. Professional police models. IBM-compatible computer systems from \$895. Catalog \$1. **AIS SATELLITE, INC., P.O. Box 126-E, Dublin, PA 18917. (215) 249-9411.**

CIRCLE 81 ON FREE INFORMATION CARD



TOOLS & TEST EQUIPMENT. Contact East's latest catalog contains many new and innovative products for testing, repairing, and assembling electronic equipment. A full selection of test instruments, precision hand tools, tool kits, and soldering supplies are just some of the products featured. Products are shown in full color with detailed descriptions, pricing and a 100% satisfaction guarantee. **CONTACT EAST, P.O. Box 786, No. Andover, MA 01845. Call (800)-225-5370**

CIRCLE 55 ON FREE INFORMATION CARD

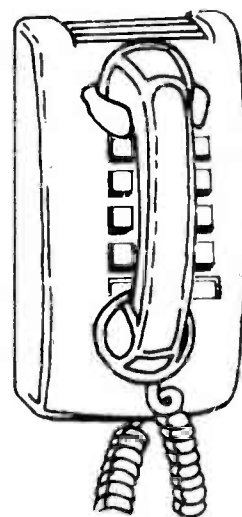

CALL NOW AND RESERVE YOUR SPACE

- 6 x rate \$745.00 per each insertion.
- Reaches 245,824 readers.
- Fast reader service cycle.
- Short lead time for the placement of ads.

Call **516-293-3000** to reserve space. Ask for Arline Fishman. Limited number of pages available. Mail materials to: Computer Admart. **RADIO-ELECTRONICS, 500-B Bi-County Blvd., Farmingdale, NY 11735.**



DECODE NEARLY ANY SINGLE LEVEL GATED PULSE SIGNAL. New circuit works with Hamlin, Jerrold, Sylvania, and Eagle systems. Decodes In-band, Out-band, AM or FM reference. Complete educational kit including P.C. board, parts, case, and 40 page gated pulse theory booklet is only \$47.00 plus \$3.00 shipping. Order no. 1PFD-1K. **ELEPHANT ELECTRONICS INC. P.O. Box 41865-R, Phoenix, AZ 85080. (602) 581-1973**

CIRCLE 120 ON FREE INFORMATION CARD

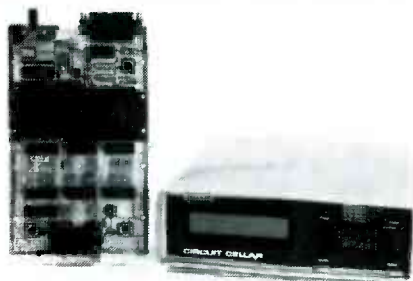

BUILD STEVE CIARCIA'S NEW SUPER IC TESTER Tests over six hundred 7400-series TTL, L, S, H, C, HC, HCT, F, AS, and ALS devices, 4000-series CMOS and PALs. Identifies unmarked chips and bad IC pins. User definable test sequence and user expandable ROM library. Tester operates standalone with LCD display, or with IBM PC or terminal. Partial kit—\$99. Full board kit—\$179. CCI, 4 Park St., Suite 12, Vernon, CT 06066. (203) 875-2751.

CIRCLE 52 ON FREE INFORMATION CARD



SIMPLY SNAP THE WAT-50 MINIATURE FM TRANSMITTER on top of a 9v battery and hear every sound in an entire house up to 1 mile away! Adjustable from 70-130 MHz. Use with any FM radio. Complete kit \$29.95 + \$1.50 S + H. Free shipping on 2 or more! COD add \$4. Call or send VISA, MC, MO. DECO INDUSTRIES, Box 607, Bedford Hills, NY 10507. (914) 232-3878.

CIRCLE 127 ON FREE INFORMATION CARD

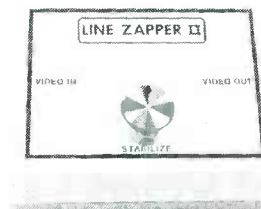

CHRISTMAS SALE on the Line Zapper II. During Nov. and Dec. only, the complete KIT (not recommended for the beginner) is only \$49.95 and the fully assembled unit is only \$89.95 (add \$3.00 ea. postage). Decode the Marco-Mess and start watching recent video tape movie releases without the flashing, jumping, jittering and video noise. ELEPHANT ELECTRONICS INC., P.O. Box 41865, Phoenix, AZ 85080 (602) 581-1973

CIRCLE 180 ON FREE INFORMATION CARD



CABLE TV CONVERTERS AND DE-SCRAMBLERS. Large selection of top quality merchandise. Low prices. Quantity discounts. We ship COD. Most orders are shipped within 24 hrs. Send \$2.00 for catalog. CABLETRONICS UNLIMITED, P.O. Box 266 Dept. R, S. Weymouth, MA 02190 (617) 843-5191

CIRCLE 188 ON FREE INFORMATION CARD

CALL NOW AND RESERVE YOUR SPACE

- 6 x rate \$745.00 per each insertion.
- Reaches 245,824 readers.
- Fast reader service cycle.
- Short lead time for the placement of ads.

Call 516-293-3000 to reserve space. Ask for Arline Fishman. Limited number of pages available. Mail materials to: Computer Admart. RADIO-ELECTRONICS, 500-B Bi-County Blvd., Farmingdale, NY 11735.

CIRCLE 80 ON FREE INFORMATION CARD

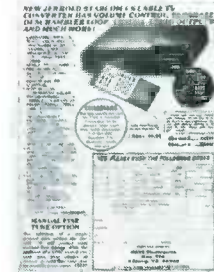

FREE 24 PAGE OCTE CATALOG! Cable TV converters, hand controls, stereo decoders and switching centers. Negative cable TV traps and noise filters. Descrambler books, schematics and parts. SCA books and kits. Nite viewers. Microwave downconverters. Telephone privacy assurance devices and automatic conversation recorders. Bug and tap detectors. Parabolic microphones. Power supplies. Surplus electronics parts. OCTE ELECTRONICS, Box 276, Alburg, VT 05440. (514) 739-9328.

CIRCLE 80 ON FREE INFORMATION CARD

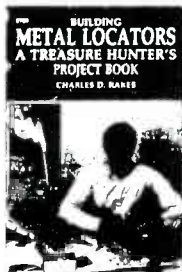

2706T—BUILDING METAL LOCATORS, A Treasure Hunter's Projects Book....\$9.95. Build your own high-quality metal detector for a fraction of the factory-built cost! The detectors described in this unique project guide will locate anything from coins and jewelry to gold and silver—and can be built quickly and easily! From TAB Books. Get your copy today. Send \$9.95 plus \$1.75 shipping to Electronic Technology Today Inc., P.O. Box 240, Massapequa Park, NY 11762-0240.



PANASONIC CABLE CONVERTERS, Wholesale and Retail. Scientific Atlanta and Pioneer Cable Converters in stock. Panasonic model 130N 68 channel converter \$79.95, Panasonic Amplified Video Control Switch Model VCS-1 \$59.95. Scientific Atlanta Brand new Model #8528 550MHZ 80 Channels Converter \$89.95. Video Corrector (MACRO, COPYGUARD, DIGITAL) ENHANCER \$89.95. We ship to Puerto Rico, Caribbean countries, & So. Amer. Write or call BLUE STAR IND., 4712 AVE. N, Dept 105, Brooklyn, NY 11234. Phone (718) 258-9495.

CIRCLE 85 ON FREE INFORMATION CARD

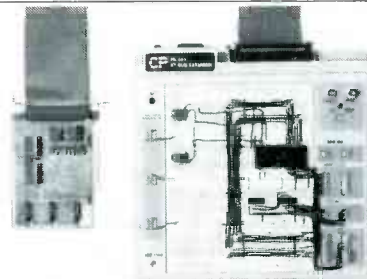

PC-601 XT BUS EXTENDER BREADBOARD LAB connects to any IBM PC compatible computer and extends all PC electrical bus connections out to the PC-601 for easy circuit prototype connection, testing and trouble-shooting. Includes large 3060 tie-point breadboard, ±5V and ±12Vdc AC line powered power supplies. Includes buffer card, 2' ribbon cable & 1-Year warranty. Price: \$369.95 CHENESKO PRODUCTS, 21 Maple St., Centereach, NY 11720. 516-736-7977, Fax: 516-732-4650

CIRCLE 193 ON FREE INFORMATION CARD

XMAS TREE

continued from page 48

Construction

The PC board can be made photographically using the foil pattern shown in PC Service, or the pattern can be used as a guide for applying liquid and tape resist by hand. Although the foil pattern itself is only 5-inches high, the PC board material must be 6¼ inches high because the tree's 1¼-inch trunk is part of the PC board. Since etching large copper areas not only takes excessive time but also shortens the life of the etchant, we suggest you trim away the unwanted PC board material before you etch the board. Or, if you prefer to cut the tree to size after the pattern is etched, protect the foil of the large unused trunk area with resist and simply let the copper remain. As long as the trunk's foil doesn't come in contact with any of the circuit traces it makes no difference whether it's there or not.

If you want to decorate the front of the tree, do it before the holes for the components are drilled. For example, the author sprayed the component side with a bright automotive metallic-green paint. To prevent a defined line, a cardboard mask was held about ½ inch above the board. Then, the edge of the PC board was "dusted" with a fine mist of white paint to simulate snow. After allowing for adequate drying, again using a cardboard mask, the trunk portion of the board was painted with a metallic-brown paint.

Allow the decorative paint to dry overnight before drilling the component mounting holes. Then install and solder the eight jumpers, the resistors, the IC's, and the capacitors. Then insert all the LED's, observing the polarities shown in Fig. 2. Position the LED's so that they are raised approximately ½ inch off the board. To do that, turn the board over and lay it down on a flat surface, being careful not to allow any LED's to fall out; that can be done easily by holding a piece of stiff cardboard against the LED's while turning the board over. Keeping the board parallel to your work surface, solder one lead of each LED. Turn the board over and carefully look across the surface to see whether the LED's are straight and at the same height. If not, correct as needed. When you're satisfied with their alignment, solder the other lead of each LED.

Adding the base

Prepare the surfaces of the battery holders and the PC board for gluing by sanding the back of each holder and a ⅜-inch strip on both sides of the circuit board at the bottom of the trunk. Mix a small amount of a 5-minute epoxy and apply some to the ⅜-inch strip on both sides of the circuit board. With the battery polarities opposite

each other, sandwich the PC board between the holders. Hold the assembly firmly on a flat surface that's covered with a piece of wax paper. You will have a few minutes working time before the epoxy sets to ensure proper alignment. Make certain that the holders are even and that the circuit board is centered and upright between the holders. In about 5 minutes the glue will have set up sufficiently, and the tree can be lifted from the wax paper. Use acetone or flux remover to clean excess glue from the bottom of the battery holders. As with most other cleaners, be careful not to touch the painted surface.

After allowing at least one hour for the epoxy to cure, solder a jumper wire at one end of the battery holders, across the adjacent positive and negative terminal lugs. From the battery source ends, solder the positive and negative leads directly to the foil traces—as shown in Fig. 2. The LED's will start to flash as soon as the batteries are installed. Any LED that fails is most likely defective, or installed with reversed polarity.

When you're certain the project is working, you can add a final "dress up" by gluing a colorful felt material over foil traces on the back of the board. **R-E**

ANALYZE WAVEFORM

continued from page 60

thinking about them, but you do go through them.

A properly designed digital readout reduces each measurement to simply pushing a button and reading a number, including the correct decimal placement and the range multiplier. Since the tests are so much easier to do, you will probably analyze waveforms more often, instead of using less effective troubleshooting methods.

Accuracy: Digital readings provide much higher accuracy than a CRT. Most people don't think much about the accuracy of a reading, but errors can add up quickly when using a standard oscilloscope. First, no scope reading can be more accurate than the calibration of the vertical and horizontal circuits. Published accuracies range from 2% to 5%, but only if the scope has been recalibrated within the past few months. If not, the circuit errors may be higher.

Next, consider the errors in determining the displacement of the trace on the CRT. A typical CRT trace has 8 major vertical divisions, each divided into 5 minor divisions. If a waveform is 4 major divisions tall (one-half the screen height), it covers a total of 20 minor divisions. Since the width of the trace is about 1 minor division, the trace thickness adds an extra 5% error to the calibration uncertainty. When we add interpolation and

TABLE 1
Peak-to-peak volts

1. Turn vertical vernier to CAL.
2. Lock waveform and adjust horizontal circuits until desired number of waveforms appear.
3. Adjust VOLTS/DIVISION control until waveform is 2 to 4 divisions tall.
4. Adjust VERT POSITION control until the bottom of waveform sits on a horizontal graticule line.
5. Adjust HORIZ POSITION control until tallest portion of waveform is on center CRT graticule.
6. Count divisions between bottom and top of waveform.
7. Multiply number of divisions times VOLTS/DIVISION setting.
8. Multiply times 10 if a $\times 10$ probe is used and input is calibrated for direct readings.

DC volts

1. Set vertical vernier to CAL.
2. Lock waveform and adjust horizontal circuits until desired number of waveforms appear.
3. Adjust VOLTS/DIVISION setting until waveform is 2 to 4 divisions tall.
4. Set INPUT COUPLING switch to ground.
5. Adjust VERT POSITION control until line is on a horizontal graticule line.
6. Move INPUT COUPLING switch to the DC position.
7. Readjust VOLTS/DIVISION switch if has trace moved off screen.
8. Estimate vertical midpoint of waveform.
9. Count number of divisions from reference in step 5 to midpoint of step 8.
10. Multiply number of divisions by the VOLTS/DIVISION setting.
11. Multiply by 10 if a $\times 10$ probe is used and input is calibrated for direct readings.

Time or frequency

1. Turn horizontal vernier to CAL.
2. Lock waveform and adjust horizontal circuits until desired number of waveforms appear.
3. Adjust the HORIZ POSITION control until left edge of signal touches a vertical graticule line.
4. Adjust VERT POSITION control until right edge of signal crosses center CRT graticule.
5. Count number of divisions between left and right edge of waveform.
6. Multiply number of divisions by the setting of the TIMEBASE-FREQ switch.
7. Divide by 10 if the horizontal $\times 10$ expander is on.
8. For frequency, invert results.

parallax errors, a scope reading will only be accurate to within 10% to 20%.

Digital scope readouts offer a much higher degree of accuracy. For instance, the peak-to-peak voltage function of the Sencore SC61 is accurate to 2%. The accuracy improvements are even greater for frequency measurements: that is because

continued on page 84

STRAIN GAGE

continued from page 63

resistance change, any difference in temperature between the strain gage and the other resistors could look like a legitimate output. But when four strain gages are used, and all are mounted on the spring element, they all see the same temperature variations. Then they will all increase or decrease by the same amount, thereby preserving the bridge balance and producing no output.

Putting it together

We are now in a position to say that the bridge output voltage is directly proportional to the force applied to the spring element. To find out what that relationship looks like all we have to do is combine equations 1, 3, and 9. Reviewing what we've learned so far:

$$e_o = E(r/R), r = (GS)R, \text{ and } S = kF$$

By substituting kF for S in the gage-factor equation and then substituting $(GkF)R$ for r in the bridge equation we find that:

$$e_o = (EGk)F \quad (10)$$

You may recognize that as the equation of a straight line that passes through the

origin. The applied force, F , is the independent variable and the bridge output voltage, e_o , is the dependent variable. The slope of the line is represented by the three constants, E , G , and k . They are shown in parentheses because once the transducer has been assembled and supplied with a suitable operating voltage, they can be treated as a single constant. The slope of the line is also known as the sensitivity of the transducer. We must know the sensitivity of the transducer in order to determine the applied force. We can make that conversion simply by dividing the output voltage by the sensitivity.

Strain-gage transducers can be purchased with or without built-in amplification. The transducer's sensitivity is specified a little differently in each case. First of all, a transducer with built-in electronics is usually provided a fixed bridge-supply voltage and enough gain to bring the maximum output up to some standard level. Adding that additional gain to equation 10 will result in:

$$e_o = (AEGk)F \quad (11)$$

where A is the gain of the built-in amplifier. Since the gain and the bridge supply voltage, as well as the gage factor and spring constant, are all fixed at the time of assembly, they can all be combined into one constant as the transducer sensitivity.

But, rather than specifying transducer sensitivity outright, transducer manufacturers often list the maximum value of the input force and the corresponding maximum output-voltage level. Both of those specifications are important in themselves, and the sensitivity is implied in the two numbers. Since equation 10 defines a line that passes through the origin, all we have to do is divide the full-scale output voltage by the full-scale input force to determine the sensitivity. A typical value for the maximum output might be 5 volts. If the maximum input force is 500 pounds, then the sensitivity of the transducer would be 5-volts/500 psi = 0.01-volts/psi.

If the transducer does not have built-in electronics, it is up to the user to provide the bridge supply voltage and whatever gain may be required. Since the output voltage is a linear function of both the applied force and the bridge supply voltage, sensitivity is then specified as output volts per bridge supply volts per input force. The maximum output voltage corresponding to a maximum input is listed for a bridge supply of one volt. That way we can determine what the maximum output voltage will be when some other value of supply voltage is used by simply multiplying the listed maximum by the supply voltage actually used. R-E

HITACHI COMPACT SERIES OSCILLOSCOPES



V-1065 DC to 100MHz With Cursor Readout
\$1595. Save \$200!

- 6" CRT with Internal Graticule
- Dual Channel X-Y Display
- Sweep Time Autoranging
- 400V High Input Voltage Protection
- TV Sync Trigger Circuit
- Delayed Sweep • CRT Readout
- Single Sweep • ±3% Accuracy
- Trigger Lock • Bandwidth Limiter

V-1060 DC to 100MHz
\$1345. Save \$150!

V-665 DC to 60MHz

\$1145. Save \$150!

V-660 DC to 60MHz

\$970. Save \$125!

Dual Channel 6" CRT Scopes

V-425 DC to 40MHz, CRT Readout
\$845. Save \$150!

V-423 DC to 40MHz, Single Time Base Delayed Sweep

\$745. Save \$250!

V-422 DC to 40MHz, DC Offset

\$795. Save \$130!

V-225 DC to 20MHz, CRT Readout

\$720. Save \$75!

V-223 DC to 20MHz, Delayed Sweep

\$695. Save \$100!

V-222 DC to 20MHz, DC Offset

\$515. Save \$200!

V-212 DC to 20MHz

\$440. Save \$175!

Dual Channel Mini-Portable Scopes

V-509 DC to 50MHz, Delayed Sweep

\$1195. Save \$250!

V-209 DC to 20MHz

\$822. Save \$175!

Quad Channel Multi-Function Scopes

V-1150 DC to 20MHz, Delayed Sweep

\$2650. Save \$300!

V-1100AU DC to 100MHz, Delayed Sweep

\$2240. Save \$250!

Digital Storage Scope

V-6020 1MHz Sampling, Dual Channels

\$1750. Save \$200!

NTSC Waveform Monitors

V-079 6" CRT

\$1625. Save \$125!

V-099 3.5" CRT

\$950. Save \$300!

NTSC Vector Scopes

V-069 6" CRT

\$1825. Save \$125!

V-089 3.5" CRT

\$1284. Save \$400!

**Instant Hard Copy!!
From Oscilloscopes**

**POLAROID®
DS-34
CAMERA**



Save \$135! \$290.

- 5", 6" and 7" Hoods (Available separately @ \$51 ea. Please Specify size)
- Pistol Grip For Ease of Operation
- Works on Any Make of Oscilloscope
- Three Full Year Warranty

**PROBES INCLUDED WITH ALL HITACHI
SCOPES AT NO EXTRA CHARGE!**



**WM. B. ALLEN
SUPPLY COMPANY**

ALLEN SQUARE

300 Block North

Rampart Street

New Orleans

Louisiana 70112

**TOLL FREE 800 535-9593 • LA 800 462-9520
NEW ORLEANS 504 525-8222 • FAX 504 525-6361**

**• American Express • Visa • MasterCard •
928 pg Catalog FREE with your order**

CIRCLE 103 ON FREE INFORMATION CARD

R-E ROBOT

continued from page 68

ously throughout a full 360° rotation of the head. Under low-light conditions the output of the eye will be a low frequency. If the eye is operating at 1 Hz and light readings are taken every 5°, it will take over a minute to rotate the head. Obviously, then, the higher the frequency output of the eye, the better. We can always divide the frequency down to get it in a range that the RPC will be able to process effectively; however, we cannot multiply a low-frequency input to obtain information faster.

The active integrator used in the circuit is based on a simple, classic design. The photodiode's output current is used to charge a capacitor; the charging time, of course, is the integral of the input voltage. A novel twist, however, is that we will use the photodiode to both charge and discharge the capacitor. A newly developed IC from Linear Technology Corporation, the LTC1043, will be used to switch the photodiode from a current-sourcing to a current-sinking configuration. That IC is also used to convert the output of the integrator to a frequency signal for input to the robot's RPC.

The integrator is built around op-amp IC1, a Linear Technology LT1022. That op-amp is chosen for its high-speed operation, modest input-bias current, and low cost. Other operational amplifiers can be substituted, but be aware that any increased input-bias current will degrade the low-light performance, and decreased output slew-rate will degrade high-light-level performance.

Construction

The PC-board's design is somewhat different in that all of the components except J1 are mounted on the *foil side* of the board; the PC pattern can be found in PC Service, and the parts-placement diagram is shown in Fig. 3. The components are mounted in that way so that the PC board can be used as one side of a light-tight structure supporting the Fresnel lens as shown in Fig. 4. Placing the traces on the inside of the box protects them somewhat from contamination; over time, that contamination can build up on the circuitry and affect performance. The completed board can also be covered with a conformal coating (that's a coating that closely conforms to the surface that it is applied to) or potted to minimize any contamination problems.

The printed circuit board is 2.3 inches by 2.3 inches. Those are the same dimensions as the Fresnel lens available from the supplier mentioned in the Parts List. Use screws or standoffs to mount the lens 1.3 inches from the photodiode. That is the

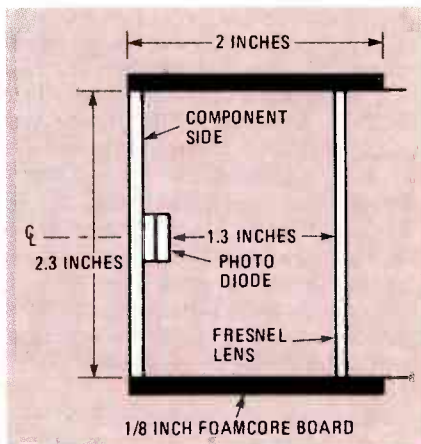

FIG. 3—ALL OF THE COMPONENTS, except J1, mount on the foil side of the PC board.

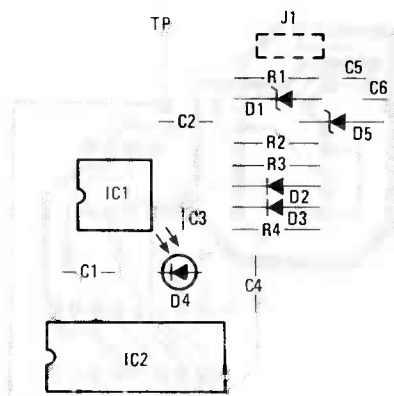

FIG. 4—A FRESNEL LENS is used to concentrate the light on the photodiode.

focal distance of the lens and will result in maximum light gathering power. To fine-focus the lens, attach an oscilloscope to the photodiode and, with the eye pointed towards a light source located several feet away, adjust the lens supports for maximum frequency output. If you find that your eye saturates too quickly, you can simply defocus the lens slightly to reduce the light level that reaches the photodiode.

After the lens has been focused, cut and mount the remaining sides of the box. Cardboard or a similar material is suitable for that; the author used Foamcore board, which is available at art supply stores. Hot-melt glue is a handy means of attaching the sides.

Paint the cardboard sides black to reduce the amount of light entering the eye except through the lens. That won't do much to stop infrared light, however. If interference due to infrared noise becomes a problem, laminate a layer of aluminum foil to the sides.

Next time

That completes the eye's construction. Now it's time to hook it up and test it. Unfortunately, at the moment there's nothing to hook it up to. That shortcoming will be taken care of next time when we show you the robot's rotating head. R-E

ANALYZE WAVEFORM

continued from page 82

a 0.001%-accurate frequency counter replaces the 10 to 20% errors associated with CRT-based frequency measurements.

Freedom from errors: The third difference may have even more impact than the first two. That's because an error in counting or multiplication—or forgetting to set the horizontal or vertical vernier to the CAL position—may lead you down a completely wrong path.

What is worse is that you won't realize that you've made the error until some time later when you re-test a signal. A direct-reading digital readout prevents that because it gives accurate results independently of display settings.

Other problems can happen, too. The verniers can be out of their calibrated position; the signal can be off of the CRT; or the triggering circuits can even be out of sync. But none of those problems will affect the digital readings.

Digital readings make it easier to use waveform analysis for more and more of your troubleshooting. You can lock the waveform onto the CRT when you want to fully analyze all seven parameters of complex waveforms. When making general tests, however, you don't even need to adjust the CRT circuits, if DC voltage, peak-to-peak voltage, or frequency readings are enough to tell you whether the circuits are operating correctly. Such general testing can speed your circuit analysis even more. And, what service technician or engineer could possibly argue with that? R-E



"Next year we get a computer."

COMPUTER DIGEST

VOL. 4 NO. 12 DEC. 1987

A NEW KIND OF MAGAZINE FOR ELECTRONICS PROFESSIONALS

FLOPPY DISKS

Bits, bytes, and copy protection

68000 COMPUTING

The big moment

```
2DA3:0100 EB 35 54 6F 74 61 6C 28 6D 65 6D 6F 72 79 3A 28  Total memory 8000
2DA3:0110 30 39 38 28 4E 42 28 28 28 28 4D 65 6D 6F 72 79  000 80  memory 2000
2DA3:0120 28 61 76 61 69 66 61 62 6C 65 3A 28 38 39 39 28  available: 000000
2DA3:0130 48 42 24 08 08 08 08 08 08 17 08 A1 33 01 0F 10 01  MS...h..13.7 9000
not sample: 1000
AX=0000 BX=0000 CX=0000 DX=0000 SP=FFFF BP=0000 SI=0000 DI=0000  F011
BS=2DA3 ES=2DA3 SS=2DA3 CS=2DA3 IP=0100 FL=0246 MW UP EI PL ZR NA PE N  0120
R1: 1000
SAMPLE: 0130
2DA3:0100 EB35 JMP START 1030
TOTAL: 1030
2DA3:0102 54 PUSH SP 1030
2DA3:0103 6F OUTSW 1030
2DA3:0104 7461 JZ CONVERT 0101
2DA3:0106 6C INSB 0001
2DA3:0107 206D65 AND [DI+65],CH FFR2
U1 - In C:\PERINRUM.COM 0001
?? 0001
The commands are: Assemble (A AU), Breakpoint (BA BB BC BI BL BM BP BR BU BV  0001
EX), Compare (C), Display (D DA DB DD DE DI DL DM DR DS DU DZ), Enter (EA ES),  0001
Fill (F), Go (G G- GA GM GT), Hex (H), In (I IR IS), Jump (J JL), Clear (K M),  0001
Load (LA LF LS), Move (M), Name (N), Out (O), Quit (Q), Register (RA RB RS),  0001
Search (S SA SC SD SR SU), Trace (T TB TR TU) Unassemble (U UR UB US), View (V  0001
WS), Write (WA WF WS), Xlate (XA XD XH), Options (O OE OH OR OS OT OU OV OX)  0001
??
```

DEBUGGING TOOLS

Hands-on report

```
Line:Stat 129-1 File:memory TURBOSwith Source Code
i := 0;
while true do begin
  i := i + 1;
  writeln (i);
  a:
end;
```

PL	MZ	NC	MU	UP	NA	PE	EI
77F5:2E3D	800000				AX,0000h		
77F5:2E40	A36002				[0250h],AX		
77F5:2E43	B00100				MOV AX,0001h		
77F5:2E46	00C0				OR AX,AX		
77F5:2E48	7503				JNE 2E40h		
77F5:2E4A	E92800				JMP 2E75h		
77F5:2E4D	A16002				MOV AX,[0250h]		

```
Level: Program [Main] Variable View
HeapPtr: Integer?? [Special System Parameter]
BufLen: Byte
Integer: 0 MOV EB 1020
```

```
10 end;
11 b:
12 writeln;
13 end;

begin
14 i := 0;
15 while true do begin
16 i := i + 1;
17 writeln (i);
18 a:
19 end;
20 end;
```

```
Source: Memory T-DebugPLUS 2.00
$ACB5:$00E4 #*gId= i|Pib u AY HFCIF(x = u 0
$ACB5:$00A4 iv #F20 i#PF2YFED i# *PE u 1 J0^ 2 0# -i# i z = u
$ACB5:$00E4 0' 0#2,H 0u 1 0#61^ P1 00y,EE-#Copyright (C) 1985 BOKLAND In
-> Memory
watch variables are removed.
WD [(parameter)] - Redraw/resize windows. (parameter) is new row for
the Window Divider. Default setting is row 14.
X (parameter) - Translate. If (parameter) is a symbol or statement number,
returns an address; if a hexadecimal offset, returns a statement number.
* da cs:0100
* =
```

CONTENTS DECEMBER 1987

Vol. 4 No. 12



91 ALL ABOUT FLOPPY DISKS

Focus on Apple and IBM formats.

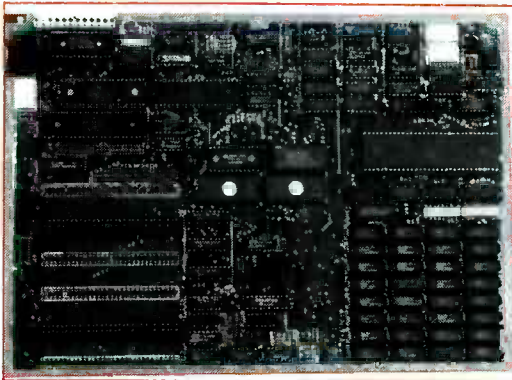

95 CD CLASSROOM, PART 3

Install the microprocessor.

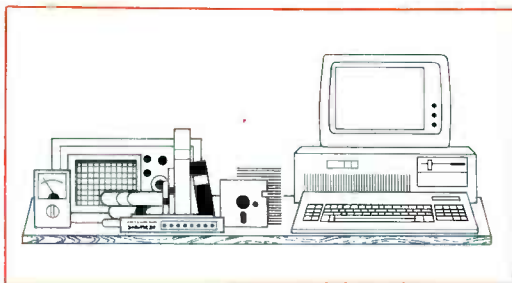

87 EDITOR'S WORKBENCH

HARDWARE: Periscope
SOFTWARE: TDebug Plus
TurboSmith

COMPUTER DIGEST

Larry Steckler,

EHF, CET: publisher & editor in chief

Art Kleiman,

editorial director

Brian C. Fenton,

managing editor

Jeff Holtzman

technical editor

Byron G. Wels,

associate editor

Carl Laron,

associate editor

Robert A. Young,

assistant editor

Teri Scaduto

editorial assistant

Ruby M. Yee,

production director

Karen Tucker,

production advertising

Robert A. W. Lowndes,

production associate

Marcella Amoroso

production assistant

Andre Duzant,

technical illustrator

Jacqueline P. Cheeseboro

circulation director

Arline R. Fishman,

advertising director

ComputerDigest
Gernsback Publications, Inc.
500-B Bi-County Blvd.
Farmingdale, NY 11735

ADVERTISING SALES 516-293-3000

Larry Steckler

Publisher

NATIONAL SALES

Joe Shere

1507 Bonnie Doone Terrace

Corona Del Mar, CA 92625

714-760-8697

Cover Photography by Herb Friedman
and Jeff Holtzman



regain control of
by resetting:
1100
ver, allow you

itch, Per-
ie finest
we've
kit for
aren't
id it
ite
ft-

J MS DOS machine-
ger. It is included with
so, so every programmer,
oyist is familiar with it. De-
or tracing and analyzing both
u write yourself, and software
y others. And with care you can
e it to create short programs without
d of an external assembler.

However, you don't have to use the pro-
gram for very long to realize that it has
limitations, the most severe of which are
limited breakpoint facilities, lack of win-
dowing, and lack of support for the sym-
bols generated by the assembler or com-
piler you use to generate object code.

Attempting to remedy those deficien-
cies, the Periscope Company sells a line of
high-quality debugging tools with varying
capabilities. The latest incarnation includes
an expansion card that allows you to trap
bus events in real time, thereby providing
many of the capabilities of a development
system for about 10% of the cost.

Actually, there are four models of Per-
iscope, which differ mainly in the hardware
included.

- Periscope I (\$345) includes a memory board with 56K of write-protected memory and a break-out switch. The memory is installed outside of the 640K DOS limit (usually in segment D000 or E000); the Periscope software runs from that memory. Pressing the break-out switch at any time—even when the system is apparently locked-up—generates a hardware interrupt that activates the Periscope software.

- Periscope II (\$175) includes just the break-out switch; the software runs from normal DOS memory, so it may be overwritten by a run-away program. In that case you may not be able to regain control of a hung system. The break-out switch does not require an expansion slot; a small finger slips in an in-use slot between the expansion card and the connector's own finger.

- Periscope II-X (\$145) includes just the software and no hardware. You may use your own break-out switch or a keyboard hot-key to activate the software.
- Periscope III (\$995) is a full-length expansion card (shown in Fig. 1) that includes 64K of write-protected memory, a break-out switch, and additional circuitry that continuously monitors the expansion bus and allows you to create breakpoints that are activated when memory locations, I/O ports, or microprocessor registers attain certain values. A small module must be inserted into your motherboard's 8087 (or 80287) socket.



FIG. 1—The Periscope board.

The software functions pretty much the same for all versions, given the hardware differences. In fact, the same software is included with all versions; during the installation you must specify your hardware configuration.

How to use it

The Periscope software comes in two parts: PS.EXE, the 50K debugger, and RUN.COM, a 7K program that loads and runs your software. First you run PS, which lies dormant in memory until you Run a program. When you do, the Periscope screen comes up, a register dump is displayed, and the first instruction is disassembled. You can then execute your program in various ways.

To ease the learning process, Periscope duplicates many Debug commands, so you can Trace a single instruction or a group thereof, or Go, starting at an address you

specify, with breakpoints at addresses you specify. In addition, you can Dump memory in the standard Debug format, Read and Write files and disk sectors, Unassemble, Examine, Search, and Fill memory, etc.

Normally, all output scrolls up the screen in standard fashion. However, you can open windows (see this month's cover for an example) that maintain information in fixed places on the screen, thereby making that information much easier to find and assimilate. Window size and color is easily specified; windows may contain registers, memory dumps (in several formats), disassembled instructions, stack dump, and a text file dump. Pressing Ctrl-F9 or Ctrl-F10 brings up default windows for mono and color windows, respectively.

The disassembly will contain the symbols and high-level instructions of your program, if an appropriate .MAP file is available. (Most assemblers and linkers can generate such a file.) For example, the program shown in Fig. 2 is written in Turbo Pascal; a utility sold by Turbo Power created the required .MAP file. Note that both Turbo source lines and the generated object code are shown. See this month's software reviews for more information.

You can add your own labels to programs and save them separately. That capability is useful when disassembling third-party software.

Breakpoints and program tracing

You can set an almost bewildering variety of breakpoints with Periscope. BC sets a Code Breakpoint, activated when your program tries to execute code at the specified address. That address may be specified using hex notation or symbolically. BI sets an Interrupt Breakpoint, activated when a software interrupt is executed. For example, to stop execution any time a DOS function (interrupt 21h) was to be executed, you'd type

BI 21

You can also set breakpoints on source-

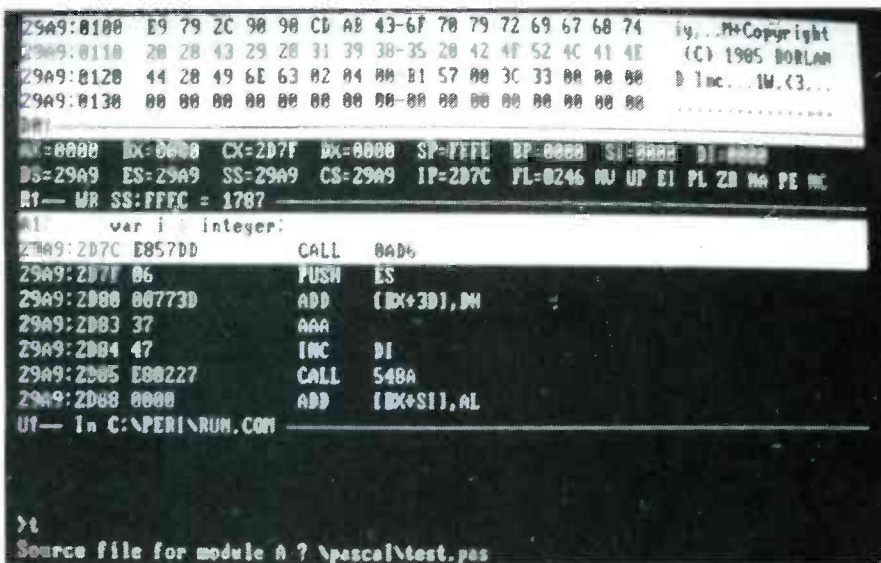

FIG. 2—The Periscope debugging screen.

code line numbers (BL), memory addresses (BM), I/O port addresses (BP), registers (BR), user-specified conditions (BU), memory contents (BW), and subroutine exit (BX). Note that those are not hardware-activated breakpoints, so execution must be started via the GT command, in which machine instructions are executed one at a time, breakpoint settings are examined, and then control reverts either to Periscope or to the user program, depending on whether the breakpoint conditions were met.

Each of the breakpoint commands may be cleared by entering the command with an asterisk. In addition, breakpoints of a particular type may be enabled (by typing +), disabled (by typing -), or displayed (by typing ?).

Hardware control

All of the commands discussed thus far may be used on any version of Periscope. Periscope III enables an additional set of breakpoint, trace, and display commands that let you execute your program in real time until a specified condition is met. The HB command, for example, sets a breakpoint when a specific bit pattern appears on the data bus. Values of 0, 1, and X (don't care) are legal. You can also trap memory and port reads or writes (or either) using the HM and HP commands, respectively. Further, using the JD command you can qualify the breakpoint so that execution will continue until data within a specified range, and at the specified address is accessed.

Periscope III's hardware buffer has sufficient memory to trap 8192 bus events. When defining a breakpoint, you can instruct the hardware to save the 8K events preceding the breakpoint, the 8K following it, or 4K on either side. You can also set up a pass count, so that, for example, the breakpoint will not be executed until the fifth time an 0Dh is output to port 61h. The HC (Hardware Control) command sets those modes.

Operation on an AT is somewhat more complicated. For example, when setting a bit breakpoint, you must specify the upper or lower half of the bus (or both). In addition, you can force a hardware breakpoint to be executed when memory beyond the one-megabyte area is accessed, again using the HC command.

Hardware buffer display

There are four commands for displaying the contents of the hardware buffer; a fifth (DW) saves the buffer to disk (or memory) for future examination. The display commands are as follows.

The HR command provides a full-screen display of the raw contents of the hardware buffer. Each line contains an address, data, operation type (input, output, read, write, DMA, instruction pre-fetch), plus an address symbol, if available. A sequence number that corresponds to the 8K of stored data is also displayed. You can scroll through the buffer and search for address, data, and operation types.

HS displays a single line in the same format as the HR command.

HT and HU provide a full-screen display of the hardware buffer, but in a more digestible format. HT provides a disassembly (with labels) plus the operation types (in, out, etc.), and HU provides just the disassembly.

Other goodies

Naturally, Periscope includes a built-in assembler. The surprise is that you can use symbols for address references—those from your program's MAP file, or those that you've defined within Periscope (using ES).

There is also (optional) on-line help. Pressing ? brings up a list of commands; pressing ? plus a command brings up a brief summary of that command.

Periscope can use two monitors—one for your program's output, and one for the Periscope debug display. When used with

an EGA and Periscope disp. 43-line mode.

The Periscope table, and the pre-recently issued co. scroll through and the new line. Limited available, and you can mand executed by pr

A word about the t you run the following pi Debug, the only way to your machine would be t

XXXX.0100 JMP L

A break-out switch will, howe to escape from the loop.

Conclusions

With or without a break-out sv scope impresses us as one of ti pieces of development software ever seen. It will be part of our too years to come. The hardware models cheap, but if you need one, you nex bad, so cost should be no object. If yo on a tight budget, you can buy the sc ware-only version and add your own brea out switch.

Turbo Pascal Debuggers

Turbo Pascal, when it was introduced some four years ago, laid to rest forever the notion that serious software development could only be done by means of the traditional and time-consuming edit-compile-link-test-repeat loop. Comprising less than 40K of code, and widely available at well under \$100, Turbo Pascal also dispelled the notion that a professional compiler had to be big or expensive. In addition, it's available for a number of operating systems (CP/M, CP/M-86, and MS-DOS).

The only thing missing from Turbo Pascal was a symbolic source-level debugger of the type that companies like Periscope (see this month's hardware review) have been selling for some time.

That lack was addressed a few years ago when a program called TDebug appeared on BBSes across the nation. Since then, the product has gone commercial; the commercial implementation, called T-DebugPlus, adds a host of new features and several extremely useful utility programs.

TurboSmith, a latecomer, provides many of the features of T-DebugPlus, as well as several unique ones, including an integrated machine-language debugger.

TurboSmith

The program is contained in a single 120K file (TSM.EXE). In keeping with the Turbo philosophy, TurboSmith costs \$69. It's writ-

ten entirely in assembly language, and requires 512K of free RAM to run. In fact, TurboSmith really needs most of 640K to function properly; it wouldn't work at all on a 3Com network station, which gobbles about 200K of memory for device drivers.

You run TSM to get into Turbo; TSM loads Turbo and adds a new item, Trace, to Turbo's main menu. (See Fig. 3.) The editor and compiler functions work just as they do without TSM; the new Trace option compiles the current program and then brings up the debugging screen. (See Fig. 4.)

That screen can display as many as three windows simultaneously. One is the source-code window, which is always displayed. The other two may contain program variables, a hex/ASCII memory dump, or a machine-language control window.

You switch among windows cyclically by pressing the F10 key; pressing F2 inside any window brings you to a command line where you can initiate various operations. For example, by typing Q you return to the Turbo menu. A full range of line-editing functions is available at each command line.

Other non-command-line operations are initiated by Ctrl-key and Alt-key combinations, and the commands work as much alike as possible inside different windows. For example, pressing Alt-B inside either the source or the machine-code window sets a breakpoint where the program will stop when it tries to execute that Pascal statement or that machine-language instruction, respectively.

In either program-control window you can execute a single statement or instruction by pressing the + key by the numeric keypad. Or press Alt-X (eXecute) to execute full-speed until a breakpoint is reached or Alt-S (Stop) is pressed. Another way of starting executing is to press Alt-A (Auto single-step). In that mode, a statement or instruction is executed, the screen is updated, and then the next program ele-

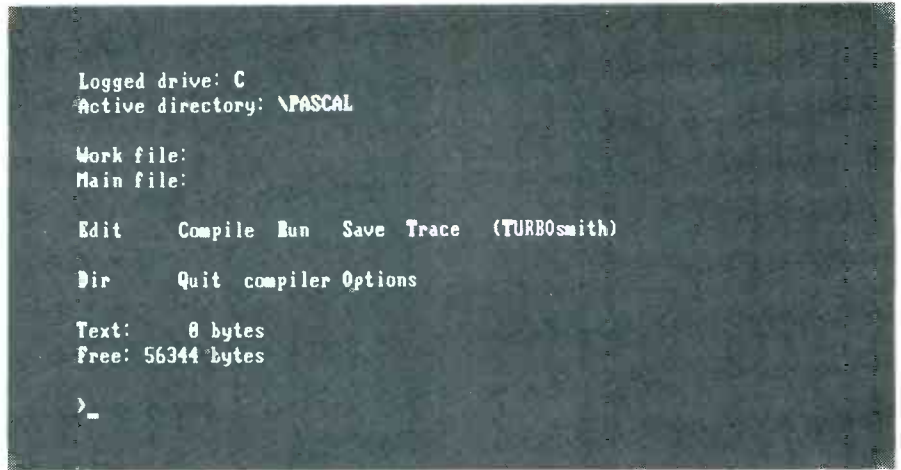

FIG. 3—TurboSmith adds a new item to the Turbo menu.

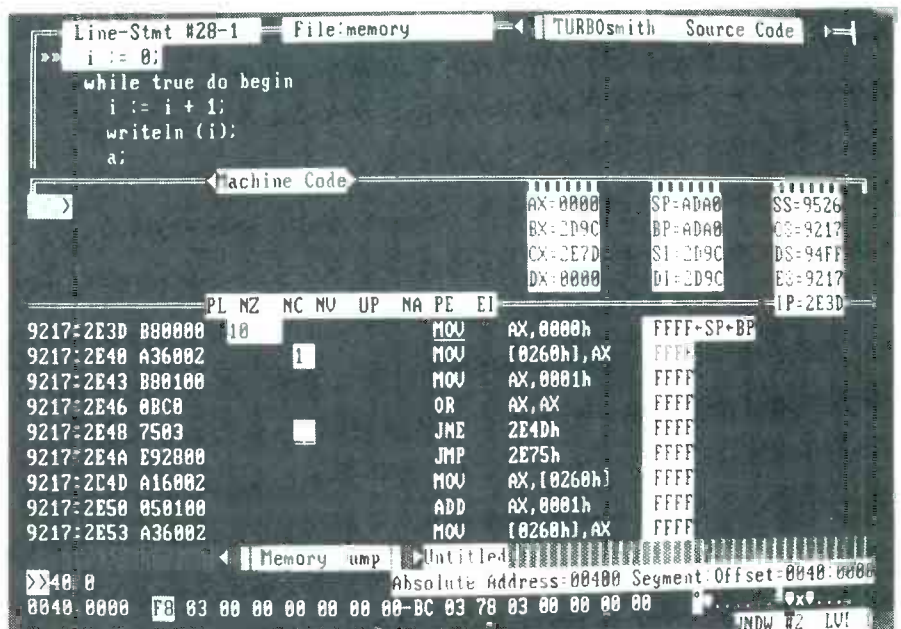

FIG. 4—The TurboSmith debugging screen.

ment is executed. Terminate Auto mode by pressing any key. Auto mode is not as useful as it might be because you can't control the speed at which statements are executed. You might want to slow execution in order to get the feel of how a loop was executing, for example.

The Variables window displays the values of all global variables, Turbo's internal variables as well as your own. You can only view variables inside a nested procedure or function when the program is executing that procedure or function. Further, you can open as many as eight window levels, each of which overlays one of the three on-screen windows. You cycle among displayed windows by pressing F10, and among levels by pressing F9. You are free to change the values of variables within any window.

Version 2.1 (which was not available in time for this review) should automatically open variable windows in nested procedures and functions.

Screen swapping

Most programs produce some sort of screen output; TSM can deal with screen output in two ways. First, and best, you can use two monitors, one mono (IBM or Hercules) and one color (CGA or EGA). In that case, program output must go to the mono screen; the debugging windows come up on the color screen. Otherwise, on a single-monitor system, you can use screen swapping, wherein TSM maintains memory images of both the debugging data and the program's output data, swapping them at the press of a key.

One useful feature is that TSM will respond to a break-out switch. If your program gets locked in a loop and the keyboard won't respond, chances are the break-out switch will allow you to regain control and continue debugging. See this month's hardware review for more information on break-out switches.

TSM's machine-language debugger provides powerful breakpoint facilities. You

Products Evaluated

- TurboSmith (\$69), Visual Age, 642 N. Larchmont Blvd., Los Angeles, CA 90004, 800-732-2345, 213-534-4202 (CA).

CIRCLE 31 ON FREE INFORMATION CARD

- T-DebugPlus (\$60), Turbo Power, 2109 Scotts Valley Drive, Scotts Valley, CA 95066, 408-438-8608.

CIRCLE 32 ON FREE INFORMATION CARD

- Turbo Pascal (\$99.95), Borland International, 4585 Scotts Valley Drive, Scotts Valley, CA, 800-255-8008, 408-438-8400 (CA).

CIRCLE 33 ON FREE INFORMATION CARD

- Periscope (price varies according to model), The Periscope Company, 14 Bonnie Lane, Atlanta, GA 30328, 404-256-3860.

CIRCLE 34 ON FREE INFORMATION CARD

can set *passpoints*, breakpoints that will occur only when an instruction has been executed a number of times (ranging from 1 to 65535). In addition, you can *tag* an instruction or a group of instructions with a number ranging from 1 to 99; you can then set, clear, or disable breakpoints by tag number. The ML debugger also provides DEGUG-like facilities for searching, filling, moving, and disassembling memory, computing hex values, inputting and outputting values to I/O ports, etc. You can also append comments to disassembled instructions, but the comments may not be saved. A macro facility allows you to record sequences of keystrokes and assign them to any key. Macros may not be saved. TSM will also accept keystrokes from a file.

In the machine-code window, you can use a non-symbolic assembler to enter assembly-language instructions into your program in one of two ways. First, by pressing Ctrl-A, you enter an overwrite mode in which your instructions overwrite whatever instructions currently reside in memory. Second, by pressing Ctrl-P, you enter a patch mode in which your instructions are inserted *between* current instructions—even if there is no space for them!

You can also patch memory in the memory-dump window, in either hex or ASCII notation. You can also force the memory-dump window to track the machine-code window, so that any time you execute a machine instruction that accesses memory, that area of memory will be displayed.

One deficiency is that you can't use TSM to debug graphics programs. Future versions of the program may correct that deficiency, but for now, you'll have to stick to text-mode debugging. Our only other complaint is that window position is hard to control; by contrast, some machine-language debuggers allow window placement by screen line number.

T-DebugPlus

Turbo Power has been selling Turbo enhancements for a long time, and the company has a number of products, including T-DebugPlus; Turbo Extender, which allows you to create very large (greater than 64K) Turbo programs; Turbo Optimizer, which allows you to compact the size of run-time files and to create and link libraries of often-used routines; and Programmer's Utilities, which contains a program structure analyzer, an execution timer and profiler, pretty printer, and several file-management utilities. Source code is available for all programs, all of which are written in Turbo Pascal.

T-DebugPlus is contained in one .COM file and one overlay file, which together occupy about 100K of disk space. To run T-DebugPlus you need about 256K of free memory. The main features that distinguish T-DebugPlus from TSM are that (a) the program is written in Turbo Pascal, and the source is included; (b) the program has no

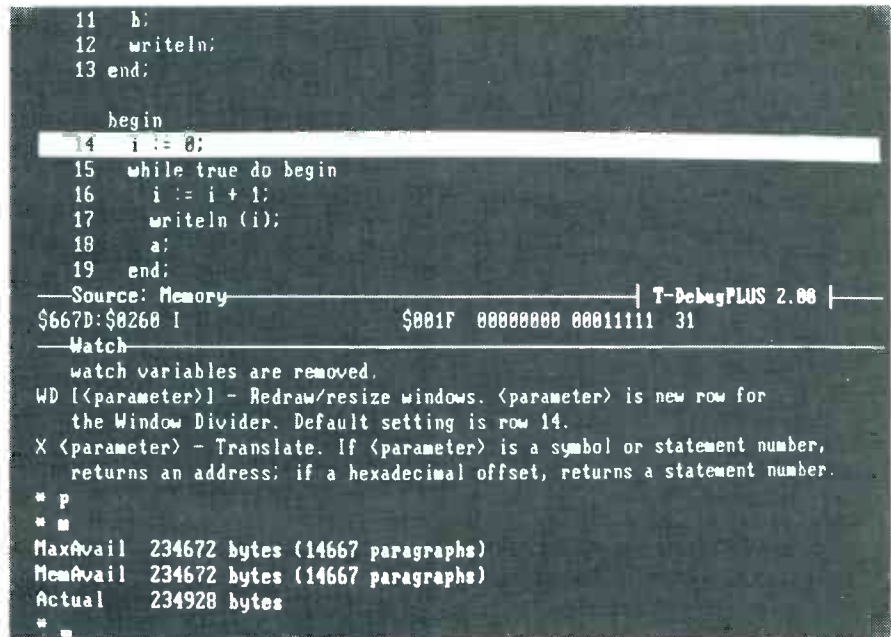

FIG. 5—The T-DebugPlus debugging screen.

built-in machine-language debugger; (c) the program does support graphics modes; (d) program and debug screens can appear on either mono or color monitors in a dual-monitor system. T-DebugPlus also has a screen-swapping mode.

In addition, T-DebugPlus includes several useful utilities, including TMAP, which generates a .MAP file for use with an external symbolic machine-language debugger; TMERGE, which allows T-DebugPlus to debug large Turbo programs (when used in conjunction with Turbo Extender), and two program-listing programs, one of which generates a symbolic disassembly. In addition, several files contain information about various routines in Turbo's run-time library; that information is extremely useful for learning about how Turbo works. All source files are contained in a single .ARC file on the distribution disk.

To use T-DebugPlus, you run the program, which, like TurboSmith, loads and runs Turbo for you. When you Run your program from Turbo's menu, T-DebugPlus's debugging screen comes up. (See Fig. 5). There you can single-step individual statements and entire functions and procedures. You can set breakpoints that become active when a variable changes or becomes equal to a specified value, or when a particular memory location is altered. You can also set breakpoints by line number and by routine name. A breakpoint may also include passpoint count values, so that the breakpoint would be executed after a routine was executed the specified number of times. In addition, you can open a memory-dump window in one of several formats, display "watch" variables, whose values are updated on the screen each time a breakpoint is reached, and examine and change the values of variables.

All commands are executed from a com-

mand line, which can be edited. No macros are allowed, but the function keys provide shortcuts to the most common commands, and F4 repeats the last command.

Although T-DebugPlus has no built-in machine-language interface, it can be used in conjunction with an external debugger—even Debug. The DG command will drop you into your debugger. Source-level debugging is not possible in that manner. However, you can use TMAP, one of the utilities included with the package, to generate a .MAP file, which most source-level debuggers can use to link source code and machine instructions.

Several miscellaneous commands provide useful functions. For example, a brief command summary is available by pressing F1. In addition, the X command allows you to find the machine addresses of variables, source-code line numbers, procedures, and functions. Conversely, you can find the nearest statement to a specified address.

Conclusions

T-DebugPlus and TurboSmith are both extremely useful accessories to anyone programming in Turbo Pascal.

Points to keep in mind, however, are that T-DebugPlus does graphics, has full dual-monitor support, and slightly more convenient breakpoint facilities (at the source level). In addition, it requires less memory, and its documentation is more concise and better produced. For beginners and those not needing full machine-language support, it may be the better choice. TurboSmith's strength are its windows, its built-in machine-language interface, and its ability to work with a break-out switch. But considering the reasonable prices of these packages, you may want to get copies of each. 

FLOPPY-DISK DATA STORAGE

Learn all about Apple and IBM disk formatting—including copy protection!

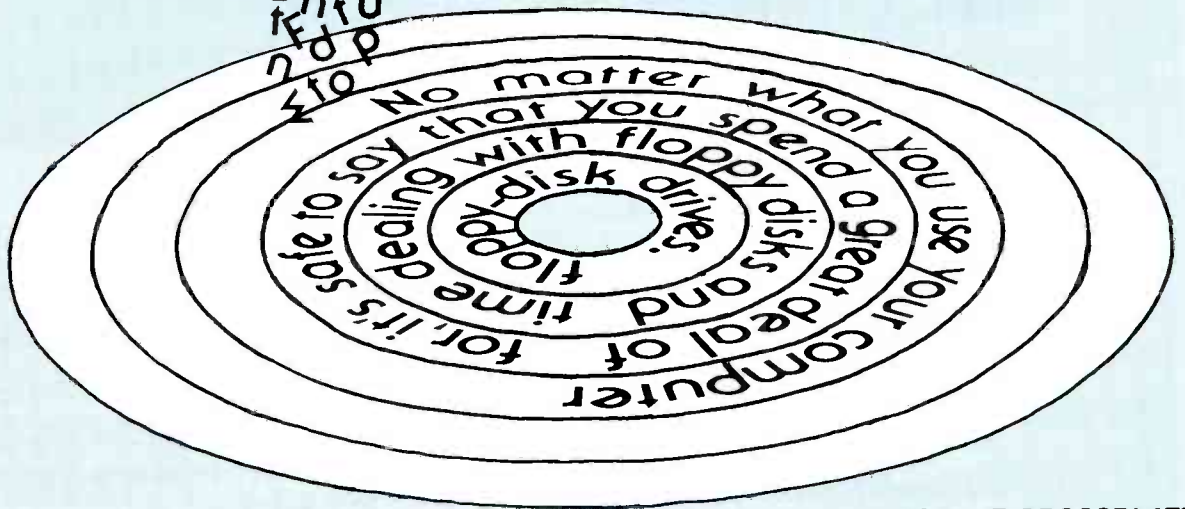

ROBERT GROSSBLATT

No matter what you use your computer for, it's safe to say that you spend a great deal of time dealing with floppy disks and floppy-disk drives. Loading programs and saving data are such common operations that we tend to forget how fragile the whole system is. But all it takes is one disk disaster to remind us of that fragility.

Of course, there are ways of protecting against those types of disasters, and other ways of dealing with them when they do occur. Performing regular backups is the best protection, but even that is not fail-safe. What happens if a disk crashes during a backup procedure?

In order to have any chance at all of recovering that data, as well as to back up copy-protected software, you need to know how data is stored on your disks. The more of the process you understand, the better your chances of successfully recovering a crashed disk. So in this article we'll examine how data is stored on both IBM and Apple floppy disks. The information provided will put you far on the road toward being a real "disk jockey."

Tracks and sectors

The standard 5¼-inch floppy disk consists of a disk of magnetically coated plastic that is contained in a jacket, as shown in Fig. 1-a. In order for your computer to use the disk, it must have a way of finding its way around the magnetic coating on the surface. It does so by treating the disk as a group of tracks that are divided into sectors. As shown in Fig. 1-b, the tracks are a series of concentric circles, each of which is divided into a number of segments, the sectors. In addition to tracks and sectors, disks also have two sides, as shown in Fig. 2. Not all disk

control hardware and software can use both sides, however.

The number of tracks and sectors determines how much data will fit on the disk. That amount is dependent on your computer's hardware and disk operating system (DOS). The numbers vary among computers and disk sizes, but the basic principles of operation are the same.

When you tell your computer to format a disk, the hardware moves the read/write head to track zero, the outermost track, and then forces it to deposit information on the surface of the disk that indicates the sector locations. The process is repeated for each track until the last track has been formatted.

Standard 5¼-inch Apple disks have 35 tracks on one side of the disk only, and the most common IBM format has 40 tracks on each side of the disk. Double-sided 3½-inch and 8-inch disks have 77 tracks per side, and the AT's quad-density 5¼-inch disks have 80 tracks on each side.

DOS (IBM or Apple) uses tracks and sectors to organize the disk's surface. At the DOS level, to find a particular piece of information, all you need are two pieces of information: track and sector numbers. With double-sided disks, you must also specify the head number.

The number of tracks per disk is usually a function of the hardware. The DOS talks to the disk controller, which, in turn, talks to the stepper motor in the drive and tells it to move the head in or out the desired number of tracks.

The number of sectors, however, is controlled by the DOS. IBM's DOS, for example, can format for eight or nine sectors per track, but standard Apple disks have sixteen sectors per track. So you can have more small sectors or fewer large sectors.

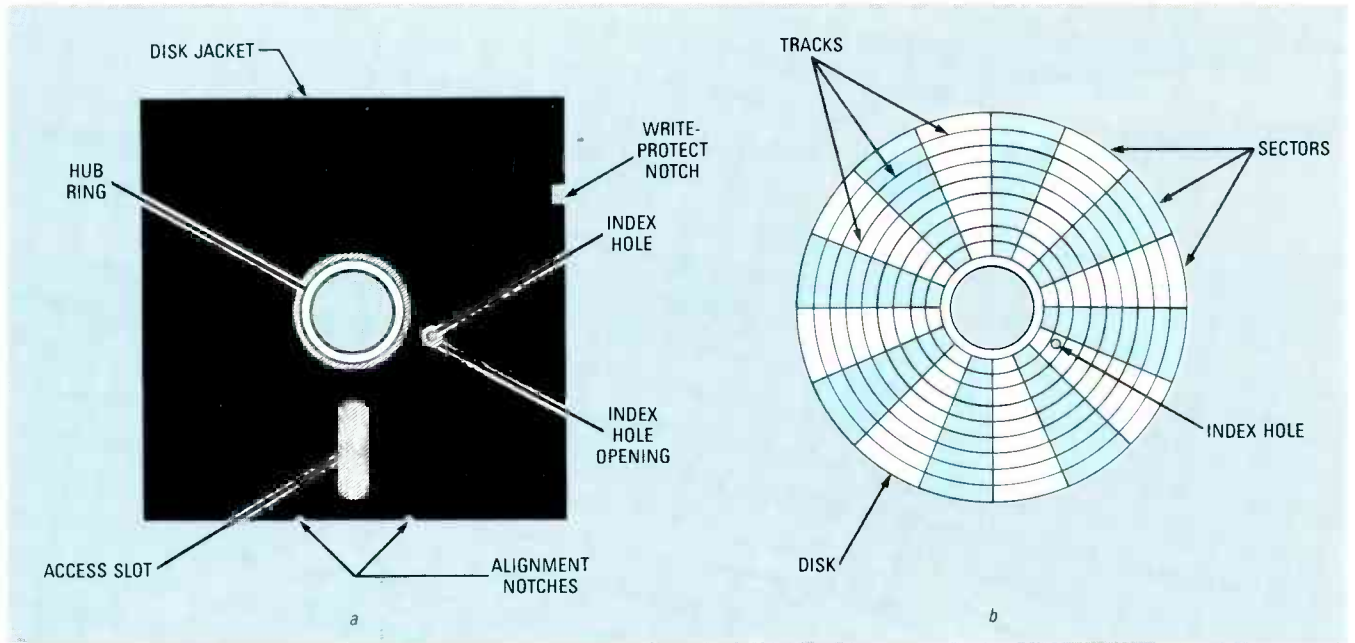

FIG. 1—DISK CONSTRUCTION: The magnetically coated disk is contained in a jacket (a), and is formatted to contain tracks and sectors (b).

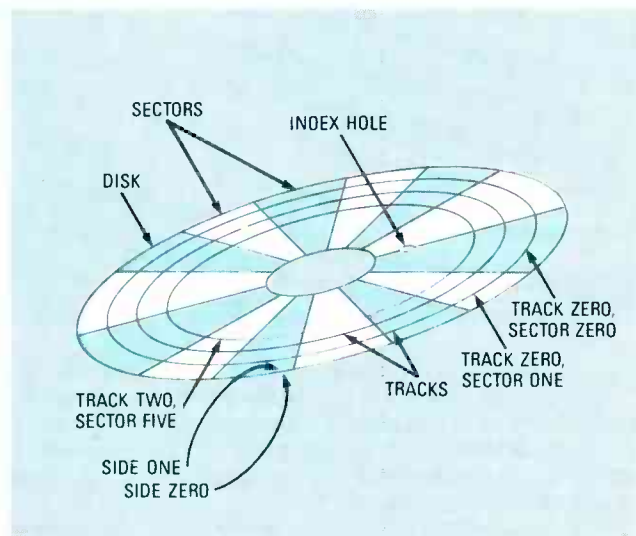

FIG. 2—BOTH SIDES of a disk are used by some disk control hardware and software.

Disk formatting

When a track is formatted, DOS writes three kinds of information in each sector: ID bytes, sync bytes, and gap bytes. The exact format of those bytes differs from computer to computer, but the same sort of scheme is used by every DOS. The reason is that DOS must have a way of determining exactly which sector it's looking at. Not only that, but there must be a way of ensuring that the special formatting bytes are never overwritten by data. If that does happen, DOS has no way to identify the sector and the result is what you might expect—a crashed disk.

There are actually two kinds of ID bytes on a sector—one is the signpost that marks the sector's location on the disk, and the other lets DOS know that it's looking at the beginning of the data stored in the sector.

Figure 3-a shows a dump of an Apple DOS 3.3 sector, and Fig. 3-b shows a dump from an IBM DOS 3.1 sector. At first glance, they both look meaningless—clearly different but equally meaningless. Those disk formats are the two most popular, and both the hardware and the software used to create them are

totally incompatible. It's even more interesting, therefore, to see that they use similar schemes to write disk data.

The ID marks on the IBM sector are written in hex on the disk; you'll find them in Fig. 3-b at offset 00A1h. The first three bytes (00, 00, and 01) show that you're looking at track 0, side 0, sector 1. The next byte (02) shows that the sector can hold 512 bytes.

Other sector sizes can be accommodated, as shown in Table 1. Normally, a maximum of about 6000 bytes can be written per track, so the final entry in the table may seem questionable. On the other hand, perhaps IBM has something up its sleeve.

The two bytes following the ID bytes contain a special error-detecting code called a CRC (cyclic redundancy check). The CRC is used by DOS to make sure that data read from the disk is correct. If the CRC calculated from the data that is read from the disk doesn't match the four CRC bytes in the header, DOS considers the data corrupt. Every time you change the data in a sector, DOS recalculates the CRC and writes it to the disk.

In order to keep those bytes from being overwritten accidentally, DOS uses sync bytes to mark the location of the ID bytes. When the floppy-disk controller writes a data byte on the disk, it sends out a steady clocked stream of ones and zeros. The Apple, for example, writes bytes to the disk at intervals of 32 microseconds. Sync bytes, however, are written at a different interval so they're easy to spot on the disk. Apple sync bytes are written in 40-microsecond intervals, and each sync "byte" is 10 bits long.

IBM sync bytes differ. The IBM sector in Fig. 3-b shows that there are three bytes containing a value of A1 beginning at offset 9D. Those are the specially written sync bytes that the floppy-disk controller uses to mark the location of the ID bytes. The twelve 00 bytes preceding the A1 bytes are also sync bytes. You can understand how they're used by tracing through the mechanics of a normal disk read.

When an IBM controller must read data, the first thing it does is make sure that it's looking at the right sector. It starts reading data, watching for a stream of 00 sync bytes, which lets it know that there's a chance that A1 sync bytes will follow. If they do, DOS knows that the following bytes are ID bytes.

Although ID bytes are used to mark both the signposts and your data, DOS can tell the difference by looking at the byte immediately following the A1 bytes. If it's an FE, the ID bytes are signposts, but if it's an FB then it's data. The amount of data is

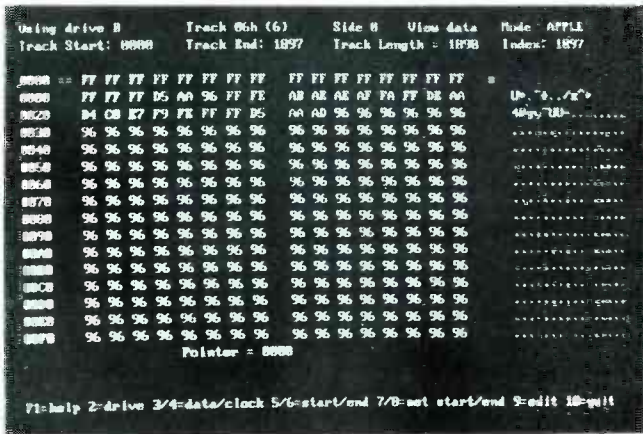

FIG. 3—SECTOR DUMP of an Apple disk (a) and an IBM disk (b).

known because the sector size is specified in the signpost. The last non-data byte on the disk is called a gap byte. Gap bytes are insurance against worst-case operation. They're needed because not all disk drives turn at the same speed, so there's no way to guarantee that writing a new block of data to a sector won't overwrite existing ID and sync bytes. A disk drive only has one head per surface, so there's no way to read and write simultaneously. As long as drive speed is within tolerance, the DOS standards have been set so that there's no possibility of destroying any of the critical bytes needed to read the sector. On an IBM disk, the gap bytes usually have a value of 4E. Apple, on the other hand, uses 10-bit FF "bytes."

As for data bytes, if the sector hasn't been used, it will be filled with the DOS formatting bytes: IBM uses F6, Apple uses 96, and CP/M uses E5.

TABLE 1—IBM SECTOR SIZE ENCODING	
ID Byte	Bytes/Sector
\$00	128
\$01	256
\$02	512
\$03	1024
\$04	2048
\$05	4096
\$06	8192

TABLE 2—APPLE DISK ENCODING	
One Byte Volume Number	= B7 B6 B5 B4 B3 B2 B1 B0
Two Byte Disk Encoding	= \$FF FE
	= 11 11 11 11 11 11 11 10
Apple's Encoded Format	= 1B7 1B5 1B3 1B1 1B6 1B4 1B2 1B0
Decoded Binary Number	= 1 1 1 1 1 1 1 0
Volume Number	= \$FE
	= 254
One Byte Track Number	= B7 B6 B5 B4 B3 B2 B1 B0
Two Byte Disk Encoding	= \$AB AE
	= 10 10 10 11 10 10 11 10
Apple's Encoded Format	= 1B7 1B5 1B3 1B1 1B6 1B4 1B2 1B0
Decoded Binary Number	= 0 0 0 0 0 1 1 0
Track Number	= \$06
	= 6
One Byte Sector Number	= B7 B6 B5 B4 B3 B2 B1 B0
Two Byte Disk Encoding	= \$AE AF
	= 10 10 11 10 10 10 11 11
Apple's Encoded Format	= 1B7 1B5 1B3 1B1 1B6 1B4 1B2 1B0
Decoded Binary Number	= 0 0 0 0 1 1 0 1
Sector Number	= \$0D
	= 13

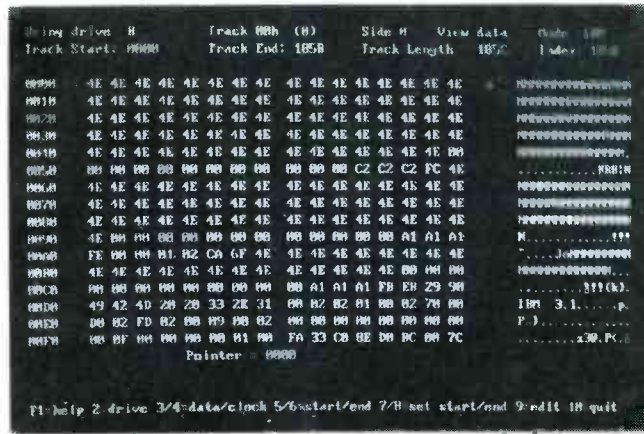

Although Apple's disk format is structurally similar to IBM's, the details are different because Apple's disk control hardware and software are unique. Most disk controllers store data in un-encoded format, so that a dump of an ASCII text file, for example, will be comprehensible.

The Apple hardware, however, limits the values that can be stored on disk. The high bit of each byte must be set, there can't be more than two adjacent zero bits, and at least two adjacent bits must be set in each byte. Some values are reserved for use as ID bytes, and hardware restrictions eliminate many others, so there are only 64 possible values that can be written to the disk to represent your data.

So, in order to be able to write all 256 combinations of eight bits, it's clear that the data must be encoded. In fact, Apple has gone through three major revisions of their encoding scheme. However, that's not a subject that can be covered here; see the books in the References sidebar for more information.

Apple format

Apple's sector format is somewhat different. Referring back to Fig. 3-a, the signpost ID bytes are located at offset 0013h after the series of FF sync bytes. The signpost bytes always begin with a prologue (D5 AA 96), which serves the same purpose as the FE marking the IBM signpost. The next eight bytes are encoded versions of the disk volume number, track, sector, and checksum. As shown in Table 2, by decoding them we see we're looking at volume 254, track 6, sector 13. The checksum is calculated by sequentially XORing all data bytes in that sector together.

Following that information is an epilogue, which can be seen beginning at offset 001Eh. It marks the end of the signpost area and has no counterpart on an IBM disk. The epilogue is there so that DOS can make sure it's been reading the correct signpost marks and that it is still in sync with the disk. They're not really necessary, but remember that the Apple system was devised in the late seventies when disk drives were not as reliable as they are today.

Following another group of sync bytes comes the data bytes. At offset 0028h is the prologue (D5 AA AD); then follow 342 bytes of data. Apple stores 256 bytes of data in each sector, but, because the data is encoded, 342 bytes are needed to do it. A checksum is calculated for the data and stored at the end of the data space along with the epilogue (DE AA EB).

Sector numbering

Although sectors are numbered sequentially, often they're not stored sequentially. When DOS looks for a particular sector, it must locate the signpost markers, read them, verify the read, and then see if they're the ones it was looking for. All that takes time, but meanwhile the disk keeps spinning, so there's a good chance the next sector will have passed beneath the read/write head while the previous sector was being analyzed.

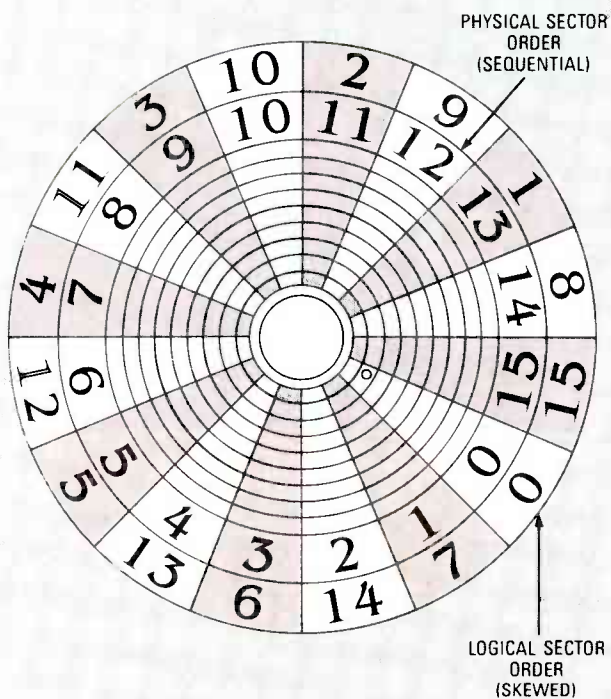

FIG. 4—LOGICAL AND PHYSICAL sector orders are not necessarily the same.

So, to make things more efficient, the sectors are interleaved, or skewed, as shown in Fig. 4. The inner circle indicates physical sector numbering; the outer circle indicates logical sector numbering.

Disk organization

Now that we know how data is stored on the disk, the next step is to see how it's organized. Once again, although the details vary from computer to computer, the basic method is the same. Let's look at the general principles and then see how they're actually applied in both Apple and IBM systems.

DOS divides the disk into four areas: System, Directory, Table of Contents, and Data. Any disk operation makes use of the information stored in all four areas.

DOS itself is stored in the System area of the disk—the first few tracks on the disk. The number of tracks depends on the size of DOS and the type of computer. The very first sector on the first track is called the *boot sector* and it's used whenever you boot a disk. It has a short machine-language program that tells the computer how to go about loading DOS from the disk. In addition, in some systems it contains data related to the directory structure, disk format, and so on.

When you boot your computer, the disk controller reads the boot sector into memory. Then the computer turns control over to the program, called the *bootstrap loader*, that is contained in that sector. Things are done that way because the controller can read in only a sector at a time. You can read in more than one sector at a time—but that's DOS's job. So it's a chicken-and-egg problem: you need DOS to read multiple sectors and you can only read in multiple sectors by using DOS. But because DOS is located in a specific place on the disk, the bootstrap loader knows how to transfer it to the computer's memory.

The Directory and the Table of Contents go hand in hand. The former is a list of the files stored on the disk, and the latter is a list of sectors telling DOS where to find them. Every time you tell DOS to access a particular file, it first goes to the Directory to see if the file exists and, if it does, DOS then turns to the Table of Contents to get the file's location on the disk.

As you might have guessed, the Data space is where DOS stores your data.

IBM stores DOS in three disk files: *IBMBIO.COM*, *IBMDOS.COM*, and *COMMAND.COM*. (Clones running MS-DOS store the first two of those programs under different names.) In order for the computer to load DOS from the disk, *IBMBIO.COM* and *IBMDOS.COM* must be the first two files on the disk. If they're not, the bootstrap loader won't be able to find them, and you'll get the infamous "NON-SYSTEM DISK OR DISK ERROR" message. Those two files contain the routines the computer uses to control the disk hardware. The third file, *COMMAND.COM*, is loaded after the first two and it's the part of DOS that executes internal DOS commands (*DIR*, *REN*, *DEL*, etc.), external programs, and batch files.

IBM's Table of Contents is called the *FAT* (file allocation table). It's used to keep track of where each chunk of each file is stored on the disk, which sectors are available for use, which sectors are bad, and so on. The basic unit of the *FAT* is called the *cluster*, and it represents a variable number of disk sectors, depending on the operating system and on the format of the disk. For example, single-sided IBM disk clusters are one sector long, double-sided IBM disk clusters are two sectors long, and higher density disks have even larger clusters.

The *Directory* is also located on track 0, right after the *FAT*. It stores the names of your files, their attributes, the date and time they were created, their size, and the location of the file's first entry in the *FAT*. The rest of the disk is set aside for your data. When you change anything on the disk by writing new data, DOS must update the *Directory* and the *FAT*, because they work together to keep your files organized.

The Apple also has a boot sector to start the process of loading DOS into the computer. The actual contents of the boot sector (as well as the organization of the disk) depends on which Apple DOS you're using. Both systems, however, differ from the IBM version in that the only job of Apple's boot sector is to start the process of loading in DOS.

There are major differences in the two current Apple operating systems, DOS 3.3 and ProDOS. Although the basic sector formatting is the same, the organization of the disk is quite different. The older system, DOS 3.3, stores the System on the first three tracks, and the directory on track 11h (in the middle of the disk). That was done, the reasoning went, because, on average, the head would have less distance to travel to get to the directory than if the directory had been located in track 0, as on the IBM. Less distance means less time, so that wasn't bad reasoning.

ProDOS, on the other hand, has a closer resemblance to the IBM system in that the directory is stored in the lower tracks. Disk space is allocated a sector at a time under DOS 3.3, and a block at a time under ProDOS. (A block equals two consecutive sectors.) The Table of Contents is called the *Volume Table of Contents* in DOS 3.3 and the *Volume Bit Map* in ProDOS.

Both are similar to the IBM's *FAT* in that each contains a table that DOS uses to keep track of which sectors are free, which are reserved, and which are otherwise used. Each file on the disk reserves a track-and-sector list sector (or block) that contains a list of the sectors where each file's data is stored. Overall, the Apple has to do about the same amount of housekeeping as the IBM. It must update the directory, the table of contents, and the track/sector list for each file you use.

Copy protection

With those facts in mind, let's examine various copy-protection schemes. But before we get into the details, let's talk about the philosophy behind copy protection. Both software publishers and software owners make strong arguments about protecting their investment—and they're both right. Nobody wants to get ripped off, so publishers should be able to make money, and owners should be able to make legitimate backup copies of software they have purchased. Of course, there is much

continued on page 100

BUILD THE PT-68K

The big moment:
add the microprocessor.

PETER STARK, STARK SOFTWARE SYSTEMS CORPORATION



©1987, Peter A. Stark

Part 3 In the first installment of the **Computer Digest** Classroom, we presented an overview of the PT-68K. In part two, we built clock, reset, and test circuits. Now let's install the 68000 and start learning how it works.

Step 7: hardware basics

The pinout of the 68000 microprocessor is shown in Fig. 1. Though it's a 64-pin IC and looks complex, it really is straightforward. Let's go over it pin by pin.

In the figure, notice first the data bus, with its 16 lines labeled D0–D15, and the address bus, with its 23 lines labeled A1–A23. In case you're wondering, there is no A0—see below.

The remaining signals are known collectively as the control lines; let's look at them in more detail. Each control line is labeled with an arrow to indicate whether it is an input, an output, or, in some cases, both.

The three active-high output lines $\overline{FC0}$, $\overline{FC1}$, and $\overline{FC2}$ output a function code that can be decoded to indicate what the 68000 is doing internally; the function code can also be used to increase the 68000's addressable memory to 64 megabytes.

The enable line (\overline{E}), the valid memory address line (\overline{VMA}), and the valid peripheral address (\overline{VPA}) line are all useful when the 68000 is used with older input-output IC's, particularly those originally intended for use with Motorola's 6800 processor. Also, \overline{VPA} provides some interrupt information.

$\overline{IPL0}$, $\overline{IPL1}$, and $\overline{IPL2}$ are interrupt-level inputs. We will discuss interrupts later; for now let us just say that an event such as a keypress can interrupt the 68000, cause it to stop whatever it's doing, and then respond to the interrupt. The three interrupt inputs tell the 68000 whether an interrupt is being asked for, and what kind of an interrupt it is.

The \overline{RESET} and \overline{HALT} inputs come from the 555 circuit shown in Part 2, Fig. 6. Note, however, that those two pins are also outputs. That explains why an open-collector 7406 inverter was used to drive them; occasionally the 68000 may output a low on one of those lines, and that would conflict with the normally high output of a standard inverter (such as a 7404).

\overline{BR} , \overline{BG} , and \overline{BGACK} are used with DMA circuitry, which is used to transfer blocks of data without help from the microprocessor. If DMA were used, the DMA controller would send a bus request (\overline{BR}) signal to the 68000, which would release the data and

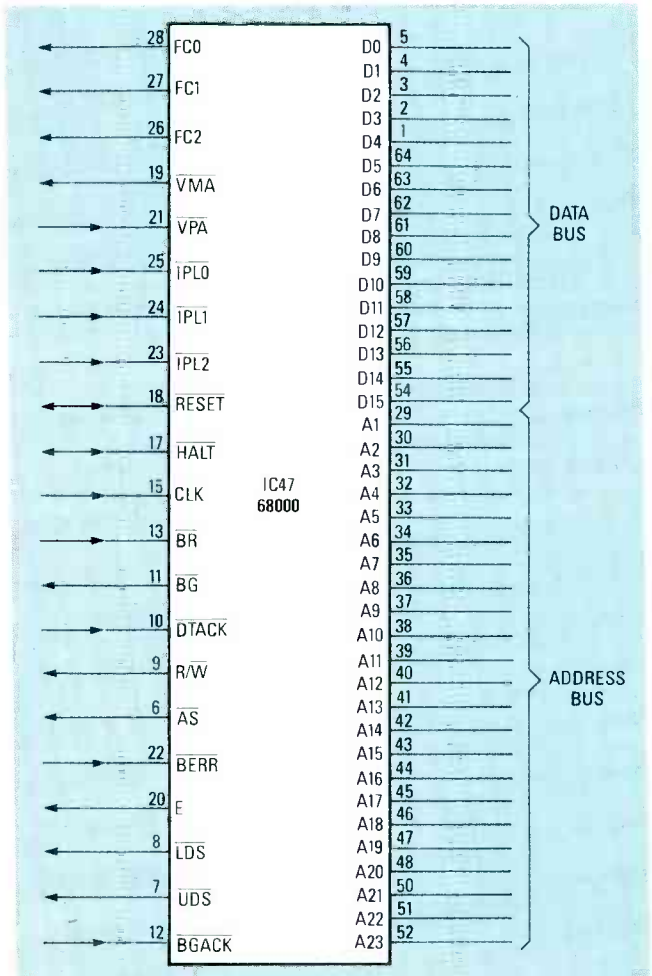

FIG. 1—THE 68000 MICROPROCESSOR has sixteen data lines, 23 address lines, and 21 control lines.

DECEMBER 1987

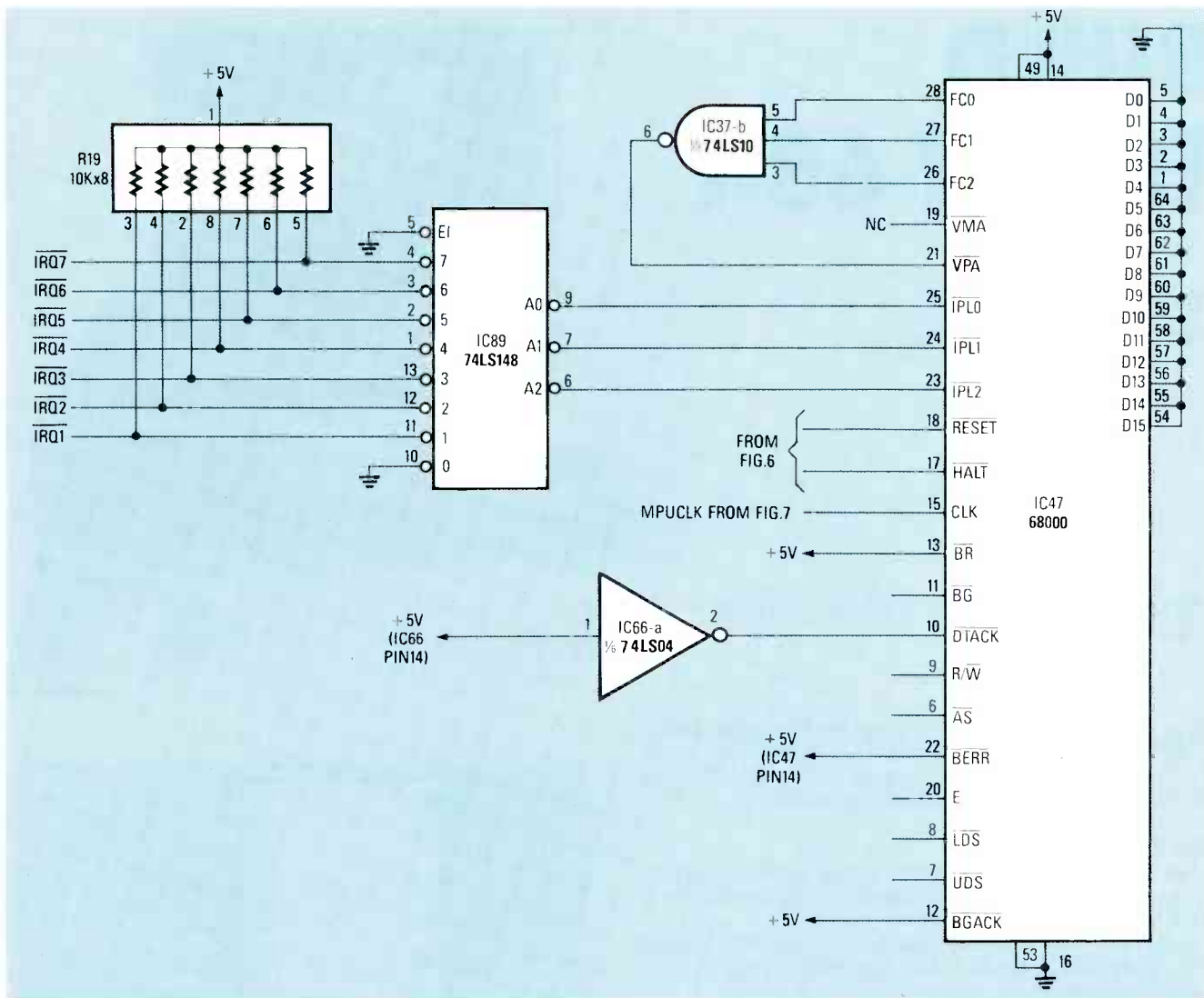

FIG. 2—68000 TEST CIRCUIT. By disabling all interrupts and grounding the entire data bus, you can force the 68000 to repetitively cycle through four million "phantom" instructions.

address buses and return a bus granted (\overline{BG}) signal. The DMA controller would then send a bus grant acknowledge (\overline{BGACK}) to confirm that it has control of the buses. Then the 68000 would sit back and wait while the DMA controller did its thing.

We mentioned that $\overline{LD_S}$ and $\overline{UD_S}$ replace address line A0; they

Past, present, future

What follows is a listing of the contents of past and projected future articles in the **Computer Digest** 68000 Classroom. The precise number of articles—and their contents—will depend on your response, so *let us know what you're interested in!*

Part 1: System overview, block diagram, parts list, memory map, ordering information.

Part 2: Parts-placement diagram, power connector mounting, LED, speaker, reset, and clock circuits.

Part 3: Introduction to the 68000, test circuit, EPROM and RAM circuits, address-bus waveforms.

Part 4: Logic symbols, \overline{MAP} circuit, address decoding, \overline{BERR} and \overline{DTACK} , RAM and ROM, HUMBUG.

Part 5: Serial interfacing and IBM-compatible expansion slots.

Part 6: Dynamic RAM.

Part 7: Disk control hardware and software. SK*DOS.

do so in an interesting way. The 68000 has a 16-bit data bus, but memory is organized as eight-bit bytes. Even so, the data bus can access two bytes at a time. The memory is wired so that half of memory—the odd-numbered locations—connects to the lower part of the data bus (bits D0–D7), and the other half of memory—the even-numbered locations—connects to the upper part of the data bus (bits D8–D15). The 68000 asserts $\overline{LD_S}$ when it wants to use the lower half of the data bus, $\overline{UD_S}$ if it wants to use the upper half of the data bus, or both if it wants to transfer 16 bits on the entire data bus. Thus an odd address turns on $\overline{LD_S}$, and an even address turns on $\overline{UD_S}$. The overall effect is similar to that provided by address line A0 in other microprocessors, where A0 is low for an even address and high for an odd address.

\overline{AS} is an address strobe which is generally asserted by the 68000 at the same time as either $\overline{LD_S}$ or $\overline{UD_S}$; it simply tells external circuitry (address decoders, for example) that there is a valid address on the address bus. That's an important point, because the address bus often carries data that is meaningless; \overline{AS} provides a way of preventing decoders from responding to invalid addresses.

Next comes the read/write line (R/\overline{W}), which is used by the 68000 to tell other circuitry whether it wants to read data in (when R/\overline{W} is high) or write data out (when R/\overline{W} is low). In other words, R/\overline{W} is high when data goes from RAM or ROM to the

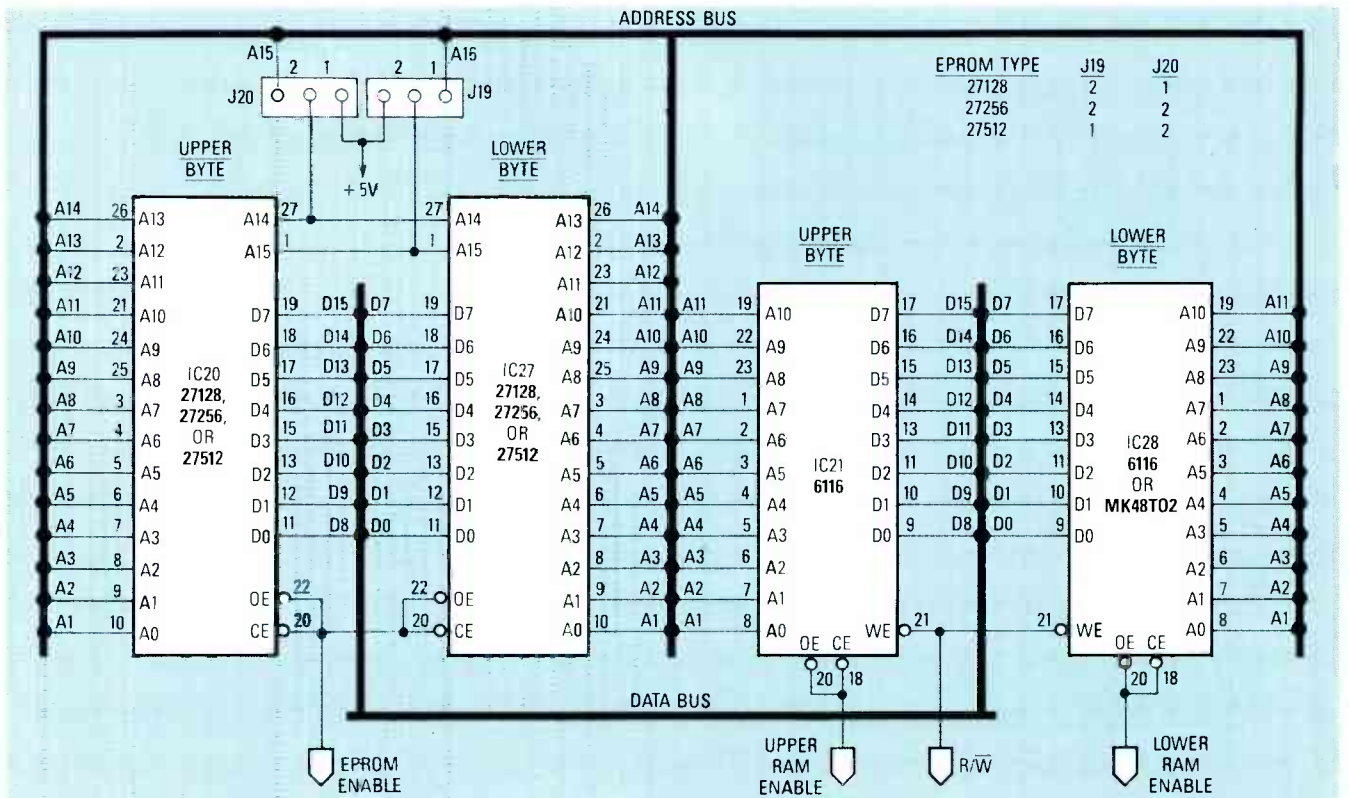

FIG. 3—EPROM AND STATIC-RAM WIRING is shown here.

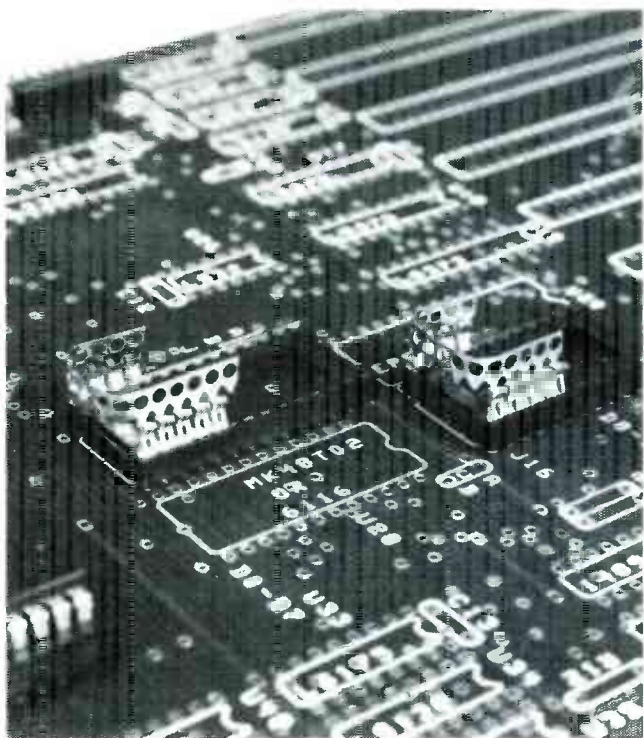

FIG. 4—USE MOLEX SOLDERCON PINS to ground all data lines without soldering.

Thanks

I'd like to thank Fred Brown of Peripheral Technology, Inc., kit supplier for this CD Classroom series. Fred is the wizard who designed the hardware of the PT-68K, without his assistance, the project would never have gotten off the ground.

68000, and low when data goes from the 68000 to RAM. Normally we don't write to a ROM.

BERR is an input to the 68000 that external circuitry uses to tell the 68000 when something has gone wrong on one of the buses. We will see how that is done later.

Last, \overline{DTACK} stands for data transfer acknowledge. Whenever the 68000 wants to read or write to memory (or an I/O device), it (a) puts the address on the address bus, (b) puts a high or low on R/\overline{W} , (c) asserts $\overline{A\overline{S}}$, (d) asserts $\overline{ID\overline{S}}$, $\overline{UD\overline{S}}$, or both, and (e) waits until either \overline{DTACK} is asserted, indicating that the transfer has completed successfully, or \overline{BERR} is asserted, indicating that something went wrong. When \overline{DTACK} is received, the 68000 goes on to the next instruction. We'll discuss what happens if \overline{BERR} is asserted later.

If \overline{DTACK} were permanently grounded, the 68000 would assume that all transfers finished quickly, so it would zip along at maximum speed. In most cases, though, \overline{DTACK} is generated by an external timer that gives memory and I/O just enough time to finish their jobs. And if a memory or I/O device is particularly slow, \overline{DTACK} can then be delayed so that the 68000 will wait for it to finish.

In practice, each 68000 memory or I/O access takes a specific amount of time, which is measured in clock cycles. If \overline{DTACK} is delayed, for even an instant, the 68000 lets an extra clock cycle slip by and checks again. If \overline{DTACK} is still off, the 68000 waits another clock cycle, and so on. Each of those clock cycles is called a *wait state*. Ideally, everything would be fast enough so that the 68000 could continue processing without wait states. However, some computers have slow memory or I/O devices, and therefore run with one or even more wait states, which obviously slows everything down. You'll be happy to know that the PT-68K runs with no wait states!

68000 test circuit

Last time we built the clock and reset circuits, and now that we have some basic familiarity with the 68000, it's time to get the system running. Normally, you need quite a bit of external hardware to get a 68000-based computer running, but there is a

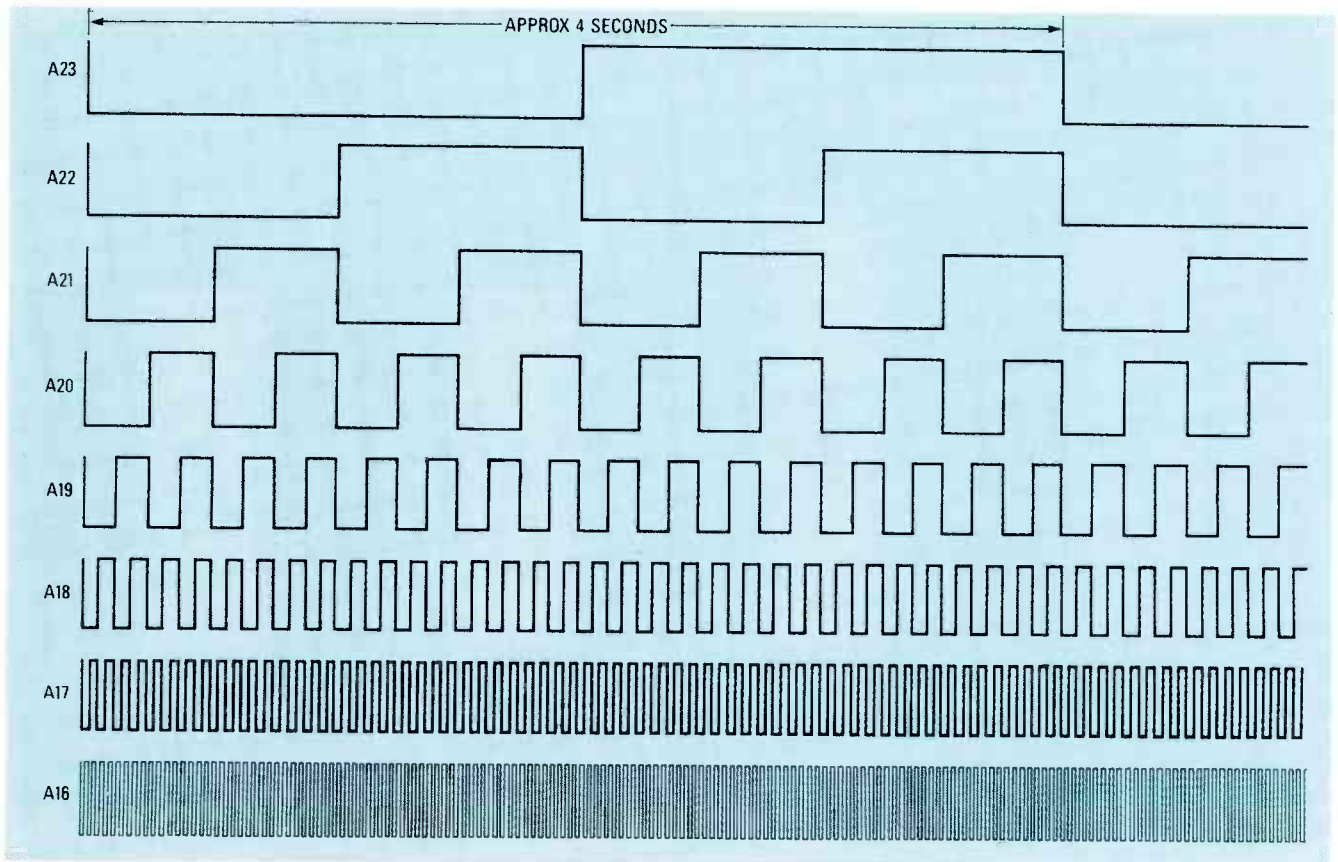

FIG. 5—EACH SUCCESSIVE ADDRESS LINE runs at half the frequency of its predecessor.

way of fooling the microprocessor into thinking the necessary support circuitry is connected, even though it isn't. Figure 2 shows how. Basically, the circuit ensures that interrupts are disabled and jams the data bus with "phantom" instructions that the 68000 will execute over and over.

In order to minimize the amount of extra wiring we have to do, we will take advantage of circuitry already on the printed-circuit board (which will be needed later anyway). For example, we can use RESET, HALT, and CLK as-is.

The circuit works like this: IC37-b is a NAND gate that asserts \overline{VPA} when $\overline{FC0}$, $\overline{FC1}$, and $\overline{FC2}$ are all high, and negates \overline{VPA} at all other times. That is done because \overline{VPA} is used only during interrupt processing; for now, we need to force it high.

Also dealing with interrupts is IC89, a priority-encoder IC. In normal operation, when an interrupt request appears on one of the \overline{IRQ} lines ($\overline{IRQ1}$ – $\overline{IRQ7}$), IC89 functions as a traffic cop that determines which line has the highest priority. $\overline{IRQ7}$ has a higher priority than $\overline{IRQ6}$, which is in turn higher than $\overline{IRQ5}$, and so on. Depending on which interrupt lines are active, IC89's three outputs send a binary number corresponding to the highest priority interrupt to the $\overline{IPL0}$, $\overline{IPL1}$, and $\overline{IPL2}$ lines of the 68000. For example, if the highest priority interrupt request is $\overline{IRQ4}$, IC89 sends the binary number 100 (4) to the 68000 by forcing $\overline{IPL2}$ high and the others low.

In our test circuit, however, the seven resistors in R19 are pulling all of the \overline{IRQ} lines high. Therefore, IC89 sees no interrupt request, so it sends the binary number 000 to the 68000, telling it that there are no interrupt requests.

By the way, we could have achieved the same result by grounding the three \overline{IPL} pins of the 68000 and by tying \overline{VPA} high. However, we can save ourselves extra labor by installing R19, IC89, and IC37, which we'll have to do eventually anyway.

Two of the inputs, labeled \overline{BR} and \overline{BGACK} , are already tied high, and a number of other pins are unconnected.

That leaves the data bus, \overline{BERR} , and \overline{DTACK} to contend with.

First, \overline{BERR} must be tied high so that the 68000 won't think a bus error has occurred. That is easily done by installing a short jumper between pins 14 and 22 of the 68000, on the foil side of the board.

Normally \overline{DTACK} will carry a meaningful signal, but for now we want to ground it to make the 68000 think that all is well on the outside. The inverter (IC66-a) that drives \overline{DTACK} was installed previously, so force the input high by installing a jumper from pin 1 to pin 14 of that IC on the foil side of the board.

Last, as shown in Fig. 2, we want to ground all sixteen data lines. The reason is that, when the 68000 is running normally, it fetches instructions and addresses from memory, so we have to provide it with some apparently meaningful data. By grounding the entire data bus, every time the 68000 tries to read anything from memory, it will read the number 0000. As it turns out, that is a valid 68000 machine-language instruction, which is written:

OR.B #0,D0

That instruction tells the microprocessor to or a 0 to register D0; the instruction consists of four 00 bytes.

Though that OR instruction seemingly does nothing, the 68000 thinks that all 16 megabytes of memory are filled with 4 million OR instructions, and so it starts executing them one after another. When it gets to the top of memory at \$FFFFFF, it simply "wraps around" and starts over at \$000000.

Fire it up

Now let's wire up the circuit and see what happens. Install the following components: sockets for IC37, IC47, and IC89; R19, a 10K single-in-line package. Pin 1 of R19, identified by a white line or dot, should point toward J25. Then install C14, C48, and C66 (0.1 μ F disc capacitors), and last jumpers from pin 14 to pin 22 of IC47 and from pin 1 to pin 14 of IC66. Both jumpers will be removed later, so install them neatly and in a way such that they can be removed easily.

Grounding all sixteen lines of the data bus at the micro-

R-E Computer Admart

Rates: Ads are 2 1/4" x 2 1/8". One insertion \$825. Six insertions \$800 each. Twelve insertions \$775. each. Closing date same as regular rate card. Send order with remittance to **Computer Admart**, Radio Electronics Magazine, 500-B Bi-County Blvd., Farmingdale, NY 11735. Direct telephone inquiries to Arline Fishman, area code-516-293-3000. **Only 100% Computer ads are accepted for this Admart.**

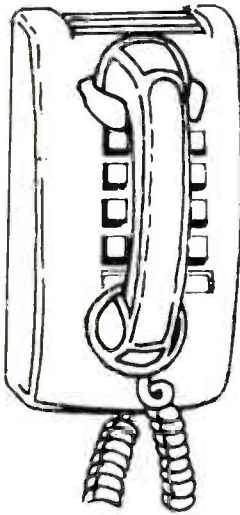

CALL NOW AND RESERVE YOUR SPACE

- 6 x rate \$800.00 per each insertion.
- Reaches 245,824 readers.
- Fast reader service cycle.
- Short lead time for the placement of ads.

Call 516-293-3000 to reserve space. Ask for Arline Fishman. Limited number of pages available. Mail materials to: Computer Admart, RADIO-ELECTRONICS, 500-B Bi-County Blvd., Farmingdale, NY 11735.

COMPUTER ASSEMBLY MANUALS



Eliminate Guesswork! Build with Confidence!

BIG BLUE SEED for IBM™ BUILDERS!
Parts list, placement diagrams, instructions, mods, for assembling over 90 IBM-compatible bare cards. Latest version with guides for 640K, Turbo, AT & Baby AT MthBds. \$17.95

APPLE™ BUILDERS NEED APPLE SEED!
Instructions for assembling over 90 Apple-compatible bare cards including II+ & IIe MthBds. For ALL Apple enthusiasts and hobbyists. \$14.95

SAVE 10% - ORDER TWO OR MORE MANUALS OVER 40 BARE IBM & APPLE CARDS IN STOCK
(MthBds - Disk - Video - Burner - MultiFn - I/O - Modem - Proto - etc)

Check/Money-order, VISA/MasterCard to:
NuScope Associates*, Dept RE
In U.S.A. In CANADA
P.O. Box 790 P.O. Box 742, Stn B
Lewiston, NY 14092 Willowdale, Ont. M2K 2R1
*A Division of Kosmic MicroTech Inc.

CIRCLE 194 ON FREE INFORMATION CARD

LASER PRINTER* P.C. COPIER OWNERS



*H.P., Apple, OASYS, QMS, and more.
Recharge Your Used Toner Cartridges.

RECHARGING:	PRINTER COPIER	
BLACK	\$45	\$40
DK BLUE/BROWN	\$65	\$60
NEW CARTRIDGE	\$89	

(RETURN SHIPPING INCLUDED)

20 Years of Laser Printing and Xerography Experience -Unconditional Guarantee-

LASER EDGE

800 W. Burlington, Fairfield, IA 52556
(800)635-8088 (515)472-7850

CIRCLE 197 ON FREE INFORMATION CARD

CHRISTMAS SPECIAL



12-16-20 MHZ.
HIGH SPEED
TURBO-286/386

- ▶ CPU-286-12/386-16 MHZ.
- ▶ 287/387 and 16-20 MHZ. opt.
- ▶ 1 MGB. on board. Max. 16 MGB.
- ▶ 2 Teac 1.2, or 360/3.5/720.
- ▶ 60 MGB. 28 MLS. with W.D. Contr.
- ▶ I/O, Serial, Parallel, Game.
- ▶ PGA, EGA, CGA, MGA, HERC. S. Sw.
- ▶ Deluxe Keybrd. 102/12 Funct. Keys.
- ▶ 200 W.P.S. Case, Digital Display.
- ▶ ☆☆ **TURBO-XT-W/Monitor...\$899.00**
- ▶ **TURBO-286/386-\$2,499.00/\$3,499.00**

COMPSTAR, INC.
(818) 842-4606

239 E. Alameda Ave., Burbank, CA 91502
TELEX: 797196 FAX: (818) 845-0739

CIRCLE 202 ON FREE INFORMATION CARD

IF YOU KNEW HOW EASY IT IS TO BUILD AN IBM® XT COMPATIBLE COMPUTER, YOU WOULDN'T PAY IBM® \$1000 TO DO IT FOR YOU!

- Anyone can do it! No special skills required □ **Takes less than 2 hours!**
- With a screw driver and my video tape you can save up to \$1000 over the price of an assembled IBM® □ Includes a list of suppliers of computer kits. (All kits have 90 day warranty and full compatibility) □ **MONEY BACK GUARANTEE** - If you aren't totally convinced that you can assemble your own computer after viewing my fail-safe, step by step video instructions, **you pay nothing!**

SEND \$29 FOR VIDEO TAPE TO:
WOLFER PRODUCTIONS, Dept. R
1015 1/2 Riverside Dr. #153
Toluca Lake, CA 91602
(California residents add 6.5% sales tax)

ICs PROMPT DELIVERY!!!

SAME DAY SHIPPING (USUALLY)
QUANTITY ONE PRICES SHOWN FOR SEPT. 27, 1987

OUTSIDE OKLAHOMA: NO SALES TAX

DYNAMIC RAM		
1Mbit	1000Kx1	100 ns \$27.50
1Mbit	256Kx1	120 ns 32.00
51258	*256Kx1	80 ns 7.40
4464	64Kx4	150 ns 3.60
41256	256Kx1	80 ns 5.50
41256	256Kx1	100 ns 4.85
41256	256Kx1	120 ns 3.95
41256	256Kx1	150 ns 3.50
41264	2-PORT	120 ns 5.25
EPROM		
27C101	1000Kx1	150 ns \$45.00
27C256	32Kx8	250 ns 6.75
27256	32Kx8	250 ns 5.60
27128	16Kx8	250 ns 5.35
STATIC RAM		
43256L-12	32Kx8	120 ns \$11.75
6264LP-15	8Kx8	150 ns 3.50

640K MOTHERBD UPGRADE: Zenith 150, IBM PC/XT, Compact Portable & Plus; hp Vectra
8087-2 \$160.00
8087-3 \$150.00
8087-4 \$140.00
8087-5 \$130.00
8087-6 \$120.00
8087-7 \$110.00
8087-8 \$100.00
8087-9 \$90.00
8087-10 \$80.00
8087-11 \$70.00
8087-12 \$60.00
8087-13 \$50.00
8087-14 \$40.00
8087-15 \$30.00
8087-16 \$20.00
8087-17 \$10.00
8087-18 \$5.00
8087-19 \$2.50
8087-20 \$1.50
8087-21 \$1.00
8087-22 \$0.50
8087-23 \$0.25
8087-24 \$0.15
8087-25 \$0.10
8087-26 \$0.05
8087-27 \$0.025
8087-28 \$0.015
8087-29 \$0.010
8087-30 \$0.005

OPEN 6 1/2 DAYS, 7:30 AM-10 PM: SHIP VIA FED-EX ON SAT.

SUNDAYS & HOLIDAYS: SHIPMENT OR DELIVERY, VIA U.S. EXPRESS MAIL

SAT DELIVERY INCLUDED ON FED-EX ORDERS RECEIVED BY 10:30 AM - \$4.10 (FR-FRI \$10.50 2 lbs)

MasterCard VISA or UPS CASH/COD

Factory New, Prime Parts, J1P

MICROPROCESSORS UNLIMITED, INC

24 000 S. Phoenix Ave. (918) 267-4961

BEIGGS DR. #6121

No minimum order. Please order in increments of \$25.00.

Range of options & quantities available. All prices are in U.S. dollars. Orders received by 3 PM CST can usually be delivered the next morning via Federal Express Standard Air. \$4.00 or guarantee next day Priority One. \$10.50 or guaranteed next day.

CIRCLE 61 ON FREE INFORMATION CARD



IBM PC/COMPATIBLES

- TEN PROGRAMS
- 100% BASIC
- EASY TO LEARN
- EASY TO USE
- WRITTEN BY EMERALD DIRECT
- SINCE 1981

NOT COPY PROTECTED

CA RESIDENTS \$49.95 + \$2 ADD STATE TAX

USA ONLY SHIPPING HANDLING

BLECHMAN ENTERPRISES

7217 BERNADINE AVE. #10

CANOGA PARK, CA 91307

INFO/ORDER: 9AM-5PM M. SAT PACIFIC TIME

818-346-7024

*Amway has not reviewed or endorsed these programs.

TURBO CHARGE YOUR PC WITH THE ACCELERATOR 286

Replaces your PC, XT, or compatibles 8088 with an 80286 processor. It includes 8K of zero-wait-state cache memory, and your software can run up to 7 times faster. So why buy an AT? Upgrade your PC with the Accelerator. **\$275**

VIDEO SHARING DEVICE \$59.95

Transmits color computer/VCR signal to any TV at home without cables. Simply plug it into computer's composite outlet or VCR's jacks. This is the least expensive way of upgrading your system to color without buying a color monitor. Minor assembly required.

PC Plus Corp. Monterey Park
710 E. Garvey Ave.
California 91754 (818) 571-6991

CIRCLE 201 ON FREE INFORMATION CARD

processor's socket could lead to problems later, so we'll do it another way. The data bus is more accessible at the two EPROM sockets (IC20 and IC27) and at the two static RAM sockets (IC21 and IC28). The wiring diagram of the EPROM and static-RAM circuitry is shown in Fig. 3. Install a 28-pin socket at IC27 and a 24-pin socket at IC21.

The D0-D7 lines of the data bus are connected to IC27 via pins 11-13 and pins 15-19, and pin 14 is conveniently grounded. So we need to short pins 11-19 together. In the same way, the D8-D15 lines of the data bus are connected to IC21 via pins 9-11 and 13-17, and pin 12 is conveniently grounded. So we need to together pins 9-17 together.

On both IC21 and IC27, those are the bottom four pins on the left and the bottom five pins on the right. Instead of soldering any wires, take a strip of Molex Soldercon pins and insert them into the sockets as shown in Fig. 4, with four pins on the left, five pins on the right, and a section of six or so pins bent in a U shape below. Molex pins are normally sold as an inexpensive substitute for sockets; they consist of individual clips joined by a perforated carrier strip that is normally broken off after soldering the pins to the PC board. In our case, we insert the thin pins into the socket, and use the entire strip as one big short circuit.

Now plug in the IC's, being careful not to bend pins, and turn on the power. Connect your LED probe to pin 52 of the 68000,

Ordering Information

Complete details were given in part one (in the October issue). To summarize: The basic kit (PT1, \$200) contains all parts except power supply, case, and video terminal or personal computer to get a small system (ROM monitor, 2K RAM) up and running. The full basic system (PT68K, \$460) includes 512K of dynamic RAM, floppy-disk controller, parallel port, battery-backed clock/calendar, and three PC-compatible expansion slots. To order, or for more information, contact Peripheral Technology, 1480 Terrell Mill Road #870, Marietta, GA 30067, (404) 984-0742.

which is address line A23. If all is well, the LED will light for about 2 seconds, go off for about 2 seconds, and so on. (That flashing rate will be faster if your PT-68K's clock is faster than 16 MHz.)

If the LED does not flash at the expected rate, recheck the signal at every pin of the 68000. Look especially for a low on \overline{DTACK} , lows on all data lines, highs on \overline{BERR} , \overline{HALT} , and \overline{RESET} . When looking at the clock signal, the LED should be slightly dim.

If the LED flashes as expected, all is probably well. What's happening is that the 68000 is racing through memory (or what it thinks is memory, all 16 megabytes worth), executing or instructions at maximum speed, one instruction per microsecond. One complete run through four million instructions (4,194,304 instructions, to be exact) therefore will take slightly more than four seconds.

During that time, the address bus is counting off the addresses where the 68000 thinks those instructions are coming from. If you look at the address bus you see that A1 alternates 0, 1, 0, 1, 0, 1, A2 also alternates, but slower: 0, 0, 1, 1, 0, 0, ...; and so on.

Figure 5 shows the waveforms present on the upper eight bits of the address bus. When the LED probe is connected to A23, it flashes on and off once every four seconds. If it is connected to A22, it repeats once every two seconds; on A21 it repeats once per second. As we go down to A20, A19, and so on, it flashes faster and faster, until at A16 (pin 44) it flashes so fast (about 32 times per second) that we can barely see it flicker; A15, flashing about 64 times per second, looks absolutely steady.

Last, if you have access to an oscilloscope or frequency counter, examine each address line to make sure that its frequency is half that of its next higher neighbor. This ensures that there are no shorts between adjacent address lines. If you use a frequency counter, keep in mind that real-world waveforms are not as well defined as the idealized ones shown in Fig. 12, so some counters may have difficulty properly counting the frequency of such a square wave.)

Next time we'll add address decoders, ROM and RAM. See you then! 

FLOPPY-DISK DATA STORAGE

continued from page 94

illegitimate software floating around, so it seems that something has to be done about basic human nature before copy protection will cease to be an issue.

Even though there are obvious (and subtle) differences between the hardware and software comprising various types of computers, the basic approach to copy protection is the same: Make the disk unreadable by the standard DOS. It's easy to do because any DOS must make a number of assumptions about disk format before it tries to read or write information. It must assume, for example, that it's going to find tracks formatted in a particular way, that each one will contain a specific number of sectors, and that those sectors will contain data written in a predefined fashion. If any of those conditions aren't met, DOS will throw in the towel, and, instead of data, all you'll get is an error message. The point is that any disk that has data organized in a non-standard way must also have a non-standard way to read that data.

When Apple introduced its disk system in the late seventies, the company emphasized software rather than hardware. That was a departure from the norm, because most disk systems were and are built around a single-IC LSI controller. As a result, Apple disks were (and still are) unreadable by most other machines. However, Central Point Software's Option Board allows an IBM to read Apple disks, and many others as well.

Doing most of the disk control in software makes it simple to

upgrade DOS. It also makes it easy for creative programmers to write copy-protection schemes that do strange things with the disk. That dependence on software, as we'll see, has produced methods of copy protection that are unique to the Apple.

Non-standard data formats

There are many methods of storing data in a non-standard format; we'll examine several in what follows. The most popular methods are these:

- Oddball track formatting
- Nibble counting
- Modified DOS
- Non-standard sectoring
- Unique data encryption
- Synchronized tracks
- Quarter tracks
- Spiral tracking

Of course, there are variations on those methods, and they're often used in combination. But attaining a good understanding of them will help you unravel any copy-protection scheme likely to come your way.

Those methods of copy protection are used on the Apple; due to differences in the IBM's disk-control hardware, it has fewer means of copy-protecting a disk. For example, the IBM cannot do quarter tracking. The most popular methods are:

- Oddball formatting
- Weak bits
- Laser burning

We'll examine those and other means of copy-protecting software next time. 

1987 ANNUAL INDEX

Radio Electronics® Volume 58 and COMPUTER DIGEST Volume 4

Abbreviations: (AR)Antique Radio; (ARE) Ask Radio-Electronics; (AUD)Audio Update; (C)Construction; (COMC)Communications Corner; (D)Department; (DB)Drawing Board; (DN)Designers Notebook; (ED)Editorial; (ER)Equipment Report; (LTR)Letter; (NI)New Ideas; (PCS)PC Service; (SC)Service Clinic; (SQ)Service Questions; (SOSS)State Of Solid State; (STV)Satellite TV

A

Acid Rain Monitor(C)(Scott)	Apr 48
Air Ionizers(ARE)	Jun 10
All About A-to-D Converters(Trietley)	Feb 71
Amplifier	
Transistor Design(Cunkelman)	Aug 55
Broadcast Band RF(NI)(Housley)	Mar 42
Another Attack on Home Taping(ED)(Home Recording Rights Coalition)	Oct 4
Antennas	
Marconi Lucked Out(COMC)(Friedman)	Jun 82
Antique Radio Clubs	May 120
Antique Radios(D)(Fitch)	Jan 74, Feb 88, Mar 86, Jun 80, Nov 39, (LTR) Sep 13
Inventors and Inventions	Mar 86
Portables	Jan 74
Restoring a Classic	Jun 80
Restoring a Classic, Part 2	Nov 39
The Telegraph and WWI	Feb 88
Arm, Robot(C)(Sarns)	Oct 56
Artificial Intelligence, The Future of(Heilmeyer)	May 85
Ask R-E(D)	Feb 12, Mar 12, Apr 8, May 10, Jun 10, Jul 7, Aug 8, Oct 10, Dec 15
110-Volt Devices on 220?	May 10
CATV Lingo, Understanding	Mar 12
Crossover Networks	Jul 7
DC-to-DC Converter	May 10
Electronic Motor Controls	Feb 12
Helical Resonator Trap	Mar 12
Motor-Speed Control, More On	Apr 8
Optoelectronics Coupler, Using An	Dec 15
Pest Repellers, More On	Mar 12
Precedence Detector	Dec 15
Reversing Motors	Oct 10
Rhombic Antenna Impedance	Oct 10
SCA Decoder	Jun 10
Scanner, Booster for	Mar 12
S-Meter and Headphone Jack	Dec 15
Solid-State Tube Substitutes	Apr 8
Speakers	Jul 7
Stereo Spread Circuit	Feb 12
Sunrise/Sunset Simulator	Aug 8
Timing Light Modification	May 10
Unloaded Vacuum-Tube Amplifiers	Dec 15
What's a Gate-Turnoff	May 10
A-to-D Converters, All About(Trietley)	Feb 71
Audio Logic Tester(NI)(Kane)	Sep 32
Audio	
Amplifier, Miniature Wideband(C)(Clawson)	May 45
Audio Update(D)(Klein)	Jan 72, Feb 85, Mar 80, Apr 68, May 74, Jun 78, Aug 32, Oct 33, Nov 33, Dec 40
Audio Answerman, The	Aug 32
Can You Believe Your Ears?	Dec 40
Joys of Equalization, The	Feb 85
Magnetically Shielded Loudspeakers	Oct 83
Psychoacoustics and Stereo Imagery	Mar 80
Resurgence of Surround Sound, The	May 74
Signal Processors	Jan 72
Stereo Spatial Imaging	Nov 33
Unwanted Sounds	Jun 78
Why Stereo Doesn't Work	Apr 68
Commercial Zapper for Your Radio(C)(Rumreich)	Apr 45
Digital Audio Tape(Fenton)	Oct 45
Great Installations(Vizard)	Jul 39
Great Systems(Vizard)	Jul 31
Stereo	
Imagery and Psychoacoustics(AUD)(Klein)	Mar 80
Spatial Imaging(AUD)(Klein)	Nov 33

Spread Circuit(ARE)(Scott)	Feb 12
TV Decoder(C)(Templin)	Jan 37, Feb 51, (PCS) Feb 79
Why Stereo Doesn't Work(AUD)(Klein)	Apr 68
Why Digital Audio Tape Isn't Here(ED)(Fenton)	Jun 4
Automotive	
Automotive World of the 21st Century, The(Petersen)	May 91
Digital	
Speedometer for Your Car(C)(Ortman)	Jul 47, (PCS) Jul 79, (LTR) Nov 8
Tachometer for Your Car(C)(Ortman)	Jun 45
(PCS) Jun 71, (LTR) Nov 8	
Great	
Installations(Vizard)	Jul 39
Systems(Vizard)	Jul 31
Avcom PSA-35A Portable Spectrum Analyzer(ER)	Jul 15

Noise Isn't Always Bad	Mar 44
Think Ferrite	May 127
Tunable IF	Jan 86
Communications in 2001: The Third Age of Video (Judge)	May 102
Inside Cellular Telephone(Bernard)	Sep 53
Compact Disc, Philips Test Set(ER)	Feb 27
Computer	
All About A-to-D Converters(Trietley)	Feb 71
Artificial Intelligence, The Future of(Heilmeyer)	May 85
Computer Board, 80188-Based, for R-E Robot (C)(Sarns)	Apr 39, (PCS) Apr 65, (PCS) May 67
Orchid PCTurbo 286E IBM-PC Accelerator	Feb 24
Card(ER)	Jan 22
Pencept Penpad 320(ER)	Nov 81
Conductive Inks and Adhesives(Mims)	Nov 81

Construction	
Acid Rain Monitor(C)(Scott)	Apr 48
Amplifier, Miniature Wideband(C)(Clawson)	May 45, (PCS) May 67
Commercial Zapper for Your Radio(C)(Rumreich)	Apr 45

B

Base Unit, R-E Robot(C)(Sarns)	Mar 52
Battery	
Backup for CMOS-Based Circuits(DN) (Grossblatt)	Apr 79
Over-Voltage Indicator(DN)(Grossblatt)	Oct 101
Using the Polapulse(Blechman)	Feb 65
Beckman Industrial DM 800 DMM(ER)	Jan 71
Biometal	
Mondo-Tronics Space Wings Robotics Kit(ER)	Oct 22
Black Vertical Bars(Shane)	Jun 70
Blue Box and Ma Bell, The(Friedman)	Nov 49
Broadcast-Band RF Amplifier(NI)(Housley)	Mar 42
Bulletin Board Service	May 122
Using the RE-BBS	May 122
Buyer's Guide to Camcorders(Vizard)	Mar 47

Descrambling	
Tri-Mode Cable-TV(C)(Coffell)	Feb 43
(LTR) May 13, (PCS) Feb 78	
TV Signal Descrambling(C)(Sheets and Graf)	Jan 53, Mar 63, Jul 58, (PCS) Mar 73
Digital Speedometer for Your Car(C)(Ortman)	Jul 47, (PCS) Jul 79, (LTR) Nov 8
Digital Tachometer for Your Car(C)(Ortman)	Jun 45, (PCS) Jun 71, (LTR) Nov 8

Electronic	
Digital Lock(C)(Renton)	Nov 107
Xmas Tree(C)(Jozwiak)	Dec 47, (PCS) Dec 69
IC Tester, In-Circuit Digital(C)(Green)	Nov 43, Dec 55, (PCS) Dec 69
Laser Listener(C)(Pearson)	Oct 39, (LTR) Nov 8
Macrovision Stabilizer(C)(Dupre)	Dec 49, (PCS) Dec 69
New life for Old Car Radios(C)(McClellan)	May 42, Jun 50, (PCS) Jun 71, (LTR) Jul 12, (LTR) Oct 15, Jan 57, (PCS) Jan 67
Nine-Station Intercom(C)(Morrison)	(PCS) Jun 71
Phonlink Interactive Remote Control(C)(Roseth)	May 39, Jun 53, (PCS) Jun 71
R-E Robot(C)(Sarns)	Jan 42, Feb 48, Mar 52, Apr 39, May 62, Jun 58, Jul 44, Aug 57, Sep 56, Oct 56, Dec 67, (LTR) Jul 12, (LTR) Oct 15, (PCS) Apr 65, (PCS) May 67
SCA FM-Stereo Receiver(C)(Sheets and Graf)	Aug 39, Sep 46, (LTR) Oct 15, (PCS) Sep 69

SMT Project: Business-Card Tone Generator(C)(Mims)	Nov 85
SMT Project: I-R Remote on a Keychain(C)(Mims)	Nov 77
SMT Project: LED Flasher(C)(Mims)	Nov 73
SMT Project: Light Meter(C)(Mims)	Nov 75
Stereo TV Decoder(C)(Templin)	Jan 37, Feb 51
Versatile Digital Timer(C)(Ortman)	Aug 45
Video Effects Generator(C) (Sheets and Graf)	Sep 41, Oct 48, (PCS) Oct 75, Jul 7
Crossover Networks(ARE)(Scott)	Jul 7

C

Camcorders, Buyer's Guide to(Vizard)	Mar 47
Car Audio	
Great	
Installations(Vizard)	Jul 39
Systems(Vizard)	Jul 31
Cassette Fidelity(LTR)	Apr 12
CATV Lingo, Understanding(ARE)	Mar 12
Cellular Telephone, Inside(Bernard)	Sep 53
Certification for Electronic Technicians(Small)	Aug 52
Clock Module, TSM 201	Nov 122
CMOS Circuits, A Battery Backup For(DN) (Grossblatt)	Apr 79
Color-Bar Generator	Nov 14
NCM's Video Wonderbox(ER)	Nov 14
Commercial Zapper for your Radio(C)(Rumreich)	Apr 45
Communications	
Corner(D)(Friedman)	Jan 86, Feb 94, Mar 44, May 127, Jun 82, Oct 31
Diversity Microphone Transmission	Aug 26
Image Interference	Feb 94
Light Makes the Perfect Wire	Oct 31
Marconi Lucked Out	Jun 82

D	
Data Sheets of RF Power Transistors, Understanding(Dye)	Nov 109

DC-to-DC Converter(ARE) May 10
 Dear Sue... (Oliver) May 84
 Decoder, Stereo TV(C)(Templin) Feb 51, (PCS) Feb 79
 Delay Circuit, A Very Simple(DN)(Grossblatt) Sep 34
Designer's Notebook(D)(Grossblatt)
 Battery Backup for CMOS-Based Circuits, A CMOS Oscillator, A Simple Delay Circuits, Very Simple Logic-Family Translation Over-Voltage Indicator Trigger Pulses Under-Voltage Monitor, An

Descrambling
 Practical Descrambling(STV)(Cooper) Feb 83
 Tri-Mode Cable-TV Scrambling(C)(Coffell) Feb 43, (PCS) Feb 79, (LTR) May 13
 TV Signal Descrambling(C) (Sheets and Graf) Jan 53, Jul 58
 Why Videocipher is Dead(STV)(Cooper) Mar 78
 Zombies, Zits, and Zowiee!(STV)(Cooper) May 77

Digital Audio Tape
 Another Attack on Home Taping(ED)(Home Recording Rights Coalition) Oct 4
 Digital Audio Tape(Fenton) Oct 45
 Why Digital Audio Tape Isn't Here(ED)(Fenton) Jun 4

Circuitry
 Logic-Gate Fundamentals(Marston) Apr 50
 Flip-Flops, Working With(Marston) Jun 64
 In-Circuit IC Tester Nov 43, Dec 55, (PCS) Dec 69
 Multimeter(SEE TEST EQUIPMENT)
 Speedometer for Your Car(C)(Ortman) Jul 47, (PCS) Jul 79, (LTR) Nov 8
 Tachometer for Your Car(C)(Ortman) Jun 45, (PCS) Jun 71, (LTR) Nov 8
 Timer, Versatile(C)(Ortman) Aug 45, (PCS) Aug 75

Drawing Board(D)(Grossblatt) Jan 82, Mar 82, Apr 76, May 123, Jul 26, Dec 77

Designer RAM
 DTMF Receiver, A Dynamic Memory Output Decoder, An Remote Control Transmitter Which Memory?

Drive System, R-E Robot(C)(Sarns) Feb 48, Mar 52

DTMF
 Receiver, A(DB)(Grossblatt) Mar 82
 Transmitter-Receiver Output Decoder, An(DB) (Grossblatt) Apr 76

E
 Early Days of Radio, The(Clifford) Apr 59, Jul 52, Dec 64
Editorial(D) Jan 12, May 4, Jun 4, Oct 4, Dec 4
 Another Attack on Home Taping(Home Recording Rights Coalition) Oct 4
 Home Appliances(Kleiman) Jan 12
 Welcome to the Twenty-First Century(Fenton) May 4
 Why Digital Audio Tape Isn't Here(Fenton) Jun 4

EEPROM's
 Non-Volatile Memory ICs(Grossblatt) Oct 60

Electronic
 Digital Lock(C)(Renton) Nov 107
 Christmas Tree(C)(Jozwiak) Dec 47, (PCS) Dec 69
 Eye, R-E Robot(C)(Sarns) Dec 67
 Motor Controls(ARE)(Scott) Feb 12

Energy
 Storage in 2001: Superconductivity(LTR) Jun 14
 Technology in the 21st Century(Kuznetsov) May 107

Equipment Reports(D) Jan 22, Feb 24, Mar 28, Apr 24, May 24, Jun 21, Jul 15, Aug 16, Sep 22, Oct 22, Nov 14, Dec 35
 Avcom PSA-35A Portable Spectrum Analyzer Jul 15
 Beckman Industrial DM 800 DMM Jan 71
 Fluke LCA-10 Line Current Test Adapter Mar 28
 Leader LCD-100 Portable DMM/Storage Oscilloscope Jun 21
 Mark V Professional Color Light Controller Dec 35
 Mondo-Tronics Space Wings Robotics Kit Oct 22
 NCM's Video Wonderbox Nov 14
 Onkyo Unifier Universal Programmable Remote Control Sep 22
 Orchid PC Turbo 286E IBMM-PC Accelerator Card Feb 24
 Pencept Penpad 320 Jan 22
 Philips Compact Disc Test Set Feb 27
 Regency Informant Scanning Receiver Aug 16
 Sencore LC75 Z Meter II" Apr 24
 TI/P-CAD PAL Starter Kit Mar 32
 Universal Wireless Remote-Control/Stereo TV Tuner May 24

Evolution of VHSIC, The(Grossblatt) Mar 59

F
Fiber Optics
 Light Makes the Perfect Wire(COMC)(Friedman) Oct 31
 Finding Cable Faults(Martin) Mar 66
 Flasher, Sequential(NI)(Ciric) Feb 36
 Flip-Flops, Working With(Marston) Jun 64, (LTR) Oct 15
 Fluke LCA-10 Line Current Test Adapter(ER) Mar 28
 FM Commercial Zapper for Your Radio(C)(Rumreich) Apr 45, (LTR) Sep 13

Future of Artificial Intelligence, The(Heilmeier) May 85

G
 Gated-Pulse Decoder(C)(Sheets and Graf) Jan 53, (PCS) Mar 73, (LTR) Apr 12
 Gravity Waves(LTR) Jan 18
Great
 Installations(Vizard) Jul 39
 Systems(Vizard) Jul 31

H
 Hand-Soldering SMCs(Mims) Nov 71
 Headlight Alarm(NI)(Lowell) Apr 67
 Helical Resonator Trap(ARE) Mar 12
HDTV
 High-Definition DBS(STV)(Cooper) Jul 62
 Is HDTV the Key to an International Standard?(STV)(Cooper) Aug 28
 High Definition TV(Bernard) Aug 48
History(See also ANTIQUE RADIO)
 Early Days of Radio, The(Clifford) Apr 59, Jul 52, Dec 64
Home
 Appliances(ED)(Kleiman) Jan 12
 Of the Future, The(MacFadyen) May 115
How to
 Analyze Waveforms(Carey) Dec 59
 Apply For a Patent(Sweeney) Jan 48, (LTR) Apr 12, May 13
 Design Oscillator Circuits(Carr) Jan 65, (LTR) Mar 16
 Humidity Monitor(LTR) Jan 18

I
 IC Tester, Digital In-Circuit(C)(Green) Nov 43, Dec 55, (PCS) Dec 69
 I-R Remote on a Keychain, SMT Project(C)(Mims) Nov 77
 Industrial SMT Assembly(Mims) Nov 65
Inside
 Cellular Telephone(Bernard) Sep 53
 The Telephone(LTR) Feb 16, (LTR) Mar 16
 Introduction to SMT(Mims) Nov 59

K
 Kit Report: TSM 201 Clock Module Nov 122

L
 Laser Listener(C)(Pearson) Oct 39, (LTR) Nov 8
 Latching Continuity Tester(LTR) Jan 18
 Leader LCD-100 Portable DMM/Storage Oscilloscope(ER) Jun 21
 LED Flasher, SMT Project(C)(Mims) Nov 73
Letters(D) Jan 18, Feb 16, Mar 16, Apr 12, May 13, Jun 14, Jul 12, Aug 12, Sep 13, Oct 15, Nov 8, Dec 24
Light
 Controller, Outdoor(NI)(Holtke) Oct 104
 Color Controller, Mark V(ER) Dec 35
 Meter, SMT Project(C)(Mims) Nov 75
 Lock, Electronic Digital(C)(Renton) Nov 107
 Logic-Family Translation(DN)(Grossblatt) Aug 30
 Logic-Gate Fundamentals(Marston) Apr 50
 Logic Tester, Audible(NI)(Kane) Sep 32
 Looking Into the Future(Clarke) May 81
 LORAN, Learning About(Sweeney) May 5

M
 Macrovision Stabilizer(C)(Dupre) Dec 49, (PCS) Dec 69
 Mark V Professional Color Light Controller(ER) Dec 35
 Medical Technology in the 21st Century(Fish) May 112
 Miniature Wideband Amplifier(C) (Clawson) May 45, (PCS) May 67
 Mondo-Tronics Space Wings Robotics Kit(ER) Oct 22
 Monitor, Acid Rain(C)(Scott) Apr 88
 Multi-Tone Generator, Simple(NI)(Khan) Nov 31

N
 NCM's Video Wonderbox(ER) Nov 14
New Ideas(D) Feb 36, Mar 42, Apr 67, Jun 40, Sep 32, Oct 104, Nov 31
 Audible Logic Tester(Kane) Sep 32
 Broadcast-Band RF Amplifier(Housley) Mar 42
 Headlight Alarm(Lowell) Apr 67

Outdoor Light Controller(Holtke) Oct 104
 Sequential Flasher(Ciric) Feb 36
 Simple Multi-Tone Generator(Khan) Nov 31
 Sound-Effects Generator(Tupue) Jun 40
 Life for Old Car Radios(C)(McClellan) May 42, Jun 50, (PCS) Jun 71, (LTR) Jul 12, (LTR) Oct 15
Lit(D) Products(D) Aug 21, Sep 31, Jan 30, Feb 34, Mar 36, Apr 30, May 30, Jun 30, Jul 21, Aug 24, Sep 24, Oct 26, Nov 22, Dec 32
 Nine-Station Intercom(C)(Morrison) Jan 57, (PCS) Jan 67
 Non-Volatile Memory ICs(Grossblatt) Oct 60

O
 On Electrons(LTR) Jun 14
 110-Volt Devices on 220?(ARE) May 10
 Onkyo Unifier Universal Programmable Remote Control(ER) Sep 22
 Op-Amp, Micropower(SOSS)(Scott) Sep 94
 Orchid Technology PC Turbo 286E IBM-PC Accelerator Card(ER) Feb 24
 Oscillator, A Simple CMOS(DN)(Grossblatt) Feb 96
 Oscilloscopes(See TEST EQUIPMENT)
 Out-Band Decoder(C)(Sheets and Graf) Mar 63, (PCS) Mar 73
 Outdoor Light Controller(NI)(Holtke) Oct 104
 Output Decoder, An(DB)(Grossblatt) Apr 76
 Over-Voltage Indicator(DN)(Grossblatt) Oct 101

P
 PC Boards, Making(LTR) Nov 8
PC Service(D) Jan 67, Feb 78, Mar 73, Apr 65, May 67, Jun 71, Jul 79, Aug 75, Sep 69, Oct 75, Nov 127, Dec 69
 Patent, How to Apply For A (Sweeney) Jan 48, (LTR) Aug 12
 Pencept Penpad 320(ER) Jan 22
 Personal Computer, R-E Robot(C)(Sarns) Jan 42
 Pest Repellers, More on(ARE) Mar 12
 Philips Compact Disc Test Set(ER) Feb 27
 Phonlink Interactive Remote Control(C) (Roseth) May 39, Jun 53, (PCS) Jun 71
 Piezoelectric Plastic Film(Iovine) Mar 57
 Polapulse Battery, Using the(Blechman) Feb 61
 Poor Man's Storage Scope(Bernard) Nov 113
Programmable Array Logic
 TI/P-CAD PAL Starter Kit(ER) Mar 32

R
Radio(see also ANTIQUE RADIOS, COMMUNICATIONS CORNER)
 Antique Radio Clubs, Listing May 120
 Commercial Zapper for Your Radio(C)(Rumreich) Apr 45
 Early Days of Radio, The(Clifford) Apr 59, Jul 52, Dec 64
 LORAN, Learning About(Sweeney) May 51
 Life for Old Car Radios(C)(McClellan) May 42, Jun 50, (PCS) Jun 71, (LTR) Jul 12, (LTR) Oct 15
 Razor-Blade Radio (LTR) Apr 12, (LTR) Jul 12
 Regency Informant Scanning Receiver(ER) Aug 16
 SCA FM-Stereo Receiver(C)(Sheets and Graf) Aug 39, Sep 46, (PCS) Sep 69
 Spread Spectrum Communications, All About(McDermott) Apr 55
RAM
 Which Memory?(DB)(Grossblatt) May 123
 Dynamic Memory(DB)(Grossblatt) Jun 71
R-E Robot(C)(Sarns) Jan 42, Feb 48, Mar 52, Apr 39, May 62, Jun 58, Jul 44, Aug 57, Sep 56, Oct 56, (LTR) Jul 12, (LTR) Oct 15, (PCS) Apr 65, (PCS) May 67, (PCS) Dec 69
 R-E BBS, Using the Mar 83, May 122
 Regency Informant Scanning Receiver(C) Aug 16
Remote Control
 Phonlink Interactive(C)(Roseth) May 39, Jun 53, (PCS) Jun 71
 DTMF Receiver, A(DB)(Grossblatt) Mar 82
 Remote Control Transmitter(DB)(Grossblatt) Jan 82
 Reversing Motors (LTR) May 13, (ARE) Oct 10
 RF1, The Reasons Behind(LTR) Mar 16
 Rhombic Antenna Impedance(ARE) Oct 10
Robotics
 Kit
 Mondo-Tronics Space Wings(ER) Oct 22
R-E Robot
 Applications(C)(Sarns) Sep 56
 Brain(C)(Sarns) Jan 42
 Command Language(C)(Sarns) Aug 57
 Control Board(C)(Sarns) Jul 44
 Control Electronics(C)(Sarns) Jun 58
 Electronic Eye(C)(Sarns) Dec 67
 Personal Computer(C)(Sarns) Apr 39, (PCS) Apr 65, May 67
 Robot in the 21st Century, The(Asimov) May 99

S

Satellite TV(D)(Cooper)	Jan 4, Feb 83, Mar 78, May 77, Jul 62, Aug 28, Sep 87, Oct 80, Dec 74
High-Definition DBS	Jul 62
International Connection, The Is HDTV the Key to an International Standard?	Sep 87, Oct 80
Practical Descrambling	Aug 28
Videocipher Has Been Cracked	Feb 83
What's Next	Jan 4
Why Videocipher is Dead	Dec 74
Zits Fraud, The	Mar 78
Zombies, Zits, and Zoweee!	Jun 76, May 77
SCA	
Decoder(ARE)	Jun 10
FM-Stereo Receiver(C)(Sheets and Graf)	Aug 39, Sep 46, (PCS) Sep 69 (LTR) Oct 15
SCR's	
Using Triacs and SCR's(Marston)	Sep 64
Working with Triacs and SCR's(Marston)	Oct 64
Scanner	
Booster for(ARE)	Mar 12
Regency Informant Scanning Receiver(C)	Aug 16
Seismic Discussion Net(LTR)	May 13
Semiconductors, Testing(Byers)	Feb 58, Mar 71, Apr 62, May 59, Jun 61, Aug 12, Sep 61, Nov 115 (LTR) Aug 12, (LTR) Nov 8
Sencore LC75 Z Meter II(ER)	Apr 24
Sequential Flasher(NI)(Circ)	Feb 36
Service	
Clinic(D)(Darr)	Jan 88, May 125, Sep 30
Funny Pictures	May 125
Leakage and Psychology	Jan 88
Quirks and Queerities	Sep 30
Questions(D)(Darr)	Jan 90
Log: Surface-Mount Components(Poe)	Nov 32
Shortwave Converter	
New Life for Old Car Radios(C)(McClellan)	May 42, Jun 50, (PCS) Jun 71, (LTR) Jul 12, (LTR) Oct 15
Simple Multi-Tone Generator(NI)(Khan)	Nov 31
Smart House	
Home of the Future, The(MacFadyen)	May 115
SMT Projects(See SURFACE MOUNT TECHNOLOGY)	
Soldering: Old Techniques and New Technology(Martin)	May 47, (LTR) Aug 12, (LTR) Sep 13
Solid-State (See also STATE OF SOLID STATE)	
Technology in the 21st Century(Gregory)	May 97
Tube Substitutes(ARE)	Apr 8
Sound-Effects Generator(NI)(Tupue)	Jun 40
Soundproofing	
Unwanted Sounds(AUD)(Klein)	Jun 78
Speakers, Magnetically Shielded(AUD)(Klein)	Oct 83
Spectrum Analyzer, Portable(See TEST EQUIPMENT)	
Speedometer, Digital(C)(Ortman)	Jul 47, (PCS) Jul 79, (LTR) Nov 8
Spread Spectrum Communications, All About(McDermott)	Apr 55
State of Solid State(D)(Scott)	Feb 92, Mar 84, Apr 80, May 129, Jun 87, Sep 94, Nov 124, Dec 42
Bang-Bang IC, A	Nov 124
Electronic Potentiometer, An	Dec 42
Instrumentation Amplifiers	Jun 87
Long-Time Timer	May 129
Micropower Op-Amp	Sep 94
Temperature Transducer	Mar 84
Tone Generator IC's	Apr 80
Transformerless 5-Volt Regulator	Feb 92
Stereo(See also AUDIO)	
Imagery amid Psychoacoustics(AUD)(Klein)	Mar 80
Spatial Imaging(AUD)(Klein)	Nov 33
Spread Circuit(ARE)(Scott)	Feb 12
TV Decoder(C)(Templin)	Jan 37, Feb 51
Why Stereo Doesn't Work(AUD)(Klein)	Apr 68

Strain-Gage Transducers(Wood)	Dec 61
Sunrise/Sunset Simulator(ARE)(Scott)	Aug 8
Surface-Mount Technology	
Surface-Mounted Components(LTR)	Feb 16
Conductive Inks and Adhesives(Mims)	Nov 81
Hand-Soldering SMC's(Mims)	Nov 71
Industrial SMT Assembly(Mims)	Nov 65
Introduction to SMT(Mims)	Nov 59
SMT Project	
Business-Card Tone Generator(C)(Mims)	Nov 85
I-R Remote on a Keychain(C)(Mims)	Nov 77
LED Flasher(C)(Mims)	Nov 73
Light Meter(C)(Mims)	Nov 75
Resource Directory	Nov 89
Service Log(Poe)	Nov 32
Surround Sound, Resurgence of(AUD)(Klein)	May 74

T

Telegraph, and WWI(AR)(Fitch)	Feb 88
Telephone	
Blue Box and Ma Bell, The(Friedman)	Nov 49
Inside Cellular Telephone(Bernard)	Sep 53
Nine-Station Intercom(C)(Morrison)	Jan 57
Phonlink, Interactive Remote Control(C)(Roseth)	May 39, Jun 53, (PCS) Jun 71
Television(See VIDEO)	
Tesla, Father of Radio	(LTR) Jun 14
Test Equipment	
Avcom PSA-35A Portable Spectrum Analyzer(ER)	Jul 15
Beckman Industrial DM 800 DMM(ER)	Jan 71
Finding Cable Faults(Martin)	Mar 66
Fluke LCA-10 Line Current Test Adapter(ER)	Mar 28
How to Analyze Waveforms(Carey)	Dec 59
In-Circuit Digital IC Tester(C)(Green)	Nov 43
Leader LCD-100 Portable DMM/Storage Oscilloscope(ER)	Jun 21
NCM's Video Wonderbox(ER)	Nov 14
Oscilloscopes, Using the New Generation(Diller)	Feb 55
Philips Compact Disc Test Set(ER)	Feb 27
Poor Man's Storage Scope(Bernard)	Nov 113
Sencore LC75 'Z Meter II'(ER)	Apr 24
Temperature Transducer(SOSS)(Scott)	Mar 84
Testing Semiconductors(Byers)	Feb 58, Mar 71, Apr 62, May 59, Jun 61, Aug 12, Sep 61, Nov 115 (LTR) Aug 12, (LTR) Nov 8
TI/P-CAD PAL Starter Kit(ER)	Mar 32
Timer, Versatile Digital(C)(Ortman)	Aug 45, (PCS) Aug 75
Timing Light Modification(ARE)	May 10
Tone Generator IC's(SOSS)(Scott)	Apr 80
Tool Organizer, Maszota(LTR)	Mar 16
Transducers, Strain-Gage(Wood)	Dec 61
Transformerless 5-Volt Regulator(SOSS)(Scott)	Feb 92
Transistor Amplifier Design(Cunkelman)	Aug 55
Triacs	
Using Triacs and SCR's(Marston)	Sep 64
Working With Triacs and SCR's(Marston)	Oct 64
Tri-Mode Cable-TV Scrambling(C)(Coffell)	Feb 43, (PCS) Feb 79, (LTR) May 13
Trigger Pulses(DN)(Grossblatt)	May 121
TSM 201 Clock Module	Nov 122
Tunable IF(COMC)(Friedman)	Jan 86
TV Signal Descrambling(C)(Sheets and Graf)	Jan 53, Mar 63, Jul 58
2001	
Automotive World of the 21st Century, The(Petersen)	May 91
Communications in 2001: The Third Age of Video(Judice)	May 102
Dear Sue,...(Oliver)	May 84
Energy Technology in the 21st Century(Kuznetsov)	May 107
Home of the Future, The(MacFadyen)	May 115

Looking Into the Future(Clarke)	May 81
Medical Technology in the 21st Century(Fish)	May 112
Robot in the 21st Century, The(Asimov)	May 99
Solid-State Technology in The 21st Century(Gregory)	May 97
Future of Artificial Intelligence, The(Heilmeier)	May 85
Welcome to the Twenty-First Century(ED)(Fenton)	May 4

U

Under-Voltage Monitor, An(DN)(Grossblatt)	Nov 41
Understanding Data Sheets of RF Power Transistors(Dye)	Nov 104
Universal Wireless Remote Control/Stereo TV Tuner(ER)	May 24
Using	
New Generation Oscilloscopes, The(Diller)	Feb 55
Polarpulse Battery, The(Blechman)	Feb 61, (LTR) Jun 14
RE-BBS, The	May 122
Triacs and SCR's(Marston)	Sep 64

V

Vacuum Tubes(LTR)	Feb 16
Versatile Digital Timer(C)(Ortman)	Aug 45, (PCS) Aug 75
VHSIC, The Evolution of(Grossblatt)	Mar 59
Video	
Communications in 2001-The Third Age of Video(Judice)	May 102
Black Vertical Bars(Shane)	Jun 70
Buyer's Guide to Camcorders(Vizard)	Mar 47
Effects Generator(C)(Sheets and Graf)	Sep 41, Oct 48, (PCS) Oct 75
Palette(C)(Sheets and Graf)	Sep 41, Oct 43 (PCS) Oct 75
High Definition TV(Bernard)	Aug 48
News(D)(Lachenbruch)	Jan 16, Feb 6, Mar 6, Apr 7, May 8, Jun 8, Jul 6, Aug 6, Sep 6, Oct 6, Nov 6, Dec 12, Jan 37, Feb 51,
Stereo TV Decoder(C)(Templin)	(PCS) Feb 79
Tri-Mode Cable-TV Scrambling(C)(Coffell)	Feb 43, (PCS) Feb 79, (LTR) May 13
TV Signal Descrambling(C)(Sheets and Graf)	Jan 53, Mar 63, (PCS) Mar 73, Jul 58
Universal Wireless Remote Control/Stereo TV Tuner(ER)	May 24
VHSIC, The Evolution of(Grossblatt)	Mar 59
Videocipher	
Practical Descrambling(STV)(Cooper)	Feb 83
The Zits Fraud(STV)(Cooper)	Jun 76
Videocipher Has Been Cracked(STV)(Cooper)	Jan 4
Why Videocipher is Dead(STV)(Cooper)	Mar 78
Zombies, Zits, and Zoweee!(STV)(Cooper)	May 77
Voltage Transformers(LTR)	Aug 12
W	
Waveforms, How to Analyze(Carey)	Dec 59
Welcome to the Twenty-First Century(ED)(Fenton)	May 4
What's	
A Gate-Turnoff Rectifier?(ARE)	May 10
New in Solid State(Scott)	Jan 61
News(D)	Jan 14, Feb 4, Mar 4, Apr 4, May 6, Jun 6, Jul 5, Aug 4, Sep 4, Nov 4, Dec 6
Working With Triacs and SCR's(Marston)	Oct 64

COMPUTER DIGEST Volume 4

January 1987 — December 1987

Abbreviations: (C)Construction; (D)Department; (Ed)Editorial; (EW)Editor's Workbench; (HWR)Hardware Review; (LTR)Letter; (SWR)Software Review

A

Add a Disk Drive(Friedman)(C) Apr 96
All About Interfacing: Part 2 (Holtzman) Jan 13
Apparat Limbo II(EW) Mar 94

B

Biofeedback(L) Feb 102
Books(EW) May 137, Nov 93
Brooklyn Bridge(EW) Sep 74
Build
Clock Board for Your PC, A(C)(Martin) Mar 97
MC68000, The(C)(Schrader, Koenig, Voelzke) Mar 101
PT-68K, The(C)(Stark) Oct 90

C

CAD
Computer-Assisted Regulator Design (Cunkelman) Feb 110
Designing PC Boards on Your Computer (Grossblatt) Jun 97
Aug 69
CD-ROM (EW) Mar 94, (EW) Mar 95, (EW) Apr 90
Cauzin Softstrip System, The(Holtzman) Apr 93
Central Point Software: The Option Board(EW) Oct 87
Certificate Maker(SWR) Feb 103
Clock
Board for Your PC (C)(Martin) Mar 97, (PCS) Mar 73
Circuit for the PT-68K(C)(Stark) Nov 101
Clones
IBM-Compatible Clone Computer(C)(Flack) Feb 104
COMDEX Report(EW) Sep 73
Commodore Pulse Generator(C)(Barbarelo) Oct 96
CompDes(EW) May 136
Computer Products(D) Jan 4, Feb 102
Computer-Assisted Regulator Design(Cunkelman) Feb 110
Computer-Controlled Robot(C) (Barbarelo) May 144, (PCS) May 67
Concurrency(Stern) Feb 112

Construction
Add a Disk Drive(C) (Friedman) Apr 96
Clock Board for Your PC (C)(Martin) Mar 97, (PCS) Mar 73
Commodore Pulse Generator(C)(Barbarelo) Oct 96
Computer-Controlled Robot(C) (Barbarelo) May 144, (PCS) May 67
IBM Incompatible, Build This(C)(Holtzman) Apr 96
MC68000, Build The(C) (Schrader, Koenig, Voelzke) Mar 101, May 138
Micro-Floppy Retrofit(C)(Friedman) Aug 67
PT-68K, Build the(C)(Stark) Oct 90, Nov 101, Dec 95
Copy Protection
The Beginning of the End... (ED)(Wels) Jan 3

D

Data Storage, Floppy-Disk(Grossblatt) Dec 91
Debugging(EW)
T-DebugPlus(EW) Dec 87
Turbo Pascal(EW) Dec 87
TurboSmith(EW) Dec 87
Designing PC Boards on Your Computer(Grossblatt) Jun 97, Aug 69
Direc-Link(EW) Sep 74
Do Me a Favor... (ED)(Wels) Feb 101

E

Editorial
Do Me a Favor...(ED)(Wels) Feb 101
The Beginning of the End... (ED)(Wels) Jan 3
Editor's Workbench Mar 93, Apr 85, May 135, Jun 93, Jul 66, Aug 63, Sep 73, Oct 87, Nov 93, Dec 87
Apparat Limbo II Mar 94
Books May 137, Nov 93
Brooklyn Bridge Sep 74
CD-ROM Mar 94, Mar 95, Apr 90
Central Point Software: The Option Board Oct 87
COMDEX Report Sep 73
CompDes May 136
Debugging Dec 87
Direc-Link Sep 74
Graphics Sep 73
Grolier's Electronic Encyclopedia Apr 90
Hardware Reviews Mar 93
Heathkit SK-203 Printer Buffer Sep 76

Hercules Graphics Card Plus Apr 85
IBM
Models 30 and 50 PC's Operating Systems: The M&M's Personal System/2 Aug 63
Keyboards Jun 93
Masters' Visible Computer: 8088 Jul 66
Memory Expansion Jul 66
Microsolutions' Matchpoint Jun 95
Mycroft Labs' Mite Mar 93
Orchid's Conquest Oct 88
PC-Sigs Dec 87
Command-Line Editor Mar 95
PC-Outline Mar 94
PS/2 Sep 73
Portable Computers(Holtzman) Nov 93
Product Reviews Mar 96, Apr 92, Jun 96, Oct 89, Nov 94
68000 Update Aug 63
T-DebugPlus Dec 87
Tseng Lab's EVA/480 May 135
Turbo Pascal Dec 87
TurboSmith Dec 87
Vericomp's Breakthru/PC Mar 94

F

5-Volt Only: The Max 232(Kreuter) Jan 10
From Keypress to Scan Code(Holtzman) Jul 70

G

Graphics(EW) Sep 73
Graphics Co-Processors(Bernard) Sep 82
Grolier's Electronic Encyclopedia(EW) Apr 90

H

Hardware
Add a Disk Drive(C)(Friedman) Apr 96
All About Interfacing: Part 2(Holtzman) Jan 13
Build the MC68000(C) (Schrader, Koenig, Voelzke) Mar 101, May 138
Build the PT-68K(C)(Stark) Oct 90, Nov 101, Dec 95
Cauzin Softstrip System, The(Holtzman) Apr 93
Commodore Pulse Generator(C)(Barbarelo) Oct 96
Concurrency(Stern) Feb 112
Editor's Workbench(EW) Mar 93
Graphics Co-Processors(Bernard) Sep 82
IBM-Compatible Clone Computer(C)(Flack) Feb 104
IBM Incompatible, Build This(C)(Holtzman) Apr 98
Floppy-Disk Data Storage(Grossblatt) Dec 91
MC68000, Build the(C) (Schrader, Koenig, Voelzke) Mar 101, May 138
Micro-Floppy Retrofit(C)(Friedman) Aug 67
Portable Computers(Holtzman) Sep 77
Heathkit SK-203 Printer Buffer(EW) Sep 76
Hercules Graphics Card Plus(EW) Apr 85

I

IBM
-Compatible Clone Computer(C)(Flack) Feb 104
-Incompatible, Build This(C)(Holtzman) Apr 98
Models 30 and 50 PC's(EW) Aug 63
Operating Systems: The M&M's(EW) Jun 93
Personal System/2(EW) Jul 66
Interfacing, All About: Part 2(Holtzman) Jan 13

J

J&M's Memory Minder(EW) Aug 63

K

Keyboards
Editor's Workbench Jul 66
From Keypress to Scan Code(Holtzman) Jul 70
Working with Surplus Keyboards(Grossblatt) Jul 74
Kepron, The(Holtzman) Jun 100

L

Letters(D) Jan 4, Feb 102
Look Inside the 6502, A(Solomon) May 141

M

Max 232: 5-Volt Only(Kreuter) Jan 10
MC68000, Build the(C) (Schrader, Koenig, Voelzke) Mar 101, May 138
Memory Expansion(EW) Mar 93
Micro-Floppy Retrofit(C)(Friedman) Aug 67
Microsolutions' Matchpoint(EW) Jun 94
Multitasking
Concurrency(Stern) Feb 112
Mycroft Labs' Mite(EW) Oct 88

O

Orchid's Conquest(EW) Mar 93

P

PC Boards, Designing on Your Computer(Grossblatt) Jun 97
PC-Sigs
Command-Line Editor(EW) Mar 95
PC-Outline(EW) Mar 94
Periscope Software(EW) Dec 87
Portable Computers(Holtzman) Sep 77, (EW)Nov 93
Product Reviews(EW) Mar 96, Apr 92, Jun 96, Oct 89, Nov 94

Programs
Commodore Pulse Generator(C)(Barbarelo) Oct 96
Computer-Assisted Regulator Design (Cunkelman) Feb 110
TV Channel Frequency Program(Kiley) Jan 12
TVRO Antenna Pointer(Tyson) Sep 73
PS/2(EW) Sep 73
PT-68K, Build the(C)(Stark) Oct 90, Nov 101, Dec 95

R

Robot, Computer-Controlled(C) (Barbarelo) May 144, (PCS) May 67

S

Software
Editor's Workbench Mar 94, Apr 90, May 136, Jun 93, Aug 63, Sep 74, Oct 88, Nov 93, Dec 87
Designing PC Boards on Your Computer: Part 2(Grossblatt) Aug 69
Masters' Visible Computer: 8088(EW) Jun 95
Periscope(EW) Dec 87
Pirates, Sinking the(Holtzman) Jun 100
Review(D) Jan 5, Feb 103
Certificate Maker(SWR) Feb 103
Webster's On-Line Thesaurus(SWR) Jan 5

6800
MC68000, Build the(C) (Schrader, Koenig, Voelzke) Mar 101, May 138
PT-68K, Build the(C)(Stark) Oct 90, Nov 101, Dec 95
68K Update(EW) Aug 63
6502, A Look Inside the(Solomon) May 141

T

Test Equipment
Commodore Pulse Generator(C)(Barbarelo) Oct 96
Tseng Lab's EVA/480(EW) May 135
TV Channel Frequency Program(Kiley) Jan 12
TVRO Antenna Pointer Program(C)(Tyson) Jan 6

V

Vericomp's Breakthru/PC(EW) Mar 94

W

Webster's On-Line Thesaurus(SWR) Jan 5
Working with Surplus Keyboards(Grossblatt) Jul 74

MARKET CENTER

FOR SALE

REPAIR your own TV...it's easy. Write RESEARCH, Rt. 3, Box 601BR, Colville, WA 99114.

CIRCUIT boards, kits, & assemblies for QST magazine articles. For price list SASE to: A & A ENGINEERING, 2521 W. La Palma Ave., Anaheim, CA 92801. (714) 952-2114.

RESTRICTED technical information: Electronic surveillance, schematics, locksmithing, covert sciences, hacking, etc. Huge selection. Free brochure. MENTOR-Z, 135-53 No. Blvd., Flushing, NY 11354.

TV tunable notch filters, free brochure. D.K. VIDEO, Box 63/6025, Margate, FL 33063. (305) 752-9202.

DESCRAMBLER catalog. All brands. Special combo Jerrod 400 and SB3 \$165. Descrambler kit \$39.00 (assemblies in half hour). Send \$1.00. MJ INDUSTRY, Box 531, Bronx, NY 10461.

IS it true...Jeeps for \$44 through the government? Call for facts! 1 (312) 742-1142, ext. 4673.

OLDTIME radio programs on high quality tapes. Comedy! Adventure! Music! Free catalog. CARL F. FROELICH, Heritage Farm, New Freedom, PA 17349.

TEST equipment, reconditioned. For sale. \$1.25 for catalog. WALTER'S, 2697 Nickel, San Pablo, CA 94806. (415) 724-0587.

CLASSIFIED AD ORDER FORM

To run your own classified ad, put one word on each of the lines below and send this form along with your check to:

Radio-Electronics Classified Ads, 500-B Bi-County Boulevard, Farmingdale, NY 11735

PLEASE INDICATE in which category of classified advertising you wish your ad to appear. For special headings, there is a surcharge of \$23.00.

() Plans/Kits () Business Opportunities () For Sale
() Education/Instruction () Wanted () Satellite Television
()

Special Category: \$23.00

PLEASE PRINT EACH WORD SEPARATELY, IN BLOCK LETTERS.

(No refunds or credits for typesetting errors can be made unless you clearly print or type your copy.) Rates indicated are for standard style classified ads only. See below for additional charges for special ads. Minimum: 15 words.

1	2	3	4	5
6	7	8	9	10
11	12	13	14	15 (\$42.75)
16 (\$45.60)	17 (\$48.45)	18 (\$51.30)	19 (\$54.15)	20 (\$57.00)
21 (\$59.85)	22 (\$62.70)	23 (\$65.55)	24 (\$68.40)	25 (\$71.25)
26 (\$74.10)	27 (\$76.95)	28 (\$79.80)	29 (\$82.65)	30 (\$85.50)
31 (\$88.35)	32 (\$91.10)	33 (\$94.05)	34 (\$96.90)	35 (\$99.75)

We accept MasterCard and Visa for payment of orders. If you wish to use your credit card to pay for your ad fill in the following additional information (Sorry, no telephone orders can be accepted.):

Card Number

Expiration Date

Please Print Name

Signature

IF YOU USE A BOX NUMBER YOU MUST INCLUDE YOUR PERMANENT ADDRESS AND PHONE NUMBER FOR OUR FILES. ADS SUBMITTED WITHOUT THIS INFORMATION WILL NOT BE ACCEPTED.

CLASSIFIED COMMERCIAL RATE: (for firms or individuals offering commercial products or services) \$2.85 per word prepaid (no charge for zip code)...MINIMUM 15 WORDS. 5% discount for same ad in 6 issues; 10% discount for same ad in 12 issues within one year; if prepaid. NON-COMMERCIAL RATE: (for individuals who want to buy or sell a personal item) \$2.30 per word, prepaid...no minimum. ONLY FIRST WORD AND NAME set in bold caps at no extra charge. Additional bold face (not available as all caps) 50¢ per word additional (20% premium). Entire ad in boldface, add 20% premium to total price. TINT SCREEN BEHIND ENTIRE AD: add 25% premium to total price. TINT SCREEN BEHIND ENTIRE AD PLUS ALL BOLD FACE AD: add 45% premium to total price. EXPANDED TYPE AD: \$4.30 per word prepaid. All other items same as for STANDARD COMMERCIAL RATE. TINT SCREEN BEHIND ENTIRE EXPANDED TYPE AD: add 25% premium to total price. TINT SCREEN BEHIND ENTIRE EXPANDED TYPE AD PLUS ALL BOLD FACE AD: add 45% premium to total price. DISPLAY ADS: 1" x 2 1/4"—\$320.00; 2" x 2 1/4"—\$640.00; 3" x 2 1/4"—\$960.00. General Information: Frequency rates and prepayment discounts are available. ALL COPY SUBJECT TO PUBLISHERS APPROVAL. ADVERTISEMENTS USING P.O. BOX ADDRESS WILL NOT BE ACCEPTED UNTIL ADVERTISER SUPPLIES PUBLISHER WITH PERMANENT ADDRESS AND PHONE NUMBER. Copy to be in our hands on the 12th of the third month preceding the date of the issue. (i.e., Sept. issue copy must be received by May 12th). When normal closing date falls on Saturday, Sunday or Holiday, issue closes on preceding working day.

CB RADIO OWNERS!

We specialize in a wide variety of technical information, parts and services for CB radios. 10M-FM conversions, repairs, books, plans, kits, high-performance accessories. Our 11th year! Catalog \$2.

CBC INTERNATIONAL, P.O. BOX 31500RE, PHOENIX, AZ 85046

TUBES, new, unused. Send self-addressed, stamped envelope for list. FALA ELECTRONICS, Box 1376-2, Milwaukee, WI 53201.

PHOTOFACT folders, under #1400 \$3.00. Others \$5.00. Postpaid. LOEB, 414 Chestnut Lane, East Meadow, NY 11554.

TI-99/4A software/hardware bargains. Hard-to-find items. Huge selection. Fast service. Free catalog. DYNA, Box 690, Hicksville, NY 11801.

FLASHLIGHT that needs no batteries measures 5" x 3" ideal for every situation, money back guarantee \$10.—SAMUELS ENTERPRISES, 724 East 231 Street, Bronx, NY 10466.

CUSTOM front panel nameplates for your projects. For details: J & E ENTERPRISES, 2457 N. Mar-mora, Chicago, IL 60639.

FREE power supply (\$7.95 value) with ASSORTMENT #103, (February '84 article) printed circuit, toko coils, transistors, IC's, diodes \$25.00. Five/\$112.50. Shipping \$3.00. JIM RHODES INC., P.O. Box 3421, Bristol, TN 37625.

Quality Microwave TV Antennas

Multi-Channel 1.9 to 2.7 GHz: 40dB Gain
12-Channel System complete \$104.95
2-Channel System complete \$84.95
Dealerships. Qty. Pricing. Replacement Parts

Philips-Tech Electronics
P.O. Box 9533 • Scottsdale, AZ 85252
(602) 947-7700 (3300 Credit all phone orders!)

LIFETIME WARRANTY MasterCard • Visa • CDS

COMMODORE chips/repairs C-64 repair \$39.95 complete. We sell chips at low cost (eg. 6526/6510-\$9.95 and many others). C-64 P.S. \$27.95. "Commodore Diagnostician," a complete chart for diagnosing faulty IC's \$6.95 + postage. Send for catalog. KASARA MICROSYSTEMS, INC., 33 Murray Hill Drive, Spring Valley, NY 10977. (800) 642-7634 (outside NY) or (914) 356-3131.

NEW 30 channel microwave TV antenna—complete \$149.95. Standard 2 channel \$99.95. Lifetime warranty—dealer pricing—C.O.D.—MC—VISA—HIGH-TECH ELECTRONICS, 337 Vineyard Ave., Suite 300, Ontario, CA. 91764. (714) 391-1655.

AMAZING SCIENTIFIC & ELECTRONIC PRODUCTS

PLANS—Build Yourself—All Parts Available in Stock

- LC7—BURNING CUTTING CO2 LASER \$20.00
- RUB4—PORTABLE LASER RAY PISTOL 20.00
- TC01—3 SEPARATE TESLA COIL 20.00

PLANS TO 1.5 MEV

- IOG1—ION RAY GUN 10.00
- GRAT1—GRAVITY GENERATOR 10.00
- EML1—ELECTRO MAGNET COIL GUN/LAUNCHER 6.00

KITS

- MFT1K—FM VOICE TRANSMITTER 3 MI RANGE 49.50
- WVPMSK—TELEPHONE TRANSMITTER 3 MI RANGE 39.50
- BTC2K—250.00 VOLT 10-14" SPARK TESLA COIL 199.50
- LHC2K—SIMULATED MULTICOLOR LASER 39.50
- BLS1K—100,000 WATT BLASTER DEFENSE DEVICE 69.50
- ITM1K—100,000 VOLT 20" AFFECTIVE RANGE INTIMIDATOR 69.50
- PSP4K—TIME VARIANT SHOCK WAVE PISTOL 59.50
- PTG1K—SPECTACULAR PLASMA TORNAO GENERATOR 149.50
- MPPK1K—SEE IN DARK KIT 169.50

ASSEMBLED

- PG70H—MULTICOLOR VARIABLE MODE PLASMA GLOBE "7" 425.00
- BTC10—50,000 VOLT—WORLD'S SMALLEST TESLA COIL 44.50
- LGU40—1MW HeNe VISIBLE RED LASER GUN 299.50
- TAT20 AUTO TELEPHONE RECORDING DEVICE 24.50
- GPV10—SEE IN TOTAL DARKNESS IR VIEWER 299.50
- LIS110—SNOOPER PHONE INFINITY TRANSMITTER 169.50
- IPG70—INVISIBLE PAIN FIELD GENERATOR—MULTI MODE 74.50

• CATALOG CONTAINING DESCRIPTIONS OF ABOVE PLUS HUNDREDS MORE AVAILABLE FOR \$1.00 OR INCLUDED FREE WITH ALL ABOVE ORDERS

PLEASE INCLUDE \$3.00 PH ON ALL KITS AND PRODUCTS PLANS ARE POSTAGE PAID. SEND CHECK, MO, VISA, MC IN US FUNDS

INFORMATION UNLIMITED
P.O. BOX 716 DEPT. RE. AMHERST, NH 03031

CABLE TV converters. "new" Zenith flash, Scientific Atlanta, Jerrold, Oak, Zenith, Hamlin. Many others. "New" video hopper "The Copy Killer". Visa, M/C & Amex 1 (800) 826-7623. B&B Inc., 10517 Upton Circle, Bloomington, MN 55431.

TUBES 59¢. Year Guarantee. Free catalog. Tube tester \$8.95. CORNELL, 4215 University, San Diego, CA 92105.

OAK 56 channel wireless remote converter/de-scrambler, original refurbished equipment, exceptional video, \$175.00; legal to own your equipment, however, Federal law prohibits hookup without cable company permission. **PONDEROSA**, (303) 661-1659. (We ship C.O.D.)!

FREE remote control converter with any de-scrambler below: Oak VN12 \$85.00; new Hamlin MLD1200 \$90.00; new SB3 \$89.00; new Trimode/Bistate \$125.00; Starcom-6 system \$125.00; Zenith cable \$175.00; legal to own your equipment, however, Federal law prohibits hookup without cable company permission. **PONDEROSA**, (303) 661-1659. (We ship C.O.D.)!

ADD 5 important features to your home telephone. SASE (805) 583-4272. **B&M ENGINEERING**, Box 823, Simi Valley, CA 93062.

 **WRITE FOR MCGEE'S SPEAKER & ELECTRONICS CATALOG**
1001 BARGAINS IN SPEAKERS
toll free 1-800-346-2433 for ordering only.
1901 MCGEE STREET KANSAS CITY, MO. 64108

CABLE TV equipment S.A., Jerrold, Zenith, Hamlin, Oak, Eagle, filters, remotes and more. Best prices C.O.D.'s accepted dealers needed. Ours work where others failed and we guarantee it! **TRANS-WORLD CABLE CO., (218) 543-6671.**

TUBES, name brands. New, 80% off list. **KIRBY**, 298 West Carmel Drive, Carmel, IN 46032.

TRANSISTORS-tubes: MRF421 \$24.00, MRF454 \$15.00, MRF455-MRF477 \$12.00, MRF492 \$16.95, SRF2072 \$13.50, 3800 \$18.95, 2SC2879 \$25.00, 6LF6-6LQ6-6JS6 \$10.95, 8950 \$15.95. New Ranger AR3500 all mode 10 meter transceiver \$319. Quantity discounts! Best prices on hard-to-find parts, antennas, mics, power supplies, & equipment! Catalog \$1.00 (refundable), or free with order. **RFPC**, Box 700, San Marcos, CA 92069. For information or same day shipment—call (619) 744-0728. Visa/MC/C.O.D.

CIRCUIT board assembly at 60¢ per hour. **FABRICANTS ELECTRONICS**, Apartado 391 Pavas, Costa Rica, C.A. Ph 320074.

SATELLITE & cable equipment. We have those hard-to-find units ready to go. Tired of junk that dont work properly, try our 10 day satisfaction guarantee & 90 day warranty (wholesale only) **HI TEC ELECTRONICS**, PO Box 42423, Detroit, MI 48242. (313) 722-9381.

 **TUBES - 2000 TYPES DISCOUNT PRICES!**
Early, hard-to-find, and modern tubes. Also transformers, capacitors and parts for tube equipment. Send \$2.00 for 20 page wholesale catalog.
ANTIQUE ELECTRONIC SUPPLY
688 W. First St. • Tempe, AZ 85281 • 602/894-9503

PLASMA sphere colorful bottled lightning, low cost prefilled 5" globes used in easily built for \$60 complete detailed plans \$10, kits, complete 5" & 9" units also available, info \$2. **RIESS**, Box 54625, Phoenix, AZ 85078.

ALARM do-it-yourself and save. Send SASE: **ERIC'S ALARM**, P.O. Box 8331, Bossier, LA 71113-8331.

TUBES: "oldest," "latest." Parts and schematics. SASE for list. **STEINMETZ**, 7519 Maplewood Ave., R.E. Hammond, IN 46324.

HACKING, crashing, pirating, and phreaking. Who's doing it, why they're doing it, and how they're doing it. Sample programs, phone numbers, and the tools of the trade. **Hacker's Handbook**, \$12.95. **Computer Underground**, \$14.95, \$1 postage to **CABLETRONICS**, Box 30502R, Bethesda, MD 20814.

Cable Converters & Decoders

*Jerrold S.B. Add On.....	\$89.00	\$58.00
*Jerrold Tri-Bi Add On.....	\$98.00	\$78.00
Jerrold Starcom CSV.....	\$139.95	Call
MTS Converter + Remote.....	\$85.00	\$69.00
Jerrold 450 DRZ-3A.....	\$95.00	\$79.00
Parental Control MTS Plus.....	\$100.00	\$85.00
Hamlin MLD 1200-3.....	\$98.00	\$58.00
Scientific Atlanta Add On.....	\$140.00	\$99.00
M-35 B Combo With VariSync.....	\$99.00	\$69.00
Mini Code N-12 VariSync.....	\$99.00	\$58.00
442 VariSync (N-12 Substitute).....	\$89.00	\$58.00
Wireless Video Sender.....	\$45.00	Call

*S.B. TRI-BI Flashing Got You Down? Try original Jerrold Equipment it might just solve your problems. Call or write for Free Catalog. All products Guaranteed 90 days plus.
M.D. Electronics 5078 So. 108th Suite 115 Omaha NE. 68137 Phone (402) 554-0417

LASER, components and accessories. Free catalog. **M.J. NEAL COMPANY**, 6672 Mallard Court, Orient, OH 43146.

MODULES. Build professional, custom, audio/music electronic devices easily. Catalog \$1.00 (refundable). **TONIX**, Box 770, Vernon, NJ 07462-770.

INTRODUCTORY offer: 100 pack 4 inch wire ties, one-piece molded 6/6 nylon, self-locking adjustable \$1.99. Product and price listing free with order or send \$1.00 refundable with first order. **NUTTER RIDGE PURVEYORS**, Star Route Province Road, Strafford, NH 03884.

DESCRAMBLER parts: I.C.'s, I.F. transformers, transistors, coils, capacitors, misc. Send S.A.S.E. to: **T-ROY**, P.O. Box 597 Marine City, MI 48039.

ELECTRONICS components, lowest prices. Free flyer, send SASE. **SANTECH ELECTRONICS**, 11 Revere, Tappan, NY 10983. (914) 359-1130.

SAMS photo facts under #1300 \$2.99 post paid. "SURPLUS," P.O. Box 219, Edgewood, NM 87123-0219.

DEAR SANTA
WITH THE WORLD POPULATION AT IT'S HIGHEST EVER I FIGURED YOU COULD STAND TO SAVE A BUCK OR 21 BELOW IS MY SHOPPING LIST FROM SILICON VALLEY SURPLUS HOLIDAY SALE

MSDOS BOOK SET \$13.99
This four book set for vers. 2.11c have the following titles **User's Guide, Debug Utility, Programmers Reference, & Pivot Enhancements** REG 15.99

MACINTOSH NOTEBOOKS \$12.00
A well illustrated 3 book set by Prentice Hall each book is 8 by 11 by 3/4! A separate book for **Macpaint, Macwrite, & Multiplan** REG 15.98

 **Multitech KEYBOARDS FOR IBM® A.T.**
Works on the P.C. or the AT but not the XT. If you do not like the "feel" return it within 15 days for a refund, limited quantity on hand.
84 KEYS KBO84 \$34.00 REG 39.00
15 no hassle money back trial

IBM COMPATIBLE FLOPPY DISK CONTROLLER WITH CENTRONICS PORT \$12.00
Printer assignment LPT 1 cannot be changed on this 3/4 size card REG 19.00
Tendon pcba 188400

this sale will be over before we can process the bingo cards... call for fast service
Call for a copy of 15 day trial agreement. Tax & freight extra. Send check or add 1.90 for COD. Price may change. Store Price may differ. While supplies last. No P.O.s, terms, or credit cards

Silicon Valley Surplus OPEN 10am-6pm CLOSED SUN & MON
415-261-4506
4401 OAKPORT OAKLAND CA, 94601
CALL OUR BBS 415-261-4513

CIRCLE 51 ON FREE INFORMATION CARD

NUTS & VOLTS P.O. Box 1111-E Placentia, CA 92670 714-832-7721
Subscription Rates: 3rd Class Mail - USA: One Year \$50.00, Two Years \$98.00, Lifetime \$500.00. 1st Class Mail: One Year USA \$18.00, Canada/Mexico \$20.00, Foreign \$25.00. Air Mail: Foreign \$35.00.
GIVE YOURSELF A BREAK—A PRICE BREAK!
NUTS & VOLTS WILL SAVE YOU MONEY ON ELECTRONIC PARTS & EQUIPMENT. Plus! SHOW US WHERE TO FIND UNIQUE, UNUSUAL AND HARD-TO-FIND ITEMS.
SUBSCRIBE TODAY!
A National Publication For The Buying And Selling Of Electronic Equipment

PHOTOVOLTAIC battery chargers by Arco solar Cars, RVs, marine, etc. From \$49.50. Brochure. **SUN POWER-TEXAS**, P.O. Box 2788A, Freeport, TX 77541.

USED books: electronics, physics, mathematics, mechanics, etc; big list: \$1.00 in stamps. **SOFTWARE**, 1515 Sashabaw, Ortonville, MI 48462.

INTERCOM 2001—An inexpensive home intercom and control system that utilizes existing touch tone telephones and their associated wiring! Easy to install and easy to use! \$499.95. **JACKSON COMMUNICATION PRODUCTS**, 604 Burnham Road, Phila., PA 19119.

PLANS AND KITS

Hi-Fi speaker systems, kits and speaker components from the world's finest manufacturers. For beginners and audiophiles. Free literature. **A&S SPEAKERS**, Box 7462, Denver, CO 80207. (303) 399-8609.

VOICE disguisers! FM bugs! Telephone transmitters! Phone snoops! More! Catalog \$1.00 (Refundable): **XANDI ELECTRONICS**, Box 25647, Dept. 60V, Tempe, AZ 85282.

A SINGER'S DREAM!

REMOVES VOCALS FROM RECORDS!
Now You can sing with the world's best bands!
The Thompson Vocal Eliminator can remove most or virtually all of a lead vocal from a standard stereo record and leave the background!
Write or call for a free brochure and demo record.
**LT Sound, Dept. R-1, P.O. Box 338,
Stone Mountain, GA 30086 (404) 493-1258**

STRANGE stuff. Plans, kits, new items. Build satellite dish \$69.00. Descramblers, bugs, adult toys. Informational photo package \$3.00 refundable. **DI-RIJO CORPORATION, Box 212, Lowell, NC 28098.**

DETECTIVES, experimenters. Exciting new plans. Hard-to-find micro and restricted devices. Large catalog \$5.00, refundable on 1st order. **WILSON, P.O. Box 5264, Augusta, GA 30906.**

VIDEOCIPHER II manual 120+ pages/Oak "Orion" 120+ pages, either—\$27.45—both \$49.95. Plans, kits, descrambling books. Catalog—\$2.00. **MICROTRONICS, P.O. Box 6426, Yuma, AZ 85364-0840.**

PLANS. Plasma display, H.V. generator, CB modulator, linear amplifiers, pain field generators, shock sensor. Plans for all \$20.00 complete. **AET, Suite 173, 5800-A, North Sharon, Amity Rd., Charlotte, NC 28215.**

NOVELTY type electronic projects for the gadgeteer. Unusual, fascinating, and fun. Free information. **TAYLOR ELECTRONICS, P.O. Box 1612, Destin, FL 32541.**

BUILD this five-digit panel meter and square-wave generator including an ohms, capacitance and frequency meter. Detailed instructions \$2.50. **BAGNALL ELECTRONICS, 179 May, Fairfield, CT 06430.**

CATALOG: hobby/broadcasting/1750 meters/hom/CB: transmitters, antennas, scramblers, bugging devices, more! **PANAXIS, Box 130-F1, Paradise, CA 95967.**

CRYSTAL radio sets, plans, kits, catalog \$1.00. **MIDCO, 660 North Dixie Highway, Hollywood, FL 33020.**

DECODING plans and theory booklets. Video tape copy protection, removes flashing and jitter, 30 pages, \$15.45. Jerrold DI and DIC decoder theory, 12 pages, \$6.95. Gated pulse decoding plus new universal single level suppression decoder, works on Hamlin, Jerrold, Sylvania, Eagle, 39 pages, \$15.00. Video scrambling techniques, the original secret manual, sinewave and Zenith SSAV1, 57 pages, \$14.95. Hidden signals on satellite TV, 178 pages, \$16.95. PC board and kits available. **ELEPHANT ELECTRONICS INC., P.O. Box 41865-J, Phoenix, AZ 85080. (602) 581-1973.**

PROJECTION TV... Convert your TV to project 7 foot picture. Results comparable to \$2,500 projectors... Total cost less than \$30.00. Plans and 8" lens \$21.95... Illustrated information Free... **MACROCAMA-GD, Washington Crossing, PA 18977.** Creditcard orders 24hrs. (215) 736-3979.

ELECTRONIC House Bimonthly magazine covering smart houses, integrated electronics, security, energy, sensors, more. Send \$14.95 for one year subscription to: **ELECTRONIC House, Dept. RE, 524 East McKinley, Mishawaka, IN 46545. (219) 256-2060.**

SURPLUS SATELLITE EQUIPMENT **SPARTAN DISTRIBUTING**
PO BOX 7 BIXBY, OKI 74008

QUALITY ELECTRONICS SINCE 1972

NEW SURPLUS INVENTORY FROM SATELLITE EQUIP. MANUF.

COMPLETE PLANS TO BUILD A HIGH QUALITY SATELLITE BLOCK RECEIVER.
KIT INCLUDES SCHEMATICS, PARTS LIST, METAL CASE, SILK-SCREENED FRONT PANEL, PRINTED CIRCUIT BOARD WITH CONTROLS ATTACHED.
\$36.00 & 2.50 SHIP. MONEY ORDERS OR CASHIERS CHECK ONLY.
SEND STAMPED ENVELOPE FOR LIST OF OTHER EQUIP AVAILABLE.

TV-SCOPE

An interesting and worthwhile project. This EASY-TO-BUILD circuit lets you use any regular TV set as a simple OSCILLOSCOPE. Build for less than \$10. NO MODIFICATIONS TO TV! Single or dual trace. Send for FREE CATALOG of other plans and kits.

DETAILED PLANS: \$4.95
PENN RESEARCH, Box 3543
Willamport, PA 17701

TOP quality imported, domestic kits, surplus, discount electronics, computer components. Free catalog. **TEKTRASONIX, 1120 Avenue of the Americas, 11/ suite 4038, New York, NY 10036.**

PLANS. Car radio amplifiers, 50W., 100W., 200W. per channel. Plans for all \$10.00 complete. **DBS, P.O. Box 261632, Tampa, FL 33685.**

SELECT TV patents plus complete explanations of authorization, polarity status, audio, sync modifications \$14.00. **SIGNAL, Box 2512-R, Culver City, CA 90231.**

PLANS: solar, wood differential thermostat; wood-stove audible blower control; microprocessor AC/DC controller; auto tremble alarm; VLF receiver. \$5.00 each. **AUTOMATION CONTROL SYSTEMS, 823 W. Durham, Cary, NC 27511.**

V20-5 10.95 V20-B 14.95 NS2650 2.50 280A CPU 1.75 280B CPU 3.75 280A CTC 1.95 280A DART'S 2.25 280A DMA 5.50 280A PIO 1.95 280A SIO 5.50 280B SIO 9.95 82C43 2.75 AMD2901 4.00 6502 2.75 8522 3.50 6800 1.75 6802 4.50 6803L 8.00 6809 5.50 6810 1.75 6821 1.75 6846 4.50 6850 1.75 6875 4.50 8035 1.75 8048 5.00 8049 2.50 9085A 2.75		RAM's 3016 1.50 21L02.3 70 2101A.4 1.50 2111A 1.75 2121.1 1.95 2114.2 1.00 21B8.4 1.75 2147.3 2.50 226 6.00 TMS34099 1.75 MK4103 90 TMS4050N 1.75 MK4096-11 1.25 4108.3 1.60 41B2.4 1.75 41B4.1 1.75 41B4.15 1.25 41256-15 2.50 4464-16 4.00 MK4802 4.00 27E104.4 2.50 61B7.3 1.80 61B79.3 4.50 6264L-15 4.50 81B18.2 4.95		TRANSISTOR SPECIAL TIP 318 NPN S-T0 220. \$4.40 TIP 328 PNP S-T0 220. \$4.40 TIP 34 PNP S-T0. \$5.95 TIP 41 PNP S-T0. \$5.50 TIP 121 NPN S-U94. \$5.00 TIP 141 NPN S-U97. \$1.00 TIP 145. \$1.35 2N2507 PNP GE TO-18. \$4.00 DP2200-DUAL. \$3.95 POWER DARL. \$3.95 2N2222 NPN S-T0-92. \$1.00 2N2507 PNP S-T0-92. \$1.00 TIP 2955 PNP S-T0. \$1.00 2N3055 NPN S-T0-3. \$1.00 MJE3055T. \$1.75 2N3772 NPN S-T0-3. \$1.00 2N3504 NPN S-T0-92. \$1.00 2N3906 PNP S-T0-92. \$1.00 2N4901 PNP S-TD-3. \$1.00 2N5296 NPN S-TD-20. \$1.00 2N6100 PNP S-TD-20. \$1.00 MJE13009A 400V NPN. \$1.00 MRF-8004 CM RF NPN. \$1.75		SCR's 1.5A 6A 35A 75A 100 35 40 140 150 35 50 140 200 40 50 180 400 60 70 240 90 600 80 100 360 1200		TRIAC's PRV 14 10A 25A 100 35 50 140 200 50 80 180 400 70 100 260 600 100 120 360		74HC SERIES 74HC02 35 74HC03 35 74HC04 35 74HC05 35 74HC08 35 74HC09 35 74HC10 35 74HC11 35 74HC12 35 74HC13 35 74HC14 35 74HC15 35 74HC16 35 74HC17 35 74HC18 35 74HC19 35 74HC20 35 74HC21 35 74HC22 35 74HC23 35 74HC24 35 74HC25 35 74HC26 35 74HC27 35 74HC28 35 74HC29 35 74HC30 35 74HC32 35 74HC33 35 74HC34 35 74HC35 35 74HC36 35 74HC37 35 74HC38 35 74HC39 35 74HC40 35 74HC42 35 74HC43 35 74HC44 35 74HC45 35 74HC46 35 74HC47 35 74HC48 35 74HC49 35 74HC50 35 74HC51 35 74HC52 35 74HC53 35 74HC54 35 74HC55 35 74HC56 35 74HC57 35 74HC58 35 74HC59 35 74HC60 35 74HC61 35 74HC62 35 74HC63 35 74HC64 35 74HC65 35 74HC66 35 74HC67 35 74HC68 35 74HC69 35 74HC70 35 74HC71 35 74HC72 35 74HC73 35 74HC74 35 74HC75 35 74HC76 35 74HC77 35 74HC78 35 74HC79 35 74HC80 35 74HC81 35 74HC82 35 74HC83 35 74HC84 35 74HC85 35 74HC86 35 74HC87 35 74HC88 35 74HC89 35 74HC90 35 74HC91 35 74HC92 35 74HC93 35 74HC94 35 74HC95 35 74HC96 35 74HC97 35 74HC98 35 74HC99 35		RCA HC 2500 60 WATTS \$34.95 SOLID STATE PNP DI LINEAR AND AUDIO AMP BAND WIDTH 30 KHZ AT 100 WATTS 7 AMP OUTPUT		TANTALUM CAPACITORS 22UF 35V 5/31.00 47UF 35V 5/31.00 68UF 35V 5/31.00 100UF 20V 5/31.00 2.2UF 20V 5/31.00 3.3UF 20V 4/31.00 4.7UF 20V 4/31.00 6.8UF 20V 4/31.00 10UF 20V 4/31.00 15UF 20V 4/31.00 22UF 20V 4/31.00 33UF 20V 4/31.00 47UF 20V 4/31.00 68UF 20V 4/31.00 100UF 20V 4/31.00 150UF 20V 4/31.00 220UF 20V 4/31.00 330UF 20V 4/31.00 470UF 20V 4/31.00 680UF 20V 4/31.00 1000UF 20V 4/31.00 1500UF 20V 4/31.00 2200UF 20V 4/31.00 3300UF 20V 4/31.00 4700UF 20V 4/31.00 6800UF 20V 4/31.00 10000UF 20V 4/31.00 15000UF 20V 4/31.00 22000UF 20V 4/31.00 33000UF 20V 4/31.00 47000UF 20V 4/31.00 68000UF 20V 4/31.00 100000UF 20V 4/31.00 150000UF 20V 4/31.00 220000UF 20V 4/31.00 330000UF 20V 4/31.00 470000UF 20V 4/31.00 680000UF 20V 4/31.00 1000000UF 20V 4/31.00 1500000UF 20V 4/31.00 2200000UF 20V 4/31.00 3300000UF 20V 4/31.00 4700000UF 20V 4/31.00 6800000UF 20V 4/31.00 10000000UF 20V 4/31.00 15000000UF 20V 4/31.00 22000000UF 20V 4/31.00 33000000UF 20V 4/31.00 47000000UF 20V 4/31.00 68000000UF 20V 4/31.00 100000000UF 20V 4/31.00 150000000UF 20V 4/31.00 220000000UF 20V 4/31.00 330000000UF 20V 4/31.00 470000000UF 20V 4/31.00 680000000UF 20V 4/31.00 1000000000UF 20V 4/31.00 1500000000UF 20V 4/31.00 2200000000UF 20V 4/31.00 3300000000UF 20V 4/31.00 4700000000UF 20V 4/31.00 6800000000UF 20V 4/31.00 10000000000UF 20V 4/31.00 15000000000UF 20V 4/31.00 22000000000UF 20V 4/31.00 33000000000UF 20V 4/31.00 47000000000UF 20V 4/31.00 68000000000UF 20V 4/31.00 100000000000UF 20V 4/31.00 150000000000UF 20V 4/31.00 220000000000UF 20V 4/31.00 330000000000UF 20V 4/31.00 470000000000UF 20V 4/31.00 680000000000UF 20V 4/31.00 1000000000000UF 20V 4/31.00 1500000000000UF 20V 4/31.00 2200000000000UF 20V 4/31.00 3300000000000UF 20V 4/31.00 4700000000000UF 20V 4/31.00 6800000000000UF 20V 4/31.00 10000000000000UF 20V 4/31.00 15000000000000UF 20V 4/31.00 22000000000000UF 20V 4/31.00 33000000000000UF 20V 4/31.00 47000000000000UF 20V 4/31.00 68000000000000UF 20V 4/31.00 100000000000000UF 20V 4/31.00 150000000000000UF 20V 4/31.00 220000000000000UF 20V 4/31.00 330000000000000UF 20V 4/31.00 470000000000000UF 20V 4/31.00 680000000000000UF 20V 4/31.00 1000000000000000UF 20V 4/31.00 1500000000000000UF 20V 4/31.00 2200000000000000UF 20V 4/31.00 3300000000000000UF 20V 4/31.00 4700000000000000UF 20V 4/31.00 6800000000000000UF 20V 4/31.00 10000000000000000UF 20V 4/31.00 15000000000000000UF 20V 4/31.00 22000000000000000UF 20V 4/31.00 33000000000000000UF 20V 4/31.00 47000000000000000UF 20V 4/31.00 68000000000000000UF 20V 4/31.00 100000000000000000UF 20V 4/31.00 150000000000000000UF 20V 4/31.00 220000000000000000UF 20V 4/31.00 330000000000000000UF 20V 4/31.00 470000000000000000UF 20V 4/31.00 680000000000000000UF 20V 4/31.00 1000000000000000000UF 20V 4/31.00 1500000000000000000UF 20V 4/31.00 2200000000000000000UF 20V 4/31.00 3300000000000000000UF 20V 4/31.00 4700000000000000000UF 20V 4/31.00 6800000000000000000UF 20V 4/31.00 10000000000000000000UF 20V 4/31.00 15000000000000000000UF 20V 4/31.00 22000000000000000000UF 20V 4/31.00 33000000000000000000UF 20V 4/31.00 47000000000000000000UF 20V 4/31.00 68000000000000000000UF 20V 4/31.00 100000000000000000000UF 20V 4/31.00 150000000000000000000UF 20V 4/31.00 220000000000000000000UF 20V 4/31.00 330000000000000000000UF 20V 4/31.00 470000000000000000000UF 20V 4/31.00 680000000000000000000UF 20V 4/31.00 1000000000000000000000UF 20V 4/31.00 1500000000000000000000UF 20V 4/31.00 2200000000000000000000UF 20V 4/31.00 3300000000000000000000UF 20V 4/31.00 4700000000000000000000UF 20V 4/31.00 6800000000000000000000UF 20V 4/31.00 10000000000000000000000UF 20V 4/31.00 15000000000000000000000UF 20V 4/31.00 22000000000000000000000UF 20V 4/31.00 33000000000000000000000UF 20V 4/31.00 47000000000000000000000UF 20V 4/31.00 68000000000000000000000UF 20V 4/31.00 100000000000000000000000UF 20V 4/31.00 150000000000000000000000UF 20V 4/31.00 220000000000000000000000UF 20V 4/31.00 330000000000000000000000UF 20V 4/31.00 470000000000000000000000UF 20V 4/31.00 680000000000000000000000UF 20V 4/31.00 1000000000000000000000000UF 20V 4/31.00 1500000000000000000000000UF 20V 4/31.00 2200000000000000000000000UF 20V 4/31.00 3300000000000000000000000UF 20V 4/31.00 4700000000000000000000000UF 20V 4/31.00 6800000000000000000000000UF 20V 4/31.00 10000000000000000000000000UF 20V 4/31.00 15000000000000000000000000UF 20V 4/31.00 22000000000000000000000000UF 20V 4/31.00 33000000000000000000000000UF 20V 4/31.00 47000000000000000000000000UF 20V 4/31.00 68000000000000000000000000UF 20V 4/31.00 100000000000000000000000000UF 20V 4/31.00 150000000000000000000000000UF 20V 4/31.00 220000000000000000000000000UF 20V 4/31.00 330000000000000000000000000UF 20V 4/31.00 470000000000000000000000000UF 20V 4/31.00 680000000000000000000000000UF 20V 4/31.00 1000000000000000000000000000UF 20V 4/31.00 1500000000000000000000000000UF 20V 4/31.00 2200000000000000000000000000UF 20V 4/31.00 3300000000000000000000000000UF 20V 4/31.00 4700000000000000000000000000UF 20V 4/31.00 6800000000000000000000000000UF 20V 4/31.00 10000000000000000000000000000UF 20V 4/31.00 15000000000000000000000000000UF 20V 4/31.00 22000000000000000000000000000UF 20V 4/31.00 33000000000000000000000000000UF 20V 4/31.00 47000000000000000000000000000UF 20V 4/31.00 68000000000000000000000000000UF 20V 4/31.00 100000000000000000000000000000UF 20V 4/31.00 150000000000000000000000000000UF 20V 4/31.00 220000000000000000000000000000UF 20V 4/31.00 330000000000000000000000000000UF 20V 4/31.00 470000000000000000000000000000UF 20V 4/31.00 680000000000000000000000000000UF 20V 4/31.00 1000000000000000000000000000000UF 20V 4/31.00 1500000000000000000000000000000UF 20V 4/31.00 2200000000000000000000000000000UF 20V 4/31.00 3300000000000000000000000000000UF 20V 4/31.00 4700000000000000000000000000000UF 20V 4/31.00 6800000000000000000000000000000UF 20V 4/31.00 10000000000000000000000000000000UF 20V 4/31.00 15000000000000000000000000000000UF 20V 4/31.00 22000000000000000000000000000000UF 20V 4/31.00 33000000000000000000000000000000UF 20V 4/31.00 47000000000000000000000000000000UF 20V 4/31.00 68000000000000000000000000000000UF 20V 4/31.00 100000000000000000000000000000000UF 20V 4/31.00 150000000000000000000000000000000UF 20V 4/31.00 220000000000000000000000000000000UF 20V 4/31.00 330000000000000000000000000000000UF 20V 4/31.00 470000000000000000000000000000000UF 20V 4/31.00 680000000000000000000000000000000UF 20V 4/31.00 1000	
---	--	--	--	--	--	--	--	---	--	--	--	--	--	---	--

If you would like to know more about these Tenma products, ask for our free catalog...
Call TOLL-FREE 1-800-543-4330
 In Ohio call 1-800-762-4315
 In Alaska or Hawaii 1-800-858-1849

TENMA 



Earth Shattering Products



#72-370 Tenma LCR Meter

- Measures inductance from 1 μ H-200H in six ranges
- Measures capacitance from .1pF-200 μ F in seven ranges
- Measures resistance from .01ohm-20Mohm in seven ranges
- 3 $\frac{1}{2}$ digit LCD display
- Fuse protected
- Low battery indicator
- Comes complete with test leads, carrying case and owners manual



#72-445 Tenma Compact DMM/Logic Probe

- 3 $\frac{1}{2}$ " shock-mounted LCD display
- Transistor gain and diode test
- Audible continuity test
- Overload protection
- Low battery indicator
- Comes complete with test leads, carrying case and owners manual



#72-040 Tenma Capacitance Meter

- 3 $\frac{1}{2}$ digit LCD display
- Zero adjustment
- In or out of circuit measurements
- Fuse protected
- Low battery indicator
- Comes complete with test leads, carrying case and owners manual



#72-050 Tenma 3 $\frac{1}{2}$ Digit LCD Multimeter

- Transistor gain and diode test
- 10Mohm input impedance
- AC and DC current up to 10A
- Low battery indicator
- Overload protection
- Comes complete with test leads, carrying case and owners manual



#72-045 Tenma Combination DMM/Capacitance Meter

- Measures capacitance from 1pF-20 μ F
- 10Mohm input impedance
- Transistor gain and diode test
- Audible continuity test
- AC and DC current up to 10A
- Resistance up to 20Mohm
- Overload protection
- Auto-polarity
- Comes complete with test leads, carrying case and owners manual



#72-058 Tenma Autorange DMM

- 3 $\frac{1}{2}$ digit LCD display
- 10Mohm input impedance
- Auto/manual range selector
- Audible continuity tester
- AC and DC current up to 10A
- Switchable Lo/Hi power ohms for in-circuit resistance tests
- Overload protection
- Low battery indicator
- Auto-polarity
- Comes complete with test leads, carrying case and owners manual



#72-060 Tenma Compact DMM

- 3 $\frac{1}{2}$ " shock-mounted LCD display
- Transistor gain and diode test
- Overload protection
- Low battery indicator
- Comes complete with test leads and owners manual



#72-075 Tenma Rotary Dial DMM

- AC and DC current up to 20A
- 10Mohm input impedance
- Overload protection
- Auto-polarity
- Low battery indicator
- Comes complete with test leads, carrying case and instruction manual



#72-430 Tenma True RMS DMM/Frequency Counter

- 4 $\frac{1}{2}$ digit LCD display
- True RMS AC voltage and current measurement
- 10Mohm input impedance
- Frequency counter
- Data hold
- Audible continuity test
- AC and DC current measurements up to 10 amps
- Overload protection
- Diode test
- Auto-polarity
- Comes complete with test leads, carrying case and owners manual

Note: All products shown have a 1 year limited warranty.



MCM ELECTRONICS

858 E. CONGRESS PARK DR.
 CENTERVILLE, OH 45459

A PREMIER Company

SOURCE NO. RE-39

REMOVE vocals the easy way from records. Mono-cable complete with instructions \$12.95. **TRONCO**, Box 453, California, MD 20619.

ULTRASONIC ranging system measures distances from 6" to 35". I/O is TTL compatible, can be connected directly to most computers. Experimenter's kit includes one SN28827 ranging module, one Polaroid 50KHz electrostatic transducer, and user's manual with data sheets. Great for alarms, computer mapping, robotics, etc. \$59.95 + \$2.00 postage, \$2.50 for COD. **I.O. MICRODEVICES**, P.O. Box 2386, Canoga Park, CA 91306. (818) 348-8312.

DESCRAMBLING, new secret manual. Build your own descramblers for **cable** and **subscription TV**. Instructions, schematics for SSAVI, gated sync, sinewave. (HBO, Cinemax, Showtime, etc.) \$8.95, \$1 postage. **CABLETRONICS**, Box 30502R, Bethesda, MD 20814.

Multi-Channel Microwave TV Receivers
1.9-2.7 GHz Parabolic Dish 40+ dB Gain
LIFETIME WARRANTY
Complete System \$89.95 (Shipping Incl.)
Dealer Rates, Replacement Components & Expert Repairs Available

K & S ELECTRONICS Call now for same
P.O. BOX 34522 day shipping!
PHOENIX, AZ 85067 (602) 230-0640

VISA/MC/COD \$2 credit on phone orders!

SATELLITE TV

SATELLITE TV receiver kits! LNA's! Instructions! Schematics! Catalog \$1.00 (refundable): **XANDI ELECTRONICS**, Box 25647, Dept. 21Y, Tempe, AZ 85282.

SATELLITE TV equipment. Buyers guide, discount prices. \$2.00 N.E.C.S. INC., Box 22808-R4, Little Rock, AR 72221.

Cable TV Converters
Why Pay A High Monthly Fee?

Jerrold Products include "New Jerrold Tri-Mode," SB-3, Hamlin, Oak VN-12, M-35-B, Zenith, Magnavox, Scientific Atlanta, and more. (Quantity discounts) 60 day warranty. For fast service C.O.D. orders accepted. Send SASE (60 cents postage) or call for info (312) 658-5320. **Midwest Electronics, Inc.**, **HIGGINS ELECTRONICS**, 5143-R W. Diversey, Chicago, IL 60639. MC/Visa orders accepted. No Illinois orders accepted. Mon.-Fri.-9 A.M.-6 P.M.CST

CABLE TV Secrets—the outlaw publication the cable companies tried to ban. HBO, Movie Channel, Showtime, descramblers, converters, etc. Suppliers list included \$8.95. **CABLE FACTS**, Box 711-R, Pataskala, OH 43062.

DESCRAMBLER. Build our low cost satellite TV video only descrambler for all major movies and sports. Uses all Radio Shack parts. Order P.C. board and instructions by sending check, money order, or Visa for \$35.00 U.S. funds to: **VALLEY MICROWAVE ELECTRONICS**, Bear River, Nova Scotia, Canada, BOS-1B0. (902) 467-3577.

SEE "after dark" with **TELEASE-MAST** assortment #301. (October '86 article) printed circuit, IC's, transistors, diodes. \$25.00. Shipping \$3.00. **JIM RHODES, INC.**, P.O. Box 3421, Bristol, TN 37625.

DESCRAMBLERS for movies, networks. \$149, video only, \$399 complete. Catalog \$4. **SKYWATCH**, 238 Davenport Road, Toronto, Ontario, Canada, M5R-1J6.

SATELLITE antenna special. 6 1/2 foot, mesh construction, polar mount, UPS shippable, \$159, D.N.F., (313) 437-5565.

SATELLITE descrambling manual, Video Cypher II. Schematics, thorough explanation of digital audio encoding, EPROM code, DES. (HBO, Cinemax, Showtime) \$10.95, \$1 postage. **CABLETRONICS**, Box 30502R, Bethesda, MD 20814.

*****SCRAMBLING NEWS*****
PAY TV AND SATELLITE DESCRAMBLING

Schematics, theory, bypasses 13 cable, 7 satellite. New SA turn-on. MLD-1200-3. \$14.95 Experiments With Videocypher. Cloning musketeering. \$14.95 Cable TV Security, design \$12.95 MDS MMS Handbook Microwave hacking \$9.95 Build Satellite Systems Under \$600 \$12.95 Any 3 \$27 Scrambling News. Monthly Feature articles, product reviews, law history patents \$24.95/yr Sample \$5 Winter catalog \$1.

Shojiki Electronics Corp. 1327A Niagara St.,
Niagara Falls, NY 14303. COD's 716-284-2163

BUSINESS OPPORTUNITIES

YOUR own radio station! AM, FM, cable. Licensed or unlicensed. **BROADCASTING**, Box 130-F12, Paradise, CA 95967.

EARN thousands with your own part time electronics business. I do. Free proof, information. **INDUSTRY**, Box 531, Bronx, NY 10461.

DEALERS wanted. Bronx filters for any channel. Send for further information or \$15 for sample unit (specify output channel of converter). **DB ELECTRONICS**, P.O. Box 8644, Pembroke Pines, FL 33084.

HOME assembly. Assemble PC boards for video accessories. We supply materials. No experience needed \$7.50 per hour. Send self-addressed stamped envelope, to: **MICRON-ELECTRONICS**, Box 4716 Akron, OH 44310.

SUPER SAVINGS - SHOP G.E.I.

MULTI NI-CAD BATTERY CHARGER
Recharge 2 or 4 NI-CAD "AA Batt" or "AAA Batt"
10.00 each

COMMODORE 64 CARTRIDGES
• Num. Nabber • Star Post
• Financial Advis. • Frog Master
• Super Smash • Avenger • Radar Rat
• Jupitree Landing • Magic Compos
• Dragons Den • Simon Basic
• Viduzzies • Star Ranger
• Golf • Blue Print • ABC Voice
• Sales Demo
\$1.50 ea. (10 pc. min.)

POWER SUPPLY FOR THE COMMODORE AMIGA
+5VDC @ 8 Amps
+12VDC @ 1 Amp
-5VDC @ 1/4 Amp
\$39 ea.

MINI FLOPPY DISK DRIVE
by Shugart #SA465-3AA
1/2 height
Quad Density
5 1/4 Inch
\$65 Ea.

PATCH CORDS
5 ft. dual RCA
color coded, stereo cords
99c Each

OPEN FRAME MONITORS
12" monitor 40-80
column display
composite Green
screen 18 Mhz. Bandwidth
\$20 Ea.

Plug in WALL TRANSFORMER
Quantity Pricing Available
• 9.5 VDC @ 1 Amp \$3.00
• 19 VAC @ 300 MA \$1.50
• 25.4 VAC @ 1 Amp \$1.95
• 14 VDC @ 200 MA \$1.00

REGULATED LINEAR POWER SUPPLY
Computer Grade
+5VDC @ 8 Amps
+12VDC @ 8 Amps
-5VDC @ 0.5 Amps
Bench Style/Great for Hobbies
\$24 ea.

PASSIVE INFRARED MOTION DETECTOR
It can pick up any moving human body heat or moving vehicle with sensing range (40 x 60 ft.) and turn on the light.
\$60 Each

GET
19 Freeman St.,
Newark, N.J. 07105
TOLL FREE
800/645-9060
201/344-8183
GIANT ELECTRONICS, INC. Fax # 201/344-3282

Parts Express INTERNATIONAL INC. **HARDWARE AND ELECTRONICS**

PIONEER 12" POLY WOOFER Clear polypropylene cone 65 watts RMS, 11 oz. magnet. Ferro fluid cooled 1 1/2" voice coil. Trim ring included 25-2500 Hz #290-100 \$15 ⁹⁵ (1-3) \$13 ⁹⁵ (4-UP)	PIONEER 8" POLY WOOFER Clear ribbed polypropylene cone. 60 watts RMS, 30 watts max power 20 oz magnet 35-2500 Hz. 4-8 ohm compatible. #290-055 \$20 ⁵⁰ (1-3) \$18 ⁹⁵ (4-UP)	PIONEER 15" WOOFER 20 oz magnet 60 watts RMS, 90 watts max 8 ohm impedance. 1 1/2" voice coil 25-2000 Hz #290-160 \$30 ⁹⁵ (1-3) \$28 ⁴⁰ (4-UP)
MOTOROLA PIEZO TWEETER Mfg #KSN1005A. 3 1/2" x 3 1/2". No crossover required. 50 watts maximum input power. #270-010 \$4 ⁹⁵ (1-79) \$3 ⁹⁵ (80-UP)	PIONEER HORN TWEETER 3" wide dispersion horn tweeter. 1800-15,000 Hz response. 35 watts RMS, 50 watts max. 8 ohm impedance. #270-050 \$6 ⁵⁰ (1-9) \$5 ⁹⁰ (10-UP)	PIONEER 5 1/4" CUP MIDRANGE Tuned cup. Paper cone, 1" voice coil. 9.3 oz magnet. 50 watts RMS, 70 watts max. Response: 320-6000 Hz. 8 ohm impedance. #280-020 \$11 ⁵⁰ (1-9) \$9 ⁹⁵ (10-UP)
CROSSOVERS		
2-Way, 30 watt #260-190 \$3 ⁹⁵	3-Way, 60 watt #260-200 \$7 ⁵⁰	3-Way, 100 watt #260-210 \$12 ⁵⁰
FREE CATALOG		
Call or write today for your free catalog containing speakers, semi-conductors, CATV products, tools, hardware, TV-VCR parts, and more.		
CALL TOLL FREE 1-800-255-3525 In Ohio: 1-800-322-3525 Local: (513) 222-0173		
<ul style="list-style-type: none"> • 15 day money back guarantee. • \$10.00 minimum order. • COD orders accepted. • 24 hour shipping. • Shipping charge = UPS chart rate (\$2.50 minimum charge). Hours: 8:30 a.m. - 6 p.m. EST M-F. 		
PARTS EXPRESS INTL. INC. 340 East First St. Dayton, Ohio 45402		
 		

RADIO-ELECTRONICS

CIRCLE 191 ON FREE INFORMATION CARD

CIRCLE 56 ON FREE INFORMATION CARD

PERSONAL computer owners can earn \$1000 to \$5000 monthly selling simple services part time. Free list of 100 services. **A.I.M.J.K.**, Box 60369, San Diego, CA 92106-8369.

PROJECTION TV...Make \$\$\$s assembling projects...easy...results comparable to \$2,500 projectors...Total cost less than \$30.00...Plans, 8" lenses and dealers information \$20.50...Illustrated information free...**MACROCOM-GDX**, Washington Crossing, PA 18977. Credit card orders 24hrs. (215) 736-2880.

CRT equipment rebuilds Sony/color tubes/other. **CRT SYSTEMS**, 633 North Semoran, Orlando, FL 32807. Call (305) 275-9543.

MICRO-Electronics engineer to design and manufacture receiver. **JPH**, 4218 Bunker Hill, Bettendorf, IA 52722. (319) 355-2927.

WANTED

INVENTORS! AIM wants—ideas, inventions, new products, improvements on existing products. We present ideas to manufacturers. Confidentiality guaranteed. Call toll free 1-(800) 225-5800 for information kit.

INVENTIONS, ideas, new products wanted! Industry presentation/national exposition. Call free 1-(800) 288-IDEA. Canada, 1-(800) 528-6060. X831.

WANTED excess inventories of I.C.s. disk drives, circuit boards, computers, etc. **WESTERN TECH.**, (818) 882-1355 (CA).

INVENTORS

INVENTORS! Can you patent and profit from your idea? Call **AMERICAN INVENTORS CORPORATION** for free information. Over a decade of service. 1-(800) 338-5656. In Massachusetts or Canada call (413) 568-3753.

BIG PROFITS **ELECTRONIC ASSEMBLY BUSINESS**

Start home, spare time. Investment knowledge or experience unnecessary. **BIG DEMAND** assembling electronic devices. Sales handled by professionals. Unusual business opportunity

FREE: Complete illustrated literature
BARTA, RE-O Box 248
Walnut Creek, Calif. 94597

DESCRAMBLER MODULE

COMPLETE cable-TV decoder in a mini-module. Latest technology upgrade for Jerrold SB-3 or Radio-Electronics Feb. 1984 project. Versatile, sophisticated, and low cost. For literature, **SOUTHTECH DISTRIBUTING**, (813) 222-3293.

NOTCH FILTERS

THE Positrap Cookbook: build 50-60dB notch filters for pennies. Construction, alignment, fixed, tunable, trimable. Comprehensive **cable TV scrambling and descrambling** theory and practice. Identifying various systems. \$9.95. **CLEARVIEW CABLE COMPANY**, P.O. Box 207, Sterling Heights, MI 48311.

EDUCATION & INSTRUCTION

F.C.C. Commercial General Radiotelephone license. Electronics home study. Fast, inexpensive! "Free" details. **COMMAND**, D-176, Box 2223, San Francisco, CA 94126.

SUPERFAST Morse Code supereasy. Subliminal cassette. \$10. Learn Morse Code in 1 hour. Amazing new supereasy technique. \$10. Both \$17 Moneyback guarantee. Free catalog: **SASE. BARR**, 2549-E7 Temple, Palmbay, FL 32905.

LEARN TV/VCR REPAIR

Now you can train at home in spare time for a money-making career as a TV/VCR Repair Specialist. No previous experience necessary. No need to quit your job or school. Everything is explained in easy-to-understand language with plenty of drawings, diagrams and photos. We show you how to troubleshoot and repair video-cassette recorders and TV sets, how to handle house calls and shop repairs for almost any make of television or VCR. Tools are included with your course so you can get "hands-on" practice as you follow your lessons step by step. Send for free facts about the exciting opportunities in TV/VCR Repair and find out how you can start making money in this great career. **MAIL COUPON TODAY!**

ICS SCHOOL OF TV/VCR REPAIR, Dept. DEOB7
SINCE 1981 Scranton, Pennsylvania 18515

Please send me full information and color brochure on how I can learn TV/VCR Repair at home in my spare time. I understand there is no obligation and no salesman will visit me.

Name _____ Age _____

Address _____

City/State/Zip _____

Phone () _____

FCC Commercial General Radiotelephone license correspondence course. 60 individual lessons for \$89.50. Payment plan. Results guaranteed! Details free. **AMERICAN TECHNICAL INSTITUTE**, Box 201, Cedar Mountain, NC 28718.

RECORD changer repairing is very profitable. Be an expert. Learn at home. Info—**R.C.T.G.**, P.O. Box 1503, Leesburg, FL 32748.

CHANGING careers? Complete handbook shows you how. \$5.00. Easy steps. **MBL**, P.O. Box 12002, Akron, OH 44312.

BUY BONDS

MICRO MART

508 Central Ave.
Westfield, N.J. 07090
(201) 654-6006

TTL SERIES	74367	80	74LS164	45	4012	25	
7400	25	74390	85	74LS185	90	4013	25
7401	25	74393	100	74LS173	45	4015	30
7402	25	74324	80	74LS174	30	4016	25
7403	25	75452	55	74LS191	45	4019	30
7404	25	74354	55	74LS194	60	4023	20
7406	30	74372	60	74LS192	60	4022	60
7407	30	74374	55	74LS193	60	4024	-5
7408	30	74376	55	74LS201	55	4025	25
7409	30	74378	75	74LS240	65	4035	60
7410	30	74380	75	74LS241	60	4040	60
7411	25	74LS500	20	74LS242	60	4041	70
7412	25	74LS501	20	74LS243	65	4042	50
7413	25	74LS502	20	74LS244	70	4046	60
7414	25	74LS503	20	74LS245	70	4047	65
7415	25	74LS504	20	74LS251	40	4049	25
7416	25	74LS505	20	74LS252	40	4050	25
7417	25	74LS506	20	74LS253	40	4051	25
7418	25	74LS507	20	74LS254	40	4052	60
7419	25	74LS508	20	74LS255	40	4053	60
7420	25	74LS509	20	74LS256	40	4054	60
7421	25	74LS510	20	74LS257	40	4055	60
7422	25	74LS511	20	74LS258	40	4056	60
7423	25	74LS512	20	74LS259	40	4057	20
7424	25	74LS513	20	74LS260	40	4058	20
7425	25	74LS514	20	74LS261	40	4059	20
7426	25	74LS515	20	74LS262	40	4060	20
7427	25	74LS516	20	74LS263	40	4061	20
7428	25	74LS517	20	74LS264	40	4062	20
7429	25	74LS518	20	74LS265	40	4063	20
7430	25	74LS519	20	74LS266	40	4064	20
7431	25	74LS520	20	74LS267	40	4065	20
7432	25	74LS521	20	74LS268	40	4066	20
7433	25	74LS522	20	74LS269	40	4067	20
7434	25	74LS523	20	74LS270	40	4068	20
7435	25	74LS524	20	74LS271	40	4069	20
7436	25	74LS525	20	74LS272	40	4070	20
7437	25	74LS526	20	74LS273	40	4071	20
7438	25	74LS527	20	74LS274	40	4072	20
7439	25	74LS528	20	74LS275	40	4073	20
7440	25	74LS529	20	74LS276	40	4074	20
7441	25	74LS530	20	74LS277	40	4075	20
7442	25	74LS531	20	74LS278	40	4076	20
7443	25	74LS532	20	74LS279	40	4077	20
7444	25	74LS533	20	74LS280	40	4078	20
7445	25	74LS534	20	74LS281	40	4079	20
7446	25	74LS535	20	74LS282	40	4080	20
7447	25	74LS536	20	74LS283	40	4081	20
7448	25	74LS537	20	74LS284	40	4082	20
7449	25	74LS538	20	74LS285	40	4083	20
7450	25	74LS539	20	74LS286	40	4084	20
7451	25	74LS540	20	74LS287	40	4085	20
7452	25	74LS541	20	74LS288	40	4086	20
7453	25	74LS542	20	74LS289	40	4087	20
7454	25	74LS543	20	74LS290	40	4088	20
7455	25	74LS544	20	74LS291	40	4089	20
7456	25	74LS545	20	74LS292	40	4090	20
7457	25	74LS546	20	74LS293	40	4091	20
7458	25	74LS547	20	74LS294	40	4092	20
7459	25	74LS548	20	74LS295	40	4093	20
7460	25	74LS549	20	74LS296	40	4094	20
7461	25	74LS550	20	74LS297	40	4095	20
7462	25	74LS551	20	74LS298	40	4096	20
7463	25	74LS552	20	74LS299	40	4097	20
7464	25	74LS553	20	74LS300	40	4098	20
7465	25	74LS554	20	74LS301	40	4099	20
7466	25	74LS555	20	74LS302	40	4100	20
7467	25	74LS556	20	74LS303	40	4101	20
7468	25	74LS557	20	74LS304	40	4102	20
7469	25	74LS558	20	74LS305	40	4103	20
7470	25	74LS559	20	74LS306	40	4104	20
7471	25	74LS560	20	74LS307	40	4105	20
7472	25	74LS561	20	74LS308	40	4106	20
7473	25	74LS562	20	74LS309	40	4107	20
7474	25	74LS563	20	74LS310	40	4108	20
7475	25	74LS564	20	74LS311	40	4109	20
7476	25	74LS565	20	74LS312	40	4110	20
7477	25	74LS566	20	74LS313	40	4111	20
7478	25	74LS567	20	74LS314	40	4112	20
7479	25	74LS568	20	74LS315	40	4113	20
7480	25	74LS569	20	74LS316	40	4114	20
7481	25	74LS570	20	74LS317	40	4115	20
7482	25	74LS571	20	74LS318	40	4116	20
7483	25	74LS572	20	74LS319	40	4117	20
7484	25	74LS573	20	74LS320	40	4118	20
7485	25	74LS574	20	74LS321	40	4119	20
7486	25	74LS575	20	74LS322	40	4120	20
7487	25	74LS576	20	74LS323	40	4121	20
7488	25	74LS577	20	74LS324	40	4122	20
7489	25	74LS578	20	74LS325	40	4123	20
7490	25	74LS579	20	74LS326	40	4124	20
7491	25	74LS580	20	74LS327	40	4125	20
7492	25	74LS581	20	74LS328	40	4126	20
7493	25	74LS582	20	74LS329	40	4127	20
7494	25	74LS583	20	74LS330	40	4128	20
7495	25	74LS584	20	74LS331	40	4129	20
7496	25	74LS585	20	74LS332	40	4130	20
7497	25	74LS586	20	74LS333	40	4131	20
7498	25	74LS587	20	74LS334	40	4132	20
7499	25	74LS588	20	74LS335	40	4133	20
7500	25	74LS589	20	74LS336	40	4134	20
7501	25	74LS590	20	74LS337	40	4135	20
7502	25	74LS591	20	74LS338	40	4136	20
7503	25	74LS592	20	74LS339	40	4137	20
7504	25	74LS593	20	74LS340	40	4138	20
7505	25	74LS594	20	74LS341	40	4139	20
7506	25	74LS595	20	74LS342	40	4140	20
7507	25	74LS596	20	74LS343	40	4141	20
7508	25	74LS597	20	74LS344	40	4142	20
7509	25	74LS598	20	74LS345	40	4143	20
7510	25	74LS599	20	74LS346	40	4144	20
7511	25	74LS600	20	74LS347	40	4145	20
7512	25	74LS601	20	74LS348	40	4146	20
7513	25	74LS602	20	74LS349	40	4147	20
7514	25	74LS603	20	74LS350	40	4148	20
7515	25	74LS604	20	74LS351	40	4149	20
7516	25	74LS605	20	74LS352	40	4150	20
7517	25	74LS606	20	74LS353	40	4151	20
7518	25	74LS607	20	74LS354	40	4152	20
7519	25	74LS608	20	74LS355	40		

SCIENTIFIC ATLANTA & SB-3

SCIENTIFIC Atlanta models 8500—8550, remote included...\$250.00. SB-3's...\$74.00. TRI-BI's...\$95.00. SBSA-3's...\$99.00. Zenith (Z-Tac) Descramblers...\$169.00. N-12 (Vari-sync)...\$89.00. M-35 B (Vari-sync)...\$99.00. Jerrold-550 converters...\$95.00—\$99.00. Dealer discount on 5 units. Brochure available. Call...N.A.S. INTERNATIONAL. (213) 631-3552.

CABLE TV TURN-ON'S

"TURN-ON" boards & kits for Jerrold 400; Jerrold 450 (all models—no internal modification); Tocom 5504 & 5503. Special requests no problem. Let us know what make and model you are interested in. Fully guaranteed. Call or write for information and prices. VIDEO SOLUTIONS, 3938 E. Grant, Suite 236, Tucson, AZ 85712. (602) 323-6072.

VIDEO TAPE COPYGUARD

Eliminate the latest copyguard problems units from \$59⁹⁵ to \$169⁹⁵

Deluxe Electronics (714) 998-6866
1432 Heim Wy., Orange, Ca. 92665

THIS IS AN EXPANDED-TYPE AD WITH A TINT SCREEN. See how it jumps out on the page. To order your ad in this format calculate the cost at \$4.30 per word for the expanded-type and add 25% for the tint background.

You can help us raise the colorectal cancer cure rate.

When detected early the cure rate for colorectal cancer is very high. That's why we urge regular checkups for men and women 50 and over.

Warning signs are a change in bowel habits, blood in the stool.

Your doctor can perform the digital and procto exams, and you take care of the stool blood test at home.

Checkup Guidelines for men and women over 50 without symptoms:

- digital exam annually
- stool blood test annually
- procto exam every 3 to 5 years after 2 negative tests 1 year apart.

No one faces cancer alone.

AMERICAN CANCER SOCIETY

CALL FOR FREE CATALOG

TEXT TO SPEECH BOARD!

PC/XT COMPATIBLE. MAKE YOUR COMPUTER TALK!

A VERY POWERFUL AND AMAZING SPEECH CARD. USES THE NEW GENERAL INSTRUMENTS SPO256-AL2 SPEECH CHIP AND THE CTS256A-AL2 TEXT TO SPEECH CONVERTER.

THIS BOARD USES ONE SLOT ON THE MOTHERBOARD AND REQUIRES A COM SERIAL PORT. BOARD MAY ALSO BE USED IN A STAND ALONE ENVIRONMENT WITH ALMOST ANY COMPUTER THAT HAS A RS232 SERIAL PORT. FEATURES ON BOARD AUDIO AMP OR MAY BE USED WITH EXTERNAL AMPS.

DEMONSTRATION SOFTWARE AND A LIBRARY BUILDING PROGRAM ARE INCLUDED ON A 5 1/4 INCH PC/XT DISKETTE. FULL DOCUMENTATION AND SCHEMATICS ARE ALSO INCLUDED.



NEW!

PRICE CUT!

\$69⁹⁵
ASSEMBLED & TESTED

NEW! IC TESTER! \$149.00

SIMILAR TO BELOW EPROM PROGRAMMER. PLUGS IN TO YOUR PC OR XT. TESTS ALMOST ALL 14, 16, AND 20 PIN 74XX SERIES. INCLUDES STANDARD POWER, "S" AND "LS" DEVICES. ALSO TESTS CD4000 SERIES CMOS. SOFTWARE INCLUDED CAN EVEN DETERMINE PART NUMBERS OF MOST UNMARKED AND HOUSE NUMBERED DEVICES WITH SIMPLE MOD. THIS UNIT CAN ALSO TEST 6.4K AND 256K DRAMS! WITH MANUAL AND SOFTWARE: \$149. PERFECT FOR SCHOOLS.

PC/XT EPROM PROGRAMMER \$169



ASK ABOUT OUR NEW PAL PROGRAMMER!

* LATEST DESIGN * PROGRAMS UP TO 4 DEVICES AT ONE TIME * FEATURES EASY TO USE MENU DRIVEN SOFTWARE THAT RUNS UNDER PC OR MS-DOS. * USES AN INTELLIGENT PROGRAMMING ALGORITHM FOR SUPER FAST (8X) EPROM BURNING. * THIS PLUG-IN BOARD ATTACHES TO AN EXTERNAL MINI CHASSIS CONTAINING 4 TEXTOL Z.I.F. SOCKETS. * NO PERSONALITY MODULES REQUIRED * AUTOMATIC VPP SELECTION: 12.5V, 21V, OR 25V. * EPROM DATA CAN ALSO BE LOADED FROM OR SAVED TO A DISKETTE. * PROGRAMMING SOFTWARE SUPPORTS: 2716, 2732, 2732A, 2764, 2764A, 27128, 27128A, 27256, 27256A, 27512, AND 27512A. * ASSEMBLED AND TESTED, BURNED IN WITH MANUAL. \$169 WITH SOFTWARE.

JUST RECEIVED. SAME AS ABOVE PROGRAMMER. BUT PROGRAMS 8 UNITS AT ONE TIME - \$299.

Digital Research Computers

P.O. BOX 381450 • DUNCANVILLE, TX 75138 • (214) 225-2309

TERMS: Add \$3.00 postage. We pay balance. Orders under \$15 add 75¢ handling. No C.O.D. We accept Visa and MasterCard. Texas Res. add 6-1/4% Tax. Foreign orders (except Canada) add 20% P & H. Orders over \$50 add 85¢ for insurance.

Copies of articles from this publication are now available from the UMI Article Clearinghouse.

For more information about the Clearinghouse, please fill out and mail back the coupon below.

UMI Article Clearinghouse

Yes! I would like to know more about UMI Article Clearinghouse. I am interested in electronic ordering through the following system(s):

- DIALOG/Dialorder
- OnType
- ITT Dialcom
- OCLC ILL Subsystem

- Other (please specify) _____
- I am interested in sending my order by mail.

Please send me your current catalog and user instructions for the system(s) I checked above.

Name _____
 Title _____
 Institution/Company _____

 Department _____
 Address _____
 City _____ State _____ Zip _____
 Phone (____) _____

Mail to: University Microfilms International
300 North Zeeb Road, Box 91 Ann Arbor, MI 48106

Electronics Paperback Books

GREAT ELECTRONICS PAPERBACKS FROM ETT

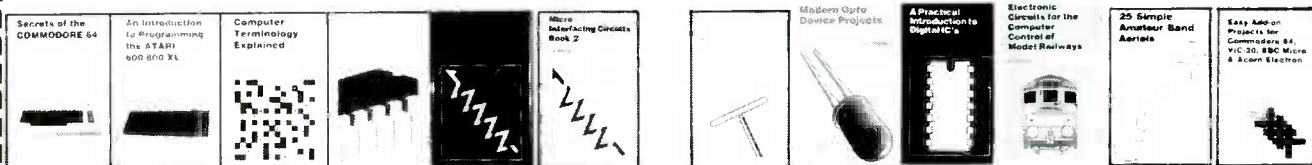

- BP125—25 SIMPLE AMATEUR BAND ANTENNAS.....\$5.00.** All are inexpensive to build, yet perform well. Diodes, beams, triangle and even a mini rhombic.
- BP128—20 PROGRAMS FOR THE ZX SPECTRUM AND 16K ZX82.....\$5.75.** Included with each program is a flow chart and a description of what happens. Notes for converting programs for use on other computers are also included.
- BP235—POWER SELECTOR GUIDE.....\$10.00.** Complete guide to semiconductor power devices. More than 1000 power handling devices are included. They are tabulated in alpha-numeric sequence, by technical specs. Includes power diodes, Thyristors, Triacs, Power Transistors and FET's.
- BP234—TRANSISTOR SELECTOR GUIDE.....\$10.00.** Companion volume to BP235. Book covers more than 1400 JEDEC, JIS, and brand-specific devices. Also contains listing by case type, and electronic parameters. Includes Darlingtons transistors, high-voltage devices, high-current devices, high power devices.
- BP99—MINI-MATRIX BOARD PROJECTS.....\$5.00.** Here are 20 useful circuits that can be built on a mini-matrix board that is just 24 holes by ten copper-foil strips.
- BP157—HOW TO WRITE ZX SPECTRUM AND SPECTRUM+ GAMES PROGRAMS.....\$5.95.** A crystal-clear step-by-step guide to writing your own graphics games programs.
- BP117—PRACTICAL ELECTRONIC BUILDING BLOCKS—Book 1.....\$5.75.** Oscillators, Timers, Noise Generators, Rectifiers, Comparators, Triggers and more.
- BP184—INTRO TO 68000 ASSEMBLY LANGUAGE.....\$6.50.** The 68000 is a great new breed of microprocessor. Programming in assembly language increases the running speed of your programs. Here's what you need to know.
- BP179—ELECTRONIC CIRCUITS FOR THE COMPUTER CONTROL OF ROBOTS.....\$5.00.** Data and circuits for interfacing the computer to the robot's motors and sensors.
- BP126—BASIC & PASCAL IN PARALLEL.....\$4.95.** Takes these two programming languages and develops programs in both languages simultaneously.
- 224—50 CMOS IC PROJECTS.....\$5.25.** Includes sections on multivibrators, amplifiers and oscillators, trigger devices, and special devices.
- 225—A PRACTICAL INTRODUCTION TO DIGITAL IC'S.....\$4.95.** Mainly concerned with TTL devices. Includes several simple projects plus a logic circuit test set and a digital counter timer.
- BP170—INTRODUCTION TO COMPUTER PERIPHERALS.....\$5.95.** Shows how to use a variety of co computer add-ons in as non-technical a way as possible.
- 227—BEGINNERS GUIDE TO BUILDING ELECTRONIC PROJECTS.....\$5.00.** How to tackle the practical side of electronics so you can successfully build electronic projects.
- BP169—HOW TO GET YOUR COMPUTER PROGRAMS RUNNING.....\$5.95.** Shows how to identify error in program and what to do about them.
- BP194—MODERN OPTO DEVICE PROJECTS.....\$6.25.** Crammed with great projects for the experimenter. Includes sections on Fiber optics, passive Infra-Red detectors, plus an assortment of miscellaneous projects.
- BP180—ELECTRONIC CIRCUITS FOR THE COMPUTER CONTROL OF MODEL RAILROADS.....\$6.25.** It's easy to interface home computers to model railroad control. The main problem is in interlacing the computer to the system.
- BP110—HOW TO GET YOUR ELECTRONIC PROJECTS WORKING.....\$5.00.** How to find and solve the common problems that can occur when building projects.
- BP33—ELECTRONIC CALCULATOR USERS HANDBOOK.....\$5.75.** Invaluable book for all calculator owners. Tells how to get the most out of your calculator.
- BP36—50 CIRCUITS USING GERMANIUM, SILICON & ZENER DIODES.....\$5.00.** A collection of useful circuits you'll want in your library.
- BP37—50 PROJECTS USING RELAYS, SCR'S & TRIACS.....\$5.00.** Build priority indicators, light modulators, warning devices, light dimmers and more.
- BP39—50 FET TRANSISTOR PROJECTS.....\$5.50.** RF amplifiers, test equipment, tuners, receivers, tone controls, etc.
- BP42—SIMPLE LED CIRCUITS.....\$5.00.** A large selection of simple applications for this simple electronic component.
- BP127—HOW TO DESIGN ELECTRONIC PROJECTS.....\$5.75.** Helps the reader to put projects together from standard circuit blocks with a minimum of trial and error.
- BP122—AUDIO AMPLIFIER CONSTRUCTION.....\$5.75.** Construction details for preamps and power amplifiers up through a 100-watt DC-coupled FED amplifier.
- BP92—CRYSTAL SET CONSTRUCTION.....\$5.00.** Everything you need to know about building crystal radio receivers.
- BP45—PROJECTS IN OPTOELECTRONICS.....\$5.00.** Includes infra-red detectors, transmitters, modulated light transmission and photographic applications.
- BP48—ELECTRONIC PROJECTS FOR BEGINNERS.....\$5.00.** A wide range of easily completed projects for the beginner. Includes some no-soldering projects.
- BP49—POPULAR ELECTRONIC PROJECTS.....\$5.50.** Radio, audio, household and test equipment projects are all included.
- BP51—ELECTRONIC MUSIC AND CREATIVE TAPE RECORDING.....\$5.50.** Shows how you can make electronic music at home with the simplest and most inexpensive equipment.
- BP56—ELECTRONIC SECURITY DEVICES.....\$5.00.** Includes both simple and more sophisticated burglar alarm circuits using light, infra-red, and ultrasonics.
- BP59—SECOND BOOK OF CMOS IC PROJECTS.....\$5.00.** More circuits showing CMOS applications. Most are of a fairly simple design.
- BP72—A MICROPROCESSOR PRIMER.....\$5.00.** We start by designing a small computer and show how we can overcome its shortcomings.
- BP74—ELECTRONIC MUSIC PROJECTS.....\$5.95.** Provides the experimenter with a variety of practical circuits including a Fuzz Box, Sustain Unit, Reverberation Unit, Tremolo Generator and more.
- BP91—AN INTRODUCTION TO RADIO DXING.....\$5.00.** How you can tune in on those amateur and commercial broadcasts from around the world in the comfort of your home.
- BP94—ELECTRONIC PROJECTS FOR CARS AND BOATS.....\$5.00.** Fifteen simple projects that you can use with your car or boat. All are designed to operate from 12-volt DC supplies.

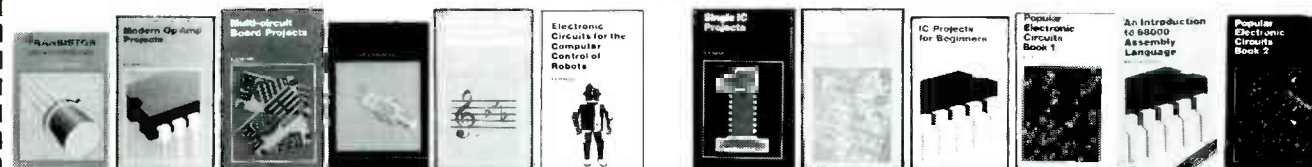

ELECTRONIC TECHNOLOGY TODAY INC.
P.O. Box 240, Massapequa Park, NY 11762-0240

SHIPPING CHARGES IN USA & CANADA

\$0.01 to \$5.00	\$1.00
\$5.01 to \$10.00	\$1.75
\$10.01 to 20.00	\$2.75
\$20.01 to 30.00	\$3.75
\$30.01 to 40.00	\$4.75
\$40.01 to 50.00	\$5.75
\$50.01 and above	\$7.00

SORRY No orders accepted outside of USA & Canada

Number of books ordered

Name _____
Address _____
City _____ State _____ Zip _____

Total price of merchandise \$ _____
Sales Tax (New York State Residents only) \$ _____
Shipping (see chart) \$ _____

All payments must be in U.S. funds Total Enclosed .. \$ _____

H1287

NEC V20 & V30 CHIPS

Replace the 8086 or 8088 in Your IBM-PC and Increase its Speed by up to 40%! Price

UPD70108-5 (5MHz) V20 Chip . . . \$ 8.75
UPD70108-8 (8MHz) V20 Chip . . . \$10.75
UPD70108-10 (10MHz) V20 Chip . . . \$29.95
UPD70116-8 (8MHz) V30 Chip . . . \$13.75
UPD70116-10 (10MHz) V30 Chip . . . \$29.95

7400

Part No.	1-9	10+	Part No.	1-9	10+
7400	29	19	7485	.65	55
7402	29	19	7486	.45	35
7404	29	19	7489	2.05	195
7405	35	25	7490	.49	39
7406	39	29	7493	.45	35
7407	39	29	74121	.45	35
7408	35	25	74123	.55	45
7410	29	19	74125	.55	45
7414	49	39	74126	.69	59
7415	29	19	74174	3.35	365
7417	39	29	74150	1.35	125
7420	35	25	74154	1.35	125
7430	35	25	74158	1.59	149
7432	39	29	74173	.85	75
7438	39	29	74174	.59	49
7442	55	45	74175	.59	49
7445	79	69	74176	.99	89
7446	89	79	74181	1.95	185
7447	89	79	74189	1.95	185
7448	2.05	1.95	74193	.79	69
7472	.89	.79	74198	1.85	175
7473	.39	.29	74221	.99	89
7474	.39	.29	74273	1.95	185
7475	.49	.39	74365	.65	55
7476	.45	.35	74367	.65	55

74LS

Part No.	29	19	Part No.	75	65
74LS00	29	19	74LS165	.75	.65
74LS02	29	19	74LS166	.99	.89
74LS04	35	25	74LS173	.59	.49
74LS05	35	25	74LS240	.69	.59
74LS06	1.09	.99	74LS175	.49	.39
74LS07	1.09	.99	74LS189	4.59	4.49
74LS08	29	19	74LS191	.59	.49
74LS10	29	19	74LS193	.79	.69
74LS14	49	39	74LS221	.69	.59
74LS27	35	25	74LS240	.69	.59
74LS30	29	19	74LS243	.69	.59
74LS32	35	25	74LS244	.69	.59
74LS42	.49	.39	74LS245	.89	.79
74LS47	.99	.89	74LS259	.99	.89
74LS73	39	29	74LS273	.89	.79
74LS74	35	25	74LS279	.49	.39
74LS75	39	29	74LS322	4.05	3.95
74LS76	55	45	74LS365	.49	.39
74LS85	.59	.49	74LS366	.49	.39
74LS86	.35	.25	74LS367	.49	.39
74LS90	.49	.39	74LS368	.49	.39
74LS93	.49	.39	74LS373	.79	.69
74LS123	.59	.49	74LS374	.79	.69
74LS125	.49	.39	74LS393	.89	.79
74LS138	.49	.39	74LS590	6.05	5.95
74LS139	.49	.39	74LS624	2.05	1.95
74LS154	1.09	.99	74LS625	2.95	2.85
74LS157	.45	.35	74LS640	1.09	.99
74LS158	.45	.35	74LS645	1.09	.99
74LS163	.59	.49	74LS670	1.09	.99
74LS164	.59	.49	74LS688	2.39	2.29

74S/PROMS*

Part No.	29	19	Part No.	1.49
74S00	29	19	74S188	1.49
74S04	35	25	74S189	2.69
74S08	35	25	74S196	2.49
74S10	29	19	74S240	1.49
74S32	35	25	74S244	1.49
74S74	.45	.35	74S253	.79
74S85	.35	.25	74S287	1.49
74S86	.35	.25	74S288	1.49
74S024	2.75	2.49	74S374	1.49
74S174	.79	.74	74S374	1.49
74S175	.79	.74	74S472	2.95

74F

Part No.	29	19	Part No.	69
74F00	29	19	74F139	69
74F04	29	19	74F157	69
74F08	29	19	74F193	2.95
74F10	29	19	74F240	99
74F32	39	29	74F244	69
74F74	39	29	74F253	69
74F86	39	29	74F373	99
74F138	.69	.59	74F374	99

CD-CMOS

Part No.	19	CD	Part No.	59
CD4001	19	CD4076	59	
CD4008	69	CD4081	25	
CD4011	19	CD4082	25	
CD4013	29	CD4083	35	
CD4016	29	CD4094	89	
CD4017	49	CD40103	2.49	
CD4018	59	CD40107	49	
CD4020	59	CD40109	.69	
CD4024	49	CD4510	79	
CD4027	49	CD4511	69	
CD4030	29	CD4520	.75	
CD4040	65	CD4522	.79	
CD4049	29	CD4538	.79	
CD4050	29	CD4541	.79	
CD4051	59	CD4543	.79	
CD4052	59	CD4553	4.95	
CD4053	59	CD4555	.79	
CD4063	1.49	CD4559	7.95	
CD4066	2.49	CD4566	2.49	
CD4067	1.29	CD4583	.89	
CD4069	25	CD4584	.39	
CD4070	25	CD4585	.89	
CD4071	.25	MC1441 P.	8.95	
CD4072	.25	MC14490P	4.49	

MICROPROCESSOR COMPONENTS

MISCELLANEOUS CHIPS

Part No.	Price
D765AC	4.95
WD9216	6.95
95H90	9.95

Z80, Z80A, Z80B SERIES

Part No.	Price
Z80	1.25
Z80-CTC	1.79
Z80 DART	4.95
Z80-PI0	1.79
Z80A	1.69
Z80A-CTC	1.79
Z80A-DART	4.95
Z80A-PI0	1.69
Z80A SIO/0	5.75
Z80B	3.49
Z80B-CTC	3.95
Z80B-PI0	4.29

6500/6800/68000 SER.

Part No.	Price
6502	2.65
6502 (CMOS)	1.95
6520	1.95
6522	3.95
6532	6.49
6551	4.49
65C802 (CMOS)	19.95
6800	1.95
6802	3.95
6810	1.25
6821	1.75
6840	3.95

6500/6800/68000 Cont.

Part No.	Price
6845	3.95
6850	1.95
6852	1.49
MC68000L8	11.95
MC68000L10	13.95
MC68010L10	49.95
MC68020RC12B	169.95
MC68881RC12A	149.95

8000 SERIES

Part No.	Price
8031	3.95
80C31	9.95
8035	1.95
8073	2.95
8080A	9.95
8085A	2.49
8086	6.95
8086-2	6.95
8087 (5MHz)	129.95
8087-1 (10MHz)	229.95
8087-2 (8MHz)	169.95
8088	8.49
8088-2	8.49
8116	4.95
8155	2.49
8155-2	3.49
8156	3.95
8202	5.95
8203	9.95
8212	1.49
8224	2.25

8000 SERIES Cont.

Part No.	Price
8228	2.95
8237-5	4.95
8243	2.25
8250A	6.49
8250B (For IBM)	6.95
8251-A	1.89
8253-5	1.95
8254	4.95
8255A-5	1.89
8257-5	1.95
8259-5	2.25
8272	4.95
8279-5	2.95
8741	9.95
8742	29.95
8748 (25V)	7.95
8748H (HMOS) (21V)	9.95
8749	9.95
8751	39.95
8755	14.95

DATA ACQUISITION

Part No.	Price
ADC0804LCN	3.19
ADC0808CCN	3.95
ADC0809CCN	5.95
ADC0816CCN	11.95
ADC1205CCJ-1	19.95
DAC0808LCN	1.95
DAC1008LCN	4.95
AY-3-1015D	4.95
AY-5-1013A	2.95

MICROPROCESSOR SALE!

Part No.	Price
8052AHBASIC CPU w/BASIC Interpreter	\$ 29.95
MC68008L8 32-Bit MPU (8-Bit Data Bus)	\$ 19.95
MC68701 8-Bit EPROM Microcomputer	\$ 14.95
MC68705P3S 8-Bit EPROM Microcomputer	\$ 14.95
MC68705U3L 8-Bit EPROM Microcomputer	\$ 10.95
80286-10 16-Bit Hi Performance MPU	\$ 99.95
80287-8 Math Co-processor (8MHz)	\$ 299.95
80287-10 Math Co-processor (10MHz)	\$ 329.95
80387-16 Math Co-processor (16MHz) ^{GRID ARRAY}	\$ 494.95

DYNAMIC RAMS

Part No.	Price	
4116-15	16,384 x 1 (150ns)	.89
4128-20	131,072 x 1 (200ns) (Piggyback)	3.25
4164-120	65,536 x 1 (120ns)	1.75
4164-150	65,536 x 1 (150ns)	1.25
4164-200	65,536 x 1 (200ns)	.99
TMS4416-12	16,384 x 4 (120ns)	3.49
8118	16,384 x 4 (120ns)	.49
41256-100	262,144 x 1 (100ns)	4.95
41256-120	262,144 x 1 (120ns)	3.95
41256-150	262,144 x 1 (150ns)	3.25
50464-15	65,536 x 4 (150ns) (4464)	4.95
511000P-10	1,048,576 x 1 (100ns) 1 Meg.	34.95
514256P-10	262,144 x 4 (100ns) 1 Meg.	29.95

STATIC RAMS

Part No.	Price	
2016-12	2048 x 8 (120ns)	1.69
2018-45	2048 x 8 (45ns)	6.95
2102-2L	1024 x 4 (250ns) Low Power	1.95
2114N	1024 x 4 (45ns)	.89
2114AN-2L	1024 x 4 (200ns) Low Power	1.49
21C14	1024 x 4 (200ns) (CMOS)	.49
2149	1024 x 4 (45ns)	2.49
5101	256 x 4 (45ns) CMOS	1.95
6116P-3	2048 x 8 (150ns) CMOS	1.89
6116LP-3	2048 x 8 (150ns) LP CMOS	1.95
6264P-12	8192 x 8 (120ns) CMOS	4.25
6264P-15	8192 x 8 (150ns) CMOS	3.49
6264LP-15	8192 x 8 (150ns) LP CMOS	3.75
6514	1024 x 4 (350ns) CMOS	3.49
43256-15L	32,768 x 8 (150ns) Low Power	11.95

EPROMS

Part No.	Price	
TMS2516	2048 x 8 (450ns) 25V	6.95
TMS2532	4096 x 8 (450ns) 25V	6.95
TMS2532A	4096 x 8 (450ns) 21V	5.95
TMS2564	8192 x 8 (450ns) 25V	9.95
TMS2716	2048 x 8 (450ns) 3 Voltage	6.95
1702A	256 x 8 (1µs)	6.95
2708	1024 x 8 (450ns)	4.95
2716	2048 x 8 (450ns) 25V	3.75
2716-1	2048 x 8 (350ns) 25V	4.25
27C16	2048 x 8 (450ns) 25V (CMOS)	5.49
27C16	2048 x 8 (450ns) 25V	4.95
2732A-20	4096 x 8 (200ns) 21V	4.25
2732A-25	4096 x 8 (250ns) 21V	3.95
27C32	4096 x 8 (450ns) 25V (CMOS)	5.95
2764-20	8192 x 8 (200ns) 21V	4.25
2764-25	8192 x 8 (250ns) 21V	3.75
2764A-25	8192 x 8 (250ns) 21V (CMOS)	3.95
2764-45	8192 x 8 (450ns) 21V	2.95
27C64-15	8192 x 8 (150ns) 21V (CMOS)	6.49
27128-20	16,384 x 8 (200ns) 21V	6.95
27128-25	16,384 x 8 (250ns) 21V	5.95
27128A-25	16,384 x 8 (250ns) 12.5V	5.25
27C128-25	16,384 x 8 (250ns) 21V (CMOS)	6.95
27256-20	32,768 x 8 (200ns) 12.5V	6.95
27256-25	32,768 x 8 (250ns) 12.5V	5.95
27C256-25	32,768 x 8 (250ns) 12.5V (CMOS)	7.95
27512-20	65,536 x 8 (200ns) 12.5V	13.49
27512-25	65,536 x 8 (250ns) 12.5V	11.95
68764	8192 x 8 (450ns) 25V	13.95

Part No.	Price	
2816A	2048 x 8 (350ns) 5V Read/Write	5.95
2817A	2048 x 8 (350ns) 5V Read/Write	7.95
2865A	8192 x 8 (250ns) 5V Read/Write	9.95
52B13 (21V)	2048 x 8 (350ns) 5V Read Only	14.95

<

Worldwide • Since 1974

• QUALITY COMPONENTS • COMPETITIVE PRICING • PROMPT DELIVERY

Mail Order Electronics • Worldwide
Jameco
ELECTRONICS

Jameco
ELECTRONICS

General Purpose NEW! Prototype PC Boards

- Wire Wrap
- Component Testing
- Point-to-Point Wiring
- 31/62 Connection



JE417 (Pictured)

- JE411 (6 1/2", No Pads, Gen. Purp.) . . . \$12.95
- JE415 (6 1/2", No Pads, PC/XT) . . . \$14.95
- JE417 (6 1/2", Plated w/Pads, PC/XT) . . . \$19.95

Extender Boards Designed for Troubleshooting and Testing



JE419 (Pictured)

- JE419 (5 1/4" Extender, 22/44 Connector) . . \$19.95
- JE421 (4 3/4" Extender, 31/62 Connector) . . \$19.95

Accessories for Commodore VIC-20, C-64 & C-128



JE232CM (Pictured)

- *CM1 (300B Modem VIC-20, C-64) . . \$19.95
- *JE232CM (RS232 Inter. VIC-20, C-64) . \$39.95
- CPS10 (C-64 Power Supply) . . . \$39.95
- CPS128 (C-128 Power Supply) . . . \$39.95

*Also compatible with C-128 in 64 mode only

ZUCKERBOARD

TANDY 1000 Expansion Memory Half Card

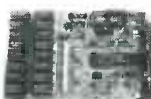

Expand the memory of your Tandy 1000 (128K Version) to as much as 640K. Also includes DMA controller chip.

- TE512 Includes 512K RAM . . . \$119.95
- TANC Plug-in Clock option chip (only) . . . \$39.95

20Meg Hard Disk

- T20MB 20MB Hard Disk Drive Board for Tandy 1000. . . \$494.95
- SX20MB 20MB Hard Disk Drive Board for Tandy 1000SX. . . \$499.95

TANDY 1000 Multifunction Board with Clock Calendar



Expand the memory on your Tandy 1000 (128K Version) to as much as 640K. Complete with an RS232 port, clock/calendar, RAM Disk, Printer Spooler and on-board DMA controller chip.

- MT512 Includes 512K RAM. . . \$199.95

DATA TRONICS

2400/1200/300 Modems



- Hayes command compatible • Bell 103/212A compatible • Auto-dial/auto-answer • FCC approved • 1-year warranty • The 1200H & 2400S include MaxiMite Communication Software • The 1200C & 2400E do not include software

- 1200H 1200/300 Baud Internal Modem. . . \$ 79.95
- 2400S 2400/1200/300 Internal Modem. . . \$174.95
- 1200C 1200/300 Baud External Modem. . . \$119.95
- 2400E 2400/1200/300 External Modem . . . \$219.95

INTRODUCING JAMECO'S NEW COMPUTER KITS!!

Jameco's IBM™ AT Compatible Kit! Mini-286 6/8/10/12 MHz Kit!

EGA Monitor
TE5154 \$399.95
EGA Card
JE1055 \$149.95
(not included)



Part No.	Description	Price
JE1043	1.2M/360K Floppy Control.	\$ 49.95
JE1015	XT/AT Style Keyboard . . .	\$ 59.95
41256-120	512K RAM (18 Chips) . . .	\$ 71.10
JE1012	Baby AT Flip-Top Case. . .	\$ 69.95
JE1032	200W Power Supply. . .	\$ 89.95
JE1022	5 1/4" High Density Disk Drive	\$109.95
JE1003	Baby AT Motherboard (Zero-K RAM-incl. Award BIOS ROM)	\$399.95

Regular List \$850.80
SAVE \$50.85!

JE1008 IBM™ AT Compatible Kit. \$799.95

Jameco's IBM PC/XT Compatible Kit



SAVE \$77.15

4164-150	128K RAM (18 Chips) . . .	\$22.50
JE1040	Floppy Controller Card . . .	\$29.95
JE1010	Flip-Top Case	\$34.95
JE1015	XT/AT Style Keyboard . . .	\$59.95
JE1030	150 Watt Power Supply . . .	\$69.95
JE1050	Mono/Graph. Crd. w/PPort	\$59.95
JE1020	5 1/4" DSDD Disk Drive. . .	\$89.95
GREEN	12" Mono. Green Monitor	\$99.95
JE1000	XT Motherboard (Zero-K RAM-incl. Award BIOS ROM) . . .	\$89.95

**FREE! QUICKSOFT PC
WRITE WORD PROCESSING
SOFTWARE INCLUDED!**

Regular List \$557.10

JE1004 (IBM™ PC/XT Compatible Kit) \$479.95

Jameco's 4.77/8MHz Turbo IBM Compatible Kit

Same as JE1004 except comes with 640K RAM, JE1001 (Turbo) 4.77/8MHz motherboard. JE1071 multi I/O with controller and graphics, and AMBER monitor.

SAVE \$70.70 Regular List \$670.65

JE1005 (IBM™ PC/XT Turbo Compatible Kit) . \$599.95

IBM Compatible Motherboards

- 4.77/8MHz operation (Turbo only)
- 8087 Math Co-processor capability
- BIOS ROM included



- JE1001 4.77/8MHz . . \$129.95 \$104.95
- JE1000 4.77MHz . . . \$109.95 \$ 89.95

Additional Add-Ons Available!

Color Graphics Card for PC/XT/AT



- Text: 40 or 80 x 25 • Graphics: 320 or 640 x 200 • Parallel Printer Port • Manual included
- JE1052 \$49.95

EGA Card for PC/XT/AT

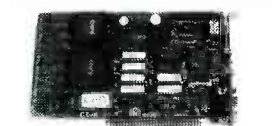

- Graphics: 720 x 348 • 16 out of 64 colors • Manual included
- JE1055 \$149.95

I/O Cards for PC/XT/AT



- Printer Port
- RS232 Port
- Game Port
- Manual included
- JE1060 (Pictured)
- JE1060 I/O for XT. . . \$59.95
- JE1065 I/O for AT. . . \$59.95

Multi I/O w/Controller & Graphics for PC/XT



- Printer port • RS232 port • Floppy controller • Graphics • Manual included
- JE1071 \$119.95

Jameco
ELECTRONICS

Solderless Breadboard Sockets



JE23



JE24



JE27

Part No.	Dim. L x W'	Contact Points	Binding Posts	Price
JE20	6 1/2 x 3/4	200	0	\$ 2.29
JE21	3 1/4 x 2 1/8	400	0	\$ 4.49
JE22	6 1/2 x 1 3/8	630	0	\$ 5.95
JE23	6 1/2 x 2 1/8	830	0	\$ 7.49
JE24	6 1/2 x 3 1/8	1,360	2	\$14.95
JE25	6 1/2 x 4 1/4	1,660	3	\$22.95
JE26	6 1/2 x 5 3/4	2,390	4	\$27.95
JE27	7 1/4 x 7 1/2	3,220	4	\$37.95

Jameco
ELECTRONICS

Extended 80-Column Card for Apple IIe



• 80 Col./64K RAM • Doubles amount of data your Apple IIe can display as well as its memory capacity • Ideal for word processing • Complete with instructions

JE864 \$49.95

ADD12 (Disk Drive II, II+, IIe) \$99.95

Additional Apple Compatible Products Available

NEW!



Seagate 20, 30 & 40MB Half Height Hard Disk Drives

ST225	20MB Drive only (PC/XT/AT) . . .	\$269.95
ST225K	20MB w/Controller (PC/XT) . . .	\$319.95
ST238	30MB Drive only (PC/XT/AT) . . .	\$299.95
ST238K	30MB w/Cont. (PC/XT/AT) . . .	\$339.95
ST251	40MB Drive only (PC/XT/AT) . . .	\$469.95
ST251XT	40MB w/Cont. Card (PC/XT) . . .	\$549.95
ST251AT	40MB w/Cont. Card (AT) . . .	\$589.95



Jameco PC/XT & AT Compatible Disk Drives

JE1022 (Pictured)

- JE1020 (360K Drive, PC/XT/AT) . . . \$ 89.95
- JE1022 (1.2MB, AT Compatible) . . . \$109.95

DATA BOOKS

30003	National Linear Data Book (82)	\$19.95
30005	Logic Data Book - Vol. II (84)	\$19.95
30009	Interstat Data Book (87)	\$14.95
21398	CMOS Cookbook (86)	\$14.95
210830	Intel Memory Handbook (87)	\$17.95
230843	Intel Microsystem Hndbk. Set (87) . . .	\$24.95

MUFFIN/SPRITE-STYLE FANS



- TA450S \$11.95
- Torin Industries (4.68" sq., 50 cfm)
- SUZ2A1 \$11.95
- EG&G Rotron (3.125" square, 34 cfm)

U.S. Funds Only
Shipping: Add 5% plus \$1.50 Insurance

California Residents:
Add 6%, 6 1/2% or 7%
Sales Tax

FAX 415-592-2503

12/87

1355 SHOREWAY RD., BELMONT, CA 94002 • FOR ORDERS ONLY 415-592-8097 • ALL OTHER INQUIRIES 415-592-8121

\$20 Minimum Order

IBM is a registered trademark of International Business Machines



Mail Order Electronics • Worldwide
Jameco
ELECTRONICS



Data Sheets — 50¢ each
Prices Subject to Change

Send \$1.00 Postage for a
FREE 1988 CATALOG

Telex: 176043

©1987 Jameco Electronics

CIRCLE 114 ON FREE INFORMATION CARD

www.americanradiohistory.com

256K STATIC 150ns 32K x 8 \$12.95 256K DRAMS 150ns 256K x 1 \$2.95

STATIC RAMS

2112	256x4	(450ns)	2.99
2114	1024x4	(450ns)	.99
2114L-2	1024x4	(200ns)(Low Power)	1.49
TMM2016-100	2048x8	(100ns)	1.95
HM6116-4	2048x8	(200ns)(CMOS)	1.79
HM6116-3	2048x8	(150ns)(CMOS)	1.85
HM6116LP-4	2048x8	(200ns)(CMOS)(LP)	1.85
HM6116LP-3	2048x8	(150ns)(CMOS)(LP)	1.90
HM6116LP-2	2048x8	(120ns)(CMOS)(LP)	2.45
HM6264LP-15	8192x8	(150ns)(CMOS)(LP)	3.95
HM6264LP-12	8192x8	(120ns)(CMOS)(LP)	4.49
HM43256LP-15	32768x8	(150ns)(CMOS)(LP)	12.95
HM43256LP-12	32768x8	(120ns)(CMOS)(LP)	14.95
HM43256LP-10	32768x8	(100ns)(CMOS)(LP)	19.95

DYNAMIC RAMS

4116-250	16384x1	(250ns)	.49
4116-200	16384x1	(200ns)	.89
4116-150	16384x1	(150ns)	.99
4116-120	16384x1	(120ns)	1.49
MMK4332	32768x1	(200ns)	6.95
4164-150	65536x1	(150ns)	1.29
4164-120	65536x1	(120ns)	1.55
MCM6665	65536x1	(200ns)	1.95
TMS4164	65536x1	(150ns)	1.95
4164-REFRESH	65536x1	(150ns)(PIN 1 REFRESH)	2.95
TMS4416	16384x4	(150ns)	3.75
41123-150	131072x1	(150ns)	5.95
TMS4464-15	65536x4	(150ns)	4.95
41256-150	262144x1	(150ns)	2.95
41256-120	262144x1	(120ns)	3.95
41256-100	262144x1	(100ns)	4.95
HM51256-100	262144x1	(100ns)(CMOS)	6.95
1 MB-120	1048576x1	(120ns)	19.95
1 MB-100	1048576x1	(100ns)	24.95

EPROMS

2708	1024x8	(450ns)	4.95
2716	2048x8	(450ns)(5V)	3.49
2716-1	2048x8	(350ns)(5V)	3.95
TMS2532	4096x8	(450ns)(5V)	5.95
2732	4096x8	(450ns)(5V)	3.95
2732A	4096x8	(250ns)(5V)(21V PGM)	3.95
2732A-2	4096x8	(200ns)(5V)(21V PGM)	4.25
27C64	8192x8	(250ns)(5V)(CMOS)	4.95
2764	8192x8	(450ns)(5V)	3.49
2764-250	8192x8	(250ns)(5V)	3.69
2764-200	8192x8	(200ns)(5V)	4.25
MCM68766	135000x1	(350ns)(5V)(24 PIN)	15.95
27128	16384x8	(250ns)(5V)	4.25
27C256	32768x8	(250ns)(5V)(CMOS)	7.95
27256	32768x8	(250ns)(5V)	5.95
27512	65536x8	(250ns)(5V)	11.95
27512	65536x8	(250ns)(5V)(CMOS)	12.95

5V- Single 5 Volt Supply 21V PGM-Program at 21 Volts

★★★★ HIGH-TECH ★★★★★

HM43256LP-15 \$12.95

- * 32K x 8 STATIC RAM
- * LOW POWER CONSUMPTION
- * HIGH SPEED — 100ns AVAILABLE
- * LOW STAND-BY CURRENT (2mA MAX.)
- * TTL COMPATIBLE INPUT AND OUTPUTS

★★★★ SPOTLIGHT ★★★★★

CMOS

4001	.19	4049	.29
4011	.19	4050	.29
4012	.25	4051	.69
4013	.35	4052	.69
4015	.29	4053	.69
4016	.29	4060	.69
4017	.46	4066	.29
4018	.69	4069	.19
4020	.59	4070	.29
4021	.69	4081	.22
4023	.25	4093	.49
4024	.49	14411	9.95
4025	.25	14433	14.95
4027	.39	14497	6.95
4028	.65	4503	.49
4040	.69	4511	.69
4042	.59	4518	.85
4044	.69	4528	.79
4046	.69	4538	.95
4047	.69	4702	12.95

HIGH SPEED CMOS

74HC00	21	74HC00	25
74HC02	21	74HC02	25
74HC04	25	74HC04	25
74HC08	25	74HC08	27
74HC14	35	74HC14	35
74HC32	35	74HC32	45
74HC74	35	74HC74	45
74HC138	45	74HC138	55
74HC161	45	74HC161	79
74HC182	45	74HC182	89
74HC139	4	74HC139	4
74HC151	59	74HC151	59
74HC154	109	74HC154	109
74HC157	55	74HC157	55
74HC244	85	74HC244	85
74HC245	85	74HC245	85
74HC273	69	74HC273	69
74HC374	69	74HC374	69
74HC376	69	74HC376	69
74HC4060	1.49	74HC4060	1.49

74LS00

74LS00	.16	74LS112	.29	74LS241	.69
74LS01	.18	74LS122	.45	74LS242	.69
74LS02	.17	74LS123	.49	74LS243	.69
74LS03	.18	74LS124	2.75	74LS244	.69
74LS04	.16	74LS125	.39	74LS245	.79
74LS05	.18	74LS126	.39	74LS251	.49
74LS08	.18	74LS132	.39	74LS253	.49
74LS09	.18	74LS133	.49	74LS257	.39
74LS10	.16	74LS136	.39	74LS258	.49
74LS11	.22	74LS138	.39	74LS259	1.29
74LS12	.22	74LS139	.39	74LS260	.49
74LS13	.26	74LS145	.99	74LS266	.39
74LS14	.39	74LS147	.99	74LS273	.79
74LS15	.26	74LS148	.99	74LS279	.39
74LS20	.17	74LS151	.39	74LS280	1.98
74LS21	.22	74LS153	.39	74LS283	.59
74LS22	.22	74LS154	1.49	74LS290	.89
74LS27	.22	74LS155	.59	74LS293	.89
74LS28	.26	74LS156	.49	74LS299	1.49
74LS30	.17	74LS157	.35	74LS322	3.95
74LS32	.18	74LS158	.29	74LS323	2.49
74LS33	.28	74LS160	.29	74LS365	.39
74LS37	.26	74LS161	.39	74LS367	.39
74LS38	.26	74LS162	.49	74LS368	.39
74LS42	.39	74LS163	.39	74LS373	.79
74LS47	.75	74LS164	.49	74LS374	.79
74LS48	.85	74LS165	.65	74LS375	.95
74LS51	.17	74LS166	.95	74LS377	.79
74LS73	.29	74LS169	.95	74LS390	1.19
74LS74	.24	74LS173	.49	74LS393	.79
74LS75	.29	74LS174	.39	74LS541	1.49
74LS76	.29	74LS175	.39	74LS624	1.95
74LS83	.49	74LS191	.49	74LS640	1.19
74LS85	.49	74LS192	.69	74LS645	.99
74LS86	.22	74LS193	.69	74LS670	.89
74LS90	.39	74LS194	.69	74LS682	3.20
74LS92	.49	74LS195	.69	74LS688	2.40
74LS93	.39	74LS196	.59	74LS783	2.25
74LS95	.49	74LS197	.59	25LS2521	2.80
74LS107	.34	74LS221	.59	26LS31	1.95
74LS109	.36	74LS240	.69	26LS32	1.95

TOLL FREE U.S. & CANADA (800) 538-5000

7400

7400	.19
7402	.19
7404	.19
7406	.29
7407	.29
7408	.24
7410	.19
7411	.25
7412	.45
7416	.25
7417	.25
7420	.19
7430	.19
7432	.29
7438	.29
7442	.49
7445	.69
7447	.69
7473	.34
7474	.33
7475	.45
7476	.35
7483	.50
7485	.59
7486	.35
7489	2.15
7490	.39
7493	.35
74121	.29
74123	.49
74125	.45
74150	1.35
74151	.55
74153	.55
74154	1.49
74157	.65
74159	1.65
74161	.99
74164	.85
74166	1.00
74175	.89
74367	.65

LINEAR

LM567	.79
NE570	2.95
NE592	.98
LM722	4.49
LM733	.98
LM741	.29
LM747	.69
LM1330	1.65
MC1498	1.19
LM1458	.35
LM1488	.49
LM1489	.49
LM1496	.89
ULN2003	7.99
XR2206	3.95
XR2211	2.95
LM2917	1.95
CA3146	8.99
CA3146	1.29
MC3373	1.29
MC3470	1.95
MC3480	8.95
MC3487	2.95
LM3900	4.49
LM3911	2.25
LM3909	.98
LM3914	1.89
LM4024	3.49
LM383	1.95
LM386	.89
LM393	.45
LM394H	5.95
LM394H	1.49
TL494	7.15
TL497	3.25
NE555	2.25
NE556	4.99
NE558	1.25
NE564	1.95
LM565	.95
LM566	1.49
NE590	2.50
H=TO-5 CAN, K=TO-3, T=TO-220	

8000

8031	3.95
8035	1.49
8039	1.95
8052AH BASIC	34.95
8080	2.49
8085	1.95
8086	6.49
8087 5MHz	99.00
8087-2 8MHz	159.95
8088	5.99
8088-2	7.95
8155	2.49
8155-2	2.99
8741	9.95
8748	7.95
8749	12.95
8755	14.95
80286	79.95
80287 6MHz	179.95
80287-8 8MHz	249.95
80287-10 10MHz	309.95

6500 1.0 MHz

6502	2.25
65C02 (CMOS)	7.95
6520	1.65
6522	2.95
6526	13.95
6532	5.95
6545	2.95
6551	2.95
6502A	2.69
6520A	2.95
6522A	5.95
6532A	11.95
6545A	3.95
6551A	6.95
6502B	4.25

Z-80 2.5 MHz

Z80-CPU	1.25
Z80A-CPU	1.29
Z80A-CTC	1.69
Z80A-DART	5.95
Z80A-DMA	5.95
Z80A-PIO	1.89
Z80A-SIO 0	5.95
Z80A-SIO 1	5.95
Z80A-SIO 2	5.95
Z80B-CPU	2.75
Z80B-CTC	4.25
Z80B-PIO	4.25
Z80B-DART	6.95
Z80B-SIO 0	12.95
Z80B-SIO 2	12.95
Z8671 ZILOG	9.95

DISK CONTROLLERS

1771	4.95
1791	9.95
1793	9.95
1795	12.95
1797	12.95
1791	19.95
1793	19.95
2797	29.95
8272	4.39
UPD765	4.39
MB8876	12.95
MB8877	12.95
1691	6.95
2143	6.95
9216	6.29

V 20 SERIES

V20 5 MHz	8.95
V20 8 MHz	10.95
V30 8 MHz	13.95
Replaces 8088 to speed up your PC by 10 to 40%	

CRYSTALS

32.768 KHz	9.95
1.0 MHz	2.95
1.8432	2.95
2.0	1.95
2.4576	1.95
3.579545	1.95
4.0	1.95
5.0	1.95
5.0688	1.95
6.0	1.95
6.144	1.95
8.0	1.95
10.0	1.95
10.738635	1.95
12.0	1.95
14.31818	1.95
16.0	1.95
18.0	1.95
18.432	1.95
20.0	1.95
22.1184	1.95
24.0	1.95
32.0	1.95

UARTS

AY5-1013	3.95
----------	------

20 MEG HARD DISK DRIVE ON A CARD \$349!

CAPACITORS

TANTALUM			
1.0µf	15V	.12	47µf .39
6.8	15V	.42	1.0 35V .45
10	15V	.45	2.2 35V .19
22	15V	.99	4.7 50V .39
22	35V	.15	10 35V .69

DISC

10µf	50V	.05	680 50V .05
22	50V	.05	.001µf 50V .05
27	50V	.05	.0022 50V .05
33	50V	.05	.005 50V .05
47	50V	.05	.01 50V .07
68	50V	.05	.02 50V .07
100	50V	.05	.05 50V .07
220	50V	.05	.1 12V .10
560	50V	.05	.1 50V .12

MONOLITHIC

.01µf	50V	.14	.1µf 50V .18
.047µf	50V	.15	.47µf 50V .25

ELECTROLYTIC

RADIAL		AXIAL	
1µf	25V .14	1µf	50V .14
2.2	35V .11	10	50V .16
4.7	50V .11	22	16V .14
10	50V .11	47	50V .19
47	35V .13	100	35V .19
100	16V .15	220	25V .25
220	35V .20	470	50V .29
470	25V .30	1000	16V .29
2200	16V .70	2200	16V .70
4700	25V 1.45	4700	16V 1.25

FRAME STYLE TRANSFORMERS

12.6 Volts AC	2 Amps (CT)	5.95
12.6 Volts AC	4 Amps (CT)	7.95
12.6 Volts AC	8 Amps (CT)	10.95
25.2 Volts AC	2 Amps (CT)	7.95

36 PIN CENTRONICS

MALE		
IDCEN36	RIBBON CABLE	3.95
CEN36	SOLDER CUP	1.85
FEMALE		
IDCEN36 F	RIBBON CABLE	4.95
CEN36PC	RT. Angle PC Mount	1.85

EDGE CARD CONNECTORS

100 Pin Soldertail	S-100	.125	3.95
100 Pin Wirewrap	S-100	.125	4.95
62 Pin Soldertail	IBM PC	100	1.95
50 Pin Soldertail	APPLE	100	2.95
44 Pin Soldertail	STD	156	1.95
44 Pin Wirewrap	STD	156	4.95

IDC CONNECTORS

DESCRIPTION	ORDER BY	CONTACTS					
		10	20	26	34	40	50
SOLDER HEADER	IDHxxS	82	1.29	1.68	2.20	2.58	3.24
RIGHT ANGLE SOLDER HEADER	IDHxxSR	85	1.35	1.76	2.31	2.72	3.39
WIREWRAP HEADER	IDHxxW	1.86	2.98	3.84	4.50	5.28	6.63
RIGHT ANGLE WIREWRAP HEADER	IDHxxWR	2.05	3.28	4.22	4.45	4.80	7.30
RIBBON HEADER SOCKET	IDSxx	63	.89	.95	1.29	1.49	1.69
RIBBON HEADER	IDMxx	---	5.50	6.25	7.00	7.50	8.50
RIBBON EDGE CARD	IDExx	.85	1.25	1.35	1.75	2.05	2.45

FOR ORDERING INSTRUCTIONS, SEE D-SUBMINIATURE CONNECTORS, BELOW

D-SUBMINIATURE CONNECTORS

DESCRIPTION	ORDER BY	CONTACTS						
		9	15	19	25	37	50	
SOLDER CUP	MALE	DBxxP	45	.59	.69	.69	1.35	1.85
	FEMALE	DBxxS	49	.69	.75	.75	1.39	2.29
RIGHT ANGLE PC SOLDER	MALE	DBxxPR	49	.69	---	79	2.27	---
	FEMALE	DBxxSR	55	.75	---	85	2.49	---
WIREWRAP	MALE	DBxxPWW	1.69	2.56	---	3.89	5.60	---
	FEMALE	DBxxSWW	2.76	4.27	---	6.84	9.95	---
IDC RIBBON CABLE	MALE	IDBxxP	1.39	1.99	---	2.25	4.25	---
	FEMALE	IDBxxS	1.45	2.05	---	2.35	4.49	---
HOODS	METAL	MHOODxx	1.05	1.15	1.25	1.25	---	---
	GREY	HOODxx	.39	.39	---	.39	.69	.75

ORDERING INSTRUCTIONS: INSERT THE NUMBER OF CONTACTS IN THE POSITION MARKED "xx" OF THE "ORDER BY" PART NUMBER LISTED. EXAMPLE: A 15 PIN RIGHT ANGLE MALE PC SOLDER WOULD BE DB15PR

MOUNTING HARDWARE 59¢

DIP CONNECTORS

DESCRIPTION	ORDER BY	CONTACTS								
		.8	14	16	18	20	22	24	28	40
TOOLED SOLDERTAIL IC SOCKETS	AUGATxxST	.62	.79	.89	1.09	1.29	1.39	1.49	1.69	2.49
TOOLED WIREWRAP IC SOCKETS	AUGATxxWW	1.30	1.80	2.10	2.40	2.50	2.90	3.15	3.70	5.40
COMPONENT CARRIES (DIP HEADERS)	ICCxx	.49	.59	.69	.99	.99	.99	.99	1.09	1.49
RIBBON CABLE DIP PLUGS (IDC)	IDPxx	.95	.49	.59	1.29	1.49	---	.85	1.49	1.59

FOR ORDERING INSTRUCTIONS, SEE D-SUBMINIATURE CONNECTORS, ABOVE

VOLTAGE REGULATORS

TO-220 CASE			TO-3 CASE		
7805T	.49	7805K 1.59	7905K 1.69		
7808T	.49	7812K 1.39	7912K 1.49		
7812T	.49				
7815T	.49				
7905T	.59				
7908T	.59				
7912T	.59	78L05 .49	79L05 .69		
7915T	.59	78L12 .49	79L12 1.49		

LM323K 5 VOLTS, 3 AMPS, TO-3 4.79
LM338K ADJUSTABLE, 5 AMPS, TO-3 6.95

RESISTOR NETWORKS

SIP 10 PIN	9 RESISTOR	.69
SIP 8 PIN	7 RESISTOR	.59
DIP 16 PIN	8 RESISTOR	1.09
DIP 16 PIN	15 RESISTOR	1.09
DIP 14 PIN	7 RESISTOR	.99
DIP 14 PIN	13 RESISTOR	.99

BYPASS CAPACITORS

.01 µf CERAMIC DISC	100/\$5.00
.01 µf MONOLITHIC	100/\$10.00
.1 µf CERAMIC DISC	100/\$6.50
.1 µf MONOLITHIC	100/\$12.50

DISCRETE

1N751	.15
1N759	.15
1N4148 25	1.00
1N4004 10	1.00
1N5402	.25
KBP02	.55
KBU8A	.95
MDA990-2	.35
N2222	.25
PN2222	.25
2N2905	.50
2N2907	.25
2N3055	.79
2N3904	.10
4N26	.69
4N27	.69
4N28	.69
4N33	.89
4N37	1.19
MCT-2	.59
MCT-6	1.29
TIL-111	2.25
2N3906	.10
2N4401	.25
2N4402	.25
2N4603	.75
2N6045	1.75
TIP31	.49

IC SOCKETS

SOLDERTAIL	1.99	100-
8 PIN ST	.11	.10
14 PIN ST	.11	.09
16 PIN ST	.12	.10
18 PIN ST	.15	.13
20 PIN ST	.18	.15
22 PIN ST	.15	.12
24 PIN ST	.20	.15
28 PIN ST	.22	.16
40 PIN ST	.30	.22
64 PIN ST	1.95	1.49

WIREWRAP		
8 PIN WWW	.59	.69
14 PIN WWW	.69	.52
16 PIN WWW	.69	.58
18 PIN WWW	.99	.90
20 PIN WWW	1.09	.98
22 PIN WWW	1.39	1.28
24 PIN WWW	1.49	1.35
28 PIN WWW	1.69	1.49
40 PIN WWW	1.99	1.80

ZERO INSERTION FORCE		
16 PIN ZIF	4.95	CALL
24 PIN ZIF	5.95	CALL
28 PIN ZIF	6.95	CALL
40 PIN ZIF	9.95	CALL

WISH SOLDERLESS BREADBOARDS

PART NUMBER	DIMENSIONS	DISTRIBUTION STRIP(S)	TIE POINTS	TERMINAL STRIP(S)	TIE POINTS	BINDING POSTS	PRICE
WBU-D	38 x 6.50"	1	100	---	---	---	2.95
WBU-T	1.38 x 6.50"	---	---	1	630	---	6.95
WBU-204-3	3.94 x 8.45"	1	100	2	1260	2	17.95
WBU-204	5.13 x 8.45"	4	400	2	1260	3	24.95
WBU-206	6.88 x 9.06"	5	500	3	1890	4	29.95
WBU-208	8.25 x 9.45"	7	700	4	2520	4	39.95

EXTENDER CARDS FOR IBM

EXT-8088 \$29.95
EXT-80286 \$39.95



SHORTING BLOCKS

1" CENTERS
GOLD CONTACTS
5/\$1.00

WHY THOUSANDS CHOOSE JDR

- ★ QUALITY MERCHANDISE COMPETITIVE PRICES
- ★ MOST ORDERS SHIPPED IN 24 HOURS
- ★ FRIENDLY, KNOWLEDGEABLE STAFF
- ★ MONEY BACK GUARANTEE (ASK FOR DETAILS)
- ★ TOLL FREE TECHNICAL SUPPORT
- ★ EXCELLENT CUSTOMER SERVICE



EPROM ERASERS

SPECTRONICS CORPORATION

Model	Timer	Chip Capacity	Intensity (µW Cm ²)	Unit Cost
PE-140	NO	9	8,000	\$89
PE-140T	YES	9	8,000	\$139
PE-240T	YES	12	9,600	\$189

DATARASE \$34.95

- ERASES 2 EPROMS IN 10 MINUTES TIME
- VERY COMPACT—NO DRAWER
- THIN METAL SHUTTER PREVENTS UV LIGHT FROM ESCAPING

LIGHT EMITTING DIODES

LED DISPLAYS

FND 357(359)	COM CATHODE	362"	1.25
FND-500(503)	COM CATHODE	5"	1.49
FND-507(510)	COM ANODE	5"	1.49
MAN-72	COM ANODE	3"	.99
MAN-74	COM CATHODE	3"	.99
TIL-313	COM CATHODE	3"	.45
TIL-311	4x7 HEX W/LOGIC	270"	10.95

DIFFUSED LEDS

JUMBO RED	T1 1/4	10	.09
JUMBO GREEN	T1 1/4	14	.12
JUMBO YELLOW	T1 1/4	14	.12
MOUNTING HDW	T1 1/4	10	.09
MINI RED	T1	10	.09

RIBBON CABLE

CONTACTS	SINGLE COLOR		COLOR CODED	
	1"	10"	1"	10"
10	.18	1.60	.30	2.75
16	.28	2.50	.48	4.40
20	.36	3.20	.60	5.50
25	.45	4.00	.75	6.85
26	.46	4.10	.78	7.15
34	.55	5.40	1.07	9.35
40	.72	6.40	1.20	11.00
50	.89	7.50	1.50	13.25

WIREWRAP PROTOTYPE CARDS

FR-4 EPOXY GLASS LAMINATE WITH GOLD-PLATED EDGE-CARD FINGERS

XT

BOTH CARDS HAVE SILK SCREENED LEGENDS AND INCLUDES MOUNTING BRACKET

IBM-PR1	WITH .5V AND GROUND PLANE	...	\$27.95
IBM-PR2	AS ABOVE W/DECODING LAYOUT	...	\$29.95

AT

IBM-PRAT	LARGE .5V & GROUND PLANES	...	\$29.95
----------	---------------------------	-----	---------

S-100

P100-1	BARE - NO FOIL PADS	...	\$15.15
P100-2	HORIZONTAL BUS	...	\$21.80
P100-3	VERTICAL BUS	...	\$21.80
P100-4	SINGLE FOIL PADS PER HOLE	...	\$22.75

APPLE

P500-1	BARE - NO FOIL PADS	...	\$15.15
P500-3	HORIZONTAL BUS	...	\$22.75
P500-4	SINGLE FOIL PADS PER HOLE	...	\$21.80
7060-45	FOR APPLE IIe AUX SLOT	...	\$30.00

PAGE WIRE WRAP WIRE

PRECUT ASSORTMENT IN ASSORTED COLORS \$27.50
100ea: 5.5", 6.0", 6.5", 7.0"
250ea: 2.5", 4.5", 5.0"
500ea: 3.0", 3.5", 4.0"

SPOOLS

100 feet	\$4.30	250 feet	\$7.25
500 feet	\$13.25	1000 feet	\$21.95

Please specify color: Blue, Black, Yellow or Red

SOCKET-WRAP I.D.™

- SLIPS OVER WIRE WRAP PINS
- IDENTIFIES PIN NUMBERS ON WRAP SIDE OF BOARD
- CAN WRITE ON THE PLASTIC, SUCH AS AN IC #

Pins	Part #	Pck. of	Price
8	IDWRAP 08	10	1.95
14	IDWRAP 14	10	1.95
16	IDWRAP 16	10	1.95
18	IDWRAP 18	5	1.95
20	IDWRAP 20	5	1.95
22	IDWRAP 22	5	1.95
24	IDWRAP 24	5	1.95
28	IDWRAP 28	5	

4164 150ns \$129

MONITOR STANDS

- MODEL MS-100** \$12.95
 • TILTS & SWIVELS • STURDY PLASTIC CONSTRUCTION
- MODEL MS-200** \$39.95
 • TILTS AND SWIVELS • BUILT-IN SURGE SUPPRESSOR
 • BUILT-IN POWER STATION INDEPENDENTLY CONTROLS UP TO 5 120 VOLT AC OUTLETS • UL APPROVED



NASHUA DISKETTES

- BOXES OF 10** 5 1/4" DS/DD SOFT SECTOR
- 5 1/4" DS DD 360K \$9.95 **49¢ ea 39¢ ea**
 5 1/4" DS HD 1.2M \$24.95
 3 1/2" DS QD 720K \$16.95 BULK QTY 50 BULK QTY 250

5 1/4" DISKETTE STORAGE FILE \$8.95

- HOLDS 70 5 1/4" FLOPPIES
- STURDY, ATTRACTIVE SMOKE ACRYLIC CASE
- COMPLETE WITH HINGED DIVIDERS



VERSION FOR 3 1/2" FLOPPIES AVAILABLE \$9.95

2 WAY SWITCH BOXES \$39.95

- CONNECT 2 PRINTERS TO 1 COMPUTER OR VICE VERSA
- SERIAL & PARALLEL MODELS AVAILABLE
- ALL LINES SWITCHED
- GOLD PLATED CONNECTORS & QUALITY SWITCHES



6' INTERFACE CABLES

- MEETS FCC REQUIREMENTS 100% SHIELDED
- IBM COMPATIBLE PARALLEL PRINTER \$9.95
 CENTRONICS (MALE TO FEMALE) \$15.95
 CENTRONICS (MALE TO MALE) \$14.95
 IBM COMPATIBLE MODEM CABLE \$7.95
 RS232 SERIAL (MALE TO FEMALE) \$9.95
 RS232 SERIAL (MALE TO MALE) \$9.95
 COILED KEYBOARD EXTENDER \$7.95

JOYSTICK \$19.95

- SET X-Y AXIS FOR AUTO CENTER OR FREE MOVEMENT
- FIRE BUTTON FOR USE WITH GAME SOFTWARE
- INCLUDES ADAPTOR CABLE FOR IBM



SWITCHING POWER SUPPLIES

- PS-135** \$59.95
 • FOR IBM XT COMPATIBLE
 • UL APP. 135 WATTS
 • 5V 15A, 12V 4.2A
 • 5V 5A, 12V 5A
 • ONE YEAR WARRANTY
- PS-150** 150W MODEL \$69.95
- PS-200** \$89.95
 • FOR IBM AT COMPATIBLE
 • 200 WATTS
 • 5V 22A, 12V 8A
 • 5V 5A, 12V 5A
 • ONE YEAR WARRANTY

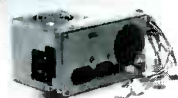

MONITORS

SAMSUNG MONOCHROME

- IBM COMPATIBLE TTL INPUT
- 12" NON-GLARE, LOW DISTORTION, AMBER SCREEN
- RES: 720 x 350
- SWIVEL BASE
- 1 YEAR WARRANTY

\$119.95

MULTISYNC BY NEC \$549.95

- ORIGINAL CGA/EGA/PGA COMPATIBLE MONITOR
- AUTO FREQUENCY ADJUSTMENT
- RESOLUTION AS HIGH AS 800 x 600



EGA BY CASPER \$399.95

- 15.75/21.85 KHz SCANNING FREQUENCIES
- RES: 640 x 200/350 • .31mm DOT PITCH
- 14" BLACK MATRIX SCREEN • 16 COLORS FROM 64

RGB BY CASPER \$279.95

- COLOR/GREEN/AMBER SWITCH • RES: 640 x 240
- RGB/IBM COMPATIBLE • 14" NON-GLARE SCREEN
- 39mm DOT PITCH • CABLE FOR IBM PC INCLUDED

MONOCHROME BY HYUNDAI \$69.95

- IBM COMPATIBLE TTL INPUT
- 12" NON-GLARE AMBER SCREEN
- ATTRACTIVE CASING WITH A TILT SWIVEL BASE

TOLL FREE U.S. & CANADA (800) 538-5000

20MB HARD DISK ON A CARD



- SAVES SPACE AND REDUCES POWER CONSUMPTION
- IDEAL FOR PCs WITH FULL HEIGHT FLOPPIES
- LEAVES ROOM FOR A HALF LENGTH CARD IN ADJACENT SLOT

\$349

RITEMAN II PRINTER



- 160 CPS DRAFT, 32 CPS NLQ MODE
- SUPPORTS EPSON/IBM GRAPHICS
- 9 x 9 DOT MATRIX
- FRICTION AND PIN FEEDS
- VARIABLE LINE SPACING & PITCH

\$219.95

- IBM COMPATIBLE PRINTER CABLE \$9.95
 REPLACEMENT RIBBON CARTRIDGE \$7.95

DISK DRIVES

5 1/4" SEAGATE HARD DISK DRIVES

- ST-225 HALF HEIGHT 20MB 65ms \$259
 ST-238 HALF HEIGHT 30MB 65ms (RL) \$299
 ST-251 HALF HEIGHT 40MB 40ms \$469
 ST-277 HALF HEIGHT 60MB 40ms (RL) \$649
 ST-4038 FULL HEIGHT 30MB 40ms \$559
 ST-4096 FULL HEIGHT 80MB 28ms \$895

1/2 HEIGHT FLOPPY DISK DRIVES

- 5 1/4" TEAC FD-55B DS/DD 360K \$109.95
 5 1/4" TEAC FD-55F DS/QUAD 720K \$124.95
 5 1/4" TEAC FD-55GFV DS/HD 1.2M \$154.95
 5 1/4" MITSUBISHI DS/HD 1.2M \$119.95
 5 1/4" DS/DD 360K \$69.95
 3 1/2" MITSUBISHI DS/DD (AT OR XT) \$129.95

DISK DRIVE ACCESSORIES

- TEAC SPECIFICATION MANUAL \$5.00
 TEAC MAINTENANCE MANUAL \$25.00
 1/2 HT MOUNTING HARDWARE FOR IBM \$2.95
 MOUNTING RAILS FOR IBM AT \$4.95
 "Y" POWER CABLE FOR 5 1/4" FDDs \$2.95
 5 1/4" FDD POWER CONNECTORS \$1.19

DRIVE ENCLOSURES WITH POWER SUPPLIES

- CAB-2SV5 DUAL SLIMLINE FOR 5 1/4" \$49.95
 CAB-1FH5 FULL HEIGHT FOR 5 1/4" \$69.95
 CAB-2SV8 DUAL SLIMLINE FOR 8" \$209.95
 CAB-2FH8 DUAL FULL HEIGHT FOR 8" \$219.95

EASYDATA MODEMS

All models feature auto-dial/answer/redial on busy, power up self test, touchtone or pulse dialing, built-in speaker. Hayes and Bell Systems 103 & 212A compatible. Full or half duplex. PC Talk III Communications software with internal models and more.

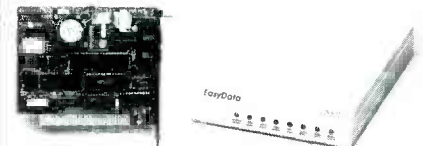

INTERNAL

- 12H 1200 BAUD 1/2 CARD \$69.95
 24B 2400 BAUD FULL CARD \$179.95

EXTERNAL

- (NO SOFTWARE INCLUDED)
 12D 1200 BAUD \$119.95
 24D 2400 BAUD \$219.95

COMPUTER CASES

Attractive, sturdy steel cases fit the popular sized motherboards and include speakers, faceplates, expansion slots and all necessary hardware.



- XT STYLE FLIP-TOP \$34.95
 XT STYLE SLIDE-TOP \$39.95
 AT STYLE SLIDE-TOP \$89.95
 • FRONT PANEL KEYLOCK AND LED INDICATORS
- JR. AT STYLE FLIP-TOP \$149.95
 • INCLUDES 180 WATT POWER SUPPLY
 • FRONT PANEL KEYLOCK AND LED INDICATORS

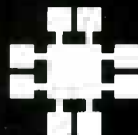

Visit our retail store located at 1256 S. Bascom Ave. in San Jose, (408) 947-8881

JDR Microdevices
 110 Knowles Drive, Los Gatos, CA 95030
 Toll Free 800-538-5000 • (408) 866-6200
 FAX (408) 378-8927 • Telex 171-110

PLEASE USE YOUR CUSTOMER NUMBER WHEN ORDERING

TERMS: Minimum order \$10.00. For shipping and handling include \$2.50 for UPS Ground and \$3.50 for UPS Air. Orders over 1 lb. and foreign orders may require additional shipping charges—please contact our sales department for the amount. CA. residents must include applicable sales tax. All merchandise is warranted for 90 days unless otherwise stated. Prices are subject to change without notice. We are not responsible for typographical errors. We reserve the right to limit quantities and to substitute manufacturer. All merchandise subject to prior sale. A full copy of our terms is available upon request. Items pictured may only be representative.

COPYRIGHT 1987 JDR MICRODEVICES

THE JDR MICRODEVICES LOGO IS A REGISTERED TRADEMARK OF JDR MICRODEVICES. JDR INSTRUMENTS AND JDR MICRODEVICES ARE TRADEMARKS OF JDR MICRODEVICES. IBM IS A TRADEMARK OF INTERNATIONAL BUSINESS MACHINES CORPORATION. APPLE IS A TRADEMARK OF APPLE COMPUTER.

8087 5MHz \$9900

80287 6 MHz \$17995

INTERFACE CARDS

FROM MODULAR CIRCUIT TECHNOLOGY
MULTIFUNCTION CARDS

MCT-MF MULTIFUNCTION **\$7995**

ALL THE FEATURES OF 6 PACK- AT HALF THE PRICE

- 0-384K DYNAMIC RAM USING 4164s
- SERIAL, PARALLEL, GAME PORTS, CLOCK/CALENDAR

MCT-MGMIO MONOGRAPHS I/O **\$11995**

TOTAL SYSTEM CONTROL FROM A SINGLE SLOT

- 2 FLOPPY CONT. SERIAL, PARALLEL, GAME PORT, CLOCK/CAL
- RUN COLOR GRAPHICS SOFTWARE ON A MONOCHROME MONITOR

MCT-MIO MULTI I/O FLOPPY **\$7995**

A PERFECT COMPANION FOR OUR MOTHERBOARDS

- SERIAL, PARALLEL, GAME PORT, CLOCK/CALENDAR
- SUPPORTS UP TO 2 360K FLOPPIES, 720K WITH DOS 3.2

MIO-SERIAL 2nd SERIAL PORT \$1595

MCT-IO MULTI I/O CARD **\$5995**

USE WITH MCT-FH FOR A MINIMUM OF SLOTS USED

- SERIAL PORT, CLOCK/CALENDAR WITH A BATTERY BACK-UP
- PARALLEL PRINTER PORT ADDRESSABLE AS LPT1 OR LPT2

IO-SERIAL 2nd SERIAL PORT \$1595

MCT-ATMF AT MULTIFUNCTION **\$13995**

ADDS UP TO 3 MEGABYTES OF RAM TO THE AT

- USER EXPANDABLE TO 1.5 MB OF MEMORY (ZERO K INSTALLED)
- INCLUDES SERIAL PORT AND PARALLEL PORT

ATMF-SERIAL 2nd SERIAL PORT \$2495

MCT-ATMF-MC PIGGYBACK BOARD (NO MEMORY) \$2995

MCT-ATIO AT MULTI I/O **\$5995**

USE WITH MCT-ATFH FOR A MINIMUM OF SLOTS USED

- SERIAL, PARALLEL AND GAME PORTS
- USES 16450 SERIAL SUPPORT CHIPS FOR HIGH SPEED OPERATION

ATIO-SERIAL 2nd SERIAL PORT \$2495

MEMORY CARDS

MCT-RAM 576K RAM CARD **\$5995**

A CONTIGUOUS MEMORY SOLUTION IN A SHORT SLOT

- USER SELECTABLE CONFIGURATION AMOUNTS UP TO 576K USING 64K & 256K RAM CHIPS (ZERO K INSTALLED)

MCT-EMS EXPANDED MEMORY CARD **\$12995**

2 MB OF LOTUS/INTEL/MICROSOFT COMPATIBLE MEMORY FOR XT

- CONFORMS TO LOTUS/INTEL EMS • USER EXPANDABLE TO 2 MB
- EXPANDED/CONVENTIONAL MEMORY, RAMDISK AND SPOOLER

MCT-ATRAM AT 4 MB RAM CARD **\$14995**

A POWER USER'S DREAM: 4 MB OF MEMORY FOR AT

- BACKFILL TO 640K, FLEXIBLE STARTING ADDRESS
- UP TO 2 MB ON CARD, 4 MB WITH OPTIONAL PIGGYBACK BOARD

MCT-ATRAM-MC PIGGYBACK BOARD (NO MEMORY) \$3995

MCT-ATEMS AT COMPATIBLE EMS **\$13995**

CAN BE USED FOR EXPANDED, EXTENDED OR CONVENTIONAL MEMORY

- CONFORMS TO LOTUS/INTEL EMS • USER EXPANDABLE TO 2 MB
- RAMDISK, PRINT SPOOLER AND LIM/EMS SOFTWARE INCLUDED

DRIVE CONTROLLERS

MCT-FDC FLOPPY DISK CONTROLLER **\$2995**

QUALITY DESIGN OFFERS 4 FLOPPY CONTROL IN A SINGLE SLOT

- INTERFACES UP TO 4 FDDs TO AN IBM PC OR COMPATIBLE
- SUPPORTS BOTH DS/DD AND DS/QD WITH DOS 3.2

MCT-HDC HARD DISK CONTROLLER **\$7995**

HD CONTROL FOR WHAT OTHERS CHARGE FOR FLOPPY CONTROL

- SUPPORTS 16 DRIVE SIZES INCLUDING 5, 10, 20, 30 & 40 MB
- DIVIDE 1 LARGE DRIVE INTO 2 SMALLER, LOGICAL DRIVES

MCT-FDC-1.2 1.2MB FLOPPY CONTROLLER **\$6995**

ADD VERSATILITY & CAPACITY TO YOUR XT

- SUPPORTS 2 DRIVES, BOTH MAY BE 360K OR 1.2 MEG
- ALLOWS DATA TO FLOW FREELY FROM XTs TO ATs

MCT-FH FLOPPY/HARD CONTROLLER **\$13995**

SYSTEM STARVED FOR SLOTS? SATISFY IT WITH THIS TIMELY DESIGN

- INTERFACES UP TO 2 FDDs & 2 HDDs, CABLING FOR 2 FDDs & 1 HDD
- SUPPORTS BOTH DS/DD & DS/QD WITH DOS 3.2

MCT-ATFH AT FLOPPY/HARD CONTROLLER **\$14995**

FLOPPY/HARD DISK CONTROL IN A TRUE AT DESIGN

- SUPPORTS UP TO 2 360K/720K/1.2MB FDDs
- AS WELL AS 2 HDDs USING STANDARD CONTROL TABLES

DISPLAY CARDS

MCT-EGA ENHANCED GRAPHICS ADAPTOR **\$14995**

100% IBM COMPATIBLE, PASSES IBM EGA DIAGNOSTICS

- 256K OF VIDEO RAM ALLOWS 640 x 350 IN 16 OF 64 COLORS
- COMPATIBLE WITH COLOR AND MONOCHROME ADAPTORs

MCT-CG COLOR GRAPHICS ADAPTOR **\$4995**

COMPATIBLE WITH IBM COLOR GRAPHICS STANDARDS

- SHORT SLOT SUPPORTS RGB, COLOR & COMPOSITE MONOCHROME
- 640/320 x 200 RESOLUTION, LIGHT PEN INTERFACE

MCT-MGP MONOCHROME GRAPHICS **\$5995**

TRUE HERCULES COMPATIBILITY, SUPPORTS LOTUS 123

- SOFTWARE DRIVER ALLOWS COLOR GRAPHICS PROGRAMS TO RUN ON A MONOCHROME MONITOR
- PARALLEL PRINTER PORT

HALF HEIGHT HARD DISK DRIVES

40 MB \$469

Seagate model ST-251 5 1/4" half height
FAST 40ms access time

60 MB \$649

Seagate model ST-277 5 1/4" half height
FAST 40ms access time (RL)

HALF HEIGHT HARD DISK SYSTEMS

20 MB \$289

30 MB \$329

Systems include Seagate 1/2 height hard drive, hard drive controller, cables and instructions.
All drives are pre-tested and warranted for one year.

IBM COMPATIBLE MOTHERBOARDS

FROM MODULAR CIRCUIT TECHNOLOGY

MCT-TURBO TURBO 4.77/8 MHz **\$10995**

- 4 77 OR 8 MHz OPERATION WITH 8088-2 & OPTIONAL 8087-2 CO-PROCESSOR
- DYNAMICALLY ADJUSTS SPEED FOR MAXIMUM THROUGHPUT & RELIABILITY DURING DISK I/O
- CHOICE OF NORMAL TURBO MODE OR SOFTWARE SELECT PROCESSOR SPEED

MCT-KTMB STANDARD MOTHERBOARD **\$9795**

MCT-ATMB 80286 6/8 MHz **\$37995**

- 8 SLOT (2 EIGHT BIT, 6 SIXTEEN BIT) AT MOTHERBOARD
- HARDWARE SELECTION OF 6 OR 8 MHz
- 1 WAIT STATE
- KEYLOCK SUPPORTED, RESET SWITCH, FRONT PANEL LED INDICATOR
- SOCKETS FOR 1 MB OF RAM AND 80287
- BATTERY BACKED CLOCK

MCT-BATMB MINI 80286 **\$42995**

- REPLACEMENT BOARD FOR XT STYLE CHASSIS
- OPERATE AT 6/10 MHz WITH UP TO 1MB ON-BOARD MEMORY (ZERO K INSTALLED)
- SOCKET FOR 80287 MATH CO-PROCESSOR
- BATTERY BACKED CLOCK
- 8 SLOTS: 2 EIGHT BIT, 6 SIXTEEN BIT
- USES CHIPS & TECHNOLOGY CHIP SET FOR RELIABILITY AND SMALL SIZE

IBM COMPATIBLE KEYBOARDS



MCT-5339 **\$7995**

- IBM ENHANCED STYLE LAYOUT
- SOFTWARE AUTONSENSE FOR XT OR AT COMPATIBLES
- LED INDICATORS
- AUTO REPEAT FEATURE
- SEPARATE CURSOR PAD

MCT-5060 **\$5995**

- IBM AT STYLE LAYOUT
- SOFTWARE AUTONSENSE FOR XT OR AT COMPATIBLES
- LED INDICATORS
- AUTO REPEAT FEATURE

MCT-5150 XT STYLE LAYOUT **\$4995**

MCT-5151 KB5151 EQUIV. **\$6995**

WHY BUY A SYSTEM FROM JDR?

- * BUILD IT YOURSELF AND SAVE
- * QUALITY COMPONENTS AT COMPETITIVE PRICES
- * TOLL FREE TECHNICAL SUPPORT IN THE U.S. AND CANADA
- * MONEY BACK GUARANTEE (ASK FOR DETAILS)
- * MORE THAN 10,000 SOLD!

I am very pleased with the computer system I purchased from you and all the outstanding support and courteous people on your staff. Your attitude & commitment to customer satisfaction is exceptional. YOUR ATTITUDE SHOULD BE INDUSTRY STANDARD!

Daryl Hammond

BUILD YOUR OWN 256K XT COMPATIBLE

- * MOTHERBOARD
- * 256K OF MEMORY
- * 135 WATT POWER SUPPLY
- * FLIP-TOP CASE
- * 5060 STYLE KEYBOARD
- * 360K FLOPPY DRIVE
- * DRIVE CONTROLLER
- * MONOCHROME MONITOR
- * GRAPHICS ADAPTOR

FOR ONLY \$49915

ANYONE CAN BUILD A SYSTEM IN ABOUT 2 HOURS USING A SCREWDRIVER AND OUR EASY-TO-FOLLOW INSTRUCTIONS!



DEVELOPMENT TOOLS

FROM MODULAR CIRCUIT TECHNOLOGY

MCT-EPRM PROGRAMMER **\$12995**

PROGRAMS 27xx & 27xxx EPROMS UP TO 27512

- SUPPORTS VARIOUS PROGRAMMING FORMATS AND VOLTAGES
- SPLIT OR COMBINE CONTENTS OF SEVERAL EPROMS OF DIFFERENT SIZES
- READ, WRITE, COPY, ERASE CHECK AND VERIFY
- SOFTWARE FOR HEX AND INTEL HEX FORMATS

MCT-EPRM-4 4 8ANG PROGRAMMER **\$18995**

MCT-EPRM-10 10 8ANG PROGRAMMER **\$29995**

MCT-PAL PAL PROGRAMMER **\$26995**

MCT-MP PROCESSOR PROG. **\$19995**

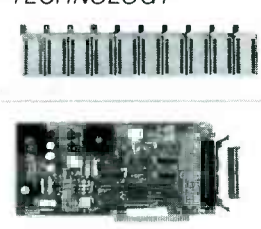

CALL FOR VOLUME QUOTES COPYRIGHT 1987 JDR MICRODEVICES

CIRCLE 183 ON FREE INFORMATION CARD

NATIONAL SEMICONDUCTOR • PANASONIC MACHINE • EWC, INC. • INTERSIL • AD EAC, INC. • J. W. MILLER • AAVIS ENGINEER • E. F. JOHNSON • ATLANTIC SEMICONDUCTOR

256K (262,144 x 1) DRAM 150NS \$5.70/1; \$39.95/9

Factory Firsts

DIODES • DIAMOND CUT • UNGAR • ES • CW INDUSTRIES • AMDEK • L.G. YGAR • YAGEO • J. W. MILLER • LUO • 3C CHEMICALS • ARIES • PLESSEY

INTEGRATED CIRCUITS

Part No.	Price
7400 TTL	1.50
7400N	1.50
7401 TTL	1.50
7401N	1.50
7402 TTL	1.50
7402N	1.50
7403 TTL	1.50
7403N	1.50
7404 TTL	1.50
7404N	1.50
7405 TTL	1.50
7405N	1.50
7406 TTL	1.50
7406N	1.50
7407 TTL	1.50
7407N	1.50
7408 TTL	1.50
7408N	1.50
7409 TTL	1.50
7409N	1.50
7410 TTL	1.50
7410N	1.50
7411 TTL	1.50
7411N	1.50
7412 TTL	1.50
7412N	1.50
7413 TTL	1.50
7413N	1.50
7414 TTL	1.50
7414N	1.50
7415 TTL	1.50
7415N	1.50
7416 TTL	1.50
7416N	1.50
7417 TTL	1.50
7417N	1.50
7418 TTL	1.50
7418N	1.50
7419 TTL	1.50
7419N	1.50
7420 TTL	1.50
7420N	1.50
7421 TTL	1.50
7421N	1.50
7422 TTL	1.50
7422N	1.50
7423 TTL	1.50
7423N	1.50
7424 TTL	1.50
7424N	1.50
7425 TTL	1.50
7425N	1.50
7426 TTL	1.50
7426N	1.50
7427 TTL	1.50
7427N	1.50
7428 TTL	1.50
7428N	1.50
7429 TTL	1.50
7429N	1.50
7430 TTL	1.50
7430N	1.50
7431 TTL	1.50
7431N	1.50
7432 TTL	1.50
7432N	1.50
7433 TTL	1.50
7433N	1.50
7434 TTL	1.50
7434N	1.50
7435 TTL	1.50
7435N	1.50
7436 TTL	1.50
7436N	1.50
7437 TTL	1.50
7437N	1.50
7438 TTL	1.50
7438N	1.50
7439 TTL	1.50
7439N	1.50
7440 TTL	1.50
7440N	1.50
7441 TTL	1.50
7441N	1.50
7442 TTL	1.50
7442N	1.50
7443 TTL	1.50
7443N	1.50
7444 TTL	1.50
7444N	1.50
7445 TTL	1.50
7445N	1.50
7446 TTL	1.50
7446N	1.50
7447 TTL	1.50
7447N	1.50
7448 TTL	1.50
7448N	1.50
7449 TTL	1.50
7449N	1.50
7450 TTL	1.50
7450N	1.50
7451 TTL	1.50
7451N	1.50
7452 TTL	1.50
7452N	1.50
7453 TTL	1.50
7453N	1.50
7454 TTL	1.50
7454N	1.50
7455 TTL	1.50
7455N	1.50
7456 TTL	1.50
7456N	1.50
7457 TTL	1.50
7457N	1.50
7458 TTL	1.50
7458N	1.50
7459 TTL	1.50
7459N	1.50
7460 TTL	1.50
7460N	1.50
7461 TTL	1.50
7461N	1.50
7462 TTL	1.50
7462N	1.50
7463 TTL	1.50
7463N	1.50
7464 TTL	1.50
7464N	1.50
7465 TTL	1.50
7465N	1.50
7466 TTL	1.50
7466N	1.50
7467 TTL	1.50
7467N	1.50
7468 TTL	1.50
7468N	1.50
7469 TTL	1.50
7469N	1.50
7470 TTL	1.50
7470N	1.50
7471 TTL	1.50
7471N	1.50
7472 TTL	1.50
7472N	1.50
7473 TTL	1.50
7473N	1.50
7474 TTL	1.50
7474N	1.50
7475 TTL	1.50
7475N	1.50
7476 TTL	1.50
7476N	1.50
7477 TTL	1.50
7477N	1.50
7478 TTL	1.50
7478N	1.50
7479 TTL	1.50
7479N	1.50
7480 TTL	1.50
7480N	1.50
7481 TTL	1.50
7481N	1.50
7482 TTL	1.50
7482N	1.50
7483 TTL	1.50
7483N	1.50
7484 TTL	1.50
7484N	1.50
7485 TTL	1.50
7485N	1.50
7486 TTL	1.50
7486N	1.50
7487 TTL	1.50
7487N	1.50
7488 TTL	1.50
7488N	1.50
7489 TTL	1.50
7489N	1.50
7490 TTL	1.50
7490N	1.50
7491 TTL	1.50
7491N	1.50
7492 TTL	1.50
7492N	1.50
7493 TTL	1.50
7493N	1.50
7494 TTL	1.50
7494N	1.50
7495 TTL	1.50
7495N	1.50
7496 TTL	1.50
7496N	1.50
7497 TTL	1.50
7497N	1.50
7498 TTL	1.50
7498N	1.50
7499 TTL	1.50
7499N	1.50
7500 TTL	1.50
7500N	1.50

INTEGRATED CIRCUITS

Part No.	Price
4000 CMOS	1.50
4001 CMOS	1.50
4002 CMOS	1.50
4003 CMOS	1.50
4004 CMOS	1.50
4005 CMOS	1.50
4006 CMOS	1.50
4007 CMOS	1.50
4008 CMOS	1.50
4009 CMOS	1.50
4010 CMOS	1.50
4011 CMOS	1.50
4012 CMOS	1.50
4013 CMOS	1.50
4014 CMOS	1.50
4015 CMOS	1.50
4016 CMOS	1.50
4017 CMOS	1.50
4018 CMOS	1.50
4019 CMOS	1.50
4020 CMOS	1.50
4021 CMOS	1.50
4022 CMOS	1.50
4023 CMOS	1.50
4024 CMOS	1.50
4025 CMOS	1.50
4026 CMOS	1.50
4027 CMOS	1.50
4028 CMOS	1.50
4029 CMOS	1.50
4030 CMOS	1.50
4031 CMOS	1.50
4032 CMOS	1.50
4033 CMOS	1.50
4034 CMOS	1.50
4035 CMOS	1.50
4036 CMOS	1.50
4037 CMOS	1.50
4038 CMOS	1.50
4039 CMOS	1.50
4040 CMOS	1.50
4041 CMOS	1.50
4042 CMOS	1.50
4043 CMOS	1.50
4044 CMOS	1.50
4045 CMOS	1.50
4046 CMOS	1.50
4047 CMOS	1.50
4048 CMOS	1.50
4049 CMOS	1.50
4050 CMOS	1.50
4051 CMOS	1.50
4052 CMOS	1.50
4053 CMOS	1.50
4054 CMOS	1.50
4055 CMOS	1.50
4056 CMOS	1.50
4057 CMOS	1.50
4058 CMOS	1.50
4059 CMOS	1.50
4060 CMOS	1.50
4061 CMOS	1.50
4062 CMOS	1.50
4063 CMOS	1.50
4064 CMOS	1.50
4065 CMOS	1.50
4066 CMOS	1.50
4067 CMOS	1.50
4068 CMOS	1.50
4069 CMOS	1.50
4070 CMOS	1.50
4071 CMOS	1.50
4072 CMOS	1.50
4073 CMOS	1.50
4074 CMOS	1.50
4075 CMOS	1.50
4076 CMOS	1.50
4077 CMOS	1.50
4078 CMOS	1.50
4079 CMOS	1.50
4080 CMOS	1.50
4081 CMOS	1.50
4082 CMOS	1.50
4083 CMOS	1.50
4084 CMOS	1.50
4085 CMOS	1.50
4086 CMOS	1.50
4087 CMOS	1.50
4088 CMOS	1.50
4089 CMOS	1.50
4090 CMOS	1.50
4091 CMOS	1.50
4092 CMOS	1.50
4093 CMOS	1.50
4094 CMOS	1.50
4095 CMOS	1.50
4096 CMOS	1.50
4097 CMOS	1.50
4098 CMOS	1.50
4099 CMOS	1.50
4100 CMOS	1.50

T.I.C. SOCKETS

Part No.	Price
11	1.15
12	1.15
13	1.15
14	1.15
15	1.15
16	1.15
17	1.15
18	1.15
19	1.15
20	1.15
21	1.15
22	1.15
23	1.15
24	1.15
25	1.15
26	1.15
27	1.15
28	1.15
29	1.15
30	1.15
31	1.15
32	1.15
33	1.15
34	1.15
35	1.15
36	1.15
37	1.15
38	1.15
39	1.15
40	1.15
41	1.15
42	1.15
43	1.15
44	1.15
45	1.15
46	1.15
47	1.15
48	1.15
49	1.15
50	1.15
51	1.15
52	1.15
53	1.15
54	1.15
55	1.15
56	1.15
57	1.15
58	1.15
59	1.15
60	1.15
61	1.15
62	1.15
63	1.15
64	1.15
65	1.15
66	1.15
67	1.15
68	1.15
69	1.15
70	1.15
71	1.15
72	1.15
73	1.15
74	1.15
75	1.15
76	1.15
77	1.15
78	1.15
79	1.15
80	1.15
81	1.15
82	1.15
83	1.15
84	1.15
85	1.15
86	1.15
87	1.15
88	1.15
89	1.15
90	1.15
91	1.15
92	1.15
93	1.15
94	1.15
95	1.15
96	1.15
97	1.15
98	1.15
99	1.15
100	1.15

1/2 Watt Carbon Film Resistors

Part No.	Price
100	1.15
101	1.15
102	1.15
103	1.15
104	1.15
105	1.15
106	1.15
107	1.15
108	1.15
109	1.15
110	1.15
111	1.15
112	1.15
113	1.15
114	1.15
115	1.15
116	1.15
117	1.15
118	1.15
119	1.15
120	1.15
121	1.15
122	1.15
123	1.15
124	1.15
125	1.15
126	1.15
127	1.15
128	1.15
129	1.15
130	1.15
131	1.15
132	1.15
133	1.15
134	1.15
135	1.15
136	1.15
137	1.15
138	1.15
139	1.15
140	1.15
141	1.15
142	1.15
143	1.15
144	1.15
145	1.15
146	1.15
147	1.15
148	1.15
149	1.15
150	1.15

DISC CAPACITORS

Part No.	Price
100	1.15
101	1.15
102	1.15
103	1.15
104	1.15
105	1.15
106	1.15
107	1.15
108	1.15
109	1.15
110	1.15
111	1.15
112	1.15
113	1.15
114	1.15
115	1.15
116	1.15
117	1.15
118	1.15
119	1.15
120	1.15
121	1.15
122	1.15
123	1.15
124	1.15
125	1.15
126	1.15
127	1.15
128	1.15
129	1.15
130	1.15
131	1.15
132	1.15
133	1.15
134	1.15
135	1.15
136	1.15
137	1.15
138	1.15
139	1.15
140	1.15
141	1.15
142	1.15
143	1.15
144	1.15
145	1.15
146	1.15
147	1.15
148	1.15
149	1.15
150	1.15

TANTALUM CAPACITORS

Part No.	Price
100	1.15
101	1.15
102	1.15
103	1.15
104	1.15
105	1.15
106	1.15
107	1.15
108	1.15
109	1.15
110	1.15
111	1.15
112	1.15
113	1.15
114	1.15
115	1.15
116	1.15
117	1.15
118	1.15
119	1.15
120	1.15
121	1.15
122	1.15
123	1.15
124	1.15
125	1.15
126	1.15
127	1.15
128	1.15
129	1.15
130	1.15
131	

MERRY CHRISTMAS

MULTI-PURPOSE MELODY GENERATOR
 This multipurpose melody generator is made with the latest CMOS LSI technology. Operating on a very low current, it can play 8-10 different songs by using two AA sized batteries (DC3V). Applications include their uses in electronic door bells, musical box and electronic clock alarm and many more. Better still, you can choose between 3 models both containing 8-10 popular, melodious tunes.

- TA-50A/B/C**
- Jingle Bell
 - Silent night
 - Rudolph, the red nosed reindeer
 - O come, All ye faithful
 - Santa Claus is coming to town
 - Joy to the world
 - I wish you a merry X'mas
 - Hark, the herald Angels sing
 - London Bridge is falling Down
 - Are you Sleeping
 - Joy Symphonny
 - Wipe away
 - Flow your Boat
 - Happy Birthday
 - Home sweet home
 - Melody on purple bamboo
 - Leau Vive (Living Water)
 - Home on the Range
 - Romance De Amor
 - Comin' Thro' The Ring
 - Wedding march
 - Happy Birthday
 - Humoresque
 - Lorelei
 - The Last Rose of summer
 - Love Song From Sings

COLOR LIGHT CONTROLLER TY-23B

As a result of the advanced technology, this unit can control various colorful spot lights or bulbs. The visual effect of which is most suitable in places like party, disco, electronic game centre and also in lightings for advertisements. Total output power is 3000W (1000W/Ch.) which can control 30 pieces of 100W or 600 pieces of 5W color light bulbs.

- TA-50A/B** \$10.75
TA-50C \$11.50
- ONLY KIT**
- TA-800** \$55.38
METAL CABINET/X'FORMER \$26/\$16.80

SUPERIOR ELECTRONIC ROULETTE



TY-47
 KIT \$16.92

TALKING CLOCKS that really tell time!

GREAT CHRISTMAS IDEA

No. 8502 No. 8501 No. 8504

- Talk: push button for voice announcement of time
- Read out: twelve hours system display for hour, minute, second (by color flash), AM & PM.
- Display: three display modes of time, alarm time & date.
- Alarm: on a flip switch with thirty seconds voice alarm.
- Snooze: reminder voice alarm of thirty seconds after 4 minutes of first vocal alarm.
- Volume: two level of voice output.
- Language available: English.

PARROT 8501.....\$17.75
 COCKATOO 8502.....\$15.90 NOT A KIT!
 MYNAH 8504.....\$16.90

SPECIAL VALUE

BOW + 80W DC LOW TIM PRE-MAIN POWER AMPLIFIER

BUILD A 160W HI-FI STEREO AMP - YOURSELF

FREE 1988 MARK V CATALOG

LCD THERMOMETER CLOCK

It reads temp. in all sensitive areas

NEW

Features:
 0.34" DIGITAL thermometer with Hi & Low temperature alarm function and 12 hours clock combination
 Measuring range: 0°F to 160°F or -20°C to +70°C
 Resolution reading: ±1.8°F
 Dimensions: 3.2" x 0.86" x 2.08"

T-1 with In/Out Door sensor.....\$20.00
 T-2 with Fahrenheit/Celsius measuring.....\$18.00 NOT A KIT

STEREO SIMULATOR TA-3000

UP GRADE YOUR TV & VCR

ONLY \$25

You can own a stereo TV from today! This simulator is special design of using the most advanced monopolized L.S.I. it produced a superior analog stereo effect since the L.S.I. is equalled 60 pcs. of LOW NOISE FET & TRANSISTOR. The simulator can even help you to promote your television from a normal one to a special one with a Hi-Fi STEREO function. Our simulator is also applicable to any other 'mono sources' in covering it to ANALOG STEREO. Undoubtedly, it is the most advanced equipment for every family, while it should contribute to your listening pleasure.

Ass. with tested.....\$30.00

PROFESSIONAL COLOR LIGHT CONTROLLER SM-328

FEATURES

- FOUR GROUPS OF INDEPENDENT OUTPUT SYSTEM 1000W/CH MAX 480W (1100/117V)
- PROFESSIONAL COLOR CONTROL SYSTEM (KEY BOARD TYPE) 3 INDEPENDENT INPUT SIGNAL ADJUSTMENT
- FOUR GROUPS OF INDEPENDENT DIMMER CONTROL
- SPEED CONTROL CHASER & AUTOMATIC CHASING CONTROL SYSTEM
- FOUR KINDS OF SPECIAL CHASING PROGRAM B. COMBINATION OF PROGRAM AND MUSIC CHASING EFFECT
- FORWARD BACKWARD CHASING CONTROL
- SM-328 color light controller is specialized for ballroom, night club disco and advertisement lighting. It consorts with several color control characteristics, which employ professional color control system and keyboard program selection. Therefore, it is capable of producing lighting effects by using chasing program and fluctuating music signal. There are two kinds of lighting effects. The first type is controlled by 'music' signal. In order to adjust the brightness of four groups of lightings, each music signal will be separated into high medium low A, and low B frequency range. Furthermore, each group of lightings is incorporated with an independent signal adjustment. The second kind is composed of electrical circuits and this is the main part for creating a special lighting effect. It has four chasing programme.

Dimensions: 14 5/16" x 8 15/16" x 3 1/16"
 Ass. with tested \$150.00 **ONLY**

ELECTRONIC ECHO AND REVERBERATION AMPLIFIER TA-2800A

RECORDS W/ ECHO EFFECT YOURSELF!

Ass. with tested.....\$99.85

NF-CR BI-FET PRE-AMP TA-2800

WITH TREBLE, MID-RANGE AND BASS 3 WAY TONE CONTROL

ONLY \$44.50

100W DYNAMIC CLASS "A" MAIN POWER AMPLIFIER

OVER 5000'S SOLD!

TA-1000A
 KIT \$51.95
 METAL CABINET/X'FORMER \$26/\$16.80

HIGH QUALITY PRE-AMPLIFIER WITH 10 BAND EQUALIZER TA-2500

NEW with CD input stage

Ass. with tested.....\$90.00

Model No	Description	Kit/Assembled	Unit Price	SM-328	PROFESSIONAL COLOR LIGHT CONTROLLER	Assm	\$150.00
TA-006	5W MINI AMPLIFIER	Kit	\$ 4.92	TR-100A	0-15V 2A REGULATED DC POWER SUPPLY	Kit/Assm	\$ 59.50/69.50
TA-007	12W STEREO POWER BOOSTER	Kit	\$ 6.28	TR-355A/B	3-5A REGULATED DC POWER SUPPLY	Kit	\$ 10.68
TA-008	AC/DC SHOULDER AMPLIFIER	Assm	\$ 48.00	TR-503	0-15V/3A POWER SUPPLY WITH SHORT CIRCUIT BREAK & OVERLOAD PROTECTOR	Kit	\$ 12.30
TA-50A/B	MULTI-PURPOSE MELODY GENERATOR	Kit	\$ 10.76	TY-1A MK4	BATTERY FLUORESCENT LIGHT DRIVER	Kit	\$ 3.99
TA-50C	MULTI-PURPOSE MELODY GENERATOR	Kit	\$ 11.50	TY-7	ELECTRONIC TOUCH SWITCH	Kit	\$ 5.50
TA-10	STEREO PRE-AMP WITH MAGNETIC MIC AMP.	Kit	\$ 6.00	TY-11A	MULTI-FUNCTIONAL CONTROL SWITCH	Kit	\$ 3.99
TA-250 MK2	PURE CLASS "A" MAIN POWER AMP. (MONO)	Kit	\$ 25.00	TY-12A	DIGITAL CLOCK WITH TIMER	Kit	\$ 13.86
TA-300	30W MULTI-PURPOSE SINGLE CHANNEL AMP.	Kit/Assm	\$ 50.00/60.00	TY-13	COLOR LED AUDIO LEVEL METER	Kit	\$ 17.50
TA-302	60W VERSATILE STEREO POWER BOOSTER	Kit	\$ 29.50	TY-14	ELECTRONIC SHOCK	Kit	\$ 9.00
TA-323A	HIGH QUALITY 30W + 30W STEREO AMP.	Kit	\$ 29.50	TY-18	HIGH PRECISION SOUND CONTROL SWITCH	Kit	\$ 7.68
TA-322 I	50W + 50W IC STEREO AMP. WITH LED LEVEL DISPLAY	Kit/Assm	\$ 55.00/65.00	TY-20	V SHAPE COLOR LED LEVEL METER	Kit	\$ 19.50
TA-377A	FULLY COMPLEMENTARY & SYMMETRICAL FET STEREO PRE-AMP.	Kit	\$ 13.84	TY-23B	COLOR LIGHT CONTROLLER	Kit/Assm	\$ 66.00/75.00
TA-400	40W SOLID STATE MONO AMP.	Kit	\$ 61.28	TY-25	STEREO LOUDSPEAKER PROTECTOR	Kit	\$ 7.68
TA-477	120W MOSFET POWER AMP. (MONO)	Kit	\$ 60.00	TY-35	FM WIRELESS MICROPHONE	Kit	\$ 16.92
TA-720	72W + 72W AC/DC STEREO HI-FI & PA AMP.	Kit	\$ 59.38	TY-38	AC/DC QUARTZ DIGITAL CLOCK	Kit	\$ 10.00
TA-800	80W + 80W DC LOW TIM PRE-MAIN POWER AMP.	Kit	\$ 39.95	TY-41 MKV	SOUND OR TOUCH CONTROL SWITCH	Kit/Assm	\$ 30.00/45.00
TA-802	80W + 80W PURE DC STEREO MAIN POWER AMP.	Kit	\$ 43.00	TY-42	INFRARED REMOTE CONTROL UNIT	Kit	\$ 21.00
TA-820A	60W + 60W OCL DC PRE-MAIN STEREO AMP.	Kit	\$ 51.95	TY-43	BAR/DOOT LEVEL METER	Kit	\$ 30.00
TA-1000A	1000W DYNAMIC CLASS "A" MAIN POWER AMP. (MONO)	Kit	\$ 67.00	TY-45	3/4 DIGITAL PANEL METER	Kit	\$ 34.95
TA-1500	100W + 100W NEW CLASS "A" DC STEREO PRE-MAIN AMP.	Kit	\$ 60.00/99.85	TY-27	20 STEPS BAR/DOOT AUDIO LEVEL DISPLAY KIT	Kit	\$ 16.92
TA-2400A	HO MULTI-PURPOSE PRE-AMP. WITH 10 BAND GRAPHIC EQ	Assm	\$ 90.00	YAMATO 4001	SUPERIOR ELECTRONIC ROULETTE	@ SET	\$ 33.80
TA-2500	HO MULTI-PURPOSE PRE-AMP. WITH 10 BAND GRAPHIC EQ	Kit	\$ 44.50	T1	3/4 DIGITAL MULTIMETER	@ SET	\$ 20.00
TA-2800	HI-FI BI-FET PRE-AMP. (WITH 3 WAY TONE CONTROL)	Kit/Assm	\$ 25.00/30.00	T2	LCD THERMOMETER CLOCK W/OUT DOOR SENSOR	@ SET	\$ 18.00
TA-3000	STEREO SIMULATOR	Kit/Assm	\$ 20.00/26.00	8501	LCD THERMOMETER CLOCK W/ °C MEASURING	@ SET	\$ 18.00
SM-43	3/4 MULTI-FUNCTIONAL LED D.P.M.	Kit/Assm	\$ 38.00/48.00	8502	TALKING CLOCK (PARROT)	@ SET	\$ 15.90
SM-48	4 1/4 HI-PRECISION D.P.M.	Kit/Assm	\$ 41.00/51.00	8504	TALKING CLOCK (COCKATOO)	@ SET	\$ 16.90
SM-48A	4 1/4 HI-PRECISION D.P.M. (WITH QIN. STANDARD ABS CASE)	Kit/Assm	\$ 41.00/51.00	620	TALKING CLOCK (MYNAH, GOLDEN OR BLACK)	@ SET	\$ 16.90
SM-100	150 MC DIGITAL FREQUENCY COUNTER	Assm	\$ 99.00		CORDESS SOLDERING IRON (RECHARGEABLE)	@ SET	\$ 22.80

WE ALSO SUPPLY HIGH POWER TRANSFORMERS AND PROFESSIONAL LOOKING METAL CABINETS FOR OUR KITS, PLEASE REFER TO OUR CATALOG!

MARK V ELECTRONICS INC.,
 248 EAST MAIN STREET, SUITE 100
 ALHAMBRA, CA 91801
 TELEX 3716914 MARK 5

1-800-423-3483
 TOLL FREE
 Only for orders paid by Master or Viscard

INFORMATION: 1-818-282-1196
 MAIL ORDER: P.O. BOX 6610
 ALHAMBRA, CA91802

CIRCLE 93 ON FREE INFORMATION CARD

www.americanradiohistory.com

What's New at AMERICAN DESIGN COMPONENTS?

"The Source" of the
electro-mechanical components
for the hobbyist.

We warehouse 60,000 items at American Design Components - expensive, often hard-to-find components for sale at a fraction of their original cost!

You'll find every part you need - either brand new, or removed from equipment (RFE) in excellent condition. But quantities are limited. Order from this ad, or visit our retail showroom and find exactly what you need from the thousands of items on display.

OPEN MON. - Sat., 9-5

THERE'S NO RISK.

With our full 90-day warranty, any purchase can be returned for any reason for full credit or refund.

ADAM COMPUTER

(Less printer)
No wiring necessary (just plugs together). Hook-up diagram included. Includes: Keyboard, 1 cassette digital data drive, 2 game controllers, power supply, & one cassette. Capable of running CP/M, has built-in word processor.



Item #7410 Complete - \$99.00

ADAM 5 1/4" DISK DRIVE

Gives your Adam fast, reliable data storage & retrieval. Can hold up to 160K bytes of information. Uses industry-standard SS/DD disks. Connects directly to your Adam memory console. Comes w/disk drive power supply, Disk Manager disk and owner's manual.



Mfr - Coleco, model 7817
Item #12830 Like New - \$199.00

ADAM PRINTER

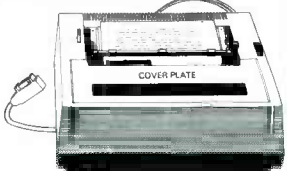

Complete, less top cover plate. Friction feed. Takes standard paper 8 1/2" x 11". (Customer returns; tested - operational.)
Item #8839 \$69.50

ADAM Accessories . . .

Data Drive - Item #6641 \$19.95

Printer Power Supply - Item #6642 \$14.95

ASCII Keyboard - Item #6643 \$19.95

Controllers - (Set of 4) Item #7013 \$9.95

Adam Cassettes - (Consisting of Smart Basic, Buck Rogers & blank cassette.) Item #7786

BAKER'S DOZEN - \$19.95

Adam Link Modem - (Software included.) Item #12358 \$29.95

Auto-Dialer - Item #12365 \$19.95

Adam Daisy Print Wheel - Item #13305 \$3.95

Adam Ribbon Cartridge - Item #13306 \$3.95

Disk Drive Power Supply - Item #14603 \$14.95

5 1/4" 10Mb HARD DISK DRIVE



(IBM® Compat.)
Fits standard 5 1/4" spacing. Shock mtd. High speed, low power.
Mfr - Seagate/Tandon
Item #13250 \$159.00 New
Controller Card for above
Item #10150 \$89.00

5 1/4" FULL HT. DISK DRIVES



48 TPI (IBM® Compat.)
Double sided/double density, full height drive. 48 T.P.I., 80 tracks.
Mfr - Tandon TM100-2
Item #7928 \$79.00
2 for \$150.00
96 TPI, DS/Quad Density
Mfr - CDC #9409T
Item #1893 \$99.00

5 1/4" 1/2 HT. DISK DRIVES



48/96 TPI 1.2 Mb. (AT Compat.)
DS/single double density; 80 track.
Mfr - Panasonic #JU-475
Item #10005 \$119.00 New
96 TPI, DS/Quad Density (DOS 3.2 Compatible)
Tandon TM55-4; DS/Quad
Item #1904 \$79.00
2 for \$150.00

5" COMPOSITE VIDEO MONITOR



Power regulated, 12VDC. Mtd. in plastic cabinet, w/brightness control knob. Mfr - Sperry
OA Dim.: 8"W x 8"H x 8 3/4" deep
Item #14536 \$24.95

5 1/4" FLOPPY DISKETTES



Single side/single density; 16 hard sectors. Mfr - Xerox #11R61630
Item #14537
Pack of 10 \$9.95 New

115 CFM MUFFIN FAN With Adjustable Speed Control



115 VAC/60 Hz., 21W., 28A., 3100 RPM; 5-blade model, aluminum housing. Can be mounted for blowing or exhaust.
Dim.: 4 1/8" sq. x 1 1/2" deep.
Item #5345S \$8.95

27 CFM MINI FANS



115VAC; 50/60Hz.; 12W. Low noise level fans, can be mtd. for blowing or exhaust.
1 1/2" STANDARD
7 metal blades
Dim.: 3 1/8" sq. x 1 1/2" deep
NEW - Rotron #SU2A1
Item #5970 \$7.95
USED - Rotron
Item #1873 \$5.95

12/24 VDC MUFFIN-TYPE FANS



55/100 CFM
8 W. Can be mounted for blowing or exhaust. Aluminum housing, brushless, ball-bearing type.
1" Thin: 5 plastic blades with feathered edges.
Mfr - Centaur #CUDC24K4-601
Item #8541 \$19.95 New
1 1/2" Standard: 5 plastic blades
Mfr - Centaur #CUDC24K4-601
Item #12109 \$14.95 RFE

American's IBM PC/XT-COMPATIBLE COMPUTER . . .

- Contains:
- 256K RAM;
 - XT/AT Style Keyboard;
 - 5 1/4" Full-Height Floppy Disk Drive
 - 10Mb Full-Height Hard Disk Drive
 - Hard Disk & Floppy Disk Controller Cards
 - Color/Monochrome Monitor Card (monitor not included).



Item #14331
\$549.95 New

MAGNIFYING LAMP



Multi position, 30", completely adjustable swing arm w/3-way metal C-clamp. Has 4" diopter magnifying lens, ruler. Porcelain lamp socket, & on/off switch; uses up to a 60W bulb. Color: Beige. UL listed.
Item #13136 \$24.95 New

BATTERIES - FANS - BLOWERS

GELL CELL/LEAD ACID BATTERIES . . .

RECHARGEABLE - Used for solar energy storage, alarm systems, remote control boats, robots, etc.



6V @ 7.5AH
Dim.: 5 7/8" L x 3 3/8" W x 2"D
Mfr - EPC #0031
Item #13324 \$5.95

6V @ 2.6AH
Dim.: 5 1/4" L x 2 3/4" W x 1 1/4" D
Mfr - EPC #0030
Item #13326 \$3.95

12V @ 4.5AH
Dim.: 6" L x 3 3/8" W x 2 1/2" D
Mfr - EPC #0027
Item #13325 \$7.95

12V @ 2.6AH
Dim.: 5 1/4" L x 3 3/8" W x 2 1/8" D
Mfr - EPC #0026
Item #13323 \$5.95

12V @ 1.2AH
Dim.: 3 3/4" L x 2 3/4" H x 1 3/4" D
Mfr - EPC #0025
Item #13327 \$3.95

COLECOVISION GAME

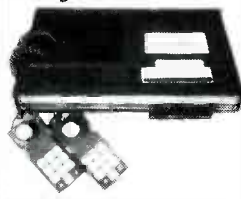

(Factory returns - tested good!)

Also includes power supply, instruction manual, modulator, and one Donkey Kong cartridge.
Item #7411 \$29.95

COLECOVISION Accessories . . .

ColecoVision to Adam Expansion Kit
Just plugs into your ColecoVision.
Item #9918 \$59.50

Expansion Module #2
Incl. Turbo cart.
Item #13146 \$39.95 New

Roller Controller
Incl. Slither cart.
Item #13147 \$39.95 New

Super Action Controller Set
Incl. Baseball cart.
Item #13148 \$39.95 New

TIMEX-SINCLAIR 1000 & ZX-81 CASSETTES

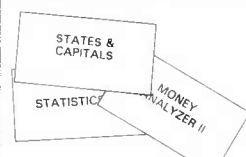

Consists of 13 assorted cassettes. May include: Money Analyzer II, States & Capitals, Casino Craps, Statistics, The Carpenter, and others.
Item #14651
Set of 13 \$19.95 New

PLUG-IN POWER SUPPLIES

COMPUTER/GAME ADAPTOR
Output: +5 VDC, .9A
 -5 VDC, .1A
 +12 VDC, .3A
Input: 120 VAC/60 Hz., .25A
Mfr - Coleco #55416
Item #1882 \$4.95 New

9VDC ADAPTOR
Input: 115 VAC, 50/60 Hz.
Output: 9.5V @ 1A.
Dim.: 2 1/2" W x 3 3/8" H x 2" deep
Mfr: Commodore #251539-01/02
Item #9393 \$5.95 New

NEON TRANSFORMER (Hi-Voltage)



7300 VAC @ 5 Ma.
May be used for powering neon lights, replacing oil burner ignition transformer, building Jacob's ladder (spark gap). A high-volt. output: 1/4 quick connect terminal & case ground input fully enclosed metal case. Weight: 12 lbs.
Base mount: 4 1/2" H x 5 1/8" W x 6 7/8" D
Item #151 \$9.95 RFE

NICAD BATTERIES (Rechargeable)

12V @ 450 ma
Contains 10 AA cells. Recharge rate: 45 ma. 16-18 hours.
Dim.: 2 1/8" H x 1 1/4" W x 2 1/8" L
Mfr - GE 123233 or equiv.
Item #5443 \$5.95 New

"D" CELLS

Dual Pack 2.4V @ 1.2Ah
2 D cells, stacked & series connected (easily ganged for carrying). Recharge in 12-14 hrs. OA
Dim.: 1 1/2" dia. x 4 3/4" L
Item #12142 (pack of 2) \$5.95
(Major mfrs.) 5 packs/\$25.00

**SEND FOR
FREE
1987 CATALOG**
OUR NEW MAILING
ADDRESS IS:
P.O. BOX 567
VAN NUYS, CA 91408
800-826-5432

QUALITY PARTS * DISCOUNT PRICES * FAST SHIPPING!

ALL ELECTRONICS CORP. ALL ELECTRONICS CORP.

BLACKLIGHT ASSEMBLY

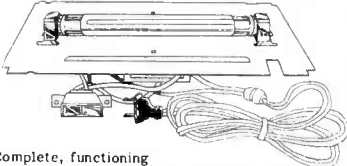

Complete, functioning assembly includes ballast, on-off switch, power cord, sockets and F4T5-BL blacklight. Mounted on a 7 1/8" X 3 1/8" X 7/8" metal plate. Use for special effects lighting or erasing EPROMS.

CAT# BLTA \$10.00 EACH

1mA METER

Modutec 0-1 mA signal strength meter with KLM logo. 1/4" X 1 3/4" X 7/8" deep.

CAT# MET-2 \$2.00 each



NI-CAD CHARGER/TESTER

DELUXE universal charger and tester for almost every size Ni-cad battery available.

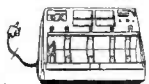

CAT# UNCC-N \$15.00 each

RECHARGEABLE NI-CAD BATTERIES

- AAA SIZE 1.25V 180MAH \$2.25
- AA SIZE 1.25V 500MAH \$2.00
- AA with solder tabs \$2.20
- C SIZE 1.2V 1200MAH \$4.25
- SUB-C SIZE solder tab \$4.25
- D SIZE 1.2V 1200MAH \$4.25

COMPUTER GRADE CAPACITORS

- 1,400 MFD 200 VDC
2" dia. X 3" high
CAT# CG-1420 \$2.00
- 7,500 MFD 200 VDC
3" dia. X 4 3/4" h.
CAT# CG-75 \$4.00
- 22,000 MFD 25 VDC
2" dia. X 4 3/4" h.
CAT# CG-22 \$2.50
- 72,000 MFD 15 VDC
2" dia. X 4 3/8" h.
CAT# CG-130 \$3.50

TRANSISTORS

- 2N2222A 3 for \$1.00
- PN2222A 4 for \$1.00
- 2N2904 3 for \$1.00
- 2N2905 3 for \$1.00
- 2N3055 \$1.00 each
- PN3569 10 for \$1.00

WALL TRANSFORMER

11.5 Vdc
1.95 AMP.
Input:
120 Vac
SIZE: 3 3/4" X
2 7/8" X 2 5/8"
CAT# DCTX-11519
\$6.50 each



A/B SWITCH

JVC# PUS3593-2
High quality
A/B
switch.
Measures:
3 3/4" X 1 7/16" X 1".
75 OHMS IN/OUT
CAT# ABS-2 \$3.50 each



13.8 VDC REGULATED POWER SUPPLY

Solid state, fully regulated 13.8 Vdc power supplies. Both feature 100% solid state construction, fuse protection and LED power indicator. UL listed.

- 2 AMP CONSTANT, 4 AMP SURGE
CAT# DVP-412 \$22.50 each
- 3 AMP CONSTANT, 5 AMP SURGE
CAT# DVP-512 \$30.00 each



ELECTRET CONDENSER MIKE

Mouser# 25LMO44 Highly sensitive mini microphone. 6" wire leads. 0.39" dia. X 0.27" high. Omni directional. Operates on 2-10 Vdc @ less than 1 mA. 1K impedance. 50 to 8 K Hz range.
CAT# MKE-1 \$1.00 EACH



SLIM LINE FAN

TOYO# TF92115A New 115 Vac cooling fan. 3 5/8" square X 1" deep. Metal housing. 5 blade impeller.
CAT# SCFE-115 \$8.50 each
10 for \$75.00



2K 10 TURN

Multi-turn pot
Spectral# MOD 534-7161
CAT# MTP-10-2
\$5.00 each



VENTED PROJECT CASE

Bopla #BO 718L. Vented top and bottom. Black plastic with removable end panels. 9" X 8 1/2" X 4"
CAT# MB-718 \$12.50 each



6-12 VDC MOTOR

Mabuchi # RS-550S
Permanent magnet motor. 1 7/16" dia X 2 1/4" long 2,600 RPM @ 6 Vdc-200 mA
5,300 RPM @ 12 Vdc
CAT# DCM-7 \$3.00 each



LED'S

Standard Jumbo Diffused
T 1-3/4 Size

- RED 10 for \$1.50
CAT# LED-1 100 for \$13.00
1000 for \$110.00
- GREEN 10 for \$2.00
CAT# LED-2 100 for \$17.00
1000 for \$150.00
- YELLOW 10 for \$2.00
CAT# LED-3 100 for \$17.00
1000 for \$150.00

FLASHING LED

w/ built in flashing circuit operates on 5 Volts...

- RED \$1.00 each
CAT# LED-4 10 for \$9.50
 - GREEN \$1.00 each
CAT# LED-4G 10 for \$9.50
- BI-POLAR LED**
Lights RED one direction, GREEN the other, two leads.
CAT# LED-6 2 for \$1.70

LED HOLDERS

Two piece holder.
CAT# HLED 10 for 65c

CLIPLITE LED HOLDER
Makes L.E.D.
look like a fancy indicator



- CLEAR CAT# HLDCL-C
- RED CAT# HLDCL-R
- GREEN CAT# HLDCL-G
- YELLOW CAT# HLDCL-Y
- 4 of one color \$1.00

48 KEY ASSEMBLY



NEW T.I. KEYBOARDS. Originally used on computers, these keyboards contain 48 S.P.S.T. mechanical switches. Terminates to 15 pin connector. Frame 4" X 9"
CAT# KP-48 \$3.50 each

PUSHBUTTON PHONE

Spectra-phone Model# OP-1 1 piece telephone with rotary (pulse) output. Operates on most rotary or touch tone systems. Features last minute redial and mute button. Includes coil cord with standard modular plug. IVORY.
CAT# PHN-1 \$8.50 EACH
2 FOR \$15.00

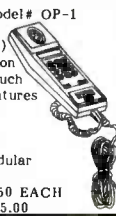

RELAYS

12 VDC-4PDT
5 amp contacts
150 ohm coil
Size: 1 1/4" X
1 3/4" X 7/8"
CAT# 4PRLY-12PC \$3.50
10 for \$30.00



10AMP SOLID STATE

Control: 3-32 Vdc
Load: 10 AMPS,
120 Vac
Size: 2 1/2" X
3/4" X 7/8"
CAT# SSRLY-10A \$9.50
10 for \$85.00



25 AMP SOLID STATE

OPTO 22# 240D25
TTL compatible.
INPUT: 3-32 VDC
OUTPUT: 25 AMPS @ 240 VAC
SIZE: 2 1/2" X 3/4" X 7/8"
CAT# SSRLY-2524 \$15.00 each



THIRD TAIL LIGHT

Sleek high-tech lamp assembly. Red lens is 2 3/4" X 5 1/2" mounted on a 4" high pedestal with up-down swivel adjustment. Has 12V replaceable bulb.
CAT# TLB \$3.95 each

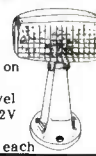

SOUND EFFECTS BOARD

P.C. board with 2 1/4" speaker, 2 LEDs, IC, battery snap, other components 2 3/8" X 3". When switch is pushed board beeps and leds light. Operates on a 9V battery (not included)
CAT# ST-3 \$1.25 each

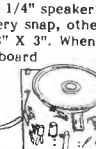

XENON FLASH TUBE

3/4" long X 1/8" dia.
CAT# FLT-1 2 for \$1.00

VIC 20 MOTHERBOARD

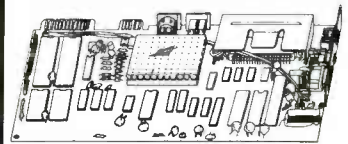

26 IC's including 6502A and 6560. 2 ea. 6522, 2 ea. 8128, 2 ea. 901486, 3 ea. 2114. Not guaranteed but great for replacement parts or experimentation.
CAT # VIC-20 \$15.00 each

SWITCHING POWER SUPPLY

Compact, well regulated switching power supply designed to power Texas Instruments computer equipment.
INPUT: 14-25 vac @ 1 amp
OUTPUT: +12 vdc @ 350 ma.
+5 vdc @ 1.2 amp
-5 vdc @ 200 ma.
SIZE: 4 3/4" square.
Includes 18 Vac @ 1 amp wall transformer designed to power this supply.
CAT# PS-TX \$5.00 / set
10 for \$45.00



LIGHT ACTIVATED MOTION SENSOR

This device contains a photocell which senses sudden change in ambient light. Could be used as a door annunciator or modified to trigger other devices. 5 1/2" X 4" X 1". Operates on 6 Vdc. Requires 4 AA batteries (not included).
CAT# LSMD \$5.75 per unit

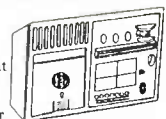

TRANSFORMERS

- 5.6 VOLT- 750ma
CAT# TX-56 \$3.00
- 12 V.c.t.-1amp
CAT# TX-121 \$4.00
- 12 V.c.t.-2amp
CAT# TX-122 \$4.85
- 12 V.c.t.-4amp
CAT# TX-124 \$7.00
- 18 VOLT-650ma
CAT# TX-186 \$2.00
10 for \$18.00
- 24 V.c.t.-1amp
CAT# TX-241 \$4.85
- 24 V.c.t.-2amp
CAT# TX-242 \$6.75
- 24 V.c.t.-3amp
CAT# TX-243 \$9.50
- 24 V.c.t.-4amp
CAT# TX-244 \$11.00

SWITCHES

- MINIATURE TOGGLE SWITCHES rated 5 Amps S.P.D.T. (ON-ON)
Non threaded brushing P.C. mount.
CAT# MTS-40PC 75c each
10 for \$7.00
- S.P.D.T. (ON-ON)
Solder lug terminals.
CAT# MTS-4 \$1.00 each
- D.P.D.T. (ON-ON)
Solder lug terminals.
CAT# MTS-8 \$2.00 each
10 for \$19.00
- MINI PUSH BUTTON
S.P.S.T. momentary. Push to make 1/4" brushing. Red button.
CAT# MPB-1 35c each
10 for \$3.00

POLARITY SWITCH

Designed to control an external coaxial relay on a satellite t.v. system. Ideal for parts. Contains a 5 Vdc relay and many other parts on a P.C. board.
CAT# RPDS \$1.75 each 10 for \$15.00



STORES:
LOS ANGELES
905 S. VERMONT AVE.
LOS ANGELES, CA 90006
(213)380-8000
VAN NUYS
6228 SEPULVEDA BLVD.
VAN NUYS, CA 91411
(818)997-1806

MAIL ORDERS TO:
ALL ELECTRONICS
P.O. BOX 567
VAN NUYS, CA 91408
TELEX
TWX-5101010163
ALL ELECTRONICS
Foreign Customers
Send \$1.50 postage for FREE Catalog!!

TOLL FREE
800-826-5432
INFO:(818)904-0524
FAX:(818)781-2653
QUANTITIES LIMITED
MINIMUM ORDERS \$10.00
CALIF. ADD SALES TAX
USA: \$3.00 SHIPPING
NO C.O.D.
FOREIGN ORDERS:
INCLUDE SUFFICIENT SHIPPING



SOUND AND VIDEO MODULATOR

Ti# UM1381-1. Designed for use with T.I. computers. Can be used with video cameras, games or other audio/video sources. Built in A/B switch enables user to switch from T.V. antenna without disconnection. Operates on channel 3 or 4. Requires 12 Vdc. Hook up diagram included.
CAT# AVMOD \$5.00 each



TELEPHONE COUPLING TRANSFORMER

STANCOR # TTCP-8
600 ohms c.t.
to 600 ohms c.t.
P.C. board mount.
3/4" X 5/8" X 3/4"
CAT# TCTXS \$2.50 each





Radio Shack Parts Place™



HOLIDAY VALUES AT A STORE NEAR YOU

Special Order Hotline

No Postal or Shipping Charge
 ■ Fast Service ■ No Minimum

Your Radio Shack store manager can special order parts and accessories not a part of our regular stock. These items include linear and digital ICs, microprocessors, diodes, semiconductors, tubes, phono styli, crystals and more. We'll call you when it arrives—in about a week.

FM Receiver on a Chip

NEW!

No IF Transformers Needed

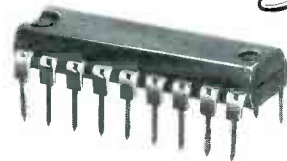

TDA7000. Combines RF mixer, IF and demodulator stages in one monolithic IC. Just what you need to build a small, inexpensive mono FM band receiver, repeater monitor or public service band monitor with a minimum of external components. Frequency-locked-loop system with 70 KHz IF. Includes pin-out and application notes. #276-1304 5.95

Reference Guide and How-To Books



NEW! Essentials For Your Test Bench

NEW! 1988 Semiconductor Reference Guide. Over 80,000 types. 288 pages. #276-4011 3.99
Getting Started in Electronics. Basic electronics projects. 128 pages. #276-5003 2.49
Timer IC Mini-Notebook. Learn to use the versatile 555 and 556 ICs. 32 pages. #276-5010 99c

Add Speech to Your Computer



SPO256-AL2 Speech Synthesizer. Easy to interface with most computers. With data. Requires 3.12 MHz crystal (special order). 28-pin DIP. #276-1784 12.95

CTS256-AL2 Text to Speech IC. Translates ASCII characters into control data. Requires 10 MHz crystal (special order). 40-pin DIP. #276-1786 16.95

First-Quality ICs

With Pin-Out & Specs

4000-Series CMOS ICs.

Type	Cat. No.	Each
4001	276-2401	.99
4011	276-2411	.99
4013	276-2413	1.19
4017	276-2417	1.49
4049	276-2449	1.19
4066	276-2466	1.19

Line Driver ICs for Data

MC1488 RS-232 Quad Line Driver. For sending peripheral data. 14-pin DIP. #276-2520 . . . 1.29

MC1489 RS-232 Quad Line Receiver. Use with above. 14-pin DIP. #276-2521 1.29

CMOS & Bipolar Timers

TLC555. Low-power CMOS. Same pin-out as 555 but operates up to 2 MHz. 8-pin DIP. #276-1718 1.39

Bipolar Resettable Timers.

Type	DIP	Cat. No.	Each
555 (Single)	8-Pin	276-1723	1.19
556 (Dual)	14-Pin	276-1728	1.49

Sight 'n Sound



(1) **NEW!** Brilliant Ruby-Red LED With Holder. #276-088 1.79
 (2) Tri-Sound-Siren Buzzer. Three extra-loud outputs. #276-C72 . . . 5.95
 (3) Pulsing Buzzer. Outputs 80 dB, 2 Hz pulse. #276-058 2.99

Project Cases



Blue styrene plastic. Internal slots for PC boards. With screws.

Size	Cat. No.	Each
4 x 2 x 1 3/16"	270-220	1.69
4 x 2 7/16 x 1 1/16"	270-221	1.89
4 3/8 x 2 1/2 x 1 1/16"	270-222	2.19
6 x 3 3/16 x 1 7/8"	270-223	2.69
7 1/2 x 4 1/2 x 2 1/4"	270-224	2.99

Audio Hookups

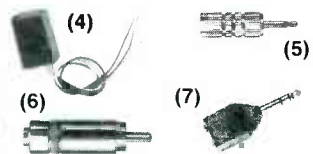
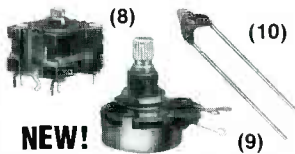

Fig	Description	Cat. No.	Each
4	1:1 Audio Transformer	273-1374	3.49
5	1/8" Jack to 3/32" Plug	274-381	1.79
6	1/8" Jack to Phono Plug	274-387	1.99
7	Two 1/8" Jack to 1/8" Plug	274-307	3.99

Micro Controls



(8) Variable Tuning Capacitor, 335 pF. #272-1337 4.95
 (9) 5-Watt, 25-Ohm Rheostat. Wire-wound pot. #271-265 2.99
 (10) High-Precision Thermistor. Range -50° to +110°C. #271-110 1.99

Parts Bargains

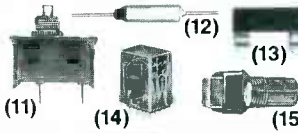
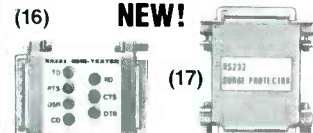

Fig	Description	Cat No	Each
11	Circuit Breaker, 2 Amps	270-1310	1.99
12	Fuses, Therm	270-1320/1321	.89
13	Digital Fuse Adapter Clip	270-1219	.99
14	DPDT Relay, 3 A, 125 AC	270-206	4.99
15	SPST On/Off Switch	275-617	1.59
—	Momentary Version	275-618	1.49

RS-232 Hardware



(16) **NEW!** RS-232 Inline Tester. Diagnose interface problems in micros and peripherals. #276-1401 14.95
 (17) RS-232 Spike Protector. AC line protection is not enough—Guard each port to be sure! #276-1402 16.95

Soldering Tools/Supplies

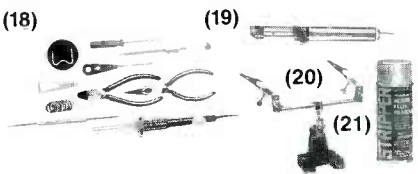

(18) Ten-Piece Electronic Tool Set. #64-2801 14.95

Fig	Description	Cat. No.	Each
19	Vacuum Desoldering Tool, Non-Stick Tip	64-2098	4.95
20	Helping Hands, 2 Adjustable Clips	64-2093	7.49
21	Rosin Flux Remover, 6 oz.	64-2324	1.89

Dual-Track Split Supply

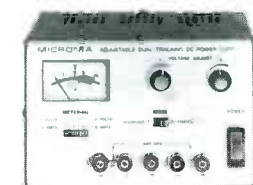

69⁹⁵

Choice of Independent Or Slave Operation

Variable 0-15 VDC or series up to 30 VDC. Delivers rock-stable DC at precisely the voltages you need. In tracking mode, a single control lets you adjust both voltages simultaneously. Independent mode to adjust voltages separately. Volt/ammeter. UL listed AC. #22-121

Bench LCD Multimeter



99⁹⁵

Low As \$15 Per Month*

Manual/Autoranging ■ Stores Min/Max Values

The 31-segment analog bar graph displays input peaks and trends. Transistor checker, diode-checker, memory function and buzzer continuity checker. Measures to 1000 VDC, 750 VAC, 10 AC/DC amps, 30 megohms resistance. Impedance: 10 megohms. #22-195

Over 1000 items in stock: Binding posts, Books, Breadboards, Buzzers, Capacitors, Chokes, Clips, Coax, Connectors, Fuses, Hardware, ICs, Jacks, Knobs, Lamps, Multimeters, PC Boards, Plugs, Rectifiers, Resistors, Switches, Tools, Transformers, Transistors, Wire, Zeners and more!

*Revolving credit from Radio Shack. Actual payment may vary depending on purchases. Prices apply at participating Radio Shack stores and dealers

Radio Shack®

A DIVISION OF TANDY CORPORATION

ADVERTISING INDEX

RADIO-ELECTRONICS does not assume any responsibility for errors that may appear in the index below.

Free Information Number	Page	190	127	82	—	—	—	120, 180	100	121	—	191	—	62	86	—	59	113, 181	182, 183	114	104	—	197	87	93	63	61	117	—	126	—	80, 81	120	112	73	113	80, 81	78	38	CV4	110	25	35	15, 14	78	13	116, 117	118, 119	115, 114	37	33	99	109	121	111	99	32	—	34, 18	27	99	81	24	99	107	110	56	101	—	78	196	184	176, 177	178, 179	51	74	—	73	92, 185	198	123	199	192	53	186	—																																																																																																																								
81	A.I.S. Satellite	80	127	Deco Industries	80, 81	71	New-Tone Electronics	27	108	AMC Sales	36	82	Digi-Key	120	194	NuScope Associates	99	80	OCTE Electronics	81	107	All Electronics	124	—	Digital Research Computers	112	110	Omnitron	24	201	PC Plus	99	—	Pacific Cable	107	106	American Design Components	123, 122	—	Parts Express	110	195	American Reliance	37	56	Pomona Electronics	5	—	Amway	99	—	Prentice-Hall/College Division	28	77, 205	B&K Precision	3	—	Radio Shack	125	206, 207	B&K Precision	3	—	Regency	46	208	B&K Precision	3	—	SEL Labs.	76	98	Beckman Industrial	26	62	Hameg	35	184	SEL Labs.	76	85	Blue Star Industries	81	86	Heath	15, 14	176, 177	Sencore	39, 41	109	C & S Sales	16	—	ISCET	78	178, 179	Sencore	43, 45	60	CIE	8	59	JDR Instruments	13	51	Silicon Valley Surplus	106	188	Cabletronics	81	113, 181	JDR Microdevices	116, 117	74	Solid State Sales	108	50	Caig	34	182, 183	JDR Microdevices	118, 119	—	Star Circuits	32	—	Caribbean Electronics	75	114	Jameco	115, 114	73	T S M	CV3	193	Chenesko Products	81	104	Jan Crystals	37	92, 185	Tektronix	23, CV2	52	Circuit Cellar	81	—	Joseph's	33	198	Tentel	36	—	Command Productions	26	197	Laser's Edge	99	123	Test Probes	17	79	Communications Electronics	7	87	MCM Electronics	109	199	U.S. Cable/Movie Time	44	202	Compstar	99	93	Mark V. Electronics	121	192	United Electronic Supply	22	55	Contact East	80	63	Micro-Mart	111	53	United Imports	38	189	Cook's Institute	36	61	Microprocessors Unltd.	99	186	WPT Publications	76	187	Crystek	44	117	Mouser	32	—	Wolfer Productions	99

DOES YOUR DIGITAL CAPACITANCE METER DO THIS?

FULL 4 DIGIT 0.5 INCH LCD DISPLAY COMPLETELY AUTORANGING WITH 10 RANGE MANUAL CAPABILITY

- AND THIS**
RANGE OF 0.0 pF to 1 FARAD (999.9 mF)
0.5% BASIC ACCURACY UP TO 100 uF
- AND THIS**
READS DIELECTRIC ABSORPTION
- AND THIS**
EXTENDED PSEUDO 5 DIGIT
RESOLUTION ON SOME RANGES ONLY
- AND THIS**
ABILITY TO ZERO LARGE CAPACITANCE
VALUES UP TO 99.99 uF
- AND THIS**
CALCULATES TRUE CAPACITANCE
IF CAPACITOR IS LEAKY
- AND THIS**
DIODE CLAMP AND FUSED
PROTECTED INPUT.
DISCHARGE RESISTOR IN OFF
POSITION AT TERMINAL INPUTS.
POWERED BY 9V BATTERY
- ONE YEAR PARTS & LABOUR WARRANTY**
- FOR ONLY THIS**



- AND THIS**
IDENTIFIES TRANSISTORS (NPN, PNP)
AND THEIR LEADS (E, B, C, ETC.)
- AND THIS**
TESTS ZENER DIODES AND RECTIFIERS.
UP TO 20V ZENER WITH AC ADAPTOR,
ZENER VOLTAGE WITH 9V BATTERY
DEPENDS ON ITS CONDITION
- AND THIS**
AUTOMATICALLY CALCULATES LENGTHS
OF CABLES IN FEET, METRES, MILES,
KILOMETRES (THEORETICAL RANGE
OF 9,999 MILES)
- AND THIS**
ABILITY TO SORT CAPACITORS IN
MANY DIFFERENT MODES
- AND THIS**
ABILITY TO READ LEAKY CAPACITANCE
(INSULATION RESISTANCE OR CURRENT)
- AND THIS**
CALCULATES TIME CONSTANTS WITH
USER DEFINED RESISTANCE VALUES
- AND THIS**
HOLD FUNCTION FREEZES DISPLAY

SHIPPING INSTRUCTIONS:
All units shipped out F.O.B. Buffalo NY via United Parcel Service (except Hawaii & Alaska) unless otherwise indicated (in which case shipments will be F.O.B. Canada)

PLEASE SEND ME	QUANTITY	U.S. FUNDS
() (QUANTITY) MC300(S) @	\$169.95	\$ _____
CARRYING CASE	\$ 16.95	\$ _____
AC ADAPTOR	\$ 9.95	\$ _____
SHIPPING AND HANDLING @ \$5.00 PER INSTRUMENT	\$ _____	\$ _____
() CHECK () MONEY ORDER	\$ _____	\$ _____
() VISA () MASTERCARD	TOTAL	\$ _____
() CARD NO. _____		
EXPIRY DATE _____	SIGNATURE _____	
NAME _____		
ADDRESS _____		
CITY _____ STATE _____	ZIP CODE _____	

Gernsback Publications, Inc.
500-B Bi-County Blvd.
Farmingdale, NY 11735
(516) 293-3000

President: **Larry Steckler**
Vice President: **Cathy Steckler**

For Advertising ONLY
516-293-3000

Larry Steckler
publisher

Arline Fishman
advertising director

Shelli Weinman
advertising associate

Lisa Strassman
credit manager

Christina Estrada
advertising assistant

SALES OFFICES

EAST/SOUTHEAST

Stanley Levitan
Eastern Sales Manager
Radio-Electronics
259-23 57th Avenue
Little Neck, NY 11362
718-428-6037, 516-293-3000

**MIDWEST/Texas/Arkansas/
Okla.**

Ralph Bergen
Midwest Sales Manager
Radio-Electronics
540 Frontage Road—Suite 339
Northfield, IL 60093
312-446-1444

**PACIFIC COAST/ Mountain
States**

Marvin Green
Pacific Sales Manager
Radio-Electronics
5430 Van Nuys Blvd. Suite 316
Van Nuys, CA 91401
1-818-986-2001

\$169.95

MODEL
MC300 Approx. Size
7" x 4" x 1 1/4"

DAETRON

a division of Bergeron Technologies Inc.
7686 KIMBEL STREET, UNIT 5
MISSISSAUGA, ONT., CANADA
L5S 1E9 (416) 676-1600

DEALER ENQUIRIES INVITED

CIRCLE 190 ON FREE INFORMATION CARD

T S M

2065 BOSTON POST ROAD, LARCHMONT, N.Y. 10538
TEL 914-937-2447 OR 914-834-7190

ELECTRONICS KITS

Mike Roth Sales Inc. 1430 South Village #N, Santa Ana, CA 92705

MECANORMA DIRECT ETCHING TRANSFER SHEETS

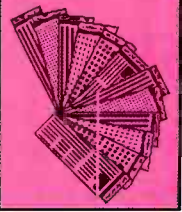

P.C.B. SYMBOLS

- OD 1 in
#2 191 100 \$2.00 each
- OD 1.25 in
#2 191 300 \$2.00 each
- OD 1.56 in
#2 191 400 \$2.00 each
- OD 2 in
#2 191 500 \$2.00 each

- OD 0.56 in
 A 0.15 in
#2 192 100 \$2.00 each

- OD 0.42 in
 A 0.2 in
#2 191 200 \$2.00 each

- OD 0.37 in
 A 0.78 in
#2 191 600 \$2.00 each

- OD 500 in
 A 63 in
 C 156 in
#2 191 800 \$2.00 each

- OD 100 in
 A 0.36 in
 B 300 in
#2 191 900 \$2.00 each

- OD 100 in
 A 0.61 in
 B 300 in
#2 192 000 \$2.00 each

- OD 100 in
 A 0.51 in
 B 300 in
#2 192 100 \$2.00 each

- OD 100 in
 A 0.51 in
 B 300 in
#2 192 200 \$2.00 each

- OD 100 in
 A 0.51 in
 B 300 in
#2 192 300 \$2.00 each

- OD 100 in
 A 0.51 in
 B 300 in
#2 192 400 \$2.00 each

- OD 100 in
 A 0.51 in
 B 300 in
#2 192 500 \$2.00 each

- OD 100 in
 A 0.51 in
 B 300 in
#2 192 600 \$2.00 each

- OD 100 in
 A 0.51 in
 B 300 in
#2 192 700 \$2.00 each

- OD 100 in
 A 0.51 in
 B 300 in
#2 192 800 \$2.00 each

- OD 100 in
 A 0.51 in
 B 300 in
#2 192 900 \$2.00 each

- OD 100 in
 A 0.51 in
 B 300 in
#2 192 000 \$2.00 each

- OD 100 in
 A 0.51 in
 B 300 in
#2 192 100 \$2.00 each



TSM 5A \$26.30
AUDIO POWER MODULE 70W PEAK POWER
35W RMS, INPUT SENSITIVITY 47K/800mV
OUTPUT 4Ω/8Ω, POWER SUPPLY 39V D.C.
/2.5A

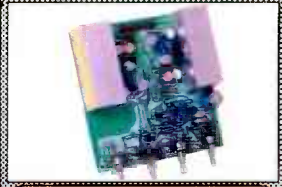

TSM 67 \$39.74
STEREO AMPLIFIER 2X40W PEAK POWER
SENSITIVITY INPUT 47K/300mV, OUTPUT
2.5Ω Ω VOLUME, BALANCE, BASS,
TREBLE CONTROLS, POWER SUPPLY
12V D.C. / 3.4A

TSM 44 \$18.88
AUDIO POWER MODULE, 50W PEAK POWER
25W RMS, INPUT SENSITIVITY 800mV/47K
OUTPUT IMPEDANCE 4/8Ω POWER SUPPLY
40V D.C./2A

TSM 11 \$15.50
AUDIO AMPLIFIER 30W PEAK POWER, 15W
RMS, INPUT SENSITIVITY 47K/150mV, 2.5
TO 8 Ω OUTPUT, COMPLETE WITH VOLUME
BASS, TREBLE CONTROL, POWER SUPPLY
12/16V D.C. / 2A

TSM 5B \$33.70
AUDIO POWER MODULE 90W PEAK POWER
45W RMS; INPUT SENSITIVITY 47K/800mV
OUTPUT 4Ω/8Ω, POWER SUPPLY 39V D.C./3A

TSM 18 \$12.97
AUDIO AMPLIFIER 15W PEAK POWER, 7.5W
RMS, INPUT SENSITIVITY 47K/150mV, 2.5
TO 8 Ω OUTPUT, COMPLETE WITH VOLUME
BASS, TREBLE CONTROL, POWER SUPPLY
12/16V D.C. / 1.5A

TSM 19 \$52.05
AUDIO 240W PEAK POWER, 120W RMS
SENSITIVITY 47K/ 0.8 V, OUTPUT 4 Ω,
THD 0.3 %, RESPONSE 15 KHZ - 100 KHZ,
POWER SUPPLY 79V MAX., HEAT-
SINKS NOT INCLUDED WITH THE KIT.

TSM 66 \$16.50
AUDIO POWER MODULE 40W PEAK POWER
20W RMS, INPUT SENSITIVITY 47K/300mV
OUTPUT 2.5/8Ω POWER SUPPLY 12V D.C./2A

TSM 68 \$22.66
STEREO AMPLIFIER 2 X 20W,
INPUT 47K/300mV, OUTPUT 2.5/8Ω SUP-
PLIED WITH HEATSINK AND BALANCE,
VOLUME, BASS, TREBLE, POWER SUPPLY
12V D.C./2.5A

TSM 155/1 \$46.30
STEREO AMP. 2 X 50W
PEAK, INPUT SENSITIVITY 47K/300mV
OUTPUT 4Ω, SUPPLIED WITH HEATSINK
AND BALANCE, VOLUME, BASS, TREBLE
CONTROLS, POWER SUPPLY 40V D.C./2A-3A

TSM 118 \$62.31
320W PEAK POWER AMPLIFIER MODULE,
8Ω OUTPUT IMPEDANCE INPUT 47K/800mV
FREQUENCY RESPONSE 15HZ TO 60KHZ,
POWER SUPPLY 2 X 40V D.C./6A,
HEATSINKS NOT INCLUDED IN THE KIT.

TSM 89 \$30.38
AUDIO BOOSTER STEREO 2 X 40W FOR
CAR RADIO, OUTPUT 2.5Ω POWER SUPPLY
12/16V D.C./4A.

TSM 102 \$22.50
18 LED OUTPUT POWER LEVEL METER,
POWERED BY THE MODULATION

TSM 128 \$20.31
2 X 6 LED OUTPUT LEVEL METER, STEREO
2 X 50W , POWER SUPPLY 15/20V D.C.

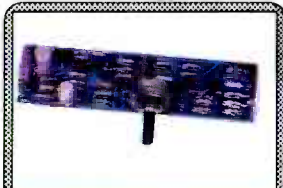

TSM 9 \$14.00
AUDIO PREAMPLIFIER FOR GUITAR, INPUT
SENSITIVITY 47K/5mV, OUTPUT LEVEL
47K/1.5V, VOLUME CONTROL VARIABLE
POWER SUPPLY 25V D.C. / 0.1A

TSM 34 \$9.18
STEREO RIAA PREAMPLIFIER, INPUT
SENSITIVITY 47K/3mV, OUTPUT 700mV,
POWER SUPPLY 12V D.C. / 0.1A

TSM 35 \$9.18
MICROPHONE STEREO PREAMPLIFIER,
INPUT SENSITIVITY 5mV/200Ω OR MOFE,
OUTPUT 700mV, POWER SUPPLY 12V D.C.
/ 0.1A

TSM 122 \$13.96
ALL-BAND FM/VHF/UHF ANTENNA 200B
AMPLIFIER, POWER SUPPLY 8/12V D.C./
0.15A

TSM 31 \$14.77
FM STEREO DECODER, POWER SUPPLY
12V D.C. / 0.1A

TSM 62 \$13.00
CAR ANTENNA PREAMPLIFIER MW/LW/FM,
POWER SUPPLY 12/16V D.C./0.1A

TSM 335 \$15.65
PHYSIOLOGIC TONE CONTROL, STEREO,
INPUT IMPEDANCE 150mV/160K, OUTPUT
LEVEL 800mV, POWER SUPPLY 25V D.C.

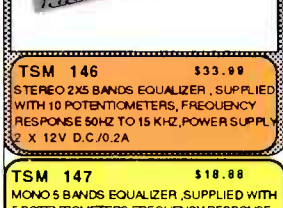

TSM 146 \$33.99
STEREO 2X5 BANDS EQUALIZER, SUPPLIED
WITH 10 POTENTIOMETERS, FREQUENCY
RESPONSE 50HZ TO 15 KHZ, POWER SUPPLY
2 X 12V D.C./0.2A



TSM 147 \$18.88
MONO 5 BANDS EQUALIZER, SUPPLIED WITH
5 POTENTIOMETERS, FREQUENCY RESPONSE
50 HZ TO 15KHZ, POWER SUPPLY 2 X 12V
D.C./0.15A.

TSM 61 \$25.48
FM RECEIVER, OUTPUT 1 WATT 4Ω,
POWER SUPPLY 12/16V D.C. / 0.2A.

TSM 158 \$27.42
FM RECEIVER, OUTPUT 20 WATTS/8Ω
POWER SUPPLY 12/16V D.C. / 2A.

TSM 211 \$10.00
MEDIUM WAVE RECEIVER, 1 W, 0.5 W RMS
AUDIO POWER, POWER SUPPLY
9-12V D.C. / 0.1 A

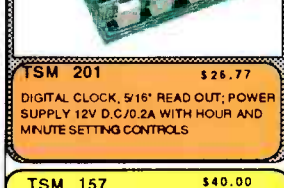

TSM 201 \$26.77
DIGITAL CLOCK, 5/16" READ OUT; POWER
SUPPLY 12V D.C./0.2A WITH HOUR AND
MINUTE SETTING CONTROLS

TSM 157 \$40.00
DIGITAL CLOCK AND UP TO 24 MN
1/100 S CHRONOMETER, COUNT-DOWN
CAPABILITY FOR THE CLOCK
POWER SUPPLY 12V D.C. OR A.C.

TSM 177 \$33.20
DIGITAL VOLTMETERS 0 V TO 999 V D.C.
POWER SUPPLY 12V D.C./0.5A

TSM 206 \$10.15
METRONOME; POWER SUPPLY 9 - 12V D.C.

TSM 210 \$10.50
FULLY RANDOMISED ELECTRONIC DICE,
POWER SUPPLY 9 - 12V D.C./0.1A

TSM 54 \$13.85
FM TRANSMITTER, POWER SUPPLY 9V
D.C. / 0.5A

TSM 150 \$82.50
HOME PROGRAMMER, 4 DEVICES CONTROL,
20 PROGRAMS, OPERATION WITH RELAYS
POWER SUPPLY 12V D.C./0.8A

TSM 130 \$26.77
24 TUNE DOOR CHIME, OUTPUT 3/4 WATTS
POWER SUPPLY 12V D.C./1A

TSM 123 \$46.15
SOUND CONDITIONER, OUTPUT LEVEL 800mV
TO BE CONNECTED TO AMPLIFIER AUXILIARY
INPUT, POWER SUPPLY 12V D.C.

TSM 78 UNIVERSAL ALARM FOR
HOME AND CAR, DELAYED EXIT TIME, AD-
JUSTABLE SOUND ALARM, TAMPER PROOF,
OPERATION WITH CONTACT SWITCHES
POWER SUPPLY 12V D.C./0.15A \$33.23

TSM 121 \$17.54
16 LED DISPLAY THERMOMETER; POWER
SUPPLY 15/18V D.C./0.15A

TSM 105 \$15.15
ELECTRONIC ALARM SIREN, 8Ω IMPEDAN-
CE, 10 WATTS RATING, POWER SUPPLY
12V D.C., HORN SPEAKER NOT INCLUDED.

TSM 85 \$22.52
TIME DELAY SYSTEM FROM 1 SEC TO 15
MINUTES, POWER SUPPLY 12V D.C.

TSM 69 \$15.93
TELEPHONE AMPLIFIER WITH INDUCTIVE
PICK-UP AND SPEAKER, ADJUSTABLE
VOLUME, POWER SUPPLY 9/12V D.C./0.1A

TSM 168 \$12.92
MOSQUITO REPELLER, POWER SOURCE
9V D.C.

TSM 86 \$36.50
ELECTRONIC MONO REVERBERATION SYS-
TEM, POWER SUPPLY 12V D.C.

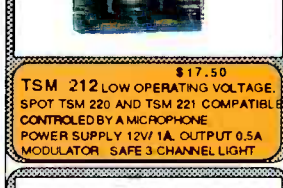

TSM 212 \$17.50
LOW OPERATING VOLTAGE,
SPOT TSM 220 AND TSM 221 COMPATIBLE
CONTROLLED BY A MICROPHONE
POWER SUPPLY 12V/1A, OUTPUT 0.5A
MODULATOR SAFE 3 CHANNEL LIGHT

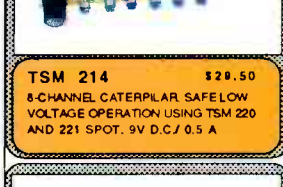

TSM 214 \$29.50
8-CHANNEL CATERPILAR SAFE LOW
VOLTAGE OPERATION USING TSM 220
AND 221 SPOT, 9V D.C./ 0.5 A



TSM 220 \$25.30
64 LED'S SPOT FOR SAFE LIGHT MODUL-
ATION, SUPPLIED WITH BOX

TSM 213 \$16.20
SAFE LOW VOLTAGE 2-WAY CATERPILAR
RANDOMLY FLASHING AND WINKING, TSM
220 AND TSM 221 SPOT COMPATIBLE,
POWER SUPPLY 12V/0.5A

TSM 221 \$17.20
25 LED'S SPOT FOR SAFE LIGHT MODUL-
ATION, SUPPLIED WITH BOX.



TSM 2 V2 \$22.20
VARIABLE SOLID STATE REGULATED POW-
ER SUPPLY 8V TO 38V/2A
TRANSFORMER IS NOT INCLUDED WITH THE
KIT

TSM 116 V5 \$11.50
REGULATED POWER SUPPLY 5V D.C.
POWER TRANSFORMER NOT INCLUDED WITH
THE KIT

TSM 116 V12 \$11.50
REGULATED POWER SUPPLY 12V D.C.
POWER TRANSFORMER IS NOT INCLUDED
WITH THE KIT.

TSM 163 \$12.82
POWER SUPPLIES 5 , 7.5 , 9 , 12V/1A
POWER TRANSFORMER NOT INCLUDED
WITH THE KIT.

TSM 2 V4 \$25.85
VARIABLE SOLID STATE REGULATED POW-
ER SUPPLY 3V TO 14V/5A TRANSFORMER
NOT INCLUDED IN THE KIT.

Nutron Computers & Electronics
821 E Roosevelt Road
Lombard, IL 60146
Tel: 312-691-8900

Auto Sound System
1269 East Main Street
El Cajon, CA 92021
Tel: 619-442-7022

Omnivox Electronics
770 Amsterdam Ave.
New York, NY 10025
Tel: 212-865-5580

Kelvin Electronics
7 Fairchild Avenue
Plainview, NY 11803
Tel: 516-349-7620

CIRCLE 73 ON FREE INFORMATION CARD

SCOPE 3½ Digital Multimeters



Model DVM-638
\$8750

Test leads included
• 11 function, 38 ranges • Logic level detector • Audible visual continuity
• Capacitance and conductance measurement

Model DVM-636
\$6750

• 7 function, 32 ranges • Transistor measurement

SCOPE 3½ Digit Capacitance Meter



Model DCM-602
\$5995

Test leads included
• 8 ranges with full scale values to 2000 uF
• LSI circuit • Crystal time base • Frequency range 800 Hz to 8Hz

SCOPE Pocket Sized Audio Signal Generator



Model RC-555
\$5995

Test leads & 9V battery included • Low distortion sine-wave signal • 46 step selected frequency • x1 range 20 Hz to 1.5 KHz/ x100 range 2 KHz to 150 KHz

SCOPE 4½ Digit LCD Bench Digital Multimeter



Model DVM-6005
\$21995

Test lead set 6, "D" size batteries included
• 0.4" high characters
• Conversion period: 500 milliseconds • Automatic, negative polarity

Mini-Meters with Maxi-Specs

SCOPE 3½ Digit LCD with 8 Full Functions

Model DVM-632

\$4495
OUR PRICE

Measures only 5 3/8" x 2 1/16" x 1 1/4"

Deluxe test leads included
• 0.5% accuracy • Transistor gain test • Audible continuity checking & diode test
• 1C Amp measurement

Zipped Carrying Case CC-30 **\$450**



SCOPE 3½ Digit LCD

Measures only 5 1/8" x 2 3/4" x 1 1/8"

Model DVM-630

\$2995

OUR PRICE
Test leads included • 0.5% accuracy • 6 functions, 19 ranges • Automatic zero adjust • Low battery indication

Zipped Carrying Case CC-30 **\$450**

ASK FOR FREE CATALOG.

Money orders, checks accepted. C.O.D.'s require 25% deposit.



Fordham

260 Motor Parkway, Hauppauge, NY 11788

Toll Free
800-645-9518
In NY State 800-832-1446

Service & Shipping Charge Schedule Continental U.S.A.

FOR ORDERS	ADD
\$25-\$100	\$4.50
\$101-\$250	\$6.00
\$251-500	\$8.00
\$501-750	\$10.50
\$751-1,000	\$12.50
\$1,001-1500	\$16.50
\$1,501-2000	\$20.00
\$2,001 and Up	\$25.00