

48783

ALL ABOUT CELLULAR TELEPHONE

\$2.25 SEPT 1987
IN CANADA \$2.75

Radio- Electronics®

TECHNOLOGY - VIDEO - STEREO - COMPUTERS - SERVICE

BUILD R-E's VIDEO PALETTE
It generates special video effects

BUILD AN SCA RECEIVER
Find hidden signals on the FM band

SCR's AND TRIACS
A circuit cookbook

R-E ROBOT
Put it into action!

COMPUTER DIGEST
Hands-on tests of seven hot portables



A
GERNSBACK
PUBLICATION

PLUS:
★ Video News
★ Satellite TV
★ New Products

NEW FROM TEK AT JUST \$995!

Light weight makes the 2225 easy to carry even to remote servicing sites.

Fully segmented graticule lines ease the way for quick, accurate voltage and time measurements.

Bright, full-size CRT with minimal geometric distortion and crisp, small spot size delivers sharp trace definition.

One-button beam finder locates off-screen signals, even when intensity is turned down.

Proven design and rugged construction offer reliability at its best. And the Tek reputation for meeting rigid environmental requirements means confidence in your measurements—and in knowing that this scope is built to last.

Sweep speeds to 5 ns/div are fast enough for making accurate pulse and timing measurements on most digital logic families, with good resolution.

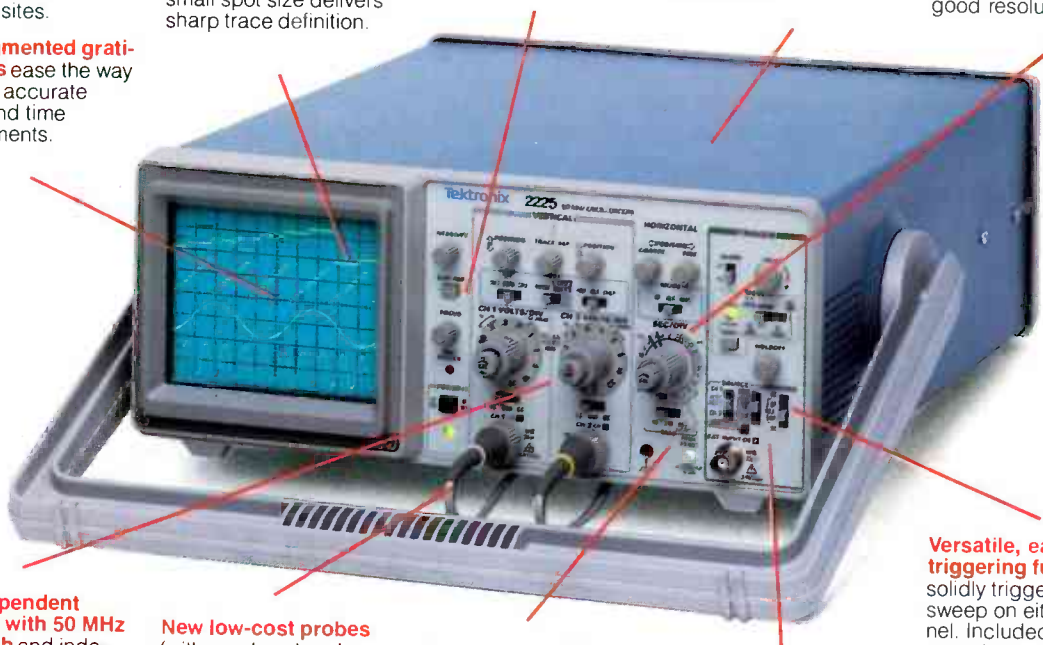

Two independent channels with 50 MHz bandwidth and independent bandwidth limiting on each channel to 5 MHz, 500 μ V/div sensitivity for low-level signal measurements and differential applications.

New low-cost probes (with nearly unbreakable tips) complement the rugged scope design. Compensation adjustments in the probe body itself eliminate the bulky compensation box at the front panel. Scope and probes are a perfect match!

Fast, accurate alternate horizontal magnification lets you choose any of three expansion levels to magnify any part of the normal waveform display—including the trigger point and end of sweep.

Now for the first time! Two vertical-channel inputs and an external Z-axis input all on the front panel. An excellent combination for manufacturing test stations and rackmount applications. And at the simple flip of a switch you can trigger on the Z-axis signal.

Versatile, easy-to-use triggering functions solidly trigger the sweep on either channel. Included are asynchronous triggering capability; flexible coupling via DC, AC, HF and LF reject filtering; hands-free triggering from virtually any signal; plus independent selection of either TV line or TV field triggering regardless of time-base setting.

Now, the professional quality and performance you expect from Tektronix... at an unexpected price: \$995 for scope, probes, 3-year warranty and 30-day free trial on approved credit. No portable in its class can match the Tek 2225 for features, versatility, convenience and value. It's the easy, economical answer to scope needs at bench and field sites, on the manufacturing floor and in the classroom. Call Tek to order, for application assistance or to get the name of your nearest Tek representative or distributor.



Call Tek direct: **1-800-426-2200**
In Oregon, call collect: **627-9000**



Tektronix
COMMITTED TO EXCELLENCE

September 1987 **Radio- Electronics**

Vol. 58 No. 9

BUILD THIS

- 41 VIDEO EFFECTS GENERATOR**
Tailor your video like a pro.
Rudolf Graf and William Sheets
- 46 SCA RECEIVER**
Part 2. Building, aligning, and using the receiver.
Rudolf Graf and William Sheets
- 56 R-E ROBOT**
Part 10. The first application.
Steven E. Sarns
- 69 PC SERVICE**
Direct-etch foil patterns for the SCA receiver.

TECHNOLOGY

- 53 INSIDE CELLULAR TELEPHONE**
The inside story on those remarkable mobile telephones.
Josef Bernard

CIRCUITS AND COMPONENTS

- 61 TESTING SEMICONDUCTORS**
Part 6. Testing op-amp parameters.
TJ Byers
- 64 USING TRIACS AND SCR'S**
Practical applications for those versatile components
Ray Marston

DEPARTMENTS

- | | |
|--|--|
| <ul style="list-style-type: none"> 6 VIDEO NEWS
What's new in this fast-changing field.
David Lachenbruch 26 EQUIPMENT REPORTS
Onkyo Unifer
Universal Remote Control 30 SERVICE CLINIC
Troubleshooting the unusual ones.
Jack Darr | <ul style="list-style-type: none"> 32 NEW IDEAS
An audible logic probe 34 DESIGNER'S NOTEBOOK
Simple delay circuits
Robert Grossblatt 87 SATELLITE TV
International politics.
Bob Cooper, Jr. 94 STATE OF SOLID STATE
A micropower op-amp
Robert F. Scott |
|--|--|



PAGE 71

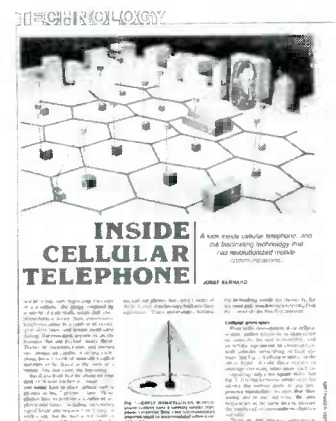

PAGE 53

AND MORE

- 114 Advertising and Sales Offices**
- 114 Advertising Index**
- 115 Free Information Card**
- 16 Letters**
- 95 Market Center**
- 31 New Lit**
- 28 New Products**
- 4 What's News**

SEPTEMBER 1987

ON THE COVER



If you have ever wanted to take complete control over the appearance of your video productions, this month's cover story is for you. It's a video-effects generator that will let you tailor a signal's tint, color, and brightness to create a custom look or to add special effects such as solarization, and posterization.

Some of the actual effects you can create with the Video Palette are shown on the screens of Sharp's model 3MM67 TV's. Sharp's digital VCR model VC-D75U was used to obtain the excellent still-frame images. We'd like to thank everyone at Sharp Electronics Corporation for their help and cooperation.

COMING NEXT MONTH

THE OCTOBER ISSUE IS ON SALE SEPTEMBER 1

BUILD THE LASER BUG

This laser receiver lets you use laser light to hear what's going on.

BUILD THE VIDEO PALETTE

Part 2 features circuit details, construction, and more.

TRIACS AND SCR's

Twenty-eight practical circuits from a zero-voltage line switch to a smart lamp-dimmer.

HOW TO SERVICE SWITCHING POWER SUPPLIES

A practical guide.

As a service to readers, RADIO-ELECTRONICS publishes available plans or information relating to newsworthy products, techniques and scientific and technological developments. Because of possible variances in the quality and condition of materials and workmanship used by readers, RADIO-ELECTRONICS disclaims any responsibility for the safe and proper functioning of reader-built projects based upon or from plans or information published in this magazine.

Since some of the equipment and circuitry described in RADIO-ELECTRONICS may relate to or be covered by U.S. patents, RADIO-ELECTRONICS disclaims any liability for the infringement of such patents by the making, using, or selling of any such equipment or circuitry, and suggests that anyone interested in such projects consult a patent attorney.

RADIO-ELECTRONICS, (ISSN 0033-7862) September 1987. Published monthly by Gernsback Publications, Inc., 500-B Bi-County Boulevard, Farmingdale, NY 11735 Second-Class Postage paid at Farmingdale, NY and additional mailing offices. Second-Class mail registration No. 9242 authorized at Toronto, Canada. One-year subscription rate U.S.A. and possessions \$16.97, Canada \$22.97, all other countries \$25.97. All subscription orders payable in U.S.A. funds only, via international postal money order or check drawn on a U.S.A. bank. Single copies \$1.95. © 1987 by Gernsback Publications, Inc. All rights reserved. Printed in U.S.A.

POSTMASTER: Please send address changes to RADIO-ELECTRONICS, Subscription Dept., Box 55115, Boulder, CO 80321-5115.

A stamped self-addressed envelope must accompany all submitted manuscripts and/or artwork or photographs if their return is desired should they be rejected. We disclaim any responsibility for the loss or damage of manuscripts and/or artwork or photographs while in our possession or otherwise.

Radio-Electronics®

Hugo Gernsback (1884-1967) founder
M. Harvey Gernsback,
editor-in-chief, emeritus

Larry Steckler, EHF, CET,
editor-in-chief
and publisher

EDITORIAL DEPARTMENT

Art Kleiman, editorial director
Brian C. Fenton, managing editor
Carl Laron, WB2SLR, associate editor
Jeffrey K. Holtzman,
assistant technical editor
Robert A. Young, assistant editor
Julian S. Martin, editorial associate
Byron G. Wels, editorial associate
M. Harvey Gernsback,
contributing editor
Jack Darr, CET, service editor
Robert F. Scott,
semiconductor editor
Herb Friedman,
communications editor
Bob Cooper, Jr., satellite-TV editor
Robert Grossblatt, circuits editor
Larry Klein, audio editor
David Lachenbruch,
contributing editor
Richard D. Fitch,
contributing editor
Teri Scaduto, editorial assistant

PRODUCTION DEPARTMENT

Ruby M. Yee, production director
Robert A. W. Lowndes,
editorial production
Andre Duzant, technical illustrator
Karen Tucker, advertising production
Marcella Amoroso, production traffic

CIRCULATION DEPARTMENT

Jacqueline P. Cheeseboro,
circulation director
Wendy Alanko,
circulation analyst
Theresa Lombardo,
circulation assistant

Typography by Mates Graphics
Cover Foto by Nick Koudis

Radio-Electronics is indexed in
Applied Science & Technology Index
and *Readers Guide to Periodical Literature*.

Microfilm & Microfiche editions are available. Contact circulation department for details.

Advertising Sales Offices listed on page 114.





\$75 DMM MEASURES CAPACITANCE, TRANSISTOR GAIN, MORE...

B&K-PRECISION'S new 2905 is a more-than-full-feature 3½ digit DMM, at a surprisingly low price. Features include 0.5% VDC accuracy; 100 µV, 0.1 µA, 0.1 Ω resolution. Measures capacitance to 20mF with up to 1pF resolution. Audible continuity and diode junction tests are built in. For field survivability, it features a drop resistant case, reverse polarity and overload protection and high-energy fusing. Contact: B&K-PRECISION, 6460 W. Cortland Street, Chicago, IL 60635 (312) 889-9087.

B&K-PRECISION'S new 2905 is a more-than-full-feature 3½ digit DMM, at a surprisingly low price. Features include 0.5% VDC accuracy; 100 µV, 0.1 µA, 0.1 Ω resolution. Measures capacitance to 20mF with up to 1pF resolution. Audible continuity and diode junction tests are built in. For field survivability, it features a drop resistant case, reverse polarity and overload protection and high-energy fusing. Contact: B&K-PRECISION, 6460 W. Cortland Street, Chicago, IL 60635 (312) 889-9087.

*RT
Check out
these features!
& prices. wow!
FL*

4½ DIGIT TRMS DMM READS FREQUENCY AND TEMPERATURE

The new 2945 is well suited for both the analog and digital worlds. DCV accuracy is 0.05%, with 10µV, 10nA, 0.01Ω resolution. Data hold freezes voltage and current readings. °C and °F temperature readings are from -20° to +1000°C frequency from 20 Hz to 200kHz. AC voltage and current are read in true RMS. Also checks continuity and diodes. \$250.00 Contact: B&K-PRECISION, 6460 W. Cortland Street, Chicago, IL 60635 (312) 889-9087.



FREQUENCY COUNTER AND DATA HOLD HIGHLIGHT NEW 4½ DIGIT DMM

For engineers in need of a high-accuracy 4½ digit DMM and a low range frequency counter the 2940 is made to order. DC voltage accuracy is 0.05%. Resolution is 10µV, 10nA, and 0.01Ω. Frequency measurements span from 20Hz to 200kHz with up to 1Hz resolution. The 2940 features a drop resistant case with full internal circuitry protection. \$155.00 Contact: B&K-PRECISION, 6460 W. Cortland Street, Chicago, IL 60635 (312) 889-9087.



HAND-HELD TEST BENCH READS VOLTAGE, RESISTANCE, CURRENT, HFE TEMPERATURE AND LOGIC.

The new 2906 3½ digit DMM from B&K-PRECISION is virtually a hand-held test bench, with a remarkable range of functions. °C and °F temperature measurements cover from -20C to 1000°C. The logic capability is ready for TTL and CMOS circuits. Other features include drop resistant case, reverse polarity and overload protection; plus high-energy fusing. DC accuracy, 0.25% VDC. \$95.00 Contact: B&K-PRECISION, 6460 W. Cortland Street, Chicago, IL 60635 (312) 889-9087.



TRUE RMS DMM OFFERS PEAK HOLD, CAPACITANCE, AND LOGIC

3½ digit true RMS handheld DMM featuring 0.1% DC accuracy. Housed in an ergonomic, drop-resistant case, the 2907 offers many functions and a low price. Resolution is 100µV, 0.1µA and 0.1Ω. Capacitance to 20µF with 1pF resolution. Peak hold feature freezes transient readings. Fully protected. Also checks logic, continuity and diodes. \$190. Contact: B&K-PRECISION, 6460 W. Cortland Street, Chicago, IL 60635 (312) 889-9087.



THE BEST DMM BUY? NOW IT'S B&K-PRECISION

- Better specs
- Lower prices
- More features
- More capabilities
- More circuit and safety protection
- Ruggedized case with safety test leads

Five all-new models step ahead of the competition with better specs and higher performance per dollar. We've also packed more features than ever into every model.

All five instruments measure voltage, current and resistance, check continuity and diodes, and feature a new ergonomic case with angled LCD readout. Depending on model, additional capabilities include logic level, capacitance measurement, transistor gain, true RMS, frequency measurement, high-current measurement, data hold, peak hold and even temperature.

Like all B&K-PRECISION instruments, these new meters are made for the real world. They offer a drop-resistant case and the triple protection of reverse polarity protection, overload protection, and high-energy fusing.

Best of all, the B&K-PRECISION DMM you want is already in stock at your local distributor. Call today for full details.



BK PRECISION
DYNASCAN CORPORATION

6460 West Cortland St. • Chicago, IL 60635 • 312-889-9087

International Sales, 6460 W. Cortland St., Chicago, IL 60635

Canadian Sales, Atlas Electronics, Ontario

South and Central American Sales, Empire Exporters, Plainview, NY 11803

CIRCLE 77 ON FREE INFORMATION CARD

WHAT'S NEWS

New chips to have more accurate spacing

Using a new technique known as mask-proximity correction, researchers at General Electric have made it possible for exposure systems that now can make chips with structures as small as 1.5 microns to be used for making next-generation devices with structures as small as 0.7 micron.

The new technique will greatly extend the effectiveness and hence the useful life of the million-dollar-plus optical lithography systems used in chip patterning.

The main problem experienced when pushing present-generation optical-exposure systems to make chips with sub-micron structures is that of proximity effects. Light from the exposure systems diffracts as it passes through the tiny openings in the masks. Because of

that, areas of dense patterning tend to be underexposed. To compensate, exposure times must be lengthened, but doing that overexposes the isolated features, causing them to be undersized.

GE's proximity-correction technique solves the problem by causing the features on the masks to be enlarged slightly in isolated areas of patterning. A special software routine analyzes the spacing between features and then causes selected dimensions in the masks to be enlarged.

The routine can specify a continuous correction range, from none, for the most dense areas, to heavy, for the most isolated features. Then when exposed, isolated features can be brought to within 0.05 micron of the target width.

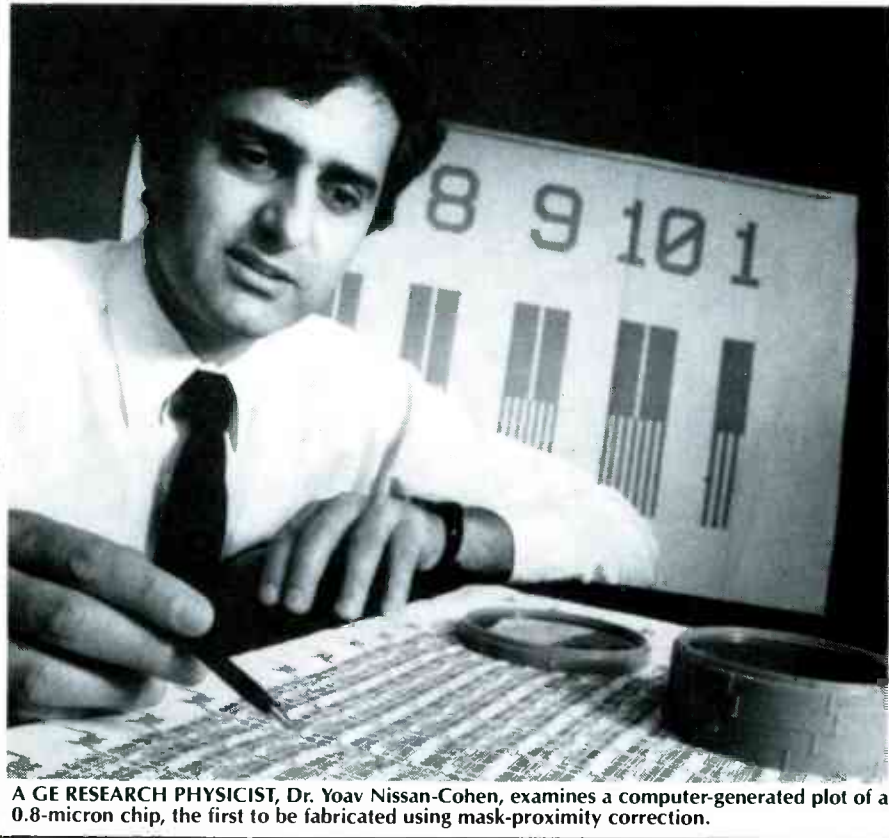

A GE RESEARCH PHYSICIST, Dr. Yoav Nissan-Cohen, examines a computer-generated plot of a 0.8-micron chip, the first to be fabricated using mask-proximity correction.

Spray painting solves problems of brittle superconductors

Scientists at IBM's Research Center at Yorktown Heights, NY report that they have found a way to circumvent the problem of brittleness in the new ceramic superconductor materials

The IBM scientist's solution is to use a plasma-spraying technique—heating the material until it is ionized, then spraying it on a suitable surface and cooling it. After annealing, the painted surface is again completely superconductive at 68 degrees Kelvin. The researchers have even coated preformed wires, and painting traces like those found in printed circuitry is comparatively simple.

New optoelectronic chip increases speed 10 times

Honeywell has developed an integrated GaAs monolithic receiver chip with a density speed about 10 times faster than that of any presently known circuit. The new chip contains a photodetector and 200 gates on the same GaAs substrate. It was demonstrated at 1-gigabit clock frequencies.

Measuring about 2×2 cm, the chip contains an optical detector, preamplifier circuit, and 1:4 demultiplexer. It was designed to decode a 1-gigabit optical signal input into four parallel 250-megabit electrical outputs. Its high data rates make the chip particularly useful for optical interconnects between computer chips.

That second-generation device is compatible with current manufacturing processes using direct ion implantation and metal organic vapor deposition for epitaxial growth. It provides greater power and capability than earlier devices because of its greater complexity and true integration of gallium-arsenide microelectronics and optical components.

TEST EQUIPMENT THAT MEASURES UP TO YOUR SPECIFICATIONS



DMM-300 \$79.95
3.5 DIGIT DMM / MULTITESTER

Our best model. A highly accurate, full function DMM loaded with many extra features. Audible continuity, capacitance, transistor temperature and conductance all in one handheld meter. Temperature probe, test leads and battery included.

- Basic DC accuracy: plus or minus 0.25%
- DC voltage: 200mv — 1000v, 5 ranges
- AC voltage: 200mv — 750v, 5 ranges
- Resistance: 20k ohms — 20M ohms, 6 ranges
- AC/DC current: 200uA — 10A, 6 ranges
- Capacitance: 2000pF — 20uF, 3 ranges
- Transistor tester: hFE test, NPN, PNP
- Temperature tester: 0° — 2000° F
- Conductance: 200ns
- Fully over-load protected
- Input impedance: 10M ohm



DMM-200 \$49.95
3.5 DIGIT FULL FUNCTION DMM

High accuracy, 20 amp current capability and many range settings make this model ideal for serious bench or field work. Til stand for hands-free operation. 2030 hour battery life with standard 9v cell. Probes and battery included.

- Basic DC accuracy: plus or minus 0.25%
- DC voltage: 200mv — 1000v, 5 ranges
- AC voltage: 200mv — 750v, 5 ranges
- Resistance: 200 ohms — 20M ohms, 6 ranges
- AC/DC current: 200uA — 20A, 6 ranges
- Fully over-load protected
- Input impedance: 10M ohm
- 180 x 86 x 37mm, weighs 320 grams



DMM-700 \$49.95
3.5 DIGIT AUTO-RANGING DMM

Autorange convenience or fully manual operation. Selectable LO OHM mode permits accurate in-circuit resistance measurements involving semi-conductor junctions. MEM mode for measurements relative to a specific reading. Probes and battery included.

- Basic DC accuracy: plus or minus 0.5%
- DC voltage: 200mv — 1000v, autoranging or 5 manual ranges
- AC voltage: 2v — 750v, autoranging or 4 manual ranges
- Resistance: 200 ohms — 20M ohms, autoranging
- AC/DC current: 20mA — 10A, 2 ranges
- Fully over-load protected
- Audible continuity tester
- Input impedance: 10M ohm
- 150 x 75 x 34mm, weighs 230 grams



DMM-100 \$29.95
3.5 DIGIT POCKET SIZE DMM

Shirt-pocket portability with no compromise in features or accuracy. Large, easy to read .5" LCD display. 2000 hour battery life with standard 9v cell provides over two years of average use. Probes and battery included.

- Basic DC accuracy: plus or minus 0.5%
- DC voltage: 2v — 1000v, 4 ranges
- AC voltage: 200v — 750v, 2 ranges
- Resistance: 2k ohms — 2M ohms, 4 ranges
- DC current: 2uA — 2A, 4 ranges
- Fully over-load protected
- Input impedance: 10M ohm
- 130 x 75 x 28mm, weighs 195 grams



MODEL 2000 \$349.95
20 MHz DUAL TRACE OSCILLOSCOPE

Model 2000 combines useful features and exacting quality. Frequency calculation and phase measurement are quick and easy in the X-Y mode. Service technicians will appreciate the TV Sync circuitry for viewing TV-V and TV-H as well as accurate synchronization of the Video Signal. Blanking Pedestals, VITS and Vertical/Horizontal sync pulses.

- Lab quality compensated 10X probes included
- Built-in component tester
- 110/220 Volt operation
- X-Y operation • Bright 5" CRT • TV Sync filter



MODEL 3500 \$499.95
35 MHz DUAL TRACE OSCILLOSCOPE

Wide bandwidth and exceptional 1mV/DIV sensitivity make the Model 3500 a powerful diagnostic tool for engineers or technicians. Delayed triggering allows any portion of a waveform to be isolated and expanded for closer inspection. Variable Holdoff makes possible the stable viewing of complex waveforms.

- Lab quality compensated 10X probes included
- Delayed and single sweep modes
- Z Axis intensity modulation
- X-Y operation • Bright 5" CRT • TV Sync filter



DPM-1000 \$54.95
3.5 DIGIT PROBE TYPE DMM

Autorange, pen style design for the ultimate in portability and ease of use. Custom 80 pin LSI chip increases reliability. Audible continuity tester and data hold feature for added convenience. Case, test leads and batteries included.

- Basic DC accuracy: plus or minus 1%
- DC voltage: 2v — 500v, autoranging
- AC voltage: 2v — 500v, autoranging
- Resistance: 2k ohms — 2M ohms, autoranging
- Fully over-load protected
- Input impedance: 11M ohm
- 162 x 28 x 17mm, weighs 75 grams

2 YEAR WARRANTY ON ALL MODELS



ORDER TOLL FREE 800-538-5000

OR VISIT OUR RETAIL STORE
1256 SOUTH BASCOM AVE.
SAN JOSE, CA. (408) 947-8881
CIRCLE 59 ON FREE INFORMATION CARD

JDR INSTRUMENTS
110 Knowles Drive, Los Gatos, CA 95030
(408) 866-6200 • FAX (408) 378-8927 • Telex 171-110

COPYRIGHT 1986 JDR MICRODEVICES
THE JDR INSTRUMENTS LOGO IS A REGISTERED TRADEMARK OF JDR MICRODEVICES.
JDR INSTRUMENTS IS A TRADEMARK OF JDR MICRODEVICES.

VIDEO NEWS



DAVID LACHENBRUCH,
CONTRIBUTING EDITOR

• **Video numbers.** As of June 1, 98% of all U.S. households had TV sets of some type. Breaking that figure down further, a color TV-set could be found in 93% of all U.S. households, projection TV-sets in 4%, LCD TV-sets in 2%, and some 7% of all U.S. households owned color TV-sets with multichannel (stereo) sound. Also, VCR's could be found in 45% of U.S. homes, camcorders in 3%, and 36% owned pre-recorded videocassettes.

Those estimates are from EIA, which also forecast that 18,300,000 color TV-sets will be sold this year. Of those, 4,300,000 will be stereo and 325,000 will be projection sets. Americans will also buy 13,725,000 VCR's, of which 12,000,000 will be table-model decks and 1,600,000 will be camcorders. Of the total VCR sales, the EIA predicts 2,500,000 will be equipped to receive and record stereo TV.

• **CD-Video Hows.** The CD has now formally been introduced in video form. Compact Disc-Video (or CDV, as it's expected to become known) has now been embraced by a sizeable number of hardware manufacturers, record companies, and movie firms. Although the audio CD is a digital medium, the visual part of the CDV is analog and uses the same record and playback principles as the *Laservision* videodisc.

The little 4 $\frac{3}{4}$ -inch CDV disc—the same size as an audio CD, but distinguished by its gold color—carries five minutes of video and up to 20 minutes of audio. The principal proponent of CDV, Phillips, has proposed changing the name of all *Laservision* players and discs to Compact Disc-Video, and several manufacturers have agreed to make players that will accommodate 4 $\frac{3}{4}$ -inch CDV's and audio-CD's, as well as 4 $\frac{3}{4}$ -, 8-, and 12-inch *Laservision* discs. Also in the works are mini-players that will play only the smaller discs; a little further down the line are possible CDV "boomboxes", portable audio-video systems with LCD displays.

Sales of CDV players and discs are scheduled to start this year. Many hardware and software manufacturers are standing aside for now, watching very closely to see if it is possible to

reincarnate the optical videodisc as a mass-market item via the magic of Compact Disc.

• **Super-VHS bargains.** When the first SVHS (Super-VHS) recorder was announced by JVC in Japan, the suggested list price was set at more than \$1,500, based on the yen-to-dollar exchange rate at the time. That led to speculation that the price of an SVHS recorder in the United States would be about \$2,000, effectively pricing the new medium out of the market. But consumer-electronics pricing can be full of surprises, and when Hitachi announced the first SVHS recorder for the American market, it was priced at about \$1,300. When JVC unveiled its model, it carried a U.S. suggested list price of just under \$1,200, although essentially the same model bore a list price of about \$1,550 in Japan. Facing that pricing challenge, other manufacturers are quoting \$1,100 for their units for the American market. Therefore, even before the first SVHS had reached the market in the U.S., prices had already come down by almost one-half.

By press time, SVHS decks had been announced for sale this year by Hitachi, JVC, Magnavox, Mitsubishi, Panasonic, Quasar, RCA, Sharp, Toshiba, and Zenith. JVC forecast that SVHS would soon replace standard VHS, but most other manufacturers disagree, arguing that there would be dual standards for some time to come.

One of the problems of SVHS currently is the lack of pre-recorded cassettes. Because cassettes recorded in the SVHS mode can't be played on standard VHS recorders (although VHS cassettes can be played on SVHS recorders), it will be some time before pre-recorded cassette makers will be willing to release much pre-recorded material in the new high-resolution format.

On another front, there is surprising interest in SVHS in the industrial and broadcast fields. Both JVC and Panasonic are preparing industrial models of SVHS, and there are forecasts that the new system could take over from the standard $\frac{3}{4}$ -inch U-matic format in industrial video. And it is also felt that the format has potential for use in broadcast newsgathering.

R-E

MAKE MORE MONEY

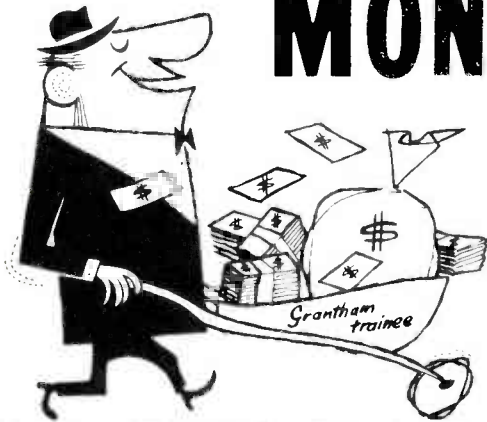

Do You REALLY Want to Make More Money?

Yes it does take *work* and a few sacrifices to climb up the electronics ladder to where the bigger money is. But, if that's where you want to be, then that's what you must do — *work* harder at learning and getting the right credentials, even if it takes a few sacrifices. A *B. S. degree* and the knowledge that rightly goes along with it can give you powerful ladder-climbing equipment in your search for *success in electronics*.

The accredited Grantham non-traditional B.S. Degree Program is intended for mature, fully-employed workers who want to upgrade their electronics careers.

TRAIN FOR ELECTRONICS

You say you're *already* trained in electronics but that you're *not* making enough money??? Well then, maybe you don't have an accredited bachelor's degree to prove that your education is *up to snuff!* Check out the Grantham Independent-Study B. S. Degree Program. It could make a *dollars and sense difference* in your electronics career.

Grantham offers this program, complete but without laboratory, to electronics technicians whose objectives are to upgrade their level of technical employment. Since the field of electronics is so enormous, opportunity for advancement is always present. Promotions and natural turnover make desirable positions available to the man who is ready to *move up*.

Grantham College of Engineering
10570 Humbolt Street
Los Alamitos, California, 90720

Put Professional Knowledge and a COLLEGE DEGREE in your Electronics Career through Independent Home Study

Study materials, carefully written by the Grantham College staff for independent study at home, are supplied by the College. Your technical questions related to these materials and the lesson tests are promptly answered by the Grantham home-study teaching staff.

Recognition and Quality Assurance

Grantham College of Engineering is accredited by the Accrediting Commission of the National Home Study Council, as a degree-granting institution.

All lessons and other study materials, as well as communications between the college and students, are in the English language. However, we have students in many foreign countries; about 80% of our students live in the United States of America.

This booklet FREE!

This free booklet explains the Grantham B.S. Degree Program, offered by independent study to those who work in electronics.

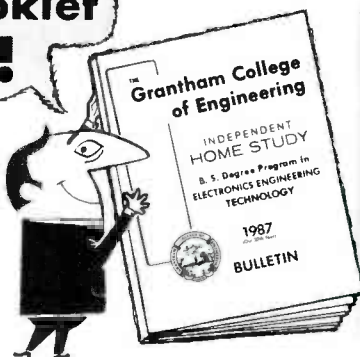

for **FREE Booklet CLIP COUPON** and mail in envelope or paste on postal card.

Grantham College of Engineering R-9-87
10570 Humbolt Street, Los Alamitos, CA 90720
Please mail me your free catalog which explains your B.S. Degree independent-study program.

Name _____ Age _____
Address _____
City _____ State _____ Zip _____

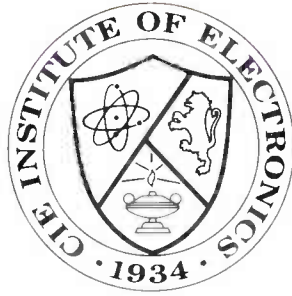

“If you’re going to learn electronics, you might as well learn it right!”

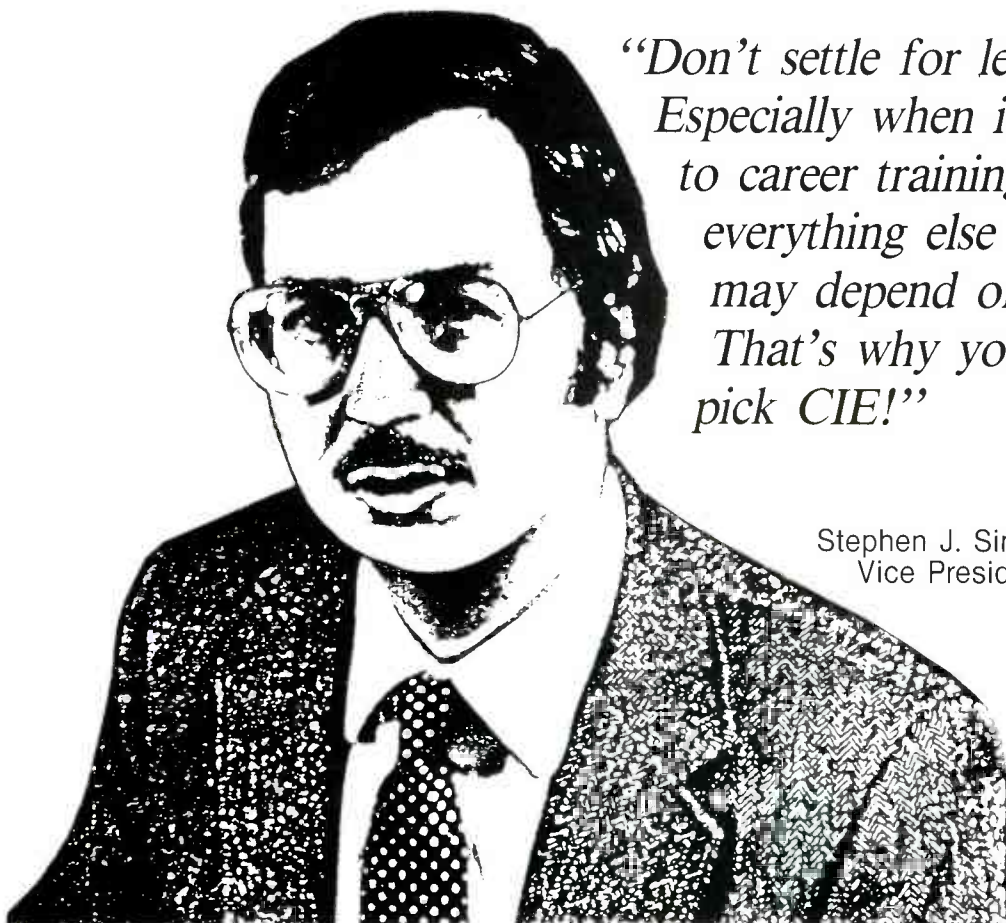

*“Don’t settle for less.
Especially when it comes
to career training...because
everything else in your life
may depend on it.
That’s why you ought to
pick CIE!”*

Stephen J. Simcic
Vice President, Academic Affairs

You've probably seen advertisements from other electronic schools. Maybe you think they're all the same. They're not! CIE is the largest independent home study school in the world that specializes exclusively in electronics.

Meet the Electronics Specialists.

When you pick an electronics school, you're getting ready to invest some time and money. And your whole future depends on the education you get in return.

That's why it makes so much sense to go with number one . . . with the specialists . . . with CIE!

There's no such thing as bargain education.

If you talk with some of our graduates, chances are you'd find a lot of them shopped around for their training. Not for the lowest priced but for the best. They pretty much knew what was available when they picked CIE as number one.

We don't promise you the moon. We do promise you a proven way to build valuable career skills. The CIE faculty and staff are dedicated to that. When you graduate, your diploma shows employers you know what you're about. Today, it's pretty hard to put a price on that.

Because we're specialists we have to stay ahead.

At CIE, we've got a position of leadership to maintain. Here are some of the ways we hang onto it . . .

Programmed Learning

That's exactly what happens with CIE's Auto-Programmed Lessons. Each lesson uses famous "programmed learning" methods to teach you important principles. You explore them, master them completely, before you start to apply them. You thoroughly understand each step before you go on to the next. You learn at your own pace.

And, beyond theory, some courses come fully equipped with electronics gear (the things you see in technical magazines) to actually let you perform hundreds of "hands-on" experiments.

Experienced specialists work closely with you.

Even though you study at home, you are not alone! Each time you return a completed lesson, you can be sure it will be reviewed, graded, and returned with appropriate instructional help. When you need additional individual help, you get it fast and in writing from the faculty technical specialist best qualified to answer your question in terms you can understand.

Pick the pace that's right for you.

CIE understands people need to learn at their own pace. There's no pressure to keep up . . . no slow learners hold you back. If you're a beginner, you start with the basics. If you already know some electronics, you move ahead to your own level.

Enjoy the promptness of CIE's "same day" grading cycle.

When we receive your lesson before noon Monday through Saturday, we grade it and mail it back the same day. You find out quickly how well you're doing!



Microprocessor Trainer

State-of-the-art Laboratory Equipment

Some courses feature the CIE Microprocessor Training Laboratory. An integral part of computers, microprocessor technology is used in many phases of business, including service and manufacturing industries.

The MTL gives you the opportunity to program it and interface it with LED displays, memory devices, and switches. You'll gain all the practical experience needed to work with state-of-the-art equipment of today and tomorrow.

CIE offers you an Associate Degree.

One of the best credentials you can have in electronics — or any other career field — is a college degree. That's why CIE gives you the opportunity to earn an Associate in Applied Science in Electronics Engineering Technology. Any CIE career course can offer you credit toward the degree — more than half of the number needed in some cases.

"Cleveland Institute of Electronics is the only accredited institution of higher learning offering an Associate Degree program with tuition based on actual study time used. The faster you complete your degree assignments, the less your overall tuition." Steve Simcic
Vice-President Academic Affairs

Which CIE Training fits you?

Beginner? Intermediate? Advanced? CIE home study courses are designed for ambitious people at all entry levels. People who may have:

1. No previous electronics knowledge, but do have an interest in it;
2. Some basic knowledge or experience in electronics;
3. In-depth working experience or prior training in electronics.

You can start where you fit and fit where you start, then go on from there to your Diploma, Associate Degree, and career.

Today is the day. Send now.

Fill in and return the postage-free card attached. If some ambitious person has removed it, cut out and mail the coupon. You'll get a FREE school catalog plus complete information on independent home study. For your convenience, we'll try to have a CIE representative contact you to answer any questions you may have.

Mail in the coupon below or, if you prefer, call toll-free 1-800-321-2155 (in Ohio, 1-800-523-9109).

ARE-68

CIE Cleveland Institute of Electronics, Inc.

1776 East 17th Street, Cleveland, Ohio 44114

Accredited Member National Home Study Council

YES...I want to learn from the specialists in electronics — CIE. Send me my FREE CIE school catalog...including details about the Associate Degree program... plus my FREE package of home study information.

Print Name _____

Address _____ Apt. _____

City _____ State _____ Zip _____

Age _____ Area Code/Phone No. _____/_____

Check box for G.I. Bill bulletin on Educational Benefits: Veteran Active Duty

MAIL TODAY!

CIRCLE 60 ON FREE INFORMATION CARD



Components and Adaptors

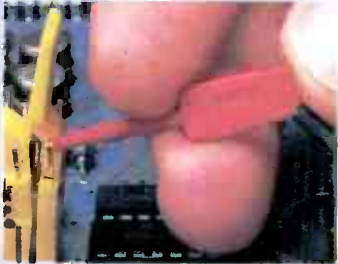

P-25 Plug-On Pico Hook

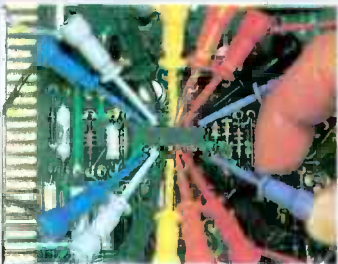

Micro-Hook

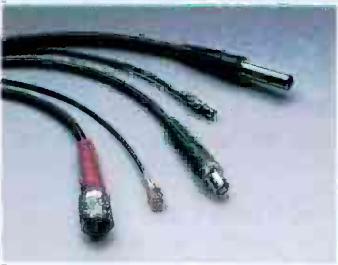

Coax Cable/Patch Cord Assemblies

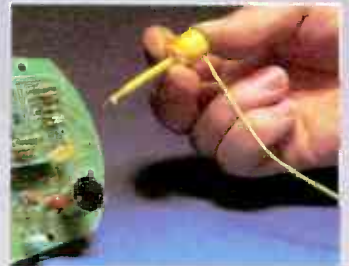
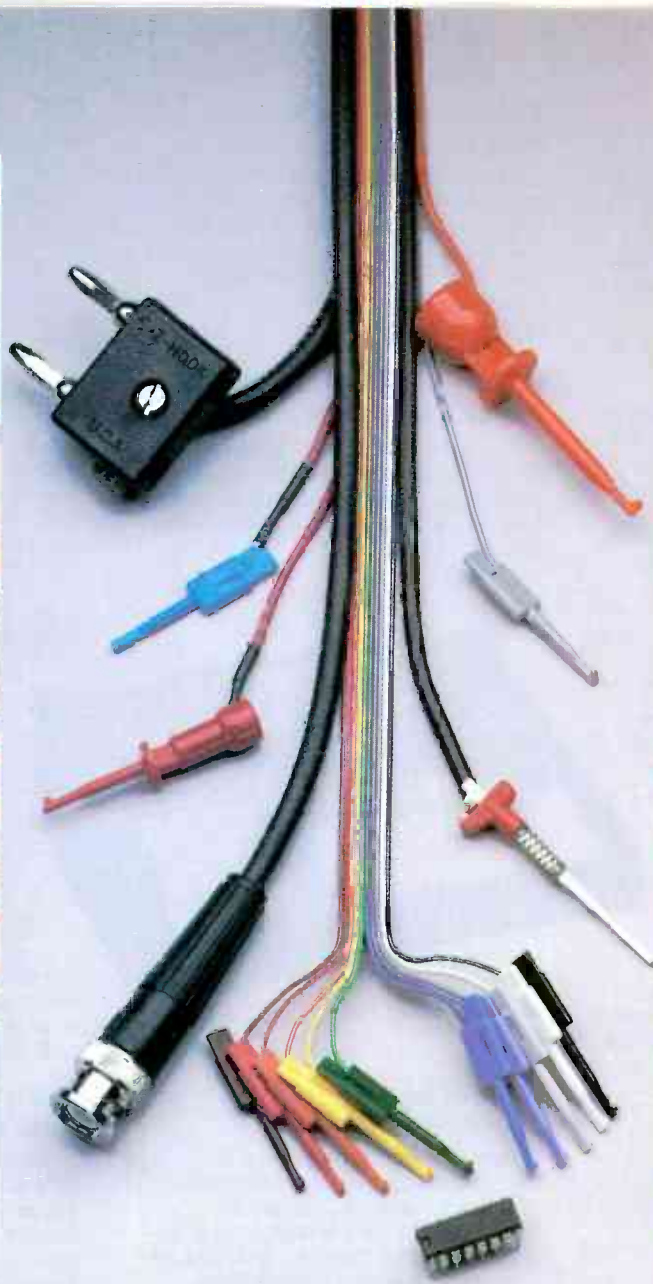

Mini-Hook Test Leads



Pico-Hook. Narrow I/C



Nail-Clip. Harnessing

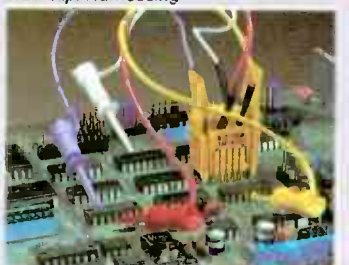

Tap-A-Dip 14 & 16 Pin Test Connectors

SIGNAL ACCURACY.

12,000 Reasons Why Industry Relies on E-Z HOOK.

Choose from over 12,000 standard test accessory products for an immediate solution to your application. They're engineered to assure a reliable contact or connection for any testing, hook-up or assembly task. And E-Z HOOK can ship what you need in 48 hours or less.

For a quick, economical answer to your testing needs, ask for our 112-page catalog of Electronic Test Accessories. It's free. And reliable.

E-Z-HOOK®

E-Z HOOK, A Division of Tektest, Inc., 225 North Second Ave., Arcadia, CA 91006
P.O. Box 450, (818) 446-6175. TWX 910-582-1614.

CIRCLE 215 ON FREE INFORMATION CARD

www.americanradiohistory.com

WE MAKE SPECIALS
SEND US YOUR REQUIREMENTS!

LETTERS



COMPONENT NUMBERING SYSTEMS

I enjoy reading your department, "Antique Radios." It's brought back memories of our first Atwater-Kent, and how I first began in radio around 1938.

Some of the history of those days is, I fear, becoming lost. One of the things that distresses me is when I hear someone refer to a diode, such as a 1N914 as an "eye-en" 914.

Did you know that the XN (1N, 2N, 3N, 4N) system of numbering

semiconductor devices was actually invented before there were transistors? Before there were transistors (prior to 1948) there were tubes and solid-state "crystal" diodes. During World War II solid-state diodes, the venerable 1N21, 1N23, 1N23A, and 1N23B among them, were used as mixers in radar receivers. Their function was to downconvert the incoming RF energy so that it could be amplified at a lower frequency.

The tube-numbering system most in favor at the time was of the

form nXn; for example a 6L6. The first number indicated the nominal filament or heater voltage. The letter indicated whether the device was an amplifier or a rectifier. Letter designations in the first half of the alphabet were amplifiers; letter designation in the second half of the alphabet were rectifiers. (From that, we see that the L in the tube number indicated that the 6L6 was an amplifier.) The final number indicated the number of active electrodes.

With CRTs, the first number in-



HAMEG Instruments

HM 205-2

the new Digital Storage Oscilloscope with 5 MHz sampling rate and 2 x 1024 / 8 bit storage realtime bandwidth DC-20 MHz **\$888.00**

HM 8148

the new intelligent Graphic Printer firmware for time, date, interval, linear interpolation zooming function **\$788.00**

DSO Software

with 13 programs incl. IEEE BUS card **\$480.00**



call toll free

(800) 247-1241

HAMEG, Inc.

88-90 Harbor Road · Port Washington, N.Y. 11050

Phone (516) 883-3837 · Telex (023) 497.4606

CIRCLE 62 ON FREE INFORMATION CARD

Pride, quality,

When you unpackage a Heathkit product, you open up a special world, a world providing a unique blend of achievement and fun. ■ With your Heathkit product, you'll enjoy the pride of building it yourself, and the confidence that it's built right. Along with the convenience and assurance of knowing how to keep it running at peak performance. ■ Plus you'll learn about new and emerging technologies. For knowledge that gives you that added edge in your field. ■ But most important, with a Heathkit product you're buying from a company whose name is synonymous with quality and enjoyment. From our easy-to-follow documentation to our renowned technical support, we make sure your kitbuilding experience is fun and relaxing – as well as rewarding.

■ And when you're done, your pride will be matched by the satisfaction of owning a product that you know inside out. And that will last a long time. ■ Thousands of people have discovered this unique dimension in product ownership. We'd like you to discover it, too.

For information on all our quality kits, send NOW for your FREE four-color Heathkit Catalog.

Send to: Heath Company, Dept. 020-576
Benton Harbor, Michigan 49022



GR-9009 9" AC/DC
Color TV – ONLY \$249.95

fun... Heathkit®

Enter the Heathkit world with...



The Heathkit ID-4001 Weather Computer, which puts weather information at your fingertips. With the press of a button, you can instantly know temperature, wind speed and direction, and barometric pressure for the exact location in which you live. For planning outdoor activities with greater assurance than ever.

And it's all done with unsurpassed accuracy. Long life IR LED's act as sensors to make both the wind speed cups and the wind direction vane as sensitive and as accurate as a costly laboratory instrument. While active solid state devices reliably measure indoor and outdoor temperatures, all stored by a microprocessor for later recall.

Attractively designed, the ID-4001 will give you extraordinary performance unheard of at such a reasonable price, **\$399.95.**

The IC-1001 Logic Analyzer is the perfect answer for transforming a PC-compatible computer or standard terminal into a versatile logic analyzer.

A top-grade troubleshooter and design aid, the compact Logic Analyzer includes 16 data lines plus clock and two qualifier lines, checksum capability, and state and timing displays with hex, octal and ASCII equivalents. You can even use it in circuits with clock speeds up to 10 MHz, trigger on any digital word and view events 2,000 pulses before trigger and up to 50,000 pulses after. High impedance inputs virtually eliminate circuit loading.

And it's easy to use! The highly intuitive user-friendly software makes the IC-1001 fully keyboard-configurable and menu-driven. All in one portable unit.

Put this most advanced technology to work for you – for only **\$269.00.**

To order, call toll-free 1-800-253-0570.

Ask for Operator 39.

We also have 66 Heath / Zenith Computers & Electronics stores in North America.

Call 616-982-3614 for the store location nearest you.

Heathkit®

Heathkit is a registered trademark of Heath Company, a subsidiary of Zenith Electronics Corporation

Prices, product availability and specifications are subject to change without notice.

**Heath
Company**

KB-103

CIRCLE 193 ON FREE INFORMATION CARD

www.americanradiohistory.com

licated the maximum screen dimension in inches instead of the heater (or filament) voltage. Thus 5BP1 was a tube with a 5-inch screen. The final "P1" indicates the phosphor type. That numbering system for CRT's is still used today, by and large, for both oscilloscope and TV CRT's.

Because solid-state diodes had no filament or heater, a different numbering system was called for. Using a zero designation would not work because there were tubes that had no filament or heater; the 0Z4, for example.) Although the specific origins of the nNxxx numbering system are obscure (at least to this writer), the following seems clear:

The prefix 1N was chosen to be distinctive from the tube designations. The initial 1 indicated one less than the number of electrodes or contacts; even though, at the time, all semiconductor devices had only two contacts. Perhaps the numbering system was chosen with an eye to a possible future where more contacts would be

added. In any event, it was a fortuitous choice, because when the transistor came along, a ready-made numbering system was already in place!

It is true that as far back as 1925 (some would say even earlier) researchers had dreamed of transistor-like devices. However, the fact remains that there were no such devices generally available until sometime after the work of Shockley, Bardeen, and Brattain that culminated in the invention of the transistor in 1948. Nor was it generally believed, prior to that time, that such a device was even possible.

HOMER B. TILTON
Tucson, AZ

FM COMMERCIAL KILLER

Here's another idea for the FM commercial killer that works on at least one station in my area:

Subtract the left and right channel from each other using a differential amp. When the station is broadcasting anything but music, the left and right channels will be

identical (mono), and that can be used to kill the audio output.

There are several ways to find out if that will work with a particular station. One is to connect one side of a speaker to the positive terminal of the left-channel output and the other to the positive terminal of the right-channel output. The signal produced will be the difference between the two channels. Adjust the balance control for no output with a mono signal, and then listen for while. If the commercials can't be heard, the technique will probably work. A more traditional way to see if the technique will work is to examine the the left and right outputs with a dual-channel oscilloscope to see if the commercials are mono or to measure the voltage between the center conductors of the left and right tape-output jacks; for a mono signal, the voltage seen on an AC voltmeter during commercials should be near zero.

STUART ENGELKE
Whitehouse Station, NJ

continued on page 92

NEW RUGGEDIZED SCOPE PROBES

Just a phone call away.

\$35 P6103

50 MHz 10x
Compensation Range
15 to 35 pF

\$58 P6109

150 MHz 10x
Compensation Range
18 to 22 pF

These new passive voltage probes can be used with any oscilloscopes having matching compensation ranges.

Screw in tips mean easy repair, no downtime.

To order call toll free **1-800-426-2200**

In Oregon, call collect (503) 627-9000.

VISA and MasterCharge accepted.

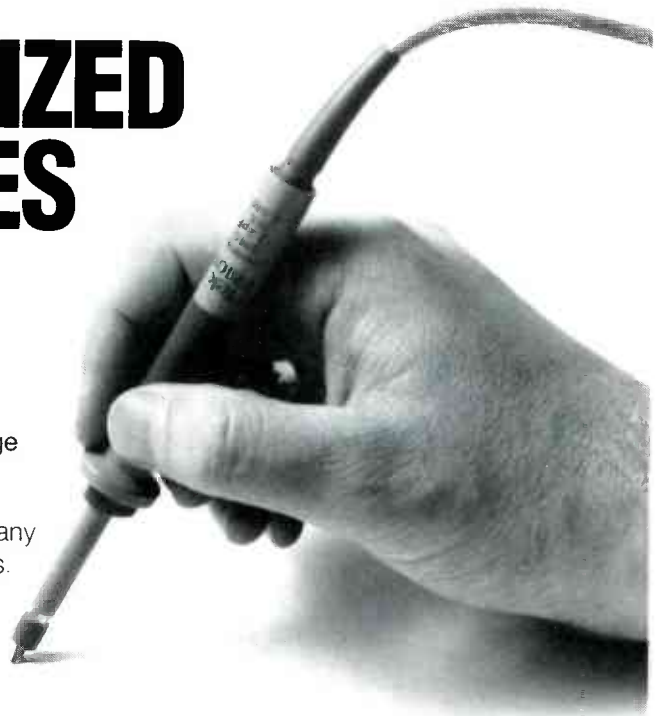

Tektronix
COMMITTED TO EXCELLENCE

Oops Proof. Now Even Better.

*Industry's Most Popular Heavy-Duty DMMs...
Now Even Better With Dual-Fuse Protection
And A Tougher Case.*

The tough just got tougher. When Beckman Industrial introduced heavy-duty DMMs tough enough to withstand accidental drops, input overloads and destructive environments, they quickly became the industry's most popular.

Now they're even tougher, thanks to the best dual-fuse protection you can buy and a new case. Covered by a one-year, no-fault guarantee against damage to the meter other than gross abuse.

For overloads, all voltage ranges can withstand transients up to 6KV. Resistance ranges are protected to 600 volts. Current ranges are protected by a 2 amp/600 volt fuse. The 10 amp range is protected by a 15 amp, 600 volt high energy fuse with 100,000 amp interrupt rating.

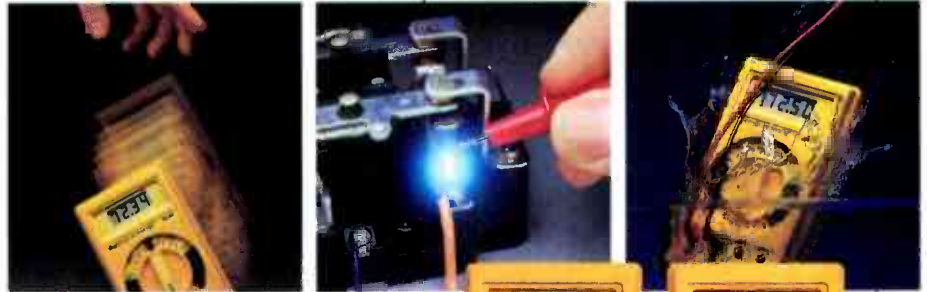

Our heavy-duty DMMs can withstand accidental drops, literally bouncing back for more, thanks to a new case made of Valox,[®] one of the most impact and corrosive chemical resistant thermoplastics around. Sensitive components are shock mounted for impact protection.

Even oil, water and industrial grime can't keep our heavy-duty DMMs away from the action. *Everything* is sealed with o-rings for maximum protection.

Of course, even the toughest DMM isn't much good if it can't deliver accuracy and the right combination of capabilities at the right price.

Check the HD DMM specs for yourself: Maximum voltage rating of 1500 volts DC, 1000 volts AC; tested to 40KHz; diode test function; and exclusive INSTA-Ohm[®] capability, now with an audible beeper, to make your HD even easier to use.

What's more, you can select just the model you need without paying extra. Start with the economical HD-100 at \$169.00 for solid, all-around meter performance. Choose the HD-110 with continuity beeper. Or, the HD-110T that lets you select Fahrenheit or Celsius temperature measurement with a simple field adjustment, accurately measuring from -4°F to +1999°F, and works with any K-type thermocouple. It also has a measurement range of 32°F to 392°F with the thermocouple provided.

You can even get the true RMS capability on the HD-130,



or with a 4 1/2 digit display required by the HD-140's accuracy.

HEAVY DUTY DMMS	HD100	HD110	HD110T	HD130	HD140
Digits	3 1/2			4 1/2	
Accuracy (Vdc)	0.25%		0.1%		0.05%
Input Impedance	22 Megohms			10 Megohms	
AC Conversion Type	Average		True RMS		True RMS
Bandwidth (AC Volts)	10KHz		40KHz		10KHz
Current Range	0.1µA			0.01µA	
Max. Reading	2A	10A (20A for 30 Seconds)			
Continuity Beeper		✓			
Battery Life (Alkaline type)	2000 Hours			100 Hours	

Visit your local Beckman Industrial distributor today. Compare. And discover why the toughest are tougher than ever.

*In Service
Instruments,
We're The One.*

Beckman Industrial™

Beckman Industrial Corporation Instrumentation Products Division
A Subsidiary of Emerson Electric Company
3883 Ruffin Rd., San Diego, California 92121-1898
(619) 565-4415 • FAX: (619) 268-0172 • T.L.N.: 249431
© 1987 Beckman Industrial Corporation

Train with NRI for a servicing

NEW!

Train with the newest Sanyo 880 Series Computer—it's fully IBM-compatible and runs almost twice as fast as the IBM PC!

Get started now by building this fully IBM PC compatible computer

Now you get it all... training for America's fastest growing career opportunity... training to service all computers... training on the newest total computer system, the Sanyo 880. Only NRI can give you the well-rounded training you need, because only NRI gives you a complete computer system... computer, monitor, disk drive, software, even test instruments like a digital multimeter and logic probe to work with and keep. It all adds up to training that builds the knowledge, competence, and ability you need to succeed as a computer service specialist.

Get inside the newest, fully IBM PC compatible Sanyo Microcomputer

As an NRI student, you'll get total hands-on training



SANYO COMPUTER—8088 CPU, double-sided disk drive, 256K RAM, 4.77 MHz and 8 MHz turbo speed.

DIGITAL MULTIMETER—Professional test instrument for quick and easy measurements.

LESSONS—Clear, well illustrated texts build your understanding of computers step-by-step.

DISK SOFTWARE—including MS-DOS, GW BASIC, WordStar, and CalcStar.

Your NRI total systems training includes: • NRI Discovery Lab* to design and modify circuits • Your four-function digital multimeter with walk-you-through instructions on audio tape • Digital logic probe for visual examination of keyboard circuits • The newest Sanyo 880 Series Computer with "intelligent" keyboard and 360K double-density, double-sided disk drive • High resolution monochrome monitor • 8K ROM, 256K RAM • Bundled software including GW BASIC, MS-DOS, WordStar, CalcStar • Reference manuals, schematics, and bite-size lessons.

as you actually build your own latest model Sanyo 880 Series computer from the keyboard up. It's fully IBM PC-compatible and, best of all, it runs programs almost twice as fast as an IBM PC. As you assemble the Sanyo 880, you'll perform

demonstrations and experiments that will give you a total mastery of computer operation and servicing techniques. You'll do programming in BASIC language—even run and interpret essential diagnostic software.

high paying career computers

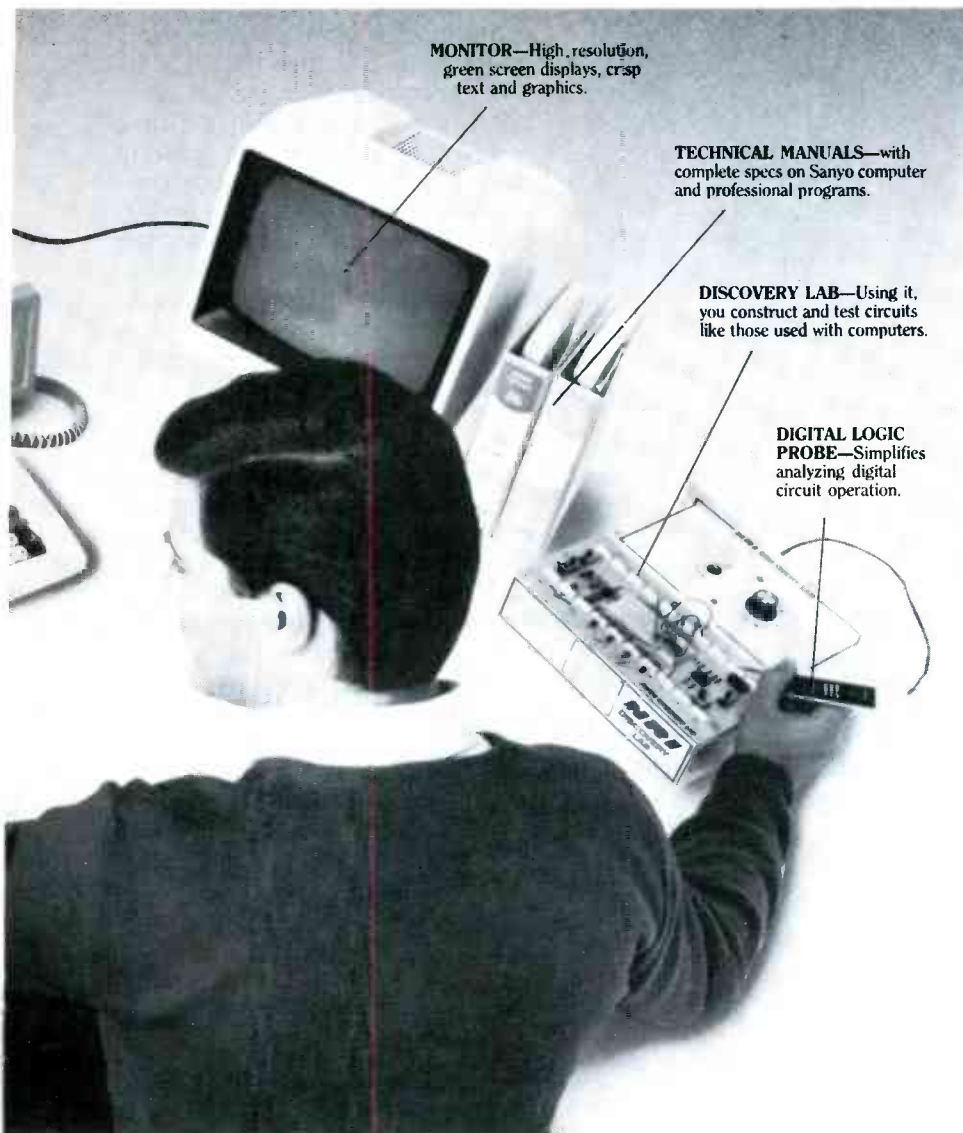

MONITOR—High resolution, green screen displays, crisp text and graphics.

TECHNICAL MANUALS—with complete specs on Sanyo computer and professional programs.

DISCOVERY LAB—Using it, you construct and test circuits like those used with computers.

DIGITAL LOGIC PROBE—Simplifies analyzing digital circuit operation.

at your own convenience, backed at all times by your own NRI instructor and the entire NRI staff of educators and student service support people. They're always ready to give you guidance, follow your progress, and help you over the rough spots to keep you moving toward your goal.

100 page free catalog tells more . . . send today

Send the postage-paid reply card today for NRI's 100 page catalog that gives all the facts about computer training, plus career training in robotics, data communications, TV/audio/video servicing, and many other fields. If the card is missing, write to NRI at the address below.



Understanding you get only through experience

You need no previous knowledge to succeed with NRI. You start with the basics, rapidly building on the fundamentals of electronics with bite-size lessons. You perform hands-on experiments

with your NRI Discovery Lab and then move on to master advanced concepts like digital logic, microprocessors, and computer memories.

Learn at home in your spare time

You train in your own home

NRI SCHOOLS
McGraw-Hill Continuing Education Center
3939 Wisconsin Avenue
Washington, DC 20016
We'll give you tomorrow



EQUIPMENT REPORTS

Onkyo Unifier Universal Programmable Remote Control

A single handheld remote control for all your audio and video needs.

CIRCLE 12 ON FREE INFORMATION CARD



It makes sense that an audio manufacturer has come up with a solution to having too much of a good thing, because the new remote-controlled CD players, stereo tuners, and amplifiers have added their share to the growing clutter of handheld remote controls on consumers' coffee tables. But the *Unifier* does more than simply remove some coffee-table clutter—it is a device that can unite audio and video functions in a single control. And the marriage of audio and video equipment is sure to sell a great many systems over the next few years.

The *Unifier* is an infrared remote control with a memory capacity of more than 100 functions. Despite the array of 35 buttons, 5 LED's,

IN MARCH 1986, WE LOOKED AT THE FIRST programmable remote control, G-E's *Control Central*. Since that time, several other companies have manufactured similar prod-

ucts. The latest entry is the model *RC-AVIM*, better known as the *Unifier*, from Onkyo (Onkyo U.S.A. Corporation, 200 Williams Drive, Ramsey, NJ 07446).

CONNECTION PROTECTION

SWITCHES & RELAYS
EDGE CONNECTORS
PLUGS & SOCKETS
POTENTIOMETERS

CONNECTING CABLES
TERMINAL STRIPS
GOLD PLATED CONNECTORS
BATTERY CONTACTS



CRAMOLIN®

Even the finest equipment in the world cannot guarantee noise-free operation. One "dirty" connection anywhere in the electrical path can cause unwanted noise or signal loss.

"MORE THAN A CONTACT CLEANER"

CRAMOLIN® is a fast-acting, anti-oxidizing lubricant that cleans and preserves all metal surfaces, including gold.

When applied to metal contacts and connectors, **CRAMOLIN®** removes resistive oxides as it forms a protective molecular layer that adheres to the metal surfaces and maintains maximum electrical conductivity.

CRAMOLIN® - USED BY THOSE WHO DEMAND THE BEST:

Beil & Howell	Hewlett Packard	MCI(Sony)	Nakamichi
Boeing	John Fluke Mfg.	Motorola	RCA
Capitol Records	McIntosh Labs	NASA	Switchcraft

SINCE 1956

CAIG LABORATORIES INC

1175-O Industrial Ave., (P.O. Box J) - Escondido, CA 92025-0051 U.S.A. • (619) 743-7143

CIRCLE 184 ON FREE INFORMATION CARD

W.S. Jenks & Ungar bring you
temperature
controlled,
anti-static
soldering with a
2-year warranty
and a great
price!



\$115.95

This soldering system can be tailored to fit your job requirements by means of interchangeable handles and tips. With a variable temperature range of 450 to 850°F, it features electronic control and 24 volt at the handle. Handles have quick disconnect plugs. A 2-position switch on the power base matches the correct calibration to the proper handle. Meets MIL-S-45743E, WS 6536E and DOD-STD-2000-1B, and is ESD safe.

Model 9920AS includes a traditional macro-size handle and heater barrel which is well suited for general electronic and standard soldering applications. Call TOLL-FREE for other handles and tips to expand this versatile soldering system.

TOLL-FREE
1-800-638-6405

W.S. JENKS & Son



1933 Montana Ave. NE Washington DC 20002
(202) 529-6020 TELEX: 89-2667 FAX: (202) 832-3411

CIRCLE 66 ON FREE INFORMATION CARD

and a 3-position slide switch on the front panel, the remote is surprisingly easy to program, and even easier to use.

The *Unifier* incorporates three major modes: AUDIO, VIDEO, and AUXILIARY; the front-panel slide switch determines which mode the unit is in. Each key can be programmed with a separate function for each mode.

The keyboard layout consists of 5 major key groupings: AMP/TV, PHONO, TUNER, TAPE/VCR, and CD/CATV and each button has one or two color-coded labels. For example, the AMP/TV section has keys labeled in white for CD, PHONO, TUNER, TAPE, etc. Those same keys are labeled in blue with the numerals 1 through 4. The white labels, of course, correspond to the audio mode, while the blue labels correspond to the video mode.

The function of each key, however, depends not on its label, but on how you program it. A keypad template is provided for any changes you make, as well as incorporating any additional auxiliary functions.

Programming the Unifier

Teaching the *Unifier* the codes of your current remote units is almost as easy as using the remotes themselves. Its 5 LED's guide you through the process.

The first step is to put the *Unifier* in the learn mode by flipping a small, recessed switch on the back of the unit to the LEARN position. Once you flip the switch, an LED labeled PRESS MATCHING FUNCTION KEYS lights. You then place the unifier head-to-head with your remote and do what you're prompted to—you simply press the matching function keys. After the *Unifier* recognizes the code, the LEARNING RELEASE LED lights, prompting you to release the keys. Immediately after doing so, you're prompted by the INPUT AGAIN LED to repeat the process for that key—a great double-check. Assuming everything is OK, the FUNCTION LEARNED/SENDING LED lights to verify that the key is set. If, for any reason, the two codes don't match, or if anything else goes wrong, the ERROR LED lets you know.

continued on page 29

HITACHI SCOPES AT DISCOUNT PRICES!

20MHZ



Model V212 \$475

Model V-212 20MHZ Dual Channel (1mV Sens.) \$475
 Model V-422 40MHZ Dual Channel (1mV Sens.) \$699
 Model V-425 40MHZ Dual Channel (with cursor) \$795
 Model V-660 60MHZ Triple Channel (Delayed Sweep) \$990
 Model V-1060 100MHZ Quad Channel (Delayed Sweep) \$1,340
 All above scopes have a 3 year guaranty on parts and labor

100MHZ



Model V1060 \$1,340

15-25%
OFF LIST
PRICE

ELENCO PRODUCTS AT DISCOUNT PRICES!

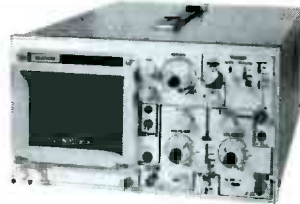

20MHZ DUAL TRACE OSCILLOSCOPE

\$359 MO-1251

TWO
100MHZ
SWITCHABLE
PROBES
INCLUDED

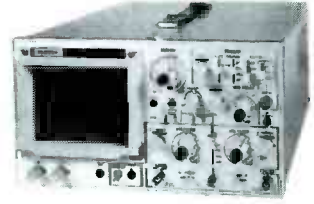

35MHZ DUAL TRACE OSCILLOSCOPE

\$498 MO-1252

Top quality scopes at a very reasonable price. Contains all the desired features. Elenco's 2 year guarantee assures you of continuous service. Two 1x, 10x probes, diagrams and manual included. Write for specs.
 100MHZ test probes, switchable 1x, 10x, Ref. (Complete W/ 5 accessories) Fits most scopes \$22



MULTIMETER with CAPACITANCE AND TRANSISTOR TESTER

Model CM-1500A \$58

Reads Volts, Ohms, Current, Capacitors, Transistors & Diodes W/Case



TRUE RMS 4 1/2 DIGIT MULTIMETER

Model M-7000 \$135

.05% DC Accuracy
.1% Resistance with Freq. Counter & Deluxe Case



Auto Ranging plus Manual Ranging
3 1/2 Digit Meter
28 Functions
Fully protected

M-1180 .7% Acy \$36.95
M-1182 .25% Acy \$39.95
M-1181 .1% Acy \$42.95



GF-8016 FUNCTION GENERATOR with Freq. Counter

\$239

- Sine, Square, Triangle
- Pulse, Ramp, 2 to 2MHz
- Frequency .1 thru 10MHz

GF-8015 without Freq. Meter \$179

10MHZ OSCILLOSCOPE

\$199

Model S-3000

- 10MHz DC or AC
- Triggered Sweep
- Calibrated Vert & Hor
- Reads Volts & Freq

BREADBOARD

Model 9436 Shown

9430 1,100 pins \$15
9434 2,170 pins \$25
9436 2,860 pins \$35



DIGITAL TRIPLE POWER SUPPLY

Model XP-765

\$195
0-20V @ 1A
0-20V @ 1A
5V @ 5A

Fully Regulated, Short Circuit Protected with 2 Limit Cont. 3 Separate Supplies
XP-680 with Analog Meters \$159.50

DIGITAL LCR METER

\$148

Model LC-1800

Measures: Inductors, Capacitors, Resistors



50MHZ LOGIC PROBE
20 nsec with memory LP-700



\$23

Logic Pulsar LP-600 \$23



DIGITAL 3 AMP POWER SUPPLY

Model XP-750

\$165

0-40V @ 1.5A
0-20V @ 3A

Fully regulated, short circuit protected current limit control
XP-650 with Analog Meters \$129.50

MULTI-FUNCTION COUNTERS



F-1000 \$245

1.2GH

F-100 \$169

120MH

Frequency, Period, Totalize, Self Check with High-Stabilized Crystal Oven Oscillator, 8 Digit LED Display

C&S SALES INC., 8744 W. North Ter., Niles, IL 60648
800-292-7711 (312) 459-9040



15 DAY MONEY BACK GUARANTEE

2 Year Limited Guarantee! Add 5% for Postage (\$10 max), IL Res., 7% Tax

CIRCLE 109 ON FREE INFORMATION CARD

HITACHI

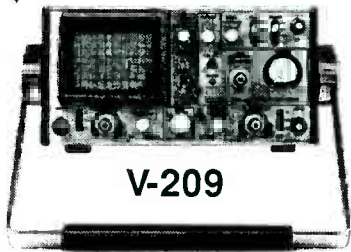

DC to 20MHz, Dual Channel Mini-Portable Scope

- 3.5" CRT with 1.5kV Potential
- 3-WAY Power Supply- AC, DC and Built-in Battery Pack
- Vertical Deflection: CH1, CH2, ALT, CHOP, ADD (DIFF)
- Max Sensitivity: 1mV/div at x10 Mag.
- X-Y Operation: 3° from DC to 100kHz

\$822. Save \$175!

V-212



\$440. Save \$175!

DC to 20MHz, Dual Channel

- 6" CRT with 2kV Potential
- Vertical Deflection: CH1, CH2, ALT, CHOP, ADD (DIFF)
- Max Sensitivity: 1mV/div at X5 Mag.
- X-Y Operation 3° from DC to 50kHz

V-222 Same as above, but with CH1 output and DC offset voltage monitor outlet available for external counter or DVM.

\$515. Save \$200!



WM. B. ALLEN SUPPLY COMPANY ALLEN SQUARE

300 Block North Rampart
New Orleans Louisiana 70112
NATIONWIDE 800 535-9593
LOUISIANA 800 462-9520
NEW ORLEANS 504 525-8222
FAX ORDER LINE 504 525-6361
• American Express • Visa • MasterCard •

CIRCLE 103 ON FREE INFORMATION CARD

NEW PRODUCTS



CIRCLE 24 ON FREE INFORMATION CARD

POWER BOOSTER for infrared remote controls, *Zapit* attaches to the front of the handheld remote, where it receives the infrared signals, and re-transmits them at a higher power. The high-power infrared output of *Zapit* bounces off

walls and ceilings so that it is not necessary to carefully point the handheld remote unit at the device you want to activate. *Zapit* has a suggested retail price of \$24.95—**Monster Cable**, 101 Townsend Street, San Francisco, CA 94107.

CURRENT CLAMP, the model *80i-1010* clamp-on probe is an accessory for digital multimeters that accurately measures AC current to 700 amperes, and DC current up to 1000 amperes. The probe clamps

around a conductor and senses the magnetic field produced by current flow, allowing safe, accurate measurements without breaking into the circuit.

A special feature of the model *80i-1010* is a thumbwheel **ZERO** control that allows the user to compensate for residual core magnetism in the clamp, thereby improving the accuracy of DC measurements down to 1 ampere.

The model *80i-1010* has a suggested U.S. list price of \$229.00.—**John Fluke Mfg. Co., Inc.**, P.O. Box C9090, Everett, WA 98206.



CIRCLE 25 ON FREE INFORMATION CARD

ELECTROSTATIC INTERFERENCE SIMULATOR, the model *2600* is designed as a complete and field-portable ESD (spark discharge)

Cable TV

DESCRAMBLER ARTICLE PARTS

February 1984 Issue

We stock the parts, PC Board and AC Adaptor for an article on building a cable TV descrambler appearing in *Radio-Electronics*.

#701 Parts Package* \$29.00

Includes all the original resistors, capacitors, diodes, transistors, integrated circuits, coils, IF transformers (Toko BKAN-K5552AXX).

#702 PC Board* \$8.95

Original etched and drilled silk-screened PC Board used in the article.

#704 AC Adaptor \$7.95

Original (14 volts DC @ 285 ma) AC Adaptor used in the article.

FREE reprint with Purchase Above

#708 Toko Coil Set \$6.95

Includes (2) BKAN-K5552AXX, (1) E520HN-300023, (1) 144LY-120K and BFQ-85 Replacement 2SC2369.

February 1987 Issue

We stock the parts, PC Board and AC Adaptor for an article on a tri-mode cable TV descrambler appearing in *Radio-Electronics*.

#301 Parts Package* \$39.00

Includes all the original resistors, capacitors, diodes, potentiometers, transistors, integrated circuits, LED's, Toko coil (E520HN-3000023) and Plessey Saw Filter (SY-323).

#302 PC Board* \$8.95

Original 5 x 8.8 etched and drilled silk-screened PC Board used in the article.

#304 AC Adaptor \$7.95

Original (14 to 18 volt DC @ 200 ma) AC Adaptor used in article.

Free Reprint with Purchase Above

#308 Plessey & Toko Set \$6.95

Includes (1) Plessey SY323 Saw Filter plus (1) Toko E520HN-300023 Coil.

Add \$2.50 Shipping & Handling; \$4.50 Canadian Orders

72-CHANNEL

MC-702 CONVERTER

CABLE CONVERTER

\$79.95

WITH INFRA-RED REMOTE CONTROL



Add \$3.50 Shipping and Handling
\$4.50 on Canadian Orders

- 72-channel capability
- Wireless, Infra-Red remote control
- Channel output 2 or 3 switchable
- Microprocessor controlled PLL operation
- Skip channel memory eliminates unused channels

- Parental control for all channels
- Last channel recall
- Fine tune memory
- UL listed/FCC approved
- Simple installation with any TV
- Includes battery and 3 foot coax cable

**ORDER TOLL FREE
1-800-227-8529**

Inside MA: 617-695-8699

VISA, MASTERCARD OR C.O.D.



*Not available to Massachusetts residents due to state law.

J & W ELECTRONICS, INC.

P.O. BOX 800 • MANSFIELD, MA 02048

©copyright 1987 by J&W Electronics, Inc.

CIRCLE 65 ON FREE INFORMATION CARD

GREAT SAVINGS ON LEATHER ATTACHES



Unsnaps for an extra 1/4" depth!

E-X-P-A-N-D-A-B-L-E LEATHER BRIEFCASES

Make a bold, new impression at your next business meeting. Order this set of TWO cases for the look and feel of designer attaches...without the high price, due to our special arrangements.

- TWO Factory New, First Quality Cases for ONE Low Liquidation Price.
- Rich Pigskin-Like Interior, Plus Generous Organization Pockets.
- Combination Locks Offer Security.
- Choose Burgundy or Black.

Large Case. It's 13" H x 18 1/4" W x 4 1/2" D and easily expands an extra 1/4" in depth if you need more room.

Banker's Case. Perfect for meetings where you need only a few documents. 11" H x 16 1/2" W x 2 1/2" D.

Shop and compare! You'll discover this is a great buy for TWO cases!

Compare At **\$229.00**

Liquidation Price For Set of TWO

\$59

Burgundy: Item H-2802-7037-518 S/H: \$5.75/set
Black: Item H-2802-7072-648 S/H: \$5.75/set

Credit card customers can order by phone, 24 hours a day, 7 days a week.

Toll-Free: 1-800-328-0609

Sales outside the 48 contiguous states are subject to special conditions. Please call or write to inquire.

SEND TO:

Item H-2802

COM Direct Marketing Corp.
1405 Xenium Lane N/Minneapolis, MN 55441-4494

Send Leather Briefcase(s) at \$59 per set, plus \$5.75 per set for ship, handling. (Minnesota residents add 6% sales tax. Sorry, no C.O.D. orders.)

Send Burgundy, Item H-2802-7037-518

Send Black, Item H-2802-7072-648

My check or money order is enclosed. (No delays in processing orders paid by check.)

PLEASE CHECK:

VISA MasterCard American Express Discover

Acct. No. _____ Exp. / _____

PLEASE PRINT CLEARLY

Name _____

Address _____ Apt. # _____

City _____

State _____ ZIP _____

Phone (____) _____

Sign Here _____

test system, consisting of an analog controller, a separate high-voltage test head, and application modules. A series of plug-in tips, in conjunction with the various operating modes available on the



CIRCLE 26 ON FREE INFORMATION CARD

controller, provide a range of functions that include spark discharge, current injection, ion generation, corona generation, and electric field propagation and collapse.

The model 2600 is a complete system, with no additional hardware or calibrators needed. It is priced at \$4195.00.—**IMCS Corporation**, 1300 Spacepark Way, Mountain View, CA 94043.

PIN LOCATOR, the *No Count*, slips over the pins of an IC test clip and remains with the clip. When the

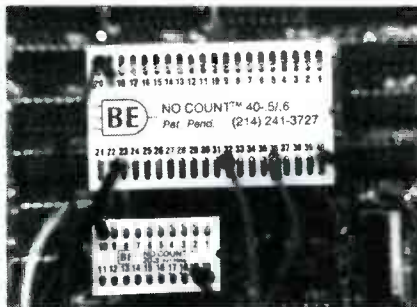

CIRCLE 27 ON FREE INFORMATION CARD

test clip is attached to the IC, each pin is easily identified, eliminating time-consuming pin counting.

No Count is available in 14 configurations from 14 to 64 pins; prices range from \$3.50 to \$6.50.—**L. J. Broder Enterprises, Inc.**, 11105 Shady Trail, Suite 115, Dallas, TX 75229.

AUDIO TAPE DECK CLEANER, *Standard System II*, combines Discwasher's Perfect-Path Cassette Head Cleaner and the Capstan Pinch Roller Cleaner to provide complete tape-deck care in one cassette shell. A deluxe version

with a carrying case is also available.

The Perfect Path Cassette Head Cleaner is designed to clean audio-cassette heads on car or home cassette decks quickly and safely. It uses no fluid and contains no alcohol that can damage cassette



CIRCLE 28 ON FREE INFORMATION CARD

mechanisms, nor are there any abrasive polishing compounds to cause excessive wear.

The Capstan Pinch Roller Cleaner is based on a special fluid formula that will not extract vital rubber stabilizers. The *Standard System II* is priced at \$11.95; the deluxe version is \$2 higher.—**Discwasher**, 4309 Transworld Road, Schiller Park, IL 60176.

SURGE SUPPRESSORS, the model *SK411*, (shown) the model *SKM411*, the model *SK416*, all contain metal-



CIRCLE 29 ON FREE INFORMATION CARD

oxide varistors and feature an indicator lamp that offers assurance that the equipment is being protected continuously.

Call 1-800-843-3338 today
to start thoroughly analyzing
and pinpointing any trouble in any
TV-RF distribution system,
automatically to FCC specifications . . .

New



with the All New
FS74 CHANNELIZER SR™ TV-RF Signal Analyzer
Patents Pending \$3495

IEEE - 488

Does your success in servicing RF distribution systems depend on locating problems quickly and accurately? If so, here's why your all new Sencore FS74 CHANNELIZER SR. will mean success for you . . .

Quickly tune in all TV/FM channels from 5 MHz to 890 MHz. Exclusive all channel, microprocessor-controlled digital tuner checks every standard and cable channel with better than FCC accuracy to fully analyze any system.

Exclusive 5 microvolt sensitivity to bring in even weak signals. Autoranged attenuator automatically selects the best sensitivity for simplifying your VHF, UHF, or FM signal measurements like never before possible.

Automatic hassle-free S/N ratio, A/V ratio, and hum level tests. Exclusive on-channel signal-to-noise ratio test eliminates time-consuming signal comparison and chart reading. Exclusive audio-to-video ratio test measures directly in dB for easy comparison to specifications.

Exclusive checks for ghosts, co-channel interference, line reflections, and other signal quality checks. Portable 4 MHz wideband battery-operated monitor lets you finally check the quality of your cable or MATV system and stop annoying callbacks.

Built-in autoranging AC/DC volt/ohmmeter makes troubleshooting a snap. Exclusive all-weather design holds tighter than FCC specifications from -4°F to +104°F. Truly portable, field-tested tough for dependable ease of use.

Begin successfully locating TV-RF signal problems more quickly and accurately than ever before possible, with the new FS74 CHANNELIZER SR. Call WATS Free 1-800-843-3338 today for a free Product Guide or an industry exclusive "Try before you buy" 15 Day Self Demo.

"CHANNELIZER SR." is a trademark of Sencore, Inc.

WATS Free 1-800-843-3338 In Canada WATS Free 1-800-851-8866



SENCORE

Means Success In Electronic Servicing

3200 Sencore Drive, Sioux Falls, South Dakota 57107
Call Collect 605-339-0100 In SD & AK

CIRCLE 187 ON FREE INFORMATION CARD

The model SKM411 is a single-outlet electronics protector, and is priced at \$22.15.

The model SKM411 is a single-outlet microwave protector, and is priced at \$26.20.

The model SK416 is a six-outlet electronic protection center surge suppressor and is a corded power center with ON/OFF switch. It is priced at \$73.80.

The model SKF416 is a six outlet protection center. In addition to suppressing surge, it also filters out radio interference noise, with 35 dB noise attenuation at 1 MHz. It has an ON/OFF switch. It is priced at \$86.75.—RCA, 2000 Clements Bridge Road, Deptford, NJ 08096.

TEMPERATURE AND HUMIDITY METERS, the model HT-410 (°C), shown in photo, and the model HT-411 (°F) are designed to aid in the control of both parameters in



CIRCLE 30 ON FREE INFORMATION CARD

applications such as pharmaceutical, chemistry, agriculture, forestry, food, electrical/electronics, and building environments.

Among the features provided by those state-of-the-art digital temperature and relative-humidity meters are excellent water resistance, enabling measurements for long periods of time, even when the main unit, sensor, and probe are subjected to condensation, and instant switching between temperature and humidity displays. Simultaneous analog outputs for temperature and humidity facilitate use in environmental control and monitoring applications.

The model HT-410 and the model HT-411 both have the same price: \$450.00 each.—North American Soar Corporation, 1125 Cornell Ave., Cherry Hill, NJ 08002.

Sterling™

precision drills

variable or constant speed . . . from the Maxi to the Mini!



Crafted in West Germany, the high-speed, low-voltage, hand-held drills are extremely quiet, lightweight and cool running with a very low vibration level. Speeds range from 0-21,000 RPM with a universal chuck to accommodate accessories up to .125 in size.

Accessories for any application!

Adapt your drill to all your exacting needs with over 100 high quality drill bits, grinding stones and wheels, saws, cutting wheels, sanders, brushes, polishers and other accessories. Available in "kits" or as separate items.

Your exacting standards demand Sterling quality.

WAHL CLIPPER CORPORATION
2900 Locust Street, Sterling, IL 61081
(815) 625-6525

CIRCLE 216 ON FREE INFORMATION CARD

MINIATURE ADHESIVE MOUNT, ABM1M is an adhesive-backed mount $\frac{1}{2} \times \frac{1}{2}$ inches, designed to meet the needs of limited-space applications. It is used with sub-miniature or miniature cable ties

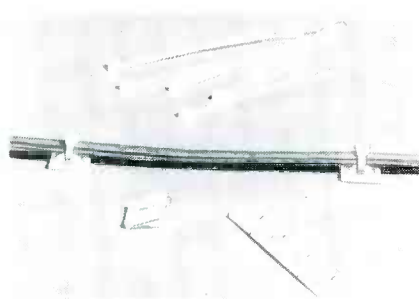

CIRCLE 32 ON FREE INFORMATION CARD

to provide secure mounting of wire and cable. Four-way entry design (of cable ties to mount) saves orientation time.

No hole-drilling or special fasteners are required. The user peels off the mount and then applies it. Four mounts are supplied on a common release liner for easy handling.

The miniature mount supports a maximum load of .13 lb. It can be used in applications with continuous temperatures up to 120°F with rubber foam-tape backing or up to 180°F with acrylic foam-tape backing. It is priced at \$24.49 per 100 pieces.—**Panduit Corporation**, 17301 Ridgeland Ave., Tinley Park, IL 60477-0981.

CABLE DESIGNATOR, the model 525, is designed for identifying individual cables in a common bundle. It can transmit through taps and a splitter, and is therefore able



CIRCLE 33 ON FREE INFORMATION CARD

to identify individual cables that are already in place, with all components installed.

The model 525 is useful in various construction applications including CATV or SMATV in

apartment buildings, local-area networks and other computer systems, schools, hospitals, offices, high-rise buildings, and ships.

The model 525 "SIX PAK," consists of one receiver, five transmitters, an operator's manual, and a carrying case; it is priced at \$395.00.—**Riser-Bond Instruments**, 505 16th Street, P.O. Box 188, Aurora, NB 68818.

OSCILLOSCOPE, the model 7934, is a screen-storage oscilloscope that takes over where digital storage leaves off.

Speed begins in the model 7934 with a high bandwidth—500 MHz—and a fast single-shot

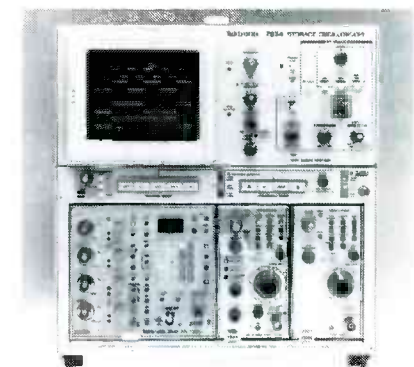

CIRCLE 34 ON FREE INFORMATION CARD

risetime—700 picoseconds. The real speed advantage, however, is in the model 7934's 4-cm/nanosecond stored writing rate.

Along with fast storage, the model 7934 also offers the flexibility of multiple-storage modes and controls to meet changing application needs. A bistable storage feature provides long viewing times, which allows time-lapse displays of changing events, which is ideal for checking pulse jitter or digital timing margins. Fast variable persistence with reduced scan captures fleeting events, such as arcing or plasma discharge. A SAVE mode gives the user up to 30 times longer viewing time; and storage level adjusts writing rate, which is useful in suppressing storage of random noise on low-level signals.

The model 7934 is priced at \$20,355.00. That price includes the 7934 mainframe, a 7A29 vertical-amplifier plug-in for a 500-MHz bandwidth, and a dual time-base plug-in for 500-MHz triggering.—**Tektronix, Inc.**, PO Box 500, Beaverton, OR 97077. **R-E**

EQUIPMENT REPORTS

continued from page 23

Using the *Unifier*

The *Unifier* is no more difficult to use than any standard remote control—once you get used to it. It has more keys than most remotes, so finding the key you're looking for can be difficult. The unit can be difficult to handle, as well, because it weighs about ½ pound and measures about 7 × 3 inches, with a thickness that ranges from about ⅝ to 1⅛ inch. What those numbers translate to is this: One-handed operation is possible for those with long fingers, but it's not easy to find a single grip that will let your thumb comfortably reach every key. For users with small hands, one-handed operation will be very clumsy. On the positive side, however, the most-used keys are grouped within easy reach, and the keys are large and spaced well enough that you won't hit a key you don't mean to.

Unfortunately, the labels used for the video functions are printed in blue, on a black background. If you keep your lights low in your media room, you may have a hard time finding the right key. Of course, searching for the VCR **PLAY** key on the *Unifier* can certainly be easier than trying to find the play key on your VCR's handheld remote unit—especially when it's buried somewhere on your coffee table between the remote for your TV, CD player, tuner, and maybe your cable box!

One problem that plagues some remotes is limited range. That's not the case here. The infrared power output from the *Unifier* is probably more powerful than the remotes you're currently using.

The *Unifier* is powered by 4 "AAA" alkaline batteries. You'll know when it's time to change the batteries thanks to a low-battery indicator. When you do change the batteries, what happens to the 100 functions that you programmed? Fortunately, a charged-capacitor backup system gives about one hour of memory retention. After that, you'll have to re-program the unit.

The *Unifier* has a suggested retail price of \$119.95. **R-E**

Walk "tough dog" troubles out of any TV & VCR in half the time . . . or your money back



with the exclusive, patented,
VA62 Universal Video Analyzer . . . \$3,295

Would you like to?

Reduce analyzing time: Isolate any problem to one stage in any TV or VCR in minutes, without breaking a circuit connection, using the tried and proven signal substitution method of troubleshooting?

Cut costly callbacks and increase customer referrals by completely performance testing TVs & VCRs before they leave your shop? Own the only analyzer that equips you to check all standard and cable channels with digital accuracy? Check complete, RF, IF, video and chroma response of any chassis in minutes without taking the back off the receiver or removing chassis plus set traps dynamically right on CRT too? Simplify alignment with exclusive multiburst pattern?

Reduce costly inventory from stocking yokes, flybacks, and other coils and transformers, for substitution only, with the patented Ringing Test. Run dynamic proof positive test on any yoke, flyback, and integrated high voltage transformer . . . in- or out-of-circuit?

Protect your future by servicing VCRs for your customers before they go to your competition? Walk out "tough dog" troubles in any VCR chrominance or luminance circuit — stage-by-stage — to isolate problems in minutes? Have proof positive test of the video record/play heads before you replace the entire mechanism?

Increase your business by meeting all TV and VCR manufacturers' requirements for profitable warranty service work with this one universally recommended analyzer?

To prove it to yourself, CALL TODAY, WATS FREE, 1-800-843-3338, for a FREE Self Demo . . . or learn how the VA62 works first by calling for your free simplified operation and application instruction guide, worth \$10.00.



Call Today Wats Free 1-800-843-3338

SENCORE

3200 Sencore Drive
Sioux Falls, SD 57107
605-339-0100 In SD Only

*innovatively designed
with your time in mind.*

CIRCLE 188 ON FREE INFORMATION CARD

CRYSTEK

The pulse of dependable communications

Reliability & Quality
From Start To Finished Product

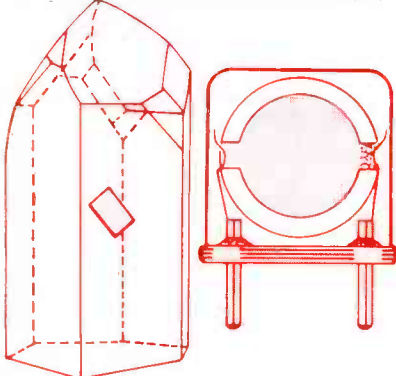

QUARTZ
CRYSTALS/OSCILLATORS
FOR
ELECTRONIC — INDUSTRIAL

- Micro-Processor Control
- Computers/Modems
- Test/Measurement
- Medical

COMMUNICATIONS-REPLACEMENT

- Mobile/2-way/Channel Elements
- Pagers
- Marine
- Aircraft
- Telemetry
- Monitors/Scanners

AMATEURS

- CB
- Hobbist
- Experimenter

- COST EFFECTIVE
- MODERATE PRICING
- FAST DELIVERY

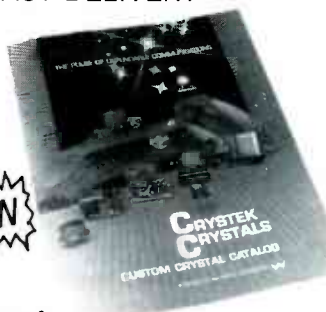

The Pulse of Dependable Communications

Crystek Crystals offers their new 16 page **FREE** catalog of crystals and oscillators. Offering state-of-the-art crystal components manufactured by the latest automated technology. Custom designed or "off the shelf." Crystek meets the need, worldwide. Write or call today!

CRYSTEK CRYSTALS

2351/2371 Crystal Dr. • Ft. Myers, FL 33907
P.O. Box 06135 • Ft. Myers, FL 33906-6135

TOLL FREE 1-800-237-3061
(813) 936-2109 - TWX 510-951-7448

CIRCLE 198 ON FREE INFORMATION CARD

SERVICE CLINIC

Quirks and queerities

THE TERM "QUEERITY" IS A SNIGLET meaning something queer and unusual. I've found my share of queerities when working on radios and TV's, so let's look a few of the tougher ones that I've had the (dis)pleasure of troubleshooting over the years.

One of my first queerities was a boat-anchor TV chassis having a queer sound. It wasn't actually oscillating, but it sounded as if it were on the verge of breaking into shrieks and whistles. Bridging all the filter and bypass capacitors didn't accomplish anything, but bridging the powerline bypass capacitor (which had nothing to do with the signal circuits) cured the problem. So I replaced the cabinet and sent it back to the customer. Although I never did figure out why the line bypass caused the instability there was no doubt that it did and the set was still working years after I made the "repair."

That case is typical of the hundreds that I've worked on since, where some component that can't possibly be the problem turns out to be the culprit. Of course, it's really impossible for unrelated components to affect circuit operation. Usually, if you trace a circuit carefully enough you'll eventually locate the feedback path: There must be one or the circuit wouldn't be oscillating.

Bad bypasses

In general, most of the queerities I've run across were caused by open or leaky bypass capacitors, which are often difficult to locate because they don't necessarily create the same problems and conditions each and



JACK DARR,
SERVICE EDITOR

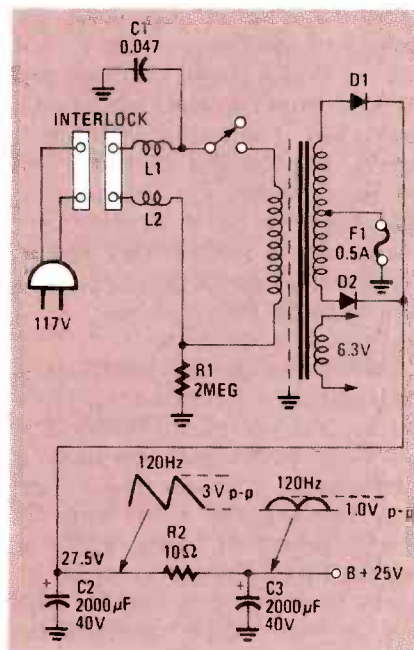

FIG. 1

every time. Bypass capacitors are in effect filters, whose job it is to remove unwanted signals from wiring before they can flow into other circuits. A defective bypass can allow signals to flow where they don't belong, resulting in mysterious oscillations, squeals, gurgles, or other strange sounds, and possibly video disturbances. For example, an open AGC bypass capacitor can cause oscillation if it permits signals to get into the grid or base circuit of the following amplifier stage.

Video problems caused by defective bypass capacitors are handled somewhat differently because you usually can see the problems they cause right on the TV screen. One of the easiest and

continued on page 89

NEW LIT

TEST EQUIPMENT CATALOG, is a letter-sized, two-color, 377-page book, addressed to all new and used test-equipment needs. It includes amplifiers, distortion analyzers, avionics, telecommunication, filters, signal and sweep generators, transistor and tube testers, logic analyzers, calibration equipment, phase/synchro/resolvers, signal conditioning, microwave components, environmental test, and many others. Photos of the equipment offered are sharp and clear. The catalog is available upon request from **Tucker Electronics Company**, 1717 Reserve, Garland TX 75042.

CIRCLE 20 ON FREE INFORMATION CARD

QUARTZ CRYSTAL CATALOG #30, is 5½ × 8½ inches, 11 pages, and covers crystal units in both fundamental and high-frequency overtone modes, microprocessor crystals, scanner crystals, marine crystals, sockets, holders, amateur-band crystals, and CB crystals—both standard and non-standard. It is available on request from **Jan Crystals**, 2400 Crystal Drive, P.O. Box 06017, FL 33906-6017.

CIRCLE 21 ON FREE INFORMATION CARD

FULL-LINE CATALOG, letter size, includes the latest in instruments for testing video, audio, components, and cable systems. Also waveform analyzers, IEEE instruments, and a complete line of instrument accessories. Complete specifications are given for all products, along with application information on each product, including nine all-new instruments exclusively designed with the technician's precious time in mind. Available free from **Sencore Electronics**, 3200 Sencore Dr., Sioux Falls, SD 57107. R-E

CIRCLE 22 ON FREE INFORMATION CARD

Exclusive, triple patented dynamic cap and coil analyzing . . . guaranteed to pinpoint your problem every time or your money back



with the all new LC75 "Z METER 2"
Capacitor Inductor Analyzer
Patented \$995

The "Z METER" is the only LC tester that enables you to test all capacitors and coils dynamically — plus, it's now faster, more accurate, and checks Equivalent Series Resistance (ESR) plus small wire high resistance coils.

Eliminate expensive part substitution and time-consuming shotgunning with patented tests that give you results you can trust every time. Test capacitor value, leakage, dielectric absorption, and ESR dynamically; with up to 600 volts applied for guaranteed 100% reliable results — it's exclusive — it's triple patented.

Save time and money with the only 100% reliable, in- or out-of-circuit inductor tester available. Dynamically test inductors for value, shorts, and opens, automatically under "dynamic" circuit conditions.

Reduce costly parts inventory with patented tests you can trust. No more need to stock a large inventory of caps, coils, flybacks, and IHVTs. The "Z METER" eliminates time-consuming and expensive parts substituting with 100% reliable LC analyzing.

Turn chaos into cash by quickly locating transmission line distance to opens and shorts to within feet, in any transmission line.

Test troublesome SCRs & TRIACs easily and automatically without investing in an expensive second tester. The patented "Z METER 2" even tests SCRs, TRIACs, and High-Voltage Diodes dynamically with up to 600 volts applied by adding the new SCR250 SCR and TRIAC Test Accessory for only \$148 or FREE OF CHARGE on Kick Off promotion.

To try the world's only Dynamic LC Tester for yourself, CALL TODAY, **WATS FREE**, 1-800-843-3338, for a FREE 15 day Self Demo.



Call Today Wats Free 1-800-843-3338

SENCORE
3200 Sencore Drive
Sioux Falls, SD 57107
605-339-0100 In SD Only

*innovatively designed
with your time in mind.*

CIRCLE 189 ON FREE INFORMATION CARD

NEW IDEAS

Audible logic tester

A LOGIC TESTER WITH AN AUDIBLE INDICATOR can be handy when troubleshooting or testing a crowded circuit board. It allows you to keep your eyes on the circuit, rather than on an LED on the tester. The project described in this article is just such a tester. It provides an audible indication of the logic level of the signal presented to its input. A logic high is indicated by a high tone, a logic low is indicated by a low tone, and oscillation is indicated by an alternating tone. The input is high impedance, so it will not load down the circuit under test. It can be used to troubleshoot TTL or CMOS logic.

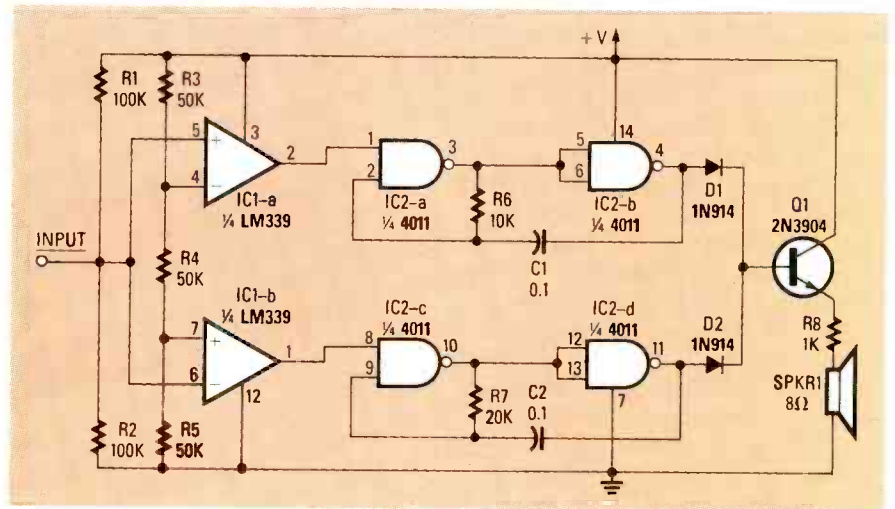

FIG. 1

Choose from 30 Career Opportunities

Get Your Specialized Associate Degree or Career Diploma at Home in Spare Time

Without attending college and with no previous experience, you can train for a money-making career. Send for free facts and color brochure on employment opportunities in the field that interests you most. See how easy it is to train at home for a great new career or advancement on your present job.



CALL TOLL FREE 1-800-228-5300 Dept. DES87
CALL ANYTIME—Operators to take your call 24 hours a day, 7 days a week. No cost. No obligation. No salesman will visit you.

OR MAIL COUPON TODAY!

ICS International Correspondence Schools
Dept. DES87, Scranton, PA 18515
Please send me free facts, color brochure and full information on how I can study at home for the career I have chosen.
CHECK ONE BOX ONLY!

ASSOCIATE IN SPECIALIZED BUSINESS DEGREE PROGRAMS

- Business Management
- Accounting
- Business Management with option in Finance
- Business Management with option in Marketing

ASSOCIATE IN SPECIALIZED TECHNOLOGY DEGREE PROGRAMS

- Civil Engineering Technology
- Mechanical Engineering Tech.
- Electrical Engineering Tech.
- Electronics Technology

CAREER DIPLOMA PROGRAMS

- High School
- Auto Mechanics
- Surveying & Mapping
- Drafting
- Air Conditioning & Refrigeration
- Wildlife/Forestry Conservation
- Police Sciences
- Diesel Mechanics
- Electrician
- Small Business Management
- Gun Repair
- Electronics
- Microcomputer Repair
- Bookkeeping
- Art
- Motorcycle Repair
- Catering/Gourmet Cooking
- Computer Programming
- Fitness & Nutrition
- TV/VCR Repair
- Photography
- Journalism/Short Story Writing

Name _____ Age _____
Address _____ Apt. # _____
City/State _____ Zip _____
Phone () _____

A Subsidiary of National Education Corporation

CIRCLE 197 ON FREE INFORMATION CARD



THE MOST POPULAR WIRE-WOUND CB ANTENNAS IN THE WORLD

Because...they perform!

FACT

"When CB was legalized in England, 'Firestik' antennas were barred from sale because the emitted signal was too strong. Fortunately, no other country, including the U.S., limits antenna efficiency."

YOU CAN HAVE SECOND BEST OR, 'Firestik'!

Call or Write for FREE Catalog
'Firestik' Antenna Company
2614 East Adams
Phoenix, Arizona 85034
(602) 273-7151

MILLIONS OF SATISFIED OWNERS

CIRCLE 100 ON FREE INFORMATION CARD

ELECTRONIC COMPONENTS CATALOG

... yours FREE by dialing

1-800-992-9943

In Texas: 817/ 483-4422

Call Today for your FREE subscription to the 1987 Mouser Electronics Catalog. Contains 176 pages featuring over 16,000 in-stock, quality electronic components.

..PLUS..Mouser's proven service and prompt delivery.
(Outside U.S.A., Send \$2.)

MOUSER ELECTRONICS

MOUSER ELECTRONICS

2401 Hwy 287 North
Mansfield, Texas 76063

DISTRIBUTION CENTERS NATIONWIDE

CIRCLE 117 ON FREE INFORMATION CARD

The circuit

A schematic of the circuit is shown in Fig. 1. The input section determines whether the logic level is high or low, and enables the appropriate tone generator; it consists of two sections of an LM339 quad comparator. One of the comparators (IC1-a) goes high when the input voltage exceeds 67% of the supply voltage. The other comparator goes high when the input drops below 33% of the supply. Resistors R1 and R2 ensure that neither comparator goes high when the input is floating or between the threshold levels.

The tone generators consist of two gated astable multivibrators. The generator built around IC2-a and IC2-b produces the high tone. The one built around IC2-c and IC2-d produces the low tone.

Two diodes, D1 and D2, isolate the tone-generator outputs. Transistor Q1 is used to drive a low-impedance speaker.

The tester can be built on a small piece of perforated construction board; a PC board could also be used, if desired. Layout is not critical. The completed board should be mounted in a case. The size of its case will most likely be determined by speaker's size.

Two notes on the IC's: The 4011 is a CMOS device. As with all other CMOS devices, extra care should be exercised in handling to avoid subjecting the IC to damaging static electricity. Also, all unused inputs on the LM339 should be tied to ground.

The tester is designed to draw its power from the circuit under test. Therefore, the power and ground leads should be terminated by small alligator clips. Connect a spare multimeter probe to the tester's input and you are all set.

Connect the power-supply lead to the positive supply rail of the circuit under test. Connect the ground lead to the circuit-under-test's ground rail. At this point, the tester should be silent. Now, touch the probe tip to the circuit's positive supply rail. The tester should produce a high-pitched tone. Next, touch the probe to the ground rail. The tester should produce a low-pitched tone. If all is well, your tester is ready for use.

—Philip L. Kane

Analyze defective waveforms faster, more accurately, and more confidently — every time or your money back

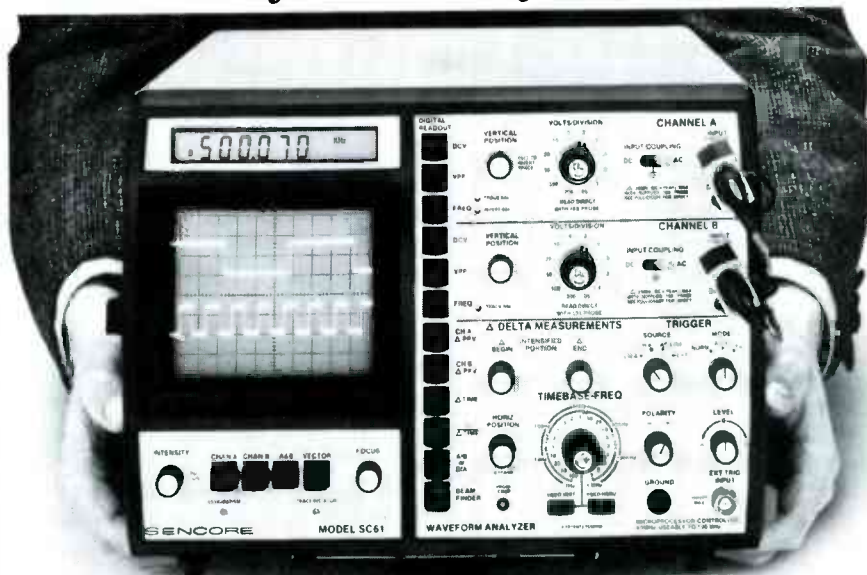

with the SC61 Waveform Analyzer
Patented \$2,995

If you value your precious time, you will really want to check out what the exclusively patented SC61 Waveform Analyzer can do for you. 10 times faster, 10 times more accurate, with zero chance of error.

End frustrating fiddling with confusing controls. Exclusive ultra solid ECL balanced noise cancelling sync amplifiers, simplified controls, and bright blue dual trace CRT help you measure signals to 100 MHz easier than ever.

Accurately and confidently measure waveforms from a tiny 5 mV all the way to a whopping 3,000 V without hesitation with patented 3,000 VPP input protection — eliminates expensive "front end" repairs and costly equipment downtime.

Make only one circuit connection and push one button for each circuit parameter test: You can instantly read out DC volts, peak-to-peak volts and frequency 100% automatically with digital speed and accuracy. It's a real troubleshooting confidence builder.

Confidently analyze complex waveforms fast and easily. Exclusive Delta measurements let you intensify any waveform portion. Analyze glitches, interference signals, rise or fall times or voltage equivalents between levels; direct in frequency or microseconds.

Speed your digital logic circuit testing. Analyzing troublesome divide and multiply stages is quicker and error free — no time-consuming graticule counting or calculations. Simply connect one test lead to any test point, push a button, for test of your choice, for ERROR FREE results.

To see what the SC61 can do for your troubleshooting personal productivity and analyzing confidence, CALL TODAY, WATS FREE, 1-800-843-3338, for a FREE 15 day Self Demo.



Call Today Wats Free 1-800-843-3338

SENCORE

3200 Sencore Drive
Sioux Falls, SD 57107
605-339-0100 In SD Only

*innovatively designed
with your time in mind.*

CIRCLE 190 ON FREE INFORMATION CARD

Get A Complete Course In

ELECTRONIC ENGINEERING

8 volumes, over 2000 pages, including all necessary math and physics. 29 examinations to help you gauge your personal progress. A truly great learning experience.

Prepare now to take advantage of the growing demand for people able to work at the engineering level.

Ask for our brochure giving complete details of content. Use your free information card number, or write us directly. **\$99.95**, Postage Included. Satisfaction guaranteed or money refunded.



CIRCLE 191 ON FREE INFORMATION CARD

Be an FCC LICENSED ELECTRONIC TECHNICIAN!

Earn up to \$30 an hour and more!

Learn at home in spare time. No previous experience needed.

No costly school. No commuting to class. The Original Home-Study course prepares you for the "FCC Commercial Radiotelephone License". This valuable license is your "ticket" to thousands of exciting jobs in Communications, Radio-TV, Microwave, Computers, Radar, Avionics and more! You don't need a college degree to qualify, but you do need an FCC License.

No Need to Quit Your Job or Go To School
This proven course is easy, fast and low cost! **GUARANTEED PASS** - You get your FCC License or money refunded. **Send for FREE facts now. MAIL COUPON TODAY!**

COMMAND PRODUCTIONS

FCC LICENSE TRAINING, Dept. 90
P.O. Box 2223, San Francisco, CA 94126

Please rush **FREE** details immediately!

NAME _____
ADDRESS _____
CITY _____ STATE _____ ZIP _____

DESIGNER'S NOTEBOOK

Very simple delay circuits

ROBERT GROSSBLATT,
CIRCUITS EDITOR

I'VE GOTTEN SEVERAL LETTERS ASKING for a simple circuit that will accept a trigger pulse, wait a specified length of time, and then output another pulse. Now, there are almost as many ways to design delay circuitry as there are uses for it; how you go about such a design depends on the particulars of your application. But if precision is

- What clock frequencies do you have available?
- What degree of accuracy do you want?

Once you know exactly what your circuit needs, you can figure out which of those IC's, or some similar one, will work best for your particular application.

The 4017 Johnson counter will

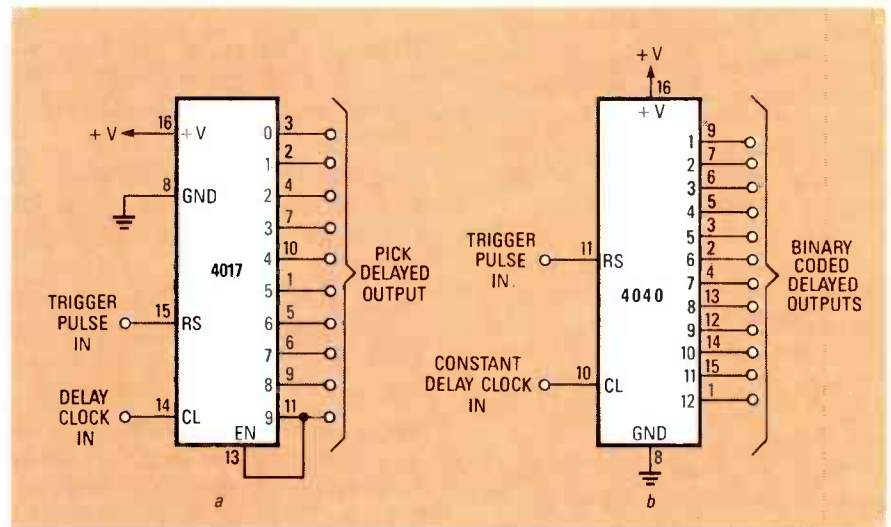

FIG. 1

what you have in mind, nothing works better than a stand-alone counter.

Two stand-alone counter "circuits" are shown in Fig. 1. Actually, we are being generous in calling them circuits because there is nothing to them aside from the IC itself. Figure 1-a is a 4017 Johnson counter; Figure 1-b is a 4040 binary counter. The choice of which one to use for your delay circuit depends on your answers to three interrelated questions:

- How much of a delay do you want?

give you a very accurate time delay for up to 10 clock pulses. All you have to do to create a delayed pulse is tie the ENABLE input to the 9 output, and your clock to—you guessed it—the CLOCK input. When you first apply power, the counter will advance and as soon as the 9 output goes high, it will freeze the count. The 4017 will stay in that condition until your trigger pulse comes along to zap the RESET pin (pin 15). That pulse will reset the counter, which will then count up to 9 and freeze again. Once the count starts you can pick off your

delayed pulse from any of the other output pins; the choice of pins is determined by the amount of delay needed.

By using a binary counter like the 4040, you can generate a much longer delay. Since there's no enable pin available, things have to be done a bit differently. The IC is set up to start counting as soon as power is applied. The trigger pulse will cause the device to reset to zero and you can pick off your delayed pulse at any of the device's output pins.

The price you pay for simplicity is that the circuit you hang on the output has to be set to ignore pulses until the trigger pulse is generated. That is because the 4040 will always be counting through its full range and your selected output will be high once per complete count. That problem can be solved with some additional gating, but the idea here is to keep the circuit as simple as possible.

In any event, those suggestions are just that—suggestions. More than likely you can think of lots of

simple alternatives that are even more flexible than these.

Product of the month

Every so often I run across a product that's not only reasonably priced and extremely handy, but helps eliminate all kinds of hassles as well. From now on, when I find one of those things, I'll be awarding it the soon-to-be-famous "Sil-



FIG. 2

ver Soldering Iron." I probably won't be bestowing that honor too often, because there's a lot of junk out there; but when I find something that's really worth honoring, I'll let you know about it.

The winner of the first Silver Soldering Iron is the *Portasol* from

The Boardworks (1077 East Edna Place, Covina, CA 91722). See Fig. 2. It's a butane-powered, pocket-sized soldering iron. Imagine, no batteries, no static electricity, no grounding problems, etc. At a list price of \$25.00, it is a really neat and inexpensive alternative to battery-powered portable soldering irons, and you don't have to worry about running out of power before you get to the last connection.

The *Portasol* can be refilled with any ordinary cigarette-lighter butane cartridge and gives about an hour of operation per charge. There are several different tips available for the unit, and the heat can be adjusted with a twist valve in much the same way a cigarette-lighter flame is regulated.

I've been using my *Portasol* for a few months and it works perfectly. It's a well-built realization of a good idea. I owe my living to electricity, but this is one time when gas is better. If you're in the market for a portable iron, get one of those. They're cheaper, faster, and much more convenient. **R-E**

#1 IN CABLE BOXES SPECIAL!

\$99.95

ANY QUANTITY

- Volume control
- 68 channels
- Mute control
- Automatic fine tuning
- Instant channel recall
- Programmable to go on at a particular channel and off automatically
- Compatible with descramblers

JERROLD CORDLESS CABLE TV CONVERTERS



\$69.95

*ADD \$5.00 FOR VISA OR MASTER CARD

JERROLD CORDLESS CABLE TV CONVERTER

\$69.95

MODEL DRX3-105/400

- 58 channels
- Remote channel changing
- Remote on/off switch
- Remote fine tuning

JERROLD CORDLESS CABLE TV CONVERTER

\$69.95/10 lot

MODEL DRZ/450

- 66 channels
- Automatic fine tuning
- A/B switch option

\$79.95 ea.

JERROLD CORDED CABLE TV CONVERTER

\$29.95/10 up

MODEL JRX3-105

\$39.95/6-9
\$49.95/1-5



"THE RABBIT" VIDEO MULTIPLYING SYSTEM

\$51.95

MODEL TR-7000

\$59.95/6-11
\$69.96/1-5

12 up



IT'S LIKE HAVING A VCR IN EVERY ROOM

OMNITRON ELECTRONICS

770 Amsterdam Ave., New York, NY 10025

SHIPPING CHARGES

For Orders	Add
\$25-100	\$6.50
\$100-500	\$8.50
\$500-750	\$10.50
\$750 and up	\$20.00

Write for FREE CATALOG 136 L-337e

MASTER CARD VISA

CIRCLE 110 ON FREE INFORMATION CARD

Join the Electronics and Control Engineers' Book Club®

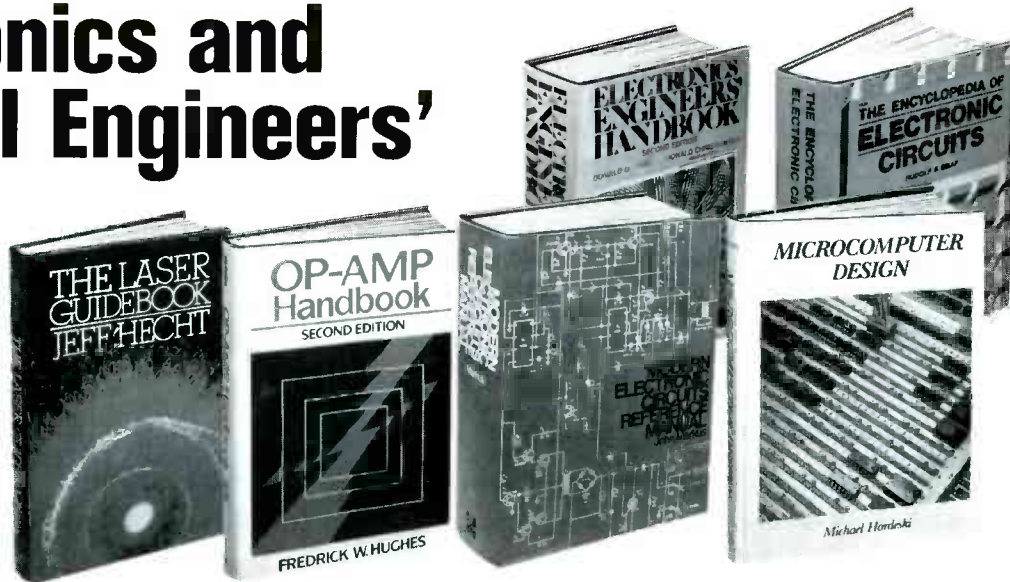

ADVANCED DIGITAL COMMUNICATIONS: Systems and Signal Processing. Edited by K. Feher. 768 pp., 436 illus. Emphasizes the newest advances and developments in telecommunications systems and networks. Chapters on subjects such as ISDN, speech coding algorithms, digital speech interpolation systems and interference are all written by international authorities to give you on-the-job expertise.
583801-X Pub. Pr., \$59.95 Club Pr., \$42.50

ELECTRONICS ENGINEERS' HANDBOOK, Second Ed. Edited by D. G. Fink & D. Christiansen. 2,272 pp., 2,189 illus. This updated and enlarged edition covers all the latest knowledge in the field, including new advances in integrated circuits, pulsed and logic circuits, laser technology, telecommunications, and much more.
209/812 Pub. Pr., \$89.00 Club Pr., \$61.50

MICROCONTROLLERS IN PROCESS AND PRODUCT CONTROL. By A. A. Berk. 211 pp., 68 illus. A practical guide filled with design information on a variety of microcontrollers used in process control, it will help you choose the right technology for a given application. There is comprehensive coverage of the basics along with many examples and new ideas.
049/009 Pub. Pr., \$39.95 Club Pr., \$29.95

THE LASER GUIDEBOOK. By J. Hecht. 368 pp., 109 illus. This book covers the operating principles, characteristics and applications of all commercially available lasers. It will help you find the specific laser that best meets your requirements.
277/338 Pub. Pr., \$49.50 Club Pr., \$37.50

TROUBLESHOOTING ELECTRONIC EQUIPMENT WITHOUT SERVICE DATA By R. G. Middleton. 303 pp., 162 illus. and tables. Packed with charts, diagrams, and case histories, this practical handbook shows you how to pinpoint defective electronic circuitry when no service data is available.
583134-1 Pub. Pr., \$27.95 Club Pr., \$19.95

ANTENNA ENGINEERING HANDBOOK, Second Ed. Edited by R. C. Johnson and H. Jasik, with contributions by 57 recognized authorities. 1,408 pp., 946 illus. This widely acclaimed Handbook gives you the guidance you need to solve problems in antenna design and application.
322/910 Pub. Pr., \$110.00 Club Pr., \$68.00

AUTOMATIC CONTROL SYSTEMS, Fifth Ed. By B. C. Kuo. 736 pp., illus. Provides an overview of automatic control systems, including in-depth coverage of classical control techniques, optimal control theory, and analog and digital control system design. This updated edition discusses the latest ideas on the use of computers to design control systems and as components of such systems.
583706-4 Pub. Pr., \$48.00 Club Pr., \$33.50

OP-AMP HANDBOOK, Second Ed. By F. W. Hughes. 320 pp., 231 illus. Organized for on-the-job reference, this handbook covers all facets of op-amps, from stability and protection to signal processing using op-amps. Includes a collection of over 60 practical circuits for a variety of applications, procedures, and experiments.
583651-3 Pub. Pr., \$36.33 Club Pr., \$27.50

CHOOSING AND USING CMOS. By M. J. Walsh. 304 pp., 155 illus. Offers a comprehensive overview of the semiconductor technology used... gives practical advice on circuit techniques to make your job easier. Specifications, characteristics and applications are included.
679/576 Pub. Pr., \$35.50 Club Pr., \$24.95

McGRAW-HILL CONCISE ENCYCLOPEDIA OF SCIENCE AND TECHNOLOGY. Editor-in-Chief S. P. Parker and the Staff of the McGraw-Hill Encyclopedia of Science and Technology. 2,065 pp., 1,600 illus. This volume serves every need for understanding today's science and technology. Written by over 3,000 of the world's topmost experts, including 19 Nobel Prize winners, it covers 75 disciplines from Acoustics to Zoology.
454/825 Pub. Pr., \$98.50 Club Pr., \$63.99

MICROPROCESSORS IN INSTRUMENTATION AND CONTROL. By S. A. Money. 246 pp., 148 illus. Provides the design procedures and applications data you need to create effective, high quality microprocessor-based systems. There is thorough coverage of programming, arithmetic and logic operations, parallel input-output, serial input-output, hardware design, analog/digital conversion and much more.
427/070 Pub. Pr., \$39.50 Club Pr., \$29.50

AMERICAN ELECTRICIANS' HANDBOOK, Eleventh Ed. By T. Croft and W. Summers. 1,824 pp., 1,560 illus. This newly updated handbook shows you how to select, install, maintain, and operate all the latest electrical equipment and wiring. It includes the most recent code requirements, basic formulas, and a wealth of circuit diagrams and illustrations.
139/326 Pub. Pr., \$64.50 Club Pr., \$46.50

POWER ELECTRONIC CONVERTERS: AC/DC Conversion. By G. Seguer. 362 pp., 144 illus. Provides a clear overview of rectifier circuits, which convert ac power to dc power. All types of rectifiers are covered, including half-wave diode, diode bridge, half-wave thyristor, thyristor bridge, and combinations, with over a hundred useful circuit diagrams, waveform diagrams, and reference tables.
560/811 Pub. Pr., \$34.95 Club Pr., \$25.95

MODERN ELECTRONIC CIRCUITS REFERENCE MANUAL. By J. Markus. 1,264 pp., 3,666 circuit diagrams. Complete with values of components and suggestions for revisions—plus the original source of each circuit in case you want additional performance or construction details.
404/461 Pub. Pr., \$82.50 Club Pr., \$61.50

New Members!
Take any one of these great professional books for only **\$289** as a premium with your first selection!

Spectacular values up to **\$110.00**

HANDBOOK OF ELECTRONIC TABLES AND FORMULAS
Sixth Edition

256 pages, illustrated. 583804-4

Up-to-date mathematical tables and electronic formulas in a convenient desk reference that you'll find indispensable. Included are basic formulas, constants, government/industry standards, symbols and codes, service data, and more. The handbook also has new sections describing how to do your calculations on a computer, and complete computer programs.

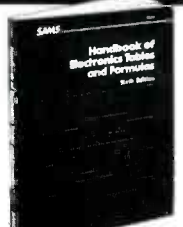

A \$19.95 Value — Yours ABSOLUTELY FREE when you join!

TELEVISION ENGINEERING HANDBOOK.—By K. B. Benson. 1,478 pp., 1,091 illus. Packed with the technical information and know-how you need to design, operate and maintain every type of TV equipment in current use.
047/790 Pub. Pr., \$89.50 Club Pr., \$62.50

STANDARD HANDBOOK FOR ELECTRICAL ENGINEERS, Twelfth Ed. By D. G. Fink and H. W. Beaty. 2,248 pp., 1,863 illus. and tables. Written and compiled by 115 leading experts, this is the essential reference for electrical engineers. It covers the basics including circuits, telecommunications, power distribution, and electrical standards, as well as the latest technology.
209/758 Pub. Pr., \$86.50 Club Pr., \$59.50

THE ENCYCLOPEDIA OF ELECTRONIC CIRCUITS. By R. Graf. 760 pp., 1,256 illus. This large volume provides circuits for virtually every type of application in 98 different categories. Each has a clear and concise explanatory text accompanying it.
583265-8 Pub. Pr., \$60.00 Club Pr., \$43.50

ELECTRONIC SPEECH RECOGNITION: Techniques, Technology, and Applications. Edited by G. Bristow. 395 pp., 117 illus. A complete sourcebook providing an introduction to voice recognition, an overview of the devices and systems now available, a list of vendors, and a collection of applications examples from companies that have used speech recognition technology.
079/137 Pub. Pr., \$48.50 Club Pr., \$35.50

INTRODUCTION TO RADAR SYSTEMS. By M. I. Skolnik. 2nd Ed., 698 pp., 244 illus. Covering every radar fundamental and all important changes, this EE text exposes you fully to the systems themselves—and to their applications! Topics include radar equation, CW and frequency-modulated radar, MTI, pulse-doppler, tracking radar, receivers, displays, duplexers, noise, and more.
579/091 Pub. Pr., \$51.95 Club Pr., \$38.95

MICROCOMPUTER DESIGN. By M. Hordeski. 406 pp., illus. Emphasizes the most current, cost effective methods for developing, debugging and testing all types of microprocessor products, including software and hardware.
583683-1 Pub. Pr., \$42.67 Club Pr., \$29.95

DESIGNING ELECTRONIC CIRCUITS. By R. G. Middleton. 351 pp., 192 illus. Covers virtually every category of circuits commonly used. This practical manual provides the basic design procedures, tables and formulas vital to effective electronic circuit design. Plus over 60 start-to-finish procedures are featured along with scores of computer programs to help you design and analyze electronic circuits.
583673-4 Pub. Pr., \$36.95 Club Pr., \$27.50

Be sure to consider these important titles as well!

OPERATIONAL AMPLIFIERS AND LINEAR INTEGRATED CIRCUITS, Third Ed. By R. F. Coughlin and F. F. Driscoll.
583754-4 Pub. Pr., \$34.95 Club Pr., \$25.95

68000 MICROPROCESSOR: ARCHITECTURE, SOFTWARE & INTERFACE TECHNIQUES. By W. A. Triebel & A. Singh.
583683-1 Pub. Pr., \$42.67 Club Pr., \$29.95

DESIGNING DIGITAL FILTERS. By C. S. Williams.
583627-0 Pub. Pr., \$43.67 Club Pr., \$30.95

APPLICATIONS IN ARTIFICIAL INTELLIGENCE. By S. J. Andriole.
583715-3 Pub. Pr., \$49.95 Club Pr., \$34.95

THE FOURIER TRANSFORM AND ITS APPLICATIONS, Second Ed., Revised. By R. N. Bracewell.
070/156 Pub. Pr., \$48.95 Club Pr., \$33.95

DIGITAL FILTERS AND SIGNAL PROCESSING. By L. B. Jackson.
583710-2 Pub. Pr., \$35.95 Club Pr., \$26.95

MICROPROCESSOR SUPPORT CHIPS. By TJ Byers.
095/183 Pub. Pr., \$44.50 Club Pr., \$35.25

INDUSTRIAL ROBOTICS. By M. P. Groover, R. N. Nagel and N. G. Odrey.
249/89X Pub. Pr., \$39.95 Club Pr., \$28.95

THE MCGRAW-HILL COMPUTER HANDBOOK. By H. Helms.
279/721 Pub. Pr., \$86.50 Club Pr., \$54.50

MICROLITHOGRAPHY: PROCESS TECHNOLOGY FOR IC FABRICATION. By D. Elliott.
193/045 Pub. Pr., \$42.00 Club Pr., \$29.50

RC ACTIVE FILTER DESIGN HANDBOOK. By F. W. Stephenson.
583350-6 Pub. Pr., \$44.95 Club Pr., \$33.75



FOR FASTER SERVICE IN ENROLLING CALL TOLL-FREE 1-800-2-MCGRAW MAIL THIS COUPON TODAY

**McGraw-Hill Book Clubs
Electronics and Control Engineers'
Book Club®**

P.O. Box 582, Hightstown, NJ 08520-9959

Please enroll me as a member and send me the two books indicated, plus the HANDBOOK OF ELECTRONIC TABLES AND FORMULAS. I am to receive one book for just \$2.89, the other at the discounted member's price, plus local tax, shipping and handling charges. I agree to purchase a minimum of two additional books during my first year of membership as outlined under the Club plan described in this ad. I understand that a shipping and handling charge is added to all shipments.

Your FREE Handbook

583804-4

Write Code No. of the \$2.89 selection here

Write Code No. for the First selection here

Signature _____
Name _____
Address/Apt. # _____
City _____
State _____ Zip _____

This order subject to acceptance by McGraw-Hill. All prices subject to change without notice. Offer good only to new members. Foreign member acceptance subject to special conditions. E3389I

Why YOU should join now!

- **BEST AND NEWEST BOOKS IN YOUR FIELD** — Books are selected from a wide range of publishers by expert editors and consultants to give you continuing access to the best and latest books in your field.
- **BIG SAVINGS** — Build your library and save money too! Savings ranging up to 40% or more off publishers' list prices.
- **BONUS BOOKS** — You will immediately begin to participate in our Bonus Book Plan that allows you savings up to 70% off the publishers' prices of many professional and general interest books!

■ **CONVENIENCE**—12-14 times a year (about once every 3-4 weeks) you receive the Club Bulletin FREE. It fully describes the Main Selection and Alternate Selections. A dated Reply Card is included. If you want the Main Selection, you simply do nothing — it will be shipped automatically. If you want an Alternate Selection — or no book at all — you simply indicate it on the Reply Card and return it by the date specified. You will have at least 10 days to decide. If, because of late delivery of the Bulletin you receive a Main Selection you do not want, you may return it for credit at the Club's expense.

As a Club member you agree only to the purchase of three books (including your first selection) during your first year of membership. Membership may be discontinued by either you or the Club at any time after you have purchased the first selection plus two additional books.

Other McGraw-Hill Book Clubs:
Architects' Book Club • Byte Book Club • Chemical Engineers' Book Club
• Civil Engineers' Book Club • Mechanical Engineers' Book Club

For more information, write to:
McGraw-Hill Book Clubs, P.O. Box 582, Hightstown, New Jersey 08520-9959

ARM YOURSELF AGAINST STATIC



WITH NTE'S PATENTED FIELD SERVICE KIT.

LOOK FOR THE FULL LINE OF QUALITY NTE
REPLACEMENT PARTS AND PRODUCTS:

Static electricity is a real hazard to sensitive electronic equipment. Now you can protect valuable components in the field and in the plant with NTE's new Field Service Kit.

Our Kit includes everything you need to keep your equipment free of static — a 24" x 24" table top work mat, wrist strap with 8' coil cord, 15' clip-on grounding line and anti-static component storage bags. Both the wrist strap cord and grounding cord contain integral current limiting resistors.

Unlike other kits currently on the market, NTE's patented* three-



- Transistors
- Thyristors
- Integrated Circuits
- Rectifiers and Diodes
- High Voltage Multipliers and Dividers
- Optoelectronic Devices
- Zeners
- Microprocessors and Support Chips
- Memory ICs
- Thermal Cut-Offs
- Bridge Rectifiers
- Unijunctions
- RF Transistors
- Microwave Oven Rectifiers
- Selenium Rectifiers
- Flameproof Resistors
- Wire Ties
- Electrolytic Capacitors
- Static Control Products

layer construction produces controlled static drain, eliminating the danger of sparking and the chance of additional component failure during the repair operation. The static-dissipative, vinyl work surface is durable and its bright green color enhances visibility. The entire Kit folds down into a compact unit and comes with its own zip-close bag.

Look for NTE's new Field Service Kit and our other static control products — including our anti-static foam, for shipping and storing equipment, and separately packaged wrist straps — at your local NTE distributor.

*Patent issued November 8, 1983.
U.S. Patent No. 4,414,260.



NTE ELECTRONICS, INC.

44 FARRAND STREET • BLOOMFIELD, NEW JERSEY 07003
(Outside N.J.) 1-800-631-1250 • (N.J. only) 1-800-624-2624

For more information or the name of your local distributor, call or write NTE.

CIRCLE 71 ON FREE INFORMATION CARD

www.americanradiohistory.com

BUILD THIS

THERE ARE MANY INSTANCES IN VIDEO work when it is desirable or necessary to modify a video signal in one way or another. In the home, modifying a video signal usually means a simple color correction attained by adjusting the TV's tint and color controls. But for professional or artistic video-signal control, a much-wider range of signal modification must be available. For example, there must be a way to correct contrast when the color is OK but the signal's luminance component is weak. Another modification might include deliberate distortions of the signal

many applications, and is also great fun—it can be more fun than a video game. Some of its serious applications are:

1. **Video Recording**
 - a. Tint correction
 - b. Chroma boost/cut
 - c. Luminance/synch boost and cut
 - d. Additions of special effects to recordings
 - e. Posterization and solarization for effects and titling
2. **Photographic Uses**
 - a. Viewing color negatives as positives (a separate camera is required)

(0–4 MHz) 75-ohm source impedance NTSC video signal having a nominal amplitude of 1 volt peak-to-peak with negative sync is applied to the system via the VIDEO IN jack. A BYPASS SWITCH is provided to bypass the system, and a VIDEO LOOP-THROUGH connection is also provided for loop-through setups. Switches enable AC or DC coupling, and 75 ohm or Hi-Z (high impedance) input, which is useful in loop-through applications or where another 75 ohm device is already terminating the input line.

A video amp boosts the input up to 3

VIDEO EFFECTS



GENERATOR

*Color correction, deliberate distortion, artistic picture control.
Our video palette puts it all at your fingertips.*

RUDOLF F. GRAF and WILLIAM SHEETS

for the purpose of creating special effects: such as color and/or luminance reversal (positive-negative); posterization, in which the video signal is altered such that there are only a few discrete values of luminance (usually 2, 3, or 4); or solarization, in which the gray scale (luminance) is "folded" on itself, producing an eerie, surrealistic-looking picture that contains both positive and negative tones. Of course, several effects may be performed simultaneously.

Devices that provide a high degree of color control are used in virtually all major TV production facilities. Regardless what the brand name might be, technicians often refer to such a device as a *video palette*; hence, we will also call our device a video palette.

Our video palette is designed to work on any standard NTSC video signal. It has

- b. Advance predictions of the finished appearance of photographic special effects
- c. Negative inspection and analysis

3. **Video Production**

- a. Simulation
- b. Special effects
- c. Artistic effects

Some of the video palette's effects are shown in Figs. 1-a, 1-b, 1-c, and 1-d, and they are just a tiny sampling of what is possible. It will be evident after an hour or so of experimentation, using a video source (VCR, TV tuner, etc.) and a video monitor to observe the results, that a wide range of effects are possible by manipulating the front-panel controls.

How it works

A block diagram of the video palette is shown in Fig. 2. A standard baseband

volts p-p, and at the same time inverts it so that the sync tips are positive. The video signal, which is now still unaltered but greater in amplitude and inverted, is then fed to a sync separator and a SPDT CMOS video switch.

The video switch splits the video signal into two components:

1. Synch, blanking, and burst pulses only;
2. Video and chroma information without sync, burst, or blanking.

The reason for the splitting up of the signal is to allow separate processing and treatment of the four signal components: sync, burst, luminance (black-and-white component), and chroma (color-difference). (Figure 3 shows the four components parts of a standard NTSC color signal.)

There are other reasons why it's necessary to extract the discrete signal compo-



FIG.1—THE VIDEO PALETTE'S EFFECTS CAN BE STACKED. In this black and white series, a is a normal picture, b is posterized, c has solarization added, d has negative video added.

nents. For example, the sync signal is used for timing and cannot be modified unless intentional scrambling of the picture is required. If we want an inverted (negative) picture, we cannot just reverse the phase of the whole signal, because the video monitor needs sync pulses of a given polarity; therefore, a simple inverter will not work. If we want to introduce special effects, we may want, for example, to just operate on the chroma signal and leave everything else the same. Therefore, the splitting up of the signal is obviously necessary; otherwise, improper operation of the sync and color-burst circuitry in the monitor, VCR, or TV receiver will result.

Sync and blanking are separated from the burst pulse by a lowpass filter having a cutoff frequency of 2.5 MHz and a maximum rejection frequency of 3.58 MHz.

Luminance and chrominance are separated the same way. Strictly speaking, a comb filter would be the ideal way to separate luminance and chrominance, but it would complicate construction and increase cost. For that application, simple M-derived filters do the job adequately.

Synchronization

A switching signal to control the video splitting is derived from the original signal's sync information. A sync separator strips the horizontal and vertical sync information from the original signal. (Note that the original signal must be a legitimate NTSC signal, with the sync tips most negative. Therefore, a scrambled signal will not operate this unit.)

The horizontal sync drives a monostable multivibrator having a nominal 53-microsecond pulse width. That multivibrator drives a second multivibrator that generates a gating pulse having a nominal 10-microsecond pulse width. The 10-microsecond pulse is timed to be coincident with the blanking pulse on the original NTSC signal; it is done by adjusting the 53-microsecond multivibrator's pulse width. The 10-microsecond pulse causes the video switch to route the video signal into the sync and burst side of the switch. When the pulse is not present (during horizontal line scan), the video is routed to the video and chroma side of the switch.

Vertical sync is separated in a similar manner. A monostable multivibrator having a delay of one frame (nominally 16 microseconds) is used to trigger a second monostable multivibrator whose output is a pulse having a width of nominally 600-microseconds. That pulse should be timed to occur during vertical retrace. Therefore, the entire composite vertical blanking pulse will be gated to the sync and burst side of the video switch. (The setup of the switching circuit consists of adjusting the delays and pulse widths of the four multivibrators so as to correctly switch the sync pulses, blanking pulses, and the burst pulses to the sync and burst outputs of the video switch.)

The video switch's sync output is fed to a lowpass filter that removes the burst. It then goes to an amplitude control, and then into a summing amplifier, which reassembles the video signal.

The burst output goes to a highpass filter that eliminates the sync. Then the signal is fed to a phase-correction network and on to the burst amplifier, a differential amplifier having two outputs 180° out of phase. A potentiometer connected across both outputs functions as both a gain and polarity control: At the center position there is zero output (no burst); fully clockwise and counterclockwise, full positive or negative burst is available respectively. In that way, the burst phase and amplitude can be altered or corrected as required, independent of everything else. The burst can be varied from plus three times normal to minus three times normal. By using a negative burst phase, the monitor or TV screen will show reversed (complimentary) colors. The burst is then fed to the summing amplifier for reassembly into a complete video signal.

Luminance is treated in a similar manner to that of the sync. It goes through a lowpass filter that is similar to the sync filter and is then fed through a level control to the input of the summing amplifier. There it is summed with the sync and the burst information.

Chrominance, or chroma, is extracted by a highpass filter. It is fed through a differential amplifier having positive and negative outputs. (It is similar to the burst differential amplifier). A potentiometer allows either positive or negative amplified chroma to be fed to the summing amplifier at any desired level. That feature allows weak chroma to be amplified or inverted. Since some 2.5 MHz (or higher) luminance components will be present along with the chroma signal, the chroma control functions as a sharpness control in black and white applications. The ability of using either positive or negative burst with positive or negative chroma at first will seem redundant because negative chroma with a negative burst will yield a positive picture. However, the phase of the high-frequency luminance components will not be the same, and the total effect can be used as a sharpness control for color video.

The summing amplifier has a nominal gain of unity when the level controls for chroma, burst, sync, and luminance are about halfway open. Since the video signal was amplified by a factor of three by the input video amplifier, allowing for normal circuit losses within the video palette, about 2 volts of composite video component is present at the input of the summing amplifier. Therefore, a 2-volt peak-to-peak reassembled video signal is present at the output of the summing amplifier.

You may be wondering what we have really accomplished so far. What we now have is the ability to disassemble the video signal, control each of its four components on an individual basis, and recombine them into a new video signal.

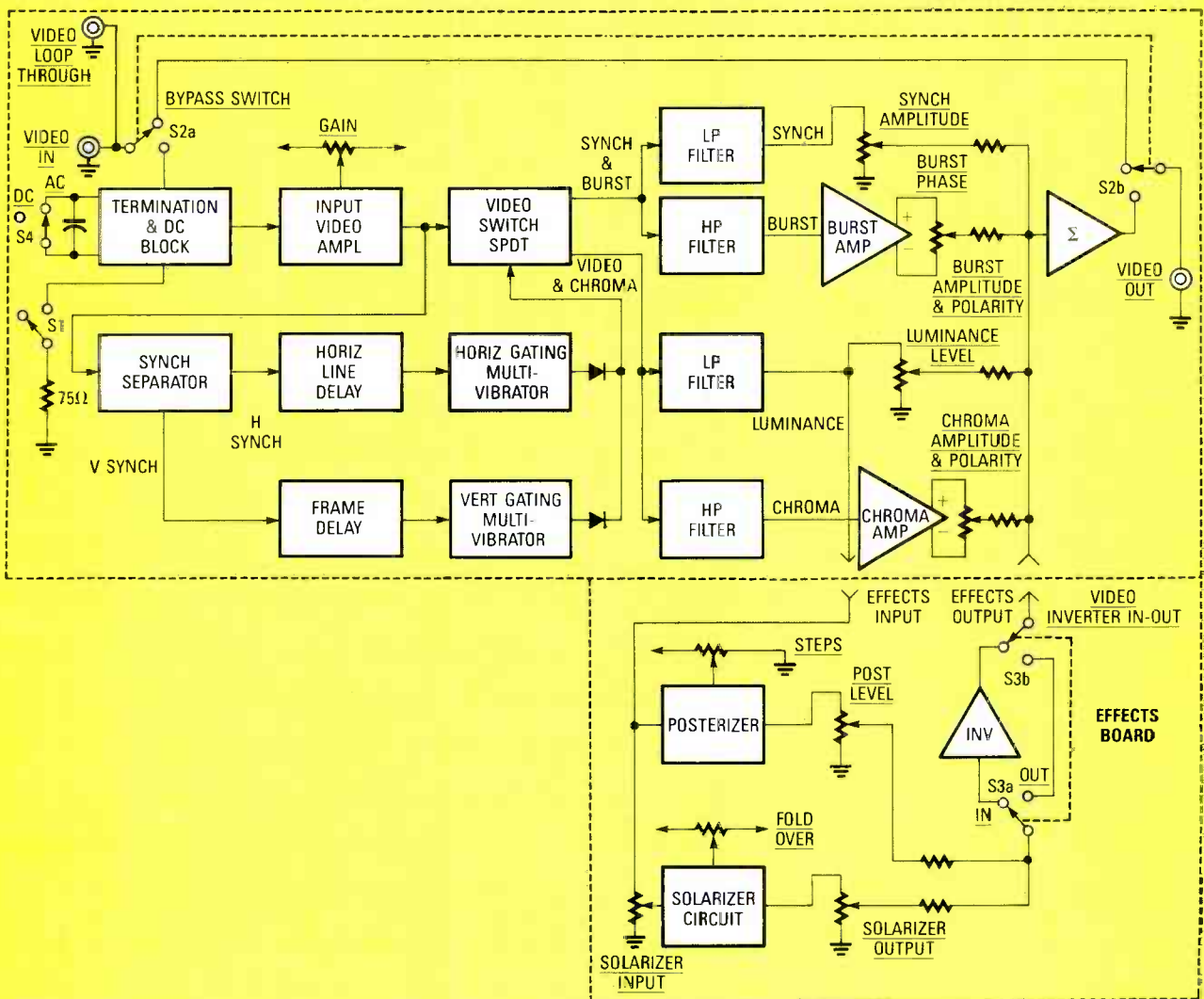

Fig. 2—THE CIRCUITS FOR THE video palette are arranged on two separate circuit boards. A bypass switch allows all functions to be instantly bypassed without having to reset the individual controls.

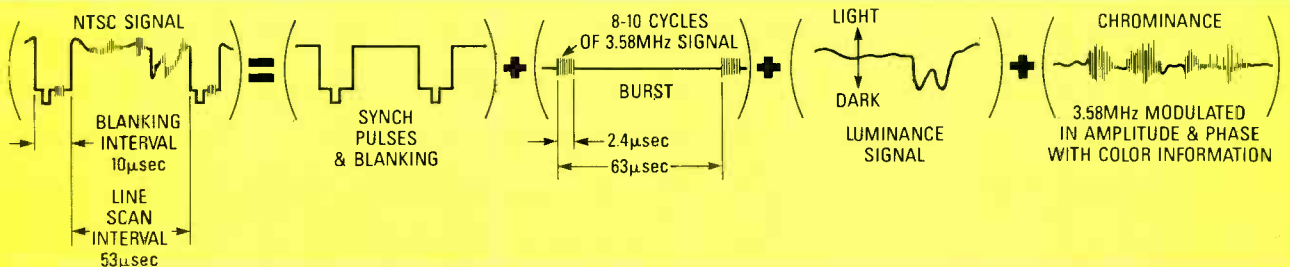

FIG. 3—AN NTSC COLOR SIGNAL has four individual components, all of which can be separately controlled by the video palette.

Depending on the settings of the controls, we might get an improved picture, a degraded picture, or an altered picture. By this method, we can custom-correct individual faults in the video signal. For all practical purposes, we have a graphic equalizer for video.

Analog effects

A few analog effects are incorporated in the video palette. Those are inversion, posterization, and solarization.

Inversion, shown in Fig. 4, is simply what it implies: the video signal levels are inverted about a given reference axis. For example, if zero volts represents maximum white and 1 volt represents maximum black (Fig. 4-a), passing the signal through an inverter such that the output is 1 volt when the input is zero volts, and the output is zero volts when the input is 1 volt, will produce an inverted video signal (Fig. 4-b).

Note that a true inverter would just

change the sign. For example, let us take the case of a signal at +0.5 volt, which would represent a middle gray. Ideally, if we invert a gray tone, it is gray. (Gray is its own complementary color.) However, a true inverter would give -0.5 volts output, which would be whiter than white. Therefore, we must add a DC offset of +1 volt to the output so that a zero volt input produces a +1 volt output, thereby restoring the original gray (Fig. 4-c). As shown in Fig. 4-d, that can be done by adding a

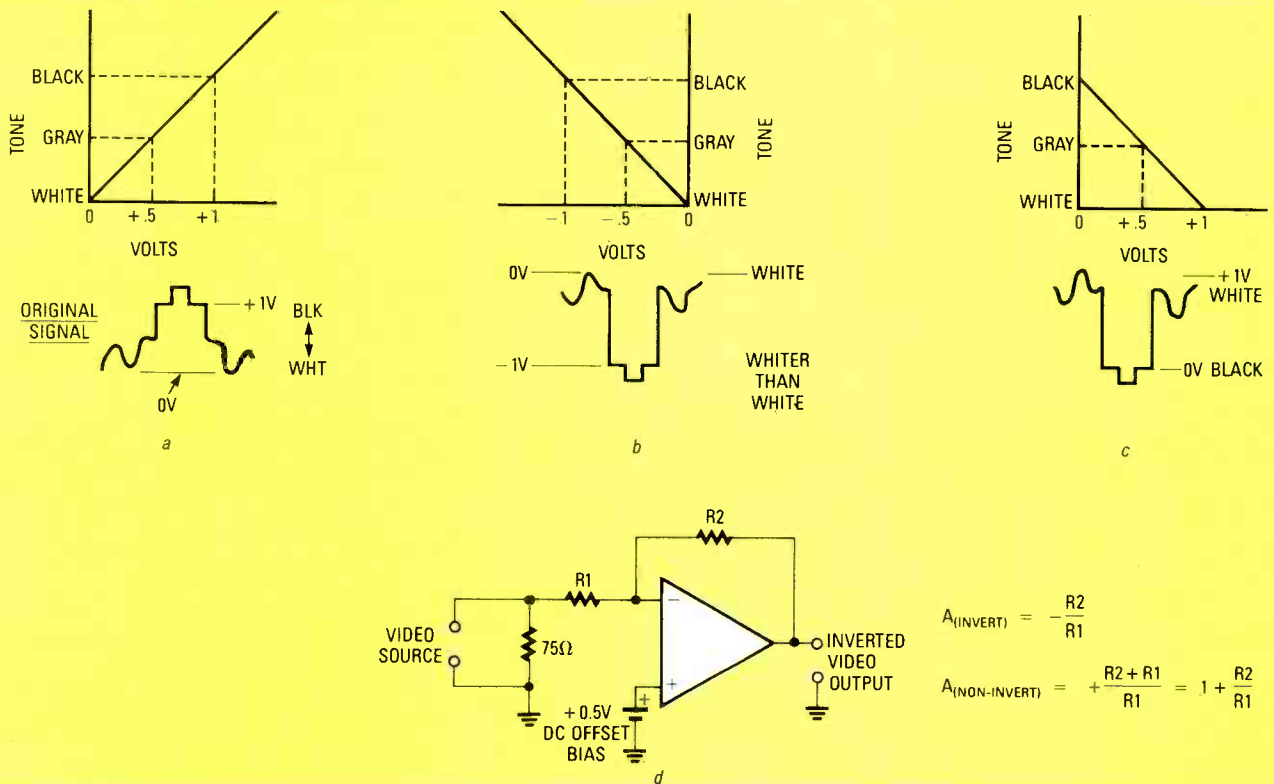

FIG. 4—SIMPLY INVERTING THE VIDEO signal (a) will result in a signal that goes whiter-than-white (b). By using a DC offset bias for the amplifier the signal-level values are restored, but the tones are reversed—white is now black (c). In d we see how the offset is applied through the amplifier's noninverting input.

DC offset level to the amplifier's input. Only +0.5 volt input is needed because the op-amp's configuration has a gain of two at the non-inverting input. ($A + \text{INPUT} = 1 + R2/R1$.)

Inverting the luminance signal produces a negative picture. If the original picture is black-and-white it will have the appearance of a black and white photographic negative. If the original is color, the colors will still be correct but the tones will be reversed. (Actually, since the color is really the sum of luminance and chrominance, the hues are unchanged but the saturations may be different, giving the effect described.)

In order to get a negative picture similar to a true color photographic negative (without the masking built into color negative film that is needed to make a color print), you would also invert either the chroma or the burst.

Using the correct light source, if you looked at a photographic color negative with a video camera/monitor set-up, and ran the resulting video through the video palette, you would see a positive color image. In fact, that technique is widely used by the commercial color-photo printing industry to predetermine correct color-printing exposure and filtration (light source color balance) so that the final photographic print is correct the first time. That kind of photo printing technique is known as *video analysis*.

Posterization

Posterization is the term used to describe the process of converting a photographic or video image of a scene containing a wide range of tones into a scene containing only a few discrete tones, sometimes only two (black and white). No intermediate shading between tones are present. Commonly, four tones are used in practice: white, light gray, dark gray, and black. Colors are sometimes left in their natural state, or they may be saturated (chroma is limited to one value—maximum). In practice, a pleasing visual effect is attained by posterizing only the luminance.

The effect of posterization is shown in Fig. 5-a. Note how the shading from white to black on the ball and cylinder is changed to discrete bands of gray by posterization. Figure 5-b shows how the video ramp waveform is changed to discrete steps by the posterization. A posterized video scene has a distinct computerized or cartoon effect because there are only a few discrete values of luminance. Since a very small difference in luminance at the transition points may produce a large difference in the posterized output, small noise signals, snow, and glitches are enormously magnified, which produces a grainy effect. Although grain is usually considered objectionable, as shown in Fig. 5-c, it can be used to add an artistic effect to the picture.

Analog to digital

Posterization is done by using an A/D converter to convert the analog video signal to a digital format, and then immediately converting back to analog.

A simplified approach to posterization is shown in Fig. 6. Four comparators are biased with a reference voltage obtained from a resistance voltage divider ($R_x \times 4$). The amplifiers are biased so that amplifier A4 has +1 volt, A3 has +3/4 volt, A2 has +1/2 volt, and A1 has +1/4 volt on their inverting inputs. All four non-inverting inputs are connected to a nominal zero-volts (white) to 1-volt (black) video source.

The outputs of each comparator can be either zero or a positive voltage ($+V_{out}$). Assume $V_{out} = 5$ volts. Each comparator's output terminates in common load resistor R_L , which is much smaller than R_Y . Typically, $R_x = 10$ ohms, $R_Y = 4700$ ohms and R_L may be about 220 ohms. The comparator amplifiers must be capable of fast response since the video input components are as high as 3 MHz.

Assume the video level is zero. All four amplifiers will have a zero output. As the video level rises to 1/4 volt, amplifier A1 will suddenly change state and about 1/4 volt will appear across R_L (5-volt output from A1 attenuated by voltage divider R_Y and R_L). As the video level exceeds 1/2 volt, A2 will change state and now A2 will contribute a current through its R_Y , so

now there is $\frac{1}{2}$ volt across R_L . (With a high-gain comparator, a few millivolts change in the video level produces an abrupt $\frac{1}{4}$ -volt change in the output across R_L .) Amplifier A3 conducts at $\frac{3}{4}$ volt, and A4 conducts at 1 volt. Therefore, a ramp input voltage produces a staircase output with four discrete levels $+\frac{1}{4}$, $+\frac{1}{2}$, $+\frac{3}{4}$, and +1 volt (actually five discrete levels because zero volts is a level as well). In that way, we can produce only several discrete levels from a continuously varying level.

By varying the reference voltage we can

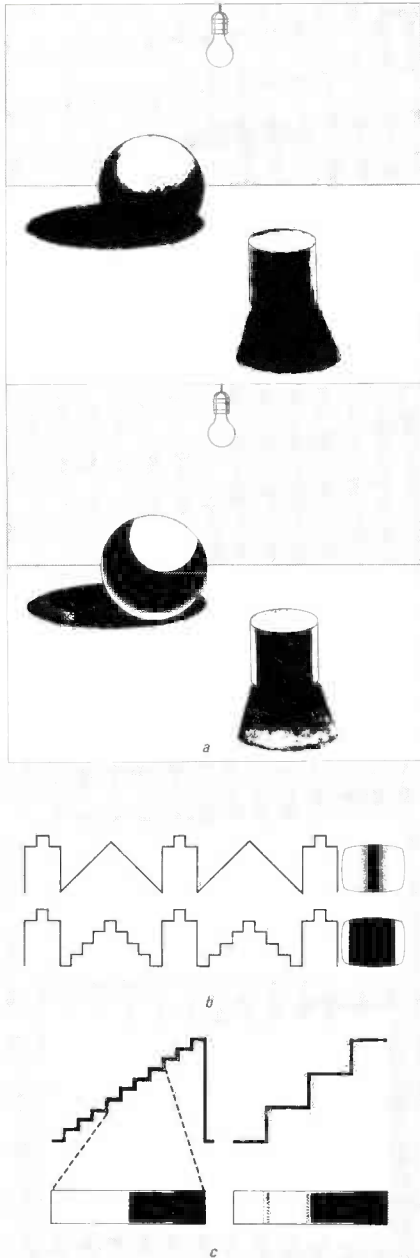

FIG. 5—POSTERIZATION CHANGES GRADUAL shading to discrete transitions (a). In b we see how the normal video signal, which originally represented increasing and decreasing ramps, is changed to a staircase. In c we see how posterization creates grain at each transition. The grain isn't necessarily a problem because it's often used as a special video effect.

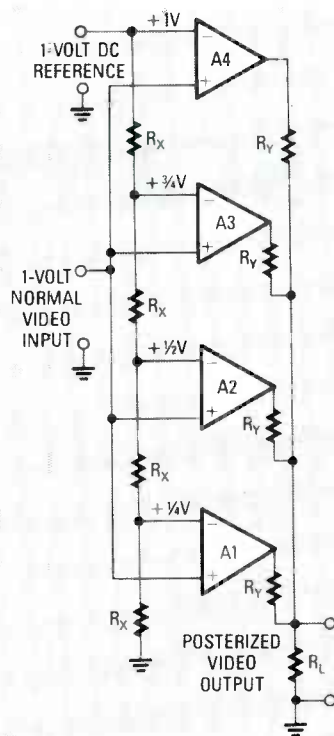

FIG. 6—AN ELEMENTARY POSTERIZER circuit. The value of the DC reference voltage determines the width of each step.

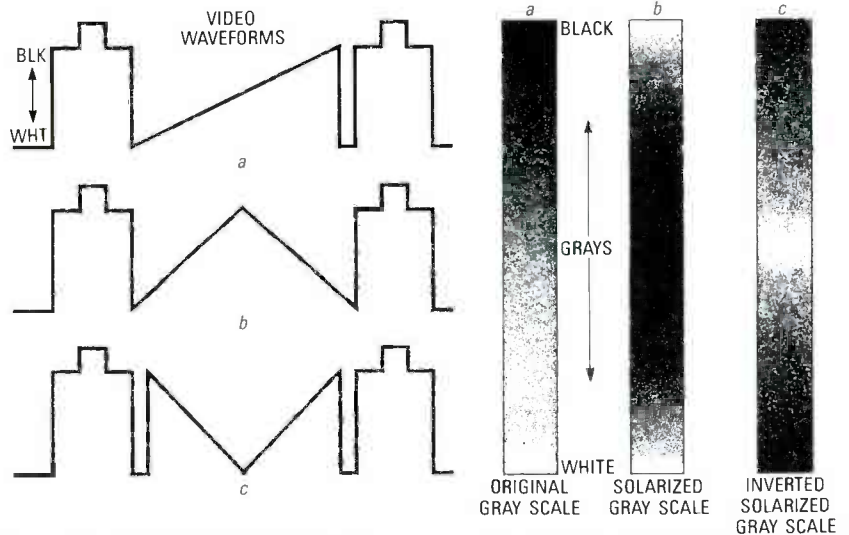

FIG. 7—SOLARIZATION FOLDS THE SIGNAL back on itself so that white remains white, gray becomes black, and black becomes white, or vice versa. The original signal is shown in a. The solarized signal is shown in b. An inverted solarized signal is shown in c. The original waveforms for each condition is shown in d.

vary the spacing between the steps, and, hence, for a given input video level the number of steps can be varied.

Solarization

In contrast to posterization, solarization is a linear distortion technique. However, as shown in Figs. 7-a, b, c, and d, what is done is to fold the gray scale back on itself. White becomes white, light gray becomes dark gray, gray becomes black. As the tones tend further toward black, the video output goes back towards white. Therefore, the picture highlights are positive and the shadows turn nega-

WHERE TO GET PARTS

Next month we will present the schematics and construction detail for the video palette, for which the following items are available from North Country Radio, P.O. Box 53, Wykagyl Station, NY 10804. The main printed-circuit board, \$12.50; the effects printed-circuit board, \$12.50; the main printed-circuit board and all parts that mount on the board, \$49.95; the effects printed-circuit board and all parts that mount on the board, \$39.95. A kit containing both the main and effects boards and their parts is \$84.95. The effects board, with or without components, is sold only in conjunction with the main board. Include \$2.50 postage and handling per total order. New York State residents must add appropriate sales tax.

tive. Inversion can be used in conjunction with solarization, so that the shadows are positive and the highlights are negative.

Solarization is accomplished by using an amplifier that has the transfer characteristic shown in Fig 8. As shown, two amplifiers, one having a gain of two and one with a delayed gain of minus four—with their outputs combined—result in

the necessary transfer characteristic. Although gains of two and four are shown, we can use any other 2:1 combination, resulting in a different gain figure. In our palette, we used gains of 0.5 and 1, giving an overall loss. That was done so that a larger input signal could be used.

As shown in Fig. 9, the solarization circuit uses a single op-amp. Assume that diode D1 is reverse biased, and that resistor R3 provides unity gain. Since $R1 = R2$, only half of the input signal appears at the inverting input.

As the input goes positive, D1 gradu-

continued on page 86

Part 2 LAST TIME, WE looked at the circuit for an FM-stereo/SCA receiver. This month we'll show you how to build that circuit.

Construction

The parts-placement diagram for the receiver is shown in Fig. 4. The pattern for the single-sided board is shown in PC Service. Upon examination, you may notice that the board uses a rather unusual parts layout. The layout shown was used to solve stability and crosstalk problems that are commonly encountered in high-gain, high-frequency designs of this type. It is based on the authors' experience with similar receivers, and with the particular IC's and transistors used.

The decision to use a single-sided board was made for several reasons. One, it makes it easier for a hobbyist with limited resources to reproduce the PC board at home. It also minimizes stray board capacitances, which can be a real problem at the frequencies involved. However, the use of a single-sided board does present some problems of its own. Such boards are much more difficult to lay out, and present RF grounding and stability problems. Those problems have been solved in the layout shown. Therefore, we *strongly* urge that you use our layout if you are contemplating building the receiver or any portion of it.

When stuffing the board, use a low-wattage iron (25 watts) and keep soldering time to a minimum to avoid overheating the components. All capacitors should be mounted as flush with the board as possible to minimize lead length. Be sure to adhere to the types and values specified in the Parts List. In particular, C16, C19, C37, C43, and C55 should be dipped silver-mica or NPO-ceramic types only.

With the obvious exception of the potentiometers (R71-R75), all resistors are 1/4-watt, 5% types. Again, make sure that all components are mounted flush with the PC board.

Be sure to observe the polarity on all appropriate components, such as the electrolytic capacitors. Varactor diodes D1, D2, and D4, and Zener diode D3 must be oriented correctly or the circuit will not work. Be sure to orient all IC's as shown in Fig. 4; otherwise they will be instantly and permanently damaged when power is applied. Care must be taken with ceramic filters FL1-FL3; they are somewhat delicate and easily broken. When you mount the A-FC jumper (between C34 and R17), use a direct run to keep the lead as short as possible.

The tuning potentiometer, R71, should

SCA/FM-STEREO RECEIVER

SCA/FM STEREO RECEIVER



Tune into the "hidden" signals on your FM dial with this SCA receiver.

RUDOLF GRAF and WILLIAM SHEETS

be mounted off the board, on the front panel. Further, it should be a good-quality multiturn unit for greatest tuning ease. (Note that the R71 included in the kit available from the supplier is a PC-mounted unit; if the supplied R71 is used, it is mounted directly on the board and R18 is deleted. While that configuration is satisfactory for testing and experimentation, we recommend using a good-quality multiturn unit as described for best re-

sults.) If desired, R74 and R75 can also be mounted on the front panel.

Use a cabinet that is ample for the board. In particular, you should be able to mount the board at least 1/2-inch away from the sides, top, or bottom. The unit shown in the photographs has a wood base and a plexiglass front panel. We mounted the board on 1/2-inch metal spacers.

You can arrange the front-panel controls to suit your needs or preferences.

WARNING!

SCA is not a broadcast service, and SCA transmissions are not intended for reception by the general public. As a result, SCA transmissions may be governed by Section 605 of the FCC Rules, which forbid unauthorized individuals from receiving such communications and using them for their own or other's profit, or divulging their contents, intent, or meaning to any other unauthorized individual.

Many for-profit services make use of SCA, and reception of those in most

cases is permitted by paying subscribers, and under certain circumstances, only. Some not-for-profit services do make use of SCA also, however, such as those providing assistance to the blind. It may be possible to receive those without obtaining prior permission or paying a subscription fee, as long as the terms of Section 605 are observed. We advise you to contact the appropriate programmers in your area for more information and to obtain any necessary authorizations.

Discover—Explore—Experience
Today's Electronics With ...

McGraw-Hill's Contemporary Electronics Series

Now you can meet the challenges of today's electronics quickly and easily. This professional level learning series is as innovative as the circuitry it explains and as fascinating as the experiments you build and explore! And it's for anyone who has an interest in electronics... from the hobbyist to the professional.

Thousands Have Already Experienced the Excitement!

Today's high-tech world demands an entirely new and innovative approach to understanding electronics. That's why McGraw-Hill has developed this unique "hands-on" learning method that brings to life the dynamics of the new electronics. It's a unique combination of interactive materials that gets you involved as you build and experiment with today's latest electronic circuitry.

Just how well this innovative learning approach meets the challenge of the new electronics is confirmed by those who have already completed the Series... "You have put me right into the middle of an extraordinary learning experience. With each lab exercise I have gained a new understanding of the intricacies of today's electronics." Or... "For me, the Series was just the answer. I felt confident within my specialty, but my grasp of other areas of electronics was slipping away. Your Series helped me upgrade my knowledge of the latest electronics concepts." Or this from a company director of training... "We manufacture sophisticated electronic products, with a lot of people in sales, assembly and purchasing. McGraw-Hill has answered a real need in helping our employees see the total picture. They now communicate with customers and each other more effectively."

Your Involvement in the New Electronics Begins Immediately.

You master one subject at a time with 15 McGraw-Hill *Concept Modules*, sent to you one

every 4 to 6 weeks. You waste no time on extraneous materials or outdated history. It's an entertaining, lively, nontraditional approach to the most modern of subject matter.

Your very first module takes you right to the heart of basic circuit concepts and gets you ready to use integrated circuits to build a digital oscillator. Then, you'll verify the operation of different electronic circuits using a light emitting diode (LED).

And each successive module brings you up to speed quickly, clarifying the latest advances in today's electronics... from digital logic and micro-processors to data communications, robotics, lasers, fiber optics, and more.

Unique Combination of Interactive Instruction Materials Makes Learning Easy.

Laboratory experiments, vividly illustrated text and interactive cassette tapes all blend together to give you a clear, simplified understanding of contemporary electronics.

With each module, you receive a McGraw-Hill *Action-Audio Cassette* that brings to life the facts and makes you feel as if you're participating in a lively dialogue with experts.

Your ability to quickly make this knowledge your own is further aided by strikingly *illustrated* texts that use diagrams, explanations, illustrations, and schematics to drive home and rein-

force the meaning of each important point. Carefully indexed binders conveniently house all this material, as well as the instructions that will guide you through your "hands-on" lab experiments.

Throughout your Series, *laboratory experiments* reinforce every significant concept. With this essential "hands-on" experience using actual electronic components, you master principles that apply all the way up to tomorrow's VLSI (Very Large Scale Integrated) circuitry.

Discover, Explore, Experience for Yourself—15-Day Trial.

In all ways, the Contemporary Electronics Series is an exciting learning experience that offers you the quickest and least expensive method available to master today's electronics... and the only one with "hands-on" experience.

To order your first module for a 15-day

trial examination, simply complete the card and send today! If the card is missing, write to us for ordering information.



McGraw-Hill
Continuing
Education Center

3939 Wisconsin Avenue, NW
Washington, DC 20016



With your first module, you'll build this solderless breadboarding system. As you add additional boards, you create increasingly complex circuits easily and quickly, bringing today's electronics concepts to life.

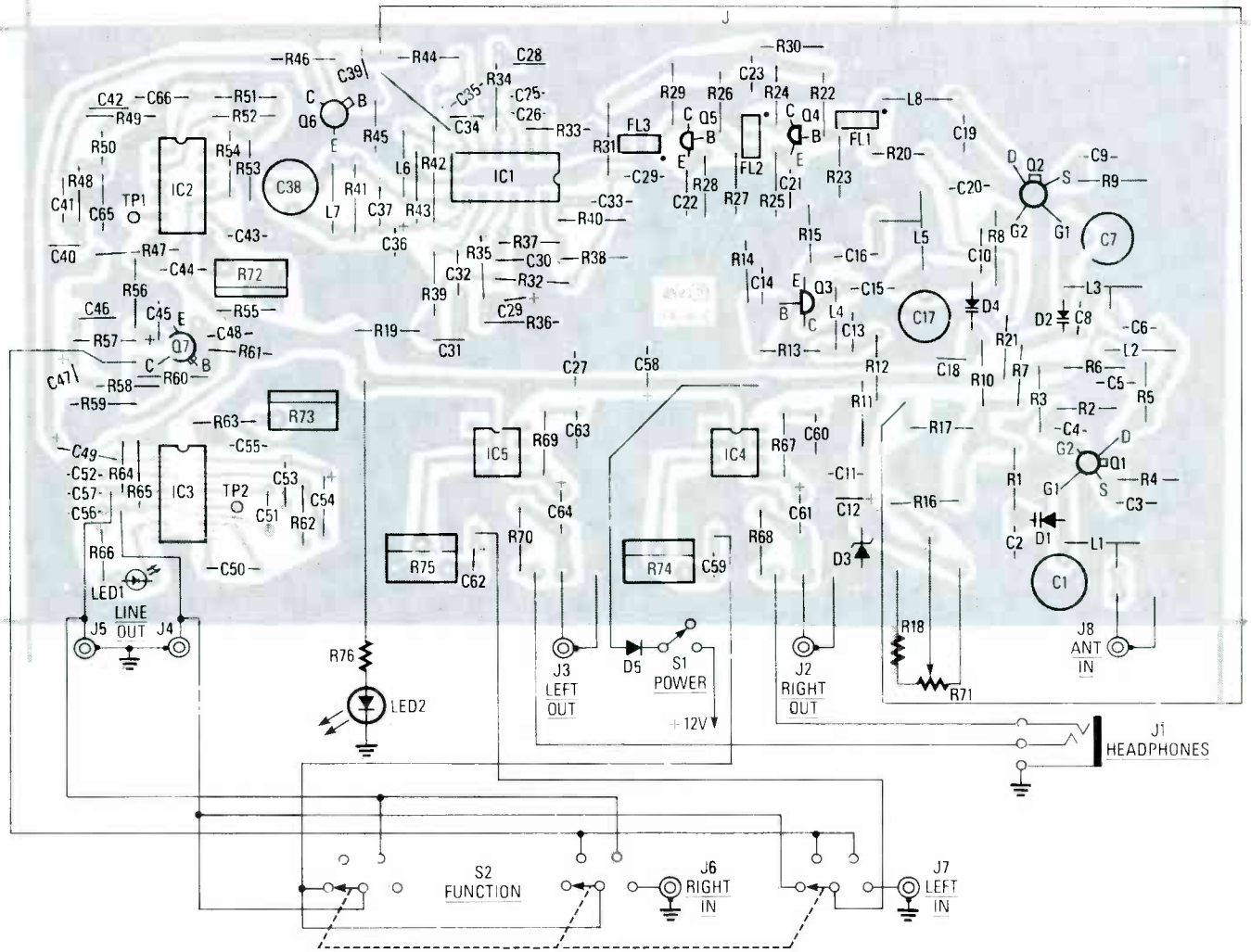

FIG. 4—MOST OF THE COMPONENTS mount on a single-sided PC board. However, for best results, we recommend removing R71, replacing it with a multiturn potentiometer, and mounting that unit on the front panel.

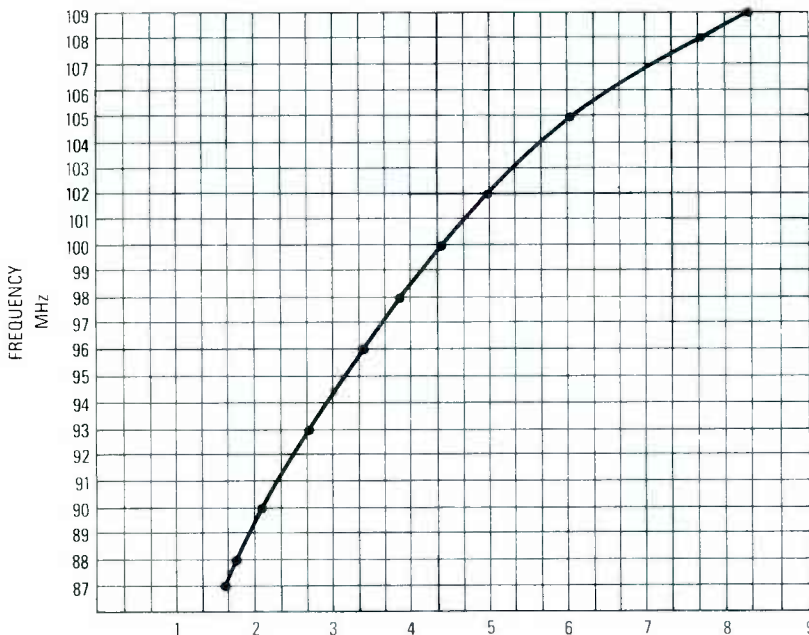

FIG. 5—USE THIS CHART to find the tuning voltage for the frequency of interest. Then adjust the setting of R71 so that voltage appears at the junction of R16 and R17 and tweak C17 until the station is received.

Connect front-panel mounted potentiometers to their appropriate pads using shielded cable for best results, especially if any of the runs are long. If the power supply is located physically close to the receiver, the AC power cord should be routed as far away from the front panel as possible. Otherwise, the leads from the potentiometers (particularly if shielded cable is not used) may be susceptible to AC-hum pickup.

The handwound coils for the front end are made using No. 20 tinned copper wire. They should be wound on a 3/16-inch form; the shank of a 3/16-inch drill bit is ideal for that purpose. Coils L1 and L3 are 5 turns each, and are tapped at 1.5 turns from the grounded end; L5 is four turns, tapped at 1.5 turns from the grounded end. The easiest way to build the coils is to wind each one, install it so that it sits 1/8- to 3/16-inch from the PC board, and then, using a length of No. 22 or 24 wire (a clipped-off lead from a resistor or capacitor is useful for that purpose) install the tap on the coil—simply tack-solder it on. You also can use short lengths of clip-

PARTS LIST

Resistors ¼ watt, 10% unless otherwise noted

R1, R3, R7, R8, R10, R46, R60—100,000 ohms
 R2—47,000 ohms
 R4, R25, R28, R68, R70—100 ohms
 R5, R31, R32, R35—470 ohms
 R6, R21, R39—150 ohms
 R9, R11—220 ohms
 R12, R14, R18—2200 ohms
 R13—3500 ohms
 R15, R30, R56, R57, R62, R66, R76—1000 ohms
 R16, R23, R27, R36—R38, R40, R43, R45, R49, R54, R58, R59, R61—10,000 ohms
 R17—1 megohm
 R19, R67, R69—10 ohms
 R20, R24, R29, R33—330 ohms
 R22, R26—33,000 ohms
 R34, R42, R44—22,000 ohms
 R41, R47, R51—R53, R64, R65—4700 ohms
 R48, R50—18,000 ohms
 R55, R63—15,000 ohms
 R71—R75—10,000 ohms, potentiometer

Capacitors

C1, C7, C17—2–18 pF trimmer
 C2, C5, C6, C8, C9, C11, C13—C15, C18, C20—C26, C28, C30—C34—0.01 µF, ceramic disc
 C3, C4, C66—470 pF, ceramic disc
 C10, C16, C37—100 pF, silver mica
 C12, C29, C35, C36, C39, C47, C49, C59, C62—10 µF, 16 volts, electrolytic
 C19—8 pF, silver mica
 C27—not used
 C38—3–40 pF, trimmer
 C40—C43—220 pF, silver mica
 C44—0.001 µF, Mylar
 C45, C60, C63—0.1 µF, Mylar
 C46, C51—0.047 µF, Mylar
 C48, C52—0.0022 µF, Mylar
 C50, C53—0.22 µF, Mylar or tantalum
 C54—0.47 µF, Mylar or tantalum
 C55, C65—470 pF, silver mica
 C56, C57—0.022 µF, Mylar
 C58, C61, C64—470 µF, 16 volts, electrolytic

Semiconductors

IC1—LM3189N FM receiver IF system (National)

IC2—LM565 phase-locked loop (National)
 IC3—LM1310N FM stereo demodulator (National)
 IC4, IC5—LM386 audio amplifier (National)
 Q1, Q2—40673 dual gate MOSFET transistor
 Q3—Q5—2N3563 NPN transistor
 Q6, Q7—2N3565 NPN transistor
 D1, D2, D4—MV2107 varactor diode
 D3—1N757 diode
 D5—1N4001 diode
 LED1—jumbo red LED
 LED2—jumbo green LED

Other components

L1, L3, L5—see text
 L2, L4—1.8 µH
 L6, L7—18 µH
 CF1—CF3—10.7 MHz ceramic filter
 J1—stereo headphone jack
 J2—J8—phono jacks, RCA type
 S1—SPST toggle switch
 S2—3P4T rotary switch
Miscellaneous—PC board, No. 20 solid uninsulated wire for winding L1, L3, and L5 (18 inches total required), wire, solder, hardware, knobs, cabinet, etc.

The following are available from North Country Radio, P.O. Box 53, Wykagyl Station, NY 10804: Kit consisting of PC board and all PC-board mounted parts (jacks, switches, D5, LED's, power-supply components, etc. not included), \$75.00 plus \$2.50 postage and handling; Etched and drilled PC board, \$12.50 plus \$2.50 postage and handling. NY residents please add appropriate sales tax.

PARTS LIST—POWER SUPPLY

C67—2200 µF, 25 volts, electrolytic
 C68—0.01 µF, ceramic disc
 C69—0.1 µF, ceramic disc
 C70—470 µF, 16 volts, electrolytic
 T1—117-volt primary, 16–18 volt 500-mA secondary
 IC6—LM7812 three-terminal regulator
 D6—D9—1N4001 diode

ped resistor or capacitor lead for the pe-board test points.

Once construction is complete, check your work carefully. Make sure that all components are oriented correctly. Examine your work for poor solder joints and for solder bridges. Once you are certain that everything is OK, you can proceed.

Checkout and alignment.

Begin by setting all potentiometers to the middle of their ranges. Set C38 so it is ½ meshed. Set C1, C7, and C17 so they are about ¼ meshed. Connect two 8-ohm speakers to the audio outputs, or a pair of 32-ohm headphones to the headphone jack. Connect about 6 feet of hookup wire to the antenna input, J8, to serve as a temporary antenna.

Once that is done, measure the DC resistance between the power and ground traces on the board. It should be above 100 ohms. If it is significantly less, you likely have a short somewhere on the board. Find it and fix it before proceeding.

If everything is OK, apply +12-volts DC to the +12-volt input. Check the current drawn from the supply: it should be about 125–150 mA at 12 volts.

When power is applied, you should hear a rushing noise in both speakers (or headphones). If not, find the source of the problem and correct it before going on. If only one channel is dead, the best place to look is around the appropriate audio amp (IC4 or IC5).

Set the FUNCTION switch (S2) for FM-stereo and rotate R71. In most areas of the

U.S. you should hear a few FM signals. Note that at this point the audio may seem distorted. Using a non-conductive tuning tool, adjust C38 for clearest audio (lowest distortion). Adjust R74 and R75 for a comfortable volume level.

Next, we'll calibrate the tuning potentiometer. Locate and identify a weak station at the high end (between 106 and 108 MHz) of the FM broadcast band using a commercial FM receiver. Try to tune that station using our receiver. If your tuning range does not extend high enough, adjust C17 to correct the tuning range. Once the station is tuned in, use Fig. 5 to find its corresponding tuning voltage. Set R71 so that that voltage appears at the junction of R16 and R17. Then tweak the setting of C17 so that the station is tuned at that setting of R71.

To calibrate at the low end of the broadcast band, locate and identify a weak station between 88 and 91 MHz. Adjust R71 to get the appropriate tuning voltage at the junction of R16 and R17 as before. Then, compress or expand the turns of L5 until that station is received at that setting of R71. Double check your calibration to be sure that the entire band is covered.

Once you are satisfied with the band coverage, adjust C1 and C7 for best reception and note their settings. To tweak reception, tune in a weak signal between 88 and 91 MHz. Adjust C1 to see if a different setting will provide better reception. If it does, note whether the adjustment results in increasing (greater meshing) or decreasing (less meshing) the capacitance of C1. Return C1 to its original setting. If increasing the capacitance resulted in better performance, compress L1 for optimum reception; if decreasing capaci-

SCA RADIO MANUFACTURERS

Commercial Elects./Multiplex Music
 38-40 Washington Avenue, St. Louis, MO 63108

Dynamic Sound, PO Box 840, Exeter, NH 03833

Fox Marketing, Inc., 4518 Taylorsville Rd., Dayton, OH 45424

Johnson Electronics, Inc., PO Box 4728, Winter Park, FL 32707.

McMartin International, Inc., 111 Camino Del Rio, Gunnison, CO 81230

Norver Co., Inc., 7300 North Crescent Blvd., Pennsauken, NJ 08110

Panasonic/Matsushita Technology Center, 1 Panasonic Way, Secaucus, NJ 07094

Radio Systems, Inc., PO Box 356, Edgemont, PA 19028

Repco, Inc., 1940 Lockwood Way, Orlando, FL 32854

SCA Data Systems, Inc., 3000 Ocean Park Blvd., Suite 1040, Santa Monica, CA 90405

SMC International, 14745 Madison Cir., Omaha, NE 68137

Toa Electronics, Inc., 480 Carlton Ct., South San Francisco, CA 94080

ADDING A FILTER

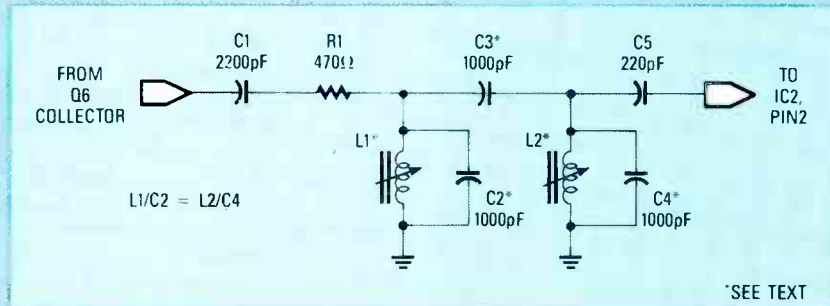

FIG. 1—THIS TUNABLE BANDPASS FILTER effectively suppresses main-channel sputter to provide superior performance for your SCA receiver.

Whether or not the main-channel audio interferes with an SCA signal depends on several factors, both at the receiver and transmitter. In particular, however, the precision of the components used in the Twin-T filter that feeds the SCA demodulator strongly affects how much main-channel sputter and splatter will be heard in the SCA signal's background. If the filter is made from high-tolerance components—1% resistors and capacitors—the main channel suppression will be adequate in most instances.

If you need an SCA signal that is virtually immune to interference by the main channel, then we suggest adding the tunable bandpass filter shown in Fig. 1 to your receiver. The value of L1 and L2 is

found from the formula $L = (1/6.28 \times f)^2 / C$, where f is the SCA subcarrier frequency and C is the value of the capacitor in the resonant circuit. The values of C2–C4 depend on a number of factors, including the characteristics of the coils used, the impedance at the filter's input and output, etc. Start with a value of 1000 pF for each as shown, but be prepared to experiment with the values of the components marked with an asterisk to obtain optimum performance. Of course, bear in mind that L1/C2 and L2/C4 must be resonant at the subcarrier frequency.

The filter can be assembled on a small PC or wire-wrap board and piggy-backed onto the main board with double-sided tape, or small metal brackets. **R-E**

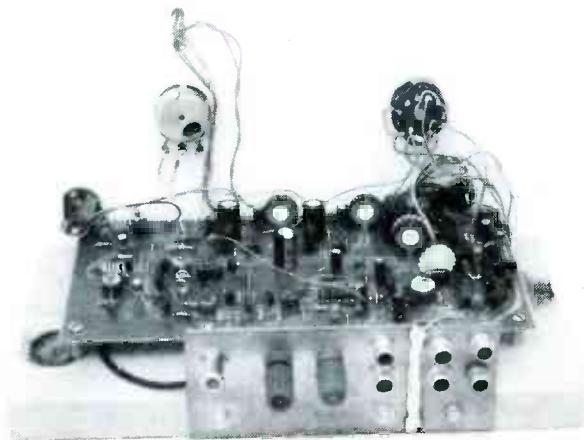

THE AUTHOR'S PROTOTYPE was mounted in a simple homemade cabinet. Whatever cabinet you use, be sure that it is ample to house the board.

tance yielded better reception, expand the coil. Repeat the procedure for C7 and L3. Then tune to a weak station at the high end of the band and repeat. Continue the process until you are satisfied that no further improvement is noted.

Adjust C38 so that the voltage across R43 is zero when a station is tuned in properly. Detuning the station should

cause that voltage to rise or fall slightly (± 1 to 2 volts is typical). Adjusting C38 in that manner should produce the clearest audio.

Next, tune in a weak station that you are certain is transmitting its signal in stereo. Adjust R73 for best stereo reception. When R73 is adjusted properly, LED1 should light. For more precise adjust-

ment, connect an oscilloscope or frequency counter to TP1 and adjust R73 to produce a 19-kHz signal.

Now, set S2 for SCA reception and R72 to its midrange position. *Slowly* tune across the FM broadcast band. You may hear several SCA signals. Tune one in and adjust R72 for best reception. If you cannot hear any SCA signals, change the setting of R72 *slightly* and try again. Note that if you do not have good fortune, aligning the receiver in this manner can be tedious and time-consuming, but with patience it can be done. There is, however, a short cut available to you if you have access to a frequency counter or an oscilloscope: Simply connect the instrument to TP2 (pin-6 of IC2) and set R72 to produce a 67-kHz signal there. To tune in other subcarrier frequencies, set potentiometer R72 to produce a pin 6 signal of the appropriate frequency.

If you know that a certain FM station has SCA activity, the receiver's TUNE function offers yet another method of alignment. When S2 is set to TUNE, the main channel audio is fed to one output, while the SCA audio is fed to the other. That allows you to hear both the main channel and the SCA subcarrier simultaneously. Using a pair of headphones for best results, tune the receiver so that the desired station's main-channel audio can be heard in one ear. Then, adjust R72 until the desired subcarrier can be heard in the other ear.

That completes the alignment procedure. Though there are a lot of steps to follow, most of the adjustments are broad and the radio should work in the FM-stereo position even with just the initial adjustments outlined. An exception to that is the setting of C38, and, to a lesser degree, the setting of C17; correctly adjusting those components requires some precision. Still, if the setting of any component is so critical that even breathing on it causes problems, something is not working properly.

Searching the bands

One of the authors lives on the New York/Vermont border, about 50 miles north of Albany, NY. From that relatively rural location he has received FM-stereo signals from as far as 170 miles away using only a two-foot clip-lead antenna. In addition, six SCA subcarriers could be received. Obviously, in major metropolitan areas many more SCA signals should be heard. In the New York City area alone, for instance, upwards of 20 FM-radio stations have some type of SCA activity. If you want to find out what stations in your area have SCA activity, and what type of programming is available, an excellent reference is the *FM Atlas and Station Directory*, written by Bruce Elving (FM Atlas Publishing, Adolph, MN 55701-0024). **R-E**

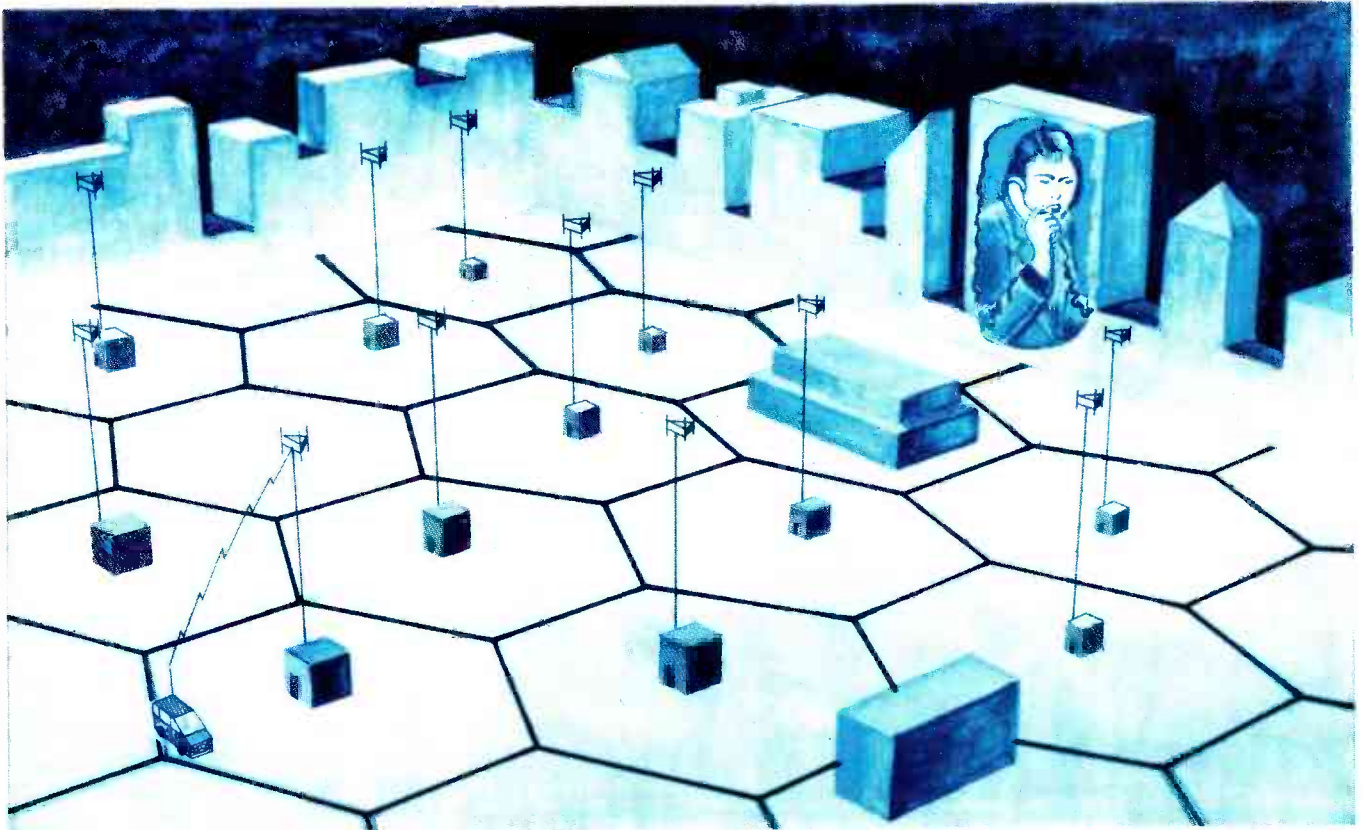

INSIDE CELLULAR TELEPHONE

A look inside cellular telephone, and the fascinating technology that has revolutionized mobile communications.

JOSEF BERNARD

NOT SO LONG AGO, WHEN ONE THOUGHT of a telephone, the image conjured up would be of a jet-black, rotary-dial, electromechanical device. Now, conventional telephones come in a rainbow of colors, sport sleek lines, and feature pushbutton dialing. But even more impressive are the features that are packed inside them. Thanks to microprocessors and memories, phones are capable of storing a telephone-book's worth of most-often-called numbers to be dialed at the push of a button. And that's only the beginning.

But if you think that the phone on your desk or in your kitchen is "smart," then you would have to place cellular mobile phones in the "genius" class. Those phones have to perform a number of sophisticated tasks, including monitoring signal levels and frequency switching, in such a way that the user is not aware of them. Because of that, many people who

use cellular phones daily aren't aware of the high level of technology built into their equipment. That's unfortunate, because

the technology inside the phones is, for the most part, much more interesting than the conversations that they transmit.

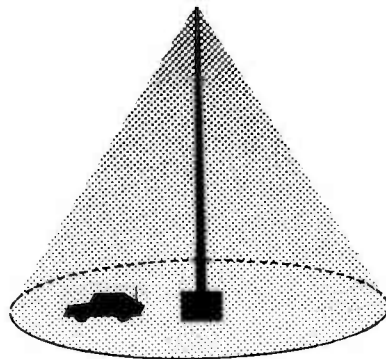

FIG. 1—EARLY, NON-CELLULAR, MOBILE-phone systems used a centrally located high-power transmitter. Only a few communications channels could be accommodated within a service region.

Cellular principles

Prior to the development of the cellular system, mobile telephone systems relied on centrally located transmitting and switching equipment to communicate with vehicles subscribing to their services. See Fig. 1. Cellular systems, on the other hand, divide their region of coverage into many small areas, each encompassing only a few square miles. See Fig. 2. It is that territorial subdivision that allows the mobile units to use low-powered transmitters (no more than three watts), and to use and reuse the same frequencies in the same area to increase the number of communications channels available.

There are 999 two-way communica-

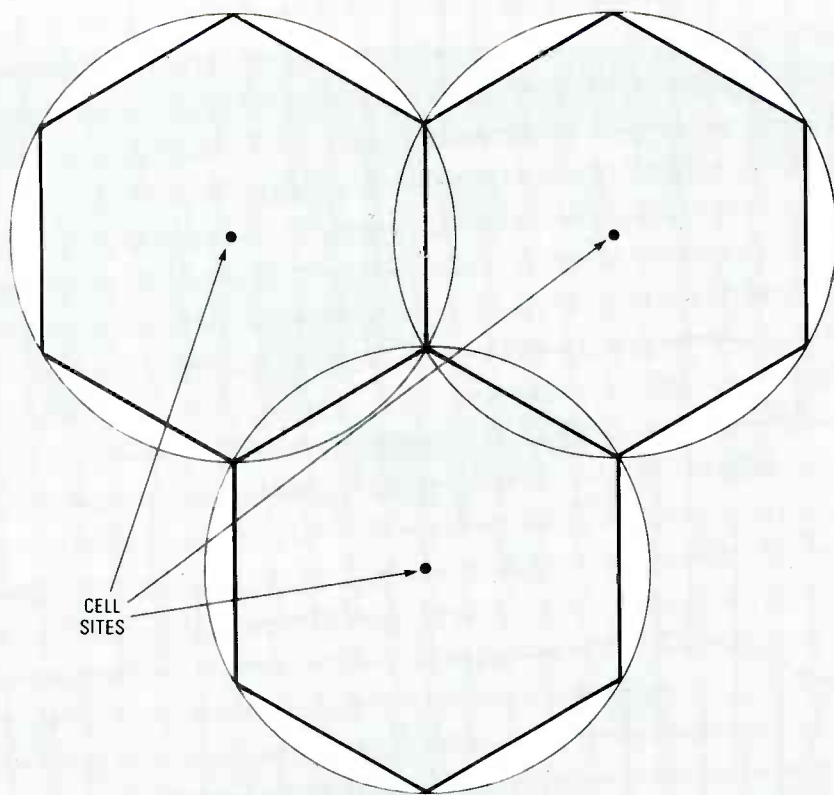

FIG. 2—A CELLULAR SYSTEM DIVIDES its region of service into a number of small cells, each with its own cell site containing a low-power transmitter and receiving equipment. As a vehicle passes between cells, the signal is analyzed and any further communications are handed off to the cell best able to handle them.

tions channels allocated for cellular service, although the phones currently available can use only 666 of them. (The other 333 frequencies were allocated in 1986 and equipment manufacturers, as of this writing, have not yet caught up with the FCC.) Of those channels, 42 are devoted to carrying control signals between cellular phones and the cell sites, where the transmitting and receiving equipment for each cell are located. It is over those channels—which you never hear, and rarely hear about—that a cellular system coordinates its activities.

All kinds of information flows on those channels, including that for coordinating frequency changes, identifying phones, and even adjusting power levels.

Handing off

When a mobile unit leaves the region of coverage of one cell site and enters that of the adjoining one, it is said to be *handed off* from one cell to the other. There is a lot of behind-the-scenes activity connected with that transfer of responsibility, and the intelligence built into cellular phones handles a lot of it.

As a vehicle equipped with a cellular phone traverses a particular cell, it eventually reaches a point where its signal is no longer strong enough for reliable communications. Fortunately, by the time it

has reached that point, it is well within the region of coverage of an adjacent cell. The handing-off process of transferring the responsibility for a call-in-progress from one cell site to another requires a lot of “intelligence” on the part of both the cell site and the mobile unit.

The first thing that has to be done is to sense when a signal is approaching the point where it is about to become too weak to be usable. That’s easy—all you need is what amounts, more or less, to a signal-strength detector. More complicated is the task of determining which new cell site is to receive the hand-off. The cell sites in the system have to “confer” to see which of them is receiving the signal in question the best, and make arrangements for transferring the call without interruption. That’s not too difficult, either. The next part of the process, however, is quite complex.

Because adjacent cell sites cannot use the same frequencies, even though others in the same system can, a new set of frequencies must be used after the hand-off. And, since the new cell site will be using different frequencies, so must the mobile phone. That is where the control channels, and the intelligence built into a cellular phone, come into play. The new cell site knows which of its frequencies are in use and which are free, and makes a

decision to allocate one of its frequency pairs (one channel) to the new conversation entering its district. It then transmits, over the control channel, instructions for the cellular phone carrying the conversation to switch to those new frequencies. The phone adjusts the voltages of its frequency synthesizer accordingly, and the conversation continues in the new cell site, on the new frequencies—all of that with only an unnoticeable interruption of a millisecond or two.

Power levels

A cellular system can use the same frequencies for different conversations at the same time, provided, of course, that the signals of one cell site do not interfere with those of another. That non-interference is accomplished in several ways.

The first is simple coordination of frequencies. While several cells in the same system may use the same frequencies, no two adjacent cells do. That puts cells using the same frequency far enough away from one another that the signal from one to a vehicle in its area, and vice versa, will override another signal from farther away. That is further ensured by the *capture effect*, which is a characteristic of FM, the transmission mode used by cellular phones. If there are two signals on the same frequency, one stronger than the other, the capture effect guarantees that a receiver will lock onto the stronger one, and ignore the weaker. Unless the two signals are nearly identical in strength, the stronger one will completely capture the receiver, and no trace at all of the weaker one will be heard.

All that is the consequence of good planning, and of the nature of FM equipment. Inside a cellular phone is circuitry that adds another level of interference protection. There is a constant dialogue going on between a cellular mobile unit and the cell site it is using. One “topic of conversation” is signal strength. Cellular equipment is low powered. Cell-site transmitters have an output of only 25–35 watts (compared to about 250 watts in older systems using central transmitters), and the mobile equipment a maximum output of three watts—and as low as 600 milliwatts for handie-talkie-size units.

One of the rules of cellular telephony is “use only as much power as you need.” Consequently, a cell site monitors the strength of the signal it receives from a mobile unit. If the strength increases to a predetermined level, the cell site sends instructions over the command channel for the low-powered phone to reduce its power to an even lower level. Conversely, if the received signal strength drops, a mobile phone can be instructed to increase its power. Cellular phones are capable of between 3 and 8 discrete output levels. Keeping output power to the minimum required for good communications

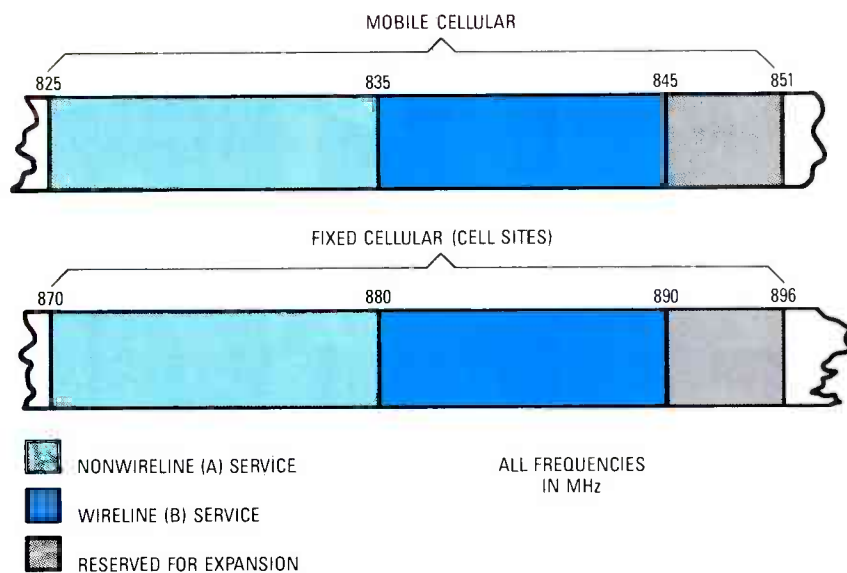

FIG. 3—THE 666-CHANNEL CELLULAR PHONE RF spectrum is divided into bands for fixed and mobile equipment (cell sites and phones), and for non-wireline (A) and wireline (B) service.

also reduces the risk of interfering with communications in a nearby cell.

NAM's

Every cellular phone contains an "identification" PROM or EPROM. In cellular terminology, this is called a NAM (Numeric Assignment Module). A phone's NAM is programmed at the time the phone is purchased; it contains such information as:

- The telephone number, or ESN (Electronic Service Number), assigned to the phone.
- The serial number given to the phone at the time of its manufacture.
- Personal codes that can be used to lock and unlock the phone electronically, to prevent its unauthorized use.

NAM information is more useful than you might at first imagine. For one thing, it is the job of the NAM to identify the phone containing it to the cellular systems it uses. When a cellular phone is turned on, it makes an announcement over a control channel that says, "Here I am." The cell site responds, "And exactly who are you?" The reply from the phone consists of information contained in its NAM.

That information tells the cellular system several things. First, of course, is that that particular phone is now on the air and is ready to receive calls placed to its number. The cell site is connected to a computer at the MTSO (Mobile Telephone Switching Office), which is the link between the cellular system and the conventional landline phone system, and which recognizes all the cellular phones registered in the calling area it is responsible for. If the phone is a local one, the process is more or less complete at the point of recognition.

Because they are mobile, cellular phones may frequently be used outside of the area in which they are permanently registered. That is called *roaming*, and is one of the outstanding features of cellular telephony. You can take your cellular phone almost anywhere in the country where there is service, turn it on, and use it to call anywhere in the world.

In some areas you can roam and use a foreign system without advance notification. Other cellular systems require that you let them know ahead of time that you are coming. In either case, the NAM information transmitted to the system allows you to log on to it, and tells that system what to do about your billing.



NOT JUST FOR CARS, cellular phones come in portable models, like this one from GE, that keep you constantly in touch.

Cellular phones have a ROAM indicator, which lights when you have left your local area and are in the operating area of another system. (The phone realizes that it has entered a system other than its own, and lets you know that.)

The serial number contained in the NAM, incidentally, can serve a second purpose. Should a phone be stolen and reported so, it is possible for a system to recognize that phone when it is next used. While tracking down the phone would be rather difficult, it is easy to cut off service to that number automatically, avoiding the possibility of your being charged for calls you never made.

A/B switching

When it established the cellular phone service, the FCC provided for two cellular carriers in each region. One, the *wireline* service, would be operated by a phone company engaged in conventional telephony, frequently the one that already provided landline service to the area. The other, known as the *non-wireline*, service would be operated by a company that was engaged in other forms of mobile communications—perhaps paging, or private two-way radio services. Sometimes a region of cellular service has both types of carriers, and sometimes only one, at least when service is inaugurated. Each service is assigned a separate set of frequencies. See Fig. 3.

Regardless of where in the country you are, the non-wireline service is referred to as the *A service*, and the wireline one as the *B service*. Normally you subscribe to only one service or the other (provided your area offers you a choice), but you may at times have occasion to use the other type—when you are roaming, for example.

To provide for that, cellular phones have A/B switches to allow you to go from one type of service (band of frequencies) to the other. Those switches are generally not mechanical devices, but are programmable from a phone's keypad. Some of the switches are more flexible in their capabilities than are others, and the more sophisticated of them offer at least the following modes of operation:

- A (or B) service only—the other is locked out.
- Give priority to one type of service over the other.
- Automatic selection of the one active service in an area.

Again, it is the intelligence a phone applies to the information coming in over its control channel that makes it possible for it to select the appropriate A or B setting.

When you are roaming, the phone lets you know you are outside of your normal area of use by illuminating its ROAM indicator. Some phones can apply their

continued on page 93

R-E ROBOT

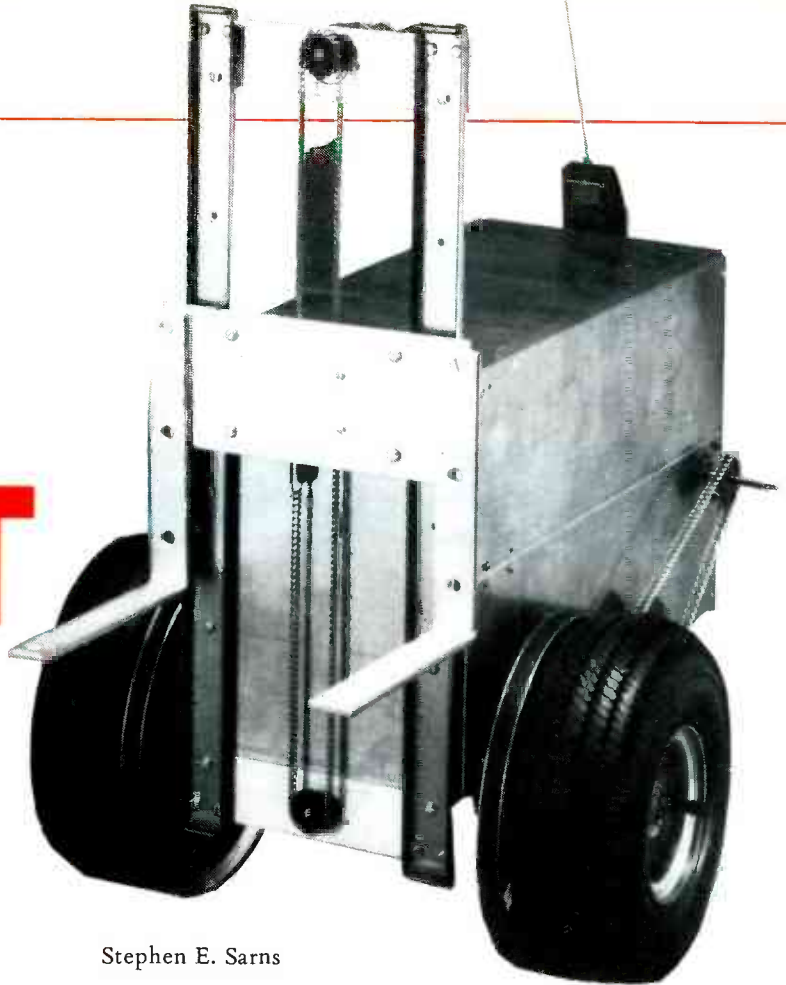

Stephen E. Sarns

Here's an application that can give
a robot builder great "joy."

Part 10 Now that we've finished building the Robotic Personal Computer (RPC), the mechanical drive system, and the interface and controller board, we have a robot that is ready to run. But what are we going to do with it? In this article we are going to show you a simple application program that will demonstrate how to:

- Develop programs on the RPC.
- Read the A/D converter.
- Read the switch status.
- Control motor direction.
- Control motor speed.

In addition, our first application, a joystick controller for the robot, illustrates the use of the underlying Forth-83 language. You will want to become familiar with Forth-83, even though you have the power of the Robotic Command Language (RCL) at your disposal, because Forth-83 allows you to extend the RCL to suit your needs. Remember, the RCL is simply an application written in Forth-83. Your application can use the resources of RCL or Forth-83 or both. That is shown graphically in Fig. 1.

The application

A joystick is attached to the discrete user bus (PL3 on the control board). Analog channel 0 is used to monitor the joystick's forward/backward position. Analog channel 1 monitors its left/right position. For safety, a pushbutton *dead-man* switch is connected to the D7 (data bit 7) input. That switch must be depressed for the robot to operate; if it is released, all power to the motors is cut. The schematic for the joystick hookup is shown in Fig. 2.

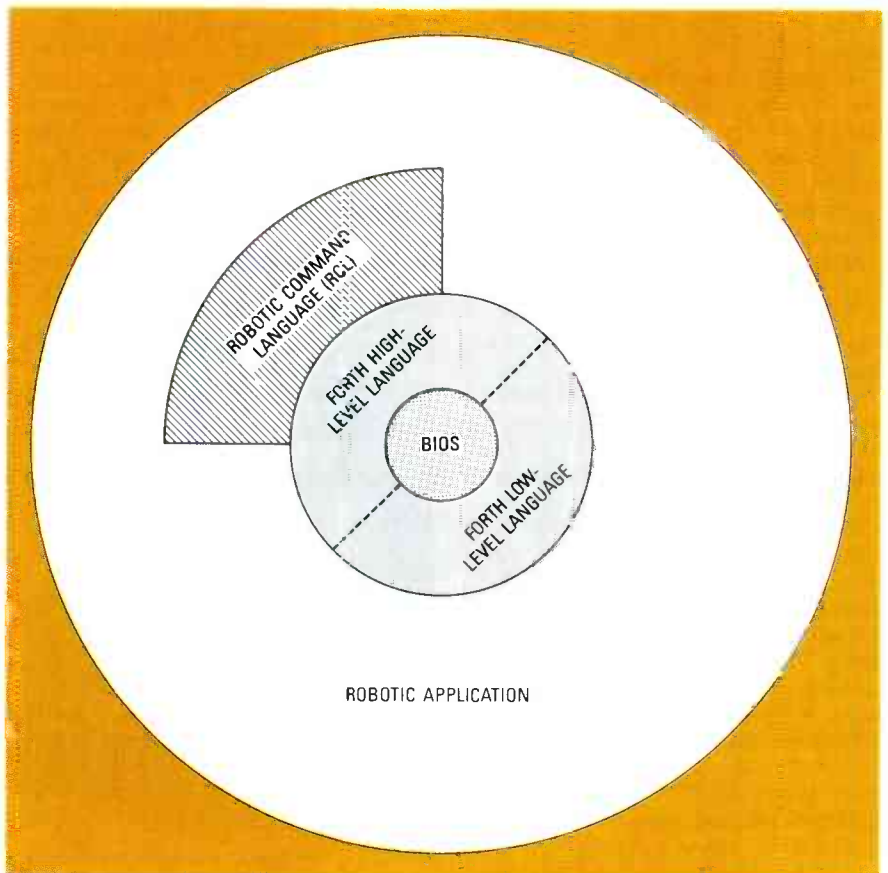

FIG. 1—AN APPLICATION PROGRAM for the robot can be written in RCL, Forth, or both.

All of the code we are going to write will fit into six Forth screens. Therefore, you do not need a disk drive. You can use the RAM word to store all of your source code in virtual memory above 32K. Alternatively, you can attach a disk drive and keep all of your code on disk. Last, you could type in all of the colon definitions from the keyboard, but doing so is handy for testing, not developing an application.

If you are going to use RAM as the development media, power down and install a RAM IC in the IC5 socket on the RPC, execute the RAM word, and remember that you now have virtual memory screens 32 to 39. If you have a disk drive attached, simply insert a disk formatted under MS-DOS version 2.x or the BIOS formatter. Decide where you want to start (never screen 0) among the 360 available screens on the disk. For simplicity and clarity, we'll assume that you'll start your first screen at 32 just like the RAM-based example. Incidentally, the example was developed on a disk, but there is no functional difference after executing the RAM or DISK word.

Install a blank 2764 EPROM at IC31, the EPROM programming socket on the RPC; once again, power should be off when doing that. It's handy to keep an EPROM installed there, especially if you are developing code in RAM and do not want to risk losing it during a power down.

Invoke the editor by typing 32 EDIT. The 32nd screen is read in from disk (or RAM), the terminal's display is cleared, and then the screen of text is listed. Alternatively, you can type EDITOR 32 LIST. Your first command will probably be WIPE; that clears the entire screen. Now begin entering the source code with the editor. When you want to test a word, make sure you FLUSH your changes to disk before you LOAD the screen, otherwise all of your changes will be lost if your system crashes.

The program

One of the most common criticisms of Forth is that it is unreadable and therefore unmaintainable. We think you will find Forth quite the opposite—if you start at

LISTING 1

```
Scr # 32
0 / joystick documentation
1
2 / analog channel 0 is used by forward/reverse joystick
3 / analog channel 1 is used by left/right joystick
4 / digital input D7 is a normally open "deadman" switch
5 / variables LSPEED and RSPEED contain the joystick position
6 /   in the range of -127 to +128
7
8
9
10
11
12
13
14
15 -->
Scr #33
0 / joystick - i/o
1 / all low level drivers for reading and controlling here
2
3 hex
4 : atod ( channel number --- byte )
5   dup 150 pc! 150 pc! 100 0 do loop 150 pc@ ;
6 : switch? ( ---f ) 120 pc@ 80 and 0= ;
7 : lmtr-period 36 103 pc! 100 /mod swap 100 pc! 100 pc! ;
8 : rmtr-period 36 113 pc! 100 /mod swap 110 pc! 110 pc! ;
9 : stop-left 0 124 pc! ; : stop-right 0 125 pc! ;
10 : enable-left 1 124 pc! ; : enable-right 1 125 pc! ;
11 : l fwd 0 121 pc! 1 120 pc! ; : r fwd 0 122 pc! 1 123 pc! ;
12 : l rev 0 120 pc! 1 121 pc! ; : r rev 0 123 pc! 1 122 pc! ;
13
14
15 -->
Scr #34
0 / joystick - joystick interrogation
1 / INTERROGATE reads both channels of a/d. Results of fore/back
2 / are stored in LSPEED and RSPEED. The left/right position is read
3 / and the contents of LSPEED and RSPEED are modified according
4 / to DIFF-CONV
5 hex
6 300 constant maxspeed      variable lspeed      variable rspeed
7
8 : speed-conv ABS 5 * maxspeed swap - ;
9 : diff-conv 5 / ;
10
11 : interrogate
12   0 atod 80 - dup lspeed ! rspeed !
13   1 atod 80 - diff-conv dup negate swap
14   lspeed +! rspeed +! ;
15 -->
```

the end and work backwards. Remember, in Forth, you can design your program

from the top down, meaning that you can figure out how it should work, write that part of the code, and later add the support words to make it work that way. By starting your examination of the application from the end, you will understand how the program works, leaving the details for later.

Therefore, for now we'll ignore the low-level words, which can be rather esoteric, and begin with screen 37, which contains a single word called JOY. That is the joystick program. While it is executing, pushing the stick forward causes the robot to go forward; pulling the stick back causes it to reverse. Turns are made by moving the joystick in the desired direc-

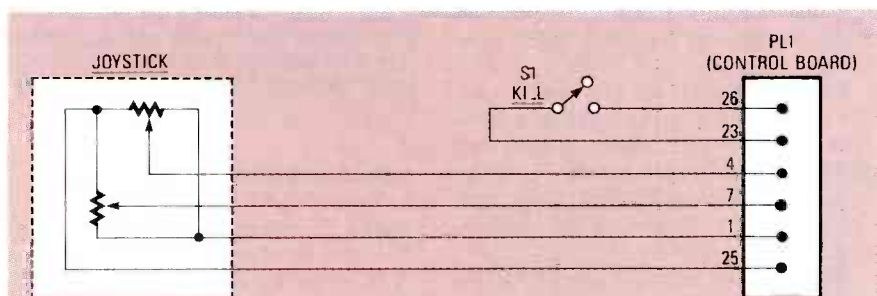

FIG. 2—A SIMPLE JOYSTICK can control the robot. The circuit is wired to the user interface on the control board. For safety, a "deadman" or kill switch must be provided.

LISTING 1 (continued)

```

Scr #35
0 / joystick - left motor control
1 decimal
2 : leftmotor
3   lspeed @ 10 > switch? and
4     if l fwd lspeed @ speed-conv lmtr-period enable-left then
5   lspeed @ -10 < switch? and
6     if l rev lspeed @ speed-conv lmtr-period enable-left
7     then
8   lspeed @ -10 10 between switch? 0= or
9     if stop-left then ;
10
11 : testleft
12   begin interrogate leftmotor lspeed @ . key ? until ;
13 -->
14
15
Scr #36
0 / joystick - right motor control
1
2 : rightmotor
3   rspeed @ 10 > switch? and
4     if r fwd rspeed @
5     speed-conv rmtr-period enable-right
6     then
7   rspeed @ -10 < switch? and
8     if r rev rspeed @
9     speed-conv rmtr-period enable-right
10    then
11  rspeed @ -10 10 between switch? 0= or
12    if stop-right then ;
13
14
15 -->
Scr #37
0 / joy
1 hex
2
3 : joy
4   begin
5     interrogate rightmotor leftmotor
6     lspeed @ 10 .r rspeed @ 10 .r
7     cr key?
8     if key 0d =
9     else 0
10    then
11    until ;
12
13 decimal
14
15

```

tion. Speed is controlled by the displacement of the joystick.

Note the BEGIN/UNTIL structure in screen 37. The code executed within the loop is indented for easier understanding. The loop repeats or ends depending on the value of an argument left by the IF/ELSE/THEN construct. The loop checks to see if a key has been pressed. If so, the KEY statement retrieves the character and it is compared to a 0DH (carriage return). If the result of the comparison is true, a *true* flag (-1) is left on the stack. If the KEY statement is false, ELSE is executed, which leaves a *false* flag on the stack (0). UNTIL causes the loop to continue until a *true* flag is found on the top of the stack. Thus, JOY will execute until the carriage-return key is pressed.

Why not terminate on any key? Sometimes after you disconnect your terminal, the floating RS-232 input can be subject to noise. Generally, after your code is in ROM and you are running without the terminal, install a shorting bar between RxD and ground on the RS-232 connector.

INTERROGATE (in line 5 of screen 37) is a word that updates the two variables LSPEED (left motor speed) and RSPEED (right motor speed). The numbers in LSPEED and RSPEED range from -128 to +127. Positive means forward, negative means reverse.

The next two words, RIGHTMOTOR and LEFTMOTOR, examine the contents of the words of LSPEED and RSPEED respectively and set the appropriate

motor's speed accordingly.

Finally, the contents of variables LSPEED and RSPEED are fetched and displayed on the screen followed by a carriage return. The .R word is used to right justify the displayed values.

Testing

Each word should be tested after it is written and compiled into the dictionary (LOADED from disk). A common test/debug method is to load up the stack with a few easily identified values, such as 1, 2, and 3. Then type in each word of the definition being tested (not in a colon definition, but interactively). After each word, execute .S, which prints out the contents of the stack without modifying it. Do so to make sure that nothing has been removed from or left on the stack.

It can be useful to define small test. For example, having defined the word ATOD, which takes a channel number off the stack and returns the value of the corresponding A/D converter, you can make sure that it works with all 8 channels by using the following word:

```

: TEST-ATOD
BEGIN 8 0
DO 1 ATOD . LOOP CR KEY?
UNTIL ;

```

That word prints out the results of all 8 A/D conversions. Your joystick should show up at the first two positions. Terminate the test by pressing any key.

SOFTWARE SOURCES

Micro K Systems (15874 East Hamilton Place, Aurora, CO 80013, 303-693-3413) will provide the following: Commented source code in RE-robot disk format, \$2.00. Printed source-code listing, \$15.00. Two 27128 EPROM's with source screens (and without comments) for the R-E Robot, \$39.00. With EPROM's you won't need a disk drive, but you should also obtain the printed listing to read the comments. The Laxen and Perry F83 Model disk with full source code and metacompiler for customizing F83, in MS-DOS 360K format, for a PC compatible computer, \$25.00. (Very useful for learning FORTH if you already have a PC.) All orders must be prepaid. NO COD's. Include \$3.00 for shipping with each order. Additional source code and applications will be available from Micro K Systems. Contact them for more information.

Speed and direction

The word RIGHTMOTOR, shown in screen 36, examines three possibilities:

- Is the value of RSPEED greater than +10 and is the switch pressed?
- Are the contents of RSPEED less than -10 and is the switch pressed?

continued on page 63

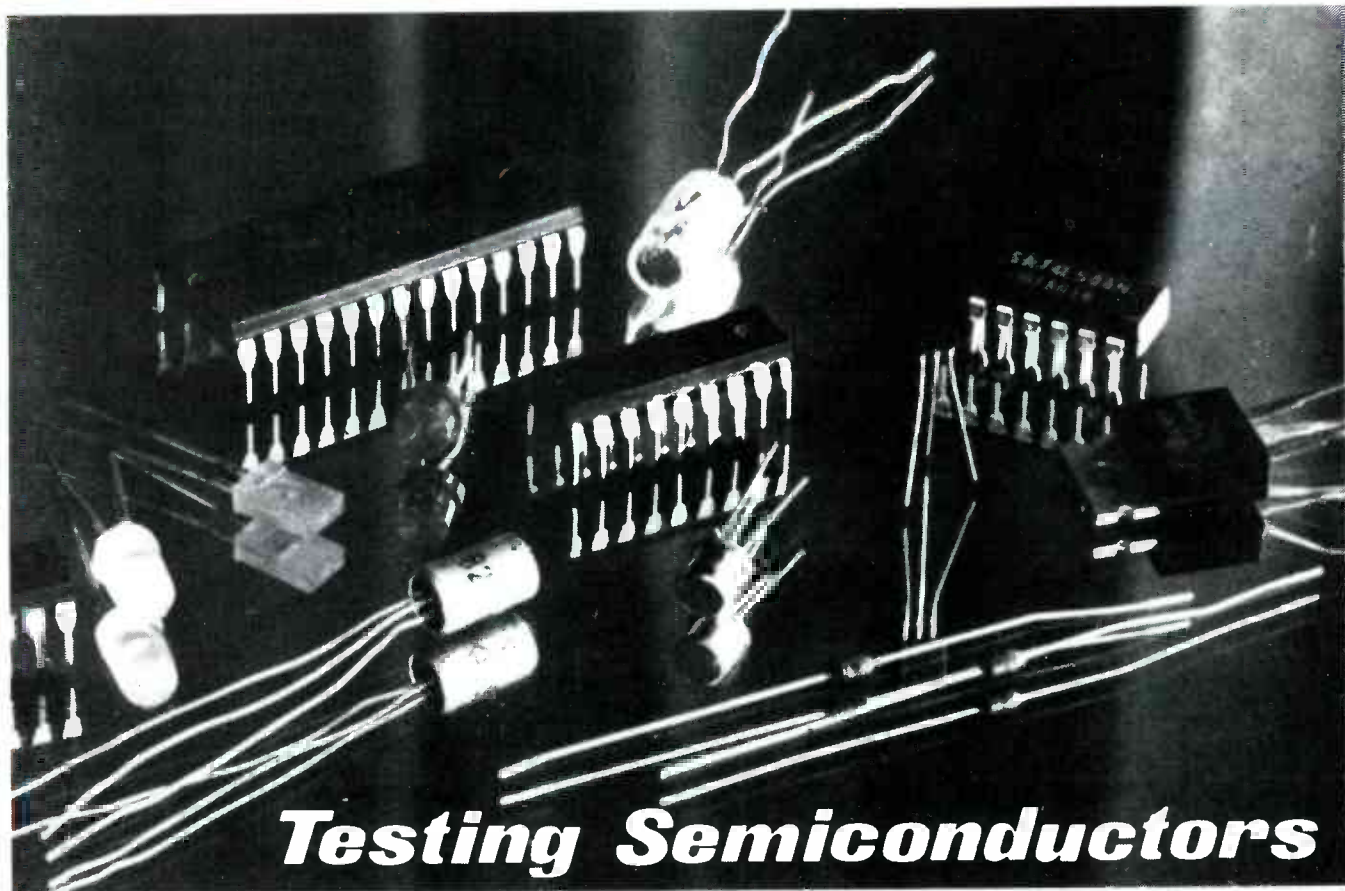

Testing Semiconductors

Op-amp characteristics and how to measure them

TJ BYERS

Part 6 THIS MONTH WE'LL turn our attention to a device that is a staple in electronics: the operational amplifier.

The term operational amplifier (op-amp) was coined some years ago to describe the building blocks of analog computers; they performed integration, multiplication, subtraction, and other mathematical operations. Today, mathematical functions are largely performed by digital circuits, and we find that the widest application of the op-amp is in signal conditioning.

Op-amp basics

There are many different types of op-amps available; they're based on bipolar, JFET, and MOSFET technologies. Regardless of internal makeup, all op-amps function in a similar manner. That is, any voltage difference between the two inputs is reflected in some form at the output. If the input signals are equal, the output voltage will be zero.

In many ways, the op-amp possesses the characteristics of the ideal amplifier: infinite-input impedance, zero-output im-

pedance, infinite bandwidth and gain, and zero noise. In fact, quantifying the ways in which an op-amp differs from the ideal amplifier is the subject of this article.

Input bias current

Ideally, an operational amplifier has infinite input resistance; realistically, it doesn't. The input transistors must have a finite bias current before they will function properly; and for current to flow there must be a finite impedance.

The value of that impedance varies depending on the type of device. Bipolar-transistor inputs consume quite a bit of current (nanoamps), and have the lowest input impedance. JFET's fare better, and MOSFET's, with their miserly picoampere input requirements, very nearly approach the ideal, with input impedances exceeding 10,000 megohms.

Input bias current is relatively independent of input voltage, and that makes measuring it easy. Input bias can be measured using the circuit shown in Fig. 1. Simply apply a voltage to the input and then read the bias currents directly from the meter.

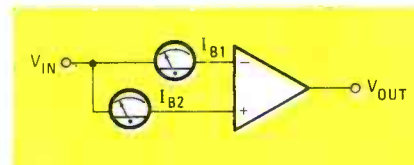

FIG. 1—MEASURE INPUT OFFSET CURRENT of each input separately by applying a common voltage to each.

Input offset current

In the ideal amplifier, operational characteristics of both inputs would be identical. In real life, though, there is always some difference between the two input transistors.

One difference is called input offset current; it's labeled I_{OS} , and is calculated as the difference between I_{B1} and I_{B2} :

$$I_{OS} = I_{B1} - I_{B2}$$

In that formula, I_{B1} is the inverting input's bias current and I_{B2} is the non-inverting input's bias current.

Actually, to obtain the true value of the bias current, the two input currents must be averaged:

$$I_{OS} = (I_{B1} + I_{B2}) / 2$$

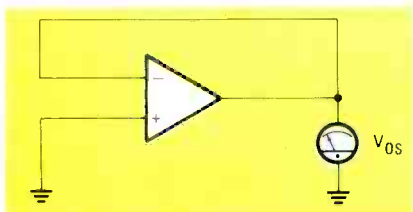

FIG. 2—MEASURE INPUT OFFSET VOLTAGE by grounding the non-inverting input. With a bipolar power supply, the inverting input is held at virtual ground by the op-amp's output.

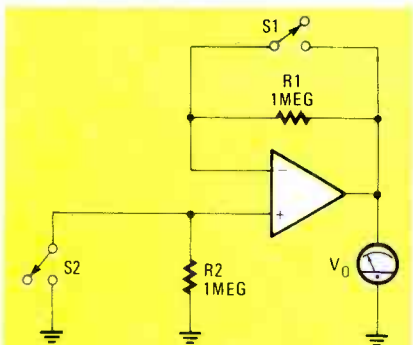

FIG. 3—OFFSET VOLTAGE AND CURRENTS may be measured with this circuit, depending on the state of S1 and S2.

As before, I_{B1} refers to the inverting input and I_{B2} refers to the non-inverting input.

Input offset voltage

Another result of mismatched differential-amplifier inputs is offset voltage, V_{OS} . The error is reflected as a voltage at the output when both of the inputs are grounded.

A test circuit for measuring V_{OS} is shown in Fig. 2. Looking at the circuit, however, we see that only one input is directly tied to ground; the other is at a *virtual ground*. That concept is important in understanding how op-amps work. One of the basic properties of an ideal op-amp is that its differential input voltage is zero. Hence, when the non-inverting input is tied low, the sum of the voltages at the inverting input must also be zero, or at ground. That sum consists of the input signal and the feedback.

In an ideal device, with no input signal there would be no output. But, in a real device mismatched base-to-emitter (or gate-to-source, as the case may be) voltages between the input transistors will cause a DC offset voltage at the output. Input offset voltage is defined as the voltage necessary at the inputs to bring the output to zero.

Returning to Fig. 2, in that configuration, the op-amp attempts to balance its inputs by forcing the inverting input voltage high or low to compensate for any voltage difference between the two inputs. The result (V_{OS}) can be read directly with a voltmeter.

A circuit that allows you to measure all three characteristics (offset voltage and

the input bias currents) is shown in Fig. 3. V_{OS} is measured by closing both switches S1 and S2. The value is read directly from the meter.

The input bias currents are measured by alternately opening each switch. With S1 open and S2 closed, we read an offset voltage that we'll call V_1 . Closing S1 and opening S2 gives us V_2 . I_{B1} is calculated from this formula:

$$I_{B1} = V_1 - V_{OS}$$

I_{B2} is calculated in a similar manner:

$$I_{B2} = V_2 - V_{OS}$$

The calculated bias currents are displayed in microamps. I_B is derived by averaging I_{B1} and I_{B2} ; I_{OS} is the difference between them (in microamps).

Variations in offset parameters

The values of I_{OS} and V_{OS} are dependent on the gains of the input transistors. Generally, the lower the gain of a transistor, the less the offset parameter will be affected. Lower input gains, however, tend to increase input bias currents, and that reduces input impedance. In addition, open-loop gain of an amplifier also has a pronounced effect on the overall influence of the offset parameters.

Temperature effects

Offset differences can be affected greatly by temperature change. It's not the offset itself that is the culprit. Offset voltage and current can be compensated for in a given circuit simply by using trimmer potentiometers.

The problem is in the tracking of the offset values. Even "perfectly" matched transistors have slightly different temperature curves. The differences arise because of slight temperature gradations within the semiconductor substrate of the device itself, and because of impurities that are introduced during the manufacture of the device.

The result is that one transistor's leakage current or offset voltage can change at a rate that is faster than that of the other transistor, thereby creating mis-matched outputs. For example, an offset voltage that is handily compensated for at room temperature may prove too much to han-

dle at 125°F. The overall effect is called temperature drift.

All op-amps are designed to minimize the effects of temperature drift—some just do it better than others. The effects of temperature drift can be measured using the circuit shown in Fig. 3. With both S1 and S2 closed, record the value of V_{OS} at room temperature. Now raise the temperature and note how V_{OS} changes. With properly tracking transistors, the change should be slight, if it's noticeable at all. The table in Fig. 4 shows how input bias current of a typical device varies with changes in temperature.

Temperature drift is normally expressed numerically in terms of temperature coefficient. The temperature coefficient of offset voltage is calculated from this formula:

$$\text{TEMPERATURE COEFFICIENT} = \frac{\delta V_{OS}}{\delta T}$$

and the temperature coefficient of offset current is calculated:

$$\text{TEMPERATURE COEFFICIENT} = \frac{\delta I_{OS}}{\delta T}$$

Temperature coefficient usually is specified in units of microvolts per degree Centigrade ($\mu V/^\circ C$) and in units of microamps, nanoamps, or picoamps per degree Centigrade ($\mu A/^\circ C$, $nA/^\circ C$, or $pA/^\circ C$), depending on the type of device.

Remember, we're not concerned with the actual change in input bias—it will fluctuate. What concerns us is that the individual input currents change together. The smaller the temperature coefficient, the better the two inputs track.

Aging

Another factor that influences how an op-amp works is aging. Op-amp characteristics have a tendency to change as operating time increases. Change is especially noticeable in the offset values. Devices that change much can be inconvenient to use, because the equipment in which they're used may have to be calibrated fairly often.

Aging is accelerated with continuous exposure to elevated temperatures—such as that frequently experienced inside an enclosure. Fortunately, aging is not a continuous process. Most changes take place within the first 100 hours of operation. Once stabilized, you can expect an amplifier to perform very reliably over the next 10,000 hours or so.

In fact, forced aging is one way to increase life and enhance the performance of a part, as we shall learn later on in this series.

Common-mode rejection ratio

Another consequence of imperfect matching is common-mode voltage. Nor-

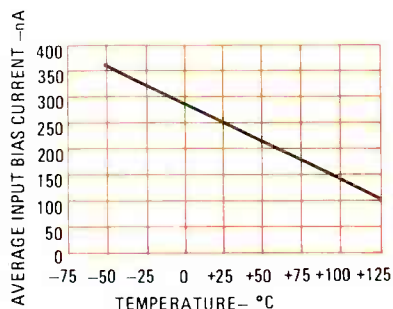

FIG. 4—INPUT BIAS CURRENT is a function of temperature.

mally you see it expressed as the common-mode rejection ratio. The common-mode rejection ratio is an important—yet often misunderstood—parameter.

In an ideal amplifier, both inputs—inverting and non-inverting—amplify equally. So, theoretically, identical signals to both inputs should be expected to

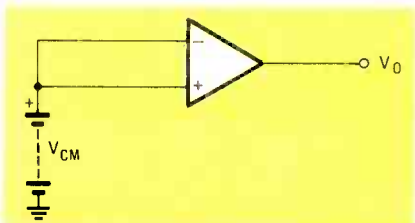

FIG. 5—SLIGHT GAIN DIFFERENCES between the inverting and the non-inverting inputs produce an erroneous output voltage. The ratio of the output voltage to the common-mode input voltage is the common-mode rejection ratio.

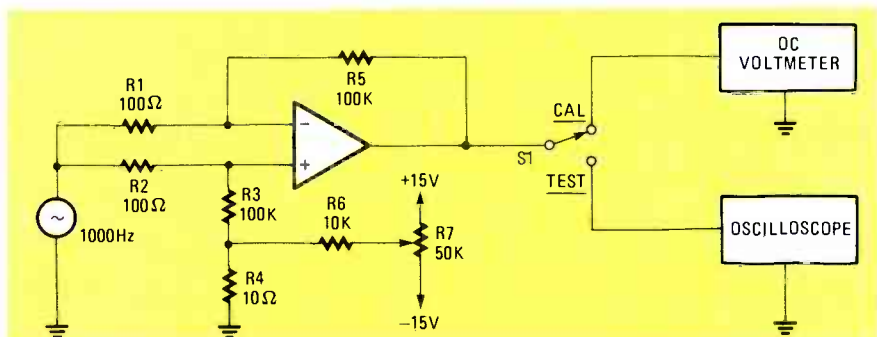

FIG. 6—TO MEASURE CMRR, use this test setup. With the 1000-Hz source off, adjust R7 for zero volts DC. Next, apply the test signal and measure the output with the oscilloscope. Last, calculate CMRR as discussed in the text.

result in zero output.

Unfortunately, that's not the case. Due to slight differences in the gain between the two inputs, some output voltage usually is produced for a common-mode input voltage.

Common mode refers to the fact that both inputs are referenced to the same identical source. One way to produce a common-mode condition is to tie the two inputs together and bias them above ground, as illustrated in Fig. 5. The output voltage of that circuit is the common-mode error voltage.

Common-mode error voltage, however, is not a useful parameter. It changes according to the gain of the amplifier and common-mode input voltage. Consequently, it is an ambiguous measurement that is dependent upon circuit conditions and does not relate easily to another amplifier for comparison.

The ratio between the common-mode output voltage and the common-mode input voltage, on the other hand, is a constant quantity. It is expressed by the term common-mode rejection ratio—or—more usually—CMRR.

Simply put, CMRR is the amount of resistance the amplifier offers to produc-

ing erroneous common-mode outputs. The higher the value of the CMRR, the smaller the common-mode error.

Although common-mode rejection ratio is a DC quantity, it is more easily measured with an AC source. The circuit shown in Fig. 6 shows one way of determining CMRR.

In that circuit, the common-mode input signal is derived from a 1-kHz signal generator that drives two identical resistors, R1 and R2. The common-mode voltage is developed across the series combination R2 and R3. The 50K potentiometer (R7) compensates for input offset voltage.

To use the test circuit, with no AC input, adjust the 50K potentiometer until the DC voltmeter reads 0 volts. Now set the signal generator to 1 kHz with an amplitude of 1 volt. Measure the AC output voltage, and calculate CMRR as follows:

$$\text{CMRR} = 100 / V_O$$

V_O is the AC voltage measured by the scope.

CMRR numbers are rather large, and that makes them difficult to work with. So CMRR is most-often expressed in decibels. The conversion is easily made using this equation:

$$\text{CMRR dB} = 20 \log (100 / V_O)$$

Monolithic operational amplifiers typically display CMRR values on the order of about 100 dB.

Be aware that the value of CMRR is valid only over a limited common-mode input range. Fortunately, that range is rather large, usually exceeding 90% of the power-supply voltage. Input voltages outside the limit often produce very high common-mode output voltages. However, errors due to CMRR only arise in applications in which the amplifier is used in the non-inverting or the differential configuration. Inverting amplifiers tend to cancel out CMRR error.

Unfortunately, that's all we have room for this time. In the next installment we'll continue our discussion of op-amp test procedures, and we'll show a special circuit for measuring various op-amp characteristics. **R-E**

R-E ROBOT

continued from page 60

- Are the contents of RSPEED between -10 and +10 or is the switch released?

You will see the three IF/THEN statements that test those cases.

Assuming motion is going to take place, RFWD (right-motor forward) or RREV (right-motor reverse) is executed. Those words enable the appropriate relay and disable the other so that motion takes place in the desired direction. It is important to notice that the relays are set before the motor is enabled. That prevents inrush currents from damaging the relay.

Next, the value of RSPEED is fetched and used as an argument to SPEED-CONV. SPEED-CONV takes an argument (from the stack) that is proportional to the speed and returns an argument (on the stack) that is the period of the motor control-frequency generator. Speed may vary from 0 to 128. When reverse motion has been requested, the speed argument is negative. We could NEGATE it before passing it to SPEED-CONV; however, it is more convenient to have SPEED-CONV use the ABS operator to make sure all arguments are positive.

As shown in lines 5 and 9 of screen 36, the output of SPEED-CONV is passed directly to RMTR-PERIOD (right-motor period), which sets the frequency of the 8253 control element in the right motor's phase-locked loop circuit on the control board.

Last, ENABLE-RIGHT (again shown in lines 5 and 9 of screen 36) electronically enables the high-power output stage of the motor-control circuit. If no motion is going to take place, STOP-RIGHT is executed. The code is identical for the left motor; it is shown in screen 35.

Moving on to screen 34, INTERGATE reads channel 0 of the analog-to-digital converter, converts it to the -128 to +127 range and stores the result in both LSPEED and RSPEED. Next channel 1 (sideways displacement) is read. That result is converted to the ± 128 range and passed as an argument to DIFF-CONVERT on the stack. The result is duplicated (DUP), one copy negated (NEGATE) and used to alter the contents of LSPEED and RSPEED.

Low-level control

Now we start getting into the low-level words shown in screen 33. Those words could be rewritten many different ways and the overall program would still function the same, but the response would change. For example, SPEED-CONV could be rewritten to provide a greater range of motion, limit the top speed, or provide a constant speed.

continued on page 86

USING TRIACS AND SCR'S

SCR's and Triacs are high-speed, solid-state switches used in AC- and DC-power control applications. Find out how they work and practical applications for them.

RAY MARSTON

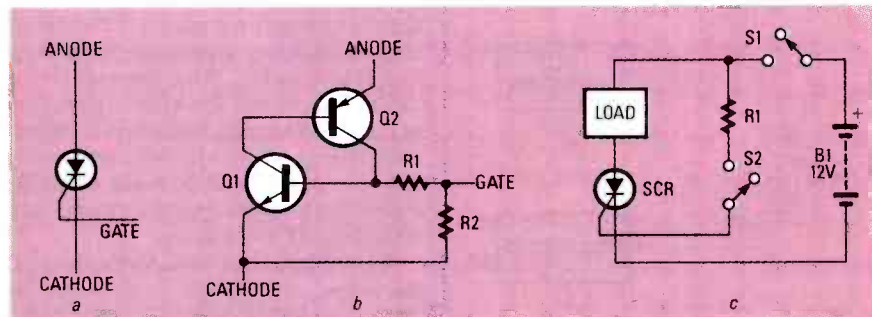

FIG. 1—THE SCR'S SYMBOL (a) and equivalent circuit (b) are shown here. In (c) is shown how the SCR can control a DC-operated load.

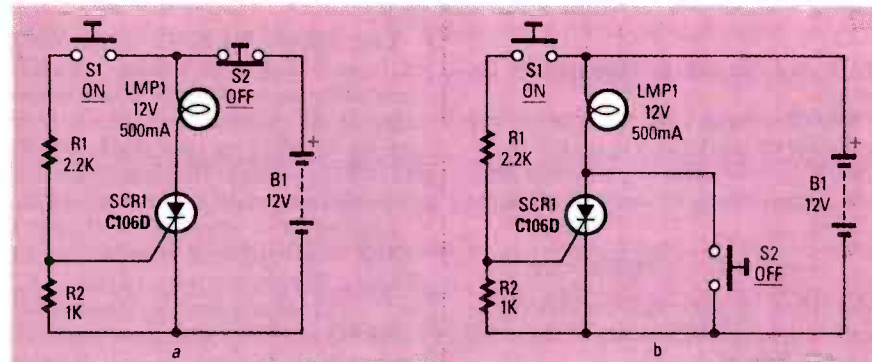

FIG. 2—PRACTICAL SCR CONTROL CIRCUITS are shown in (a) and (b). Both circuits have separate on and off switches.

SCR'S AND TRIACS ARE BOTH MEMBERS OF the thyristor family. The SCR (Silicon Controlled Rectifier), is a four-layer (PNPN) sandwich of semiconductor material. Its symbol is shown in Fig. 1-a, and its equivalent circuit is shown in Fig. 1-b. The circuit is a complementary regenerative switch in which Q1's base current is derived from the collector of Q2, whose base current is in turn derived from the collector of Q1. We'll discuss that regenerative action in much greater detail shortly.

Figure 1-c shows the basic circuit that lets you use the SCR as a switch in a DC

power-control circuit. The circuit works as follows. When power is first applied to the SCR by closing S1, the SCR is "blocked" and appears as an open-circuit switch. That action can be understood by examining Fig. 1-b, where it can be seen that, because Q1's base is shorted to the cathode terminal via R1 and R2, Q1 is cut off through lack of base current. Therefore Q1 feeds no base current to Q2, so it is also cut off. Because both transistors are cut off, only a small amount of leakage current can flow between the anode and cathode terminals.

The SCR can be turned on (made to act

like a closed switch or a forward-biased silicon rectifier) simply by applying a positive gate current. That can be done in the circuit shown in Fig. 1-c simply by closing S2. The gate current thus applied causes the SCR to switch on very quickly.

If the externally applied gate current is sufficiently large, it will cause Q1 to start to turn on. As it does, its collector current feeds Q2's base, thereby causing Q2 to turn on and feed additional base current to Q1, and so on. The way in which the two transistors feed each other is called regenerative switching.

After the SCR turns on and is conducting significant forward current, the SCR stays on even if gate drive is subsequently removed. Therefore, only a brief pulse of gate current will be needed to latch the SCR on. Note in Fig. 1-b that, because of the presence of R1 and R2, the SCR cannot be turned off by shorting or reverse-biasing the gate-cathode terminals of the device.

In fact, the only way of turning the SCR off is by momentarily reducing its anode current below a value known as the *minimum holding current* (I_{H1}). So it follows that turn-off occurs automatically in an AC circuit near the zero-crossing point at the end of each half cycle.

A finite amount of internal capacitance exists between anode and gate of an SCR. Consequently, if a sharply rising voltage is applied to the anode, that internal capacitance can cause part of the rising voltage to break through to the gate and thus trigger the SCR on. That "rate effect" turn-on can be caused by supply-line transients, and it sometimes occurs at the moment when power is applied to the SCR's anode. Rate-effect problems can usually be overcome by wiring a simple RC "snubber" network between the anode and the cathode of an SCR; the network limits the rate-of-rise to a safe value.

Those are the basic characteristics of the SCR. As you can see, it's a fairly simple device. When choosing an SCR for a particular application, you'll usually find that the most-significant parameters are the peak voltage and current ratings, the gate sensitivity rating, and (occasionally) the value of the device's minimum holding current. Table 1 lists basic specifications of several popular SCR's.

Basic DC circuits

SCR's are used in both AC and DC power-control circuits; let's look first at some basic DC circuits. Two ways of using the SCR as a pushbutton-controlled power switch are shown in Fig. 2. In both circuits, the SCR (and thereby the lamp) can be latched on by momentarily closing S1, thereby feeding gate drive to the SCR via R1. In both circuits the gate is tied to

TABLE 1—POPULAR SCR'S

Device	PIV	Current rms/average	V _{GT} (max)	I _{GT} (max)	I _H (max)
C106D	400V	4A 2.5A	0.8V	0.2mA	3mA
2N3525	400V	5A/3.2A	2V	15mA	20mA
BT109	500V	6.5A 4A	2V	15mA	3mA
IR122A	100V	8A 5A	1.5V	25mA	30mA
IR122D	400V	8A 5A	1.5V	25mA	30mA
C116D	400V	8A/5A	1.5V	20mA	35mA
C126M	600V	12A 7.5A	1.5V	30mA	35mA

the cathode via R2 to improve stability of the circuit.

Of course, after the SCR turns on, it can be turned off again only by momentarily reducing anode current below the device's I_H value. In Fig. 2-a the SCR is turned off by momentarily opening S2; in Fig. 2-b that is done by using S2 to short the anode and cathode terminals of the SCR momentarily.

Figure 3 shows another way of turning the SCR off. Here, after the device turns on, C1 charges up to almost the full supply voltage via R3 and the anode of the SCR. When S2 is subsequently closed, it clamps the positive end of C1 to ground, and the charge on C1 forces the anode of the SCR to swing negative momentarily,

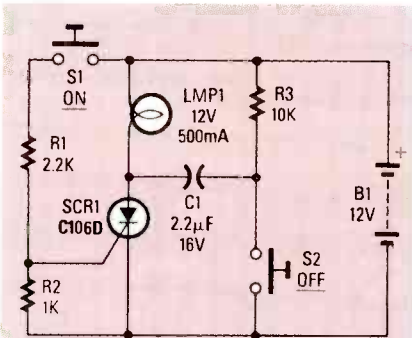

FIG. 3—CAPACITOR TURN-OFF CIRCUIT: C1 charges via R3 so that its right side is positive. When S2 is closed, C1 dumps its charge into the SCR (which is oppositely polarized), thereby turning it off.

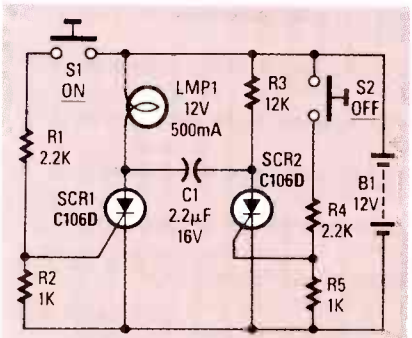

FIG. 4—ANOTHER CAPACITOR TURN-OFF circuit uses a second SCR (SCR2) to control charge dumping by C1.

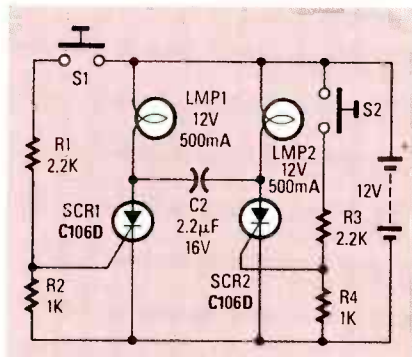

FIG. 5—A BISTABLE LATCH (or flip-flop) can be built from two SCR's.

thereby reverse-biasing the SCR and causing it to turn off. The capacitor's charge bleeds away rapidly, but it has to hold the SCR's anode negative for only a few microseconds to ensure turn-off. Note that C1 must be a non-polarized type.

A variation of the capacitor turn-off circuit is shown in Fig. 4. A slave SCR (SCR2) replaces the turn-off switch (S2) in Fig. 3. The master SCR (SCR1) is turned off by briefly turning on SCR2 via S2. The slave SCR turns off after S2 is released, because the anode current provided by R3 is lower than SCR2's holding current.

Figure 5 shows how the previous circuit can be modified so that it acts as a bistable latch (flip-flop) that drives two independent lamps. To understand how it works, assume first that SCR1 is on and SCR2 is off, so that C1 is fully charged, with its LMP2 end positive. The state of the circuit can be changed by pressing S2. As SCR2 turns on, it turns SCR1 off capacitively via its anode. Capacitor C1 then recharges in the opposite manner (i. e., the left end is now positive). The state of the circuit can be changed again by pressing S1, thus driving SCR1 on by way of its gate, and driving SCR2 off capacitively via its anode.

The DC circuits that we have looked at so far have all used simple resistive loads (lamps), and they have inevitably produced a self-latching action in the SCR's. The circuit shown in Fig. 6, however, shows a simple DC alarm that drives a

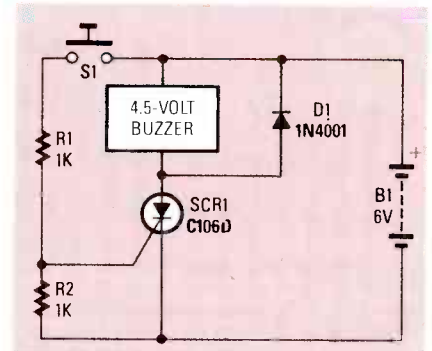

FIG. 6—A BUZZER (or other self-interrupting device) can be used to build an SCR power controller that remains on only so long as S1 is pressed.

“self-interrupting” load, such as a bell or a buzzer. That circuit provides a non-latching action.

When a self-interrupting device is connected to a voltage source, a current flows through a built-in solenoid via a pair of contacts. That current induces a magnetic field in the solenoid, and it causes a striker to fly outwards and open the contacts, thereby causing the current to fall to zero and the magnetic field to collapse. After the field collapses, the striker releases and the contacts close again, so current is again applied to the solenoid. That oscillatory action will repeat *ad infinitum*, as long as power is applied to the circuit.

The point is that that type of load functions as a switch that repeatedly opens and closes. When a load of that sort is connected to the Fig. 6 circuit, therefore, the circuit does not latch in the normal way, so the alarm operates only as long as S1 is closed. Because of the inductive nature of that type of load, a damping diode (D1) must be wired across it.

The circuit can be modified to provide a self-latching action simply by wiring a 470Ω resistor in parallel with the alarm, as shown in Fig. 7. The circuit latches because the anode current of the SCR does not fall to zero when the alarm self-interrupts, but to a value that is deter-

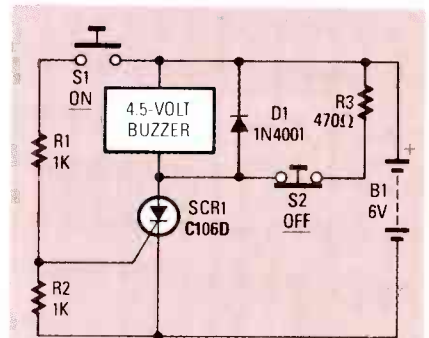

FIG. 7—ADDING A RESISTOR (R3) to the previous circuit allows you to latch on. Turn it off by pressing S2.

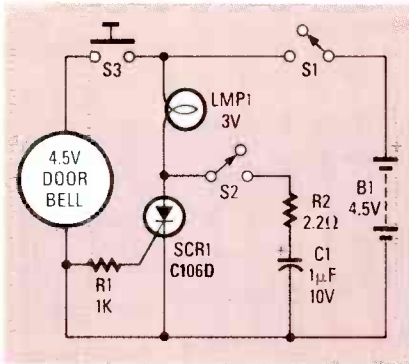

FIG. 8—RATE-EFFECT TURN-ON: Note that the SCR has no input signal connected directly to its gate. Closing S1 does not trigger the SCR, but closing S3 does. However, by filtering the spikes generated by the doorbell (by closing S2), the SCR once again will not turn on.

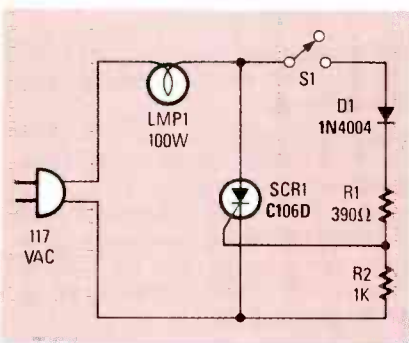

FIG. 9—AC POWER-CONTROL CIRCUIT: Close S1 to apply power to the load. After opening S1, the circuit will de-energize at the next zero crossing of the AC signal. Power is only delivered to the load during positive half-cycles.

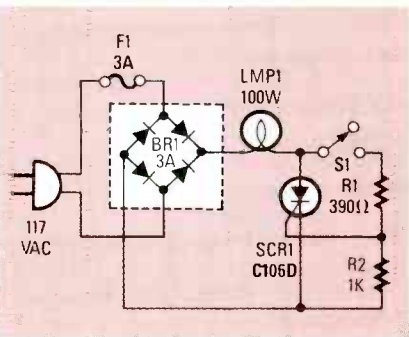

FIG. 10—FULLWAVE POWER-CONTROL CIRCUIT: Power will be delivered to the load during each AC half-cycle.

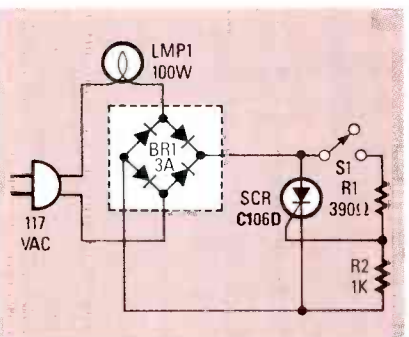

FIG. 11—ALTERNATE FULLWAVE power-control circuit places the load in series with the AC side of the bridge, rather than the DC side, as in the previous figure.

mined by the value of R3. The circuit can be unlatched by pressing S2, thereby enabling the anode current to fall to zero when the alarm self-interrupts.

To complete our discussion of DC SCR circuits, Fig. 8 shows a circuit that can be used to demonstrate the rate-effect turn-on of the SCR, and a method of suppressing rate-effect turn-on. In that circuit the SCR uses a 3-volt lamp as its anode load, and it is connected to the 4.5-volt battery supply via S1. In addition, a 4.5-volt doorbell can be connected across the supply via S3; the doorbell allows transient modulation to be applied to the supply line, and thereby to the anode of SCR1. That modulation can cause rate-effect turn-on of the SCR, which has a critical rate-of-rise value of 20 volts/μs. The snubber formed by R2 and C1 can be used to defeat rate-effect turn-on by closing S2.

To demonstrate the rate-effect, open S2, close S1, and then close S3 so that the bell rings. The resulting supply line transients should be enough to trigger the SCR and turn the lamp on; if not, wire a 1-ohm resistor in series with the battery. After the SCR and the lamp turn on, they can be turned off by opening S1.

To demonstrate the effect of the suppresser network, close S2 and S1, and then operate the doorbell via S3. The resistance of the lamp (in combination with R2) acts with C1 as a smoothing network that reduces the rate-of-rise of the anode modulation signal, thereby protecting the SCR against false triggering. The reason that R2 is wired in series with C1 is to limit the capacitor's discharge current to a safe value when the SCR triggers on a legitimate signal.

Basic AC circuits

Figure 9 shows a basic halfwave on/off circuit driving a 100-watt lamp from the AC power line. With S1 open, no gate drive is applied to the circuit, so the SCR and the lamp are off. When S1 is closed, during a negative half-cycle, the SCR is reverse-biased, and gate signals are inhibited by D1, so the SCR is off. On a positive half-cycle, however, the full available line voltage is applied to the gate via the lamp, D1, and R1.

Shortly after the start of the half-cycle, sufficient voltage is available to trigger the SCR, so it turns on. As it does, its anode voltage falls to near zero, thus removing the gate drive, but the SCR remains self-latched for the duration of the half-cycle. The SCR automatically turns off again when the half-cycle ends and anode current falls to zero.

That circuit provides halfwave operation only. Figures 10 and 11 show two ways of obtaining fullwave operation. In those circuits, the AC is converted to unsmoothed DC via a bridge rectifier, and the rough DC is applied to the SCR. With S1 open the SCR is off, so zero current

flows through the bridge and the load. When S1 is closed, however, the SCR is driven on shortly after the start of each half-cycle of rough DC, so power is applied to the load during both half-cycles.

As the SCR goes on in each half-cycle, gate drive is removed automatically, but the SCR stays latched on for the duration of the half-cycle. The SCR switches off at the end of each half-cycle as its anode current falls to zero, so power is removed from the load when S1 is opened.

In the Fig. 10 circuit the load is connected to the DC side of the bridge. A fuse must be placed on the AC side of the bridge to protect against a possible short in the bridge. However, in the Fig. 11 circuit, the load is placed on the AC side of the bridge. No fuse is needed in that circuit because the load itself will limit currents to a safe value in the event of a bridge failure. You may, however, wish to include a fuse anyway, to protect against a possible load failure.

A pair of SCR's can be wired in inverse parallel (anode to cathode and cathode to anode) to provide fullwave power control without using a bridge rectifier. However, a far more effective way of obtaining fullwave power control is to use a Triac rather than a pair of SCR's.

Basic Triac theory

You can think of a Triac as two conventional SCR's connected in inverse parallel, arranged so that they share a single gate terminal. The Triac acts as a solid-state power switch that can conduct current in both directions, and that can be switched from off to on by a gate signal of either polarity.

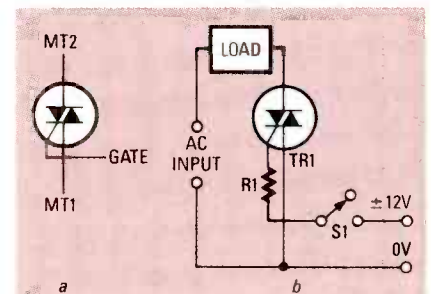

FIG. 12—THE TRIAC'S symbol (a) and basic control circuit (b) are shown here.

Figure 12-a shows the Triac's symbol, and Fig. 12-b shows the basic circuit for using the device as an AC power switch. The load is wired in series with the Triac's main terminals, and the combination is wired directly across the AC power line. DC gate drive can be applied to the Triac by closing S1. The basic characteristics of the Triac are as follows.

1. Normally, with no gate signal applied, the Triac is off and functions as an open-circuit switch.

2. If MT2 is appreciably positive or negative with respect to MT1, the Triac

TABLE 2—POPULAR TRIAC'S

Device	PIV	Current rms	V_{GT} (max)	I_{GT} (max)	I_H (max)
C206D	400V	3A	2V	5mA	30mA
2N6073	400V	4A	2.5V	30mA	70mA
C226D	400V	8A	2.5V	50mA	60mA
SC146D	400V	10A	2.5V	50mA	75mA
TIC246D	400V	15A	2.5V	50mA	50mA

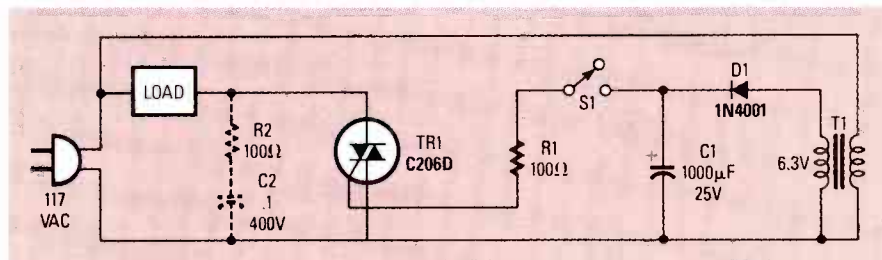

FIG. 13—STEP-DOWN TRANSFORMER T1 provides a low-voltage DC signal for triggering the Triac. The optional R2-C2 network can be used to suppress RFI.

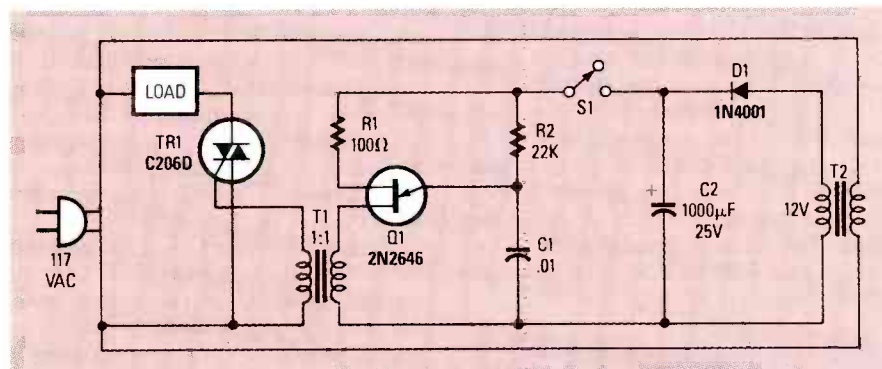

FIG. 14—THE CONTROL CIRCUIT connected to the secondary of T2 causes UJT Q1 to oscillate at about 50 Hz. The secondary circuit is isolated from the primary circuit here, unlike the previous figure.

can be turned on by applying a brief pulse to the gate of the Triac. The device takes only a few microseconds to turn on. A saturation potential of one or two volts is developed across the Triac in the on state. After the Triac turns on, it self-latches and remains on for as long as main-terminal current continues to flow.

3. After the Triac self-latches, it can only be turned off again by reducing its main-terminal current below a minimum holding value. When the Triac is used as an AC power switch therefore, turn-off occurs automatically at the zero-crossing point at the end of each half-cycle, as main-terminal currents fall to zero.

4. The Triac can be turned on by either a positive or a negative gate signal, irrespective of the polarities of the main-terminal voltages. The device thus has four possible triggering modes or "quadrants." With current flowing through MT2 in either the positive or the negative direction, gate current can be either positive or negative. The differences among the four modes are primarily that the device's gate sensitivity is greater when both MT2 current and gate current are the same (positive or negative).

5. Triacs can handle very high surge currents. Typically, a device with a 10-amp (rms) rating may be able to handle a single-cycle non-repetitive 60-Hz surge current of 100 amps.

Table 2 shows basic specifications for several popular Triacs. The information presented there should be sufficient to help you to select a Triac for many applications. With the basics in mind, let's move on and look at practical ways of using the Triac.

Basic Triac circuits

Figure 13 shows the circuit of a simple DC-triggered Triac power switch, in which the DC supply is derived via step-down transformer T1. When S1 is open, no current flows to the gate of the Triac, so it remains off. When S1 is closed, however, gate drive is applied to the Triac, so it and the load turn on. If an inductive load (a motor, for example) is used in this circuit, the R2-C2 snubber network must be wired in place as indicated to prevent false rate-effect triggering.

In that circuit the negative side of the DC supply is connected directly to one side of the AC power line, so it's live and

therefore dangerous. That snag can be overcome in the UJT-triggered isolated-input circuit shown in Fig. 14. In that circuit, as long as S1 is closed, the UJT oscillates at several kHz and thus delivers roughly 50 trigger pulses to the gate of the Triac (via isolation pulse transformer T1) during each half-cycle of the AC power line waveform. Consequently, the Triac is fired by the first trigger pulse occurring in each half-cycle; that pulse occurs within a few degrees of the start of the half-cycle. The point is that the Triac is on almost constantly while S1 is closed, so virtually full power is applied to the load.

Figure 15 shows how the Triac can be used as a simple line switch with line-derived triggering. With S1 open, no gate drive is applied, so the Triac and the lamp are off. Suppose, however, that S1 is closed. At the start of each half-cycle the Triac is off, so voltage is applied to the gate via the lamp and R1. Shortly after the start of the half-cycle, enough drive is available to trigger the Triac, so it and the lamp go on. As the Triac goes on and self-latches, it saturates and thereby removes gate drive until the start of the next half-cycle, thus minimizing R1's dissipation.

The circuit in Fig. 15 can be modified to

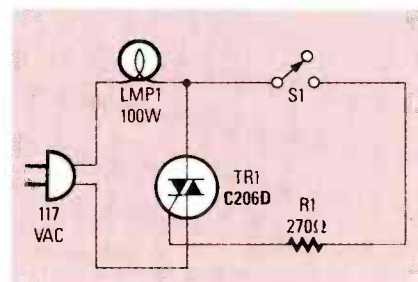

FIG. 15—SIMPLEST TRIAC CIRCUIT is composed of a switch, a resistor, and a Triac.

provide halfwave operation by placing a diode between S1 and R1. The diode's polarity will determine whether the Triac will trigger on positive or negative half cycles.

Phase-triggered power control

The SCR and Triac circuits that we have looked at so far have all been designed to give a simple on/off form of power control. The same devices can, however, easily be used to give fully-variable power control in AC circuits. In fact, they're widely used in lamp dimmers and electric-motor speed controllers, etc. The most widely used system of AC variable-power control is known as the *phase triggering* system.

In a basic phase-triggering circuit that uses a Triac as the power-control element, rather than triggering the Triac directly from the AC power line, it is triggered via a variable phase-delay network that is connected between the power line and the gate of the Triac.

Phase delay works like this. If the Triac

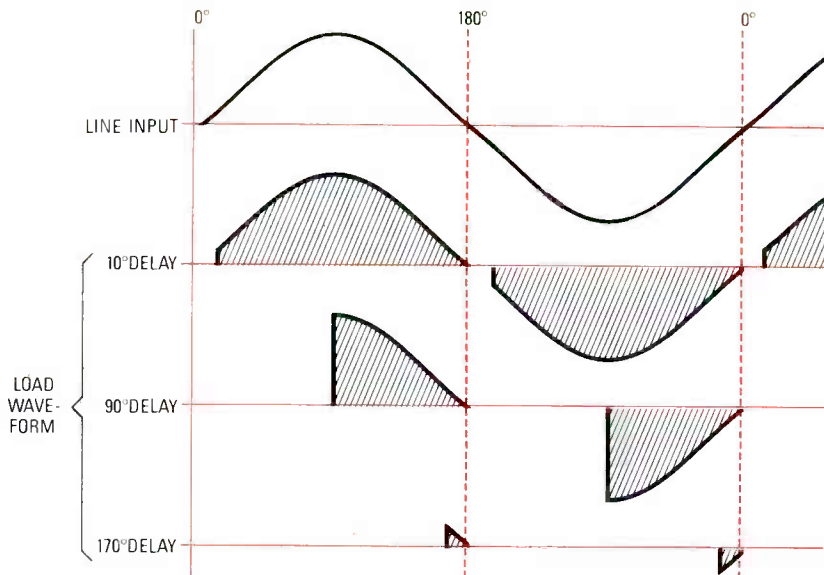

FIG. 16—A VARIABLE AMOUNT OF POWER is delivered to the load depending on when in the AC cycle the device is triggered.

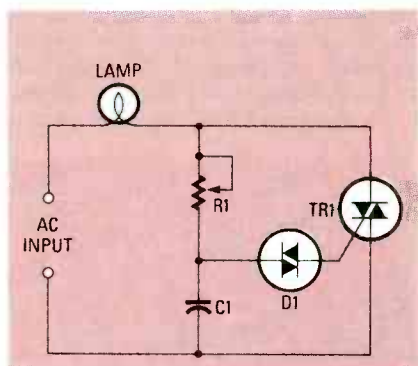

FIG. 17—A DIAC and an RC network provide a simple means of implementing a variable phase-delay network.

is triggered 10° after the start of each half-cycle, most of the power of that half-cycle is fed to the load. On the other hand, if the Triac is triggered 90° after the start of each half-cycle, only half the available power is fed to the load. Finally, if the Triac is triggered 170° after the start of each half-cycle, only a very small part of the available power is fed to the load. Figure 16 illustrates how phase delay works.

There are several methods of obtaining variable phase-delay triggering, but the three most popular ones are to use a line-synchronized UJT, a special-purpose IC, or a Diac/RC network. The latter approach is shown in Fig. 17.

The Diac can be regarded as a bilateral threshold switch. When connected across a voltage source, it functions as a high impedance until the applied voltage rises to about 35 volts, at which point it switches into a low-impedance state and remains there until the applied voltage falls to about 30 volts, at which point it reverts to the high impedance state. It stays in that state until the applied voltage rises to 35 volts, at which point the process repeats.

In the Fig. 17 circuit, during each half-cycle, the R1-C1 network applies a variably phase-delayed version of the AC waveform to the Triac's gate via the Diac. Each time the voltage across C1 rises to 35 volts, the Diac fires and delivers a trigger pulse to the Triac's gate, thereby turning the Triac on and applying power to the load. The mean power delivered to the load is thus fully variable from near-zero to maximum via R1.

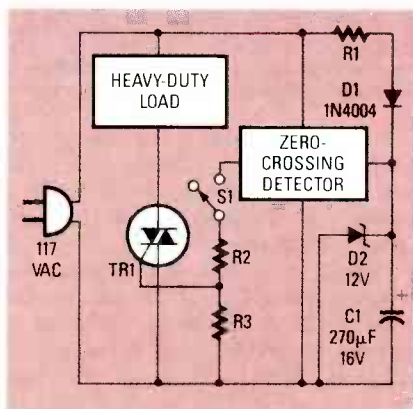

FIG. 18—A ZERO-CROSSING DETECTOR can be used to trigger a triac when power is at a minimum, thereby reducing RFI to a minimum.

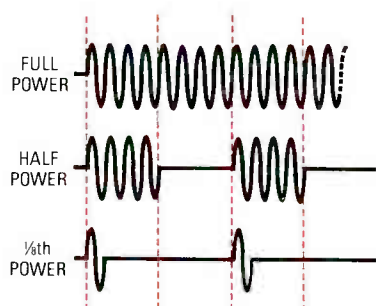

FIG. 19—AN INTEGRAL NUMBER OF CYCLES are passed by the zero-crossing detector to the load.

Radio-frequency interference

Each time the Triac turns on, load current rises abruptly (in a few microseconds) from zero to a value determined by the load resistance and the instantaneous supply voltage. That transition generates RFI (Radio Frequency Interference). RFI is greatest when the Triac is triggered at 90° , and it is least when the Triac is triggered close to the 0° and 180° zero-crossing points of the waveform.

In a lamp-dimmer circuit where there may be considerable lengths of wiring between the Triac and the load, RFI may be offensive. So, in a practical lamp dimmer, the circuit is usually provided with an LC RFI-suppression network.

Zero-crossing techniques

When a high-power load (an electrical heater, for example) is driven from Triac circuitry, special techniques must be used to minimize RFI. Even if the Triac is used as a simple on-off switch in such applications, a "spurt" of RFI will be generated each time the switch is turned on; that spurt will be of maximum amplitude if the instantaneous phase delay happens to be 90° at the moment of turn-on. RFI problems can be eliminated in high-power applications by using the synchronous or "zero crossing" gating technique illustrated in Fig. 18.

Here, a low-power 12-volt DC supply is generated directly from the AC lines via R1, D1, D2, and C1. A simple zero-crossing detector (which could be built from several transistors) is connected directly across the power line; it controls the passage of current from C1 to S1 in such a way that the C1 current is made available for only 5° or so on either side of each zero-crossing point of the waveform. So, if S1 is closed, a pulse of gate current is fed to the Triac at the start of each half-cycle at the point at which voltage is closest to zero. Therefore, the Triac always generates minimal RFI as it turns on.

The zero-crossing technique can be used to provide RFI-free variable power to a high-power load by replacing S1 with a variable mark/space-ratio waveform generator, so that a variable and integral number of complete AC cycles are alternately fed (or not fed) to the load.

Figure 19 illustrates the basic principle, in which the total integral period is equal to eight power-line cycles. If power is alternately switched on for four cycles and off for four cycles, the mean load power is equal to half the total available power, and if the power is on for one cycle and off for seven cycles, the mean power is equal to only one eighth of the total available power.

That concludes our discussion of the SCR and the Triac. In this article we've seen many practical example circuits. Now it's up to you to put them to use in your own designs.

R-E

PC SERVICE

One of the most difficult tasks in building any construction project featured in **Radio-Electronics** is making the PC board using just the foil pattern provided with the article. Well, we're doing something about it.

We've moved all the foil patterns to this new section where they're printed by themselves, full sized, with nothing on the back side of the page. What that means for you is that the printed page can be used directly to produce PC boards!

Note: The patterns provided can be used directly only for *direct positive photoresist methods*.

In order to produce a board directly from the magazine page, remove the page and carefully inspect it under a strong light and/or on a light table. Look for breaks in the traces, bridges between traces, and in general, all the kinds of things you look for in the final etched board. You can clean up the published artwork the same way you clean up your own artwork. Drafting tape and graphic aids can fix incomplete traces and doughnuts, and you can use a hobby knife to get rid of bridges and dirt.

An optional step, once you're satisfied that the artwork is clean, is to take a little bit of mineral oil and carefully wipe it across the back of the artwork. That helps make the paper translucent. Don't get any on the front side of the paper (the side with the pattern) because you'll contaminate the sensitized surface of the copper blank. After the oil has "dried" a bit—patting with a paper towel will help speed up the process—place the pattern front side down on the sensitized copper blank, and make the exposure. You'll probably have to use a longer exposure time than you are used to.

We can't tell you exactly how long an exposure time you will need as it depends on many factors but, as a starting point, figure that there's a 50 percent increase in exposure time over lithographic film. But you'll have to experiment to find the best method for you. And once you find it, stick with it.

Finally, we would like to hear how you make out using our method. Write and tell us of your successes, and failures, and what techniques work best for you. Address your letters to:

Radio-Electronics
Department PCB
500-B Bi-County Blvd.
Farmingdale, NY 11735

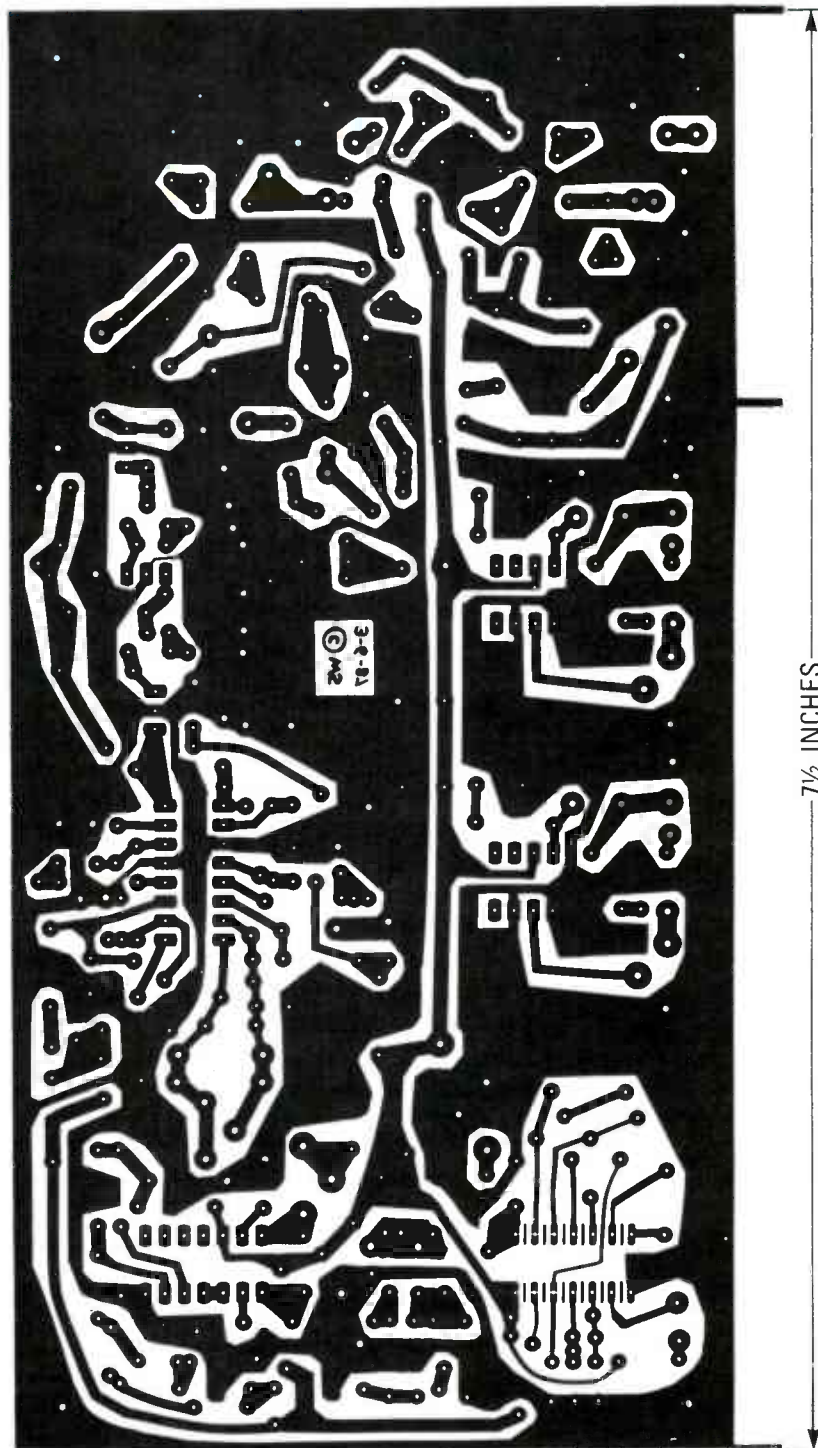

TUNE IN THE HIDDEN WORLD of FM radio with the SCA receiver. Most of the components mount on this single-sided PC board.

PC SERVICE

COMPUTER DIGEST

VOL. 4 NO. 9 SEPT. 1987

A NEW KIND OF MAGAZINE FOR ELECTRONICS PROFESSIONALS



BONDWELL 8



DATAVIEW 25



IBM PC CONVERTIBLE

PORTABLE COMPUTERS

Hands-on tests of 7 hot models



NEC MULTISPEED

GRAPHICS PROCESSORS

For fast, hi-res images



TOSHIBA T1100 PLUS



TOSHIBA T3100



ZENITH Z183

A
GERNSBACK
PUBLICATION

CONTENTS

SEPTEMBER

1987

Vol. 4 No. 9

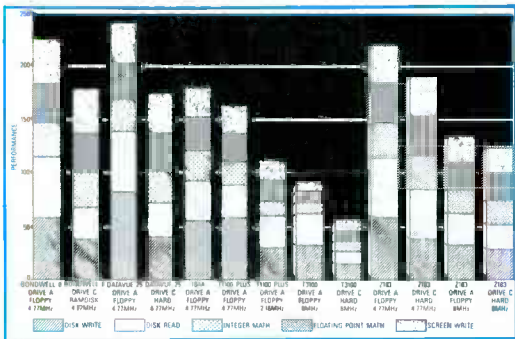

77 PORTABLE COMPUTERS
Hands-on reviews of seven hot portables

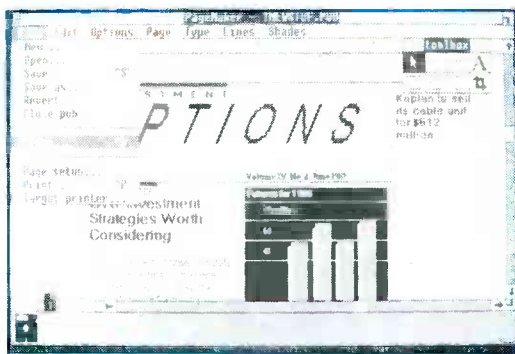

82 GRAPHICS CO-PROCESSORS
New chips enhance speed, cut costs

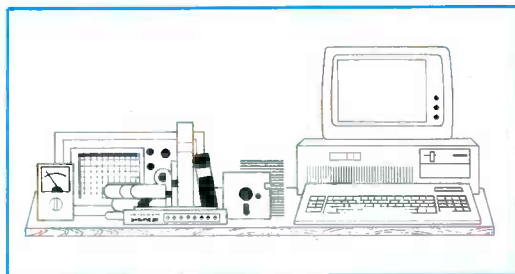

73 EDITOR'S WORKBENCH
HARDWARE: Heathkit printer buffer
SOFTWARE: Direc-link, The Brooklyn Bridge

COMPUTER DIGEST

Larry Steckler,
EHF, CET: publisher & editor in chief

Art Kleiman,
editorial director

Brian C. Fenton,
managing editor

Jeff Holtzman
technical editor

Byron G. Wels,
associate editor

Carl Laron,
associate editor

Robert A. Young,
assistant editor

Teri Scaduto
editorial assistant

Ruby M. Yee,
production director

Karen Tucker,
production advertising

Robert A. W. Lowndes,
production associate

Marcella Amoroso
production assistant

Andre Duzant,
technical illustrator

Jacqueline P. Cheeseboro
circulation director

Arline R. Fishman,
advertising director

ComputerDigest
Gernsback Publications, Inc.
500-B Bi-County Blvd.
Farmingdale, NY 11735

ADVERTISING SALES 516-293-3000

Larry Steckler
Publisher

NATIONAL SALES

Joe Shere
1507 Bonnie Doone Terrace
Corona Del Mar, CA 92625
714-760-8967

Cover Photography by Jeff Holtzman
and André Duzant

EDITOR'S WORK- BENCH

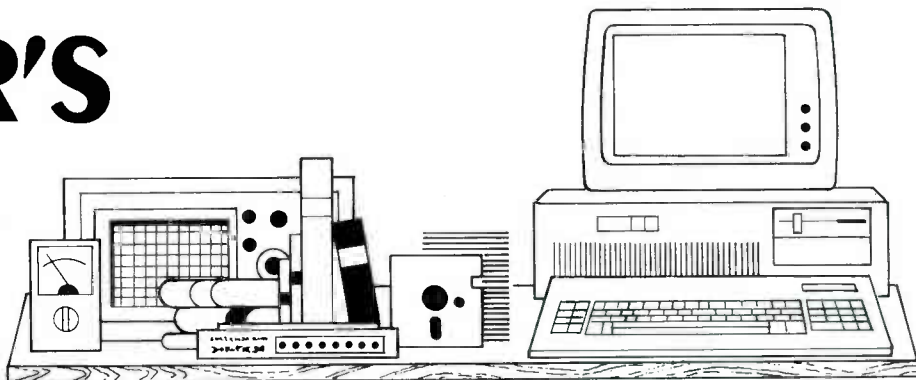

REPORT FROM ATLANTA

Comdex, held twice a year, is the Computer Dealer's Exposition. As the name suggests, dealers get together with manufacturers, distributors, independent developers, and members of the press to show hardware and software, discuss trends, make deals, eat, drink, and generally be merry. Because of current market conditions (good and getting better), things were merry indeed this year for those involved in the business end of things. For those interested in the technical end of things, there was less cause for celebration.

By number of booths and square feet of floor space, clone manufacturers, distributors, and dealers easily were the most prevalent exhibitors. Most have products that are virtually indistinguishable from one another; very few have products that offer truly advanced features.

The graphics explosion

There is a great deal of activity in micro-computer graphics these days. There are two reasons for that activity: falling hardware prices (of RAM and custom video chips), and the increasing popularity of graphically oriented software (CAD, drawing and painting programs, and desktop publishing).

Just before Comdex, NEC introduced two new members of the MultiSync line: the MultiSync Plus and the MultiSync XL, with pixel resolutions of 960 × 720 and 1024 × 768, respectively. All MultiSync monitors are compatible with all members of the PC family (PC, XT, AT, and PS/2), as well as the Macintosh II. Other monitor manufacturers scrambled to clone the original MultiSync, and will probably do so again with the new models.

Complementing the new high-res monitors, many companies introduced

new high-res adapter cards, most of which provide EGA compatibility, as well as proprietary new modes with resolutions approaching the one-mega-pixel (1024 × 1024) level, often with 16 or more colors. Even though the new boards provide backward compatibility with at least some previous standards (CGA, MDA, Hercules, and EGA), the companies manufacturing those boards must write special drivers for the new non-standard high-resolution modes to be useful, and a special driver must be written for each program that is to use a high-res mode. Inevitably, only the most popular programs (AutoCAD, PageMaker, etc.) will be supported.

The problem is that those video supersets are all incompatible with each other at the software level, even though a multi-scanning monitor can save users from premature hardware obsolescence. Therefore the user may suffer if he buys a video adapter to run a specific application and later on discovers he wants to run other applications that are not supported.

Overall, IBM must take the blame for the situation, because it has been so slow to introduce better adapters, not to mention truly serviceable ones (technical problems prevent an EGA from being used in a multi-tasking environment, for example). In fact, in many ways VGA is really only IBM's attempt to catch up to what other companies have been doing (640 × 480 lines × 16 colors) for some time.

Eventually Microsoft Windows may be what saves PC users from the lack of a true video standard. Programs written to run under Windows are supposed to be ignorant of the underlying hardware, so that, after installation, boards from Tseng Labs, Number Nine Computer, STB, or anyone else will run programs in the best possible resolution, etc. Of course, few programs currently take advantage of the device-independence that Windows can provide. And you need an AT-class machine to run

Windows at an acceptable rate. However, hardware prices are falling, and Windows applications programs are starting to appear, most of which are graphically oriented (drawing and painting programs, desktop publishing, and CAD).

PS/2

As you might expect, there was much discussion of the impact that the new PS/2 line will have. Right now, it seems that, outside of the corporate market, PS/2 will have little impact. The clone manufacturers clearly aren't worried. In fact, some industry analysts think that IBM may have made a huge marketing blunder, and may even now be offending the corporate market that is its real bread and butter. The reason is that it is currently impossible to buy "classic" machines (XT's and AT's) in quantity. IBM seems to be saying: "Go PS/2 or go elsewhere." It will be interesting to see which way corporate America does go.

We attended a technical seminar on the internal workings of OS/2, and it's clear that the operating system has the kind of facilities that power users have been clamoring for. However, there are two big problems associated with OS/2: it's not available, and it won't let programs written for DOS 2.x and 3.x make use of the new facilities (multi-tasking and megabytes of memory).

Under the 80286 version of OS/2, you'll be able to run only a single DOS application at a time, and it will be a good two years before OS/2-specific programs start to appear. And there's not even a projected release date for a version of OS/2 that takes full advantage of the 80386. However, 386 control programs are available from other vendors (Quarterdeck Systems, The Software Link) right now that will allow you to run multiple DOS sessions. But those control programs are not true operating systems, so you don't get true multi-tasking, wherein several parts of the same program can run simultaneously, pass messages to

each other and to other programs, etc.

It may turn out that OS/2 is the only major program written for the 80286! The editor of a leading computer publication claimed to have seen half a dozen 386-specific applications, and none for the 286. And one analyst stated that anyone writing for the '286 must be as brain-damaged as the chip itself!

Regardless, an intermediate class of programs (called "Family" applications by IBM) will be able to run on both OS/2 and DOS 3.3 (or higher—Microsoft has hinted rather strongly that DOS 3.30 will not be the final release), because the new versions of DOS can provide a pseudo-multi-tasking environment. However, whether any serious software will be written to conform to the "Family" API (Application Program Interface) remains to be seen.

Optical storage

Several companies (Panasonic and Kodak being among the more prominent) are displaying advanced optical-storage systems. Almost no one was talking about CD-ROM, except one pundit (and president of a company that is a major developer of programming languages) who predicted that CD-ROM will go the route of bubble memory—nowhere. The reason? Actually, there are two: (1) Because read/write optical technology is what's really needed, and (2) the difficulty of mastering (not physically producing) a CD-ROM product.

CASE

You've probably heard of CAE—Computer Aided Engineering. CASE is the corresponding discipline for software types—Computer Aided Software Engineering. It's not a big field yet, but several companies are getting involved in it commercially. The idea behind CASE is to provide an organized way of developing really large software projects that involve many people and an evolving set of design goals. CASE provides a set of graphically-oriented tools for developing design specs, translating them into simulated screens, generating code, obtaining user feedback, incorporating that feedback into the design specs, and so on. By linking all steps by computer, it is hoped that the design cycle can be shortened considerably, thereby allowing evolving user needs to influence design decisions before they are finalized. If you're just starting out and are interested in the design of large systems, check out CASE—it's the wave of the future.

KEYBOARD DEMO PROGRAM UPDATE

Dave Schubert of The Casino PCBoard BBS (609-652-6030, 300/1200/2400/9600 baud, 8/1/N) was kind enough to send the following corrections and enhan-

cements to the keyboard demo program that appeared in the article "From Keypress to Scan Code" on page 70 of the July issue. Merge the following three lines into the program:

```
235 IF INSTR(NOPRINT$,A$) = 0 THEN
    PRINT A$," "; ELSE PRINT " ";
1210 XBOX = 19:YBOX = 4:XLEN = 7
    :YLEN = 3
3090 DATA F1,F2,F3,F4,F5,F6,F7,F8,F9,
    F10,F11,F12
```

In line 235, note that there is a single space in the quoted string following A\$, and that there are two spaces in the quoted string at the end of the line. The revised line 1210 prevents the right edge of the box from being erased, and the revised line 3090 provides for displaying the F11- and F12-key labels when using an enhanced (101-key) keyboard. Thanks, Dave. 



THE BROOKLYN BRIDGE AND DIREC-LINK

Life is simple with one computer. But with two or more, life gets complex, if not chaotic. The problem is this: How do you share files (not to mention printers, disk drives, and other peripherals) among several machines?

More than one fortune has been made in the computer business attempting to answer that question, but, until recently, those answers were too expensive for the hobbyist and small business.

However, things are changing rapidly, especially in the MS DOS world. Now there are many inexpensive ways to connect two (and sometimes more) computers together.

Two solutions to the problem of connectivity (chief buzzword of 1987) are simple hardware/software combinations that allow two PC's (desktop, laptop, or transportable) to communicate via the RS-232 port at speeds about ten times what we normally consider maximum.

There are at least half a dozen "bridge" solutions on the market now; we'll discuss two of the original and more useful of them. One (Direc-Link) emphasizes ease of set up and use; the other (The Brooklyn Bridge) sacrifices easy set-up to provide greater power. We'll examine the latter first.

The Brooklyn Bridge

White Crane Systems, Inc. (Suite 151, 6889 Peachtree Ind. Blvd., Norcross, GA 30092, 404-454-7911) developed and markets The Brooklyn Bridge (\$129.95). You use it by adding a special driver program to the CONFIG.SYS file of the master machine—the one at whose keyboard you'll be typing. For each device (disk drive(s), printer(s), clock, RAM disk, modem—any legitimate DOS device) you wish to access from the remote machine, you add an additional driver (to the master's CONFIG.SYS).

Next you run a program called BRIDGE.COM at the remote machine. Then you reboot the master. At that point you can access the devices for which you have installed drivers. A few examples should make the process clear.

Suppose you want to access the hard disk of a PC from a dual-drive laptop. First add BRIDGE.DEV to the laptop's CONFIG.SYS. BRIDGE.DEV takes care of the first few block (disk) devices—usually two floppies and a hard disk. Then run BRIDGE.COM on the PC. Now you can access the PC's floppy disks and hard disk (as drives C:, D:, and E:) from the laptop with all normal DOS commands (COPY, CD, RD, DEL, etc.).

To access a second hard disk or a RAM disk, you'd add another driver, REMOTE.DEV. To access both the hard disk and the RAM disk, you'd add two REMOTE.DEV files. White Crane also includes a program (DEVICES.COM) that displays the devices installed on your machine and the appropriate line to add to the CONFIG.SYS file.

You can also access serial and parallel ports, and the system clock, by installing a driver for each device. For example, to access the PC's parallel printer from the laptop, you'd add the following line to the laptop's CONFIG.SYS file:

```
device = remote.dev lpt1
```

Depending on your system, the installation procedure can be tricky. For example, at the office I use a single-drive clone with four network drives, a RAM disk, and serial and parallel ports. To access that machine from a laptop, the following lines were added to the laptop's CONFIG.SYS:

```
device = bridge.dev 1
device = remote.dev 2
device = remote.dev 3
device = remote.dev lpt1
```

The first line provides access to the clone's floppy disks; the second, to the network "drives" (C:, D:, E:, F:); the third, to the RAM disk (G:); and the fourth, to the printer attached to the clone. Adding those four drivers consumed only about 3.4K of available memory.

Direc-Link

Sold by the Micro-Z company (4 Santa Bella Road, Rolling Hills Estates, CA 90274,

R-E Computer Admart

Rates: Ads are 2 1/4" x 2 7/8". One insertion \$825. Six insertions \$800 each. Twelve insertions \$775. each. Closing date same as regular rate card. Send order with remittance to Computer Admart, Radio Electronics Magazine, 500-B Bi-County Blvd., Farmingdale, NY 11735. Direct telephone inquiries to Arline Fishman, area code 516-293-3000. Only 100% Computer ads are accepted for this Admart.

ICs PROMPT DELIVERY!!!

SAME DAY SHIPPING (USUALLY)
QUANTITY ONE PRICES SHOWN FOR JUNE 21, 1987

OUTSIDE OKLAHOMA: NO SALES TAX

DYNAMIC RAM		
1Mbit	TC511002P-12	\$27.50
51258	256Kx1 100 ns	6.95
1Mbit	256Kx4 120 ns	32.00
1Mbit	1000Kx1 100 ns	27.50
4464	64Kx4 150 ns	3.50
41256	256Kx1 80 ns	5.35
41256	256Kx1 100 ns	4.40
41256	256Kx1 120 ns	3.45
41256	256Kx1 150 ns	3.20
EPROM		
27512	64Kx8 200 ns	\$9.95
27C256	32Kx8 250 ns	5.40
27256	32Kx8 250 ns	5.50
27128	16Kx8 250 ns	4.65
STATIC RAM		
62256	32Kx8 120 ns	\$12.75
6264LP-15	8Kx8 150 ns	3.25

OPEN 6 1/2 DAYS, 7:30 AM-10 PM: SHIP VIA FED-EX ON SAT.

SUNDAYS & HOLIDAYS: SHIPMENT OR DELIVERY VIA U.S. EXPRESS MAIL

SAT DELIVERY INCLUDED ON FED-EX ORDERS RECEIVED BY: TH 3:30 AM \$4.10; FR 11:50 \$2.10; NO MINIMUM ORDER. Please note that prices are subject to change. Shipping & insurance extra. A up to \$1 for packing materials. Orders received by 9 PM CST can usually be delivered the next morning, via Federal Express Standard Air - \$4.00, or guaranteed next day Priority One - \$10.50. All parts quarantined.

MasterCard VISA or UPS CASH COD
Factory New, Prime Parts **µP**
MICROPROCESSORS UNLIMITED, INC.
24 000 S. Phoenix Ave. (918) 267-4961
BEGGS, OK 74421

IBM PC XT, Compaq Portable & Plus; hp Vectra
640K MOTHERBOARD UPGRADE: Zenith 150.
IBM PC AT, Compaq Portable & Plus; hp Vectra
8087-2 \$160.00
8087-4 \$8087-16 \$575.00
8087-8 \$250.00

CIRCLE 61 ON FREE INFORMATION CARD

DISK SERVICE MANUAL \$20

Maintain, Repair, Adjust, Align Drives Without Special Equipment or Software. 5.25", 8", Microfloppies, IBM-PC/Compatible, Apple, Commodore, Kaypro, Tandy, Atari, TI, HP, DEC, etc. 12 Chapters, 100+ Photos, Figures. SAVZ 553

COMPUTER PHREAKING \$15

Dozens Computer Crime Methods and Countermeasures. How Systems are Penetrated. BBS Advice; Password Defeats; TEMPEST, Van Eck Methods; Crosstalk Amps). 200 Phreak-Term GLOSSARY.

CRYPTANALYSIS TECHNIQUES \$15

Five Cryptanalysis Programs (COM, BAS, Source Code) for MSDOS Systems. N-Gram, Kasiski, NR, IC Analyses. Disk + Manual \$25.

PHONE COLOR BOXES \$15

PHONE RED, BLUE, BLACK, GRAY, SILVER, YELLOW, GREEN, BROWN, PURPLE, WHITE, BEIGE, SAN, CLEAR, CHEESE, and MUTE BOX Plans. Plus CALL-FORWARDING - Much More! Use not recommended.

HIGH VOLTAGE DEVICES \$15

STUNNER, ZAPPER, BLASTER, JAMMER, FLASHER, STIMULATOR, JACOB'S LADDER, OZONE/PLASMA/VAN DE GRAAFF GENERATORS, GEIGER COUNTER, FENCE CHARGER, etc. Plans. Shocking!

RADIONICS MANUAL \$20

Comprehensive Manual, Plans on ElectroMagnetic Therapies, Diagnoses, Preventions. 30+ figures. Includes FDA-approved.

ELECTROMAGNETIC BRAINBLASTER \$20

Comprehensive Manual and Plans on ElectroMagnetic Weapons and Lab. Devices. Dozens of figures. Mind Boggling!

CONSUMERTRONICS

2011 CRESCENT DR. P.O. DRAWER 537
ALAMOGORDO, NM 88310

CIRCLE 203 ON FREE INFORMATION CARD

COMPUTER ASSEMBLY MANUALS



Eliminate Guesswork!
Build with Confidence!

BIG BLUE SEED for IBM™ BUILDERS
Parts list, placement diagrams & instructions for assembling over 75 IBM-compatible bare cards. Latest version includes guides for 640K, Turbo, & AT MthBds.\$17.95

APPLE SEED II for APPLE™ BUILDERS
Instructions for assembling over 85 Apple-compatible bare cards including II+ & IIe MthBds. For all Apple enthusiasts ..\$14.95

Both for \$30.00! Also bare cards in stock!
Check/money-order, VISA/MasterCard to:

NuScope Associates*, Dept RE
P.O. Box 790 • Lewiston, NY • 14092

*A Division of Kosmic MicroTech Inc.

CIRCLE 210 ON FREE INFORMATION CARD

Heath/Zenith H/Z90 Break the format barrier!

EMULATE — Lets your Heath computer read and write these disk formats:

Atrix	DEC Rainbow	Magnolia	Royal/Triumph
Altos	Eagle II	Morrow MD	Sanyo 1100
AMPRO	Epson QX-10	NEC DecMate 5	Superbrain
Beehive Tpr	Fujitsu CP/M86	NEC PC-8001A	Televideo
CDR Systems	IBM CP/M86	Osborne 1	TRS80 CP/M
Cromemco	IMS 5000	Otrona	Xerox 820
DEC VT180	Kaypro II	PMC MicroMate	Zorba

H37 version includes formatting capability.

H89 or H8 with H37\$59
For CDR BIOS 2.91\$49

CPC CP/M ↔ PCDOS

Transfer files between PCDOS and CP/M disks. Includes access to subdirectories. For H89 or H8 with soft sector control er.

CPC — specify controller\$35

Products for Heath/Zenith and other CP/M computers.

Call or write for catalog. Add \$4 per order for S/H. Terms: Check or Money Order — VISA/MC — COD. CA residents add 6% tax.

ANAPRO 805/688-0826

213 Teri Sue Lane Buellton, CA 93427

CIRCLE 202 ON FREE INFORMATION CARD

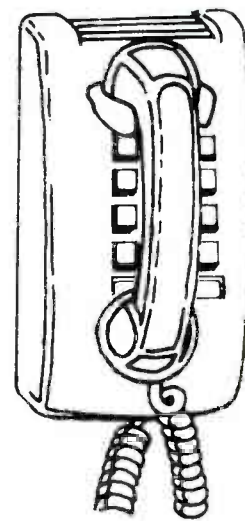

CALL NOW AND RESERVE YOUR SPACE

- 6 x rate \$800.00 per each insertion.
- Reaches 242,400 readers.
- Fast reader service cycle.
- Short lead time for the placement of ads.

Call 516-293-3000 to reserve space. Ask for Arline Fishman. Limited number of pages available. Mail materials to: Computer Admart, RADIO-ELECTRONICS, 500-B Bi-County Blvd., Farmingdale, NY 11735.

Hands-on

Brooklyn Bridge proved invaluable in setting up our laptop machines for the reviews elsewhere in this issue. Using the XCOPY command of DOS 3.2, we were able to copy entire branch structures (directories with subdirectories) directly to the hard

213-377-1640) for \$59.50 plus \$5 for shipping, Direc-Link takes the point-and-shoot approach to file transfer. You needn't mess with device drivers; just connect the two machines electrically and run DLINK.COM on both machines. Each machine then displays a diagram of the tree structure of the current disk. You can change disks within the program.

To send a file (or a group of files), use the cursor keys to move the highlight bar to the desired subdirectory. By pressing F9, a list of all files in that subdirectory is displayed. You can mark all files, individual files, or groups of files specified with wildcard characters (* and ?) for transfer. Then press Return to send a file. You have the option of changing the name during transfer. Press

Ctrl-Return to send all marked files with no further intervention.

One nice feature is that you can control both machines from the keyboard of one. Pressing Scr-Lock toggles between local and remote modes. However, in remote mode you must watch the screen of the remote machine; each screen only displays information related to the machine it is connected to.

Another nice feature is that you can set up "script files" to automate transfer of files. You might use a such a file to transfer a salesman's orders on a daily basis.

The first time you run the program, it creates and saves a map of your directory structure. Then, next time you run the program, it loads the map without re-scanning,

disks of the Toshiba and Zenith laptops—all with a single command. However, after initial set-up, we found Direc-Link easier to use, especially for transferring just one or two files.

By the way, you can copy an entire sub-directory using Direc-Link, but you must first create it on the target machine. In addition, Direc-Link works only with a single directory at a time—it will not copy branch structures in the point-and-shoot mode, although it can copy multiple directories in script-file mode.

All in all, we'd be hard pressed to say that either program is superior to the other. Brooklyn Bridge allows more flexibility, but it can be difficult to install, and its manual is not well done. Direc-Link is so intuitive that you don't need to read the manual at all. In addition, the cables supplied with Direc-Link had shielded shells and were of better construction than those supplied with The Brooklyn Bridge.

A cable is included with The Brooklyn Bridge for the purchase price; you must buy cables separately to use Direc-Link. Micro-Z sells a set (one with 25-pin females on both ends, and two 9-pin female to 25-pin males) for \$32.50. So even with extra cost, Direc-Link is less expensive than The Brooklyn Bridge. For do-it-yourselfers, the manuals of both products include cable wiring diagrams. Both Micro-Z and White Crane Systems include all software on both 5¼ and 3½ format diskettes. **◆◆**



HEATHKIT SK-203 PRINTER BUFFER

Some computer accessories are spoilers. After using one, you're spoiled—you can't imagine how you got along without it, and you can't imagine how you'd survive if you had to give it up.

Case in point: the printer buffer. Sure, you can pick up a software spooler from most BBS's, but software spoolers have problems of their own. First, they use up valuable system RAM that might be put to better use loading a spelling checker's dictionary or more data in a CAD or desktop publishing program. Second, an external device can perform tricks that are simply impossible with a software spooler.

The problem with an external buffer—until recently—has only been one of cost.

However, Heathkit's new SK-203 printer buffer (shown in Fig. 1) retails for \$199.95, and, although you can buy a cheaper buffer, you can't buy one with the capabilities of the SK-203 for anything near that price.

How it works

Like any printer buffer, the SK-203 has a chunk of memory that sits between your computer and your printer. The base model comes with 64K, which can be upgraded to a total of 512K. The remaining features discussed below are included as standard equipment.

The SK-203 has both serial and parallel inputs and outputs, and there are four ways they may be configured: (1) The parallel input can be routed to the parallel output and the serial input can be routed to the serial output; (2) Inputs and output can be



FIG. 1



FIG. 2

crossed—serial-to-parallel and parallel-to-serial; (3) Both inputs can be routed to the parallel output; (4) Both inputs can be routed to the serial output. A front-panel-mounted pushbutton, Swap (shown in Fig. 1), allows limited re-configuration without re-setting DIP switches.

The SK-203 maintains file integrity in all configurations. In other words, when two inputs are fed simultaneously (regardless of output destination), the received files are kept separate. Likewise, when multiple files are received sequentially (regardless of input), they are kept separate.

Pushbutton control

Front-panel controls include two sets (one each for the serial and parallel inputs) of Clear, Copy, P. Print (see below), Restart, and Offline pushbuttons, and the single Swap pushbutton. (See Fig. 2) Three seven-segment LED's continuously monitor the amount of free memory remaining.

Pressing Clear removes all files (received from the associated input port) from memory. Pressing Copy allows you to increment (to a maximum of 99) and decrement the

number of copies of a file that will be printed. The file that will be copied is the next one received.

The P. Print switch allows you to interrupt a job in progress and send a file to the buffer that will be printed immediately. Restart allows you to begin printing the current file from the beginning, in case of printer malfunction (end of ribbon, out of paper, etc.). Restart also allows you to program the timeout delay that the buffer uses to determine when one file ends and another begins. The default is six seconds. Last, Offline halts output to the associated port. Incoming data continues to be buffered while the buffer is offline.

The rear panel has two 25-pin female sockets for the parallel ports, and two 9-pin (AT-style) male plugs for the serial ports. In addition, the power switch is mounted on the rear panel, and the power jack is also accessible there. A small wall-mounted transformer powers the SK-203.

Inside are three DIP switches and a dozen or so jumper blocks that allow complete control over the serial-communication parameters (150–38,400 baud, word length, stop bits, and parity), data routing, auto form feed, handshake type and polarity, and RAM-IC size (64K or 256K).

Circuit details

Controlling operation of the buffer is an HD64180 (the Z80 upgrade made by Hitachi) running at 12.288 MHz. It's interesting that the circuit contains no UART—the microprocessor's built-in port handles the serial-to-parallel conversion. All software is contained in an 8K EPROM (2764). There are a total of 34 IC's on the circuit board (if all RAM sockets are filled).

The power cube supplies a nominal nine volts DC; the RS-232 voltages are generated by an Intersil 7662, a CMOS charge pump that uses a couple of 100-µF capacitors to generate the negative RS-232 voltage.

Building it

The kit went together smoothly. The circuit board is good quality, double sided, and has silk-screened legends marking all component locations. Order of assembly is for the most part logical. Anyone with the slightest experience in electronics assembly would have no trouble building the SK-203; expect to spend eight or ten hours in doing so. Only small hand tools are required; solder is included with the kit.

The acid test

After tracking down one assembly error (a solder bridge that totally disabled the microprocessor), we put the SK-203 to work, and it has performed flawlessly.

We have two minor complaints with the unit: (1) The lack of detailed troubleshooting information, and (2) The rather disorganized configuration instructions.

In operation, the SK-203 is a fine unit. We recommend it highly. **◆◆**

PORTABLE COMPUTERS

We evaluate seven portable PC compatibles.



BONDWELL 8



DATAVIEW 25



IBM PC CONVERTIBLE

JEFF HOLTZMAN, TECHNICAL EDITOR



NEC MULTISPEED

For several years if you wanted to compute on-the-go, you were limited to using small machines with hard-to-read screens, small amounts of RAM, and software that was (to be charitable) serviceable, but nothing like that obtainable for a desktop machine. However, times have changed. Now you can buy machines from a number of manufacturers that run all standard PC software, in many cases faster than on a standard desktop machine.

For purposes of this review we examined seven machines with list prices ranging from \$1400 to \$4200. (See Table 1.) Screen displays of most battery-powered portables still can't measure up to those of a real CRT, but some (Zenith's and NEC's, for exam-

ple) have improved dramatically. And the screens of several non-battery-powered portables (from Toshiba and DataVue) are every bit as good as a CRT.

To obtain objective measures of performance, we ran special benchmark tests to determine each machine's speed. To obtain some idea of each machine's subjective appeal, we had several persons evaluate each machine. All our findings are presented in tabular form below, along with comments by our reviewers.

Keyboard layouts of all reviewed machines are shown in Figs. 1-7. Of the battery-powered machines, only the NEC has a separate numeric/cursor pad, and only it has full-size function keys arrayed at the left



TOSHIBA T1100 PLUS



TOSHIBA T3100



ZENITH Z183



FIG. 1—Bondwell 8



FIG. 2—DatuVue 25



FIG. 3—IBM PC Convertible



FIG. 4—NEC MultiSpeed



FIG. 5—Toshiba T1100 Plus



FIG. 6—Toshiba T3100

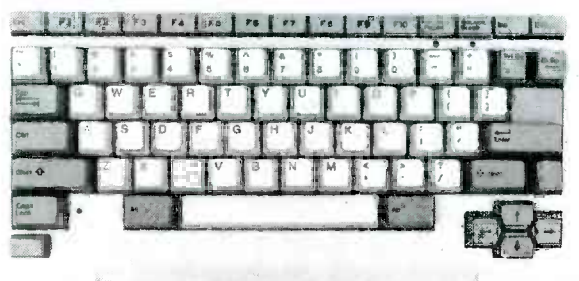

FIG. 7—Zenith Z183

side of the machine. (The DataVue's detachable keyboard also has a separate pad containing the numeric/cursor keys.) The other battery-powered machines embed the numeric pad in the main typing area; you must press a special key (usually labeled "FN") simultaneously with the desired key to access the embedded functions. In addition, most of those machines provide a separate cursor-control pad, operation of which will make you appreciate a full-size keyboard.

To get started with our evaluations, first we'll give an overview of each machine's features, and then we'll examine the objective ratings. Next we'll discuss each machine in detail, and wrap up by making recommendations.

Overview

The Bondwell, DataVue, and IBM machines all use 8088 or 80C88 microprocessors, run at 4.77 MHz, and have no turbo mode. The MultiSpeed and the T1100 Plus use full 16-bit processors and have turbo modes. The Zenith machine uses an 80C88, but provides a turbo mode. Last, the Toshiba T3100 uses an 80286 running at 8 MHz, which gives it the raw processing power of an AT-class machine (and a corresponding price tag).

All reviewed machines except, ironically, IBM's come with a version of DOS; various machines run various versions of DOS, ranging from 2.11 to 3.20. Some machines include software: BASIC, system utilities (SideKick, SuperKey), or applications programs. Table 2 shows the software included with each machine.

Type of screen (and readability) varied tremendously. The T3100 and the DataVue 25 have radiant screens that are visible under just about any lighting condition. However, those machines run only on AC power. The IBM Convertible, the MultiSpeed, and the T1100 Plus have LCD screens without backlighting, which makes them hard to

TABLE 1—BASIC FEATURES

Machine	Price	RAM	Floppy Disk	Hard Disk
Bondwell 8	\$1399	512K	1	---
DatuVue 25	\$3495	768K	1	10 Meg
IBM PC Convertible	\$1695*	640K	2	---
NEC MultiSpeed	\$2195	640K	2	---
Toshiba T1100 Plus	\$2099	640K	2	---
Toshiba T3100	\$4199	640K	1	10 Meg
Zenith Z183	\$3499	640K	1	10 Meg

* Does not include serial/parallel adapter (\$80)

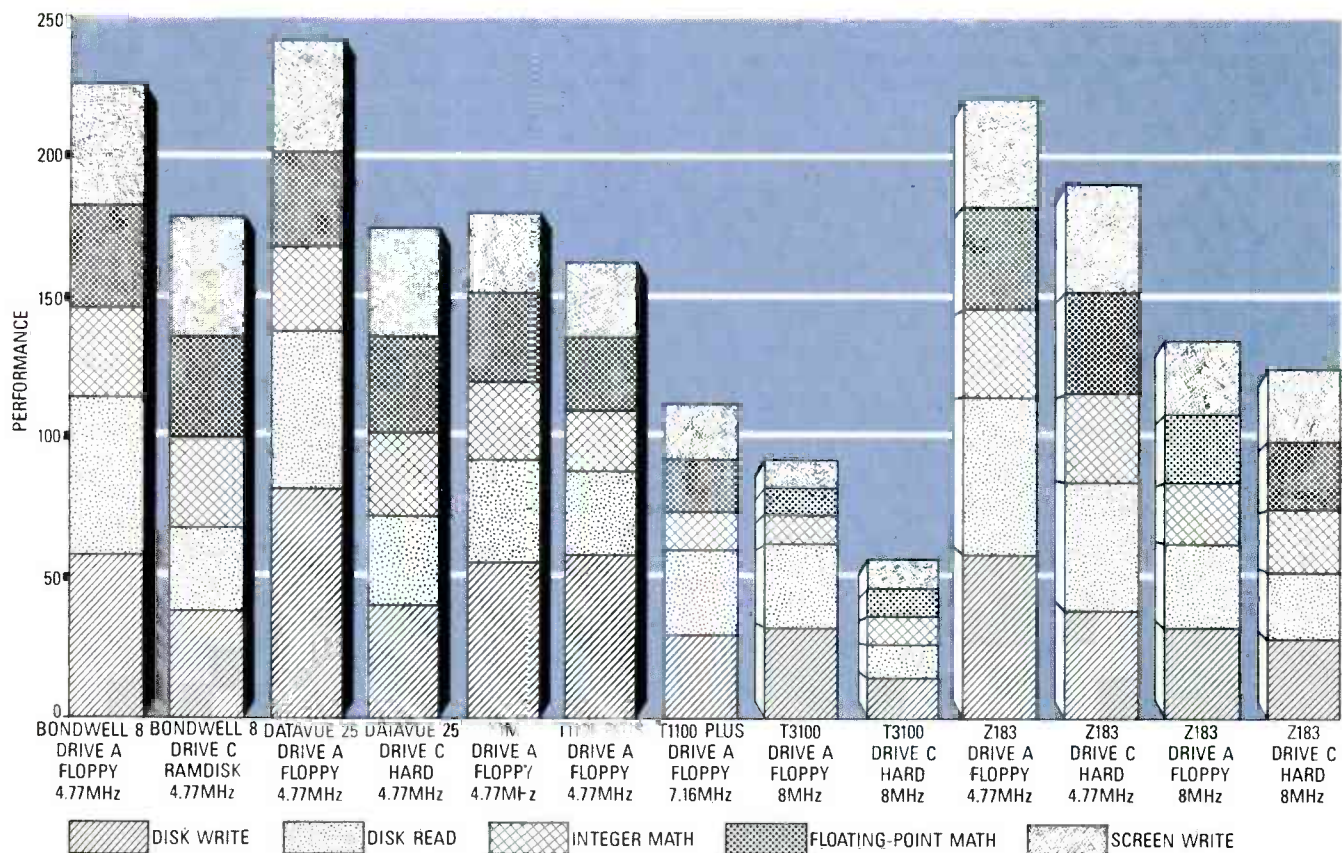

FIG. 8—Benchmark results

read, and makes their cursors hard to locate, under some lighting conditions. Their screens, however, are much more readable than those of a few years ago, so, if you haven't looked at an LCD screen for awhile, you're in for a pleasant surprise. The Bondwell has a backlit LCD screen that is more legible than the non-backlit types, but the best display (of the battery-operated machines) is provided by the Zenith.

Portable speed

Shown in Fig. 8 are the results of running five benchmark tests (similar to those used by *Byte* magazine) on each machine. The benchmarks test the speed of reading and writing sequential disk files, processing speed of both integer and floating-point math, and screen-writing speed.

No results are shown for the NEC MultiSpeed because the version of GW-BASIC we had in-house would not run on the MultiSpeed. However, the results of other benchmark programs indicate that the

MultiSpeed is nearly as fast as an AT (and the T3100).

Other than the MultiSpeed, we ran all tests on each machine several times, depending on the number and type of drives, and whether the machine had a turbo mode. In addition, because the Bondwell 8 has only a single floppy-disk drive, we also ran the disk-speed benchmark on a RAM disk. (The RAM-disk program is included with the machine.)

As you can see, the Toshiba T3100 is the fastest machine by far. In fact, it was able to complete *all* tests in approximately the same amount of time it took several other machines to complete just the disk write test. Of course, the T3100 is also the most expensive of the machines we tested.

Now let's discuss each machine. Unless otherwise noted, all machines have as standard features a serial port, a parallel port, and RGB and composite-video outputs, and an external AC adapter.

Bondwell 8

At \$1399, the Bondwell is the least expensive of the machines we reviewed. It's also one of the lightest, at 10.5 pounds. It has a single floppy-disk drive, a back-lit LCD screen, and a built-in 300-baud modem. The LCD's backlight can be turned off to conserve power. The machine's serial port is accessed through a non-standard nine-pin female—not male—D connector, so you may need a gender-reverser to access the serial port.

The Bondwell's screen, like that of the Toshiba T1100 Plus, is of the "squashed" variety—it has an aspect ratio of about 3:1, giving graphic images a distorted look. On the plus side, the backlighting provides contrast that is better than the non-backlit models.

Working with one drive can be inconvenient, but inclusion of the RAM-disk program partially offsets that inconvenience. However, any memory used for the RAM disk decreases the size of main memory. But that shouldn't be a problem for intended users—not those running large spreadsheets, databases, etc.

The machine comes with a 300-baud modem as standard equipment, and a special implementation of a public-domain communications program to operate it.

TABLE 2—SOFTWARE

Machine	Dos Version	Software Included
Bondwell 8	2.11	GW-BASIC, RAM-disk, Modem8
Datavue 25	2.11	World Clock, dumb terminal
IBM PC Convertible	3.2*	Application Selector
NEC MultiSpeed	3.2	**
Toshiba T1100 Plus	3.2	Sidekick
Toshiba T3100	3.2	Sidekick, SuperKey
Zenith Z183	3.2	None

* DOS not included
 ** See text

One quirk is that to format a floppy for 720K capacity, which is standard for 3½ disks, you must add "/3" to the FORMAT command. Otherwise, the disk is formatted for 360K capacity.

DataVue 25

This machine is one of two AC-only powered models we examined; the Toshiba T3100 is the other. The DataVue is the only machine we tested that comes in the "lunchbox" configuration, wherein the keyboard flips down from a vertically oriented system unit to reveal the screen. The DataVue 25 is available in a wide variety of configurations, some for very good prices, so examine the alternatives carefully.

The DataVue's screen is somewhat squashed, but it uses highly readable electroluminescent backlighting with red letters on an orange background (or vice versa). You can control screen contrast, brightness, and mode directly from the keyboard. The screen tilts through about 45°, latching in six places.

The keyboard is a lightweight battery-operated device (using two AA cells) that communicates with the main unit by infrared light. Our test unit had a maximum range of about 18 inches. To increase range, you can also connect keyboard and system unit with an optional cable.

Although the DataVue comes with a hard disk, you cannot boot from it; you must boot from a floppy and then transfer operations to the hard disk. Because DOS 2.11 is supplied with the machines, files are allocated in 8K chunks, so even a short batch file, for example, is listed in the directory as having a length of 8192 bytes. However, the hard disk has an automatic head-parking mechanism that is activated whenever the machine is turned off.

At 16 pounds, the DataVue 25 is the heaviest of the machines that we reviewed. As one of our reviewers stated, "It's portable—for Mt. T."

The documentation is well-thought-out, well-written, and well-printed. It includes a "Quick-start" section for experienced users, and more-detailed information for those needing instruction in computer and MS-DOS basics.

IBM PC Convertible

The Convertible is an odd machine that received bad publicity when it was first released. However, IBM dropped the price recently, bringing it more in line with the competition. The machine itself consists only of 640K of RAM and two floppy-disk drives. DOS is not included, nor are serial, parallel, and video ports. However, a program (called The Application Selector) is included, as shown in Fig. 9, the program is a visually oriented shell that allows users to run applications from a graphical interface. In addition, the Application Selector includes several stand-alone programs of its own, including a word processor, a telephone-list manager, a calculator, a scheduler, help screens, and various tools for formatting and copying disks. All those programs run under the Application Selector; you don't need DOS to run them. Further, the user can link his own

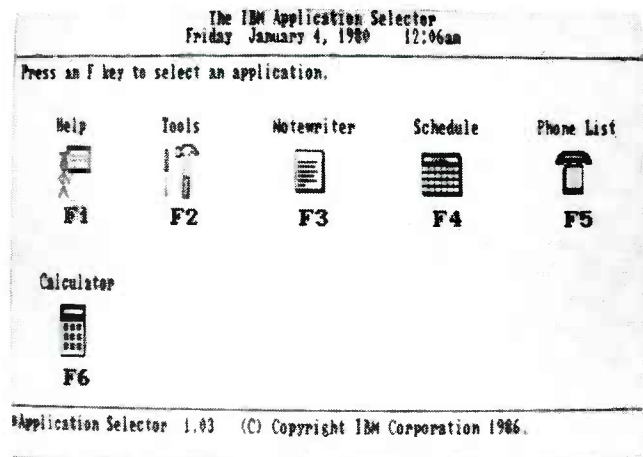

FIG. 9—IBM's application selector

programs to the system and run them from the main menu.

The Convertible's screen is a non-backlit LCD, but it has higher contrast than all other plain LCD's we've seen. The keyboard has the best (stiffest) feel of all the portables we evaluated, but the layout has quirks of its own. (The CapsLock and Control keys are reversed, for example.)

The main unit has no provision for internal add-on hardware, but a number of modules are available that plug into the rear of the unit. (See Fig. 10.) Doing so is simple, but increases size and cost. However, for on-the-road use, the modules can be disconnected easily, thereby increasing portability.

The Convertible has a special "resume" mode that allows you to resume automatically after powering down in the middle of an application program. For example, if you're running a word-pro-



FIG. 10—IBM add-on modules

cessing program and shut the power off, the next time you power up, you'll be at the same place in the same program with all your data intact.

The Convertible's manual is not among the best. It is full of technical jargon ("IPL mode," for example) that tends to negate the ease of use provided by the Application Selector. The applications programs included with the Application Selector are serviceable but limited; they are not acceptable for professional use. However, a beginner can use them for learning purposes, and graduate to more-sophisticated software when ready.

Rumors abound that IBM will introduce a new version of the Convertible with a turbo mode and a backlit screen, but, of course, those are only rumors. If the company does do so (and leaves the price alone), it will have a hot product.

NEC MultiSpeed

A fast machine with half a megabyte of ROM-based software, the MultiSpeed is highly attractive. It has a supertwist LCD screen that is eminently readable. (Supertwist screens provide higher contrast than regular screens.) Our only complaint is the fact that the friction-locked screen-tilting mechanism is difficult to adjust properly, so we usually propped the screen from the rear to obtain an acceptable reading angle.

The MultiSpeed is very fast, but it wouldn't run our benchmark program, as noted above. We noticed no other incompatibilities. Speed is switchable at the keyboard between 4.77 MHz and 9.54 MHz; the MultiSpeed uses a V30 microprocessor, NEC's version of the 8086. The V30 has a true 16-bit data bus, as opposed to the eight-bit bus of the 8088 microprocessor.

RAM has been implemented in an unusual fashion: 512K of volatile RAM, and 128K of non-volatile (battery-backed) RAM. Part or all of the latter can be configured as a RAM disk whose contents won't go away when power is removed. So, by careful configuration, you could use the MultiSpeed as a "notebook" computer in

the manner of Radio Shack's low-cost non-DOS machines.

The MultiSpeed has 512K of ROM-based software, including a word processor, an outliner, a dialer, a communications program, and a set-up utility. Like that included with the IBM Convertible, the MultiSpeed's software is no match for commercial packages, but it will suffice to get a beginner started. And it can be useful on the road if you want to avoid transporting a number of floppy disks.

Toshiba T1100 Plus

Another lightweight, compact unit, the T1100 Plus compresses a fast machine in a small package. The supertwist LCD screen is readable under average lighting conditions, but the high aspect ratio (2.2:1) gives graphic images a flattened look. The keyboard's layout (which is identical to the T3100's) is not bad, but we'd prefer a stiffer feel. It's easy to add an internal modem, but the external port connectors are unprotected and are subject to damage in transit. The carrying handle is not centered, so the computer does not hang in a balanced fashion—it bumps into either your leg or external objects. Overall speed (in turbo mode) was the fastest of the machines we tested, except for the T3100 (and the MultiSpeed). Increasing the value of the T1100 Plus is the inclusion of a copy of SideKick. Documentation is excellent, for both beginners and experienced users. A separate MS DOS manual is included.

Toshiba T3100

We have no hesitation in stating that the T3100 was our favorite machine (and the most requested by our reviewers). Its gas-plasma display (shown in Fig. 11) is visible under all lighting conditions (even in a totally dark room), but also necessitates AC-only operation. The machine's speed is simply phenomenal, considering its size. The keyboard (which is identical to the T1100's) is adequate, and the hard disk is slow, even compared with the hard disk on a standard XT. But overall, the T3100 provides maximum performance in minimum space. It comes with copies of SideKick and SuperKey, and, as with the T1100 Plus, documentation is excellent.

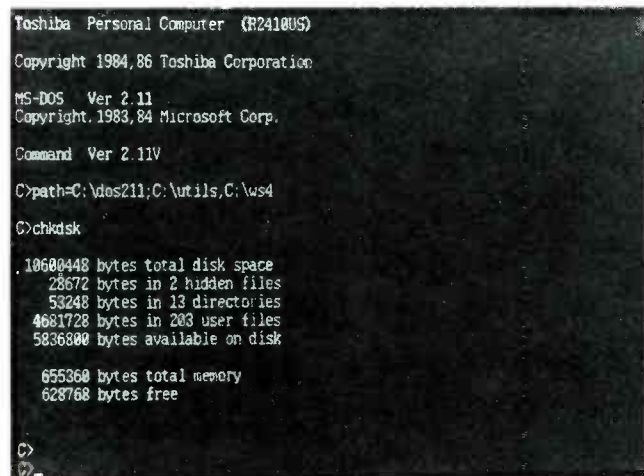

FIG. 11—Toshiba T3100's screen

Zenith Z183

More reasonably priced than the T3100 is Zenith's machine. It is a battery-powered machine that contains a hard disk, a backlit supertwist LCD screen, and a dual-speed 80C88. The machine is not the heaviest of those we tested, but it will challenge your ability to handle it and carry-on baggage simultaneously. Speed in turbo mode exceeds that of a standard PC, but the Z183 is not as fast as the Toshiba models or the MultiSpeed.

Standard equipment includes a 10-megabyte hard disk, a single 720K floppy disk, and 640K of RAM. In addition, slide controls vary screen brightness and contrast, and LEDs indicate drive activity and low power.

The screen is simply wonderful, for a non-radiant type. It is

legible in just about all lighting conditions, has a true aspect ratio, and is nearly as large as a nine-inch CRT. It is unquestionably the best of the battery-powered machines, and sets a standard that is sure to be emulated. Our only complaint is that at the best contrast/brightness settings for readability, the cursor becomes difficult and sometimes impossible to locate. By reducing contrast, the cursor becomes more visible, but legibility suffers.

The front-mounted carrying handle is properly centered, and a flip-down lid covers the rear-mounted ports. Slots on the left side allow insertion of a modem and a standard keyboard connector. The Z183's keyboard itself has a good feel, and a fairly good layout. The cursor pad is easier to manipulate than that on some portables. A single DIP switch sets the number of drives, turbo or standard speed (8 or 4.77 MHz), etc.

Upgrades

Since making our evaluations, several manufacturers have introduced new or enhanced models. NEC's MultiSpeed EL is identical to the standard model except for a new backlit screen that provides approximately the same readability as the Z183. The standard model can be upgraded, by the user or by NEC, for about \$500; the upgrade is worthwhile if you use the machine more than occasionally.

Toshiba has introduced several new models, including a six-pound single-drive unit (with DOS 2.11 in ROM, 512K of RAM, and an 80C88), the T1000, that lists for about \$1000. If the street price goes as low as usual, the T1000 will be irresistible. Toshiba also introduced a battery-powered hard-disk model, the T1200.

In early spring, President Reagan imposed trade sanctions on a number of high-tech products from Japan, and portable computers are among the hardest hit. That has led to some price increases, and to forestall further increases, several companies are considering manufacturing their machines in the U.S. NEC, for example, already has several plants employing 6000 workers in this country; gearing up for production of MultiSpeeds should not be difficult.

Recommendations

There is no single machine that is best for all persons in all circumstances. Depending on your needs and budget, one machine may be more suitable than another. Note that our tables include list prices, which vary from time to time, and which many dealers discount by 30% and even more. Shop around.

For flat-out performance, the T3100 is far and away the best machine. It's also the most expensive, and it requires AC power. If you need a battery-powered portable with a hard disk, then the Z183 is the way to go. Or, if you don't need the hard disk, the Z181 may be suitable; it's a dual-floppy cousin of the Z183.

For the budget shopper, the Bondwell 8 (or possibly the new T1000) is suitable. The IBM Convertible is a solidly built machine, and it includes "starter" software that may suffice students and beginners for some time. It also has a full range of accessories available, and the "resume" mode is a great convenience.

For best overall balance of power and price, you must choose between the T1100 Plus and the MultiSpeed. And due to the MultiSpeed's higher clock speed, the 128K of non-volatile RAM, and the ROM-based software, it represents the best overall value.

Credits

Our thanks to the manufacturers who generously supplied machines for review: Bondwell (47358 Fremont Blvd., Fremont, CA 94538, 415-490-4300), DataVue (One Meca Way, Norcross, GA 30093-2919, 404-564-5668), IBM (100 Summit Avenue, Montvale, NJ 07645, 800-IBM-2468), NEC Home Electronics (1255 Michael Drive, Wood Dale, IL 60191, 312-860-9500), Toshiba America (Information Systems Division, 9740 Irvine Blvd., Irvine, CA 92718, 714-380-3000), and Zenith Data Systems (1000 Milwaukee Avenue, Glenview, IL 60025).

Further thanks to our reviewers (Julian Martin, Byron Wels, Brian Fenton, Shelli Weinman, Robert Young) for their comments and evaluations. ▶◀

HIGH-RES HIGH-SPEED

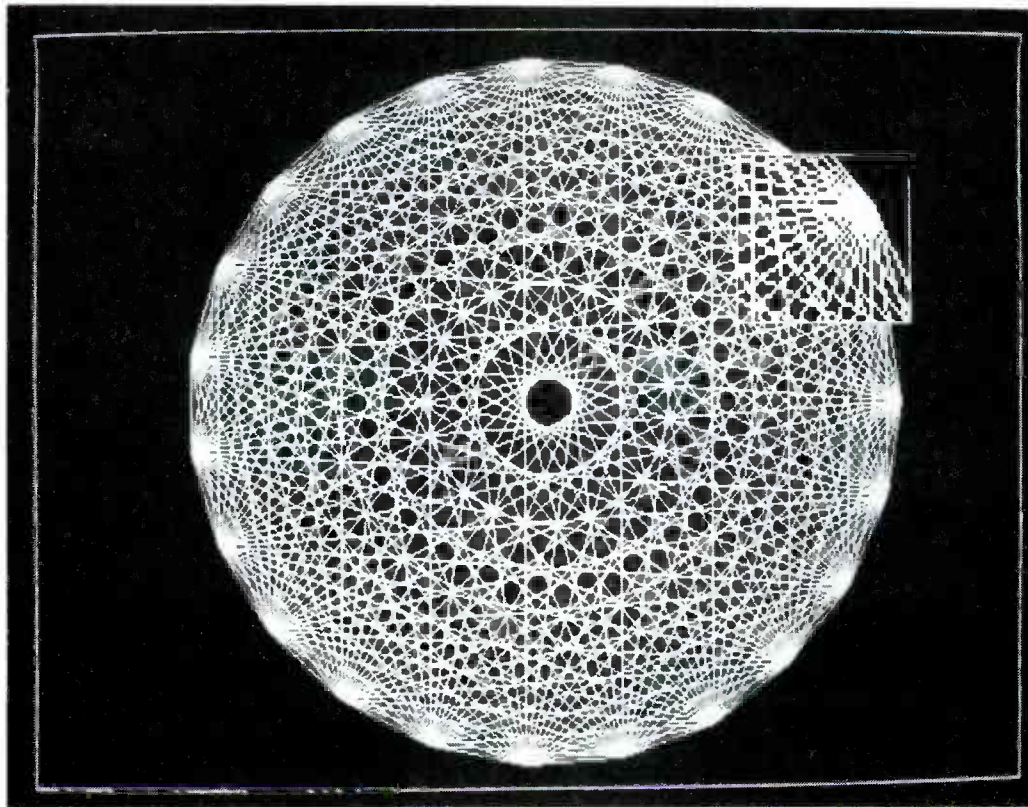

GRAPHICS CO-PROCESSORS

Great new graphics processors jazz up computer displays like never before.

JOSEF BERNARD

Video games used to be the only activities you needed graphics for, but that's no longer the case. Graphics are essential to CAD (Computer Assisted Design) programs, WYSIWYG (What You See is What You Get) word processors, desktop publishing programs, and even operating-system environments including Microsoft Windows, Digital Research's GEM, and IBM's presentation manager.

The problem is that, on most desktop computers, graphics-dependent programs are slow. And as those programs become more capable and more complex, they extract a greater toll in computational overhead from the computer's microprocessor. Therefore, the microprocessor winds up spending too much time manipulating images and too little time carrying out your commands. That slowdown leads only to frustration.

For example, in high-resolution mode, the output of IBM's relatively crude CGA (Color Graphics Adapter) is composed of an array of 640×200 (128,000) pixels, and the position of each must be recalculated every time the display is updated fully. Doing so takes time, and, what is more important from a human-factors point of view, it also frustrates the person using the system, who can do nothing but twiddle his thumbs during the update.

More and more graphics-intensive software is becoming available these days, and, fortunately, special IC's that are specifically designed to increase graphics processing speed are also becoming available. You know that a math co-processor can drastically increase the speed with which the computer does complex math, thereby freeing the microprocessor for other tasks. In a similar

manner, a graphics processor can manipulate graphic images, and doing so has two advantages: the graphics processor can do its work much faster than a general-purpose microprocessor, and it can do it while the microprocessor is working on other things.

The new generation

Display processors (NEC's 7220, for example) have been around for several years, but the new IC's offer greater capabilities. For example, Intel's 82786 is a true co-processor that, after having been instructed to perform a task, can go off on its own and do it, thereby freeing the microprocessor for other work. And Texas Instruments' TMS34010 is really a complete microprocessor with special graphics-control capabilities.

The Intel device—and most others that have been announced—is a co-processor that works in conjunction with a system's microprocessor. It has a built-in repertory of drawing operations, as shown in Table 1, and it can execute them with little or no attention from the microprocessor after the initial instruction has been given.

The TI device is more than a smart controller. And even though the operations it performs are less sophisticated than those of other graphics IC's, it is much more flexible, so you can accomplish just about anything in software. In fact, TI has developed a library of routines that allow you to program the IC in C. By way of contrast, other graphics controllers are more or less restricted to a fixed set of commands, and in some circumstances much programming may be required to achieve the desired results.

What is it that makes those graphics devices so special? A few quotations from Intel's spec sheet for the 82786 will give you an idea (and keep in mind that the TMS34010 is just as amazing):

- Four megabytes of graphics memory
- 200-MHz CRT's
- 640 × 480 (color) or 1400 × 1400 (monochrome) resolution
- 256 simultaneous colors
- Bit-blitting (block graphics-data transfer).

A block diagram of the TMS34010 is shown in Fig. 1. The IC contains almost all that is required for a complete graphics processing and display system. Note the barrel register, a special type of shift register. In the TMS34010, it can contain a field of 32 bits, and the IC can rotate it completely in a single instruction cycle, which potentially can speed up graphics manipulations enormously. Although the TMS34010 is a 32-bit device, it can be interfaced readily to an eight- or sixteen-bit bus.

Bit-blitting and hardware windows

The new IC's are intended for use in memory-mapped graphics displays. In that type of display, each pixel on the screen corresponds to a location in the computer's memory. Conversely, the contents of each memory location determines what will appear at a given point on the display.

Several screens of images, libraries of images, or portions of a single image can be stored in RAM simultaneously. By using bit-blitting techniques, those blocks of data can then be moved or operated on as a whole almost instantaneously, making it possible to change or update a display with pre-computed graphics information—there's no need to sit around and wait while the computer recalculates all the lines and shapes that must be redrawn each time the image changes.

TABLE 1—82786 COMMANDS

Command	Opcode
LINK	02
NOP	03
DEF_TEXTURE_OPAQUE	06
DEF_TEXTURE_TRANSPARENT	07
DEF_CHAR_SET_WORD	0A
DEF_CHAR_SET_BYTE	0B
INTR_GEN	0E
ENTER_MACRO	0F
EXIT_MACRO	17
DEF_BIT_MAP	1A
DUMP_REG	29
LOAD_REG	34
DEF_COLOR	3D
DEF_LOGICAL_OP	41
ENTER_PICK	44
EXIT_PICK	45
DEF_CLIP_RECT	46
DEF_CHAR_SPACE	4D
DEF_CHAR_ORIENT	4E
ABS_MOVE	4F
REL_MOVE	52
POINT	53
LINE	54
RECT	58
BIT_BLT	64
ARC_EXCLUSION	68
ARC_INCLUSION	69
POLYGON	73
POLYLINE	74
CIRCLE	8E
CHAR_OPAQUE	A6
CHAR_TRANSPARENT	A7
BIT_BLT_M	AE
INCR_POINT	B4
HORIZ_LINES	BA

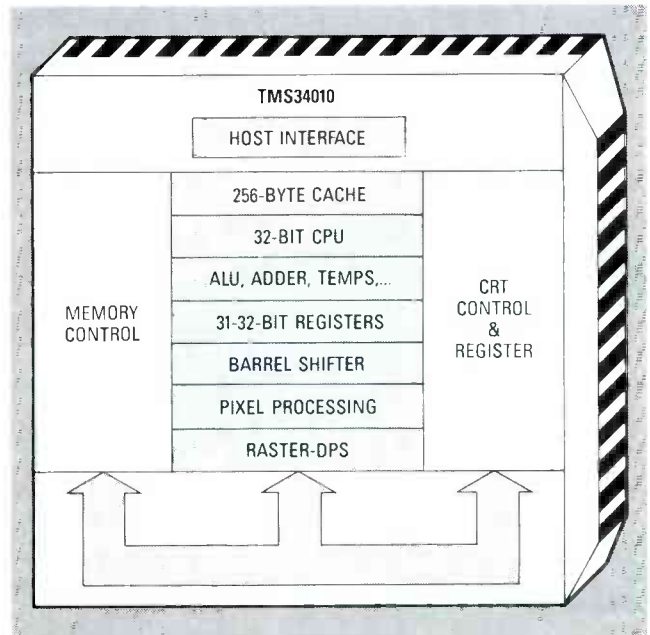

FIG. 1—TEXAS INSTRUMENTS TMS34010 is a 32-bit graphics processor, complete with its own on-board microprocessor.

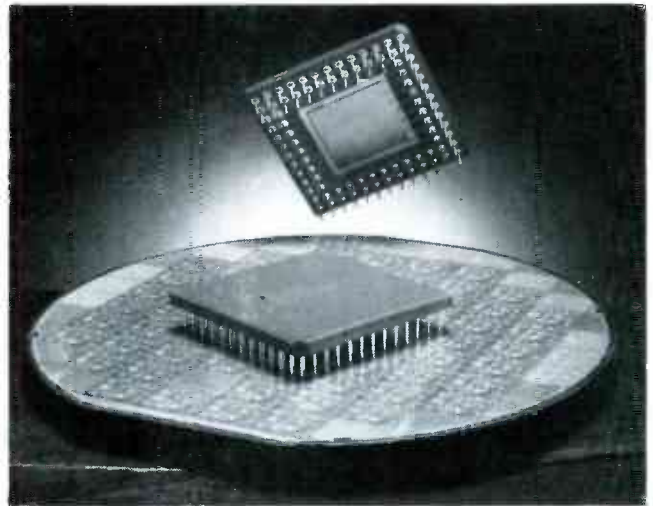

FIG. 2—INTEL'S 82786. The complexity of graphics-processor IC's requires a large number of input and output pins.

Bit-blitting is not a new technique: Commodore and Amiga machines have been using it for some time to achieve high-quality animation and graphics. However, the new graphics controllers will make bit-blitting—and even more advanced techniques—available on MS-DOS systems.

Hardware windowing is one advanced technique that is available on the 82786. Rather than moving big chunks of graphics data around in memory to assemble a complete screen image, hardware windowing allows you to move pointers that tell the 82786 where the data is located. The graphics processor then picks up the data wherever it happens to be located. Speed is thereby increased tremendously.

Hardware overview

For all that they have to offer, the new graphics controllers are remarkably simple. They require relatively little support from other hardware, because they contain built-in registers for DMA transfers, internal controllers for video DRAM, programmable video timing, and other capabilities.

The TI processor comes in a 68-pin square PLCC (Plastic Leaded Chip Carrier) package, the Intel device in a slightly larger 88-pin package. (See Fig. 2) Both are manufactured using a high-density CMOS process. Power consumption is low; the TMS34010 uses 500 mW and the 82786, 1000 mW.

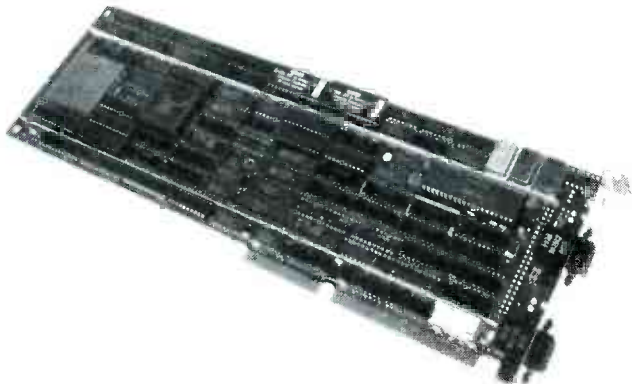

FIG. 3—NUMBER NINE COMPUTER'S SGT Pepper Graphics System uses both a TMS34010 and an 82786 in order to achieve high performance.



FIG. 4—NEW MONITOR TECHNOLOGIES allow you to see an entire page of text at a time, and make working with CAD and desktop-publishing programs easy. Shown here is the Genius, made by Micro Display Systems.

Putting them to work

There's more to using the new graphics controllers than just plugging them into a socket and turning on the computer. They require auxiliary hardware to drive a display, and, of course, software, which is usually provided in ROM.

For example, Number Nine Computer (725 Concord Avenue, Cambridge, MA 02138, 617-492-0999) in its SGT Pepper Graphic System, shown in Fig. 3, provides a firmware (software in ROM) interface called NNIO (Number Nine Intelligent Operating System). The Pepper board actually contains both an 82786 and a TMS34010; NNIO routes appropriate graphics commands to either, depending on which is more suitable for a given task.

The firmware interface is important because it provides a software standard, of which there are several at the present time. A standard is useful because it gives software developers an easy way to develop applications for various graphics controllers and boards without worrying about the underlying hardware.

The on-board drivers make adapting software to display hardware relatively simple. There is no need for the programmer even to know what kind of board will be used; the firmware will take care of everything else, including determining the resolution at which images will be displayed. Higher-resolution boards will provide more detail than lower-resolution ones automatically.

Black and white and read all over

It's easy to drive a monochrome display with the new graphics controllers. The primary consideration is bandwidth, and it is not difficult to produce a monochrome display capable of "swallowing" the output of a high-resolution graphics board. Many such monitors exist today, some can even display the contents of an entire page of text (with appropriate software, of course).

For example, the Genius monitor shown in Fig. 4 has a resolution of 736 × 1008, which enables it to show a full 66 lines of 80-column text. It can also do wonders with CAD and desktop publishing programs. The Genius is manufactured by Micro Display Systems, Inc., 1310 Vermillion Street, P.O. Box 455, Hastings, MN 55033, 800-328-9524.

Color displays, particularly the CRT's used, are another story. Ignoring bandwidth issues, the resolution of a color CRT is determined by the number of phosphor dots it contains, and by the size and spacing of those dots. (See Fig. 5). The more dots there are, the more detail will be possible. For example, NEC's MultiSync monitor increased the resolution possible with reasonably priced color monitors to 800 × 560. Previous monitors in the same price range were restricted to a resolution of 640 × 350.

The dot pitch of a CRT, which is usually specified in hundredths of a millimeter, refers to the spacing between phosphor elements. The finer the pitch—the smaller the number—the smaller the dots and the closer together they are. The more dots you can pack together in a given surface area, the greater the resolution you can obtain.

The CRT's used in garden-variety monitors usually have a dot pitch of 0.33 mm, which is adequate for resolving the output of an ordinary CGA card. More expensive monitors have CRT's with a pitch of 0.31 or 0.28 mm. Finer dot pitches are preferred by users of systems containing high-resolution EGA (Enhanced Graphics Adapter) and PGC (Professional Graphics Controller, until recently, IBM's highest-quality PC-based graphics sub-system) cards. But even CRT's with a 0.28-mm pitch may not be capable of doing full justice to the output of the new graphics cards embodying graphics processors.

Monitors that meet the qualifications required for really high-resolution graphics display are not cheap, and probably never will be. However, demand is increasing and manufacturing techniques are improving, so prices should decrease. But, currently, the price of a high-resolution display can easily rival that of the system that drives it.

Graphics applications

The new graphics controllers offer capabilities that greatly exceed those of the display controllers in common use today. In fact, some people believe that the new IC's do *too* much, and that their capabilities are unnecessary in the PC marketplace.

However, even though the EGA and the PGC offer much better resolution than the original IBM CGA, there are several reasons why the new graphics controllers are finding a great deal of support now, and why they will continue to do so in the future.

First is speed. If you've ever used a graphics-oriented program environment like Windows on a garden-variety PC (or clone), you know how maddeningly slow the program runs. Windows, in theory, is a terrific idea. The current version does not have the ability to run several programs simultaneously, but it does make it easy to switch among several applications at will. However, each time you switch, Windows has to recompute and redraw the entire screen. Where high-resolution graphics such as CAD images or specialized word-processing fonts—or even the Windows screen itself—are involved, redrawing the screen can take several seconds. The first time you watch it, it's fascinating. But it becomes interminably

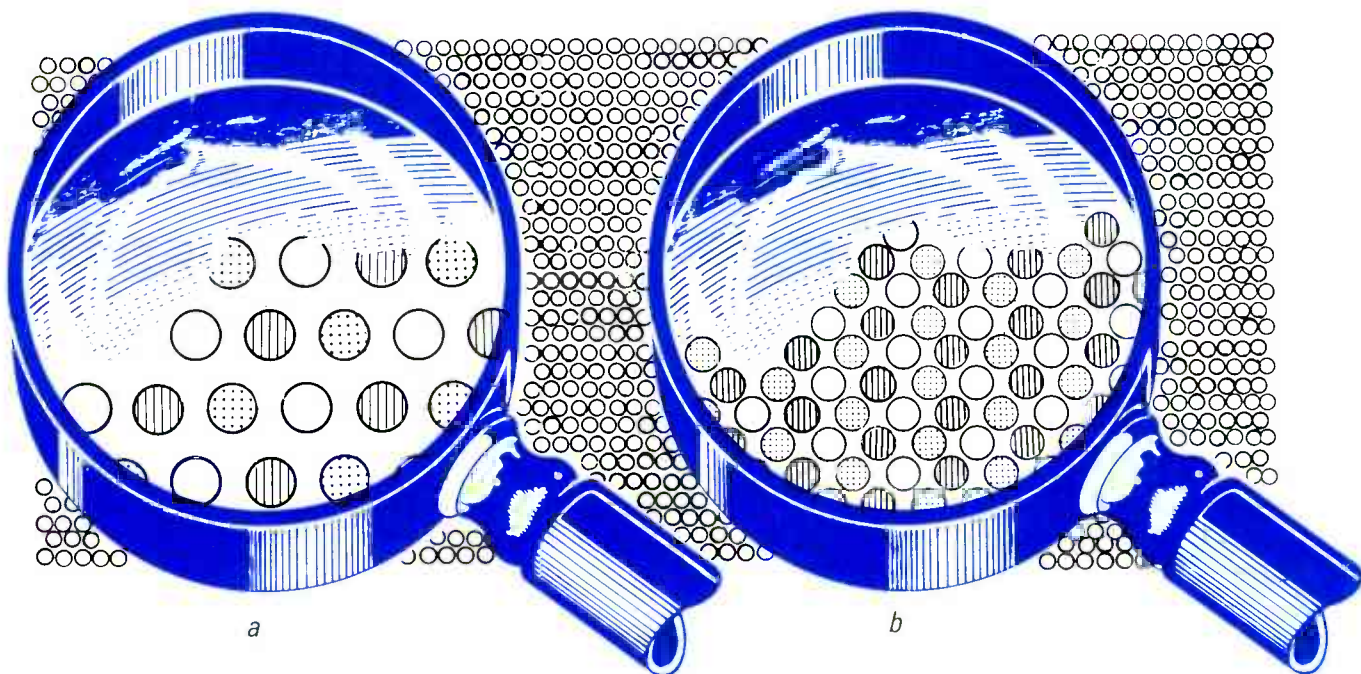

FIG. 5—RESOLUTION is determined by the number of dots, their size, and their spacing. Inexpensive monitors have relatively large dots spaced far apart (a). High-res monitors decrease dot size and spacing (b).

boring if you have to sit through it again and again.

With their bit-blitting ability, the new ICs can, depending on the amount of RAM available in a system, store several complete image screens in memory, and recall them as needed in their entirety, without having to recalculate and redraw them each time. That makes switching from one program to another (especially with a fast disk drive or a RAM disk) almost instantaneous, and that in turn makes working in a windowing environment bearable. Animation also becomes practical on a high-resolution scale, providing that the necessary RAM is available.

Display resolution

The resolution offered by EGA and even PGC boards is inadequate for some applications. Desktop publishing programs, for example, still struggle on most PC systems to show what the finished page will look like. Figures 6 and 7 show how two popular

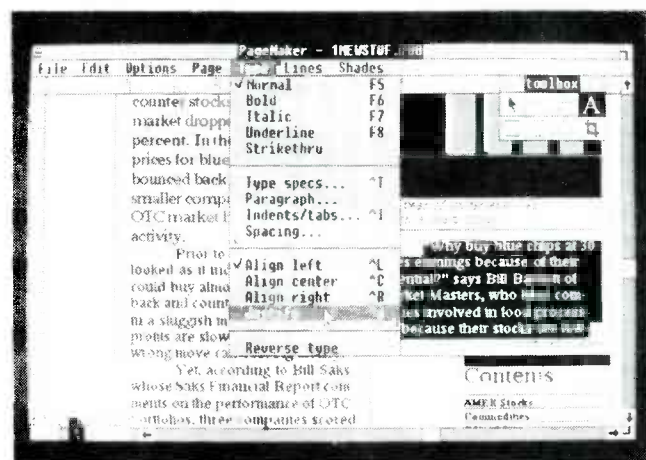

FIG. 6—ALDUS' PAGEMAKER, the original desktop-publishing program, was designed first for Apple's Macintosh, and recently has been adapted for the IBM PC family.

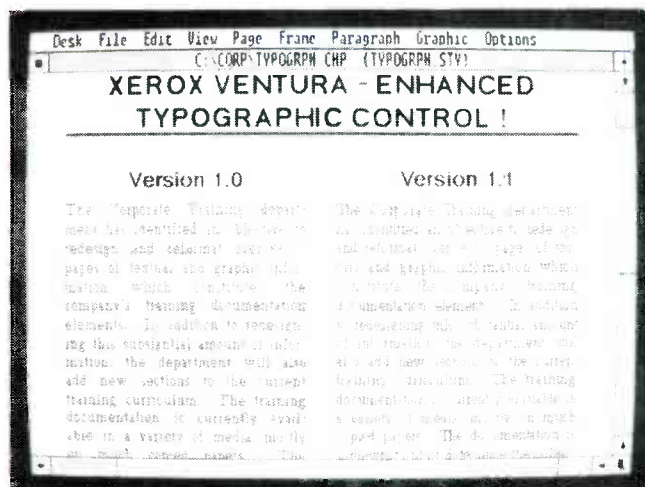



FIG. 7—XEROX' VENTURA is another high-stakes player in the desktop-publishing market. The latest version allows you to vary the spacing between letters, thereby improving readability.

programs (Aldus' PageMaker and Xerox's Ventura, respectively) do it. As you can see, those programs try their best to show you how your layout, which may include several typefaces in several sizes, will appear; but what you see on the screen is *not* exactly what you are going to get.

That's a problem because many computer users have no patience with—or understanding of—the limitations imposed by hardware or software. They don't understand why the machine can't show them exactly what they feel they have the right to expect. If what they see isn't close to perfect, then it isn't good enough. For computers to become a more natural and accepted part of the workplace, they will have to come much closer to perfection.

The point is that, due to advances in computer hardware in general, and graphics processing systems in particular, physical page layouts will become as important as—and as easy to manipulate as—the contents of that document. Now that it can easily be previewed and manipulated without a great deal of drudgery, physical appearance will matter as much as correct spelling. 

R-E ROBOT

continued from page 63

ATOD takes the channel number from the top of the stack, duplicates it, and stores it (using PC!) at I/O port 150H. That sets up the analog input-channel multiplexer. The duplicate copy is used to execute the same sequence of instructions a second time. Although the first port store to 150H started the A/D converter, we

would like to have a few microseconds for the MUX to settle. Starting the converter a second time ensures that the A/D converter has a clean input, one that is not full of switching transients.

SWITCH? fetches the byte of data at port 120H, masks the most significant bit (D7), and tests whether the result is equal to zero. The flag is returned on the stack.

LMTR-PERIOD writes a control byte to the configuration register of the 8253 at 100H. The 8253 is configured for square-wave output and a 16-bit frequency di-

visor. The next two bytes written to the 8253 will be the 16-bit divisor. LMTR-PERIOD takes an argument from the stack and divides it by 100H, leaving the quotient and remainder (/MOD). That effectively splits the word into the two 8-bit components. Each of these is stored in the 8253 timer 0 at 100H with the two-port store commands (PC!).

STOP-LEFT and STOP-RIGHT disable the motors. ENABLE-LEFT and ENABLE-RIGHT enable the motors. LFWD (left-motor forward), LREV (left-motor reverse), RFWD (right-motor forward), and RREV (right-motor reverse) each set the direction-control relays to the correct state.

That completes the program. Note that screen 32 contains no code at all, simply some explanations and definitions. It can be omitted if desired.

ROMING your code

After entering, testing, and debugging the source code, it's time to burn an EPROM. The 2764 will hold 8 screens of Forth-83 source code, more than enough. Transfer one screen at a time with the word PROGRAM as follows:

```
32 0 PROGRAM
33 1 PROGRAM
34 3 PROGRAM
35 4 PROGRAM
36 5 PROGRAM
37 6 PROGRAM
```

If you execute ROMed applications, you probably will not have your terminal attached. Until now we have invoked our applications by typing JOY at the terminal. You must include the command JOY as the last word of the last screen. Power down, remove the programmed EPROM, and install it at IC30 on the RPC board, the autostart socket for Forth-83. Press the reset switch and a few seconds later JOY will assume control of the robot.

Utility of JOY

Actually JOY is quite a bit of fun. You can sit on the robot and drive it anywhere you want to go. The values shown allow about 1 mph forward speed and slow turns. You can rotate the robot with one wheel stopped or each wheel going in opposite directions. The application is a natural for a wheelchair that needs more intelligence than a simple analog joystick could provide.

However, if you ride the robot, **be extremely careful!** Some values in the routines SPEED-CONV and DIFF-CONV will result in fast acceleration. If you are not careful, it's easy to get pitched off.

After riding, examine your chassis in the vicinity of the motor mounts. If the chassis is becoming bowed out, the torque imposed by the load is too great. Reinforce the rear with a bracket between the two sides before riding again. **R-E**

VIDEO GENERATOR

continued from page 45

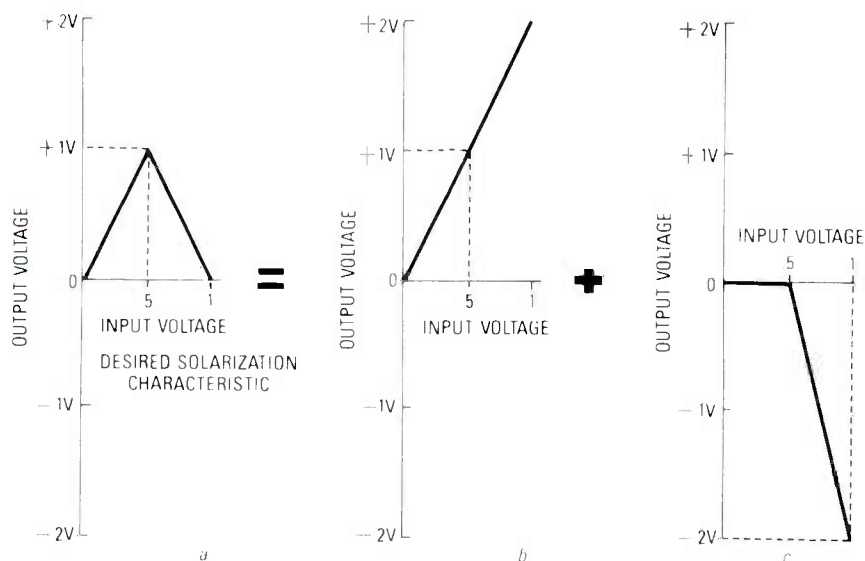

FIG. 8—THE DESIRED AMPLIFIER characteristic needed for solarization, shown in a, can be attained by using two amplifiers having the characteristics shown in b and c. The video palette, however, accomplishes the same task using single controlled-gain amplifier.

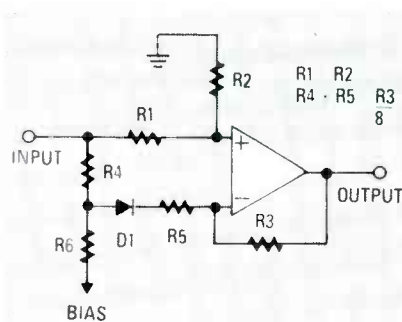

FIG. 9—BY VARYING THE FEEDBACK characteristics of an op-amp, a single stage of amplification can be made to function as a solarizer.

ally becomes forward-biased: The bias from R6 determines the level at which that occurs. When D1 conducts, resistors R3, R5, and R4 form a new feedback network that causes the amplifier gain to increase and also change polarity, which causes the output to reverse direction as the input gets larger.

Strictly speaking, R3 should equal four times R4 and R5. We got visually more

sal occurs depends on R6's bias. (Optimum visual effect requires adjusting both the solarization input drive level and the foldover controls. The output level determines the picture contrast and also can be adjusted separately. We decided to use three controls in the circuit for best flexibility.

Referring back to Fig. 2, the three circuits on the effects board can be operated simultaneously to create various interesting effects. The inverted output, or the uninverted but processed luminance is eventually fed into the summing amplifier. When using the special effects, the main luminance level control is usually—but not always—set to zero. The only thing the operator must watch for is that the video levels do not exceed the sync tip or blanking levels, which can cause picture instability. Bear in mind that the summing amplifier merely combines everything: it can handle only two to three volts peak before clipping occurs.

Next time we'll show how to build, adjust, and troubleshoot the palette. **R-E**

SATELLITE TV



BOB COOPER, JR.,
SATELLITE-TV EDITOR

The international connection

THE FAR-REACHING COVERAGE OF GEO-stationary satellites has been well known, significantly documented, and somewhat troublesome to the regulators of the world since the dawn of satellite communications. After more than a decade of active involvement in the business of presenting and delivering programming via satellite, the programming industry worldwide is finally beginning to come to grips with the effects of such wide coverage.

In its most simplistic terms, a satellite transmission has two types of coverage; *intended* recipients and *non-intended* recipients. Under most national (and international) regulations, a satellite signal is considered a national or sub-national service. It is intended to be received by one or more receiving locations, each of which is known to the satellite programmer/operator in advance of the transmission being sent. Those are the intended recipients. Each country in the world has its own laws or rules regulating reception of those transmissions, or there are no laws at all. (We'll get to that situation in a moment.) The content of those laws varies widely and only the United States, Great Britain, and a handful of other countries actually recognize by law that at least some of the transmissions on satellite are open to use by non-intended recipients.

International law

In cases where laws making it "legal" to intercept transmissions not intended for you do not exist, the attitude of most nations is that it is *not* legal to do so. In other



FIG. 1

words, reception is illegal unless it has been made specifically legal by legislation/law.

However, remember that satellite signals are virtually all national in nature; U.S. satellite signals are intended for U.S. users, Canadian satellites are for Canadian users, Mexican satellites are for Mexican users, and so on. In Europe, only the French presently have a national satellite service and most of the European countries share one or more common satellites (Eutelsat). There, while the satellite may be owned, operated, and shared by multiple countries, the individual channels or transponders are leased by and operated by individual countries. Therefore, under various national laws in Europe, it may be legal to receive and use one channel on Eutelsat (that one that originates in or is intended for use within the recipient's country) but not other channels on the same satellite if those channels carry programming originating in or intended for other countries in Europe.

All of that is very confusing to the layman who buys or builds a satellite-receiving system and discovers not only his own country's signals and programs but those

from neighboring (or not so neighboring) countries. The science of satellite transmissions has not matured yet to the point where it is possible to build a satellite that covers only the United States.

Nor is it possible, or economical, to build a satellite for Europe where one channel covers the UK, another France, a third Denmark and so on. The signals spill outside of the intended coverage area routinely; people with the appropriate equipment can receive those foreign signals, often with great ease. Figure 1 shows the test pattern for a Caribbean superstation that transmits on Westar 5, transponder 23. Though that station's signals are intended for reception in the Caribbean, the photo shown was taken in the U.S.

With rapidly developing domestic markets for their programs, that unintended spillover was largely ignored by programmers for nearly a decade. As an example, if a U.S. satellite programmer purchases rental or "showing rights" for a movie, it pays a negotiated fee based upon the size of its domestic market. No payment is made for viewers located outside of the U.S., and in fact the programmer has no distribution rights outside of the U.S. That means that it can not collect user fees from Bermuda even though there are unintended users there. What's more, legally the programmer must prevent the movie from being seen by those who are located outside the U.S.

Preventing reception

One method of protecting themselves from unintended

viewing, either inside or outside the region where they have distribution rights, is to encrypt the signal and only accept fees from people residing within the defined viewing area. A British service called The Sky Channel, for example, encrypts their signal and closely controls the distribution of the decoders so that they are available only to viewers located within their domestic market.

Another method of controlling use to within intended regions is

to seek the legal support of the governments outside of the intended viewing areas. For example, through the U.S. State Department, HBO has been successful in getting hotels and other public establishments in Jamaica to cease using HBO's programming in that country. To accomplish that, HBO enlisted the aid of an official agency within the U.S. to intercede with an official agency within the Jamaican government.

Encrypting signals is not a

Caribbean Electronics Magazine

A brand new monthly publication called *Caribbean Electronics Magazine* intended just for people living in and around the Caribbean region is now available from Bob Cooper. If you live in the Caribbean, Florida, or Latin America (only!) and wish to receive a free sample copy, write to CEM, P.O. Box 100858, Ft. Lauderdale, FL 33310, or telephone 305-733-9955. Enclose either business card or amateur/CB QSL card as proof of your residence or business location.

foolproof technique to shut off program use in non-intended areas, of course, since a decoder can be moved from an authorized location to a non-authorized location and still function. And in Europe, where the encryption technology used by satellite programmers is not as secure as it might be, (i.e. bootleg) decoders are freely offered for sale in many countries. A Swiss court recently ruled that within Switzerland it is not illegal to offer for sale or use a decoder that decrypts a French pay-television service.

Similar rulings have come from Canadian courts and they seem to be saying "It is not illegal to offer for sale (non-authorized) decoders within our country if the programming services received with the decoder are not offered in commerce here."

That sort of national attitude bothers programmers who face a form of double jeopardy when their programming is used by non-intended receivers. First, the programmers are under pressures to control the distribution of their services. Should the programmer fail to exercise due diligence (such as by encryption), he is often contractually bound to financial penalties payable to his program sources. But program sources are getting smarter and when they feel that encryption is not adequate due diligence, they are pressuring programmers such as HBO to take things a step further, as was the case in Jamaica.

Not all countries will assist the programmers with their business problems. We'll see why, and then delve deeper into the topic of international satellite reception next time.

R-E

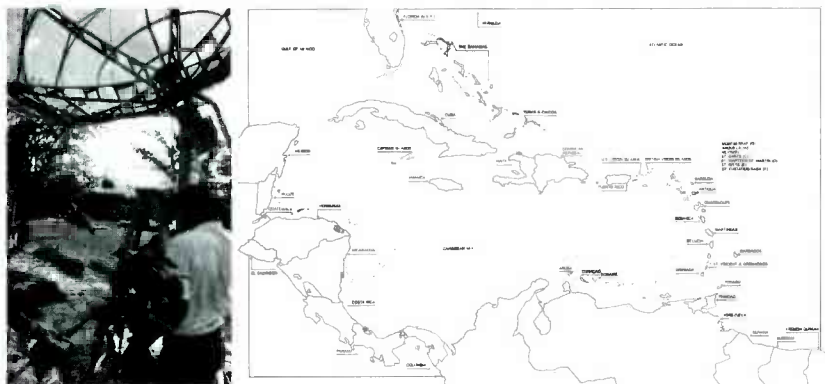

IF YOU LIVE IN THE CARIBBEAN, CENTRAL AMERICA, NORTHERN S. AMERICA or FLORIDA . . .

WIN A PARACLIPSE HOME DISH SYSTEM!

Bob Cooper's **CARIBBEAN ELECTRONICS MAGAZINE** is giving away 12 complete Paraclipse 12' home dish systems between September 1, 1987 and August 31, 1988. **FREE.** No obligation of any kind! If you are an amateur radio operator in the 'qualifying area' (see map), simply send us your Ham radio QSL card. If you are in electronics but not a licensed amateur, send your business card. You may enter once per month for each of the 12 months but no more than once per month. The home dish system winners are announced in 'CEM' monthly starting with the November 1987 issue.

PLUS - when we receive your QSL card or business card, we will send you a **FREE** sample copy of the most exciting electronics magazine in the Caribbean; Caribbean Electronics. CEM covers every aspect of communications and broadcasting, just for those who live in the Caribbean and countries surrounding the Caribbean. And we do it in English and Spanish with special Spanish summaries for all feature articles.

OUR twelve **FREE** home dish systems feature the highly acclaimed Paraclipse 12 foot dish with tuned feed, state-of-the-art solid state actuator/controller, and the top-rated by test AVCOM 2 series receiver system with remote control. This is the best, quality system for home or commercial use in the Caribbean. Find out how our CEM Lab rates everything from power line filters to VCRs, shortwave radios to home computers for Caribbean use in Caribbean Electronics Magazine. Send us your QSL card or business card today!

CARIBBEAN ELECTRONICS MAGAZINE
P.O. Box 100858, Ft. Lauderdale, FL 33310 USA
Telephone: 305/733-9955; in Florida 800-367-8150

SERVICE CLINIC

continued from page 30

simplest ways of hunting for an open bypass is to bridge each one with a known-good capacitor and watch the screen to see what effect, if any, the "good" capacitor has on the interference. If the trouble clears up, the bypass you are bridging is open and should be replaced.

If it happens that you can't find a defective bypass by simply bridging it with a known-good capacitor, then it's time to test the suspect capacitor under actual operating conditions. As you would expect, an oscilloscope is a top choice when it comes to making in-circuit tests. (In fact, it's tough to do the job at all without an oscilloscope.)

To use a scope to check a bypass capacitor for proper operation, you set the vertical-input selector to AC and simply touch the test probe to the capacitor's "hot" (non-grounded) terminal. If the bypass capacitor is doing the job it's supposed to be doing you will see no signal on the scope because any AC signal of necessity will have been bypassed to ground. On the other hand, however, if the capacitor is open or leaky, the screen will show some kind of AC signal component because some or all of the signal isn't being bypassed to ground.

One reason the scope's vertical input must be set for AC input rather than for DC is because an open bypass capacitor often has no effect on the B+ value. If you simply measure the B+ voltage it will usually look good because the DC trace displacement can conceal a small AC component. But if the scope cannot display DC at all, unbypassed AC—even a very small amount—will be seen, though it might be necessary to crank up the vertical gain in order to get a readable display.

On the other hand, a leaky bypass capacitor often affects the B+ value, because when a capacitor is "leaky" there is actually a relatively low DC resistance between the positive and negative leads. In a powered (active) circuit, the leak-

age resistance usually becomes part of an unintended voltage divider, thereby reducing the circuit voltage to some degree. Therefore, DC voltage measurements taken on the bypassed circuit will usually point directly at the defective component.

There are even some conditions in which an open bypass capacitor will affect the DC circuit voltage. For example, although an open bypass in a plate or collector decoupling network won't affect the DC circuit values, an open B+ input filter capacitor, such as C2 in Fig. 1, will result in a lower B+. That is because the input filter capacitor charges to, or almost to, the peak value of the rectified AC. If the input filter capacitor is open the rectified AC is processed by the second filter capacitor, which often follows a resistor (for instance, it follows resistor R2 in Fig. 1); hence, under load the voltage across the second capacitor does not reach the peak value, so the overall B+ value is somewhat less than normal.

Video distortion

Unlike radio oscillation, which usually is heard as squeals and howls, video oscillations caused by defective bypass capacitors often manifest themselves as small distortions in parts of the raster, as traveling wiggles, or as the *Leaning Tower of Pisa* effect, wherein parts of the picture lean to either side. When you see anything in a TV picture that looks odd or out-of-place, start bridging the bypass capacitors while you keep an eye on the picture. You'll know that you've hit the right one because when it is bridged the picture snaps to attention and turns rock-steady.

Often, normal picture detail obscures distortions caused by defective bypass capacitors. You can usually get a better idea of what's going on if you use an oscilloscope to observe a square-wave test signal, because anomalies in the squarewave are immediately apparent—nothing stays concealed when you use your oscilloscope properly. Simply start bridging the bypass capacitors one at a time until the waveform snaps to its square shape. R-E

ATTENTION! ELECTRONICS TECHNICIANS

EARN YOUR
**B.S.E.E.
DEGREE**



THROUGH HOME STUDY

Our New and Highly Effective Advanced-Placement Program for experienced Electronic Technicians grants credit for previous Schooling and Professional Experience, and can greatly reduce the time required to complete Program and reach graduation. No residence schooling required for qualified Electronic Technicians. Through this Special Program you can pull all of the loose ends of your electronics background together and earn your B.S.E.E. Degree. Upgrade your status and pay to the Engineering Level. Advance Rapidly! Many finish in 12 months or less. Students and graduates in all 50 States and throughout the World. Established Over 40 Years! Write for free Descriptive Literature.

COOK'S INSTITUTE
OF ELECTRONICS ENGINEERING



347 RAYMOND ROAD
P.O. BOX 20345
JACKSON, MISSISSIPPI 39209

CIRCLE 209 ON FREE INFORMATION CARD

SUPER LONG PLAY TAPE RECORDERS

10 Hour Model — \$95.00*
14 Hour Model — \$159.00*

Modified Panasonic Slimline, high quality, AC-DC Recorders provide 5 or 7 continuous hours of quality recording & playback on each side of cassette for a total of 10 or 14 hours depending on model. Built-in features include • Voice level control, • Digital counter, etc. TDK DC 180 Cassette Furnished.



PHONE RECORDING ADAPTER

Records calls automatically. All Solid state connects to your telephone jack and tape recorder. Starts recording when phone is lifted. Stops when you hang up. **\$24.50***



VOX VOICE ACTIVATED CONTROL SWITCH

Solid state. Self contained. Adjustable sensitivity. Voices or other sounds automatically activate and control recorder. Uses either recorder or remote mike. **\$24.95***



*Add for ship & hdg. Phone Adapter & Vox \$1.50 ea. Recorders \$4.00 ea. Cal. Res. add tax. Mail order, VISA, MIC, COD's OK. Money Back Guarantee. Qty. disc. avail.. Dealer Inquiries invited, Free data. ©
AMC SALES, Dept. A 9335 Lubec St., Box 928, Downey, CA (213) 90241 Phone 869-8519

CIRCLE 108 ON FREE INFORMATION CARD

Radio-Electronics mini-ADS



WITH "TV LINE GRABBER" LOOK AT INDIVIDUAL LINES of composite video with your oscilloscope in either Field 1 or 2. Output signals of Line Trigger, Vertical Sync and Field 1/Field 2. Input signal is composite video (RS170 Compatible). Complete unit including wall plug-in power supply, **\$94.95 + \$5.00 S & H.** C.O.D. orders accepted. **MONITRONICS, INC., 800 W. Rock Creek Rd., Norman OK 73069. (405) 364-0245.**

CIRCLE 214 ON FREE INFORMATION CARD

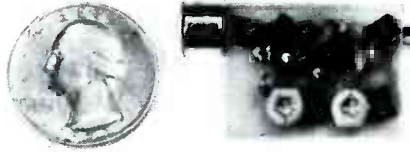

SIMPLY SNAP THE WAT-50 MINIATURE FM TRANSMITTER on top of a 9v battery and hear every sound in an entire house up to 1 mile away! Adjustable from 70-130 MHz. Use with any FM radio. Complete kit **\$29.95 + \$1.50 S + H.** Free shipping on 2 or more! COD add \$4. Call or send VISA, MC, MO. **DECO INDUSTRIES, Box 607, Bedford Hills, NY 10507. (914) 232-3878.**

CIRCLE 127 ON FREE INFORMATION CARD



APPLIANCE REPAIR HANDBOOKS—13 volumes by service experts; easy-to-understand diagrams, illustrations. For major appliances (air conditioners, refrigerators, washers, dryers, microwaves, etc.), elec. housewares, personal-care appliances. Basics of solid state, setting up shop, test instruments. **\$2.65 to \$5.90 each.** Free brochure. **APPLIANCE SERVICE, P.O. Box 789, Lombard, IL 60148. 1-(312) 932-9550.**

CIRCLE 84 ON FREE INFORMATION CARD



CHAPMAN MFG. CO. KIT #6320 is the most popular tool set in the Chapman line. This kit contains twelve allen hex type adapters, two slotted, two phillips, one 1/4" square drive adapter plus a midget ratchet, screwdriver handle and extension. Packaged in a pocket sized (4" x 6") vinyl covered steel case. Only **\$22.94 plus \$2.00 for shipping.** Other kits available. Write for free brochures. **THE CHAPMAN MFG. CO., P O Box 250, Dept. RE9, Durham, CT 06422. (203) 349-9228.**

CIRCLE 195 ON FREE INFORMATION CARD



SYLVANIA 4040 CONVERTER/DECODER \$169. Gated sync, reconditioned with new wireless remote; 10-day money-back guarantee/30-day warranty. **ZENITH SSAVI \$169, Level II \$199,** reconditioned. SSAVI project handbook **\$6.50** ppd. Surplus N-12s, MLD-1200s; converters, amplifiers, accessories. Radar speed guns for baseball, racing, skiing, etc., from **\$275** used. Catalog **\$1.** Quantity discounts. **AIS SATELLITE, INC., P.O. Box 1226-S, Dublin, PA 18917. 215-249-9411.**

CIRCLE 81 ON FREE INFORMATION CARD

CALL NOW AND RESERVE YOUR SPACE

- 6 x rate \$745.00 per each insertion.
- Reaches 242,400 readers.
- Fast reader service cycle.
- Short lead time for the placement of ads.
- We typeset and layout the ad at no additional charge.

Call **516-293-3000** to reserve space. Ask for Arline Fishman. Limited number of pages available. Mail materials to: mini-ADS, RADIO-ELECTRONICS, 500-B Bi-County Blvd., Farmingdale, NY 11735.



THE LEVITATOR SUSPENDS A METALLIC BALL in mid-air. The Levitator will amaze everybody as it defies the most basic law of nature. **\$79.95** **NUKE ALERT**, pocket-sized radiation detector monitors Beta, Gamma, and X-ray radiation. Seen on Good Morning America. CES. USA Today. **\$79.95.** All products ready to use Guaranteed. Call or write free catalog (402) 554-0383. Order 1-800-624-1150. **UNITED IMPORTS & MFG., 6846 Pacific St. #2, Omaha, NE 68106.**

CIRCLE 213 ON FREE INFORMATION CARD

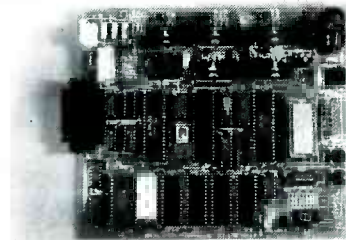

BUILD STEVE CIARCIA'S INTELLIGENT SERIAL EPROM PROGRAMMER. • Use Standalone or with Computer/Terminal; • Programs Standard or Fast Algorithm Mode; • Menu Selectable, No Configuration Jumpers; • Programs All 5V 27XXX EPROMs from 2716 to 27512. Includes CMOS and 12.5V Vpp; • Read, Copy, Verify after Write; • Intel Hex File Upload/Download. Full Programmer Kit **\$199.00**, Power Supply add **\$19.00.** S & H \$5 in USA. **CCI, 4 Park St., Suite 12, Vernon, CT 06066. (203) 875-2751.**

CIRCLE 200 ON FREE INFORMATION CARD



PANASONIC CABLE CONVERTERS, Wholesale and Retail. Scientific Atlanta and Pioneer Cable Converters in stock. Panasonic model 130N 68 channel converter **\$79.95**, Panasonic Amplified Video Control Switch Model VCS-1 **\$59.95**. Scientific Atlanta Brand new Model #8528 550MHZ 80 Channels Converter **\$89.95**. Video Corrector (MACRO, COPYGUARD, DIGITAL) ENHANCER **\$89.95**. Write or call **BLUE STAR IND., 4712 AVE. N, Dept 105, Brooklyn, NY 11234. Phone 1-718-258-9495.**

CIRCLE 85 ON FREE INFORMATION CARD

Radio-Electronics mini-ADS



THE ULTIMATE COMPUTER. IBM-compatible 8 MHz TURBO-XT system. Fully expandable, up to 6 extra cards, 3 extra drives, 6 ROMs and 640K memory. Include monitor, graphics/printer display card, 362K floppy drive, game/serial ports, 256K 120nS memory, AT-style keyboard, free \$150 program/supply package, including DOS & basic. Monochrome system **\$895**; color system **\$1095**. Many options available. **AIS SATELLITE, INC.,** P.O. Box 1226-C, Dublin, PA 18917. 215-249-9411.

CIRCLE 211 ON FREE INFORMATION CARD

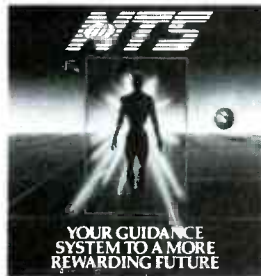

A CAREER START FOR THE 21ST CENTURY. Since 1905, National Technical Schools has helped people build successful careers. Enter the 21st Century through home study courses in Robotics, Computer Technology and Servicing, Microprocessors, Video Technology, Basic Electronics, Transportation Technology, Climate Control Technology or TV and Radio Servicing. For a FREE catalog, call 1-800-B-BETTER. Or write **NTS/INDEPENDENT TRAINING GROUP,** 456 West M. L. King Jr. Blvd. L.A., CA 90037.

CIRCLE 182 ON FREE INFORMATION CARD

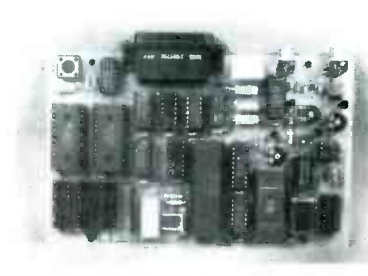

BUILD STEVE CIARCIA'S NEW VIDEO DIGITIZER. • True "Frame Grabber", pic takes 1/60th sec • Not bus Dependent - Standalone digitizer • Serial output, transmits 300bps to 57.6Kbps • Resolution: 256 x 244 x 6 w/64 level grayscale • Accepts any NTSC video input, B&W or Color • Optional Rec/Display makes Video Telephone • Images can be stored & displayed on IBM PC. Full Digitizer/Serial Transmitter Kit - **\$249**. Call for other options and specs. **CCI, 4 Park St., Suite 12, Vernon, CT 06066.** (203) 875-2751.

CIRCLE 201 ON FREE INFORMATION CARD



NEW 442 SYNE WAVE DECODER WITH VARI SYNC—Replaces the oak N-12 **\$80.00**, S.B. add on decoder **\$99.00**, S.B. Tri-Bi decoder **\$100.00**, Zenith SSAVI **\$185.00**, S.B.-S.A. decoder **\$140.00**, Starcom converter **\$139.95**. Buy a decoder take off **(\$10.00)**. Guaranteed. (402) 331-4957. Call or write for your free catalog. Many other products & quantity pricing. **M.D. ELECTRONICS, 5078 So. 108th #115A, Omaha, NE 68137.**

CIRCLE 212 ON FREE INFORMATION CARD



LOOKSOUND FM SUNGLASSES. Super durable sunglasses with that great look. Each one has a state of the art micro FM radio built right in. Great for jogging, bicycling, boating, sports events, etc. **\$39.95** plus **\$3.00** shipping and handling. Visa, mastercard, and cod. 1-800-522-2636 for orders. (617) 843-1900 for information. **CAMEO ENTERPRISES INC.** P.O. Box 63 Accord, MA 02018.

CIRCLE 89 ON FREE INFORMATION CARD

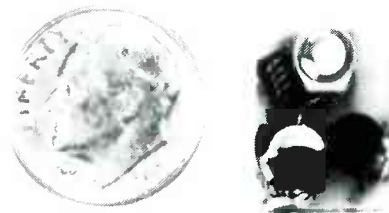

THE MODEL WTT-20 IS ONLY THE SIZE OF A DIME, yet transmits both sides of a telephone conversation to any FM radio with crystal clarity. Telephone line powered - never needs a battery! Up to ¼ mile range. Adjustable from 70-130 MHz. Complete kit **\$29.95 + \$1.50 S+H**. Free Shipping on 2 or more! COD add **\$4**. Call or send VISA, MC, MO. **DECO INDUSTRIES, Box 607, Bedford Hills, NY 10507.** (914) 232-3878.

CIRCLE 127 ON FREE INFORMATION CARD



DECODE THE NEW VIDEO TAPE COPY PROTECTION SCHEME. Bothered by brightness changes, vertical jittering and video noise while watching rented tapes? Stop it with the **LINE ZAPPER**. New kit removes copy protection that often interferes with normal television operation. Complete KIT only **\$69.95**. Assembled with 1 year warranty **\$124.95**. Add **\$3.00** shipping per unit. Dealer inquiries welcome. **ELEPHANT ELECTRONICS, Box 41865-L, Phoenix, AZ 85080.** (602) 581-1973. Allow 6 weeks for delivery.

CIRCLE 120 ON FREE INFORMATION CARD



FREE CATALOG OF HARD-TO-FIND TOOLS is packed with more than 2000 quality items. Your single source for precision tools used by electronic technicians, engineers, instrument mechanics, schools, laboratories and government agencies. Also contains Jensen's line of more than 40 tool kits. Send for your free copy today! **JENSEN TOOLS INC., 7815 46th St., Phoenix, AZ 85044.** (602) 968-6231.

CIRCLE 115 ON FREE INFORMATION CARD



TRI-MODE DESCRAMBLER PARTS Original parts as called up in Radio Electronics Feb 1987 article on tri-mode descrambling. Includes pc board, ac adaptor, resistors, capacitors, diodes, pots, transistors, IC's, LED's, toko coil and Plessoy SAW filler. Article included. **\$59** plus **\$2.50** shipping. **ELECTRONIC PARTS, Box 276, Alburg, VT 05440** (514) 739-9328.

CIRCLE 194 ON FREE INFORMATION CARD

R-E Engineering Admart

Rates: Ads are 2 1/4" x 2 7/8". One insertion \$825. Six insertions \$800 each. Twelve insertions \$775 each. Closing date same as regular rate card. Send order with remittance to Engineering Admart, Radio Electronics Magazine, 500-B Bi-County Blvd., Farmingdale, NY 11735. Direct telephone inquiries to Arline Fishman, area code-516-293-3000. Only 100% Engineering ads are accepted for this Admart.

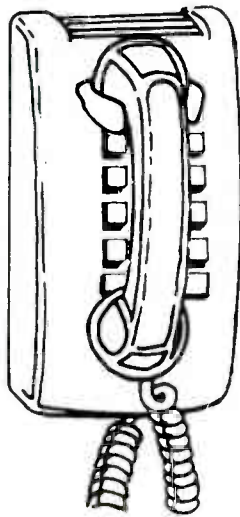

CALL NOW AND RESERVE YOUR SPACE

- 6 x rate \$800.00 per each insertion.
- Reaches 242,400 readers.
- Fast reader service cycle.
- Short lead time for the placement of ads.

Call 516-293-3000 to reserve space. Ask for Arline Fishman. Limited number of pages available. Mail materials to: Engineering Admart, RADIO-ELECTRONICS, 500-B Bi-County Blvd., Farmingdale, NY 11735.

Circuit Board Layout Made Easy!

Create and Revise
P-C-B Artwork on your
IBM or Compatible

- User Friendly
- Supports Microsoft Mouse
- On-line Help Screen
- 2X artwork on printer

Requirements: IBM or compatible PC - 256K memory - CGA card - IBM graphics compatible printer.

ONLY \$99.00

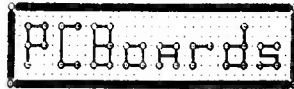

2145 Highland Ave./Ste. 201
Birmingham, Al. 35205
(205) 933-1122

DEMO DISK \$10.00

CIRCLE 205 ON FREE INFORMATION CARD

LIL' BITTY TESTER™

LIL' BITTY TESTER™ — A NEW, FAST, PORTABLE, CONVENIENT, AND AFFORDABLE TESTER. A GO-NO-GO TESTER THAT FITS IN A SHIRT POCKET. DESIGNED FOR THE PROFESSIONAL ELECTRONIC TECHNICIAN FOR FIELD OR SHOP WORK AND ALSO EASY ENOUGH FOR THE HOBBYIST TO USE.

TEST IN OR OUT OF CIRCUIT:

- Transistors
- Field Effect Transistors (FET)
- Silicon Controlled Rectifiers (SCR)
- Triacs
- Diodes
- Light Emitting Diodes (LED)
- Bipolar Light Emitting Diodes
- Bridge Rectifiers
- Incandescent Lamps

TEST CAPABILITIES:

- Continuity
- Detect Transistor Leakage
- *Detect a DC Voltage
- *Detect the Polarity of a DC Voltage
- Discrete Components

*CAUTION: Test leads must never be used to test a live circuit.



\$39.95
VISA
MASTERCARD

FEATURES:

- Built-in self-test. No adjustments or calibration required.
- Operates with a Bipolar LED and Audible Tone to indicate test results.
- Color coded test leads with alligator clips for fast, dependable connections.
- Test leads permanently attached to the tester and can not be misplaced.
- Over 75 hours of testing on a single 9 volt DC transistor battery.

SPECIFICATIONS:

- Power required — 9V DC transistor battery (not supplied)
- Max. current — 154 ma
- Avg test current — 181 ma
- Size — 3 1/2" L, 2 7/16" W, 7/8" H
- Weight — 2.8 oz. (w/o battery), 4.0 oz. (with battery)
- Test leads — 24 inches long

LIL' BITTY TESTER, Inc.™

3154 Main Street • Chula Vista, CA 92011 • (619) 425-1472

CIRCLE 185 ON FREE INFORMATION CARD

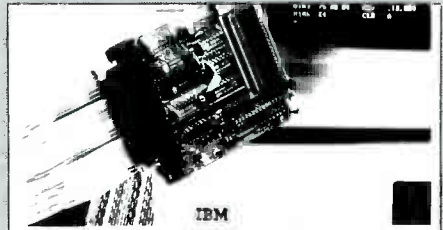

IBM 8031

IBM® PC based emulators for the 8031 family
(8031, 8032, 8344, 80535)

- IBM® PC plug in boards
- Commands like ICE™-51
- 16 MHz real time emulation
- 64K emulation memory
- 48 bits wide, 16K deep trace buffer with loop counter
- Powerful Macro commands
- Supports PL/M-51 and C-51
- In-line assembler, disassembler
- No external boxes
- Execution time counter
- Trace can be viewed during emulation!

PRICE: Emulator \$1795, Trace \$1495

CALL OR WRITE FOR FREE DEMO DISK!

IBM is a registered trade mark of IBM Corp. ICE is a trade mark of Intel Corp.

NOHAU

CORPORATION
164 Calle Larga
Los Gatos, CA 95030
(408) 866-1820

IN EUROPE

NOHAU

ELEKTRONIK AB
Foslevägen 6, S-214 31 Malmö
Sweden NAT-4640922425

CIRCLE 183 ON FREE INFORMATION CARD

LINEAR IC EQUIVALENTS & PIN CONNECTIONS

Linear IC
Equivalents
and Pin
Connections

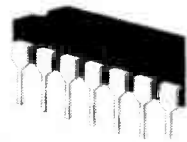

BP141—Shows equivalents & pin connections of a popular user-oriented selection of European, American and Japanese linear IC's 320 pages, 8 x 10 inches. **\$12.50 Plus \$2.75 shipping.** **ELECTRONIC TECHNOLOGY TODAY INC., PO Box 240, Massapequa Park, New York 11762-0240.**

LETTERS

continued from page 16

SOLDERING TECHNOLOGY

When I received by May 1987 issue of *Radio-Electronics* the other day, I was very pleased to see the article entitled "Soldering: Old Techniques and New Technology." Much to my dismay, however, I found the article to contain errors. The thought behind the article was a good one, but some of the information was very confusing. The charts shown on pages 47

and 49 can be misleading, which may have lead the author to believe that solder for electrical connections and electronics circuits is composed of 40% tin and 60% lead. A 60/40 tin-lead solder has an alloy designation of Sn60, and, as we learned in high school chemistry, Sn is the chemical symbol for tin. Hence, Sn60 is 60 percent tin.

Also, it should be noted that all good 60/40 solder is cored with rosin flux, and additional flux should not be added to the connection unless you are certain that the added flux is compatible with the flux in the core of the solder.

An exception would be rework of a connection where the original flux has already been "boiled" away.

The author also makes a general statement that no solder can melt at a lower temperature, when, in fact, what he should have said was that no tin/lead solder can melt at a lower temperature.

As always, I am very interested in seeing articles on state-of-the-art technology. Unfortunately, that one left much to be desired.

D.A. HOPKINS
Senior Instructor, PC-Board Repair
Techniques
Fort Gorden, GA

CELLULAR TELEPHONE

continued from page 55

knowledge of A and B services to that indicator, causing it to flash if the service it encounters is different from the one you have selected. That notifies you that, if you have to switch services manually (perhaps you have locked into one or the other—the recommended method), that is the time to do so.

What else?

In addition to performing those invisible tasks, the sophistication of cellular phones and phone systems makes using them more convenient.

Of course, they provide such things as auto-redial, muting, and memories that can hold up to 32 phone numbers that can be dialed by just a keypress or two. But just about every phone these days has those features. Cellular phones provide even more!

A few cellular phones give you the luxury of speech recognition for hands-free dialing. It's really more than a luxury—the less your attention is diverted from your driving, the longer you're likely to be around to make more phone calls. One phone, available from AT&T, not only

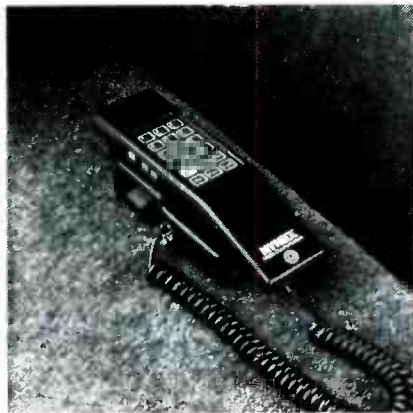

THE MODEL CDL205 is from Nynex Mobile Communications.

understands what you say to it but also talks back to you. When you pick up the handset it says, "Name please," and waits for you to tell it whom to call (it can also associate names with phone numbers). If the person you are calling is one of those stored in the phone's memory, the phone will dial the number after you speak the name. If you dial the phone manually, it will announce the digits entered as you punch them in. If the line is busy, you can later tell the phone to redial the number.

Cellular phones also use their intel-

ligence to keep you informed of situations they encounter. We've already seen what the ROAM indicator can tell you. Another indicator, labeled NO SERVICE lights if the phone encounters no response on its control channels, meaning that there is no cellular service in the area you're in at the moment. That indicator also can be used to let you know when a call is terminated, or when a signal dropout occurs.

Because they already contain a clock circuit for the control of a microprocessor, cellular phones can also provide time-keeping services. The simplest just tell you the length of the last call you made. Others tell you how long you've been engaged in the call you're currently making (that can be quite useful, since cellular phone calls are billed on a per-minute basis). Some phones can tell you how long you've been talking, the total length of time you've used the phone (the timer can be reset to zero whenever you like), and the total number of calls you've made.

Finally, if you leave them on while you're away from them, most cellular phones are able to notify you when you return if you had a call in your absence. They can't tell you who called (although at least one firm has plans to introduce an answering machine for your car), but if you were expecting a call, at least you'll know that it probably came. **R-E**

**You Can Be
One Of The
20,000 Technicians
Certified BY IS CET**

The International Society Of Certified Electronics Technicians offers permanent certification by administering the CET exam with the FCC recognized communications option for \$20. A second exam on FCC regulations for a \$10 fee is required for a Radiotelephone License. Upon passing, technicians receive both a permanent Radiotelephone Operator Certificate and a CET Certificate issued by IS CET.

IS CET Offers License Renewal

IS CET has developed a program for registration of those who currently hold a valid Radiotelephone Operator License. By sending a completed application, a photocopy of your FCC License, and \$10 your license will be renewed with the assurance of a recognized national technicians association behind it.

For More Information Contact:
IS CET 2708 W. Berry, Ft. Worth, TX 76109. (817) 921 - 9101

Learn micro-processing with the new **MICRO-PROFESSOR 1P**

Students, engineers or technicians—upgrade your micro-processing skills with the new Micro-Professor 1P.

The MPF-1P features:

- extensive software support
- more built-in memory
- improved keyboard
- larger display

Three tutorial guides help cover all capabilities. The ideal training tool! MPF-1P will deliver you into the growing world of micro-processing. Invest now!

Plus—FREE GIFT Only **\$199.95**

Check this box for **FREE Z-80 Microprocessor Programming and Interfacing textbook** when you order within 7 days. \$16.95 value. (Include \$7.50 postage & handling)

ETRONIX Dept. RE0987
5326 9th Ave. N. E.
Seattle, WA 98105-3617

For immediate action call TOLL FREE:
1-800-426-1044

Full money back guarantee.

Pictured with optional printer

CIRCLE 111 ON FREE INFORMATION CARD

LEARN TV/VCR REPAIR

No Previous Experience Necessary

Now you can train at home in spare time for a money-making career as a TV/VCR Repair Specialist. No need to quit your job or school. We show you how to troubleshoot and repair videocassette recorders and TV sets, how to handle house calls and shop repairs for almost any make of television or VCR. You learn about TV receivers, tuners and antennas, x-ray emission, the characteristics of sound, how electrical impulses are converted into a TV picture, and much, much more. Tools are included with your course so you can get "hands-on" practice as you follow the lessons step by step. Send for free facts about opportunities in TV/VCR Repair and find out how you can start making money in this great career. Experts show you what to do, how to do it...guide you every step of the way! Everything is explained in easy-to-understand language with plenty of drawings, photos and diagrams.

CALL TOLL-FREE
1-800-228-5300 Dept. DE087
CALL ANY TIME—Operators to take your call 24 hours a day, 7 days a week. No cost. No obligation. No salesman will visit you.

OR MAIL COUPON TODAY

ICS SCHOOL OF TV VCR REPAIR, Dept. DE087
(SINCE 1981) Scranton, Pennsylvania 18515

Please send me free facts on how I can learn TV/VCR Repair at home in my spare time. No salesman will visit.

Name _____ Age _____
Address _____ Apt. # _____
City/State/Zip _____
Phone () _____

© A Subsidiary of National Education Corporation

CIRCLE 196 ON FREE INFORMATION CARD

STATE OF SOLID STATE



ROBERT F. SCOTT,
SEMICONDUCTOR EDITOR

Micropower op-amp

PRECISION MONOLITHICS, INC. CLAIMS that their new OP-90 micropower op-amp sets new performance standards for similar devices. Although the OP-90's performance is comparable to that of the OP-07, it draws less than 20 μA —which is 1/200,000 the current needed for the OP-07. The OP-90's gain exceeds 700,000 (700V/mV), and common mode rejection is better than 100 dB.

In addition to its unusually low current drain, the op-amp can operate from a single-ended (single) power supply of +1.6 to +36 volts, or from a bipolar (dual) supply of ± 0.8 to ± 18 volts. As a single-source device, both input and output are referenced to ground and "zero-in/zero-out" (no static DC output) operation is possible. Input offset is less than 150 μV , so external nulling is not required in most applications.

The OP-90's low offset voltage and high gain enables it to provide precision performance in low-frequency micropower applications. Its exceptionally low voltage and current requirements make the device ideal for battery and solar-power operation in such applications as portable instruments, remote sensors, and satellites.

The OP-90 has the same pinout as the 741, has nulling to V^- , and can be used to upgrade low-frequency equipment that presently uses the OP-20, ICL8021, HA5141, LF441, or the OPA21. It is available as the OP-90GP in an 8-pin plastic DIP with a commercial temperature range. (At $T_A = 25^\circ\text{C}$, maximum offset voltage is 450 μV .) It is also available as the OP-90AZ

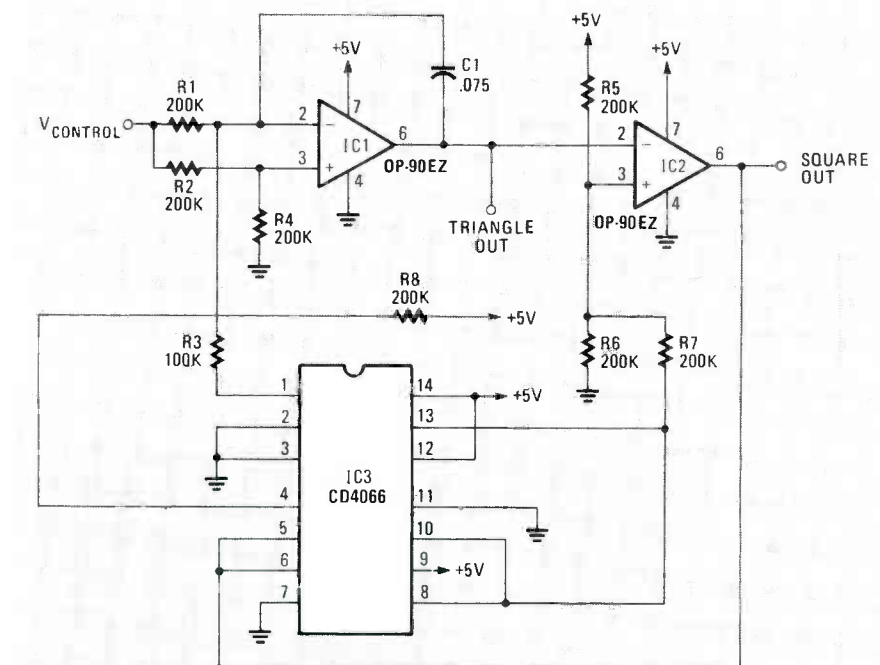

FIG. 1

and OP-90EZ; those are hermetic 8-pin DIP's with the former operating in the military temperature range and the latter in the industrial range. Both have $V_{OS(max)}$ of 150 μV at 25°C available. Another version, the OP-90FZ, also in a hermetic DIP; that device operates in the industrial temperature range and has 250- μV maximum voltage offset.

Figure 1 shows how two OP-90's and a CD4066 CMOS quad bilateral switch can be used to make an inexpensive precision voltage-controlled oscillator. The oscillator provides squarewave and triangular-wave outputs up to a few hundred hertz, and draws only 50 μA from a 5-volt power supply.

Op-amp IC1 is connected as an integrator. Op-amp IC2 is used as a Schmitt trigger, with resistors R5, R6, R7 and the associated internal CMOS switches setting the hysteresis to precisely 1.67 volts. The Schmitt-trigger action shapes IC1's output into a triangular waveform of 3.33 volts peak (5.00V - 1.67V). IC2's output is a squarewave whose amplitude swing is essentially zero to +5 volts.

The output frequency for the oscillator shown in Fig. 1 is:

$$f_{out} = V_{in}(\text{volts}) \times 10\text{Hz/V}$$

however, frequency can be varied—within limits—by changing the value of integrating capacitor C1. R-E

MARKET CENTER

FOR SALE

TV tunable notch filters, free brochure. **D.K. VIDEO**, Box 63/6025, Margate, FL 33063. (305) 752-9202.

VIDEO surveillance system for pvt inv. ins. Adj P.D. radio remote control operates unattended free brochure. **BILL PRICE AND ASSO.**, P.O. Box 568, Niceville, FL 32578.

CLASSIFIED AD ORDER FORM

To run your own classified ad, put one word on each of the lines below and send this form along with your check to:

Radio-Electronics Classified Ads, 500-B Bi-County Boulevard, Farmingdale, NY 11735

PLEASE INDICATE in which category of classified advertising you wish your ad to appear. For special headings, there is a surcharge of **\$23.00**.

() Plans/Kits () Business Opportunities () For Sale
() Education/Instruction () Wanted () Satellite Television
() _____

Special Category: \$23.00

PLEASE PRINT EACH WORD SEPARATELY, IN BLOCK LETTERS.

(No refunds or credits for typesetting errors can be made unless you clearly print or type your copy.) Rates indicated are for standard style classified ads only. See below for additional charges for special ads. **Minimum: 15 words.**

1	2	3	4	5
6	7	8	9	10
11	12	13	14	15 (\$42.75)
16 (\$45.60)	17 (\$48.45)	18 (\$51.30)	19 (\$54.15)	20 (\$57.00)
21 (\$59.85)	22 (\$62.70)	23 (\$65.55)	24 (\$68.40)	25 (\$71.25)
26 (\$74.10)	27 (\$76.95)	28 (\$79.80)	29 (\$82.65)	30 (\$85.50)
31 (\$88.35)	32 (\$91.10)	33 (\$94.05)	34 (\$96.90)	35 (\$99.75)

We accept MasterCard and Visa for payment of orders. If you wish to use your credit card to pay for your ad fill in the following additional information (Sorry, no telephone orders can be accepted.):

Card Number

Expiration Date

Please Print Name

Signature

IF YOU USE A BOX NUMBER YOU MUST INCLUDE YOUR PERMANENT ADDRESS AND PHONE NUMBER FOR OUR FILES. ADS SUBMITTED WITHOUT THIS INFORMATION WILL NOT BE ACCEPTED.

CLASSIFIED COMMERCIAL RATE: (for firms or individuals offering commercial products or services) \$2.85 per word prepaid (no charge for zip code)...**MINIMUM 15 WORDS.** 5% discount for same ad in 6 issues; 10% discount for same ad in 12 issues within one year; if prepaid. **NON-COMMERCIAL RATE:** (for individuals who want to buy or sell a personal item) \$2.30 per word, prepaid...no minimum. **ONLY FIRST WORD AND NAME** set in bold caps at no extra charge. Additional bold face (not available as all caps) 50¢ per word additional (20% premium). Entire ad in boldface, add 20% premium to total price. **TINT SCREEN BEHIND ENTIRE AD:** add 25% premium to total price. **TINT SCREEN BEHIND ENTIRE AD PLUS ALL BOLD FACE AD:** add 45% premium to total price. **EXPANDED TYPE AD:** \$4.30 per word prepaid. All other items same as for STANDARD COMMERCIAL RATE. **TINT SCREEN BEHIND ENTIRE EXPANDED TYPE AD:** add 25% premium to total price. **TINT SCREEN BEHIND ENTIRE EXPANDED TYPE AD PLUS ALL BOLD FACE AD:** add 45% premium to total price. **DISPLAY ADS:** 1" x 2 1/4"—\$320.00; 2" x 2 1/4"—\$640.00; 3" x 2 1/4"—\$960.00. **General Information:** Frequency rates and prepayment discounts are available. **ALL COPY SUBJECT TO PUBLISHERS APPROVAL. ADVERTISEMENTS USING P.O. BOX ADDRESS WILL NOT BE ACCEPTED UNTIL ADVERTISER SUPPLIES PUBLISHER WITH PERMANENT ADDRESS AND PHONE NUMBER.** Copy to be in our hands on the 12th of the third month preceding the date of the issue. (i.e., Sept. issue copy must be received by May 12th). When normal closing date falls on Saturday, Sunday or Holiday, issue closes on preceding working day.

RESTRICTED technical information: Electronic surveillance, schematics, locksmithing, covert sciences, hacking, etc. **Huge selection. Free brochure MENTOR-Z**, 135-53 No. Blvd., Flushing, NY 11354.

COMMODORE chips, distributor factory fresh (e.g. 6526-\$9.95 and many others). C64 power supply—\$27.00...."Commodore Diagnostician", a complete chart for diagnosing faulty IC's \$6.95. Send for complete chips/parts catalog. **Kasara MICROSYS, INC.**, 33 Murray Hill Drive, Spring Valley, NY 10977. (800) 642-7634 (outside NY) or (914) 356-3131.



Quality Microwave TV Antennas

Super High Gain System \$99.95 (+ shipping)
AMR High Gain System \$79.95 (+ shipping)
Multi-Channel 1.9 to 2.7 GHz

Dealerships, Qty. Pricing, Replacement Parts

Phillips-Tech Electronics

P.O. Box 8533 • Scottsdale, AZ 85252

(602) 947-7700 (\$3.00 Credit all phone orders!)
MasterCard • Visa • C00 s

LIFETIME WARRANTY

TUBES: "Oldest," "Latest." Parts and schematics. **SASE** for list. **STEINMETZ**, 7519 Maplewood Ave., RE Hammond, IN 46324.

TEXT 2 upgrade CD players, other equipment with Audio Amateur, world's only audio construction quarterly. \$18/year; \$30/two. Satisfaction guaranteed. **MC/VISA** (603) 924-9464; checks to **Box 576, Dept. E78**, Peterborough NH 03458-0576.

APEX^R screwdriving bits. Any size. Free bargain list. Write. **R. SHOCKEY'S**, 5841 Longford, Dayton, OH 45424.

WHOLESALE car stereos, alarms, electronics. Huge selection. Send **SASE**. **NORMAN ELECTRONICS**, Box 3579A Ridgewood, NY 11386.

PRINTER switch w/cables, serial/ parallel \$39.85. Free brochure. **HAWK**, 2430 Oarfish Lane, Oxnard, CA 93035.

PLASMA sphere, fascinating lightning display. Build yours for \$50, plans \$10, prefilled sphere parts kit \$50, deluxe kit \$75, assembled \$125. exotic catalog \$2. **RIESS**, POB 54625, Dept. E, Phoenix, AZ 85078.

LASER power supplies 120V battery operation 1 to 5MW. Adjustable kit \$39.00 1MW kit \$29.00. Send for free data sheet **GENERAL SCIENCE & ENGINEERING ROCH.** N.Y. PO Box 447, 14603.

MICROWAVE antennas, multi-channel 1.9-2.7 ghz, dual polarity. Now only \$49.95. Oldest and largest manufacturer. **STAR ELECTRONICS CORP.**, Call 1-800-247-1151 or 1 (602) 939-1151.

SILVER solder syringe just add heat \$13.95. **MISCO**, 7619 Detour, Cleveland, OH 44103.

SIZZLING deals: Zenith (The Real Thing): Jerold oak scientific Atlanta. No Michigan sales **HOTRONICS** (313) 283-4299.

CB RADIO OWNERS!

We specialize in a wide variety of technical information, parts and services for CB radios. 10M-FM conversions, repairs, books, plans, kits, high-performance accessories. Our 11th year! Catalog \$2.

CBC INTERNATIONAL, P.O. BOX 31500RE, PHOENIX, AZ 85046

FLASHLIGHT that needs no batteries measures 5' x 3' ideal for every situation money back guarantee \$10.—**SAMUELS ENTERPRIZES**, 724 East 231 Street, Bronx, NY 10466.

FREE catalog—quality low noise, high gain, UHF/UHF pre-amplifiers, VHF to UHF converters. PSU's, power amplifiers 10-1000 MHz, filters, etc. Contact **K.T. ELECTRONICS**, Rathorum, Co. Wicklow, Ireland.

RADIO tubes. Send \$1.00 (refundable) for extensive lists. **DIERS**, 4276-E North 50th Street, Milwaukee, WI 53216-1313.

TUBES, name brands. New, 80% off list, **KIRBY**, 298 West Carmel Drive, Carmel, IN 46032.

FREE power supply with **Assortment #103** (February '84 article, has printed circuit, TOKO coils(4), 2N3904(2), BFQ85, 7812, 74123, MC1330, 1N914, 1N5231B. **TELE-ASE-MAST ASSORTMENT #301** (October Article) Printed Circuit with all IC's, transistors, diodes. Only \$25.00/each assortment. Five/\$112.50. Shipping \$3.00. 1 (800) 821-5226 Ext. 426. (orders) or write **JIM RHODES INC.**, P.O. Box 3421, Bristol, TN 37625.

DESCRAMBLER catalog. All brands. Special combo Jerrold 400 and SB3 \$165. Descrambler kit \$39.00 (assembles in half hour). Send \$1.00. **MJ INDUSTRY**, Box 531, Bronx, NY 10461.

TUBES! 59¢. Year guarantee. Free catalog. Tube tester \$8.95. **CORNELL**, 4215 University, San Diego, CA 92105.

IS it true...Jeeps for \$44 through the government? Call for facts! 1 (312) 742-1142, ext. 4673.

OLDTIME radio programs on high quality tapes. Comedy! Adventure! Music! Free catalog. **CARL F. FROELICH**, Heritage Farm, New Freedom, PA 17349.

TEST equipment, reconditioned. For sale. \$1.25 for catalog. **WALTER'S**, 2697 Nickel, San Pablo, CA 94806. (415) 724-0587.

OLD radio TV schematics. Send \$1.00, make, model. **RADIO MAPS**, P.O. Box 791, Union City, CA 94587.

A SINGER'S DREAM!

REMOVES VOCALS FROM RECORDS!
Now You can sing with the world's best bands!
The Thompson Vocal Eliminator can remove most or virtually all of a lead vocal from a standard stereo record and leave the background!
Write or call for a free brochure and demo record.
LT Sound, Dept. R-1, P.O. Box 338, Stone Mountain, GA 30086 (404) 493-1258

LASERS, components and accessories. Free catalog, **M.J. NEAL COMPANY**, 6672 Mallard Ct., Orient, OH 43146.

BUILD your own pro monitors 32 pg. 5 part manual discloses design criteria utilized by major manufacturers of pro monitoring systems. Blueprints included! \$25.00 complete to: **BRIX ENTERPRISES INC.**, 2419 Richmond Road, S.I. NY 10306.

TUBES, new, unused. Send self-addressed, stamped envelope for list. **FALA ELECTRONICS**, Box 1376-2, Milwaukee, WI 53201.

ZENITH SSAVI, ready to go \$100.00 plus shipping, order C.O.D. 1 (305) 752-9202.

DECODE nearly any Gated Pulse signal with our new super simple circuit. Works on In-band, AM or FM pilot tone—use with Hamlin, Jerrold, Sylvania. Complete plans and theory only \$13.50 plus \$1.50 P&H. **ELÉPHANT ELECTRONICS INC.**, Box 41865-J, Phoenix, AZ 85080. (602) 581-1973.

ROBOT! kits. Books and Plans! Learn to build your own robots. Free catalogs contain hundreds of affordable robot systems. Explore the world of robotics today. Catalog: **CEARGS-ROBOTS!**, POB 458, Peterborough, NH 03458. (603) 924-3843.

VIDEO scrambling techniques, the original "secret manual" covers Sinewave, Gatedpulse, and SSAVI systems. 56 pages of solid, useful, legible information, only \$14.95 **ELÉPHANT ELECTRONICS INC.**, Box 41865-J, Phoenix, AZ 85080. (602) 581-1973.

PHOTOFACT folders, under #1400 \$3.00. Others \$5.00. Postpaid. **LOEB**, 414 Chestnut Lane, East Meadow, NY 11554.

EQUIPMENT liquidation: Surplus remote-control converters, with touch-type remotes, favorite channel programmable, digital PLL synthesized, automatic fine tuning, switched TV outlet, 30 day warranty, \$35.00. Quantity package 25+ units \$15.00@, field run, as is (includes service manual). Oak minicore N12 decoders quantity package 25+ units \$20.00@, field run, as is. "Beeping", notch filter CH3 decoders, 30-day warranty, \$15.00@, quantity 25+ \$10.00@, field run, as is, shipped prepaid. All others add \$3.00 unit shipping. Send money order to **ELECTRONICS PRESS**, PO Box 10009, Colorado Springs, CO 80932.

TI-99/4A software/hardware bargains. Hard to find items. Huge selection. Fast service. Free catalog. **DYNA**, Box 690, Hicksville, NY 11801.

FREE IBM clone motherboards/bare send \$6.00 P&H. **DRUIZ**, P.O. Box 26201, Santa Ana, CA 92799-6201.

CABLE TV CONVERTERS. Scientific Atlanta, Jerrold, Oak, Zenith, Hamlin. Many others. "New" **VIDEO HOPPER** "The Copy Killer". Visa, M/C & Amex Accepted. Toll Free **1-800-826-7623**. **B&B Inc.**, 10517 Upton Circle, Bloomington, Mn. 55431.

TOUCH ON LAMP conversion module convert your metallic lamp in minutes to touch on, 3 levels, 200 watts, \$19.95 LSE, Box 424, Sun Prairie, WI 53590

CABLE-TV converters and descramblers. Low prices, quality merchandise, we ship C.O.D. Send \$2.00 for catalog. **CABLETRONICS UNLIMITED** P.O. Box 266, South Weymouth, MA 02190 (617) 843-5191.

Parts Express **HARDWARE AND ELECTRONICS**

MAGNIFIER LAMP
• 4" diopter magnifying lens
• Uses up to a 60 watt bulb (not included). UL listed, 117VAC
#350-010 **\$26⁹⁵**

COPPER CLAD PC BOARD
9" x 8" Double Sided #055-300 **\$1⁵⁰**
18" x 12" Double Sided #055-320 **\$3⁹⁵**

RS-232 DATA SWITCH
• 2 position, rotary type • Fully shielded, FCC approved
#130-010 **\$27⁹⁵**

PIONEER HORN TWEETER
• Frequency response 1800 to 15,000Hz • Power handling capabilities: 35W RMS, resonant frequency 2 kHz 3/4" x 3/4"
#270-050 **\$6⁵⁰** **\$5⁹⁰** (10-UP)

12" PIONEER WOOFER
• Power: 65W RMS • 11 oz. magnet • 25 to 2500 Hz response • 1 1/2" voice coil
#290-100 **\$1⁵⁰** **\$13⁹⁵** (4-10)

TOROIDAL TRANSFORMER
• 120 volt primary, 2 - 20V, 5A secondaries • 4 1/2" round • 4 lbs
#120-150 **\$12⁵⁰** **\$9⁹⁵** (1-3) (4-10)

FREE CATALOG

Our new 56 page catalog contains thousands of items that you need every day for do-it-yourself projects, product engineering, electronics repair and more. Call us today for your free copy and start saving!

300 PIECE CAPACITOR KIT
• A great assortment of different values and working voltages. Includes electrolytics, ceramics, mylars, and more!
#020-920 **\$4⁹⁵**

CALL TOLL FREE 1-800-255-3525

In Ohio: 1-800-322-3525
Local: (513) 222-0173

• 15 day money back guarantee. • \$10.00 minimum order. • COD orders accepted. • 24 hour shipping. • Shipping charge - UPS chart rate (\$2.50 min. - 5 p.m. EST M-F. - 11 p.m. charge). Hours 8:30 a.m. - 6 p.m. EST M-F.

PARTS EXPRESS INTL. INC.
340 East First St.
Dayton, Ohio 45402

AMERICAN CANON SOCIETY®

Visa
MasterCard

You can help us raise the colorectal cancer cure rate.

When detected early, the cure rate for colorectal cancer is very high. That's why we urge regular checkups for men and women 50 and over.

Warning signs are a change in bowel habits, blood in the stool.

Your doctor can perform the digital and procto exams, and you take care of the stool blood test at home.

Checkup Guidelines for men and women over 50 without symptoms:
• digital exam annually
• stool blood test annually
• procto exam every 3 to 5 years after 2 negative tests 1 year apart

PLANS AND KITS

BUILD this five-digit panel meter and square-wave generator including an ohms, capacitance and frequency meter. Detailed instructions \$2.50. **BAGNALL ELECTRONICS**, 179 May, Fairfield, CT 06430.

HI-FI speaker systems, kits and speaker components from the world's finest manufacturers. For beginners and audiophiles. Free literature. **A&S SPEAKERS**, Box 7462, Denver, CO 80207. (303) 399-8609.

VOICE disguisers! FM bugs! Telephone transmitters! Phone snoops! More! Catalog \$1.00 (Refundable): **XANDI ELECTRONICS**, Box 25647, Dept. 60R, Tempe, AZ 85282.

PROJECTION TV...Convert your TV to project 7 foot picture. Results comparable to \$2,500 projectors...Total cost less than \$30.00 plans and 8" lens \$21.95...Illustrated information **FREE**...**MACROCOMA-GA**, Washington Crossing, PA 18977. Creditcard orders 24hrs. (215) 736-3979.

JERROLD gated pulse theory. Twelve information-packed pages covering DI & DIC converter operation. Includes introduction to trimode system. \$6.95 plus \$1.50 postage and handling. **ELÉPHANT ELECTRONICS INC.**, Box 41865-J, Phoenix, AZ 85080. (602) 581-1973.

DESCRAMBLE the latest video cassette copy-protection scheme. Our simple line zapper circuit takes the jitter out of your picture. Complete plans and theory only \$13.95 plus \$1.50 postage and handling. PC board and complete kits also available. **ELÉPHANT ELECTRONICS INC.**, Box 41865-J, Phoenix, AZ 85080. (602) 581-1973.

MINIATURE electronic devices, like James Bond's. Catalog \$2.00. **F&P ENTERPRISES**, Box 51272, Palo Alto, CA 94303-L.



DO YOU REALLY GET THE BEST BUY FROM THEM?

Let's face it: There will always be some outfit that can undercut a published price. They do it by having no overhead, and no responsibility to you, the consumer.

"So, you want that Jerrold 450 combo? The one that Pacific Cable Co., Inc., is offering for \$199⁰⁰? Well, that's a good price, but here's what I'll do..." What may happen is that you may save a couple of bucks at the time. But suppose there's a problem (and it happens to the best of them,) and you call that "Dealer"... This could be what you'll hear:

"No, Steve isn't here. He moved out, the bum! And he owes me \$437⁰⁰ on the phone bill! No, I don't know about any guarantees on your Gerald, who's that? Listen, if you see that creep..." etc.

At Pacific Cable Co., you've got an established company who will be here for you, time after time. We may be tough competitors, but we've got a soft spot for our clients! Try us, and be treated right—and we'll prove it by giving a one-year warranty on everything we sell.

Check our prices on Scientific Atlanta Units!

ITEM	1 UNIT	10 OR MORE	ITEM	1 UNIT	10 OR MORE
RCA 36 Channel Converter (Ch.3 output only)	29.00	18.00	*Minicode (N-12) with Vari Sync.....	99.00	62.00
Panasonic Wireless Converter (our best buy).....	88.00	69.00	*Minicode VariSync with Auto On-Off.....	145.00	105.00
400 or 450 Converter (manual fine tune).....	88.00	69.00	Econocode (minicode substitute).....	79.00	52.00
*Jerrold 400 Combo.....	169.00	119.00	Econocode with VariSync.....	89.00	56.00
Jerrold 400 Hand Remote Control.....	29.00	18.00	*MLD-1200-3 (Ch.3 output).....	99.00	58.00
Jerrold SB-Add-On.....	89.00	58.00	*MLD-1200-2 (Ch.2 output).....	99.00	58.00
*Jerrold SB-Add-On with Trimode.....	99.00	70.00	*Zenith SSAVI Cable Ready.....	175.00	125.00
*M-35 B Combo unit (Ch 3 output only).....	99.00	70.00	Interference Filters (Ch.3 only).....	24.00	14.00
*M-35 B Combo unit with VariSync.....	109.00	75.00	*Eagle PD-3 Descrambler (Ch.3 output only).....	119.00	65.00
*Minicode (N-12).....	89.00	58.00	*Scientific Atlanta Add-on Replacement Descrambler.....	119.00	75.00

CHECK US OUT—WE'LL MEET OR BEAT THE OTHER'S ADVERTISED WHOLESALE OR RETAIL PRICES!



Pacific Cable Co., Inc.

7325½ Reseda Blvd., Dept. R-09
Reseda, CA 91335
(818) 716-5914 • (818) 716-5140

• NO COLLECT CALLS! •

IMPORTANT • When ordering, please have the make and model number of the equipment used in your area—Thank you!

*Call for availability

Prices subject to change without notice

Jerrold is a registered trademark of General Instruments Corp.

Quantity	Item	Output Channel	Price Each	TOTAL PRICE

California Penal Code #593-D forbids us from shipping any cable descrambling unit to anyone residing in the state of California.

Prices subject to change without notice

PLEASE PRINT

Name _____

Address _____ City _____

State _____ Zip _____ Phone Number () _____

Cashier's Check Money Order C.O.D. Visa Mastercard

Acct. # _____ Exp. Date _____

Signature _____

FOR OUR RECORDS

DECLARATION OF AUTHORIZED USE — I, the undersigned, do hereby declare under penalty of perjury that all products purchased, now and in the future, will only be used on cable TV systems with authorization from local officials or cable company officials in accordance with all applicable federal and state laws.

Dated: _____ Signed: _____

SUBTOTAL	
Shipping Add	\$3.00 per unit
COD & Credit Cards—Add 5%	
TOTAL	

CRYSTAL radio sets, plans, parts, kits, catalog \$1.00. MIDCO, 660 North Dixie Highway, Hollywood, FL 33020.

CATALOG: hobby/broadcasting/1750 meters/ham/CB: transmitters, antennas, scramblers, bugging devices, more! PANAXIS, Box 130-F10, Paradise, CA 95967.

FREE catalog 99-cent kits—audio, video, TV, computer parts. ALLKIT, 434 W. 4th St., West Islip, NY 11795.

STRANGE stuff. Plans, kits, new items. Build satellite dish \$69.00. Descramblers, bugs, adult toys. Informational photo package \$3.00 refundable. DIRIJO CORPORATION, Box 212, Lowell, NC 28098.

PAC-TEC Enclosure specified in Feb. '87 R-E article on Tri-Mode. Pre-drilled. \$24.95 plus \$2.50 or send to THE HOBBY HELPER, P.O. Box 308, Bridgewater, MA 02324.



**WRITE FOR
McGEE'S
SPEAKER & ELECTRONICS CATALOG**
1001 BARGAINS IN SPEAKERS
toll free 1-800-346-2433 for ordering only.
1901 MCGEE STREET KANSAS CITY, MO. 64108

DETECTIVES, experimenters. Exciting new plans. Hard to find micro and restricted devices. Large catalog \$5.00 refundable on 1st order. WILSON, P.O. Box 5264, Augusta, GA 30906.

FREE microprocessors, memory chips, etc. Free electronics magazine subscriptions. Free education in computers. For information write MICROSAT CORPORATION, 2401 N.E. Cornell, Bldg. 133, Mail Stop 125, Hillsboro, OR 97124.



**VIDEO TAPE
COPYGUARD**
Eliminate the latest copyguard problems
units from \$59⁹⁵ to \$169⁹⁵
Deluxe Electronics (714) 998-6866
1432 Heim Wy., Orange, Ca. 92665

DESCRAMBLING, New secret manual. Build your own descramblers for Cable and Subscription TV. Instructions, schematics for SSAVI, gated sync, sinewave. (HBO, Cinemax, Showtime, etc.) \$8.95 + \$1.00 postage. Catalog \$1.00. CABLETRONICS, Box 30502R, Bethesda, MD 20814.

SATELLITE descrambling manual, Video Cypher II. Schematics, thorough explanation of digital audio encoding, EPROM code, DES. (HBO, Cinemax, Showtime.) \$10.95 + \$1.00 postage. Catalog \$1.00. CABLETRONICS, Box 30502R, Bethesda, MD 20814.

WEIRD, fascinating, unusual, fun projects for the electronics gadgeteer. Free information. TAYLOR ELECTRONICS, P.O. Box 1612, Destin, FL 32541.

BUSINESS OPPORTUNITIES

MECHANICALLY inclined individuals desiring ownership of small electronics manufacturing business—without investment. Write: **BUSINESSES,** 92-R, Brighton 11th, Brooklyn, NY 11235.

PROJECTION TV... Make \$\$\$'s assembling projectors...easy...results comparable to \$2,500 projectors. Total cost less than \$30.00. **PLANS, 8" LENS** and dealers information \$20.50. Illustrated information free. **MACROCOMA-GAX,** Washington Crossing, PA 18977. Creditcard orders 24hrs. (215) 736-2880.

YOUR own radio station! AM, FM, cable. Licensed or unlicensed. **BROADCASTING,** Box 130-F10, Paradise, CA 95967.

PERSONAL computer owners can earn \$1000 to \$5000 monthly offering simple services part time. Free list of 100 services. Write: **C.I.L.G.B.,** P.O. Box 60369, San Diego, CA 92106-8369.



**ELECTRONIC
ASSEMBLY BUSINESS**
Start home, spare time. Investment knowledge or experience unnecessary. **BIG DEMAND** assembling electronic devices. Sales handled by professionals. Unusual business opportunity.
FREE: Complete illustrated literature
BARTA, RE-O Box 248
Walnut Creek, Calif. 94597

EARN thousands with your own electronics business. I do. Free proof, information. **INDUSTRY,** Box 531, Bronx, NY 10461.

HOME assembly Assemble PC boards for video accessories. We supply materials. No experience needed. \$7.50 per hour. Send self-addressed stamped envelope, to: **MICRON-ELECTRONICS,** Box 4716, Akron OH 44310.

SATELLITE TV

CABLE TV Secrets—the outlaw publication the cable companies tried to ban. HBO, Movie Channel, Showtime, descramblers, converters, etc. Suppliers list included \$8.95. **CABLE FACTS,** Box 711-R, Pataskala, OH 43062.

SATELLITE TV equipment. Buyers guide, discount prices. \$3.00 **N.E.C.S. INC.,** Box 22808-R1, Little Rock, AR 72221.

GREAT VALUES • FAST SHIPPING • QUANTITY DISCOUNTS

150MC Digital Frequency Counter SM-100

 Frequency Range: 10Hz - 150MHz
 Event Counter: 0 to 99999999 counts (8 Digit)
 Input sensitivity: KHz range 10Hz - 10MHz 50mVrms.
 MHz range 1MHz - 150MHz 40mVrms.
 Response time: 0.2 second
 Hold Function: Holds the last input signal.
 Power Supply: DCEV Battery or DC9V Adaptor
 Dimensions: 9 7/8" x 6 11/16" x 2 3/4"
 Assembled with tested \$99.00
FREE AC ADAPTOR AVAILABLE UNTIL STOCKS LAST

HIGH QUALITY PRE-AMPLIFIER WITH 10 BAND EQUALIZER TA-2500

 NEW with CD input stage
 Ass. with tested \$90.00

FREE CATALOG
2nd Anniversary
FREE \$10 Coupon
 with every purchase over \$10

100W + 100W NEW CLASS 'A' DC STEREO PRE-MAIN AMPLIFIER TA-1500

200W POWERFUL AMP W/MIC MIXER!
 KIT \$67.00
 METAL CABINET/'X'FORMER \$26/\$16.80

INFRARED REMOTE CONTROL UNIT TA-41 MKV

FREE DELUXE CONTROL BOX
CAN BE SWITCHED ON TO ANY ELECTRICAL APPLIANCES UP TO 200W!

120W MOSFET POWER AMPLIFIER TA-477

 Kit Metal Cabinet/'X'Former (Optional) \$61.28 \$26.00/\$19.88

ELECTRONIC ECHO AND REVERBERATION AMPLIFIER TA-2400A

RECORDS W/ ECHO EFFECT YOURSELF!
 Ass. with tested \$99.85

STEREO SIMULATOR TA-3000

UP GRADE YOUR TV & VCR
MARK V PROMISES TO SERVE YOU THE BEST
 KIT ONLY \$25

PROFESSIONAL COLOR LIGHT CONTROLLER SM-328

FEATURES
 1. FOUR GROUPS OF INDEPENDENT OUTPUT SYSTEM 1000W EACH
 BOARD TYPE 1 2. PROFESSIONAL INPUT COLOR CONTROL SYSTEM (KEY GROUPS OF INDEPENDENT DIMMER CONTROL, 5 SPEED CONTROL, CHASER, 6 AUTOMATIC CHASING CONTROL SYSTEM 7 FOUR KINDS OF SPECIAL CHASING PROGRAM 8 COMBINATION OF PROGRAM AND CONTROL SM 328 color light controller is specialized for ballroom, night club and advertisement lighting. It consists with several color control program and fluctuating music signal. There are two kinds of lighting effects incorporated with an independent signal adjustment. The first type is controlled by "music" signal will be separated into high, medium and low A, and low B frequency range. Furthermore, each group of lighting is independent of electrical circuits and this is the main part for creating a special lighting effect. It has four chasing programme.
 Dimensions 14 5/16" x 8 15/16" x 3 3/16"
 Ass. with tested \$150.00 ONLY

TERMS: \$10 min order • \$20 min charge card order • Check, money order or phone order accepted • We ship UPS Ground • Add 10% of total order (min \$2.50) for shipping, outside USA add 20% (min \$5.00) • CA residents add sales tax • All merchandise subject to prior sale • Prices are subject to change without notice • Any goods proved to be defective, **MUST BE RETURNED** IN ORIGINAL FORM WITH A COPY OF YOUR INVOICE WITHIN 30 DAYS FOR REPLACEMENT.

You can own a stereo TV from today!
 This simulator is special design of using the most advanced, monophonic L.S.I. It produced a superior analog stereo effect since the L.S.I. is equalled 60 pcs. of LOW NOISE FET & TRANSISTOR. The simulator can even help you to promote your television from a normal one to a special one with a Hi-Fi STEREO function. Our simulator is also applicable to any other "mono sources" in covering it to ANALOG STEREO. Undoubtedly, it is the most advanced equipment for every family, while it should contribute to your listening pleasure.
 Ass. with tested \$30.00

OFFICE HOURS:
 (PACIFIC TIME)
 MON.—FRI. 9:30 to 5:00 SAT. 10:00 to 5:00

MARK V ELECTRONICS INC.,
 248 EAST MAIN STREET, SUITE 100,
 ALHAMBRA, CA 91801
 TELEX: 3716914 MARK 5

1-800-423-3483
 TOLL FREE
 Only for orders paid by Master or VisaCard
 IN CAL.: 1-800-521-MARK

INFORMATION: 1-818-282-1196
 MAIL ORDER: P.O. BOX 6610
 ALHAMBRA, CA 91802

RADIO-ELECTRONICS

CIRCLE 93 ON FREE INFORMATION CARD



Plug a Friend into Radio-Electronics this Christmas ... and Save \$12!

This Christmas give an electrifying gift ... plug a friend into Radio-Electronics and brighten his whole new year! Whether electronics is his livelihood or his hobby, your gift will sharpen his focus and illuminate the whole spectrum of electronics throughout the coming year.

Radio-Electronics will keep him informed and up-to-date with new ideas and innovations in all areas of electronic technology ... computers, video, radio, stereo, solid state technology, satellite TV, industrial and medical electronics, communications, robotics, and much, much more.

He'll get complete plans and printed circuit patterns for building valuable test equipment and electronic devices for home and car — practical money-savers like these ... a TV signal descrambler ... a video test generator ... an auto exhaust analyzer ... a clockboard for his PC ... a radio commercial zapper ... a solid state barometer ... a working robot ... and many others!

PLUS ... equipment repair and troubleshooting ... circuit design ... new

product news and buyer's guides ... service clinics ... equipment test reports ... a special "ComputerDigest" section ... regular columns on video, stereo, radio, circuits, solid state, satellite TV and robotics ... and lots more exciting features and articles.

SAVE \$12 ... OR EVEN \$24 ... For each gift of Radio-Electronics you give this Christmas, you save a full \$12.00 off the newsstand price. And as an R-E gift donor, you're entitled to start or extend your own subscription at the same Special Holiday Gift Rate — you save an additional \$12.00!

No need to send money ... if you prefer, we'll hold the bill till January, 1988. But you must rush the attached Gift Certificate to us to allow time to process your order and send a handsome gift announcement card, signed with your name, in time for Christmas.

So do it now ... take just a moment to fill in the names of a friend or two and mail the Gift Certificate to us in its attached, postage-paid reply envelope. That's all it takes to plug your friends into a whole year of exciting projects and new ideas in Radio-Electronics!

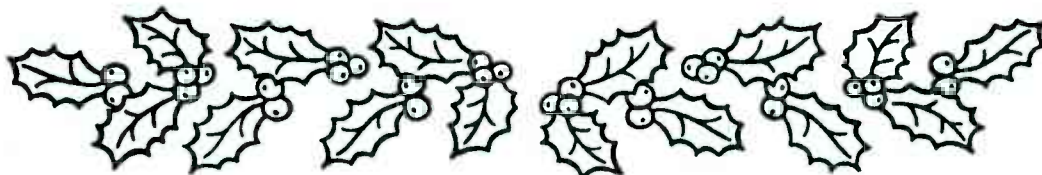

DESCRAMBLER. Build our low cost satellite TV video only descrambler for all major movies and sports. Uses all Radio Shack parts. Order P.C. board and instructions by sending cheque, money order, or Visa for \$35.00 U.S. funds to: **VALLEY MICROWAVE ELECTRONICS**, Bear River, Nova Scotia, Canada, BOS-1BO (902) 467-3577.

Multi-Channel Microwave T.V. Receivers



1.9-2.7 GHz Parabolic Dish 40+ dB Gain
LIFETIME WARRANTY
 Complete System \$89.95 (Shipping Incl.)
 Replacement Components & Expert Repairs Available
K & S ELECTRONICS Call now for same
 P.O. BOX 34522 day shipping!
 PHOENIX, AZ 85067 (602) 230-0640
 VISA/MC/COD For Dealer Rates Call 602-888-4080

SATELLITE TV receiver kits! LNA's! Instructions! Schematics! Catalog \$1.00 (refundable): **XANDI ELECTRONICS**, Box 25647, Dept. 21T, Tempe, AZ 85282.

SCIENTIFIC Atlanta cable users series 8500 8550 get all channels instructions for simple modification costs under \$10.00 to make. Complete instructions. Send \$10.00 no checks to **K.F. SPECIALTIES**, P.O. Box 443, Forked River, NJ 08731.

SATELLITE systems \$295 up. VISA/MC available. Catalog \$3. **STARLINK INC.**, 2603-16R Artie, Huntsville, AL 35805.

10ft Satellite system, remote controlled, tracker and descrambler with 1 yr free subscription to 20 channels. \$1,495 plus UPS. **VISTA VISION**, 1 (602) 458-5482 after 10 a.m.

DESCRAMBLERS for movies, networks. \$149. video only; \$399. complete. Catalog \$4.00. **SKY-WATCH**, 238 Davenport Road, Toronto, Ontario, Canada M5R-1J6.

Cable TV Converters
Why Pay A High Monthly Fee?

Jerrold Products include "New Jerrold Tri-Mode," SB-3, Hamlin, Oak VN-12, M-35-B, Zenith, Magnavox, Scientific Atlanta, and more. (Quantity discounts) 60 day warranty. For fast service C.O.D. orders accepted. Send SASE (60 cents postage) or call for info (312) 658-5320. **Midwest Electronics, Inc./, HIGGINS ELECTRONICS**, 5143-R W. Diversey, Chicago, IL 60639. MC/Visa orders accepted. No Illinois orders accepted. Mon.-Fri. -9 A.M. - 6 P.M. CST

WANTED

INVENTORS! AIM wants—ideas, inventions, new products, improvements on existing products. We present ideas to manufacturers. Confidentiality guaranteed. Call toll free 1-(800) 225-5800 for information kit.

INVENTIONS, ideas, new products wanted! Industry presentation/national exposition. Call free 1-(800) 288-IDEA. Canada, 1-(800) 528-6060. X831.

SURPLUS INVENTORIES of ICs, transistors, etc., no quantity too small or large. Call **WESTERN TECHNOLOGY**, (303) 444-4403. FAX (303) 444-4473.

INVENTORS

INVENTORS! Can you patent and profit from your idea? Call **AMERICAN INVENTORS CORPORATION** for free information. Over a decade of service. 1-(800) 338-5656. In Massachusetts or Canada call (413) 568-3753

DO IT YOURSELF TV REPAIRS

NEW...REPAIR ANY TV...EASY. Anyone can do it. Write **RESEARCH**, Rt. 3, Box 601R, Colville, WA 99114.

TUBES - 2000 TYPES
DISCOUNT PRICES!

Early, hard-to-find, and modern tubes. Also transformers, capacitors and parts for tube equipment. Send \$2.00 for 20 page wholesale catalog.

ANTIQUE ELECTRONIC SUPPLY
 688 W. First St. • Tempe, AZ 85281 • 602/894-9503

EDUCATION & INSTRUCTION

F.C.C. Commercial General Radiotelephone license. Electronics home study. Fast, inexpensive! "Free" details. **COMMAND**, D-176, Box 2223, San Francisco, CA 94126.

CASSETTE recorded home study for new **General Class FCC license** examinations. Seminars in Philadelphia, Detroit, Boston, Washington. **BOB JOHNSON TELECOMMUNICATIONS**, 1201 Ninth, Manhattan Beach, CA 90266. (213) 379-4461.

HAM licenses supereasy. Cut exam preps 50%. All classes. Free catalog. **SAE. BAHR**, 2549-E4 Temple, Palm Bay, FL 32905.

FCC Commercial General Radiotelephone license correspondence course. 60 individual lessons for \$89.50. Payment plan. Results guaranteed! Details free. **AMERICAN TECHNICAL INSTITUTE**, Box 201, Cedar Mountain, NC 28718.

IBM-PC SOFTWARE

COMPSS—Computer-Aided circuit design, selections from basic electricity to circuit designs. Very educational. \$49.95 (614) 491-0832. **ESOF SOFTWARE**, 444 Colton Road, Columbus, OH 43207.

COMPUTERS

TANDY computers! MSDOS, IBM, compatible. Discount prices! For quote or purchase call 1-800-36-SHACK. **EDGEWOOD COMPUTER CENTER.**

PAY TV AND SATELLITE DESCRAMBLING
NOW 120 PAGES

Schematics, theory bypasses 13 cable, 7 satellite systems including After Dark Video \$14.95 6 Ed Update Only \$8.95 Experiments With Videocipher Latest circuits, cloning, musketeering data \$12.95 Cable TV Two-way, security systems, design \$12.95 MDS/MMS Handbook For microwave hackers \$9.95 Build Satellite Systems Under \$600. \$12.95 Any 3:326 Summer catalog \$1

Shojiki Electronics Corp. 1327A Niagara St. Niagara Falls, NY 14303. COO's 716-284-2163

DESCRAMBLER MODULE

COMPLETE cable-TV decoder in a mini-module. Latest technology upgrade for Jerrold SB-3 or Radio-Electronics Feb. 1984 project. Available at very low cost. For literature, **SOUTHTECH DISTRIBUTING**. 1-(800)-821-5226 ext. 130.

NOTCH FILTERS

NOTCH filters for any channel. Send \$15.00 for sample unit. Specify output channel of converter. Money back guarantee. **DB ELECTRONICS**, P.O. Box 8644, Pembroke Pines, FL 33084.

THE POSITRAP COOKBOOK: Build 50-60dB notch filters for pennies. Construction, alignment, fixed, tunable, trimable. Comprehensive **CABLE TV SCRAMBLING AND DESCRAMBLING** theory and practice. Identifying various systems. \$9.95 **CLEARVIEW CABLE COMPANY**, P.O. Box 207, Sterling Heights, MI 48311.

LOOK SPECIAL INTRODUCTORY OFFER

Mention This Ad
And Take 10% OFF PRICES LISTED BELOW

***5-1/4" FLOPPY DISKS**

Software excess, erraced, Guaranteed. DSDD, with New Labels & Sleeves. \$29.50/100
LARGE QTY. PRICES AVAILABLE

INFRARED ENERGY DETECTOR KIT

Just **\$8.88**
 Allows you to listen to infrared Energy & AC Current.

COMPLETE 1Mw LASER TUBE & POWER SUPPLY KIT



* Assembly Must Conform to Gov't Specs.

- JUST \$129.90**
- * 2Mw Laser Tube (uncased) . . . \$139.95
 - * 5Mw Laser Tube (uncased) . . . \$159.95
 - * 7 to 25 Watt Laser Diode. . . . \$14.88
 - * Infrared Goggles (AN/PAS5) . . . \$399.95
 - * Jacobs Ladder/Tesla Coil Kit. . . . \$19.88

BNF Enterprises
 119r FOSTER St.
 Peabody MA 01960
 (617) 531-5774
 Free! 36 Page Catalog
Customer Pays All Shipping Charges

CIRCLE 206 ON FREE INFORMATION CARD

NUTS & VOLTS MAGAZINE P.O. Box 1111-E Placentia, CA 92670 714-832-7721

GIVE YOURSELF A BREAK—A PRICE BREAK!
NUTS & VOLTS WILL SAVE YOU MONEY ON ELECTRONIC PARTS & EQUIPMENT. PLUS SHOW YOU WHERE TO FIND UNIQUE, UNUSUAL AND HARD-TO-FIND ITEMS.

SUBSCRIBE TODAY!

Subscription Rate	U.S. FUNDS REQUIRED
3rd Class Mail - USA	
ONE YEAR \$10.00	
TWO YEARS \$18.00	
LIFETIME \$50.00	
1st Class Mail	
ONE YEAR USA \$18.00	
CANADA/MEXICO \$20.00	
Air Mail	
FOREIGN \$35.00	

A National Publication For The Buying And Selling Of Electronic Equipment

SCIENTIFIC ATLANTA & SB-3

SCIENTIFIC ATLANTA Models 8500 - 8550, remote included...\$240.00 SB-3's...\$74.00 TRI-BI's...\$95.00 SBSA-3's...\$99.00. Zenith (Z-Tac) Descramblers...\$169.00. N-12 (Vari-sync)...\$89.00. M-35B (Vari-sync)...\$99.00. Jerrold-450 and 550-Meg converters...\$95.00. Dealer Discount on (5) units. Brochure available. Call...N.A.S. (213) 631-3552.

REMOTE CONTROL KEYCHAIN



Complete w/mini-transceiver and +3-15vdc receiver Fully assembled including plans to build your own auto alarm

\$14.95 Check, Visa or M/C 30 days return

VISITECT INC (415) 872-0128
 PO BOX 5442, SO. SAN FRAN., CA 94080

Copies of articles from this publication are now available from the **UMI Article Clearinghouse.**

UMI Article Clearinghouse

Mail to: University Microfilms International
 300 North Zeeb Road, Box 91 Ann Arbor, MI 48106

Here is just a sample of what you'll find at MCM Electronics

Tenma 15MHz Dual Trace Portable Oscilloscope

- Dual trace model capable of displaying signals up to 15MHz, for up to two hours on a single charge of its internal battery
- Power can be supplied from either a 12VDC or 120/240V 50/60Hz AC source

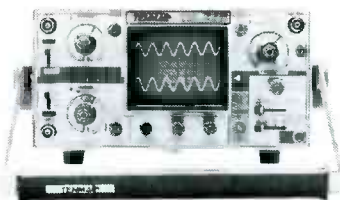

Tenma LCR Meter

- LCR Meter provides a convenient way to accurately measure inductance, capacitance and resistance (.01ohm resolution) on its 3 1/2 digit LCD display



For more specs and Test Equipment see pages 146-154 of Catalog #15

Anti-Static Work Mat

- A must for the modern service shop. ■ Use in conjunction with our #21-660 wrist strap to help eliminate static related problems
- 18" x 26"



Anti-Static Wrist Strap

- This wrist strap when used with our anti-static work mat, will effectively dissipate static charges
- The five foot coiled, cord with 1Mohm resistor, snaps to wrist strap to give user added mobility
- Cord is terminated with a banana plug and alligator clip



For complete information see page 136 of Catalog #15



MCM ELECTRONICS

858 E. CONGRESS PARK DR.
CENTERVILLE, OH 45459

A PREMIER Company



Tenma Soldering Station

- Adjustable temperature range of 150°-420° C (300°-790° F)
- Grounded tip for soldering static sensitive devices
- Overheat protection with closed loop temperature control
- Replaceable iron clad tip
- Improved circuit design for greater temperature stability

Tenma Deluxe Anti-Static Desoldering Tool

- Rugged metal construction
- Anti-static tip ■ Nozzle cleaner
- Lightweight and compact
- Disassembles easily for cleaning
- 7 1/4" long x 3/4" diameter

Additional Soldering Equipment can be found on pages 137 and 138 of Catalog #15

Super Wash

- Powerful spray cleans intricate electronic assembly without harming plastics
- Dries instantly
- Spray literally blasts dirt and grease away
- 24 oz.



Tuner Cleaner

- Cleans, lubricates, protects
- Cleans and restores dirty and corroded contacts
- Doesn't harm plastics
- 16 oz.



For more Chemicals see pages 128-130 of Catalog #15



Diskette File Box

- Stores up to 70 — 5 1/4" diskettes
- Case made of anti-static ABS plastic with smoked acrylic cover
- Six adjustable index dividers

Deluxe Joystick for Atari and Commodore

- For use with Atari, Commodore and other VCS compatible systems
- Two firing buttons
- 5.5' cord with 9 pin plug

Catalog #15 has other Computer Equipment and Accessories on pages 119-127

©1987 MCM Electronics



Be Sure To Call For Your FREE Catalog!
Over 9,000 Items!
Call Toll Free 1-800-543-4330

In Ohio 1-800-762-4315 In Alaska and Hawaii 1-800-858-1849

SOURCE CODE: RE-36

CIRCLE 87 ON FREE INFORMATION CARD

Mail Order Electronics - Worldwide

Jameco ELECTRONICS

Mail-Order Electronics

FOR ORDERS ONLY ALL OTHER INQUIRIES
415-592-8097 415-592-8121

NEC V20 & V30 CHIPS

Replace the 8086 or 8088 in Your IBM-PC and Increase Its Speed by up to 40%!

Part No.	Price
UPD70108-5 (5MHz) V20 Chip	\$ 9.95
UPD70108-8 (8MHz) V20 Chip	\$11.95
UPD70108-10 (10MHz) V20 Chip	\$34.95
UPD70116-8 (8MHz) V30 Chip	\$14.95
UPD70116-10 (10MHz) V30 Chip	\$34.95

7400

Part No.	1-9	10+	Part No.	1-9	10+
7400	29	19	7485	65	55
7402	29	19	7486	45	35
7404	35	25	7489	2.05	1.95
7405	39	29	7493	49	39
7406	39	29	7493	45	35
7407	39	29	74121	45	35
7408	35	25	74123	59	49
7410	35	25	74125	55	45
7414	49	39	74126	75	65
7416	35	25	74134	49	39
7417	45	35	74150	1.35	1.25
7420	35	25	74154	1.35	1.25
7430	35	25	74158	1.59	1.49
7432	39	29	74173	85	75
7438	39	29	74174	85	75
7442	35	25	74174	65	55
7445	79	69	74176	39	29
7446	89	79	74181	1.95	1.85
7447	89	79	74189	2.05	1.95
7448	2.05	1.95	74193	7.9	69
7472	75	65	74198	1.85	1.75
7473	35	25	74220	39	29
7474	45	35	74273	2.05	1.95
7475	49	39	74365	69	59
7476	45	35	74367	69	59

74LS

74LS00	29	19	74LS165	75	65
74LS02	29	19	74LS166	99	89
74LS04	35	25	74LS173	59	49
74LS05	35	25	74LS240	49	39
74LS06	1.09	99	74LS175	49	39
74LS07	1.09	99	74LS189	4.59	4.49
74LS08	29	19	74LS191	59	49
74LS10	29	19	74LS193	79	69
74LS14	49	39	74LS221	69	59
74LS27	35	25	74LS240	79	69
74LS30	29	19	74LS243	79	69
74LS32	35	25	74LS244	79	69
74LS42	49	39	74LS245	89	79
74LS47	99	89	74LS259	99	89
74LS73	39	29	74LS273	89	79
74LS74	35	25	74LS279	49	39
74LS75	39	29	74LS322	4.05	3.95
74LS76	55	45	74LS365	49	39
74LS85	59	49	74LS366	49	39
74LS86	35	25	74LS367	49	39
74LS90	49	39	74LS368	49	39
74LS93	49	39	74LS373	79	69
74LS123	59	49	74LS374	79	69
74LS125	49	39	74LS393	89	79
74LS138	49	39	74LS590	6.05	5.95
74LS139	49	39	74LS624	2.05	1.95
74LS154	1.09	99	74LS629	2.29	2.19
74LS157	45	35	74LS640	1.09	99
74LS158	45	35	74LS645	1.09	99
74LS163	59	49	74LS670	1.09	99
74LS164	59	49	74LS688	2.05	1.95

74S/PROMS*

74S00	29	74S188	1.29
74S04	35	74S189	1.69
74S08	35	74S196	2.49
74S10	29	74S240	1.49
74S32	35	74S244	1.49
74S74	45	74S253	79
74S85	59	74S287	1.49
74S86	35	74S288	1.49
74S124	2.95	74S373	1.49
74S174	1.49	74S374	1.49
74S175	79	74S472	2.95

74F

74F00	39	74F139	89
74F04	39	74F157	95
74F08	39	74F193	3.95
74F10	39	74F240	1.39
74F32	39	74F244	1.39
74F74	39	74F253	99
74F86	59	74F373	1.39
74F138	89	74F374	1.39

CD-CMOS

CD4001	19	CD4076	65
CD4008	89	CD4081	25
CD4011	19	CD4082	25
CD4013	29	CD4093	35
CD4016	29	CD4094	29
CD4017	55	CD40103	2.49
CD4018	55	CD40107	69
CD4020	59	CD40109	1.49
CD4024	49	CD4510	69
CD4027	49	CD4511	69
CD4030	29	CD4520	75
CD4040	65	CD4522	79
CD4049	29	CD4538	79
CD4050	29	CD4541	69
CD4051	59	CD4543	79
CD4052	59	CD4545	4.95
CD4053	59	CD4555	79
CD4063	1.95	CD4566	2.49
CD4066	29	CD4572 (MC14572)	39
CD4067	2.39	CD4583	89
CD4069	25	CD4584	39
CD4070	25	CD4585	89
CD4071	25	MC14411P	8.95
CD4072	25	MC14490P	4.49

MICROPROCESSOR COMPONENTS

MISCELLANEOUS CHIPS		6500/6800/68000 Cont.		8000 SERIES Cont.	
Part No.	Price	Part No.	Price	Part No.	Price
D765AC	4.49	6845	2.95	8228	2.49
WD9216	9.95	6850	1.49	8237-5	4.95
Z80, Z80C, Z80B SERIES					
Z80	1.25	6852	9.95	8243	2.25
Z80-CTC	1.79	MC6800QLB	11.95	8250A	5.49
Z80-DART	4.95	MC68000-10	19.95	8250B (For IBM)	6.95
Z80-PIO	1.79	MC68010L10	49.95	8251A	1.75
Z80A	1.35	MC68020RC12B	199.95	8253-5	1.95
Z80A-CTC	1.49	MC68081RC12A	199.95	8254	4.95
Z80A-DART	4.95	8000 SERIES			
Z80A-PIO	1.49	8031	2.95	8255A-5	1.69
Z80A-SIO/O	4.95	80C31BH	44.95	8257-5	2.49
Z80B	2.95	8035	1.49	8259-5	1.95
Z80B-CTC	3.49	8073	29.95	8272	4.49
Z80B-PIO	4.29	8080A	2.49	8279-5	2.95
6500/6800/68000 SER.					
6502	2.25	8085A	2.29	8748D (25V)	9.55
65C02 (CMOS)	8.95	8086	6.95	8748H (IMOS) (2IV)	10.95
6520	2.75	8086-2	8.95	8751	39.95
6522	6.49	8087 (5MHz)	125.00	8755	14.95
6532	2.49	8087-2 (8MHz)	159.95	DATA ACQUISITION	
6551	3.29	8088	6.49	ADC08080CN	3.19
65C802 (CMOS)	19.95	8088-2	8.95	ADC0808CCN	3.95
6800	1.75	8115-2	2.49	ADC0816CCN	14.95
6802	3.49	8156	3.95	ADC1205CCJ-1	19.95
6810	1.25	8202	9.95	DAC08080CN	3.95
6821	1.29	8203	14.95	DAC1008LCN	6.49
6840	3.95	8212	1.49	AY-3-1015D	4.95
COMMODORE CHIPS					
WD1770 14.95					
SI-3052P 5.95					
6502 2.25					
6504A 1.95					
6507 3.49					
6510 9.95					
6520 1.75					
6522 2.95					
6525 4.95					
6526 14.95					
6529 2.95					
6532 6.49					
6545-1 2.49					
6551 3.29					
6560 10.95					
6567 14.95					
6569 10.95					
6572 10.95					
6581 (12V) 14.95					
6582 (9V) 14.95					
8360 10.95					
8501 10.95					
8502 5.95					
8563 15.95					
8564 12.95					
8566 15.95					
8701 9.95					
*8721 14.95					
8722 7.95					
*251104-04 10.95					
318018-03 15.95					
318019-03 15.95					
318020-04 15.95					
325302-01 15.95					
*325572-01 24.95					
*825100PLA** 13.95					
901225-01 11.95					
901226-01 11.95					
901227-03 11.95					
901229-05 15.95					
*No specs. available					
**Note: 82S100PLA U17 (C-64)					

MICROPROCESSOR SALE!

MC68000L8	16-Bit MPU (8MHz)	\$ 11.95
MC68000L10	16-Bit MPU (10MHz)	\$ 14.95
MC68000L12	16-Bit MPU (12MHz)	\$ 17.95
MC68010L10	16-Bit MPU (10MHz)	\$ 49.95
MC68020RC12B	32-Bit MPU (12MHz)	\$199.95
MC68701	8-Bit EPROM Microcomputer	\$ 9.95
MC68705P3S	8-Bit EPROM Microcomputer	\$ 9.95
MC68705U3L	8-Bit EPROM Microcomputer	\$ 10.95
MC68881RC12A	Floating Point Co-processor	\$199.95

DYNAMIC RAMS

Part No.	Price
4116-15	89
4126-20	3.25
4164-120	1.75
4164-150	1.15
4164-200	95
TMS4416-12	3.75
8118	69
41256-120	3.95
41256-150	2.75
50464-15	4.95
51100P-10	2.95
514256P-10	29.95

STATIC RAMS

2016-12	1.69
TM2018D-45	6.95
2102-2L	1.95
2114N	99
2114N-2L	1.49
21C14	49
2149	3.49
5101	1.95
6116P-3	1.99
6116LP-3	1.95
6264LP-12	4.25
6264P-15	3.59
6264LP-15	3.75
6514	3.95
43256-15L	17.95

EPROMS

1702A	256 x 8 (1µs)	6.95
TMS2516	2048 x 8 (450ns) 25V	4.95
TMS2532	4096 x 8 (450ns) 25V	6.95
TMS2532A	4096 x 8 (450ns) 21V	6.49
TMS2564	16384 x 8 (450ns) 25V	4.95
2708	1024 x 8 (450ns)	4.95
TMS2716	2048 x 8 (450ns) 3 Voltage	9.95
2716	2048 x 8 (450ns) 25V	3.75
2716-1	2048 x 8 (350ns) 25V	6.49
27C10	4096 x 8 (450ns) 25V (CMOS)	3.95
2732	4096 x 8 (150ns) 25V	3.95
2732A-20	4096 x 8 (200ns) 21V	4.25
2732A-25	4096 x 8 (250ns) 21V	3.95
27C32	4096 x 8 (450ns) 25V (CMOS)	6.49
2764-20	8192 x 8 (200ns) 21V	4.25
2764-25	8192 x 8 (250ns) 21V	4.25
2764A-25	8192 x 8 (250ns) 12.5V	4.25
2764-45	8192 x 8 (450ns) 21V	3.49
27C64-15	8192 x 8 (150ns) 21V (CMOS)	6.49
27128-20	16384 x 8 (200ns) 21V	5.95
27128-25	16384 x 8 (250ns) 21V	5.25
27128A-25	16384 x 8 (250ns) 12.5V	5.95
27C128-25	16384 x 8 (250ns) 21V (CMOS)	5.95
27256-20	32768 x 8 (200ns) 12.5V	6.95
27256-25	32768 x 8 (250ns) 12.5V	5.95
27C256-25	32768 x 8 (250ns) 12.5V (CMOS)	8.95
27512-20	65536 x 8 (200ns) 12.5V	19.95
68764	65536 x 8 (250ns) 12.5V	16.95
68764	8192 x 8 (450ns) 25V	15.95

EEPROMS

2816A	2048 x 8 (350ns) 5V Read/Write	5.95
2817A	4096 x 8 (350ns) 5V Read/Write	8.95
2865A	8192 x 8 (250ns) 5V Read/Write	14.95
52B13 (21V)	2048 x 8 (350ns) 5V Read/Write	1.69

SATELLITE TV DESCRAMBLER CHIP

The MM5321 is a TV camera sync generator designed to supply the basic sync functions for either color or monochrome 525 line/60Hz interlaced and camera video recorder applications. COLOR BURST GATE & SYNC
ALLOW STABLE COLOR OPERATION
MM5321N \$11.95

INTERSL Also Available!

74HC HI-SPEED CMOS

Part No.	Price	Part No.	Price
74HC00	25	74HC.75	69
74HC02	25	74HC221	99
74HC04	29	74HC240	79
74HC08	29	74HC244	79
74HC10	29	74HC245	89
74HC14	49	74HC253	59
74HC30	29	74HC259	85
74HC32	29	74HC273	79
74HC74	39	74HC373	79
74HC75	39	74HC374	79
74HC76	45	74HC595	1.19
74HC85	79	74HC598	69
74HC86	39		

Worldwide • Since 1974

• QUALITY COMPONENTS • COMPETITIVE PRICING
• PROMPT DELIVERY

Mail Order Electronics - Worldwide
Jameco
ELECTRONICS

Jameco ELECTRONICS General Purpose NEW! Prototype PC Boards

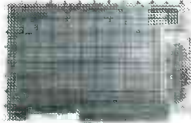

JE417 (Pictured)

- Wire Wrap
 - Component Testing
 - Point-to-Point Wiring
 - 31/62 Connection
- JE411 (6 1/2", No Pads, Gen. Purp.) . . . \$12.95
JE415 (6 1/2", No Pads, PC/XT) . . . \$14.95
JE417 (6 1/2", Plated w/Pads, PC/XT) . . . \$19.95



Extender Boards Designed for Troubleshooting and Testing

JE419 (Pictured)

- JE419 (5 1/4" Extender, 22/44 Connector) . . \$19.95
JE421 (4 3/4" Extender, 31/62 Connector) . . \$19.95

Commodore VIC-20 and C-64 Motherboards



- May have to troubleshoot or just use for spare parts
CV20 Includes: (1) 6560, (2) 6522, (1) 6502, (2) 6116P-4, and much more!
CV64 Includes: (1) 6567, (1) 6581, (1) 6510, (1) 82-S100PLA, (1) 901227-03, (2) 6526, and much more!
CV20 (VIC-20 Motherboard) . . . \$14.95
08903-3 (SAMS VIC-20 Schematics) . . . \$19.95
CV64 (C-64 Motherboard) . . . \$49.95
08906-8 (SAMS C-64 Schematics) . . . \$19.95

Additional Commodore Accessories

- ***CM-1** (300B Modem VIC-20, C-64) . . . \$19.95
***JE232CM** (RS232 Inter. VIC-20, C-64) . . . \$39.95
CPS-10 (C-64 Power Supply) . . . \$39.95
CPS-128 (C-128 Power Supply) . . . \$59.95

*Also compatible with C-128 in 64 mode only.

ZUCKERBOARD TANDY 1000 Expansion Memory Half Card

Expand the memory of your Tandy 1000 (128K Version) to as much as 640K. Also includes DMA controller chip.

- TAN-EM512K** Includes 512K RAM . . . \$119.95
TAN-C Plug-in Clock option chip (only) \$39.95

SALE! 20Meg Hard Disk SALE!

- T20MB** 20MB Hard Disk Drive Board for Tandy 1000 . . . \$579.95 \$494.95
SX20MB 20MB Hard Disk Drive Board for Tandy 1000SX \$569.95 \$499.95

TANDY 1000 Multifunction Board with Clock Calendar

Expand the memory on your Tandy 1000 (128K Version) to as much as 640K. Complete with an RS232 port, clock/calendar, RAM Disk, Printer Spooler and on-board DMA controller chip.

- MTAN-512K** Includes 512K RAM . . . \$199.95

INTRODUCING JAMECO'S NEW COMPUTER KITS!!

Jameco's IBM™ AT Compatible Kit! Mini-286 6/8/10/12MHz Kit!

JE1059 \$569.95
EGA Monitor & Card
(not included)

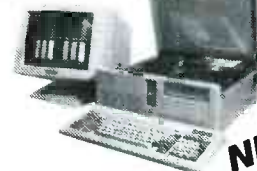

Part No.	Description	Price
JE1015	XT/AT Style Keyboard . . .	\$ 59.95
41256-120	512K RAM (18 Chips) . . .	\$ 71.10
JE1012	Baby AT Flip-Top Case . . .	\$ 79.95
JE1032	200W Power Supply . . .	\$ 99.95
JE1022	5 1/4" High Density Disk Drive	\$119.95
JE1045	Hard Disk/Floppy Controller	\$199.95
JE1003	Baby AT Motherboard (Zero-K RAM-incl. Award BIOS ROM)	\$449.95

NEW! Regular List \$1,080.80
SAVE \$105.85!

- JE1008 IBM™ AT Compatible Kit \$974.95**
JE1059 EGA Monitor & Card SAVE \$30.00 . . \$569.95

Jameco's IBM PC/XT Compatible Kit

4164-150	128K RAM (18 Chips) . . .	\$20.70
IBM-FCC	Floppy Controller Card . . .	\$34.95
IBM-Case	Flip-Top Case	\$34.95
JE1015	XT/AT Style Keyboard . . .	\$59.95
JE1030	150 Watt Power Supply . . .	\$69.95
JE1050	Mono/Graph. Crd. w/P/Port	\$69.95
JE1020	5 1/4" DSDD Disk Drive . . .	\$99.95
IBM-MON	12" Mono. Green Monitor	\$99.95
IBM-MB	XT Motherboard (Zero-K RAM-incl. DTK/ERSO BIOS ROM) . . .	\$99.95

SAVE \$90.35

**FREE! QUICKSOFT PC
WRITE WORD PROCESSING
SOFTWARE INCLUDED!**

Regular List \$590.30

- JE1004 (IBM™ PC/XT Compatible Kit) \$499.95**

Jameco's 4.77/8MHz Turbo IBM Compatible Kit

Same as JE1004 except comes with 640K RAM, TURBO 4.77/8MHz motherboard, JE1071 multi I/O with controller and graphics, and AMBER monitor.

SAVE \$146.50 Regular List \$746.45

- JE1005 (IBM™ PC/XT Turbo Compatible Kit) . \$599.95**

Additional Add-Ons Available!

RS232HC	RS232 Serial Half Card (PC/XT)	\$ 29.95
EM-100	Expansion Memory Half Card (without RAM) (PC/XT) . .	\$ 59.95
AMBER	12" Amber Monitor (PC/XT/AT)	\$109.95
PM1200B-2	1200/300Bd Half Card Modem w/out software (PC/XT/AT)	\$119.95
PM1200B-2S	1200/300Bd Half Card Modem w/Mirror Sftw. (PC/XT/AT)	\$149.95
TTX-1410	14" RGB Color Monitor (PC/XT/AT)	\$289.95

Color Graphics Card for PC/XT/AT

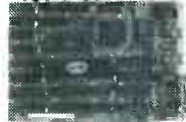

* Text: 40 or 80 x 25 * Graphics: 320 or 640 x 200 * Manual included

- JE1052 \$59.95**

EGA Card for PC/XT/AT

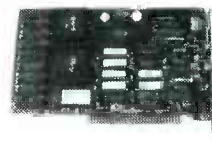

* Graphics: 720 x 348 * 16 out of 64 colors * Manual included

- JE1055 \$199.95**

I/O Cards for PC/XT/AT

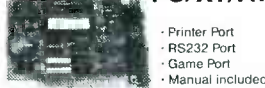

- Printer Port
- RS232 Port
- Game Port
- Manual included

- JE1060 (Pictured)**
JE1060 I/O for XT \$69.95
JE1065 I/O for AT \$69.95

Multi I/O w/Controller & Graphics for PC/XT



* Printer port * RS232 port * Floppy controller * Graphics * Manual included

- JE1071 \$159.95**

Jameco ELECTRONICS Solderless Breadboard Sockets

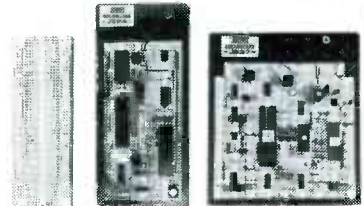

JE23 JE24 JE27

Part No.	Dim. L' x W"	Contact Points	Binding Posts	Price
JE20	6 1/2 x 3/8	100	0	\$ 2.49
JE21	3 1/4 x 2 1/8	400	0	\$ 4.95
JE22	6 1/2 x 1 3/8	630	0	\$ 6.49
JE23	6 1/2 x 2 1/8	830	0	\$ 7.49
JE24	6 1/2 x 3 1/8	1,360	2	\$13.95
JE25	6 1/2 x 4 1/8	1,660	3	\$24.95
JE26	6 1/8 x 5 3/8	2,390	4	\$29.95
JE27	7 1/4 x 7 1/2	3,220	4	\$39.95

Jameco ELECTRONICS Extended 80-Column Card for Apple IIe

• 80 Col / 64K RAM • Doubles amount of data your Apple IIe can display as well as its memory capacity • Ideal for word processing • Complete with instructions

- JE864 \$59.95**

ADD-12 (Disk Drive II, II+, IIe) \$99.95

Additional Apple Compatible Products Available

NEW! Seagate 20, 30 & 40MB Half Height Hard Disk Drives

ST225	20MB Drive only (PC/XT/AT)	\$274.95
ST225K	20MB w/Controller (PC/XT)	\$339.95
ST238K	30MB w/Cont. (PC/XT/AT) . . .	\$399.95
ST251XT	40MB w/Cont. Card (PC/XT) . . .	\$599.95
ST251AT	40MB w/Cont. Card (AT) . . .	\$659.95

Jameco PC/XT & AT Compatible Disk Drives

- JE1020** (360K Drive. PC/XT/AT) . . . \$ 99.95
JE1022 (1.2MB. AT Compatible) . . . \$119.95

DATA BOOKS

30003	National Linear Data Book (82)	\$14.95
30005	Logic Data Book - Vol. II (84)	\$14.95
30009	Intersil Data Book (86)	\$ 9.95
30032	National Linear Supplement (84)	\$ 6.95
210830	Intel Memory Handbook (87)	\$17.95
230843	Intel Microsystem Hndbk. Set (87)	\$24.95

MUFFIN/SPRITE-STYLE FANS

MUF60	\$9.95
Torin Industries (4.68" sq, 60 cfm)	
SU2A1	\$8.95
EG&G Rotron (3.125" square, 20 cfm)	

\$20 Minimum Order - U.S. Funds Only
Shipping: Add 5% plus \$1.50 Insurance

California Residents: Add 6%, 6 1/2% or 7% Sales Tax
IBM is a registered trademark of International Business Machines

Data Sheets - 50¢ each
Prices Subject to Change

Send \$1.00 Postage for a
FREE Seasonal Flyer
FAX 415-592-2503



Send \$1.00 Postage for a
FREE 1987 CATALOG
Telex: 176043

©1987 Jameco Electronics

1355 SHOREWAY RD., BELMONT, CA 94002 • FOR ORDERS ONLY 415-592-8097 • ALL OTHER INQUIRIES 415-592-8121

Radio Shack Parts Place™

Come in for Your Free '88 Catalog Today!

Fast "Hotline" Replacement Service

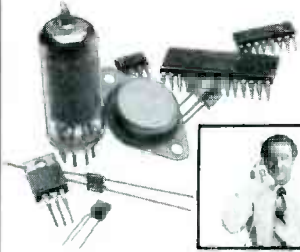

We Can Replace Almost Any IC or Semi—Over 200,000 Substitutions
No Postage ■ No Minimum



If the part you need is not in our regular stock, we'll check our sub guide and special-order a replacement from the warehouse. Radio Shack also offers this service on selected tubes, crystals and styli.

We're Your Connector Connection

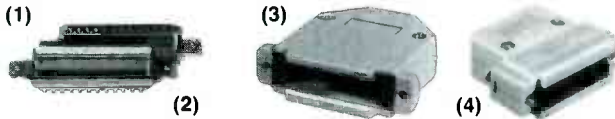

Fig.	Type	Pos.	Cat. No.	Only
1	D-Sub Male	25	276-1547	1.99
2	D-Sub Female	25	276-1548	2.99
3	Hood for Above	25	276-1549	1.99

Type	Pos.	Cat. No.	Only
D-Sub Male	9	276-1537	1.49
D-Sub Female	9	276-1538	2.49
Hood for Above	9	276-1539	1.99

(4) **Shielded 25-Position Hood.** Metallized plastic. Preserves EMI/RFI protection when used with shielded cable. #276-1536 1.99

Give Your Computer a Voice!



12⁹⁵

Easy to Interface

16⁹⁵

SPO256-AL2 Speech Synthesizer IC. This 28-pin device uses a stored program to produce natural-sounding speech. With circuit examples and data. #276-1784 12.95

CTS256-AL2 Text-to-Speech IC. Translates ASCII characters into control data for IC at left. Connects to RS-232. With data. 40-pin DIP. #276-1786 16.95

A Sampling of Solid-State Values

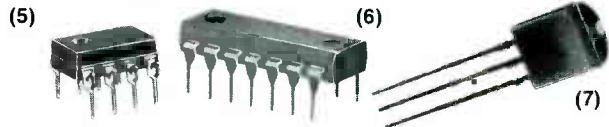

(5) **741 Op-Amp.** #276-007 .. 79c
1458 Dual Op-Amp.
#276-038 99c

TLO82 Dual Bifet Op-Amp.
#276-1715 1.89

555 Timer IC. #276-1723 1.19
(6) **LM324 Quad Op-Amp.**
#276-1711 1.29

(7) **2N2222A NPN Transistor.**
#276-2009 59c

Attention-Getters



(8) **Electronic Chime.** Delivers pleasing 80 dB "ding-dong" at 12 VDC. #273-071 7.95

(9) **Blinking Red LED.** Built-in IC driver. #276-036 1.29

Blinking Green LED. Use as an alterer or in jewelry. #276-030 1.29

Bargain Bundles

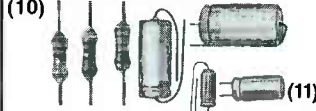

(10) **1/4-Watt Carbon-Film Resistors.** 5% tolerance. Jumbo 500-piece set. #271-312 7.95

Metal-Film. 1/4 watt, 1% tolerance. 50 pieces. #271-309 2.79

(11) **Electrolytic Capacitors.** Twenty pieces, assorted values. Up to 50 WVDC. #272-802 1.98

Low-Cost "Insurance"



(12) **3" Brushless DC Fan.** Lightweight and quiet, yet delivers 27 CFM airflow. Excellent for AC-sensitive circuits. 7 to 13.8 VDC supply. #273-243 14.95

(13) **Heavy-Duty Metal Oxide Varistor.** #276-568 1.99

Project Finishers



(14) **Project Enclosure.** 1 13/16 x 4 1/8 x 5 1/2". #270-210 3.29

(15) **Instrument Case.** 2 7/8 x 5 5/8 x 5 1/8". #270-250 4.99

(16) **Four-Position Fuse Block.** #270-742 2.19

(17) **Panel-Mount Fuse Holder.** #270-367 1.59

Switch & Relay Values

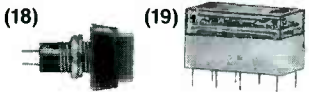

(18) **SPST Push-On/Off.** 3A at 125 VAC. #275-1565 1.59

Momentary. #275-1566 1.49

(19) **Submini DPDT Relay.** 12 VDC coil. Contacts rated 1 amp at 125 VAC. #275-213 3.99

5 VDC-Coil Submini DPDT Relay. Rated as above. #275-215 3.99

Capture Solar Energy

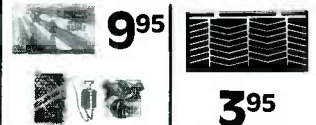

Solar Energy Project Kit. Complete with solar cell, DC motor, color wheels, propeller and project booklet. #277-1201 9.95

Silicon Solar Cell. Manufacturer's prime. 2.5 x 5cm cell. #276-124 3.95

Audio Amp/Speaker



High-Gain Design
Terrific as a test-bench or general-purpose amp. Has on/off/volume control, 1/8" phono jacks for input and an external speaker or ear-phone. 200 mW output. Compact—only 3 3/8 x 3 3/16 x 1 3/4". Battery extra. #277-1008

SW Antenna & Wire



(20) **Complete Shortwave Antenna Kit.** 75 feet of copper antenna wire, 50 feet of lead-in wire, window feedthrough, insulators and instructions. #278-758 8.49

(21) **Heavy-Duty Antenna Wire.** 65 feet. 22-gauge. #278-1329 4.59

Electronic Tool Kit

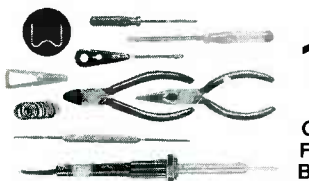

14⁹⁵

Get One For Your Beginner

Ten-piece set has everything necessary to get started—UL listed AC 30-watt soldering iron, stand, solder, soldering aid, needle-nose pliers, diagonal cutter, three screwdrivers and a heat sink. #64-2801

New! 28-Range FET VOM

49⁹⁵

Works Like A Solid State VTVM

Ten-megohm input sensitivity! Jumbo 5-inch, 3-color scale, beep continuity mode. Measures to 1000 VAC, DC current to 10 amps, resistance to 100 megohms. #22-220



Dual DC Power Supply

69⁹⁵

Independent Or Slave Operation

Quality and features you wouldn't expect at this low price! Adjustable 0 to 15 volts, up to 30 volts in series mode. Switchable volt/amp meter. Maximum current: 1 amp per channel. Fuse-protected. UL listed AC. #22-121



Over 1000 items in stock: Binding posts, Books, Breadboards, Buzzers, Capacitors, Chokes, Clips, Connectors, Fuses, Hardware, ICs, Jacks, Knobs, Lamps, Multitesters, PC Boards, Plugs, Rectifiers, Relays, Resistors, Switches, Tools, Transformers, Transistors, Wire, Zeners and more!

Radio Shack®
A DIVISION OF TANDY CORPORATION

Prices apply at participating Radio Shack stores and dealers

20 MEG HARD DISK DRIVE ON A CARD \$389!

STATIC RAMS / DYNAMIC RAMS

2101	256x4	(45ns)	1.95
2102L-4	1024x1	(45ns)(LP)	.99
2112	256x4	(45ns)	2.99
2114	1024x4	(45ns)	.99
2114L-4	1024x4	(45ns)(LP)	1.09
2114L-2	1024x4	(200ns)(LP)	1.49
2114L-15	1024x4	(150ns)(LP)	1.95
TMS4044	4096x1	(45ns)	1.95
TMM2016-150	2048x8	(150ns)	1.49
TMM2016-100	2048x8	(100ns)	1.95
HM6116-4	2048x8	(200ns)(CMOS)	1.89
HM6116-3	2048x8	(150ns)(CMOS)	1.95
HM6116LP-4	2048x8	(200ns)(CMOS)(LP)	1.95
HM6116LP-3	2048x8	(150ns)(CMOS)(LP)	2.05
HM6116LP-2	2048x8	(120ns)(CMOS)(LP)	2.95
HM6264P-15	8192x8	(150ns)(CMOS)	3.89
HM6264LP-15	8192x8	(150ns)(CMOS)(LP)	3.95
HM6264LP-12	8192x8	(120ns)(CMOS)(LP)	4.49
HM43256LP-15	32768x8	(150ns)(CMOS)(LP)	12.95
HM43256LP-12	32768x8	(120ns)(CMOS)(LP)	14.95
HM43256LP-10	32768x8	(100ns)(CMOS)(LP)	19.95
4116-250	16384x1	(250ns)	.49
4116-200	16384x1	(200ns)	.89
4116-150	16384x1	(150ns)	.99
4116-120	16384x1	(120ns)	1.49
MK4332	32768x1	(200ns)	6.95
4164-150	65536x1	(150ns)	1.29
4164-120	65536x1	(120ns)	1.95
MCM6665	65536x1	(200ns)	1.95
TMS4164	65536x1	(150ns)	1.95
4164-REFRESH	65536x1	(150ns)(REFRESH)	2.95
TMS4416	16384x4	(150ns)	4.95
41128-150	131072x1	(150ns)	6.95
TMS4464-15	65536x4	(150ns)	6.95
41256-150	262144x1	(150ns)	2.95
41256-100	262144x1	(100ns)	4.95
HM51258-100	262144x1	(100ns)(CMOS)	6.95
1 MB-120	1048576x1	(120ns)	19.95
1 MB-100	1048576x1	(100ns)	24.95

LP=Low power REFRESH=Pin 1 Refresh

★★★★ HIGH-TECH ★★★★★

NICKEL EXPRESS \$69⁹⁵

PC/XT SPEED UP KIT

- * INCREASE THE SPEED OF YOUR PC BY 67% OR MORE!
- * SIMPLE NO-SLOT INSTALLATION
- * SOFTWARE OR HARDWARE SPEED SELECTION
- * 8 MHz V20 PROCESSOR & SOFTWARE INCLUDED
- * SELECT FOR 3 TURBO FREQUENCIES
- * EXTERNAL RESET SWITCH
- * OPTIONAL 8088 8 MHz PROCESSOR AVAILABLE

Certain early PCs may not run at 8 MHz—these machines may be switched to one of the slower speeds: 6.66 MHz-40% 7.37 MHz-55% 8.0 MHz-67%

★★★★ SPOTLIGHT ★★★★★

EPROMS

2708	1024x8	(45ns)	4.95
2716	2048x8	(45ns)(5V)	3.49
2716-1	2048x8	(350ns)(5V)	3.95
TMS2532	4096x8	(45ns)(5V)	5.95
2732	4096x8	(45ns)(5V)	3.95
2732A	4096x8	(250ns)(5V)(21V PGM)	3.95
2732A-2	4096x8	(200ns)(5V)(21V PGM)	4.25
27C64	8192x8	(250ns)(5V)(CMOS)	5.95
2764	8192x8	(45ns)(5V)	3.49
2764-250	8192x8	(250ns)(5V)	3.95
2764-200	8192x8	(200ns)(5V)	4.25
MCM68766	8192x8	(350ns)(5V)(24 PIN)	17.95
27128	16384x8	(250ns)(5V)	4.25
27C256	32768x8	(250ns)(5V)(CMOS)	10.95
27256	32768x8	(250ns)(5V)	7.49
27512	65536x8	(250ns)(5V)	11.95
27C512	65536x8	(250ns)(5V)(CMOS)	12.95

5V=Single 5 Volt Supply 21V PGM=Program at 21 Volts

ORDER TOLL FREE

800-538-5000



SPECTRONICS CORPORATION EPROM ERASERS



Model	Timer	Capacity Chip	Intensity (uW/Cm ²)	Unit Price
PE-14	NO	9	8,000	\$83.00
PE-14T	YES	9	8,000	\$119.00
PE-24T	YES	12	9,600	\$175.00

8000

8035	1.49
8039	1.95
8052AH BASIC	34.95
8080	2.95
8085	2.49
8087 5 MHz	129.00
8087-2 8 MHz	169.95
8088	6.95
8088-2	9.95
8155	2.49
8748	7.95
8755	14.95
80286	129.95
80287 6 MHz	199.95
80287-8 8 MHz	299.95
80287-10 10 MHz	399.95

V 20 SERIES

V20 5 MHz	8.95
V20 8 MHz	10.95
V20 10 MHz	13.95

* Replaces 8088 to speed up your PC by 10 to 40%

6500 1.0 MHz

6502	2.69
65C02 (CMOS)	12.95
6507	9.95
6520	1.95
6522	4.95
6526	26.95
6532	6.95
6545	6.95
6551	5.95
6561	19.95
6581	34.95

CRYSTALS 32.768 KHz

1.0 MHz	.95
1.8432	2.95
2.0	1.95
2.097152	1.95
2.4576	1.95
3.2768	1.95
3.579545	1.95
4.0	1.95
4.032	1.95
5.0	1.95
5.0688	1.95
6.0	1.95
6.144	1.95
6.5536	1.95
8.0	1.95
8.0	1.95
10.738635	1.95
12.0	1.95
14.31818	1.95
15.0	1.95
16.0	1.95
17.430	1.95
18.432	1.95
20.0	1.95
22.1184	1.95
24.0	1.95
32.0	1.95

74LS00

74LS00	.16	74LS165	.65
74LS01	.18	74LS166	.95
74LS02	.17	74LS169	.95
74LS03	.18	74LS173	.49
74LS04	.16	74LS174	.39
74LS15	.18	74LS175	.39
74LS08	.18	74LS177	.49
74LS09	.18	74LS192	.69
74LS10	.16	74LS193	.69
74LS11	.22	74LS194	.69
74LS12	.22	74LS195	.69
74LS13	.26	74LS196	.59
74LS14	.39	74LS197	.59
74LS15	.17	74LS224	.69
74LS20	.17	74LS240	.69
74LS21	.22	74LS241	.69
74LS22	.22	74LS242	.69
74LS23	.23	74LS243	.69
74LS28	.26	74LS244	.69
74LS30	.17	74LS245	.79
74LS31	.17	74LS251	.49
74LS33	.28	74LS253	.49
74LS37	.26	74LS256	.79
74LS38	.26	74LS257	.39
74LS42	.39	74LS258	.49
74LS47	.75	74LS259	1.29
74LS48	.85	74LS260	.49
74LS51	.39	74LS264	.39
74LS73	.29	74LS273	.79
74LS74	.24	74LS279	.39
74LS75	.29	74LS280	.98
74LS76	.29	74LS283	.59
74LS83	.49	74LS290	.89
74LS85	.49	74LS293	.89
74LS86	.22	74LS299	1.49
74LS90	.39	74LS321	3.95
74LS92	.49	74LS323	2.49
74LS93	.39	74LS364	1.95
74LS95	.49	74LS365	.39
74LS107	.34	74LS367	.39
74LS109	.36	74LS368	.39
74LS112	.29	74LS373	.79
74LS124	.45	74LS374	.79
74LS123	.49	74LS375	.95
74LS124	2.75	74LS377	.79
74LS125	.39	74LS378	1.18
74LS126	.39	74LS390	1.19
74LS132	.39	74LS393	.79
74LS133	.49	74LS541	1.49
74LS134	.39	74LS542	1.95
74LS138	.39	74LS640	.99
74LS139	.39	74LS645	.99
74LS145	.99	74LS669	1.29
74LS147	.99	74LS670	.89
74LS148	.99	74LS682	3.20
74LS151	.39	74LS683	3.20
74LS153	.39	74LS684	3.20
74LS154	1.49	74LS688	7.99
74LS155	.59	74LS783	22.95
74LS156	.49	81LS95	1.49
74LS157	.35	81LS96	1.49
74LS158	.29	81LS97	1.49
74LS160	.29	81LS98	1.49
74LS161	.39	25LS251	2.80
74LS162	.49	25LS269	2.95
74LS163	.39	26LS31	1.95
74LS164	.49	26LS32	1.95

HIGH SPEED CMOS

A new family of high speed CMOS logic featuring the speed of low power Schottky (8ns typical gate propagation delay), combined with the advantages of CMOS: very low power consumption, superior noise immunity, and improved output drive.

74HC00

74HC: Operate at CMOS logic levels and are ideal for new, all-CMOS designs.

74HC00	.59	74HC148	1.19
74HC02	.59	74HC151	.89
74HC04	.59	74HC154	2.49
74HC08	.59	74HC157	.89
74HC10	.59	74HC158	.95
74HC14	.79	74HC163	1.15
74HC20	.59	74HC175	.99
74HC22	.59	74HC240	1.89
74HC30	.59	74HC244	1.89
74HC32	.69	74HC245	1.89
74HC51	.59	74HC257	.85
74HC74	.75	74HC259	1.39
74HC85	1.35	74HC273	1.89
74HC86	.69	74HC299	.49
74HC93	1.19	74HC368	.99
74HC107	.79	74HC373	2.29
74HC109	.79	74HC374	2.29
74HC112	.79	74HC390	1.39
74HC125	1.19	74HC393	1.39
74HC132	1.19	74HC4017	1.99
74HC137	.69	74HC393	1.59
74HC138	.99	74HC4049	.89
74HC139	.99	74HC4050	.89

74HCT00

74HCT: Direct, drop-in replacements for LS TTL and can be intermixed with 74LS in the same circuit.

74HCT00	.69	74HCT166	3.05
74HCT02	.69	74HCT174	1.09
74HCT04	.69	74HCT193	3.39
74HCT08	.69	74HCT194	2.19
74HCT10	.69	74HCT240	1.19
74HCT11	.69	74HCT241	2.19
74HCT27	.69	74HCT244	2.19
74HCT30	.69	74HCT245	2.19
74HCT32	.79	74HCT257	.99
74HCT74	.85	74HCT259	1.59
74HCT75	.95	74HCT273	2.09
74HCT138	1.15	74HCT367	1.09
74HCT139	1.15	74HCT373	2.49
74HCT154	2.99	74HCT393	1.59
74HCT157	.99	74HCT4017	2.19
74HCT158	.99	74HCT4049	1.59
74HCT161	1.29	74HCT4050	1.59
74HCT164	1.39	74HCT4060	1.49

74F00

74F00	.69	74F74	.79	74F251	1.69
74F02	.69	74F86	.99	74F253	1.69
74F04	.79	74F138	1.69	74F257	1.69
74F08	.69	74F139	1.69	74F280	1.79
74F10	.69	74F157	1.69	74F283	3.95
74F32	.69	74F240	2.49	74F373	4.29
74F64	.89	74F244	3.29	74F374	4.29

8200

8205	3.29
8212	1.49
8216	1.49
8224	2.25
8237	4.95
8237-5	5.49
8250	6.95
8251	1.69
8251A	1.89
8253	1.89
8253-5	1.95
8255	1.69
8255-5	1.89
8259	1.95
8259-5	2.29
8272	4.95
8279	2.49
8279-5	2.95
8282	3.95
8284	2.95
8286	3.95
8288	4.95

CRT CONTROLLERS

6845	4.95
6845B	8.95
6847	11.95
HD46505SP	6.95
MC1372	2.95
8275	26.95
7220	19.95
CRT5027	12.95
CRT5037	9.95
TMS9918A	19.95

DISK CONTROLLERS

1771	4.95
1791	9.95
1793	9.95
1795	12.95
1797	12.95
2791	19.95
2793	19.95
2797	29.95
8272	4.95
8279	2.49
8282	3.95
8284	2.95
8286	3.95
8288	4.95
UPD765	4.95
MB8876	12.95
MB8877	12.95
1691	6.95
2143	6.95
9216	7.95

2.0 MHz

6502A	2.95
6520A	2.95
6522A	5.95
6532A	11.95
6545A	7.95
6551A	6.95

3.0 MHz

6502B	6.95
-------	------

6800 1.0 MHz

6800	1.95
6802	

EGA CARD AND MONITOR NOW ONLY \$569!

MONITOR STANDS

MODEL MS-100 \$12.95

- TILTS AND SWIVELS
- STURDY ABS PLASTIC CONSTRUCTION

MODEL MS-200 \$39.95

- TILTS AND SWIVELS
- BUILT-IN POWER STATION
- INDEPENDANTLY CONTROLS UP TO 5 120 VOLT AC OUTLETS
- BUILT-IN SURGE SUPPRESSOR
- UL APPROVED



CRT MONITORS FOR ALL APPLICATIONS



CASPER EGA MONITOR

- EGA & CGA COMPATIBLE
- SCANNING FREQUENCIES 15.75 / 21.85 KHz
- RES. 640 x 200 / 350
- 31mm DOT PITCH, 25 MHz
- 16 COLORS OUT OF 64
- 14" BLACK MATRIX SCREEN

\$399.95



CASPER RGB MONITOR

- COLOR: GREEN/AMBER SWITCH ON REAR
- DIGITAL RGB-IBM COMPATIBLE
- 14" NDN-GLARE SCREEN
- RESOLUTION: 640H x 240V
- 39mm DOT PITCH
- CABLE FOR IBM PC INCLUDED

\$299.95



FORTRONICS MONOCHROME

- IBM COMPATIBLE TTL INPUT
- 12" NON-GLARE SCREEN
- VERY HIGH RESOLUTION 1100 LINES (CENTER)
- 25 MHz BANDWIDTH
- CABLE FOR IBM PC INCLUDED

\$99.95

AMBER OR GREEN AVAILABLE

SOLDER STATION
JDR PART #: 168-2C

- FULLY ADJUSTABLE HEAT SETTING WITH TIP TEMPERATURE READOUT
- QUICK HEATING AND RECOVERY
- VARIETY OF REPLACEMENT TIPS ARE AVAILABLE
- RANGE: 200°-900°F
- UL APPROVED

\$49.95



DISK DRIVES FOR APPLE COMPUTERS

AP-150 \$99.95

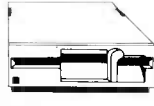

- 1/2 HT. DIRECT DRIVE
- 100% APPLE COMPATIBLE
- SIX MONTH WARRANTY

AP-135 \$129.95



- FULL HT SHUGART MECHANISM
- DIRECT REPLACEMENT FOR APPLE DISK II
- SIX MONTH WARRANTY

APPLE COMPATIBLE INTERFACE CARDS



EPROM PROGRAMMER

- DUPLICATE OR BURN ANY 27x SERIES EPROM (2716 TO 27128)
- MENU DRIVEN SOFTWARE
- HIGH SPEED WRITE ALGORITHM

RP-525 \$59.95



16K RAMCARD

- FULL 2 YEAR WARRANTY
- EXPAND YOUR 48K MACHINE TO A FULL 64K OF MEMORY
- CAN BE USED IN PLACE OF THE APPLE LANGUAGE CARD

RAM-CARD \$39.95



IC TEST CARD

- QUICKLY TESTS MANY COMMON ICs
- SUPPORTS EPSON/IBM GRAPHICS
- TEST 4000 & 74HC SERIES CMOS, 7400, 74LS, 74L, 74H & 74S

IC-TESTER \$129.95

20 MEGABYTE HARD DISK CARD



- SAVES SPACE AND REDUCES POWER CONSUMPTION
- IDEAL FOR PCs WITH FULL HEIGHT FLOPPIES
- LEAVES ROOM FOR A HALF LENGTH CARD IN ADJACENT SLOT

ONLY \$389

AD-3C \$139.95

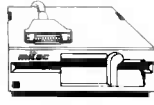

- 100% APPLE IIc COMPATIBLE
- READY TO PLUG IN, W/ SHIELDED CABLE & MOLDED 19 PIN CONNECTOR
- FAST, RELIABLE SLIMLINE DIRECT DRIVE
- SIX MONTH WARRANTY

DISK DRIVE ACCESSORIES

FDD CONTROLLER CARD \$49.95
IIc ADAPTOR CABLE \$19.95
ADAPTS STANDARD APPLE DRIVES FOR USE WITH APPLE IIc

MOLDED INTERFACE CABLES
6 FOOT, 100% SHIELDED, MEETS FCC



IBM PARALLEL PRINTER CABLE	9.95
CENTRONICS (MALE TO FEMALE)	15.95
CENTRONICS (MALE TO MALE)	14.95
MODEM CABLE (FOR IBM)	7.95
RS232 SERIAL (MALE TO FEMALE)	9.95
RS232 SERIAL (MALE TO MALE)	9.95
KEYBOARD EXTENDER (COILED)	7.95
APPLE II JOYSTICK EXTENDER	4.95

C. ITOH RITEMAN II PRINTER



- 160 CPS DRAFT, 32 CPS NLQ
- 9 x 9 DOT MATRIX
- SUPPORTS EPSON/IBM GRAPHICS
- FRICTION AND PIN FEEDS
- VARIABLE LINE SPACING AND PITCH

\$219.95

IBM PRINTER CABLE \$9.95
REPLACEMENT RIBBON CARTRIDGE \$7.95

Seagate

5 1/4" HARD DISK DRIVES

ST-225	HALF HT 20MB 65ms	\$275
ST-238	HALF HT 30MB 65ms (RL)	\$299
ST-251	HALF HT 40MB 40ms	\$599
ST-277	HALF HT 60MB 40ms (RL)	CALL
ST-4038	FULL HT 30MB 40ms	\$559
ST-4096	FULL HT 80MB 28ms	\$1195

KB-1000 \$79.95

CASE WITH KEYBOARD FOR APPLE TYPE MOTHERBOARD

- USER DEFINED FUNCTION KEYS
- NUMERIC KEYPAD W/ CURSOR CONTROL
- CAPS LOCK
- AUTO-REPEAT



SWITCH BOXES
ALL LINES SWITCHED, GOLD PLATED CONNECTORS, QUALITY SWITCHES

2 WAY \$39.95
CONNECTS 2 PRINTERS TO 1 COMPUTER OR VICE VERSA

AB-P (CENTRONICS PARALLEL)
AB-S (RS232 SERIAL)



3 WAY \$99.95
CONNECTS 3 PRINTERS TO 1 COMPUTER OR VICE VERSA

SWITCH-3P (CENTRONICS PARALLEL)
SWITCH-3S (RS232 SERIAL)



NASHUA DISKETTES

NASHUA DISKETTES WERE JUDGED TO HAVE THE HIGHEST POLISH AND RECORDED AMPLITUDE OF ANY DISKETTES TESTED (COMPARING FLOPPY DISKS, BYTE 9/84)

N-MD2D	DS/DD 5 1/4" SFT	\$9.90
N-MD2F	DS/QUAD 5 1/4" SOFT	\$19.95
N-MD2H	DS/HD 5 1/4" FOR AT	\$24.95
N-FD1	SS/DD 8" SOFT	\$27.95
N-FD2D	DS/DD 8" SOFT	\$34.95

1/2 HEIGHT FLOPPY DISK DRIVES

5 1/4" TEAC FD-55B DS/DD	\$109.95
5 1/4" TEAC FD-55F DS/QUAD	\$124.95
5 1/4" TEAC FD-55GFV DS/HD	\$154.95
5 1/4" MITSUBISHI DS/HD	\$129.95
3 1/2" TOSHIBA KIT DS/DD	\$149.95

KIT INCLUDES MOUNTING HARDWARE TO FIT 5 1/4" SLOT & FACEPLATES FOR AT & XT

DISK DRIVE ACCESSORIES

TEAC SPECIFICATION MANUAL	\$5.00
TEAC MAINTENANCE MANUAL	\$25.00
1/2 HT MNTG HARDWARE FOR IBM	\$2.95
MOUNTING RAILS FOR IBM AT	\$4.95
"Y" POWER CABLE FOR 5 1/4" FDDs	\$2.95
5 1/4" FDD POWER CONNECTORS	\$1.19

JOYSTICK GC-10 \$19.95

- SET X-Y AXIS FOR AUTO CENTER OR FREE MOVEMENT
- FIRE BUTTON FOR USE WITH GAME SOFTWARE
- ATTRACTIVE, SOLID, PLASTIC CASE
- INCLUDES ADAPTOR CABLE FOR IBM, APPLE II, IIc



POWER STRIP \$9.95
JDR PART #: POWER-S*RP

- 15 AMP CIRCUIT BREAKER
- 6 RECEPTACLES
- 6 FOOT POWER CORD
- PILOT SWITCH

WITH SURGE PROTECTION
JDR PART #: MT-660

\$12.95



BULK DISKETTE SALE
5 1/4" SOFT SECTOR, DS/DD W/ TYVEC SLEEVES & HUB RINGS

\$9.90 BOX OF 10
69¢ ea BULK QTY 50
59¢ ea BULK QTY 250

DISK DRIVE ENCLOSURES WITH POWER SUPPLIES

CAB-2SV5	DUAL SLIMLINE 5 1/4"	\$49.95
CAB-1FH5	FULL HT 5 1/4"	\$69.95
CAB-2SV8	DUAL SLIMLINE 8"	\$209.95
CAB-2FH8	DUAL FULL HT 8"	\$219.95

DISKETTE FILES

5 1/4" DISKFILE HOLDS 70	\$8.95
3 1/2" DISKFILE HOLDS 40	\$9.95



BUILD STEVE CIARCIA'S INTELLIGENT EPROM PROGRAMMER

AS SEEN IN BYTE, OCT. 86

- STAND-ALONE OR RS-232 SERIAL OPERATION
- MENU SELECTABLE EPROM TYPES
- NO CONFIGURATION JUMPERS
- PROGRAMS ALL 5V 27XXX EPROMS FROM 2716 TO 27512
- READ, COPY OR VERIFY EPROM
- UPLOAD/DOWNLOAD INTEL HEX FILES
- PROGRAMMER DRIVER USER MODIFIABLE

Kit includes PCB & all components except case & power supply

\$199



CALL FOR VOLUME QUOTES COPYRIGHT 1987 JDR MICRODEVICES.

CIRCLE 178 ON FREE INFORMATION CARD

20 MEG HARD DISK DRIVE ON A CARD \$389!

NEW! EVERYTHING-IN-ONE CARD

MCT-MGMIO \$119.95

- HERCULES COMPATIBLE MONOCHROME GRAPHICS, 720 x 384 PIXELS
- 1 STANDARD SERIAL PORT INSTALLED
- OPTIONAL 2nd PORT AVAILABLE
- 1 PARALLEL PORT AND REAL TIME CLOCK / CALENDAR INCLUDED
- SUPPORTS BOTH DS/DD & DS/QD WHEN USED W/ DOS 3.2 OR JFORMAT



QUALITY IBM COMPATIBLE MOTHERBOARDS

TURBO 4.77 / 8 MHZ \$129.95

JDR PART #: MCT-TURBO

- 4.77 OR 8 MHZ OPERATION WITH 8088-2 & OPTIONAL 8087-2 CO-PROCESSOR
 - DYNAMICALLY ADJUSTS SPEED DURING DISKETTE OPERATION FOR MAXIMUM THROUGHPUT AND RELIABILITY
 - CHOICE OF NORMAL / TURBO MODE OR SOFTWARE SELECT PROCESSOR SPEED
- STANDARD MOTHERBOARD \$109.95**

JDR PART #: MCT-XTMB



80286 6 / 8 MHZ \$499.00

JDR PART #: MCT-ATMB

- 8 SLOT (2 EIGHT BIT, 6 SIXTEEN BIT) AT MOTHERBOARD
- HARDWARE SELECTION OF 6 OR 8 MHZ
- 1 WAIT STATE
- RESET SWITCH, FRONT PANEL LED INDICATOR AND KEYLOCK SUPPORTED
- SOCKETS FOR 1 MB OF RAM AND 80287 ON BOARD
- ON BOARD BATTERY BACKED CLOCK OPERATES WITH PC-DOS OR MS-DOS

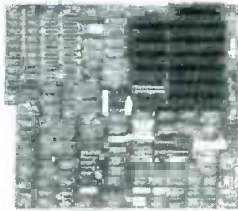

3 1/2" FDD KIT BY TOSHIBA

JDR PART #: FDD-3.5 KIT

- 720K FORMAT, DOS 3.2 COMPATIBLE
- ALLOWS DATA INTERCHANGE WITH NEW IBM MACHINES
- MOUNTING HARDWARE FOR 5 1/4" SLOT
- FACEPLATES FOR BOTH AT & XT

\$149.95

IBM COMPATIBLE FLOPPY DISK DRIVE

JDR PART #: FDD-360

- GOOD QUALITY DRIVES BY MAJOR MANUFACTURERS SUCH AS QUME, TANDON & CDC
- 5 1/4" HALF HEIGHT
- 360K STORAGE CAPACITY
- DS/DD
- 48 TPI

\$69.95

IBM XT STYLE COMPUTER CASE

AN ATTRACTIVE STEEL CASE WITH A HINGED LID. FITS THE POPULAR PC/XT COMPATIBLE MOTHERBOARDS



- SWITCH CUT-OUT ON SIDE FOR PC/XT STYLE POWER SUPPLY
- CUT-OUT FOR 8 EXPANSION SLOTS
- ALL HARDWARE INCLUDED

\$34.95

XT STYLE SLIDE TYPE CASE \$38.95
AT STYLE SLIDE TYPE CASE \$89.95

BUILD YOUR OWN 256K XT COMPATIBLE SYSTEM

- XT MOTHERBOARD \$109.95
- PRO-BIOS (A \$20 VALUE) FREE!
- 256K RAM \$26.55
- 130W POWER SUPPLY \$69.95
- FLIP-TOP CASE \$34.95
- MCT-5150 KEYBOARD \$59.95
- 360K DRIVE \$89.95
- FDD CONTROLLER \$34.95
- MONOGRAPHS CARD \$59.95
- FORTRONICS MONITOR \$99.95

TOTAL: \$566.15

IBM COMPATIBLE KEYBOARDS

MCT-5060 \$59.95

- IBM AT STYLE LAYOUT
- SOFTWARE AUTOSENSE FOR XT OR AT COMPATIBLES
- EXTRA LARGE SHIFT & RETURN KEYS
- LED INDICATORS FOR SCROLL, CAPS & NUMBER LOCK
- AUTO REPEAT FEATURE

MCT-5339 \$89.95

- IBM ENHANCED STYLE LAYOUT
- SOFTWARE AUTOSENSE FOR XT OR AT COMPATIBLES
- 12 FUNCTION KEYS
- EXTRA LARGE SHIFT & RETURN KEYS
- LED INDICATORS FOR SCROLL, CAPS & NUMBER LOCK
- AUTO REPEAT FEATURE
- SEPARATE CURSOR PAD

MCT-5150 \$59.95
XT STYLE LAYOUT

MCT-5151 \$79.95
KB5151* EQUIVALENT



EASYDATA MODEMS

All models feature auto-dial/answer/redial on busy, Hayes compatible, power up self test, touchtone or pulse dialing, built-in speaker, PC Talk III Communications software, Bell Systems 103 & 212A full or half duplex and more.

INTERNAL

EASYDATA-12H \$99.95
1200 BAUD HALF CARD

EASYDATA-12B \$119.95
1200 BAUD 10" CARD

EASYDATA-24B \$199.95
2400 BAUD FULL CARD

EXTERNAL

NO SOFTWARE INCLUDED

EASYDATA-12D \$119.95
1200 BAUD

EASYDATA-24D \$219.95
2400 BAUD

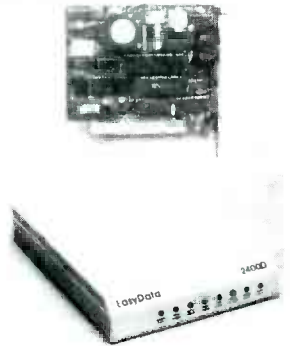

MCT DISPLAY CARDS

MCT-EGA

\$179.95

100% IBM COMPATIBLE, PASSES IBM EGA DIAGNOSTICS

- COMPATIBLE WITH IBM EGA, COLOR GRAPHICS AND MONOCHROME ADAPTORES
- TRIPLE SCANNING FREQUENCY FOR DISPLAY ON EGA, STANDARD RGB OR HIGH RESOLUTION MONOCHROME MONITOR
- FULL 256K OF VIDEO RAM ALLOWS 640 x 350 PIXELS IN 16 OF 64 COLORS
- LIGHT PEN INTERFACE



MCT-CG

\$49.95

COMPATIBLE WITH IBM COLOR GRAPHICS STANDARD

- SHORT SLOT CARD USES VLSI CHIPS TO INSURE RELIABILITY
- SUPPORTS RGB, COMPOSITE MONOCHROME & COLOR AND AN RF MODULATOR OUTPUT
- 320 x 200 COLOR GRAPHICS MODE
- 640 x 200 MONOGRAPHS MODE
- LIGHT PEN INTERFACE



MCT-MGP

\$59.95

COMPATIBLE WITH IBM MONOCHROME AND HERCULES GRAPHICS STANDARDS

- SHORT SLOT CARD USES VLSI CHIPS TO INSURE RELIABILITY
- PARALLEL PRINTER PORT, CONFIGURABLE AS LPT1 OR LPT2
- 720 x 348 GRAPHICS MODE
- LOTUS COMPATIBLE
- CAN RUN WITH COLOR GRAPHICS CARD IN THE SAME SYSTEM



MCT DEVELOPMENT TOOLS

MCT-PAL

PAL PROGRAMMER

\$269.95

ONE ARRAY LOGIC CHIP CAN REPLACE 4-5 TTL ICs

- PROGRAMS 20 & 24 PIN PALS FROM TI, NSC & MMI
- EASY TO USE MENU-DRIVEN SOFTWARE ALLOWS PROGRAMMING, VERIFICATION READING, MAP BUILDING & BURNING THE SECURITY FUSE
- READ AND SAVE BURN PROFILES IN JEDEC FORMAT ON YOUR DISK



CUPL STARTER KIT \$49.95

MCT-MP

MICROPROCESSOR PROGRAMMER

\$199.95

PROGRAMS 8741/2/8/9 PROCESSOR CHIPS

- EASY TO USE MENU-DRIVEN SOFTWARE SUPPORTS READ, WRITE, BLANK CHECK AND VERIFY OPERATIONS
- PORT ADDRESS SELECTION IS USER CONFIGURABLE
- SAVE AND RESTORE PROGRAM IMAGES ON DISK
- INCLUDES SOFTWARE FOR STANDARD HEX AND INTEL HEX FORMATS



MCT-EPROM

EPROM PROGRAMMERS

\$129.95

PROGRAMS 27xx AND 27xxx SERIES EPROMS UP TO 27512

- SUPPORTS VARIOUS MANUFACTURERS FORMATS WITH 12.5, 21 AND 25 VOLT PROGRAMMING
- MENU-DRIVEN SOFTWARE ALLOWS EASY MANIPULATION OF DATA FILES
- SPLIT OR COMBINE THE CONTENTS OF SEVERAL EPROMS OF DIFFERENT SIZES
- READ, WRITE, COPY, ERASE CHECK AND VERIFY WITH EASY ONE KEY SELECTION
- INCLUDES SOFTWARE FOR STANDARD HEX AND INTEL HEX FORMATS

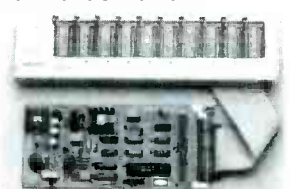

4 GANG PROGRAMMER \$189.95

10 GANG PROGRAMMER \$299.95

MCT PRODUCTS CARRY A ONE YEAR WARRANTY

COPYRIGHT 1987 JDR MICRODEVICES

CIRCLE 179 ON FREE INFORMATION CARD

www.americanradiohistory.com

1200B MODEM \$99⁹⁵

**FOR IBM W/
SOFTWARE**

2400B MODEM \$199⁹⁵

MULTIFUNCTION CARDS

FROM MODULAR CIRCUIT TECHNOLOGY

MCT-MF \$79.95

ALL THE FEATURES OF AST'S SIX PACK PLUS AT HALF THE PRICE!

- 0-348K DYNAMIC RAM USING 4164s
- INCLUDES SERIAL PORT, PARALLEL PRINTER PORT, GAME CONTROLLER PORT AND CLOCK/CALENDAR
- SOFTWARE FOR A RAMDISK, PRINT SPOOLER AND CLOCK/CALENDAR



MCT-ATMF \$139.95

ADDS UP TO 3 MB OF 1 BIT RAM TO THE AT

- USER EXPANDABLE TO 1.5 MB OF ON-BOARD MEMORY (NO MEMORY INSTALLED)
- FLEXIBLE ADDRESS CONFIGURATION
- INCLUDES SERIAL PORT AND PARALLEL PORT
- OPTIONAL PIGGYBACK BOARD PERMITS EXPANSION TO 3 MB



ATMF-SERIAL 2nd SERIAL PORT \$24⁹⁵
MCT-ATMF-MC \$29⁹⁵
PIGGYBACK BOARD (ZERO K INSTALLED)

MCT-MIO \$79.95

A PERFECT COMPANION FOR OUR MOTHERBOARD

- 2 DRIVE FLOPPY DISK CONTROLLER
- INCLUDES SERIAL PORT, PARALLEL PORT, GAME PORT AND CLOCK/CALENDAR WITH BATTERY BACK-UP
- SOFTWARE FOR A RAMDISK, PRINT SPOOLER AND CLOCK/CALENDAR



MIO-SERIAL 2nd SERIAL PORT \$15⁹⁵

MCT-IO \$59.95

USE WITH MCT-FH FOR A MINIMUM OF SLOTS USED

- SERIAL PORT ADDRESSABLE AS COM1, COM2, COM3 OR COM4
- PARALLEL PRINTER PORT ADDRESSABLE AS LPT1 OR LPT2 (x378 OR x278)
- CLOCK/CALENDAR WITH A BATTERY BACK-UP



IO-SERIAL 2nd SERIAL PORT \$15⁹⁵

MCT-ATIO \$59.95

USE WITH MCT-ATFH FOR A MINIMUM OF SLOTS USED

- SERIAL PORT ADDRESSABLE AS COM1, COM2, COM3 OR COM4
- PARALLEL PRINTER PORT ADDRESSABLE AS LPTA OR LPTB (x378 OR x278)
- GAME PORT
- USES 16450 SERIAL SUPPORT CHIPS FOR HIGH SPEED OPERATION IN AN AT

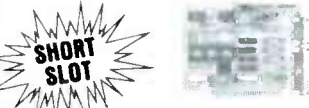

ATIO-SERIAL 2nd SERIAL PORT \$24⁹⁵



Seagate

HARD DISK SYSTEMS
20 MB 30 MB
\$339 \$399

Systems include half height hard disk drive, hard disk drive controller, cables and instructions. Drives are pre-tested and warranted for one year.

Seagate 40 MB AT DRIVE
FAST 40ms ACCESS TIME



\$599

DISK CONTROLLER CARDS

FROM MODULAR CIRCUIT TECHNOLOGY

MCT-FDC \$34.95

QUALITY DESIGN OFFERS 4 FLOPPY CONTROL IN A SINGLE SLOT

- INTERFACES UP TO 4 FDDs TO AN IBM PC OR COMPATIBLE
- INCLUDES CABLING FOR 2 INTERNAL DRIVES
- USES STANDARD DB37 CONNECTOR FOR EXTERNAL DRIVES
- SUPPORTS BOTH DS/DD AND DS/QD WHEN USED W/ OOS 3.2 OR JFORMAT



MCT-HDC \$89.95

HARD DISK CONTROL FOR WHAT OTHERS CHARGE FOR FLOPPY CONTROL

- IBM XT COMPATIBLE CONTROLLER SUPPORTS 16 DRIVE SIZES INCLUDING 5, 10, 20, 30 & 40MB
- OPTIONS INCLUDE THE ABILITY TO DIVIDE 1 LARGE DRIVE INTO 2 SMALLER, LOGICAL DRIVES
- INCLUDES CABLING FOR 1 INTERNAL DRIVE



MCT-RLI \$119.95

GET UP TO 50% MORE STORAGE SPACE ON YOUR HARD DISK

- INCREASES THE CAPACITY OF PLATED MEDIA DRIVES BY 50%
- RLI 2.7 ENCODING FOR MORE RELIABLE STORAGE
- TRANSFER RATE IS ALSO 50% FASTER: 750K/sec vs 500K/sec
- USE WITH ST-238 DRIVE TO ACHIEVE 30+ MB IN A HALF HEIGHT SLOT



MCT-FH \$139.95

STARVED FOR SLOTS? SATISFY IT WITH THIS TIMELY DESIGN

- INTERFACES UP TO 2 FDDs & 2 HDDs
- CABLING FOR 2 FDDs & 1 HDD
- FLOPPY INTERFACE SUPPORTS BOTH DS/DD & DS/QD WHEN USED WITH OOS 3.2 OR JFORMAT
- ALL POPULAR HDD SIZES ARE SUPPORTED, INCLUDING 5, 10, 20, 30 & 40MB
- CAN DIVIDE 1 LARGE DRIVE INTO 2 SMALLER, LOGICAL DRIVES



MCT-ATFH \$169.95

FLOPPY AND HARD DISK CONTROL IN A TRUE AT DESIGN

- AT COMPATIBLE, CONTROL UP TO 2 360K/720K OR 1 2MB FDDs AS WELL AS 2 HDDs USING THE AT STANDARD CONTROL TABLES
- SUPPORTS AT STYLE FRONT PANEL LED TO INDICATE HD ACTIVITY
- 16 BIT BUS PROVIDES RAPID DATA TRANSFERS
- FULLY SUPPORTED BY AT BIOS



RAM CARDS

FROM MODULAR CIRCUIT TECHNOLOGY

MCT-RAM \$69.95

A CONTIGUOUS MEMORY SOLUTION FOR YOUR SHORT OR REGULAR SLOT

- SHORT SLOT, LOW POWER PC COMPATIBLE DESIGN
- CAN OFFER UP TO 576K OF ADDITIONAL MEMORY
- USER SELECTABLE CONFIGURATION AMOUNTS OF 192, 384, 512, 256 & 576K, USING COMBINATIONS OF 64 & 256K RAM



MCT-ATRAM \$149.95

A POWER USER'S DREAM, 4MB OF MEMORY FOR THE AT

- USER EXPANDABLE TO 2MB OF ON-BOARD MEMORY
- USES FULL 16 BIT PARITY CHECKED MEMORY, 64K OR 256K DYNAMIC RAM
- FLEXIBLE STARTING ADDRESS, ROUND OUT CONVENTIONAL MEMORY TO 640K & ADD EXTENDED MEMORY ABOVE 1MB



MCT-ATRAM-MC \$39⁹⁵
2MB PIGGYBACK BOARD (ZERO K INSTALLED)

MCT-EMS \$129.95

2MB OF LOTUS/INTEL/MICROSOFT COMPATIBLE MEMORY FOR THE XT

- CONFORMS TO LOTUS/INTEL EMS
- USER EXPANDABLE TO 2 MB
- USES 64K OR 256K DYNAMIC RAM (NO MEMORY INSTALLED)
- USE AS EXPANDED OR CONVENTIONAL MEMORY, RAMDISK OR SPOOLER
- SOFTWARE INCLUDES EMS DEVICE DRIVERS, PRINT SPOOLER AND RAMDISK



MCT-ATEMS \$139⁹⁵
AT VERSION OF THE MCT-EMS

JDR Microdevices 110 Knowles Drive, Los Gatos, CA 95030
Toll Free 800-538-5000 • (408) 866-6200 • FAX (408) 378-8927 • Telex 171-110

THE JDR MICRODEVICES LOGO IS A REGISTERED TRADEMARK OF JDR MICRODEVICES. JDR INSTRUMENTS AND JDR MICRODEVICES ARE TRADEMARKS OF JDR MICRODEVICES. IBM IS A TRADEMARK OF INTERNATIONAL BUSINESS MACHINES CORPORATION.

CIRCLE 180 ON FREE INFORMATION CARD

COPYRIGHT 1987 JDR MICRODEVICES

www.americanradiohistory.com

SEPTEMBER 1987

109

1200B MODEM \$99.95

**FOR IBM W/
SOFTWARE**

2400B MODEM \$199.95

BARGAIN HUNTERS CORNER

300 BAUD MODEM FOR IBM
INCLUDES ASCII PRO-EZ SOFTWARE
NOW ONLY \$29.95

720K FLOPPY DISK DRIVE

BY MITSUBISHI

- * 5 1/4" HALF HEIGHT
- * 96 TPI
- * 100% IBM COMPATIBLE
- * DOUBLE SIDED/QUAD DENSITY

ONLY \$99.95

SPECIAL ENDS 8/31/87

PAGE WIRE WRAP WIRE
PRECUT ASSORTMENT
IN ASSORTED COLORS \$27.50

100ea: 5.5", 6.0", 6.5", 7.0"
250ea: 2.5", 4.5", 5.0"
500ea: 3.0", 3.5", 4.0"

SPOOLS

100 feet \$4.30 250 feet \$7.25
500 feet \$13.25 1000 feet \$21.95

Please specify color:
Blue, Black, Yellow or Red

EXTENDER CARDS

IBM-PC \$29.95
IBM-AT \$39.95

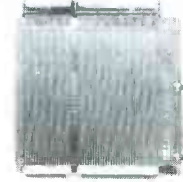

WIRE WRAP PROTOTYPE CARDS
FR-4 EPOXY GLASS LAMINATE
WITH GOLD-PLATED EDGE-CARD FINGERS



XT

BOTH CARDS HAVE SILK SCREENED LEGENDS
AND INCLUDES MOUNTING BRACKET

IBM-PR1 WITH -5V AND GROUND PLANE \$27.95
IBM-PR2 AS ABOVE W/DECODING LAYOUT \$29.95

AT

IBM-PRAT LARGE -5V & GROUND PLANES \$29.95

S-100

P100-1 BARE - NO FOIL PADS \$15.15
P100-2 HORIZONTAL BUS \$21.80
P100-3 VERTICAL BUS \$21.80
P100-4 SINGLE FOIL PADS PER HOLE \$22.75

APPLE

P500-1 BARE - NO FOIL PADS \$15.15
P500-3 HORIZONTAL BUS \$22.75
P500-4 SINGLE FOIL PADS PER HOLE \$21.80
7060-45 FOR APPLE IIe AUX SLOT \$30.00

SOCKET-WRAP I.D.™

- SLIPS OVER WIRE WRAP PINS
- IDENTIFIES PIN NUMBERS ON WRAP SIDE OF BOARD
- CAN WRITE ON PLASTIC, SUCH AS IC #

PINS	PART#	PCK. OF	PRICE
8	IDWRAP 08	10	1.95
14	IDWRAP 14	10	1.95
16	IDWRAP 16	10	1.95
18	IDWRAP 18	5	1.95
20	IDWRAP 20	5	1.95
22	IDWRAP 22	5	1.95
24	IDWRAP 24	5	1.95
28	IDWRAP 28	5	1.95
40	IDWRAP 40	5	1.95

PLEASE ORDER BY NUMBER OF PACKAGES (PCK. OF)

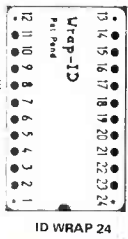

FRAME STYLE TRANSFORMERS

12.6V AC CT	2 AMP	5.95
12.6V AC CT	4 AMP	7.95
12.6V AC CT	8 AMP	10.95
25.2V AC CT	2 AMP	7.95

25 PIN D-SUB GENDER CHANGERS
\$7.95



SWITCHING POWER SUPPLIES

PS-IBM \$69.95

- FOR IBM PC-XT COMPATIBLE
- 135 WATTS
- +5V @ 15A, +12V @ 4.2A
- -5V @ .5A, -12V @ 5A
- ONE YEAR WARRANTY

PS-IBM-150



PS-IBM-150 \$79.95

- FOR IBM PC-XT COMPATIBLE
- 150 WATTS
- +12V @ 5.2A, +5V @ 16A
- -12V @ .5A, -5V @ 5A
- ONE YEAR WARRANTY



PS-AT \$89.95

- FOR IBM PC-AT COMPATIBLE
- 220 WATTS
- +5V @ 22A, +12V @ 8A
- -5V @ .5A, -12V @ 5A
- 1 YEAR WARRANTY

PS-AT



PS-A \$49.95

- USE TO POWER APPLE TYPE SYSTEMS, 79.5 WATTS
- +5V @ 7A, +12V @ 3A
- -5V @ .5A, -12V @ 5A
- APPLE POWER CONNECTOR

PS-A



PS-1558 \$34.95

- 75 WATTS, UL APPROVED
- +5V @ 7A, +12V @ 3A
- -12V @ 250ma, -5V @ 300ma

PS-1558



CAPACITORS

TANTALUM

1.0µf	15V	.35	47µf	35V	.45
6.8	15V	.70	1.0	35V	.45
10	15V	.80	2.2	35V	.65
22	15V	1.35	4.7	35V	.85
22	35V	.40	10	35V	1.00

DISC

10µf	50V	.05	680	50V	.05
22	50V	.05	.001µf	50V	.05
27	50V	.05	.0022	50V	.05
33	50V	.05	.005	50V	.05
47	50V	.05	.01	50V	.07
68	50V	.05	.02	50V	.07
100	50V	.05	.05	50V	.07
220	50V	.05	.1	12V	.10
560	50V	.05	.1	50V	.12

MONOLITHIC

.01µf	50V	.14	.1µf	50V	.18
.047µf	50V	.15	.47µf	50V	.25

ELECTROLYTIC

RADIAL		AXIAL			
1µf	25V	.14	1µf	50V	.14
2.2	35V	.15	10	50V	.16
4.7	50V	.15	22	16V	.14
10	50V	.15	47	50V	.20
47	35V	.18	100	35V	.25
100	16V	.18	220	25V	.30
220	35V	.20	470	50V	.50
470	25V	.30	1000	16V	.60
2200	16V	.70	2200	16V	.70
4700	25V	1.45	4700	16V	1.25

DATARASE EPROM ERASER \$34.95

- ERASES 2 IN 10 MINUTES
- COMPACT-NO DRAWER
- THIN METAL SHUTTER PREVENTS UV LIGHT FROM ESCAPING



1/4 WATT RESISTORS

5% CARBON FILM ALL STANDARD VALUES FROM 1 OHM TO 10 MEG. OHM

10 PCS same value .05 100 PCS same value .02
50 PCS same value .025 1000 PCS same value .015

RESISTOR NETWORKS

SIP	10 PIN	9 RESISTOR	.69
SIP	8 PIN	7 RESISTOR	.59
DIP	16 PIN	8 RESISTOR	1.09
DIP	16 PIN	15 RESISTOR	1.09
DIP	14 PIN	7 RESISTOR	.99
DIP	14 PIN	13 RESISTOR	.99

SPECIALS ON BYPASS CAPACITORS

.01 µf CERAMIC DISC 100/\$5.00
.01 µf MONOLITHIC 100/\$10.00
.1 µf CERAMIC DISC 100/\$6.50
.1 µf MONOLITHIC 100/\$12.50

BOOKS BY STEVE CIARCIA

BUILD YOUR OWN 280 COMPUTER \$19.95
CIRCUIT CELLAR VOL 1 \$17.95
CIRCUIT CELLAR VOL 2 \$18.95
CIRCUIT CELLAR VOL 3 \$18.95
CIRCUIT CELLAR VOL 4 \$18.95
CIRCUIT CELLAR VOL 5 \$19.95

MUFFIN FANS

3.15" SQ 14.95 3.63" SQ 14.95
3.18" SQUARE 16.95

6' LINE CORDS

2 conductor .39 3 conductor .99
3 conductor w/ female socket 1.49

EMI FILTER \$4.95

WISH SOLDERLESS BREADBOARDS

PART NUMBER	DIMENSIONS	DISTRIBUTION STRIP(S)	TIE POINTS	TERMINAL STRIP(S)	TIE POINTS	BINDING POSTS	PRICE
WBU-D	.38 x 6.50"	1	100	---	---	---	2.95
WBU-T	1.38 x 6.50"	---	---	1	630	---	6.95
WBU-204-3	3.94 x 8.45"	1	100	2	1260	2	17.95
WBU-204	5.13 x 8.45"	4	400	2	1260	3	24.95
WBU-206	6.88 x 9.06"	5	500	3	1890	4	29.95
WBU-208	8.25 x 9.45"	7	700	4	2520	4	39.95



LITHIUM BATTERY

AS USED IN CLOCK CIRCUITS

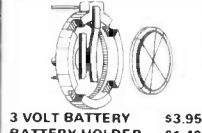

3 VOLT BATTERY \$3.95
BATTERY HOLDER \$1.49

2 VOLUME SET IC MASTER
THE INDUSTRY STANDARD

\$129.95

NEW STORE HOURS! M-F: 9-7, SAT: 9-5 & SUN: 12-4

Visit our retail store located at 1256 S. Bascom Ave. in San Jose, (408) 947-8881

JDR Microdevices

110 Knowles Drive, Los Gatos, CA 95030

Toll Free 800-538-5000 • (408) 866-6200

FAX (408) 378-8927 • Telex 171-110

COPYRIGHT 1987 JDR MICRODEVICES

THE JDR MICRODEVICES LOGO IS A REGISTERED TRADEMARK OF JDR MICRODEVICES. JDR INSTRUMENTS AND JDR MICRODEVICES ARE TRADEMARKS OF JDR MICRODEVICES. IBM IS A TRADEMARK OF INTERNATIONAL BUSINESS MACHINES CORPORATION. APPLE IS A TRADEMARK OF APPLE COMPUTER.

TERMS: Minimum order \$10.00. For shipping and handling include \$2.50 for UPS Ground and \$3.50 for UPS Air. Orders over 1 lb. and foreign orders may require additional shipping charges—please contact our sales department for the amount. CA. residents must include applicable sales tax. All merchandise is warranted for 90 days unless otherwise stated. Prices are subject to change without notice. We are not responsible for typographical errors. We reserve the right to limit quantities and to substitute manufacturer. All merchandise subject to prior sale. A full copy of our terms is available upon request.

PUT US TO THE TEST!



AF Signal Generator

\$139

Q-1310

Square/Sine wave output audio signal generator, essential for work on huge range of circuits. With wide 10Hz - 1MHz attun. output and sync.output, it is the perfect partner for the above RF generator.

SPECIFICATIONS:

Frequency Range: 10Hz - 1MHz
Accuracy: +/-3 +2Hz
Output Impedance: 600 ohms unbalanced
Output Control: 0, -20dB, -40dB and Fine Adjuster
Sine Wave Output: 10Hz - 1MHz, BV, RMS (max)
Square Wave Output: 10Hz - 10KHz, 10Vp-p (max), 5ma rise time
Synch: +/-3% of oscillator frequency per V RMS

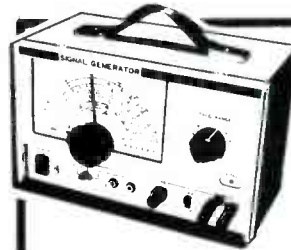

Wideband RF Signal Generator

\$139

Q-1312

Now a low cost RF signal generator that's great for checking and aligning IF circuits and tuners in AM, FM, and TV sets plus a huge range of general purpose service, troubleshooting and development work.

SPECIFICATIONS:

Frequency Range: 100kHz to 150MHz in six overlapping ranges.
Accuracy: +/-3%
RF Output: 100mV rms approx. (up to 35MHz)
Modulation: 1kHz internal, 50Hz - 20kHz external
Audio Output: 1kHz at 1V rms (fixed)
Crystal Oscillator: 1-15MHz external crystal, HC-6/u holder
Supply Voltage: 110V

FET Input Multimeter

This 10MΩ Input impedance FET multimeter is just the tool for quick measurements & reliable service. A high impact shock resistant case, tilt stand, power on LED, and comes with 1 x 9V & 2 x "AA" batteries. The meter scale is mirrored for accuracy and measures 4 1/2".



DC Volts 0-0.3, 1, 1.2, 30, 120, 300, 1200V
RMS and peak to peak
AC Volts: 0-0.3, 1.2, 30, 120, 1200V
DC Current: 0-0.1uA, 0.3, 3.30, 300mA, 12A
AC Current: 0-12A
Resistance: 0-1000MΩ, 6 ranges

\$79⁹⁵

Q-1143

Rack Mount Cabinets

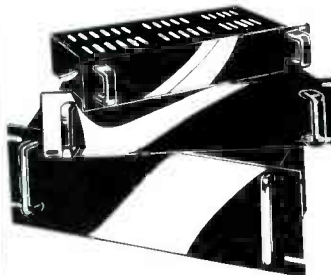

Now in three sizes, these professional quality black instrument cases of aluminum & steel fit standard 19" racks. Heavy gauge (1/8") front panel, ventilated top & bottom panels. Supplied flat, assembles in minutes.

- Slim**
16 1/2" x 9 1/2" x 1 1/2" 5lbs. 10.5oz. Cat H-2483 **\$24⁹⁵**
- Medium**
16 1/2" x 9 1/2" x 3 1/4" 7lbs. 8oz. Cat H-2482 **\$27⁵⁰**
- Large**
16 1/2" x 9 1/2" x 5 1/2" 9lbs. 5oz. Cat H-2481 **\$29⁹⁵**

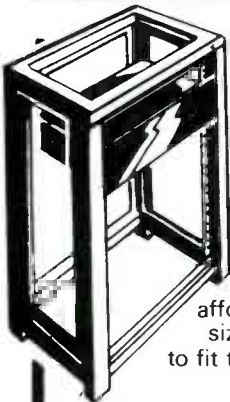

Zip Rack To Suit 19" Cabinets

The industry standard 19" rack, used by engineers, designers & scientists for years is now available at an affordable price. We carry three sizes of the 19" wide cabinets to fit the 19" rack.

\$49⁹⁵

Panels To Suit H-2470

\$39⁹⁵ Custom fit flush mount aluminum top & side panels.
H-2471

L Rack To Suit 19" Cabinet

L-shaped 8 section rack constructed of our 3/32 in. angle iron welded at L joint for maximum strength has a rear crossbar for rigidity.

\$17⁹⁵

H-2468



Order by Phone 415-368-1066

Mon - Fri 7a.m. - 6p.m. Pacific Time

14-Day Satisfaction Guarantee

MAIL ORDERS

DSE, P.O. Box 8021, Redwood City, CA 94063

HEAD OFFICE: 390 Convention Way, Redwood City, CA 94063

We ship UPS Ground unless otherwise requested. Add 5% of order total minimum \$1.50 for shipping. Outside USA add 20% (min \$4). There is an additional \$1.50 handling fee. California residents please add sales tax. VISA and MASTERCARD welcome. Minimum order value \$20.00.

DICK SMITH ELECTRONICS

To receive your copy of our 148 page catalog circle Reader Service 176

SEND FOR FREE 1987 CATALOG... 48 PAGES!

***QUALITY PARTS* DISCOUNT PRICES *FAST SHIPPING!**

ALL ELECTRONICS CORP.

SPRING LEVER TERMINALS

Two color coded terminals on a sturdy 2 1/4" x 3 1/4" bakelite plate. Great for speaker enclosures or power supplies.
75¢ EACH 10 for \$6.00

FUSES

3AG (AGC) SIZE
1, 1 1/2, 2, 2 1/2, 3, 4, 5, 6 AMP
GMA SIZE
1, 2, 3, 4, 5 AMP
5 of any ONE amperage 75¢

LIGHT ACTIVATED MOTION SENSOR

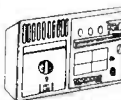

This device contains a photocell which senses sudden changes in ambient light. When an object or person passes within its field of view (about 5') it beeps for several seconds then resets. Could be used as a door annunciator or modified to trigger other devices. 5 1/2" x 4" x 1. Operates on 6 Vdc. Requires 4 AA batteries (not included).
CAT# LSMD \$5.75 per unit

SOUND EFFECTS BOARD

PC board with 2 1/4" speaker, 2 LEDs, IC, battery snap, other components 2 3/8" x 3". When switch is pushed board beeps and leads light. Operates on 9v battery (not included).
Experimenter's delight*
CAT# ST-3 \$1.25 ea.



MICRO-CASSETTE MECHANISM

Micro-cassette tape transport for standard MC60 or MC45 micro-cassettes. 3 Vdc operation. Contains: drive motor, belt, head, capstan, pinch wheel and other components. 3 1/2" X 2 1/4" X 5/8"
CAT# MCMEC \$3.00 each 10 for \$27.50



EDGE CONNECTORS

ALL ARE .156" SPACING.

22 EDGE CONNECTOR \$1.25 ea
solder lug style 10 for \$11.00
22/44 EDGE CONNECTOR \$2.00 ea
PC style 10 for \$18.00
22/44 EDGE CONNECTOR
solder lug style \$2.50 each
28/56 EDGE CONNECTOR
PC style \$2.50 ea
36/72 EDGE CONNECTOR
PC style \$3.00 each
43/86 EDGE CONNECTOR
PC style \$4.50 each

2K 10 TURN

MULTI-TURN POT SPECTROL # MOD 534-7161
\$5.00 EACH

RELAYS
10 AMP SOLID STATE

CONTROL: 3 - 32 vdc
LOAD: 140 vac 10 amp
SIZE: 2 1/2" x 3/4" x 7/8"
\$9.50 EACH 10 FOR \$90.00

ULTRA-MINIATURE 5 VDC RELAY

Fujitsu # FBR211NED005M20
High sensitivity
COIL: 120 ohms
CONTACTS: 1 amp
Mounts in 14 pin DIP socket
\$1.25 each 10 for \$10.00

MINIATURE 6 VDC RELAY

Aromat # RSD-6V
Super Small
S.P.D.T. relay
Gold cobalt contacts rated
1 amp @ 30 vdc. Highly sensitive. TTL direct drive possible. 120 ohm coil.
Operate from 4 - 3 - 6 vdc.
COIL: 120 ohms \$1.50 each
1 1/2" x 1 1/2" x 1 1/8" 10 for \$13.50

13 VDC RELAY

CONTACTS: S.P.N.C.
10 amp @ 120 vac
Energize coil to open contact.
COIL: 13 vdc 650 ohms
SPECIAL PRICE \$1.00 each
4PDT RELAY
14 pin KH style...
3 amp contacts...
USED but fully tested... \$1.70 each
Specify coil voltage desired
Either 24 vdc or 120 vac
LARGE QUANTITIES AVAILABLE
SOCKETS FOR KH RELAY 75¢ each

PHOTO-FLASH CAPACITORS

170 MFD 330 Volt
CAT# PPC-170 75¢ each
400 MFD 330 Volt
CAT# PPC-400 \$1.00 ea

MINIATURE TOGGLE SWITCHES ALL ARE RATED 5 AMPS @ 125 VAC

S.P.D.T. (on-on)
PC style non-threaded bushing
75¢ each 10 for \$7.00

S.P.D.T. (on-on)
Solder lug terminals
\$1.00 each 10 for \$8.00

S.P.D.T. (on-off-on)
Solder lug terminals
\$1.00 each 10 for \$8.00

S.P.D.T. (on-off-on)
PC lugs threaded bushing.
\$1.00 each 10 for \$8.00

D.P.D.T. (on-on)
Solder lug terminals
\$2.00 each 10 for \$19.00

COMPUTER GRADE CAPACITORS

1,400 mfd. 200 Vdc
3" x 2" dia. \$2.00
6,400 mfd 60 Vdc
4 1/4" x 1 3/8" dia. \$2.50
7,500 mfd 200 Vdc
5 3/4" x 3" dia. \$4.00
12,000 mfd 40 Vdc
4 1/4" x 2" dia. \$2.50
22,000 mfd 25 Vdc
4 3/4" x 2" dia. \$2.50
48,000 mfd 10 Vdc
3" x 2 1/2" dia. \$2.50
66,000 mfd 15 Vdc
3 3/4" x 3" dia. \$3.50
72,000 mfd 15 Vdc
4" x 2" dia. \$3.50
100,000 mfd 10 Vdc
6" x 2 1/2" dia. \$1.00

SP.S.T. TOGGLE SWITCH
CARLING (on-off) RATED: 10 amp @ 125 Vac. All plastic body and toggle.
CAT# STS-1 \$1.00 ea.
10 for \$8.50
100 for \$7.50
LARGE QUANTITIES

LED'S STANDARD JUMBO DIFFUSED T 1-3/4
RED 10 for \$1.50
100 for \$13.00
GREEN 10 for \$2.00
100 for \$17.00
YELLOW 10 for \$2.00
100 for \$17.00

FLASHER LED
5 volt operation red/jumbo T 1 1/4 size
CAT# LED-4 \$1.00

NEW GREEN FLASHER
CAT# LED-4G \$1.00

BI-POLAR jumbo T 1 1/4 size
2 for \$1.70

XENON FLASH TUBE
3/4" long X 1/8" dia. Flash tube designed for use in compact camera flash units. Ideal for experimenters.
CAT# FLT-1 2 for \$1.00

LED HOLDERS
Two piece holder for jumbo LED
100 for \$5.00

CLEAR CLIPLITE LED HOLDER
Make LED a fancy indicator. Clear.
4 for \$1.00

3rd TAIL LIGHT ?

Sleek high-tech lamp assembly. Could be used as a third auto tail light, emergency warning light, or special-effects lamp. Red reflective lens is 2 3/4" x 5 1/2" is mounted on a 4" high pedestal with up-down swivel adjustment. Includes 12v replaceable bulb.
CAT# TLB \$3.95 each.

48 KEY ASSEMBLY FOR COMPUTER OR HOBBYIST
NEW T.I. KEYBOARDS. Originally used on computers, these keyboards contain 48 S.P.S.T. mechanical switches. Terminates to 15 pin connector. Frame 4" x 9"
CAT# KP-48 \$3.50 each

WE'VE MOVED
Our Mail Order Operations to serve U better
NEW MAILING ADDRESS
P.O. BOX 567
VAN NUYS, CA 91408

WALL TRANSFORMERS

all plug directly into 120 vac outlet

4 VDC @ 70 ma. \$2.00
6 VAC @ 500 ma. \$3.50
6 VDC @ 750 ma. \$4.50
9 VDC @ 500 ma. \$5.00
12.5 VAC @ 265 ma. \$3.00
16 VAC @ 18 VA and 8.5 VAC @ 128 VA \$3.50
24 VAC @ 250 ma. \$3.00
MULTI-VOLTAGE @ 500 ma. 3, 4, 5, 6, 7, 8, 9 or 12 VDC \$7.50

TRANSISTORS

2N706 4 for \$1.00
2N2222A 3 for \$1.00
2N2904 3 for \$1.00
2N2905 3 for \$1.00
MJ2855 \$1.50
2N3055 \$1.00
PMD 10K40 \$1.00
TIP 121 75¢
TIP 125 75¢

TRANSFORMERS

120 volt primaries

5.6 volts @ 750 ma. \$3.00
6.3 volt @ 600 ma. \$1.75
12 V.C.T. @ 200 ma. \$2.00
12 V.C.T. @ 400 ma. \$3.00
12 V.C.T. @ 1 amp \$4.00
12 V.C.T. @ 2 amp \$4.85
12 V.C.T. @ 4 amp \$7.00
18 volts @ 650 ma. \$2.00
24 V.C.T. @ 200 ma. \$2.50
24 V.C.T. @ 1 amp \$4.85
24 V.C.T. @ 2 amp \$6.75
24 V.C.T. @ 3 amp \$9.50
24 V.C.T. @ 4 amp \$11.00

TI SWITCHING POWER SUPPLY

Compact, well-regulated switching power supply designed to power Texas Instruments computer equipment.
SPECIAL PRICE
INPUT: 14 - 25 vac @ 1 amp
OUTPUT: + 12 vdc @ 350 ma.
+ 5 vdc @ 1.2 amp
- 5 vdc @ 200 ma.
SIZE: 4 1/4" x 4 1/4" x 1 1/4" high
\$3.50 each

13.8 VDC REGULATED POWER SUPPLY

These are solid state, fully regulated 13.8 vdc power supplies. Both feature 100% solid state construction, fuse protection, and L.E.D. power indicator. U.L. listed.
2 amp constant, 4 amp surge \$20.00 each
3 amp constant, 5 amp surge \$27.50 each

TELEPHONE COUPLING TRANSFORMER

Stancor # TTPC-8
600 ohms c.t. to 600 ohms c.t.
P.C. board mount
3/4" x 5/8" x 3/4"
\$1.25 each

SOUND AND VIDEO MODULATOR

TI#UM1381-1 Designed for use with T.I. computers. Can be used with video cameras, games or other audio/video sources. Built in A/B switch enables user to switch from T.V. antenna without disconnection. Channel 3 or 4 selection. Operates on 12 Vdc. Hook-up diagram included.
CAT# AVMOD \$5.00 each.

RECHARGEABLE NI-CAD BATTERIES

AAA SIZE 1.25V \$1.85
AA SIZE 1.25V 500MAH \$1.85
AA with solder tab \$2.00
C SIZE 1.2V 1200MAH \$3.50
SUB-C SIZE solder tab \$3.50
D SIZE 1.2V 1200MAH \$3.50

NI-CAD CHARGER TESTER

Will charge most every size Ni-cad battery available.
Cat# UNCC-N \$12.50

8" 15 WATT SPEAKER

C.T.S Model 8B3079
Full range speaker, 100-10,000Hz. Ideal for PA systems. Mounting holes for line-matching transformer.
CAT#SK-815 \$3.50 ea. Case of 8 pcs. \$25.00 per case

STORES
LOS ANGELES, CA
905 S. Vermont Ave.
213 380-8000
VAN NUYS, CA
6228 Sepulveda Blvd.
818 997-1806

MAIL ORDERS TO:
ALL ELECTRONICS
P.O. BOX 567
91408
TWX - 101010163
ALL ELECTRONIC

QUANTITIES LIMITED
MINIMUM ORDERS \$10.00
CALIF. ADD SALES TAX
USA: \$3.00 SHIPPING
NO C.O.D.'S
FOREIGN ORDERS:
INCLUDE SUFFICIENT SHIPPING

TOLL FREE ORDERS
800-826-5432
INFO • (213) 380-8000
FAX - (213) 389-7073

POLARITY SWITCH
external coaxial relay on a satellite TV system. IDEAL FOR THE EXPERIMENTOR AS PARTS Heavy chassis box containing a CA 358 op amp and other parts. Catalog # RDP5
\$1.75 each 10 for \$15.00

SOLID STATE BUZZER
Star # SMB-06L
6 vdc
TTL compatible.
\$1.00 each 10 for \$9.00

ADVERTISING INDEX

RADIO-ELECTRONICS does not assume any responsibility for errors that may appear in the index below.

Free Information Number	Page		
81, 211	A.I.S. Satellite	90	— McGraw Hill Book Club 36
108	AMC Sales	89	61 McGraw Hill Cont. Ed. Series 49
107	All Electronics	113	214 Microprocessors Unltd. 75
103	Allen W.B.	24	117 Monitronics 90
—	Amazing Devices	114	— Mouser 32
199	American Design Components	105	182 NRI 18
202	Annapro	75	182 NTS 91
84	Appliance Service	90	71 Mew-Tone Electronics 40
206	B N F Enterprises	100	183 Nohau 92
77	B&K Precision	3	210 NuScope Associates 75
191	Banner Technical Books	34	110 Omnitron 35
98	Beckman Industrial	17	205 PC Boards 92
85	Blue Star Industries	91	— Pacific Cable 97
109	C & S Sales	23	208 Parts Express 96
—	C.O.M.B.	26	204 Pro Corp. 75
60	CIE	8	78 Radio Shack 104
184	Caig Laboratories	22	187, 188 Sencore 27, 29
89	Cameo Enterprises	91	189, 190 Sencore 31, 33
—	Carribean	88	186 Silicon Valley Surplus 114
195	Chapman Tools	90	92, 207 Tektronix CV2, 16
200, 201	Circuit Cellar	90, 91	213 United Imports 90
—	Command Productions	34	66 W.S. Jenks 22
203	Consumertronics	75	216 Wahl Clipper 28
209	Cook's Institute	89	
198	Crystek	30	
127	Deco Industries	90, 91	
176	Dick Smith Electronics	111	
82	Digi-Key	112	
215	E-Z Hook	12	
—	Electronic Technology Today	CV3	
194	Electronic Parts	91	
—	Electronics Book Club	57	
120	Elephant Electronics	91	
111	Etronix	93	
100	Firestik II	32	
—	Fordham Radio	CV4	
—	Grantham College of Engineering	7	
62	Hameg	13	
193	Heath	14, 15	
196, 197	ICS Computer Training	32, 93	
—	ISCET	93	
65	J & W	25	
59	JDR Instruments	5	
113, 178	JDR Microdevices	106, 107	
179, 180	JDR Microdevices	108, 109	
181	JDR Microdevices	110	
114	Jameco	102, 103	
115	Jensen Tools	91	
185	Lil' Bitty Tester	92	
87	MCM Electronics	101	
212	MD Electronics	91	
93	Mark V. Electronics	98	

Gernsback Publications, Inc.
 500-B Bi-County Blvd.
 Farmingdale, NY 11735
 (516) 293-3000
 President: Larry Steckler
 Vice President: Cathy Steckler

For Advertising ONLY
 516-293-3000
Larry Steckler
 publisher
Arline Fishman
 advertising director
Shelli Weinman
 advertising associate
Lisa Strassman
 credit manager
Christina Estrada
 advertising assistant

SALES OFFICES
EAST/SOUTHEAST
Stanley Levitan
 Eastern Sales Manager
 Radio-Electronics
 259-23 57th Avenue
 Little Neck, NY 11362
 718-428-6037, 516-293-3000

MIDWEST/Texas/Arkansas/Okla.
Ralph Bergen
 Midwest Sales Manager
 Radio-Electronics
 540 Frontage Road—Suite 339
 Northfield, IL 60093
 312-446-1444

PACIFIC COAST/ Mountain States
Marvin Green
 Pacific Sales Manager
 Radio-Electronics
 15335 Morrison St.—Suite 227
 Sherman Oaks, CA 91403
 818-986-2001

AMAZING SCIENTIFIC & ELECTRONIC PRODUCTS

PLANS—Build Yourself—All Parts Available In Stock

- LC7—BURNING CUTTING CO₂ LASER \$ 20.00
- RUB4—PORTABLE LASER RAY PISTOL 20.00
- TCG1—3 SEPARATE TESLA COIL
- PLANS TO 1.5 MEV 20.00
- IOG1—ION RAY GUN 10.00
- GRA1—GRAVITY GENERATOR 10.00
- EML1—ELECTRO MAGNET COIL GUN/LAUNCHER 6.00

KITS

- MFT1K—FM VOICE TRANSMITTER 3 MI RANGE 49.50
- VWP5K—TELEPHONE TRANSMITTER 3 MI RANGE 39.50
- BTC3K—250,00 VOLT 10-14" SPARK TESLA COIL 199.50
- LHC2K—SIMULATED MULTICOLOR LASER 39.50
- BLS1K—100,000 WATT BLASTER DEFENSE DEVICE 69.50
- ITM1K—100,000 VOLT 20" AFFECTIVE RANGE INTIMIDATOR 69.50
- PSP4K—TIME VARIANT SHOCK WAVE PISTOL 59.50
- PTG1K—SPECTACULAR PLASMA TORNADO GENERATOR 149.50
- MVP1K SEE IN DARK KIT 169.50

ASSEMBLED

- PG70H—MULTICOLOR VARIABLE MODE PLASMA GLOBE '7 425.00
- BTG10—50,000 VOLT—WORLD'S SMALLEST TESLA COIL 44.50
- LGU40—1MW HeNe VISIBLE RED LASER GUN 299.50
- TAT20 AUTO TELEPHONE RECORDING DEVICE 24.50
- GPV10—SEE IN TOTAL DARKNESS IR VIEWER 299.50
- LST10—SNOOPER PHONE INFINITY TRANSMITTER 169.50
- IPG70—INVISIBLE PAIN FIELD GENERATOR—MULTI MODE 74.50

• CATALOG CONTAINING DESCRIPTIONS OF ABOVE PLUS HUNDREDS MORE AVAILABLE FOR \$1.00 OR INCLUDED FREE WITH ALL ABOVE ORDERS.
 PLEASE INCLUDE \$3.00 PH ON ALL KITS AND PRODUCTS PLANS ARE POSTAGE PAID. SEND CHECK, MO, VISA, MC IN US FUNDS.

INFORMATION UNLIMITED
 P.O. BOX 716 DEPT. RE, AMHERST, NH 03031

MACINTOSH NOTEBOOKS

PRENTICE HALL BOOKS BY JOHN HEILBORN

BUY ALL 3 AND GET 1 FREE

8 1/2 by 11" WELL ILLUSTRATED BOOKS WITH EASY TO READ TYPE. EACH IS OVER 200 PAGES AND IS FILLED WITH HINTS, AND, SHORTCUTS KNOWN ONLY TO PROGRAM DESIGNERS

MacPaint I HAVE USED MacPaint FOR TWO YEARS AND THIS BOOK TAUGHT ME SOME NEW TRICKS

MacWrite THIS BOOK CAN CUT YOUR TIME BY 20% WHILE IMPROVING THE APPEARANCE OF YOUR WORK

MultiPlan ALL THE HINTS AND SHORTCUTS THE OWNER'S MANUAL LET OUT ARE IN THIS BOOK

MSDOS 3 BOOK SET 15.99 SET
 BY MICRO SOFT

■ USERS GUIDE ■ DEBUG UTILITY
 ■ PROGRAMMERS REFERENCE
 BUY THIS 3 BOOK SET AND LEARN "DOS" AT HOME.

FLOPPY DISK CONTROLLER
 IBM COMPATIBLE WITH PRINTER PORT

CONTROLS 2 DRIVES. THE PRINTER PORT IS A DB 25 CENTRONICS AT LPT 1. MADE BY TANDON PART NUMBER 188400

18.99
 (MONEY BACK IF IT DOESN'T WORK ON YOUR CLONE)

ROBOTICS PARTS

ARM ASSEMBLY \$299.00
 ■ ARM MOVES IN 3 DIRECTIONS
 ■ WRIST ROTATES 200 DEGREES
 ■ GRIPS ITEMS UP TO 2 INCHES
 ■ CENTRONICS INTERFACE

P.W.M. SERVO AMP. \$49.00
 ■ CONTROLS 6 MOTORS
 ■ CENTRONICS INTERFACE

MOTORIZED PLATFORM \$99.00
 ■ STRONG STEEL CHASSIS
 ■ 2 MOTORS AND WHEELS

Call for a copy of 15 day trial agreement. Tax & freight extra. Send check or add 1.90 for COD. Price may change. Store Price may differ. While supplies last. No POs, terms, or credit cards \$5 min postage and handling charge.

Silicon Valley Surplus OPEN 10am-6pm
 415-261-4506 CLOSED SUN & MON
 4401 OAKPORT OAKLAND CA, 94601

CALL OUR BBS 415-261-4513

CIRCLE 186 ON FREE INFORMATION CARD

RADIO-ELECTRONICS

Electronics Paperback Books

EVERY BOOK IN THIS AD \$6 OR LESS!

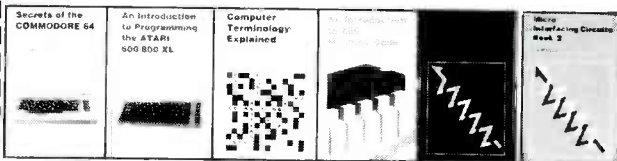

- BP125—25 SIMPLE AMATEUR BAND ANTENNAS.....\$5.00.** All are inexpensive to build, yet perform well. Diodes, beams, triangle and even a mini rhombic.
- BP128—20 PROGRAMS FOR THE ZX SPECTRUM AND 16K ZX82.....\$5.75.** Included with each program is a flow chart and a description of what happens. Notes for converting programs for use on other computers are also included.
- 160—COIL DESIGN & CONSTRUCTION MANUAL.....\$5.95.** How the hobbyist can build RF, IF, audio and power coils, chokes and transformers. Covers AM, FM and TV applications.
- 208—PRACTICAL STEREO & QUADROPHONY HANDBOOK.....\$3.00.** A reference book for all interested in stereo and multichannel sound reproduction.
- BP99—MINI-MATRIX BOARD PROJECTS.....\$5.00.** Here are 20 useful circuits that can be built on a mini-matrix board that is just 24 holes by ten copper-foil strips.
- BP157—HOW TO WRITE ZX SPECTRUM AND SPECTRUM+ GAMES PROGRAMS.....\$5.95.** A crystal-clear step-by-step guide to writing your own graphics games programs.
- BP117—PRACTICAL ELECTRONIC BUILDING BLOCKS—Book 1.....\$5.75.** Oscillators, Timers, Noise Generators, Rectifiers, Comparators, Triggers and more.
- 219—SOLID-STATE NOVELTY PROJECTS.....\$4.95.** Fun projects include the Optomin, a musical instrument that is played by reflecting a light beam with your hand, and many more.
- BP179—ELECTRONIC CIRCUITS FOR THE COMPUTER CONTROL OF ROBOTS \$5.00.** Data and circuits for interfacing the computer to the robot's motors and sensors.
- BP126—BASIC & PASCAL IN PARALLEL.....\$4.95.** Takes these two programming languages and develops programs in both languages simultaneously.
- 224—50 CMOS IC PROJECTS.....\$5.25.** Includes sections on multivibrators, amplifiers and oscillators, trigger devices, and special devices.
- 225—A PRACTICAL INTRODUCTION TO DIGITAL IC'S.....\$4.95.** Mainly concerned with TTL devices. Includes several simple projects plus a logic circuit test set and a digital counter timer.
- BP170—INTRODUCTION TO COMPUTER PERIPHERALS.....\$5.95.** Shows how to use a variety of co computer add-ons in as non-technical a way as possible.
- 227—BEGINNERS GUIDE TO BUILDING ELECTRONIC PROJECTS.....\$5.00.** How to tackle the practical side of electronics so you can successfully build electronic projects.
- BP169—HOW TO GET YOUR COMPUTER PROGRAMS RUNNING.....\$5.95.** Shows how to identify error in program and what to do about them.
- 123—FIRST BOOK OF PRACTICAL ELECTRONIC PROJECTS.....\$3.75.** Projects include audio distortion meter, super FET receiver, guitar amplifier, metronome and more.
- BP24—52 PROJECTS USING IC 741.....\$5.25.** Lots of projects built around this one available IC.
- BP110—HOW TO GET YOUR ELECTRONIC PROJECTS WORKING.....\$5.00.** How to find and solve the common problems that can occur when building projects.

- BP33—ELECTRONIC CALCULATOR USERS HANDBOOK.....\$5.75.** Invaluable book for all calculator owners. Tells how to get the most out of your calculator.
- BP36—50 CIRCUITS USING GERMANIUM, SILICON & ZENER DIODES.....\$5.00.** A collection of useful circuits you'll want in your library.
- BP37—50 PROJECTS USING RELAYS, SCR'S & TRIACS.....\$5.00.** Build priority indicators, light modulators, warning devices, light dimmers and more.
- BP183—AN INTRODUCTION TO CP/M.....\$5.75.** To run and use programs operating under the CP/M operating system you will find this book extremely useful.
- BP42—SIMPLE LED CIRCUITS.....\$5.00.** A large selection of simple applications for this simple electronic component.
- BP127—HOW TO DESIGN ELECTRONIC PROJECTS.....\$5.75.** Helps the reader to put projects together from standard circuit blocks with a minimum of trial and error.
- BP122—AUDIO AMPLIFIER CONSTRUCTION.....\$5.75.** Construction details for preamps and power amplifiers up through a 100-watt DC-coupled FED amplifier.
- BP92—CRYSTAL SET CONSTRUCTION.....\$5.00.** Everything you need to know about building crystal radio receivers.
- BP45—PROJECTS IN OPTOELECTRONICS.....\$5.00.** Includes infra-red detectors, transmitters, modulated light transmission and photographic applications.
- BP48—ELECTRONIC PROJECTS FOR BEGINNERS.....\$5.00.** A wide range of easily completed projects for the beginner. Includes some no-soldering projects.
- BP49—POPULAR ELECTRONIC PROJECTS.....\$5.50.** Radio, audio, household and test equipment projects are all included.
- BP51—ELECTRONIC MUSIC AND CREATIVE TAPE RECORDING.....\$5.50.** Shows how you can make electronic music at home with the simplest and most inexpensive equipment.
- BP56—ELECTRONIC SECURITY DEVICES.....\$5.00.** Includes both simple and more sophisticated burglar alarm circuits using light, infra-red, and ultrasonics.
- BP59—SECOND BOOK OF CMOS IC PROJECTS.....\$5.00.** More circuits showing CMOS applications. Most are of a fairly simple design.
- BP72—A MICROPROCESSOR PRIMER.....\$5.00.** We start by designing a small computer and show how we can overcome its shortcomings.
- BP74—ELECTRONIC MUSIC PROJECTS.....\$5.95.** Provides the experimenter with a variety of practical circuits including a Fuzz Box, Sustain Unit, Reverberation Unit, Tremolo Generator and more.
- BP91—AN INTRODUCTION TO RADIO DXING.....\$5.00.** How you can tune in on those amateur and commercial broadcasts from around the world in the comfort of your home.
- BP94—ELECTRONIC PROJECTS FOR CARS AND BOATS.....\$5.00.** Fifteen simple projects that you can use with your car or boat. All are designed to operate from 12-volt DC supplies.

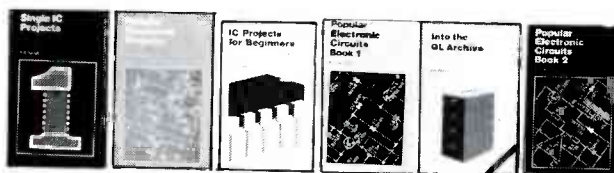
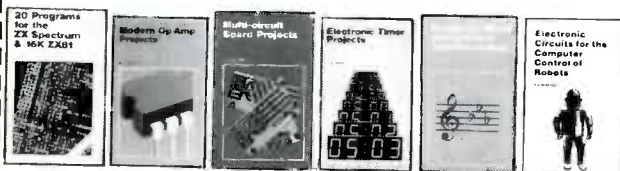

ELECTRONIC TECHNOLOGY TODAY INC.
P.O. Box 240, Massapequa Park, NY 11762-0240

Name _____
Address _____
City _____ State _____ Zip _____

SHIPPING CHARGES IN USA & CANADA

\$0.01 to \$5.00 \$1.00
\$5.01 to \$10.00 \$1.75
\$10.01 to 20.00 \$2.75
\$20.01 to 30.00 \$3.75
\$30.01 to 40.00 \$4.75
\$40.01 to 50.00 \$5.75
\$50.01 and above \$7.00

OUTSIDE USA & CANADA Number of books ordered

Multiply Shipping by 2 for sea mail
Multiply Shipping by 4 for air mail

Total price of merchandise \$ _____
Sales Tax (New York State Residents only) \$ _____
Shipping (see chart) \$ _____

All payments must be in U.S. funds Total Enclosed ... \$ _____

R-9-87

SCOPE 3 1/2 Digital Multimeters

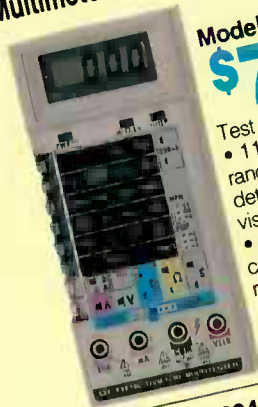

Model DVM-638
\$7995

- Test leads included
- 11 function, 38 ranges
- Logic level detector
- Audible visual continuity
- Capacitance and conductance measurement

SCOPE 3 1/2 Digit Capacitance Meter



Model DCM-602
\$5500

- Test leads included
- 8 ranges with full scale values to 2000 uF
- LSI circuit
- Crystal time base
- Frequency range 800 Hz to 8Hz

SCOPE Pocket Sized Audio Signal Generator



Model RC-555
\$4995

- Test leads & 9V battery included
- Low distortion sine-wave signal
- 46 step selected frequency
- x1 range 20 Hz to 1.5 KHz
- x100 range 2 KHz to 150 KHz

SCOPE 4 1/2 Digit LCD Bench Digital Multimeter



Model DVM-6005
\$19995

- Test lead set 6, "D" size batteries included
- 0.4" high characters
- Conversion period: 500 milliseconds
- Automatic, negative polarity

Model DVM-634
\$5275

- 7 function, 32 ranges
- Transistor measurement

Model DVM-636
\$5875

- 8 function, 37 ranges
- Capacitance measurement

Mini-Meters with Maxi-Specs

SCOPE 3 1/2 Digit LCD with 8 Full Functions

Model DVM-632

\$4495
OUR PRICE

Measures only 5 3/8" x 2 13/16" x 1 1/4"

- Deluxe test leads included
- 0.5% accuracy
- Transistor gain test
- Audible continuity checking & diode test
- 10 Amp measurement

Zipped Carrying Case CC-30 **\$450**



SCOPE 3 1/2 Digit LCD



Measures only 5" x 2 3/4" x 7/8"

Model DVM-630

\$2995

OUR PRICE

- Test leads included
- 0.5% accuracy
- 6 functions, 19 ranges
- Automatic zero adjust
- Low battery indication

Zipped Carrying Case CC-30 **\$450**

ASK FOR FREE CATALOG.

Money orders, checks accepted. C.O.D.'s require 25% deposit.



Fordham

260 Motor Parkway, Hauppauge, NY 11788

Toll Free

800-645-9518

In NY State 800-832-1446

Service & Shipping Charge Schedule Continental U.S.A.

FOR ORDERS	ADD
\$25-\$100	\$4.50
\$101-\$250	\$6.00
\$251-500	\$8.00
\$501-750	\$10.50
\$751-1000	\$12.50
\$1,001-1500	\$16.50
\$1,501-2000	\$20.00
\$2,001 and up	\$25.00