

Radio- WHAT'S NEW IN CAR STEREO

\$2.25 JULY 1987
IN CANADA \$2.75

Electronics®

TECHNOLOGY - VIDEO - STEREO - COMPUTERS - SERVICE

AUTO SOUND

Great systems
Great installations

IBM's NEW PC's



R-E ROBOT

Build a
controller
board

EARLY DAYS OF RADIO

Amplifier
beginnings

TV SIGNAL DESCRAMBLING

Digital audio encoding

BUILD A DIGITAL SPEEDOMETER

For a high-tech dashboard

COMPUTER DIGEST

IBM's new PC's

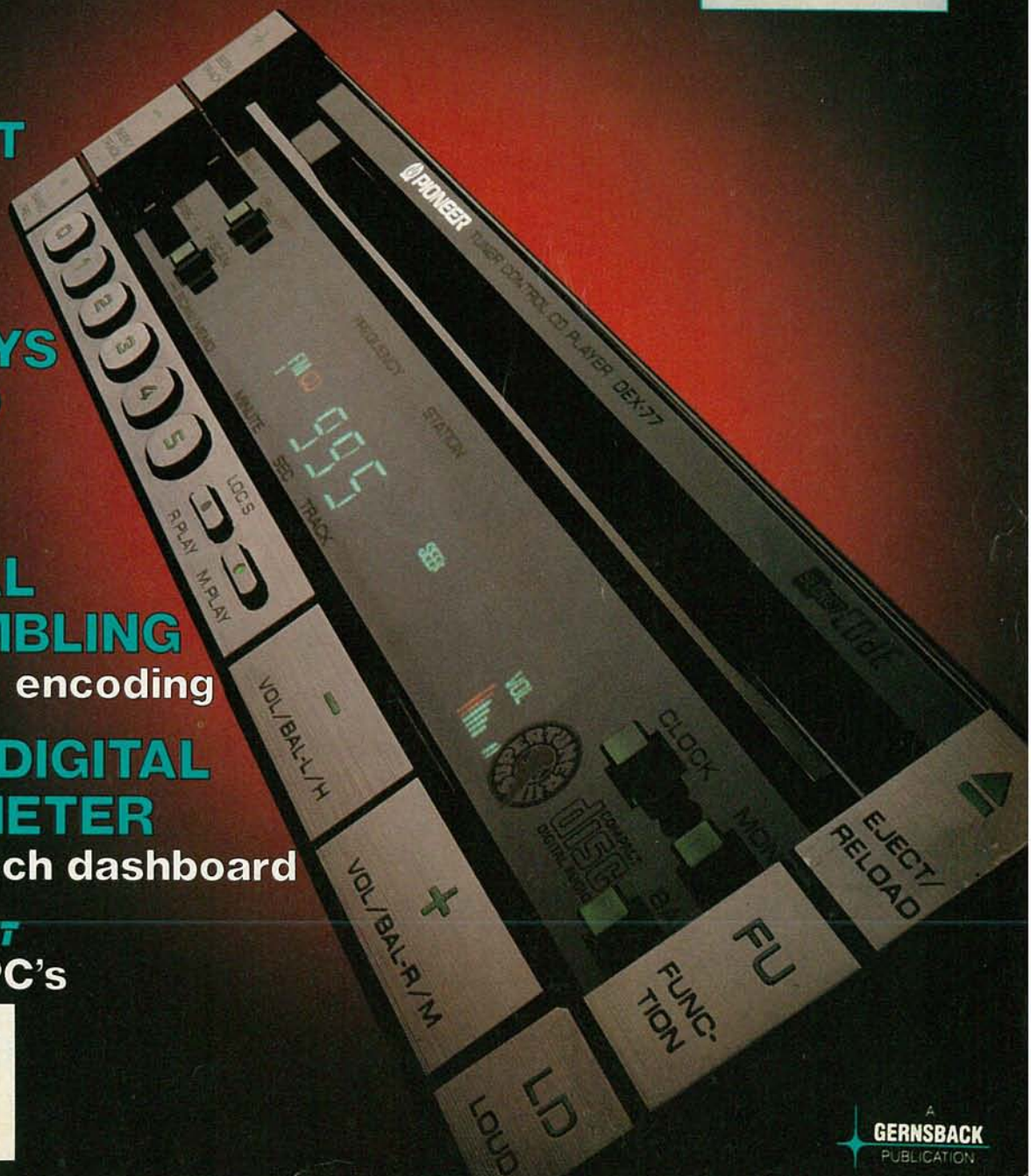

A
GERNSBACK
PUBLICATION

NOW GET SCOPE, COUNTER AND DMM INPUT ALL AT ONCE THROUGH ONE PROBE!

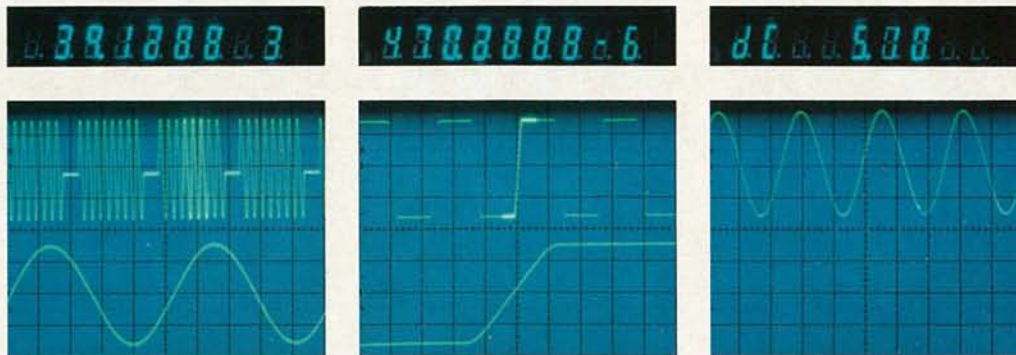

Gated frequency measurement. B sweep triggering during the intensified portion of the A sweep. Intensified portion frequency is measured with the counter/timer/DMM.

Delay time measurement. Delay time from the start of A sweep to the start of the B sweep is measured with crystal accuracy.

Channel 1 dc volts measurement. The average dc component of a waveform is measured directly through channel 1 with direct digital fluorescent readout.

The Tek 2236 combines 100 MHz, dual timebase scope capability with counter/timer/DMM functions integrated into its vertical, horizontal and trigger systems. For the same effort it takes to display a waveform you can obtain digital readout of frequency, period, width, totalized events, delay time and Δ -time to accuracies of 0.001%.

The same probe is used to provide input for the CRT display and the digital measurement system, resulting in easy set-up, greater measurement confidence and reduced circuit loading. Probe tip volts can also be measured through the Ch 1 input.

Precision measurements at the touch of a button.

Auto-ranging frequency, period, width and gated measurements are push-button-simple. And the 2236 offers an independent floating 5000 count, auto-ranging multimeter with side inputs for DC voltage mea-

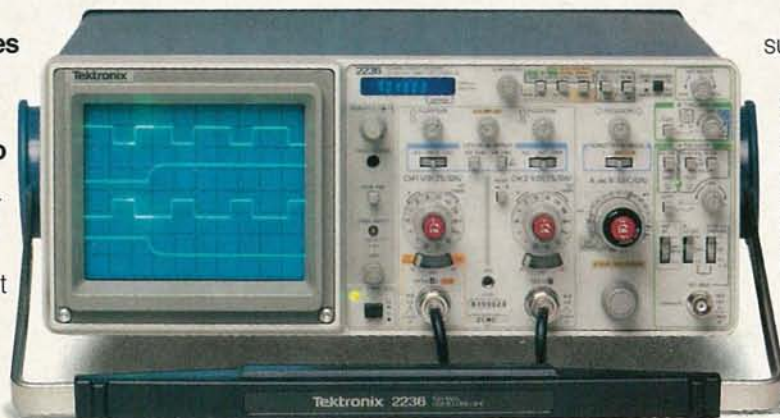

Bandwidth	100 MHz
No of Channels	2+ Trig. View
Max. Sweep Speed	5 ns/div
Digital Readout Features	Direct Ch 1 Voltage Meas. 0.5% DC; 2.0% AC RMS Resistance: .01 Ω to 200 Meg Ω Continuity/Temp: Audible/C $^{\circ}$ or F $^{\circ}$ Totalizing Counter: — 1 counts to 8,000,000 Direct Freq. Meas: 100 MHz to 0.001% acc. Period, Width Meas: 10 ns with 10 ps max. resolution
Timing Meas. Accuracy	.001% (delay and Δ -time with readout)
Trigger Modes	P-P Auto, Norm, TV Field, TV Line, Single Sweep
Weight	7.3 kg (16.2 lb)
Price	\$2650
Warranty	3-year including CRT (plus optional service plans to 5 years)

surements to 0.1%.

A built-in, auto-ranging ohmmeter provides resistance measurements from 0.01 Ω to 2G Ω —as well as audible continuity. Automatic diode/junction detection and operator prompts serve to simplify set-up and enhance confidence in your measurements.

The 2236: scope, counter, timer, DMM plus a 3-year warranty—all for just \$2,650.

Contact your nearest distributor or call Tek toll-free. Technical personnel on our direct-line will answer your questions and expedite delivery. Orders include probes, 30-day free trial and service worldwide.

Call Tek direct:

1-800-433-2323 for video tape or literature,

1-800-426-2200 for application assistance or ordering information.

In Oregon, call collect:
1-627-2200

Tektronix
COMMITTED TO EXCELLENCE

SPECIAL SECTION

- 31 GREAT SYSTEMS**
A look at the latest and the greatest in autosound.
Frank Vizard
- 39 GREAT INSTALLATIONS**
Some classic autosound installations, and a few unusual ones, too.
Frank Vizard

BUILD THIS

- 44 R-E ROBOT**
Part 8. Building the control board.
Steven E. Sarns
- 47 DIGITAL SPEEDOMETER FOR YOUR CAR**
An accurate, eye-catching upgrade for your dashboard.
Ross Ortman
- 79 PC SERVICE**
Use the direct-etch foil patterns to make circuit boards for the digital speedometer.

TECHNOLOGY

- 6 VIDEO NEWS**
A review of the fast-changing video scene.
David Lachenbruch
- 58 TV-SIGNAL SCRAMBLING**
Part 9. Digitally scrambled audio.
William Sheets and Rudolf F. Graf
- 62 SATELLITE TV**
HDTV and DBS.
Bob Cooper, Jr.

CIRCUITS AND COMPONENTS

- 26 DRAWING BOARD**
Dynamic memories.
Robert Grossblatt

RADIO

- 52 EARLY DAYS OF RADIO**
Early amplifiers
Vaughn D. Martin

EQUIPMENT REPORTS

- 15 Avcom PSA-35A Portable Spectrum Analyzer**

COMPUTER DIGEST

- 66 EDITOR'S WORKBENCH**
IBM's new machines and keyboard reviews.
- 70 FROM KEYPRESS TO SCAN CODE**
How PC keyboards work.
Jeff Holtzman
- 74 WORKING WITH SURPLUS KEYBOARDS**
Interface any keyboard with your computer.
Robert Grossblatt

DEPARTMENTS

- 102 Advertising and Sales Offices**
- 102 Advertising Index**
- 7 Ask R-E**
- 103 Free Information Card**
- 12 Letters**
- 84 Market Center**
- 21 New Products**
- 5 What's News**

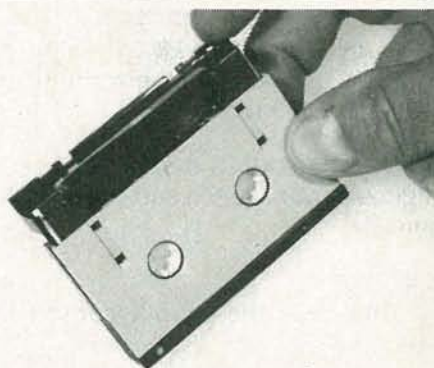

DIGITAL AUDIO TAPE: It's coming in the future. We'll cover the technical details of this promising new audio tape format in an up-coming issue.

COVER 1



Hi-Fi autosound has come a long way since the days of 8-track tape. This month, we'll look at some of the latest and the greatest that the autosound industry has to offer, like Pioneer's DEX-77 CD player and tuner. Included in our discussions are high-tech receivers, cassette players, CD players, CD changers, and speakers, and what makes them special. We'll also look ahead to the next wave in autosound, the DAT player.

But there's more to great mobile sound than just selecting a system and throwing it in your car. And today's downsized vehicles offer tough challenges for even the most skillful installer. However, with effort, electrifying results can be achieved. To prove that, we'll show you how car manufacturers and independent installers have merged automobiles and high-fidelity sound systems to produce concert halls on wheels.

Our two-part special look at autosound begins on page 31.

NEXT MONTH

THE AUGUST ISSUE IS
ON SALE JULY 2

HDTV

The next wave in television is brought into sharp focus.

BUILD AN SCA RECEIVER

Build this special FM receiver and hear what you've been missing.

BUILD THE TALKING BOX

It digitizes your speech and stores it electronically.

R-E ROBOT

Part 9 looks at the robot's control language.

TRANSISTOR AMPLIFIER DESIGN

Hints and pointers for your next project.

As a service to readers, RADIO-ELECTRONICS publishes available plans or information relating to newsworthy products, techniques and scientific and technological developments. Because of possible variances in the quality and condition of materials and workmanship used by readers, RADIO-ELECTRONICS disclaims any responsibility for the safe and proper functioning of reader-built projects based upon or from plans or information published in this magazine.

Since some of the equipment and circuitry described in RADIO-ELECTRONICS may relate to or be covered by U.S. patents, RADIO-ELECTRONICS disclaims any liability for the infringement of such patents by the making, using, or selling of any such equipment or circuitry, and suggests that anyone interested in such projects consult a patent attorney.

Radio-Electronics®

Hugo Gernsback (1884-1967) founder
M. Harvey Gernsback,
editor-in-chief, emeritus

Larry Steckler, EHF, CET, editor-in-chief
and publisher

EDITORIAL DEPARTMENT

Art Kleiman, editorial director
Brian C. Fenton, managing editor
Carl Laron, WB2SLR, associate editor
Jeffrey K. Holtzman,
assistant technical editor
Robert A. Young, assistant editor
Julian S. Martin, editorial associate
Byron G. Wels, editorial associate
M. Harvey Gernsback,
contributing editor
Jack Darr, CET, service editor
Robert F. Scott,
semiconductor editor
Herb Friedman,
communications editor
Bob Cooper, Jr. satellite-TV editor
Robert Grossblatt, circuits editor
Larry Klein, audio editor
David Lachenbruch,
contributing editor
Richard D. Fitch,
contributing editor
Teri Scaduto, editorial assistant

PRODUCTION DEPARTMENT

Ruby M. Yee, production director
Robert A. W. Lowndes,
editorial production
Andre Duzant, technical illustrator
Karen Tucker, advertising production
Marcella Amoroso, production traffic

CIRCULATION DEPARTMENT

Jacqueline P. Cheeseboro,
circulation director
Wendy Alanko,
circulation analyst
Theresa Lombardo,
circulation assistant

Typography by Mates Graphics

Cover Foto by Brian Kosoff

Radio-Electronics is indexed in
Applied Science & Technology Index
and *Readers Guide to Periodical Literature*.

Microfilm & Microfiche editions are
available. Contact circulation department
for details.

Advertising Sales Offices listed
on page 102.



the fourth law of robotics

A robot shall make learning fun for man and thereby improve the quality of life for mankind.



A robot is a robot is a robot... was a robot. Until HERO 2000.

HERO 2000 is much more than a robot. It's a walking, talking 16-bit computer. With 64K ROM and 24K RAM expandable to more than half a megabyte. And a fully articulated arm with five axes of motion. Yours to program. Command. Modify and expand. Total system access and solderless experimenter boards provide almost limitless possibilities. Its remote RF console with ASCII keyboard gives total control. Available with three self-study courses. Backed by Heath Company, world leader in electronic kits.

Build your own HERO 2000. Or buy it assembled. Have fun learning skills that translate directly to the world of work.



HERO[®] 2000

the
knowledge
builder

FREE. Send today for latest Heathkit Catalog.

Heathkit[®]
Heath
Company

A subsidiary of Zenith Electronics Corporation.



Mail coupon today to receive a **FREE** Heathkit Catalog featuring HERO 2000.

Mail to: Heath Company
Dept. 020-558
Benton Harbor, Michigan 49022

Name _____

Address _____

City _____ State _____

Zip _____

RO-141

CIRCLE 204 ON FREE INFORMATION CARD

Oops Proof. Now Even Better.

*Industry's Most Popular Heavy-Duty DMMs...
Now Even Better With Dual-Fuse Protection
And A Tougher Case.*

The tough just got tougher. When Beckman Industrial introduced heavy-duty DMMs tough enough to withstand accidental drops, input overloads and destructive environments, they quickly became the industry's most popular.

Now they're even tougher, thanks to the best dual-fuse protection you can buy and a new case. Covered by a one-year, no-fault guarantee against damage to the meter other than gross abuse.

For overloads, all voltage ranges can withstand transients up to 6KV. Resistance ranges are protected to 600 volts. Current ranges are protected by a 2 amp/600 volt fuse. The 10 amp range is protected by a 15 amp, 600 volt high energy fuse with 100,000 amp interrupt rating.

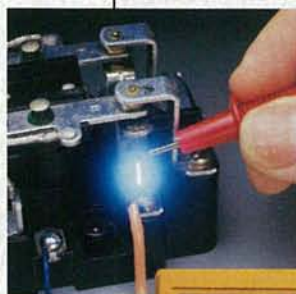

Our heavy-duty DMMs can withstand accidental drops, literally bouncing back for more, thanks to a new case made of Valox[®], one of the most impact and corrosive chemical resistant thermoplastics around. Sensitive components are shock mounted for impact protection.

Even oil, water and industrial grime can't keep our heavy-duty DMMs away from the action. *Everything* is sealed with o-rings for maximum protection.

Of course, even the toughest DMM isn't much good if it can't deliver accuracy and the right combination of capabilities at the right price.

Check the HD DMM specs for yourself: Maximum voltage rating of 1500 volts DC, 1000 volts AC; tested to 40KHz; diode test function; and exclusive INSTA-Ohm[®] capability, now with an audible beeper, to make your HD even easier to use.

What's more, you can select just the model you need without paying extra. Start with the economical HD-100 at \$169.00 for solid, all-around meter performance. Choose the HD-110 with continuity beeper. Or, the HD-110T that lets you select Fahrenheit or Celsius temperature measurement with a simple field adjustment, accurately measuring from -4°F to +1999°F, and works with any K-type thermocouple. It also has a measurement range of 32°F to 392°F with the thermocouple provided.

You can even get the true RMS capability on the HD-130,



or with a 4 1/2 digit display required by the HD-140's accuracy.

HEAVY DUTY DMMs	HD100	HD110	HD110T	HD130	HD140
Digits	3 1/2			4 1/2	
Accuracy (Vdc)	0.25%		0.1%		0.05%
Input Impedance	22 Megohms			10 Megohm	
AC Conversion Type	Average		True RMS		True RMS
Bandwidth (AC Volts)	10KHz		40KHz		10KHz
Current Range Min. Reading	0.1µA			0.01µA	
Max. Reading	2A	10A (20A for 30 Seconds)			
Continuity Beeper	✓				
Battery Life (Alkaline type)	2000 Hours			100 Hours	

Visit your local Beckman Industrial distributor today. Compare. And discover why the toughest are tougher than ever.

*In Service
Instruments,
We're The One.*

Beckman Industrial[™]

Beckman Industrial Corporation Instrumentation Products Division
A Subsidiary of Emerson Electric Company
3883 Ruffin Rd., San Diego, California 92123-1898
(619) 565-4415 • FAX: (619) 268-0172 • TLX: 249031

© 1987 Beckman Industrial Corporation

CIRCLE 98 ON FREE INFORMATION CARD

Valox[®] is a registered trademark of General Electric.

WHAT'S NEWS

Superconduction possible at room temperatures?

Recent reports in superconductivity research make it seem that

the science is on the verge of performing the impossible—developing a material that has nearly no resistance at room temperatures.

New Solid-state battery operates at 200° Celsius

A high-performance hermetically sealed 2.4-volt solid-state battery that will operate continuously at 200° C (392° F) has been developed by the Eveready Battery Co. The high-temperature performance of the new battery has been achieved while preserving both the high discharge rate (greater than that of most conventional solid-state batteries) and the outstanding shelf life of solid-state batteries.

A patented isostatic-compression process (see "What's News", **Radio-Electronics**, Feb. 1986) is used to assemble the batteries from a lithium anode, an inorganic

solid-state electrolyte, and a titanium disulphide cathode. The high temperature—far above the limits of ordinary battery systems—can be tolerated because there are no liquids in the battery. That feature makes it particularly attractive for use in applications that require high-temperature memory retention or sensor operation (as in automotive engine compartments, or in military applications). It will also survive heavy shock or vibration at 200° C.

Initial sample batteries will be provided in 2.4- and 4.8-volt configurations. Each will contain two 40-milliampere-hour cells.

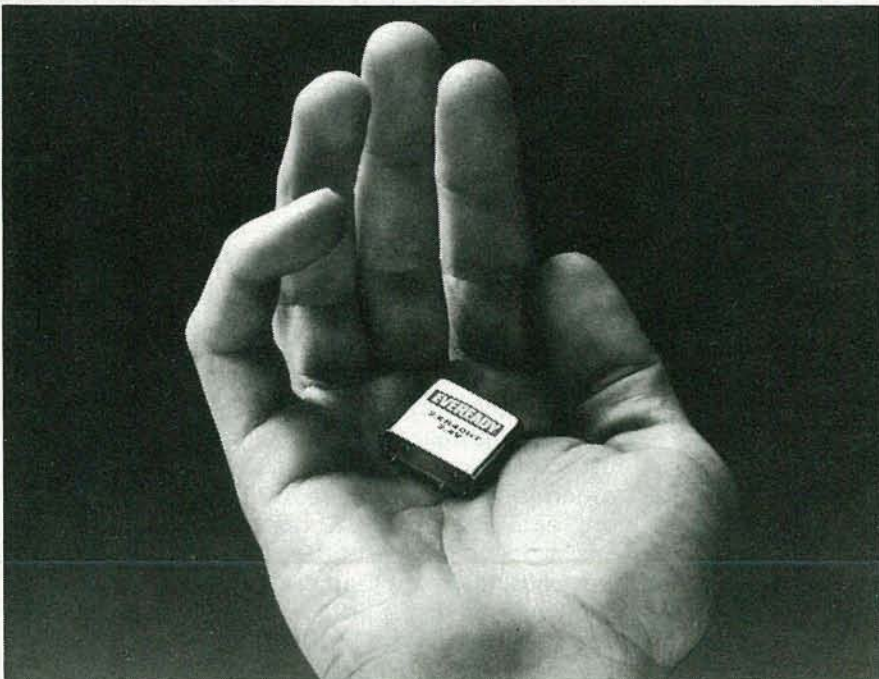

ONE TOUGH CUSTOMER. This new Eveready solid-state battery can operate at temperatures as high as 200° C (392° F) and withstand severe shocks. It is ideal for applications in harsh environments.

Superconductivity is the condition in which a metal loses all its electrical resistance. That normally happens only at extreme low temperatures, near absolute zero (−459.4° F). If conductors could be made superconductive at practical temperatures, our whole electrical world could be revolutionized. Motors could be drastically miniaturized, computers could be made to operate at even higher speeds, and high-voltage transmission lines could be abandoned. In short, a complete change in most electrical techniques could take place.

Since superconductivity was discovered in 1911, in metals at 4° C above absolute zero (4° Kelvin), the threshold of superconductivity has been raised in slow steps, largely through the discovery of new materials. In 1973, a maximum of 23 degrees Kelvin (−419° F) was apparently obtained.

However, in January 1986, a breakthrough occurred. Superconductivity was obtained in a new class of materials at 30° K. This past December, a new record was set at 39° K. In February 1987, superconductivity at a temperature of 98° K was reached using an oxide material composed of yttrium, barium, copper, and oxygen, a combination that would be a pretty fair resistor at ordinary temperatures.

Since then there have been reports of "indications" of superconductivity at 240° K (−28° F) and even hints of "superconducting phenomena" at room temperature. Old theories have been abandoned, and many scientists believe that there is no theoretical temperature limit for superconductivity. Research is going on at a feverish pace, with new results being reported daily, or even faster. One report from Bell Labs bore the dateline: Update, noon, 3/19/87.

R-E

JULY 1987

VIDEO NEWS



DAVID LACHENBRUCH,
CONTRIBUTING EDITOR

• **Sony answers Super VHS.** Sony has fired an answering salvo in the latest phase of the war between VHS and Beta. And in announcing a new version of their Beta recording format, called ED Beta (*Extended Definition Beta*), Sony appears to have recaptured its long-held technological advantage over VHS.

Like Super VHS (*Video News*, June 1987), ED Beta provides a better-than-broadcast-quality picture. However, Sony's ED-Beta system is claimed to provide 500 lines of horizontal definition, as compared with about 430 for Super VHS. Also, ED Beta raises the luminance bandwidth to 6.8–8.6 MHz, as opposed to Super VHS's 5.4–7 MHz, with a deviation of 1.8 MHz (vs. Super VHS's 1.6). Where Super VHS uses a high-coercivity oxide tape, ED Beta uses metal particle tape in a standard Beta cassette. As in the Super-VHS system, the new Beta machines can play back the older conventionally recorded tapes and record tapes in the conventional (standard Beta) manner, but the new higher definition tapes can't be played on standard machines.

ED-Beta cassettes use newly developed TSS (Tilted Sputtered Sendust) heads and a tape stabilizer system to reduce jitter. Sony claims third- and fourth-generation copies made with ED Beta are almost indistinguishable from the original. Super-VHS machines will be available in the United States soon. Sony says ED Beta will be on the Japanese market this fall, but hasn't disclosed export plans. Both Super VHS and ED Beta were developed in anticipation of a new compatible high-resolution broadcasting system in Japan, which could be inaugurated as early as next year.

• **Next stop, S terminal.** The back of an up-to-date TV set has begun to resemble a piece of Swiss cheese. There are video inputs and outputs, audio inputs and outputs, RGB terminals, etc. Now, add the "S" terminal to all of that. That's the name JVC gives to a two-connector input for the Y (luminance) and C (chrominance) output signals of the Super-VHS recorder. Of course, Super-VHS recorders will also have standard RF and video/audio outputs, but to get the super

performance of the system, you will need a high-resolution set equipped with Y and C inputs. JVC, in fact, has already introduced four monitor-receivers with S terminals. Of course, a good monitor receiver without a Y/C input presumably can be modified to inject the super signal into the proper circuits. It's probably only a matter of time before we see Sony TV's with "ED" terminals.

• **Digital videodisc.** A completely unexpected development brought the audience at a recent CD-ROM seminar to its feet with a spontaneous round of applause. A project initiated by RCA at what is now SRI's David Sarnoff Research Center (*Radio-Electronics*, June 1987) has resulted in what could be the first relatively low-cost digital-storage system for full-motion, full-resolution video pictures. Until now, pictures stored digitally on CD-ROM's have been stills, or at best, limited-motion, cartoon-like diagrams. The demonstration by GE/RCA made it clear that the developers' claim of one full hour or more of digital full-motion video plus audio on a standard five-inch optical Compact Disc is now attainable. The developers say that production models could be available for less than \$1,000 within two years. As shown on a PC monitor, the system currently has a resolution of 256 × 200 pixels, which is nearly TV quality.

The DVI (Digital Video Interactive) system uses data compression to get full motion on the disc. Without compression, only 30 seconds of full-motion video would fit on a five-inch disc and it would require a full hour to play it back. The home-video potential of DVI is clear, Sarnoff Center engineers say, but they stress the interactive capabilities of the system. "This is much too powerful a medium to just put movies on," said one. The DVI breakthrough casts some doubt on the future of CD-I (Compact Disc-Interactive), for which standards have just been finalized to permit still video along with data and audio, as well as on Philips' CDV (Compact Disc Video), essentially a reinvention of the videodisc that provides five minutes of analog video and 20 minutes of digital audio on a Compact Disc (*Radio-Electronics*, March 1987). **R-E**

ASK R-E

CROSSOVER NETWORKS

I am putting together a speaker system and need information on the values for components in the crossover network. —S.P., Corona, NY.

A two-way crossover network consists of a low-pass filter to feed the woofer and a high-pass filter to feed the tweeter. The high- and low-frequency outputs are equal at the crossover frequency. The sharper the desired rate of attenuation outside the crossover point, the more complex the divider network becomes. The rate of attenuation is usually expressed in terms of decibels per octave. (An octave is the interval between two frequencies that have a ratio of 2:1 or 1:2. For example, if the crossover is at 1 kHz, one octave below is 500 Hz and one octave above is 2 kHz.)

If you are simply adding a tweeter to an existing system, you can use a capacitor in series with the tweeter as a high-pass network. The value of the capacitor in microfarads is determined from:

$$C = 79,6000 / (f_c \times R_o)$$

where f_c is the crossover or cutoff frequency and R_o is the speaker impedance. The simplest crossover network is shown in Fig. 1. There, we have a capacitor feeding the high frequencies to the tweeter and an inductor feeding the lows to the woofer. That circuit is a single element of a constant-resistance type filter. The values of the inductor in millihenries and the capacitor in microfarads are easily found from the following equations:

$$L = (159 \times R_w) / f_c$$

$$C = 159,000 / (f_c \times R_T)$$

where R_w is the impedance of the

Now test and restore every CRT on the market . . . without ever buying another adaptor socket or coming up embarrassingly short in front of your customer . . . or your money back



with the new improved CR70 "BEAM BUILDER"™
Universal CRT Tester and Restorer
Patented \$995

Have you ever?

Thrown away a good TV CRT, data display CRT, or scope CRT that could have been used for another two or three years because you had no way to test or restore it?

Lost valuable customers because you advised them that they needed a new CRT when another technician came along and restored the CRT for them?

Lost the profitable extra \$35 or more that you could have gotten for restoring a CRT while on the job and locked in the profitable CRT sale later?

Avoided handling profitable trade-ins or rentals because you were afraid you'd have to replace the picture tube when you could have restored it?

Had a real need to test a CRT on the job, but didn't have the right adaptor socket or setup information in your setup book?

If any of these things have happened to you, **CALL TODAY, WATS FREE, 1-800-843-3338**, for a FREE 15 day Self Demo.

"BEAM BUILDER" is a trademark of Sencore, Inc.



Call Today Wats Free 1-800-843-3338

SENCORE

3200 Sencore Drive
Sioux Falls, SD 57107
605-339-0100 In SD Only

*innovatively designed
with your time in mind.*

CIRCLE 184 ON FREE INFORMATION CARD

V-1150

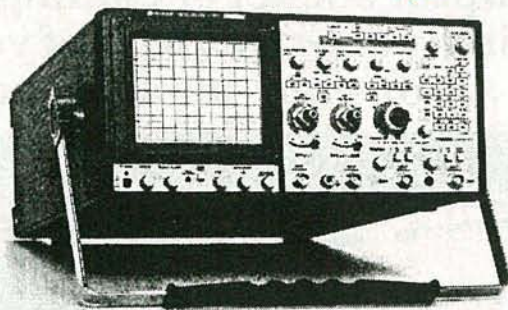

DC TO 150MHz,
Quad Channels,
Delayed Sweep

\$2550.

Save \$400!

- **CRT Readout Functions:** DVM, Freq. Counter, Events Counter, Cursor Readout, Ground Level Indicator, Comments Display, Panel Settings Display.

- **CRT:** 6" rectangular with 20 kV Potential
- **X-Y Operation:** (CH1:X, CH2:Y) 3° or less from DC to 1MHz
- **Weight:** 10kg(22 lb)

VC-6020

\$1750.

Save \$200!

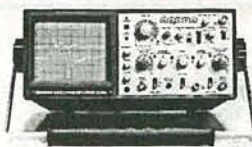

- 1MHz Sampling, Dual Channels
- Usable as both a conventional oscilloscope and a digital storage scope.
 - **CRT:** 6" rectangular with 2k V Potential
 - **Vertical Deflection:** Ver. Modes: CH1, CH2, DUAL, ADD (DIFF). Bandwidth: DC to 20MHz(-3dB). Sensitivity: 5mV/div to 5V/div. GPIB, IEEE 488
 - **Digital Storage Functions:** Max. Sampling Rate: 1 MHz (for Dual Channels). Ver. Resolution: 8 bit. Max. Storage Freq: 100k Hz(-3dB). Memory Capacity: 1k words/ch. Hor. Resolution: 100 point/div. Sweep Time: 0.1m/div to 1s/div. Pre-trigger: Provided. Data output: Analog.

V-223 \$695. Save \$100!

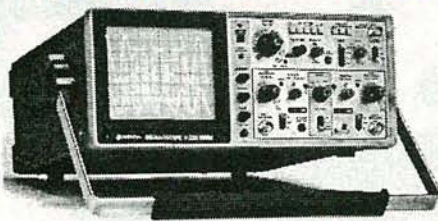

DC to 20MHz, Dual Channels,
Delayed Sweep

- **CRT:** 6" rectangular with 2k V Potential
- **Vertical Deflection:** Ver. Modes: CH1, CH2, ALT, CHOP, ADD (DIFF). Bandwidth: DC to 20MHz(-3dB). Sensitivity: 5mV/div to 5V/div. Max Sensitivity: 1mV/div at X5 Mag. Extends.
- **X-Y Operation** (CH1:X, CH2:Y): 3° or less from DC to 50kHz
- **Weight:** 7kg (15.5 lb)

POLAROID®

DS-34 CAMERA



Save \$135! \$280.

- **Instant Hard Copy From Oscilloscopes**
- **5", 6" and 7" Hoods** (Available separately @ \$51 ea. Please Specify size)
- **Pistol Grip For Ease of Operation**
- **Works on Any Make of Oscilloscope**
- **Three Full Year Warranty**

V-209 DC to 20MHz, Dual Channels

- **CRT:** 6" rectangular with 1.5k V Potential
- **Vertical Deflection:** Ver. Modes: CH1, CH2, ALT, CHOP, ADD (DIFF) Bandwidth: DC to 20MHz(-3dB). Sensitivity: 5mV/div to 5V/div. Max Sensitivity: 1mV/div at X5 Mag. Extends.
- **X-Y Operation** (CH1:X, CH2:Y): 3° or less from DC to 100kHz
- **Weight:** 5kg (11 lb)

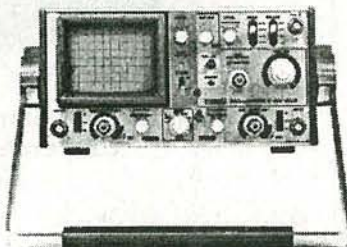

V-212 \$465. Save \$150!

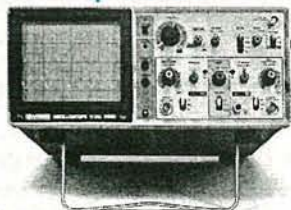

DC to 20MHz, Dual Channels

- **CRT:** 6" rectangular with 2k V
- **Vertical Deflection:** Ver. Modes: CH1, CH2, ALT, CHOP, ADD (DIFF). Bandwidth: DC to 20MHz(-3dB). Sensitivity: 5mV/div to 5V/div. Max Sensitivity: 1mV/div at X5 Mag. Extends.
- **X-Y Operation** (CH1:X, CH2:Y): 3° or less from DC to 50kHz
- **Weight:** 6kg (13.3 lb)

V-222

• Same as above, but with CH1 output and DC offset voltage monitor outlet available for external counter or DVM.

\$515. Save \$200!

\$847. Save \$150!



WM. B. ALLEN SUPPLY COMPANY

ALLEN SQUARE

The 300 Block • North Rampart Street
New Orleans • Louisiana 70112-3106

NATIONWIDE 800 535-9593

LOUISIANA 800 - 462 - 9520
NEW ORLEANS (504) 525 - 8222

• American Express • Visa • MasterCard •

V-1100A DC to 100MHz, Quad Channels, Delayed Sweep
\$2240. Save \$250!

V-680 DC to 60MHz, Triple Channels, Delayed Sweep
\$1340. Save \$150!

V-423 DC to 40MHz, Dual Channels, Single Time Base Delayed Sweep
\$745. Save \$250!

V-1050F DC to 100MHz, Quad Channels, Delayed Sweep
\$1445. Save \$150!

V-650F DC to 60MHz, Triple Channels, Delayed Sweep
\$1070. Save \$125!

V-422 DC to 40MHz, Dual Channels
\$795. Save \$130!

V-509 DC to 50MHz, Dual Channels, Delayed Sweep
\$1195. Save \$250!

V-058G DC to 5MHz, Dual Channels
\$838. Save \$100!

V-134 DC to 10MHz, Dual Channels
\$1420. Save \$200!

V-425 DC to 40MHz, Dual Channels
\$845. Save \$150!

woofer, R_T is the impedance of the tweeter, and f_c is the crossover frequency in hertz. The network's attenuation is 6-dB per octave.

Two types of filters are used in crossover networks. One is the M-derived filter, which, in its basic form, has a rolloff at 12 dB per octave. Each half-section has two capacitors and two inductors. The inductors have different values, as do the capacitors. The other type of filter is the constant-resistance type. We are showing the latter here because the values of both capacitors are equal; the same is true of the two inductors. Both the constant-resistance and M-derived filters can be arranged so the speakers are fed either in series or in parallel.

Figure 2 shows the four most common constant-resistance networks. Series and parallel quarter-section filters with 6-dB/octave rolloffs are shown in Figs. 2-a and

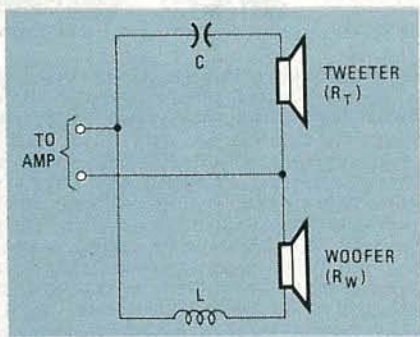

FIG.1

2-b, respectively; half-sections with 12-dB/octave rolloffs are shown in Figs. 2-c and 2-d, respectively. The values of the inductors in henries and capacitors in farads in those networks are as follows:

$$L1 = R_O / (2\pi f_c)$$

$$L2 = R_O / (2\sqrt{2}\pi f_c)$$

$$L3 = (\sqrt{2}R_O) / (2\pi f_c)$$

$$C1 = 1 / (2\pi f_c R_O)$$

$$C2 = \sqrt{2} / (2\pi f_c R_O)$$

$$C3 = 1 / (2\sqrt{2}\pi f_c R_O)$$

where f_c is the crossover frequency in hertz and R_O is the speaker (and input) impedance in ohms.

Your choice of a series or parallel arrangement will probably be determined by component availability and cost. For example, when we compute the values for

Walk "tough dog" troubles out of any TV & VCR in half the time . . . or your money back



with the exclusive, patented,
VA62 Universal Video Analyzer . . . \$3,295

Would you like to?

Reduce analyzing time: Isolate any problem to one stage in any TV or VCR in minutes, without breaking a circuit connection, using the tried and proven signal substitution method of troubleshooting?

Cut costly callbacks and increase customer referrals by completely performance testing TVs & VCRs before they leave your shop? Own the only analyzer that equips you to check all standard and cable channels with digital accuracy? Check complete, RF, IF, video and chroma response of any chassis in minutes without taking the back off the receiver or removing chassis plus set traps dynamically right on CRT too? Simplify alignment with exclusive multiburst pattern?

Reduce costly inventory from stocking yokes, flybacks, and other coils and transformers, for substitution only, with the patented Ringing Test. Run dynamic proof positive test on any yoke, flyback, and integrated high voltage transformer . . . in- or out-of-circuit?

Protect your future by servicing VCRs for your customers before they go to your competition? Walk out "tough dog" troubles in any VCR chrominance or luminance circuit — stage-by-stage — to isolate problems in minutes? Have proof positive test of the video record/play heads before you replace the entire mechanism?

Increase your business by meeting all TV and VCR manufacturers' requirements for profitable warranty service work with this one universally recommended analyzer?

To prove it to yourself, CALL TODAY, WATS FREE, 1-800-843-3338, for a FREE Self Demo . . . or learn how the VA62 works first by calling for your free simplified operation and application instruction guide, worth \$10.00.



Call Today Wats Free 1-800-843-3338

SENCORE

3200 Sencore Drive
Sioux Falls, SD 57107
605-339-0100 In SD Only

*innovatively designed
with your time in mind.*

CIRCLE 185 ON FREE INFORMATION CARD

Increase your knowledge about all aspects of electronics

An absolutely no-risk guarantee.

Select 5 Books for only \$3⁹⁵ and get a Free Gift!

values to \$135.70

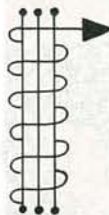
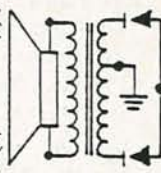

2839 \$15.95



2635 \$19.95



1532P \$14.95



1977 \$26.95



1909P \$14.95



1793 \$14.95



1531P \$11.50



2758 \$24.95



1672P \$12.95



1665P \$17.95



2795 \$29.95
Counts as 2



1199P \$16.95



1586 \$17.95

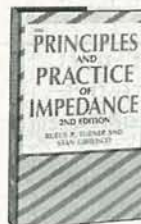

2725 \$21.95



2655P \$16.95

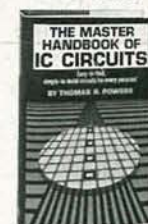

1370 \$26.95



1529P \$14.95



1250P \$14.95



1599P \$16.95



2755 \$17.95



2753 \$23.95



2792 \$21.95



728P \$10.95



1693 \$21.95

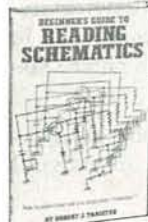

1536 \$14.95



1604P \$15.95

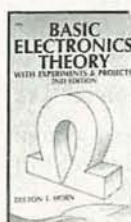

1775 \$29.95
Counts as 2



2707 \$24.95



1925 \$24.95



2645 \$16.95

Membership Benefits • Big Savings. In addition to this introductory offer, you keep saving substantially with members' prices of up to 50% off the publishers' prices. • **Bonus Books.** Starting immediately, you will be eligible for our Bonus Book Plan, with savings of up to 80% off publishers' prices. • **Club News Bulletins.** 14 times per year you will receive the Book Club News, describing all the current selections—mains, alternates, extras—plus bonus offers and special sales, with hundreds of titles to choose from. • **Automatic Order.** If you want the Main Selection, do nothing and it will be sent to you automatically. If you prefer another selection, or no book at all, simply indicate your choice on the reply form provided. As a member, you agree to purchase at least 3 books within the next 12 months and may resign at any time thereafter. • **Ironclad No-Risk Guarantee.** If not satisfied with your books, return them within 10 days without obligation! • **Exceptional Quality.** All books are quality publishers' editions especially selected by our Editorial Board.

(Publishers' Prices Shown)

FREE guide to mail order sources for electronic parts and components

A \$6.95 Value!



ELECTRONICS BOOK CLUB

P.O. Box 10, Blue Ridge Summit, PA 17214

Please accept my membership in the Electronics Book Club and send the 5 volumes circled below, plus my FREE copy of *The Electronics Buyer's Guide* (345P), billing me \$3.95 plus shipping and handling charges. If not satisfied, I may return the books within ten days without obligation and have my membership canceled. I agree to purchase at least 3 books at regular Club prices (plus shipping/handling) during the next 12 months, and may resign any time thereafter.

728P	1199P	1250P	1370	1529P	1531P	1532P	1536	1586	1599P
1604P	1665P	1672P	1693	1775	1793	1909P	1925	1977	2635
2645	2655P	2707	2725	2753	2755	2758	2792	2795	2839

Name _____
 Address _____
 City _____
 State/Zip _____ Phone _____

Valid for new members only. Foreign applicants will receive ordering instructions. Canada must remit in U.S. currency. This order subject to acceptance by the Electronics Book Club. RE-787

Exclusive, triple patented dynamic cap and coil analyzing . . . guaranteed to pinpoint your problem every time or your money back



with the all new LC75 "Z METER 2"
Capacitor Inductor Analyzer
Patented \$995

The "Z METER" is the only LC tester that enables you to test all capacitors and coils dynamically — plus, it's now faster, more accurate, and checks Equivalent Series Resistance (ESR) plus small wire high resistance coils.

Eliminate expensive part substitution and time-consuming shotgunning with patented tests that give you results you can trust every time. Test capacitor value, leakage, dielectric absorption, and ESR dynamically; with up to 600 volts applied for guaranteed 100% reliable results — it's exclusive — it's triple patented.

Save time and money with the only 100% reliable, in- or out-of-circuit inductor tester available. Dynamically test inductors for value, shorts, and opens, automatically under "dynamic" circuit conditions.

Reduce costly parts inventory with patented tests you can trust. No more need to stock a large inventory of caps, coils, flybacks, and IHVTs. The "Z METER" eliminates time-consuming and expensive parts substituting with 100% reliable LC analyzing.

Turn chaos into cash by quickly locating transmission line distance to opens and shorts to within feet, in any transmission line.

Test troublesome SCRs & TRIACs easily and automatically without investing in an expensive second tester. The patented "Z METER 2" even tests SCRs, TRIACs, and High-Voltage Diodes dynamically with up to 600 volts applied by adding the new SCR250 SCR and TRIAC Test Accessory for only \$148 or FREE OF CHARGE on Kick Off promotion.

To try the world's only Dynamic LC Tester for yourself, CALL TODAY, WATS FREE, 1-800-843-3338, for a FREE 15 day Self Demo.

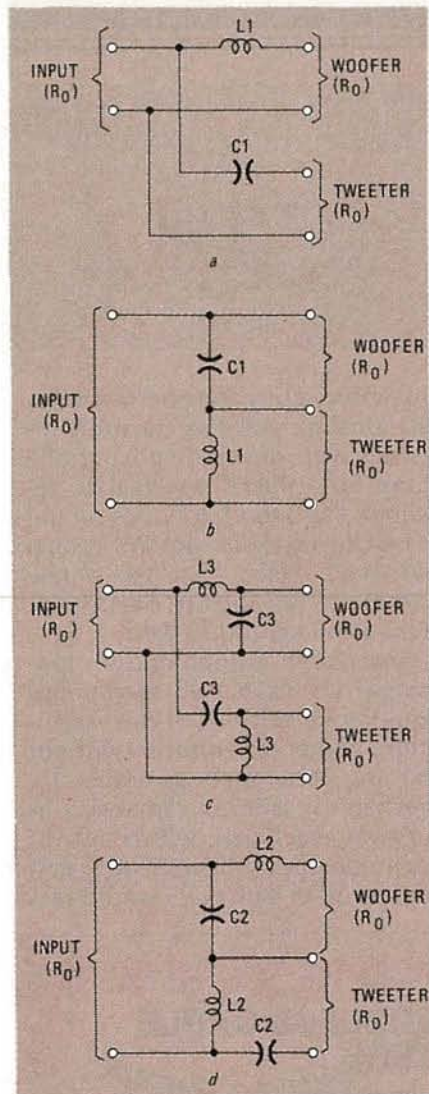

FIG. 2

the inductors and capacitors in the 12-dB half-section networks, we find that the values of the capacitors in the series configuration are twice that of those in the parallel configuration. On the other hand, the values of the inductors in the series configuration are half that of the inductors in the parallel configuration. If you've priced enameled copper wire lately (used for winding the inductors), you'll realize that economy will probably dictate using the series network.

Ideally, the capacitors should be paper or oil-filled types with a tolerance not greater than 10%. Practically, we use non-polarized or back-to-back electrolytics.

The inductor must be wound with fairly heavy wire, such as 16 or 18 gauge, so its resistance will be negligible when compared to the speaker impedance. R-E



Call Today Wats Free 1-800-843-3338

SENCORE

3200 Sencore Drive
Sioux Falls, SD 57107
605-339-0100 In SD Only

*innovatively designed
with your time in mind.*

CIRCLE 186 ON FREE INFORMATION CARD

LETTERS



OLD CAR RADIOS
After reading your article, "New Life for Old Car Radios," in the April 1987 issue of *Radio-Electronics*, I was inspired to make use of an old AM/FM cassette deck that had been sitting in my closet idly for over a year.

I integrated the unit into the shelf of a computer desk, using an old pair of bookshelf speakers, a 12-volt power supply from my junkbox, mounting brackets that had come with the radio, and a 16-inch rubber car antenna that I purchased for less than \$6.00.

The cassette deck was mounted on the underside of the top shelf

of the desk. The antenna was mounted through a hole that was drilled in a rear corner of that shelf. The speakers were placed on top of the shelf. The setup provides me with an excellent sound system that takes up little space at my computer workstation.

MICHAEL K. MIZOTE
Gardena, CA

THE R-E ROBOT

I have enjoyed the "Build the R-E Robot" series that is currently appearing in *Radio-Electronics*. In fact, I have just re-subscribed, after an absence of some years, because of it. I've been a roboticist

since I was a boy, long before it was fashionable, and I'm currently involved with developing a mobile robot for artificial intelligence research. I also teach robotics for the State University of New York, on a part-time basis. Now for a few comments about Mr. Sarns' design, as presented to date.

Automated equipment is more dangerous than non-automated equipment, because it can start—under computer control—without warning. Program bugs or electro/mechanical failures can result in runaway machines, which (as Mr. Sarns correctly points out) can cause a lot of damage. I would rec-

Send Purchase Order
Check, Money Order, or C.O.D.
or Call Toll Free
800-223-0826
in N.Y. State (212) 865-5580

#1 IN CABLE BOXES
SPECIAL!

- Volume control
- 68 channels
- Mute control
- Automatic fine tuning
- Instant channel recall
- Programmable to go on at a particular channel and off automatically
- Compatible with descramblers

JERROLD CORDLESS CABLE TV CONVERTERS

MODEL STARCOM-460

\$99⁹⁵

ANY QUANTITY



*ADD \$5.00 FOR VISA OR MASTER CARD

JERROLD CORDLESS CABLE TV CONVERTER

MODEL DRX3-105/400

\$69⁹⁵

- 58 channels
- Remote channel changing
- Remote on/off switch
- Remote fine tuning



JERROLD CORDLESS CABLE TV CONVERTER

MODEL DRZ/450

- 66 channels
- Automatic fine tuning
- A/B switch option

\$69.95/10 lot

\$79.95 ea.



JERROLD CORDED CABLE TV CONVERTER

MODEL JRX3-105

\$34.95/10 up

\$39.95/6-9
\$49.95/1-5



"THE RABBIT" VIDEO MULTIPLYING SYSTEM

TR-7000

\$51⁹⁵

\$59.95/6-11
\$69.96/1-5

12 up



IT'S LIKE HAVING A VCR IN EVERY ROOM

MASTER CARD VISA

OMNITRON

ELECTRONICS

770 Amsterdam Ave., New York, NY 10025

SHIPPING CHARGES

For Orders	Add
\$25-100	\$6.50
\$100-500	\$8.50
\$500-750	\$10.50
\$750 and up	\$20.00

Write for

FREE CATALOG

136 pages

commend the addition of the following safety features to the design:

- A clearly marked and easily accessible cutoff switch that would be in series with the motor(s)' power bus. That will allow quick disabling of a runaway machine without interrupting power to the computer/memory.

- A motor-bypass switch on each motorized subassembly that would redirect motor power to a set of forward/reverse/on/off indicators. That is invaluable for troubleshooting and program debugging.

- Lead acid batteries pose three risks—hydrogen gas production during charge/discharge cycles; very high voltage-discharge rates in the event of a short circuit; and finally, the acid itself. You should ventilate the battery compartment, fuse the main power bus at the battery post, and line the battery compartment with an acid-resistant material. Plastic boxes are available at low cost. It may be desirable to add baking soda to the packing material in the battery compartment to neutralize spilled acid. (I can assure you, from personal experience, that all mobile robots turn over sooner or later.)

Also, any machine that uses a chain or belt drive, as does the R-E Robot is a potential hazard. A ¼-horsepower motor geared down to 12:1 can sever young fingers caught between the belts/chain and pulleys/sprockets. *Please* put guards over the drive trains. They are easy to fashion and will add mere ounces to the machine.

Thank you for **Radio-Electronics'** continued interest in robotics. I hope that my comments here will not be taken as overly critical; Mr. Sarns' overall design has been excellent, and I am looking forward to reading the rest of the series.

JOSEPH A. COPPOLA
Sherrill, NY

Mr. Coppola is absolutely correct. The R-E Robot was designed as a heavy-duty workhorse quite unlike most hobby robots. The standing joke here at Vesta is to equip a unit with over-sized, knob-by tires and take pictures of it crushing Hero 2000's. Seriously though, the safety issues cannot

Analyze defective waveforms faster, more accurately, and more confidently — every time or your money back

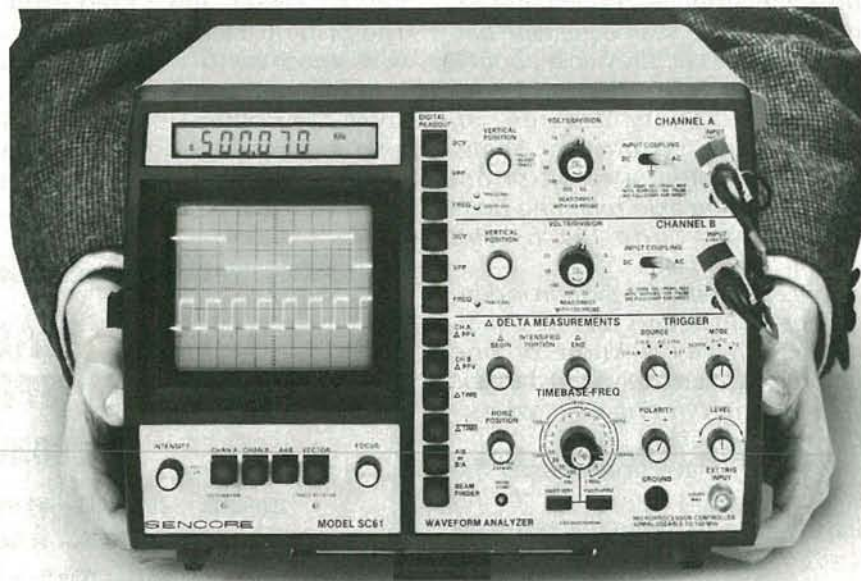

with the SC61 Waveform Analyzer
Patented \$2,995

If you value your precious time, you will really want to check out what the exclusively patented SC61 Waveform Analyzer can do for you. 10 times faster, 10 times more accurate, with zero chance of error.

End frustrating fiddling with confusing controls. Exclusive ultra solid ECL balanced noise cancelling sync amplifiers, simplified controls, and bright blue dual trace CRT help you measure signals to 100 MHz easier than ever.

Accurately and confidently measure waveforms from a tiny 5 mV all the way to a whopping 3,000 V without hesitation with patented 3,000 VPP input protection — eliminates expensive "front end" repairs and costly equipment downtime.

Make only one circuit connection and push one button for each circuit parameter test: You can instantly read out DC volts, peak-to-peak volts and frequency 100% automatically with digital speed and accuracy. It's a real troubleshooting confidence builder.

Confidently analyze complex waveforms fast and easily. Exclusive Delta measurements let you intensify any waveform portion. Analyze glitches, interference signals, rise or fall times or voltage equivalents between levels; direct in frequency or microseconds.

Speed your digital logic circuit testing. Analyzing troublesome divide and multiply stages is quicker and error free — no time-consuming graticule counting or calculations. Simply connect one test lead to any test point, push a button, for test of your choice, for ERROR FREE results.

To see what the SC61 can do for your troubleshooting personal productivity and analyzing confidence, CALL TODAY, WATS FREE, 1-800-843-3338, for a FREE 15 day Self Demo.



Call Today Wats Free 1-800-843-3338

SENCORE

3200 Sencore Drive
Sioux Falls, SD 57107
605-339-0100 In SD Only

*innovatively designed
with your time in mind.*

CIRCLE 187 ON FREE INFORMATION CARD

JULY 1987

13

be overstated. Mr. Coppola's suggestions are well taken. We have added a main power switch to each of our units that shuts everything off. One solution to the risks posed by using lead acid batteries is to substitute sealed gel type batteries. However, they cost about 5 to 10 times more than the conventional variety. I agree, all mobile robots do turn over. Sometimes it's simply a result of not tightening the axle retaining bolts sufficiently (one learns the ramifications fast!)

The external drive system is dangerous—old fingers may be equally in jeopardy. I know of one company (Micro K Systems) that is considering offering a set of vacuum formed chain guards.

Perhaps I have not stressed the safety issues as much as I should have. I have assumed that if you, as a robot hobbyist, are intelligent enough to assemble, program, and test the robot, most of the safety issues will be self-evident.

Many of the issues raised relate to the difference between a project and a product. A product with the price/performance advantages that the R-E Robot offers would be impossible. But as a project, one is not forced to protect the "innocent" with expensive safety features that are not needed in your specific application, and the basic cost is kept down.

It is also worth pointing out that the series, from the beginning, has encouraged robot experimenters to use our robot only as a guide or an example. We are most happy when we hear of builders modifying our basic design.—Steven E. Sarns

THE "FOX-HOLE" RADIO

As a follow-up to the razor-blade detector discussions in "Letters" in December 1986 and April 1987, I thought that you and the readers might be interested in the following item about Lt. M. L. Rupert of Springfield, MO, who made a most ingenious radio during World War II. The information, including part of a letter from Lt. Rupert., is on a plaque that has been hanging on a wall at the Armed Forces Radio and Television Service as long as anyone can remember. The letter reads:

"...Your Marlin double-edged blade is used to make a foxhole radio for the Yank infantrymen on this beachhead. All that's needed is a coil of wire, insulated, a safety pin, a headset, and a used blade. The blade is tacked down, with a wire attached to it and going to one side of the coil and on to the aerial. The other side of the coil goes to the ground and to one side of the headset. A wire from the other side of the headset goes to a

safety pin driven into the wood, leaving the other end of the pin free to be moved across the unground part of the Marlin blade to find your station. Reception is very good and at night we get several stations including the Berlin Sally propaganda put out in English."

Have any of your readers seen any earlier references to the "razor detector?"

THOMAS P. SMITH ICI-USN
Sun Valley, CA

R-E



CABLE TV SPECIALS CONVERTERS



JERROLD: JRX-3 DIC—36 Channel Corded Remote \$149.⁹⁹
JSX-3 DIC—36 Channel Set Top \$129.⁹⁹
SB-3—'The Real Thing' \$119.⁹⁹
SB-3A-4 port \$99.⁹⁹

ZENITH: Z-TAC Cable Add-On \$199.⁹⁹

VIEW STAR: EVSC-2010—60 Channel Wireless—
with Parental Lockout \$ 99.⁹⁹
EVSC-2010 A-B—Same as above with
A-B Switch \$109.⁹⁹
View Star 2501—60 Channel Wireless
with Volume \$119.⁹⁹

MISCELLANEOUS

OAK: N-12 Mini-Code \$ 89.⁹⁵
N-12 Mini-Code Vari-Sync \$109.⁹⁵
N-12 Mini-Code Vari-Sync Plus Auto On-Off . . \$165.⁰⁰

JERROLD: 400 & 450 Handheld Transmitters \$ 29.⁹⁹

HAMLIN: MLD-1200 \$ 99.⁹⁹

NEW ITEMS: Ripco Tape Copy Stabilizer \$149.⁹⁵

Scientific Atlanta **Call for Price**

OAK: E-13 Mini-Code Substitute \$ 79.⁹⁵
E-13 Mini-Code W/Vari-Syn \$ 89.⁹⁵

ALL UNITS GUARANTEED. QUANTITY PRICES AVAILABLE.

UNITED ELECTRONIC SUPPLY

P.O. BOX 1206 • ELGIN, ILLINOIS 60121 • 312-697-0600

EQUIPMENT REPORTS

AVCOM PSA-35A Portable Spectrum Analyzer

An indispensable tool for
TVRO installation and
servicing.



CIRCLE 10 ON FREE INFORMATION CARD

IF YOU THINK OF SPECTRUM ANALYZERS as instruments that cost tens of thousands of dollars and are at home on—and are hardly ever moved from—a laboratory test bench, you better think again! The TVRO industry has fueled many advances in microwave components. The same technology and components that have helped the cost of satellite receiving equipment to drop so dramatically during this decade has benefited test equipment for microwave frequencies as well. We recently had the opportunity to inspect one of the benefactors: the PSA-35A portable spectrum analyzer from Avcom of Virginia, Inc., (500 South Lake Blvd., Richmond, VA 23235).

A spectrum analyzer is a scanning radio receiver that displays the signals present in a given part

of the RF spectrum. It can be an extremely valuable tool for a TVRO installer. Using it, a technician can greatly speed up the dish-aiming process and polarizer adjustment. He can measure the performance of LNA's and downconverters, troubleshoot cabling and connector problems, and even spot Terrestrial Interference (TI) problems. Before we look at how the analyzer can be put to work in practical applications, let's take a look at its general specifications and features.

The PSA-35A offers 5 low bands of coverage from less than 10 MHz to greater than 1500 MHz, and a single high band from 3.7 to 4.2 GHz. The low bands are configured as follows:

- a) less than 10 MHz to 500 MHz
- b) 270 MHz to 770 MHz
- c) 400 to 900 MHz
- d) 950 to 1450 MHz

The fifth low-frequency band can be preset by the user to cover any 500-MHz band between 300 MHz and 1500 MHz (or up to 1900 MHz on special order).

The PSA-35A offers two input connectors: The low band connector is a BNC type, and the high-band connector is an N type. Because it is a TVRO service tool, the

continued on page 20

Avcom	PSA-35A									
OVERALL PRICE	[Red bar]									
EASE OF USE	[Red bar]									
INSTRUCTION MANUAL	[Red bar]									
PRICE/VALUE	[Red bar]									
	1	2	3	4	5	6	7	8	9	10
	Poor		Fair			Good			Excellent	

FUN FOR PROJECT BUILDERS



◀ **BP82—PROJECTS USING SOLAR CELLS** . . . \$5.00. Simple circuits have applications around the home. All are powered by the energy of the sun. Have fun and stop buying batteries.



◀ **BP83—VMOS PROJECTS** . . . \$5.50. Primarily concerned with VMOS power FET's. Projects include audio circuits, sound generator circuits, DC control circuits, and signal control circuits.



◀ **BP99—MINI-MATRIX BOARD PROJECTS** . . . \$5.00. Includes 20 useful projects that can all be assembled on a small circuit board, Vero board, or solderless breadboard. Try them, you'll like them.



◀ **BP103—MULTI-CIRCUIT BOARD PROJECTS** . . . \$5.00. Make only one printed-circuit board and you can build all of the 21 different projects in this book. Whenever possible, the same components are used too.



◀ **BP95—MODEL RAILWAY PROJECTS** . . . \$5.00. Useful but reasonably simple projects for the model railroader. Controllers, signal and sound effects, and more.



◀ **BP94—PROJECTS FOR CARS AND BOATS** . . . \$5.00. Fifteen fairly simple devices for use with your car and/or boat. Complete description of how each one works and a circuit board pattern.

MAIL TO: **Electronic Technology Today**
P.O. Box 240
Massapequa Park, NY 11762-0240

SHIPPING CHARGES IN USA & CANADA
\$0.01 to \$5.00 . . . \$1.00 \$30.01 to 40.00 . . . \$4.75
\$5.01 to \$10.00 . . . \$1.75 \$40.01 to 50.00 . . . \$5.75
\$10.01 to 20.00 . . . \$2.75 \$50.01 and above \$7.00
\$20.01 to 30.00 . . . \$3.75

OUTSIDE USA & CANADA

Multiply Shipping by 2 for sea mail
Multiply Shipping by 4 for air mail

Total price of merchandise . . . \$ _____
Shipping (see chart) . . . \$ _____
Subtotal . . . \$ _____
Sales Tax (NYS only) . . . \$ _____
Total Enclosed . . . \$ _____

Name _____
Address _____
City _____ State _____ Zip _____

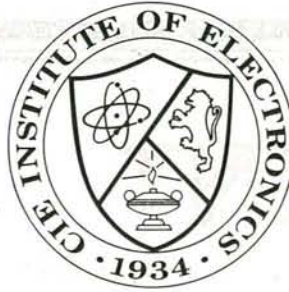

“If you’re going to learn electronics, you might as well learn it right!”

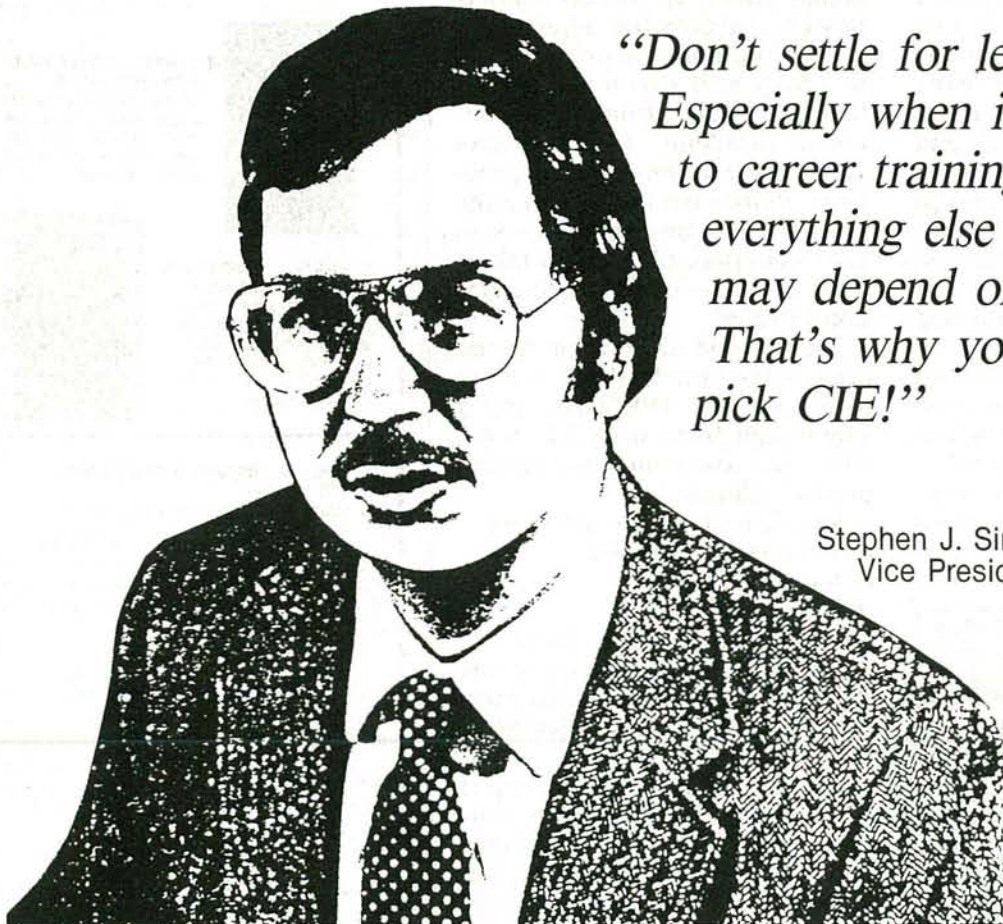

*“Don’t settle for less.
Especially when it comes
to career training...because
everything else in your life
may depend on it.
That’s why you ought to
pick CIE!”*

Stephen J. Simcic
Vice President, Academic Affairs

You've probably seen advertisements from other electronic schools. Maybe you think they're all the same. They're not!

CIE is the largest independent home study school in the world that specializes exclusively in electronics.

Meet the Electronics Specialists.

When you pick an electronics school, you're getting ready to invest some time and money. And your whole future depends on the education you get in return.

That's why it makes so much sense to go with number one . . . with the specialists . . . with CIE!

There's no such thing as bargain education.

If you talk with some of our graduates, chances are you'd find a lot of them shopped around for their training. Not for the lowest priced but for the best. They pretty much knew what was available when they picked CIE as number one.

We don't promise you the moon. We do promise you a proven way to build valuable career skills. The CIE faculty and staff are dedicated to that. When you graduate, your diploma shows employers you know what you're about. Today, it's pretty hard to put a price on that.

Because we're specialists we have to stay ahead.

At CIE, we've got a position of leadership to maintain. Here are some of the ways we hang onto it . . .

Programmed Learning

That's exactly what happens with CIE's Auto-Programmed Lessons. Each lesson uses famous "programmed learning" methods to teach you important principles. You explore them, master them completely, before you start to apply them. You thoroughly understand each step before you go on to the next. You learn at your own pace.

And, beyond theory, some courses come fully equipped with electronics gear (the things you see in technical magazines) to actually let you perform hundreds of "hands-on" experiments.

Experienced specialists work closely with you.

Even though you study at home, you are not alone! Each time you return a completed lesson, you can be sure it will be reviewed, graded, and returned with appropriate instructional help. When you need additional individual help, you get it fast and in writing from the faculty technical specialist best qualified to answer your question in terms you can understand.

Pick the pace that's right for you.

CIE understands people need to learn at their own pace. There's no pressure to keep up . . . no slow learners hold you back. If you're a beginner, you start with the basics. If you already know some electronics, you move ahead to your own level.

Enjoy the promptness of CIE's "same day" grading cycle.

When we receive your lesson before noon Monday through Saturday, we grade it and mail it back the same day. You find out quickly how well you're doing!

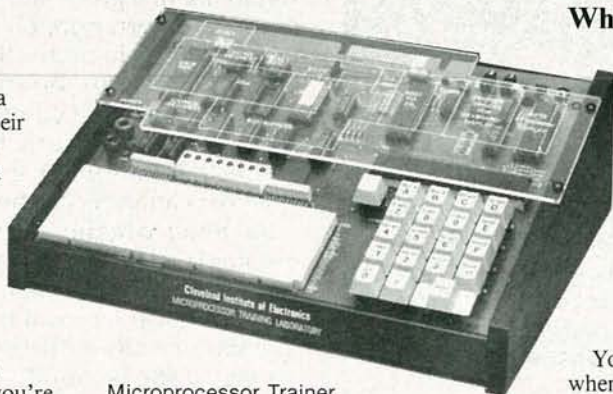

Microprocessor Trainer

State-of-the-art Laboratory Equipment

Some courses feature the CIE Microprocessor Training Laboratory. An integral part of computers, microprocessor technology is used in many phases of business, including service and manufacturing industries.

The MTL gives you the opportunity to program it and interface it with LED displays, memory devices, and switches. You'll gain all the practical experience needed to work with state-of-the-art equipment of today and tomorrow.

CIE offers you an Associate Degree.

One of the best credentials you can have in electronics — or any other career field — is a college degree. That's why CIE gives you the opportunity to earn an Associate in Applied Science in Electronics Engineering Technology. Any CIE career course can offer you credit toward the degree — more than half of the number needed in some cases.

"Cleveland Institute of Electronics is the only accredited institution of higher learning offering an Associate Degree program with tuition based on actual study time used. The faster you complete your degree assignments, the less your overall tuition."

Steve Simcic
Vice-President Academic Affairs

Which CIE Training fits you?

Beginner? Intermediate? Advanced? CIE home study courses are designed for ambitious people at all entry levels. People who may have:

1. No previous electronics knowledge, but do have an interest in it;
2. Some basic knowledge or experience in electronics;
3. In-depth working experience or prior training in electronics.

You can start where you fit and fit where you start, then go on from there to your Diploma, Associate Degree, and career.

Today is the day. Send now.

Fill in and return the postage-free card attached. If some ambitious person has removed it, cut out and mail the coupon. You'll get a FREE school catalog plus complete information on independent home study. For your convenience, we'll try to have a CIE representative contact you to answer any questions you may have.

Mail in the coupon below or, if you prefer, call toll-free 1-800-321-2155 (in Ohio, 1-800-523-9109).

CIE Cleveland Institute of Electronics, Inc.

1776 East 17th Street, Cleveland, Ohio 44114

Accredited Member National Home Study Council

YES...I want to learn from the specialists in electronics — CIE. Send me my FREE CIE school catalog...including details about the Associate Degree program... plus my FREE package of home study information.

Print Name _____

Address _____ Apt. _____

City _____ State _____ Zip _____

Age _____ Area Code/Phone No. _____/_____

Check box for G.I. Bill bulletin on Educational Benefits: Veteran Active Duty

MAIL TODAY!

CIRCLE 60 ON FREE INFORMATION CARD

ARE64

HAMEG Instruments

2 year warranty

HM 205-2

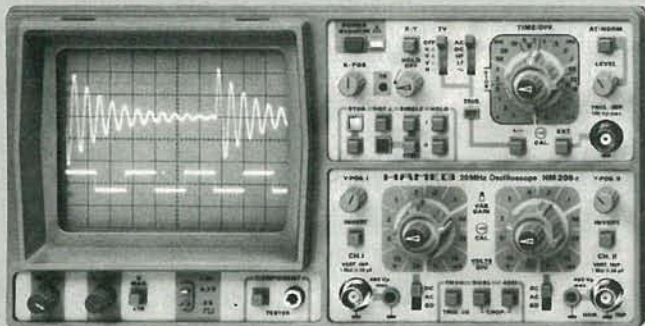

A new Storage Oscilloscope with 5MHz sampling rate.

This instrument offers all the outstanding features of a state-of-the-art **20MHz** realtime oscilloscope. In addition, it provides digital storage capability for signals between **50s** and **5 μ s** duration. Maximum memory is **1024x8** bits for each channel. A Dot Join feature permits linear interpolation between sample points. An X-Y recorder option and an optional **GPIB interface** allow full integration in automatic test systems.

In many cases, the **HM205-2** can easily replace considerably more expensive digital storage oscilloscopes.

Price incl. 2 Probes 888,- \$

Demonstration of the excellent transmission performance of the HM205-2 in analog mode with a fast risetime 1MHz square wave signal. All HAMEG Oscilloscopes are specified to have less than 1% aberrations and overshoot.

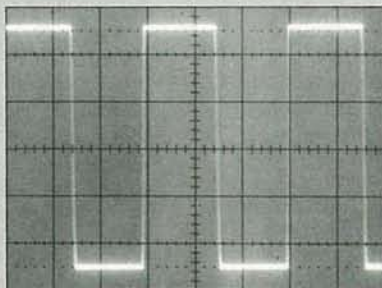

This screen photo shows a 20kHz sine wave signal in storage mode. The screen resolution of 1024 x 256 points offers an outstanding display that can easily be compared to those found on analog instruments.

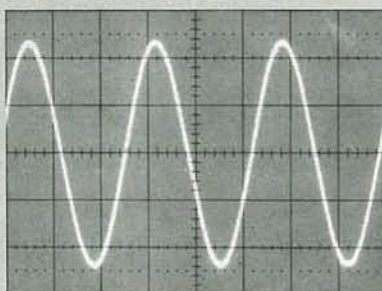

Write or call toll free 800 247 1241

HAMEG, INC.

88-90 Harbor Road · Port Washington N.Y. 11050
Phone (516) 883.3837 · TWX (023) 497.4606

connectors can supply (at the flick of a front-panel switch) +18 volts DC (Which is required by most LNA's and block downconverters).

Signals are displayed behind a 10 x 7 graticule. The horizontal (frequency) scale can be adjusted using the continuously variable **SCAN** control from 1 MHz per division to 50 MHz per division. In other words, you could expand the entire display to show a 10 MHz bandpass, or compress it to show the signals in a 500 MHz bandpass—all the transponders on a given satellite, for example. The vertical (amplitude) scale can be either 10 dB per division or 2 dB per division.

Using the analyzer

A TVRO installation technician could use the **PSA-35AA** in a number of ways—even before the actual installation. The first step in any TVRO installation procedure is a *site survey*, which determines the suitability of a given site for installation. A clear view of the southern horizon is not the only factor determining site suitability; the site must also be free of interference from terrestrial microwave links. That's where the **PSA-35A** comes in. When used along with an auxiliary feedhorn that Avcom calls the **TISH** (Terrestrial Interference Survey Horn), the spectrum analyzer can indicate the presence or absence of TI.

Knowing whether TI is present *before* a dish is installed can save an installer a lot of headaches and a lot of extra work. In many cases, a suitable site can be found not too far from the first, but with some tree, building, or other obstruction blocking the TI.

Once a site is found, and a dish and feedhorn are installed, a spectrum analyzer can again make the job easier. At a glance, the analyzer can show the signals in a given band and their strengths. It can make homing in on the Clarke belt a breeze. And because the spectrum analyzer is so sensitive, using it to aim the dish is much more reliable than using a receiver and a monitor. Small adjustments of the dish that would make little difference on the picture seen with a strong transponder would be seen quite dramatically on the display, especially when the unit is switched to an amplitude sensitivity of 2 dB per division. The result is better overall TVRO operation.

The spectrum analyzer again shows its strengths when it's time to align the polarizer. You can display the outputs of several transponders on the screen and watch the cross-polarized transponders null out.

The manual included with the **PSA-35A** is written directly for the TVRO installer. Its application section gives several excellent examples of how to use the instrument in TVRO installation and service. It also includes several pre-cut acetate sheets that can be slipped directly over the display so that the signal and switch settings can be traced and kept on record. It also includes a form that Avcom calls a **SASAR** (Spectrum Analyzer System Analysis Report) for recording all pertinent information of an installation. If problems develop in the future, a comparison of **SASAR** measurements could allow the serviceman to quickly solve the problem.

The **PSA-35A** is an excellent servicing tool. It has a suggested list price of \$1965. If you are involved in TVRO service, you can expect to recoup the cost quickly.

R-E

CIRCLE 62 ON FREE INFORMATION CARD

NEW PRODUCTS



CIRCLE 30 ON FREE INFORMATION CARD

HI-FI VHS VCR, the model VR6600F, is a front-loading recorder and it offers two video heads with HQ circuitry for virtually noise-free pictures; hi-fi stereo audio recording/playback; built-in MTS decoder for stereo-TV broadcasts; and 110-channel, cable-compatible, frequency-synthesized tuning. The recorder also features a 14-day/6-event program-

mable timer, three-speed record and playback functions, auto rewind, picture search, pause/still, and one-touch recording.

The model VR6600F measures 3 $\frac{3}{8}$ inches high, by 16 $\frac{15}{16}$ inches wide, by 13 $\frac{1}{16}$ inches deep. The suggested retail price is \$649.95.—**Samsung Electronics, America**, 301 Mayhill Street, Saddle Brook, NJ 07662.

SURGE PROTECTOR, the model DE-LSP, is designed to protect valuable video equipment against induced transients from lightning. The simple-to-install in-line device is designed with extremely low capacitance circuitry for minimal insertion loss; there are external ground connections for extra protection against high-potential surges from chassis ground to earth ground.



CIRCLE 31 ON FREE INFORMATION CARD

The model DE-LSP is priced at \$92.00.—**Diamond Electronics, Inc.**, P.O. Box 200, Lancaster, OH 43130.

SCANNER, the model R1090, is 45-channel and includes bank scanning, weather scan, and a priority control. It is designed for beginners as well as veteran scanning enthusiasts, and covers more than 15,000 frequencies from six of the most popular VHF and UHF bands. Coverage includes VHF low (30–50 MHz), VHF amateur (144–148 MHz), VHF high (148–174 MHz), UHF amateur (440–450 MHz), UHF (450–470 MHz), and UHF-T (470–512 MHz). 45 popular frequencies are pre-programmed at the factory, so that the unit can be operated right out of the box.



Good as Gold.

The 70 Series Multimeter: The Shining Standard By Which Others Are Measured

These multimeters give you solid value for your money. A 3-year warranty keeps you from paying the price over and over for lesser quality meters.

Choose from either the basic 73 or the feature-rich 75 and 77. You'll find the features you need at the price you can afford. Touch Hold™ for holding readings. Audible tones for continuity checks. Autoranging for simple operation.

Uncompromised quality at competitive prices. Get your hands on a 70 Series Multimeter at leading electronics distributors nationwide. Or call toll free 1-800-227-3800, ext. 229 for more information.

FROM THE WORLD LEADER IN DIGITAL MULTIMETERS.

FLUKE 73, 75, 77

\$79, \$109, \$145	3-year warranty
0.7%, 0.5%, and 0.3% basic dc accuracy	Audible continuity (75 & 77)
Analog/digital display	Range hold (75 & 77)
Volts, ohms, 10A, diode test	Multipurpose holster (77)
Autorange	Touch Hold function (77)
2000+ hour battery life	



TAKE ANY ONE OF THESE HANDBOOKS — when you join the ELECTRONICS AND

- your one source for engineering books from over 100 different publishers
- the latest and best information in your field
- discounts of up to 40% off publishers' list prices

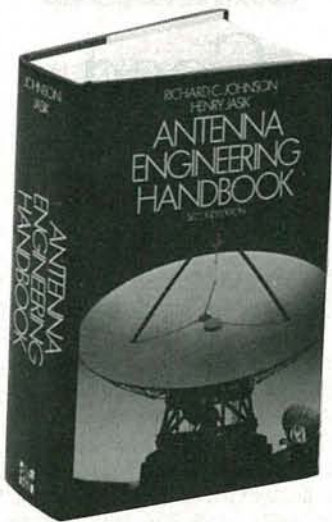

322/910

Publisher's Price \$110.00

ANTENNA ENGINEERING HANDBOOK, Second Edition

Edited by R. C. Johnson and H. Jasik

- 1,408 pages, 946 illustrations
- covers all types of antennas currently in use with a separate chapter devoted to each
- provides detailed data on physical fundamentals, operating principles, design techniques, and performance data
- up-to-the-minute information on antenna applications
- a must for those involved in any phase of antenna engineering

Publisher's Price \$64.50

STANDARD HANDBOOK OF ENGINEERING CALCULATIONS, Second Edition

By T. G. Hicks

- 1,468 pages, 793 illustrations, 499 tables
- puts more than 1,100 specific calculation procedures at your fingertips
- every calculation procedure gives the exact, numbered steps to follow for a quick, accurate solution
- virtually all procedures can be easily programmed on your PC or calculator
- uses USCS and SI units in all calculation procedures

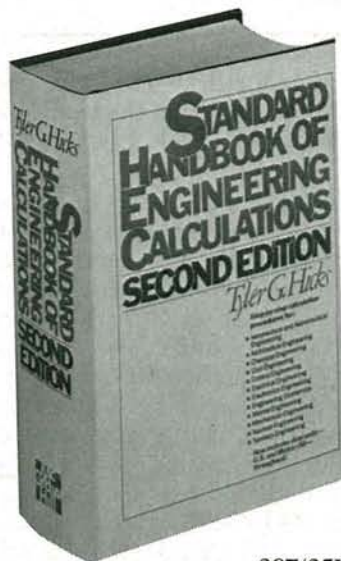

287/35X

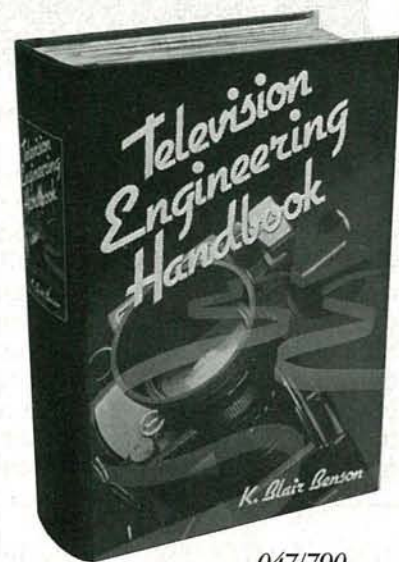

047/790

Publisher's Price \$89.50

TELEVISION ENGINEERING HANDBOOK

Edited by K. B. Benson

- 1,478 pages, 1,091 illustrations
- packed with all the technical information today's engineer needs to design, operate, and maintain every type of television equipment
- extensive coverage of receivers, broadcast equipment, video tape recording, video disc recording, and the latest technological advances
- provides television system and industry standards for the U.S. and other countries
- the most comprehensive book on the subject of television engineering

FOR ONLY \$14.95 – VALUES UP TO \$110.00 CONTROL ENGINEERS' BOOK CLUB®

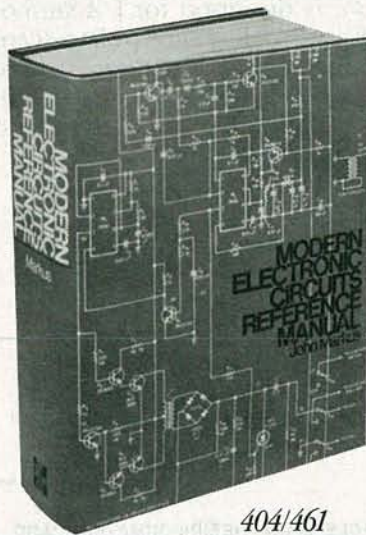

404/461

Publisher's Price \$82.50

MODERN ELECTRONIC CIRCUITS REFERENCE MANUAL

By J. T. Markus

- 1,264 pages, 3,666 circuit diagrams
- a handy, desktop reference with 103 chapters organized by "family" grouping
- filled with predesigned and use-tested circuits to save you production time and money
- includes concise summaries of all the recent applications notes, journal articles, and reports on each circuit, efficiently organized and indexed for the practicing engineer



4 reasons to join today!

1. Best and newest books from ALL publishers! Books are selected from a wide range of publishers by expert editors and consultants to give you continuing access to the best and latest books in your field.

2. Big savings! Build your library and save money, too! Savings range up to 40% off publishers' list prices.

3. Bonus books! You will immediately begin to participate in our Bonus Book Plan that allows you savings up to 70% off the publishers' prices of many professional and general interest books!

4. Convenience! 14-16 times a year (about once every 3-4 weeks) you receive the Club Bulletin FREE. It fully describes the Main Selection and alternate selections. A dated Reply Card is included. If you want the Main Selection, you simply do nothing — it will be shipped automatically. If you want an alternate selection — or no book at all — you simply indicate it on the Reply Card and return it by the date specified. You will have at least 10 days to decide. If, because of late delivery of the Bulletin you receive a Main Selection you do not want, you may return it for credit at the Club's expense.

As a Club member you agree only to the purchase of three additional books during your first year of membership. Membership may be discontinued by either you or the Club at any time after you have purchased the three additional books.

Publisher's Price \$89.00

ELECTRONICS ENGINEERS' HANDBOOK, Second Edition

By D. G. Fink and D. Christiansen

- 2,272 pages, 2,189 illustrations
- unrivaled for its completeness, authority, reliability and timeliness
- 80% new or extensively revised
- prepared by a staff of 173 expert contributors
- brings you more than 2,000 formulas and equations
- has over 2,500 bibliographic entries



209/812

FOR FASTER SERVICE IN ENROLLING CALL TOLL FREE 1-800-2-MCGRAW

McGraw-Hill Book Clubs

Electronics and Control Engineers' Book Club®

11 West 19th Street

4th floor

New York, NY 10011

Please enroll me as a member of the Electronics and Control Engineers' Book Club® and send me the book I have chosen for only \$14.95, plus local tax, postage, and handling. I agree to purchase a minimum of three additional books during my first year as outlined under the Club plan described in this ad. Membership in the club is cancellable by me or McGraw-Hill any time after the three book purchase requirement has been fulfilled. A shipping and handling charge is added to all shipments.

I wish to order the following book:

- ANTENNA ENGINEERING HANDBOOK (322/910)
- MODERN ELECTRONIC CIRCUITS REFERENCE MANUAL (404/461)
- ELECTRONICS ENGINEERS' HANDBOOK (209/812)
- TELEVISION ENGINEERING HANDBOOK (047/790)
- STANDARD HANDBOOK OF ENGINEERING CALCULATIONS (287/35X)

Signature _____

Name _____

Address/Apt. # _____

City/State/Zip _____

This order subject to acceptance by McGraw-Hill. Offer good only to new members. Foreign member acceptance subject to special conditions. This offer expires July 1, 1987.

E33890

JULY 1987

CRYSTEK

The pulse of dependable communications

Reliability & Quality
From Start To Finished Product

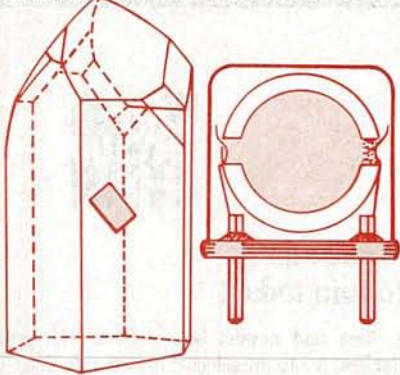

QUARTZ CRYSTALS/OSCILLATORS FOR ELECTRONIC — INDUSTRIAL

- Micro-Processor Control
- Computers/Modems
- Test/Measurement
- Medical

COMMUNICATIONS—REPLACEMENT

- Mobile/2-way/Channel Elements
- Pagers
- Marine
- Aircraft
- Telemetry
- Monitors/Scanners

AMATEURS

- CB
- Hobbier
- Experimenter

- COST EFFECTIVE
- MODERATE PRICING
- FAST DELIVERY



The Pulse of Dependable Communications

Crystek Crystals offers their new 16 page FREE catalog of crystals and oscillators. Offering state-of-the-art crystal components manufactured by the latest automated technology. Custom designed or "off the shelf," Crystek meets the need, worldwide. Write or call today!

CRYSTEK CRYSTALS

2351/2371 Crystal Dr. • Ft. Myers, FL 33907
P.O. Box 06135 • Ft. Myers, FL 33906-6135

TOLL FREE 1-800-237-3061
(813) 936-2109 - TWX 510-951-7448

CIRCLE 193 ON FREE INFORMATION CARD



CIRCLE 32 ON FREE INFORMATION CARD

For added convenience, frequencies can be grouped into any of four channels for "bank scanning". (For example, "Bank One" could include all common police frequencies; "Bank Two" can include fire channels, etc.) All four banks can be scanned at once, or individual banks can be scanned to speed up the scanning cycle. When the "weather scan" key is pressed, the scanner automatically searches all National

Weather Service frequencies to find the active frequency in a few seconds.

The model R1090 has a suggested retail price of \$239.95.—Regency Electronics, 7707 Records Street, Indianapolis, IN 46226.

ANTENNA/AMPLIFIER, the model RF-36, is designed for FM-stereo, VHF- and UHF-TV, or police-scanner applications. Features include 50- to 950-MHz bandwidth, 12-dB signal gain, 75-ohm output, and 117-volt AC operation.

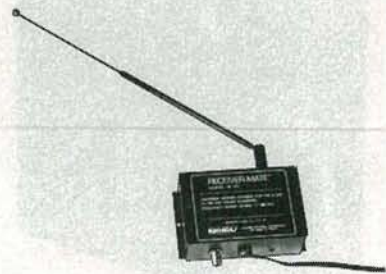

CIRCLE 33 ON FREE INFORMATION CARD

The unit's small size and construction allow it to be remotely mounted, hidden, or placed on a shelf. The model RF-36 is priced at \$79.95.—Rhoades National Corp., P.O. Box 1316 Dept. ZN9, Columbia, TN 38402.

CABLE CHECKER, the model DX-50, is pocket-sized, and instantly evaluates the integrity of any 2, 3, or 6-wire RJ-11 modular telephone or data cables. To use, simply plug in both cable ends and examine the three two-color LED's on the front panel to determine the integrity of the cable pairs. Si-



CIRCLE 34 ON FREE INFORMATION CARD

Get A Complete Course In

ELECTRONIC ENGINEERING

8 volumes, over 2000 pages, including all necessary math and physics. 29 examinations to help you gauge your personal progress. A truly great learning experience.

Prepare now to take advantage of the growing demand for people able to work at the engineering level.

Ask for our brochure giving complete details of content. Use your free information card number, or write us directly. \$99.95, Postage included. Satisfaction guaranteed or money refunded.



**Banner
Technical
Books, Inc.**

1203 Grant Ave.
Rockford, IL 61103

CIRCLE 183 ON FREE INFORMATION CARD

multaneously, the color of the LED's determine whether the cable is properly wired for data use with straight-through pinning (lights red), or for voice communication with crossed pinning (lights green). The high-impact case is 2.4" x 3.8" x 1" and operates from one alkaline 9-volt battery (supplied). The model *DX-50* is priced at \$26.95.—**L-Com Data Products**, 1755 Osgood Street, North Andover, MA.

DIGITAL THERMOMETER, the model *DT-160*, is pocket-sized and, in addition to its extendable temperature probe, has a temperature sensor mounted on its front panel. That allows the user to switch between reading room temperatures and probe temperatures in seconds. There is also a built-in clock that displays time when selected, and the unit is programmable at two individual temperature limits that trigger an audible alarm. The model *DT-160* has a built-in tilt stand and spring clip that allows it to be placed in almost any location. Its range is 0°s–159.8 F (–19.9° to 71° C).



CIRCLE 35 ON FREE INFORMATION CARD

The model *DT-160* comes with battery, 34" attached probe lead, and one-year warranty; it is priced at \$45.00.—**A. W. Sperry Instruments, Inc.**, 245 Marcus Boulevard, Hauppauge, NY 11788.

CASSETTE TERMINAL, the model *5450XL*, is microprocessor-based, with extended baud-rate capability. The new model now oper-



CIRCLE 36 ON FREE INFORMATION CARD

ates at 4800, 9600, and 19,200 baud, in addition to its existing rates of 110–2400 baud. Existing units can be upgraded through the purchase of an upgrade kit. It is fully compatible with ANSI/ECMA, RS-232C-BUS, and CCITT V.24-BUS standards, and cassette interchangeability is guaranteed. Each terminal incorporates cassette tape drive, microprocessor controller, and dual interface ports; it is particularly designed for data-collection and data communications applications.

The model *5450XL* is priced at \$2495.00.—**Memtec**, Keewaydin Drive, Salem, NH 03079. **R-E**

continued on page 81

Cash in on the Video-Cassette Boom!
START YOUR OWN TV/VCR REPAIR BUSINESS
at Home in Spare Time



Now it's easy for you to get into this money-making business. Be the person in demand by the millions of families who own videocassette recorders—the fastest-growing product in the home entertainment field. Train at home in your spare time for an exciting career as a TV/VCR Repair Specialist. Experts show you how to start small at home with low overhead. Later you can go after repair business from hotels, offices, hospitals and other companies who use TVs and VCRs in their daily operations.

Experts show you what to do, how to do it...guide you every step of the way!

Learn how to handle house calls and shop repairs—everything you need to know to get started fast. Tools are included with your course so you get "hands-on" practice as you follow your lessons step by step. Everything is explained in easy-to-understand language, but if there is ever anything in your lessons you don't understand, you can write or phone your instructor and you can count on getting an authoritative answer. Get free facts and color brochure that tell about home business opportunities. No cost. No obligation. No salesman will visit.

MAIL COUPON TODAY!

ICS SCHOOL OF TV/VCR REPAIR, Dept. DE067
Scranton, Pennsylvania 18515

Please send me free facts on how I can learn TV/VCR Repair at home in my spare time.

Name _____ Age _____
Address _____
City/State/Zip _____
Phone () _____

CIRCLE 192 ON FREE INFORMATION CARD

COMB

Authorized Liquidator



Fully Portable Pocket Model!

10 CHANNEL SCANNER

Hear the Action As It's Happening! Pick up all the listening excitement including fire, police, weather, and more...with this pocket-size, hand-held Bearcat® Scanner. Rebuilt-like-new by trained technicians, this Model 50XL carries a **90-Day Limited Vendor Warranty on Parts and Labor**. Order now at a **LOW liquidation price!**

- Scans 10 Channels Over 10 Bands.
- Covers Frequencies 29-54; 136-174; 406-512 MHz. Scans 15 Channels Per Second. Built-In 3 Second Delay, Cuts Missed Transmissions.
- Keyboard Lock Prevents Accidental Information Entry.
- Frequency LCD, Squelch, Volume, Lock-out and Review Controls.
- 6½" Flex Antenna. Belt Clip. Uses 5 "AA" Batteries (Not Included).

Compare At **\$229.99**

Liquidation Priced At **\$139**

Item H-2504-7146-384 S/H: \$4.00 ea.

Credit card members can order by phone, 24 hours a day, 7 days a week.

Toll-Free: 1-800-328-0609

Sales outside the 48 contiguous states are subject to special conditions. Please call or write to inquire.

SEND TO: Item H-2504
C.O.M.B. Direct Marketing Corp.
1405 Xenium Lane N/Minneapolis, MN 55441-4494

Send Bearcat® Hand-Held Scanner(s) Item H-2504-7146-384 at \$139 each, plus \$4 each for ship, handling. (Minnesota residents add 6% sales tax. Sorry, no C.O.D. orders.)

My check or money order is enclosed. (No delays in processing orders paid by check.)

PLEASE CHECK: VISA MasterCard Discover American Express

Acct. No. _____ Exp. _____

PLEASE PRINT CLEARLY

Name _____

Address _____

City _____

State _____ ZIP _____

Phone () _____

Sign Here _____

COMB COMB COMB



**THE MOST POPULAR
WIRE-WOUND CB ANTENNAS
IN THE WORLD**

Because...they perform!

FACT

"When CB was legalized in England, 'Firestik' antennas were barred from sale because the emitted signal was too strong. Fortunately, no other country, including the U.S., limits antenna efficiency."

**YOU CAN HAVE SECOND
BEST OR, 'Firestik'!**

Call or Write for **FREE Catalog**
'Firestik' Antenna Company
2614 East Adams
Phoenix, Arizona 85034
(602) 273-7151

MILLIONS OF SATISFIED OWNERS

CIRCLE 100 ON FREE INFORMATION CARD

**ATTENTION!
ELECTRONICS
TECHNICIANS**



**EARN YOUR
B.S.E.E.
DEGREE
THROUGH HOME STUDY**

Our New and Highly Effective Advanced-Placement Program for experienced Electronic Technicians grants credit for previous Schooling and Professional Experience, and can greatly reduce the time required to complete Program and reach graduation. No residence schooling required for qualified Electronic Technicians. Through this Special Program you can pull all of the loose ends of your electronics background together and earn your B.S.E.E. Degree. Upgrade your status and pay to the Engineering Level. Advance Rapidly! Many finish in 12 months or less. Students and graduates in all 50 States and throughout the World. Established Over 40 Years! Write for free Descriptive Literature.

**COOK'S INSTITUTE
OF ELECTRONICS ENGINEERING**

347 RAYMOND ROAD
P.O. BOX 20345
JACKSON, MISSISSIPPI 39209

CIRCLE 195 ON FREE INFORMATION CARD

DRAWING BOARD



ROBERT GROSSBLATT

Dynamic memory

UP UNTIL ABOUT EIGHT OR NINE YEARS ago, systems designers would avoid dynamic memory like the plague. The reason for that was simple: the disadvantages far outweighed the advantages. You could plop static RAM in a circuit and use it without much other thought, but dynamic RAM required a lot of support circuitry. In fact, back in those days a 16K dynamic RAM was a big deal: it needed three supply voltages and was very particular about timing.

Things have changed.

Today's cheap 64K dynamic RAM's are much easier to use and, since they give so many bits for the buck, any designer worth his salt has to be familiar with them. Lots

of special dynamic RAM controllers are available that take care of all of a dynamic RAM's special needs, and make them almost as easy to use as static RAM. To help you get a good grasp on how to use dynamic RAM, we'll put together a simple system; and although the system won't be state-of-the-art, once you understand how it works you'll have a good grasp of the basic considerations of designing with dynamic RAM.

Keeping in mind the DRAM (Dynamic Random Access Memory) characteristics we discussed last month, you can see that any system using them has to have certain building blocks. The block diagram in Fig. 1 describes not only the system we're putting together,

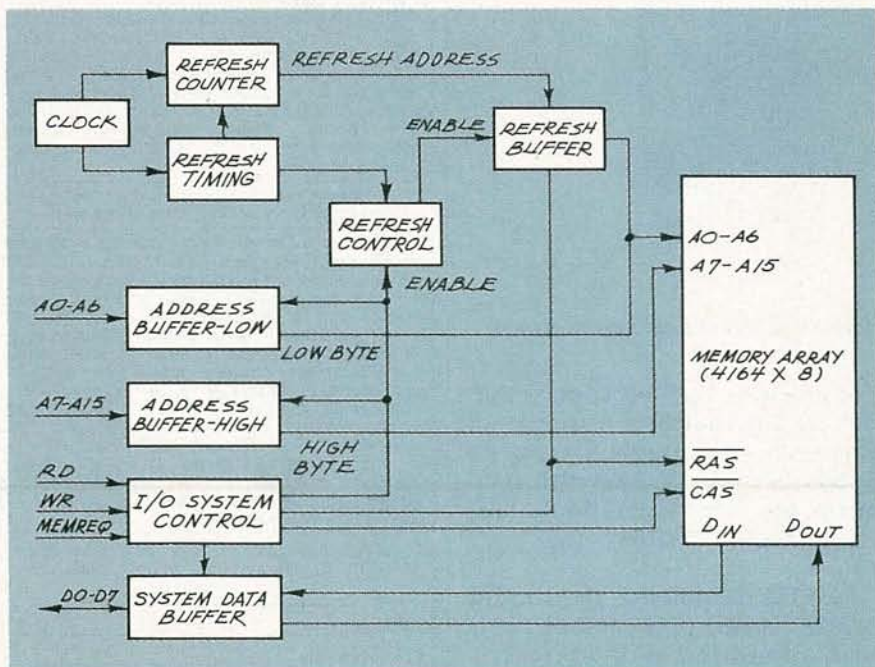

FIG. 1

but also one that uses the most sophisticated LSI DRAM controller. The difference between the two is where the elements are found. A lot of the discreet parts we'll be using are packed together in the substrate of LSI devices such as Intel's 8208 family. Once you're familiar with our system, putting together an LSI system will be a relatively easy task.

The system has three main sections, and although each one does a separate job, they have to interact as well.

1. The memory array: That section contains only the actual storage devices. In our circuit it's made up of eight 4164's, each of which is organized as 64K x 1 bit.

2. The refresh circuit: That produces the control signals, sequential addresses, and the timing logic to maintain the data in the memory array.

3. The I/O circuitry: That circuitry generates the necessary timing and control signals to let an external device get access to the memory array.

Let's look at each of the sections individually.

First section

You should be familiar with the memory array because we've already spent lots of time talking about dynamic RAM in general and 4164's in particular. Each of the eight IC's has its address and control lines bused together. The DATA IN and DATA OUT pins on each IC are also tied together, because the direction of data flow will be controlled by the rest of the system, and the 4164 can be told to restate its output.

Second section

The refresh circuitry is designed to count systematically through all the addresses needed to maintain the stored data. That is, of course, the big drawback of using dynamic RAM. IC designers have made refresh as easy as possible and, if you read a 4164 data sheet, you'll see that there are several ways in which it can be done. We'll be doing a *RAS-only refresh*, which means that we present a row address to the A0 to A6 address pins of the memory array and then bring the RAS line low. That will

NOISE REDUCTION FOR UNDER \$10.

MIXING CONSOLES
SWITCHES

MICROPHONE CONNECTORS

SNAKE CABLES

BATTERY CONTACTS



ALL PLUGS & JACKS
(XLR, PHONE, PHONO, DIN, MIDI, ETC.)

PATCHBAYS

FADERS, POTS

TERMINAL STRIPS

SPEAKER TERMINALS

CRAMOLIN®

Even the finest equipment in the world cannot guarantee noise-free operation. One "dirty" connection anywhere in the electrical path can cause unwanted noise or signal loss.

"MORE THAN A CONTACT CLEANER"

CRAMOLIN® is a fast-acting, anti-oxidizing lubricant that cleans and preserves all metal surfaces, including gold.

When applied to metal contacts and connectors, **CRAMOLIN®** removes resistive oxides as it forms a protective molecular layer that adheres to the metal surfaces and maintains maximum electrical conductivity.

CRAMOLIN® - USED BY THOSE WHO DEMAND THE BEST:

Bell & Howell	Hewlett Packard	MCI(Sony)	Nakamichi
Boeing	John Fluke Mfg.	Motorola	RCA
Capitol Records	McIntosh Labs	NASA	Switchcraft

SINCE 1956

CAIG LABORATORIES INC

1175-O Industrial Ave., (P.O. Box J) - Escondido, CA 92025-0051 U.S.A. • (619) 743-7143

CIRCLE 181 ON FREE INFORMATION CARD

Try the

Radio-Electronics

bulletin board system

(RE-BBS)

516-293-2283

The more you use it the more useful it becomes.

We support 300 and 1200 baud operation.

Parameters: 8N1 (8 data bits, no parity, 1 stop bit) or 7E1 (7 data bits, even parity, 1 stop bit).

Add yourself to our user files to increase your access.

Communicate with other R-E readers.

Leave your comments on R-E with the SYSOP.

RE-BBS
516-293-2283

COMB

Authorized Liquidator

Commodore Compatible
Total Telecommunications™
MODEM



Factory New!
First Quality!

FCC Approved

- Access the stock market, take college classes, do your shopping and more.
- For Commodore 64K or SX64.
- Has modular jacks for quick, easy hookup to your phone system!
- Works on TouchTone™ and Rotary (pulse) dialing (not PBX).

Overstock liquidation. Simple communications package connects 64K or SX64 for on-line telephone use. No special computer knowledge required. This super-intelligent software is completely menu-driven and easy to understand.

Features: 30K software buffer. 300 Baud. Auto-dial simplifies complex modem steps. Upload, download of text, programs, data files. Captures and displays hi-resolution, mapped graphics files. Color selection menu. **Equipment needed:** C64, monitor, and disk drive or SX64.

NOTE: Price includes trial subscription to over 52 data base services for vast information. Initial sign-up fee is FREE. All you pay is the on-line time you use, plus monthly rate.

90-Day Limited Factory Warranty.

Mfr. List: \$109.95

Liquidation Priced At **\$19**

Item H-2544-3646-007 Ship, hand: \$4.00 ea.



Credit card members can order by phone, 24 hours a day, 7 days a week.

Toll-Free: 1-800-328-0609

Sales outside the 48 contiguous states are subject to special conditions. Please call or write to inquire.

C.O.M.B. Direct Marketing Corp. Item H-2544
1405 Xenium Lane N/Minneapolis, MN 55441-4494

Send ___ Modem(s) Item H-2544-3646-007 at \$19 each, plus \$4 each for ship, handling. (Minnesota residents add 6% sales tax. Sorry, no C.O.D. orders.)

My check or money order is enclosed. (No delays in processing orders paid by check.)

PLEASE CHECK: VISA MasterCard DISCOVER AMERICAN EXPRESS

Acct. No. _____ Exp. / _____

PLEASE PRINT CLEARLY

Name _____

Address _____

City _____

State _____ ZIP _____

Phone (____) _____

Sign Here _____

COMB Direct Marketing Corp.
Authorized Liquidator
1405 Xenium Lane North
Minneapolis, Minnesota 55441-4494

JULY 1987

Radio-Electronics mini-ADS



FREE CATALOG OF HARD-TO-FIND TOOLS is packed with more than 2000 quality items. Your single source for precision tools used by electronic technicians, engineers, instrument mechanics, schools, laboratories and government agencies. Also contains Jensen's line of more than 40 tool kits. Send for your free copy today! **JENSEN TOOLS INC., 7815 46th St., Phoenix, AZ 85044. (602) 968-6231.**

CIRCLE 115 ON FREE INFORMATION CARD



THE MODEL WTT-20 IS ONLY THE SIZE OF A DIME, yet transmits both sides of a telephone conversation to any FM radio with crystal clarity. Telephone line powered - never needs a battery! Up to 1/4 mile range. Adjustable from 70-130 MHz. Complete kit **\$29.95 + \$1.50 S+H**. Free Shipping on 2 or more! COD add **\$4**. Call or send VISA, MC, MO. **DECO INDUSTRIES, Box 607, Bedford Hills, NY 10507. (914) 232-3878.**

CIRCLE 127 ON FREE INFORMATION CARD

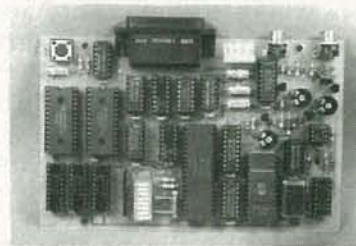

BUILD STEVE CIARCIA'S NEW VIDEO DIGITIZER. • True "Frame Grabber", pic takes 1/60th sec • Not bus Dependent - Standalone digitizer • Serial output, transmits 300bps to 57.6Kbps • Resolution: 256 x 244 x 6 w/64 level grayscale • Accepts any NTSC video input, B&W or Color • Optional Rec/Display makes Video Telephone • Images can be stored & displayed on IBM PC. Full Digitizer/Serial Transmitter Kit - **\$249**. Call for other options and specs. **CCI, 4 Park St., Suite 12, Vernon, CT 06066. (203) 875-2751.**

CIRCLE 206 ON FREE INFORMATION CARD



TUNABLE NOTCH FILTER—for elimination of any TV, FM, or VHF signal. Can be tuned precisely to ANY signal within these ranges: *MODEL 26-Ch's. 2-6 plus FM [54-108 Mhz] *MODEL 1422-Ch's. 14(A)-22(I) [120-174 Mhz] *MODEL 713-Ch's. 7-13 [174-216 Mhz] Highly selective 60dB notch. Send **\$30** each. Quantity prices as low as **\$14**. **STAR CIRCUITS, P.O. Box 8332, Pembroke Pines, FL. 33084**

CIRCLE 94 ON FREE INFORMATION CARD

CALL NOW AND RESERVE YOUR SPACE

- 6 x rate \$745.00 per each insertion.
- Reaches 239,312 readers.
- Fast reader service cycle.
- Short lead time for the placement of ads.
- We typeset and layout the ad at no additional charge.

Call **516-293-3000** to reserve space. Ask for Arline Fishman. Limited number of pages available. Mail materials to: mini-ADS, RADIO-ELECTRONICS, 500-B Bi-County Blvd., Farmingdale, NY 11735.



A CAREER START FOR THE 21ST CENTURY. Since 1905, National Technical Schools has helped people build successful careers. Enter the 21st Century through home study courses in Robotics, Computer Technology and Servicing, Microprocessors, Video Technology, Basic Electronics, Transportation Technology, Climate Control Technology or TV and Radio Servicing. For a FREE catalog, call 1-800-B-BETTER. Or write **NTS/INDEPENDENT TRAINING GROUP, 456 West M. L. King Jr. Blvd. L.A., CA 90037.**

CIRCLE 182 ON FREE INFORMATION CARD



NEW 442 SYNE WAVE DECODER WITH VARI SYNC—Replaces the oak N-12 **\$80.00**, S.B. add on decoder **\$99.00**, S.B. Tri-Bi decoder **\$100.00**, Zenith SSAVI **\$185.00**, S.B.-S.A. decoder **\$140.00**, Starcom converter **\$139.95**. Buy a decoder take off **\$(10.00)**. Guaranteed. (402) 331-4957. Call or write for your free catalog. Many other products & quantity pricing. **M.D. ELECTRONICS, 5078 So. 108th #115A, Omaha, NE 68137**

CIRCLE 208 ON FREE INFORMATION CARD



RADAR SPEED GUNS. Professional (used by police). From **\$275**. Used for clocking speeds in baseball, car/boat racing, bowling, skiing, etc. **ZENITH SSAVI \$169 +**. Reconditioned, original UHF equipment. Satellite components. Surplus TV equipment: N-12, SB-3, Hamlin 1200, Ztac, etc. Converters, amplifiers, TV accessories. Catalog & coupon **\$1**. SSAVI modification/troubleshooting handbook **\$6.50** ppd. **AIS SATELLITE, INC., P.O. Box 1226-M, Dublin, PA 18917. 215-249-9411.**

CIRCLE 81 ON FREE INFORMATION CARD



SEE IN TOTAL DARKNESS - BUILD THIS AMAZING IR VIEWER. Applications include; night surveillance, IR photography, laser tracking, fibre optic observations, hi-temp thermal viewing, IR alarms, IR communications & controls, IR astronomy & microscopy, document examination, painting & stamp authentication etc. Kit **\$189** delivered. (Dealers wanted). Catalog **\$1**. **514-739-9328. OCTE ELECTRONICS, Box 840, Champlain, N.Y. 12919**

CIRCLE 190 ON FREE INFORMATION CARD

automatically refresh all the memory cells located in that row.

A 4164's memory matrix is organized as 128 rows by 512 columns, so it's only necessary to sequence through 128 addresses to completely refresh the device. We're using 7 address lines, (A0 to A6), because two to the seventh is 128. On the simplest level, refresh is done by putting out a 7-bit address and strobing RAS, but there are other things to deal with as well. As we'll see, timing is the really critical factor and the state of the other memory-control pins has to be considered as well.

Third Section

The last section of our circuit handles the I/O. It's all well and good to build a system that can properly massage dynamic RAM, but it's not much good unless there's some way to store and access the data in the RAM. Any system wanting access to our circuit only has to give it an address, data, and a read or write request, and then sit back until it's notified that

the job is done. Doing that with static RAM is simple, but the constant refresh activity that is going on in a dynamic RAM system complicates things.

Servicing a memory request means accessing a location somewhere in the memory array's address space. The chances are slight that the requested location is going to be on the row that's currently being refreshed; and it would take too long, and require a lot of extra circuitry, to wait until the refresh circuitry reaches the particular row containing the requested location. An external memory request means that the refresh activity has to be halted, access has to be given to the requested location, and then the refresh circuit can regain control of the memory.

If you're beginning to think that here is a real nightmare for a circuit designer, you're starting to appreciate and understand the reservations that most circuit people have about using dynamic RAM. Given all the needs of our

system, putting one together with a gates-only approach would be extremely complex, even if the job were done using MSI components.

One of the major problems when dealing with dynamic RAM is the strict timing parameters. A standard 4164 will retain the data stored in its pint-sized capacitor cells for only 2 milliseconds. That means that your circuit has to perform a refresh on each cell within 2 milliseconds or the data is lost.

Since a RAS-type refresh works on a whole row at a time, and since there are 128 rows in a 4164, the refresh must be performed at least every 16 microseconds. The circuit that takes care of all that for you must be designed to sequence through several steps for each refresh operation.

1. The refresh counter has to increment to the next address.
2. That address has to be put on the address bus for the RAM.
3. A RAS signal has to be generated and fed to all the RAM.

continued on page 81

TEST INSTRUMENTS

High Quality
Lowest Prices
Off-The-Shelf

Zippered Carrying Case CC-30 . . . \$4.50

New! MINI-METERS w/MAXI-SPECS

SCOPE 3 1/2 Digit LCD with 8 Full Functions

Model DVM-632 \$4495

Deluxe test leads included • 0.5% accuracy • Transistor gain test • Audible continuity checking & diode test • 10 Amp measurement

SCOPE 3 1/2 Digit LCD Multimeter

Model DVM-630 \$2995

Test leads included • 0.5% accuracy • 6 functions, 19 ranges • Automatic zero adjust • Low battery indication • Measures 5" x 2 3/4" x 7/8"

B & K 20 MHz Dual Trace

Model 2120 \$37995

Probes included • 20 and 26 MHz band widths • TVV and TVH • X-Y operation • Trace rotation: adjustable front panel • Channel 1 output

SCOPE 3 1/2 Digit Capacitance

Model DCM-602 \$6995

Test leads included • 8 ranges with full scale values to 2000 uF • LSI circuit • Crystal time base • Frequency range 800 Hz to 8 Hz

SCOPE 3 1/2 Digital Multimeters

Model DVM-638 \$7995

Test leads included • 11 function, 38 ranges • Logic level detector • Audible visual continuity • capacitance and conductance measurement.

Model DVM-634 \$4875 • 7 function, 32 ranges • Transistor measurement

Model DVM-636 \$6275 • 8 function, 37 ranges • Capacitance measurement

SCOPE Pocket Sized Audio Signal Generator

Model RC-555 \$6995

Test leads & 9V battery included • Low distortion sine-wave signal • 46 step selected frequency • x1 range 20 Hz to 1.5 KHz/x100 range 2KHz to 150 KHz

HITACHI 35 MHz Dual Trace Oscilloscope

Model V-355 \$59995

(Reg. \$899.95)

Probes included • Thin, lightweight, compact • Large 6" rectangular, internal graticule CRT • Autofocus

FORDHAM Sweep Function Generator

Model FG-801 \$21995

(Reg. \$289.95)

Test leads included • 7 frequency ranges, 0.2 Hz to 2 MHz • Accuracy to ±5%

FORDHAM 550 MHz Frequency Counter

Model FM-8 \$16995

(Reg. \$249.95)

Completely assembled, pre-tested, precalibrated • High intensity 8-digit LED display

New! **SCOPE 4 1/2 Digit LCD Bench Digital Multimeter**

Model DVM-6005 \$19995

Test lead set & 6 "D" size batteries included • 0.4" high characters • Conversion period: 500 milliseconds • Automatic, negative polarity

Phone orders accepted.

Fordham

260 Motor Parkway, Hauppauge, NY 11788

Ask for our **FREE** Catalog
TOLL FREE **800-645-9518**
In New York State 800-832-1446

Service & Shipping Charge Schedule
Continental U.S.A.

FOR ORDERS	ADD	FOR ORDERS	ADD
\$25-100	\$4.50	\$751-1,000	\$12.50
\$101-250	\$6.00	\$1,001-1,500	\$16.50
\$251-500	\$8.00	\$1,501-2,000	\$20.00
\$501-750	\$10.50	\$2,001 and up	\$25.00

MAKE MORE MONEY



TRAIN FOR ELECTRONICS

You say you're *already* trained in electronics but that you're *not* making enough money??? Well then, maybe you don't have an accredited bachelor's degree to prove that your education is *up to snuff!* Check out the Grantham Independent-Study B. S. Degree Program. It could make a *dollars and sense* difference in your electronics career.

Grantham offers this program, complete but without laboratory, to electronics technicians whose objectives are to upgrade their level of technical employment. Since the field of electronics is so enormous, opportunity for advancement is always present. Promotions and natural turnover make desirable positions available to the man who is ready to *move up*.

Grantham College of Engineering
10570 Humbolt Street
Los Alamitos, California, 90720

Do You REALLY Want to Make More Money?

Yes it does take *work* and a few sacrifices to climb up the electronics ladder to where the bigger money is. But, if that's where you want to be, then that's what you must do — *work* harder at learning and getting the right credentials, even if it takes a few sacrifices. A *B. S. degree* and the knowledge that rightly goes along with it can give you powerful ladder-climbing equipment in your search for *success in electronics*.

The accredited Grantham non-traditional B.S. Degree Program is intended for mature, fully-employed workers who want to upgrade their electronics careers.

Put Professional Knowledge and a COLLEGE DEGREE in your Electronics Career through Independent Home Study

Study materials, carefully written by the Grantham College staff for independent study at home, are supplied by the College. Your technical questions related to these materials and the lesson tests are promptly answered by the Grantham home-study teaching staff.

Recognition and Quality Assurance

Grantham College of Engineering is accredited by the Accrediting Commission of the National Home Study Council, as a degree-granting institution.

All lessons and other study materials, as well as communications between the college and students, are in the English language. However, we have students in many foreign countries; about 80% of our students live in the United States of America.

This booklet FREE!

This free booklet explains the Grantham B.S. Degree Program, offered by independent study to those who work in electronics.



for **FREE Booklet CLIP COUPON** and mail in envelope or paste on postal card.

Grantham College of Engineering RE787
10570 Humbolt Street, Los Alamitos, CA 90720

Please mail me your free catalog which explains your B.S. Degree independent-study program.

Name _____ Age _____

Address _____

City _____ State _____ Zip _____

the modern, downsized vehicle. In fact, once hi-fi was available for cars, like early home stereo it soon attained cult status, becoming the latest "must have" for the up-and-coming young professional—or anyone else who wanted to be part of the "having it all generation."

To fulfill their fantasy of sitting in Philharmonic Hall while barreling to the next stoplight, the new generation of auto-sound stereophiles actively sought out the small coterie of installers having the acoustical expertise needed to compensate for the harsh environmental conditions posed by a moving vehicle. The best among those installers learned how to match specific products to individual car models to get the best sound possible. The lessons learned by the early pioneers in autosound passed into the mainstream of high-fidelity sound, and sound systems tailored to specific cars are now a commonplace objective that is being met on two different and distinct levels.

On one level, car manufacturers have recognized that high-fidelity highway-sound can be an important consideration to potential new-car buyers, so many models either are supplied initially with a high-fidelity sound system, or make it available as an optional package. Generally, the factory-installed hi-fi systems are acoustically tailored to a particular model car through the expertise of recognized hi-fi experts; in particular, speaker manufacturers. For example, General Motors' Delco Radio Division has developed a partnership with Bose Corporation. Similarly, Ford relies on the expertise of JBL, and Chrysler seeks the advice of Infinity Systems.

On another level, a legion of autosound retailers who specialize in installing various brands and types of equipment have become what is collectively called the "aftermarket." The aftermarket survives because its offerings are generally more advanced than the equipment sold with most new cars. The "advancements" are principally in the area of features and flexibility. While the car companies can offer a good, basic autosound system, the array of aftermarket equipment available is such that you may find:

1. Products having more conveniences and better performance than the factory-installed equipment.

2. Equipment as good as what is usually supplied factory-installed, but at lower cost than what the car dealer charges. Although the car dealers do offer the convenience of one-stop shopping, if you're willing to spend time checking out several dealers the chances are that you'll end up with better sound and features for the same basic cost.

Buying an autosound system necessitates making choices in three areas: signal source, power, and speakers. Each area, however, has a common consideration:

the space limitation of your vehicle. Different cars have variously-sized holes slated for radios and speakers. A particular cassette/receiver, for example, might not fit into a dashboard without extensive, and often expensive, cutting to enlarge the opening. Conversely, a small unit may not fit without the use of an adapter to fill up the extra space left in the opening. Likewise, the almost "standard" 6 × 9-inch speaker will not fit easily—if at all—into compact and sub-compact cars.

Choosing a signal source means opting for a product that offers a radio, tape, or Compact Disc (CD) combination. To complicate your decision, the coming months will see the arrival of Digital Audio Tape (DAT), a new cassette format that rivals the performance of even the compact disc.

Although existing autosound speakers and amplifiers are compatible with DAT, because of the projected high initial expense of the early DAT players, at least for the foreseeable future the primary pre-recorded signal source for highway hi-fi will be Dolbyized cassette tapes; followed by the Compact Disc, which is only now starting to make significant inroads into autosound installations.

Autosound CD player equipment is available in a number of configurations. CD/receivers are similar to cassette/receivers in that they combine an all-stereo AM/FM or an AM/FM-stereo receiver with a compact disc player. Typical of CD/receivers is the Audiovox *HCD-1000*. The tuner section includes 12 station presets that you can program with your favorite radio stations, a station seek that automatically locates the next strongest station, and a scan for easy sampling of many different stations.

The *HCD-1000*'s CD section offers an auto-index that allows the user to preview each disc "track" or selection for eight seconds, a repeat button for playing the track over again, fast-forward and fast-

reverse selection search, and digital indicators for the track number and elapsed time. Suggested list price for the *HCD-1000* is \$699.95.

While the *HCD-1000* is a typical CD/receiver, it is somewhat unusual in that the disc must be inserted into a cartridge before it can be played. The cartridge system is also used by JVC, Yamaha, Clarion, and Blaupunkt to facilitate loading while also providing the disc with much added protection.

Pioneer's DIN-mount *DEX-77* CD/receiver is one of the most high-tech models available; it is specifically designed to withstand the rigors of an automotive environment. It uses a three-beam tracking system to insure error-free tracking, and a "Last-Address Memory" function that ensures pickup on the right track even on rough, jarring roads. The CD player can be programmed for the order of track play, automatic scan, all track repeat, and random play, whereby the player automatically shuffles the order of track play. The receiver section features a "Best Station Memory," which remembers the six strongest stations in descending order of signal strength. The Pioneer *DEX-77* is priced at \$850.

Player-only models are another CD configuration. These tuner-less CD players may be suitable if your car is already equipped with a cassette/receiver and you simply want to have the option of CD.

If you want to listen to both CDs and cassettes, you may want to buy a cassette receiver that is equipped with an input jack for a CD player. The jack gives you the option of easily adding a personal CD player by simply plugging it into the jack. Conversely, Sanyo's CD players have an input jack for "Walkman-type" personal tape players.

Sony offers an alternative to those wanting to listen to both cassettes and CD's: That product is a slim cassette-only player to be used in conjunction with its companion model *CDX-R88* CD receiver.



WORRIED ABOUT THEFT? Some receivers, like this one from Alpine, can be slipped out of the dash easily for concealment.

List price for the CD/receiver is \$750, while the add-on cassette player has a suggested list price of \$270.

A related product is the Philips *CD-10*, an autostand CD player that slides out of the dashboard for use as a personal or portable CD player. List price for the *CD-10* is \$400.

Another approach to CD is provided by Sony and Alpine. Both companies offer CD disc changers that mount in the trunk. A cable from the changer to a control unit mounted up front near the driver's seat allows the driver (or passenger) to control the music selection. The Alpine changer holds 12 discs in a removable "magazine," while the Sony *DiscJockey* holds 10 discs. The Alpine control unit mounts in-dash while the Sony controls can be hand-held or mounted. Optional tuners are available for both units so that the CD changer can also function as an AM/FM-stereo radio.

The cassette/receiver may represent an older technology, but they are still the mainstay of most autostand systems. Because of its nearly universal use, development of cassette/receivers has not ground to a halt since the introduction of CD. The old "tin can" with two knobs on either side is giving way to sleek, flat-panel (no knobs) models housing more features than some of the older models could ever hope to offer.

High-tech

A number of companies, in fact, are offering cassette/receivers in which only the cassette mechanism represents older technology. A case in point is Blaupunkt's *Berlin TQR 07* model listing for \$1500. The *TQR 07* incorporates so many features that many of the buttons on the faceplate have multiple functions defined by the mode selected. Possible modes are tape, radio, security, and ARI, the latter being a system that either turns up the radio volume or interrupts tape play during traffic advisories from participating radio stations. An LCD (Liquid Crystal Display) indicates the selected mode.

In addition to the more commonplace features found on virtually every cassette/receiver, the *TQR 07* features AM stereo, 16 station presets, last-station memory, and an automatic volume control that adjusts to changes in ambient noise, plus *Dolby-B* and *Dolby-C* noise reduction for eliminating tape hiss.

Coordinating all the functions of the *TQR 07*, including monitoring the tuning and adjusting the AM and FM filtering, is the task of a 16-bit, 32K microprocessor that uses a digital data bus to relay information between the dash-mounted control panel and cassette deck, and an independent module that houses the tuners and the volume- and tone-control components. Use of a separate mounted-out-of-sight module is a technique used by an increas-

NEXT STOP: DIGITAL

What's coming in car audio in the future? DAT or Digital Audio Tape. DAT, which has specifications rivaling those of compact discs, is a practical format for car audio because it is easy to handle. A digital audio tape cassette, is about half the size of a standard cassette, yet it has a two-hour capacity. A self-closing door protects the tape, so that special handling isn't required.

At press time, there is still some doubt about whether the DAT format will ever reach the U.S. market because the recording industry is insisting that anti-taping devices be included in all DAT recorders (so that pre-recorded material cannot be taped) and the CD player manufacturers are concerned that DAT players could cut into their market and perhaps kill

the CD industry. However, as you can see from the photos, the tape manufacturers and the hardware manufacturers are ready for the new format.

We'll keep you posted on the legal questions regarding DAT, and on its technical specifications in upcoming issues.

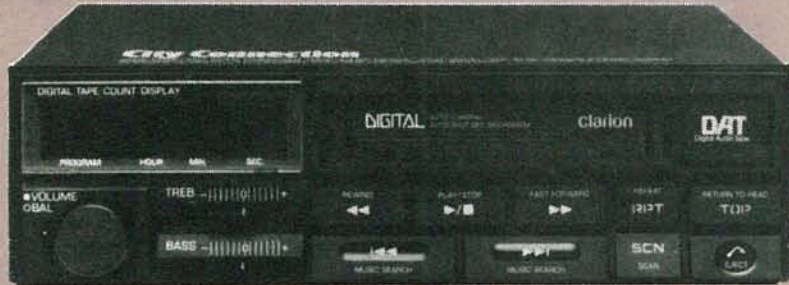

ing number of other manufacturers, including Kenwood and Sony.

Technology is also having a great effect on the appearance of cassette/receivers. Among the most dramatic is the appearance of Pioneer's *KEX-900*. A single LCD faceplate displays information on five key functions: AM/FM tuning, cassette deck, graphic equalizer, spectrum analyzer, and time (clock). A seven-band equalizer offers more precise adjustment of the frequency response than does conventional tone controls, while the spectrum analyzer presents a visual indication of the program's frequency content.

Cassettes are loaded into the *KEX-900* by flipping down the front panel. Behind the door is the cassette mechanism and a number of less-frequently used controls. The "hidden door" trick is used by other manufacturers as well. The flip-down door on Sharp's *RG-F882*, for example, conceals a seven-band equalizer. List price for Pioneer's *KEX-900* is \$580. Sharp's *RG-F882* lists for \$449.95.

Most technological advancements appear first in the higher-priced cassette/receivers. There are exceptions, of course. Fujitsu's model *Ten*, for example, includes a dual azimuth adjusting system in its series of cassette/receivers that list between \$250 and \$350. (The head-to-tape alignment of auto-reverse decks can sometimes be accurate in one direction

but skewed in the opposite direction—an error that can severely effect high frequency response. Dual-azimuth adjustments optimize the alignment for each of the directions.)

A feature becoming increasingly common on high-end autostand equipment is a built-in security system. Generally, the security system requires that a three to five digit code be entered via the preset station buttons before the CD or cassette/receiver can be used: The equipment is inoperable until the correct code is entered. Another anti-theft system allows the user to simply slide the radio or the tuning unit from a dash-mounted sleeve so it can be concealed in the trunk, or even carried away from the vehicle.

More volume

As a general rule of thumb, high-end autostand systems usually provide more output power than "original equipment" or "replacement" receivers. The reason for the extra power, of course, is to avoid amplifier overload when the volume is cranked up to overcome ambient road and car noises. Power capabilities vary enormously. For example, the specialty autostand amplifier maker HiFonics Corp. offers amplifiers ranging from a low of 16 watts per channel to a high of 275 watts per channel.

Although the average autostand stereo

NRI Trains You At Home—As You Build Your Own IBM PC Compatible Computer

GET THE KNOW-HOW TO SERVICE EVERY COMPUTER ON THIS PAGE... AND MORE!

Learn the Basics the NRI Way— and Earn Good Money Troubleshooting Any Brand of Computer

The biggest growth in jobs between now and 1995, according to Department of Labor estimates, will occur in the computer service and repair business, where demand for trained technicians will actually double.

You can cash in on this opportunity—either as a full-time corporate technician or an independent service-person—once you've learned all the basics of computers the NRI way. NRI's practical combination of "reason-why" theory and "hands-on" building skills starts you with the fundamentals of electronics, then guides you through advanced electronic circuitry and on into computer electronics. You also learn to program in BASIC and machine language, the essential languages for troubleshooting and repair.

Total Computer Systems Training, Only From NRI

No computer stands alone... it's part of a total system. To really service computers, you have to understand computer *systems*. And only NRI includes a powerful computer system as part of your training, centered around the new, fully IBM PC compatible Sanyo 880 Series computer.



IBM is a Registered Trademark of IBM Corporation.
Epson is a Registered Trademark of Epson America, Inc.
Apple and the Apple logo are Registered Trademarks of Apple Computer, Inc.
Compaq is a Registered Trademark of COMPAQ Computer Corporation.
© 1985 AT&T Technologies, Inc.

NEW!

Train with the newest Sanyo 880 Series Computer—it's fully IBM-compatible and runs almost twice as fast as the IBM PC!



Start with step-by-step assembly of the new, highly-rated, Sanyo computer. You install and trouble-shoot the "intelligent" keyboard. Then you assemble the computer supply, install the disk drive, and add extra memory to give you a powerful 256K RAM system. The new 880 computer has two operating speeds: standard IBM speed of 4.77 MHz and a remarkable speed of 8 MHz, making it almost twice as fast as the IBM PC. Next, you'll interface the high-resolution monitor and begin to use the valuable software included with your complete computer system. It all adds up to confidence-building, real-world experience that includes training in programming, circuitry, and peripheral maintenance. You'll be learning about working with, servicing, and troubleshooting an entire computer system—monitor, keyboard, computer, disk drive, power

supply—to ensure that you have all the essential skills you need to succeed as a professional computer service technician.

No Experience Needed, NRI Builds It In

This is the kind of practical, hands-on experience that makes you uniquely prepared, with the skills and confidence you need for success. You learn at your own convenience in your own home. No classroom pressures, no night school, no need to quit your present job until you're ready to make your move. Your training is backed by your personal NRI instructor and the NRI technical staff, ready to answer your questions and help you when you need it. You get it all with NRI at-home training.

100-Page Free Catalog Tells More

Send the postage-paid reply card today for NRI's big, 100-page, color catalog on NRI's electronics training, which gives you all the facts about NRI courses in Microcomputers, Robotics, Data Communications, TV/Audio/Video Servicing, and other growing, high-tech career fields. If the reply card is missing, write to the address below.

Your NRI total systems training includes:
• NRI Discovery Lab® to design and modify circuits • Your four-function, digital multimeter with walk-you-through instructions on audio tape • Digital logic probe for visual examination of keyboard circuits • The newest Sanyo 880 Series Computer with "intelligent" keyboard and 360K double-density, double-sided disk drive • High resolution monochrome monitor • 8K ROM, 256K RAM • Bundled software including GW BASIC, MS-DOS, WordStar, CalcStar • Reference manuals, schematics, and bite-size lessons.



SEND COUPON TODAY FOR FREE NRI CATALOG!

NRI SCHOOLS

McGraw-Hill Continuing Education Center
3939 Wisconsin Avenue, NW, Washington, DC 20016

We'll give you tomorrow.

For Career courses approved under GI Bill
 check for details.

CHECK ONE FREE CATALOG ONLY

- | | |
|--|---|
| <input type="checkbox"/> Computer Electronics | <input type="checkbox"/> Basic Electronics |
| <input type="checkbox"/> TV/Audio/Video Servicing | <input type="checkbox"/> Electricians |
| <input type="checkbox"/> Satellite Electronics | <input type="checkbox"/> Small Engine Repair |
| <input type="checkbox"/> Robotics & Industrial Control | <input type="checkbox"/> Air Conditioning, Heating, & Ref. |
| <input type="checkbox"/> Industrial Electronics | <input type="checkbox"/> Locksmithing & Electronic Security |
| <input type="checkbox"/> Telephone Servicing | <input type="checkbox"/> Photography |
| <input type="checkbox"/> Digital Electronics Servicing | <input type="checkbox"/> Bookkeeping & Accounting |

Name (Please print) _____

Age _____

Street _____

City/State/Zip _____

Accredited by the National Home Study Council

10-077



IF YOU LIKE YOUR MUSIC to go on forever, you can install a compact disc remote changer in the trunk of your car and play music from up to 12 CD's.

system contains only one stereo amplifier that is intended for use with a single pair of left and right speakers, many auto-sound installations have multiple speaker systems (perhaps front and rear), and the two stereo speaker systems are simply connected in parallel (left front to left rear and right front to right rear, or criss-cross). Connecting the speakers in parallel splits each channels output power, which was intended for one speaker, between two speakers. The alternative to sharing one stereo amplifier between two speaker systems is a receiver such as Kenwood's *KAC-8070*, which has two independent stereo amplifiers, each specifically intended to drive a single stereo speaker system. The *KAC-8070* lists for \$279.

One brand, manufactured by the ADS Company, has gone as far as to develop

two six-channel amplifiers, the *PH12* and the *PH15*, which allow a subwoofer to be easily added to an autosound system. List prices for the *PH12* and *PH15* are \$320 and \$560 respectively. The *PH12* provides 20 watts per channel, while the *PH15* delivers 40 watts per channel. ADS also makes four-channel amplifiers, the *PQ8* and the *PQ20*, listing for \$200 and \$680 respectively.

Speakers

Speakers come in a wide variety of configurations and sizes. The material used for the cone itself can range from traditional paper to polypropylene, a flexible material that is more resistant than paper to heat, cold and moisture.

The magnet, the other critical speaker component, is also being improved. The GM Delco/Bose system in the Cadillac *Seville* and *Eldorado*, and the Chevrolet *Camaro*, uses a new high-energy neodymium magnet. The high energy potential of neodymium allows Bose to use a smaller magnet, thereby reducing the overall size of the speaker, particularly in its depth.

Speakers range in size from 3/4-inch tweeters to 6 x 9-inch woofers, and there are various two, three, and even four-way combinations of tweeters, midranges, and woofers available. Two companies, Spar-komatic and Philips, even have models with the speakers and their amplifiers built into the same enclosure.

Some autosound systems use one or two subwoofers to reproduce extremely low bass frequencies. One large woofer is often enough considering the omnidirectional characteristics of low frequencies.

Two smaller subwoofers are used when space limitations prohibit the use of a larger woofer.

Special speakers have also been developed for light trucks and other types of sports/utility vehicles. Typical of that new breed of speakers is *The Force* from Jensen, which consists of a large, wedge-shaped enclosure housing an eight-inch woofer and an upward-firing tweeter. Its list price is \$299.95.

Crossover networks handle the routing of specific frequencies to the appropriate speaker. Most crossover networks are offered as separate components. Some speakers, such as the *ALS-500* from Altec Lansing, have built-in, highly efficient crossover networks.



DOOR MOUNTING SPEAKERS can either provide the only full-range sound in a vehicle, or work in conjunction with in-dash and rear-shelf speakers to completely envelope the listener.

An autosound system can be a very complex purchase. A vehicle's environment is hostile to the the reproduction of high-fidelity sound. The amount of equipment sometimes needed can be intimidating, and its installation can be tricky and time-consuming. In fact, tackling anything beyond the most basic installation is probably not advisable unless you have the time and skill required. However, you should keep in mind that most dealers won't do installation work unless they have sold you some or all of the necessary components.

When all is said and done, however, you should have a system that will rival your home system. When that happens, you'll probably be joining the thousands of people who do most of their music listening on the road.

R-E



TO AVOID DAMAGE, and to make it easier to handle CD's without fingerprints, some auto-sound compact disc players require that each disc be installed in a special protective cartridge.

Like writing a great novel, designing and installing a great auto sound-system is part inspiration, and part perspiration.

FRANK VIZARD

Great Installations

AUTO SOUND

WHEN INSTALLED PROPERLY, AN AUTOMOTIVE sound system can become a concert hall on wheels. In fact, many owners of high-end systems find themselves listening to music almost exclusively in their cars since the acoustical effects are often superior to those offered by their home systems.

But there can be more to installing a system than meets the eye. When selecting a system, the type of vehicle it is to be installed in should be carefully considered. Space limitations, for example, may restrict the size of the speakers used. Likewise, every dashboard doesn't have the same size radio hole, which means

that not every cassette/receiver or CD/tuner will fit in every car.

Compounding the problem is a lack of standardization that can confound even the most-gifted do-it-yourselfer; one manufacturer's green wire is another's yellow wire. And improper wiring can lead to blown speakers and amplifiers. Further, unidentifiable noise can be caused by almost any electronic component in the car, including the alternator or ignition system. Such noise can render a system unlistenable, and finding its source can be a time-consuming nightmare. Therefore, it's not all that surprising that a \$2000 installation often can take up to 35 hours

to accomplish if the installer is a pro; an amateur installer is almost sure to be at it a lot longer.

Despite all of that, a top-notch sound system can be found for just about any application and for just about any car. To prove that, **Radio-Electronics** has assembled a portfolio of eight car-audio systems. Four systems are available as original equipment from car manufacturers. The remainder use aftermarket equipment installed by car-audio retailers to satisfy particular needs and varying installation requirements. All the systems have one thing in common: They'll please even the most discriminating listener.

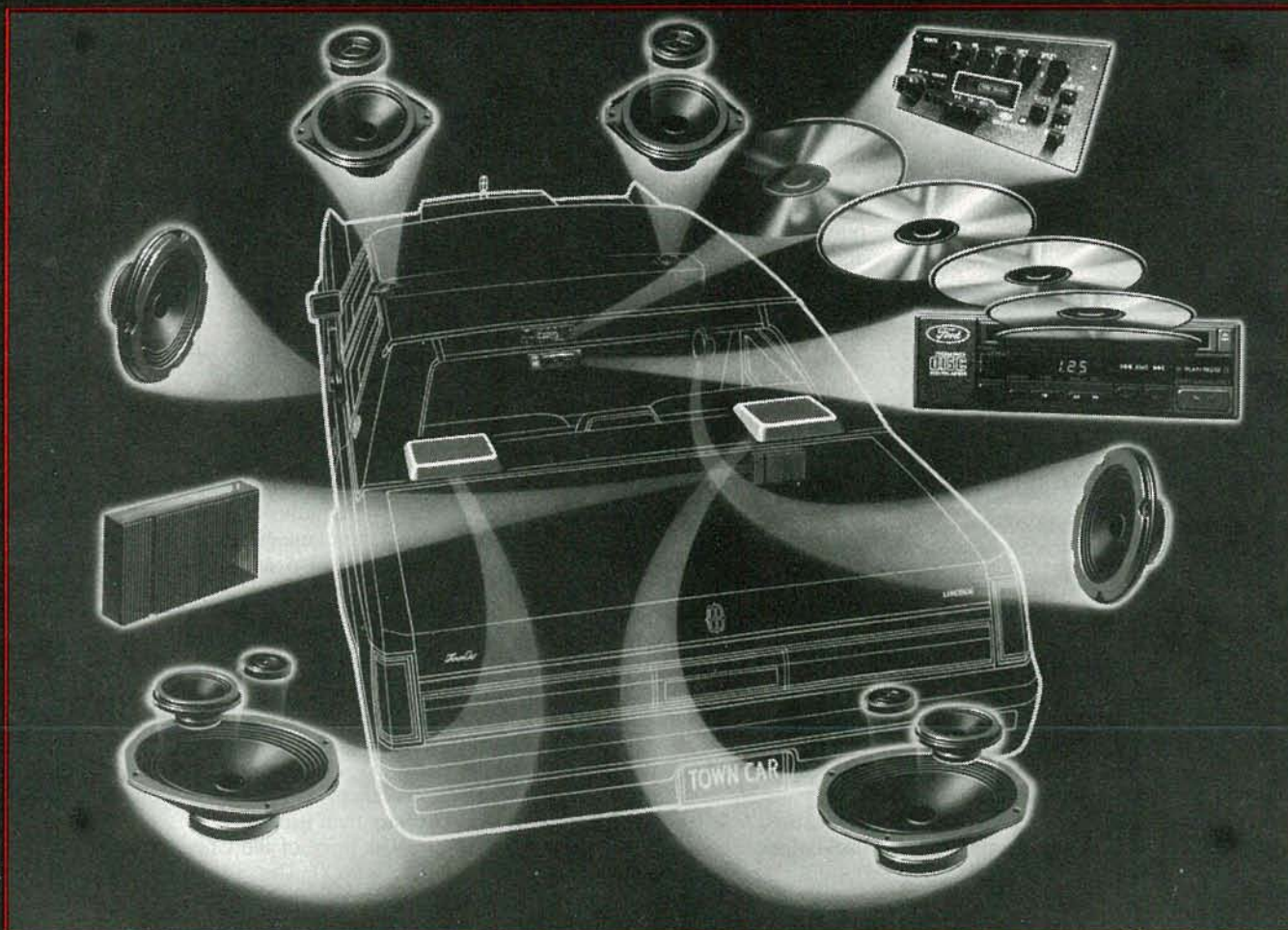

**Chevrolet Camaro:
Delco/Bose**

General Motors was the first car maker to turn to a well-known loudspeaker company, Bose Corp., for help in developing a premium sound system. While Delco, GM's radio division, and Bose have joined forces to outfit a number of GM cars with top-flight auto sound-systems, the Delco/Bose system installed in the 1987 Chevrolet *Camaro* shown in Fig. 1 represents the best the partnership has to offer.

The most noticeable difference between the Delco/Bose system in the *Camaro* and the Delco/Bose system installed in other GM cars is the size of the speaker enclosures. Each enclosure is also required to house a 25-watt amplifier. Such enclosures generally take up a lot of room, which is not much of an issue in a large Cadillac but of definite concern in a much smaller *Camaro*.

For the 1987 *Camaro*, Bose reduced the size of the speaker to a thin wafer only 32-mm deep. That reduction in size at no cost to sound quality is made possible by one of the first commercial uses of neodymium, a high-energy magnetic material. The "wafer" speakers are also four times lighter than their predecessors. The new speaker/amplifier modules, like the



FIG. 1—SHALLOW CLEARANCES in this Chevrolet *Camaro* required designing a speaker only 32-mm deep.



FIG. 2—THIS DELCO/BOSE cassette/receiver features automatic recognition of *Dolby-B* encoded tapes

old enclosures, are mounted in the doors and on the rear deck. The same technology is also being used in the new Cadillac *Allante*, *Seville*, and *Eldorado*.

Like its competitors, a Delco/Bose system positions its loudspeakers so that the listener is off-axis to the near speaker and on-axis to the far speaker. Delco/Bose believes it has accomplished its task so successfully that they omit the left/right balance control typical of other systems.

System Configuration
Cassette/receiver, 4 speaker/amp modules (Delco/Bose)
Key Features
Wafer-thin (32mm) speakers, automatic Dolby-B recognition, AM stereo
Power (per channel)
25 watts
Price
\$900

The cassette/receiver, shown in Fig. 2, does include most of the other features found in competitive models. Those features include auto reverse, bi-directional music search, seek/scan and Dynamic Noise Reduction (DNR) for the radio, and five AM and FM presets. AM stereo is also available.

More unusual is the fact that the cassette/receiver automatically recognizes *Dolby-B* encoded tapes and makes the appropriate adjustment for playback.

The Delco/Bose system in the *Camaro* lists for about \$900. Add about \$200 for the standard radio that comes with the car and the overall cost is roughly \$1100. A compact disc player is not available.

**Dodge Lancer:
Chrysler/Infinity**

The premium sound system offered by Chrysler in its 1987 Dodge *Lancer* (Fig. 3) is the least expensive and perhaps the most unusual of the auto sound offerings made by the "big three" U.S. car-manufacturing companies.



FIG. 3—THE CHRYSLER/INFINITY sound system is offered as standard equipment in this Dodge *Lancer*.

Like Ford and General Motors, Chrysler entered into a partnership with a major audio company to develop that system. In Chrysler's case, the audio partner is Infinity Systems, Inc., a well-known maker of home and car loudspeakers.

The Chrysler/Infinity system uses six speakers. One pair of 3/4-inch tweeters are installed in the dashboard. Another pair of 5/4-inch midrange/woofer speakers are in the front doors. Lastly, a pair of 5 x 7-inch coaxial speakers are mounted on the rear deck.

How those speakers are powered is the unusual feature of the Chrysler/Infinity system. While many auto sound systems are bi-amplified, meaning that separate amplifiers are used to power woofers and tweeters/midranges, the Chrysler/Infinity systems use an unusual method of bi-amplification. The tweeters in the dashboard and in the rear deck are powered by amplifiers built into the cassette/receiver. The door speakers and the woofers in the rear, however, are independently powered by miniature amplifiers attached to the back of each speaker. The audio signal must also pass through a low-pass filter before reaching each woofer. A total of 32 watts power the speakers while an additional 56 watts power the woofers.

The Chrysler cassette/receiver has many of the features common to the genre, including auto reverse, *Dolby B*, DNR, AM stereo, and 10 AM and 10 FM radio presets.

The digital display is a vacuum-fluorescent type. It shows radio frequency, tape type, noise-reduction status, and tape-play direction. When the unit is shut off, the display doubles as a clock, accurately showing the time of day. The display is clearly visible in sunlight. It's visible at night, too: All displays and controls are backlit.

Less common is a built-in, five-band equalizer that takes the place of the tone controls. With it, sound can be tailored for

System Configuration
Cassette/receiver, 6 speakers (Chrysler/Infinity)
Key Features
Bi-amplification, 5-band equalizer, ambiance control, joystick balance control, AM stereo
Power (per channel)
See text
Price
\$600

the listener's preference. Slide controls allow the adjustment of bass, midbass, midrange, upper midrange, and treble. There is also an "ambiance" feature, which is designed to create a "concert hall" effect.

The relative merit of the ambiance feature is questionable, however, since even the owner's manual advises against its overuse. Also, Chrysler has opted to have front/rear and left/right balance controlled by a joystick that rotates in all directions, making placement of the soundstage even easier than usual.

The price of the Chrysler/Infinity system is \$600. The same system you'll find also available in the *New Yorker* and *LeBaron GTS*.

**Lincoln Town Car:
Ford/JBL**

The Ford/JBL sound system in the Lincoln *Town Car* (shown in Fig. 4) offers the most power and uses the highest number of drivers of any auto sound-system offered by an American car company. Like its two major competitors, Ford used an audio company, JBL, as its partner in developing its system.

The Ford/JBL system, which is shown in its entirety in the opening of this article on page 39, uses six speakers—a pair of speakers is mounted in the dashboard, in the front doors, and on the rear deck. The five-inch dashboard speakers are coaxial units, the 6×9-inch rear deck speakers



FIG. 4—THE LINCOLN TOWN CAR is equipped with the Ford/JBL system illustrated at the beginning of this article.



FIG. 5—THIS SEPARATE CD PLAYER is offered as an option in the *Town Car*.

are three-way units, and the 5¼-inch door speakers are full-range units. The speakers are powered by a 140-watt four-channel amplifier.

The Ford/JBL system in the *Town Car* has three potential sources of music—radio or tape from the cassette/receiver, and compact disc from a separate player. See Fig. 5. The cassette/receiver is rather unusual in that the radio is digitally tuned but the controls for the cassette section operate very mechanically, albeit efficiently. Features include *Dolby B*, DNR, four-AM and four-FM presets, auto reverse, seek/scan, and bi-directional music search for tape.

The Ford cassette/receiver lacks AM

System Configuration
Cassette/receiver, 6 speakers, optional CD player; (Ford/JBL)
Key Features
Optional CD player, automatic tape equalization
Power (per channel)
35 watts
Price
\$1500 (with CD player)

stereo, a feature provided by GM and Chrysler. However, Ford's unit automatically sets the correct tape equalization for tape playback.

The compact-disc player offers most of the features you would expect to find, including automatic music search to locate any track at the touch of a button, scan, and a dual repeat mode for replay of an individual track or the entire disc.

The Ford/JBL system is priced at about \$1500. Without the CD player, system cost is about \$850. That price includes the cost of the equipment that is supplied as standard on the *Town Car*; that equipment must be removed before the Ford/JBL system can be installed.

**Sterling 825S/825SL:
Philips/Elac**

One of the newest car lines on the market is the Sterling, the product of a joint development program between Great Britain's Austin Rover Group and Japan's Honda Motor Co. The engine and the exterior are of Japanese design while the interior creature comforts are of European design. There are two models of the Sterling, the 825S and the 825SL (shown in Fig. 6).

The sound system in the 825SL is a mixture of Dutch and English expertise. The cassette/receiver is made by Philips, the Dutch electronics manufacturer. The unit includes most of the standard features you would expect to find, including auto reverse, *Dolby-B* noise reduction, and five-AM and five-FM presets.

The cassette/receiver also has two rather unusual features as well. The first is



THE CASSETTE/RECEIVER in the Sterling 825SL is made by Philips.

an anti-theft system; it is armed using a three-digit code that is entered into the cassette/receiver using the five preset buttons. The second is an "auto-store" feature; that feature lets you override the permanently stored presets, without erasing them, and select the five strongest radio stations in an area. It can be an especially handy feature if you're traveling out-of-town.

Power is supplied by an amplifier capable of delivering 20 watts to each of four channels. (The sound system in the 825S comes without the amplifier, reducing

System Configuration
Cassette/receiver, amp (Philips); 6 speakers (Elac)
Key Features
Anti-theft system, temporary preset override
Power (per channel)
20 watts
Price
\$1000

power to only seven watts through each of four channels.)

The speakers in the 825SL are supplied by Elac, a British company. The rear deck houses a pair of 6½ inch coaxials, while a pair of 5¼-inch full range and ¾-inch tweeters are separately installed in the front doors. The speaker setup is standard for a car of the Sterling type, providing a balanced sound radiation pattern, front and rear.

The sound systems in the Sterling 825SL and 825S come as standard equipment in the cars. The 825SL carries a sticker price of \$23,900; the estimated retail value of the sound system is about \$1000. The 825S has a sticker price of \$19,000; its lower powered sound system is somewhat less expensive than that of the 825SL.

**Porsche 911 Carrera:
Custom installation**

For a little more money, you sometimes get a lot more. A case in point is the Autotek (855 Cowan Rd., Burlingame, CA 94010) sound system shown in Fig. 7, which has been installed in the 1985 Porsche shown in Fig. 8. At \$1000, that system is only slightly more expensive than auto sound-systems offered by car companies, but offers more power and features.

Why is more power better? Assuming that the amplifiers meet acceptable standards, higher power levels allow us to hear low music levels more clearly. Therefore, due to road and wind noise, power is very critical in a car.



FIG. 7—A CD INPUT and *Dolby-C* noise reduction are two of the advantages offered by the Autotek SR500.



FIG. 8—THE PORSCHE 911 Carrera.

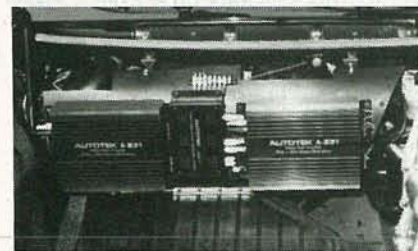

FIG. 9—THE AMPS and the crossover.

The SR500 cassette/receiver that is part of the system has many of the usual features: auto reverse, 12 radio presets, seek/scan, and electronic tuning. But two features of the SR500 can not be found in the cassette/receivers offered by the major U.S. car companies. One is *Dolby-C* noise reduction (in addition to the more

System Configuration
Cassette/receiver, 2 amplifiers, two-way crossover network, 6 speakers (Auto Tek)
Key Features
Dolby C, CD input
Power (per channel)
See text
Price
\$1000

usual *Dolby B*). The other is a CD input that allows a personal compact-disc player to be plugged into the system.

The SR500 supplies a great deal of power on its own: 20 watts per channel. In that installation, the 20 watts are used to power a pair of coaxial speakers mounted beneath the dashboard at the extreme right and left.

In addition, a pair of amplifiers with a rating of 130-watts each power the other four speakers in the system: a pair of four-inch three-way speakers in the doors and a pair of 6×9-inch three-way speakers in the rear deck. Signal routing chores are performed by an XOU-1 two-way crossover (Fig. 9).

**Ford Thunderbird:
Custom Installation**

Installing a new sound system doesn't necessarily mean junking all the original equipment that came with the vehicle. The sound system in the 1983 Ford Thunderbird shown in Fig. 10 uses the standard Ford cassette/receiver, but adds a variety of equipment from ADS (One Progress Way, Wilmington, MA 01887) and Sony (Sony Drive, Park Ridge, NJ 07656). The end result is a fine sound system that uses three sound sources and produces 320 watts of power.

Two of the sound sources are, of course, the standard radio and the cassette; the third is an add-on compact-disc player. Having a CD player in a car is becoming less unusual, but this installation is different in that it incorporates a Sony *DiscJockey* CD changer. Installed in the trunk, the *DiscJockey* stores 10 discs in a removable magazine. See Fig. 11. A



FIG. 10—THE FORD THUNDERBIRD.



FIG. 11—THE SONY DISCJOCKEY.

cable connects the CD changer to a control unit mounted into the dashboard beneath the cassette/receiver. The Sony CD changer comes with an optional tuner pack, but because of the existing Ford cassette/receiver, this installation didn't require it.

To fully appreciate the dynamic range provided by compact discs, the installation has plenty of power. A pair of ADS 320i 5½-inch coaxial speakers are installed in the doors, while a pair of ADS L200CC mini-speakers, a four-inch mid-range and a one-inch tweeter housed in their own cabinet, sit atop the rear deck. Adding punch to the system is a single 10-inch subwoofer mounted beneath the rear deck.

The division of labor among the speakers is handled by the ADS 642CSi, a unit that acts both as an electronic crossover and signal processor. That unit, which

System Configuration
Cassette/receiver, (Ford); CD player/changer (Sony); 5 speakers, 2 amplifiers, crossover network, (ADS)
Key Features
CD player with 10-disc changer, 10-inch subwoofer
Power (per channel)
See text
Price
\$3400

serves as the interface between the Ford cassette/receiver and the Sony *DiscJockey*, is equipped with four inputs and six outputs and directs high and low frequencies to the appropriate speaker. In this installation, a constant bass signal is applied to the door speakers to augment the signal at the subwoofer. Fading between the front and rear speakers is independent of the subwoofer.

Power is supplied by two ADS PQ10 four-channel amplifiers. One amplifier powers the door speakers while the second powers the rear speakers and the subwoofer. In terms of power, 80 watts is supplied to each door speaker, another 80 watts is supplied to the subwoofer, and 40 watts to each rear deck speaker.

The price of the system is about \$3400.

**GMC Jimmy:
Custom installation**

Where normal passenger cars fear to travel, four-wheel drive vehicles like the GMC Jimmy love to go. To provide off-road music for an off-road vehicle, a Kenwood (1315 E. Watsoncenter Rd., Carson, CA 90745) music system was added to the Jimmy.

The heart of the Kenwood system is the KRC-838 cassette/receiver shown in Fig. 12. It is one of a new breed of "theft-proof" models available from several aftermarket manufacturers. The KRC-838 is considered theft-proof because it can be removed by the owner easily; the cassette/receiver is installed inside a sleeve. A lever on the left side of the KRC-838 releases the unit from the sleeve so that it can be taken with you when you leave the vehicle.

The KRC-838 offers most of what we've come to expect in the way in of features, and adds a few others as well. Both Dolby-B and Dolby-C noise reduction are available, as is Kenwood's own ANRCII circuitry—the latter providing roughly the same benefit as the DNR circuitry found in cassette/receivers offered by other suppliers.

Other features include a signal meter to judge station strength, 24 presets that can be arranged in any combination of AM



FIG. 12—THE LEVER AT THE LEFT lets you remove the Kenwood KRC-838 receiver.

and FM stations, and a "tuner-call" feature that automatically switches on the radio when a tape is in fast-forward or rewind. Lastly, the KRC-838 features a mute button that lowers the volume 20 dB; that's handy for toll booths.

While standard bass and treble controls are incorporated into the cassette/receiver, the system's sound can be more precisely adjusted using the KQC-9400 graphic equalizer installed under the cassette/receiver. That unit lets you contour the sound over seven bands.

Space is limited in the Jimmy, so all the speakers are installed in the door. High frequencies are reproduced using a pair of 1½-inch tweeters that feature a built-in overload protection circuit. Midrange and some higher bass frequencies are handled by a pair of five-inch speakers mounted next to the tweeters. Very low bass fre-

System Configuration
Cassette/receiver, 6 speakers (Kenwood)
Key Features
Dolby C, ANRCII, graphic equalizer, mute, removable cassette/receiver unit
Power (per channel)
See text
Price
\$2000

quencies are reproduced by a pair of eight-inch woofers that are installed below the tweeters and midranges.

The eight-inch woofers are very power hungry, requiring a minimum of 35 watts each. That power is supplied by a KAC-8020 amplifier, which feeds 80 watts to each woofer. A second amplifier, a KAC-8070, powers the tweeter and the midrange. That amplifier is unusual in that it is a four-channel amplifier delivering two different power levels through each pair of channels. In our system, it is used to deliver 20 watts per channel to the tweeters and another 37 watts per channel to the midranges.

The entire system costs \$2000.

**Chevrolet Corvette:
Custom installation**

At first glance, the sound system in the 1985 Corvette, appears to be a perfect marriage of original equipment that came with the car and aftermarket gear. Looks can be deceiving.

In truth, all that's left of what was once a GM Delco/Bose system is the speaker grilles and the cassette/receiver. What's more, the cassette/receiver doesn't work. Its only purpose is cosmetic; it's used to cover the hole in the dash.

The owner of that Corvette has opted solely for a CD/tuner system using Sony's DiscJockey. Unlike the Thunderbird installation discussed previously, this setup makes use of the DiscJockey's optional AM/FM tuner pack, making the Delco radio redundant. Adding the tuner pack was a less expensive alternative to incorporating the Delco/Bose cassette/receiver into the system; the lack of line outputs on the original equipment, as well as some voltage-level problems, would require the use of complicated and expensive switching devices that are also unattractive.

The DiscJockey is built into a special enclosure that sits in the rear of the Corvette. That enclosure also houses two Sony L20 subwoofers, which reproduce all bass frequencies below 100 Hz. Also installed in the enclosure are two Hifonics (845 Broad Ave., Ridgefield, NJ 07657) Callisto electronic crossovers. The Disc-



FIG. 13—THE CD CHANGER'S remote control is stowed away in the center console.

Jockey's operation is controlled via a wired remote control that is stowed away in an accessory compartment in the center console. See Fig. 13.

The original Delco/Bose speakers in the car were replaced with Hifonics units. A pair of one-inch tweeters were installed in the dashboard so that the sound will reflect off the windshield and radiate throughout the car. Four-inch midranges were installed in the doors. Another pair of one-inch tweeters and four-inch midranges were placed side-by-side in each of the larger speaker cavities in the rear of the car. The new Hifonics speakers were covered with the original Delco/Bose grilles except for the front tweeters which were covered with acoustically transparent cloth.

The system also incorporates two Hifonics amplifiers. A Thor amplifier

System Configuration
CD player/changer/tuner, 2 subwoofers (Sony); 2 crossovers, 2 amplifiers, parametric equalizer, 8 speakers (Hifonics)
Key Features
10-disc CD changer/player, parametric equalizer, 2 subwoofers
Power (per channel)
See text
Price
\$3260

supplies 125 watts to the rear subwoofers while a Gemini four-channel amplifier is used to supply 70 watts to the front and rear speakers.

The system's sound can be tailored to suit your taste with a Hifonics Ceres IV parametric equalizer. The Ceres IV is the only parametric equalizer we know of that is designed for automotive applications. With a graphic equalizer response can be raised or lowered only along predetermined bands. Parametric equalizers, on the other hand, allow you to adjust response within a range of frequencies.

The cost of the upgrade, while ignoring the cost of the original equipment, was \$3260.

R-E

R-E ROBOT

*This month we show you how to
build the control board.*

Part 8 THE PAST TWO MONTHS
we've looked at how the robot's control circuitry works. Now it's time to get our hands dirty and build the control board.

Construction

Building the control board is a straightforward operation. The double-sided pattern is shown in PC Service. Note that because of its large size, the pattern is shown half size, so it must be enlarged before etching. The board is also available from the supplier mentioned in the Sources box. The supplier provides a board with two-ounce copper, plated-through holes, and a solder mask. If you choose to etch your own board we recommend that you use a blank with two-ounce plating, solder all components on both sides of the board, and install feedthroughs at any unused pads. The reason for the heavier copper is that it provides better power handling capacity and better noise margins.

Once you've either bought or etched the board, check it for power to ground shorts. Those will be very difficult to locate after all of the components have been installed. Then stuff the board following the parts-placement diagram that is shown in Fig. 1.

All of the control-board components can be obtained from most electronics distributors. The Fujitsu relays specified can be found at many relay specialists. If you have trouble finding them, you can substitute units from other manufacturers as long as they have a contact rating of more than 10 amps. If you make any substitutions, you may also need to modify the board to accommodate the substitutes.

The control board is designed to be

mounted on standoffs in the forward bulkhead of the chassis as shown in Fig. 2. When mounting the board, it should be oriented so that the terminal strip is located at the top edge of the chassis.

The RPC mounts over the board on one-inch standoffs. Use fixed standoffs at the top edge of the board, and hinged standoffs at the bottom. That will allow the RPC to be swung down and out of the way during troubleshooting.

Holes should be punched in the forward bulkhead for the wires. The motor-power, battery-power, and return wires should all be fed through one hole. All other wires, such as the leads from the shaft encoders, should be fed through a second, separate hole. The return wire from the control board's single-point ground should be as heavy as possible. Also, the motor-power wires should be as heavy as required to handle the current they must carry.

If you are going to use large drive motors with current requirements over 10 amps, the two main switching transistors and their associated diodes may be removed from the circuit board and mounted on the forward bulkhead to take advantage of the huge heat-sinking capacity of the robot's chassis. Use sockets, of course, and connect the sockets to the board with short lengths of heavy-gauge wire. After the control board has been assembled and both it and the RPC have been installed, the forward bulkhead will contain all of the robot's electronics. Now we're ready for bench testing.

Testing

To do the testing you will need a DC supply capable of producing 14–30 volts at 3 amps. If you can't find a suitable supply, you can build one using a high-current transformer, a full-wave bridge, and a suitable filter circuit. Be sure to select diodes (for the bridge) and capacitors (for the filter) whose ratings are appropriate. We built a unit that supplied 18-volts DC at 3 amps for our testing. Whenever the motors were accelerated too quickly, the power supply sagged, the motor relays dropped out, and that brought the motors to a stop. The power supply was completely adequate for testing, however.

Begin testing by connecting the control board to the power supply, but not to the RPC. Apply power and examine the sleep circuit for proper operation. If it is being clocked at 10-Hz as designed, the state of pin 4 should change once every 15 seconds. If all is well, you have confirmed that power is correctly bused to the board.

Proceeding, defeat the sleep circuit by soldering a jumper from R10 to ground, causing RY1 to close. That will energize the system. (Don't forget to remove that jumper when testing and troubleshooting are completed!) Now you should verify that IC9 delivers +5-volts DC and that IC30 delivers +12-volts DC. Also check that +5 volts is available at the correct pins at PL4, the RPC connector.

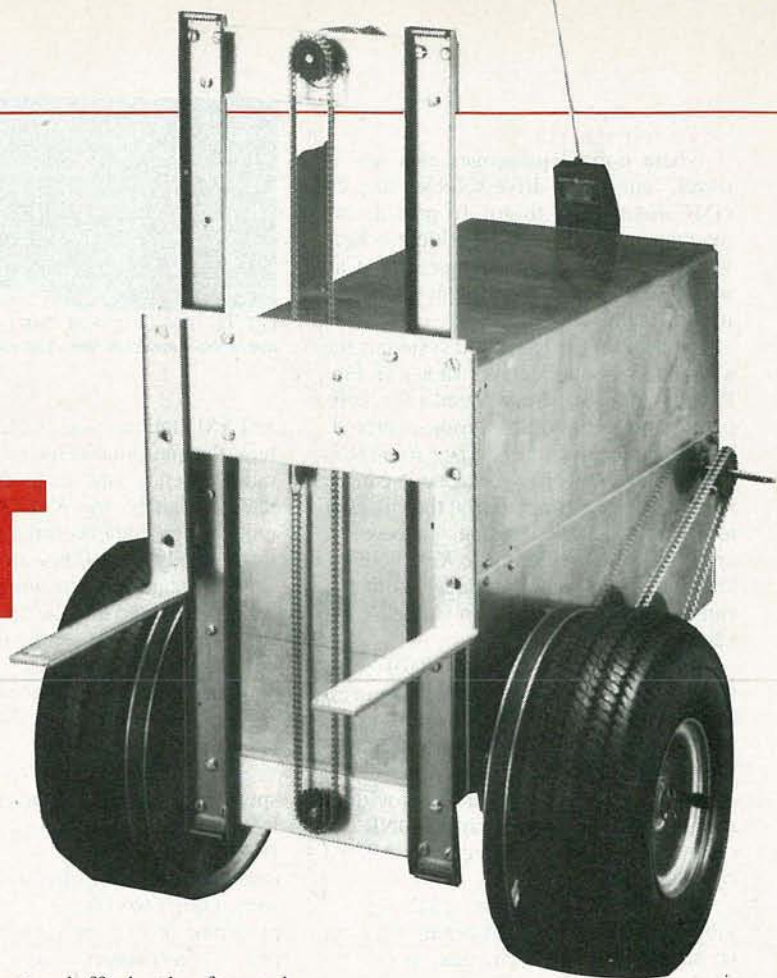

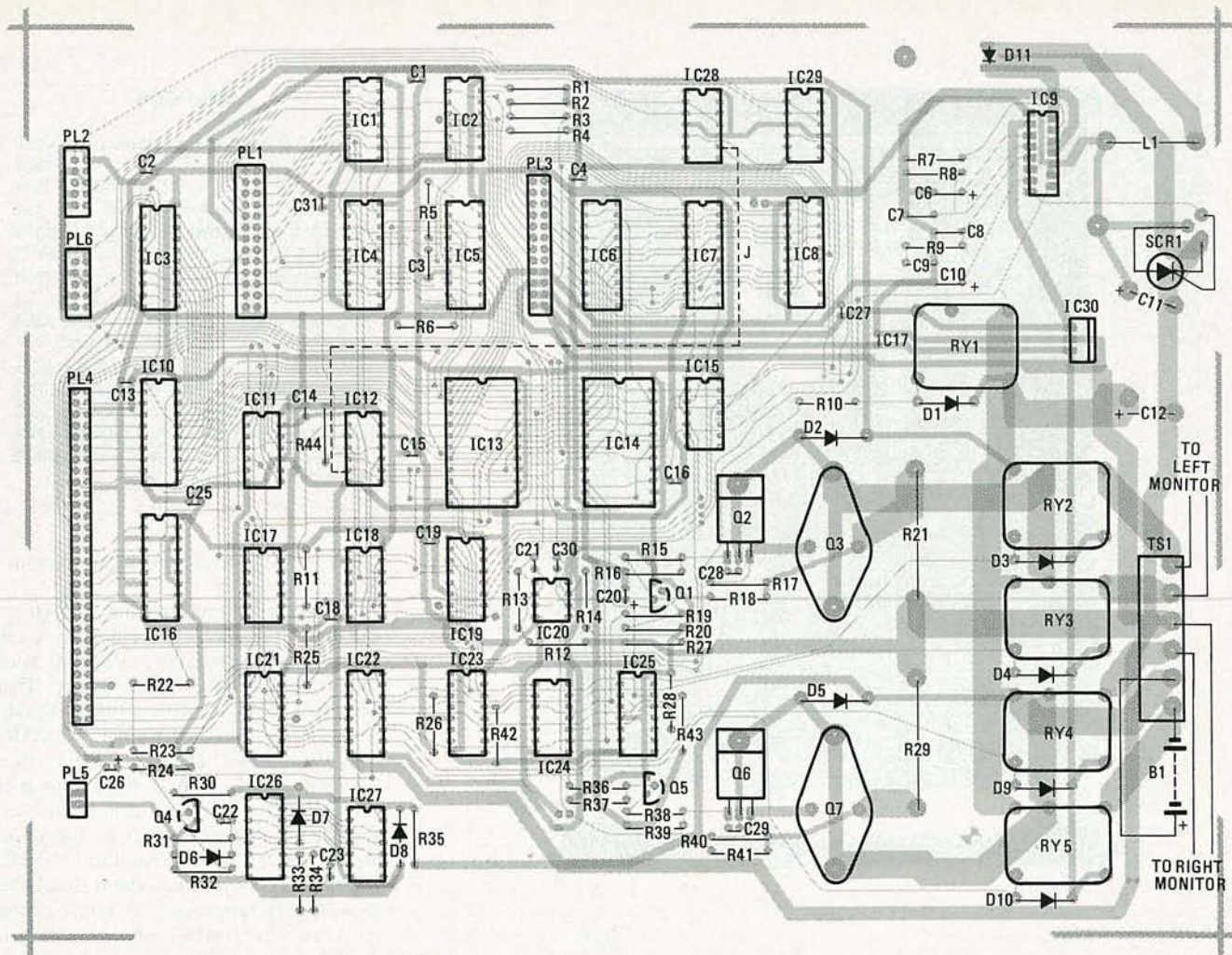

FIG. 1—ALL OF THE CONTROL CIRCUITRY mounts on one double-sided board. Follow this guide when assembling the board; the patterns can be found in PC Service.

PARTS LIST

All resistors 1/4-watt, 5%, unless otherwise noted

- R1, R4, R6, R7—not used
- R2, R12, R16, R18—R20, R22, R23, R26—R28, R30, R34, R36, R37, R39, R41, R44—10,000 ohms
- R3—62,000 ohms
- R5, R9—15,000 ohms
- R8—4700 ohms
- R10—220 ohms
- R11, R35, R42, R43—1000 ohms
- R13, R14—1 megohm
- R15, R38—47 ohms
- R17, R24, R40—100 ohms
- R21, R29—0.1 ohms, 5 watts, 1%
- R25, R31—R33—100,000 ohms

Capacitors

- C1, C2, C4, C5, C13—19, C22, C25, C27, C31—0.1 μ F, monolithic ceramic
- C3—100 pF, 50 volts, ceramic disc
- C6, C10, C21, C30—2.2 μ F, 50 volts, ceramic disc
- C7—0.002 μ F, 50 volts, ceramic disc
- C8—330 pF, 50 volts, ceramic disc
- C9—0.047 μ F, 50 volts, ceramic disc
- C11, C12—2200 μ F, 25 volts, electrolytic
- C20, C23, C24, C26—10 μ F, 16 volts, electrolytic
- C28, C29—not used

Semiconductors

- IC1, IC2—4051 multiplexer
- IC3, IC6—74LS541 octal buffer/line driver
- IC4—74LS377 octal D-flip-flop
- IC5—ADC0804 8-bit A/D converter
- IC7, IC8—74LS374 octal D-flip-flop
- IC9—L296 switching regulator (SGS)
- IC10—74LS645 octal three-state bus transceiver
- IC11—74LS125 quad three-state buffer
- IC12—74LS266 quad 2-input exclusive NOR gate
- IC13, IC14—8253 programmable interval timer
- IC15—74LS32 quad 2-input OR gate
- IC16—74ALS520 8-bit comparator
- IC17—74LS164 8-bit serial-in/parallel-out shift register
- IC18—74LS393 dual 4-bit binary ripple counter
- IC19—74LS138 1-of-8 decoder
- IC20—LM358 dual op-amp
- IC21—74LS259 8-bit addressable latch
- IC22—ULN2003 Darlington array
- IC23, IC25—4046 PLL
- IC24—74LS00 quad 2-input NAND gate
- IC26—4060 14-stage ripple counter
- IC27—4078 8-input NOR/OR gate
- IC28, IC29—dual D-flip-flop
- IC30—LM340-12 12-volt regulator

- Q1, Q5—2N3906 PNP transistor
- Q2, Q6—TIP29A NPN transistor
- Q3, Q7—2N3772 NPN transistor
- Q4—2N3904 NPN transistor
- SCR1—C106Y1 (GE) SCR
- D1, D3, D4, D9, D10—1N4001 rectifier
- D2, D5, 1N5400 rectifier
- D6, D7—1N4148 switching diode
- D8—1N754 6.8-volt Zener diode
- D11—8R05 Schottky diode (SGS)

Other Components

- L1—300 μ H
- RY1—RY5—DPST relay, 12-volt coil, Fujitsu FBR-631D012 or equivalent
- PL1, PL3—26-conductor plug, dual row, 0.025-inch spacing
- PL2, PL6—10-conductor plug, dual row, 0.025-inch spacing
- PL4—60-conductor right-angle plug, dual row, 0.025-inch spacing
- PL5—2-conductor plug, single row, 0.025-inch spacing
- TS1—6 connector terminal strip
- B1—see text

Miscellaneous: PC board, IC sockets, heat sinks (Thermalloy 601 or equivalent for IC9, Thermalloy 286 or equivalent for IC30), mounting hardware, nuts, bolts, wire, solder, etc.

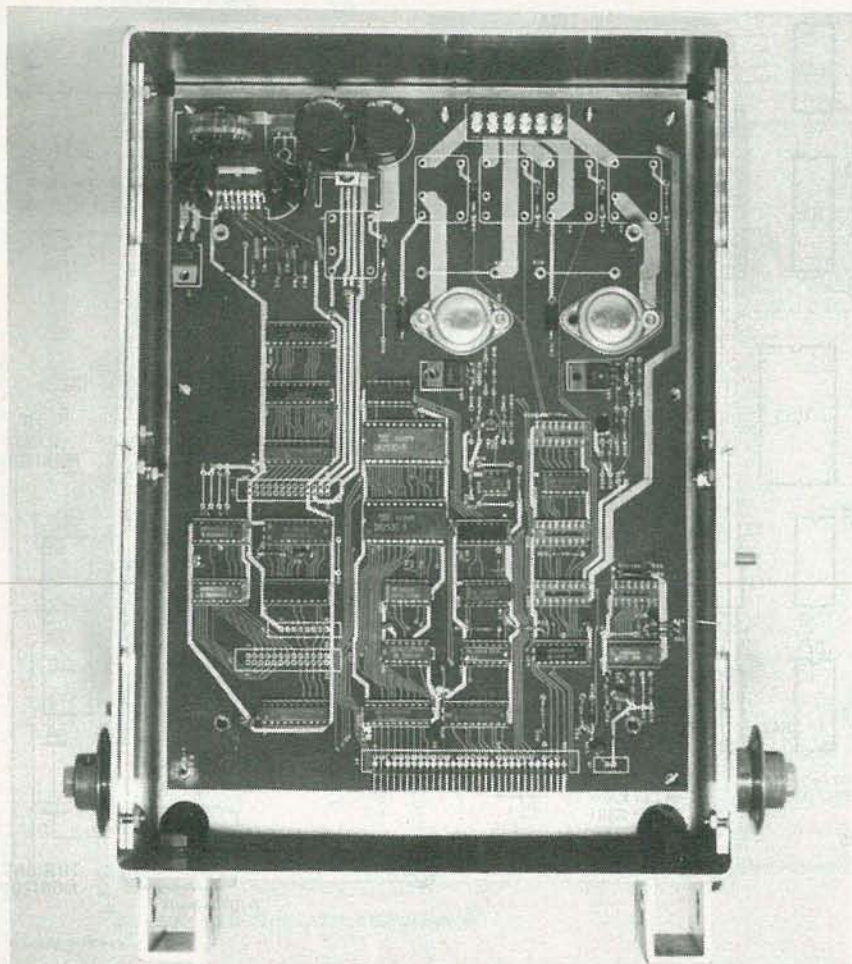

FIG. 2—THE ROBOT'S ELECTRONICS mount on standoffs in the forward bulkhead. The control board is shown here; the RPC mounts above it on hinged standoffs.

TABLE 1—OUTPUT FUNCTIONS

Address	Function
120	Left forward relay
121	Left reverse relay
122	Right forward relay
123	Right forward relay
124	Left motor control enable
125	Right motor control enable
126	Beeper
127	not used

If all is well, connect the RPC. Write the following diagnostic word (in the hex-number base) and execute it:

```
: TEST0 BEGIN 0 127 PC! 1 127 PC!
?TERMINAL UNTIL ;
```

As mentioned last time, the scope of this article prevents us from going into a detailed discussion of Forth and its structure. However, note that the while Forth requires statements like the preceding one to be entered as a single line, for space reasons it is impossible for us to show it that way. When you enter such statements, be sure to enter them as single lines or they will not be processed correctly. If you are not familiar with Forth, we recommend the book *Starting Forth*, by Leo Brodie; it is published by Prentice-Hall. You can probably obtain a copy from the Forth

TABLE 2

: PCX!	(data address ----)	(address is 0 to F)
SWAP 130 PC!		(write data to latch)
F AND DUP C0 OR 140 PC!		(write address)
DUP 40 OR 140 PC!		(set write strobe lo)
C0 OR 140 PC! ;		(set write strobe hi)
: PCX@	(address ---- data)	
F AND DUP 80 OR 140 PC!		(write addr, read lo)
130 PC@		(get data)
SWAP C0 OR 140 PC! ;		(set strobes hi)

SOURCES

The following are available from Vesta Technology, 7100 W. 44th St., Wheatridge, CO 80033 (303-422-8088): Bare RE-Robot controller board, \$41; assembled and tested RE-Robot controller board, \$200; assembled and tested RPC, fully populated for the robot function, \$294. Add \$8.00 shipping per board. Colorado residents add appropriate sales tax. Mastercard and Visa accepted.

Optical encoders (100 counts/revolution, quadrature output) are available from EMC Corp., 373 Hillsboro Way, Goleta, CA 93117 (805-968-3060) for \$40 each. California residents must add appropriate sales tax.

Interest Group or at your local computer bookstore.

Let's briefly look at what TEST0 is, and how it works. The colon tells the interpreter to compile the following word called TEST0 into the dictionary. That word is a begin-until loop that will loop until activity from the terminal (?TERMINAL) is detected. The loop itself stores a 0 to port 127H, then stores a 1 to port 127H. Compilation stops at the semicolon and the interpreter returns to the interpretive mode. After compiling TEST0, you can execute your new word simply by typing TEST0 and a carriage return on the keyboard. The word will execute until you touch any key.

During execution, you should observe the output of IC16, the 74ALS520. The address-latching pulse should be about 1 microsecond long, indicating that the wait-state generator is working correctly. Now examine the state of pin 12 of IC21 with an oscilloscope; you should see it toggling. That shows that the RPC and the control board are working together.

Testing the digital inputs and outputs is a very simple process with our operating system in ROM. We have only to write a few diagnostic words and execute them.

The individual outputs can be toggled with the following test word:

```
: TEST1 BEGIN 8 0 DO 0 120 I + PC!
1 120 I + PC! LOOP 0 UNTIL ;
```

The function of each of the individual outputs is as shown in Table 1.

Next, connect a speaker to the J6 and test the beep function:

```
: DELAY 0 DO 10 0 DO LOOP LOOP ;
: BEEP 1000 0
DO 1 126 PC! 2 DELAY
0 126 PC! 2 DELAY
LOOP ;
```

Notice that here we used "pretty" source-code formatting techniques. That becomes increasingly important as the complexity of our code increases.

continued on page 78

Digital Speedometer

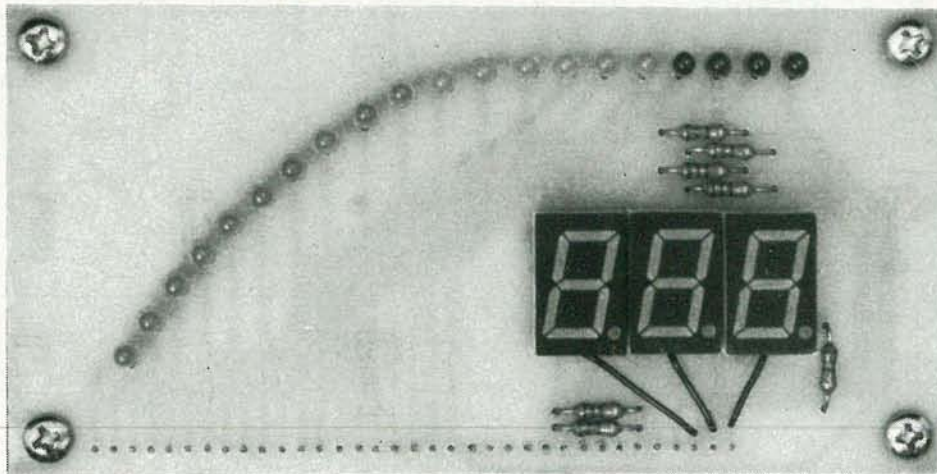

for your Car

Dual display delivers both an accurate digital readout and a rapid-read analog display.

ROSS ORTMAN

YOU PROBABLY SPEND MORE TIME WATCHING your speedometer than any other part of your dashboard. However, because most speedometers are mechanical devices and analog in nature, they are prone to error. And just as other parts of your car wear out and must be replaced, so must your speedometer. Besides, the most common speedometer is simply a pointer with a background scale; so exact speed is hard to determine accurately.

Our digital speedometer will accurately display vehicle speed both on a three-digit seven-segment display for precise speed

readings, and on a quick easy-to-read analog bar-graph display. The speedometer can be calibrated to read in miles per hour or in kilometers per hour, whichever is preferred. In addition, the bar-graph's "red line" can be set to any desired speed—probably 55 mph.

Theory of operation

The digital speedometer operates by monitoring the speed of driveshaft rotation (on a rear-wheel-drive vehicle) or one of the transaxle output shafts (on a front-wheel-drive vehicle.) Rotational speed is

monitored by sensing four magnets (that are secured to the driveshaft or output shaft) with a pickup coil that is mounted to the chassis or body of the automobile. As each magnet passes the pickup coil, a pulse is generated and sent to the digital speedometer, which then counts the number of pulses that occur during a preset time interval and converts this number to display the vehicle's actual speed. The pickup coil and magnets are commercial units that are available from many auto-parts stores.

Because the speedometer uses magnets

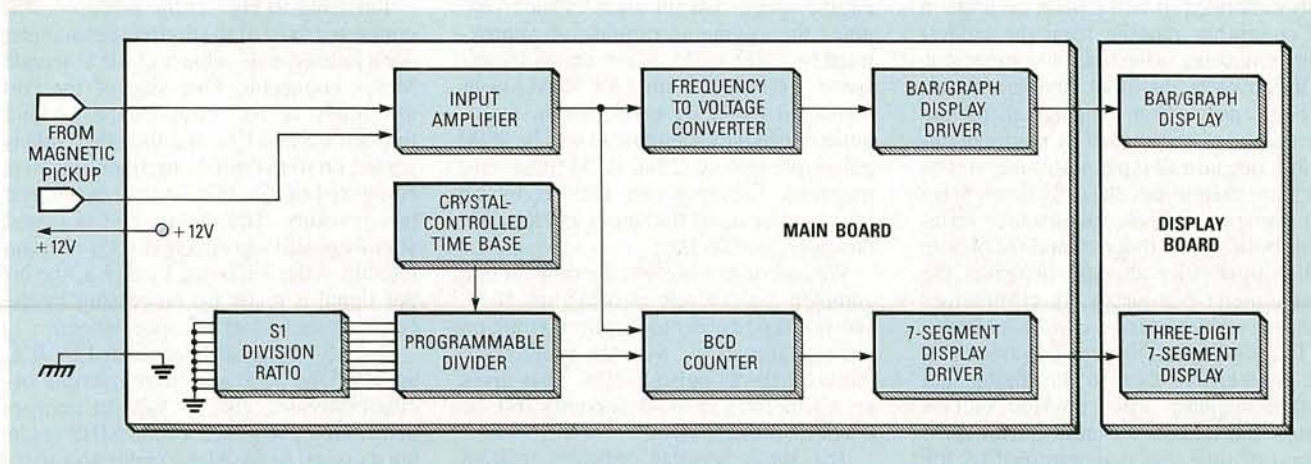

FIG. 1—BLOCK DIAGRAM OF THE SPEEDOMETER: The input amplifier conditions the signal from the magnetic pickup for processing by the counting and display circuitry.

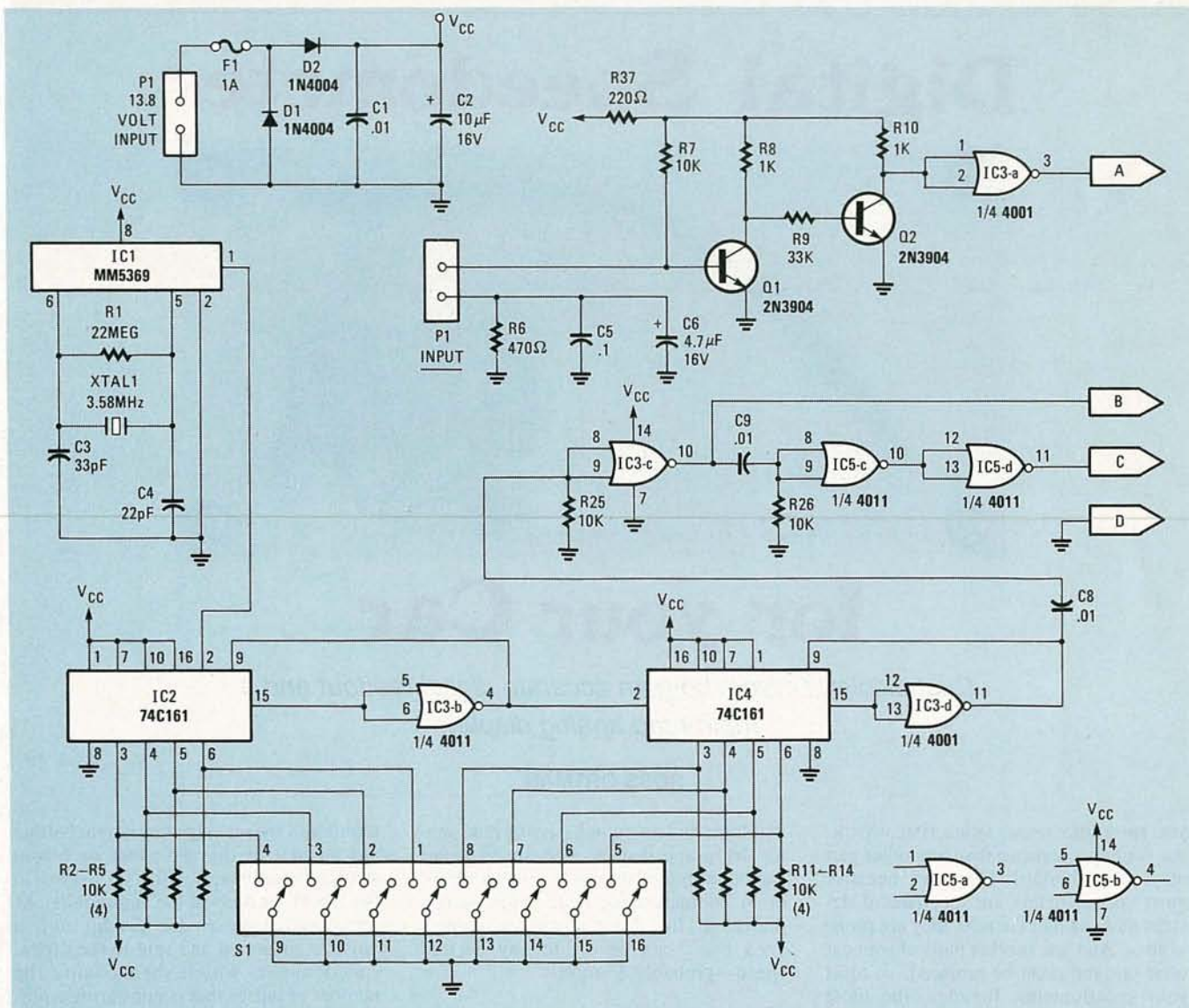

FIG. 2—THE INPUT AMPLIFIER AND TIMEBASE circuitry are shown here. DIP switch S1 sets the divide ratio for calibrating the speedometer.

for sensing (just as many aftermarket cruise-control devices do), dirt, moisture, and weather will not affect its operation. Also, because the speedometer is digitally calibrated, it will remain accurate in all conditions ranging from the coldest winter morning to the hottest summer day.

Referring to the block diagram shown in Fig. 1, pulses from the magnetic pickup are amplified and shaped by the input circuitry. Because all input pulses may not be the same amplitude (due to different magnet strengths and possible distance variations between the magnets and the pickup coil), input-pulse shaping increases the speedometer's accuracy by eliminating multiple counts, missed counts, or both.

The conditioned input pulses are sent to the counter and then to the digital and analog displays. The counting section counts the number of input pulses for a period of time that is determined by the setting of the programmable timebase.

Let's take an example of how the time-

base is set for a particular vehicle. On most vehicles, the gear ratio in third (or high) gear is 1:1. In other words, driveshaft speed is equal (or very close) to engine speed. On an eight-cylinder engine, the engine is running at approximately 2200 RPM when the vehicle's speed is 60 mph. With 2200 RPM as our driveshaft speed, we know that the input-pulse rate to the speedometer will be 8800 pulses per minute (2200 RPM times four magnets). Dividing that number by 60 gives us our input frequency in Hertz, in this case, 146.66 Hz.

We now determine that the time for one complete pulse cycle is 6.818 ms ($1 \div 146.66$ Hz). In order to display 60 mph on our digital readout, we must count 60 of those 6.818-ms pulse cycles. That gives us a timebase of 0.41 seconds (60×6.818 ms), or 2.44 Hz.

The analog display indicates relative speed by converting the input frequency to a voltage that is then processed for

display by the bar-graph display driver IC's (IC8 and IC9).

Circuit description

Referring to Fig. 2, the pickup coil is connected to P1 of the digital speedometer via a twisted-pair cable and a 0.1" female Molex connector. One side of the coil assembly is AC coupled to ground through C5 and C6, and the other side is passed on to the input amplifier, which is composed of Q1, Q2, and the associated bias resistors. The pickup coil is biased slightly positive to ensure that Q1 turns on reliably. After buffering by IC3-a, the input signal is ready for processing by the counting section of the speedometer.

The 60-Hz signal is generated by IC1, an MM5369 17-stage programmable oscillator/divider, and its support components. Here, IC1 uses a 3.58 MHz colorburst crystal to produce a stable and accurate 60-Hz reference.

The programmable divider uses two

PARTS LIST

All resistors are 1/4-watt, 5% unless otherwise noted.

R1—22 megohms
 R2—R5, R7, R11—R14, R25, R26, R30, R32—10,000 ohms
 R6, R33—470 ohms
 R8, R10, R22—R24, R27—1000 ohms
 R9—33,000 ohms
 R15—R21, R37—220 ohms
 R28—22,000 ohms
 R29—50 ohms, 5 watts, wire-wound
 R31—220,000 ohms
 R34—10,000 ohms, vertical trimmer potentiometer
 R35—2,200 ohms
 R36—22,000 ohms

Capacitors

C1—0.01 μ F disc
 C2—10 μ F, 16 volts, electrolytic
 C3—33 pF disc
 C4—22 pF disc
 C5, C12—0.1 μ F disc
 C6—4.7 μ F, 15 volts, electrolytic
 C7—0.001 μ F disc

C8, C9—0.01 μ F disc
 C10—0.022 μ F mylar
 C11—1 μ F, 16 volts, electrolytic
Semiconductors
 IC1—MM5369 17-stage oscillator/divider
 IC2, IC4—74C161 synchronous binary counter
 IC3, IC5—4001 quad NOR gate
 IC6—MC14553 three-digit BCD counter
 IC7—74C48 BCD to 7-segment decoder/driver
 IC8, IC9—LM3914 dot/bar display driver
 IC10—LM2917N frequency-to-voltage converter
 D1, D2—1N4004 rectifier diode
 D3—1N4001 rectifier diode
 Q1, Q2—2N3904 NPN transistor
 Q3—Q5—2N3906 PNP transistor
 LED1—LED10—0.125" green diffused
 LED11—LED16—0.125" yellow diffused
 LED17—LED20—0.125" red diffused
 DISP1—DISP3—7-segment common-cathode display (Panasonic LN516RK, Digi-Key P351; P352, P353, & P354

may also be used)

Miscellaneous

F1—1 amp slo-blow fuse
 S1—eight-position DIP switch
 P1, P2—0.1" 2-pin Molex connector
 XTAL1—3.58-MHz color-burst crystal

Other components

L1—pick-up coil (ARA part #2701278), magnets, strap mount (ARA part #2701279), wire, solder, PC boards, etc.

Note: ARA cruise control parts are available through your local automotive supply house. They may also be ordered as follows from Dakota Digital, R.R. 1 Box 83 Canistota, SD 57012: display PC board (#430105), \$6.95; main PC board (#430106), \$12.95; Pick-up coil (#2701278), \$11.95; Magnets (#2701279) \$4.75 (for a set of 4). Add \$1.50 for shipping and handling. South Dakota residents add 5% sales tax.

74C161 synchronous 4-bit counters (IC2 and IC3) to produce a divider that can be programmed to divide by a factor ranging from 4 to 256. The division ratio is set via eight-position DIP switch S1. The text box that appears elsewhere in this article indicates how switch positions correspond with different division ratios.

The output of the programmable divider is fed to two pulse generators consisting of: IC3-c, C8, and R25; and IC5-c, C9, and R26. The pulse generators produce two sequential pulses; a latch pulse followed by a clear pulse. The latch pulse latches the current counter value for display, and the clear pulse resets the 14553 counter (IC6, shown in Fig. 3) so that it begins counting from zero for the next sample period.

The heart of the digital display section (shown in Fig. 3) is IC6, an MC14553 three-digit BCD counter. That IC counts the incoming signal for the duration of the timebase and outputs the value through IC7, a 74C48 BCD to 7-segment decoder, and on to displays DISP1, DISP2, and DISP3. Resistors R15–R21 limit the amount of current that passes through the displays. The three digits are multiplexed by Q3, Q4, and Q5.

The analog display section (shown in Fig. 4) consists of IC10, an LM2917N frequency-to-voltage converter, and its associated components. That IC produces a DC voltage that is proportional to the frequency of the input signal. That relative voltage is then used to drive two cascaded LM3914 bar-graph display drivers (IC8 and IC9), which, in turn, drive the 20-element discrete LED display. The analog display is calibrated simply by setting potentiometer R34.

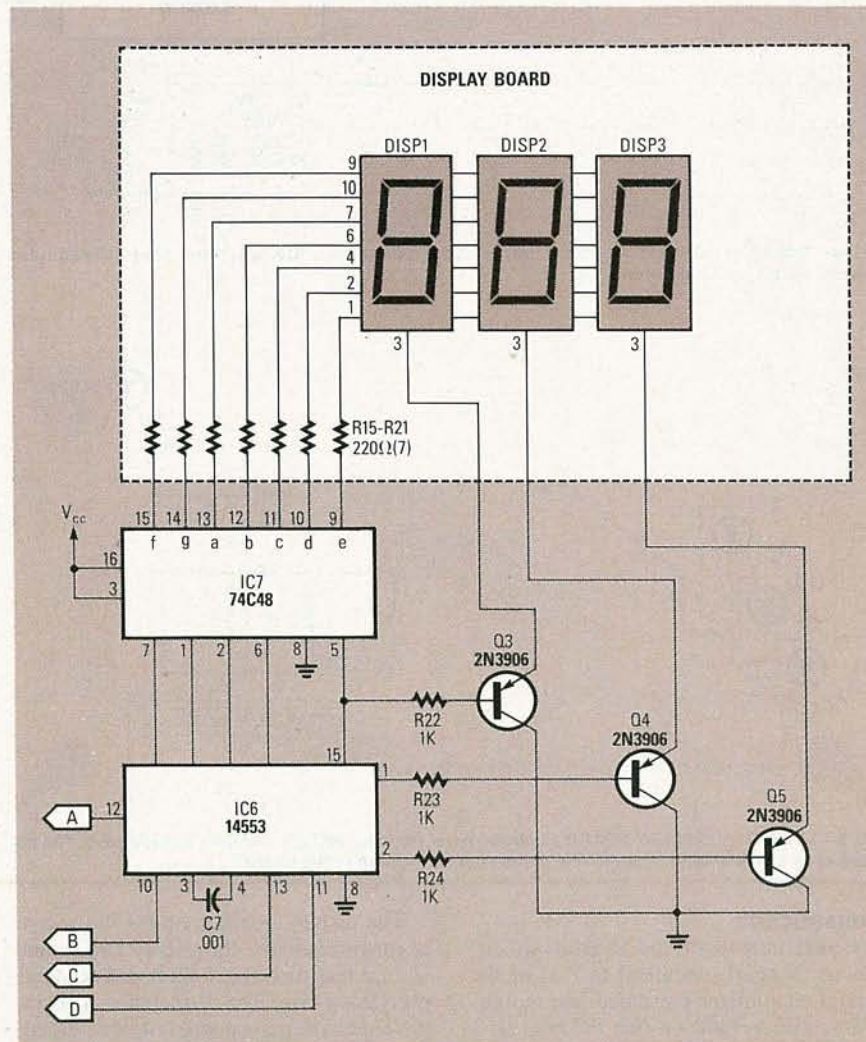

FIG. 3—THE DIGITAL DISPLAY section of the circuit uses a 14553 (IC6) to count pulses, and a 74C48 (IC7) to display the count.

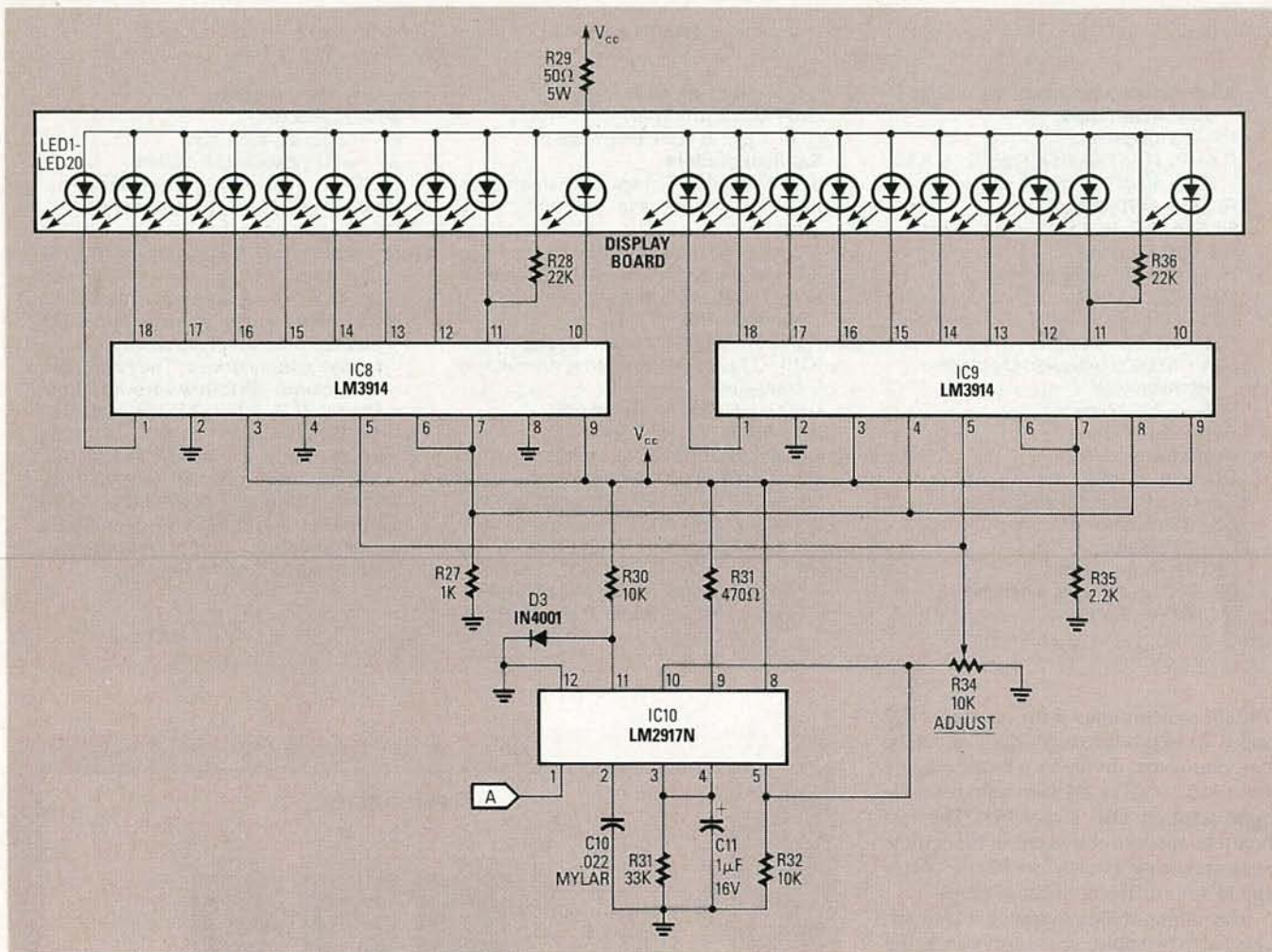

FIG. 4—THE ANALOG DISPLAY uses a frequency-to-voltage converter (IC10) to convert the counted pulses into displayable form.

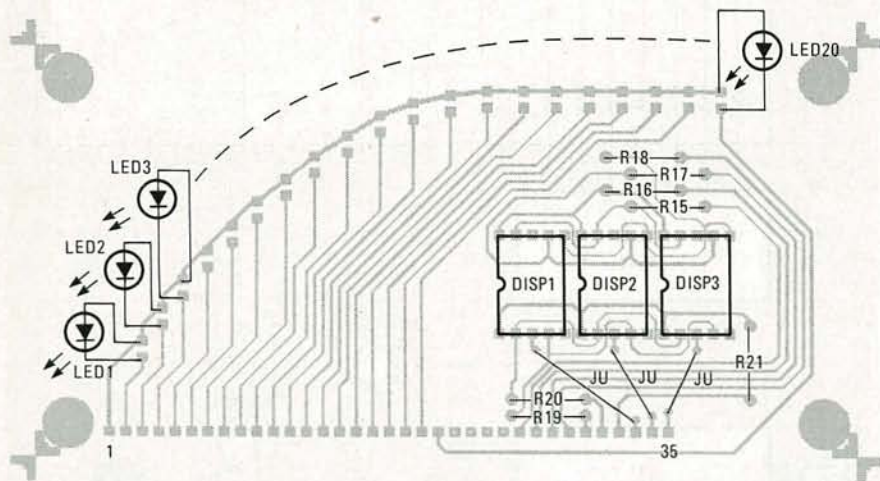

FIG. 5—STUFF THE DISPLAY BOARD as shown here. Don't forget to install the three jumpers. The flat sides of all LED's should face the row of holes at the bottom of the board.

Construction

Construction of the digital speedometer is nearly identical to that of the digital tachometer presented last month. The circuit is built on two PC boards: a display board and a main board. The two boards are connected by 35 jumpers.

The display board contains the seven-segment readouts, the twenty LED's and several resistors; the main board contains everything else. The display board is single-sided; the main board is double-sided. The PC boards can be made using the foil patterns shown in PC Service, or they may

be purchased from the supplier mentioned in the Parts List. If you etch your own boards, be sure to solder both sides of the main board.

Begin stuffing the boards with resistors, diodes, and other low-profile parts. Refer to Fig. 5 and Fig. 6 for part locations. If you are using IC sockets, which we recommend, install them next. If you don't use sockets, install the IC's last and solder only a few legs of each IC at a time to prevent overheating. Whether sockets are used or not, observe CMOS handling precautions: use a ground strap, ground your soldering iron, and work only on an anti-static surface.

Continue installing the rest of the parts, including the DIP switch, the capacitors, and the crystal, on the main board. The transistors are installed with the base or center leg bent toward the flat side of the body of the device. Install each transistor about 1/4 inch above the board.

When stuffing the display board, begin by inserting and soldering the three seven-segment displays. And don't forget to install the three jumpers located just below the displays. Then insert the discrete LED's into the board with ten green

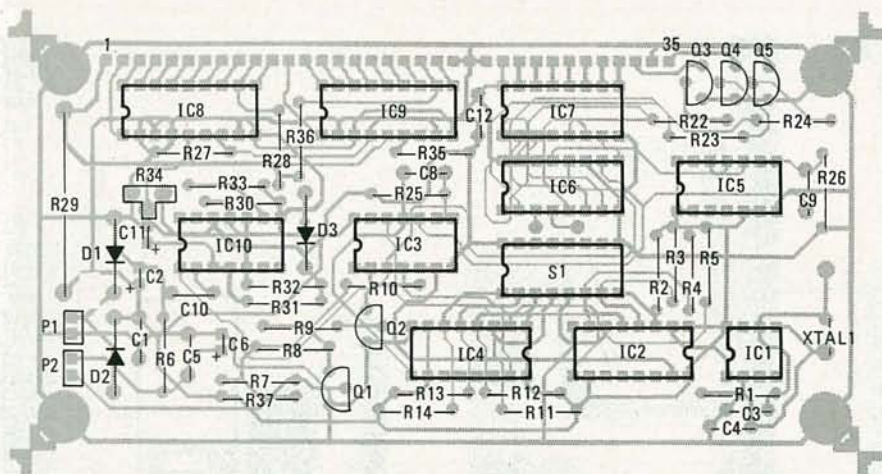

FIG. 6—STUFF THE MAIN BOARD as shown here, and, after checking both boards for errors, connect them together with 35 pieces of short bare wire. The solder sides of the board should face each other.

LED's (LED1–LED10) starting in the lower left corner. Do not solder them in yet. Next insert six yellow LED's and then four red LED's. Double-check to be absolutely certain that the LED's are oriented properly; the cathode (usually the flat side) of the LED should face the bottom of the board.

Next, turn the board over and lay it down on a flat surface, being careful not to allow any LED's to fall out. That's accomplished easily by holding a piece of stiff cardboard against the LED's while turning the board over. Now, to keep the board parallel to your working surface, apply pressure to the board where the seven-segment displays are mounted, and solder one lead of the end and middle LED's. Next, carefully look across the surface that the board is lying on to see whether the LED's are at the same height as the seven-segment displays. If not, correct their positions and then continue soldering one lead each of the remaining LED's.

SWITCH SETTINGS

For a front-wheel-drive vehicle, the transaxle output shaft's speed can be determined from this formula:

$$DF = 5.355 \cdot R$$

where DF is the division factor, and R is the radius of the front wheel. For a rear-wheel-drive vehicle, the driveshaft's speed can be estimated from the engine speed. If you have an overdrive transmission, use the gear ratio found in the owner's manual to convert the engine speed to the driveshaft speed. The output of each programmable divider (IC2 and IC4) can be determined from the chart below. The total division factor provided by the two IC's is the product of the individual DF's provided by each separately.

For example, a 10" wheel requires a division factor of $5.355 \times 10 = 53.55$. We could approximate that value by setting IC2 to divide by 5 and IC4 to divide by 10. To do so, the DIP switch would be set like this: 01001001.

Turn the board over and align the LED's so that they stand up straight and follow a smooth curve. When you're satisfied with their positions, solder the other leg of each LED.

WARNING

Although the speedometer can be mounted above, below, or inside the dashboard, some conditions must be met if the unit is to be installed in place of the original speedometer. First, Federal law prohibits any tampering with the odometer section of the speedometer and imposes harsh penalties on those in violation of that law. That does not mean that a person is forbidden to replace the original speedometer with the digital speedometer presented here. However, if the device is installed, it must be done in a manner that will keep the vehicle's odometer fully operational.

To replace the original speedometer with the digital speedometer, remove the face plate and pointer of the original, making sure that you leave the original gearing and odometer mechanism intact. The digital speedometer can then be installed in the space left by the old face plate and pointer. Also, the original speedometer cable must be left connected; to remove it is also a violation of Federal law. Check your state laws, too, as they may have additional restrictions.

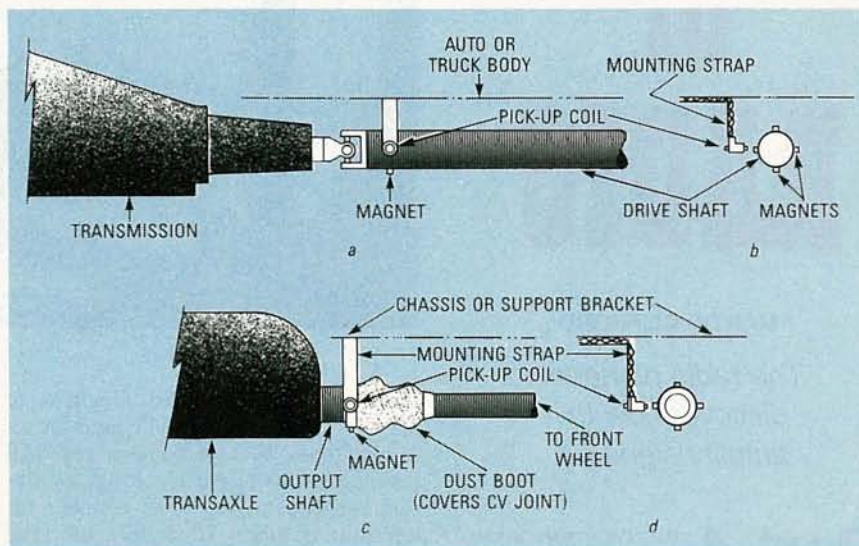

FIG. 7—MAGNET AND PICKUP-COIL MOUNTING METHODS: For a car with a transmission and driveshaft, mount the magnets and pickup coil as shown in a and b, respectively. For a car with front-wheel drive, mount those parts as shown in c and d.

After you have installed and soldered all components, check your work carefully for errors. Fix any errors, and then complete the assembly by connecting the boards, mechanically and electrically, to each other. Mount the boards back to back (foil side to foil side) with #6 hardware. The boards must be spaced at least 1/4-inch apart using spacers or standoffs. Keep in mind that the board will be mounted to the dashboard (or custom-built case) by the same bolts that hold the boards together.

After the two boards are mechanically secured to each other, run short pieces of solid bare hook-up wire between corresponding pads on the two boards. Make sure that the wires are straight and do not

touch each other. The boards can be "folded apart" for troubleshooting or repair, if necessary.

Bench testing

The next step is to test the speedometer to ensure that it is completely operational before installing it in an automobile. Apply twelve volts to power connector P2, which is located on the main board. Note that the positive pin is the one closest to five-watt resistor R29. After power is applied, the two right-hand digits should display zeros, and none of the LED's should be lit.

If your displays differ, check the supply
continued on page 82

The Early Days of RADIO

MARTIN CLIFFORD

The radio pioneers discover how to amplify signals.

Part 4 THE INVENTION OF THE triode vacuum tube by de Forest opened the floodgates to the design of high-gain circuits. Although the crystal and the vacuum-tube diode were adequate radio signal detectors, neither could amplify; hence, circuit design was sharply circumscribed. But once the experimenters had a device that could amplify, there was almost nothing the early pioneers could not and did not try.

Tube design

Some early tube designs were “off the wall”; some because they were attempts to bypass de Forest’s patent; others because their designers thought they had invented devices with better performance. One of those unusual designs—now practically unknown—was the “horned triode” (Fig. 1), a tube in which the plate-

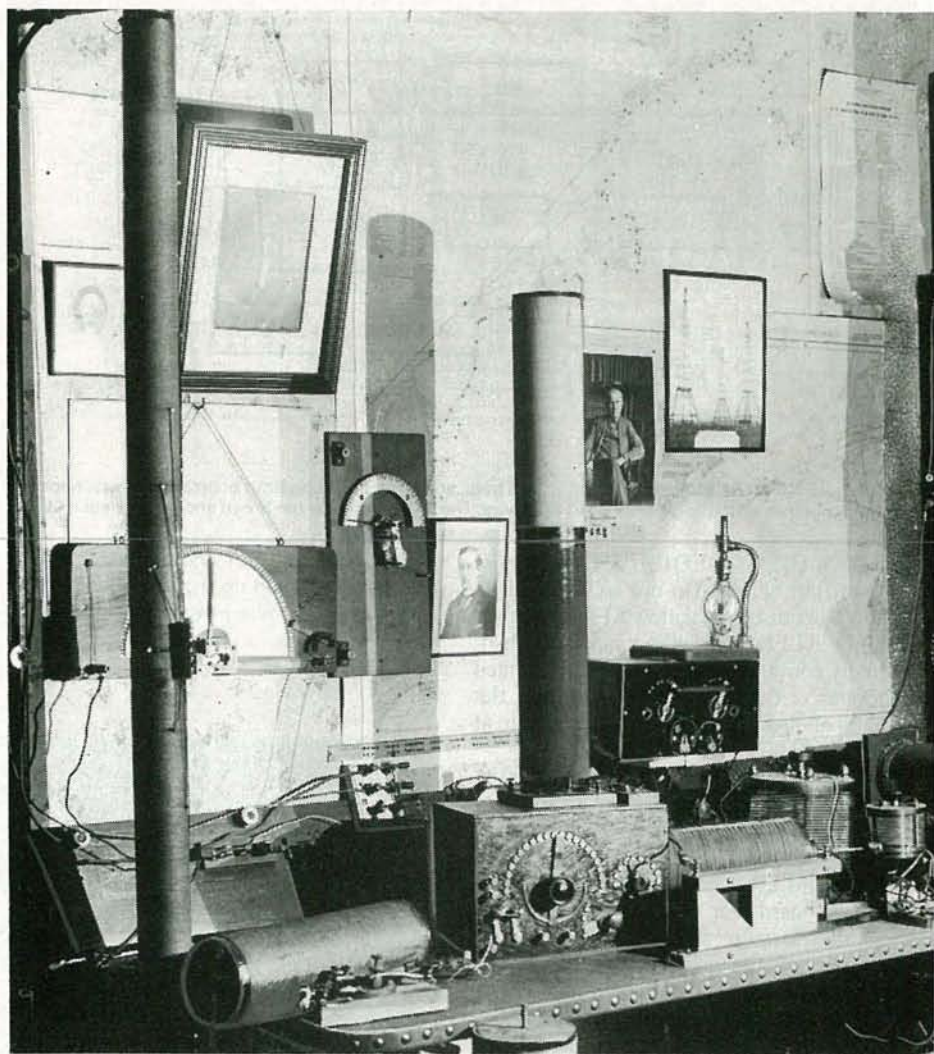

and control-grid leads were brought out at the top. The idea didn’t take hold for receiving tubes, because it had no practical reason to justify its existence; but a variation subsequently became adopted for transmitting tubes. Ultimately, tube design went on a four-pin base, although there were commonly used tube types having a base with five and six pins.

Early radio tubes such as the WD-11, UX-199, UX-120, UX 201A, and the UX-200A had a filament made from a mixture of tungsten and thorium, which was, in turn, coated with metallic thorium. Tungsten was used because of its ability to withstand high temperatures; thorium was used because it is a prolific source of electrons. When electron emission became low, the filament could be reactivated by simply raising the filament voltage to increase the filament temperature, thereby “boiling off” the oxidation products that were interfering with release of the electrons. Generally, the voltage was raised 200–300% for 10 to 15 seconds. For users without the necessary

equipment to adjust the filament voltage (see Fig. 2), a “filament renewal service” was available in radio stores for a nominal charge of 25 cents per tube.

If the tungsten/thorium filament was good, something else must be better, so the search for a “better filament” was something like the search for the Holy Grail. Just about everything was tried, including various alloys of platinum, pure nickel, and alloys of nickel such as chromium nickel and titanium nickel. Barium and strontium carbonates in oxide form were also used as the electron source; but, unlike oxide-coated filaments, they could not be reactivated.

Soft and hard tubes

Any trace of air remaining in a tube following its manufacture resulted in a higher plate current that usually could not be controlled by the grid, which resulted in erratic operation. Typically, an electric light bulb had an internal gas pressure of 150 millionths of atmospheric pressure (which is 14.7 lbs/square inch at sea

Make your home into something special!

That's exactly what your home will be when you fill it with Heathkit electronic products – products that make your life easier and more enjoyable. Within our diverse line are kit and assembled products sure to enhance each room in your home.



1. Make your entryway more secure and easy to use with the Keyless Doorlock. You'll never again be locked out because of lost or forgotten keys. All it takes is a simple fingertip entry of a four-digit code, and the Keyless Doorlock unlocks your door.

2. Add a new dimension to your living room with your own Computerized Weather Station. This Digital Weather Station displays up-to-the-minute temperature, wind, and barometric pressure readings, along with time and date.



3. Give your kitchen a unique blend of style and efficiency with our Digital Wall Clock. This easy-to-build kit keeps time with quartz-crystal accuracy. And with its simulated oak wood-grain finish cabinet, you'll have a timepiece that fits into almost any decor.



4. Put your den to greater use with this IBM PC AT Compatible Computer. Do word processing, personal accounting and more when you run exciting IBM-compatible software on your fast and powerful HS-241. And you can build it yourself in just a few hours.



5. Bring the latest in digital technology to your bathroom. This Digital Scale lets you closely monitor your weight with electronic precision. And, it's battery operated so it's safe to use right out of the shower.



6. Add a video entertainment center to your bedroom. Our 19" diagonal stereo TV kit gives you an extra-sharp color-corrected picture with full stereo sound, and convenient viewing that you can control from your bed. Comes in a simulated walnut cabinet that complements your room.



7. Transform your rec room into a haven for hobby fun. Put our Deluxe QRP CW Transceiver in this room and enjoy superb HAM radio operation that excels in performance and features. It offers expandable transmission and reception capabilities.



8. Give your workbench a touch of professionalism with this oscilloscope. Whether you're a service technician or a hobbyist, you'll love the wide range of measurement capability our laboratory-grade Dual Trace 10 MHz Oscilloscope gives you.



9. Add practicality to the utility room and save money, too. Avoid expensive food spoilage with our Freezer Alarm that



warns you when the inside temperature of your freezer rises too high. Prevent water damage with our Food Alarm that warns you of water that's where it shouldn't be.



10. Make your coming and going easier than ever. Your garage door will open with incredible

ease and dependability with our Deluxe Garage Door Opener. Easy to install, this opener is durable and includes a handy security light.

You'll find fun and excitement with every Heathkit product. Whether they're in kit form or already assembled, our products will help you enjoy your home more than you ever dreamed possible.

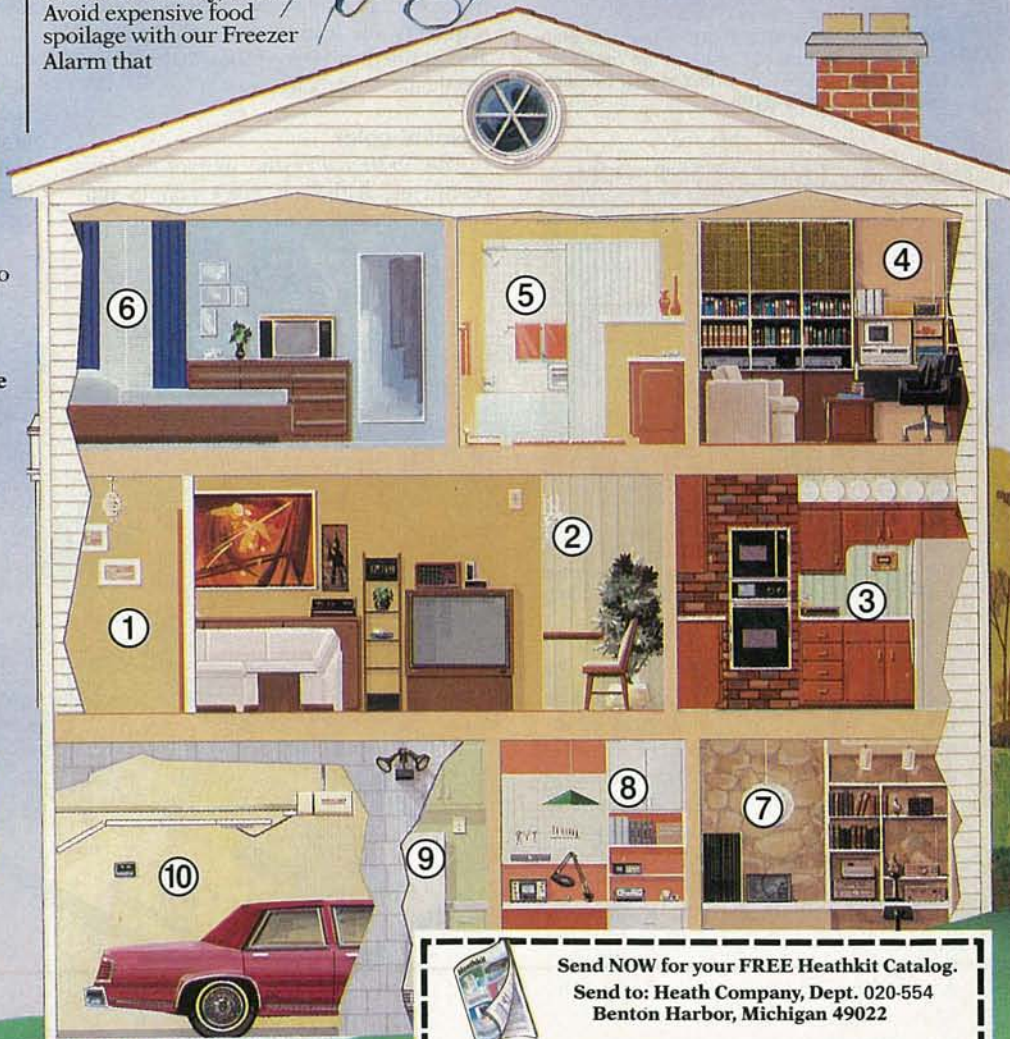

Heathkit[®]
Heath
Company



Send NOW for your FREE Heathkit Catalog.
Send to: Heath Company, Dept. 020-554
Benton Harbor, Michigan 49022

Name _____

Address _____

City _____ State _____ Zip _____

A subsidiary of Zenith Electronics Corporation CL-789A

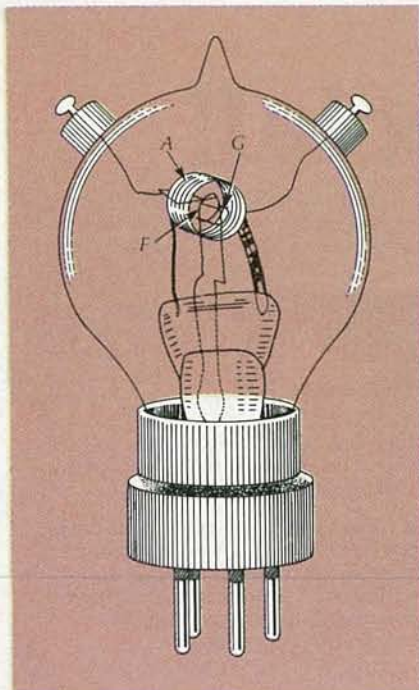

FIG. 1—THE HORNED TRIODE had the plate (anode A) and grid (G) leads at the top of the tube. The base had four pins, but only two were used for the filament (F).

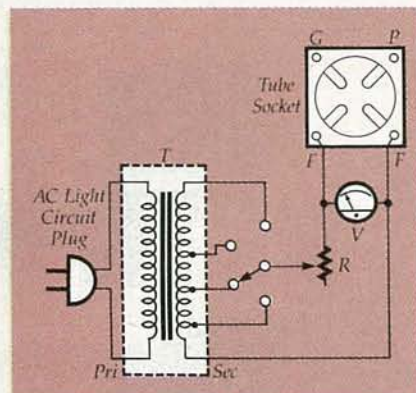

FIG. 2—AN ADJUSTABLE VOLTAGE was often used to reactivate tubes having thoriated tungsten filaments.

level), but that was much too high for radio tubes, whose gas pressure could be made as low as 2 or 3 millionths of atmospheric pressure. One way of ensuring the least possible air following evacuation of the tube was to "flash" a chemical inside the tube. That was done by including a tiny saucer-like structure that contained a chemical such as magnesium, calcium, strontium, barium, or mercury. A current-carrying coil surrounding the tube ignited the chemical and the "flash" depleted any oxygen remaining in the tube. The result of the process was the deposition of a silvery substance on the interior surface of the tube.

The presence in a tube of even a trace of oxygen resulted in collisions between the filament-to-plate current and the air molecules, thereby ionizing the gas atoms. As

a result, the ions, having lost one or more electrons, were positively-charged and migrated toward the filament. Because of their relatively large structure (compared to electrons), the ionic bombardment was able to destroy sections of the filament. Tubes that contained oxygen displayed a flickering blue glow toward the bottom end of the glass bulb and were called "soft." A "hard" tube, on the other hand, was one that produced no glow, thereby indicating little internal air.

Microphonics

As tubes were made smaller, the internal pins that supported the various elements were so small they didn't provide adequate support, so the elements were more susceptible to vibration. Element vibration resulted in microphonics, whose chief characteristic was a variation in sound volume that was sometimes accompanied by howling. The problem was relieved somewhat by putting lead weights on top of the tube to give it greater mass, and thereby reduce vibration. Subsequently, the lead-weight technique was also applied to larger tubes that had microphonic tendencies.

A riot of color

The 1920's was the age of the experimenter. Although most people purchased complete ready-to-operate radios,

many purchased parts and assembled their own radios, using circuits they designed or tweaked. Aesthetic beauty was often an important aspect of circuit-design and assembly, so it wasn't unusual to find that the wiring used in early radios was covered with "spaghetti," a varnished cambric insulation that was available in most of the colors of the rainbow. The innards of many an early radio were a riot of color—and beauty.

Early experimenter receivers were actually built on a breadboard, and so was at least one commercial receiver: the five-tube Atwater Kent *Model 10*. Although cabinets were available to experimenters, many breadboard receivers were left open to solicit the *oh's* and *ah's* of friends and neighbors. It's on record that one builder, who wanted both protection for the receiver and neighborly acclaim, used sheets of glass for both the front panel and the cabinet so that the radio could be used even while it was on display.

Circuit diagrams

Like the radio itself, circuit diagrams have gone through many changes. Early builders made use of pictorial diagrams, such as the one shown in Fig. 3, to show how the equipment was assembled. In some instances the diagram was a combination of a pictorial and a schematic circuit, as in Fig. 4.

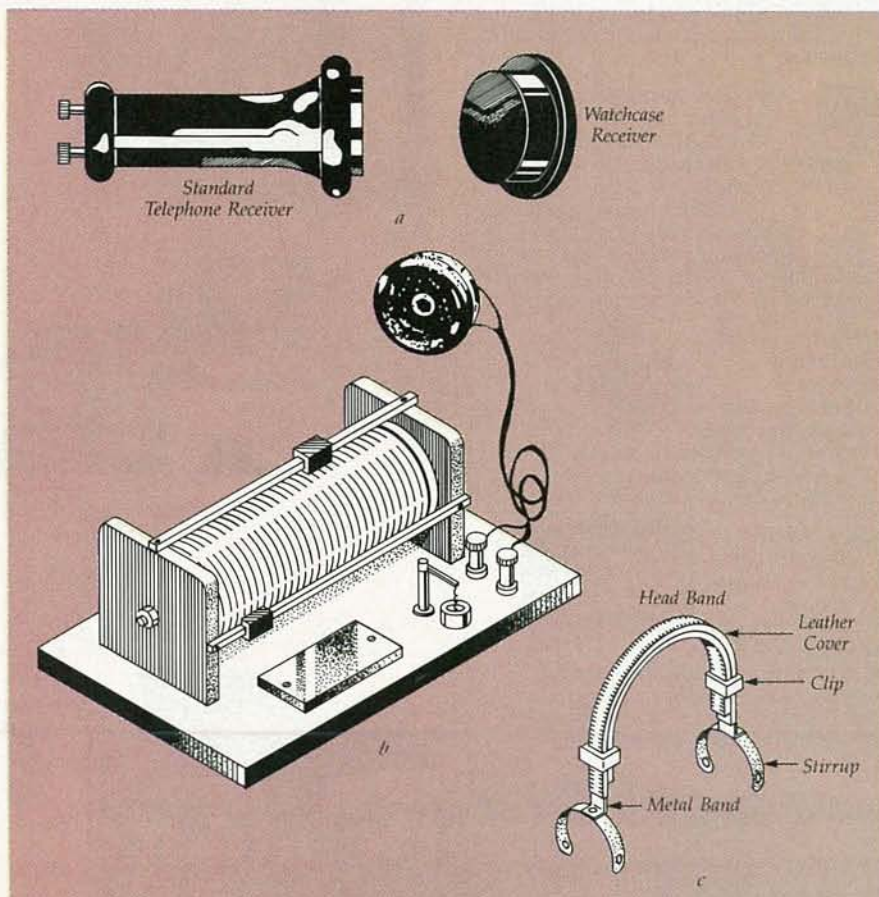

FIG. 3—PICTORIAL DIAGRAMS WERE often used instead of schematics to show the working of radio circuits.

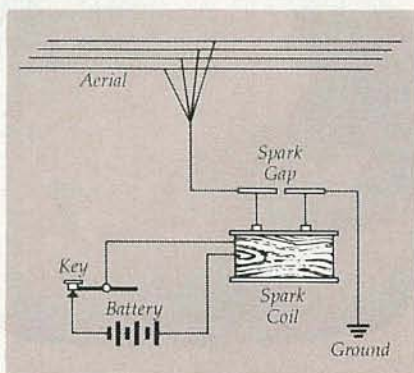

FIG. 4—SOMETIMES, A CIRCUIT was described by using both pictorials and component symbols in the same schematic.

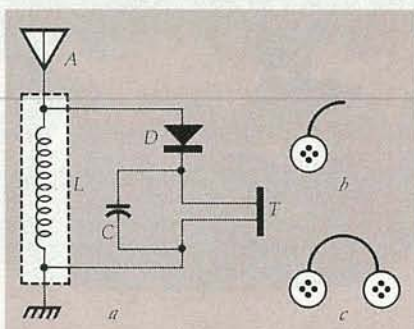

FIG. 5—STEPS IN THE DEVELOPMENT of the circuit symbol for headphones. Originally, the vertical bar identified by the letter T represented a telephone receiver.

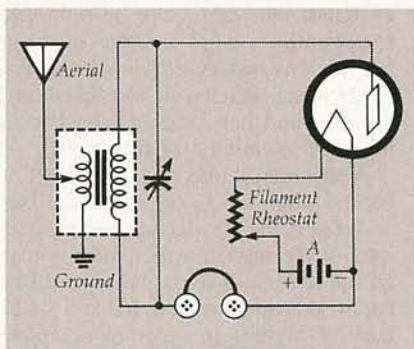

FIG. 6—THIS IS HOW THE FLEMING diode was used in early receivers.

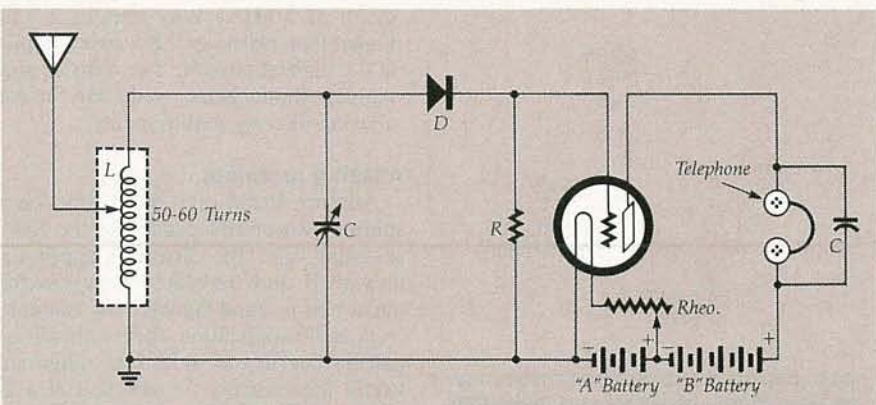

FIG. 7—AN EARLY CRYSTAL SET having one stage of audio amplification. Subsequently, it was realized that the tube could be used as a detector as well as an amplifier.

The symbols used in drawings and schematics also evolved along with the components and circuits they represented. Figure 5 shows how the simple symbol representing a headphone developed over the years. In Fig. 5-a, an original schematic from the early days of radio, the headphone is represented by a vertical bar followed by the letter T; the T being used to indicate that the bar represented a telephone receiver. The bar eventually evolved into the single headphone symbol shown in Fig. 5-b, which in turn evolved into the symbol shown in Fig. 5-c, the one used today to represent a headphone having two receivers.

Early circuits

The first use of the vacuum tube was as a detector. Figure 6 shows a common (for its time) receiver that used a Fleming diode instead of a crystal for the detector. As you can see, except for the tube the circuit is essentially the same as that of a conventional crystal receiver. The rheostat in the filament circuit was used as a way to apply higher-than-normal filament voltage, which was an early attempt to increase plate current, and therefore, the output volume. (It also shortened the life of the filament.)

De Forest's triode was initially regarded strictly as an amplifier. Early experimenters were not aware that it could be used as a detector/amplifier, so one early circuit used the crystal as a detector, followed by the triode as an audio amplifier (Fig. 7). In time, experimenters learned that the triode could be used as a detector/amplifier, which eliminated the need for a separate detector. Initially, it was known that the control grid of the triode needed bias, a fact that was brought home when the action of an unbiased grid blocked plate current flow. Initially, grid bias was provided by batteries, which were labeled C to indicate they were used for biasing the grid. Although a C battery could last its entire shelf life, since they often were not replaced until their acid had oozed out and damaged the radio, experimenters searched for a better way to bias

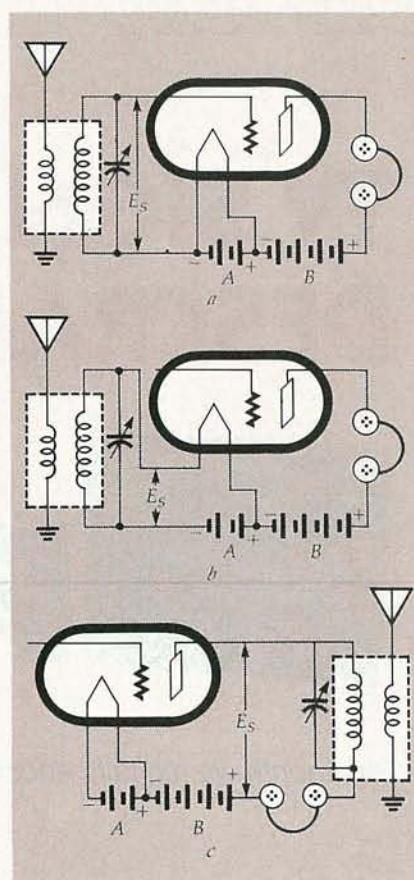

FIG. 8—SEVERAL METHODS WERE USED to feed a signal into a triode. Note that in b and c the grid is floating.

the grid. The better way was a large resistor connected from grid to ground—called a *grid leak*—that was usually shunted directly or indirectly by a capacitor (that stored the voltage developed across the grid leak).

As shown in Fig. 8, various techniques for getting extra oomph from the triode were tried. It was learned early that the best triode circuit was the one shown in Fig. 8-a, wherein the input signal (E_s) is injected between the control grid and the filament. Some attempts were made to put the signal across the filament (Fig. 8-b), or between the plate and the filament as shown in Fig. 8-c.

Although it offered superior performance, it took a number of years for the triode vacuum tube to replace the crystal detector because crystals were considerably less expensive than tubes and required no power source other than that supplied by the signal itself. Also, in many areas radio signals could supply satisfactory reception using a crystal detector; there was no need for additional sensitivity (amplification).

In fact, the primary concern with early radio reception was not sensitivity but selectivity. In the next installment of this series, we'll look at ways that selectivity was increased and at some audio-coupling schemes that were used.

R-E

TV SIGNAL DESCRAMBLING

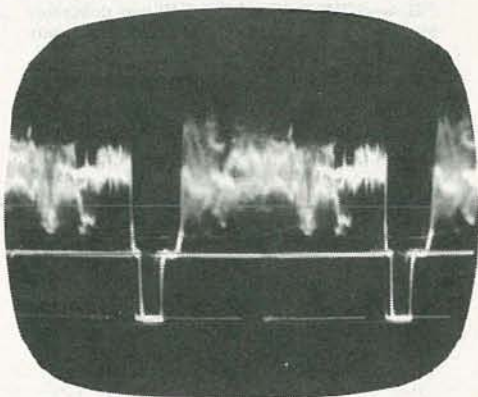
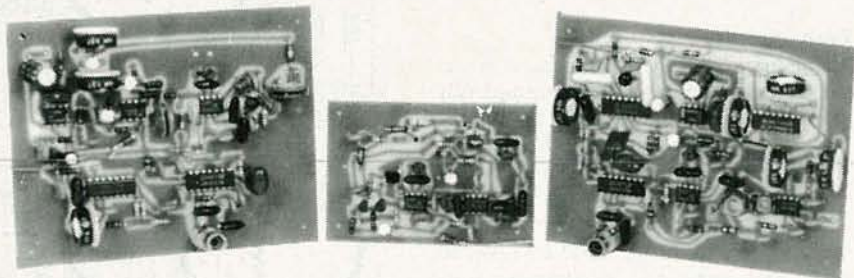

This month we digitally encode the sound.

WILLIAM SHEETS and RUDOLF F. GRAF

Part 9 IN PREVIOUS PARTS OF this series, we discussed encryption of audio signals using an analog method. Basically, all that was done was to remove the audio from the main channel and place it on a subcarrier. Since the subcarrier, by itself, is inaudible, the audio could not be heard by casual or unauthorized listeners. The recovery of the audio program was accomplished by demodulation of the subcarrier.

Although subcarrier-based scrambling techniques are fairly effective, they are relatively easy to defeat; they are suitable primarily for low-to-moderate security applications. A more secure encryption system that uses digital encoding (the Oak Orion and MA/Com Videocipher II) has been developed for satellite audio systems.

In the *Orion/Videocipher II* kind of encoding, a digital representation of the audio signal is substituted for the TV signal's horizontal sync pulse, which is located within the horizontal blanking interval. Figure 1 shows how the substitution is made. Since the audio is moved to the horizontal blanking interval, the TV signal's aural (sound) carrier has no program modulation. It can be left unmodulated, or modulated by sound having no relation to the TV picture—perhaps music or "billboard" announcements. Naturally, to hear the program sound, the digitized audio must be restored to an analog signal.

There are several ways by which conventional audio signals can be digitized (converted to digital form). The best approach for a given situation depends on the signal frequency, accuracy required, and cost considerations. We will discuss several approaches to A/D and D/A conversion.

First, a word about basic digitizing theory. Analog signals are digitized by taking minute discrete samples of the analog

waveform. Digital sampling theory tells us that a signal of length T and a frequency bandwidth of f_m can be completely specified by $2 \times f_m T$ samples of the signal. (In this instance, "completely specified" means that the analog signal can be digitized and then restored to analog with essentially no distortion.)

Alternately, it may be said that if $T = 1$ second, then $2 \times f_m$ (or twice the bandwidth samples per second) are required to specify the signal; which means that a typical TV-audio signal having a 12-kHz bandwidth must be sampled at a 24-kHz rate (or higher) in order to completely specify the signal. (Because "it's already available," a convenient audio sampling rate is twice the horizontal scan frequency, or 31.5 kHz.) Why sample at a rate higher than necessary? Because sampling at the highest possible rate reduces aliasing distortion, thereby reducing the anti-aliasing filtering requirements.

Aliasing products

Aliasing distortion is the production of spurious waveforms caused by too low a sampling rate. The distortion appears as unwanted and unrelated very-low-frequency or in-band signals. For example, in an audio application, the baseband signal may be in the 0–12 kHz range and would theoretically be sampled at a 24 kHz rate. However, because of distortion within the audio amplifiers, some audio

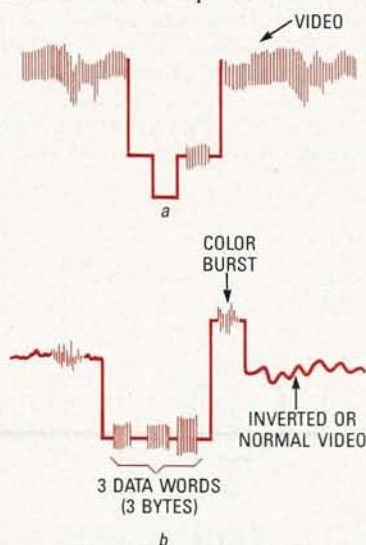

FIG.1—DIGITIZED AUDIO IS SUBSTITUTED for the video signal's horizontal sync pulse. Only the first two data words represent audio. The third is used for housekeeping.

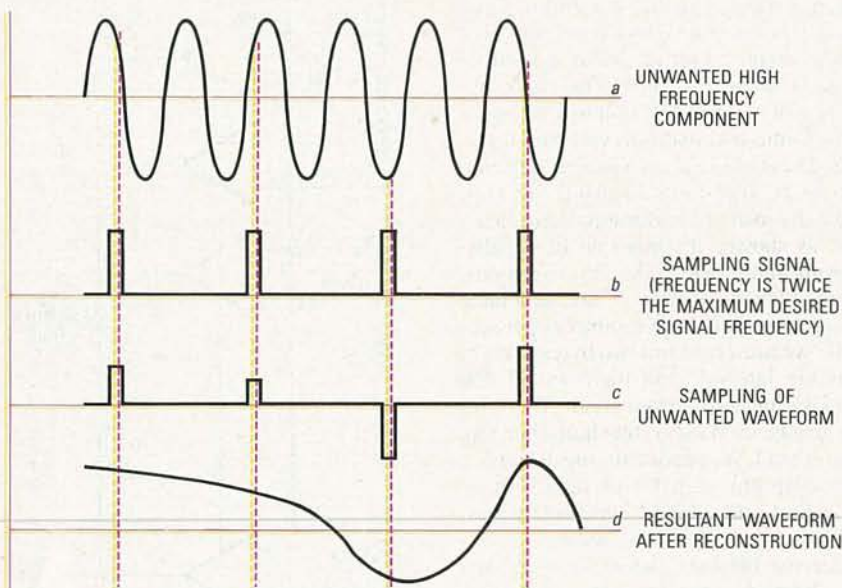

FIG. 2—ALIASING IS THE PRODUCTION of false, unwanted signals caused by too low a sampling rate.

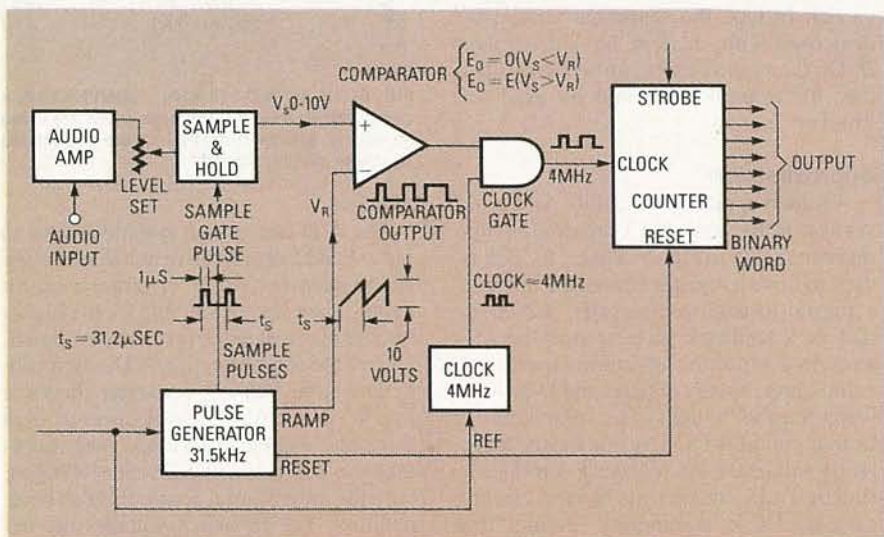

FIG. 3—A COMPARATOR can be used to digitize an analog signal at TTL levels.

components as high as 24 or 30 kHz might be present, and they would also be sampled during the digitizing process. Figure 2 shows what might occur. The top waveform (Fig. 2-a) represents audio frequencies above 12 kHz caused by distortion within the analog audio amplifiers. The sampling pulses (Fig. 2-b) are obviously not twice the frequency of Fig. 2-a, so they produce the unwanted sampling pulses shown in Fig. 2-c. After normal filtering, we get the unwanted reconstructed waveform—caused by aliasing distortion—shown in Fig. 2-d: a distorted waveform of very low frequency having no relation to the original analog audio signal. Aliasing can be reduced by adequate audio-bandwidth limiting, and by using as high a sampling rate as possible.

Binary numbers

Typically, the audio is digitized by gen-

erating discrete binary numbers to represent the analog level. If we have a binary word n bits long, we can specify 2^n discrete levels. Obviously, it is necessary to specify a large number of samples to reproduce minute changes in analog level. One hundred levels would take care of 1% (-40 dB) uncertainty, meaning a 40 dB dynamic range. And if 256 levels were used, uncertainty would now be less than -46 dB, which is adequate for TV audio. A single data byte can do that.

However, since we only have horizontal blanking pulses at a 15.75 kHz rate, how can a 31.5 kHz sampling rate be produced? Simply by having each blanking interval contain two bytes rather than one byte. In this way, 31,500 bytes-per-second are available, which is adequate for a 12-kHz audio baseband. In addition, a third byte is inserted in the blanking interval: It is a coded digital word that can be used to

determine where the horizontal and vertical starting points are located (to ensure proper vertical and horizontal timing). It can also be used for other purposes; for example, to obtain two 12-bit audio samples (total 24 bits).

Figure 3 shows how an audio signal can be digitized. The output from the audio amplifier is level-set for proper dynamic range, and then sampled every 31.2 microseconds (31.5 kHz rate). The analog value is stored in a sample-and-hold circuit until the next sample is taken; let us assume it may be any value between zero and ten volts. That analog level is then fed to one input of a comparator. The other comparator input is fed with a linear ramp (sawtooth) whose amplitude rises from 0 to 10 volts. (The ramp starts slightly after the sampling interval and ends just before the next audio sample is taken, because some time must be reserved for sampling and resetting the ramp to zero.) If the audio sample is relatively large (say 7 to 10 volts) in amplitude, the ramp will have to rise to that value before the comparator's output voltage will drop to zero. If the analog sample is small (say 1 volt), the comparator will drop to zero when the ramp exceeds one volt. (The comparator's output is a logic high (1) when $V_S > V_R$, it is a logic low (0) when $V_S < V_R$. Therefore, the comparator output is a train of pulses having a frequency of 31.5 kHz and a pulse width ranging from nearly zero to 30 microseconds (depending on the sample amplitude.)

The variable-length pulse represents the analog value of the audio sample's amplitude. A narrow (5 microsecond) pulse represents low values (say 0 to 2 volts). A wide pulse of 25 microseconds would represent 8 or 9 volts. (Ideally, we should get about 3 microseconds pulse-width per volt in this instance.) Next, the pulse has to be converted to a binary value, which can be done by using the pulse as a gating pulse for a counter that is clocked by a much higher clock frequency. If we had a 4-MHz clock, 120 clock pulses would be counted in 30 microseconds. By using two separate (alternating) systems and the full line-scan time (63.5 microseconds), it is possible to count up to 240 clock pulses, therefore generating a full 8-byte binary word. That is possible because each byte is only needed every 63.5 microseconds, and there are two bytes.

Therefore, the counter can be reset to zero, the high-frequency clock signal can be gated by the variable-length pulse, and the width of the variable-length pulse will determine how many cycles of the high-frequency clock will be input to the counter. The counter will count to a state that is proportional to the length of the variable pulse, whose width depends on the analog

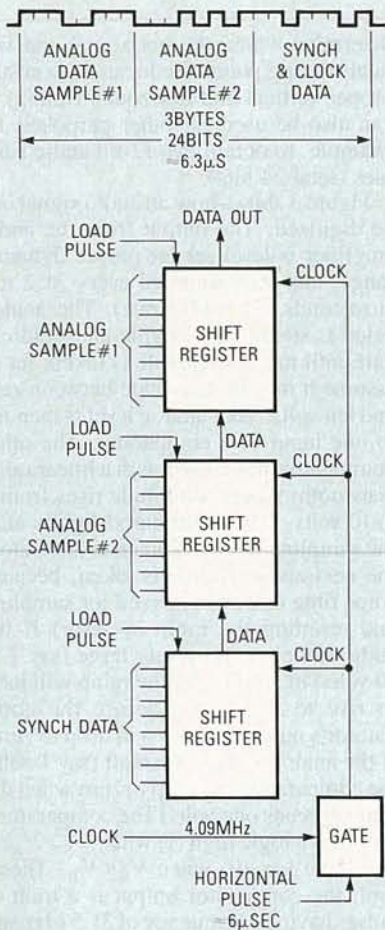

FIG. 4—SHIFT REGISTERS CAN BE USED to organize three digital samples into a serial data stream.

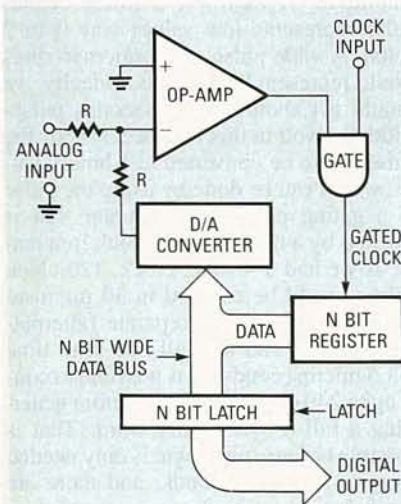

FIG. 5—THIS IS THE FUNCTIONAL circuit of a successive-approximation register-type A/D converter.

value of the audio sample. Therefore, a binary number appears at the output of the counter that is proportional to the analog value of the audio sample and is its digital equivalent in parallel format.

Next, as shown in Fig. 4, the binary number—which we'll call *Sample 1*, is stored in parallel format in a shift register. During the horizontal blanking interval, it is clocked out in serial format, appearing as an 8-bit digital word. The clock frequency of 4.0909 MHz shown in Fig. 4 has a 6-microsecond interval, which permits 24 bits (3 bytes) of digital information to be transmitted during the sync pulse. By using two additional shift registers, as shown, it's possible to serially-transmit three bytes. The first two bytes, *Sample 1* and *Sample 2*, are generated because we need 31,500 samples per second—we must transmit two bytes in every blanking interval, and there are 15,750 blanking intervals per second. The third byte can be used for system housekeeping or overhead. As previously mentioned, it can represent signals for determining horizontal and vertical sync references, and have special-purpose coding.

Because the audio is both digitized and piggybacked on the sync interval, it is no longer found on the TV signal's sound carrier. In fact, the sound carrier can be dispensed with, as done by *Videocipher II*. Or, the sound carrier can be put to other use; for example, it could be used for "barker" audio.

Approximation

Another approach to audio A/D conversion is the successive-approximation register shown in Fig. 5. There, a clock is used to drive a register connected through a digital-to-analog converter, which is part of a feedback loop around the op-amp. In a sense the op-amp is used as a comparator, but the register and D-A converter may be thought of as an integrator. In that circuit a DC level (a steady logic level) will cause the register to produce a successively increasing binary count, since the DC level is merely "gating" the clock signal. As the register is counting, the D/A converter produces a rising ramp output voltage. When the D/A converter's ramp output voltage is equal to that of the analog input to the op-amp the output of the op-amp will flip low, thereby shutting off the clock gate. (At that point, the binary number seen at the register's input or the D/A converter input is the digital equivalent, in parallel form, of the analog input signal. That signal can be stored in a latch or another register for later use.)

The speed of conversion of the successive-approximation system depends on the clock frequency, the bandwidth of the operational amplifier, and the system's stability. Normally, the clock frequency must be much higher than the input signal frequency. For example, if a 256-level (8-bit) resolution is wanted, the clock must be 256 times faster than the analog sampling rate. Actually, it must be even greater to allow for setup times, latching, and sampling of digital-data output to the bus

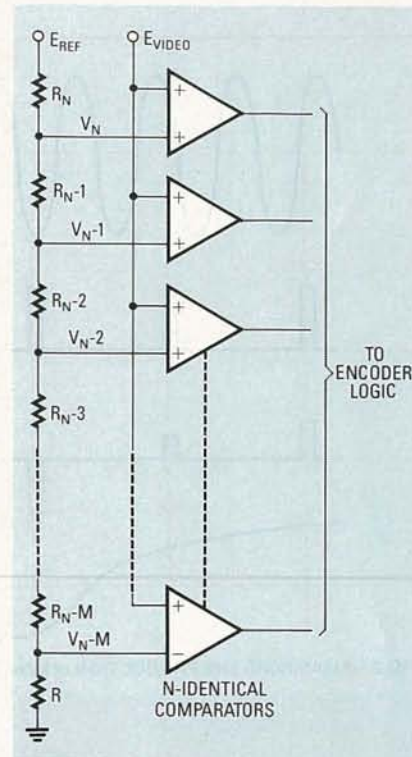

FIG. 6—IN AN A/D "FLASH" CONVERTER, a comparator's output goes high when the video voltage is greater than that of the associated reference divider tap-off.

interface.

The A/D conversion systems shown in Figs. 4 and 5 are effective at low to moderate frequencies, such as those used for audio. They are not suitable for the higher frequencies that make up the video signal. One of the most effective A/D video converters is the "flash" converter shown in Fig. 6. It is simply a collection of high speed wideband op-amp comparators that use independent reference voltages, with the video signal common to all comparators. The reference voltages are derived from a resistive voltage divider.

Each of the 256 steps that make up a data byte requires its own comparator, so a practical circuit would require LSI technology. The "flash" comparator's output feeds encoding logic that provides 8-bit binary data corresponding to the analog value of the video signal sample.

Bear in mind that regardless of the kind of digitizing used for video, a bandwidth of 4.2 MHz is required for NTSC video, and digitized video is processed either a line or a frame at a time. Generally, eight bits or more must be used to describe the signals adequately and to avoid visible deterioration of the picture. That corresponds to 256 levels (0 to 255), each step being 48 dB below peak video. Since the sample rate must be at least 2×4.2 , or 8.4 MHz, more likely 10 MHz would be used so there would be a small amount of leeway. To allow for glitches and pulse-settling time, and to reduce aliasing, bandwidths of 20 MHz are necessary.

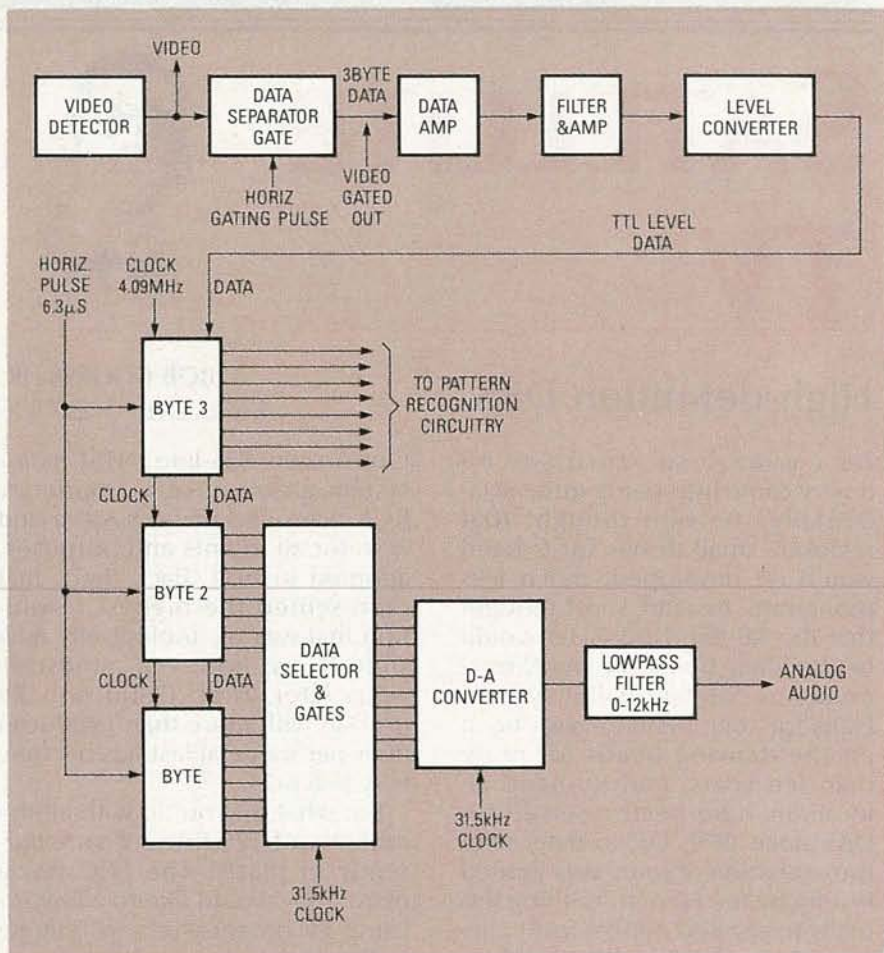

FIG. 7—A COMPLETE DIGITAL DECODER. The analog output from the lowpass filter is an accurate reproduction of the original audio signal.

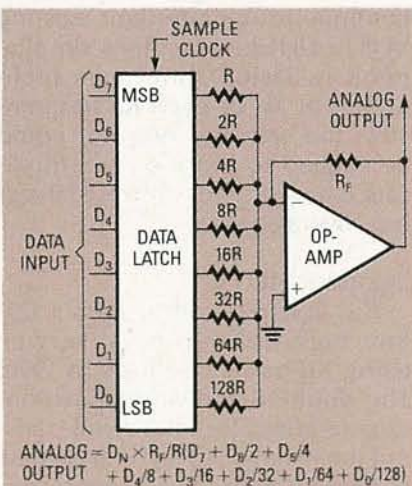

FIG. 8—A SINGLE OP-AMP and a precision voltage divider can also be used for digital decoding. The analog output is proportional to the active data inputs.

Descrambling

To demodulate digitized audio, the digitizing process is simply reversed. Figure 7 shows the block diagram of a sync-interval digital-audio decoder. A data-separator gate following the TV's video detector extracts the audio-data pulses

from the video signal. The output from the separator is a squarewave containing unwanted components, among them possibly video "spill," and a 15-Hz sinewave that is used to prevent the accidental use of the digital data as TV synchronizing pulses. All extraneous signals, re-

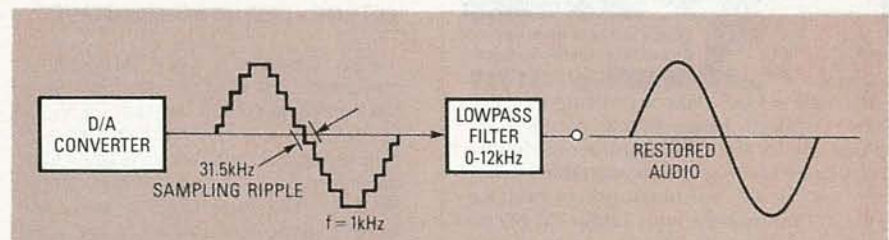

FIG. 9—A RESTORED WAVEFORM contains a 31.5 kHz sampling-frequency ripple that must be removed by a lowpass filter

gardless of type, are removed by the filter/amplifier so that only the digital data appears at the input to the level converter.

The level converter makes the data signal TTL compatible (or whatever is necessary for the logic circuitry that follows). The compatible data is clocked into a 24-bit shift register, which can easily be made up of three 8-bit shift registers, as shown. One shift register contains the first audio

sample, another the second sample, and the remaining register contains the encoded third byte. The third byte is fed to a pattern-recognition system that specifically interprets the encoding of the third byte.

Byte 1 and byte 2 are fed in parallel form to a data selector that is driven by a 31.5-kHz clock, which is derived from the horizontal-synch circuit. Bytes 1 and 2 are alternately selected and fed in parallel form to a D/A converter, which converts the audio data back to analog form. The filter, which we'll get to shortly, completes the restoration process by "smoothing" the analog waveform.

Figure 8 shows how an op-amp and a resistor network create an elementary D/A converter. Resistor R_f is the feedback resistor from the op-amp's output to its inverting input. Using a ± 15 -VDC supply and TTL signal levels, values for R_f and R might be 10K and 5K respectively.

The converter works this way: Assume that data-input D_7 is the most-significant data bit, having 128 times the effect on the output compared to D_0 , which is the least-significant bit. And assuming that R_f is 10K and that R is 5K. If D_7 is high and all other data lines are low, we would get 10 volts out of the D/A converter. If D_7 were low and D_6 were high, the D/A output would be 5 volts. A high D_5 would produce 2.5 volts; a high D_4 would produce 1.25 volts, and so on, until D_0 , which would produce $1/128$ volts. Note that each data line produces twice the effect of its lower neighbor. Any binary number would therefore produce a definite analog voltage.

As shown in Fig. 9, due to the sampling process the output of a D/A converter used for decoding is an analog signal having a 31.5 kHz component. The lowpass filter, (also shown in Fig. 7) removes the 31.5 kHz component, thereby producing a low-

distortion waveform that closely resembles the input signal.

Not really scrambled

Although we have been referring to "scrambled" audio, as you can see by now, the audio signal itself is not really scrambled, it is simply digitized. But since it cannot be received by a con-

continued on page 82

VIDEO TAPE COPY PROTECTION GOT YOU DOWN?

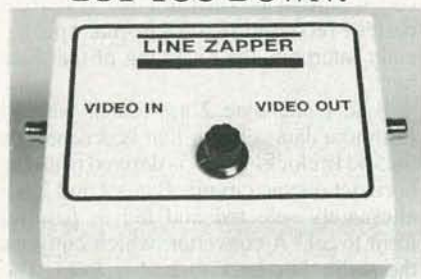

STABILIZE YOUR PICTURE WITH THE NEW, IMPROVED LINE ZAPPER

Bothered by brightness changes, vertical jumping and jittering, and video noise? Tired of renting or buying tapes and being forced to watch an unstable washed out picture? Solve your problems with the Line Zapper.

The Line Zapper accepts direct video from any VCR and monitors the signal, line by video line. When it sees the copy protection signal it Zaps it, giving you a normal, clean signal at the output.

Available in both kit form and fully assembled. The kit is only \$69.95 (Not recommended for the beginner) plus \$3.00 shipping. Assembled, tested units with a 90 day warranty are only \$124.95 plus \$3.00 shipping.

Arizona residents must add 6.7% sales tax. Please allow 6 to 8 weeks for delivery. Dealer inquiries welcome.

ELEPHANT ELECTRONICS INC.



BOX 41865-F
PHOENIX, AZ 85080
(602) 581-1973

CIRCLE 120 ON FREE INFORMATION CARD

Be an FCC LICENSED ELECTRONIC TECHNICIAN!

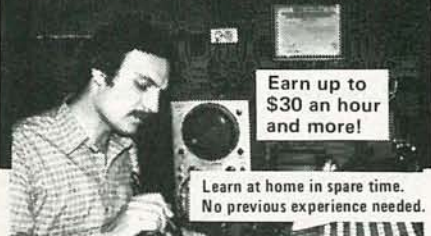

Learn at home in spare time.
No previous experience needed.

No costly school. No commuting to class. The Original Home-Study course prepares you for the "FCC Commercial Radiotelephone License". This valuable license is your "ticket" to thousands of exciting jobs in Communications, Radio-TV, Microwave, Computers, Radar, Avionics and more! You don't need a college degree to qualify, but you do need an FCC License.

No Need to Quit Your Job or Go To School
This proven course is easy, fast and low cost! **GUARANTEED PASS** - You get your FCC License or money refunded. **Send for FREE facts now. MAIL COUPON TODAY!**

COMMAND PRODUCTIONS

FCC LICENSE TRAINING, Dept. 90
P.O. Box 2223, San Francisco, CA 94126
Please rush FREE details immediately!

NAME _____
ADDRESS _____
CITY _____ STATE _____ ZIP _____

SATELLITE TV



BOB COOPER, JR.
SATELLITE-TV EDITOR

High-definition DBS

THE C-BAND HOME SATELLITE-TV INDUSTRY came into being quite accidentally; no one thought that relatively small dishes for C band would be developed, much less proliferate. Instead, most thought that the Ku-band (12 GHz) would be the likely home for any Direct-Broadcast Satellite (DBS) system. Plans for such systems have been on the drawing board for more than ten years, and Ku-band allocations have been reserved for DBS since 1979. But to date, with the exception of some very limited testing by the French, nothing has really happened on that front anywhere in the world. Further, nothing is likely to happen before 1990, at the earliest. But after that, watch out!

Here comes HDTV

Now there is serious planning underway to change the very nature of television broadcasting.

INTERESTED IN SCRAMBLING?

Bob Cooper's *CSD Magazine* maintains a 24 hour per day *Scramble-Fax-Hotline* telephone service (305/771-0575) which you may call to obtain a 3-minute recorded update on the latest happenings in the satellite scrambling world. *Scramble-Fax Newsletter* is also published to keep you abreast of the latest events in descrambling, including sources for descrambling chips and equipment. For information, write *Scramble Fax*, P.O. Box 100858, Ft. Lauderdale, FL. 33310 or telephone 305-771-0505.

If you have a dish of your own, tune in the Caribbean Super Station (Western 5, transponder 23) Tuesdays at 7 PM eastern for a special weekly Bob Cooper report. Also tune-in *Boresight* at 9 PM Thursday nights (Spacenet 1, transponder 9) for a weekly one-hour report on the activities in the home TVRO field.

Our present 525-line, NTSC color system grew out of a proprietary RCA black-and-white system and was, for all intents and purposes, adopted in 1939. Back then, that represented the highest resolution that was technologically possible. Now, however, almost 50 years later, *High Definition TV* (HDTV) with more than 1,000 scan lines per frame at last has become very practical.

But what do you do with all the millions of 525-line TV sets currently in place? The FCC has a plan: They would like to allow existing TV broadcasters to operate in the Ku band using high definition (1,125-line, 5 x 3 aspect-ratio) video; the broadcasters would continue to operate their existing VHF or UHF local stations simultaneously. Using spot-beam techniques at Ku or even Ka frequencies, the satellite footprint could be shaped to more or less duplicate a broadcaster's terrestrial-signal coverage area.

Japanese HDTV

The Japanese will launch 1,125-line high-definition TV service using Ku-band satellites in 1990. The double-bandwidth transponders required for HDTV will transmit their signals to an entirely new generation of TV receivers designed to process the signals. The audio will be digital, stereo, and capable of supporting multiple languages and even closed captioning in the same transmission. The aspect ratio or width of the pictures will be enlarged from the present 4 x 3 format (see Fig. 1-a) to 5 x 7 (see Fig. 1-b).

This past January, Japanese scientists conducted a public dem-

onstration in the U.S. Using a special side-by-side allocation, approved for the occasion by the FCC, two UHF channels were used to allow the Japanese to demonstrate their high-definition video. The demonstration was widely applauded by the National Association of Broadcasters (NAB), which represents U.S. broadcasting interests before the FCC and Congress. It's now clear that the NAB, and apparently the FCC, both are in favor of allowing wideband, high-definition transmission to develop here as well.

Because our present VHF- and UHF-TV spectrum is filled, and because high-definition video requires twice the bandwidth of present NTSC video, the only logical home for HDTV is on microwave frequencies using direct satellite transmission. But who is to own and operate such a system?

Turning it over to the broadcasters is one way to allay their worries that a superior technology might erode the value of their licenses. In late 1986, a VHF television station in New York City sold

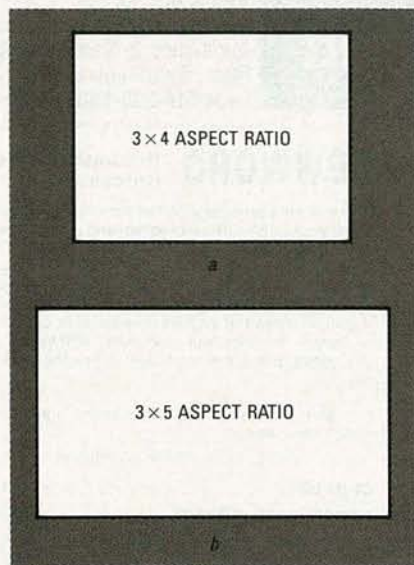

FIG. 1

for more than the cost of buying and launching more than three 24-channel C-band satellites!

Best laid plans

All of that flies contrary to the present on-record plans for Ku-band DBS. Under the original FCC plan, DBS was to be a separate service allowing programmers to

provide a sort of wireless cable. But with the entry of HDTV, the best-laid plans for DBS seemed to be headed out the window.

High-definition TV requires twice the bandwidth per transponder as DBS, and it has a ready-made user list that includes all of the existing TV broadcasters in the U.S. That seems to exclude any other use for Ku or Ka frequencies. In fact, it will take some very careful allocation planning to ensure that all of the broadcasters who might like access to the service will receive it. But through frequency re-use techniques, transponder assignments can be repeated often enough to allow each terrestrial broadcaster a viewing area that's essentially the same as the one it now serves.

That sort of change in television service will have profound and long-lasting impact on everything related to television in North America. After 50 years of NTSC as our standard, there is serious energy now being devoted to updating the system and to adapting it to the improved techniques. **R-E**

ACHIEVE INSTANT SUPERTECH STATUS

THE PATENTED (pending) EDS-59C SEMIANALYZER® WILL CUT YOUR TROUBLESHOOTING TIME DRAMATICALLY—GUARANTEED!*

- ▶ CHECKS CONDITION, POLARITY, AND NUMBER OF JUNCTIONS OF SEMICONDUCTORS **IN CIRCUIT**.
- ▶ DISPLAYS PARAMETERS IN PLAIN ENGLISH ON BRIGHT **LED** DISPLAY.
- ▶ BEEPS DIFFERENT TONES FOR IMPORTANT CIRCUIT CONDITIONS.
- ▶ CHECKS ZENER DIODES IN-CIRCUIT.
- ▶ CHECKS CAPACITORS FOR LEAKAGE AND VOLTAGE BREAKDOWN.
- ▶ BUILT-IN AMPLIFIER FINDS NOISY OR INTERMITTANT COMPONENTS.
- ▶ TWO-YEAR LIMITED WARRANTY ON PARTS AND LABOR.
- ▶ MADE IN THE U.S.A.



* WE GUARANTEE THAT THE EDS-59C SEMIANALYZER WILL MAKE YOU A FASTER, LESS-FRUSTRATED "SUPERTECH", OR YOUR MONEY BACK. TRY ONE FOR 60 DAYS, AND IF IT DOESN'T EARN ITS KEEP, SHIP IT BACK FOR A FULL REFUND.

ELECTRONIC DESIGN SPECIALISTS, INC.
P.O. Box 9609, Coral Springs, FL 33065

VISA/MASTER CARD ORDER LINE
TOLL-FREE 1-800-544-4150
Florida 305-726-7416

R-E Computer Admart

Rates: Ads are 2 1/4" x 2 7/8". One insertion \$825. Six insertions \$800 each. Twelve insertions \$775. each. Closing date same as regular rate card. Send order with remittance to Computer Admart, Radio Electronics Magazine, 500-B Bi-County Blvd., Farmingdale, NY 11735. Direct telephone inquiries to Arline Fishman, are code-516-293-3000. Only 100% Computer ads are accepted for this Admart.

ICs PROMPT DELIVERY!!!

SAME DAY SHIPPING (USUALLY)
QUANTITY ONE PRICES SHOWN FOR APRIL 26, 1987
OUTSIDE OKLAHOMA NO SALES TAX

DYNAMIC RAM			
1Mbit	1000Kx1	100 ns	\$28.50
51258	256Kx1	100 ns	6.95
4464	64Kx4	150 ns	3.50
41256	256Kx1	100 ns	4.35
41256	256Kx1	120 ns	3.50
41256	256Kx1	150 ns	3.25
4164	64Kx1	150 ns	1.30
EPROM			
27512	64Kx8	200 ns	\$10.50
27C256	32Kx8	250 ns	5.15
27256	32Kx8	250 ns	4.85
27128	16Kx8	250 ns	4.10
27C64	8Kx8	150 ns	4.85
2764	8Kx8	250 ns	3.75
STATIC RAM			
62256	32Kx8	120 ns	\$12.95
6264LP-15	8Kx8	150 ns	2.95

OPEN 6 1/2 DAYS, 7:30 AM-10 PM. SHIP VIA FED-EX ON SAT.

SUNDAYS & HOLIDAYS: SHIPMENT OR DELIVERY, VIA U.S. EXPRESS MAIL.

SAT DELIVERY INCLUDED ON FED-EX ORDERS RECEIVED BY: Th: 5:00 PM, Fr: 1:00 PM, Sa: 11:00 AM. MasterCard/VISA or UPS CASH COD. Factory New, Prime Parts μ P MICROPROCESSORS UNLIMITED, INC. 24,000 S. Peoria Ave., BEGGS, OK, 74421. (918) 267-4961. No minimum order. Please note that prices are subject to change. Shipping & insurance extra. & up to \$1 for packing materials. Orders received by 9 PM CST can usually be delivered the next morning, via Federal Express Standard Air in \$6.00, or guaranteed next day Priority One in \$13.00! All parts guaranteed.

CIRCLE 61 ON FREE INFORMATION CARD

DO YOU REPAIR COMPUTERS? (or want to?)

Your one-stop source for computer repair products:

- trouble-shooting guides
- test equipment & tools
- diagnostic programs
- computer repair courses
- schematics & much more

Computing Technology

247 Balsam St. Ridgecrest, CA 93555
(619) 375-5744

CIRCLE 198 ON FREE INFORMATION CARD

COMPUTER ASSEMBLY MANUALS



Eliminate Guesswork!
Build with Confidence!

BIG BLUE SEED for IBM™ BUILDERS
Parts list, placement diagrams & instructions for assembling over 75 IBM-compatible bare cards. Latest version includes guides for 640K, Turbo, & AT MthBds. \$17.95

APPLE SEED II for APPLE™ BUILDERS
Instructions for assembling over 85 Apple-compatible bare cards including II+ & IIe MthBds. For all Apple enthusiasts .. \$14.95

Both for \$30.00! Also bare cards in stock! Check/money-order, VISA/MasterCard to:

NuScope Associates*, Dept RE
P.O. Box 790 • Lewiston, NY • 14092

*A Division of Kosmic MicroTech Inc.

CIRCLE 196 ON FREE INFORMATION CARD

NEWWORD—the better word processor

This fine word processor can be considered a clone of the popular WordStar program and it even uses the same commands. However, NewWord is faster, easy to customize, has the mail merge feature built-in, supports more printers, has an UNDELETE function and excellent documentation. It also includes the WORD Plus spelling checker by Oasis — an excellent product in itself! We offer this package at a discount. Just check the prices below.

Available in most computer formats including Heath hard sector.

30 Day Money-Back Guarantee!

CP/M 80 \$115
PCDOS, Z100, CP/M 86 \$269

Add \$4 per order for shipping and handling. Terms: Check or Money Order — VISA/MC — COD. California residents add 6% tax.

ANAPRO 805/688-0826

213 Teri Sue Lane Buellton, CA 93427

CIRCLE 202 ON FREE INFORMATION CARD

DISK SERVICE MANUAL \$20

Maintain, Repair, Adjust, Align Drives Without Special Equipment or Software. 5.25", 8", Microfloppies. IBM-PC/Compatible, Apple, Commodore, Kaypro, Tandy, Atari, TI, HP, DEC, etc. 12 Chapters, 100+ Photos, Figures. SAVE \$\$\$!

COMPUTER PHREAKING \$15

Dozens Computer Crime Methods and Countermeasures. How Systems are Penetrated. BBS Advice; Password Defeats; TEMPEST; Van Eck Methods; Crosstalk Amps). 200 Phreak-Term GLOSSARY.

CRYPTANALYSIS TECHNIQUES \$15

Five Cryptanalysis Programs (COM, BAS, Source Code) for MSDOS Systems. N-Gram, Kasiski, MR, IC Analyses. Disk + Manual — \$25.

PHONE COLOR BOXES \$15

PHONE RED, BLUE, BLACK, GRAY, SILVER, YELLOW, GREEN, BROWN, PURPLE, WHITE, BEIGE, SLM, CLEAR, CHEESE and MUTE BOX Plans. Plus CALL-FORWARDING — Much More! Use not recommended.

HIGH VOLTAGE DEVICES \$15

STUNNER, ZAPPER, BLASTER, JAMMER, FLASHER, STIMULATOR, JACOB'S LADDER, OZONE/PLASMA/VAN DE GRAAFF GENERATORS, GEIGER COUNTER, FENCE CHARGER, etc. Plans. Shocking!

RADIONICS MANUAL \$20

Comprehensive Manual, Plans on ElectroMagnetic Therapies, Diagnoses, Preventions. 30+ Figures. Includes FDA-approved.

ELECTROMAGNETIC BRAINBLASTER \$20

Comprehensive Manual and Plans on ElectroMagnetic Weapons and Lab. Devices. Dozens of Figures, Mind Boggling!

CONSUMERTRONICS

2011 CRESCENT DR. P.O. DRAWER 537
ALAMOGORDO, NM 88310

CIRCLE 197 ON FREE INFORMATION CARD



COMPATIBLE CLONES

XT & AT

EASY TO FOLLOW INSTRUCTIONS.
CALL FOR TODAY'S COMPETITIVE PRICE.
+ TALK TO A TECH, NOT JUST A SALES PERSON.

EPROM PROGRAMMING

EPROM BLASTER + SOFTWARE
\$11900

4x EPROM BLASTER + SOFTWARE
\$15900

EPROMS CALL!
RAM CHIPS CALL!
MODEMS CALL!

PROCORP, INC.
500 S. CHALLIS ST.
SALMON, ID 83467

HOW TO
COPY IBM® BIOS AND USE IN YOUR CLONE TO RUN BASICA AND OTHER ROM DEPENDENT PROGRAMS MEMORY LOCATIONS. Easy To Follow Instructions. Hardware Lists & Where & How To Buy. Send \$6.95 + \$1.00 Shipping & Handling.

(208) 756-4505
MON.-FRI. 8:00-5:00
1-800-548-0004
SAME DAY SHIPPING

CIRCLE 199 ON FREE INFORMATION CARD

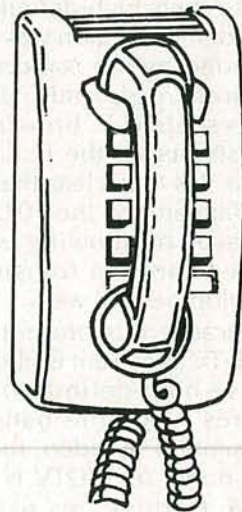

CALL NOW AND RESERVE YOUR SPACE

- 6 x rate \$800.00 per each insertion.
- Reaches 239,312 readers.
- Fast reader service cycle.
- Short lead time for the placement of ads.

Call 516-293-3000 to reserve space. Ask for Arline Fishman. Limited number of pages available. Mail materials to: Computer Admart, RADIO-ELECTRONICS, 500-B Bi-County Blvd., Farmingdale, NY 11735.

SWITCH!

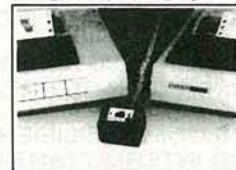

- ✓ **SWITCH!** Connects two Parallel printers to IBM-PC/XT/AT.
- ✓ **SWITCH!** Comes with all cables.
- ✓ **SWITCH!** Lets you forget the bulky boxes.

Price: Only \$59.00 (Part No 1/2C/O)

(CA residents add 6.5% Shipping/Handling (USA) add \$4 on all orders. Item subject to availability and price change without notice. Send check or money order.)

We carry interfaces and cables for most major computers and printers:

TecTrans
6925 Rosemead Blvd.,
San Gabriel, CA 91775
(818) 285-3121 • (818) 799-4570

CITIZEN is a Trademark of Citizen, Santa Monica
IBM PC/XT/AT are Trademarks of International Business Machines

CIRCLE 201 ON FREE INFORMATION CARD

COMPUTER DIGEST

VOL. 4 NO. 7 JULY 1987

A NEW KIND OF MAGAZINE FOR ELECTRONICS PROFESSIONALS

KEYBOARDS, KEYBOARDS AND KEYBOARDS!

The man-machine
interface



IBM's NEW PC's

First impressions of Big Blue's new entries

A
GERNSBACK
PUBLICATION

EDITOR'S WORK- BENCH

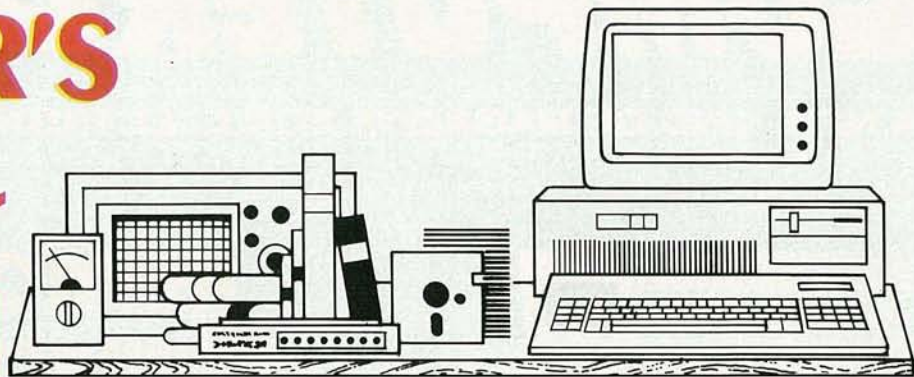

IBM's Personal System/2

Following months of speculation and rumor, IBM has finally released a quartet of new computers, a new version of DOS, and a slew of new peripherals, including an optical disk drive.

It's immediately apparent that the new computers are intended to open new directions for IBM, as well as to maintain continuity with past machines. And it doesn't seem that IBM has made the kind of marketing blunder it did with the PC JR and the PC Portable.

There are four new Personal System/2 computers, as shown in Fig. 1; they're dubbed the Models 30, 50, 60, and 80, and base models of each list for \$1695, \$3595, \$5295, and \$6995, respectively. As you can see, the Models 30 and 50 are desktop models, and the others are floor-standing.

The Model 30 is basically an upgraded PC (or XT); the Models 50 and 60 are

basically upgraded versions of the AT; and the Model 80 is IBM's long-awaited 386 machine. The Model 30 has been rated to run about twice as fast as the PC, and the Models 50 and 60 (which differ mainly in the number of expansion slots each contains), twice as fast as the AT. The Model 80 is rated twice as fast the Models 50 and 60. Specifications are summarized in Table 1.

New features

Technical details are hard to come by at this early date, but here's what we've learned so far. (We hope to have a hands-on review next month.) The main features that distinguish the Personal System/2 computers from the old models are the new disk drives, the new video hardware, the new expansion slots, and the new unreleased operating system called Operating System/2 (OS/2).

All the new models come with 3½" disk drives. Each Model 30 disk holds 720K (twice that of a standard 5¼ inch disk); new disks for the other machines hold 1.44

megabytes each, and the Model 50, 60, and 80 disk drives can read both types of disks. The 720K disks are used in many portables currently on the market.

The new video hardware is compatible with the old CGA standard, but it also adds several new modes that are incompatible with all other standards, including IBM's own EGA as well as the Hercules standards. The new video modes offer higher resolution and more colors than the CGA, and they require new analog monitors that are incompatible with all other IBM-compatible monitors currently on the market.

The Models 30 and 50 have three expansion slots each; the Models 60 and 80 have seven slots. The slots in the Model 30 are electrically compatible with the old-style slots, but expansion slots shouldn't be necessary because the Model 30 includes most common add-on hardware: 640K of RAM, a video adapter, serial and parallel ports, mouse adapter, and a battery-backed clock/calendar. The expansion slots in the other models are totally incompatible with the old-style slots, but the new bus, which IBM calls the Micro Channel, can operate at a much higher speed than the old bus. The Models 50 and 60 have 16-bit buses; the Model 80 has a 32-bit bus.

DOS and OS/2

There is a new version of DOS (DOS 3.3) and a totally new operating system, which won't be released before the end of the year. DOS 3.3 has a few added commands (including a CALL statement for use in batch files), and has enhanced some old programs (BACKUP and RESTORE, for example), but all in all the new DOS does very little more than provide support for the new hardware. It runs on all past and present IBM PC's.

The other new operating system is called Operating System/2, and it contains many of the advanced features power users and network managers have been clamoring for.

OS/2 supports three "environments" and will come in three versions. The three en-

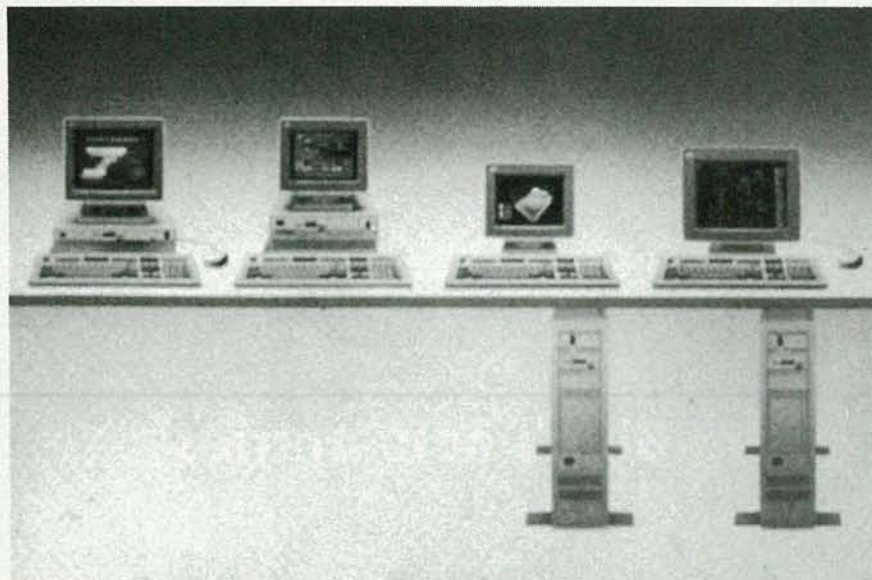

FIG. 1

TABLE 1—IBM PERSONAL SYSTEM/2

	Model 30	Model 50	Model 60	Model 80
Microprocessor	8086	80286	80286	80386
Potential system throughput	Up to 2½ times PC XT™	Up to 2 times Personal Computer AT®	Up to 2 times Personal Computer AT	Up to 3½ times Personal Computer AT
Standard memory	640KB	1MB	1MB	Up to 2MB
Expandable to		7MB	15MB	16MB
Diskette size and capacity	3.5-inch 720KB	3.5-inch 1.44MB	3.5-inch 1.44MB	3.5-inch 1.44MB
Fixed disk	20MB	20MB	44, 70MB	44, 70, 115MB
Additional options			44, 70, 115MB	44, 70, 115MB
Maximum configuration	20MB	20MB	185MB	230MB
Expansion slots	3	3	7	7
Operating system(s)	PC DOS 3.3	PC DOS 3.3 and Operating System/2™	PC DOS 3.3 and Operating System/2	PC DOS 3.3 and Operating System/2

vironments (DOS, Family, and OS/2) allow various levels of software compatibility. The DOS environment should be totally compatible with existing programs; the OS/2 environment will allow full access to the features of the new computers (what we call the M & M's: Multi-tasking and extended Memory); and the Family environment provides a bridge between the two.

The Standard Edition Version 1.0 of OS/2 will include extensive on-line help facilities and support for the M & M's. IBM expects to release 1.0 in the first quarter of 1988. The Standard Edition Version 1.1 will include all the capabilities of 1.0, plus a Macintosh-style graphics/window user interface. IBM expects to announce a release date for 1.1 by the end of 1987. According to the rumor mill, the window interface may be Microsoft Windows, IBM's own (and neglected) Top View, or some combination thereof.

IBM calls the third version of OS/2 the Extended Edition, and it will include an advanced relational database manager, an advanced communications program (that will allow background communications), and terminal emulation. The extended edition seems to be aimed primarily at users who do a great deal of work on both PC's and mainframes.

Price and performance

It's easy to see that IBM is not going after the rock-bottom clone market, although the new models are not hopelessly expensive, either. For example, one week after IBM's announcement, Model 30's were being sold across the counter in New York City for about \$1400 for the dual-floppy model and about \$1800 for the floppy/hard-disk model. That price doesn't include a monitor, which runs an extra \$225 or \$475 (street price) for monochrome or color, respectively. However, that price does include everything IBM and the clone makers previously sold separately—video adapter card, ports, RAM, etc. Meanwhile, prices of the old models have dropped on the order

of 30%, so now you can get a real IBM for the cost of a clone.

Technically speaking, the new machines indicate that 5¼" disk drives are on the way out and that 3½" drives are on the way in. The takeover will be gradual, but it is inevitable—as was the transition from 8" to 5¼" disks—because the new disks are much more durable and hold much more information than the old ones.

The problem with video is much more difficult to discuss, mainly because at this early date there is little hard data. We know that the new graphics hardware is not compatible with EGA and Hercules standards, but we've been unable to find out whether it's possible to run an EGA or Hercules card in a Model 30. (The bus structure of the more powerful machines precludes EGA/Hercules use in those machines.) If it's not possible, until present-day graphics software is adapted to the new video standard, it will have to run in CGA mode. On the other hand, it appears that text-mode software will be able to take advantage of the new higher-resolution hardware, so word processors, outline processors, and the like should benefit immediately.

What to buy

If you want to buy a PC now, first you must choose between IBM and non-IBM equipment. If you choose IBM, you have to choose between old technology and the Model 30, on the one hand, and the Models 50, 60, and 80 on the other. And the choice may not be easy, depending on your needs. If you're quite sure of your present and future needs, and an old-technology machine or a Model 30 will meet those needs, buy one. Present hardware and software will power those machines for perhaps another five years without looking too dated. However, beware that software developers will gradually shift the focus of their efforts over to the new machines, and that development efforts for the old machines will gradually cease (as happened with CP/M).

Choosing among a Model 30, an IBM PC (or XT), and a clone is difficult, but if I were buying today I'd lean strongly toward a Model 30 because it bridges past and future technologies.

On the other hand, if you want a machine that you can grow with, one that will be able to take advantage of the M & M's and the applications software that will put the hardware to work, buy one of the more-powerful new machines. ▶◀



KEYBOARD MEDLEY

Keyboards are not all created equal. Like people, they come in a variety of sizes and shapes, and they all work differently. The differences among keyboards may seem trivial, but if you spend much time pounding on one, you'll want to ensure that it has the right feel for you. If you work on a number of different keyboards, trying to adapt to the differences among them can make you yearn for a long rest in a well-padded cell.

We want to keep you out of that cell, so here's the lowdown on various keyboards. We've got fat ones, thin ones, plain ones, fancy ones—there are eight in all, and they cover the majority of styles (PC, AT, and Enhanced) in common use. And several have features that make them attractive for special applications (typing, CAD, use by untrained users, etc.).

The original

IBM introduced the PC in 1981. The first thing many people noticed was that IBM completely abandoned the layout it had standardized on the Selectric series of typewriters. (See Fig. 1.) The major faults are that the Return key is small and hard to reach, and that the Backslash key is located between the "Z" key and the Left Shift key. Other features (which some users love, but many hate) are that the keys must be depressed far to get a response, and each depression causes the keyboard to emit a loud mechanical click (as opposed to a soft, electronically controlled one).

In addition, the Caps Lock, Num Lock, and Scroll Lock keys have no indicator lights, so you can't tell which mode you're in without typing something (and then erasing it!). Also, the layout of the numeric keypad leaves much to be desired. For example, there is no Enter key, but the "+" key occupies the space of three keys!

Key Tronic 5151

The first attempt to improve that unpopular layout was made by the Key Tronic company; it has become a standard in its own right, although it is not without its problems too.

The 5151 keyboard addressed many of the faults of the original. The biggest difference is that an additional keypad was added so that it is not necessary to toggle the Num Lock key to alternate between using the keypad to type numbers and move the cursor. The Return key was also enlarged, the Backslash key was moved to the far side of the Right Shift key, and the Grave key (`) was moved above the Return key, to leave more room for the latter.

In addition, the function keys were moved from the dual row on the left side of

the keyboard to a single row above the main portion of the keyboard. Indicator lights were added to the toggle keys, and an Enter key (which is equivalent to the Return key) was added to the existing numeric keypad.

The feel of the keys is mushy, and, although you're unlikely to press the backslash key accidentally with the 5151's layout, it's also hard to get to it (without looking) when you do want to press it. In addition, KeyTronic placed the Caps Lock key between the "A" key and the Ctrl key, so it's easy to hit it by mistake.

A Zenith clone

The keyboard Zenith Data Systems sells with several computers is shown in Fig. 3. It corrects many of the faults of the original IBM board, has a slightly mushy feel (but not as much as the KeyTronic model), and emits a nice keyclick (through the speaker in the system unit). The Return key is large, and there is an Enter key in the numeric keypad. The Backslash key was moved down a row, so that it's between the Spacebar and the Alt key. You're not likely to hit it accidentally, but it can be hard to home in on, especially if you also use an IBM or other keyboard. One nice feature is that the toggle keys all have internal LED's. The keyboard is available separately; see Table 1 for more detailed information.

The AT layout

Everyone in the industry knew that there was widespread dissatisfaction with the original IBM layout, but IBM ignored that dissatisfaction when it introduced the XT in 1983. In fact, it wasn't until the AT was introduced in 1984 that IBM attempted to correct its error. We were unable to obtain an AT keyboard to photograph, but the layout

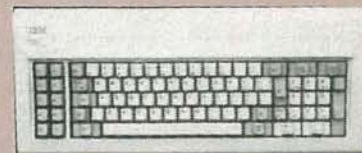

FIG. 1—IBM'S ORIGINAL KEYBOARD



FIG. 2—THE KEY TRONIC KB5151, AN EARLY CLONE



FIG. 3—A ZENITH CLONE



FIG. 4—A FOREIGN CLONE (IN THE AT STYLE)

TABLE 1—PRODUCTS REVIEWED

Product	Manufacturers
RapidWriter \$595	Quixote Corporation One East Wacker Drive Chicago, IL 60601. 800-325-1850 (Illinois) 800-523-8356 (Elsewhere)
KB5151 \$255	Key Tronic Corporation P.O. Box 14687 Spokane, WA 99214 800-262-6006
KB5153 \$299	
Turbo-101 \$149.95	DataDesk International 7650 Haskell Avenue Van Nuys, CA 91406 800-826-5398
100-1861 \$125	Heath Company Parts Department Benton Harbor, MI 49022 616-982-3571

Contact your local IBM representative for information on the IBM Enhanced keyboard.

of the AT-style clone keyboard (shown in Fig. 4) is quite similar. Notice that the Enter key is much larger now. However, the BackSpace key is smaller, and the Backslash key has been moved to the upper row (between the BackSpace and the "=" keys).

The clone board shown in the photo has an Enter key in the keypad, but the AT does not. In addition, on the AT, the upper right keypad key is labeled SysReq; that key is not normally used by DOS. Beneath it is the PrtSc key, followed by the "-" key and the "+" keys. On the AT, the "+" key occupies the space of two keys.

The strangest thing about the AT layout is that the Esc key has been moved from its traditional place at the upper left corner of the main keyboard to the upper left corner of the numeric keypad. One can only speculate why that was done. The Grave key was moved to the normal Esc position. The AT keyboard also has indicator lights for the toggle keys.

IBM's Enhanced keyboard

Two years after the announcement of the AT, IBM introduced the XT 286, a machine



FIG. 5—IBM'S ENHANCED KEYBOARD



FIG. 6—THE DATADESK TURBO-101



FIG. 7—QUIXOTE CORPORATION'S RAPIDWRITER

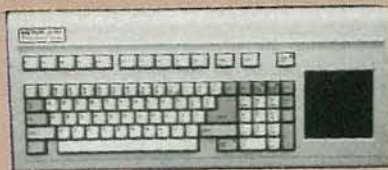

FIG. 8—THE KEY TRONIC KB5153

halfway between the XT and the AT in computing power. Along with the XT 286 came a new keyboard, the so-called Enhanced keyboard. If you had never seen a computer keyboard before, you'd probably say that it's a work of art. (See Fig. 5.) The main keyboard has a symmetrical layout and there are separate numeric and cursor keypads. Also, there are two new function keys, for a total of twelve function keys, and 101 keys overall.

The feel of the new keyboard is wonderful; you don't have to press the keys very far or very hard. There's no audio feedback, but you don't need it; the keys themselves provide a pleasant yet unobtrusive click.

In fact, there's only one real problem with the Enhanced keyboard: the Ctrl key. Actually there are two Ctrl keys and two Alt keys, located symmetrically on both sides of the Spacebar. The normal position for the Ctrl key is now occupied by the Caps Lock key. If you're used to a keyboard with Ctrl in the normal position, you may go wild trying to adapt to the new position.

Another anomaly of the Enhanced keyboard is that the Esc has been moved yet

again—now it's at the left edge of the upper row of keys, by the Function keys. At least that's the same general area as normal.

The numeric keypad finally has an Enter key, and the Backslash key is now in a reasonable location: just above the Enter key in the main keyboard. In addition, the Back-Space key is now large and easy to find; it's located just above the Backslash key.

The DataDesk Turbo-101

There's always someone waiting to correct an IBM mistake. The Turbo-101 has much going for it, including a switch that allows you to swap the functions of the Caps Lock and the Left Ctrl keys, and keycaps to make it look as if the keyboard had been designed that way from the beginning.

In addition, another switch adapts the board for use with either a PC (or XT) or an AT. The board can also be used with either the old BIOS ROM (which doesn't recognize the new function keys) or new BIOS ROM's (which do). If you use the Turbo-101 with an old BIOS ROM, F11 generates Alt-F9 and F12 generates Alt-F10 key codes. By cutting the leads of two diodes, you can force the keyboard to generate the new scan codes for those keys. Further, the Turbo-101 comes with a copy of Borland's Turbo Lightning, a combination spelling checker and thesaurus.

The only problem with the keyboard is that each key has a soft detent that is inferior to that of IBM's Enhanced keyboard. Other than that, the Turbo-101 is a good deal.

Special keyboards

Several firms have taken the idea of improving the IBM keyboard further than merely re-arranging the layout. For example, the RapidWriter (shown in Fig. 7) is a hardware/software combination that is designed to increase secretarial efficiency by automating the process of typing repetitive words and phrases.

The keyboard is identical to the KeyTronic 5151. (Just as we were going to press Quixote Corporation informed us that future versions of RapidWriter will come with a 101-key enhanced keyboard. The software has also been upgraded.)

The software loads a special keyboard driver that senses when several keys are pressed simultaneously. That condition is called a "chord" by Quixote. When the keys corresponding to a previously stored chord are pressed, an entire word or phrase flows into the current document, just as if that word or phrase had been typed at the keyboard. Chords are stored in dictionaries; each dictionary can contain 250 chords for a total of 16,000 characters. You can have an unlimited number of dictionaries, as each is stored in a separate disk file.

You can cause the first letter of a chord to be capitalized by pressing a Shift key when you press the chord. Or you can capitalize the entire chord by pressing Caps Lock with the chord. In addition, you can define

chords that pause one or more times during chord expansion, allowing you to type information at the keyboard. And a chord can "call" another chord, expand it, and return to the calling chord. You can also edit and print chords.

KeyTronic 5153

The most innovative and useful special keyboard we've seen is the KeyTronic 5153 (shown in Fig. 8), because it contains a programmable keypad (on the right side of the unit) instead of separate numeric and cursor keypads.

The basic keyboard layout is in the AT style, with the Escape key in the numeric keypad. The keyboard has the typical KeyTronic feel—mushy, but not so mushy as some inexpensive clones. The programmable keypad is like a digitizing tablet; it can resolve motion to a precision of about 0.001 inch. You use the keypad by pressing it with your finger or with a plastic stylus.

The keypad has several modes of operation. You can use it as a cursor keypad, in which each press is converted into equivalent cursor-key codes. In the function-key mode, the pad is divided into a number of squares, each of which is freely programmable. KeyTronic supplies program files (and plastic overlays) for common DOS commands (DATE, TIME, TYPE, FORMAT, etc.), and for popular applications programs, including WordStar and Lotus 1-2-3. KeyTronic also supplies software that allows you to create your own keypad macro files (for matrix sizes of 2 x 2, 3 x 3, 4 x 4, or 5 x 5), and blank overlays.

In the mouse mode, the keypad emulates operation of the Microsoft mouse; to use it, you run the stylus across the keypad. A graphics mode functions similarly, but each point on the keypad corresponds to a point on the display screen. You can also use the keypad in several modes that combine the above modes.

Conclusions

Each of the keyboards we examined has merit; some are better for particular applications than others. The main features you'll want to consider when buying a keyboard are the overall layout, indicator lights, feel (mushy, "clicky," or somewhere between the two), and extra features (bundled software, for example). The most important feature is layout, so examine it carefully; layout can make the difference between productive and non-productive use of a machine. Try before you buy.

Which would we choose? For general use, the IBM Enhanced keyboard. It has by far the best feel, and is now the standard of IBM's entire line of PC's.

The KeyTronic 5153 is our runner-up. It has a good feel, and the keypad can save the cost of a mouse, a digitizing tablet, or both. A person just starting out in computing could get by with it until he or she could justify the cost of the extra peripheral. ♦♦♦

FROM KEYPRESS TO SCAN CODE

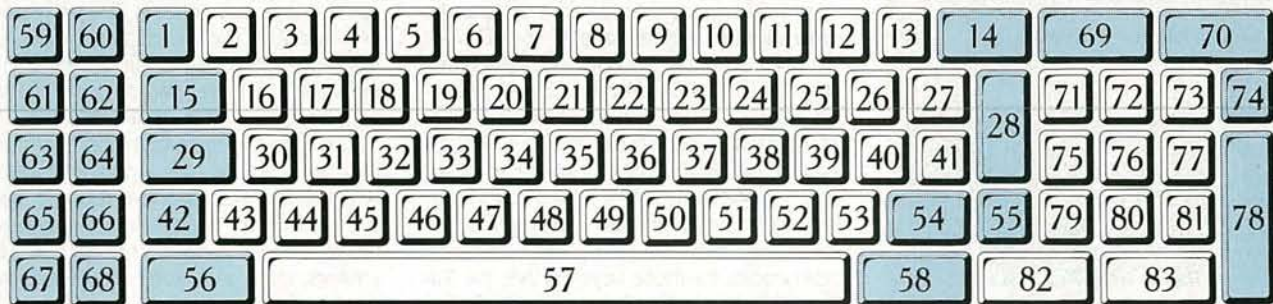

*IBM keyboards come in a variety of sizes and shapes—
here's how they work and how they differ from
one another.*

JEFF HOLTZMAN,

TECHNICAL EDITOR

IBM's *Technical Reference* manuals are notorious sources of both information and misinformation—or perhaps we should say non-information. Keyboard documentation is a perfect example. The “schematic diagram” (from the manual for the original PC) is little more than a block diagram, and is little help in understanding how the keyboard works. The circuit functions basically as discussed in our other article on keyboards this issue, except that the 8048 microprocessor performs the matrix scanning that the logic IC's do in the discrete-logic versions.

The most informative (and interesting) information about how the keyboard functions in the IBM PC is contained in the software listings in IBM's *Technical Reference* manuals. In this article we'll discuss how the software processes the raw key codes generated by the hardware, and we'll present a BASIC program that demonstrates graphically how your keystrokes are interpreted at various levels by the computer.

Hardware, BIOS, DOS

You can view the IBM PC from three different perspectives, as shown in Fig. 1. At the lowest level is the hardware: the microprocessor, RAM and ROM memory, the disk drives, the display

adapter card, the monitor—and the keyboard. Controlling the hardware, of course, is software; and, in the IBM, there are two levels of control software.

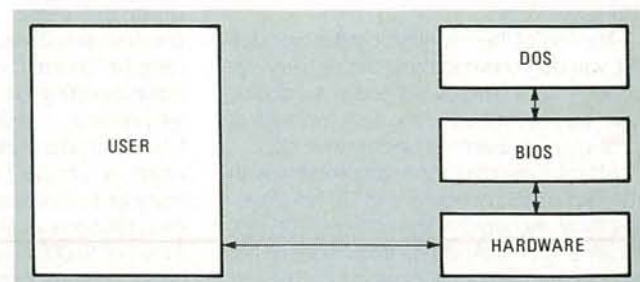

FIG. 1—HARDWARE AND TWO LEVELS OF SOFTWARE comprise the IBM PC. The user interacts with the hardware, which communicates with the BIOS. DOS provides a number of high-level functions for programmers to use in accomplishing a wide variety of tasks, including reading and writing disk drives, communications ports, and the keyboard.

The lower of those two levels is the BIOS (Basic Input/Output System); it is contained in a ROM (or in an EPROM on most clones). Code in the BIOS ROM is responsible for all of the low-level functions of the computer: displaying characters on the screen, sending them to the printer, transferring data to and from the disk drives, getting keystrokes from the keyboard, etc.

The upper software level is the DOS (Disk Operating System), which is contained in several files on disk. DOS is the level through which programmers are supposed to display data, manipulate disk files, and get keystrokes. However, to improve performance (or sometimes just by preference), many programmers go to the BIOS (or even to the hardware itself).

Interrupts

To understand how the hardware communicates with the software, you must understand the basics of interrupts. A device (the keyboard, for example) can interrupt the normal processing of the

Other software interrupts, at both BIOS and DOS levels, allow many operations, including displaying characters, getting user input from the keyboard, reading and writing disk drives, reading and writing communications ports, etc. As we saw, interrupts can interrupt each other (sometimes—but that's a story that we'll not get into here.) With the basics of interrupts in mind, now let's see how the keyboard-interrupt-processing software works.

Keyboard hardware, BIOS software

Keyboard processing on the IBM provides a good example of how the hardware meshes with the software. As we said, each keypress generates an interrupt 9. That interrupt is processed in the BIOS ROM and then passed on to DOS for further, more sophisticated handling.

There are 83 keys on the standard IBM keyboard; each has an associated eight-bit scan code. The keys and their scan codes are shown in our lead illustration and in Table 1. Each time you press a

TABLE 1—IBM KEYBOARD CODES

Code	Label	Code	Label	Code	Label	Code	Label
1	Esc	22	U	43	\	64	F6
2	1	23	I	44	Z	65	F7
3	2	24	O	45	X	66	F8
4	3	25	P	46	C	67	F9
5	4	26	[47	V	68	F10
6	5	27]	48	B	69	NumLk
7	6	28	Retn	49	N	70	ScrLk
8	7	29	Ctrl	50	M	71	Home
9	8	30	A	51	,	72	UpArw
10	9	31	S	52	.	73	PgUp
11	0	32	D	53	/	74	—
12	—	33	F	54	RShft	75	LftAr
13	=	34	G	55	PrtSc	76	5
14	Bksp	35	H	56	Alt	77	RgtAr
15	Tab	36	J	57	Space	78	-
16	Q	37	K	58	CapLk	79	End
17	W	38	L	59	F1	80	DwnAr
18	E	39	;	60	F2	81	PgDn
19	R	40	/	61	F3	82	Ins
20	T	41	\	62	F4	83	Del
21	Y	42	LShft	63	F5		

computer's 8088 microprocessor. When you press a key at the keyboard, it generates a signal that is sent to the computer; that signal says "Hey! Somebody pressed a key!"

The microprocessor then stops what it is doing and loads the address corresponding to the keyboard handler (interrupt 9) from a special location in memory. (Unless otherwise specified, all numbers in this article are in decimal notation). Processing continues at that address as the 8088 reads the keyboard port, converts the raw key code into something meaningful, and stores it for use by whatever program was running before the interrupt occurred. Last, the 8088 performs a special instruction (IRET, for Interrupt Return) that allows it to continue where it left off before the interrupt took place.

Devices other than the keyboard (the disk drives and the serial ports, for example) generate their own interrupts, which the 8088 processes in the same fashion. The difference is that each interrupt is directed to a different location in memory.

In addition to hardware interrupts, the 8088 also allows software interrupts for many commonly used functions. For example, when you press Shift-PrtSc, whatever is displayed on the screen is sent to the printer. That works as follows: First the two keypresses (Shift and PrtSc) generate their own interrupts. The computer processes those interrupts one at a time, and, when it realizes that a print-screen operation should be performed, it generates interrupt 5 (from within the interrupt-9 handler). Interrupt 5 does the screen-print and then returns to the interrupt-9 handler, which then returns to whatever program was in control when Shift-PrtSc was pressed.

key (any key, including the ones you don't normally think of as generating a code—the Shift keys, Alt, Ctrl, etc.), the keyboard interrupts the microprocessor, sending it the scan code. Each time you release a key, the keyboard generates another interrupt, sending it the same scan code, but now with the high bit set (i. e., the scan code + 128).

The BIOS then translates the scan codes into ASCII and other codes, depending on the state of eight keys: Control, Alt, Delete, Insert, Left Shift, Right Shift, Num Lock, Caps Lock, and Scroll Lock. For example, the "A" key has a (hardware-level) scan code of 30. So when that key is pressed, the 8048 in the keyboard sends a 30 to the IBM BIOS through Interrupt 9. When the key is released, the keyboard sends a 158 (30 + 128) to the computer. If the "A" key is pressed continuously, the 8048 continuously sends 30's until the key is released, at which time a 158 is sent.

The BIOS would translate that 30 into a lowercase "a" (ASCII 97). But suppose that one of the shift keys were pressed simultaneously with the "A." In that case, the BIOS would translate that 30 into an uppercase "A" (ASCII 65). If the Control key were pressed, the hardware-level 30 would become a BIOS-level Cntl-A (ASCII 1). If Caps Lock were on and one of the shift keys were pressed, a lowercase "a" would be generated.

However, if the Alt key is pressed with the "A" key, something funny happens: The BIOS now generates two codes, the first of which is a zero, and the second of which is often (but not always) the scan code for that key. And the scan code, of course, bears no relation to standard ASCII codes. The Function keys, the arrow keys,

LISTING 1

```

10 REM Computer Digest Keyboard Demo
20 REM Copyright      Jeff Holtzman      03-27-87
30 GOSUB 2000
100 REM main loop -----
110 GOSUB 150          : REM update shift key display
120 AS=INKEY$
130 IF AS<>" " THEN GOSUB 200      : REM update DOS display
140 GOTO 110
150 REM Update status key display -----
160 YBOX=21:XBOX=-7:FLAG1=PEEK(&H17)
170 FOR SK=1 TO 8
175   XBOX=XBOX+10
180   IF FLAG1 AND 2^(SK-1) THEN GOSUB 500 ELSE GOSUB 400
185 NEXT
190 RETURN
200 REM Display DOS keys -----
205 A=ASC(AS)
210 LOCATE 13,36:PRINT A;
220 IF A=0 THEN PRINT ASC(MID$(AS,2)); ELSE PRINT " ";
230 LOCATE 5,22
235 IF INSTR(NOPRINT$,A$)=0 THEN PRINT A$; ELSE PRINT " ";
240 LOCATE 5,32:PRINT " ";
250 LOCATE 5,32
260 IF A > 127 THEN PRINT "Extended (8-bit) ASCII";:GOTO 300
270 IF A > 31 THEN PRINT "Regular (7-bit) ASCII";:GOTO 300
280 IF A > 0 THEN PRINT "Cntl-";CHR$(A OR &H40);:GOTO 300
290 PRINT DESC$(ASC(MID$(AS,2)));
300 RETURN
400 REM Clear box -----
410 REM inputs: xbox,ybox
420 LOCATE YBOX,XBOX
430 PRINT " ";
440 LOCATE YBOX+1,XBOX
450 PRINT " ";
460 RETURN
500 REM Fill box -----
510 REM inputs: xbox, ybox
520 LOCATE YBOX,XBOX
530 PRINT FILL$
540 LOCATE YBOX+1,XBOX
550 PRINT FILL$
560 RETURN
600 REM draw box -----
610 REM inputs: xbox,ybox : start position
630 REM      xlen,ylen : length
640 REM first do corners
650 LOCATE YBOX,XBOX
660 PRINT CHR$(201);
670 LOCATE YBOX,XBOX+XLEN-1
680 PRINT CHR$(187);
690 LOCATE YBOX+YLEN-1,XBOX
700 PRINT CHR$(200);
710 LOCATE YBOX+YLEN-1,XBOX+XLEN-1
720 PRINT CHR$(188);
730 REM now do horiz lines
740 FOR BOX=1 TO XLEN-2
750   LOCATE YBOX,XBOX+BOX
760   PRINT CHR$(205);
770   LOCATE YBOX+YLEN-1,XBOX+BOX
780   PRINT CHR$(205);
790 NEXT BOX
800 REM now do vert lines
810 FOR BOX=1 TO YLEN-2
820   LOCATE YBOX+BOX,XBOX
830   PRINT CHR$(186);
840   LOCATE YBOX+BOX,XBOX+XLEN-1
850   PRINT CHR$(186);
860 NEXT BOX
870 RETURN
900 REM Draw shift keys -----

```

```

910 YBOX=20:XLEN=8:YLEN=4
930 FOR FKEY=2 TO 72 STEP 10
940   XBOX=FKEY
950   GOSUB 600
960 NEXT
970 RESTORE 1070
980 FOR FKEY=3 TO 73 STEP 10
990   LOCATE 18,FKEY
1000  READ AS
1010  PRINT AS
1020  LOCATE 19,FKEY
1030  READ AS
1040  PRINT AS
1050 NEXT
1060 RETURN
1070 DATA Right,Shift,Left,Shift,,Control,,Alt
1080 DATA Scroll,Lock,Num,Lock,Caps,Lock,,Insert
1100 REM Draw BIOS box -----
1110 LOCATE 11,30
1120 PRINT "BIOS-level scan code ";
1130 XBOX=35:YBOX=12:XLEN=10:YLEN=3
1140 GOSUB 600
1150 RETURN
1200 REM Draw DOS boxes -----
1210 XBOX=20:YBOX=4:XLEN=5:YLEN=3
1220 GOSUB 600
1230 LOCATE 7,20
1240 PRINT "ASCII";
1250 XBOX=30:YBOX=4:XLEN=26:YLEN=3
1260 GOSUB 600
1270 LOCATE 7,32
1280 PRINT "Description";
1290 LOCATE 3,31
1300 PRINT "The DOS Interpretation";
1310 RETURN
2000 REM Initialize -----
2010 KEY OFF:CLS:DEFINT A-Z:DEF SEG=&H40
2020 FOR I=1 TO 6:FILL$=FILL$+CHR$(219):NEXT
2030 FOR I=1 TO 10:KEY I,"":NEXT
2040 NOPRINT$=CHR$(7)+CHR$(9)+CHR$(10)+CHR$(12)+CHR$(13)
2050 LOCATE 1,19,0
2055 PRINT "Computer Digest Keyboard Demonstration";
2060 GOSUB 900 : REM draw shift keys
2070 GOSUB 1100 : REM draw BIOS box
2080 GOSUB 1200 : REM draw DOS box
2090 DIM DESC$(132)
2100 RESTORE 3010
2110 FOR I=1 TO 132:READ DESC$(I):NEXT
2120 RETURN
3000 REM Key label data -----
3010 DATA ,,Null,,,,,,,,,,,,
3020 DATA Back-Tab
3030 DATA Alt-Q,Alt-W,Alt-E,Alt-R,Alt-T,Alt-Y,Alt-U,Alt-I,Alt-O,Alt-P
3040 DATA ,,
3050 DATA Alt-A,Alt-S,Alt-D,Alt-P,Alt-G,Alt-H,Alt-J,Alt-K,Alt-L
3060 DATA ,,
3070 DATA Alt-Z,Alt-X,Alt-C,Alt-V,Alt-B,Alt-N,Alt-M
3080 DATA ,,
3090 DATA F1,F2,F3,F4,F5,F6,F7,F8,F9,F10,,
3100 DATA Home,Up-arrow,PgUp,,Left-arrow,,Right-arrow,,End,Down-arrow
3110 DATA PgDn,Ins,Del
3120 DATA Shift-F1,Shift-F2,Shift-F3,Shift-F4,Shift-F5
3130 DATA Shift-F6,Shift-F7,Shift-F8,Shift-F9,Shift-F10
3140 DATA Cntl-F1,Cntl-F2,Cntl-F3,Cntl-F4,Cntl-F5
3150 DATA Cntl-F6,Cntl-F7,Cntl-F8,Cntl-F9,Cntl-F10
3160 DATA Alt-F1,Alt-F2,Alt-F3,Alt-F4,Alt-F5
3170 DATA Alt-F6,Alt-F7,Alt-F8,Alt-F9,Alt-F10
3180 DATA Cntl-PrtSc,Cntl-Left-arrow,Cntl-Right-arrow
3190 DATA Cntl-End,Cntl-PgDn,Cntl-Home
3200 DATA Alt-1,Alt-2,Alt-3,Alt-4,Alt-5
3210 DATA Alt-6,Alt-7,Alt-8,Alt-9,Alt-0
3220 DATA Alt-,Alt=,Cntl-PgUp

```

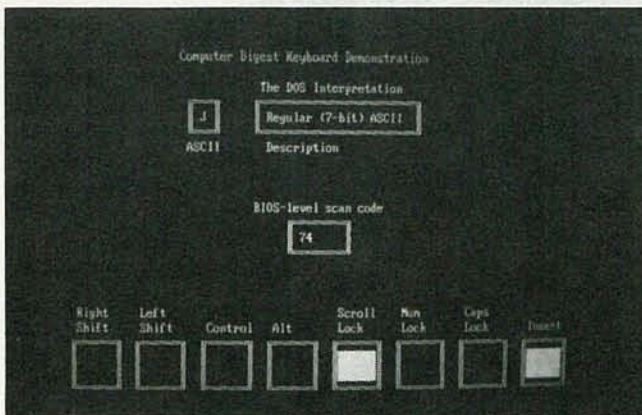

FIG. 2—OUR DEMONSTRATION PROGRAM shows the state of all shift keys, BIOS-level scan codes, and the high-level interpretation of those codes.

Home, etc., all generate the two-byte codes.

If you want to see which codes are generated by which keys (and combinations of keys), the program in Listing 1 provides a graphic representation of how those keys are interpreted. You can download the program (KEYMON.BAS) from our BBS (516-293-2283); if you type it in yourself, make sure you enter all the commas in the DATA statements.

For example, after pressing Scroll Lock, Insert, and the "J" key, the screen appears as shown in Fig. 2. You'll notice that the boxes corresponding to the Shift keys, Ctrl, and Alt light up as long as you press those keys and go dim when you release them. By contrast, Num Lock, Scroll Lock, Caps Lock, and Insert are toggles—each time you press one of those keys, an internal flag is alternately set and reset that indicates the given state (on or off).

You'll notice that some keys and key combinations produce no display. For example, the "5" key in the keypad produces no code when Num Lock is off. It's important to understand that every time you press any key the keyboard generates an interrupt (unless the keyboard buffer is full, at which point the keyboard will beep). If pressing a key produces no apparent result, that's because the BIOS has defined no code for that key (or combination).

Some programs make use of the "undefined" keys. For example, Cruise Control (reviewed in this month's Editor's Workbench), uses that "5" key (when Scroll Lock is off) as a special hotkey for controlling various functions. However, to get at those undefined keys, you have to write a complete Interrupt 9 handler—and that's no trivial pursuit.

Our demonstration program has several "bugs." Those bugs are due to differences between the ways that BASIC and DOS treat the keyboard. For example, if you print a CHR\$(12) to the screen in BASIC, the screen will be cleared. In DOS, however, you'll see the "female" symbol (a circle over a cross). There are several such anomalies; tracking them down will teach you much about BASIC and DOS, as well as the keyboard.

ASCII, extended ASCII, and special codes

Basically, ASCII is a seven-bit code that provides a total of 128 (2⁷) unique codes. However, personal-computer memory is organized in eight-bit (or 16-bit) chunks. So why didn't IBM encode all the special keys in the upper 128 ASCII codes? The reason is that IBM wanted to retain the upper codes for use by displayable characters. For example, most of the codes from 128 to 167 are foreign-language characters. Others include box-drawing characters, special math symbols, etc.

You know how to type in standard ASCII codes and the two-byte special codes—but how do you type in the extended ASCII codes? Some programs let you do so directly (for example, by associating special characters with the Function keys); the IBM BIOS lets you type in any ASCII code from 1 to 255 as follows. Press the Alt key, and hold it down. Now type the three-digit decimal code that corresponds to the desired character. Use only the keypad

keys, not the number keys above the main keyboard. After you release the Alt key, the character will be displayed. That procedure works in BASIC, at the DOS command line, and in some (but not all) applications programs.

New keyboards

When IBM introduced the IBM PC AT in 1984, it introduced a new keyboard. The AT keyboard has a new layout (as shown in the review in Editor's Workbench this issue), and it works differently. The biggest hardware difference is that the keyboard now both transmits and receives data. You can force it to stop scanning temporarily, resume scanning, set the "Typematic" (repeat) rate, and turn the status-indicator LED's on and off.

In addition, the hardware-level scan codes have changed. The keys have different numbers, and there is one new key. However, those hardware differences are transparent at all levels above (and including) the BIOS. So our demonstration BASIC program works on the AT. But any program that works with the keyboard at the Interrupt 9 level must know whether it is running on an AT or a standard PC.

IBM still wasn't satisfied with the state of keyboard confusion, so, when the company introduced the XT 286 last fall, it introduced yet another keyboard. The new keyboard has 101 keys, even more commands issuable by the system, and three (!) software-selectable sets of scan codes. The first set is similar to the PC/XT set; the second set is similar to the AT set; and the third set is similar to the AT set, except that every key generates a unique code, regardless of the state of any of the shift keys (including Cntl, Alt, etc.) The last set should make it unnecessary for keyboard-enhancement programs to take over the keyboard-processing interrupts completely. However, such programs will still have to contend with the PC/XT and AT keyboards. Set 2 is the power-up default set.

To give you some idea of how the three sets of scan codes are related, consider this example. The enhanced keyboard has two Insert keys, one in the numeric pad (key 99), the other in the new cursor-control pad (key 75) located between the typewriter and the numeric-keypad sections. Table 2 shows the codes that are generated from each set when Insert is pressed and no shift keys are pressed.

TABLE 2—ENHANCED KEYBOARD INSERT CODES

Code Set	Key 75		Key 99	
	Make	Break	Make	Break
1	E0 52	E0 D2	52	D2
2	E0 70	E0 F0 70	70	F0 70
3	67	F0 67	70	F0 70

Programming and the special keys

In BASIC, you can use the normal INKEY\$ function to get both standard and special keys. Normally INKEY\$ collects single characters, but when a special key is pressed, INKEY\$ returns two characters, the first of which is a CHR\$(0). As at the BIOS level, that's a sign that another character is available. You can test for the existence of a special code by checking the length of the string that INKEY\$ returns. Our demonstration program illustrates the procedure; see lines 100-220.

If you're interested in working with the keyboard in assembly language, you'll want to understand how BIOS interrupts 9 and 16, and DOS interrupt 33 (function calls less than 10) work. The best sources of information for BIOS listings and scan codes are IBM's *Technical Reference* manuals for the PC (or the XT), the AT, and the XT 286, as well as the DOS *Technical Reference* manual. Some of those manuals are hard to obtain (and expensive), so you may wish to consult Peter Norton's *Programmer's Guide To The IBM PC* and Ray Duncan's *Advanced MS DOS*. Both are published by Microsoft Press, and both are excellent sources of information on the BIOS, DOS and other subjects. ▶◀



WORKING WITH SURPLUS KEYBOARDS

How they work, and how to use 'em.

Robert Grossblatt

Once upon a time, most of us had to throw switches and turn dials, but if you spent some extra bucks, you could talk to your equipment by pressing buttons. Things stayed like that until calculators showed up. When computers hit the market, keyboards became commonplace.

Adding a keyboard to your own circuit is easy. And with the parts market loaded with surplus keyboards, it's inexpensive. But using a keyboard successfully means understanding how it works, how it's driven, and what you need to get it working. Once we know the theory, we'll talk about how to use those surplus keyboards sold in the back of this magazine.

All keyboard circuits are made up of three parts—the switches themselves, decoding circuitry, and encoding circuitry. The keys are wired so that each one produces a unique code that can be passed on to the decoder, the circuit's main section. The encoder will take the keypress and translate it into whatever kind of information is needed by the equipment the keyboard is talking to. Let's discuss each circuit in turn.

Two methods

The two methods most frequently used to wire up switches are with a common leg and in a row-and-column matrix. In Figure 1 you can see that both arrangements will let each keypress generate a unique code. A common-leg set-up (Fig. 1-a) is much simpler to design but is only suited to applications where a few switches are needed. Since each switch you add means another lead coming from the keyboard, large numbers of switches become wiring nightmares. A matrix keyboard (Fig. 1-b) has fewer connections but it usually needs more support circuitry.

The break-even point for connections is eight switches. A common-leg keyboard that size will need nine leads, and a matrix keyboard will need eight. Since there are advantages and disadvantages to both, which is best depends on what you're doing.

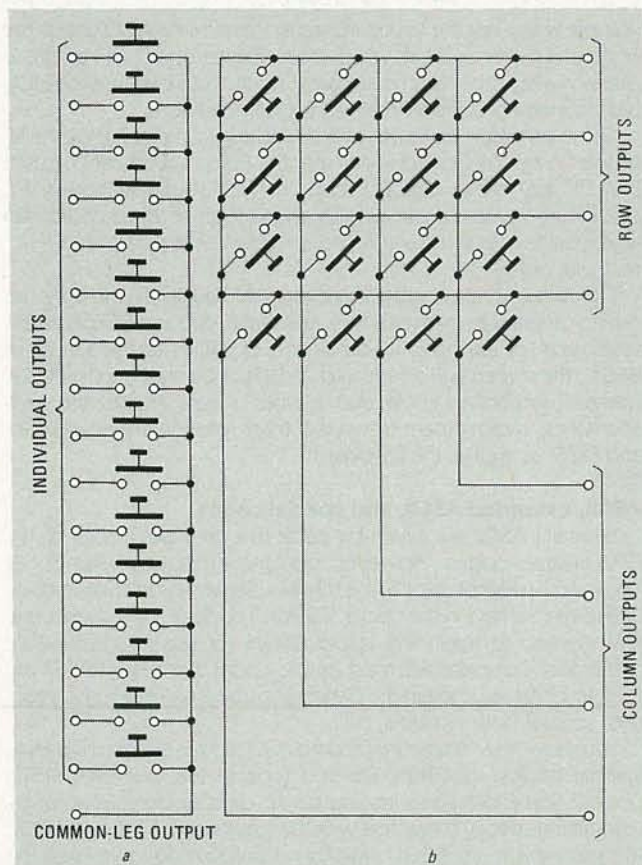

FIG. 1—A KEYBOARD can be wired from a linear array of switches (a) or in an X-Y matrix (b).

dition when its output was selected. In that case, the circuit would cycle through another count as the clock kept running. Only a valid keypress would produce valid data.

Two-key rollover

That circuit has two-key rollover. D1 to D16 isolate each of the 4514's output lines, so, if two keys are closed at the same time, the circuit will output the second bit of data as soon as the first key is released.

Figure 4 shows a circuit for a matrix keyboard. Though we're encoding the same number of switches as we did in the common leg arrangement, we only need nine leads from the keyboard instead of seventeen. The setup is different too. The basic idea behind using a matrix keyboard is to have the control signal come in on one side of the matrix and leave on the other. In Fig. 4, IC4 is a 4028 BCD-to-decimal converter. A binary address on the inputs causes the selected output to go high while all the rest remain low. As we're only handling a four-by-four switch matrix, we only need two of the inputs.

The two low-order bits from the 4520 are routed to the 4028, and the two high-order bits are routed to the 4512, an eight-channel data selector. When one of its inputs is selected, the signal at the input appears at the output. If a key is pressed, the high signal at the output of the 4028 is channeled through the 4512 and serves the same function as the common switch leg did in Fig. 3. It disables both the clock and the counter and also becomes our Any-Key-Pressed line to let other circuitry know that there's valid data on the bus. The circuit also has two-key rollover.

Look at Fig. 4—what about all those unused inputs and outputs on the 4028 and 4512? And what about the other half of the 4520? Even though we're only using a four-by-four keyboard, this same circuit can be set to handle a ten-by-eight keyboard! We'd cascade

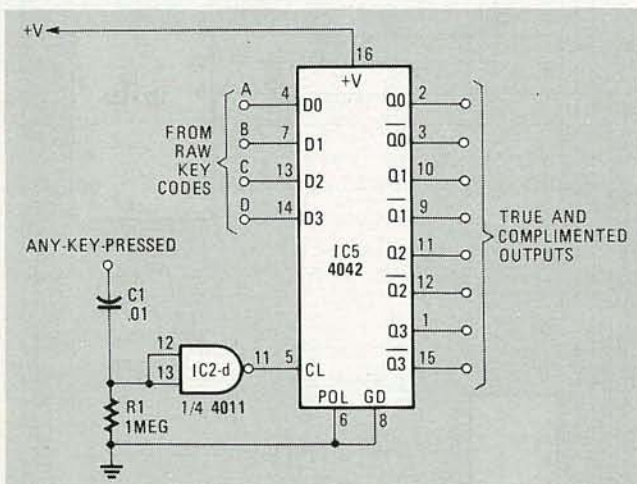

FIG. 5—YOU CAN LATCH THE OUTPUTS of the previous keyboard encoders with the circuit shown here.

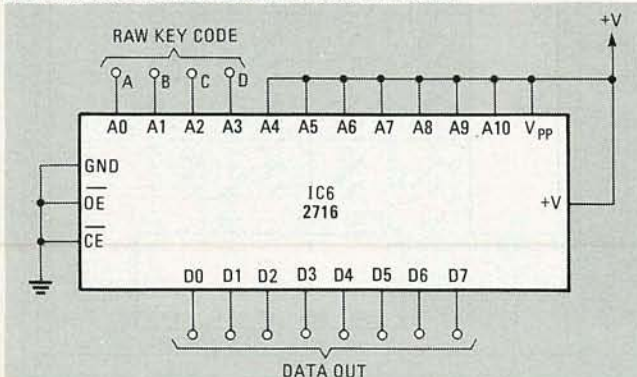

FIG. 6—A 2716 EPROM makes an inexpensive yet highly flexible keyboard decoder. It can be re-programmed an essentially unlimited number of times.

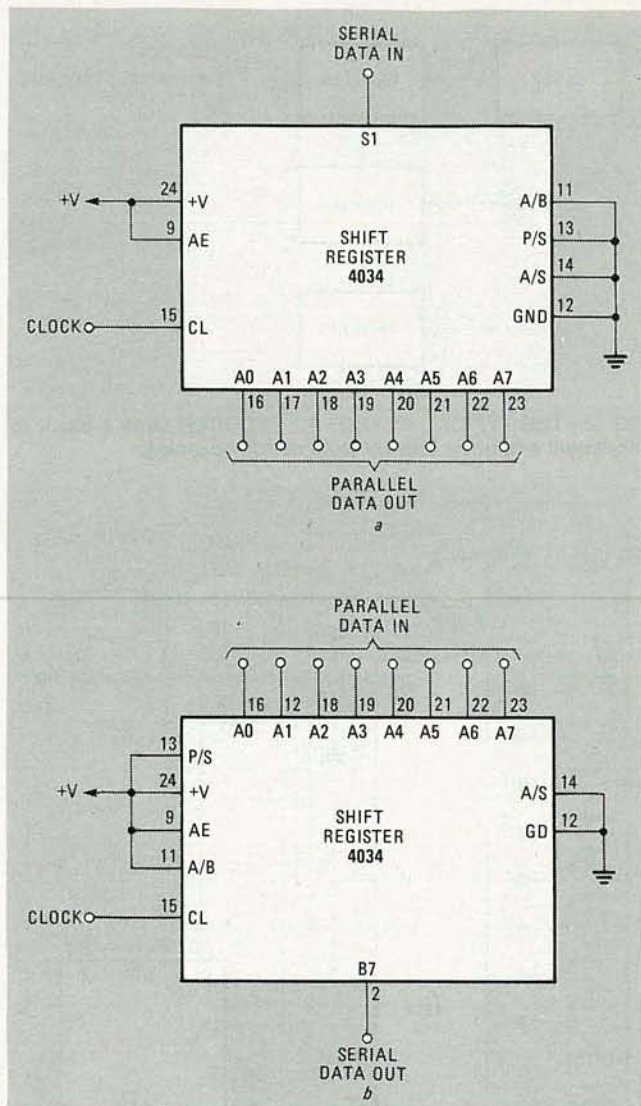

FIG. 7—A SHIFTR REGISTER can be used to convert the output of a serial keyboard to parallel form (a), or the output of a parallel keyboard to serial form (b).

the two halves of the 4520 to get the seven-bit word length we need and use the last bit to reset the counter.

Now that we've looked at these two basic approaches to keyboard design, it's plain to see why large keyboards use matrix switches instead of common-leg arrangements. But all we have is a keyboard that puts out raw code, and not elegantly. To remedy the situation, the first thing is to hang a latch on the bus. Which latch you use depends on what you want to do with the keyboard. As we're dealing with a four-bit word length, the 4042 seems a good choice, but we have to do something to control how data is clocked into the latch.

If we use the Any-Key-Pressed line to directly control storing data in the latch, there's a chance we're going to get flaky behavior because of timing problems. Things have to happen in sequence. First valid data has to be on the bus, then it has to be clocked into the latch. The Any-Key-Pressed line has to signal something else that waits a while and then opens the latch for storage.

Since we have a NAND gate left over, we'll use it to build an edge detector and control the latch as shown in Fig. 5. Since the latch's polarity control, pin 6, is tied low, the latch will ignore its inputs as long as the store control, pin 5, stays high. Bringing the store input low will write data into the latch. The edge detector made from IC2-d will generate a negative-going pulse when it sees a positive pulse at its input. With the values given for C3 and R4, the pulse will be about 10 milliseconds wide.

R-E Engineering Admart

Rates: Ads are 2 1/4" x 2 7/8". One insertion \$825. Six insertions \$800 each. Twelve insertions \$775 each. Closing date same as regular rate card. Send order with remittance to **Engineering Admart**, Radio Electronics Magazine, 500-B Bi-County Blvd., Farmingdale, NY 11735. Direct telephone inquiries to Arline Fishman, area code-516-293-3000. **Only 100% Engineering ads are accepted for this Admart.**

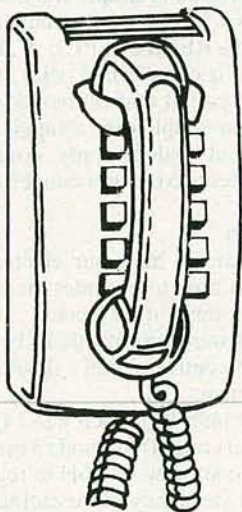

CALL NOW AND RESERVE YOUR SPACE

- 6 x rate \$800.00 per each insertion.
- Reaches 239,312 readers.
- Fast reader service cycle.
- Short lead time for the placement of ads.

Call 516-293-3000 to reserve space. Ask for Arline Fishman. Limited number of pages available. Mail materials to: Engineering Admart, RADIO-ELECTRONICS, 500-B Bi-County Blvd., Farmingdale, NY 11735.

Circuit Board Layout Made Easy!

Create and Revise
P-C-B Artwork on your
IBM or Compatible

- User Friendly
- Supports Microsoft Mouse
- Economical
- 2X artwork on printer
- On-line Help Screen

Requirements: IBM or compatible PC - 256K memory - CGA card - IBM graphics compatible printer.

ONLY \$99.00

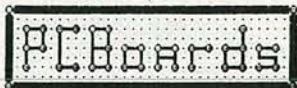

2145 Highland Ave./Ste. 201
Birmingham, Al. 35205
(205) 933-1122

DEMO DISK \$10.00

CIRCLE 203 ON FREE INFORMATION CARD

DIAGNOSE VHS VCR MECHANICS

WE'LL SHOW YOU HOW!

One of the most important VCR servicing tools for preventing tape damage is a precision torque gauge for Take-up, Stop, FF, and REW brake and clutch torque.

The New Tentel TQ-600 dial torque gauge comes complete with instructions and a specially modified cassette to allow critical readings to be made quickly and easily: Only \$139; and there's a 30 day money back guarantee if you aren't 100% satisfied. Tentel also manufactures other test instruments to make VCR mechanical testing fast and easy. Call or send for details and ordering information today!

Toll Free 800-538-6894

TENTEL Corp.
1506 Dell Ave
Campbell CA 95008



408-379-1881

800-538-6894 (except Calif.)

CIRCLE 180 ON FREE INFORMATION CARD

117 PRACTICAL IC PROJECTS BUILD YOU CAN

2645T—117 PRACTICAL IC PROJECTS YOU CAN BUILD.....

\$10.95. Dozens of fully-tested, ready-to-build circuits you can put together from readily-available, low cost IC's! There are a total of 117 IC circuits ranging from an audio mixer and a signal splitter to a tape-deck amplifier and a top-octave generator organ! From TAB Books. To order your copy send \$10.95 plus \$2.75 shipping to Electronic Technology Today Inc., P.O. Box 240, Massapequa Park, NY 11762-0240



LINEAR IC EQUIVALENTS & PIN CONNECTIONS

Linear IC
Equivalents
and Pin
Connections

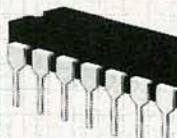

BP141—Shows equivalents & pin connections of a popular user-oriented selection of European, American and Japanese linear IC's 320 pages, 8 x 10 inches. \$12.50 Plus \$2.75 shipping. ELECTRONIC TECHNOLOGY TODAY INC., PO Box 240, Massapequa Park, New York 11762-0240.

So there they are, two complete keyboard circuits that will latch unique keycodes from matrix and common-leg keyboards. While you could use the circuits as they are, the data they generate is raw... We still need the third basic part of any keyboard—an encoder.

The encoder

The encoder takes raw data from the keyboard and translates it into something useful—ASCII, custom data, control signals, etc. And there are lots of ways to build one. You can do it with gates, but that buys you a lot of complexity at the cost of flexibility. ROM is a much better way to go. It only takes one chip and the whole configuration of the keyboard can be changed by switching memory. Unless you've got a lot of money, the best memories to use are EPROM's. They're cheap, easy to program, and erasable.

In Fig. 6 you can see how an EPROM would be connected to the circuits we've put together. Since Chip Enable (pin 18), and Output Enable (pin 20), are both held low, a unique address on the address lines (the inputs), will result in programmed data at the outputs. And the data you put in the EPROM is whatever you want for your

particular application. It can be discrete code, or, if you add a bit of clocking, whole strings of data.

Now that we know how keyboards work, what about those keyboards that are available on the surplus market? There are different types—some are ASCII encoded, some are oddball encoded, and some are not encoded at all. The data can come out of the keyboard in either parallel or serial form. You can convert between parallel and serial with only a shift register and a clock. The circuit of Fig. 7-a will convert from serial to parallel, and the circuit of Fig. 7-b will go the other way. You can build a small clock circuit or steal some pulses from the keyboard you're converting.

One last point: Although we've built our keyboards with discrete IC's, there are lots of IC's around that do all the work for you. All you do is connect the switches and add a handful of parts. Most commercial keyboards will use either this approach or do the whole job with something like an 8048 and some software. A gates-only design is a good compromise between cost and complexity. The important point is that no matter how the keyboard works, it has to have the three basic parts we covered. ▶◀

R-E ROBOT

continued from page 46

The byte-wide input and output ports can also be tested. The following word tests the output latch.

```
: TEST2 BEGIN 0 150 PC! FF 150 PC!
?TERMINAL UNTIL ;
```

The parallel input port can be tested with the following test word. Four lines

are available to you at PL1:

```
: TEST3 BEGIN 120 PC@ 10 / . CR
?TERMINAL UNTIL ;
```

Execute TEST3 and then short some of the inputs to ground. As you short each input, you should see the display on the screen change.

Expansion

The robot can be expanded in various ways. If your expansion project requires full use of the RPC, simply couple your

circuits to the RPC bus. To interface the circuitry, you need only duplicate the wait-state generator and the bus-buffer interface described in Part 6 (May, 1987). Select a block of I/O space between 0100H and E000H and start designing.

If your circuit is simple and needs only one or two I/O locations connect it directly to the RERBUS, PL3. Address decoding is accomplished with a single integrated circuit and no bus drivers are needed. For simple digital inputs, digital outputs, and analog inputs, connect the circuit directly to the user connector, PL1.

Operation

Now that we have our electronics in place, it is time to consider the software required to make it all work.

The software commands to be sent to the motor control circuits should follow this sequence:

- Set up timer 0 of each 8253 (left and right wheel control) for mode 3 operation. We write control word 36H to register 3.
- Write a frequency representing a slow speed into timer 0. We write 0200H to register 0.
- Close the forward or reverse relay. Write 1 to location 0120H.
- Now enable the PLL. Write 1 to location 0124H.

Notice that the relays are closed before the circuit is enabled. That prevents arcing when the contacts close or open.

All those functions are programmed using RCL (Robotic Control Language), a sophisticated language that is implemented in Forth. The RCL lets us control the robot's motions and functions using simple commands. Further, because Forth is extensible, RCL is extensible. That means that any code we write becomes part of the language.

That last feature is especially valuable. For instance, to control circuits connected to the RERBUS we have to change the way in which the byte store and byte fetch words operate—it's like writing new PEEK and POKE words in BASIC.

Forth's extensibility allows us to create two new words, PCX! and PCX@, that we can use to access the RERBUS. Those words will operate just like PC! and PC@ but they'll do all of the data manipulation required by the RERBUS. The computer code used to create those words is shown in Table 2.

Notice that we have documented our code with comments to allow you to determine how it operates in case something goes wrong or you want to change it. The comment immediately after the word being defined is a standard Forth-notation comment showing the effect of the word on the stack. For example, PC@ pops one argument off the stack (the address) and pushes one argument on the stack (the data). Next time, we will examine the RCL in greater depth.

R-E

ELENCO PRODUCTS AT DISCOUNT PRICES!



TWO
100MHz
SWITCHABLE
PROBES
INCLUDED



20MHz DUAL TRACE OSCILLOSCOPE
\$349 MO-1251

35MHz DUAL TRACE OSCILLOSCOPE
\$498 MO-1252

Top quality scopes at a very reasonable price. Contains all the desired features. Elenco's 2 year guarantee assures you of continuous service. Two 1x, 10x probes, diagrams and manual included. Write for specs.

MULTIMETER with CAPACITANCE AND TRANSISTOR TESTER
Model CM-1500 **\$65**
Reads Volts, Ohms, Current, Capacitors, Transistors & Diodes

TRUE RMS 4 1/2 DIGIT MULTIMETER
Model M-7000 **\$135**
.05% DC Accuracy
.1% Resistance with Freq. Counter & Deluxe Case

Auto Ranging plus Manual Ranging
3 1/2 Digit Meter
28 Functions Fully protected
M-1180 .7% Acy \$36.95
M-1182 .25% Acy \$39.95
M-1181 .1% Acy \$42.95

GF-8016 FUNCTION GENERATOR with Freq. Counter
\$219
• Sine, Square, Triangle
• Pulse, Ramp, .2 to 2MHz
• Frequency .1 thru 10MHz
GF-8015 without Freq. Meter \$189

10MHz OSCILLOSCOPE
\$199
Model S-3000
• 10MHz DC or AC
• Triggered Sweep
• Calibrated Vert & Hor
• Reads Volts & Freq

BREADBOARD
Model 9436 Shown
9430 1,100 pins \$15
9434 2,170 pins \$25
9436 2,860 pins \$35

DIGITAL TRIPLE POWER SUPPLY
Model XP-765 **\$195**
0-20V @ 1A
0-20V @ 1A
5V @ 5A
Fully Regulated, Short Circuit Protected with 2 Limit Cont. 3 Separate Supplies
XP-860 with Analog Meters \$149.50

DIGITAL LCR METER
\$148
Model LC-1800
Measures: Inductors, Capacitors, Resistors

50MHz LOGIC PROBE
20 nsec with memory LP-700
Logic Pulsar LP-600 **\$23**

DIGITAL 3 AMP POWER SUPPLY
Model XP-750 **\$165**
0-40V @ 1.5A
0-20V @ 3A
Fully regulated, short circuit protected current limit control
XP-650 with Analog Meters \$119.50

MULTI-FUNCTION COUNTERS
F-1000 1GHz **\$245**
F-100 100MHz **\$169**
Frequency, Period, Totalize, Self Check with High-Stabilized Crystal Oven Oscillator, 8 Digit LED Display

C&S SALES INC., 8744 W. North Ter., Niles, IL 60648 **15 DAY MONEY BACK GUARANTEE**
800-292-7711 (312) 459-9040 ASK FOR CATALOG

2 Year Limited Guarantee! Add 5% for Postage (\$10 max), IL Res., 7% Tax
CIRCLE 109 ON FREE INFORMATION CARD

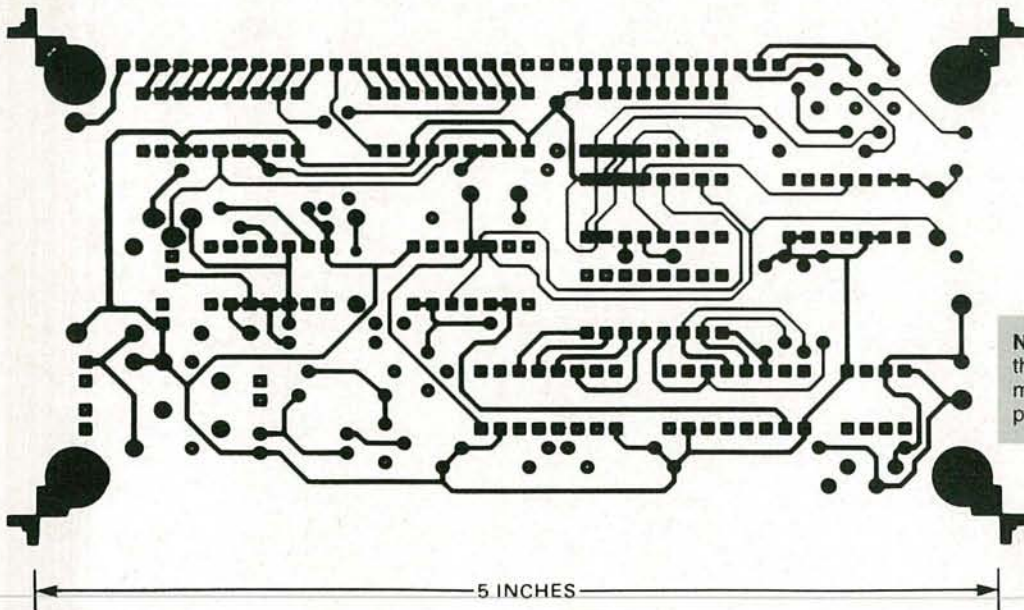

Note: The pattern for the display board of the tachometer will be presented next month along with the robot control board patterns.

THE SOLDER SIDE of the speedometer's main board is shown here.

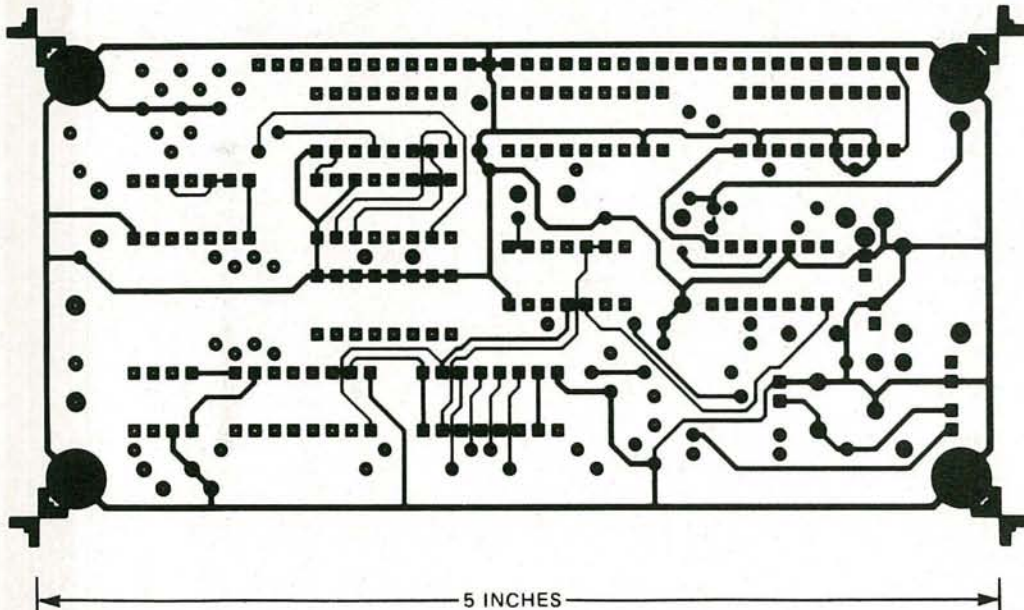

THE COMPONENT SIDE of the speedometer's main board. When mounting components, be sure to solder all leads completely.

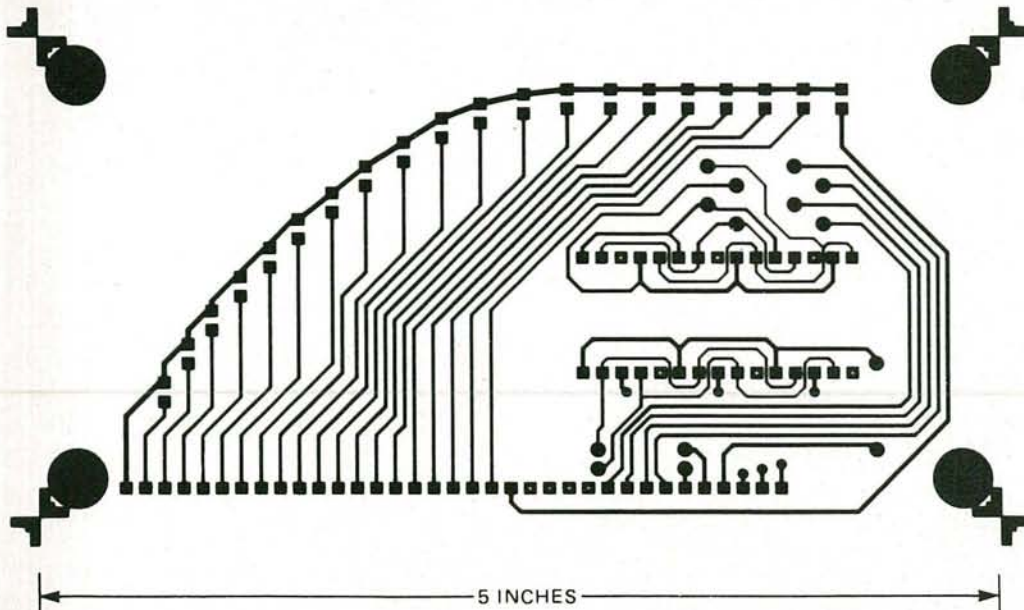

THE SPEEDOMETER'S DISPLAY BOARD. It is connected to the main board using 35 jumper wires.

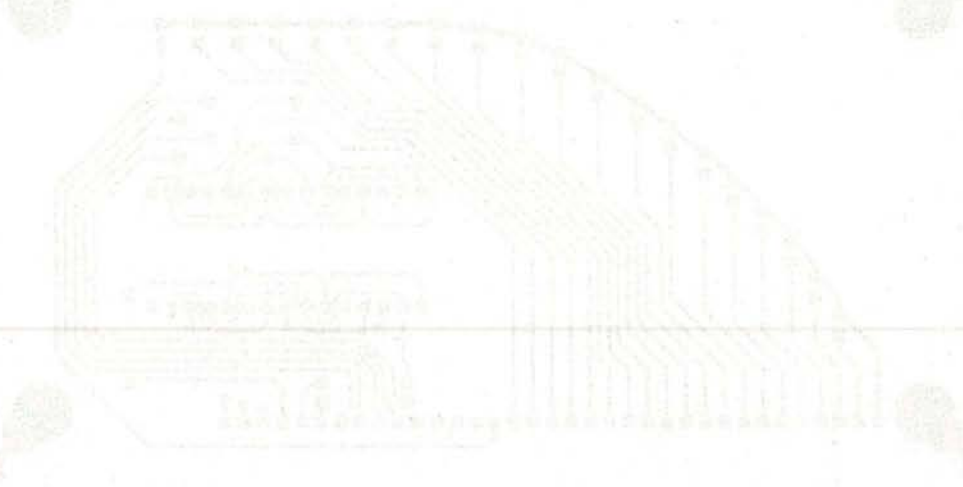
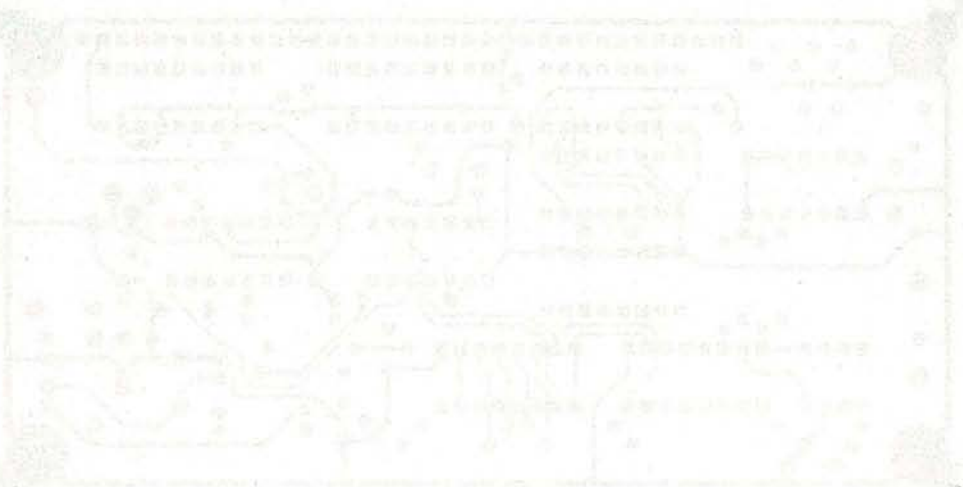
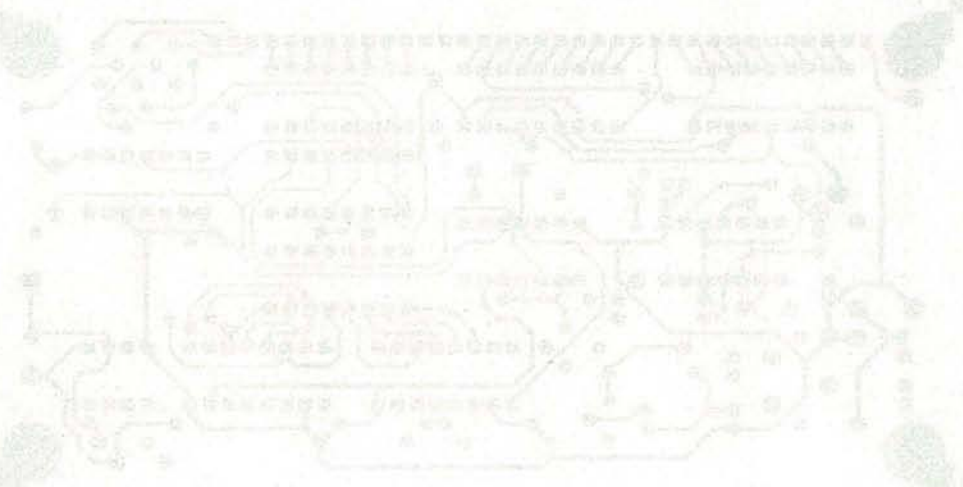

FIG. 1. Schematic diagram of a radio receiver circuit.

FIG. 2. Schematic diagram of a radio receiver circuit.

FIG. 3. Schematic diagram of a radio receiver circuit.

FIG. 4. Schematic diagram of a radio receiver circuit.

DRAWING BOARD

continued from page 29

Timing is important

As you can see, the sequence and timing of those steps have to be done properly if you want the system to work. And all that we've been talking about so far is the refresh operation. Somewhere in there we have to allow for the time needed for data to be stored to, or read from, the memory. After all, that's the whole reason for building the system in the first place.

The interaction between all the components of a dynamic memory system has to be carefully controlled in order for the circuit to work properly. Refresh has to be constant, and memory access has to be kept to a short operation that won't interfere with maintaining the data. Since a gates-only solution to the problem is so complex as to be impractical, it's obvious we have to look elsewhere for a way to handle all the problems.

Although we can use LSI controllers, they are expensive and hard to locate. The route we're going to follow should already have crossed your mind. Since we're putting together a complex system in which timing and access are the major problems, we can use a microprocessor to handle the job.

Microprocessor control

The Z-80 is the perfect CPU for the job. It has many memory-control signals as well as built-in circuitry especially designed for controlling dynamic RAM. An internal refresh counter will automatically provide the sequential addressing we need to take care of refresh, and the address is put on the bottom of the address bus during the tail end of each op code fetch.

The beauty of that scheme is that the Z-80 doesn't have any need for the address bus once it's loaded the op code. During portions of the instruction cycle the memory is idle. That gives us the time we need to use the address to refresh the RAM. Since the Z-80 is busy elsewhere during that time, it doesn't have to slow down or wait for the refresh operation to be carried out.

When we pick this up again next time, we'll start designing the circuitry that is needed to handle the system shown in Fig. 1, and we'll show how to calculate the system speed, timing parameters, and so on. So pull out your Z-80 data books; you'll be needing them because we'll be poking around the Z-80 anatomy.

Finally, next time I'll be announcing the free-subscription winners of the DTMF remote control system contest. R-E

NEW PRODUCTS

continued from page 25

OPTICAL FIBER TOOL SET, model 06808, is designed for preparing single-mode and multimode optical fibers and cables.

The tool set consists of *Kevlar-Strip* tool—a hand tool designed to remove any length of Kevlar-reinforced protective sleeving between 2.5mm and 6.5mm diameter; sleeve guides to ensure correct positioning of the sheath (the guides are selected according to the sheath diameter); *Opti-Strip* tool—designed to remove secondary coatings from optical fibers and small cables less than 2.5mm in diameter; guide bushings; *Silicon-Strip* tool—used for

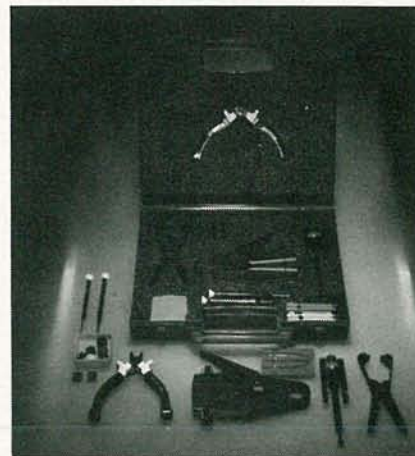

CIRCLE 37 ON FREE INFORMATION CARD

fast removal of silicone coatings; cutters, and screwdrivers.

The model 06808 costs \$157.25. —**Davle Tech, Inc.**, 2-05 Banta Place, Fair Lawn, NJ 07410. R-E

SUPER LONG PLAY TAPE RECORDERS

10 Hour Model — \$95.00*
14 Hour Model — \$159.00*

Modified Panasonic Slimline, high quality, AC-DC Recorders provide 5 or 7 continuous hours of quality recording & playback on each side of cassette for a total of 10 or 14 hours depending on model. Built-in features include • Voice level control, • Digital counter, etc. TDK DC 180 Cassette Furnished.

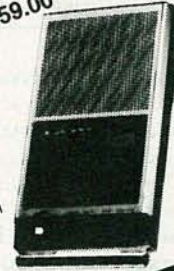

PHONE RECORDING ADAPTER

Records calls automatically. All Solid state connects to your telephone jack and tape recorder. Starts recording when phone is lifted. Stops when you hang up. \$24.50*



VOX VOICE ACTIVATED CONTROL SWITCH

Solid state. Self contained. Adjustable sensitivity. Voices or other sounds automatically activate and control recorder. Uses either recorder or remote mike. \$24.95*



*Add for ship & hdg. Phone Adapter & Vox \$1.50 ea. Recorders \$4.00 ea. Cal. Res. add tax. Mail order, VISA, M/C, COD's OK. Money Back Guarantee. Qty. disc. avail., Dealer inquiries invited, Free data. © AMC SALES, Dept. A 9335 Lubec St., Box 928, Downey, CA (213) 90241 Phone 869-8519

CIRCLE 108 ON FREE INFORMATION CARD

Technicians,
Get Serious
About Your
Profession



Being a certified electronics technician lets people know that you are a professional in your field. It tells them that you are serious about your work and can perform up to CET standards.

Now you can order the "Study Guide for the Associate-Level CET Test" from the International Society of Certified Electronics Technicians. It includes material covering the most often missed questions on the Associate CET exam. 8½" x 11", paperback, 60 pages.

For More Information Contact:

ISCET, 2708 W. Berry, Fort Worth, TX 76109; (817) 921-9101

NAME _____
ADDRESS _____
CITY _____ STATE _____
ZIP _____

_____ copies @ \$5 (+ \$1 postage.)

_____ send material about ISCET and becoming certified.

JULY 1987

SCRAMBLING

continued from page 61

ventional TV receiver, it is, for all intents and purposes, scrambled. To actually scramble the signal we must rearrange the bits and bytes that represent the audio. For example, we could scramble the audio by encoding the data bits themselves—the 16 audio bits in each horizontal blanking interval. That could be done by adding a random set of digital numbers to the binary numbers that represent the audio signal. Or, we could use matrix encoding to generate a non-related encoding of each binary number. For example, binary 63 might be transformed to binary 35, while binary 94 is transformed to binary 181, etc. For 256 words (a 16-bit system) there are 256! possible combinations. (256! represents 256 factorial, which means: $256! = [256 \times 255 \times 254 \dots \times 2 \times 1]$).

The algorithm used in *Videocipher II* is the NBS Data Encryption Standard. In that method, the data is encoded using a 64-bit algorithm (eight of which are used for parity checking), leaving 256 possible combinations for a de-encryption key. 256 is a rather large number—about 72 thousand million million (72 quadrillion). Unless the correct key is known, it is therefore essentially impossible to decode the audio.

In review

Over the last year or so, we've highlighted a number of scrambling and descrambling topics. For those newcomers who have picked up the series in mid-stream, here's a review of those topics, and when they appeared:

In the June, 1987 issue we looked at the basic structure of a video signal and some of the simpler scrambling techniques, such as inverting the video and suppressing the sync. Also discussed were the ways in which audio signals are hidden.

In July we discussed a hypothetical digital video-scrambling system.

In the August issue we showed some of the basic circuitry used in POPULAR scrambling systems such as in-band gated sync and SSAVI. Those circuits included several different variable-attenuators and variable-gain amps. We also showed some rudimentary but workable descramblers including one built around a Phase Locked Loop (PLL) that was used to recover a suppressed sync pulse.

In September we looked at PLL's in greater depth, and briefly discussed sine-wave, SSAVI, and outband decoding. The SSAVI system was discussed in greater depth in November.

In December we moved from the theoretical to the practical by presenting a functional sine-wave descrambler for experimenters. In January and March, 1987 we did the same for those interested in the

in-band gated sync and the outband scrambling systems.

To make getting the parts easier, North Country Radio (P.O. Box 53, Wykagyl Station, New Rochelle, NY 10804) provided kits of parts, including PC boards. The following are still available.

- Pulse Decoder: Item PD-1: PC board plus all components on the PC board. \$54.95 + \$2.50 shipping and handling.
- Outband Decoder: Item OB-1: PC board plus all components on the PC board. \$34.95 + \$2.50 to cover shipping and handling.
- Sinewave Decoder: Item SW-1: PC board plus all components on the PC board including C13, C14, C15, CR1, and R17 necessary for the interface box. \$52.95 + \$2.50 postage and handling.
- All three items, PD-1, OB-1, and SW-1, \$129.95 + \$3.50 shipping and handling.

New York State residents please add the appropriate sales tax.

Finally, the authors of this series have written a book on the topic entitled *Video Scrambling and Descrambling for Satellite and Cable TV*. It is published by Howard W. Sams and can be purchased at most local bookstores and electronics distributors. It can also be purchased direct from the publisher (ask for book number 22499). It retails for \$19.95. **R-E**

DIGITAL SPEEDOMETER

continued from page 51

voltage at the appropriate pins of each IC. After debugging any problems, apply a test signal to the speedometer. Connect a sine-wave generator to P1 and apply a one-volt peak-to-peak signal. For test purposes, set S1 so that the first three switches are off, the next three are on, and the last two are off (00011100). Also, set the generator's frequency to 138 Hz. If everything is working correctly, the seven-segment LED's should display a value of 60, and at least some of the discrete LED's should be lit.

Installation

The most difficult part of construction is installing the speedometer in an automobile. The two main tasks are installing the PC-board assembly and installing the magnetic sensor and magnets.

To install the boards, first choose a suitable mounting location for the unit, one that provides a good view of the device, but does not obstruct the driver's field of vision. After choosing your mounting location, prepare it to receive the speedometer. Whether you are building a custom enclosure or planning to install the assembly in the dash, use a front panel that will both protect the display and make it readable in bright sunlight.

Smoked Plexiglass makes an excellent front panel, especially if it is lettered and masked. Masking is accomplished by painting the area not occupied by displays or LED's. The easiest method is to mask all areas that are occupied by displays and LED's on the back side of the front panel and then paint the back side of the panel with black spray paint. Apply several coats to ensure a uniform covering. After the paint dries, peel off the masking tape and install the front panel.

The next step is to secure the magnets to the driveshaft (or output shaft) and mount the pick-up coil to the body or chassis of the automobile. To do that, you'll probably have to drive your car up on ramps. If you do not have a set of ramps, borrow or buy a set. Never get under a car that is supported only by jacks. It's also a good idea not to work under a car alone.

After raising the car, find a suitable location for mounting the magnets. On rear-wheel-drive vehicles, the best location is at the front of the driveshaft, near the transmission. At that place the driveshaft has the least vertical movement, so the magnets will maintain a constant distance from the pick-up coil. To mount the magnets, locate them around the driveshaft at 90° intervals and secure them in some way. The magnets we used in our prototype come with a strap that simplifies installation; you can purchase the

Try the

Radio-Electronics

bulletin board system

(RE-BBS)

516-293-2283

The more you use it the more useful it becomes.

We support 300 and 1200 baud operation.

Parameters: 8N1 (8 data bits, no parity, 1 stop bit) or 7E1 (7 data bits, even parity, 1 stop bit).

Add yourself to our user files to increase your access.

Communicate with other R-E readers.

Leave your comments on R-E with the SYSOP.

RE-BBS

516-293-2283

Radio-Electronics mini-ADS

set at a local auto-parts store or from the source mentioned in the Parts List.

On a front-wheel-drive vehicle, the magnets can be mounted reliably to the outer ring of the constant-velocity joint's dust boot near the transaxle. In that type of installation, there should be a metal strap on each side of the dust boot. Mount the magnets to the strap that is located nearest the transaxle, and secure the pick-up coil and its metal strip. If the boot is not easily accessible, the magnets may be mounted directly to the output shaft or one of the drive shafts, but be sure to place them where the least amount of vertical movement takes place.

Next mount the pick-up coil to the underside of the automobile using a strip of inch-wide metal. Of course, the length of the strip and the locations of the mounting holes will depend on your installation. But you'll probably want to bend the strip so that the front of the mounting coil and its bolt are about 1/2 inch from the magnets. Figures 7-a-7-d indicate several mounting schemes for driveshaft and transaxle installations.

After the magnets and pick-up coil are installed, run the signal wires from the pick-up coil through the fire wall to where the PC boards are located. Use plenty of wire ties or plastic tape. If you purchase the pick-up coil mentioned in the Parts List, you must replace its connector with a Molex-style connector.

Run a power wire from the mounting location to the fuse box and connect it to a circuit that is active only when the ignition key is in the *on* position. Remember to hook the ground wire to the chassis ground of the automobile.

Calibration

To calibrate the speedometer, first decide whether you want the readout to be in miles or kilometers per hour. The next step can be accomplished in several ways. You can either calculate the speed of your driveshaft as discussed in the text box, or you can use the trial-and-error method.

To use the trial and error method, have a friend drive on an open stretch of highway, and, while watching your old speedometer, try setting S1 in different positions until the speedometer displays the correct value. Make sure your friend watches the road and his speed while you calibrate the speedometer! Next, have your friend drive at the "red line" speed, and set R34 so the first red LED lights up.

If the digital speedometer reads erratically while the vehicle is standing still, reduce the value of R6 from 470 ohms to 330 ohms or less. That reduces input sensitivity and prevents the unit from picking up electrical noise.

After calibration is complete, it's time for final installation. Mount the unit in its permanent housing, then secure and conceal all cables.

R-E



PANASONIC CABLE CONVERTERS, Wholesale and Retail. Scientific Atlanta and Pioneer Cable Converters in stock. Panasonic model 130N 68 channel converter **\$79.95**, Panasonic Amplified Video Control Switch Model VCS-1 **\$59.95**. Scientific Atlanta Brand new Model #8528 550MHZ 80 Channels Converter **\$89.95**. Video Corrector (MACRO, COPYGUARD, DIGITAL) ENHANCER **\$89.95**. Write or call **BLUE STAR IND., 4712 AVE. N, Dept 105, Brooklyn, NY 11234. Phone 1-718-258-9495.**

CIRCLE 85 ON FREE INFORMATION CARD

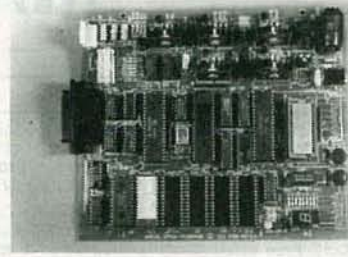

BUILD STEVE CIARCIA'S INTELLIGENT SERIAL EPROM PROGRAMMER. • Use Standalone or with Computer/Terminal; • Programs Standard or Fast Algorithm Mode; • Menu Selectable, No Configuration Jumpers; • Programs All 5V 27XXX EPROMs from 2716 to 27512. Includes CMOS and 12.5V Vpp; • Read, Copy, Verify after Write; • Intel Hex File Upload/Download. Full Programmer Kit **\$199.00**, Power Supply add **\$19.00**. S&H \$5 in USA. **CCI, 4 Park St., Suite 12, Vernon, CT 06066. (203) 875-2751.**

CIRCLE 205 ON FREE INFORMATION CARD

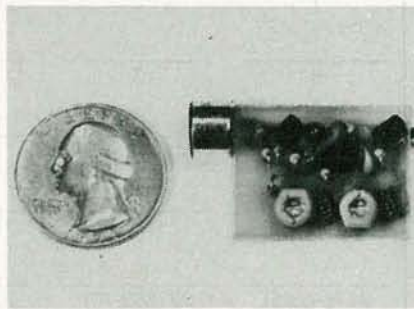

SIMPLY SNAP THE WAT-50 MINIATURE FM TRANSMITTER on top of a 9v battery and hear every sound in an entire house up to 1 mile away! Adjustable from 70-130 MHz. Use with any FM radio. Complete kit **\$29.95 + \$1.50 S + H**. Free shipping on 2 or more! COD add \$4. Call or send VISA, MC, MO. **DECO INDUSTRIES, Box 607, Bedford Hills, NY 10507. (914) 232-3878.**

CIRCLE 127 ON FREE INFORMATION CARD

CALL NOW AND RESERVE YOUR SPACE

- 6 x rate \$745.00 per each insertion.
- Reaches 239,312 readers.
- Fast reader service cycle.
- Short lead time for the placement of ads.
- We typeset and layout the ad at no additional charge.

Call **516-293-3000** to reserve space. Ask for Arline Fishman. Limited number of pages available. Mail materials to: mini-ADS, RADIO-ELECTRONICS, 500-B Bi-County Blvd., Farmingdale, NY 11735.



LOOKSOUND FM SUNGLASSES. Super durable sunglasses with that great look. Each one has a state of the art micro FM radio built right in. Great for jogging, bicycling, boating, sports events, etc. **\$39.95 plus \$3.00 shipping and handling.** Visa, mastercard, and cod. 1-800-522-2636 for orders. (617) 843-1900 for information. **CAMEO ENTERPRISES INC. P.O. Box 63 Accord, MA 02018**

CIRCLE 89 ON FREE INFORMATION CARD



APPLIANCE REPAIR HANDBOOKS—13 volumes by service experts; easy-to-understand diagrams, illustrations. For major appliances (air conditioners, refrigerators, washers, dryers, microwaves, etc.), elec. housewares, personal-care appliances. Basics of solid state, setting up shop, test instruments. **\$2.65 to \$5.90 each.** Free brochure. **APPLIANCE SERVICE, PO Box 789, Lombard, IL 60148. 1-(312) 932-9550.**

CIRCLE 84 ON FREE INFORMATION CARD

MARKET CENTER

FOR SALE

RESTRICTED technical information: Electronic surveillance, schematics, locksmithing, covert sciences, hacking, etc. **Huge selection. Free brochure MENTOR-Z**, 135-53 No. Blvd., Flushing, NY 11354.

ROBOT! kits, Books and Plans! Learn to build your own robots. Free catalogs contain hundreds of affordable robot systems. Explore the world of robotics today. Catalog: **CEARGS-ROBOTS!**, POB 458, Peterborough, NH 03458. (603) 924-3843.

CB Tune-up manual Volume II. Specific adjustments, modifications for peaking all popular CB's. Covers over 1300 radios. \$19.95, Visa, MasterCard to: **THOMAS PUBLISHING**, 127-R Westwood, Paris, IL 61944.

CABLE TV equipment. All major brands. Specializing in Scientific Atlanta, Jerrold, and Zenith, add-ons. Our units have worked where others have failed. Send \$3.00 for catalog to **K.D. VIDEO**, P.O. BOX 29538, MLPS, MN 55429.

LATEST high-performance op-amps, power mosfets. First quality. Send stamped envelope for list. **ANZA INSTRUMENT CO.**, Box 60907, Palo Alto, CA 94306.

PROPAGANDA broadcast tapes! Authentic, rare recordings of WW-II shortwave broadcasts by "Tokyo Rose," "Axis Sally," others. Cassette \$9.95. **D-W RESEARCH**, 4548 Auburn Blvd., #231-C, Sacramento, CA 95841.

CABLE television converter, descrambler and wireless remote control video equipment accessories catalog free. **CABLE DISTRIBUTORS UNLIMITED**, 116- Main Road, Washington, AR 71862.

NUTS & VOLTS P.O. Box 1111-E
MAGAZINE Placentia, CA 92670
714-932-7721

GIVE YOURSELF A BREAK — A PRICE BREAK!
NUTS & VOLTS WILL *Save* YOU MONEY
ON ELECTRONIC PARTS & EQUIPMENT
Plus SHOW YOU WHERE TO FIND UNIQUE,
UNUSUAL AND HARD-TO-FIND ITEMS.

SUBSCRIBE TODAY!

Subscription Rates
1 Yr. Only \$16.95
3rd Class Mail - USA
One Year \$10.00
Two Years \$18.00
Lifetime \$50.00
1st Class Mail
One Year USA \$18.00
Canada/Mexico \$20.00
Air Mail
Foreign 1 Yr. \$50.00

A National Publication For The Buying And Selling Of Electronic Equipment

WHOLESALE car-radio computer telephone audio video accessories antenna catalog (718) 897-0509 **D&WR**, 68-12 110th St., Flushing, NY 11375.

DESCRAMBLER catalog. Special combo Jerrold 400 and SB3 \$165. Descrambler kit \$39.00 (assembles in half hour). Much more send \$1.00. **MJ INDUSTRY**, Box 531, Bronx, NY 10461.

TUBES! 59¢. Year guarantee. Free catalog. Tube tester \$8.95. **CORNELL**, 4215 University, San Diego, CA 92105.

TI-99/4A software/hardware bargains. Hard-to-find items. Huge selection. Fast service. Free catalog **DYNA**, Box 690, Hicksville, NY 11801.

IS it true...Jeeps for \$44 through the government? Call for facts! 1 (312) 742-1142, ext. 4673.

OLDTIME radio programs on high quality tapes. Comedy! Adventure! Music! Free catalog. **CARL F. FROELICH**, Heritage Farm, New Freedom, PA 17349.

LINEAR PARTS—transistors: MRF454 \$15, MRF455 \$12, MRF477 \$11, MRF492 \$16.75, MRF421 \$22.50, SRF2072 \$13, SRF3662 \$25, 3800 \$18.75, 2SC2290 \$19.75, 2SC2879 \$25. **Tubes:** 6KD6 \$10.50, 6LQ6 \$9.75, 6LF6 \$9.75, 8950 \$16.75. Best prices on Palomar road noise mics, Ranger AR3300. New 16-page catalog listing radio/amplifier tricks—channel modification, PLL-sliders, peaking for range, hard-to-find linear parts—mail \$1.00 to: **RFPC**, Box 700, San Marcos, CA 92069. For same day parts shipment, call (619) 744-0728.

TV tunable notch filters, free brochure. **D.K. VIDEO**, Box 63/6025, Margate, FL 33063. (305) 752-9202.

ZENITH, SSAVI, ready to go \$100.00 plus shipping, order C.O.D. 1-(305) 752-9202.

CLASSIFIED AD ORDER FORM

To run your own classified ad, put one word on each of the lines below and send this form along with your check to:

Radio-Electronics Classified Ads, 500-B Bi-County Boulevard, Farmingdale, NY 11735

PLEASE INDICATE in which category of classified advertising you wish your ad to appear. For special headings, there is a surcharge of **\$23.00**.

() Plans/Kits () Business Opportunities () For Sale
() Education/Instruction () Wanted () Satellite Television
() _____

Special Category: \$23.00

PLEASE PRINT EACH WORD SEPARATELY, IN BLOCK LETTERS.

(No refunds or credits for typesetting errors can be made unless you clearly print or type your copy.) Rates indicated are for standard style classified ads only. See below for additional charges for special ads. **Minimum: 15 words.**

1	2	3	4	5
6	7	8	9	10
11	12	13	14	15 (\$42.75)
16 (\$45.60)	17 (\$48.45)	18 (\$51.30)	19 (\$54.15)	20 (\$57.00)
21 (\$59.85)	22 (\$62.70)	23 (\$65.55)	24 (\$68.40)	25 (\$71.25)
26 (\$74.10)	27 (\$76.95)	28 (\$79.80)	29 (\$82.65)	30 (\$85.50)
31 (\$88.35)	32 (\$91.10)	33 (\$94.05)	34 (\$96.90)	35 (\$99.75)

We accept MasterCard and Visa for payment of orders. If you wish to use your credit card to pay for your ad fill in the following additional information (Sorry, no telephone orders can be accepted.):

Card Number _____

Expiration Date _____

Please Print Name _____

Signature _____

IF YOU USE A BOX NUMBER YOU MUST INCLUDE YOUR PERMANENT ADDRESS AND PHONE NUMBER FOR OUR FILES. ADS SUBMITTED WITHOUT THIS INFORMATION WILL NOT BE ACCEPTED.

CLASSIFIED COMMERCIAL RATE: (for firms or individuals offering commercial products or services). \$2.85 per word prepaid (no charge for zip code)...**MINIMUM 15 WORDS.** 5% discount for same ad in 6 issues; 10% discount for same ad in 12 issues within one year; if prepaid. **NON-COMMERCIAL RATE:** (for individuals who want to buy or sell a personal item) \$2.30 per word, prepaid...no minimum. **ONLY FIRST WORD AND NAME** set in bold caps at no extra charge. Additional bold face (not available as all caps) **50¢ per word additional (20% premium).** Entire ad in boldface, add 20% premium to total price. **TINT SCREEN BEHIND ENTIRE AD:** add 25% premium to total price. **TINT SCREEN BEHIND ENTIRE AD PLUS ALL BOLD FACE AD:** add 45% premium to total price. **EXPANDED TYPE AD:** \$4.30 per word prepaid. All other items same as for STANDARD COMMERCIAL RATE. **TINT SCREEN BEHIND ENTIRE EXPANDED TYPE AD:** add 25% premium to total price. **TINT SCREEN BEHIND ENTIRE EXPANDED TYPE AD PLUS ALL BOLD FACE AD:** add 45% premium to total price. **DISPLAY ADS:** 1" x 2 1/4"—\$320.00; 2" x 2 1/4"—\$640.00; 3" x 2 1/4"—\$960.00. **General Information:** Frequency rates and prepayment discounts are available. **ALL COPY SUBJECT TO PUBLISHERS APPROVAL. ADVERTISEMENTS USING P.O. BOX ADDRESS WILL NOT BE ACCEPTED UNTIL ADVERTISER SUPPLIES PUBLISHER WITH PERMANENT ADDRESS AND PHONE NUMBER.** Copy to be in our hands on the 12th of the third month preceding the date of the issue. (i.e., Sept. issue copy must be received by May 12th). When normal closing date falls on Saturday, Sunday or Holiday, issue closes on preceding working day.

ATTENTION looking for surplus test equipment signal generator voltmeter oscilloscope. **J.B. ELECTRONICS**, 9518 Grand, Franklin Park, IL 60131.

INTEL, RCA, National, OKI, SGS, and more. Factory prime and surplus parts catalog. **LYNBAR INDUSTRIES**, 205 Main, Box 822, St. Joseph, MI. 49085-0822.

TEST equipment, reconditioned. For sale. \$1.25 for catalog. **WALTER'S**, 2697 Nickel, San Pablo, CA 94806. (415) 724-0587.

VIDEO copier (\$69.95) connects between two VCR's (stereo) and makes copies as good as the original. For info/order write or call **VIDEO VIBES**, 657 Allerton Ave., Bronx, NY 10467. Tel. (212) 653-4644.

OLD radio TV schematics. Send \$1.00, make model. **RADIO MAPS**, P O Box 791, Union City, CA 94587.

OSCILLOSCOPES and reconditioned test equipment. Teletronix, H.P., etc. Free list. **CAL-SCOPES**, 983D Ponderosa Ave., Sunnyvale, CA 94086 (408) 730-4573.

WANTED: Western Electric, McIntosh, Marantz, RCA, Dynaco, Altec, Telefunken, JBL, tubes, speakers, amplifiers, (713) 728-4343. **MAURY**, 11122 Atwell, Houston, TX 77096.

LASERS, components and accessories. Free catalog. **M.J. NEAL COMPANY**, 6672 Mallard Ct., Orient, OH 43146.

CABLE TV converters. Scientific Atlanta, Jerrold, Oak, Zenith, Hamlin. Many others. "New" Video Hopper "The copy killer". Visa, M/C & Amex accepted. Toll free 1-(800) 826-7623. **B&B INC.**, 10517 Upton Circle, Bloomington, MN 55431.

SATELLITE systems \$349 up. VISA/MC available. Catalog \$3.00. **STARLINK, INC.**, 2603-16R Artie, Huntsville, AL 35805.

"BUGS" miniature transmitters, "James Bond" type spy gadgets. Catalog \$2.00 (refundable) **CUDWELL**, Salvisa, KY 40372-0034.

PHONE RECORDER CONTROL

- Automatically records phone conversations when receiver is lifted.
 - Interfaces your phone to any tape recorder.
 - Meets all FCC requirements.
 - Guaranteed to work.
- Send 19.95 plus 3.00 shipping & handling to (VISA, MASTER CHARGE, or COD) to: **ELECTRONIC DEVICES**, 2429 Central Ave. St. Petersburg, FLA. 33173. Dealer inquiries welcomed.

OST's 1921-1985; some for 1917, 1919, 1920. CQ's 1945-1984. Make offer including postage. Radio-Electronics, '50-'64. **MRS. RUTH E. SHEER**, 429 Junell Drive, Sulphur Springs, TX 75482.

B&K test equipment 25% discount selected scopes otherwise 20% on all products authorized distributor free catalog. **CENTURY ELECTRONICS**, 3511 North Cicero, Chicago, IL 60641.

ELECTRONIC test equipment and parts. Lowest prices. Free catalog. **EF ELECTRONICS**, Box 249 Aurora, IL 60507.

BUILD your own pro monitors 32 pg. 5 part manual discloses design criteria utilized by major manufacturers of pro monitoring systems. Blueprints included! \$25.00 complete to: **BRIX ENTERPRISES INC.**, 2419 Richmond Road, S.I.N.Y. 10306.

MACROVISION eliminator video link 154. 1 year warranty! \$69.00 C.O.D.'s welcomed free info available. **GMR ELECTRONICS**, Box 2444, Titusville, FL 32781. (305) 267-2741.

SCANNING disc television. Read all about it! "The Mechanics of Television." (1987) 182 pages \$20.00 postpaid. **TESLA ELECTRONICS**, 835 Bricken, Warson Woods, MO 63122.

MICROCONTROLLER clock-timer MCT 200 two programs: A- 24 Hr. battery back-up clock with 4 time switches. B- countdown timer with 4 outputs. A&T \$68.00, kit \$48.00, manual only \$2.00. **L.S. ELECTRONIC**, 2280 Camilla Rd., Mississauga, Ontario, Canada L5A2J8.

FREE power supply with **Assortment #103** (February '84 article, has printed circuit, TOKO coils(4), 2N3904(2), BFQ85, 7812, 74123, MC1330, 1N914, 1N5231B. **TELE-ASE-MAST ASSORTMENT #301** (October Article) Printed Circuit with all IC's, transistors, diodes. **Only \$25.00/each assortment. Five/\$112.50.** Shipping \$3.00. 1 (800) 821-5226 Ext. 426. (orders) or write **JIM RHODES INC.**, P.O. Box 3421, Bristol, TN 37625.

TUBES, name brands, new, 80% off list. **KIRBY**, 298 West Carmel Drive, Carmel, IN 46032.

WRITE FOR

1001 BARGAINS IN SPEAKERS
 toll free 1-800-346-2433 for ordering only.
1901 MCGEE STREET KANSAS CITY, MO. 64108

LEADER LF-945 signal level meter \$425.00. (312) 771-4661.

SUPERFAST morse code supereasy. Subliminal cassette. \$10.00 amazing mnemonics: Learn Morse Code in 1 hour; Q Signals supereasy; novice written exam supereasy! \$5.00 each. Moneyback guarantee. Free catalog: **SASE. BAHR**, 2549-E2 Temple, Palmbay, FL 32905.

TUBES, new, unused. Send self-addressed, stamped envelope for list. **FALA ELECTRONICS**, Box 1376-2, Milwaukee, WI 53201.

TUBES: "Oldest," "latest." Parts and schematics. **SASE** for list. **STEINMETZ**, 7519 Maplewood Ave., RE Hammond, IN 46324.

CABLE TV blowout viewstar 2501 volume, audio video ports, decoder loop, \$129.95 buy a decoder take off \$10.00, Star base decoder 1 \$99.00, 10 \$75.00, tri mode/bi state 1 \$100.00, 10 \$75.00, MLD 1200-3 1 \$99.00, 10 \$65.00, N-12 replacement 1 \$99.00, 10 \$61.00, better than original auto on off boards 1 \$65.00, 10 \$45.00, Scientific Atlanta decoder 1 \$140.00, 10 \$104.00, Pioneer 5000 decoder 1 \$140.00, 10 \$104.00, much more. Call or write for your free catalog (402) 331-4957. All products guaranteed 90 days. **M.D. ELECTRONICS**, 5078 So. 108th #115, Omaha, NE 68108.

Parts Express **HARDWARE AND ELECTRONICS**

MAGNIFIER LAMP
 • 4" diopter magnifying lens.
 • Uses up to a 60 watt bulb (not included). UL listed, 117VAC.
 #350-010 **\$26.95**

COPPER CLAD PC BOARD
 9" x 8" Double Sided #055-300 **\$150**
 18" x 12" Double Sided #055-320 **\$395**

RS-232 DATA SWITCH
 • 2 position, rotary type. • Fully shielded, FCC approved.
 #130-010 **\$27.95**

PIONEER HORN TWEETER
 • Frequency response: 1800 to 15,000Hz. • Power handling capabilities: 35W RMS, resonant frequency 2 kHz. 3/4" x 3/4".
 #270-050 **\$650** (1-8) **\$590** (10-UP)

12" PIONEER WOOFER
 • Power: 65W RMS • 11 oz. magnet
 • 25 to 2500 Hz response • 1/2" voice coil
 #290-100 **\$1550** (1-3) **\$1395** (4-10)

TOROIDIAL TRANSFORMER
 • 120 volt primary, 2-20V, 5A secondaries. • 4 1/2" round. • 4 lbs.
 #120-150 **\$1250** (1-3) **\$995** (4-UP)

FREE CATALOG
 Our new 56 page catalog contains thousands of items that you need every day for do-it-yourself projects, product engineering, electronics repair and more. Call us today for your free copy and start saving!

300 PIECE CAPACITOR KIT
 • A great assortment of different values and working voltages. Includes electrolytics, ceramics, mylars, and more!
 #020-920 **\$4.95**

CALL TOLL FREE 1-800-255-3525
 In Ohio: 1-800-322-3525
 Local: (513) 222-0173

• 15 day money back guarantee. • \$10.00 minimum order. • COD orders accepted. • 24 hour shipping.
 • Shipping charge = UPS chart rate (\$2.50 minimum charge). Hours 8:30 a.m. - 6 p.m. EST M-F.

PARTS EXPRESS INT'L INC.
 340 East First St.
 Dayton, Ohio 45402

VISA
 MasterCard

Employers

Willing workers available now at as little as 1/2 your usual cost.

This is your chance to get help you've needed, but thought you couldn't afford.

No business too large or too small. Call your private industry council or write **National Alliance of Business**, P.O. Box 7207, Washington, D.C. 20044

COPYGUARD !
 Eliminate the latest Video copyguard "DECODE A TAPE" units from \$59.95 to \$169.95
 Deluxe Electronics 1432 Heim Wy., Orange, Ca. 92665 (714) 998-6866

PLANS AND KITS

BUILD this five-digit panel meter and square wave generator including an ohms, capacitance and frequency meter. Detailed instructions \$2.50. **BAGNALL ELECTRONICS**, 179 May, Fairfield, CT 06430.

PROJECTION TV...Convert your TV to project 7 foot picture. Results comparable to \$2,500 projectors...Total cost less than \$30.00 plans and 8" lens \$21.95...Illustrated information **FREE**...**MACROCOMA-GK**, Washington Crossing, PA 18977. Creditcard orders 24hrs. (215) 736-3979.

TOP QUALITY imported, domestic kits, surplus, discount electronics, computer components. **FREE** catalog. **TEKTRONIX**, 1120 Avenue of the Americas, 1/f suite 4038, New York, NY 10036.



HI-FI speaker systems, kits and speaker components from the world's finest manufacturers. For beginners and audiophiles. Free literature. **A&S SPEAKERS**, Box 7462, Denver, CO 80207. (303) 399-8609.

VOICE disguisers! FM bugs! SWL active antenna! Receivers! More! Catalog \$1.00 (refundable): **XANDI ELECTRONICS**, Box 25647, Dept. 60M, Tempe, AZ 85282.

Multi-Channel Microwave T.V. Receivers

1.9-2.7 GHz Parabolic Dish 40+ dB Gain
LIFETIME WARRANTY
 Complete System \$89.95 (Shipping Incl.)
 Replacement Components
 & Expert Repairs Available

K & S ELECTRONICS Call now for same
 P.O. BOX 34522 day shipping!
 PHOENIX, AZ 85067 (602) 230-0640

VISA/MC/COD For Dealer Rates Call 602-888-4080

PAC-TEC enclosure specified in Feb. '87 R-E article on Tri-Mode. Pre-drilled. \$24.95 plus \$2.50 S&H. VISA/MASTERCARD accepted. Call (617) 339-1026 or send to **THE HOBBY HELPER**, P.O. Box 308, Bridgewater, MA. 02324.

ULTRASONIC pest repeller: Exceptional design! Complete quality kit \$25.00, assembled \$30.00. **UFO DETECTING BOOK**: Electronic projects, theories, schematics, \$6.00 (NY + 7.5%). **UFONICS**, Box 1847-R, W. Babylon, NY 11704.

WHY not build something interesting? Easily constructed circuit lets you use any TV as a simple oscilloscope. No modifications to TV necessary! Low parts count. Detailed plans \$4.95 **SCOPE**, Box 3543, Williamsport, PA 17701.

MELODY IC, Piezo element and application sheet only \$3.00. **BELL CERAMIC INDUSTRIES, INC.**, 31 Passmore Avenue, Unit 28, Toronto, Ontario, Canada M1V4T9.

A SINGER'S DREAM!

REMOVES VOCALS FROM RECORDS!
 Now You can sing with the world's best bands!
 The Thompson Vocal Eliminator can remove most or virtually all of a lead vocal from a standard stereo record and leave the background!
 Write or call for a free brochure and demo record.
LT Sound, Dept. R-1, P.O. Box 338,
Stone Mountain, GA 30086 (404) 493-1258

STRANGE stuff. Plans, kits, new items. Build satellite dish \$69.00. Descramblers, bugs, adult toys. Informational photo package \$3.00 refundable. **DI-RIJO CORPORATION**, Box 212, Lowell, NC 28098.

TELEPHONE. Electronic ring generator. Schematic \$3.00. For testing or experimentation. **COMPUTEC**, 141 Greenvillage, Northport, AL 35476.

SATELLITE descrambling manual, Video Cypher II. Schematics, thorough explanation of digital audio encoding, EPROM code, DES. (HBO, Cinemax, Showtime.) \$10.95 + \$1.00 postage. Catalog \$1.00 **CABLETRONICS**, Box 30502R, Bethesda, MD 20814.

WIRELESS remote cable converters \$60.00 with purchase of selected video kit \$50.00 boards and parts for video and hobby projects from magazines and other sources. SA turn on kit \$40.00. Video decipher kit \$75.00. Call or write for list and details. **WIZARD**, 1-(419) 243-7856, 24 East Central, Toledo, OH 43608.

INFRARED kits, complete line of engineering and surveillance viewers, infrared light sources, infrared filters. Send \$1.00 to **IRSCIENTIFIC, INC.**, Box 110, Carlisle, MA 01741.

DESCRAMBLING, New secret manual. Build your own descramblers for cable and subscription TV. Instructions, schematics for SSAVI, gated sync, sinewave. (HBO, Cinemax, Showtime, etc.) \$8.95 + \$1.00 postage. Catalog \$1.00. **CABLETRONICS**, Box 30502R, Bethesda, MD 20814.

CRYSTAL radio sets, plans, parts, kits, catalog \$1.00. **MIDCO**, 660 North Dixie Highway, Hollywood, FL 33020.

CATALOG: hobby/broadcasting/1750 meters/ham/CB: transmitters, antennas, scramblers, bugging devices, more! **PANAXIS**, Box 130-F7, Paradise, CA 95967.

FREE catalog 99-cent kits—audio, video, TV, computer parts. **ALLKIT**, 434 W. 4th St., West Islip, NY 11795.

CABLE television converter, descrambler and wireless remote control video equipment accessories catalog free. **CABLE DISTRIBUTORS UNLIMITED**, 116-P Main Road, Washington, AR 71862.

EDUCATION & INSTRUCTION

F.C.C. Commercial General Radiotelephone license. Electronics home study. Fast, inexpensive! "Free" details. **COMMAND**, D-176, Box 2223, San Francisco, CA 94126.

FCC commercial general radiotelephone license correspondence course. 60 individual lessons for \$89.50. Payment plan. Results guaranteed! Details free. **AMERICAN TECHNICAL INSTITUTE**, Box 201, Cedar Mountain, NC 28718.

GREAT VALUES • FAST SHIPPING • QUANTITY DISCOUNTS

150MC Universal Digital Frequency Counter



FREE AC ADAPTOR AVAILABLE UNIT STOCKS LAST!

Frequency Range: 10Hz - 150MHz
 Event Counter: 0 to 99999999 counts. (8 Digit)
 Input sensitivity: KHz range 10Hz - 10MHz 50mVrms.
 MHz range 1MHz - 150MHz 40mVrms.
 Response time: 0.2 second.
 Hold Function: Hold the last input signal.
 Power Supply: DC6V Battery or DC9V Adaptor.
 Dimensions: 9 7/8" x 6 11/16" x 2 3/4"
 Assembled with tested\$99.00

100W + 100W NEW CLASS 'A' DC STEREO PRE-MAIN AMPLIFIER

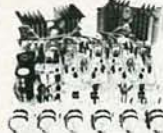

200W POWERFUL AMP W/MIC MIXER!

TA-1500
 KIT\$67.00
 METAL CABINET/XFORMER\$26/\$16.80

ELECTRONIC ECHO AND REVERBERATION AMPLIFIER



REMIK RECORDS YOURSELF!

TA-2400A
 Ass. with tested\$99.85

TERMS: \$10 min order * \$20 min charge card order * Check, money order or phone order accept * We ship UPS Ground * Add 5% of total order (min \$1.50) for shipping, outside LA add 10% (min \$2.50), outside USA add 20% (min \$5.00) CA residents add sales tax * All merchandise subject to prior sale * Prices are subject to change without notice * Any goods proved to be defective, may be returned in ORIGINAL FORM WITH A COPY OF YOUR INVOICE WITHIN 30 DAYS FOR REPLACEMENT.

HIGH QUALITY PRE-AMPLIFIER WITH 10 BAND EQUALIZER



NEW with CD input stage

TA-2500
 Ass. with tested\$90.00

INFRARED REMOTE CONTROL UNIT



CAN BE SWITCHED ON TO ANY ELECTRICAL APPLIANCES UP TO 200W!

TY-41 MKV
FREE DELUXE CONTROL BOX

STEREO SIMULATOR

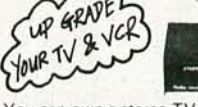

MARK V PROMISES TO SERVE YOU THE BEST

TA-3000
 KIT\$30
 Ass. with Tested\$45
UP GRADE YOUR TV & VCR
NEW FOR 81
 KIT ONLY \$25

You can own a stereo TV from today!
 This simulator is special design of using the most advanced monolpoided L.S.I. it produced a superior analog stereo effect since the L.S.I. is equalled 60 pcs. of LOW NOISE FET & TRANSISTOR. The simulator can even help you to promote your television from a normal one to a special one with a HI-FI STEREO function. Our simulator is also applicable to any other "momo sources" in covering it to ANALOG STEREO. Undoubtedly, it is the most advanced equipment for every family, while it should contribute to your listening pleasure.
 Ass. with tested\$30.00

LCD THERMOMETER CLOCK



FREE CATALOG

It reads temp. in all sensitive areas

Features:
 0.34" DIGITAL thermometer with Hi & Low temperature alarm function and 12 hours clock combination.
 Measuring range: 0°F to 160°F or -20°C to +70°C
 Resolution reading: ±1.8°F
 Dimensions: 3.2" x 0.86" x 2.08"
 T-1 with In/Out Door sensor\$20.00
 T-2 with Fahrenheit/Celsius measuring\$18.00 NOT A KIT

PROFESSIONAL COLOR LIGHT CONTROLLER



SM-328

FEATURES:
 1. FOUR GROUPS OF INDEPENDENT OUTPUT SYSTEM 1000W/CH MAX BOARD TYPE) 2. PROFESSIONAL COLOR CONTROL SYSTEM (KEY-CHASER 6. AUTOMATIC DIMMER SIGNAL ADJUSTMENT 4. FOUR OF SPECIAL CHASING PROGRAM CONTROL 5. SPEED CONTROL MUSIC CHASING EFFECT 9. FORWARD/BACKWARD CHASING program and advertisement lighting. It consists of specialized for ballroom, night club and disco and advertising lighting. It is specialized for ballroom, night club program and fluctuating music signal. There are two kinds of lighting effects. The first type is controlled by "music" signal. In order to adjust the brightness of low A, and low B frequency range. Furthermore, each group of lightings is incorporated with an independent signal adjustment. The second kind is independent of electrical circuits and this is the main part for creating a special lighting effect. It has four chasing programme.
 Dimensions: 14 5/16" x 8 15/16" x 3 3/16"
 Ass. with tested\$150.00 ONLY

OFFICE HOURS: (PACIFIC TIME) MON.—FRI. 9:30 to 5:00 SAT. 10:00 to 5:00

MARK V ELECTRONICS INC.,
 248 EAST MAIN STREET, SUITE 100,
 ALHAMBRA, CA 91801.
 TELEX 3716914 MARK 5.

1-800-423-3483
TOLL FREE
 Only for order paid by Master or VISAcard
IN CAL.: 1-800-521-MARK

INFORMATION: 1-818-282-1196
MAIL ORDER: P.O. BOX 6610
ALHAMBRA, CA91802

CIRCLE 93 ON FREE INFORMATION CARD

SATELLITE TV

CABLE TV Secrets—the outlaw publication the cable companies tried to ban. HBO, Movie Channel, Showtime, descramblers, converters, etc. Suppliers list included \$8.95. **CABLE FACTS**, Box 711-R, Pataskala, OH 43062.

Cable TV Converters

Why Pay A High Monthly Fee?

Jerrold Products include "New Jerrold Tri-Mode," SB-3, Hamlin, Oak VN-12, M-35-B, Zenith, Magnavox, Scientific Atlanta, and more. (Quantity discounts) 60 day warranty. For fast service C.O.D. orders accepted. Send SASE (60 cents postage) or call for info (312) 658-5320. **Midwest Electronics, Inc.**, **HIGGINS ELECTRONICS**, 5143-R W. Diversey, Chicago, IL 60639. MC/Visa orders accepted. No Illinois orders accepted. Mon.-Fri.-9 A.M.-6 P.M. CST

SATELLITE TV receiver kits! Instructions! Schematics! Catalog \$1.00 (refundable); **XANDI ELECTRONICS**, Box 25647, Dept. 21P, Tempe, AZ 85282.

DESCRAMBLER build our low cost satellite TV video only descrambler for all major movies and sports. Uses all Radio Shack parts. Order P.C. board and instructions by sending cheque, money order, or Visa for \$35.00 U.S. funds to: **VALLEY MICROWAVE ELECTRONICS**, Bear River, Nova Scotia, Canada, BOS-1BO. (902) 467-3577.

10 1/2ft satellite system, remote controlled, tracker, and descrambler with 1 yr free subscription to 20 channels. \$14.95 plus UPS. Visa or Master Card accepted. 1-(602) 378-6275.

Quality Microwave TV Antennas

12-channel system \$99.95 (plus shipping)
2-channel system \$79.95 (plus shipping)
40dB Gain 1.9 to 2.7 Ghz

Dealerships, Qty. Pricing, Replacement Parts

Phillips-Tech Electronics
P.O. Box 8533 • Scottsdale, AZ 85262

(602) 947-7700 (\$3.00 Credit all phone orders!)

LIFETIME WARRANTY

MasterCard • Visa • C.O.D.

VIDEOCIPHER data disk, Apple II and PC, dial (011)(52) (451)42268 (Mexico), 4-10 PM. CST. for information.

VIDEOCIPHER turn ons, bypasses, schematics. Complete information. Order now. Only \$20.00. **GILMORE**, Route 3, Old Town, FL 32680.

CABLE converters compatible with all systems. Guaranteed lowest prices, immediate delivery, call now!!! (516) 795-0643.

CONSULTING SERVICES

DIGITEK turns your ideas into hardware. Design and/or prototyping. Send SASE for free feasibility and cost analysis. No job too small. **DIGITEK**, Box 195 Levittown, PA 19059. (215) 949-2260.

COMPUTERS

TANDY computers! MSDOS, IBM, compatible. Discount prices! For quote or purchase call 1-800-36-SHACK. **EDGEWOOD COMPUTER CENTER**.

DESCRAMBLER MODULE

COMPLETE cable-TV decoder in a mini-module. Latest technology upgrade for Jerrold SB-3 or Radio-Electronics Feb. 1984 project. Available at very low cost. For literature, **SOUTHTECH DISTRIBUTING**. 1-(800)-821-5226 ext. 130.

NEW!! INSTALLATION and REPAIR of VideoCipher® 2000 and 2100

The Only VCR Instructional Video Program Demonstrating:

- Normal & Special Installation • Setting External Controls • Performing Internal Adjustments
- Determining and Repairing Common Board Problems • Replacing Parts Covered by Epoxy
- Static Precautions & Special Soldering Techniques. Using **PROTEC**, the electronic test device for the professional TVRO dealer

Everything you've wanted to know shown for the first time, for only \$59.95

VideoCipher is a registered trademark of General Instruments Corporation
Shipping \$9.50. Send check or add \$2.50 C.O.D. (Cash, certified check or MO on C.O.D.) No credit card, terms, P.O.'s. N.Y. add 8% tax.

TVRO dealers receive \$10.00 rebate towards 1st purchase of **PROTEC** plus discounts worth more than \$50.00 on soldering equipment and accessories.

TESTRON, Inc.,
dept R1, 184 Jericho Turnpike, Floral Park, N.Y. 11001
800-221-1002 ext. 301 24 hrs.—7 days (in NY) 516-358-9414

WANTED

INVENTORS! AIM wants—ideas, inventions, new products, improvements on existing products. We present ideas to manufacturers. Confidentiality guaranteed. Call toll free 1-(800) 225-5800 for information kit.

INVENTIONS, ideas, new products wanted! Industry presentation/national exposition. Call free 1-(800) 528-6050. Canada, 1-(800) 528-6060. X831.

WANTED surplus inventories of ICs, transistors etc. No quantity too small or large. Call **WESTERN TECHNOLOGY**, (303) 444-4403. FAX (303) 444-4473.

MICRO-Electronic manufacturing business or individual engineer/hobbyist for help in design and/or production of receiver write **OEO**, 4218-Bunker Hill, Bettendorf, IA 52722, (319) 355-2927.

INVENTORS

INVENTORS! Can you patent and profit from your idea? Call **AMERICAN INVENTORS CORPORATION** for free information. Over a decade of service. 1-(800) 338-5656. In Massachusetts or Canada call (413) 568-3753.

BIG PROFITS

ELECTRONIC ASSEMBLY BUSINESS

Start home, spare time. Investment knowledge or experience unnecessary. **BIG DEMAND** assembling electronic devices. Sales handled by professionals. Unusual business opportunity.

FREE: Complete illustrated literature
BARTA, RE-O Box 248
Walnut Creek, Calif. 94597

BUSINESS OPPORTUNITIES

MECHANICALLY inclined individuals desiring ownership of small electronics manufacturing business—without investment. Write: **BUSINESSES**, 92-R, Brighton 11th, Brooklyn, NY 11235.

PROJECTION TV...Make \$\$\$'s assembling projectors...easy...results comparable to \$2,500 projectors. Total cost less than \$30.00. **PLANS**, 8" **LENS** and dealers information \$20.50. Illustrated information free. **MACROCOMA-GKX**, Washington Crossing, PA 18977. Creditcard orders 24hrs. (215) 736-2880.

EASY, lucrative. One man CRT rebuilding machinery. Free info: (815) 459-0666 **CRT**, 1909 Louise, Crystalake, IL 60014.

YOUR own radio station! AM, FM, cable. Licensed or unlicensed. **BROADCASTING**, Box 130-F7, Paradise, CA 95967.

CRT equipment rebuilds Sony/color tubes/other. **CRT SYSTEMS**, 633 North Semoran, Orlando, FL 32807. Call (305) 275-9543.

PERSONAL computer owners can earn \$1000 to \$5000 monthly offering simple services part time. Free list of 100 services. Write: **C.I.L.G.B.**, P.O. Box 60369, San Diego, CA 92106-8369.

PAY TV AND SATELLITE DESCRAMBLING NOW 120 PAGES!

Theory and working schematics. 13 cable and 7 satellite systems. Turnons, detection, countermeasures \$14.95. 20 Page Supplement Only \$8.95. Experiments with VideoCipher turnons, cloning procedures. \$12.95 Cable TV Design, security systems. \$12.95 MDS/ MMS Handbook For Microwave Hackers \$9.95. Build Satellite Systems Under \$600 \$12.95. Any 3/26 Summer catalog \$1.

Shojiki Electronics Corp. 1327A Niagara St.,
Niagara Falls, NY 14303. COD's 716-284-2163

TV sales & repair shop, Cape Coral, FL, exclusive Sylvania sales and service, 16 years same location, total price \$85,000. Unbelievable net, call John Thompson, Realtor-Associate, **CENTURY 21 AAIM REALTY GROUP, INC.**, Out-of-Florida 1-800-237-3342, in Florida (813) 337-1121.

BUY direct from Taiwan, Singapore, and Hong Kong! Send SASE for details. **BUY DIRECT**, 51 SW 69th Avenue, Miami, FL 33144-2809.

SCIENTIFIC ATLANTA & SB-3

SCIENTIFIC Atlanta cable converters (original units), models—8500 and 8550, remote control...\$240.00. **SB-3's**...\$74.00. **Tri-Bi's**...\$95.00. **SBSA-3's**...\$99.00. **Zenith** (Tag-ons)...\$159.00. **Jerrold-450** converters...\$95.00. **Dealer discount** on (5) units. Call **N.A.S.**, (213) 631-3552.

NOTCH FILTERS

THE Positrap Cookbook: build 50-60dB notch filters for pennies. Construction, alignment, fixed, tunable, trimable. Comprehensive **Cable TV scrambling and descrambling** theory and practice. Identifying various systems. \$9.95 **CLEARVIEW CABLE COMPANY**, P.O. Box 207, Sterling Heights, MI 48311.

NOTCH filters for any channel. Send \$15.00 for sample unit. Specify output channel of converter. Money back guarantee. **DB ELECTRONICS**, P.O. Box 8644, Pembroke Pines, FL 33084.

CB RADIO OWNERS!

We specialize in a wide variety of technical information, parts and services for CB radios. 10M-FM conversions, repairs, books, plans, kits, high-performance accessories. Our 11th year! Catalog \$2.

CBC INTERNATIONAL, P.O. BOX 31500RE,
PHOENIX, AZ 85046

DO IT YOURSELF TV REPAIRS

NEW...REPAIR ANY TV...EASY. Retired serviceman reveals secrets. Write **RESEARCH**, Rt. 3, Box 601B, Colville, WA 99114.

CABLE TV DESCRAMBLERS

CABLE television converter, descrambler and wireless remote control video equipment accessories catalog free. **CABLE DISTRIBUTORS UNLIMITED**, 116-C Main Road, Washington, AR 71862.

IBM-PC SOFTWARE

COMPDES—computer-aided circuit design, selections from basic electricity to circuit designs. Very educational. \$49.95 (614) 491-0832. **ESOF SOFTWARE**, 444 Colton Road, Columbus, OH 43207.

THIS IS AN EXPANDED TYPE AD. Notice how it stands out on this page. To get your ad set in this type style mark your classified ad order, "Expanded-type ad," and calculate your cost at \$3.75 per word.

1200B MODEM

\$9995

FOR IBM W/
SOFTWARE

2400B MODEM

\$19995

STATIC RAMS

2101	256x4	(450ns)	1.95
5101	256x4	(450ns)(CMOS)	3.95
2102L-4	1024x1	(450ns)(LP)	.99
2112	256x4	(450ns)	2.99
2114	1024x4	(450ns)	.99
2114L-4	1024x4	(450ns)(LP)	1.09
2114L-2	1024x4	(200ns)(LP)	1.49
2114L-15	1024x4	(150ns)(LP)	1.95
TMS4044-4	4096x1	(450ns)	1.95
TMM2016-150	2048x8	(150ns)	1.49
TMM2016-100	2048x8	(100ns)	1.95
HM6116-4	2048x8	(200ns)(CMOS)	1.89
HM6116-3	2048x8	(150ns)(CMOS)	1.95
HM6116LP-4	2048x8	(200ns)(CMOS)(LP)	1.95
HM6116LP-3	2048x8	(150ns)(CMOS)(LP)	1.19
HM6116LP-2	2048x8	(120ns)(CMOS)(LP)	2.95
HM6264P-15	8192x8	(150ns)(CMOS)	3.89
HM6264LP-15	8192x8	(150ns)(CMOS)(LP)	3.95
HM6264LP-12	8192x8	(120ns)(CMOS)(LP)	4.49

LP=Low power

DYNAMIC RAMS

4116-250	16384x1	(250ns)	.49
4116-200	16384x1	(200ns)	.89
4116-150	16384x1	(150ns)	.99
4116-120	16384x1	(120ns)	1.49
MK4332	32768x1	(200ns)	6.95
4164-200	65536x1	(200ns)(5v)	1.19
4164-150	65536x1	(150ns)(5v)	1.29
4164-120	65536x1	(120ns)(5v)	1.95
MCM6665	65536x1	(200ns)(5v)	1.95
TMS4164	65536x1	(150ns)(5v)	1.95
4164-REFRESH	65536x1	(150ns)(5v)(REFRESH)	2.95
TMS4416	16384x4	(150ns)(5v)	4.95
41126-150	131072x1	(150ns)(5v)	5.95
TMS4464-15	65536x4	(150ns)(5v)	6.95
41256-200	262144x1	(200ns)(5v)	2.95
41256-150	262144x1	(150ns)(5v)	2.95

5v=Single 5 Volt Supply

REFRESH=Pin 1 Refresh

★★★★ HIGH-TECH ★★★★★

NEC V20 UPD70108 \$1195

REPLACES 8088 TO SPEED UP IBM PC 10-40%

* HIGH-SPEED ADDRESS CALCULATION
IN HARDWARE

* PIN COMPATIBLE WITH 8088

* SUPERSET OF 8088 INSTRUCTION SET

* LOW POWER CMOS

8MHZ V20 UPD70108-8 \$13.95

8MHZ V30 UPD70116-8 \$19.95

★★★★ SPOTLIGHT ★★★★★

ORDER TOLL FREE 800-538-5000



EPROMS

2708	1024x8	(450ns)	4.95
2716	2048x8	(450ns)(5V)	3.49
2716-1	2048x8	(350ns)(5V)	3.95
TMS2532	4096x8	(450ns)(5V)	5.95
2732	4096x8	(450ns)(5V)	3.95
2732A	4096x8	(250ns)(5V)(21V PGM)	3.95
2732A-2	4096x8	(200ns)(5V)(21V PGM)	4.25
27C64	8192x8	(250ns)(5V)(CMOS)	5.95
2764	8192x8	(450ns)(5V)	3.49
2764-250	8192x8	(250ns)(5V)	3.95
2764-200	8192x8	(200ns)(5V)	4.25
MCM68766	8192x8	(350ns)(5V)(24 PIN)	17.95
27128	16384x8	(250ns)(5V)	4.25
27C256	32768x8	(250ns)(5V)(CMOS)	10.95
27256	32768x8	(250ns)(5V)	7.49

5V=Single 5 Volt Supply 21V PGM=Program at 21 Volts

SPECTRONICS CORPORATION EPROM ERASERS



Model	Timer	Capacity Chip	Intensity (uW/Cm ²)	Unit Price
PE-14	NO	9	8,000	\$83.00
PE-14T	YES	9	8,000	\$119.00
PE-24T	YES	12	9,600	\$175.00

8000

8035	1.49
8039	1.95
8080	2.95
8085	2.49
8087-2	169.95
8087	129.00
8088	6.95
8088-2	9.95
8155	2.49
8155-2	3.95
8748	7.95
8755	14.95
80286	129.95
80287	199.95

CRT CONTROLLERS

6845	4.95
68B45	8.95
6847	11.95
HD46505SP	6.95
MC1372	2.95
8275	26.95
7220	19.95
CRT5027	12.95
CRT5037	9.95
TMS9918A	19.95

6500

6502	2.69
65C02 (CMOS)	12.95
6507	9.95
6520	1.95
6522	4.95
6526	26.95
6532	6.95
6545	6.95
6551	5.95
6561	19.95
6581	34.95

CRYSTALS

32.768 KHz	.95
1.0 MHz	2.95
1.8432	2.95
2.0	1.95
2.097152	1.95
2.4576	1.95
3.2768	1.95
3.579545	1.95
4.0	1.95
4.032	1.95
5.0	1.95
5.0688	1.95
6.0	1.95
6.144	1.95
6.5536	1.95
8.0	1.95
10.0	1.95
10.738635	1.95
12.0	1.95
14.31818	1.95
15.0	1.95
16.0	1.95
17.430	1.95
18.0	1.95
18.432	1.95
20.0	1.95
22.1184	1.95
24.0	1.95
32.0	1.95

74LS00

74LS00	.16
74LS01	.18
74LS02	.17
74LS03	.18
74LS04	.16
74LS05	.18
74LS08	.18
74LS09	.18
74LS10	.16
74LS11	.22
74LS12	.22
74LS13	.26
74LS14	.39
74LS15	.26
74LS20	.17
74LS21	.22
74LS22	.22
74LS27	.23
74LS28	.26
74LS30	.17
74LS32	.18
74LS33	.28
74LS37	.26
74LS38	.26
74LS42	.39
74LS47	.75
74LS48	.85
74LS51	.17
74LS73	.29
74LS74	.24
74LS75	.22
74LS76	.29
74LS83	.49
74LS85	.49
74LS86	.22
74LS90	.39
74LS92	.49
74LS93	.39
74LS95	.49
74LS107	.34
74LS109	.36
74LS112	.29
74LS122	.45
74LS123	.49
74LS124	2.75
74LS127	.39
74LS126	.39
74LS132	.39
74LS133	.49
74LS136	.39
74LS138	.39
74LS139	.39
74LS145	.95
74LS157	.95
74LS148	.95
74LS151	.39
74LS153	.39
74LS154	1.49
74LS155	.59
74LS156	.49
74LS158	.39
74LS158	.29
74LS160	.29
74LS161	.39
74LS162	.49
74LS163	.39
74LS164	.49

HIGH SPEED CMOS

A new family of high speed CMOS logic featuring the speed of low power Schottky (8ns typical gate propagation delay), combined with the advantages of CMOS: very low power consumption, superior noise immunity, and improved output drive.

74HC00

74HC: Operate at CMOS logic levels and are ideal for new, all-CMOS designs.

74HC00	.59	74HC148	1.19
74HC02	.59	74HC151	.89
74HC04	.59	74HC154	2.49
74HC08	.59	74HC157	.89
74HC10	.59	74HC158	.95
74HC14	.79	74HC163	1.15
74HC20	.59	74HC175	.99
74HC27	.59	74HC240	1.89
74HC30	.59	74HC244	1.89
74HC32	.69	74HC245	1.89
74HC51	.59	74HC257	.85
74HC74	.75	74HC259	1.39
74HC85	1.35	74HC273	1.89
74HC86	.69	74HC293	4.99
74HC93	1.19	74HC368	.99
74HC107	.79	74HC373	2.29
74HC109	.79	74HC274	2.29
74HC112	.79	74HC390	1.39
74HC125	1.19	74HC393	1.39
74HC132	1.19	74HC4017	1.99
74HC133	.69	74HC4020	1.39
74HC138	.99	74HC4049	.89
74HC139	.99	74HC4050	.89

74HC00

74HC: Direct, drop-in replacements for LS TTL and can be intermixed with 74LS in the same circuit.

74HC00	.69	74HC166	3.05
74HC02	.69	74HC174	1.09
74HC04	.69	74HC193	1.39
74HC08	.69	74HC194	1.19
74HC10	.69	74HC240	2.19
74HC11	.69	74HC241	2.19
74HC127	.69	74HC244	2.19
74HC30	.69	74HC245	2.19
74HC32	.79	74HC257	.99
74HC74	.85	74HC259	1.59
74HC75	.95	74HC273	2.09
74HC138	1.15	74HC367	1.09
74HC139	1.15	74HC373	2.49
74HC154	2.99	74HC374	2.49
74HC157	.99	74HC393	1.59
74HC158	.99	74HC4017	2.19
74HC161	1.29	74HC4040	1.59
74HC164	1.39	74HC4060	1.49

74F00

74F00	.69	74F74	.79	74F251	1.69
74F02	.69	74F86	.99	74F253	1.69
74F04	.79	74F138	1.69	74F257	1.69
74F08	.69	74F139	1.69	74F280	1.79
74F10	.69	74F157	1.69	74F283	3.95
74F32	.69	74F240	3.29	74F373	4.29
74F64	.89	74F244	3.29	74F374	4.29



Visit our retail store located at 1256 S. Bascom Ave. in San Jose, (408) 947-8881

JDR Microdevices

110 Knowles Drive, Los Gatos, CA 95030

Toll Free 800-538-5000 • (408) 866-6200

FAX (408) 378-8927 • Telex 171-110



COPYRIGHT 1987 JDR MICRODEVICES

THE JDR MICRODEVICES LOGO IS A REGISTERED TRADEMARK OF JDR MICRODEVICES. JDR INSTRUMENTS AND JDR MICRODEVICES ARE TRADEMARKS OF JDR MICRODEVICES. IBM IS A TRADEMARK OF INTERNATIONAL BUSINESS MACHINES. APPLE IS A TRADEMARK OF APPLE COMPUTER.

PLEASE USE YOUR CUSTOMER NUMBER WHEN ORDERING

TERMS: Minimum order \$10.00. For shipping and handling include \$2.50 for UPS Ground and \$3.50 for UPS Air. Orders over 1 lb. and foreign orders may require additional shipping charges - please contact our sales department for the amount. CA residents must include applicable sales tax. All merchandise is warranted for 90 days unless otherwise stated. Prices are subject to change without notice. We are not responsible for typographical errors. We reserve the right to limit quantities and to substitute manufacturer. All merchandise subject to prior sale.

EGA CARD AND MONITOR NOW ONLY \$569!

DISK DRIVES FOR APPLE COMPUTERS

AP-150
\$99.95

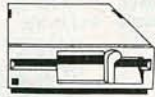

- 1/2 HT. DIRECT DRIVE
- 100% APPLE COMPATIBLE
- SIX MONTH WARRANTY

AP-135
\$129.95



- FULL HT SHUGART MECHANISM
- DIRECT REPLACEMENT FOR APPLE DISK II
- SIX MONTH WARRANTY

DOUBLE SIDED!

MAC535
\$249.95

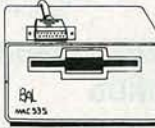

- 3.5" ADD-ON DISK DRIVE
- 100% MACINTOSH COMPATIBLE
- DOUBLE SIDED 800K BYTE STORAGE
- HIGH RELIABILITY DRIVE HAS AUTO-EJECT MECHANISM
- FULL ONE YEAR WARRANTY

AD-3C
\$139.95

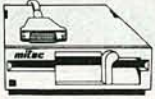

- 100% APPLE IIc COMPATIBLE. READY TO PLUG IN, W/ SHIELDED CABLE & MOLDED 19 PIN CONNECTOR
- FAST, RELIABLE SLIMLINE DIRECT DRIVE
- SIX MONTH WARRANTY

DISK DRIVE ACCESSORIES

- FDD CONTROLLER CARD \$49.95
- IIc ADAPTOR CABLE \$19.95
- ADAPTS STANDARD APPLE DRIVES FOR USE WITH APPLE IIc

KB-1000 \$79.95

CASE WITH KEYBOARD FOR APPLE TYPE MOTHERBOARD

- USER DEFINED FUNCTION KEYS
- NUMERIC KEYPAD W/ CURSOR CONTROL
- CAPS LOCK
- AUTO-REPEAT



KEYBOARD-AP \$49.95

- REPLACEMENT FOR APPLE II KEYBOARD
- CAPS LOCK KEY, AUTO-REPEAT
- ONE KEY ENTRY OF BASIC OR CP/M COMMANDS

JOYSTICK CG-10 \$19.95

- SET X-Y AXIS FOR AUTO CENTER OR FREE MOVEMENT
- FIRE BUTTON FOR USE WITH GAME SOFTWARE
- ATTRACTIVE, SOLID, PLASTIC CASE
- INCLUDES ADAPTOR CABLE FOR IBM, APPLE II, IIc, ATARI & VIC 20/64



POWER STRIP \$12.95

- UL APPROVED
- 15A CIRCUIT BREAKER

GRT MONITORS FOR ALL APPLICATIONS



CASPER EGA MONITOR

- EGA & CGA COMPATIBLE
- SCANNING FREQUENCIES: 15.75 / 21.85 KHz
- RES: 640 x 200 / 350
- .31mm DOT PITCH, 25 MHz
- 16 COLORS OUT OF 64
- 14", BLACK MATRIX SCREEN

\$399.95

CASPER RGB MONITOR

- COLOR / GREEN / AMBER SWITCH ON REAR
- DIGITAL RGB-IBM COMPATIBLE
- 14" NON-GLARE SCREEN
- RESOLUTION: 640H x 240V
- .39mm DOT PITCH
- CABLE FOR IBM PC INCLUDED

\$299.95

SAMSUNG MONOCHROME

- IBM COMPATIBLE TTL INPUT
- 12" NON-GLARE AMBER, LOW DISTORTION SCREEN
- RESOLUTION: 720H x 350V
- ATTRACTIVE CASE WITH SWIVEL BASE
- ONE YEAR WARRANTY

\$119.95

FORTRONICS MONOCHROME

- IBM COMPATIBLE TTL INPUT
- 12" NON-GLARE SCREEN
- VERY HIGH RESOLUTION: 1100 LINES (CENTER)
- 25 MHz BANDWIDTH
- CABLE FOR IBM PC INCLUDED
- AMBER OR GREEN AVAILABLE

\$99.95

TILT & SWIVEL MONITOR STAND \$12⁹⁵ WITH POWER CENTER \$39⁹⁵

APPLE COMPATIBLE INTERFACE CARDS

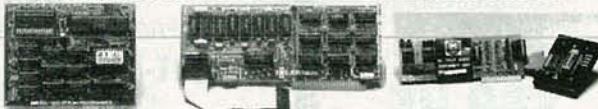

EPROM PROGRAMMER

- DUPLICATE OR BURN ANY 27xx SERIES EPROM (2716 TO 27128)
- MENU-DRIVEN SOFTWARE
- HIGH SPEED WRITE ALGORITHM

RP-525 \$59⁹⁵

16K RAMCARD

- FULL 2 YEAR WARRANTY
- EXPAND YOUR 48K MACHINE TO A FULL 64K OF MEMORY
- CAN BE USED IN PLACE OF THE APPLE LANGUAGE CARD

RAM-CARD \$39⁹⁵

IC TEST CARD

- QUICKLY TESTS MANY COMMON ICs
- DISPLAYS PASS OR FAIL
- TEST 4000 & 74HC SERIES CMOS, 7400, 74LS, 74L, 74H & 74S

IC-TESTER \$129⁹⁵

MOLDED INTERFACE CABLES

6 FOOT, 100% SHIELDED, MEETS FCC



- IBM PARALLEL PRINTER CABLE 9.95
- CENTRONICS (MALE TO FEMALE) 15.95
- CENTRONICS (MALE TO MALE) 14.95
- MODEM CABLE (FOR IBM) 7.95
- RS232 SERIAL (MALE TO FEMALE) 9.95
- RS232 SERIAL (MALE TO MALE) 9.95
- KEYBOARD EXTENDER (COILED) 7.95
- APPLE II JOYSTICK EXTENDER 4.95

C. ITOH RITEMAN II PRINTER



- 160 CPS DRAFT, 32 CPS NLQ
- 9 x 9 DOT MATRIX
- SUPPORTS EPSON / IBM GRAPHICS
- FRICTION AND PIN FEEDS
- VARIABLE LINE SPACING AND PITCH

\$219.95

- IBM PRINTER CABLE \$9.95
- REPLACEMENT RIBBON CARTRIDGE \$7.95

SWITCH BOXES

ALL LINES SWITCHED, GOLD PLATED CONNECTORS, QUALITY SWITCHES

2 WAY \$39.95

- CONNECTS 2 PRINTERS TO 1 COMPUTER OR VICE VERSA

AB-P (CENTRONICS PARALLEL)

AB-S (RS232 SERIAL)



3 WAY \$99.95

- CONNECTS 3 PRINTERS TO 1 COMPUTER OR VICE VERSA

SWITCH-3P (CENTRONICS PARALLEL)

SWITCH-3S (RS232 SERIAL)



300B MODEM \$49.95

- FOR APPLE OR IBM
- INCLUDES ASCII PRO-EZ SOFTWARE
- FCC APPROVED
- BELL SYSTEMS 103 COMPATIBLE
- INCLUDES AC ADAPTOR
- AUTO-DIAL
- DIRECT CONNECT
- CABLE FOR APPLE IIc \$14.95

NASHUA DISKETTES

NASHUA DISKETTES WERE JUDGED TO HAVE THE HIGHEST POLISH AND RECORDED AMPLITUDE OF ANY DISKETTES TESTED (COMPARING FLOPPY DISKS, BYTE 9/84)

- N-MD2D DS/DD 5 1/4" SOFT \$9.90
- N-MD2F DS/QUAD 5 1/4" SOFT \$19.95
- N-MD2H DS/HD 5 1/4" FOR AT \$24.95
- N-FD1 SS/DD 8" SOFT \$27.95
- N-FD2D DS/DD 8" SOFT \$34.95

BULK DISKETTE SALE

- 5 1/4" SOFT SECTOR, DS/DD W/ TYVEC SLEEVES & HUB RINGS
- \$990** BOX OF 10
- 69c^{ea}** BULK QTY 50
- 59c^{ea}** BULK QTY 250

DISKETTE FILES

- 5 1/4" DISKFILE HOLDS 70 \$8.95
- 3 1/2" DISKFILE HOLDS 40 \$9.95



Seagate

5 1/4" HARD DISK DRIVES

- ST-225 HALF HT 20MB 65ms \$275
- ST-238 HALF HT 30MB 65ms (RL) \$299
- ST-251 HALF HT 40MB 40ms \$599
- ST-277 HALF HT 60MB 40ms (RL) CALL
- ST-4038 FULL HT 30MB 40ms \$559
- ST-4096 FULL HT 80MB 28ms \$1195

1/2 HEIGHT FLOPPY DISK DRIVES

- 5 1/4" TEAC FD-55B DS/DD \$109.95
- 5 1/4" TEAC FD-55F DS/QUAD \$124.95
- 5 1/4" TEAC FD-55GFV DS/HD \$154.95
- 5 1/4" MITSUBISHI DS/HD \$129.95
- 3 1/2" TOSHIBA KIT DS/DD \$149.95
- KIT INCLUDES MOUNTING HARDWARE TO FIT 5 1/4" & FACEPLATES FOR AT & XT

DISK DRIVE ACCESSORIES

- TEAC SPECIFICATION MANUAL \$5.00
- TEAC MAINTENANCE MANUAL \$25.00
- 1/2 HT MNTG HARDWARE FOR IBM \$2.95
- MOUNTING RAILS FOR IBM AT \$4.95
- "Y" POWER CABLE FOR 5 1/4" FDDs \$2.95
- 5 1/4" FDD POWER CONNECTORS \$1.19

DISK DRIVE ENCLOSURES WITH POWER SUPPLIES

- CAB-25V5 DUAL SLIMLINE 5 1/4" \$49⁹⁵
- CAB-1FH5 FULL HT 5 1/4" \$89⁹⁵
- CAB-25V8 DUAL SLIMLINE 8" \$209⁹⁵
- CAB-2FH8 DUAL FULL HT 8" \$219⁹⁵

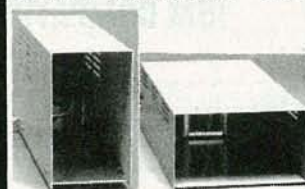

BUILD STEVE GIARGIA'S INTELLIGENT EPROM PROGRAMMER

AS SEEN IN BYTE, OCT. 86

- STAND-ALONE OR RS-232 SERIAL OPERATION
- MENU SELECTABLE EPROM TYPES—NO CONFIGURATION JUMPERS
- PROGRAMS ALL 5V 27XXX EPROMS FROM 2716 TO 27512
- READ, COPY OR VERIFY EPROM
- UPLOAD / DOWNLOAD INTEL HEX FILES
- PROGRAMMER DRIVER USER MODIFIABLE

ONLY \$199

KIT INCLUDES PCB AND ALL COMPONENTS EXCEPT CASE & POWER SUPPLY

CALL FOR VOLUME QUOTES COPYRIGHT 1987 JDR MICRODEVICES

CIRCLE 176 ON FREE INFORMATION CARD

JULY 1987

EGA CARD AND MONITOR NOW ONLY \$569!

QUALITY IBM COMPATIBLE MOTHERBOARDS

FROM MODULAR CIRCUIT TECHNOLOGY

TURBO 4.77 / 8 MHZ \$129.95

JDR PART #: MCT-TURBO

- 4.77 OR 8 MHZ OPERATION WITH 8088-2 & OPTIONAL 8087-2 CO-PROCESSOR
- DYNAMICALLY ADJUSTS SPEED DURING DISKETTE OPERATION FOR MAXIMUM THROUGHPUT AND RELIABILITY
- CHOICE OF NORMAL / TURBO MODE OR SOFTWARE SELECT PROCESSOR SPEED

STANDARD 4.77 MHZ \$109.95

JDR PART #: MCT-XTMB

- 8088 CPU, OPTIONAL 8087 CO-PROCESSOR
- 8 EXPANSION SLOTS
- EXPANDABLE TO 640K ON-BOARD MEMORY (0K RAM INSTALLED)
- ALL ICs SOCKETED-HIGHEST QUALITY PCB
- ACCEPTS 2764 OR 27128 ROMS

BOTH WITH FREE MCT BIOS!

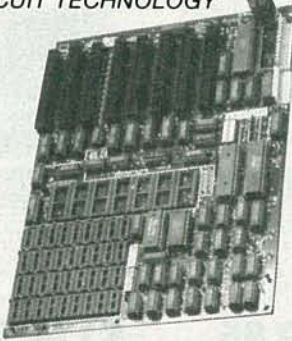

FARADAY FDD CONTROLLER

JDR PART #: FAR-FDD

- SUPPORTS UP TO 4 INTERNALLY MOUNTED FDDs
- IBM COMPATIBLE, INTERFACES TO 360K OR 720K USING DOS 3.20
- INCLUDES CABLE FOR 2 DISK DRIVES

\$24.95

IBM COMPATIBLE FLOPPY DISK DRIVE

JDR PART #: FDD-360

GOOD QUALITY DRIVES BY MAJOR MANUFACTURERS SUCH AS QUME, TANDON & CDC

- 5 1/4" HALF HEIGHT
- 360K STORAGE CAPACITY
- DS/DD
- 48 TPI

\$69.95

IBM STYLE COMPUTER CASE

AN ATTRACTIVE STEEL CASE WITH A HINGED LID. FITS THE POPULAR PC/XT COMPATIBLE MOTHERBOARDS



- SWITCH CUT-OUT ON SIDE FOR PC/XT STYLE POWER SUPPLY
- CUT-OUT FOR 8 EXPANSION SLOTS
- ALL HARDWARE INCLUDED

\$34.95

SLIDE TYPE CASE \$39.95

BUILD YOUR OWN 256K XT COMPATIBLE SYSTEM

- XT MOTHERBOARD \$109.95
- PRO-BIOS (A \$20 VALUE) FREE!
- 256K RAM \$26.55
- 130 WATT POWER SUPPLY \$69.95
- FLIP-TOP CASE \$34.95
- KEY TRONIC™ KEYBOARD \$49.95
- 360K DRIVE \$69.95
- FARADAY CONTROLLER \$24.95
- MONOCHROME ADAPTOR \$49.95
- FORTNONS MONITOR \$99.95

TOTAL: \$536.15

IBM COMPATIBLE KEYBOARDS



MCT-5150 \$59.95

- "5150" STYLE KEYBOARD
- FULLY IBM COMPATIBLE
- LED STATUS INDICATORS FOR CAPS & NUMBER LOCK
- LARGE, EASY TO REACH SHIFT & RETURN KEYS
- 83 KEY TYPEWRITER LAYOUT

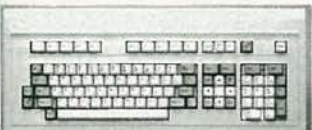

MCT-5151 \$79.95

- REPLACEMENT FOR KEY TRONIC™ KB-5151 KEYBOARD
- SEPARATE CURSOR & NUMERIC KEYPAD
- CAPS LOCK & NUMBER LOCK INDICATORS
- IMPROVED KEYBOARD LAYOUT



MCT-5060 \$59.95

- IBM AT STYLE LAYOUT
- SOFTWARE AUTONSENSE FOR XT OR AT COMPATIBLES
- EXTRA LARGE SHIFT & RETURN KEYS
- LED INDICATORS FOR SCROLL, CAPS & NUMBER LOCK
- AUTO REPEAT FEATURE



MCT-5339 \$89.95

- IBM ENHANCED STYLE LAYOUT
- SOFTWARE AUTONSENSE FOR XT OR AT COMPATIBLES
- 12 FUNCTION KEYS
- EXTRA LARGE SHIFT & RETURN KEYS
- LED INDICATORS FOR SCROLL, CAPS & NUMBER LOCK
- AUTO REPEAT FEATURE
- SEPARATE CURSOR PAD

EASYDATA MODEMS

All models feature auto-dial/answer/redial on busy, Hayes compatible, power up self test, touchtone or pulse dialing, built-in speaker, PC Talk III Communications software, Bell Systems 103 & 212A full or half duplex and more.

INTERNAL

EASYDATA-12H \$99.95

1200 BAUD HALF CARD

EASYDATA-12B \$119.95

1200 BAUD 10" CARD

EASYDATA-24B \$199.95

2400 BAUD FULL CARD

EXTERNAL

NO SOFTWARE INCLUDED

EASYDATA-12D \$119.95

1200 BAUD

EASYDATA-24D \$219.95

2400 BAUD

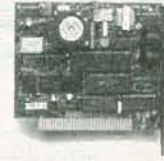

DISPLAY CARDS

FROM MODULAR CIRCUIT TECHNOLOGY

MCT-EGA

\$179.95

100% IBM COMPATIBLE, PASSES IBM EGA DIAGNOSTICS

- COMPATIBLE WITH IBM EGA, COLOR GRAPHICS AND MONOCHROME ADAPTORS
- TRIPLE SCANNING FREQUENCY FOR DISPLAY ON EGA, STANDARD RGB OR HIGH RESOLUTION MONOCHROME MONITOR
- FULL 256K OF VIDEO RAM ALLOWS 640 x 350 PIXELS IN 16 OF 64 COLORS
- LIGHT PEN INTERFACE



MCT-CG

\$49.95

COMPATIBLE WITH IBM COLOR GRAPHICS STANDARD

- SHORT SLOT CARD USES VLSI CHIPS TO INSURE RELIABILITY
- SUPPORTS RGB, COMPOSITE MONOCHROME & COLOR AND AN RF MODULATOR OUTPUT
- 320 x 200 COLOR GRAPHICS MODE
- 640 x 200 MONOGRAPHICS MODE
- LIGHT PEN INTERFACE



MCT-MGP

\$59.95

COMPATIBLE WITH IBM MONOCHROME AND HERCULES GRAPHICS STANDARDS

- SHORT SLOT CARD USES VLSI CHIPS TO INSURE RELIABILITY
- PARALLEL PRINTER PORT, CONFIGURABLE AS LPT1 OR LPT2
- 720 x 348 GRAPHICS MODE
- LOTUS COMPATIBLE
- CAN RUN WITH COLOR GRAPHICS CARD IN THE SAME SYSTEM



MCT-MG

\$79.95

COMPATIBLE WITH IBM MONOCHROME AND HERCULES GRAPHICS STANDARDS

- SERIAL PORT OPTION
- PARALLEL PRINTER PORT
- 720 x 348 GRAPHICS MODE
- 80 x 25 TEXT MODE
- LOTUS COMPATIBLE
- SELECTABLE TO RUN ALONG WITH COLOR GRAPHICS CARD IN THE SAME SYSTEM



MG-SERIAL OPTIONAL SERIAL PORT \$19.95

MCT-MONO

\$49.95

ANOTHER FANTASTIC VALUE FROM JDR!

- IBM COMPATIBLE TTL INPUT
 - 720 x 348 PIXEL DISPLAY
- PLEASE NOTE: THIS CARD WILL NOT RUN LOTUS GRAPHICS AND DOES NOT INCLUDE A PARALLEL PORT

EPROM PROGRAMMERS

FROM MODULAR CIRCUIT TECHNOLOGY

MCT-EPROM

\$129.95

PROGRAMS 27xx AND 27xxx SERIES EPROMS UP TO 27512

- SUPPORTS VARIOUS MANUFACTURERS FORMATS WITH 12.5, 21 AND 25 VOLT PROGRAMMING
- MENU-DRIVEN SOFTWARE ALLOWS EASY MANIPULATION OF DATA FILES
- SPLIT OR COMBINE THE CONTENTS OF SEVERAL EPROMS OF DIFFERENT SIZES
- READ, WRITE, COPY, ERASE CHECK AND VERIFY WITH EASY ONE KEY SELECTION
- INCLUDES SOFTWARE FOR STANDARD HEX AND INTEL HEX FORMATS

4 GANG PROGRAMMER \$189.95

10 GANG PROGRAMMER \$299.95

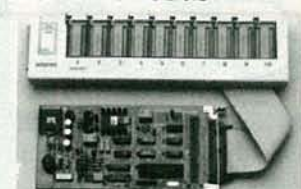

MCT PRODUCTS CARRY A ONE YEAR WARRANTY

COPYRIGHT 1987 JDR MICRODEVICES

1200B MODEM \$99⁹⁵ FOR IBM W/
SOFTWARE

2400B MODEM \$199⁹⁵

MULTIFUNCTION CARDS

FROM MODULAR CIRCUIT TECHNOLOGY

MCT-MF \$79.95

ALL THE FEATURES OF AST'S SIX PACK PLUS AT HALF THE PRICE!

- 0-348K DYNAMIC RAM USING 4164s
- INCLUDES SERIAL PORT, PARALLEL PRINTER PORT, GAME CONTROLLER PORT AND CLOCK/CALENDAR
- SOFTWARE FOR A RAMDISK, PRINT SPOOLER AND CLOCK/CALENDAR

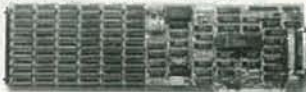

MCT-ATMF \$139.95

ADDS UP TO 3 MB OF 1 BIT RAM TO THE AT

- USER EXPANDABLE TO 1.5 MB OF ON-BOARD MEMORY (NO MEMORY INSTALLED)
- FLEXIBLE ADDRESS CONFIGURATION
- INCLUDES SERIAL PORT, PARALLEL PORT AND CLOCK/CALENDAR
- OPTIONAL PIGGYBACK BOARD PERMITS EXPANSION TO 3 MB



ATMF-SERIAL 2nd SERIAL PORT \$24⁹⁵

MCT-ATMF-MC \$29⁹⁵

PIGGYBACK BOARD (ZERO K INSTALLED)

MCT-MIO \$79.95

A PERFECT COMPANION FOR OUR MOTHERBOARD

- 2 DRIVE FLOPPY DISK CONTROLLER
- INCLUDES SERIAL PORT, PARALLEL PORT, GAME PORT AND CLOCK/CALENDAR WITH BATTERY BACK-UP
- SOFTWARE FOR A RAMDISK, PRINT SPOOLER AND CLOCK/CALENDAR



MIO-SERIAL 2nd SERIAL PORT \$15⁹⁵

MCT-IO \$59.95

USE WITH MCT-FH FOR A MINIMUM OF SLOTS USED

- SERIAL PORT ADDRESSABLE AS COM1, COM2, COM3 OR COM4
- PARALLEL PRINTER PORT ADDRESSABLE AS LPT1 OR LPT2 (x378 OR x278)
- CLOCK/CALENDAR WITH A BATTERY BACK-UP



SHORT SLOT

IO-SERIAL 2nd SERIAL PORT \$15⁹⁵

MCT-ATIO \$59.95

USE WITH MCT-ATFH FOR A MINIMUM OF SLOTS USED

- SERIAL PORT ADDRESSABLE AS COM1, COM2, COM3 OR COM4
- PARALLEL PRINTER PORT ADDRESSABLE AS LPTA OR LPTB (x378 OR x278)
- GAME PORT
- USES 16450 SERIAL SUPPORT CHIPS FOR HIGH SPEED OPERATION IN AN AT



SHORT SLOT

ATIO-SERIAL 2nd SERIAL PORT \$24⁹⁵

RAM CARDS

FROM MODULAR CIRCUIT TECHNOLOGY

MCT-RAM \$69.95

A CONTIGUOUS MEMORY SOLUTION FOR YOUR SHORT OR REGULAR SLOT

- SHORT SLOT, LOW POWER PC COMPATIBLE DESIGN
- CAN OFFER UP TO 576K OF ADDITIONAL MEMORY
- USER SELECTABLE CONFIGURATION AMOUNTS OF 192, 384, 512, 256 & 576K, USING COMBINATIONS OF 64 & 256K RAM



SHORT SLOT

MCT-ATRAM \$149.95

A POWER USER'S DREAM, 4MB OF MEMORY FOR THE AT

- USER EXPANDABLE TO 2MB OF ON-BOARD MEMORY
- USES FULL 16 BIT PARITY CHECKED MEMORY, 64K OR 256K DYNAMIC RAM
- FLEXIBLE STARTING ADDRESS, ROUND OUT CONVENTIONAL MEMORY TO 640K & ADD EXTENDED MEMORY ABOVE 1MB



MCT-ATRAM-MC \$39⁹⁵

2MB PIGGYBACK BOARD (ZERO K INSTALLED)

MCT-EMS \$129.95

2MB OF LOTUS/INTEL/MICROSOFT COMPATIBLE MEMORY FOR THE XT

- CONFORMS TO LOTUS/INTEL EMS
- USER EXPANDABLE TO 2 MB
- USES 64K OR 256K DYNAMIC RAM (NO MEMORY INSTALLED)
- USE AS EXPANDED OR CONVENTIONAL MEMORY, RAMDISK OR SPOOLER
- SOFTWARE INCLUDES EMS DEVICE DRIVERS, PRINT SPOOLER AND RAMDISK



MCT-ATEMS AT VERSION OF THE MCT-EMS \$139⁹⁵

Seagate

HARD DISK SYSTEMS
20 MB 30 MB
\$339 \$399

Systems include half height hard disk drive, hard disk drive controller, cables and instructions. Drives are pre-tested and warranted for one year.

Seagate 40 MB AT DRIVE
FAST 40ms ACCESS TIME

NEW!
1/2 HEIGHT

\$599

DISK CONTROLLER CARDS

FROM MODULAR CIRCUIT TECHNOLOGY

MCT-FDC \$34.95

QUALITY DESIGN OFFERS 4 FLOPPY CONTROL IN A SINGLE SLOT

- INTERFACES UP TO 4 FDDs TO AN IBM PC OR COMPATIBLE
- INCLUDES CABLING FOR 2 INTERNAL DRIVES
- USES STANDARD DB37 CONNECTOR FOR EXTERNAL DRIVES
- SUPPORTS BOTH DS/DD AND DS/QD WHEN USED W/ DOS 3.2 OR JFORMAT

SHORT SLOT

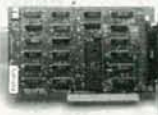

MCT-HDC \$89.95

HARD DISK CONTROL FOR WHAT OTHERS CHARGE FOR FLOPPY CONTROL

- IBM XT COMPATIBLE CONTROLLER SUPPORTS 16 DRIVE SIZES INCLUDING 5, 10, 20, 30 & 40MB
- OPTIONS INCLUDE THE ABILITY TO DIVIDE 1 LARGE DRIVE INTO 2 SMALLER, LOGICAL DRIVES
- INCLUDES CABLING FOR 1 INTERNAL DRIVE

SHORT SLOT

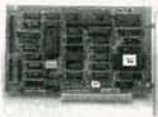

MCT-RLI \$119.95

GET UP TO 50% MORE STORAGE SPACE ON YOUR HARD DISK

- INCREASES THE CAPACITY OF PLATED MEDIA DRIVES BY 50%
- RLI 2.7 ENCODING FOR MORE RELIABLE STORAGE
- TRANSFER RATE IS ALSO 50% FASTER: 750K/sec vs 500K/sec
- USE WITH ST-238 DRIVE TO ACHIEVE 30+ MB IN A HALF HEIGHT SLOT

SHORT SLOT



NEW!

MCT-FH \$139.95

STARVED FOR SLOTS? SATISFY IT WITH THIS TIMELY DESIGN

- INTERFACES UP TO 2 FDDs & 2 HDDs
- CABLING FOR 2 FDDs & 1 HDD
- FLOPPY INTERFACE SUPPORTS BOTH DS/DD & DS/QD WHEN USED WITH DOS 3.2 OR JFORMAT
- ALL POPULAR HDD SIZES ARE SUPPORTED, INCLUDING 5, 10, 20, 30 & 40MB
- CAN DIVIDE 1 LARGE DRIVE INTO 2 SMALLER, LOGICAL DRIVES

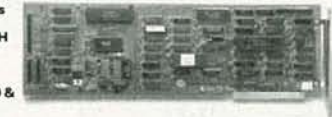

MCT-ATFH \$169.95

FLOPPY AND HARD DISK CONTROL IN A TRUE AT DESIGN

- AT COMPATIBLE, CONTROL UP TO 2 360K/720K OR 1.2MB FDDs AS WELL AS 2 HDDs USING THE AT STANDARD CONTROL TABLES
- SUPPORTS AT STYLE FRONT PANEL LED TO INDICATE HD ACTIVITY
- 16 BIT BUSS PROVIDES RAPID DATA TRANSFERS
- FULLY SUPPORTED BY AT BIOS



JDR Microdevices

110 Knowles Drive, Los Gatos, CA 95030
Toll Free 800-538-5000 • (408) 866-6200 • FAX (408) 378-8927 • Telex 171-110

THE JDR MICRODEVICES LOGO IS A REGISTERED TRADEMARK OF JDR MICRODEVICES. JDR INSTRUMENTS AND JDR MICRODEVICES ARE TRADEMARKS OF JDR MICRODEVICES. IBM IS A TRADEMARK OF INTERNATIONAL BUSINESS MACHINES.

CIRCLE 178 ON FREE INFORMATION CARD

JULY 1987

1200B MODEM \$99⁹⁵

**FOR IBM W/
SOFTWARE**

2400B MODEM \$199⁹⁵

**BARGAIN HUNTERS CORNER
NEW FROM RIM ELECTRONICS**

**NICKEL EXPRESS \$69⁹⁵
PC/XT SPEED UP KIT**

- * INCREASE THE SPEED OF YOUR PC BY 67% OR MORE!
- * SIMPLE NO-SLOT INSTALLATION
- * SOFTWARE OR HARDWARE SPEED SELECTION
- * 8 MHz V20 PROCESSOR & SOFTWARE INCLUDED
- * SELECT FOR 3 TURBO FREQUENCIES
- * EXTERNAL RESET SWITCH
- * OPTIONAL 8088 8 MHz PROCESSOR AVAILABLE

Certain early PCs may not run at 8 MHz-these machines may be switched to one of the slower speeds:
6.66 MHz=40% 7.37 MHz=56% 8.0 MHz=67%

SPECIAL ENDS 7/31/87

**PAGE WIRE WRAP WIRE
PRECUT ASSORTMENT**

IN ASSORTED COLORS \$27.50
100ea: 5.5", 6.0", 6.5", 7.0"
250ea: 2.5", 4.5", 5.0"
500ea: 3.0", 3.5", 4.0"

SPOOLS

100 feet \$4.30 250 feet \$7.25
500 feet \$13.25 1000 feet \$21.95

Please specify color:
Blue, Black, Yellow or Red

EXTENDER CARDS

IBM-PC \$29.95
IBM-AT \$39.95



**WIRE WRAP PROTOTYPE CARDS
FR-4 EPOXY GLASS LAMINATE
WITH GOLD-PLATED EDGE-CARD FINGERS**

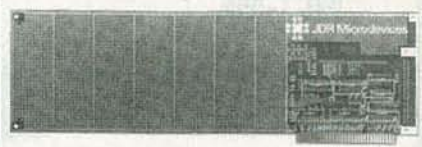

IBM-PR2

IBM

BOTH CARDS HAVE SILK SCREENED LEGENDS
AND INCLUDES MOUNTING BRACKET

IBM-PR1 WITH +5V AND GROUND PLANE . . . \$27.95
IBM-PR2 AS ABOVE WITH DECODING LAYOUT \$29.95

S-100

P100-1 BARE - NO FOIL PADS \$15.15
P100-2 HORIZONTAL BUS \$21.80
P100-3 VERTICAL BUS \$21.80
P100-4 SINGLE FOIL PADS PER HOLE \$22.75

APPLE

P500-1 BARE - NO FOIL PADS \$15.15
P500-3 HORIZONTAL BUS \$22.75
P500-4 SINGLE FOIL PADS PER HOLE \$21.80
7060-45 FOR APPLE IIe AUX SLOT \$30.00

SOCKET-WRAP I.D.™

- * SLIPS OVER WIRE WRAP PINS
 - * IDENTIFIES PIN NUMBERS ON WRAP SIDE OF BOARD
 - * CAN WRITE ON PLASTIC, SUCH AS IC #
- | PINS | PART# | PCK. OF | PRICE |
|------|-----------|---------|-------|
| 8 | IDWRAP 08 | 10 | 1.95 |
| 14 | IDWRAP 14 | 10 | 1.95 |
| 16 | IDWRAP 16 | 10 | 1.95 |
| 18 | IDWRAP 18 | 5 | 1.95 |
| 20 | IDWRAP 20 | 5 | 1.95 |
| 22 | IDWRAP 22 | 5 | 1.95 |
| 24 | IDWRAP 24 | 5 | 1.95 |
| 28 | IDWRAP 28 | 5 | 1.95 |
| 40 | IDWRAP 40 | 5 | 1.95 |
- PLEASE ORDER BY NUMBER OF PACKAGES (PCK. OF)



FRAME STYLE TRANSFORMERS

12.6V AC CT	2 AMP	5.95
12.6V AC CT	4 AMP	7.95
12.6V AC CT	8 AMP	10.95
25.2V AC CT	2 AMP	7.95

**25 PIN D-SUB
GENDER CHANGERS
\$7.95**



SWITCHING POWER SUPPLIES

PS-IBM \$69.95

- * FOR IBM PC-XT COMPATIBLE
- * 135 WATTS
- * +5V @ 15A, +12V @ 4.2A
- * -5V @ 5A, -12V @ 5A
- * ONE YEAR WARRANTY



PS-IBM-150 \$79.95

- * FOR IBM PC-XT COMPATIBLE
- * 150 WATTS
- * +12V @ 5.2A, +5V @ 16A
- * -12V @ 5A, -5V @ 5A
- * ONE YEAR WARRANTY

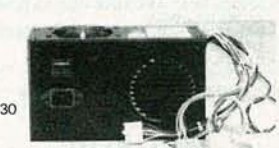

PS-130 \$99.95

- * 130 WATTS
- * SWITCH ON REAR
- * FOR USE IN OTHER IBM TYPE MACHINES
- * 90 DAY WARRANTY



PS-A \$49.95

- * USE TO POWER APPLE TYPE SYSTEMS, 79.5 WATTS
- * +5V @ 7A, +12V @ 3A
- * -5V @ 5A, -12V @ 5A
- * APPLE POWER CONNECTOR



PS-1558 \$34.95

- * 75 WATTS, UL APPROVED
- * +5V @ 7A, +12V @ 3A
- * -12V @ 250ma, -5V @ 300ma



BOOKS BY STEVE CIARCIA

- | | |
|-----------------------------|---------|
| BUILD YOUR OWN Z80 COMPUTER | \$19.95 |
| CIRCUIT CELLAR VOL 1 | \$17.95 |
| CIRCUIT CELLAR VOL 2 | \$18.95 |
| CIRCUIT CELLAR VOL 3 | \$18.95 |
| CIRCUIT CELLAR VOL 4 | \$18.95 |
| CIRCUIT CELLAR VOL 5 | \$19.95 |

MUFFIN FANS

3.15" SQ 14.95 3.63" SQ 14.95
3.18" SQUARE 16.95

6' LINE CORDS

2 conductor .39 3 conductor .99
3 conductor w/female socket 1.49

EMI FILTER \$4.95

CAPACITORS

TANTALUM

1.0µf	15V .35	.47µf	35V .45
6.8	15V .70	1.0	35V .45
10	15V .80	2.2	35V .65
22	15V 1.35	4.7	35V .85
.22	35V .40	10	35V 1.00

DISC

10µf	50V .05	680	50V .05
22	50V .05	0.01µf	50V .05
27	50V .05	.0022	50V .05
33	50V .05	.005	50V .05
47	50V .05	.01	50V .07
68	50V .05	.02	50V .07
100	50V .05	.05	50V .07
220	50V .05	.1	12V .10
560	50V .05	.1	50V .12

MONOLITHIC

.01µf	50V .14	.1µf	50V .18
.047µf	50V .15	.47µf	50V .25

ELECTROLYTIC

RADIAL		AXIAL	
1µf	25V .14	1µf	50V .14
2.2	35V .15	10	50V .16
4.7	50V .15	22	16V .14
10	50V .15	47	50V .20
47	35V .18	100	35V .25
100	16V .18	220	25V .30
220	35V .20	470	50V .50
470	25V .30	1000	16V .60
2200	16V .70	2200	16V .70
4700	25V 1.45	4700	16V 1.25

DATARASE EPROM ERASER \$34.95

- * ERASES 2 IN 10 MINUTES
- * COMPACT-NO DRAWER
- * THIN METAL SHUTTER PREVENTS UV LIGHT FROM ESCAPING



1/4 WATT RESISTORS

5% CARBON FILM ALL STANDARD VALUES
FROM 1 OHM TO 10 MEG. OHM

10 PCS	same value .05	100 PCS	same value .02
50 PCS	same value .025	1000 PCS	same value .015

RESISTOR NETWORKS

SIP	10 PIN	9 RESISTOR	.69
SIP	8 PIN	7 RESISTOR	.59
DIP	16 PIN	8 RESISTOR	1.09
DIP	16 PIN	15 RESISTOR	1.09
DIP	14 PIN	7 RESISTOR	.99
DIP	14 PIN	13 RESISTOR	.99

SPECIALS ON BYPASS CAPACITORS

.01 µf CERAMIC DISC	100/\$5.00
.01 µf MONOLITHIC	100/\$10.00
.1 µf CERAMIC DISC	100/\$6.50
.1 µf MONOLITHIC	100/\$12.50

WISH SOLDERLESS BREADBOARDS

PART NUMBER	DIMENSIONS	DISTRIBUTION STRIP(S)	TIE POINTS	TERMINAL STRIP(S)	TIE POINTS	BINDING POSTS	PRICE
WBU-D	.38 x 6.50"	1	100	---	---	---	2.95
WBU-T	1.38 x 6.50"	---	---	1	630	---	6.95
WBU-204-3	3.94 x 8.45"	1	100	2	1260	2	17.95
WBU-204	5.13 x 8.45"	4	400	2	1260	3	24.95
WBU-206	6.88 x 9.06"	5	500	3	1890	4	29.95
WBU-208	8.25 x 9.45"	7	700	4	2520	4	39.95



**LITHIUM BATTERY
AS USED IN CLOCK CIRCUITS**

3 VOLT BATTERY \$3.95
BATTERY HOLDER \$1.49

**2 VOLUME SET
IC MASTER
THE INDUSTRY STANDARD**

\$129.95

Visit our retail store located at 1256 S. Bascom Ave. in San Jose, (408) 947-8881



JDR Microdevices
110 Knowles Drive, Los Gatos, CA 95030
Toll Free 800-538-5000 • (408) 866-6200
FAX (408) 378-8927 • Telex 171-110

PLEASE USE YOUR CUSTOMER NUMBER WHEN ORDERING

TERMS: Minimum order \$10.00. For shipping and handling include \$2.50 for UPS Ground and \$3.50 for UPS Air. Orders over 1 lb. and foreign orders may require additional shipping charges - please contact our sales department for the amount. CA residents must include applicable sales tax. All merchandise is warranted for 90 days unless otherwise stated. Prices are subject to change without notice. We are not responsible for typographical errors. We reserve the right to limit quantities and to substitute manufacturer. All merchandise subject to prior sale.

COPYRIGHT 1987 JDR MICRODEVICES

THE JDR MICRODEVICES LOGO IS A REGISTERED TRADEMARK OF JDR MICRODEVICES. JDR INSTRUMENTS AND JDR MICRODEVICES ARE TRADEMARKS OF JDR MICRODEVICES. IBM IS A TRADEMARK OF INTERNATIONAL BUSINESS MACHINES. APPLE IS A TRADEMARK OF APPLE COMPUTER.

SEND FOR
FREE

1987 CATALOG...
48 PAGES!

★ QUALITY PARTS ★ DISCOUNT PRICES ★ FAST SHIPPING!

ALL ELECTRONICS CORP.

ALL ELECTRONICS CORP.

SPRING LEVER TERMINALS

Two color coded terminals on a sturdy 2 3/4" x 3 3/4" bakelite plate.
Great for speaker enclosures or power supplies.
75¢ each 10 for \$6.00

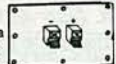

FUSES

3AG (AGC) SIZE
1, 1 1/2, 2, 2 1/2, 3, 4, 5, 6 AMP
GMA SIZE
1, 2, 3, 4, 5 AMP
5 of any ONE amperage 75¢



LIGHT ACTIVATED MOTION SENSOR



This device contains a photocell which senses sudden changes in ambient light. When an object or person passes within its field of view (about 5') it beeps for several seconds then resets. Could be used as a door annunciator or modified to trigger other devices. 5 1/2" x 4" x 1. Operates on 6 Vdc. Requires 4 AA batteries (not included).
CAT# LSMD \$5.75 per unit

SOUND EFFECTS BOARD

PC board with 2 1/4" speaker, 2 LEDs, IC, battery snap, other components 2 3/8" x 3". When switch is pushed board beeps and leds light. Operates on 9v battery (not included).
Experimenter's delight*
CAT# ST-3 \$1.25 ea.



MICRO-CASSETTE MECHANISM

Micro-cassette tape transport for standard MC60 or MC45 micro-cassettes. 3 Vdc operation. Contains: drive motor, belt, head, capstan, pinch wheel and other components. 3 1/2" X 2 1/4" X 5/8"
CAT# MCMC \$3.00 each 10 for \$27.50



EDGE CONNECTORS

ALL ARE .156" SPACING.

22 EDGE CONNECTOR \$1.25 ea
solder lug style 10 for \$11.00
22/44 EDGE CONNECTOR \$2.00 ea
PC style 10 for \$18.00
22/44 EDGE CONNECTOR solder lug style \$2.50 each
28/56 EDGE CONNECTOR PC style \$2.50 ea
38/72 EDGE CONNECTOR PC style \$3.00 each
43/86 EDGE CONNECTOR PC style \$4.50 each

2K 10 TURN

MULTI-TURN POT SPECTROL #MOD 534-7161 \$5.00 EACH

RELAYS

10 AMP SOLID STATE CONTROL: 3 - 32 vdc LOAD: 140 vac 10 amp SIZE: 2 1/2" x 3/4" x 1 1/2" \$9.50 EACH 10 FOR \$90.00

ULTRA-MINIATURE 5 VDC RELAY

Fujitsu #FBR211NED005M20 High sensitivity COIL: 120 ohms CONTACTS: 1 amp Mounts in 14 pin DIP socket \$1.25 each 10 for \$10.00

MINIATURE 6 VDC RELAY

Aromat #RSD-6V Super Small S.P.D.T. relay Gold coil contacts rated 1 amp @ 30 vdc. Highly sensitive. TTL direct drive possible. 120 ohm coil. Operate from 4.3 - 6 vdc. COIL: 120 ohms \$1.50 each 10 for \$13.50

13 VDC RELAY

CONTACTS: S.P.N.C. 10 amp @ 120 vac Energize coil to open contact. COIL: 13 vdc 650 ohms

4PDT RELAY

14 pin KH style... 3 amp contacts... USED but fully tested... \$1.70 each Specify coil voltage desired Either 24 vdc or 120 vac LARGE QUANTITIES AVAILABLE SOCKETS FOR KH RELAY 75¢ each

PHOTO-FLASH CAPACITORS

170 MFD 330 Volt CAT# PPC-170 75¢ each
400 MFD 330 Volt CAT# PPC-400 \$1.00 ea

COMPUTER GRADE CAPACITORS

1,400 mfd. 200 Vdc 3" X 2" dia. \$2.00
6,400 mfd 60 Vdc 4 1/4" x 1 3/8" dia. \$2.50
7,500 mfd 200 Vdc 5 3/4" x 3" dia. \$4.00
12,000 mfd 40 Vdc 4 1/4" x 2" dia. \$2.50
22,000 mfd 25 Vdc 4 3/4" x 2" dia. \$2.50
48,000 mfd 10 Vdc 3" x 2 1/2" dia. \$2.50
66,000 mfd 15 Vdc 3 3/4" x 3" dia. \$3.50
72,000 mfd 15 Vdc 4" x 2" dia. \$3.50
100,000 mfd 10 Vdc 6" x 2 1/2" dia. \$1.00

MINIATURE TOGGLE SWITCHES

ALL ARE RATED 5 AMPS @ 125 VAC

S.P.D.T. (on-on) PC style non-threaded bushing. 75¢ each 10 for \$7.00
S.P.D.T. (on-on) Solder lug terminals. \$1.00 each 10 for \$9.00
S.P.D.T. (on-off-on) Solder lug terminals. \$1.00 each 10 for \$9.00
S.P.D.T. (on-off-on) PC lugs threaded bushing. \$1.00 each 10 for \$9.00
D.P.D.T. (on-on) Solder lug terminals. \$2.00 each 10 for \$19.00

D.P.S.T. LIGHTED ROCKER SWITCH

115 vac lighted rocker. snap mounts in 7/8" x 1 1/4" hole. Orange lens. 16 amp contact. \$1.50

MINI-PUSH BUTTON S.P.S.T. momentary normally open 1/4" bushing. Red button. 35¢ each 10 for \$3.00

SNAP ACTION SWITCH

Cherry elect. #E-21. N.O. or N.C. 0.1A contacts. Suitable for alarms and other low energy circuits. 1 1/4" lever. 45¢ EACH 10 FOR \$4.20

WALL TRANSFORMERS

all plug directly into 120 vac outlet.
4 VDC @ 70 ma. \$2.00
6 VDC @ 500 ma. \$3.50
6 VDC @ 750 ma. \$4.50
9 VDC @ 500 ma. \$5.00
12.5 VDC @ 265 ma. \$3.00
18 VDC @ 18 VA and 8.5 VDC @ 1.28 VA \$3.50
24 VDC @ 250 ma. \$3.50
MULTI-VOLTAGE @ 500 ma. 3, 4, 5, 6, 7, 9 or 12 VDC \$7.50

TRANSISTORS

2N706 4 for \$1.00
2N2222A 3 for \$1.00
PN2222A 4 for \$1.00
2N2904 3 for \$1.00
2N2905 3 for \$1.00
MJ2955 \$1.50
2N3055 \$1.00
PMD 10K40 \$1.00
TIP 121 75¢
TIP 125 75¢

LED'S STANDARD JUMBO DIFFUSED T 1-3/4

RED 10 for \$1.50 100 for \$13.00
GREEN 10 for \$2.00 100 for \$17.00
YELLOW 10 for \$2.00 100 for \$17.00

FLASHER LED

5 volt operation red jumbo T 1 1/4 size CAT# LED-4 \$1.00
NEW GREEN FLASHER CAT# LED-4G \$1.00

BI-POLAR jumbo T 1 1/4 size

2 for \$1.70

LED HOLDERS

Two piece holder for jumbo LED 10 for 65¢ 100 for \$5.00

CLEAR CLIPLITE LED HOLDER

Make LED a fancy indicator. Clear. 4 for \$1.00

WE'VE MOVED

Our Mail Order Operations to serve U better

NEW MAILING ADDRESS P.O. BOX 567 VAN NUYS, CA 91408



3rd TAIL LIGHT ?

Sleek high-tech lamp assembly. Could be used as a third auto tail light, emergency warning light, or special-effects lamp. Red reflective lens is 2 3/4" x 5 1/2" is mounted on a 4" high pedestal with up-down swivel adjustment. Includes 12v replaceable bulb. CAT# TLB \$3.95 each.



XENON FLASH TUBE

3/4" long X 1 1/8" dia. Flash tube designed for use in compact camera flash units. Ideal for experimenters. CAT# FLT-1 2 for \$1.00

48 KEY ASSEMBLY FOR COMPUTER OR HOBBYIST

NEW T.I. KEYBOARDS. Originally used on computers, these keyboards contain 48 S.P.S.T. mechanical switches. Terminates to 15 pin connector. Frame 4" x 9". CAT# KP-48 \$3.50 each



TELEPHONE COUPLING TRANSFORMER

Stancor # TTPC-8 600 ohms c.t. to 600 ohms c.t. P.C. board mount 3/4" x 5/8" x 3/4" \$1.25 each



SOUND AND VIDEO MODULATOR

TI#UM1381-1 Designed for use with T.I. computers. Can be used with video cameras, games or other audio/video sources. Built in A/B switch enables user to switch from T.V. antenna without disconnection. Channel 3 or 4 selection. Operates on 12 Vdc. Hook-up diagram included. CAT# AVMOD \$5.00 each.



RECHARGEABLE NI-CAD BATTERIES

AAA SIZE 1.25V \$1.85
AA SIZE 1.25V 500mAh \$1.85
AA with solder tab \$2.00
C SIZE 1.2V 1200mAh \$3.50
SUB-C SIZE solder tab \$3.50
D SIZE 1.2V 1200mAh \$3.50



NI-CAD CHARGER TESTER

Will charge most every size Ni-cad battery available. Cat# UNCC-N \$12.50



8" 15 WATT SPEAKER

C.T.S Model 8B3079 Full range speaker. 100-10,000Hz; Ideal for PA systems. Mounting holes for line-matching transformer. CAT#SK-815 \$3.50 ea. Case of 6 pcs. \$25.00 per case



STORES
LOS ANGELES, CA 905 S. Vermont Ave. 213 380-8000
VAN NUYS, CA 6228 Sepulveda Blvd. 818 997-1806

MAIL ORDERS TO: ALL ELECTRONICS P.O. BOX 567 91408 TWX - 10101013 ALL ELECTRONIC

QUANTITIES LIMITED MINIMUM ORDERS \$10.00 CALIF. ADD SALES TAX USA: \$3.00 SHIPPING NO C.O.D.I FOREIGN ORDERS: INCLUDE SUFFICIENT SHIPPING

TOLL FREE ORDERS 800-826-5432 INFO • (213) 380-8000 FAX - (213) 389-7073

POLARITY SWITCH

external coaxial relay on a satellite TV system. IDEAL FOR THE EXPERIMENTER AS PARTS Heavy chassis box containing a CA 358 op amp and other parts. Catalog # RDPS \$1.75 each 10 for \$15.00

SOLID STATE BUZZER

Star #SMB-06L 6 vdc TTL compatible. \$1.00 each 10 for \$9.00



Worldwide • Since 1974

• QUALITY COMPONENTS • COMPETITIVE PRICING • PROMPT DELIVERY

Mail Order Electronics • Worldwide
Jameco
ELECTRONICS

COMMODORE COMPATIBLE ACCESSORIES



COMMODORE 300 Baud Modem
FOR VIC-20 AND C-64
Connects directly to User Port • Manual Answer/
• Function keys defined for convenience
Includes Midwest Micro Associates communi-
cation software.
-1 (For VIC-20 and C-64) ~~\$34.95~~ \$24.95

External Power Supplies

S-10 (For C-64) \$39.95
S-128 (For C-128) \$59.95

RS232 Interface

Provides connection of standard serial devices.
RS232CM (For VIC-20, C-64 & C-128) . . . \$39.95
*Operation with the C-128 in 64 mode only.

S-80/TANDY COMPATIBLE ACCESSORIES

E-X-P-A-N-D TRS-80 MEMORY

All kits come complete with documentation
-80 MODEL 4, 4P, & 4D 64K/128K EXPANSION
-64K-2 \$7.95
Includes Model 4 from 16K-64K or Model 4 (Gate Array
only), 4P and 4D from 64K-128K
-64K-2PAL \$14.95
Includes Model 4 (Non-Gate Array Version) from 64K to 128K
-80 MODEL 100 8K EXPANSION
108K \$19.95 ea. or 3 for \$54.95

ZUCKERBOARD

TANDY 1000 Expansion Memory Half Card
Expand the memory of your Tandy 1000 (128K Version) to as much as 640K. Also includes DMA controller chip.
-EM256K Includes 256K RAM \$ 99.95
-EM512K Includes 512K RAM \$119.95
-C Plug-in Clock option chip (only) \$39.95

NEW! 20Meg Hard Disk NEW!

20MB 20MB Hard Disk Drive Board for Tandy 1000. \$579.95
120MB 20MB Hard Disk Drive Board for Tandy 1000SX. \$589.95

TANDY 1000 Multifunction Board with Clock Calendar

and the memory on your Tandy 1000 (128K Version) to as much as 640K. Complete with an RS232 port, clock/calendar, A Disk Printer Spooler and on-board DMA controller chip.
AN-256K Includes 256K RAM. \$179.95
AN-512K Includes 512K RAM. \$199.95

NEW! Multifunction Board for TANDY 1000SX NEW!

256K Includes 256K RAM. \$189.95

UV-EPROM ERASER



Erases all EPROMs. Erases up to 8 chips within 21 minutes (chip in 15 minutes). Maintains constant exposure distance (1"). Special conductive foam liner eliminates static build-up. It-in safety lock to prevent UV exposure. Compact - 9.00" L x 7.00" W x 2.60" H. Complete with holding tray for 8 chips.
E-4 UV-EPROM Eraser. \$69.95
VS-11EL Replacement Bulb. \$19.95
CF-2 Cond. Foam 12x24x1/4 Hard Blk. \$ 8.95

NOW YOU CAN BUILD AN IBM PC/XT COMPATIBLE!



Save \$75.00

IBM Compatible Kit No. 2

- IBM-64K (2) 64K RAM Chips (18) . . . \$ 19.90
- KB5160 AT Style Keyboard . . . \$ 59.95
- IBM-FCC Floppy Controller Card \$ 34.95
- IBM-Case Flip-Top Case. \$ 39.95
- IBM-MCC Monochrome Card . . . \$ 59.95
- IBM-PS Power Supply. \$ 69.95
- FD55B TEAC 5 1/4" Disk Drive . . . \$109.95
- IBM-MON 12" Monochrome Monitor \$ 99.95
- IBM-MB Motherboard. \$109.95
(with Zero-K RAM - incl. BIOS-ROM)

FREE! QUICKSOFT PC WRITE WORD PROCESSING SOFTWARE INCLUDED!

Weight: 48 lbs. **Regular List \$604.50**

IBMSP2 (Includes 9 items above) \$529.95

ADDITIONAL ADD-ONS AVAILABLE!

- RS232HC RS232 Serial Half Card. \$ 29.95
- EM-100 Expansion Memory Half Card (without RAM) . . \$ 59.95
- IBM-ICB Integrated Color Board w/Printer Port. . . . \$ 99.95
- IMFC Multifunction 0-384K RAM (without RAM). . . \$109.95
- PM1200B-2 1200/300 Baud Half Card Modem without software. . . \$129.95
- PM1200B-2S 1200/300 Baud Half Card Modem with Mirror Software . . \$159.95
- IBM-EGA Enhanced Graphics 256K Video RAM \$229.95
- TTX-1410 14" RGB Color Monitor. \$289.95
- IBM-20MBK 20MB Hard Disk Drive, Controller & Cable. . . \$429.95
IBM is a registered trademark of IBM Computers

NEW PRODUCTS!



NEW! Logitech Mice
IBM PC/XT Compatible

- C7BASE C7 Mouse with 3.1 Software. \$84.95
- C7PLUS C7 Mouse w/PLUS Pkg. Software. \$94.95
- C7BUS C7 Mouse w/Bus Brd. & PLUS Pkg. Stwr. \$119.95

IBM PC/XT/AT Compatible Keyboard

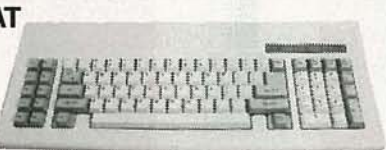

NEW! AT Style Layout

• Tactile touch keyswitches • AT style layout • Switch selectable between PC/XT or AT • Illuminated Caps Lock, Num Lock and Scroll Lock indicators • Low profile design • 8 1/2 foot cord • Manual included • Size: 18" L x 7 1/4" W x 1 1/2" H
KB5160. \$59.95

IBM PC/XT Compatible Enhanced Keyboard

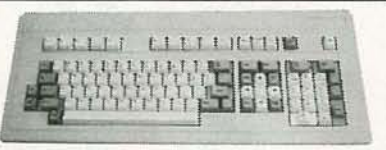

• Enhanced PC/XT keyboard (equiv. to Keytronic™ 5151) • Separate cursor and numeric keyboard • Typewriter style layout makes it easier to learn! • LED indicators • Manual included • Color: off-white • Size: 20" L x 8 1/2" W x 1 1/2" H
IBM-ENH. \$79.95

Turbo 4.77/8MHz Motherboard



IBM PC/XT Compatible
• 75% faster than the IBM PC while in the turbo mode • Turbo Mode selectable through either software or hardware
• Expandable to 640K (comes w/zero-K)
• DTK/ERSO BIOS included

TURBO. \$129.95

APPLE COMPATIBLE ACCESSORIES

Parallel Printer Card for Apple II, II+ and IIe



- Intelligent interface to most dot matrix graphics printers
- Centronics standard
- Advanced text printing

JE880 Parallel Printer Card. \$49.95
JE883 64K Buffer for JE880 ~~\$69.95~~ \$59.95
JE8803 JE880 and JE883 ~~\$109.90~~ \$99.95

Extended 80-Column Card for Apple IIe

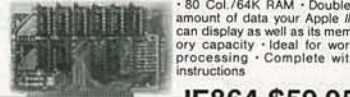

• 80 Col./64K RAM • Doubles amount of data your Apple IIe can display as well as its memory capacity • Ideal for word processing • Complete with instructions
JE864 \$59.95

Additional Apple Compatible Products Available

JE310 Fiber Optics Experimenter Kit



NEW!
• Educational device gives students and engineers hands-on experience with fiber optic technology
• Step by step instructions • Includes transmitter & receiver circuits boards, as well as all nec. IC's, cables & connectors
JE310 Fiber Optic Kit. \$19.95

JE450 Solderless Proto-Type Builder

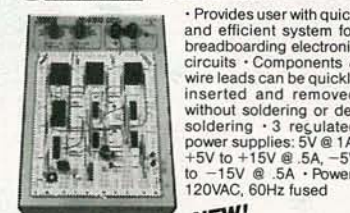

NEW!
• Provides user with quick and efficient system for breadboarding electronic circuits • Components & wire leads can be quickly inserted and removed without soldering or desoldering • 3 regulated power supplies: 5V @ 1A, +5V to +15V @ 5A, -5V to -15V @ .5A • Power: 120VAC, 60Hz fused
JE450 Solderless Proto-Type Builder . . . \$119.95

IBM Compatible! DISK DRIVES

- FD55B Teac 5 1/4" DS 1/2-H (IBM PC/XT) . . . \$109.95
- JU-455 Panasonic 5 1/4" DS 1/2-H (IBM PC/XT) \$109.95
- JU-475 Panasonic 5 1/4" DS 1/2-H (IBM AT) . . \$119.95

DATA BOOKS

- 30003 National Linear Data Book (82). \$14.95
- 30009 Intersil Data Book (86). \$ 9.95
- 30013 Zilog Data Book (85). \$14.95
- 30032 National Linear Supplement (84). \$ 6.95
- 210830 Intel Memory Handbook (87). \$17.95
- 230843 Intel Microsystem Hndbk. Set (87). . . . \$24.95

MUFFIN/SPIRITE-STYLE FANS

- MUF60. \$9.95
Torin Industries (4.68" sq., 60 cfm)
- SU2A1. \$8.95
EG&G Rotron (3.125" square, 20 cfm)

\$20 Minimum Order - U.S. Funds Only California Residents: Add 6%, 6 1/2% or 7% Sales Tax Data Sheets - 50¢ each
Shipping: Add 5% plus \$1.50 Insurance We reserve the right to substitute IC manufacturers. Prices Subject to Change













Send \$1.00 Postage for a FREE Seasonal Flyer
FAX 415-592-2503
7/87



Send \$1.00 Postage for a FREE 1987 CATALOG
Telex: 176043

1355 SHOREWAY ROAD, BELMONT, CA 94002 • PHONE ORDERS WELCOME 415-592-8097 ©1987 Jameco Electronics

Your Only Move Is To MCM Electronics

	Antennas		Alarm Accessories		Cables	
CATV Equipment		Computer		Connectors		 
	Customer Service		Fast Delivery		Friendly Staff	 
Semiconductors				High Voltage	Speakers	
	Switches			Telephone		Test Equipment
Video & VCR		Volume Discounts		Anti-Static Products		Free Catalog
	Chemicals		Toll-Free Lines			
Quality Products		Competitive Prices				 

Make Your Move By Dialing TOLL-FREE 1-800-543-4330
 In Ohio, 1-800-762-4315 — In Alaska and Hawaii, 1-800-858-1849



MCM ELECTRONICS

858 E. CONGRESS PARK DR.
 CENTERVILLE, OH 45459

A PREMIER Company

CIRCLE 87 ON FREE INFORMATION CARD

Summer Fun starts at Dick Smith Electronics!

Get the latest books for summer reading & reference!

Know Your Oscilloscope (B-2003) \$11.95
The fourth edition of this classic text provides oscilloscope users whether new, part-time, or experienced with a wealth of practical data covering a broad range of uses. From the basics of CRT's to the test hi-tech scopes, this book is perfect for hands-on learning.

World Radio-TV Handbook (B-2087) \$19.95
The new 1987 edition of this practical guide to the world's radio & television services features comprehensive country-by-country listings of long, medium, & short-wave broadcasters by frequency, time & language, and much more!

987 Radio Amateurs Callbook (B-2187) \$25.00
North American listing, 65th anniversary edition includes 478, 267 licensed Radio Amateurs and many features.

Yagi Antenna Design (B-2307) \$15.00
Based on a series of articles that originally appeared in *Ham Radio*, this important reference covers all aspects of the design of high performance Yagi antenna systems. Radio amateurs will find the theoretical & practical data in this hardcover text extremely valuable.

Shortwave Radio Listening with the Experts (B-2315) \$22.95
"WU"lers & "DX"ers! This is the one book you need for your radio shack! Learn to identify various foreign languages and foreign & local broadcasts, locate elusive stations, and get many other handy tips from 25 seasoned listeners.

Troubleshooting & Repairing of Microprocessor-based Equipment (B-2376) \$21.95
This comprehensive guide provides the service technician, field service engineer, or student with a basic approach to troubleshooting almost all devices controlled by microprocessors. Includes tricks & procedures for diagnosing, isolating & locating circuit faults.

The Cellular Connection (B-3951) \$9.95
As a shopper's guide or owner's reference, this is an up-to-date, fact-filled, easy-reading guide to the booming world of mobile telephones. Includes many pages of informative illustrations & photographs, pager access numbers, glossary, & a look at the future.

Video Production Guide (B-3984) \$28.95
Become a video mogul! This thorough text provides a broad overview of television production from the viewpoint of the producer & director. It covers studio & location work from pre- through post-production with emphasis on both technology & human organization.

IC Substitution Manual (B-4001) \$29.95
This is an essential reference for every workshop, lab, factory or service office that uses IC's. Find equivalents or substitutes for an incredible range of IC's identified by either manufacturer or number.

IC Master 1987 Edition (B-4002) \$130.00
The original and only complete guide to currently available IC's, microcomputer boards, development systems, gate arrays, & other related components of concern to the design engineer or active hobbyist is bigger & better this year! Includes expanded sections on CAE/CAD technology, custom semicustom products, military parts, microcomputer boards, and surface mount devices.

Illustrated Dictionary of Microcomputers (B-4006) \$14.95
The 2nd edition of the most current & complete reference available on microcomputer terms & concepts - completely updated & expanded to include nearly 4000 new entries - over 8000 key terms in all! Includes over 350 illustrations.

Electronics Math (B-4007) \$15.95
Just the right combination of practical problems and theory makes the mathematics of circuitry amazingly easy to understand & use. This is the perfect text for student or hobbyist as well as an easy-to-use reference for the technician.

Logic Data Set (B-4062) \$24.95
A complete & comprehensive set containing details on MMS4HC/74HC/54HC/74HCT high speed micro CMOS family, CD4000 family, MMS4C/74C family, CMOS, LSI and VLSI families. Previously sold as separate volumes, B-4060 and B-4061 are now available as a set at savings of over 15%!

Here's the meter you've been waiting for!
Handheld 4-digit LCD capacitance meter measures from 0.1 pF to 999.9nF. Features extended resolution; calculates true capacitance; shows leakage; calculates time constants; reads dielectric absorption; auto/manual zeroing; sorts capacitors; identifies transistor types & leads; calculates cable length & much more!

Daetron 4-digit Auto-range Capacitance Meter \$169.95
Q-1560

Stores in BERKELEY, CA (415) 486-0755; REDWOOD CITY, CA (415) 368-8844; SAN JOSE, CA (408) 241-2266

14-Day Satisfaction Guarantee
MAIL ORDERS
DSE, P.O. BOX 8021, Redwood City, CA 94063
We ship UPS Ground unless otherwise requested. Add 5% of order total (min \$1.50) for shipping. Outside USA add 20% (min \$4). There is an additional \$1.50 handling fee. California residents please add sales tax. VISA and MASTERCARD welcome. Minimum order value \$20.00.

Practical projects are fun to build & use!

SKILL LEVELS: ★ Beginner ★★ Intermediate ★★★ Advanced

SUPERTEXT TC K-6314 \$139
★★★



Closed-caption decoding is for everyone!
Many TV programs carry specially encoded signals that provide captions to allow hearing-impaired people to follow dialogue & narration. The National Education Association and PTA have also endorsed closed-captioning as an educational tool! Since many popular children's programs are captioned, kids can now develop reading skills & confidence in their leisure hours. With DSE's SuperText TC, low-cost decoding is available for everyone! This easy-to-build kit uses licensed decoding technology and requires only basic bench tools & good soldering technique to assemble. Requires direct audio/video TV inputs or use RF modulator K-6040 (\$9.95). Use power supply M-9526 (\$6.95) or similar.

Radio Direction Finder Kit K-6345 \$99
★★★



Here's a versatile instrument for work or play!
Locate the source of any transmission! DSE's RDF has a 50-500 MHz range with internal alignment reference and 170° calibration. Features adjustable internal monitor speaker, stable digital circuitry, & self-aligning commutating filters. 12V operation ideal for mobile use. M-9530 power supply (\$13.95) required for base station use. Antennas not included (try 4 x D-4205, \$15.50 each). Compare with \$500 & up for a similar commercial unit - it's a great value!

Get on the air this summer with a fantastic DSE transceiver kit.

UHF Transceiver Kit (K-6300) ★★★ \$169.00
440-450MHz; 10kHz channel spacing (offset 5kHz); FM; 10W output; 5kHz max. deviation (limited to 10kHz with 20dB overdrive @ 1kHz; 10% deviation at 3kHz); receiver sensitivity 0.5 uV pd for 10dB sinad; selectivity 6dB @ 7.5 kHz, 60dB @ 25kHz, 55dB @ 50kHz; audio output 1W into 8 ohms; distortion <120% fully driven. See review in 73 for Radio Amateurs, Oct. 1986

VHF Transceiver Kit (K-6308) ★★★ \$159.00
144-148 MHz; 10 kHz channel spacing (offset 5 kHz); FM; 10W nominal output (15W max.); receiver sensitivity 0.5 uV for 12dB quieting; selectivity 60dB @ 25 kHz; full repeater capability (±600kHz). See review in 73 for Radio Amateurs, May 1986.

NOTE: We can't keep up with the demand for this popular Australian kit, so order now to insure the earliest possible delivery!

HF Transceiver Kit (K-6330) ★★★ \$199.00
Any 500 kHz range within 2-30MHz; LSB, USB, CW; power output 30W PEP (SSB), 15W (CW); occupied bandwidth 8 kHz (±25dB); harmonic suppression >60dB; receiver sensitivity >0.5uV (10dB S+N); selectivity 6dB @ 4kHz, 60dB @ 7 kHz; image rejection >50dB; audio output 2W into 8 ohms; IF impulse noise blanker. 80 meter version supplied - call for info on band upgrade packs!

Introduce a youngster or novice to the exciting world of electronics!

FunWay Into Electronics Gift Set (K-2605) ★ \$18.95

Try Dick Smith's legendary electronics course in a box! This set includes *FunWay Into Electronics, Volume 1*, which introduces electronics terms & concepts in 20 entertaining projects. All parts necessary to build any of the projects are included as well as a re-usable plastic parts tray. All you'll need is a 9V battery (try DSE# S-3286, \$1.49!).

R-E Reader's Special

Save on Stereo Satellite Receiver Kit!

For a limited time only you can get our Australis 1 Satellite Receiver kit together with the Stereo Upgrade kit, saving \$13.95 off separate kit prices.

10% off package ONLY
\$105

\$118.95 Value! K-6316/K-6317

CLOSEOUT! Offer good while supplies last.

Going away for summer vacation? Don't leave your home unprotected!

KEEPSAFER PLUS L-5505 \$349



Install your own system for safety & savings

You can have virtually all the features & security of a professionally installed security system at a fraction of the cost. Wireless technology means easy installation, and false alarms (from RFI) are prevented by Keepsafer's 8-bit digitally coded signal (which must be received by the control unit at least four times in less than one second to be acknowledged). This nationally advertised system consists of a Master Control Console (with powerful built-in alarms), 3 sets of Transmitter with sensors, & Remote Control unit to operate the system from anywhere within range of the master console. You can easily expand or customize your system with additional Transmitter with Sensor sets or other unique accessories!

Add on for complete flexibility. . . .

- Transmitter with sensor (L-5508) \$24.95
- Bedside Alarm (L-5509) \$25.99
- Remote Control (L-5512) \$64.75
- Emergency Dialer (L-5510) \$99.75
- Alerts National Central Monitor Station when alarm sounds.
- Area Detector (L-5511) \$125.00
- Infrared people detector adds security.
- Alarm Siren (C-2705) \$5.95

DSE has the tools you need for pro-quality projects!

IDC Bench Assembly Press

\$139

T-5260 **PAWAVISE**

Custom cables are quick & easy!

This quarter-ton manual press is a rugged, practical installation tool for low volume mass termination of various IDC connectors on flat (ribbon) cable. Interchangeable base plates accommodate a broad range of IDC connectors.

- Cutters**
- Flat cable (T-5261) \$54.95 ● Strip header (T-5262) \$49.95
- Base Plates \$29.95 each**
- Female socket transition connectors (T-5263)
 - Card edge connectors (T-5264) ● DIP plugs (T-5265)
 - D-sub connectors (T-5266)

Mini Drill Set (T-4751) \$9.95
For the hobbyist, toolmaker or technician. Set contains 4 high-speed twist drills with 3 collets, grinding bit, wrench, tommy bar & DC power cable in a plastic case.



Mini Drill Stand (T-4753) \$12.95
Fits T-4751 drill (above) making clean, accurate holes a cinch.

- TORX Screwdrivers**
- | | |
|--------------------------|---------------------|
| #08 (T-4208) \$2.70 each | 10 & up \$2.60 each |
| #10 (T-4210) \$3.15 each | 10 & up \$3.05 each |
| #15 (T-4212) \$3.40 each | 10 & up \$3.30 each |
| #20 (T-4214) \$3.60 each | 10 & up \$3.50 each |

Don't let the kids get bored this summer - give them this affordable Apple-compatible computer!

The Laser 128™ gives you the best of both Apples at half the price! It runs virtually any Ile or Iic program: educational, business or game. Built-in features include 128K RAM, 32K ROM w. Micro-soft™ BASIC, 40/80 column text, 5¼" floppy drive, hi-res graphics, serial modem port, joystick/mouse interfaces. And it's expandable! It supports RGB monitors & LCD displays, offers expansion slots & much more!



LASER 128™ X-6000 \$399
Apple-compatible monitor for Laser 128 (X-1130) \$79
Call for current prices & availability of our XT- and AT- compatible computer kits!

DICK SMITH ELECTRONICS

EVERYTHING FOR THE ELECTRONICS ENTHUSIAST

Order Toll Free
1-800-332-5373
Pre-paid & Credit Card Orders Only!
Mon - Fri 7am - 6pm Pacific Time
California Orders call 415-368-1066
For information call 415-368-8849

To receive your copy of our colorful 148 page catalog, circle Reader Service 95

Radio Shack Parts Place™

PARTS FOR YOUR PROJECTS AT EVERYDAY LOW PRICES!

Try Our Fast Special-Order Service



- No Minimum Order!
- No Postage Charge!

Your Radio Shack store manager can special-order thousands of parts and supplies not listed in our catalog—tubes, linear and digital ICs, modules, diodes, transistors, crystals, phono cartridges, styli and computer accessories. Delivery time for most items is one week. Come in and order today!

Mini-Notebook Series

All books feature building tips and easy-to-read schematic diagrams. Use these proven circuits as starting points for your own designs!

Subject	Cat. No.	Only
Timer ICs	276-5010	.99
Op Amps	276-5011	1.49
Optoelectronics	276-5012	1.49
Semiconductors	276-5013	1.49
Digital Logic	276-5014	1.49
Communications	276-5015	1.49



Add Speech to Your Computer

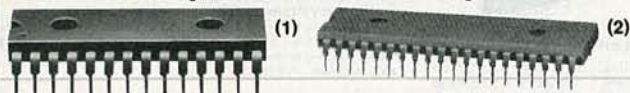

Easy to Interface! Data Included

(1) SPO256-AL2 Speech-Synthesis IC. Preprogrammed MOS device with detailed data. Requires 3.12 MHz crystal (special-order, above). #276-1784 . . . 12.95

(2) CTS256-AL2 Text-to-Speech IC. Translates ASCII into control data for synthesizer. Requires 10 MHz crystal (available via special-order). #276-1786 . . . 16.95

Computer Hookups

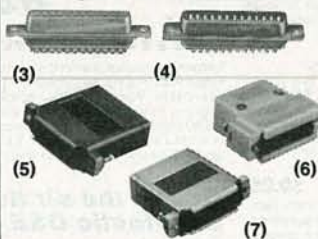

Subminiature "D" Connectors.

Type	Positions	Cat. No.	Each
Male	9	276-1537	1.49
Female	9	276-1538	2.99
Hood	9	276-1539	1.99

Fig.	Type	Positions	Cat. No.	Each
3	Male	25	276-1547	1.99
4	Female	25	276-1548	2.99
5	Hood	25	276-1549	1.99

(6) Shielded 25-Position Hood. For EMI/RFI protection. #276-1536 . . . 1.99

(7) Multipurpose Hood. Use as hood or null modem foundation. #276-1520, 1.79

RS-232 Line Driver ICs for Computer Interfacing



1²⁹ Each

The MC1488 quad line driver and its companion receiver provide a complete interface between TTL and RS-232C.

MC1488 RS232 Quad Line Driver. #276-2520 . . . 1.29

MC1489 RS232 Quad Line Receiver. #276-2521 . . . 1.29

4000-Series CMOS ICs With Pin-Out and Specs

Type	Cat. No.	Each
4001	276-2401	.79
4011	276-2411	.79
4013	276-2413	1.19
4017	276-2417	1.49
4049	276-2449	.99
4066	276-2466	1.19

Attention-Getting Sounds and Sights



(8) Tri-Sound Electronic Siren. Creates three unique sounds at a piercing 80 dB sound pressure level. 3 VDC. #273-072 . . . 5.95

(9) Green Flasher LED. #276-030, 1.19
Red Flasher LED. #276-036 . . . 1.19

Fast Fuse Fixes

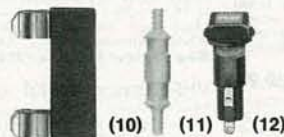

(10) Pigtail Fuse Adapter. Easy! Snaps over blown fuse, accepts 1/4 x 1/4" replacement fuse. Ideal for TV service. #270-1219 . . . 99¢

(11) Solderless Holder. #270-1211, 99¢
(12) Panel Holder. #270-365 . . . 99¢

Let Shack® Supply Your Power Supply

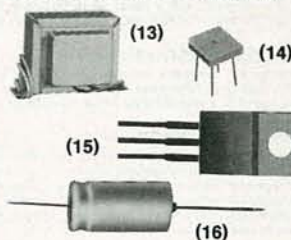

(13) 120 VAC Power Transformers.

Secondary (CT)	Cat. No.	Each
12.6 at 3.0 A	273-1511	6.99
25.2 at 2.0 A	273-1512	7.49
18.0 at 2.0 A	273-1515	6.99

(14) 6-Amp, 250 PIV Full-Wave Rectifier. #276-1181 . . . 1.99

(15) LM317T Adjustable Voltage Regulator. #276-1778 . . . 1.99

Fixed Regulators. Rated 1 amp.

Type	Output	Cat. No.	Each
7805	5 VDC	276-1770	1.19
7812	12 VDC	276-1771	1.19
7815	15 VDC	276-1772	1.19

(16) 2200 µF Filter Capacitor. 50 WVDC. #272-1048 . . . 3.49

Test Cable Sets



Set of 10, 14" leads, insulated clip at ends. #278-1156 . . . 3.79

Set of 6 Heavy-Duty Cables. 40" leads, claw-type clip at ends. #278-002 . . . 3.79

Switch-A-Rama!

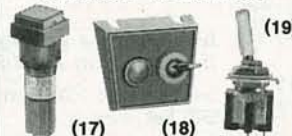

(17) Lighted SPDT Push-On/Off. 3 amps at 120 VAC. 12-volt lamp. 1/2" mtg. hole. #275-676 . . . 5.29

(18) Automotive Switch & Lamp Panel. Rated 6 A, 12 V. #275-703 . 2.99

(19) Submini Toggles. 3 A, 125 VAC. SPST. #275-612, 1.89 SPDT. #275-613, 1.99

Wireless Remote Control System



Never Enter a Dark House! 39⁹⁵

Turn lights and appliances on/off from driveway, porch, yard, inside. Includes one 15-amp receiver module. Add up to 3 more Plug 'n Power™ receiver modules, any time. UL listed. #61-2675

Dual-Tracking DC Supply

69⁹⁵

Switchable Volt/Amp Meter
Independent or "Slave" Modes



Quality and performance you wouldn't expect to find at this low price—check the features! 0 to 15 VDC adjustable output, up to 30 VDC in series mode. Fuse protection, vented steel cabinet. 1 amp per side, max. UL listed AC. #22-121

Bench Digital Multimeter

99⁹⁵

Memory Storage!

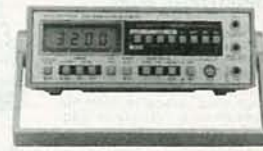

Pushbutton operation, accuracy and features that compare with meters costing much more! Full autoranging. High-contrast LC display plus built-in 31-position bargraph. Transistor checker, H_{FE} test, buzzer continuity. 2 1/16 x 8 x 4 3/4". With probes and manual. Batteries extra. #22-195

Over 1000 items in stock: Binding posts, Books, Breadboards, Buzzers, Capacitors, Chokes, Clips, Coax, Connectors, Fuses, Hardware, ICs, Jacks, Knobs, Lamps, Multitesters, PC Boards, Plugs, Rectifiers, Relays, Resistors, Switches, Tools, Transformers, Transistors, Wire, Zeners, more!

Radio Shack®

A DIVISION OF TANDY CORPORATION
Prices apply at participating Radio Shack stores and dealers

DIGI KEY CORPORATION

1-800-344-4539

AK, Puerto Rico - 218-611-6674 Telex - 62827914 FAX - 218-681-3370 TWX - 910508982 DIGI KEY CORP

NATIONAL SEMICONDUCTOR • PANASONIC
 QK MACHINE • EMLC, INC. • INTERSIL
 EAC, INC. • J. W. MILLER • AAVD ENGINEER
 E. F. JOHNSON • ATLANTIC SEMICONDUCTOR

NEW 256K (262,144 x 1) DRAM 150NS \$570/1; \$39.95/9
Factory Firsts

MODES • DIAMOND TOOL • UNGAR •
 C. E. INDUSTRIES • AMERK • C. B. •
 UNGAR • YAGED • J. V. MILLER • LUXO
 3C CHEMICALS • ARIES • PLESSEY

INTEGRATED CIRCUITS

Part No.	Description	Price
7400 TTL	7400	1.10
7401	7401	1.10
7402	7402	1.10
7403	7403	1.10
7404	7404	1.10
7405	7405	1.10
7406	7406	1.10
7407	7407	1.10
7408	7408	1.10
7409	7409	1.10
7410	7410	1.10
7411	7411	1.10
7412	7412	1.10
7413	7413	1.10
7414	7414	1.10
7415	7415	1.10
7416	7416	1.10
7417	7417	1.10
7418	7418	1.10
7419	7419	1.10
7420	7420	1.10
7421	7421	1.10
7422	7422	1.10
7423	7423	1.10
7424	7424	1.10
7425	7425	1.10
7426	7426	1.10
7427	7427	1.10
7428	7428	1.10
7429	7429	1.10
7430	7430	1.10
7431	7431	1.10
7432	7432	1.10
7433	7433	1.10
7434	7434	1.10
7435	7435	1.10
7436	7436	1.10
7437	7437	1.10
7438	7438	1.10
7439	7439	1.10
7440	7440	1.10
7441	7441	1.10
7442	7442	1.10
7443	7443	1.10
7444	7444	1.10
7445	7445	1.10
7446	7446	1.10
7447	7447	1.10
7448	7448	1.10
7449	7449	1.10
7450	7450	1.10

TTL IC SOCKETS

Part No.	Description	Price
1	1	1.10
10	10	1.10
100	100	1.10
1000	1000	1.10

5% Carbon Film Resistors

Available in 1/4, 1/2, 1, 2, 5, 10 Watt

Part No.	Value	Price
100	100	1.10
1000	1000	1.10

DISC CAPACITORS

Part No.	Value	Price
100	100	1.10
1000	1000	1.10

TANTALUM CAPACITORS

Part No.	Value	Price
100	100	1.10
1000	1000	1.10

7400 TTL

Part No.	Description	Price
7400	7400	1.10
7401	7401	1.10
7402	7402	1.10
7403	7403	1.10
7404	7404	1.10
7405	7405	1.10
7406	7406	1.10
7407	7407	1.10
7408	7408	1.10
7409	7409	1.10
7410	7410	1.10
7411	7411	1.10
7412	7412	1.10
7413	7413	1.10
7414	7414	1.10
7415	7415	1.10
7416	7416	1.10
7417	7417	1.10
7418	7418	1.10
7419	7419	1.10
7420	7420	1.10
7421	7421	1.10
7422	7422	1.10
7423	7423	1.10
7424	7424	1.10
7425	7425	1.10
7426	7426	1.10
7427	7427	1.10
7428	7428	1.10
7429	7429	1.10
7430	7430	1.10
7431	7431	1.10
7432	7432	1.10
7433	7433	1.10
7434	7434	1.10
7435	7435	1.10
7436	7436	1.10
7437	7437	1.10
7438	7438	1.10
7439	7439	1.10
7440	7440	1.10
7441	7441	1.10
7442	7442	1.10
7443	7443	1.10
7444	7444	1.10
7445	7445	1.10
7446	7446	1.10
7447	7447	1.10
7448	7448	1.10
7449	7449	1.10
7450	7450	1.10

4116 200 nsec 16,384 1-D Ram

Part No.	Description	Price
4116	4116	1.10

1 AMP SILICON RECTIFIERS

Part No.	Description	Price
100	100	1.10
1000	1000	1.10

5% Wirewound Res. Resistors

Part No.	Value	Price
100	100	1.10
1000	1000	1.10

PANASONIC V-SERIES

Part No.	Value	Price
100	100	1.10
1000	1000	1.10

7400 TTL

Part No.	Description	Price
7400	7400	1.10
7401	7401	1.10
7402	7402	1.10
7403	7403	1.10
7404	7404	1.10
7405	7405	1.10
7406	7406	1.10
7407	7407	1.10
7408	7408	1.10
7409	7409	1.10
7410	7410	1.10
7411	7411	1.10
7412	7412	1.10
7413	7413	1.10
7414	7414	1.10
7415	7415	1.10
7416	7416	1.10
7417	7417	1.10
7418	7418	1.10
7419	7419	1.10
7420	7420	1.10
7421	7421	1.10
7422	7422	1.10
7423	7423	1.10
7424	7424	1.10
7425	7425	1.10
7426	7426	1.10
7427	7427	1.10
7428	7428	1.10
7429	7429	1.10
7430	7430	1.10
7431	7431	1.10
7432	7432	1.10
7433	7433	1.10
7434	7434	1.10
7435	7435	1.10
7436	7436	1.10
7437	7437	1.10
7438	7438	1.10
7439	7439	1.10
7440	7440	1.10
7441	7441	1.10
7442	7442	1.10
7443	7443	1.10
7444	7444	1.10
7445	7445	1.10
7446	7446	1.10
7447	7447	1.10
7448	7448	1.10
7449	7449	1.10
7450	7450	1.10

4116 200 nsec 16,384 1-D Ram

Part No.	Description	Price
4116	4116	1.10

1 AMP SILICON RECTIFIERS

Part No.	Description	Price
100	100	1.10
1000	1000	1.10

5% Wirewound Res. Resistors

Part No.	Value	Price
100	100	1.10
1000	1000	1.10

PANASONIC V-SERIES

Part No.	Value	Price
100	100	1.10
1000	1000	1.10

Service Charges \$ 0.00 - \$ 9.99 Add \$2.00
 \$ 10.00 - \$ 29.99 Add \$3.00
 \$ 30.00 - \$ 49.99 Add \$4.00
 \$ 50.00 - \$ 99.99 Add \$5.00
 \$ 100.00 - \$ 199.99 Add \$6.00
 \$ 200.00 - \$ 499.99 Add \$7.00
 \$ 500.00 - \$ 999.99 Add \$8.00
 \$ 1000 & Up No Charge

Volume Discount \$ 0.00 - \$ 99.99 NET
 \$ 100.00 - \$ 499.99 Less 10%
 \$ 500.00 - \$ 999.99 Less 15%
 \$ 1000 & Up Less 25%

IS YOUR CORD
TOO SHORT?
DON'T HAVE THE
REACH?

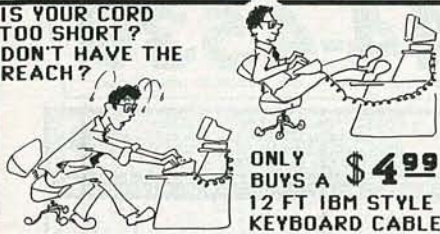

ONLY
BUYS A \$4⁹⁹
12 FT IBM STYLE
KEYBOARD CABLE

This fully shielded 5 ft cable will extend to over 18 ft. The computer end has a 5 pin DIN connector to fit all IBM & clones. The keyboard end has a 6 pin molex .1 inch spacing with movable wires to fit most keyboard brands. Installation requires the removal and replacement of the keyboard case some keyboards may require soldering.

MSDOS* BOOK SET

- USERS GUIDE
- PROGRAMMERS REFERENCE
- DEBUG UTILITY

\$15⁹⁹

GET THE JUMP ON YOUR CO-WORKERS BUY THIS 3 BOOK SET AND LEARN "DOS" AT HOME. BECOME THE OFFICE IBM EXPERT. *MSDOS IS A TRADEMARK OF MICROSOFT.

DYSAN BRAND ALIGNMENT DISKS

■ 224/A 5 INCH ■ 360-A 8 INCH
Analog recorded disks give precise head alignment display on your "0" scope

\$24⁰⁰
your choice

IBM COMPATIBLE FLOPPY DISK CONTROLLER WITH CENTRONICS PORT

Call for a copy of 15 day trial agreement. Tax & freight extra. Send check or add 1.90 for COD. Price may change. Store price may differ. While supplies last. No POs, terms, or credit cards \$5 min postage and handling charge.

\$19⁰⁰

Tandon
pcba 188400

Silicon Valley Surplus
415-261-4506
4401 OAKPORT OAKLAND CA, 94601

OPEN
10am-6pm
CLOSED
SUN & MON

CALL OUR BBS 415-261-4513

CIRCLE 200 ON FREE INFORMATION CARD

AMAZING SCIENTIFIC & ELECTRONIC PRODUCTS

PLANS—Build Yourself—All Parts Available In Stock

- LCT—BURNING CUTTING CO₂ LASER \$ 20.00
- RUBA—PORTABLE LASER RAY PISTOL 20.00
- TCC1—3 SEPARATE TESLA COIL
PLANS TO 1.5 MEV 20.00
- IOG1—ION RAY GUN 10.00
- GRA1—GRAVITY GENERATOR 10.00
- EML1—ELECTRO MAGNET COIL GUN/LAUNCHER 6.00

KITS

- MFT1K—FM VOICE TRANSMITTER 3 MI RANGE 49.50
- WVPMSK—TELEPHONE TRANSMITTER 3 MI RANGE 39.50
- BTC3K—250.00 VOLT 10-14" SPARK TESLA COIL 199.50
- LHQ2K—SIMULATED MULTICOLOR LASER 39.50
- BL51K—100,000 WATT BLASTER DEFENSE DEVICE 69.50
- TM1K—100,000 VOLT 20" EFFECTIVE
RANGE INTIMIDATOR 69.50
- PSP4K—TIME VARIANT SHOCK WAVE PISTOL 59.50
- PTG1K—SPECTACULAR PLASMA
TORNADO GENERATOR 149.50
- MVIK SEE IN DARK KIT 169.50

ASSEMBLED

- PG70H—MULTICOLORED VARIABLE
MODE PLASMA GLOBE "7" 425.00
- BTC10—50,000 VOLT—WORLD'S SMALLEST
TESLA COIL 44.50
- LGL40—1MW HeNe VISIBLE RED LASER GUN 299.50
- TAT20 AUTO TELEPHONE RECORDING DEVICE 24.50
- GPV10—SEE IN TOTAL DARKNESS IR VIEWER 299.50
- LIS10—SNOOPER PHONE INFINITY TRANSMITTER 169.50
- IPG70—INVISIBLE PAIN FIELD GENERATOR—
MULTI MODE 74.50

• CATALOG CONTAINING DESCRIPTIONS OF ABOVE PLUS HUNDREDS MORE AVAILABLE FOR \$1.00 OR INCLUDED FREE WITH ALL ABOVE ORDERS.

PLEASE INCLUDE \$3.00 PH ON ALL KITS AND PRODUCTS PLANS ARE POSTAGE PAID. SEND CHECK, MO, VISA, MC IN US FUNDS.

INFORMATION UNLIMITED
P.O. BOX 715, DEPT. RE, AMHERST, NH 03031

ADVERTISING INDEX

RADIO-ELECTRONICS does not assume any responsibility for errors that may appear in the index below.

Free Information Number	Page	
81	A.I.S. Satellite 28	61 McGraw Hill Book Club 22
108	AMC Sales 81	61 Microprocessors Unltd. 64
107	All Electronics 95	— NRI 34-37
103	Allen W.B. 8	182 NTS 28
—	Amazing Devices 102	196 NuScope Associates. 64
207	American Design Components 89	— Nuts & Volts 84
202	Annapro 64	190 OCTE Electronics 28
84	Appliance Service 83	110 Omnitron 12
183	Banner Technical Books 24	203 PC Boards 77
98	Beckman Industrial 4	— Pacific Cable 85
85	Blue Star Industries 83	189 Parts Express 86
109	C & S Sales 78	199 Pro Corp. 64
—	C.O.M.B. 25, 27	78 Radio Shack 100
60	CIE 16-19	184,185 Sencore 7,9
181	CAIG 27	186,187 Sencore 11,13
89	Cameo Enterprises 83	200 Silicon Valley Surplus. 102
205, 206	Circuit Cellar 28, 83	94 Star Circuits 28
—	Command Productions 62	201 Tectrans 64
198	Computer Technologies 64	92 Tektronix CV2
197	Consumertronics 64	180 Tentel 77
195	Cook's Institute 26	188 United Electronic Supply 14
193	Crystek 24	
127	Deco Industries 28, 83	
95	Dick Smith Electronics 99	
82	Digi-Key 101	
194	Electronic Design Specialists 63	
—	Electronic Industry Assoc. CV3	
—	Electronic Technology Today 15	
191	Electronics Book Club 10	
120	Elephant Electronics 62	
100	Firestik II 26	
121	Fluke Manufacturing 21	
—	Fordham Radio 29	
—	Grantham College of Engineering 30	
62	Hameg 20	
86, 204	Heath 55, 3	
192	ICS Computer Training 25	
—	ISCET 81	
59	JDR Instruments CV4	
113, 176	JDR Microdevices 90, 91	
177, 178	JDR Microdevices 92, 93	
179	JDR Microdevices 94	
114	Jameco 96, 97	
115	Jensen Tools 28	
87	MCM Electronics 98	
208	MD Electronics 28	
93	Mark V. Electronics 87	

Gernsback Publications, Inc.
500-B Bi-County Blvd.
Farmingdale, NY 11735
(516) 293-3000
President: Larry Steckler
Vice President: Cathy Steckler

For Advertising ONLY 516-293-3000

Larry Steckler
publisher
Arline Fishman
advertising director
Shelli Weinman
advertising associate
Lisa Strassman
credit manager
Christina Estrada
advertising assistant

SALES OFFICES

EAST/SOUTHEAST

Stanley Levitan
Eastern Sales Manager
Radio-Electronics
259-23 57th Avenue
Little Neck, NY 11362
718-428-6037, 516-293-3000

MIDWEST/Texas/Arkansas/Okla.

Ralph Bergen
Midwest Sales Manager
Radio-Electronics
540 Frontage Road—Suite 339
Northfield, IL 60093
312-446-1444

PACIFIC COAST/ Mountain States

Marvin Green
Pacific Sales Manager
Radio-Electronics
15335 Morrison St.—Suite 227
Sherman Oaks, CA 91403
818-986-2001

**YOU NEED
DISTRIBUTORS
FOR
JUST-IN-TIME...**

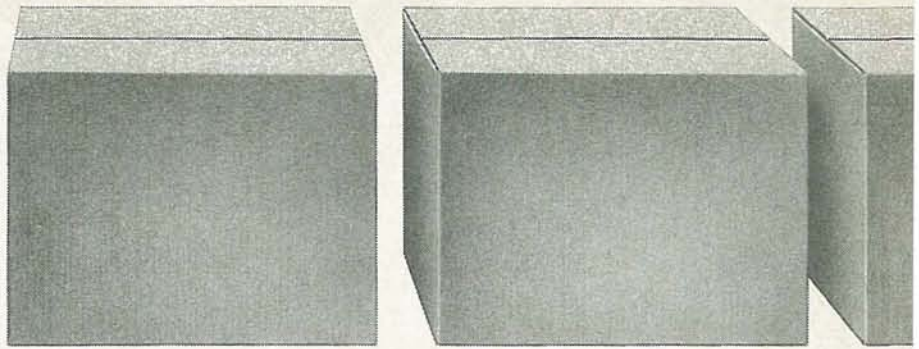

**AND
EVEN MORE
FOR
JUST-IN-CASE!**

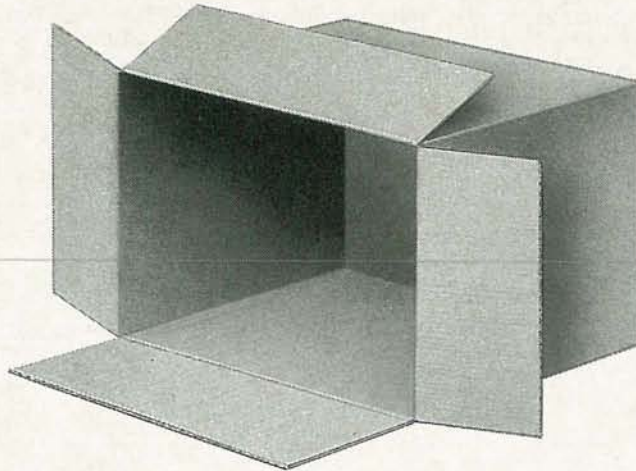

Let's not get lost in the buzzwords. Timely scheduling of component deliveries is not new... it's been at the forefront of the growth of industrial electronic distribution. Distributors have been stocking the quantity inventories necessary to parallel your production schedules for over a quarter of a century.

But your distributor is more than just a convenient, nearby source for OEM product. You also count on him to have on hand the important single piece you suddenly need... to locate those hard-to-find replacement parts... to keep your lines from shutting down for want of missing components.

Your distributor is your key resource... for just in time, for just in case.

Why are we, as electronics manufacturers, "pushing" distribution? Because it's our way of serving you better! It makes our wares more accessible to more buyers; it speeds our components to you faster than we could deliver them. And by extending our sales, warehouse, and credit capabilities, distributors help us keep down our costs, and hence your price!

The sponsors of this message are among over 150 member firms of the Electronic Industries Association, Distributor Products Division, all committed to marketing through distributors, because it benefits buyer and seller. **Want more information?** Contact Herbert Rowe, Senior Vice President, EIA Components Group, 2001 Eye Street, N.W., Washington, D.C. 20006. Telephone (202) 457-4930.

Alpha Wire Corporation
Wire, Cable, Tubing Connectors

AMP Incorporated
Electrical/Electronic Connectors; IC Sockets; PCB Switches

Amphenol Products
Amphenol, Bendix & Spectra-Strip Connectors, Cable & Cable Assemblies

Arrow Hart Division/Cooper Industries
Power & Control Switches

Belden Electronic Wire & Cable
Thermosetting, Thermoplastic Wire & Cable for Electronic Applications

Carol Cable Company, Inc.
Electronic and Electrical Wire and Cable and Power Supply Cords

Cornell-Dubilier Electronics, Inc.
Capacitors, Relays, EMI Filters & EMI Systems Engineering Services

**Corning Glass Works,
CORNING ELECTRONICS**
MLCC Capacitors (leaded) and Chips, Power & Glass Capacitors, Fixed Metal Film Resistors, Resistor Chips, Resistor & Capacitor Networks (standard & customs), and Tantalum Capacitors.

CTS Corporation
DIP Switches, DIP/SIP Resistor Networks, Hybrids, Clock Oscillators, Crystals, Potentiometers & Rotary Switches

Dale Electronics, Inc.
Resistors, Networks, Oscillators, Displays, Connectors, Inductors & Thermistors, Electronic Components

Lampronix Co., Ltd.
Miniature/Subminiature, & Incandescent & Neon Lamps

Matrix Science Corporation
MIL-C-38999, MIL-C-24308, MIL-C-83723, MIL-C-5015 & MIL-C-81714

Murata Erie North America, Inc.
Monolithics, Discs, Variable Capacitors; Potentiometers; RF/EMI Filters; Crystals; Oscillators; Piezo Alarms; and High Voltage Products

NTE Electronics, Inc.
Semiconductors, Flameproof Resistors, Wire-ties

Ohmite/A North American Philips Company
Resistors, Rheostats, & Control Components

Perma Power Electronics, Inc.
Portable Sound Systems, Amplifiers, Power Line Surge Suppressors & Multiple Outlet Strips

**Philips ECG/
A North American Philips Company**
Semiconductors, Picture Tubes, Receiving Tubes & Chemicals

Potter & Brumfield
Electromechanical, Time Delay, & Solid State Relays; I/O Modules; Circuit Breakers

Quam-Nichols Co., Inc.
Loudspeakers and Commercial Sound Products

RCA Distributor & S.P. Division
Electronic Parts, Semiconductor Devices, Receiving, Industrial & Picture Tubes, Video Tape & Accessories

SL Weber, A Division of SL Industries, Inc.
Surge & Noise Suppressors, Uninterruptible Power Supplies, Multiple Outlet Strips

Simpson Electric Co.
Analog & Digital Panel Meters, Meter Relays, VOM's, DMM's, Electrical-Electronic Test Equipment, Elapsed Time & Frequency Meters

Switchcraft, Inc.
Switches, Connectors, Fiber Optic Connectors, Jacks, Plugs, Keyboards, Jackfields & Audio Accessories

Waldom Electronics
Capacitors, Connectors, Hardware, PCB Accessories, Relays, Switches, Lamps/Lights, IC Sockets, Terminals & Tools



DISTRIBUTOR
PRODUCTS
DIVISION

TEST EQUIPMENT THAT MEASURES UP TO YOUR SPECIFICATIONS



DMM-300 \$79.95

3.5 DIGIT DMM / MULTITESTER

Our best model. A highly accurate, full function DMM loaded with many extra features. Audible continuity, capacitance, transistor, temperature and conductance all in one hand-held meter. Temperature probe, test leads and battery included.

- Basic DC accuracy: plus or minus 0.25%
- DC voltage: 200mv — 1000v, 5 ranges
- AC voltage: 200mv — 750v, 5 ranges
- Resistance: 200 ohms — 20M ohms, 6 ranges
- AC/DC current: 200uA — 10A, 6 ranges
- Capacitance: 2000pf — 20uf, 3 ranges
- Transistor tester: hFE test, NPN, PNP
- Temperature tester: 0° — 2000° F
- Conductance: 200ns
- Fully over-load protected
- Input impedance: 10M ohm



DMM-200 \$49.95

3.5 DIGIT FULL FUNCTION DMM

High accuracy, 20 amp current capability and many range settings make this model ideal for serious bench or field work. Tilt stand for hands-free operation. 2000 hour battery life with standard 9v cell. Probes and battery included.

- Basic DC accuracy: plus or minus 0.25%
- DC voltage: 200mv — 1000v, 5 ranges
- AC voltage: 200mv — 750v, 5 ranges
- Resistance: 200 ohms — 20M ohms, 6 ranges
- AC/DC current: 200uA — 20A, 6 ranges
- Fully over-load protected
- Input impedance: 10M ohm
- 180 x 86 x 37mm, weighs 320 grams



DMM-700 \$49.95

3.5 DIGIT AUTORANGING DMM

Autorange convenience or fully manual operation. Selectable LO OHM mode permits accurate in-circuit resistance measurements involving semi-conductor junctions. MEM mode for measurements relative to a specific reading. Probes and battery included.

- Basic DC accuracy: plus or minus 0.5%
- DC voltage: 200mv — 1000v, autoranging or 5 manual ranges
- AC voltage: 2v — 750v, autoranging or 4 manual ranges
- Resistance: 200 ohms — 20M ohms, autoranging
- AC/DC current: 20mA — 10A, 2 ranges
- Fully over-load protected
- Audible continuity tester
- Input impedance: 10M ohm
- 150 x 75 x 34mm, weighs 230 grams



DMM-100 \$29.95

3.5 DIGIT POCKET SIZE DMM

Shirt-pocket portability with no compromise in features or accuracy. Large, easy to read 5" LCD display. 2000 hour battery life with standard 9v cell provides over two years of average use. Probes and battery included.

- Basic DC accuracy: plus or minus 0.5%
- DC voltage: 2v — 1000v, 4 ranges
- AC voltage: 200v — 750v, 2 ranges
- Resistance: 2k ohms — 2M ohms, 4 ranges
- DC current: 2mA — 2A, 4 ranges
- Fully over-load protected
- Input impedance: 10M ohm
- 130 x 75 x 28mm, weighs 195 grams

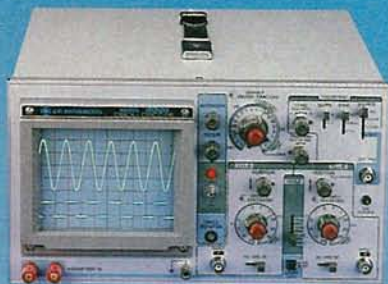

MODEL 2000 \$349.95

20 MHz DUAL TRACE OSCILLOSCOPE

Model 2000 combines useful features and exacting quality. Frequency calculation and phase measurement are quick and easy in the X-Y Mode. Service technicians will appreciate the TV Sync circuitry for viewing TV-V and TV-H as well as accurate synchronization of the Video Signal, Blanking Pedestals, VITS and Verticle/Horizontal sync pulses.

- Lab quality compensated 10X probes included
- Built-in component tester
- 110/220 Volt operation
- X-Y operation • Bright 5" CRT • TV Sync filter

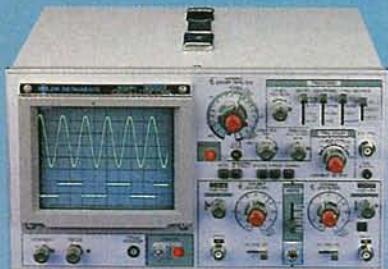

MODEL 3500 \$499.95

35 MHz DUAL TRACE OSCILLOSCOPE

Wide bandwidth and exceptional 1mV/DIV sensitivity make the Model 3500 a powerful diagnostic tool for engineers or technicians. Delayed triggering allows any portion of a waveform to be isolated and expanded for closer inspection. Variable Holdoff makes possible the stable viewing of complex waveforms.

- Lab quality compensated 10X probes included
- Delayed and single sweep modes
- Z Axis intensity modulation
- X-Y operation • Bright 5" CRT • TV Sync filter



DPM-1000 \$54.95

3.5 DIGIT PROBE TYPE DMM

Autorangeing, pen style design for the ultimate in portability and ease of use. Custom 80 pin LSI chip increases reliability. Audible continuity tester and data hold feature for added convenience. Case, test leads and batteries included.

- Basic DC accuracy: plus or minus 1%
- DC voltage: 2v — 500v, autoranging
- AC voltage: 2v — 500v, autoranging
- Resistance: 2k ohms — 2M ohms, autoranging
- Fully over-load protected
- Input impedance: 11M ohm
- 162 x 28 x 17mm, weighs 75 grams

2 YEAR WARRANTY ON ALL MODELS

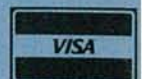

JDR INSTRUMENTS
110 Knowles Drive, Los Gatos, CA 95030
(408) 866-6200 • FAX (408) 378-8927 • Telex 171-110

ORDER TOLL FREE 800-538-5000

OR VISIT OUR RETAIL STORE
1256 SOUTH BASCOM AVE.
SAN JOSE, CA. (408) 947-8881
CIRCLE 59 ON FREE INFORMATION CARD

COPYRIGHT 1986 JDR MICRODEVICES
THE JDR INSTRUMENTS LOGO IS A REGISTERED TRADEMARK OF JDR MICRODEVICES.
JDR INSTRUMENTS IS A TRADEMARK OF JDR MICRODEVICES.