

48783 **Radio** - BUILD A COMMERCIAL ZAPPER

\$2.25 APR. 87
IN CANADA \$2.75

Electronics

TECHNOLOGY - VIDEO - STEREO - COMPUTERS - SERVICE

BUILD THIS ROBOT BRAIN

Construction details for a
robotics-control computer

LOGIC-GATE PRIMER

Fundamentals of
buffers and gates

COMMUNICATIONS TECHNOLOGY

Spread-spectrum systems

BUILD AN ACID-RAIN MONITOR

Measure the danger yourself

THE EARLY DAYS OF RADIO

Radio pioneers and their contributions

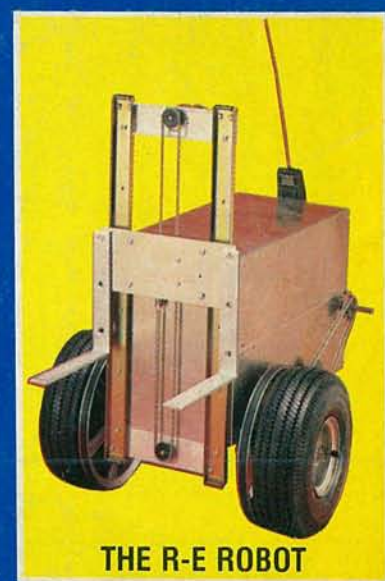

- PLUS:**
- ★ **COMPUTER DIGEST**
 - ★ **Video News**
 - ★ **Ask R-E**
 - ★ **Designer's Notebook**



A
GERNSBACK
PUBLICATION

New GPS Series: Tek sets the pace with SmartCursors™ and push-button ease.

Work faster, smarter, with two new general purpose scopes from Tektronix. The four-channel, 100 MHz 2246 and 2245 set the new, fast pace for measurements at the bench or in the field. They're easy to use and afford, by design.

On top: the 2246 with exclusive integrated push-button measurements. Measurements are accessed through easy, pop-up menus and implemented at the touch of a button. Measure peak volts, peak-to-peak, \pm peak, dc volts and gated volts with new hands-off convenience and on-screen readout of values.

SmartCursors™ track voltmeter measurements in the 2246 and visually indicate where ground and trigger levels are located. Or use cursors in the manual mode for immediate, effortless measurement of waveform parameters.

Both scopes build on performance you haven't seen at the bandwidth or prices. Lab grade features include sweep speeds to 2 ns/div. Vertical sensitivity of 2 mV/div at full bandwidth for low-level signal capture. Plus trigger

Features	2246	2245
Bandwidth	100 MHz	100 MHz
No. of Channels	4	4
Scale Factor Readout	Yes	Yes
SmartCursors™	Yes	No
Volts Cursors	Yes	No
Time Cursors	Yes	No
Voltmeter	Yes	No
Vertical Sensitivity	2 mV/div	2 mV/div
Max. Sweep Speed	2 ns/div	2 ns/div
Vert/Hor Accuracy	2%	2%
Trigger Modes	Auto Level, Auto, Norm, TV Field, TV Line, Single Sweep	
Trigger Level Readout	Yes	No
Weight	6.1 kg	6.1 kg
Warranty	3-year on parts and labor including CRT	
Price	\$2400	\$1875

sensitivity to 0.25 div at 50 MHz, to 0.5 div at 150 MHz.

Accuracy is excellent: 2% at vertical, 2% at horizontal. And four-channel capability includes two channels optimized for logic signals.

Best of all, high performance comes with unmatched convenience. You can see it and feel it — in the

responsive controls and simple front-panel design, in extensive on-screen scale factor readouts, and in simplified trigger operation that includes Tek's Auto Level mode for automatic triggering on any signal. Start to finish, the GPS Series saves steps and simplifies tasks.

Get out in front! Call toll-free today to order, to get more details or a videotape demonstration.

1-800-433-2323

In Oregon, call collect 1-627-9000

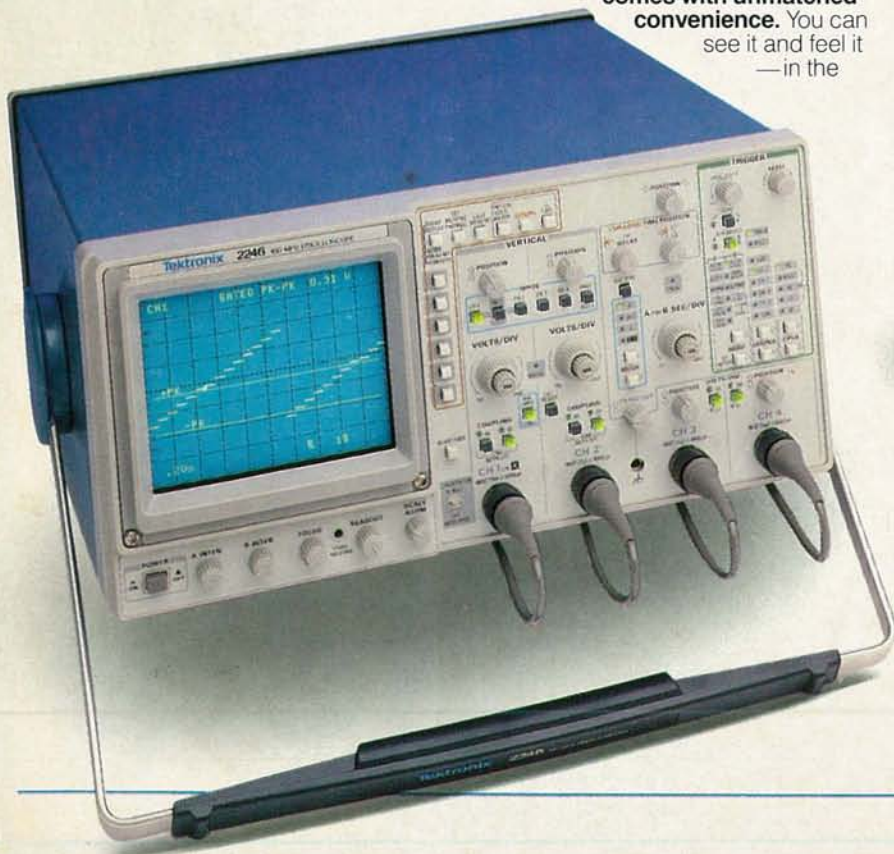

Featuring four channels, flexible triggering, extensive CRT readouts and push-button ease of use, the new Tek 2246 (left) and 2245 (above) bring high-quality, low-cost analysis to diverse applications in digital design, field service and manufacturing.

Tektronix
COMMITTED TO EXCELLENCE

- BUILD THIS**
- 39 **R-E ROBOT**
Part 5. A detailed look at the R-E robot's on-board computer. **Steven E. Sarns**
 - 45 **COMMERCIAL ZAPPER FOR YOUR RADIO**
Get rid of annoying commercials on FM radio. **Mark Rumreich**
 - 48 **ACID RAIN MONITOR**
This inexpensive circuit helps you keep an eye on the environment. **Walter D. Scott**
 - 65 **PC SERVICE**
Use our exclusive foil patterns to make circuit boards for the R-E Robot's computer.

- TECHNOLOGY**
- 7 **VIDEO NEWS**
Inside the fast-changing video scene. **David Lachenbruch**
 - 55 **ALL ABOUT SPREAD SPECTRUM COMMUNICATIONS**
Learn how government agencies and others use wideband communication techniques to defeat jamming, and more. **James E. McDermott**
 - 68 **AUDIO UPDATE**
Why stereo doesn't work. **Larry Klein**

- CIRCUITS AND COMPONENTS**
- 50 **LOGIC GATE FUNDAMENTALS**
Learn how to build different types of logic devices from just a few basic building blocks. **Ray Marston**
 - 62 **TESTING SEMICONDUCTORS**
Part 3. Diode characteristics and how to test them. **TJ Byers**
 - 67 **NEW IDEAS**
A headlight alarm for your car.
 - 76 **DRAWING BOARD**
Finishing up the remote control system **Robert Grossblatt**
 - 79 **DESIGNER'S NOTEBOOK**
A battery backup for CMOS. **Robert Grossblatt**
 - 80 **STATE OF SOLID STATE**
Tone Generator IC's. **Robert F. Scott**

RADIO

- 59 **EARLY DAYS OF RADIO**
Learn about the many inventions and individuals that contributed to the birth of radio. **Martin Clifford**

COMPUTERS

- 83 **COMPUTER DIGEST**
Part two of "Build the MC 68000" will appear next month.
- 85 **EDITOR'S WORKBENCH**
- 93 **CAUZIN SOFTSTRIP SYSTEM**
- 96 **ADD A DISK DRIVE**
- 99 **BUILD THIS PC INCOMPATIBLE**

EQUIPMENT REPORTS

- 24 **SENCORE LC75 Z-METER II**

DEPARTMENTS

- 128 **Advertising and Sales Offices**
- 128 **Advertising Index**
- 8 **Ask R-E**
- 129 **Free Information Card**
- 12 **Letters**
- 103 **Market Center**
- 27 **New Literature**
- 30 **New Products**
- 4 **What's News**

COVER 1



The past few months we've described a versatile robot that you can build. Up to now, much of the discussion has been devoted to the logic behind the design, and some of the goals we'd like the robot to achieve. What construction details we did present were pretty much confined to the mechanical systems.

Now it's time to get to the heart of the matter. Or, to be a bit more precise, the brain. If our robot is to be a useful servant, an on-board computer is a necessity. The one we've designed for our robot offers great power and flexibility; it is built around an upgraded version of the microprocessor used in the IBM PC. To find out more about the computer, turn to page 39.

NEXT MONTH

THE MAY ISSUE IS ON SALE APRIL 2

A SPECIAL DOUBLE ISSUE
FEATURING A LOOK
AT ELECTRONICS IN
THE YEAR 2001.

Leading writers and authorities in their fields give **Radio-Electronics** readers a sneak preview of expected developments in robotics, artificial intelligence, medical electronics, automotive electronics, communications, energy technology, and other fields, and show how they will impact our lives. Among the featured writers are:

Arthur C. Clarke

Issac Asimov

Donald E. Petersen (Chairman of the Board and Chief Executive Officer, Ford Motor Company)

George Heilmeyer (Senior Vice President and Chief Technical Officer, Texas Instruments)

And many others!

We'll also have the full line of articles and columns you've come to expect every month in **Radio-Electronics**. Don't miss this very important issue!

As a service to readers, RADIO-ELECTRONICS publishes available plans or information relating to newsworthy products, techniques and scientific and technological developments. Because of possible variances in the quality and condition of materials and workmanship used by readers, RADIO-ELECTRONICS disclaims any responsibility for the safe and proper functioning of reader-built projects based upon or from plans or information published in this magazine.

Since some of the equipment and circuitry described in RADIO-ELECTRONICS may relate to or be covered by U.S. patents, RADIO-ELECTRONICS disclaims any liability for the infringement of such patents by the making, using, or selling of any such equipment or circuitry, and suggests that anyone interested in such projects consult a patent attorney.

Radio-Electronics

Hugo Gernsback (1884-1967) founder
M. Harvey Gernsback,
editor-in-chief, emeritus

Larry Steckler, EHF, CET, editor-in-chief
and publisher

EDITORIAL DEPARTMENT

Art Kleiman, editorial director
Brian C. Fenton, managing editor
Carl Laron, WB2SLR, associate editor
Jeffrey K. Holtzman,
assistant technical editor
Robert A. Young, assistant editor
Julian S. Martin, editorial associate
Byron G. Wels, editorial associate
M. Harvey Gernsback,
contributing editor
Jack Darr, CET, service editor
Robert F. Scott,
semiconductor editor
Herb Friedman,
communications editor
Bob Cooper, Jr. satellite-TV editor
Robert Grossblatt, circuits editor
Larry Klein, audio editor
David Lachenbruch,
contributing editor
Richard D. Fitch,
contributing editor
Teri Scaduto, editorial assistant

PRODUCTION DEPARTMENT

Ruby M. Yee, production director
Robert A. W. Lowndes,
editorial production
Andre Duzant, technical illustrator
Karen Tucker, advertising production
Geoffrey S. Weil, production traffic

CIRCULATION DEPARTMENT

Jacqueline P. Cheeseboro,
circulation director
Wendy Alanko,
circulation analyst
Theresa Lombardo,
circulation assistant

Typography by Mates Graphics

Radio-Electronics, Gernsback Publications, Inc., 500-B Bi-County Blvd., Farmingdale, NY 11735. 516-293-3000

Radio-Electronics is indexed in *Applied Science & Technology Index* and *Readers Guide to Periodical Literature*.

Microfilm & Microfiche editions are available. Contact circulation department for details.

Advertising Sales Offices listed
on page 128.



TEST EQUIPMENT THAT MEASURES UP TO YOUR SPECIFICATIONS



DMM-300 \$79.95
3.5 DIGIT DMM / MULTITESTER

Our best model. A highly accurate, full function DMM loaded with many extra features. Audible continuity, capacitance, transistor, temperature and conductance all in one hand-held meter. Temperature probe, test leads and battery included.

- Basic DC accuracy: plus or minus 0.25%
- DC voltage: 200mv — 1000v, 5 ranges
- AC voltage: 200mv — 750v, 5 ranges
- Resistance: 200 ohms — 20M ohms, 6 ranges
- AC/DC current: 200uA — 10A, 6 ranges
- Capacitance: 2000pf — 20uf, 3 ranges
- Transistor tester: hFE test, NPN, PNP
- Temperature tester: 0° — 2000° F
- Conductance: 200ns
- Fully over-load protected
- Input impedance: 10M ohm



DMM-200 \$49.95
3.5 DIGIT FULL FUNCTION DMM

High accuracy, 20 amp current capability and many range settings make this model ideal for serious bench or field work. Tilt stand for hands-free operation. 2000 hour battery life with standard 9v cell. Probes and battery included.

- Basic DC accuracy: plus or minus 0.25%
- DC voltage: 200mv — 1000v, 5 ranges
- AC voltage: 200mv — 750v, 5 ranges
- Resistance: 200 ohms — 20M ohms, 6 ranges
- AC/DC current: 200uA — 20A, 6 ranges
- Fully over-load protected
- Input impedance: 10M ohm
- 180 x 86 x 37mm, weighs 320 grams



DMM-700 \$49.95
3.5 DIGIT AUTORANGING DMM

Autorange convenience or fully manual operation. Selectable LO OHM mode permits accurate in-circuit resistance measurements involving semi-conductor junctions. MEM mode for measurements relative to a specific reading. Probes and battery included.

- Basic DC accuracy: plus or minus 0.5%
- DC voltage: 200mv — 1000v, autoranging or 5 manual ranges
- AC voltage: 2v — 750v, autoranging or 4 manual ranges
- Resistance: 200 ohms — 20M ohms, autoranging
- AC/DC current: 20mA — 10A, 2 ranges
- Fully over-load protected
- Audible continuity tester
- Input impedance: 10M ohm
- 150 x 75 x 34mm, weighs 230 grams



DMM-100 \$29.95
3.5 DIGIT POCKET SIZE DMM

Shirt-pocket portability with no compromise in features or accuracy. Large, easy to read .5" LCD display. 2000 hour battery life with standard 9v cell provides over two years of average use. Probes and battery included.

- Basic DC accuracy: plus or minus 0.5%
- DC voltage: 2v — 1000v, 4 ranges
- AC voltage: 200v — 750v, 2 ranges
- Resistance: 2k ohms — 2M ohms, 4 ranges
- DC current: 2mA — 2A, 4 ranges
- Fully over-load protected
- Input impedance: 10M ohm
- 130 x 75 x 28mm, weighs 195 grams

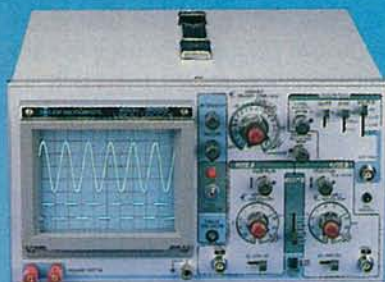

MODEL 2000 \$349.95
20 MHz DUAL TRACE OSCILLOSCOPE

Model 2000 combines useful features and exacting quality. Frequency calculation and phase measurement are quick and easy in the X-Y Mode. Service technicians will appreciate the TV Sync circuitry for viewing TV-V and TV-H as well as accurate synchronization of the Video Signal. Blanking Pedestals, VITS and Verticle/Horizontal sync pulses.

- Lab quality compensated 10X probes included
- Built-in component tester
- 110/220 Volt operation
- X-Y operation • Bright 5" CRT • TV Sync filter

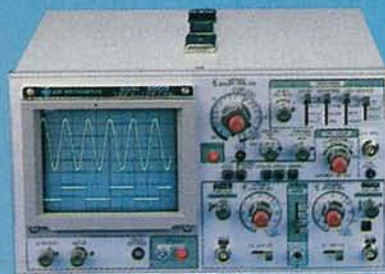

MODEL 3500 \$499.95
35 MHz DUAL TRACE OSCILLOSCOPE

Wide bandwidth and exceptional 1mV/DIV sensitivity make the Model 3500 a powerful diagnostic tool for engineers or technicians. Delayed triggering allows any portion of a waveform to be isolated and expanded for closer inspection. Variable Holdoff makes possible the stable viewing of complex waveforms.

- Lab quality compensated 10X probes included
- Delayed and single sweep modes
- Z Axis intensity modulation
- X-Y operation • Bright 5" CRT • TV Sync filter



DPM-1000 \$54.95
3.5 DIGIT PROBE TYPE DMM

Autoranging, pen style design for the ultimate in portability and ease of use. Custom 80 pin LSI chip increases reliability. Audible continuity tester and data hold feature for added convenience. Case, test leads and batteries included.

- Basic DC accuracy: plus or minus 1%
- DC voltage: 2v — 500v, autoranging
- AC voltage: 2v — 500v, autoranging
- Resistance: 2k ohms — 2M ohms, autoranging
- Fully over-load protected
- Input impedance: 11M ohm
- 162 x 28 x 17mm, weighs 75 grams

2 YEAR WARRANTY ON ALL MODELS



JDR INSTRUMENTS
110 Knowles Drive, Los Gatos, CA 95030
(408) 866-6200 • FAX (408) 378-8927 • Telex 171-110

ORDER TOLL FREE 800-538-5000

OR VISIT OUR RETAIL STORE
1256 SOUTH BASCOM AVE.
SAN JOSE, CA. (408) 947-8881
CIRCLE 59 ON FREE INFORMATION CARD

COPYRIGHT 1986 JDR MICRODEVICES
THE JDR INSTRUMENTS LOGO IS A REGISTERED TRADEMARK OF JDR MICRODEVICES.
JDR INSTRUMENTS IS A TRADEMARK OF JDR MICRODEVICES.

WHAT'S NEWS

New broadcast stations coming

In 1979, WARC (the World Administrative Radio Conference) allocated or reallocated the 1605-1705-kHz band to radio Region 2 (the Western Hemisphere). An Expanded-Band Conference

was scheduled to plan the broadcast use of that band. The FCC made two proposals to that Conference: One was that allotment planning be used; the other was that station power be limited to 10 kW.

Allotment planning has several advantages over assignment planning, the alternative. In assignment planning, each signatory country must submit its complete and detailed requirements, pinpointing each prospective station and stating power, antenna systems, and other characteristics for each.

Under allotment planning, designated frequencies are made available for designated areas. Although the allotment of frequencies is based on the presumption of stations with defined characteristics within defined areas, the signatories are not bound to follow the exact details of the plan and may depart from the plan provided that the radiation toward other signatories does not exceed what would have resulted from operating stations with the presumed characteristics.

As to the proposed 10kW power limit, the FCC believes that such a maximum power provides for adequate service range for each station, while making it possible to have enough stations to meet the requirements of the area.

The first session of the Conference, held in the spring of 1986, approved both the allotment system and the 10-kW power limit. Unless unexpected difficulties crop up at the second and final session, to be held near the end of 1988, it is expected that the portion of the band between 1665 and 1705 kHz will be opened July 1, 1990. Some stations in the 1605 to 1665 portion of the band may be actually on the air well before that date.

Under present allocations, a small part of the 1605-1705 kHz band is in use for broadcasting. The rest of that band is divided between fixed and mobile stations; those stations chiefly are used for navigational aids. **R-E**

"Unmanned" warfare due in the future?

General Electric researchers are engaged in a project to improve the image-understanding abilities of machine-vision systems. The purpose is to permit an unmanned vehicle to recognize objects in its range of "vision" and to take appropriate action—steer around an obstacle, stop at a body of water, or turn and flee from a hostile tank.

To do that, it is necessary to teach the vehicle's computer "geometric reasoning;" that is, to train it to recognize objects by matching their geometric features (lines and corners) with those of images stored in memory. Hundreds of images will have to be remembered, including those of landmarks, vehicles, and other objects the vehicle may encounter.

To store the images, the computer is "shown" photos, drawings, or mockups of objects from several viewpoints, including front views, side views, three-quarter views, etc. That is done with a TV camera that converts the images into digital data that the computer can deal with. The computer then manipulates the data to create a model of the object, which is filed away in memory.

When the vehicle's camera spots an unidentified object in its path, the computer starts processing the image to extract rough geometric data, looking for lines and vertices where there are sharp changes. That produces a two-dimensional representation (resembling a crude line drawing) showing the boundaries of the ob-



MODEL MAKING. General Electric scientist Daniel Thompson is preparing one of the many images required to make the three-dimensional model from which the jeep could be identified.

ject. That is compared with all the possible two-dimensional orientations of the three-dimensional models in the computer's memory. If several features of any rotation of the 3-D model agree with the computer's 2-D image, the computer assumes a tentative identification. It then examines finer details to confirm or reject the identification.

The project is supported by a \$1 million contract from DARPA (the U.S. Defense Advanced Research Projects Agency), and is aimed at evaluating the potential of unmanned vehicles for military operations, such as surveillance and reconnaissance missions, or shuttling supplies to front lines.

Your Best Source for Banana Plugs and Adapters is POMONA ELECTRONICS

STANDARD DOUBLE BANANA
PLUG: MODEL MDP



BNC FEMALE TO STANDARD
DOUBLE BANANA PLUG:
MODEL 1269



STANDARD DOUBLE BINDING
POSTS TO BNC MALE:
MODEL 1296



DOUBLE BANANA JACK:
MODEL 2269



FREE 1987 GENERAL CATALOG

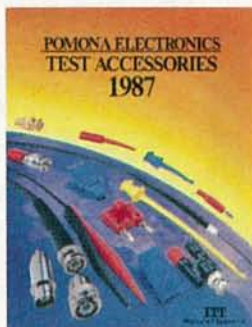

ITT Pomona Electronics
1500 E. Ninth St., Pomona, CA 91766
Tel: (714) 623-3463

SINGLE BINDING POST TO BNC
MALE: MODEL 3430



STANDARD BINDING POST:
MODEL 3760



CONNECTOR TEST ADAPTERS:
SOCKET TYPE (LEFT) MODEL
4690; PIN TYPE (RIGHT)
MODEL 4691



BNC FEMALE TO PHONO PLUG:
MODEL 2957



Our Products are available through your favorite electronics parts distributor.
CIRCLE 101 ON FREE INFORMATION CARD

Make your home into something special!

That's exactly what your home will be when you fill it with Heathkit electronic products – products that make your life easier and more enjoyable. Within our diverse line are kit and assembled products sure to enhance each room in your home.

1. Make your entryway more secure and easy to use with the Keyless Doorlock. You'll never again be locked out because of lost or forgotten keys. All it takes is a simple fingertip entry of a four-digit code, and the Keyless Doorlock unlocks your door.

2. Add a new dimension to your living room with your own Computerized Weather Station. This Digital Weather Station displays up-to-the-minute temperature, wind, and barometric pressure readings, along with time and date.

3. Give your kitchen a unique blend of style and efficiency with our Digital Wall Clock. This easy-to-build kit keeps time with quartz-crystal accuracy. And with its simulated oak wood-grain finish cabinet, you'll have a timepiece that fits into almost any decor.

4. Put your den to greater use with this IBM PC AT Compatible Computer. Do word processing, personal accounting and more when you run exciting IBM-compatible software on your fast and powerful HS-241. And you can build it yourself in just a few hours.

5. Bring the latest in digital technology to your bathroom. This Digital Scale lets you closely monitor your weight with electronic precision. And, it's battery operated so it's safe to use right out of the shower.

6. Add a video entertainment center to your bedroom. Our 19"-diagonal stereo TV kit gives you an extra-sharp color-corrected picture with full stereo sound, and convenient viewing that you can control from your bed. Comes in a simulated walnut cabinet that complements your room.

7. Transform your rec room into a haven for hobby fun. Put our Deluxe QRP CW Transceiver in this room and enjoy superb HAM radio operation that excels in performance and features. It offers expandable transmission and reception capabilities.

8. Give your workbench a touch of professionalism with this oscilloscope. Whether you're a service technician or a hobbyist, you'll love the wide range of measurement capability our laboratory-grade Dual Trace 10 MHz Oscilloscope gives you.

9. Add practicality to the utility room and save money, too. Avoid expensive food spoilage with our Freezer Alarm that

warns you when the inside temperature of your freezer rises too high. Prevent water damage with our Food Alarm that warns you of water that's where it shouldn't be.



10. Make your coming and going easier than ever. Your garage door will open with incredible

ease and dependability with our Deluxe Garage Door Opener. Easy to install, this opener is durable and includes a handy security light.

You'll find fun and excitement with every Heathkit product. Whether they're in kit form or already assembled, our products will help you enjoy your home more than you ever dreamed possible.

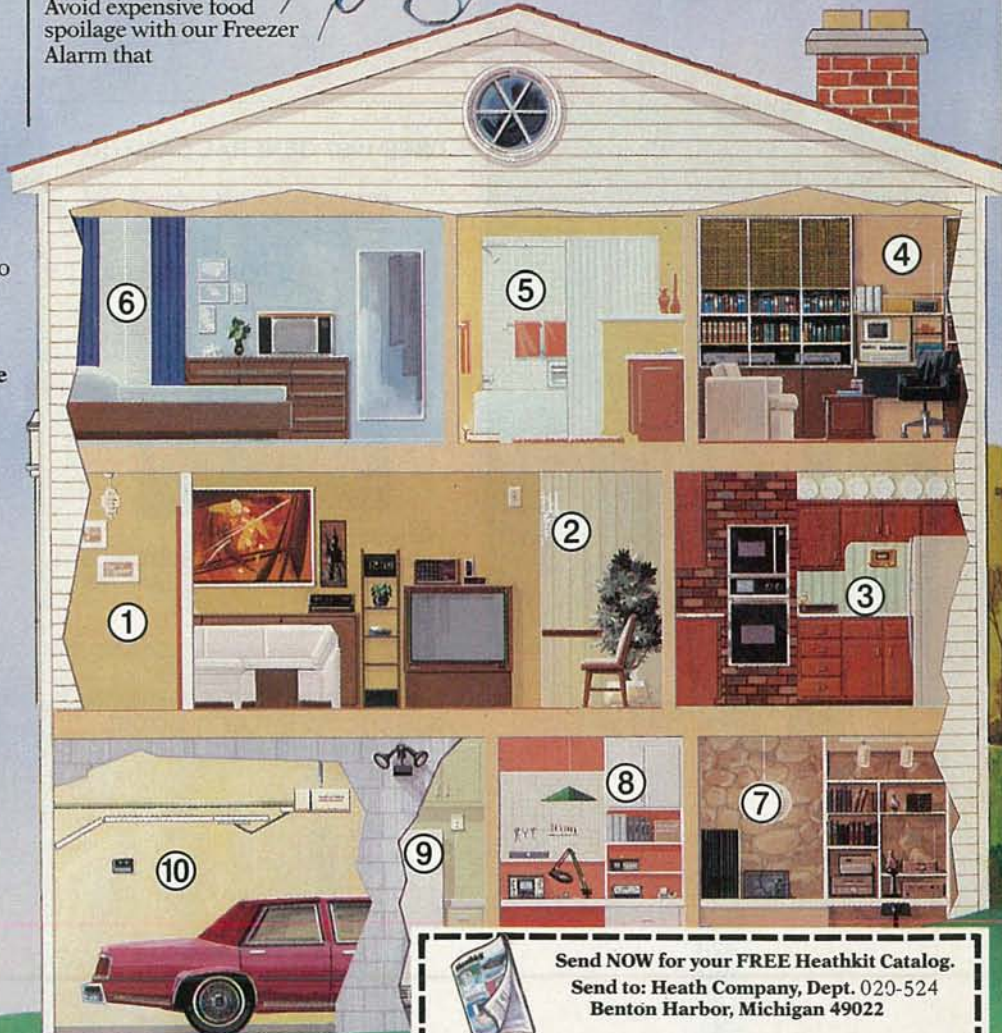

Send NOW for your FREE Heathkit Catalog.
Send to: Heath Company, Dept. 020-524
Benton Harbor, Michigan 49022

Name _____
Address _____
City _____ State _____ Zip _____
A subsidiary of Zenith Electronics Corporation CL-789A

Heathkit
Heath
Company

CIRCLE 86 ON FREE INFORMATION CARD

VIDEO NEWS



DAVID LACHENBRUCH,
CONTRIBUTING EDITOR

● **EDTV.** A new program in Japan has as its goal a major change in television transmission standards by 1988. The new standard will produce a sharply-improved picture, but will maintain compatibility with existing standards and TV sets.

The Broadcasting Technology Association, a Japanese government-industry association, has announced that it established the following guidelines for its proposed new *Extended Definition TV* (EDTV) system:

- Complete compatibility with existing receiving equipment and standards.
- Picture quality that is sufficient for viewing at a distance of four times tube height (rather than the existing optimum of 10 times the tube height). Therefore, under the standard, a 30-inch tube (tubes of that size are expected to be common in the near future) would be ideally viewable from eight feet away.
- Horizontal resolution of 450 lines (compared with today's approximately 330 lines) and vertical resolution of 450 lines compared with today's 300 lines) by using a progressive non-interlaced scanning system.
- Reduction of cross-color and cross-luminance to unnoticeable levels.
- Ghost cancellation, possibly by means of a reference signal transmitted along with the TV program.

The details of the proposed specifications are scheduled to be released this summer, after which it will be the responsibility of Japan's Ministry of Posts and Telecommunications to implement the new standards.

The Broadcasting Technology Association currently has 38 member companies, 19 of which are manufacturers, including the Japanese subsidiaries of Philips and RCA. The association is maintaining liaison with the U.S.'s Advanced Television Systems Committee, which is working on similar proposals, but with less well-defined deadlines.

● **HDTV.** Another study in Japan, this one by an affiliate of NHK (Japan Broadcasting Company), is developing specifications for a

reasonably priced VCR system for Japan's *High Definition TV* (HDTV) system, which uses an 1,125-line widescreen picture. Existing videotape recorders for the system cost between \$250,000-\$300,000 and use open-reel one-inch videotape.

The proposed new system would use half-inch tape, probably metal coated, in a cassette similar to that used by the VHS format. Nine Japanese electronics manufacturers have agreed to use the new standard that is developed as the result of the study. The HDTV VCR's could be used for projection in motion picture theaters, closed-circuit performances of various kinds, and high-quality electronic publishing. Japan is preparing for the direct satellite broadcasting of high-definition TV to theaters and to specially equipped homes.

● **Electronic still camera.** The first electronic still camera to be introduced for the consumer market has been announced by Casio. It will go on sale in the United States and Japan around the middle of 1987. The camera uses the standard two-inch "video floppy" developed for electronic still photography; the video floppy can hold up to 25 full frames or as many as 50 fields of color pictures.

The camera has an MOS image sensor capable of 280,000-pixel resolution. Shutter speeds range from $\frac{1}{8}$ to $\frac{1}{1000}$ of a second. It differs from other such cameras shown to date in that it includes playback capability; a recorded image can be played back on any television set without the need for a separate player. Other features include erase capability and the ability to shoot five fields continuously in one second.

Furthermore, the price announced for the two-pound camera in Japan is by far the lowest reported for any proposed such camera to date: \$650, although it may be somewhat higher in the U.S. Although electronic still cameras have been developed and tested by many manufacturers, the only other one currently on the market is a professional model by Canon, which sells at \$2,400. Casio says it also will offer a color printer for about \$1,250.

R-E

ASK R-E

WRITE TO:

ASK R-E
Radio-Electronics
500-B Bi-County Blvd.
Farmingdale, NY 11735

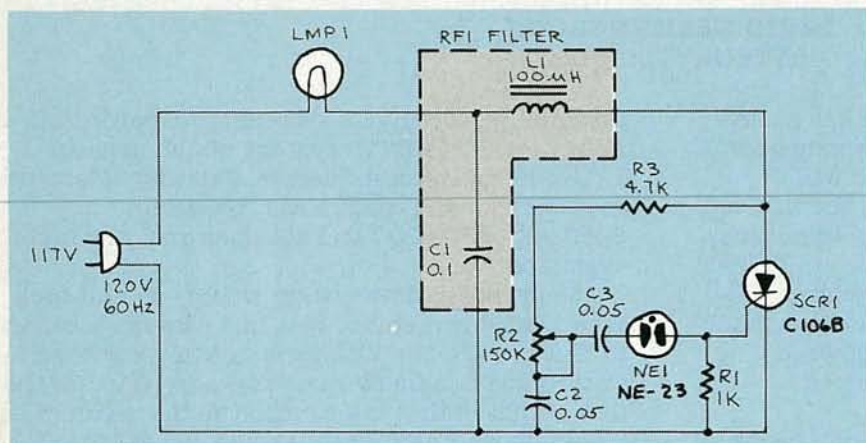

FIG. 1

INTERFERENCE FROM LIGHT DIMMERS

How can I prevent electronic light dimmers from interfering with reception on my AM radios? Whenever I use a dimmer-controlled light, a loud buzz makes reception impossible.—P.B., Gustavus, AK

Literally thousands of the early electronic light dimmers were marketed before the manufacturers realized that there was a problem. Those dimmers used a Triac or an SCR as the control device. What they failed to account for was that Triacs and SCR's produce harmonic-rich squarewaves that cause RFI (Radio-Frequency Interference) unless steps are taken to prevent it. Later dimmers have built-in filters and shielding to prevent the harmonic interference from feeding back into the power line, or use zero-crossing control switching to eliminate the noise. Figure 1 shows the schematic of one of the newer versions; it was developed by General Electric. The RFI filter in that circuit is enclosed in the dashed box.

As for do-it-yourself remedies, you could connect a 0.0047- μ F ca-

pacitor across the dimmer to reduce the interference. But if not done carefully, making such a modification could produce a shock or fire hazard. In the interest of safety, the best approach would be to simply replace the noisy dimmers with models that incorporate an RFI filter.

MORE ON MOTOR-SPEED CONTROL

In a recent column, I replied to queries from C.S., TX and J.C., TN. One reader wanted to reverse a small universal fan motor and the other wanted to vary the speed of a drill-press motor. I was not able to give specific advice to either reader. Well, if you guys are still "listening" both problems were solved over twenty years ago in a *Popular Mechanics* article entitled "Electronic Drill-Press Drive."

In the article, the author describes how he replaced his drill-press motor with a 1-horsepower universal motor salvaged from a Hoover canister-type vacuum cleaner. He shows how to reverse that motor by shifting the pole and field coil assemblies to the opposite side of the brush-holder

centerline. Further, he used an SCR in a conventional circuit to vary the speed of a drill-press from below 1000 rpm to 10,000 rpm. If you want more information, the article appeared on pages 188 through 193 of the February 1964 issue of *Popular Mechanics*. Back issues are often available at larger public or university libraries.

WHAT IS THIS IC?

I have a Fairchild 40-pin IC marked "3805." I'm not sure if it is a UART or a microprocessor. Can you tell me what it is compatible with and where I can get a data sheet?—T.A., Logansport, IN

The type number is unknown to anyone I've been able to contact at Fairchild. One person suggested that the device was probably made for an equipment manufacturer who specified that his own part number be used. Another wondered if you had transposed the last two figures while copying the numbers off of the device. In that case, possibly the device is a 3850 CPU (Central Processing Unit) for the Fairchild F8 microprocessor system. For information on the 3850 and its applications, refer to the F8 User's Guide and/or write to Fairchild, Microcomputer Division, 464 Ellis St., Mountain View, Ca 94042

SOLID-STATE TUBE SUBSTITUTES

In my job I service U.S. Army electronic equipment that uses vacuum tubes. I've heard that there are solid-state replacements for vacuum tubes such as the 12AT7, 12AU7, 6AL5, 6AK5 and 6SN7. Is that true? If so, where can I find them?—R. L., Anaheim, CA

Back in the mid-1960's, several manufacturers attempted to de-

Simpson Electric Co.
Introduces

mercer

The Ultimate in Low-Cost Test Equipment

At last! Here is your opportunity to take your pick from a new test equipment line that has all the features you need and more... and at a price that is unbelievably low.

MODEL 9340

Pocket size, 3½-digit DMM with 20 megohm range and 10 megohm input resistance

\$44⁰⁰

MODEL 9670

Digital capacitance tester covering 0.1 pF to 20,000 µF

\$99⁰⁰

MODEL 9101

Compact VOM with 27 ranges, including a 100 megohm range

\$29⁰⁰

MODEL 9301

3½-digit, hand-held DMM with 0.25% basic accuracy and 2,000-hour battery life

\$69⁰⁰

MODEL 9120

Analog VOM with 12 A DC range and output jack

\$39⁰⁰

MODEL 9401

4½-digit, full function, hand-held DMM with .05% accuracy and data hold

\$129⁰⁰

MODEL 9701

digi-clamp™ compact AC clamp-on volt-ohm-ammeter with data hold

\$69⁰⁰

MODEL 9370

3½-digit autoranging DMM with a memory mode and 0.5% basic DC accuracy

\$59⁰⁰

mercer

ELECTRONICS

Division of Simpson Electric Company

859 Dundee Avenue, Elgin, IL 60120-3090
(312) 697-2265 • Telex 72-2416

Mercer Electronics products reflect the design and quality standards established by Simpson Electric Company, an industry leader for over 50 years and known worldwide for its integrity and product excellence.

In Stock... Available Now! Stop in at your nearest distributor and see this new, complete line of Mercer test instruments. For the name of the MERCER distributor in your area, call (312) 697-2265, or send for our new line catalog.

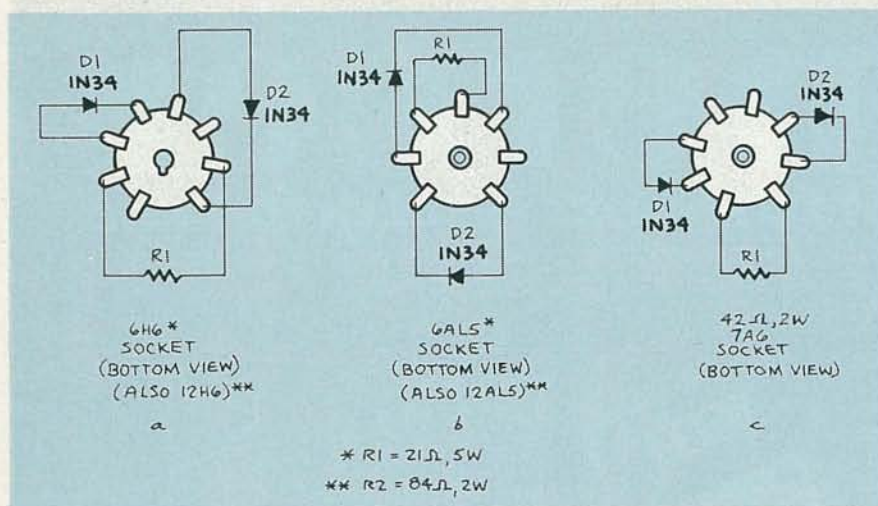

FIG. 2

velop lines of universal semiconductor replacements for vacuum-tube diodes and triodes. Their efforts were short-lived because substituting a semiconductor device for a tube usually meant that the adjacent circuitry had to be extensively modified.

One approach was using two transistors connected in a cascode arrangement as a plug-in replace-

ment for a triode voltage-amplifier tube. Similarly, semiconductor diodes were offered replacements for vacuum-tube diodes. To my knowledge, none of the solid-state replacements for tubes included a resistor as the equivalent of the tube's heater. A resistor would have to be hard-wired into the circuit to take the place of the heater in series heater-string sets.

Of all the plug-in solid-state replacements tried, the most practical and successful were those for power rectifiers. For a short period in the 1960's, five IN-type silicon rectifier assemblies were offered as replacements for some popular vacuum-tube rectifiers. Those were the IN1237 for the 0Z4, the IN1238 for the 5U4-GB, the IN1239 for the 5R4, the IN1262 for the 6AU4-GTA, and the IN2637 for the 866-A.

If you are permitted to make permanent modifications in the equipment you are servicing, then you might consider hard-wiring 1N34 semiconductor diodes as replacements for small-signal detector tubes.

Figure 2 shows how to do that for 5 popular tubes. The scheme for replacing a 6H6 or 12H6 is shown in Fig. 2-a, the scheme for replacing a 6AL5 or 12AL5 is shown in Fig. 2-b, and the scheme for replacing a 7A6 is shown in Fig. 2-c. The resistors shown need only be installed in circuits where the tube heaters are wired in series. R-E

Fluke breaks the old mold.



Dollar for dollar the Fluke 37 breaks into the market with more features for the money than any other bench DMM. It's bold new design includes built-in handle and storage compartment, and it has all the high performance features of the world's best, most reliable 3½-digit DMMs.

Autoranging, to eliminate guesswork. Audible Continuity, so you don't have to look at the display. An exclusive analog and digital display. Superior EMI shielding. Plus a two-year warranty.

And, how many other bench/portable meters give you these features? Min-Max recording, for monitoring signals. 38 components dedicated exclusively to input protection. Relative mode, to help you calculate changes in readings. And Fluke's patented Touch Hold, to give you an extra set of hands when you're taking critical measurements.

None. Only the Fluke 37.

For more information call 1-800-426-0361.

FLUKE[®]

© 1986, Fluke

CIRCLE 121 ON FREE INFORMATION CARD

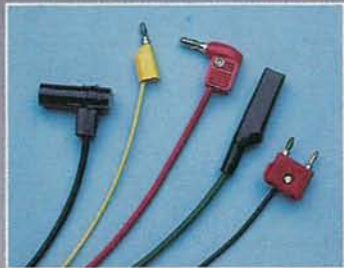

Components and Adaptors

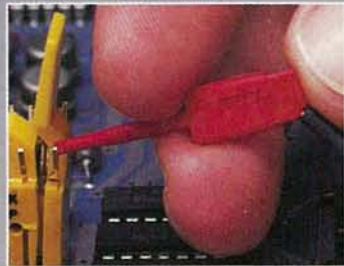

P-25 Plug-On Pico Hook

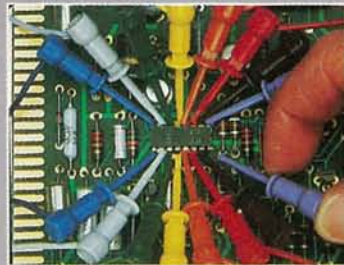

Micro-Hook



Coax Cable/Patch Cord Assemblies

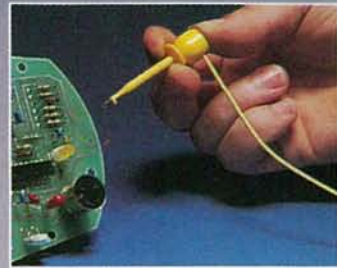
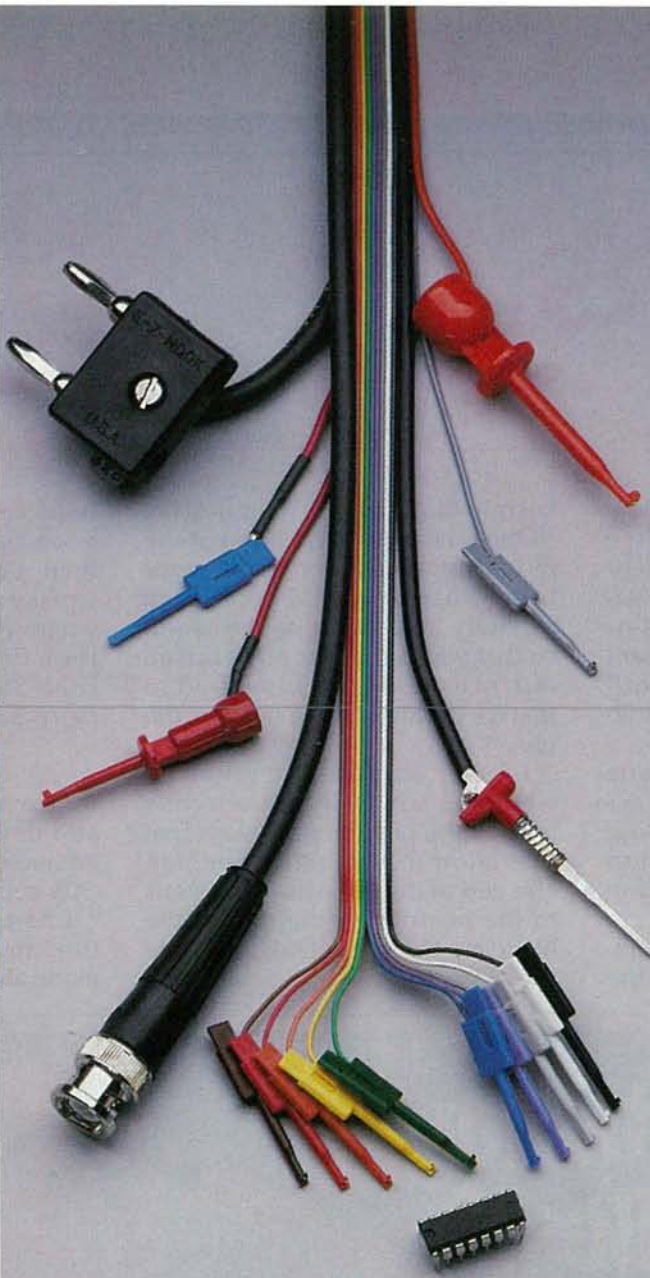

Mini-Hook Test Leads



Pico-Hook, Narrow/IC

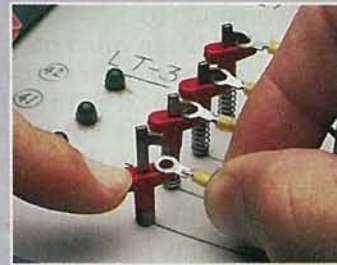

Nail-Clip. Harnessing



Tap-A-Dip 14 & 16 Pin Test Connectors

SIGNAL ACCURACY.

12,000 Reasons Why Industry Relies on E-Z HOOK.

Choose from over 12,000 standard test accessory products for an immediate solution to your application. They're engineered to assure a reliable contact or connection for any testing, hook-up or assembly task. And E-Z HOOK can ship what you need in 48 hours or less.

For a quick, economical answer to your testing needs, ask for our 112-page catalog of Electronic Test Accessories. It's free. And reliable.

E-Z-HOOK®

E-Z HOOK, A Division of Tektest, Inc., 225 North Second Ave., Arcadia, CA 91006
P.O. Box 450. (818) 446-6175. TWX 910-582-1614.

CIRCLE 203 ON FREE INFORMATION CARD

WE MAKE SPECIALS
SEND US YOUR REQUIREMENTS!

LETTERS

RAZOR-BLADE DETECTOR

I enjoyed, and have just finished reading, the "Letters" department in the December 1986 issue of *Radio-Electronics*. Matthew Kleinmann of Binghamton, NY, mentioned the "razor-blade detector," which was used in the first radio that I constructed.

The razor blade *must* be a blue blade (*quench-type, not lacquered—Editor*). It is the bluing process which, in conjunction with the lead, allows the detection of radio waves.

Mount the blade flat. Take a medium-size safety pin and bend the

latch so that it may be mounted flat to the board, with the point of the pin facing the center of the razor blade. Sharpen a No. 2 pencil, and carefully cut away enough wood so that you can break off about an inch of lead. Then affix the lead so that it extends past the point of the pin.

I fastened mine together by wrapping some fine wire tightly around the pin and the lead. (That operation may require a helper. The end of the pin where it fastens to the board, and the end of the blade are the connecting points of the detector.) The pin must be



bent to where the lead makes good contact with the blade. It is then moved around like the "cat whisker" until a spot is found where it will detect radio waves. Have fun.

DON SMITH
Perrysburg, OH

CASSETTE FIDELITY

I am an old-time audio research and development engineer, and an audio buff dating back to the '30's and '40's, now retired.

I have been highly skeptical of the flowery advertising claims made about the fidelity that can be

Why Settle for Second Best?

Introducing lower pricing on 3M's A P Products™ line of quality breadboards.

A P Products invented solderless breadboarding. We understand the finest details of the design. We build our A•C•E Board™ 200 Series with absolute reliability in mind and we stand behind every breadboard we make. Every A•C•E Board we make is consistently reliable time after time, design after design, contact to contact. No import can make this claim.

Now we're giving you the opportunity to purchase the finest solderless breadboards made for approximately the same as you would have to pay for second best.

Compare, and you'll agree. After all, you wouldn't submit a design that's only second best. If you haven't got A P Products brand A•C•E Boards, now's your chance to

experience our quality and reliability at a really affordable price.

Call your A P Products Prototype & Test Devices dealer today. For immediate response telephone 800-321-9668, or (216) 354-2101 in Ohio.

We Solve Problems

Associated Electronics/3M

A P Products Prototype & Test Devices
9325 Progress Parkway
P.O. Box 540
Mentor, Ohio 44060

had nowadays on prerecorded audio cassettes. As a consequence, I resisted getting any such equipment until recently.

Unfortunately, the cassettes I have obtained left a great deal to be desired. I found that the high-end response depended on which deck it was played back on. Further, that response seemed to vary from one playing to another, and often it changed in the middle of a program. On decks in which the high frequency response seemed deficient, I could lift or twist the cartridge slightly and have the highs fade in and out. That discovery put me on a two-week personal fact-finding project, in the interest of my own education. My discoveries have convinced me, positively, that my skepticism was well founded.

Applying my old R and D experience, I recorded a full-track-width cassette with a 5-kHz audio tone for a head-alignment test. (I first tried to buy such a cassette, but was unable to find one for sale anywhere. I suspect that the deck manufacturers do not want such cassettes available, because such a test is too severe for the playback equipment available on the consumer market.)

On twenty decks I plugged my tape into, barely four of them had the heads aligned properly. Most of the rest were well down at 5 kHz, one of them to almost zero. I could put a very slight pressure, one way or the other, on any of them and bring my test signal up to full output.

Another problem: The guides on most decks are welded directly to the heads. When the head is tilted when aligning, the tape is also forced to track higher or lower on the head. That causes the output level to vary at the same time that the high-end response is maximized. Furthermore, the tape-tracking within the cartridges is so loose and sloppy that the tape tends to walk up and down on the head, depending on a slight tipping up or down of the cartridge. Also, the springs behind the pressure pads are often not perfectly flat, or the pad itself is tipped or twisted slightly, causing an unbalanced pressure against the face of the head. That causes the tape to

With the **HEATHKIT** **ONLINE CATALOG**

**you can order
over 400 kit
and assembled
computer and
electronic
products – with
the press of
a button.**



As a CompuServe® user, you want the full advantages this system can offer. And what better way to make

CompuServe work for you than to let it bring you the Heathkit Online Catalog. Menu-Driven, our catalog lets you browse over 400 kit and assembled products from 17 major product categories. You can even order a free hardcopy version of our catalog.

Among the many high-quality products you'll find are:

- IBM AT-compatible advanced personal computers
- IBM PC-compatible compact personal computers • IBM PC-compatible expandable personal computers
- Portable and desktop PCs • Laptop computers with built-in software • Microcomputer-Aided Drafting and Design programs • the HERO® 2000 Robot • Test Instruments
- Home Security Systems • TV's and video recorders
- Amateur Radio gear and more

All of our products are meticulously engineered and backed by excellent service and support. And as an added plus, our kits offer you the satisfaction of building a high-tech quality product yourself.

You'll also find complete hands-on training courses in areas ranging from basic electricity and programming languages to microprocessors and robotics. All courses are designed by educators knowledgeable in their respective fields.

And for added convenience, you can place your order through your computer using your Visa, MasterCard or Heath Revolving Charge – it's that easy.

**To benefit from this
unique opportunity, type**

GO HTH

**at any "!" or "OK" prompt on
the system**

The Heathkit Online Catalog –
your direct line to quality high tech products

Heathkit®

**Heath
Company**

CompuServe is a registered trademark of CompuServe Inc. An H&R Block Company.

CL-785R1

INTRODUCING THE REPLACEMENT FOR OUR REPLACEMENT GUIDE.

SK
Series

Reliable
Replacement
Semiconductors

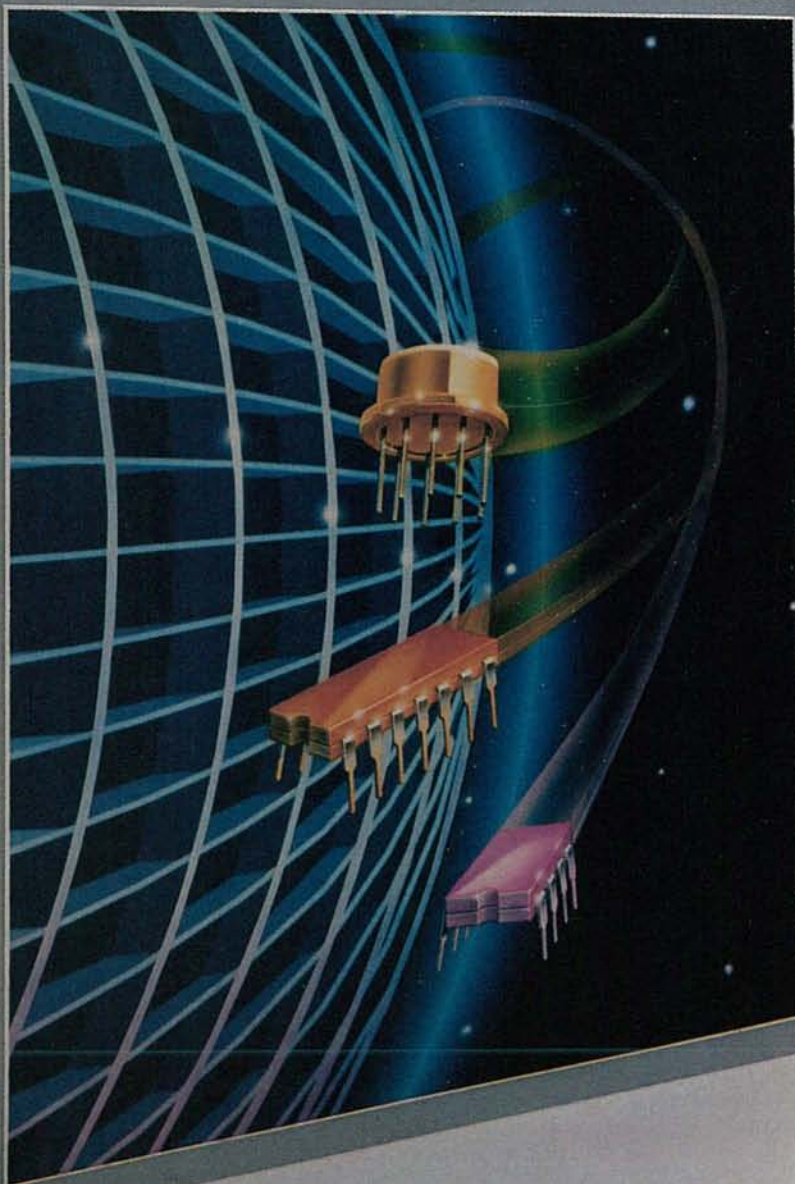

RCA SK Series Solid State Replacement Guide

RCA's new SK Guide gives you fast, accurate solid state replacements.

In the world of semiconductor replacements, no one outperforms RCA's engineering excellence. We're in the business of manufacturing semiconductors, so you can depend on our reliability.

Our new, expanded RCA SK Guide to Reliable Replacement Semiconductors lists more than 2,900 SK and KH types that replace over 214,000 industry types. And, for the first time, QMOS logic devices and an extensive line of RF types are included.

The new RCA SK Replacement Guide (SKG202E). It's the only solid state replacement source you need. For a copy, see your RCA SK Distributor. Or mail a check or money order for \$3.25 to RCA Distributor and Special Products Division, Box 597, Woodbury, New Jersey 08096-2088.

RCA SK Replacement
Solid State

wander up or down, or twist ever so slightly, but more than enough to wipe out the high-end response.

In addition to the above, the pressure rollers were frequently not square with the capstan. That also tended to make the tape walk up or down with the capstan, forcing the tape to twist out of alignment.

I suspect that the only way that you can realize frequency response at 5 kHz or higher is when you record and play back on the same machine. I did that, however, and I still had a problem some of the time, due to the internal cartridge slop, which caused the tape to screw up or down, depending on room temperature, whether the tape had just been fast-forward or reverse wound, and other impossible-to-control variables.

I challenge anyone to record 5 kHz on his or her best machine, using the highest quality cartridge, and then see what it looks like when played back and viewed on one's own scope. The dropouts, semi-dropouts, and volume fluctuations are quite unbelievable. After that, try your recording on a few other machines and see what happens.

My conclusion? Fortunately, the average listener does not have a "golden ear." And the dropout problem is hard to detect by ear on music, rather than on a sustained pitch. The average listener, on hearing 3- or 4-kHz tones interprets them as "super" high-frequency response. If all recorded music on cassettes were to be given a boost at 3 or 4 kHz, and then chopped off above 5 kHz, I suspect that everyone would be pleased, and fully convinced of his or her listening quality. I sort of suspect that the cassettes being sold now are so recorded, and that very few listeners out in the real world know the difference.

JACOB ANTHES

Glidden, WI

You have either purchased some really low-priced junk, or have managed to acquire manufacturing rejects. All high-fidelity type machines and tapes that we have tested here over a period of many years can easily record to 15 kHz (not 5 kHz) and will hold its

alignment within tolerable limits from 12 kHz and higher. In fact, the cassette system is so good, including its resistance to dropouts, that even rock-bottom priced machines and tapes are popular as low-cost data storage systems for personal computers.—Editor

ATTENTION: MR. MICHAEL HARDY

First, let me compliment **Radio-Electronics** for an excellent magazine. I have been an avid cover-to-

cover reader for several years. I have never found another publication that covers all conceivable interests and subject matters within its range. Please keep up the good work; don't change a thing.

Second, an open reply to Mr. Michael Hardy, of Massillon, OH, and other interested job-candidates in the electronics field.

I suggest that you pick up a copy of the *Sunday Atlanta Journal-Constitution* at your local library.
continued on page 20

SALE PRICES ON FLUKE DMM'S! JOSEPH ELECTRONICS HAS THE LOWEST PRICES PLUS FREE SHIPPING*



3 YEAR WARRANTY

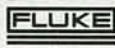

3 1/2 DIGIT 3200 COUNT ANALOG/DIGITAL MULTIMETERS

		Reg.	Sale
73	Value Leader—World's Most Popular DMM—Autoranging	\$ 79	\$ 69
75	Autoranging + Range Hold Audible Continuity Function	\$109	\$ 95
77	Touch-Hold Feature + Features of Model 75	\$145	\$125
37	Bench/Portable, 0.1 VDC Accuracy 10 A. Range, 2 yr. Warranty	\$229	\$199



2 YEAR WARRANTY

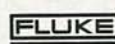

3 1/2 DIGIT HIGH-ACCURACY HAND HELD

		Reg.	Sale
8021B	0.25% DC Accuracy, Audible Continuity Function	\$169	\$149
8020B	0.1% DC Accuracy, Audible Continuity & Conductance Function	\$199	\$175
8024B	0.1% DC Accuracy, 11 Functions Peak Hold, Temperature	\$249	\$219
8026B	0.1% DC Accuracy True RMS AC Volts & Current	\$219	\$195



1 YEAR WARRANTY



4 1/2 DIGIT TRUE RMS HAND HELD

		Reg.	Sale
8060A	Measures True RMS AC Volts & AMPS, dB + Frequency From 12 Hz to 200 kHz, Resistance to 300 M Ω	\$359	\$315
8062A	Same as 8060A, but Less Frequency & dB	\$295	\$265



*True RMS ac to 50kHz
*Conductance Function
Checks High Resistance
1 YEAR WARRANTY

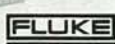

TRUE RMS BENCH DMMS

		Reg.	Sale
8010A	3 1/2 Digit 10 AMP Range	\$289	\$255
8010A-01	With Rechargeable Battery	\$329	\$295
8012A	3 1/2 Digit Two Low Ω Ranges	\$359	\$319
8012A-01	With Rechargeable Battery	\$399	\$355
8050A	4 1/2 Digit Relative Ref. Function 0.03% DC Accuracy	\$399	\$355
8050A-01	With Rechargeable Battery	\$439	\$389

HURRY! QUANTITIES LIMITED AT ABOVE SALE PRICES!

ORDER TOLL-FREE: 1-800-323-5925

IN ILLINOIS: 312-297-4200

CHECK • MONEY ORDER • VISA • MASTERCARD • DISCOVER
Open Account to Rated Companies. Illinois Residents Add 7% Tax.
*FREE SHIPPING ON FLUKE TO UPS SHIPPABLE DESTINATIONS.

SINCE 1947
Joseph Electronics
8830 N. Milwaukee
Niles, IL 60648

APRIL 1987

Train with NRI for a servicing

NEW!

Train with the newest Sanyo 880 Series Computer—it's fully IBM-compatible and runs almost twice as fast as the IBM PC!

Get started now by building this fully IBM PC compatible computer

Now you get it all... training for America's fastest growing career opportunity... training to service all computers... training on the newest total computer system, the Sanyo 880. Only NRI can give you the well-rounded training you need, because only NRI gives you a complete computer system... computer, monitor, disk drive, software, even test instruments like a digital multimeter and logic probe to work with and keep. It all adds up to training that builds the knowledge, competence, and ability you need to succeed as a computer service specialist.

Get inside the newest, fully IBM PC compatible Sanyo Microcomputer

As an NRI student, you'll get total hands-on training

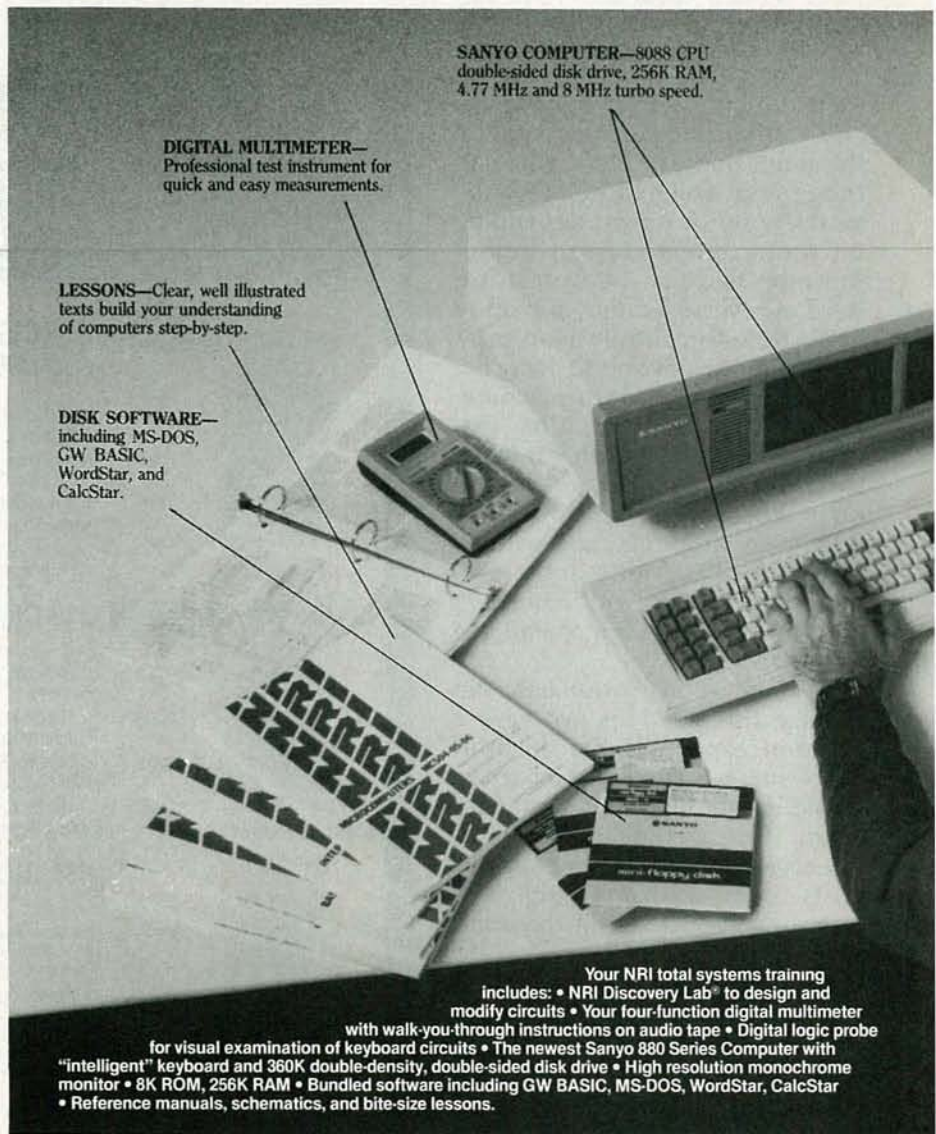

as you actually build your own latest model Sanyo 880 Series computer from the keyboard up. It's fully IBM PC-compatible and, best of all, it runs programs almost twice as fast as an IBM PC. As you assemble the Sanyo 880, you'll perform

demonstrations and experiments that will give you a total mastery of computer operation and servicing techniques. You'll do programming in BASIC language—even run and interpret essential diagnostic software.

high paying career computers



at your own convenience, backed at all times by your own NRI instructor and the entire NRI staff of educators and student service support people. They're always ready to give you guidance, follow your progress, and help you over the rough spots to keep you moving toward your goal.

100 page free catalog tells more . . . send today

Send the postage-paid reply card today for NRI's 100 page catalog that gives all the facts about computer training, plus career training in robotics, data communications, TV/audio/video servicing, and many other fields. If the card is missing, write to NRI at the address below.



Understanding you get only through experience

You need no previous knowledge to succeed with NRI. You start with the basics, rapidly building on the fundamentals of electronics with bite-size lessons. You perform hands-on experiments

with your NRI Discovery Lab and then move on to master advanced concepts like digital logic, microprocessors, and computer memories.

Learn at home in your spare time

You train in your own home

NRI SCHOOLS
McGraw-Hill Continuing Education Center
3939 Wisconsin Avenue
Washington, DC 20016
We'll give you tomorrow



The North-Atlanta area is covered with high-tech industry. In fact, the entire North-Georgia area is booming. We have the factories; all we need is more technicians. I am sure that most manufacturers in this area will tell you that they can't find enough techs. If you don't want to go to Georgia, try Florida. With firms like Harris Semiconductor (Gates Radio) there I am sure that you'll be satisfied.

The point, Mr. Hardy, is that jobs are available. They might not be down the street from your house, but if you are serious about your profession, there is work to be had. Right in your home state, the Cleveland Institute of Electronics publishes a newspaper called the *Electron*. Many, many jobs are listed there, and not just open to CIE graduates.

I wish you the best of luck. It took me three months to find the right position, but I have never gone hungry since.

MICHAEL MALLORY
Carrollton, GA

PATENT COSTS

I enjoyed reading Dave Sweeney's article, "How to Apply for a Patent," in the January 1987 issue of *Radio-Electronics*. The information is very good, with the exception of the cost of obtaining copies of already issued patents. Like the 5-cent cigar, 28-cents-per-gallon gasoline, and 10-cent Coca-Cola, the day of the 50-cent patent copy is long gone. The current price is \$1.50 per copy from the Commissioner of Patents and Trademarks, Washington, DC 20231. Provide the patent number with your fee and, in 6-8 weeks time you'll get your copies. If you need faster service, many large cities have patent depositories where you can even make copies yourself.

Being an inventor with three recent patents, I have used the Boston Public Library for obtaining copies of relevant patents. If any reader writes to me and encloses a self-addressed, stamped envelope (SASE), I'll provide the location of the nearest patent depository in his or her area. Also, if

requested, I'll include information about using expired patents that saved me time and money in conducting my own patent search.

I am confident that the information I provide regarding the cost and process for obtaining patent copies will expedite ordering.

JOSEPH R. BIRKNER, President
Star Research Co.
P.O. Box 2121,
West Peabody, MA 01960.

ON SAMS PHOTOFACTS

I should like to comment on your answer to D.D., in the "Ask R-E" section of the December 1986 *Radio-Electronics*.

You were unquestionably correct when you told the reader that the Philco service data that he needed could be found in *Sams Photofact #794-8*, and then you gave him the telephone number of the company.

But you failed to mention that most of the old "Photofacts" are out of print, and that those that are available cost \$9.95 per set.

And you failed to tell him that

SCOPE PRICE BREAKTHROUGH!

New B&K-PRECISION Dual-Trace 20MHz Scope... \$440!!

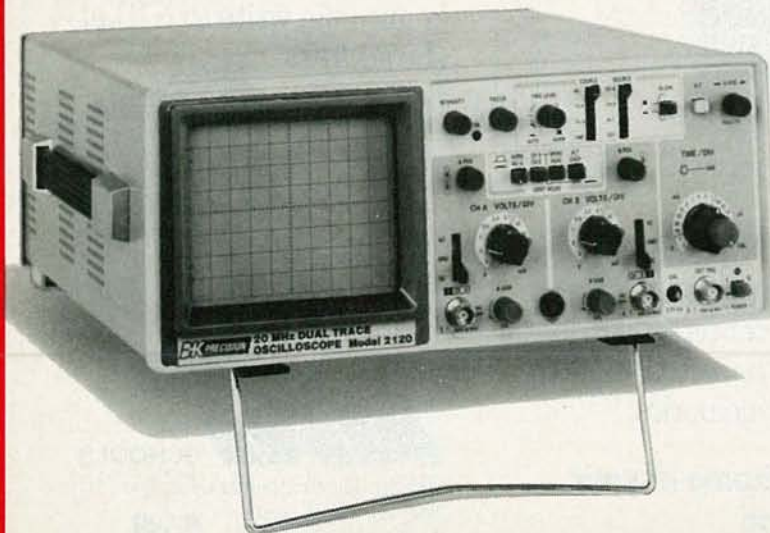

Now you can own a professional quality 20MHz, dual-trace scope for under \$450. Best of all, it's a full featured instrument, from B&K-PRECISION—famous for quality, dependable products.

Compare these outstanding features, then compare price!

- Dual or single trace operation • 1mV/div sensitivity
- 20MHz response at a true -3dB • AUTO/NORM triggered sweep operation with AC, TVH, TVV and Line coupling
- Calibrated 18 step timebase with x10 magnifier • X-Y operation
- Bright, sharp rectangular CRT with P31 phosphor
- Front-panel trace rotation control • Tilt stand and soft handle
- Selectable +/- slope • Built-in calibration source
- Compact low-profile design.

For immediate delivery, contact your local B&K-PRECISION distributor or call B&K-PRECISION today.

BK PRECISION DYNASCAN CORPORATION

6460 West Cortland Street • Chicago, Illinois 60635 • 312/889-9087
International Sales, 6460W Cortland St., Chicago, Illinois 60635 • Canadian Sales, Atlas Electronics, Ontario
South and Central American Sales, Empire Exporters, Plainview, NY 11803

CIRCLE 77 ON FREE INFORMATION CARD

Regency "Scanner Answer" Giveaway



Here's your chance to win a complete monitoring package from Regency Electronics and Lunar Antennas. 18 scanners in all will be awarded, including a grand prize of the set-up you see above: the Regency HX1500 handheld, the Z60 base station scanner, the R806 mobile unit, and a Lunar GDX-4 Broadband monitoring/reference antenna.

channels, keyboard programming, priority control, digital display and permanent memory.

Lunar Antenna

Also included in the grand prize is a broadband monitoring/reference antenna from Lunar Electronics. The GDX-4 covers 25 to 1300 MHz, and includes a 6 foot tower.



ELECTRONICS INC.
7707 Records Street
Indianapolis, IN 46226

55 Channels to go!

When you're on the go, and you need to stay tuned into the action, take along the Regency HX1500. It's got 55 channels, 4 independent scan banks, a top mounted auxiliary scan control, liquid crystal display, rugged die-cast aluminum chassis, covers ten public service bands including aircraft, and, it's keyboard programmable.

Compact Mobile

With today's smaller cars and limited installation space in mind, Regency has developed a new compact mobile scanner, the R806. It's the world's first microprocessor controlled crystal scanner. In addition, the R806 features 8 channels, programmable priority, dual scan speed, and bright LED channel indicators.

Base Station Plus!

Besides covering all the standard public service bands, the Regency Z60 scanner receives FM broadcast, aircraft transmissions, and has a built-in digital quartz clock with an alarm. Other Z60 features include 60

Grand Prize (1 awarded)

- 1—Regency Z60 Base station scanner
- 1—Regency HX1500 Handheld scanner
- 1—Regency R806 Mobile scanner
- 1—Lunar GDX-4 Antenna

First Prize (5 awarded)

- 1—Regency Z60 Base station scanner
- 1—Regency R806 Mobile scanner

Second Prize (5 awarded)

- 1—Regency HX1500 scanner

Contest rules: Just answer the questions on the coupon, (all answers are in the ad copy) fill in your name and address and send the coupon to Regency Electronics, Inc., 7707 Records Street, Indianapolis, IN 46226. Winners will be selected from all correct entries. One entry per person. No purchase necessary. Void where prohibited by law. Contest ends June 30, 1987.

1. The Regency Z60 is
 - a digital alarm clock an FM radio
 - a scanner all of the above
2. The Regency R806 is the world's first _____ controlled crystal scanner.
3. The Regency HX1500 features
 - 55 channels Bank scanning
 - Liquid crystal display all of the above
4. The Lunar GDX-4 antenna covers _____ to _____ MHz.

Name: _____

Address: _____

City: _____ State: _____ Zipcode: _____

I currently own _____ scanners.

Brands owned: _____



Send in a photo (like this one of Mike Nikolich and his Regency monitoring station) and receive a free gift from Regency. Be sure to include your name, address and phone number.

Radio-Electronics has a constant advertiser (me) who sells previously-owned individual folders for \$3.00 or \$5.00 each, and has a stock that is more than 99% complete up to set #1600, plus many later numbers.

They are genuine Sams folders (not copies). Many of them are unused, and all are complete and clean. There is also an equally complete stock of Sams specialized books on auto radios, tape recorders, CB sets, modular hi-fi, etc.

ALLEN J. LOEB
414 Chestnut Lane,
East Meadow, NY 11554.

FILAMENT CHECKER

The filament checker in the "Antique Radio" section of **Radio-Electronics**, December 1986, should use a 1.5-volt battery and a #49 lamp. Using the #14 bulb and a 3-volt source could blow out old battery tubes with 1.4-volt, 50-mA filaments. Ignoring the inrush resistance of a #14 lamp, 2.3 volts would be applied to a 1.4-volt fila-

ment. A fresh, new tube might stand that, but not a 40-year-old relic. (Of course, your local distributor probably has a shelf full of 1A7's worth \$1.25 each.)

STEVE DOW
Powell River, BC, Canada

POWER-SUPPLY OVERLOAD

Your "Service Clinic" and "Service Questions" are my favorite parts of **Radio-Electronics**, and I am very disappointed when either or both do not appear, as happens occasionally.

This letter is occasioned by the letter from A.H., Eureka, CA, entitled "Power-Supply Overload." Your reply is fine, but I want to call to your attention another possible explanation, because I have encountered similar problems at least a couple of times in the past.

The most recent was a TV set in which the TV filament was supplied from the horizontal-output transformer, but rectified by a single diode. There was no picture, and I found that there was no voltage at the socket's filament termi-

nals. However, I checked with the socket removed from the tube and found that the full voltage was present.

After some searching and testing, I discovered that one of the diode (rectifier) connections had resistance that did not affect the reading without the tube, but was high enough to drop the voltage with the load of the tube filament. Present-day meters use so little current that that can easily happen with a poor solder joint.

CHARLES W. MARTEL
Belmont, MA.

MEMORIES

I read with interest the query concerning razor-blade radio detectors in the December 1986 section of "Letters" in **Radio-Electronics**. It brought back memories of the sets built when I was just a teenager, using scraps and junk scrounged from the junkbox of a local radio repairman.

RON E. CASH
Pierre, SD

continued on page 29

HIGH TEK - LOW COST



HITACHI V-680 OSCILLOSCOPE
60MHz, CRT readout, 3 channels, 6 traces, Delayed sweep, cursor measured value readout and scale factor, Display function, Frequency readout, Ref/A, Ch 1 range, Ch 2 range-and much more!
USER NET \$1490.00
OUR PRICE: **\$1369.**

HITACHI V-212 OSCILLOSCOPE
20MHz, Extremely portable, 1MV/Div. sensitivity, ±3% Accuracy, Dual channels, TV sync, XY mode
USER NET \$615.00
OUR PRICE: **\$428.**



HITACHI V-222 OSCILLOSCOPE
20MHz, 1MV/Div. sensitivity, D.C. offset for DMM output, CH1 output, X1-X10mag., TV sync, XY mode
USER NET \$715.00
OUR PRICE: **\$509.**

HITACHI V-209 OSCILLOSCOPE
20MHz, Battery operated, Super mini-portable 1MV/Div. sensitivity, auto focus, 3 power sources (AC, DC and External), self-charging, TV sync, XY mode, WITH FRONT COVER!
USER NET \$1013.00
OUR PRICE: **\$815.**



WM. B. ALLEN SUPPLY COMPANY, INC.

Allen Square • The 300 Block • North Rampart Street
New Orleans • Louisiana 70112-3106

WM. B. ALLEN CARRIES 18 LINES OF TEST & MEASUREMENT EQUIPMENT-CALL FOR PRICING

Call TOLL-FREE 800 535-9593

Louisiana 800-462-9520 Local (504) 525-8222

ALL MAJOR
CREDIT CARDS
HONORED

ALL MAJOR
CREDIT CARDS
HONORED

Where's Your **ELECTRONICS** Career Headed?

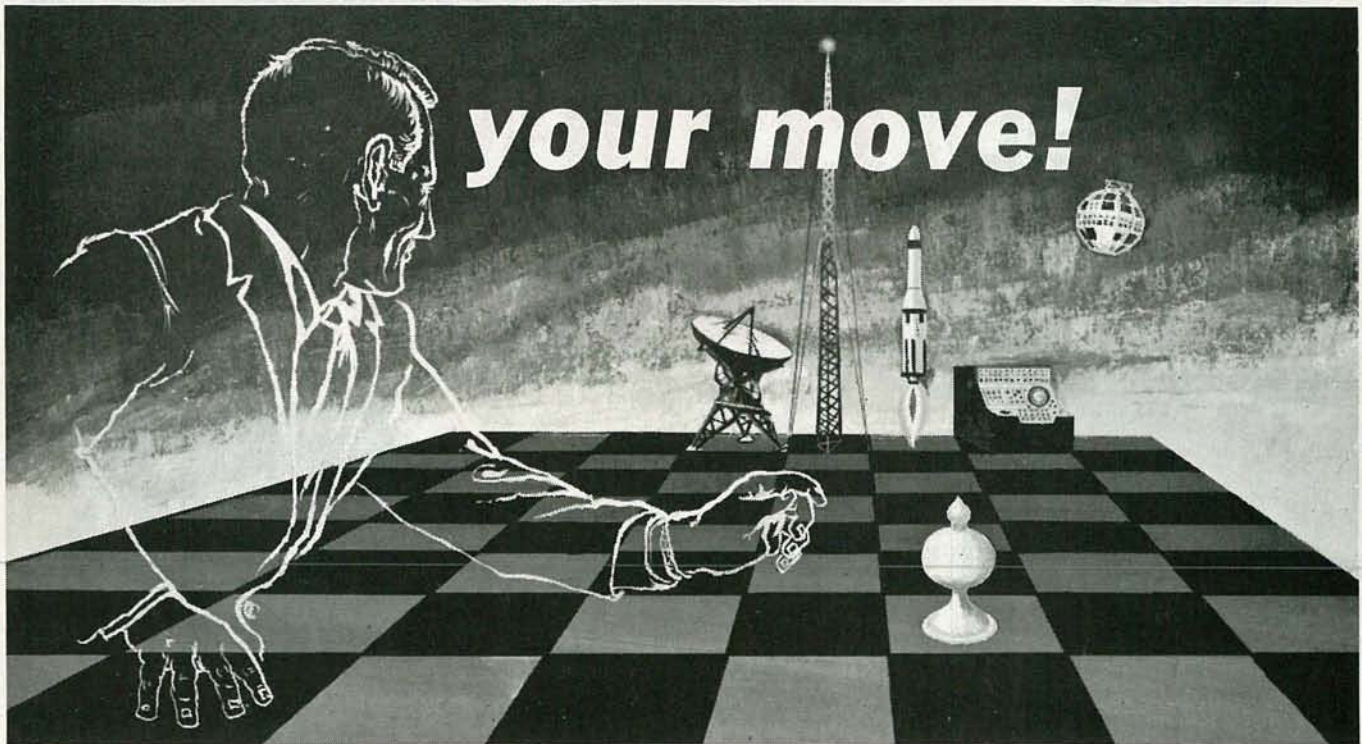

The Move You Make Today Can Shape Your Future

Yes it's your move. Whether on a chess board or in your career, you should plan each move carefully. In **electronics**, you can *move ahead* faster and further with a

B. S. DEGREE

Put professional knowledge and a COLLEGE DEGREE in your electronics career. Earn your degree through independent study at home, with Grantham College of Engineering. No commuting to class. Study at your own pace, while continuing your present job.

The accredited Grantham non-traditional degree program is intended for mature, fully employed workers who want to upgrade their careers . . . and who can successfully study electronics and supporting subjects through

INDEPENDENT STUDY, AT HOME

Free Details Available from:

Grantham College of Engineering
10570 Humbolt Street
Los Alamitos, California 90720

Independent Home Study Can Prepare You

Study materials, carefully written by the Grantham staff for independent study at home, are supplied by the College, and your technical questions related to those materials and the lesson tests are promptly answered by the Grantham teaching staff.

Recognition and Quality Assurance

Grantham College of Engineering is accredited by the Accrediting Commission of the National Home Study Council.

All lessons and other study materials, as well as communications between the college and students, are in the English language. However, we have students in many foreign countries; about 80% of our students live in the United States of America.

Grantham College of Engineering R-4-87
10570 Humbolt Street, Los Alamitos, CA 90720

Please mail me your free catalog which explains your B.S. Degree independent-study program.

Name _____ Age _____

Address _____

City _____ State _____ Zip _____

COAX ADAPTER CABLE KIT

50 OHM
RG-58A/U

\$125⁰⁰

20 cables &
2 wall racks

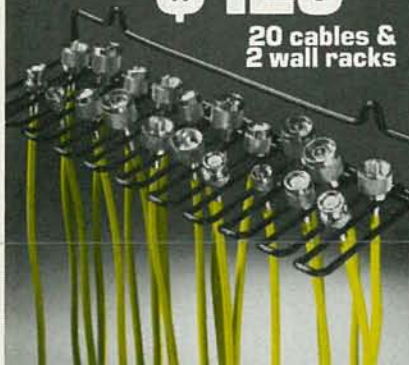

WORTH OVER \$250⁰⁰

- 20 combinations of 8 different connectors to interface BNC TNC N UHF MINI-UHF E-Z Hook
- HIGH VISIBILITY "MINE SAFETY" YELLOW CABLES Soft, pliable, easy to handle, durable
- Many hard to find adapters including MINI-UHF
- Brass, nickel plated connectors
- Silver plated contacts
- CONVENIENT—Easy to spot, close at hand, use one cable instead of adapter plus cable
- Add individual cables of the same or different combinations
- Includes 2 wall racks
- Designed to applicable MIL-SPECS.

SATISFACTION GUARANTEED

or complete refund if returned
within 10 days after receipt.

- Please RUSH _____ Model TPI-5000 COAX ADAPTER CABLE KIT(s) at \$125.00 each. Enclosed is my check or money order for

\$ _____
NOTE: Check or money order must accompany each order except where credit approval previously received. Postage and handling included in price. Add 6% sales tax for California delivery.

800-368-5719

800-643-8382
in Calif.

TEST PROBES, INC. TPI

P.O. Box 2113
La Jolla, California 92038

EQUIPMENT REPORTS

Sencore LC75 "Z Meter II"

Measure inductance and
capacitance at the touch of
a button!

CIRCLE 9 ON FREE INFORMATION CARD



BECAUSE THE MODERN IC-BASED CIRCUIT usually has tighter parameters than the older vacuum-tube and transistor designs, the inductors and capacitors used in the circuit must likewise have tighter parameters, or at the very least, be tested within a narrower range of tolerances. Much, if not all of the older service-grade LCR test equipment has neither the precision nor the testing capabilities needed to ensure proper performance from the capacitors and inductors used in modern circuits.

Critical parameter tests of capacitors and inductors require new techniques of measurement, and that is precisely what's to be found in Sencore's "Z meter II."

The Z Meter II uses an autoranging $3\frac{1}{2} \times 0.5$ -inch LED display to indicate: capacitor and inductor values; capacitor leakage, inter-element capacitor leakage, capacitor effective series resistance, capacitor "memory," and air-core coil shorted turns and opens.

No bridges

Unlike conventional C and L meters that employ some kind of bridge configuration to determine reactance (which is then interpolated to capacitance and inductance values), the Z-meter mea-

sures both directly. Capacitance is determined by measuring how long it takes to charge an unknown capacitor to +5 volts through a precision resistor. (Remember: $t=RC$.) Inductance is determined by measuring the *emf* caused by a constantly-varying current in the coil being tested.

The capacitance test range is 1 pF to 200,000 μ F in 10 automatically-selected ranges. Accuracy is $\pm 1\%$ of reading + resolution error ± 1 pF to 1000 μ F, with the reading error increasing to $\pm 5\%$ above 1000 μ F.

The inductance test range is 10 μ H to 2 H in 6 automatic ranges. Accuracy is $\pm 2\%$ of reading + resolution error.

In addition to capacitance value, a stepped variable output voltage range of 3- to 600-VDC permits capacitors to be tested for leakage at their operating voltage (not necessarily their rated voltage); charts are provided showing the leakage limits for various capacitor types and test voltages. The stepped variable output voltage can also be used to "reform" electrolytic capacitors.

Unusual tests

Two other unusual Z-meter capacitor tests are those for

dielectric absorption and ESR (Equivalent Series Resistance). Dielectric absorption is the inability of a capacitor to completely discharge. It is often referred to as "memory," or "battery action," and all capacitors have some amount of dielectric absorption. Until the age of critical solid-state circuits, high values of dielectric absorption passed unnoticed. Unfortunately, modern circuits can be disabled by unusually high dielectric absorption, which usually goes undetected by conventional service-grade capacitor tests. (It's the unseen force that can "blow" computer components if you fool with the circuit even after the powerline has been disconnected.) The Z-meter, on the other hand, will uncover excessive capacitor "memory."

All electrolytic capacitors have ESR—equivalent series resistance—which is not usually a problem in non-critical circuits. When it is a problem, it usually can't be determined by conventional test equipment. The Z-

Sencore LC75 "Z Meter"											
OVERALL PRICE											
EASE OF USE											
INSTRUCTION MANUAL											
PRICE/VALUE											
		1	2	3	4	5	6	7	8	9	10
		Poor		Fair		Good		Excellent			

meter has a one-button test for ESR.

Two inductor tests

The Z-meter actually has two kinds of inductor tests. The conventional kind determines the value of an unknown inductor. The second test is a "ringing current" test used to determine the condition of non-iron-core coils, such as TV yokes and flybacks. Basically, the ringing test measures the coil's "Q."

It works this way. The Z-meter applies a single pulse to a coil and then digitally counts the number

of ringing cycles produced by the pulse until the signal is damped to the reference level. For most non-iron-core coils, 10 ringing cycles is considered "normal," or "good." A shorted coil will lower the Q and produce less than 10 ringing cycles, while an open coil will produce no ringing. So, less than 10 rings, or no rings, means a bad yoke or flyback.

Actually, any air-wound coil can be ring-tested; however, because of their low impedance, coils of less than 10 μ H usually display only 2 to 4 rings.

Tracing defective cables

Both the capacitance and inductance functions can be used to determine cable lengths, or the distance to either a short-circuit or an open in a length of cable. Open coaxial cable is capacitive. To determine the length of a cable or the distance to an open you simply measure the capacitance of one foot of cable, then measure the input capacitance of the open cable. Divide the open-cable read-

TEST INSTRUMENTS High Quality Lowest Prices Off-The-Shelf

New! MINI-METERS w/MAXI-SPECS

SCOPE 3 1/2 Digit LCD with 8 Full Functions
Model DVM-632 \$4495
 Deluxe test leads included • 0.5% accuracy • Transistor gain test • Audible continuity checking & diode test • 10 Amp measurement

SCOPE 3 1/2 Digit LCD Multimeter
Model DVM-630 \$2995
 Test leads included • 0.5% accuracy • 6 functions, 19 ranges • Automatic zero adjust • Low battery indication • Measures 5" x 2 3/4" x 7/8"

B & K 20 MHz Dual Trace
Model 2120 \$37995
 Probes included • 20 and 26 MHz band widths • TVV and TVH • X-Y operation • Trace rotation: adjustable front panel • Channel 1 output

SCOPE 3 1/2 Digit Capacitance
Model DCM-602 \$6995
 Test leads included • 8 ranges with full scale values to 2000 μ F • LSI circuit • Crystal time base • Frequency range 800 Hz to 8 Hz

SCOPE 3 1/2 Digital Multimeters
Model DVM-638 \$7995
 Test leads included • 11 function, 38 ranges • Logic level detector • Audible visual continuity • capacitance and conductance measurement.

Model DVM-634 \$4875 • 7 function, 32 ranges • Transistor measurement
Model DVM-636 \$6275 • 8 function, 37 ranges • Capacitance measurement

SCOPE Pocket Sized Audio Signal Generator
Model RC-555 \$6995
 Test leads & 9V battery included • Low distortion sine-wave signal • 46 step selected frequency • x1 range 20 Hz to 1.5 KHz / x100 range 2KHz to 150 KHz

HITACHI 35 MHz Dual Trace Oscilloscope
Model V-355 \$59995
 (Reg. \$899.95)
 Probes included • Thin, lightweight, compact • Large 6" rectangular, internal graticule CRT • Autofocus

FORDHAM Sweep Function Generator
Model FG-801 \$21995
 (Reg. \$289.95)
 Test leads included • 7 frequency ranges, 0.2 Hz to 2 MHz • Accuracy to \pm 5%

FORDHAM 550 MHz Frequency Counter
Model FM-8 \$16995
 (Reg. \$249.95)
 Completely assembled, pre-tested, precalibrated • High intensity 8-digit LED display

SCOPE 4 1/2 Digit LCD Bench Digital Multimeter
Model DVM-6005 \$19995
 Test lead set & 6 "D" size batteries included • 0.4" high characters • Conversion period: 500 milliseconds • Automatic, negative polarity

Zippered Carrying Case CC-30... \$4.50

Phone orders accepted.

Fordham

260 Motor Parkway, Hauppauge, NY 11788

Ask for our **FREE** Catalog

TOLL FREE 800-645-9518
 In New York State 800-832-1446

Service & Shipping Charge Schedule Continental U.S.A.			
FOR ORDERS	ADD	FOR ORDERS	ADD
\$25-100	\$4.50	\$751-1,000	\$12.50
\$101-250	\$6.00	\$1,001-1,500	\$16.50
\$251-500	\$8.00	\$1,501-2,000	\$20.00
\$501-750	\$10.50	\$2,001 and up	\$25.00

ing by the 1-foot value and you'll be very close to the distance to the end of the cable, or the distance to the open.

The same technique is used for shorted cable. However, a shorted cable appears inductive rather than capacitive. Measure the inductance of a one-foot length of cable that is shorted at the far end and use the indicated value as a reference. Then measure the inductance of a length of cable that you believe has an internal short-circuit. Divide the total cable-reading by the 1-foot value and you are within inches of the short-circuit's location.

How do we get within inches of an open or a short? It works this way. Assume the problem is an open length of RG-59. You measure an exact one-foot length and find it has a capacitance of 27 pF. You measure the defective cable and find its capacitance is 859 pF. Dividing 859 by 27 give you 31.8. In other words, the open is 31.8 feet from the input to the cable. Since 0.8 foot equals almost 10 inches

(actually 9.6), the open is 31 feet, 10 inches from the input to the cable. Allowing for assorted measurement errors, the open will be near, but probably not precisely, 31.8 feet.

Measuring very small values

A logical question is "What happens when capacitor and inductor values get so small they are actually less than those of the test leads and wires." Good question, but the Z-meter has a good answer. A front panel control that is normally used to balance out the test lead inductance or capacitance can be used as an offset for small values. For example, it is no problem to balance out the inherent capacitance of the test leads by using the front panel LEAD ZERO control. However, that doesn't solve the "window" problem of digital measurement—a small area that must be overcome before the instrument reads. For example, a 2-pF capacitor won't push the reading off zero because of the window's inertia; but the basic reading can

be offset to perhaps 10 pF by the LEAD ZERO control. Connecting a 1-pF capacitor will result in a reading of 11-pF. Since you know that 10 pF is an offset value, the true value must be 11 pF less 10 pF, or 1 pF. The offset measurement procedure is used the same way when measuring very small inductor values

While the intricacies of the measurement systems give an appearance of complexity, the Z-meter is notably easy to use because the readings themselves are autoranging, thereby restricting function selectors to only a few switches and controls. Stepped selectors are provided for the DC leakage/capacitor reform output voltages and the inductance ringing tests. Rocker switches are provided for leakage range (aluminum electrolytics or all other types) and power. A conventional potentiometer is used for the test-lead zeroing. Five push-buttons are used for: capacitor leakage, value, and ESR; and inductor value and the ringing tests.

Send Purchase Order
Check, Money Order, or C.O.D.
or Call Toll Free
800-223-0826
in N.Y. State (212) 865-5580

#1 IN CABLE BOXES
SPECIAL!

\$99.95

ANY QUANTITY

- Volume control
- 68 channels
- Mute control
- Automatic fine tuning
- Instant channel recall
- Programmable to go on at a particular channel and off automatically
- Compatible with descramblers

JERROLD CORDLESS CABLE TV CONVERTERS

MODEL STARCOM-460



*ADD \$5.00 FOR VISA OR MASTER CARD

JERROLD CORDLESS CABLE TV CONVERTER

MODEL DRX3-105/400

\$69.95

- 58 channels
- Remote channel changing
- Remote on/off switch
- Remote fine tuning



JERROLD CORDLESS CABLE TV CONVERTER

MODEL DRZ/450

- 66 channels
- Automatic fine tuning
- A/B switch option

\$69.95/ 10 lot
\$79.95 ea.



JERROLD CORDED CABLE TV CONVERTER

MODEL JRX3-105

\$49.95

- 36 channels
- push button



"THE RABBIT" VIDEO MULTIPLYING SYSTEM

TR-7000

\$51.95

\$59.95/6-11
\$69.95/1-5

12 up



IT'S LIKE HAVING A VCR IN EVERY ROOM

■ MASTER CARD ■ VISA

OMNITRON ELECTRONICS

770 Amsterdam Ave., New York, NY 10025

SHIPPING CHARGES

For Orders	Add
\$25-100	\$6.50
\$100-500	\$8.50
\$500-750	\$10.50
\$750 and up	\$20.00



For the infrequent times when you must hold down a button—such as when using the leakage test to reform an electrolytic capacitor—a small spring-loaded device is provided that slips between the handle and the button, which keeps the function button depressed as long as needed.

User calibration

Non-laboratory (user) calibration of the digital reading is made possible by three screwdriver adjustments (located on the rear apron) for *Zero Meter Reading*, *Capacitor Zero* (with test leads open), and *ESR zero*.

The Z-meter has a fused BNC input connector. It is supplied with a test cable terminated in miniature-hook test clips: Adapters are provided for making connection to capacitors having screw terminals.

The Z-meter is list-priced at \$995. For additional information on the instrument, write to Sencore, 3200 Sencore Drive, Sioux Falls, SD 57107. **R-E**

Now test and restore every CRT on the market . . . without ever buying another adaptor socket or coming up embarrassingly short in front of your customer . . . or your money back



**with the new improved CR70 "BEAM BUILDER"™
Universal CRT Tester and Restorer
Patented \$995**

Have you ever?

Thrown away a good TV CRT, data display CRT, or scope CRT that could have been used for another two or three years because you had no way to test or restore it?

Lost valuable customers because you advised them that they needed a new CRT when another technician came along and restored the CRT for them?

Lost the profitable extra \$35 or more that you could have gotten for restoring a CRT while on the job and locked in the profitable CRT sale later?

Avoided handling profitable trade-ins or rentals because you were afraid you'd have to replace the picture tube when you could have restored it?

Had a real need to test a CRT on the job, but didn't have the right adaptor socket or setup information in your setup book?

If any of these things have happened to you, **CALL TODAY, WATS FREE, 1-800-843-3338**, for a **FREE 15 day Self Demo**.

"BEAM BUILDER" is a trademark of Sencore, Inc.

NEW LIT

INFORMATION BOOKLET, the *Surface Mount Technology Handbook*, is 24 pages, letter size, on coated stock, and is fully illustrated with photos, tables, and diagrams.

Among the points covered are: board retention, strain relief, housing insulators, thermal mismatch, materials, lead design, automated PC-board assembly, and solder-reflow methods.

The handbook includes a glossary of SMT terms, and a description of the surface-mounting process. Last but not least, the handbook contains a catalog of Molex's surface-mount connectors. Available free on request from **Molex Incorporated**, 2222 Wellington Ct., Lisle, IL 60532.



Call Today Wats Free 1-800-843-3338

SENCORE

3200 Sencore Drive
Sioux Falls, SD 57107
605-339-0100 In SD Only

*innovatively designed
with your time in mind.*

CIRCLE 182 ON FREE INFORMATION CARD

AN OUNCE OF PREVENTION.



The complete line of Flameproof Resistors from NTE Electronics.

NTE Flameproof Resistors are designed to provide you with a premium quality replacement device... that won't flameout or short even under the most severe overloads.

Our resistors range in capability from $1/8$ Watts to 25 Watts with resistance values from 10 to 2.2 Megohms.

They're totally noncombustible with a metallic resistance material between a nonresistant core and a special ceramic outer cover.

NTE Flameproof Resistors are the ideal replacement components for electronic games, telecommunications, medical, data processing, military, broadcast and home entertainment equipment.

Don't take chances with your expensive equipment. Use NTE Flameproof Resistors... they handle the current.

LOOK FOR THE FULL LINE OF QUALITY NTE REPLACEMENT PARTS AND PRODUCTS:

- Transistors
- Thyristors
- Integrated Circuits
- Rectifiers and Diodes
- High Voltage Multipliers and Dividers
- Optoelectronic Devices
- Zeners
- Microprocessors and Support Chips
- Memory ICs
- Thermal Cut-Offs
- Bridge Rectifiers
- Unijunctions
- RF Transistors
- Microwave Oven Rectifiers
- Selenium Rectifiers
- Flameproof Resistors
- Wire Ties
- Electrolytic Capacitors
- Static Control Products



For more information or the name of your local distributor, call or write NTE.



NTE ELECTRONICS, INC.

44 Farrand Street, Bloomfield, New Jersey 07003
(Outside N.J.) 1-800-631-1250 • (N.J. only) 1-800-624-2624

CIRCLE 71 ON FREE INFORMATION CARD

LETTERS

continued from page 22

GATED SYNC DESCRAMBLER

We've made a number of modifications to the gated-sync descrambler that was featured in the February 1987 issue of **Radio-Electronics**. In addition, several errors crept in.

Starting with the modifications, resistor R1 has been deleted. Resistor R3 is now connected between R2 and the cathode of D1. C15 has been replaced by a 3-40-pF trimmer connected in parallel with a 47-pF fixed unit. L2 is now 18 μ H fixed unit.

Also, if you require AM detection of the sound subcarrier, the following modifications can be performed: Connect C27 to pin 4 of IC2 (rather than pin 12 of IC4). Increase C11 to 100 pF. Remove three turns from L1; it will now be 5½ turns on an 8-32 screw. When tuning L2, it should be adjusted for the appropriate sound subcarrier (65.75 MHz for Channel 3 or 71.25 MHz for Channel 4) as you now want to pass sound and reject video. If you have trouble rejecting the video, you can also try adding a trap to IC2. That trap should consist of a 100-pF NPO capacitor and 5½ turns of No. 22 enamelled wire on an 8-32 screw. Connect the trap in series between pin 7 of the MC1330 and ground. For more information see *Video Scrambling and Descrambling for Satellite and Cable TV* (H.W. Sams), by the authors.

Turning to the errors. There are several mis-identified components on the PC board (Fig. 2). There are two C5's; the one located between C18 and L2 is actually C15. There are two R20's; the potentiometer located below switch S1 is actually R30. There are two R21's; the one located above C3 is R29. There are two C14's; the one located between R14 and R15 is actually C19. There are two C20's; the one located below IC5 is actually C30.

Finally, C13 and C22 should both be 0.1- μ F units and C24 should be a 39- μ F unit; a 47-pF unit can also be used for C24.

RUDOLF F. GRAF and WILLIAM SHEETS

R-E

Walk "tough dog" troubles out of any TV & VCR in half the time . . . or your money back

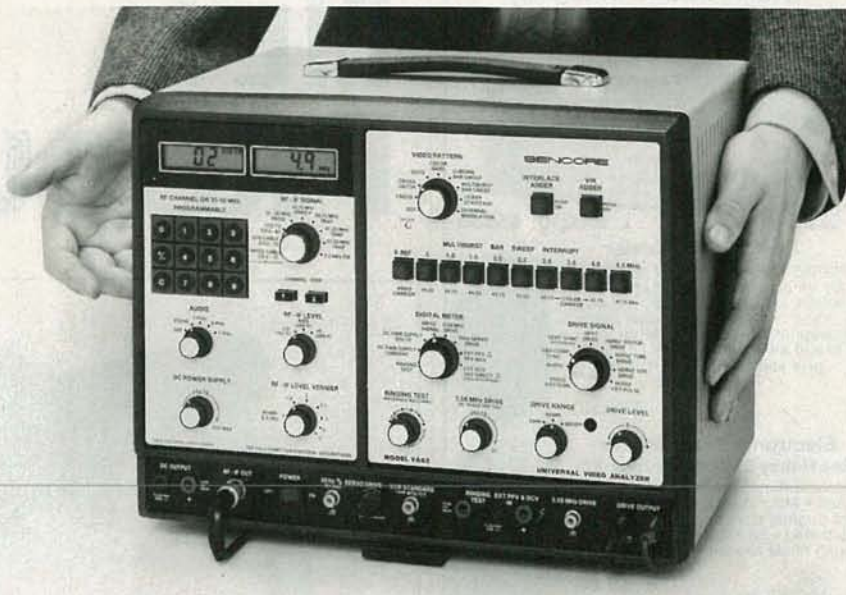

with the exclusive, patented,
VA62 Universal Video Analyzer . . . \$3,295

Would you like to?

Reduce analyzing time: Isolate any problem to one stage in any TV or VCR in minutes, without breaking a circuit connection, using the tried and proven signal substitution method of troubleshooting?

Cut costly callbacks and increase customer referrals by completely performance testing TVs & VCRs before they leave your shop? Own the only analyzer that equips you to check all standard and cable channels with digital accuracy? Check complete, RF, IF, video and chroma response of any chassis in minutes without taking the back off the receiver or removing chassis plus set traps dynamically right on CRT too? Simplify alignment with exclusive multiburst pattern?

Reduce costly inventory from stocking yokes, flybacks, and other coils and transformers, for substitution only, with the patented Ringing Test. Run dynamic proof positive test on any yoke, flyback, and integrated high voltage transformer . . . in- or out-of-circuit?

Protect your future by servicing VCRs for your customers before they go to your competition? Walk out "tough dog" troubles in any VCR chrominance or luminance circuit — stage-by-stage — to isolate problems in minutes? Have proof positive test of the video record/play heads before you replace the entire mechanism?

Increase your business by meeting all TV and VCR manufacturers' requirements for profitable warranty service work with this one universally recommended analyzer?

To prove it to yourself, CALL TODAY, WATS FREE, 1-800-843-3338, for a FREE Self Demo . . . or learn how the VA62 works first by calling for your free simplified operation and application instruction guide, worth \$10.00.



Call Today Wats Free 1-800-843-3338

SENCORE

3200 Sencore Drive
Sioux Falls, SD 57107
605-339-0100 In SD Only

*innovatively designed
with your time in mind.*

CIRCLE 183 ON FREE INFORMATION CARD

APRIL 1987

29

Fantastic Kits To Build

From Constructors Feature Projects in Radio Electronics and Hobby Electronics Magazines.

Bench Top Power Supply (See Radio Electronics June '86)

Features: • Output Variable between 3-30V • Full 1 amp output over entire voltage range • Short circuit protection • Fully variable current limiting.



K 3210 \$59.95

Zener Diode Tester

"Simply plugs Into Your Multimeter"

By simply plugging this handy little tester into your multimeter, it allows you to read out the actual Zener voltage of any Zener Diode up to 60 volts and will also test LEDs! as well as give you a reading of its forward voltage drop. K 2620

\$12.50



Electronic Fluoro Starter (See Hobby Electronics June '87)

• Extend fluoro Tube life by 1000's of hours • Mounts on single PCB - fits into original starter capsule • Smooth rapid start - no more flicker • No light wiring mods needed. K 6300

\$9.50



Voice Operated Relay (See Hobby Electronics March '87)

Great for Voice Control of PA systems, Transmitters, Tape Recorder, Slide Projector, Intercom etc.

K 5540 \$15.00

Touch Lamp Dimmer (See Hobby Electronics March '87)

Controlled by the latest Siemens Light Dimmer IC, The S 576A

Instantly turn lamps on and off with just a light touch on a wall panel. Alternatively you can dim or brighten the lamps to any desired level by merely touching the panel for two or three seconds - very classy!

Supplied with Gold Touch Plate
K 6319 \$35.00

Infra Red Remote Control For Touch Lamp Dimmer (See Hobby Electronics May '87)

Operate your touch lamp dimmer from your favourite arm chair!
K 6322 \$25.00

FM Radio Microphone (See Hobby Electronics April '87)

This simple FM Microphone kit only requires an ordinary FM Radio for reception

- runs from single 9V battery
- High Sensitivity • Long range approximately 100 ft.

USES:

- Wireless Microphone • Professional Eavesdropping
- Listen to the TV in the kitchen • Makes an excellent child minder.

K 1106 \$9.50

Drill Speed Controller For Brush Motors up to 3 Amps

Varies motor speed from a few RPM to full speed while maintaining good torque. Suitable for - Drills and Drill Presses - Circular Saws - Jig Saws - food Mixers - Movie Projectors.

Pack & Shipping Charges (USA Mainland)

\$2 K 5540, K 1106, K 6322, K 6300, K 1724, K 2620, K 6005, K 6319. \$4 K 2522 \$5 K 3210

Please note COD charges slightly extra
Foreign Orders Please Add 10% To Order Total

Imtronics Industries Ltd.

11930 31st Court, St. Petersburg
FLORIDA U.S.A. 33702

Phone: 813 5779010

NEW PRODUCTS



CIRCLE 30 ON FREE INFORMATION CARD

SOUND SENDER, is a device that makes it possible to play a portable cassette player, Walkman, or CD player through an FM auto-sound system by merely plugging it in to the cigarette lighter of a car, truck, van, RV, or boat. There is no extra wiring needed.

The device eliminates the need for earphones while driving, which are prohibited by law in many states. It also reduces the possibility of theft, because the

cassette radio in the dashboard is usually the target of thieves.

The *Sound Sender* weighs 2 ounces and consists of a small plastic housing (4½" × 1¾" × 1¾") and a wire with a cigarette-lighter plug at one end and a jack for a cassette player at the other. The suggested retail price is under \$30.—**Dynasound Organizer**, a Division of Hartzell Manufacturing, Inc., 2516 Wabash Ave., St. Paul MN.

SCANNER, the Regency model R1070, has ten channels, and can receive more than 15,000 frequencies over six of the most popular public-service bands, including

VHF-low (30-50 MHz), VHF-amateur (144-148 MHz), VHF-high (148-174 MHz), UHF-amateur (440-450 MHz), UHF (450-470 MHz), and UHF-T (470-512 MHz). No crystals are required, and the scanner is pre-programmed with 10 of the most-popular frequencies.

Programmed frequencies can be changed or added by touching the fingertip controls. A dual-level vacuum-fluorescent digital display flashes messages to aid in programming; and once a frequency is entered into a channel, a special test key automatically verifies the



CIRCLE 31 ON FREE INFORMATION CARD

frequency, while checking all microprocessor functions.

In addition to scanning as many as 10 channels, the scanner can search an entire frequency range to find active frequencies. Other features include a channel lockout for skipping channels that are not of current interest, manual search and scan controls, and sliding volume and squelch controls. During a power failure, a built-in capacitor will save the frequencies in memory for several hours, without the need for batteries.

The Regency model R1070 comes complete with an AC power-supply cord, telescopic antenna, and an easy-to-follow instruction manual. The suggested retail price is \$159.95.—**Regency Electronics, Inc.**, 7707 Records Street, Indianapolis, IN 46226.

MINIATURE HANDHELD DMM, the Circuitmate model DM78, is designed for the electronics hobbyist, but is also convenient for computer and field technicians to carry as a supplement or backup to their larger DMM.



CIRCLE 32 ON FREE INFORMATION CARD

The model DM78 has 0.7% accuracy: It includes diode test, continuity test, and autoranging capabilities. The meter weighs 3½ ounces, including the supplied carrying case. It can measure AC or DC voltages over the four ranges of 2-, 20-, 200-, and 450-volts, full scale. Resistance ranges on the model DM78 are 2K, 20K, 200K, and 2000K, full scale. Bandwidth is specified as 40–500 Hz. There is overload protection to 650-volts DC or peak AC, and the battery life is 70 hours. Test leads are included.

Exclusive, triple patented dynamic cap and coil analyzing . . . guaranteed to pinpoint your problem every time or your money back



with the all new LC75 "Z METER 2"
Capacitor Inductor Analyzer
Patented \$995

The "Z METER" is the only LC tester that enables you to test all capacitors and coils dynamically — plus, it's now faster, more accurate, and checks Equivalent Series Resistance (ESR) plus small wire high resistance coils.

Eliminate expensive part substitution and time-consuming shotgunning with patented tests that give you results you can trust every time. Test capacitor value, leakage, dielectric absorption, and ESR dynamically; with up to 600 volts applied for guaranteed 100% reliable results — it's exclusive — it's triple patented.

Save time and money with the only 100% reliable, in- or out-of-circuit inductor tester available. Dynamically test inductors for value, shorts, and opens, automatically under "dynamic" circuit conditions.

Reduce costly parts inventory with patented tests you can trust. No more need to stock a large inventory of caps, coils, flybacks, and IHVTs. The "Z METER" eliminates time-consuming and expensive parts substituting with 100% reliable LC analyzing.

Turn chaos into cash by quickly locating transmission line distance to opens and shorts to within feet, in any transmission line.

Test troublesome SCRs & TRIACs easily and automatically without investing in an expensive second tester. The patented "Z METER 2" even tests SCRs, TRIACs, and High-Voltage Diodes dynamically with up to 600 volts applied by adding the new SCR250 SCR and TRIAC Test Accessory for only \$148 or FREE OF CHARGE on Kick Off promotion.

To try the world's only Dynamic LC Tester for yourself, CALL TODAY, **WATS FREE, 1-800-843-3338**, for a FREE 15 day Self Demo.



Call Today Wats Free 1-800-843-3338

SENCORE

3200 Sencore Drive
Sioux Falls, SD 57107
605-339-0100 In SD Only

*innovatively designed
with your time in mind.*

CIRCLE 180 ON FREE INFORMATION CARD

The model *DM78* is priced at \$29.95.—**Beckman Industrial Corporation**, 630 Puente Street, Brea, CA 92621.

CD-PLAYER ADAPTOR, the Sparkomatic model *CDA50*, will allow portable compact-disc players to be played through a car-stereo system. It operates by inputting a standard FM-stereo signal having a carrier frequency of 90.1 MHz into the antenna input of the car radio.

A switch is incorporated into the adaptor that turns on the unit; power-on status is indicated by an LED. The switch also disconnects the external antenna so that the only signal reaching the car radio will be that of the model *CDA50*.

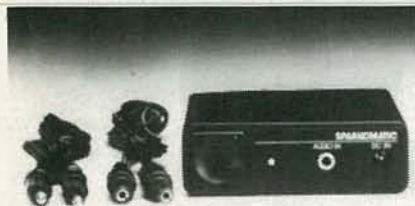

CIRCLE 33 ON FREE INFORMATION CARD

In addition to compact-disc players, the unit can be used for playing portable cassette players that have a line out or headphone jack. The unit also provides a 9-volt output that is suitable for powering audio equipment requiring that voltage. The unit is intended for under-dash mounting, and appropriate mounting brackets are supplied. The model *CDA50* has a suggested retail price of \$19.95.—**Sparkomatic Corporation**, Milford, PA 18337.

REPAIR STATIONS, the OK Industries model *BTR-55*, (shown), the model *BTR-35*, and the model *BTR-25*, are self-contained repair stations specifically developed to meet the requirements of delicate multilayer PC-board rework.

The desolder section of the model *BTR-55* features a 100-watt desoldering tool; spike-free operation; pistol-grip handpiece; accurate temperature indication via thermocouple tip-temperature sensing; temperature adjustable 280°C – 470°C (535°F – 800°F); heavy



CIRCLE 34 ON FREE INFORMATION CARD

duty, quick-rise diaphragm pump; adjustable hot-air blower; 24-volt handpiece; long-life desolder nozzles.

The solder section features: spike-free operation; 48-watt, heavy-duty soldering iron with thermocouple tip-temperature sensing; and temperature control adjustable from 280°C – 470°C (535°F – 880°F).

The hand-tool section features: 12-volt DC drill and grinder; variable power output, continuously adjustable up to 16,500 rpm, and 3-volt AC output.

The model *BTR-35* combines the same performance features as the

EASY LISTENING

- FOR 810 TO 912 MHz BAND SUPER CONVERTER 8001
- FOR YOUR UHF SCANNING RECEIVER AND OTHERS

A super-converter 8001 has been certified by FCC part 15 regulation.

HOW TO ORDER

Name: _____

Address: _____

City: _____ State: _____

Zip: _____ Phone () _____

Make Check or Money Order payable to
GRE AMERICA, INC.

Mail to: GRE AMERICA, INC.
425 Harbor Blvd., Belmont, CA 94002

Unit Cost @ \$59.94 × Qty. = Total

CA. Residents Add 6.5% Tax
Shipping & Handling @ \$4.00/

Unit × Qty. =

PAYMENT METHOD TOTAL ▶

Check Money Order

Mastercard Visa

Card No. _____

Expiration Date _____

Signature _____

**PHONE ORDER: 800-233-5973
or 415-591-1400**



The Super Converter 8001 Features:

- Listening to 810–912 MHz Band on a UHF Scanner and /or Other Monitor Receivers
- Easy Connections to Your Receiver
- 9 Volts Battery Operation Power Source and Power On Indicator by LED Display
- External Power Jack Size: 79(w) × 30(H) × 100(D)mm

Warranty

- 180 Days From Date of Purchase

Unit Cost

- \$59.94 plus \$4.00 Shipping and Handling Charge

model BTR-55 but without the hand-tool section. The model BTR-25 contains the multi-layer desolder section of the model BTR-55.

The BTR series systems start at \$565.00.—OK Industries, 3455 Conner Street, Bronx, NY 10475.

DMM, the A.W Sperry Instruments model DM-1 "Pocket Pro" is a miniature, 3½ digit, ultra slim digital multimeter that provides the measurement capabilities of a 14-range digital instrument in a pocket-calculator size.



CIRCLE 35 ON FREE INFORMATION CARD

The model DM-1 measures a mere 4.2" in height, is 2.0" wide, 0.4" deep, and weighs 3.5 ounces. It features autoranging, manual ranging, electronic overload protection on all ranges, auto-polarity, and audible-continuity indication.

The model DM-1 comes with two 1.5-volt LR-44 button-type batteries, a carrying case, built-in test leads, and one-year warranty; it is priced at \$29.95.—A. W. Sperry Instruments, Inc., 245 Marcus Boulevard, Hauppauge, NY 11788.

SCREWDRIVER, the model T-15 Torx driver, features an extra-long 9¾" blade. It makes servicing difficult-to-reach areas of MacIntosh and other personal computers a



CIRCLE 36 ON FREE INFORMATION CARD

far-easier task. The overall length is 13¾", with a break-resistant plastic handle. The model T-15 is priced at \$6.95.—Jensen Tools, Inc., 7815 South 46th Street, Phoenix, AZ 85044. R-E

Analyze defective waveforms faster, more accurately, and more confidently — every time or your money back



with the SC61 Waveform Analyzer
Patented \$2,995

If you value your precious time, you will really want to check out what the exclusively patented SC61 Waveform Analyzer can do for you. 10 times faster, 10 times more accurate, with zero chance of error.

End frustrating fiddling with confusing controls. Exclusive ultra solid ECL balanced noise cancelling sync amplifiers, simplified controls, and bright blue dual trace CRT help you measure signals to 100 MHz easier than ever.

Accurately and confidently measure waveforms from a tiny 5 mV all the way to a whopping 3,000 V without hesitation with patented 3,000 VPP input protection — eliminates expensive "front end" repairs and costly equipment downtime.

Make only one circuit connection and push one button for each circuit parameter test: You can instantly read out DC volts, peak-to-peak volts and frequency 100% automatically with digital speed and accuracy. It's a real troubleshooting confidence builder.

Confidently analyze complex waveforms fast and easily. Exclusive Delta measurements let you intensify any waveform portion. Analyze glitches, interference signals, rise or fall times or voltage equivalents between levels; direct in frequency or microseconds.

Speed your digital logic circuit testing. Analyzing troublesome divide and multiply stages is quicker and error free — no time-consuming graticule counting or calculations. Simply connect one test lead to any test point, push a button, for test of your choice, for ERROR FREE results.

To see what the SC61 can do for your troubleshooting personal productivity and analyzing confidence, CALL TODAY, WATS FREE, 1-800-843-3338, for a FREE 15 day Self Demo.



Call Today Wats Free 1-800-843-3338

SENCORE
3200 Sencore Drive
Sioux Falls, SD 57107
605-339-0100 In SD Only

*innovatively designed
with your time in mind.*

CIRCLE 181 ON FREE INFORMATION CARD

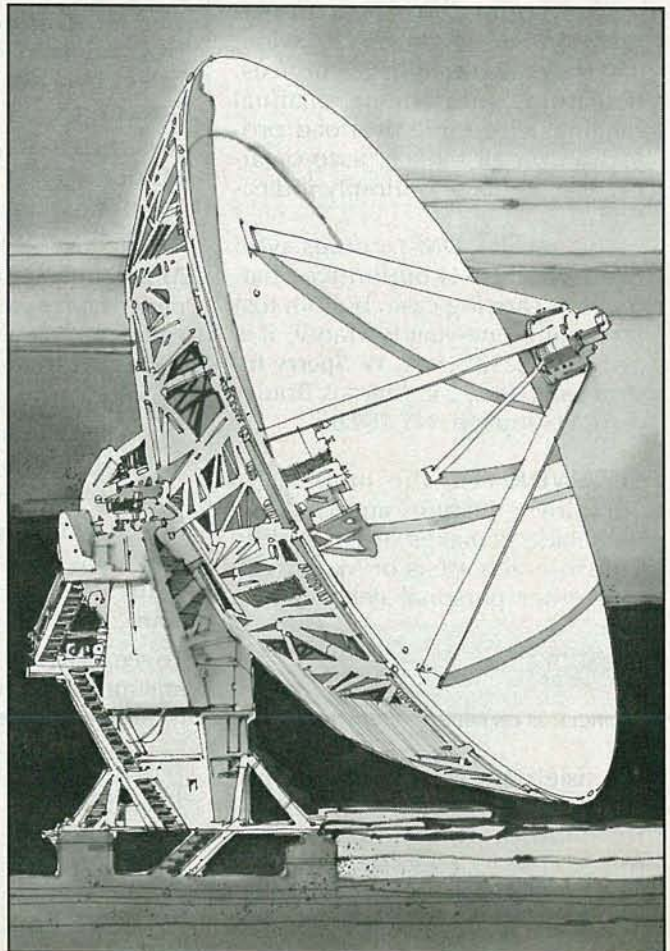
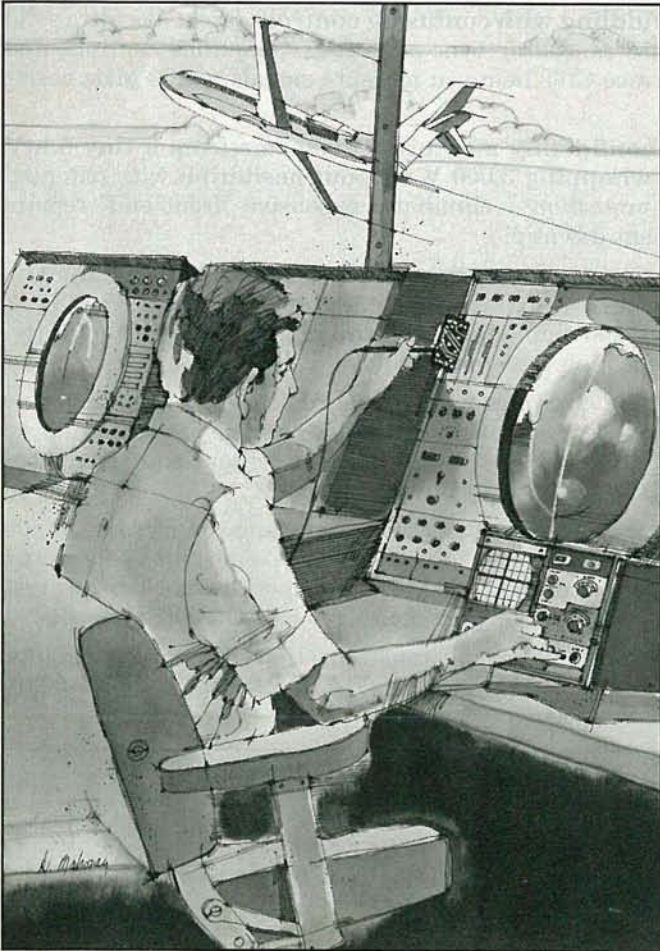
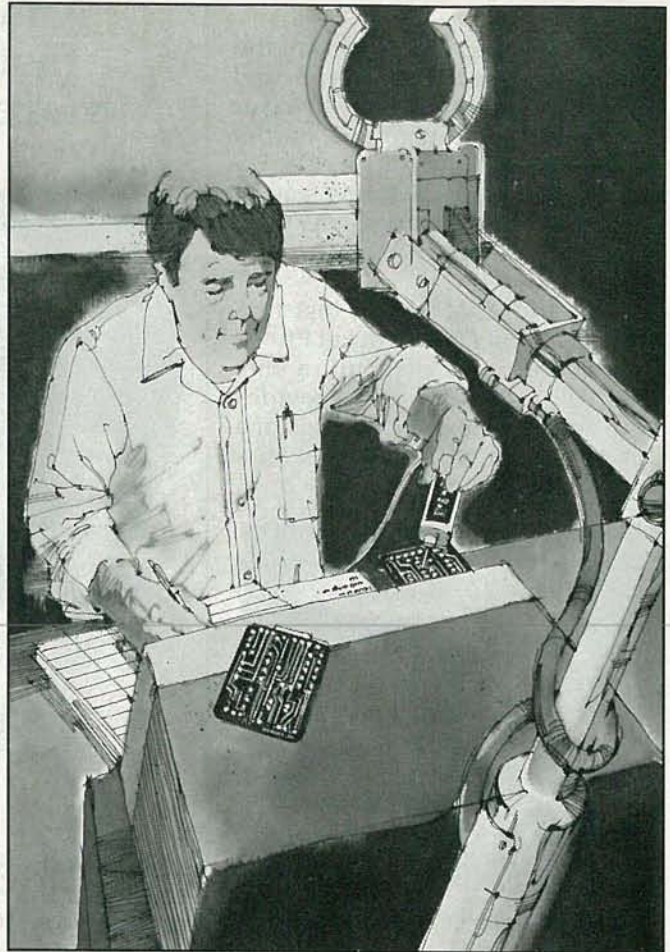

CIE MAKES THE WORLD OF ELECTRONICS YOURS.

Today's world is the world of electronics. To be part of it, you need the right kind of training, the kind you get from Cleveland Institute of Electronics, the kind that can take you to a fast growing career in business, aerospace, medicine, science, government, communications, and more.

Specialized training.

You learn best from a specialist, and that's CIE. We're the leader in teaching electronics through independent study, we teach only electronics and we've been doing it for over 50 years. You can put that experience to work for you just like more than 25,000 CIE students are currently doing all around the world.

Practical training.

You learn best with practical training, so CIE's Auto-Programmed® lessons are designed to take you step-by-step, principle-by-principle. You also get valuable hands-on experience at every stage with sophisticated electronics tools CIE-designed for teaching. Our 4K RAM Microprocessor Training Laboratory, for example, trains you to work with a broad range of computers in a way that working with a single, stock computer simply can't.

Personalized training.

You learn best with flexible training, so we let you choose from a broad range of courses. You start

with what you know, a little or a lot, and you go wherever you want, as far as you want. With CIE, you can even earn your Associate in Applied Science Degree in Electronics Engineering Technology. Of course, you set your own pace, and, if you ever have questions or problems, our instructors are only a toll-free phone call away.

The first step is yours.

To find out more, mail in the coupon below. Or, if you prefer, call toll-free **1-800-321-2155 (in Ohio, 1-800-523-9109)**. We'll send a copy of CIE's school catalog and a complete package of enrollment information. For your convenience, we'll try to have a representative contact you to answer your questions.

CIE Cleveland Institute of Electronics 1776 East 17th St., Cleveland, Ohio 44114

YES! I want to get started. Send me my CIE school catalog including details about the Associate Degree Program. I am most interested in:

- | | |
|--|---|
| <input type="checkbox"/> computer repair | <input type="checkbox"/> television/high fidelity service |
| <input type="checkbox"/> telecommunications | <input type="checkbox"/> medical electronics |
| <input type="checkbox"/> robotics/automation | <input type="checkbox"/> broadcast engineering |
| <input type="checkbox"/> other _____ | |

Print Name _____

Address _____ Apt. _____

City _____ State _____ Zip _____

Age _____ Area Code/Phone No. _____

Check box for G.I. Bulletin on Educational Benefits **ARE-58**
 Veteran Active Duty **MAIL TODAY!**

R-E ROBOT

Here are the hardware details of the 80188-based computer board. We also discuss the principles of bringing up a microprocessor system for the first time.

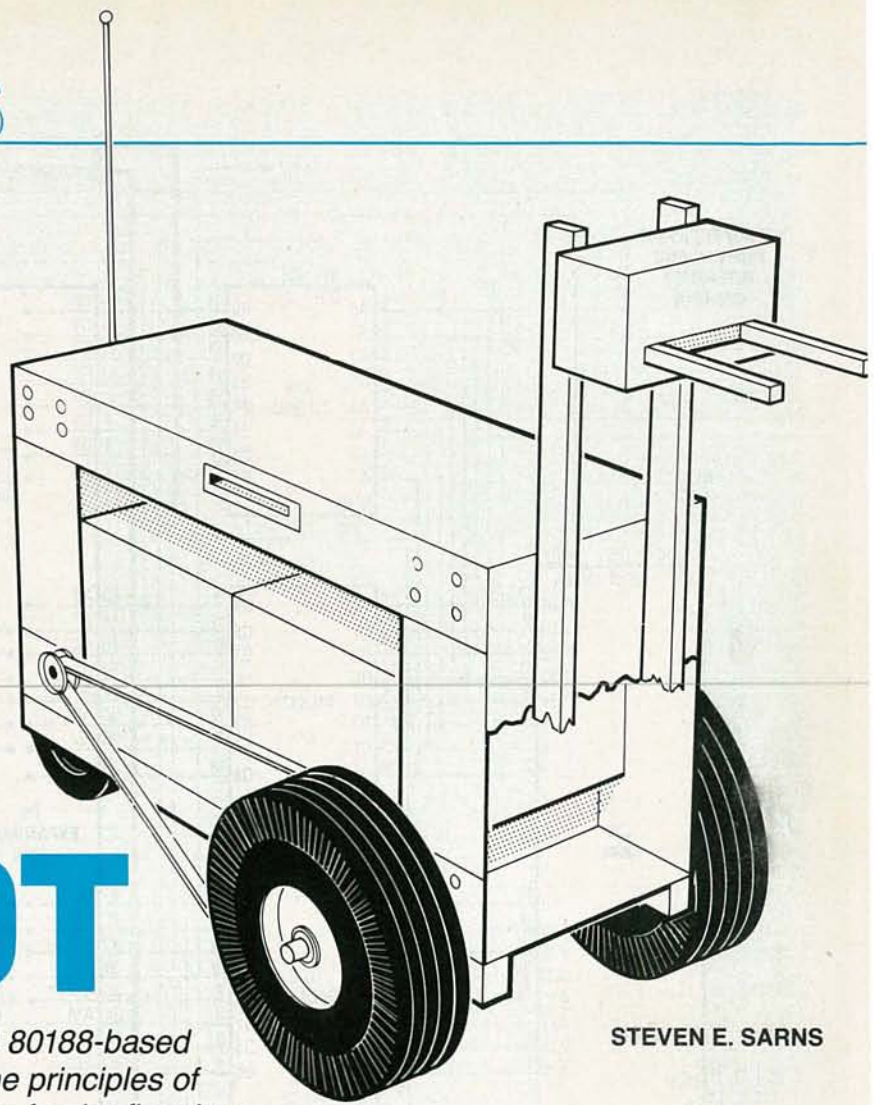

STEVEN E. SARNS

THE ROBOTIC PERSONAL COMPUTER (RPC) was introduced in the January 1987 issue. To gain an overall understanding of how the board works, see the block diagram (Fig. 1), and the memory (Fig. 3) and I/O maps (Fig. 4) presented in that issue. Now we'll discuss the basics of how the separate sub-sections function, and then go on to discuss construction and debugging.

Data buses

To begin, note that three functionally equivalent but electrically isolated data buses exist on the RPC. The data-bus outputs of the 80188 feed IC14, which feeds the three buses: the expansion bus (see Fig. 1), the memory bus (through IC16, shown in Fig. 2), and the auxiliary bus (through IC17, shown in Fig. 3).

The microprocessor's address bus is buffered by IC15, IC22, and IC21; the outputs of those octal latches feed the expansion connector and all on-board IC's that need access to the address bus.

The 80188's major control signals are buffered by IC13, which also buffers the microprocessor's timer output, which in turn feeds the resulting signal through C18 to speaker SPKR1. The 8259 interrupt

controller connects to the auxiliary data bus through IC17. Three-to-eight line decoder IC41 decodes the microprocessor states for the expansion bus.

Memory interface

The RPC provides decoding for sixteen RAM/ROM sockets in two 64K banks (0000:0000 to 0000:FFFF and 1000:0000 to 1000:FFFF). However, due to PC-board space limitations, the upper bank (IC44-IC51), if used, must be mounted physically above the lower bank (IC1-IC8). Only the chip-enable (\overline{CE}) pins (pin 20 of each IC) are routed to separate pads. The parts-placement diagram, which appears along with the PC pattern in PC service, indicates how those pins are connected.

Otherwise, the memory interface is fairly straightforward. Octal transceiver IC16 provides an isolated bus for the low-memory RAM (IC1-IC8, and IC44-IC51). The two three-to-eight line decoders (IC11 and IC12) provide the \overline{CE} signals for the low-memory IC's. In a similar manner, half of two-to-four line decoder IC39 provides the \overline{CE} for the BIOS and language ROM's (IC23, IC24,

IC30, IC31).

Several jumpers (JU1, JU2, JU10-JU13) allow you to provide a different decoding scheme, or to accommodate RAM IC's of other sizes. Jumpers JU3-JU9, when connected as shown, allow you to provide battery backup for selected (or all) low-memory RAM IC's. Note that the jumpers enable and disable battery backup in pairs (IC1 and IC44, IC2 and IC45, etc.). If battery backup is not desired (for example, if EPROM's are used in low-memory sockets), the appropriate jumper(s) should be grounded.

Clock and disk controller

As shown in Fig. 3, gates IC28-a-IC28-c, IC27-a, and IC26-d decode the 80188's peripheral select, read, and write lines, to enable the WD1770 disk controller (IC34) when appropriate. Data-bus buffering is provided by IC17 (which also feeds most of the RPC's peripheral circuits); IC37 provides outputs for selecting one of four drives. One bit (Q4, pin 12) of IC37 drives an LED that indicates disk drive activity; another bit (Q3, pin 9) provides the \overline{STROBE} signal for the parallel printer interface (shown in Fig. 4).

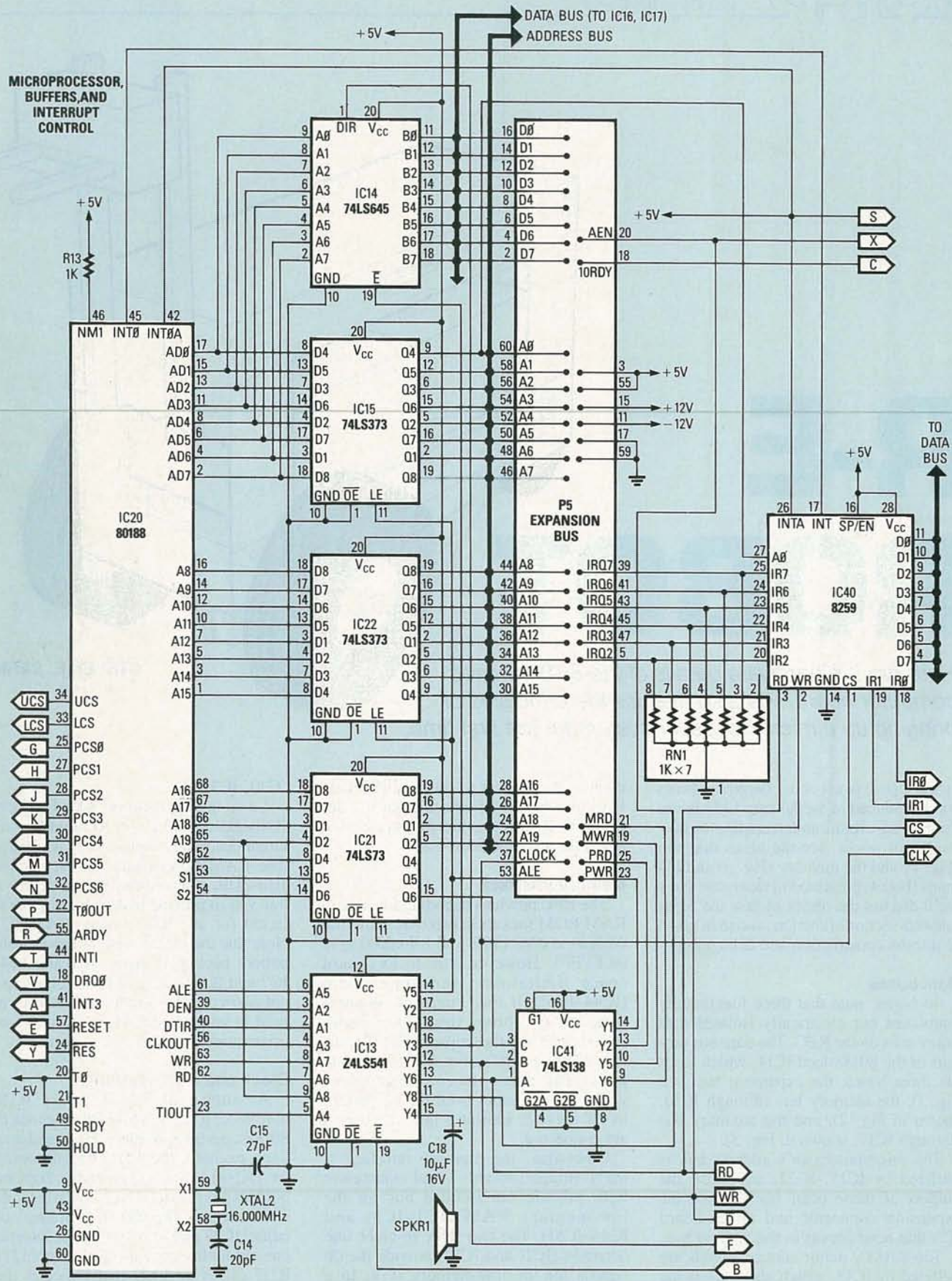

FIG. 1—THREE OCTAL LATCHES, IC15, IC21 and IC22 buffer the microprocessor's address line. The output of those latches feed the expansion bus and any on-board IC's that need access to the address line.

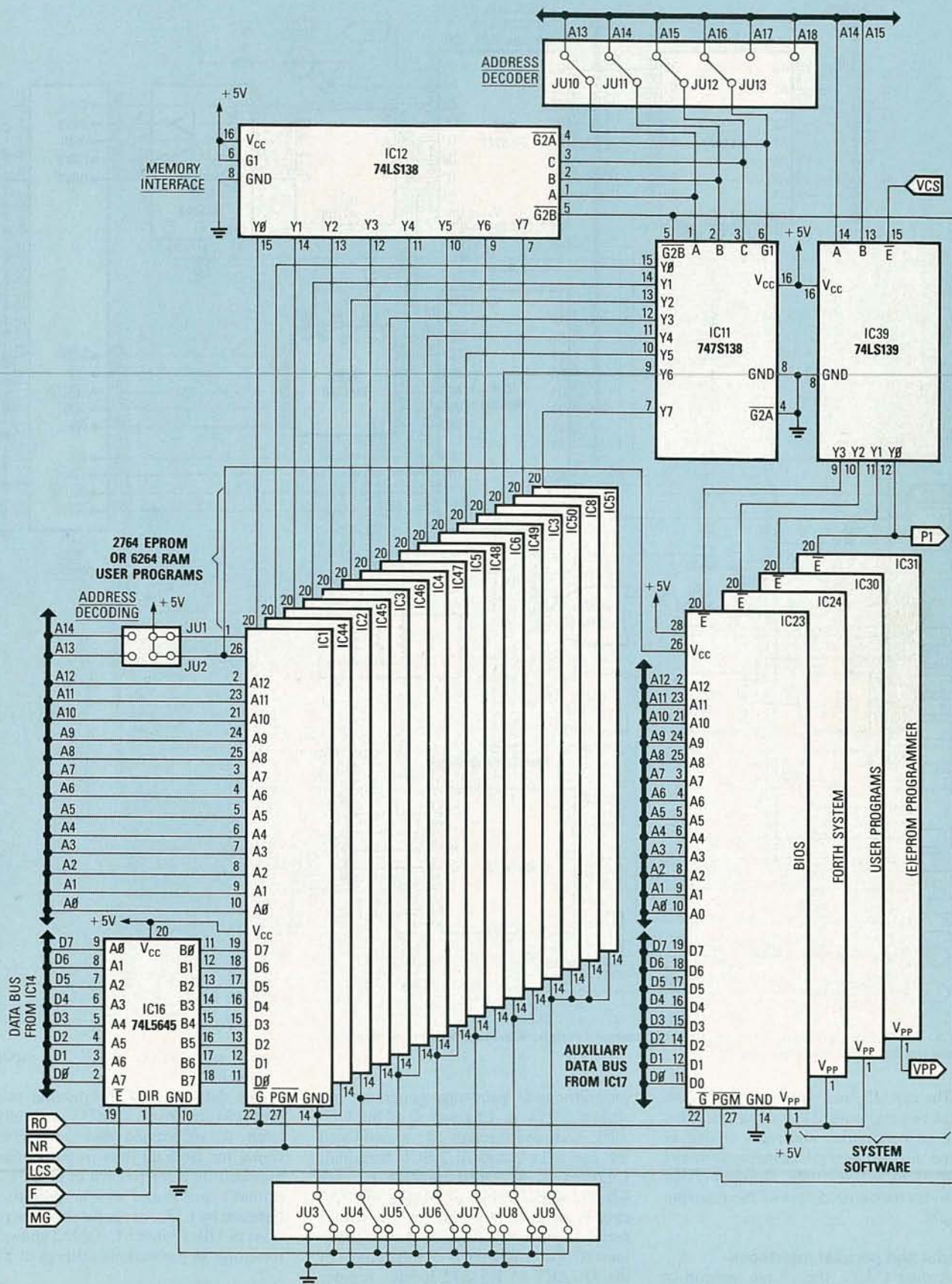

FIG. 2—DECODING FOR 16 RAM/ROM SOCKETS, in two 64K banks, is provided by the Robotic Personal Computer.

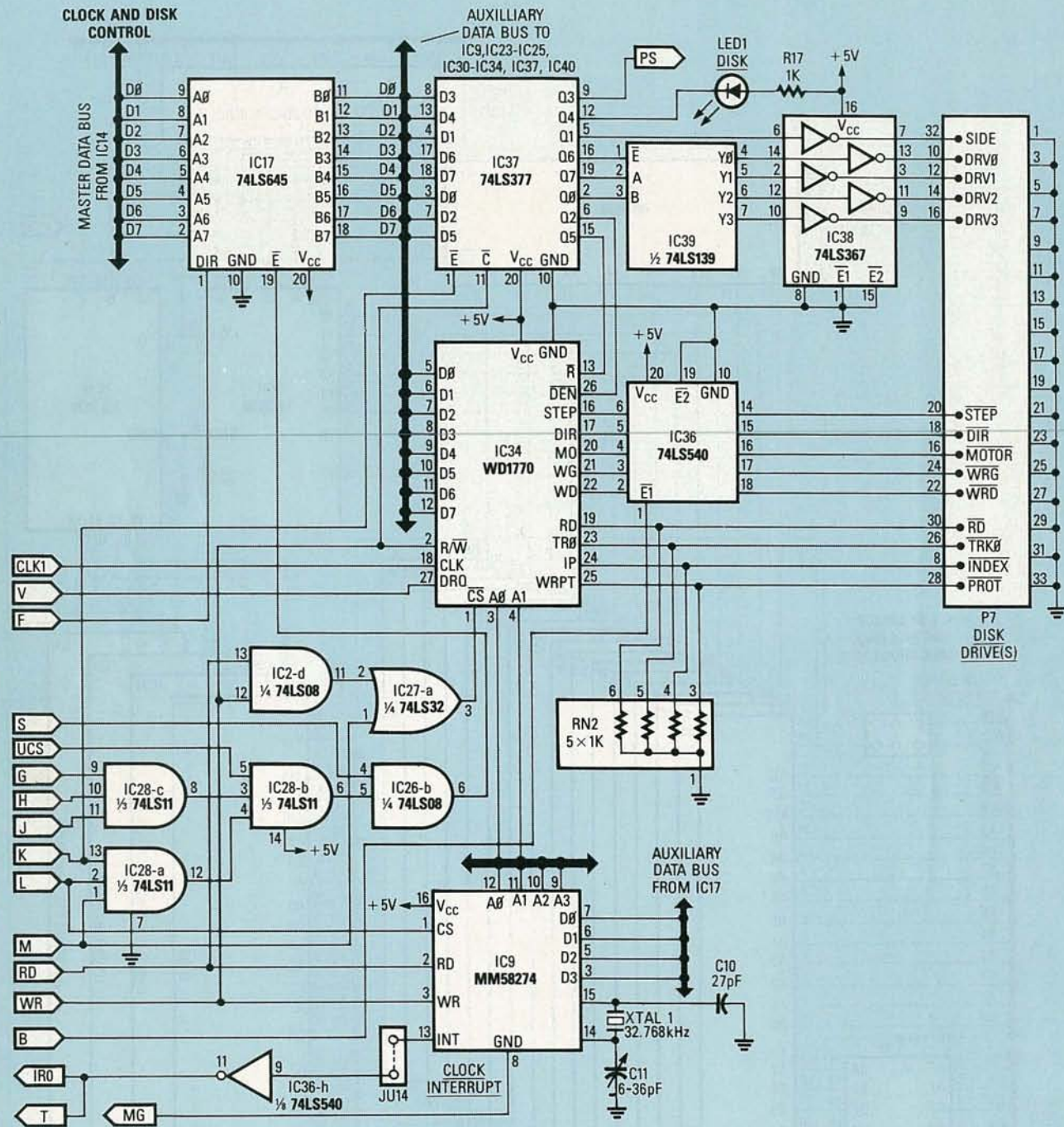

FIG. 3—SIX GATES are used to decode the microprocessor's peripheral select, read, and write lines to enable the disk controller when appropriate.

The clock IC is a National MM58274; it can be programmed to provide one interrupt or continuous interrupts at one of seven selected intervals, ranging from 0.1 second to 60 seconds. Jumper JU14 provides hardware defeat of the interrupt output.

Serial and parallel interfaces

A dual UART, the 28-pin version of Signetics' 2681, is used for serial communications; the IC has a built-in software-

programmable baud-rate generator. As shown in Fig. 4, Channel A of the DUART, accessed through P1, is dedicated for use by a standard ASCII terminal. Channel B, accessed through P2 (for RS-232 signal levels) or P4 (for TTL levels), is an auxiliary port for use with a serial printer, modem, etc. Level translator IC18 converts the +5-volt outputs of the DUART to RS-232 levels. Jumper JU16 allows you to defeat the "busy" input of DUART channel B; JU17 allows

you to select TTL or RS-232 input to Channel B.

The data lines of the parallel printer port (P6) are driven by IC33, an eight-bit latch. As mentioned above, the STROBE signal for latching data in the printer is provided by IC37 (shown in Fig. 3). The printer's BUSY and ERROR outputs are buffered by IC32, as are the separate positions of DIP switch S1. Table 1 shows the meanings of the various settings of S1.

Power supply

The RPC requires only +5 volts at

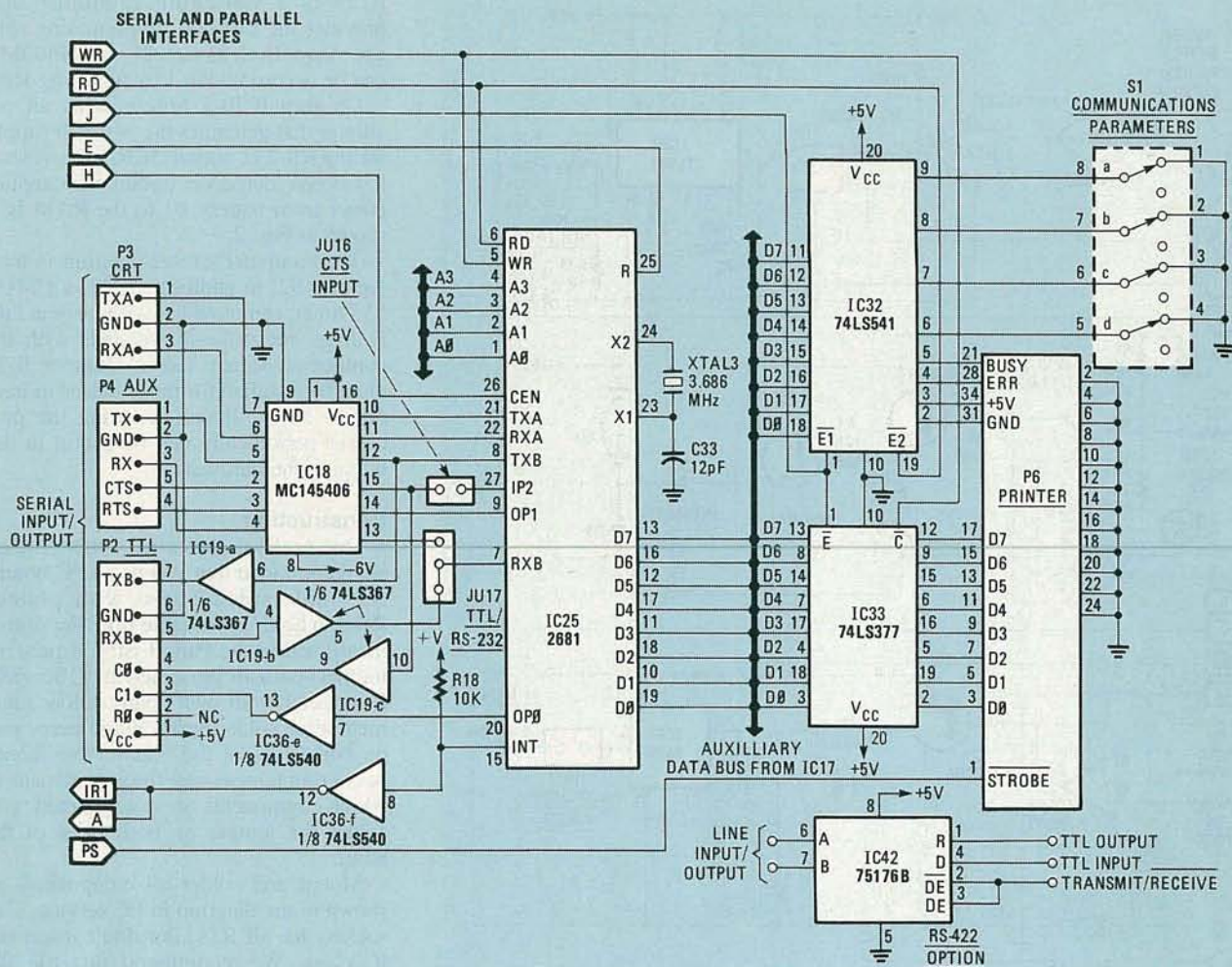

FIG. 4—A DUAL UART is used for serial communications. The IC used, a 28-pin Signetics 2681, has a built-in programmable baud-rate generator.

PARTS LIST

All resistors are 1/4-watt, 5% unless otherwise noted.

R1, R8, R10, R15, R18, R21—10,000 ohms
 R2, R3, R9, R11, R13, R14, R17—1000 ohms
 R4, R6, R7—100,000 ohms
 R5, R20—unused
 R12—1 megohm
 R16—10,000 ohms, trimmer potentiometer
 R19—15 megohms
 RN1—1K × 7 SIP resistor pack
 RN2—1K × 5 SIP resistor pack

Capacitors

C1, C34—unused
 C2—C9, C12, C19—C32, C35—C38, C40, C42—C50, C52, C53—0.1 μF, bypass
 C10, C15, C33—27 pF, disk
 C11—6–36 pF variable trimmer capacitor
 C13, C18—10 μF, 16 volts, electrolytic
 C14—20 pF, disk
 C17, C39—100 pF, disk
 C41—4.7 μF, 16 volts, electrolytic
 C51—1 μF, 35 volts, tantalum

Semiconductors

IC1—IC8, IC44—IC51—6264 RAM or 2764 EPROM

IC9—MM58274, clock
 IC10—LM393, op-amp
 IC11, IC12, IC41—74LS138, 3-to-8 line decoder
 IC13, IC32—74LS541, octal buffer
 IC14, IC16, IC17—74LS645, octal transceiver
 IC15, IC21, IC22—74LS373, octal latch
 IC18—MC145406, RS-232 line driver/receiver
 IC19, IC38—74LS367, hex buffer
 IC20—80188, microprocessor
 IC23, IC24, IC30, IC31—BIOS and language EPROMs (see text)
 IC25—SCN2681AC1N28—Dual UART (Signetics)
 IC26—74LS08, quad two-input AND gate
 IC27—74LS32, quad two-input OR gate
 IC28—74LS11, triple three-input AND gate
 IC29—TL497, switching regulator
 IC33, IC37—74LS377, octal latch
 IC34—WD1770, floppy disk controller
 IC35—LM336-2.5, precision voltage reference (2.5 volt)
 IC36—74LS540, octal buffer
 IC39—74LS139, dual 2-to-4 line decoder
 IC40—8259A, interrupt controller

IC42—SN75176B, RS-422 controller (optional)

IC43—7555, CMOS 555 timer
 D1—D3—1N4148 switching diode
 D4—1N759 6.8-volt Zener diode
 LED1—standard
 Q1, Q2, Q4—2N3906, PNP transistor
 Q3—2N3904, NPN transistor

Other components

L1, L2—56 μH coil
 P1, P3—3-pin 0.025" post connector
 P2—7-pin 0.025" post connector
 P4—5-pin 0.025" post connector
 P5—60-pin dual-row 0.025" post connector
 P6, P7—34-pin dual-row 0.025" post connector
 P8—4-pin 0.025" post connector
 S1—four position DIP switch
 S2—normally-open pushbutton switch
 XTAL1—32.768 kHz crystal
 XTAL2—16,000 MHz crystal
 XTAL3—3.6864 MHz crystal

Note: The RPC is available from Vesta Technology, 7100 W. 44th Ave., Suite 101, Wheatridge, CO 80033; 303-422-8088

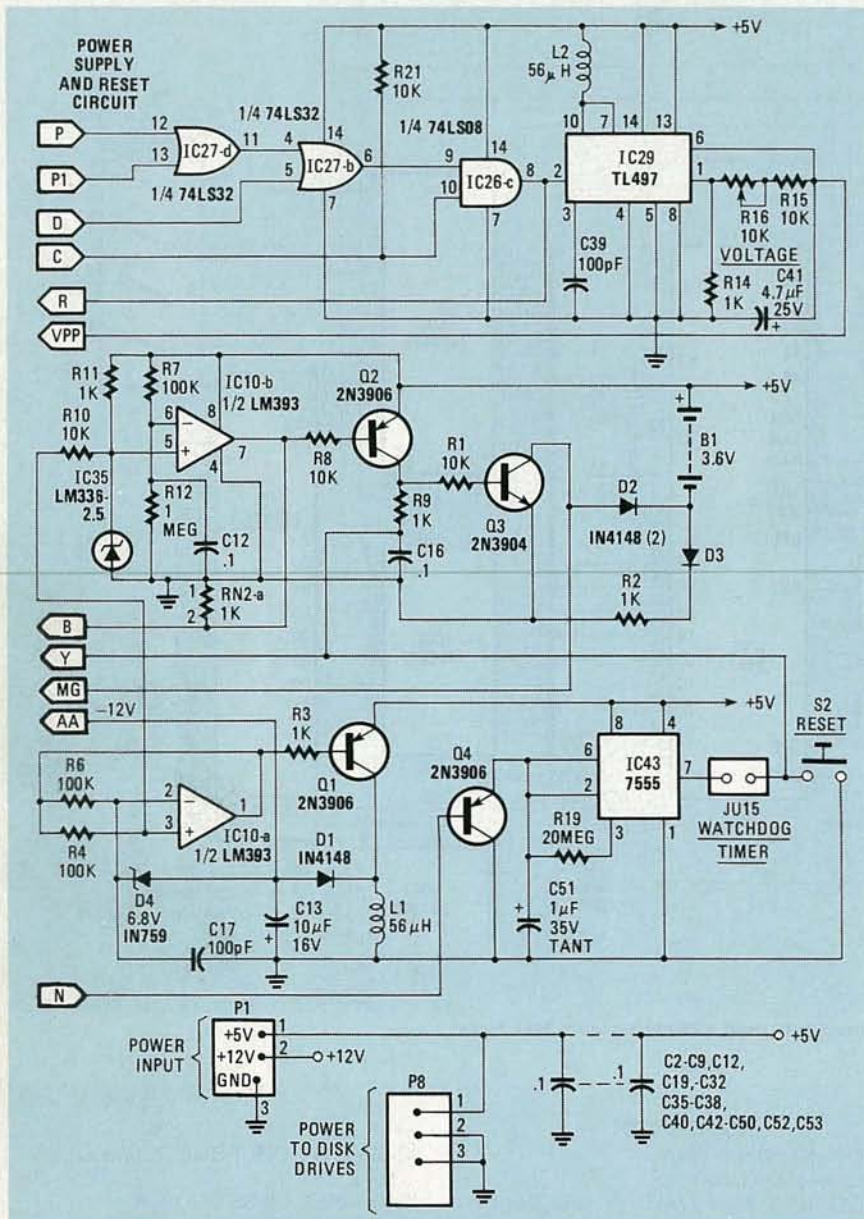

FIG. 5—THE COMPUTER CAN BE RESET using switch S 2. Further, when jumper JU15 is installed, IC43 can provide reset pulses at fairly long intervals—30 seconds with the component values shown.

TABLE 1—S1 COMMUNICATIONS PARAMETERS

Positions				Baud rate	Double-stacked memory socket
a	b	c	d		
0	0	0	0	150	Yes
0	0	0	1	300	Yes
0	0	1	0	600	Yes
0	0	1	1	1200	Yes
0	1	0	0	2400	Yes
0	1	0	1	4800	Yes
0	1	1	0	9600	Yes
0	1	1	1	19200	Yes
1	0	0	0	150	No
1	0	0	1	300	No
1	0	1	0	600	No
1	0	1	1	1200	No
1	1	0	0	2400	No
1	1	0	1	4800	No
1	1	1	0	9600	No
1	1	1	1	19200	No

about 850 mA. The power connector (P1) also routes +12 volts to the disk-drive connector (P7) and the expansion con-

ductor (P5). The RPC does not itself use +12 volts; other necessary voltages are generated on-board. As shown in Fig. 5,

IC29 is a switching regulator that provides the EPROM programming voltage (V_{PP}). Both 12- and 21-volt EPROM's can be accommodated by adjusting R16.

Op-amp IC10-a functions as an oscillator that generates the -6-volt supply for the RS-232 output; IC10-b provides a low-power detection circuit that applies power from battery B1 to the RAM IC's shown in Fig. 2.

The computer's reset function is handled by S2; in addition, IC43, a CMOS 555 timer, can provide reset pulses at fairly long intervals—30 seconds with the component values shown. Jumper JU15 must be installed for those pulses to have effect. As we'll see, resetting the processor periodically can be useful in debugging the hardware.

Construction

Due to the complexity of this project, we recommend that you use a PC board. A double-sided board with plated-through holes is available from the source mentioned in the Parts List; foil patterns for that board are presented in PC Service. If you etch your own board, allow some method of soldering each and every pad on both sides of the board. You should pass a thin jumper wire through all pads in which components are *not* mounted, and solder the jumper on both sides of the board.

Mount and solder all components as shown in the diagram in PC service. Use sockets for all IC's, but don't insert the IC's yet. We recommend that the PC board be wave soldered for several reasons:

- Solder will fill the plated-through holes, thereby increasing their reliability.
- The solder wave will cause the traces under the solder mask to reflow, thereby forming a better circuit.
- Wave-soldered joints are more reliable.

A local electronics assembly shop may be able to wave solder the board for you. After soldering, remove all solder flux and check all work carefully.

Testing and debugging

The next step is the most exciting—and the trickiest. Bringing up an untested microprocessor system is a difficult task, especially without the aid of sophisticated test equipment. However, the following has served us many times, using only a 50-MHz dual-channel oscilloscope.

The first task is to check power distribution. Use an ohmmeter to confirm that the +5-volt line is not shorted to ground. Next, apply power, and check all sockets for power at the correct pins.

The next step is to try to execute code. Install the microprocessor and all of the support circuits required to read from ROM (IC11-IC17, IC21, IC22, IC39). *continued on page 102*

BUILD THIS

COMMERCIAL ZAPPER FOR YOUR RADIO

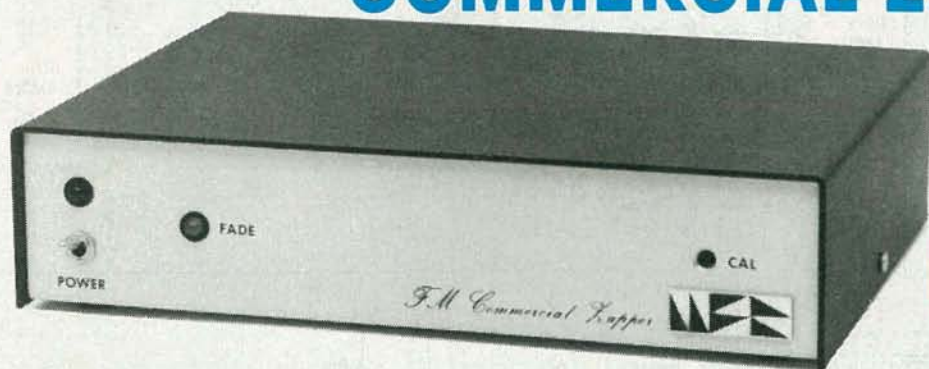

MARK RUMREICH

Bothered by commercial interruptions on FM? Kill 'em with this zapper.

MANY SMALL OFFICES USE FM EASY-LISTENING stations to supply background music. Often, the commercials broadcast by those stations are unobjectionably loud. If you'd like to restore peace and quiet to your office, just connect our commercial killer in your receiver's tape-monitor loop. The circuit automatically senses large changes in volume and reduces output accordingly. In addition, it's easy to build, and inexpensive.

How it works

The commercial killer monitors the incoming signal and reduces output according to how much the input resembles a commercial (we'll discuss how it makes its decision in a moment). In reducing output, the commercial killer takes account of the past few seconds of signal in determining how much to reduce output. Doing so reduces the number of errors and creates a smoother overall effect as it fades out of commercials and fades into music. It is less objectionable to miss the first few seconds of music than to hear the first few seconds of a commercial, so the commercial killer has different attack and decay times.

Whether a signal is "commercial-like" is determined by the rate of large volume transitions. Because music (especially that on "light" stations) is typically composed of a number of instruments playing more or less continuously, the volume (or envelope) stays fairly constant over a short period of time. In a typical commercial, however, the instantaneous volume changes rapidly over time as the announcer pauses between words, and as various additional sound sources are mixed in and out.

Music with much dynamic range (rock and roll, for example) has a high rate of large volume transitions, so the commercial killer probably will trigger erroneously with that type of music.

Figure 1 shows a block diagram of the commercial killer. A summing amplifier adds the left- and right-channel inputs. The summing amp has adjustable gain so that you can find the optimum signal level for the station you use the commercial killer with.

Next comes an envelope detector, which produces a waveform that represents the instantaneous volume of the signal. A comparator (with hysteresis) produces a transition whenever the output of the envelope detector goes either above or below pre-set thresholds. The output of the comparator is conditioned via the transition converter, which produces a pulse of fixed width and amplitude for each transition of the comparator. Those pulses feed a "leaky integrator," whose output determines the gain of the left and right VCA's (Voltage Controlled Amplifiers). The output of the leaky integrator is a DC voltage whose value depends on the

pulse rate from the transition converter.

The VCA's are what actually reduce the output signals during commercials. An LED connected to the VCA's provides a visible indication of the amount of volume reduction taking place.

Figure 2 shows the schematic of the circuit. Diodes D5-D8 form a bridge rectifier that feeds Zener diode D9, which provides a regulated single-ended 16-volt supply for the circuit. Because a single-ended supply is used, a reference voltage (V_{REF}) is generated via the voltage divider composed of R36 and R37 and transistor Q3. That reference voltage is used to bias the op-amps precisely.

Op-amps IC1-a and IC1-b function as buffers that drive both the summing amp (IC2-a) and the VCA's (IC1-c and IC1-d). The outputs of IC1-a and IC1-b are, of course, biased to the reference voltage. To achieve maximum dynamic range, a positive envelope detector follows the

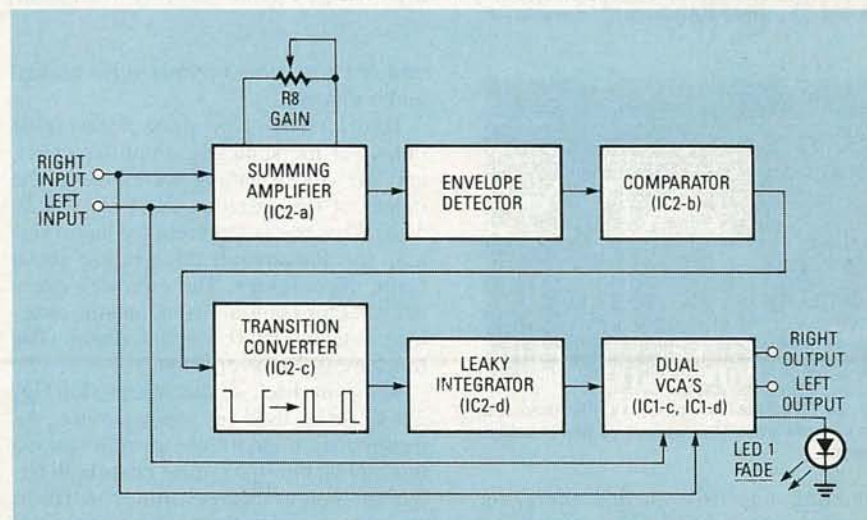

FIG. 1—BLOCK DIAGRAM OF THE COMMERCIAL KILLER: The envelope of the signal is used to vary the pulse rate from IC2-c. The pulses are integrated; the resulting signal controls the gains of a pair of VCA's.

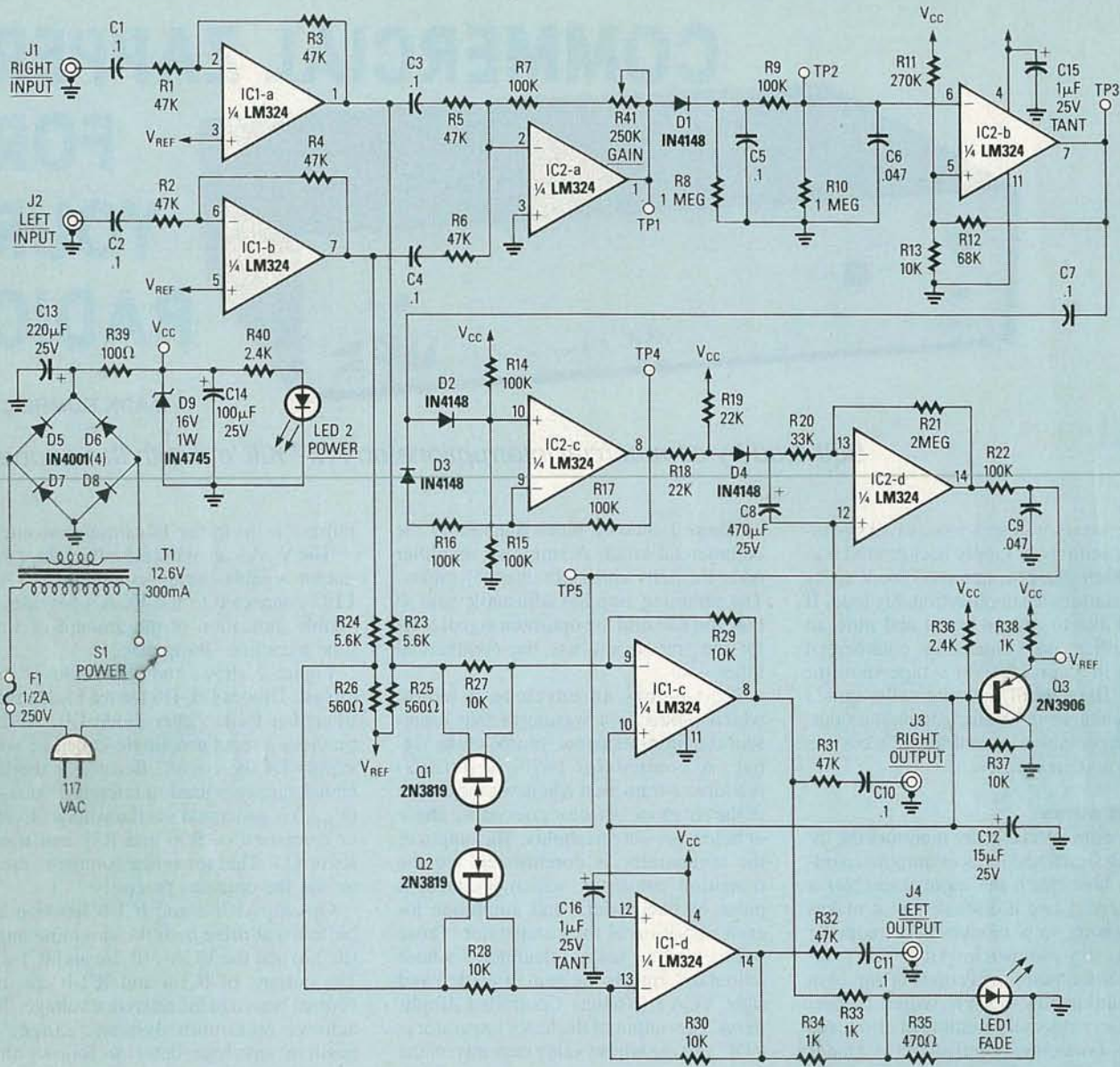

FIG. 2—THE COMMERCIAL KILLER'S SCHEMATIC: Q3 provides a reference voltage for the op-amps; Q1 and Q2 control the gain of IC1-c and IC1-d.

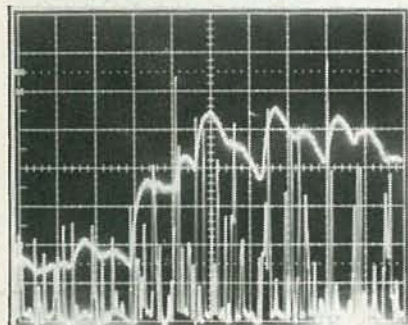

FIG. 3—THE SPIKES represent L + R audio, and the smooth trace, the output of the envelope detector.

summing amp (IC2-a); that allows the summer to be referenced to ground (not V_{REF}). The envelope detector has a sec-

ond-order network optimized for normal audio material.

Figure 3 shows typical waveforms at the output of the summing amplifier (TP1), and the corresponding waveform at the output of the envelope detector (TP2). The spiked traces represent the audio signal, and the smooth trace riding above them, the envelope. The summer's channel is set for 1 volt/division, and the envelope detector for 0.5 volt/division. The timebase is 20 ms/division.

Referring back to the schematic (Fig. 2), IC2-b is used as a comparator. As mentioned earlier, the comparator has two thresholds; the signal must cross both before the output changes from positive to negative (or vice-versa). The equations describing the lower and upper threshold

voltages (V_{LO} and V_{HI} , respectively) as functions of the supply voltage and bias resistors are as follows:

$$A = (R12 \times R13) / (R12 + R13)$$

$$V_{LO} = (A \cdot V_{CC}) / (A + R11)$$

$$B = (R11 \times R12) / (R11 + R12)$$

$$V_{HI} = (R13 \cdot V_{CC}) / (R13 + B)$$

In this case, $V_{LO} \approx 0.5$ volts and $V_{HI} \approx 2.48$ volts.

Figure 4 shows the envelope-detector's output (TP2) at 0.5 volts/division and the comparator's output (TP3) at 2 volts/division (both at 20 ms/division). The square waveform in the center of the photo is the comparator's output; the other waveform is the envelope detector's output. Notice that the comparator does not respond to

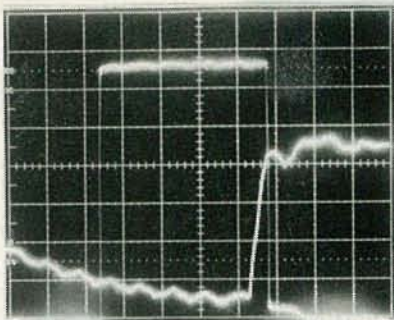

FIG. 4—THE SQUARE WAVEFORM represents the output of the comparator; the other waveform is the output of the envelope detector.

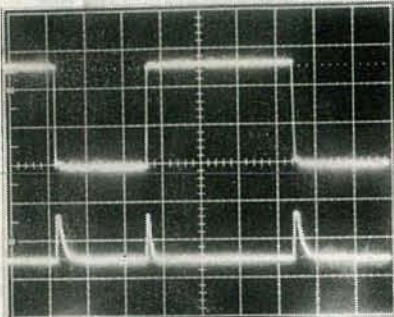

FIG. 5—THE COMPARATOR'S OUTPUT is shown in the upper trace; the output of the transition converter is shown in the lower trace. Every time the comparator changes state, another pulse is generated.

the minor transitions in the early part of the waveform; the comparator's output changes state only after both thresholds have been crossed.

Because the inverting input of the comparator is used for threshold detection, the output is inverted with respect to the input. The comparator responds to specifically designed threshold levels, so it is important that the output of the summing amp provide that level. We'll show how to make the adjustment later.

Figure 5 shows a typical output of the transition converter (TP4) along with the corresponding input from the hysteresis comparator, in the upper and lower traces, respectively. The transition-converter waveform is shown at 5 volts/division, with the bottom graticule at 0 volts; the timebase is 100 ms/division. Notice that the baseline is approximately eight volts ($V_{CC}/2$); that is due to the bias at the non-inverting input of IC2-c.

The leaky integrator (IC2-d) produces a DC voltage that depends on the pulse rate from the transition converter. When no pulses are present, diode D4 is reverse-biased, and the output of IC2-d will be equal to the voltage present at its non-inverting input, V_{REF} . When pulses arrive, diode D4 is forward-biased, so the voltage across capacitor C8 increases. The output of IC2-d then decreases by a factor of about 60 ($R21/R20$). When the pulse rate is high, the output voltage will be between six and nine volts, thereby providing minimum gain from the VCA's. But when the pulse rate is low, capacitor C8 will discharge through resistor R20 to V_{REF} , thereby restoring the gain op-amp to maximum.

The trick about the VCA circuits is that a matched pair of N-channel JFET's act as voltage-controlled input resistors. When gate-to-source voltage (V_{GS}) is near 0 volts, the FET acts as a small resistor, and gain is maximum—about 5 dB with respect to the output of the buffer stages (IC1-a and IC1-b).

However, when V_{GS} is less than -3 volts, the FET acts as a large resistor, so the gain of the op-amp is minimized—it provides about 20 dB of attenuation. In order to provide good left/right matching, the two FET's should have similar voltage and current characteristics, especially at drain-to-source voltages of 0.6 volts.

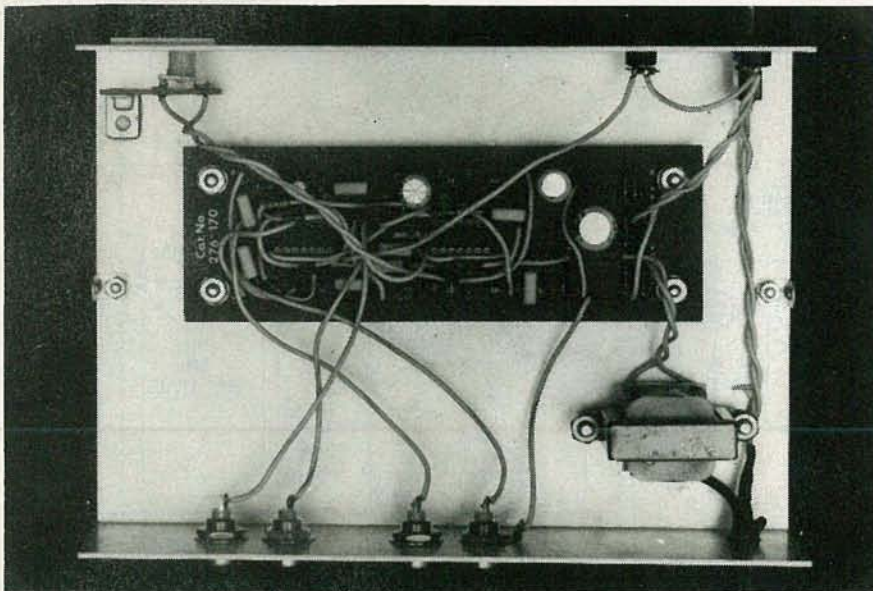

FIG. 6—THE AUTHOR'S PROTOTYPE was built on a piece of perfboard using point-to-point wiring. Keep your lead lengths short, and be careful with the 117-volt primary circuit.

PARTS LIST

All resistors are 1/4-watt, 5% unless otherwise noted.

R1-R6, R31, R32—47,000 ohms
 R7, R9, R14-R17, R22—100,000 ohms
 R8, R10—1 megohm
 R11—270,000 ohms
 R12—68,000 ohms
 R13, R27-R30, R37—10,000 ohms
 R18, R19—22,000 ohms
 R20—33,000 ohms
 R21—2 megohms
 R23, R24—5600 ohms
 R25, R26—560 ohms
 R33, R34, R38—1000 ohms
 R35—470 ohms
 R36, R40—2400 ohms
 R39—100 ohms
 R41—250,000 ohms, trimmer potentiometer

Capacitors

C1-C5, C7, C10, C11—0.1 μ F, ceramic disc
 C6, C9—0.047 μ F, ceramic disc
 C8—470 μ F, 25 volts, electrolytic
 C12—15 μ F, 25 volts, electrolytic
 C13—220 μ F, 25 volts, electrolytic
 C14—100 μ F, 25 volts, electrolytic
 C15, C16—1 μ F, 25 volts, tantalum

Semiconductors

IC1, IC2—LM324 quad op-amp
 D1-D4—1N4148 signal diode
 D5-D8—1N4001 rectifier diode
 D9—Zener diode, 16 volt, 1 watt (1N4745 or similar)
 LED1, LED2—standard
 Q1, Q2—2N3819 N-channel JFET
 Q3—2N3906 (or similar)

Other components

J1-J4—Chassis-mount RCA connectors
 F1—Fuse, 0.5 amp, 125 volts AC
 S1—SPST, 1 amp, 125 volts AC
 T1—Transformer, 12.6 volts, 300 mA (Radio Shack 273-1385 or similar)

NOTE: The following are available from MFR Engineering, 5333 N. Guilford, Indianapolis, IN 46220: Etched and drilled circuit board, \$11; matched set (Q1 and Q2) \$2.50. All prices postpaid. Indiana residents must add applicable sales tax.

Construction hints

Figure 6 shows the author's prototype, which was built on a piece of prototype board. The author used two LM324 quad op-amps, because they're inexpensive and easy to obtain. However, slightly better frequency response and signal-to-noise ratio may be obtained by replacing the op-amps with low-noise JFET op-amps (TL074's, for example). Whichever op-amps you use, make sure that the buffer amps (IC1-a-IC1-d) are not in the same physical package as the processing amps (IC2-a-IC2-d). Also, be sure to connect a good decoupling capacitor, near the IC, from the V_{CC} pin to ground.

Alignment and troubleshooting

To align the commercial killer, adjust the detector-gain potentiometer (R41) to

continued on page 75

BUILD THIS

Concerned about acid rain?
This inexpensive monitor
will keep you informed.



WALTER D. SCOTT

ACID RAIN MONITOR

THE EFFECTS OF ACID RAIN HAVE BEEN widely debated, often with little hard evidence to back up either side's point of view. Actually, it's not difficult to provide hard evidence. A simple one-transistor circuit can be used to sense the acidity of local rainfall (and other liquids). Accuracy is as good as the source used to calibrate the meter. The project can be built for about \$30 using all new parts; many of the parts are of the junkbox variety, so with just a little bit of luck the cost could be even less.

The sensor can be mounted in a remote location; it has a built-in solenoid-operated drain valve. The meter indicates acidity in terms of pH, which refers to the concentration of hydrogen ions in a solution. The meter's range is from 7 (neutral) to 2.5 (highly acidic).

How it works

The schematic diagram of the circuit is shown in Fig. 1. A simple bridge rectifier and 12-volt regulator powers the MOSFET sensing circuit. The unregulated output of the bridge rectifier operates the drain solenoid via switch S1. The sensor itself is built from two electrodes, one made of copper, the other of lead. In combination with the liquid trapped by the sensor, they form a miniature lead-acid cell whose output is amplified by MOSFET Q1. The maximum output produced by our prototype cell was about 50 μ A.

MOSFET Q1 serves as the fourth leg of a Wheatstone bridge. When sensed acidity causes the sensor to generate a voltage, Q1 turns on slightly, so its drain-to-source resistance decreases. That resistance variation causes an imbalance in the bridge, and that imbalance is indicated by meter M1.

Construction

The circuit is simple, but the sensor must be built exactly as shown for calibration to be accurate. As shown in Fig. 2 and Fig. 3, the electrodes must have a diameter of $\frac{1}{4}$ inch, and they must be spaced $\frac{3}{8}$ inch apart in a plastic funnel with a handle to ensure accurate calibration. The positive electrode is a $1\frac{1}{2}$ " length of $\frac{1}{4}$ " copper tubing. The negative electrode is a strip of lead that is formed to the same size and shape as the copper electrode. You should be able to get lead strip from a sporting-goods store; it's used to make fishing sinkers. Otherwise, try a junkyard.

Use flux-less solid-core solder to make connections to the electrodes, and waterproof all exposed joints and wiring. Seal the electrodes in the bottom of the funnel by melting the plastic with a soldering

iron, or plug the funnel with epoxy putty. Use a good-quality waterproof cable to connect the electrodes and solenoid to the control box.

The solenoid assembly must be waterproof, otherwise, water may leak into the solenoid housing and cause a short. But first, remove the valve and coat the plunger with grease, preferably silicone, for temperature resistance. Also, coat all metal solenoid parts with acrylic spray or clear lacquer. Then epoxy the solenoid's valve to the funnel stem through a 1" washer with a drain hole. Mount the solenoid in a 35mm film canister or other waterproof container. It may be necessary to trim off some of the valve's exit tube in order to fit it inside the 35mm film canister.

The method of fitting the solenoid to the cap of the film canister and the mount-

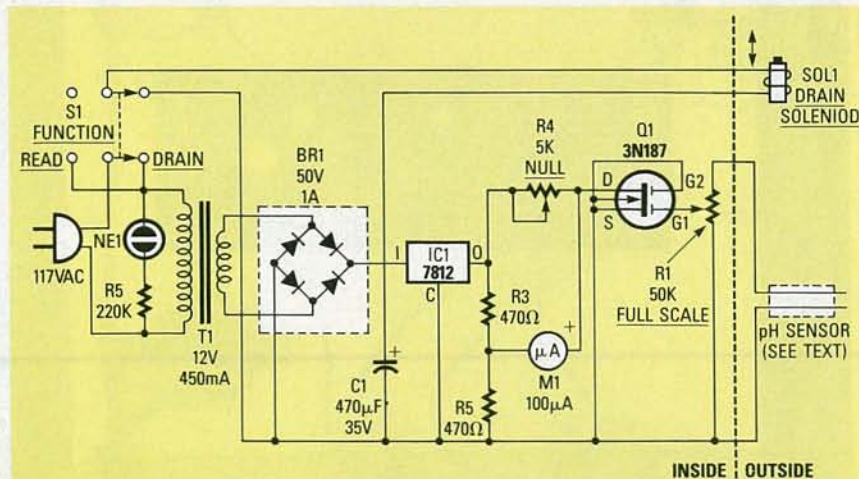

FIG. 1—THE DRAIN-TO-SOURCE RESISTANCE of Q1 varies depending on the acidity of the sample presented to Q1's gate circuit. That variable resistance varies the current flowing through the bridge; that current is proportional to pH.

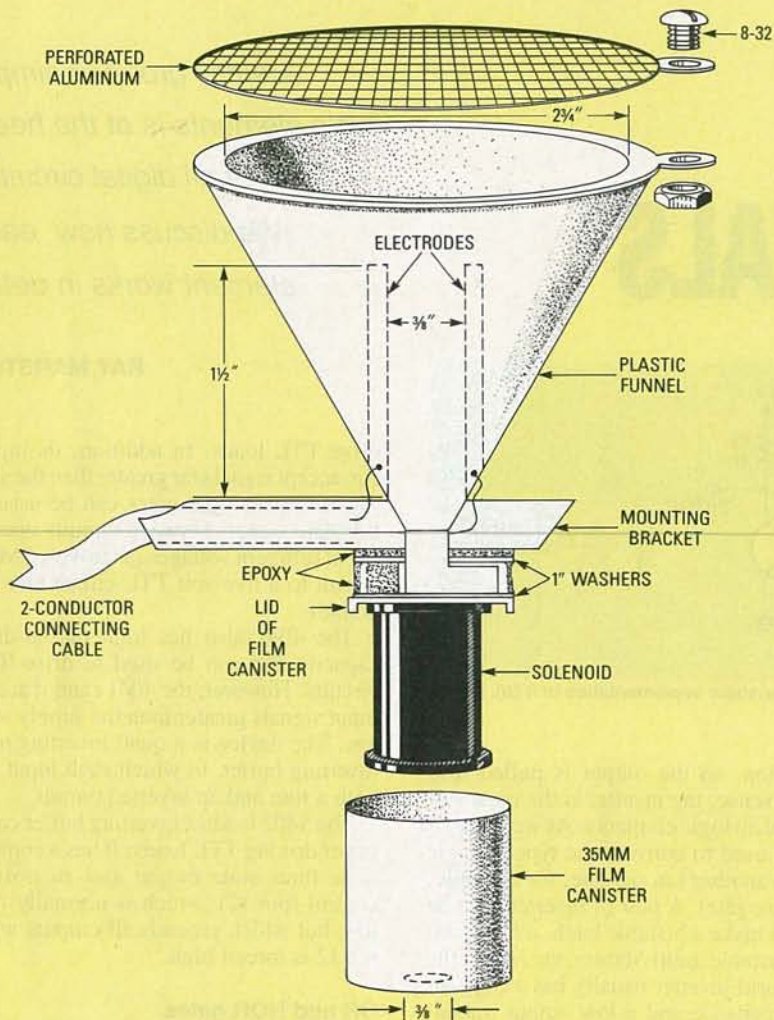

FIG. 2—TWO 3/8-INCH ELECTRODES, made of copper and lead, are mounted inside the funnel, spaced 3/8-inch apart. A solenoid valve attached to the mouth of the funnel is used to drain it as necessary.

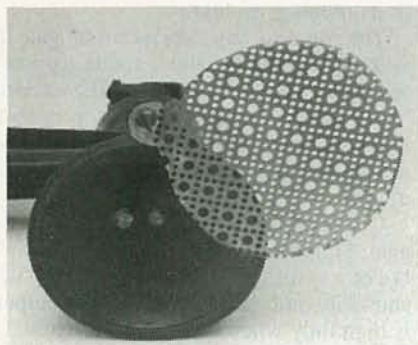

FIG. 3—CLOSE-UP OF THE FUNNEL assembly: the screen keeps foreign matter, which could affect pH, out of the funnel.

ing bracket will depend on the type of solenoid you have. Use epoxy, screws, or both.

As shown in Fig. 4, a swing-away filter cut from perforated sheet aluminum is bolted to the funnel's handle. In addition to preventing drain-clogging or electrode-shortening by air-borne particles, the screen

prevents false pH readings that might be caused by pine needles, oak leaves, or other acidic contaminants. You should

PARTS LIST

All resistors are 1/4-watt, 5% unless otherwise noted.

R1—50,000 ohms, pc-mount, linear potentiometer

R2, R3—470 ohms

R4—5000 ohms, PC-mount, linear potentiometer

R5—220,000 ohms

Capacitors

C1—470 μ F, 35 volts, electrolytic

Semiconductors

IC1—7812, 12-volt regulator

Q1—3N187 MOSFET transistor

BR1—50-volt 1-amp bridge rectifier

Other components

M1—100- μ A panel meter

NE1—Neon lamp

S1—DPDT, 117-volt, toggle, center off

SOL1—12-volt DC solenoid valve

T1—12-volt 450-mA power transformer

TABLE 1—CALIBRATION

pH	μ A
3	82
3.5	76
4	68
4.5	64
5	61
5.5	59
6	56
6.5	53

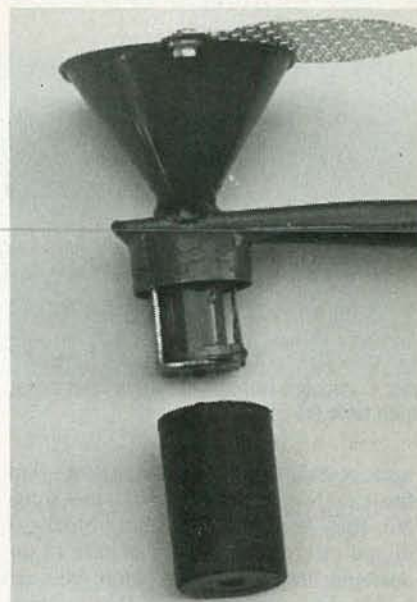

FIG. 4—A 35mm FILM CANISTER provides a water-tight enclosure for the solenoid valve.

also coat the filter with lacquer to prevent aluminum-oxide contamination. Plastic screening is also available and may be used.

All parts were mounted and wired point-to-point on a piece of perfboard; the perfboard was then mounted in a case, as shown in Fig. 5.

Calibration

Our prototype was calibrated against a professional pH meter using precisely-diluted sulphuric acid (which is, by the way, a major ingredient of industrial pollution.) After setting the zero and full-scale points, you can calibrate the meter using Table 1. Otherwise, you can, as we did, measure known solutions with your meter and a professional meter, and mark your meter's scale accordingly.

The first step is to null the meter; 0 μ A represents neutrality, a pH of 7. With the sensor connected through the same cable that will be used for the final installation, set R1 for lowest resistance and fill the receptor funnel with distilled water. Adjust R4 until the meter reads exactly zero.

You'll need to connect a 1.5-volt battery in series with a 5,000-ohm linear potentiometer to calibrate the remaining

continued on page 73

LOGIC-GATE FUNDAMENTALS

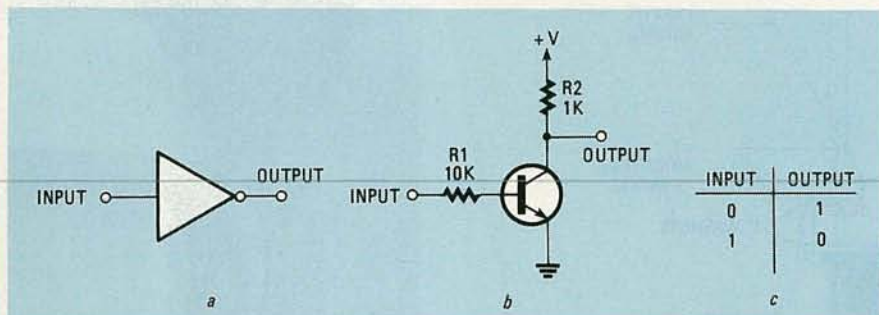

FIG. 1—SHOWN HERE ARE THE INVERTER (a), a resistor-transistor implementation of it (b), and its truth table (c).

AND, NAND, OR, NOR, XOR, XNOR—ARE those the words to some children's song? No, they're the basic building blocks of digital electronics. And you have to understand how they work before you can tackle the microprocessor that controls your car, your stereo receiver, your VCR, even your dishwasher.

Logic elements come in many different forms, and they're built from both integrated circuits and discrete components. Many logic circuits may be designed in more than one way; a detailed understanding of the basic logic elements can help you optimize your design based on the materials at hand. We'll give specific examples of how that's done later; for now let's get our feet wet.

The inverter

Shown in Fig. 1 is the most basic element of digital electronics: the inverter. The symbol for an IC inverter is shown in Fig. 1-a; an inverter may also be built from discrete components, as shown in Fig. 1-b. However it's built, it functions according to the truth table shown in Fig. 1-c.

In any digital circuit, all input and output signals can be at only one of two levels, high or low. A logic high is usually represented by a "1," and a logic low by a "0." When the inverter's input is low (0), its output is high (1), and when its input is high (1), its output is low (0).

In the resistor-transistor circuit (Fig. 1-b), when the input is low, the transistor is cut off, so the output floats high. When the input is high, the transistor goes into

saturation, so the output is pulled low.

In a sense, the inverter is the most versatile of all logic elements. As we'll see, it can be used to convert one type of logic gate to another (an OR gate, for example, to a NOR gate). A pair of inverters can be used to make a bistable latch, a monostable or astable multivibrator, etc. Also, the real-world inverter usually has a high input impedance and a low output impedance, so it can be used as an impedance buffer.

However, not all buffers are of the inverting type. Figure 2-a shows the standard circuit symbol of a non-inverting buffer, which can be made by cascading two inverters, as shown in Fig. 2-b. The truth table in Fig. 2-c shows how the non-inverting buffer works: When the input is low, the output is low, and when the input is high, the output is high.

Of course, both inverters and buffers are available in IC form. For example, the 4049 and the 4069 are hex inverters, and the 4050 is a hex (non-inverting) buffer. The 4069 is especially useful, because it has high output-drive capacity, so it can

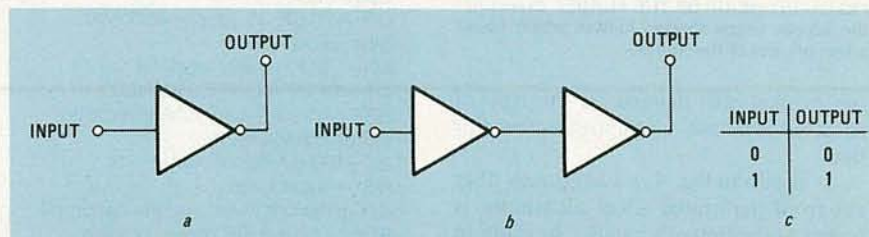

FIG. 2—SHOWN HERE ARE THE NON-INVERTING BUFFER (a), a dual-inverter implementation of it (b), and its truth table (c).

A small group of simple logic elements is at the heart of all digital circuitry. We discuss how each element works in detail.

RAY MARSTON

drive TTL loads. In addition, its inputs can accept signals far greater than the supply voltage, so the gates can be used to translate signals between circuits operating at different voltages (a ten-volt CMOS circuit to a five-volt TTL circuit, for example).

The 4041 also has high output-drive capacity and can be used to drive TTL circuits. However, the 4041 cannot accept input signals greater than the supply voltage. The device is a quad inverting/non-inverting buffer, in which each input has both a true and an inverted output.

The 5402 is a hex inverting buffer capable of driving TTL loads. It has a controllable three-state output and an INHIBIT control (pin 12), which is normally held low, but which grounds all outputs when pin 12 is forced high.

OR and NOR gates

Figure 3-a shows the standard symbol of a two-input OR gate, and Fig. 3-b shows its truth table. As indicated by its name, the output of the OR gate goes high if any of its inputs goes high.

The simplest way to make an OR gate is with several diodes and a single load resistor, as shown in Fig. 4. The diode-based OR gate is reasonably fast, very cost effective, and can readily be expanded to accept any number of inputs by adding a diode to the circuit for each new input.

Closely related to the OR gate is the NOR gate. Figure 5-a shows the standard symbol of a two-input NOR gate, and Fig. 5-b shows its truth table. Note that the output is high only when both inputs are low.

It's easy to convert an OR gate to a NOR gate; Fig. 6 shows several methods. As shown in Fig. 6-a, the diode-based OR gate can be followed by a transistor inverter to produce a NOR gate. Or, as shown in Fig. 6-b, a digital inverter can produce the same effect.

In fact, OR and NOR gates can function in a variety of other ways. As shown in Fig. 7-a, following an OR gate with an

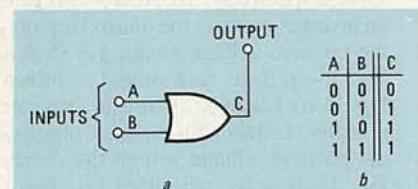

FIG. 3—THE TWO-INPUT OR GATE (a) and its truth table (b).

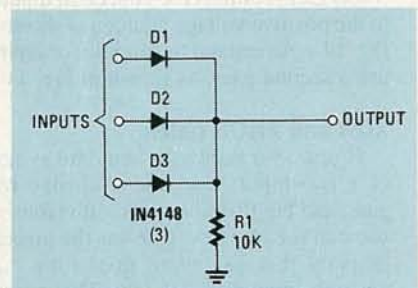

FIG. 4—A THREE-INPUT OR GATE may be built from several diodes and a resistor.

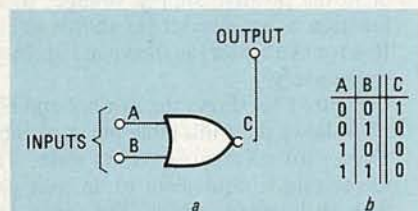

FIG. 5—THE TWO-INPUT NOR GATE (a) and its truth table (b).

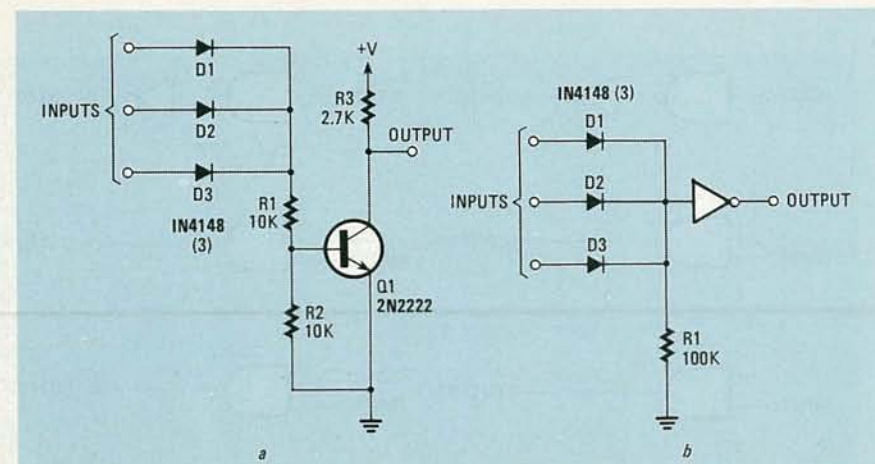

FIG. 6—SEVERAL IMPLEMENTATIONS OF A THREE-INPUT NOR GATE: a diode-transistor version is shown at (a), and a diode-inverter version at (b).

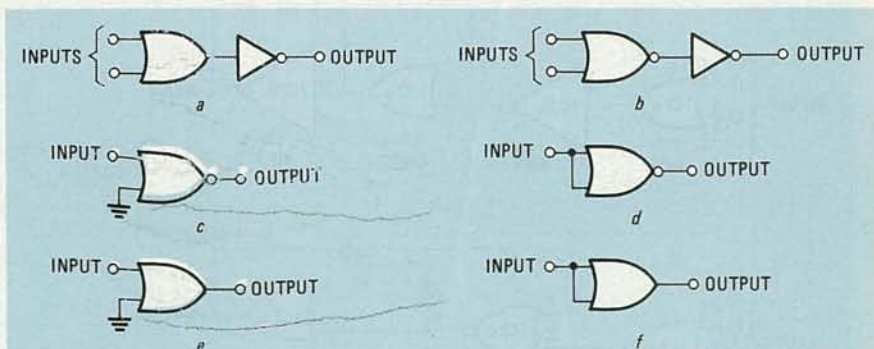

FIG. 7—BY COMBINING A NOR OR AN OR GATE WITH AN INVERTER, you can convert an OR gate to a NOR gate (a), or a NOR gate to an OR gate (b). To use a NOR gate as an inverter, ground the unused input(s) (c) or connect the inputs together (d). To use an OR gate as a buffer, ground (e) or short (f) the unused inputs.

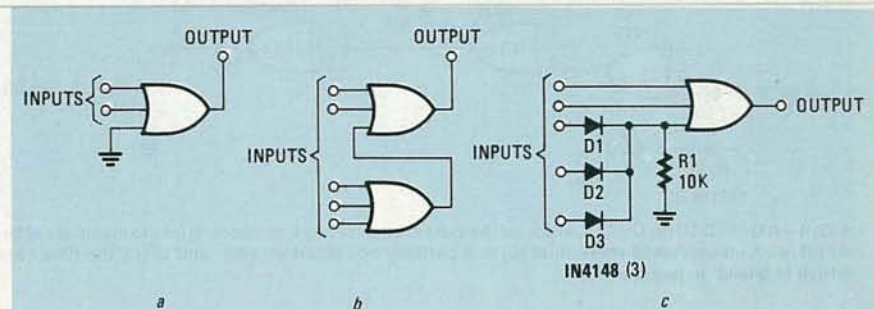

FIG. 8—GROUND UNUSED OR-GATE INPUTS (a); to increase the number of inputs, cascade gates (b), or use diode-resistor logic (c).

inverter produces a NOR gate. Similarly, following a NOR gate with an inverter produces an OR gate (Fig. 7-b). The NOR gate can also function as a simple inverter. Figure 7-c and Fig. 7-d show several ways of configuring a NOR gate as an inverter. Likewise, the OR gate can function as a simple buffer, as shown in Fig. 7-e and Fig. 7-f.

Sometimes a circuit requires more or fewer inputs than the available gates

provide. For example, as shown in Fig. 8-a, you could ground an unused input of a multi-input OR gate. To expand the number of inputs, you can cascade gates, as shown in Fig. 8-b, or you can add resistor-diode logic to one input, as shown in Fig. 8-c.

You might think it's wasteful to use a multiple-input gate as a simple buffer or inverter. In general, that's true, but there are occasions when doing something of that nature is desirable. For example, assume that a design requires an inverter for some function, but that no inverters are available. If there is a spare NOR gate available in another IC it could be used instead.

A practical example

Suppose you want to build a low-power tone generator that can be activated by any one of four inputs. A non-optimal version of such a circuit is shown in Fig. 9-a. For the oscillator composed of IC3-a and IC2-b to work, the pin-2 input of IC3-a must be low. Therefore, the output of the input OR gate must be inverted, so IC2-a is used.

To simplify the circuit, it quickly becomes apparent that IC1-a and IC2-a simply form a NOR gate, so they can be replaced by a single four-input NOR gate.

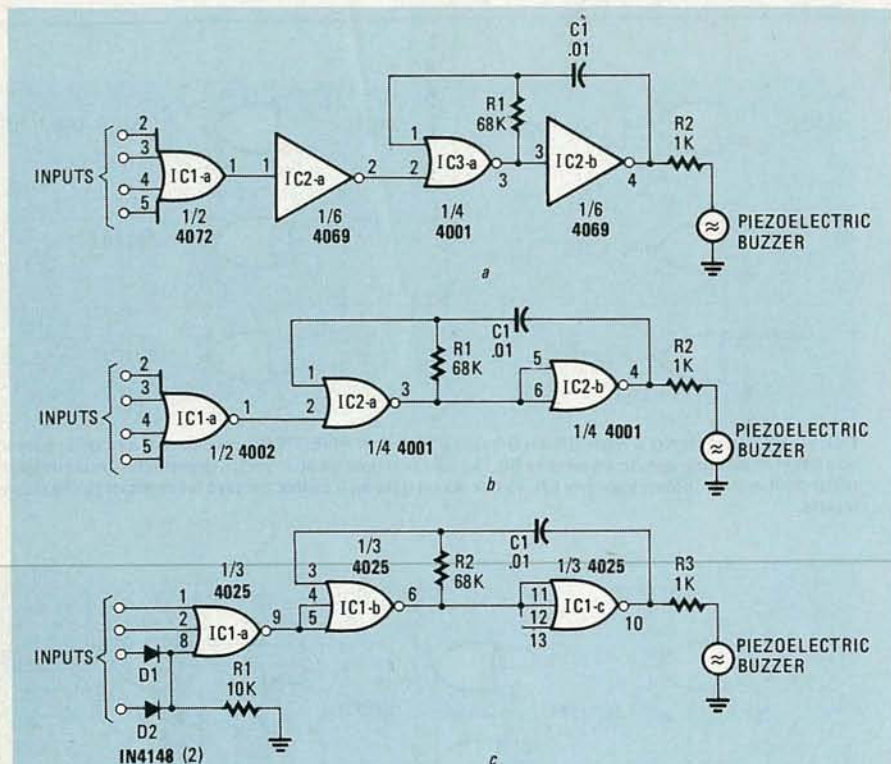

FIG. 9—A GATED TONE OSCILLATOR can be built in several ways, depending on the materials at hand. At (a) is an un-optimized version; at (b) is a partially optimized version; and at (c), the final circuit, which is based on just one IC.

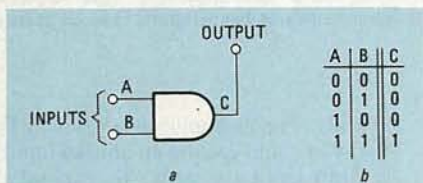

FIG. 10—THE AND GATE schematic symbol (a) and its truth table (b).

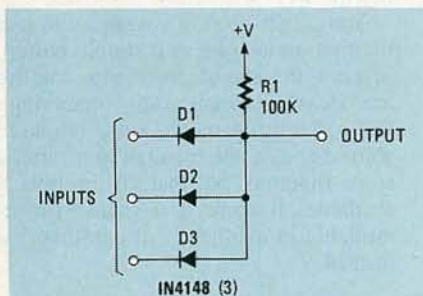

FIG. 11—BUILD AN AND GATE from diodes and a resistor.

as shown in Fig. 9-b. Further, one of the extra two-input NOR gates in IC2 can be used instead of IC2-b, further simplifying the circuit.

However, a little work can reduce the entire circuit to a single IC, as shown in Fig. 9-c. In that circuit three three-input NOR gates are used. The first, IC1-a, is expanded to a four-input gate with resistor-diode logic. The second, IC1-b, functions as a two-input gate. And the third, IC1-c, functions simply as an inverter.

AND and NAND gates

Figure 10-a shows the standard symbol, and Fig. 10-b, the truth table, of a two-input AND gate. As indicated by its name, the output of the AND gate is high only when both of its inputs are high. As shown

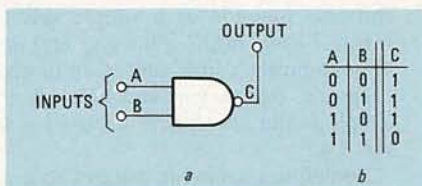

FIG. 12—THE NAND GATE schematic symbol (a) and its truth table (b).

in Fig. 11, the simplest way to make an AND gate is with several diodes and a resistor. Like the OR gate, additional inputs may be obtained by adding an extra diode for each new input.

Figure 12-a shows the standard symbol of a two-input NAND gate; its truth table is shown in Fig. 12-b. As you can see, the output of the NAND gate is low only when both inputs are high.

You can convert a NAND gate to an AND gate or an AND gate to a NAND gate using an inverter, as shown in Fig. 13-a and Fig. 13-b, respectively. To use a NAND gate as an inverter, connect the unused input(s) to the positive voltage source (as shown in Fig. 13-c), or to each other (as shown in Fig. 13-d). Likewise, to use an AND gate as a buffer, connect the unused input(s) to the positive voltage source (as shown in Fig. 13-e) or to each other (as shown in Fig. 13-f).

To reduce the number of inputs to a NAND gate, connect the unneeded input(s) to the positive voltage source, as shown in Fig. 14-a; to expand the number of inputs, use a second gate, as shown in Fig. 14-b.

XOR and XNOR gates

Figure 15-a shows the standard symbol of a two-input XOR (for eXclusive OR) gate, and Fig 15-b shows its truth table. As you can see, the XOR gate has the unusual property that its output goes high only when its inputs are different. That property gives the XOR gate unusual flexibility; by connecting its unused input to ground or to the positive supply voltage, it can function as an inverter (as shown in Fig. 16-a) or as a buffer (as shown in Fig. 16-b), respectively.

Figure 17-a shows the symbol and Fig. 17-b shows the truth table of a two-input XNOR (for eXclusive NOR) gate. The XNOR gate is equivalent to an XOR gate with an inverted output. The XNOR gate gives a high output only when both inputs are identical; it's very useful in logic-comparator applications.

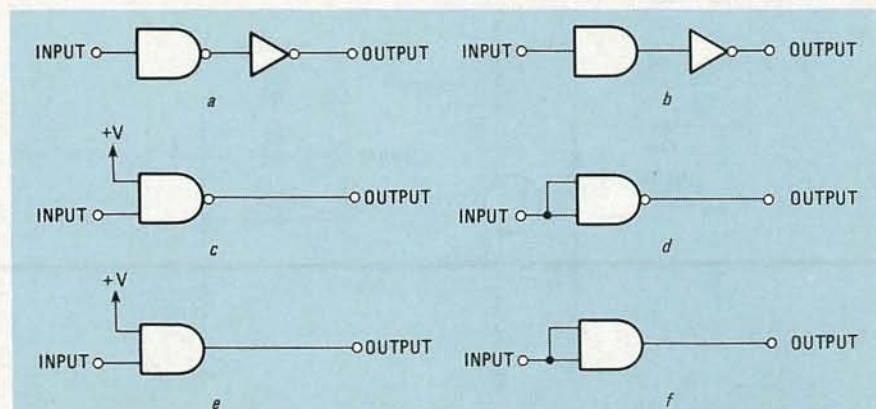

FIG. 13—BY COMBINING A NAND OR AN AND GATE WITH AN INVERTER, you can convert a NAND gate to an AND gate (a), or an AND gate to a NAND gate (b). To use a NAND gate as an inverter, tie the unused input(s) high (c) or connect the inputs together (d). To use an AND gate as a buffer, tie the unused input(s) high (e) or short (f) the inputs.

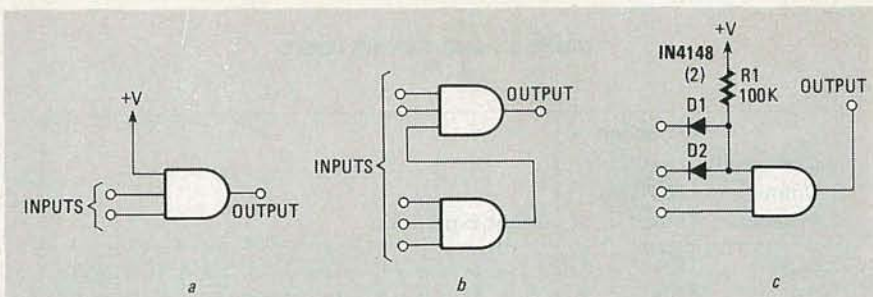

FIG. 14—TIE UNUSED AND-GATE INPUTS high (a); to increase the number of inputs, cascade gates (b) or use diode-resistor logic (c).

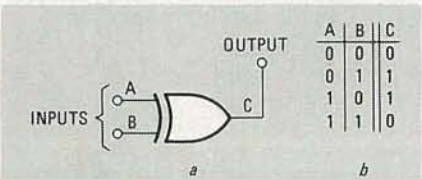

FIG. 15—THE XOR GATE schematic symbol (a) and its truth table (b).

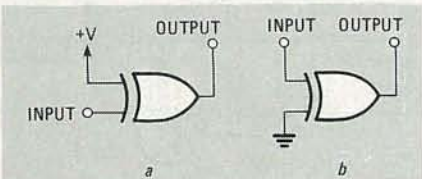

FIG. 16—USE THE XOR GATE AS AN INVERTER (a) or as a buffer (b).

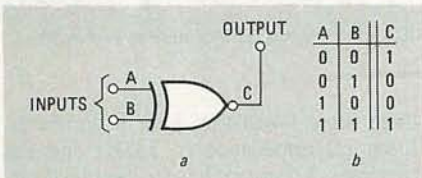

FIG. 17—THE XNOR GATE schematic symbol (a) and its truth table (b).

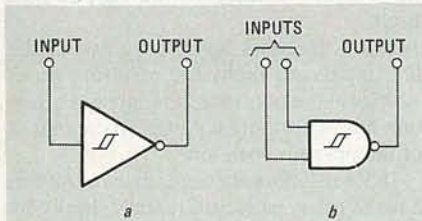

FIG. 18—AN INVERTING SCHMITT TRIGGER (a) and a NAND-gate Schmitt trigger. Use a Schmitt trigger to square up slowly changing input signals.

The Schmitt trigger

CMOS inverters and gates are generally intended to be driven by logic signals, signals that are either fully high (logic 1) or fully-low (logic 0). If inputs linger between those two states for more than a few microseconds, there is a danger that the inverter/gate will become unstable and act as a high-frequency oscillator, thereby generating false output signals. So if slow signals are present at one or more of CMOS inputs, those signals should be

“conditioned” (given fast rise and fall times) before being applied to the actual logic circuitry.

The most useful conditioning element is the Schmitt trigger. Schmitt triggers come in many forms; Fig. 18-a and Fig. 18-b illustrate one section of a hex Schmitt inverter (the 40106) and one section of a quad NAND gate (the 4093), respectively. Schmitt-type gates logically function the same as regular CMOS and TTL gates; only the electrical switching and current-drive characteristics vary.

Programmable logic

Most logic IC's are dedicated devices.

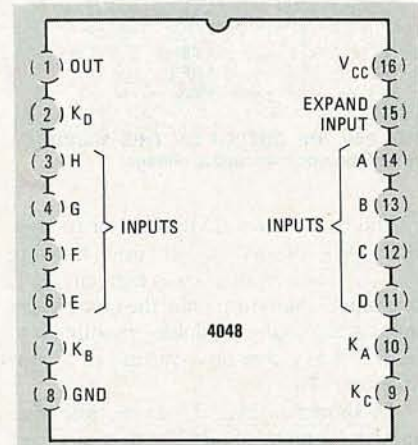

FIG. 19—THE 4048 EXPANDABLE, PROGRAMMABLE eight-input logic gate. Eight logic functions are possible (see Table 1).

TABLE 1—4048 FUNCTIONS

Output Function	Control Inputs			Unused Inputs
	K _A	K _B	K _C	
NOR	0	0	0	0
OR	0	0	1	0
OR/AND	0	1	0	0
OR/NAND	0	1	1	0
AND	1	0	0	1
NAND	1	0	1	1
AND/NOR	1	1	0	1
AND/OR	1	1	1	1

K_D = 1 FOR NORMAL ACTION
 K_D = 0 FOR HIGH-Z OUTPUTS
 EXPAND INPUT = 0

Without external components, a NAND gate, for example, can't function as anything else. There are, however, special logic elements that can be programmed to function as any one of a variety of gates, in various configurations.

One such gate is the 4048, a multifunc-

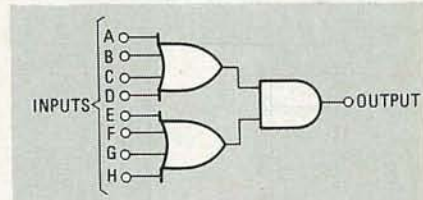

FIG. 20—THE 4048 MAY BE CONFIGURED as a dual four-input OR/AND gate.

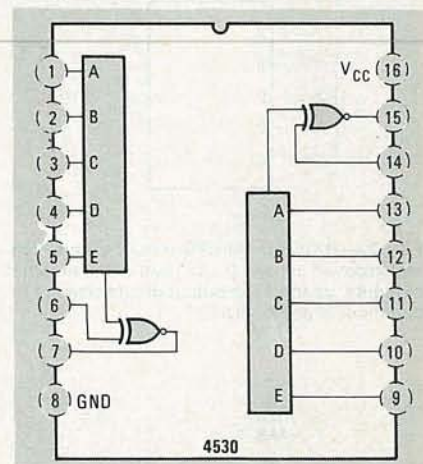

FIG. 21—THE 4530 MAJORITY LOGIC IC. Its output becomes active when more inputs are high than low.

tion programmable eight-input gate. Its pin-out is shown in Fig. 19. The IC has two groups of four logic inputs (A-H), an expansion input, and four control inputs (K_A-K_D) that allow you to select the mode of operation.

Control input K_D allows you to select operation of the outputs: either normal or three-state. The remaining control inputs (K_A, K_B, and K_C) enable one of eight different logic functions to be selected, as shown in Table 1.

Operation in the AND, OR, NAND, and OR NOR modes is conventional, but operation in the other modes (OR/AND, OR/NAND, AND/OR and AND/NOR) is slightly more complex. In the latter cases, the inputs are broken into two groups of four, which provides the first logic function. Those outputs are then combined according to the second function. So, for example, to use the 4048 as an eight-input OR/AND gate (as shown in Fig. 20), K_A and K_C would be connected to ground, and K_B would be connected to the positive supply voltage.

The EXPAND input of the 4048B allows IC's to be cascaded, so that, for example,

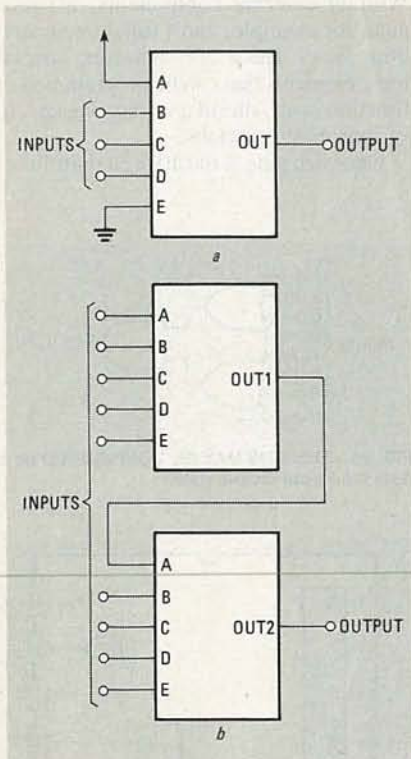

FIG. 22—UNUSED INPUTS must be tied high and grounded in pairs (a). To expand the number of inputs, connect the output of one element to one input of another (b).

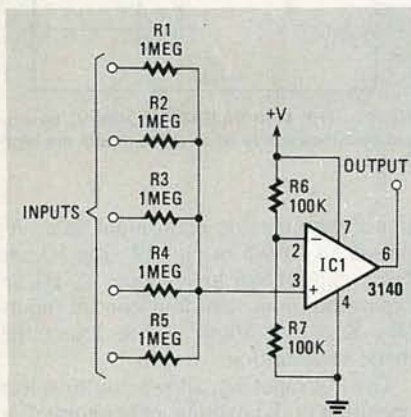

FIG. 23—BUILD A MAJORITY-LOGIC function from discrete components as shown here. The output swings from ground to several volts below the positive supply voltage.

two IC's could function as a single 16-input gate by feeding the output of one IC into the EXPAND input of the other. Note that, when using expanded logic, the overall logic functions of the two IC's may differ; Table 2 summarizes the configurations and their output expressions.

Majority logic

Less well known than the logic families we've already discussed is *majority* logic, which, as the name implies, gives an output when the majority of an odd number of inputs are high, irrespective of which inputs are active.

TABLE 2—4048 EXPAND LOGIC

Combined Output Function	Function needed at EXPAND input	Output expression
NOR	OR	$J = \overline{(A + B + C + D + E + F + G + H)} + (\text{EXP})$
OR	OR	$J = (A + B + C + D + E + F + G + H) + (\text{EXP})$
AND	NAND	$J = \overline{(ABCDEFGH)} \cdot \overline{(\text{EXP})}$
NAND	NAND	$J = (ABCDEFGH) \cdot (\text{EXP})$
OR/AND	NOR	$J = (A + B + C + D) \cdot \overline{(E + F + G + H)} \cdot \overline{(\text{EXP})}$
OR/NAND	NOR	$J = (A + B + C + D) \cdot \overline{(E + F + G + H)} \cdot (\text{EXP})$
AND/NOR	AND	$J = \overline{(ABCD)} + \overline{(EFGH)} + (\text{EXP})$
AND/OR	AND	$J = (ABCD) + (EFGH) + (\text{EXP})$

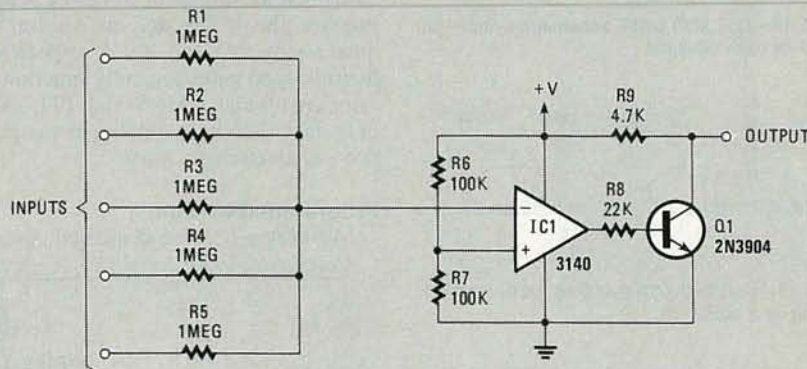

FIG. 24—THE OUTPUT OF THIS MAJORITY-LOGIC circuit swings from ground to within 50 mV of the positive supply voltage.

The best known CMOS majority-logic IC is the 4530, a dual 5-bit unit shown in Fig. 21. The output of each element feeds one input of an XNOR gate; the other XNOR input is externally available, enabling it to be wired as either an inverting or a non-inverting stage.

As shown in Fig. 22-a, the effective number of inputs of a 4530 can be reduced by wiring half of the unwanted inputs high and the other half low. On the other hand, the effective number of inputs can be increased by cascading elements, as shown in Fig. 22-b.

Majority-logic IC's can be difficult to find, but it's easy to simulate majority logic with an op-amp, as shown in Fig. 23. In that circuit the op-amp functions as a voltage comparator; voltage-divider R6-R7 applies one-half the supply voltage to the inverting input (pin 2) of the op-amp, and the five input resistors (R1-R5, each of which must be connected either to ground or to the positive supply voltage) form a voltage divider that supplies a fraction of the supply voltage to the op-amp's non-inverting input (pin 3).

To understand how it works, suppose that two input resistors are connected to ground and that three resistors are connected to the positive supply voltage. The

three logic-1 resistors have a combined (parallel) impedance of 333K, and the two logic-0 resistors have a combined impedance of 500K. Therefore the resulting voltage on pin 3 is greater than one-half the supply voltage, so the output goes high.

If, on the other hand, only two of the five inputs go high, the resulting pin-3 voltage at the non-inverting input is below one-half the supply voltage, so the output of the op-amp goes low.

If 5% resistors are used, that circuit can have as many as eleven inputs, simply by adding additional one-megohm input resistors. The output of the circuit goes all the way to ground, but it only rises to within several volts of the value of the supply voltage when the output is high. In many applications that's of little importance; it does, however, mean that elements cannot be cascaded to increase the total effective number of inputs.

That defect can be overcome by using the "compound" circuit shown in Fig. 24. In that circuit, the output is inverted and level-shifted by Q1, and the op-amp inputs are transposed. The output of that circuit swings to within 50 mV of either supply rail, enabling circuits to be cascaded without limit.

R-E

A NOCTURNAL BAT EMITS WEAK ULTRASONIC chirps as it bobs and weaves through a maze of obstacles; a deep-space probe accurately broadcasts its position to an earth-based tracking station; and a military radio link is maintained despite powerful enemy jamming signals. In all of those situations, a modulation technique known as *spread spectrum* is used.

As its name implies, in spread spectrum a communications signal is spread over a wide frequency range. Among the potential advantages offered by spread-spectrum communications are message privacy, signal invisibility, noise rejection, and accurate signal timing.

In this article we will look at some of the various spread-spectrum techniques in use today. Among them are frequency hopping, time hopping, chirping, and direct sequence. But before we can fully understand those techniques and their applications in space, military, and commercial communications, some necessary groundwork must be laid.

Time vs. frequency

A signal can be represented in one of two ways. Most often, a signal is represented as a function of time (change in amplitude vs. change in time). That is also called a *time-domain* representation. But signals can also be represented as a function of frequency (change in amplitude vs. change in frequency). That is called a *frequency-domain* representation.

In Fig. 1 are two common signals; both are shown in the time and the frequency domain. In Fig. 1-a is the time-domain representation of a wide data pulse; the frequency-domain representation of that signal is shown in Fig. 1-b. A narrow pulse or spike is shown in the time domain in Fig. 1-c; the frequency-domain version of that signal is shown in Fig. 1-d.

Any signal can be shown in either the time or the frequency domain. It is also possible to convert a time-domain representation to a frequency-domain representation, and vice versa, using a mathematical operator called a *transform*. The most familiar of those, at least to advanced students of electronics, are the *Fourier* and the *Laplace* transforms. As a meaningful discussion of transforms requires a working knowledge of calculus, we will not go into further depth on that subject here. Consult your local library for more information on the subject.

Bandwidth

The most familiar type of frequency-domain representation shows us the *bandwidth* or spectrum of a signal at an instant of time. Such a representation is called an *instantaneous bandwidth* and can be thought of as a snapshot view of a signal's

ALL ABOUT

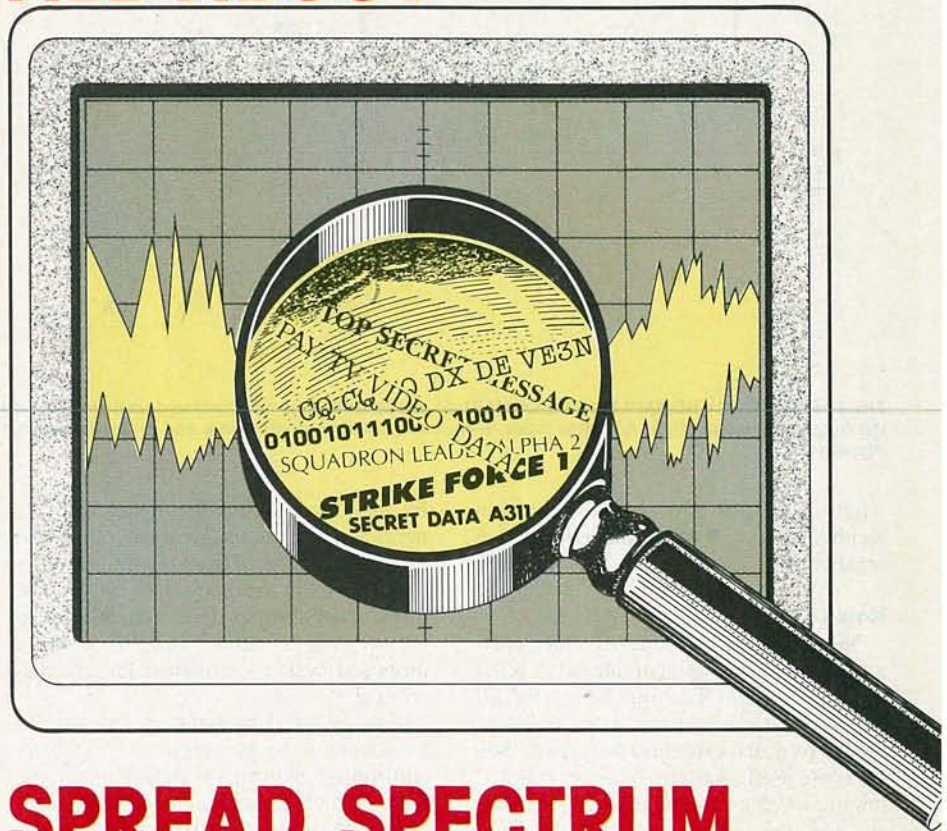

SPREAD SPECTRUM COMMUNICATIONS

Learn about the methods used by the government

and others to achieve reliable

communications under the most difficult conditions.

JAMES E. McDERMOTT

frequency spectrum. Instantaneous bandwidth is most useful when discussing pulsed signals.

In some spread-spectrum techniques, the bandwidth of a signal changes significantly over time. For instance, in a frequency-hopping system (such systems will be discussed later on in this article) the instantaneous bandwidth may be narrow; but over time, signal components may be present over a wide frequency range. For such signals, the concept of *hopped bandwidth* is useful. Hopped bandwidth is analogous to time-lapse photography and describes the full extent of the frequency spectrum covered by the signal.

A spread-spectrum signal, by definition, occupies a larger bandwidth than necessary to convey information. The

minimum bandwidth required to convey the information contained in the signal is called the *information bandwidth*. For example a voice signal requires approximately 2000 Hz of bandwidth to be faithfully reconstructed; a television signal may require 6 MHz. A typical spread-spectrum signal carrying a single voice message may occupy a hopped bandwidth of 100 MHz, or an instantaneous bandwidth of 10 MHz or more.

For a signal-processing technique to be useful it must offer some gain over an unprocessed signal. That gain is called *process gain*. In spread-spectrum systems, the process gain is the ratio of the spread-spectrum bandwidth to the information bandwidth; it can be expressed in decibels by the formula:

$$G_P = 10 \text{ LOG } (BW_{RF}/BW_I)$$

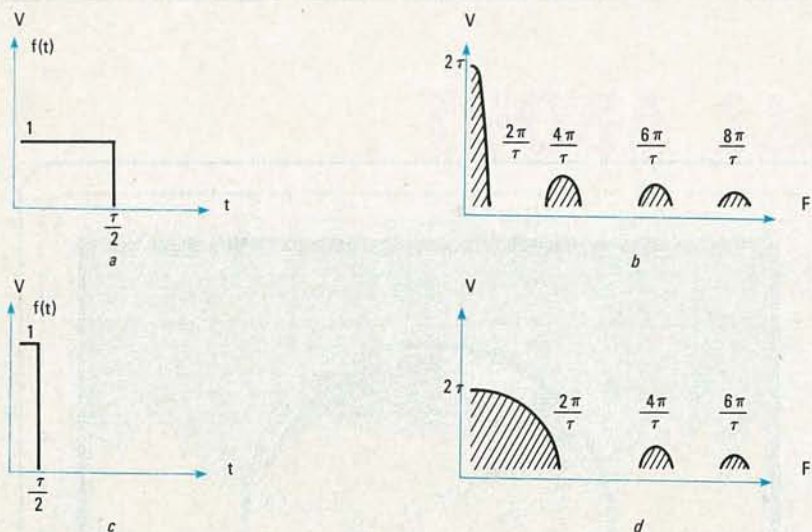

FIG. 1—FREQUENCY DOMAIN VS. TIME DOMAIN. A wide pulse is shown in the time domain in *a* and in the frequency domain in *b*. A narrow pulse is shown in the time domain in *c* and in the frequency domain in *d*.

where BW_{RF} is the spread-spectrum bandwidth and BW_I is the information bandwidth.

Noise

Noise can be considered as all RF energy other than the signal of interest; it is the most significant limiting factor for all communications systems. For a signal to be received, its level must be greater than the noise level. A useful quantity in determining whether a signal will be received, and how well, is the Signal-to-Noise Ratio (SNR). The SNR can be expressed in dB's using the following formula:

$$SNR = 10 \text{ LOG (signal-power/noise-power)}$$

In designing a communications system, the goal is to maximize the effective SNR. When increasing the signal strength is either impractical or illegal, the only recourse is to minimize the effects of the noise degrading the signal. Depending on the nature of the signal and the noise, there are various techniques that can be used to achieve that goal.

When faced with white or flat noise, narrowband signals are transmitted so that effective filtering can be done at the receiver. A bonus is that the use of narrow bandwidths allows for greater use of the crowded communications bands.

Willful interference, especially from narrowband, high-power jammers, is quite another story, however. Spread spectrum is a powerful weapon in combating that type of interference.

Some history

As early as the 1920's, engineers proposed using broadband signals, primarily to counteract the effects of fading on communications links. The idea was to spread the signal energy over a wide range of frequencies, then to reconstruct the signal

by gathering all the frequency components at the receiver. Then when one part of the band suffered from fading, the combined signal in the receiver would only be diminished slightly. Unfortunately, technology was far behind insight, so those proposed systems remained largely theoretical.

World War II brought an urgent need for secure communications as engineers confronted man-made problems in the form of high-power jammers. Engineers tackled the problem using that era's more-advanced technology. Before the war's end both sides were using sophisticated communications systems, many of which used bandspreading techniques.

By occupying large bandwidths, spread-spectrum signals increase their ability to withstand interference by improving what is referred to as *jamming*

margin. For example, if a narrowband signal is marginally readable under a certain level of jamming or interference, and 20 dB of G_p is added by using a spread-spectrum technique, then the signal can withstand 20 dB, or 100 times, more jamming power.

A useful byproduct of the bandwidth spreading process is a proportional reduction in signal density, making the signal virtually undetectable by an uninformed receiver. That has a particular appeal in tactical and strategic systems; today the military is one of the largest users of spread-spectrum systems.

A communications shell game

A frequency hopper is a communications signal in which the carrier frequency is continuously changed to one of a great many frequency slots. The resulting signal has a large hopped bandwidth, often in the hundreds of MHz. Figure 2-a shows the resulting spectrum for a 10-slot system, although typical systems in use today may have 1000 or more such "hop slots." A noise source, usually a digital PseudoNoise (PN) sequence generator, is used to determine the current hop slot. A typical hop sequence for a ten-slot system is shown in Fig. 2-b. A typical frequency-hopper system is shown in block diagram form in Fig. 3.

Frequency hoppers can be subdivided into fast hoppers, which can change frequency in less than a microsecond, and slow hoppers, which may use each slot frequency for several seconds at a time. Fast hoppers are generally used in tactical military environments where jammers can quickly home in and swamp a slow-hopping signal. Such a system is usually based around expensive state-of-the-art frequency synthesizers. Fast hoppers are limited by the speed at which the synthesizer can be effectively switched, al-

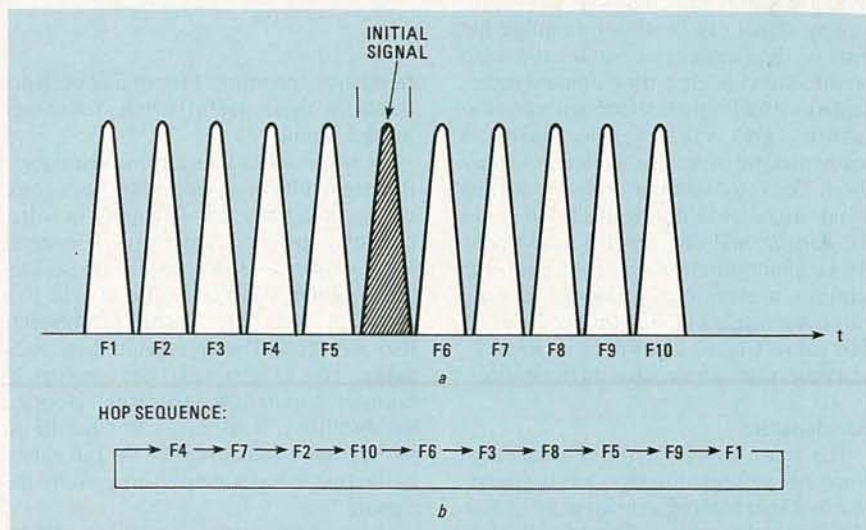

FIG. 2—A FREQUENCY HOPPER will jump from one frequency slot to another over time. The spectrum of a simple 10-slot system is shown in *a*. One possible hop sequence for the system shown in *a* is shown in *b*.

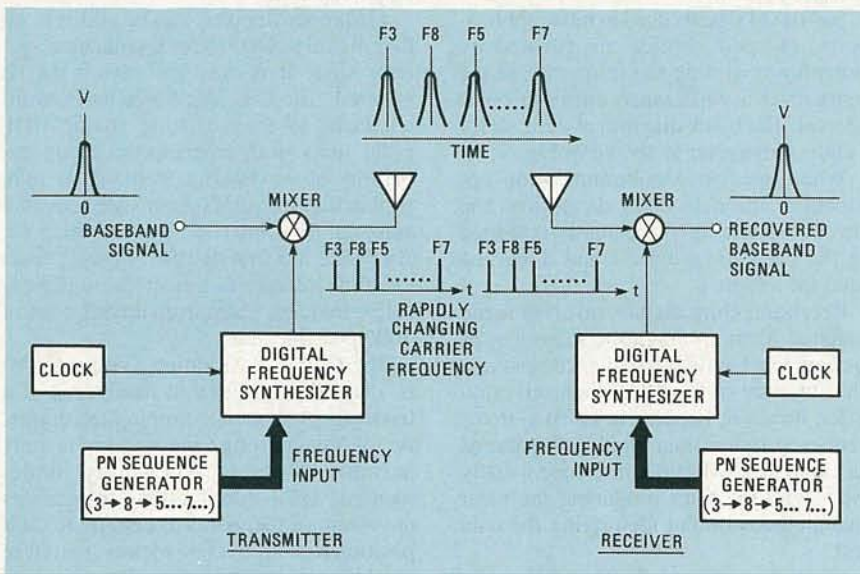

FIG. 3—BLOCK DIAGRAM of a typical frequency-hopper system. The pseudo-random noise-sequence generators at both the transmitter and receiver are set up to output the same sequence.

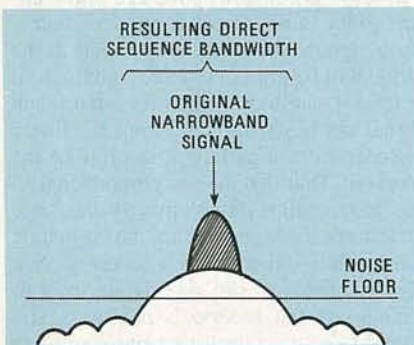

FIG. 4—WHEN AN RF SIGNAL IS MODULATED by a digital pulse, the carrier widens. If that pulse were replaced with a chip sequence, extremely wide bandwidths would result.

though many can hop over a 1-GHz range in less than 1 μ s.

Slow hoppers are normally used where low cost is important and where any expected jamming lacks sophistication. Slow hoppers are also used as an inexpensive way to share a band among many users. By carefully selecting the hopping sequences or codes to prevent overlap, several slow-hopped systems can co-exist in the same band and in so doing increase band efficiency. A jammer attempting to interfere with a specific signal is now even less effective since it may be impossible to isolate that signal from the rest of those using the band. (Of course, a jammer could always just knock the entire band out of service.)

Signal shredders

Imagine shredding an important message into a million pieces and then scattering them into a tornado. A thousand miles away someone gathers up all or almost all of the snippets and reconstructs the original message. If you substitute communications signals for the paper you have the

essence of the most sophisticated and exciting of the spread-spectrum techniques: direct-sequence spreading.

In the direct-sequence technique, bandspreading is accomplished by exploiting the inherent properties of digital modulation. That is, whenever a pulse stream is mixed with a carrier signal, a slight broadening of the RF carrier oc-

curs. However, if instead of a single bit, a long code sequence, called a *chip sequence*, is sent in the same time interval, large instantaneous bandwidths can be produced, as shown in Fig. 4. The wide bandwidths are a direct consequence of the extremely narrow pulse widths of the bits in the chip sequence.

In the receiver, the RF signal must be *correlated*; that is the signal must undergo a de-spreading or bandwidth-collapsing procedure. First, the signal is converted back to baseband by mixing it with an appropriate carrier signal. The resulting baseband signal contains noise as well as the chip sequence. That noise, which includes willful interference, must be removed. That task can be handled in many ways, but one design makes use of a *matched filter*, a circuit that compares the received chip sequence with a predetermined sequence and looks for a match.

One popular matched-filter design is built around an analog shift register, as shown in Fig. 5. As each bit in the chip sequence is received, it is fed into the input of the register. As the bits are cycled through the register, the contents of each cell are sampled and summed. The output of the filter is a current that is proportional to the degree of the match. The filter shown in Fig. 5 is set up to look for a sequence of 1101101. When the bits in each cell match that sequence exactly, the out-

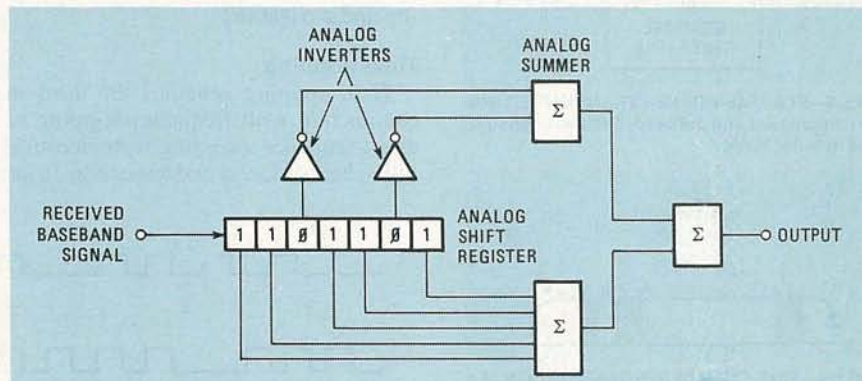

FIG. 5—MATCHED FILTERS are used to search for particular chip sequences. The one shown here, which is built around an analog shift register, searches for the sequence 1101101.

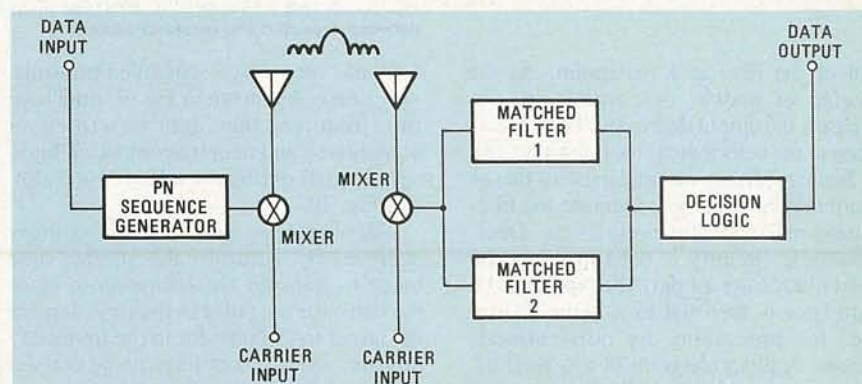

FIG. 6—MULTIPLE MATCHED FILTERS are used in direct-sequence receivers to increase the likelihood of successful correlation. Decision logic is used to select the filter output that is most likely to be correct.

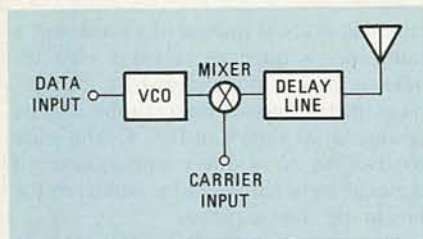

FIG. 7—A CHIRP-SYSTEM transmitter is shown here in block diagram form.

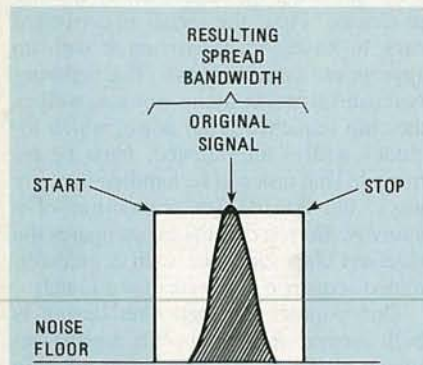

FIG. 8—THE CHIRP SIGNAL'S carrier frequency is continuously swept through part of a band. Intelligence is conveyed by the direction of the sweep.

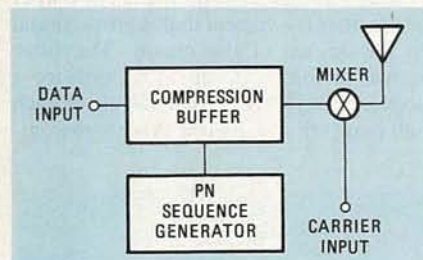

FIG. 9—IN A TIME-HOPPER TRANSMITTER data is compressed and buffered, and then transmitted in burst form.

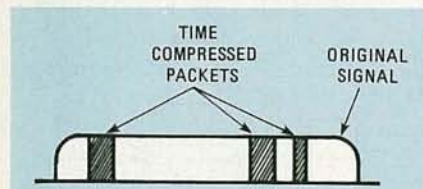

FIG. 10—TIME-DOMAIN REPRESENTATION of a time-hopped signal. In the frequency domain, the resulting spectrum would be similar to that of a direct sequence signal.

put of the filter is a maximum. As the degree of match, or correlation, decreases, the output decreases. If the bits in none of the cells match, the output is zero.

Some receivers will make use of two or more matched filters to increase the likelihood of successful correlation. Decision-logic circuitry is used to select the most likely filter output. The output of the correlator is then fed to a demodulator, etc. for processing by conventional means. A block diagram of a typical direct-sequence system, up to the output of the correlator at the receiver, is shown in Fig. 6.

Chirp systems

Similar to signals used in radar applications, chirped signals are formed by sweeping or sliding the frequency of the signal over a wide range during a pulse interval. The block diagram of a circuit for a chirp transmitter is shown in Fig. 7.

When used in a communication application, the data input determines the direction of the chirp: frequency is shifted up for a logic 1 and down for a logic 0.

Receiving chirp signals involves using matched filters in much the same way as they are used in direct-sequence systems. The structure of the filters themselves do differ, however, because in chirp systems frequency rather than amplitude patterns are of interest. Multiple filters are usually used, with the filter producing the most unambiguous output identifying the data sent.

Chirp systems usually use a linear frequency sweep instead of a noise source and so in strict terms don't qualify as a spread spectrum signal. However, as you can see in Fig. 8, they do have larger than required bandwidths and so produce processing gain. See Fig. 8.

Although many experimental wartime systems used some form of chirping, it is not often used today for communications—at least not for human communications. However, it is believed that dolphins use complex chirp signals for communications; bats use similar signals for ranging and navigation.

Time hopping

Time-hopping schemes are used in conjunction with frequency-hopping or direct-sequence spreading to provide multiple-channel access or data security in the

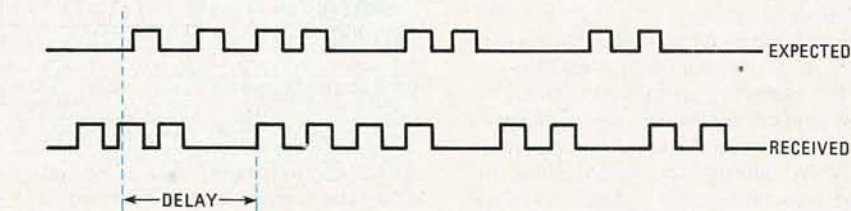

FIG. 11—IN THE GPS RANGING SYSTEM, distance to the transmitter is determined by the time delay between expected and received signals.

form of "randomly" scheduled transmission times. As shown in Fig. 9, time hopping requires that data be stored or compressed and then transmitted in high-speed bursts during the allotted time slot. See Fig. 10.

The processing gain of time hopping is achieved by virtue of the shorter time taken to transmit the information, since the narrower the pulse in the time domain the larger the bandwidth in the frequency domain. Since scheduling can be derived from a random or pseudo-random source, time-hopping systems are bonafide members of the spread-spectrum family.

Applications

Frequency hopping can be added to either digital or analog communication systems since it is only the carrier that is affected. The U.S. Air Force has retrofitted many of their existing analog UHF radio links with frequency-hopping capability as an interim step while more sophisticated digital systems are being developed. That interim system, which the Air Force has branded *Have Quick*, uses the time of day to select the currently active frequency slot from among a set of 7000 possible slots.

The Global Positioning System (GPS) is a satellite system that makes use of a basic direct-sequence ranging technique. As of this writing, the system is only partially in place. When fully implemented, GPS could allow subscribers anywhere in the world to determine their position to within a few meters, therefore revolutionizing navigation.

The GPS will consist of a fleet of 18 satellites in low-altitude circular orbits that allow contiguous coverage of the entire globe with direct-sequence microwave signals. Virtually every spot on the globe will be able to receive signals from at least 4 satellites. When decoded, each signal can be used to determine the linear distance from a particular satellite to the receiver. That distance is proportional to the propagation delay; that is the time difference between when the signal is transmitted and when it is received. See Fig. 11. Three of the signals are used to triangulate the receiver's position. The signal from the fourth satellite is used to correct clock drift and other error effects.

The Joint Tactical Information Distribution System (JTIDS) is designed primarily for military use. Using frequency-

hopped, direct-sequence modulation the system provides communication, navigation, and control facilities to air-, land-, and sea-based subscribers. The system uses a 5-MHz wide MSK (Minimum Shift Keying, which is closely related to frequency shift keying) direct-sequence signal. The signal is then frequency hopped over a 52-frequency set, with 3 MHz of separation between hopped frequencies. After a user synchronizes with the system, which is done using special preamble signals, data can be exchanged with any other authorized user within a range of 500 nautical miles. R-E

HISTORY

The Early Days of RADIO

MARTIN CLIFFORD

*Learn about the many
discoveries and inventions
that led to the
development of radio.*

Part 3 TWO GREAT TECHNOLOGICAL "revolutions" have changed the nature of civilization. One was the Industrial Revolution, which is commonly agreed to have begun in 1750. It was a revolution in the invention, design, and use of machinery for mass manufacturing.

Perhaps less renowned (at least in some circles), though no less important, was the "electronics revolution." It can be considered to have begun with the article "A Dynamical Theory of the Electromagnetic Field," written by James Clerk Maxwell, a Scottish physicist. That article was published in *Philosophical Transactions* in 1865.

The most significant result of the elec-

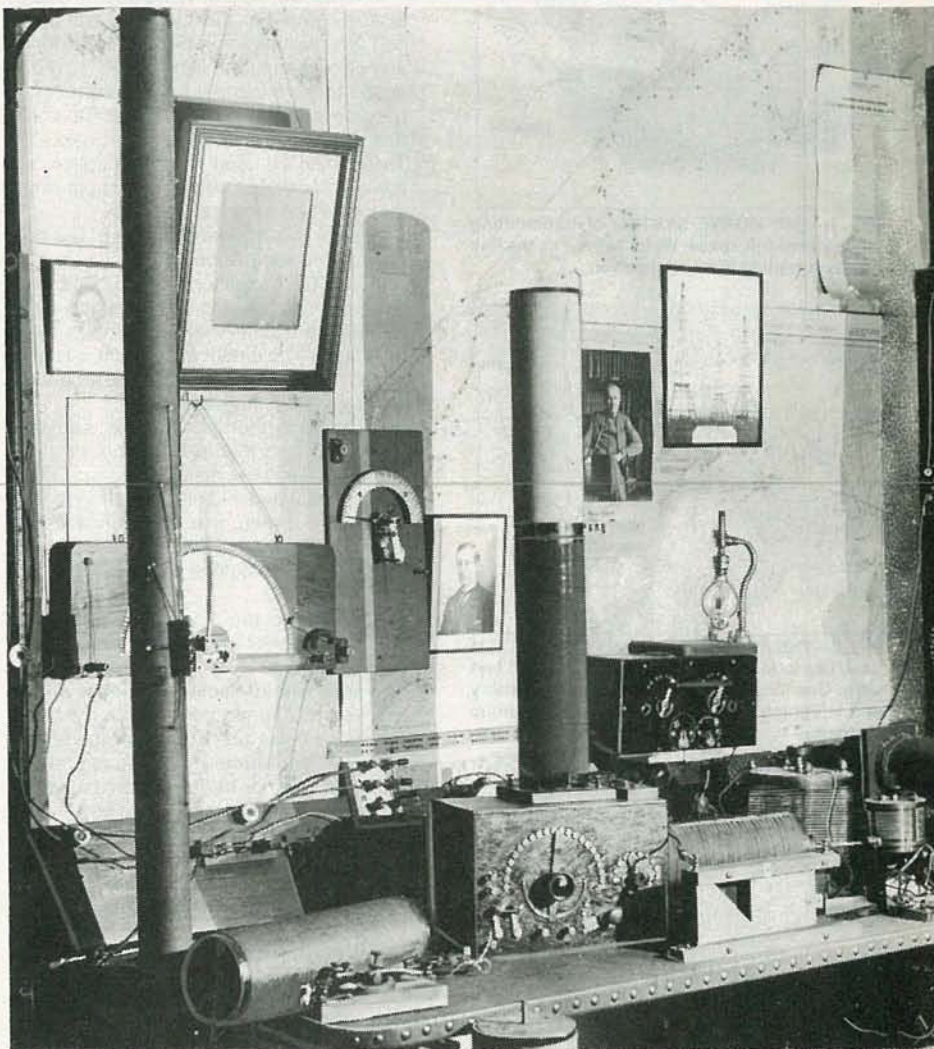

tronics revolution was radio. But, as is so often the case, radio was not the brain-child of a solitary inventor. Instead, numerous developments by independent researchers and teams led to the evolution of radio.

Remember also that many laws of radio that we take for granted now were only developed during the second half of the 19th century. For instance, by the Civil War, telegraphy was well established and telegraph wires crisscrossed the countryside. Even so, experimenters were hard at work looking for some way of communicating without wires. However, their work was severely hindered by some of the misconceptions of the time.

For one, most people were convinced that there had to be some connecting mechanism between the transmitter and receiver. Around the middle of the 19th century, Samuel F.B. Morse, the inventor of wired telegraphy, tried a wireless system that substituted water for wire over part of a telegraph loop. The system is illustrated in Fig. 1. Note that there is no

wired connection between the receiver on one bank and the key on the other. Instead, the link is provided by the water in the stream.

Morse and others also experimented with inductive schemes. In 1885, Sir William Preece, Engineer-In-Chief of the British Post Office, tried using the circuit shown in Fig. 2. He was able to establish communications over a distance of about 1000 yards, using loops of wire that each were hundreds of feet long.

The antenna

Electricity and the possibility of wireless communications attracted enthusiasts and experimenters of all kinds. One of those was Dr. Mahlon Loomis. Dr. Loomis was a prominent Philadelphia dentist who, at the age of 28, had patented a process for making false teeth.

Dr. Loomis is also credited with making the first wireless transmission, in West Virginia in 1865. As shown in Fig. 3, the Loomis "transmitter" consisted of a telegraph key that was connected in series

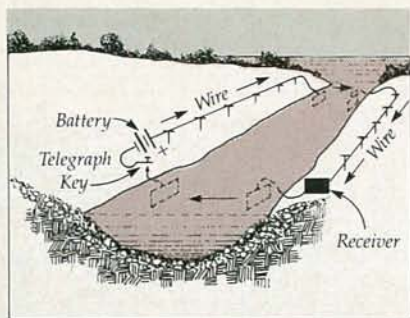

FIG. 1—THE MORSE SYSTEM of transmitting signals through space. Water served as the link between transmitter and receiver.

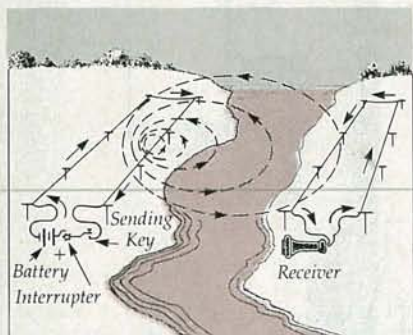

FIG. 2—THE PREECE TRANSMISSION SYSTEM used two loops of wire, each over a hundred feet long. One loop (for transmitting) had a battery and telegraph key; the other loop, a telephone handset.

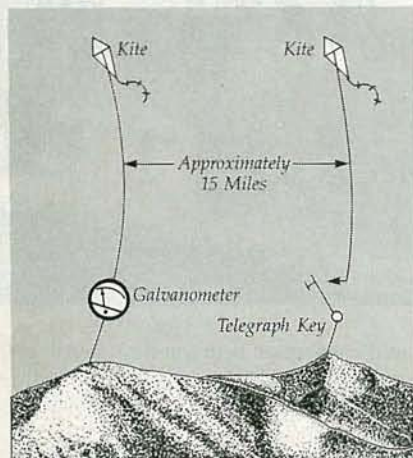

FIG. 3—DR. LOOMIS' transmitting and receiving system. The copper wires were held aloft by kites.

with a long length of fine copper wire. The wire was held aloft by a kite in which a small section of wire mesh was embedded. The receiver, which was located some 15 miles away was similar, except that the key was replaced by a galvanometer that was used to indicate signal reception.

Dr. Loomis was the first to use the word "aerial;" it was the term he used to describe the copper wire. He received a patent for his scheme in 1872. It was the first patent ever issued for wireless telegraphy. Dr. Loomis' wireless system was demonstrated publicly in Philadelphia in late 1879.

Despite Dr. Loomis' work, Marconi is

SO THEY SAID

- While working for the Marconi Wireless Telegraph Co. Ltd. in 1916, David Sarnoff, who subsequently became President and Chairman of the Board of RCA, proposed to his superiors that the company become involved in the manufacture and sale of what Sarnoff called "music boxes." They would be used for the reception of not only music but educational programs that would be broadcast by radio.

Sarnoff was advised that there was no merit to his suggestion.

- In 1882, Professor Amos E. Dolbear applied for a patent for his invention of a wireless transmitter that used an inductive technique. The patent application was rejected by the patent office on the grounds that it was "contrary to science."

- On November 12, 1913, Dr. Lee de Forest went on trial in New York on the charge of using the mails to defraud. The indictment stated that his patents were for "a strange device, like an incandescent lamp, which he (de Forest) called an Audion, and which device had proven to be worthless."

According to the Federal District Attorney, "de Forest has said in many newspapers and over his signature that it would be possible to transmit the human voice across the Atlantic before many years. Based on these absurd and deliberately misleading statements, the misguided public, your honor, has been persuaded to purchase stock in his company, paying as high as \$10 and \$20 a share for the stock.

De Forest was acquitted by the jury, but the judge advised him to "get a common garden variety of job and stick to it."

- Charles Babbage, the designer of a calculating machine that can be regarded as the ancestor of today's computers, was asked in 1843 by British Prime Minister Robert Peel to use the machine to "calculate the time at which it will be of use." **R-E**

widely recognized as the inventor of the antenna, even though Edison also held a prior patent in the field. Edison's method, shown in Fig. 4, used large metal plates at the transmitter and receiver. Those plates formed what was essentially a huge ca-

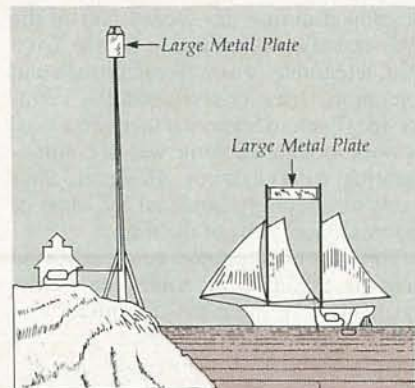

FIG. 4—THE EDISON capacitor antenna used a large plate for transmitting and a similar large plate for receiving.

pacitor. Electrostatic charges at the transmitter plate induced a charge at the receiver plate. The system was suitable for short-distance communications only, and Edison subsequently sold the antenna patent rights to Marconi.

In 1895, while experimenting with the oscillator circuit developed by Hertz, Marconi decided to ground one side of the oscillator and extend a lead at the other side of the oscillator into the air. That lead somewhat resembled the antennae of an insect, hence the word "antenna" was soon applied to that arrangement. It was quickly noted that the use of an antenna allowed communications over far greater distances.

The detector

Wireless telegraphy introduced several problems that were of no concern to the developers of wired telegraphy. For instance, a wired system operates on DC. Signals were sent by interrupting the current flow. At the receiving end, those interruptions were made audible by an electromechanical sounder.

With a wireless system, however, some means of extracting or detecting a signal is required. That task is handled by a rectifier, which is a device that allows current to flow in only one direction. Because of the function they serve, rectifiers are also called detectors.

We discussed crystal detectors in the first installment of this occasional series. (See the July 1986 issue of **Radio-Electronics**.) However, early detectors used other schemes. One of the first detectors consisted of two metal electrodes that were immersed in an electrolytic or acid solution. Initially developed in the late 1850's, years later detectors of that type, which by then were called electrolytic interrupters, became extremely popular with amateur experimenters and wireless-telegraphy hobbyists. See Fig. 5 for an example of an electrolytic detector.

Another early detector was the coherer. The basic principal behind that device was discovered first in 1850 by Guitard. He noted that particles of dust in electrically charged air tended to adhere to each other. Later, in 1883, Sir Oliver Lodge noted that metallic dust, which is normally a poor conductor, becomes a good conductor when exposed to high frequencies.

Those discoveries led Edouard Branly to develop the Branly coherer, which was also called the Branly wave detector. See Fig. 6. The coherer consists of a small glass tube filled with metal filings. In 1894 Lodge used the coherer to detect signals from a transmitter located 150 yards away.

The coherer was not without its problems. Perhaps the most significant problem was that the filings would adhere to each other each time a signal was passed through them; that is, after each dot or

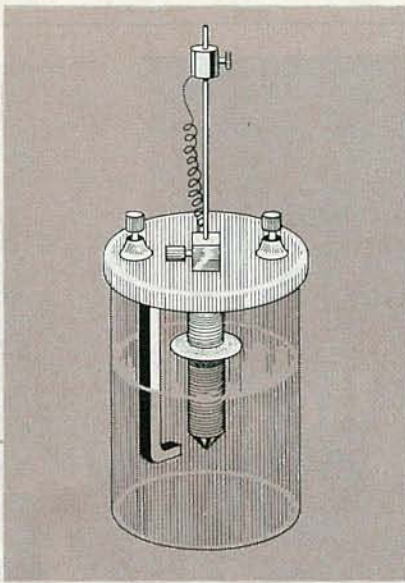

FIG. 5—THE ELECTROLYTIC DETECTOR consisted of two metal rods submerged in an electrolyte or acid solution. Such detectors eventually were very popular with hobbyists and experimenters.

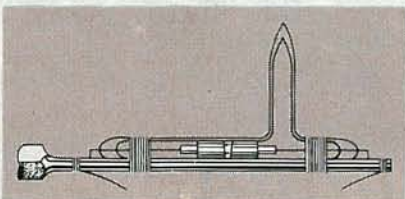

FIG. 6—THE BRANLY COHERER. One drawback was that the metal filings in the glass tube tended to stick to each other.

dash. To separate the filings some type of automatic tapping device was required to mechanically tap or shake the tube after each signal passed.

Marconi used an improved version of the Branly coherer in some of his work. Marconi's coherer used filings made from

a nickel-silver alloy. Although a tapping device was still required, the coherer was able to detect signals from a transmitter located two miles away.

Marconi, with the assistance of Lodge and Dr. John Ambrose Fleming, also developed the electromagnetic detector shown in Fig. 7. That detector consisted of a moving band of iron wire (A) mounted on a pair of wheels (E). The band passed through a coil (B) that was connected to the antenna. As a section of the band passed through a pair of permanent magnets (D), it was magnetized. When that section later passed through coil B, a magnetic field that varied with the signal applied to the coil via the antenna was created. That field was electromagnetically coupled to coil C, which was connected to a telephone receiver. In many ways, Marconi's detector resembled the wire recorder, which would not be developed until over four decades later.

Edison and radio

Edison's work in developing the electric light also played an important part in the development of radio. That's because it led to the invention of the vacuum-tube diode, and later to the triode.

Edison was not the first person to turn his attention to developing an electric light, however his work was the most successful. One problem with earlier efforts, like that of W. Edward Staite, was that the filament was exposed to the atmosphere, allowing rapid oxidation. Once Edison hit upon the idea of placing the filament in an evacuated globe, he was on the way to success. But there were still obstacles to overcome.

Edison's difficulties with his electric light are well documented. One of the most significant was that one side of the

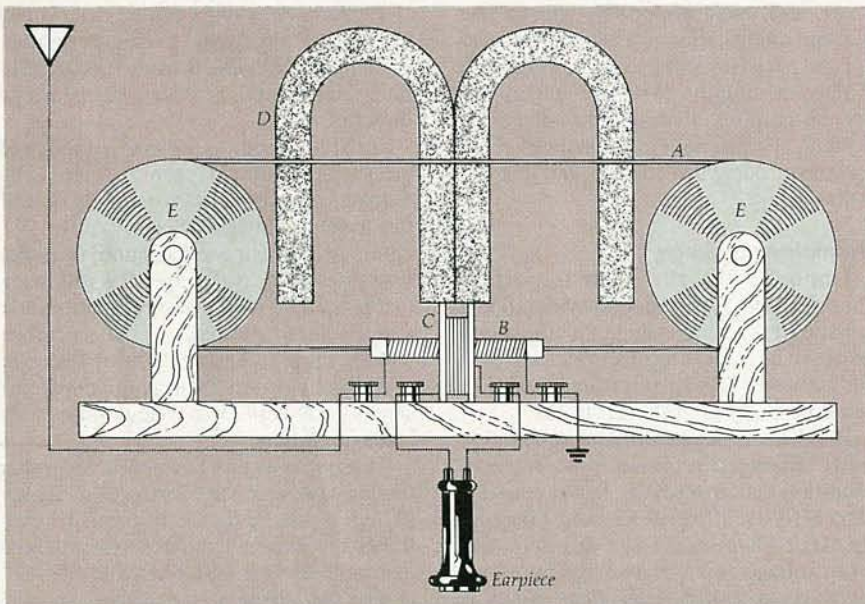

FIG. 7—MARCONI'S MAGNETIC DETECTOR used electromagnetic induction to produce an audible signal in the earpiece.

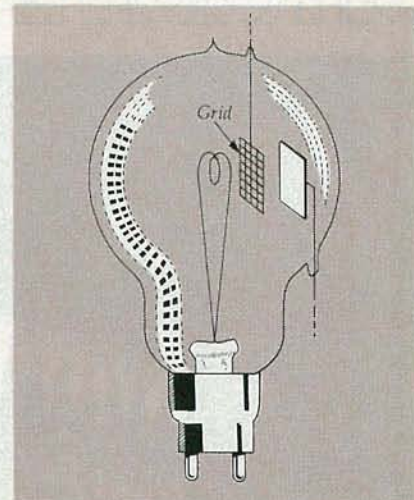

FIG. 8—DE FOREST'S TRIODE vacuum tube in its final form. The tube was designed for both signal rectification and amplification.

filament behaved in a different manner than the other side. As a result, the glass envelope of the light would blacken. Edison tried various schemes to eliminate the problem. In 1883, as an experiment, Edison inserted a metal plate between the filament wires. By connecting the plate to the positive terminal of a battery he was able to measure the current between the filament and that plate. Although the information did not lead to an answer to the blackening problem, he deemed the discovery significant enough to obtain a patent for it.

Fleming felt that Edison's discovery might be the answer to the ongoing problem of signal detection. In 1904, Fleming modified Edison's design by replacing the metal plate with a metal cylinder that completely surrounded the filament. Also, the filament was designed to carry a larger current than was required by Edison's bulb. That was made possible by the development of the thoriated tungsten filament by Irving Langmuir in 1900. (adding thorium to a filament improves a filament's emission.)

The triode

De Forest's invention of the triode vacuum tube was a major step forward for radio. It was the first device that had the ability to amplify. De Forest tried many approaches before finally meeting with success. In one of the earliest designs tube was actually a duo-diode—two diodes within a single envelope. In another approach, de Forest tried to influence current flow by wrapping wires around the outside of the envelope.

Eventually the design shown in Fig. 8 took shape. That tube was actually a diode/triode, since the device was used to both rectify and amplify. Rectification was done by using the grid and the filament as a diode.

continued on page 102

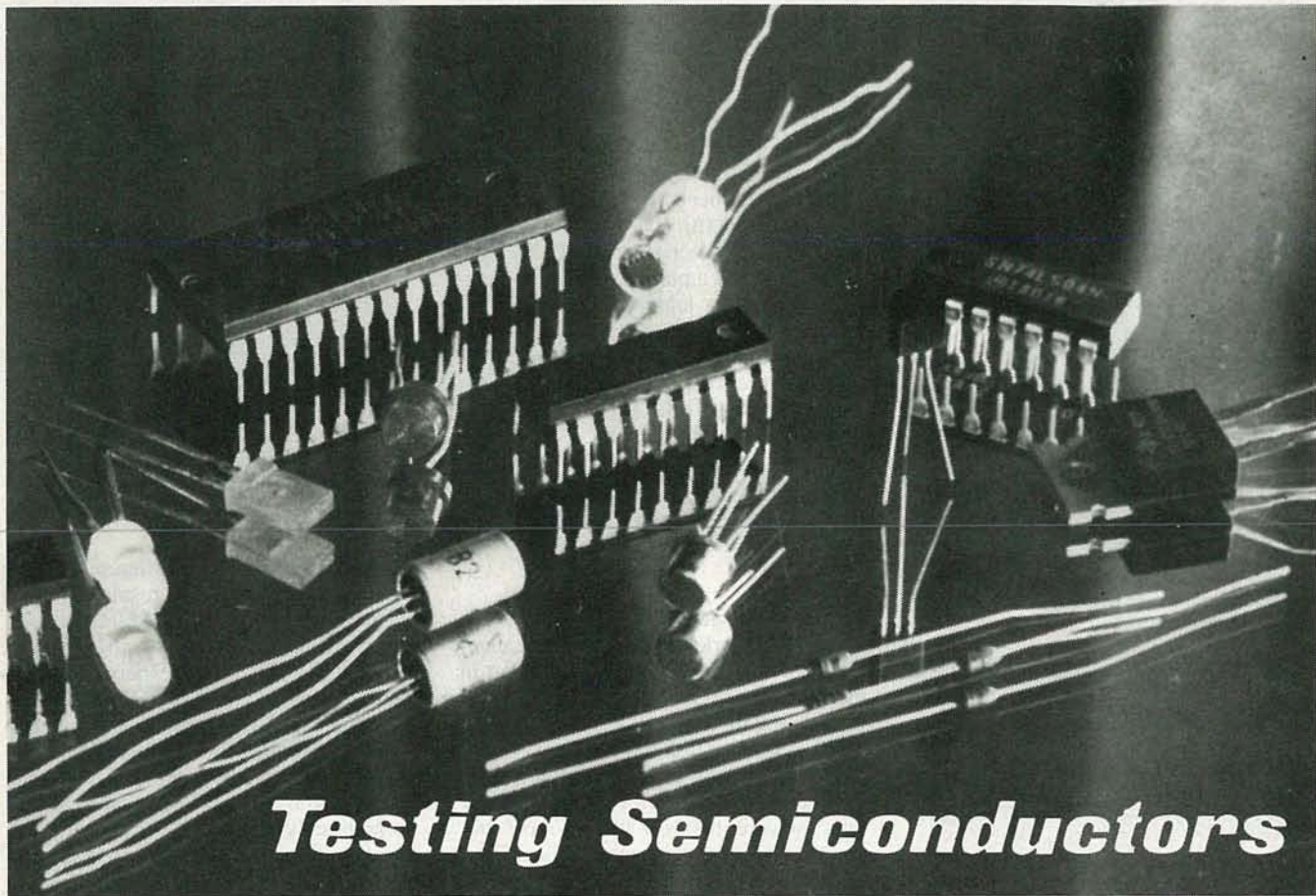

Testing Semiconductors

Our back-to-school series continues this month with a discussion of diodes and their characteristics.

TJ BYERS

BY NOW YOU SHOULD HAVE A GOOD UNDERSTANDING of semiconductor junctions and their behavior. We have explored the relationship between leakage current and breakdown voltage, looked into transistor construction, and shown how different voltage and current combinations affect the performance of bipolar transistors and FET's.

However, transistors were not the only products of the semiconductor revolution. Other devices with such unlikely names as silicon-controlled rectifier, tunnel diode, and Triac were introduced, and are still very useful. As exotic as they may sound, you are now in a position to deal with them intelligently. Armed with the information from the first two parts of this series, we're ready to perform static measurements on just about any semiconductor device we happen to run across. This month we turn our attention to semiconductor diodes.

Diodes

It can be said that diodes are the fore-runners of the semiconductor revolution.

We had diodes long before we had transistors. They come in a variety of shapes, sizes, and, most important, voltage and current ratings. Some are used for very special purposes; others are used in a wide variety of circuits. Whether general- or special-purpose, all diodes have three important characteristics: breakdown voltage, reverse leakage current, and forward voltage drop.

Breakdown voltage

Undoubtedly, the most important characteristic is the junction's breakdown voltage. It is at that voltage that the diode ceases to be a one-way electronic valve; at and above the breakdown voltage, current can flow freely in both directions.

Breakdown occurs when a reverse-biased diode junction goes into avalanche, a condition that is normally fatal to the device if it is allowed to continue unchecked. Data sheets list diode breakdown voltage as V_R or P_{RV} (which stand for Reverse Voltage and Peak Reverse Voltage, respectively), depending on the type of diode and its intended function.

For all intents and purposes, though, the terms are interchangeable.

Breakdown voltage can be determined in one of two ways: It can be mathematically interpolated from leakage currents and charts, or it can be measured directly.

In the first method, we take a number of diodes and subject each to increasing amounts of reverse voltage, taking note of the leakage currents (I_R) as we do. We continue increasing voltage until the junction goes into avalanche. By following that procedure with a number of similarly manufactured diodes, we can correlate leakage currents and breakdown voltages, and thereby derive a family of curves that shows how breakdown voltage varies with leakage current.

Those results can be used to test other diodes with identical construction. By applying a voltage that is one-half to two-thirds the expected breakdown potential across the device under test and by measuring the resultant I_R current, we can predict the diode's breakdown voltage.

In fact, that's how many semiconductor

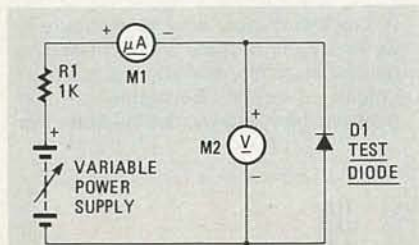

FIG. 1—REVERSE LEAKAGE CURRENT (I_R) may be measured at various voltages with this set-up.

manufacturers test their diodes. By specifying a maximum allowable current at a given voltage, the manufacturer can guarantee that the actual breakdown voltage of a diode equals or exceeds the specified breakdown voltage. Any diode that fails the leakage test will more than likely also fail to sustain the maximum voltage; therefore it's rejected.

Figure 1 shows a setup for measuring I_R and predicting V_R . The power supply is adjusted to a specific reverse voltage as indicated by the voltmeter, and the leakage current is noted on the milliammeter. Then the appropriate chart (supplied by the manufacturer) would be consulted to predict V_R .

While we're on the subject of reverse leakage current, let's emphasize the importance of I_R in several different applications. Leakage, for example, plays an important part in signal-diode circuits, particularly when the diode is used for purposes of isolation or modulation. Many times diodes must be matched—and that can be expensive. Measuring the value of I_R of a handful of general-purpose samples, however, often will yield a matched pair for about one tenth the price of a commercially matched set.

Peak reverse voltage

It's true that V_R and P_{RV} are often interchangeable, but there actually is a distinction between them. Both define the voltage at which the diode junction fails. However, P_{RV} is usually used in connec-

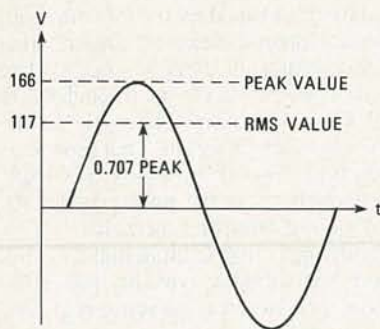

FIG. 2—A SINEWAVE with an rms voltage of 110 has a peak voltage of 166. A diode with a breakdown voltage of 125 volts would fail when subjected to a 110-volt rms signal, because the peak voltage exceeds the rating of the diode, even though the rms value doesn't.

tion with rectifier diodes that are subjected to AC voltages, rather than DC.

The distinction is made because of the different ways AC voltages are specified. A 110-volt rms AC signal can accomplish the same amount of work as 110-volts DC. In truth, though, the AC signal only has a value of 110 volts for a brief moment during each cycle. As shown in Fig. 2, for a sine wave to have an rms value of 110 volts, the peak voltage must reach 166—nearly one-third more than you might expect.

Consequently, if you place a diode with a breakdown voltage of 125 volts in a 110-volt AC circuit, it would fail because the peak voltage exceeds the diode's rating, even though the rms value doesn't. The same diode in a 110-volt DC circuit would survive. Hence, the industry adopted the term P_{RV} as a means of indicating that peak—not rms—voltage is the important breakdown characteristic.

In a true P_{RV} test, the diode junction is forced into avalanche and voltage is measured. Usually, however, P_{RV} is tested using a pulse generator, rather than a steady DC source. The peak pulse voltage exceeds the P_{RV} rating of the diode, thereby forcing the junction into avalanche. Voltage is then measured with an oscilloscope. The test procedure has the advantage that it subjects the diode to operating conditions like those normally found in actual service, and it reduces the possibility of destroying the diode junction by allowing the heat to dissipate between test pulses. The test circuit is shown in Fig. 3.

Forward voltage drop

The third characteristic that all diodes share is forward voltage drop (V_F). It is the amount of voltage you would measure across the diode during normal operation. The value of V_F is generally a fixed quantity and is largely determined by the quantum gap in the semiconductor junction.

More simply put, it is a function of the semiconductor material itself. Silicon diodes, for example, typically have a V_F of 0.7 volts. The V_F of a germanium diode, on the other hand, is 0.3 volts.

If semiconductor type was the only factor affecting V_F , its measurement would be academic, indeed. However, junction shape, ambient temperature, and current flow all affect forward voltage drop. Consequently, V_F must be measured for each type of device. It is measured by passing a specific current through the diode and measuring the voltage drop across it. A representative circuit is shown in Fig. 4.

Forward current flow is an important characteristic that is related to forward voltage drop. Normally, the diode displays a fixed voltage drop. A point is reached, however, where the junction becomes saturated with electrons, and the

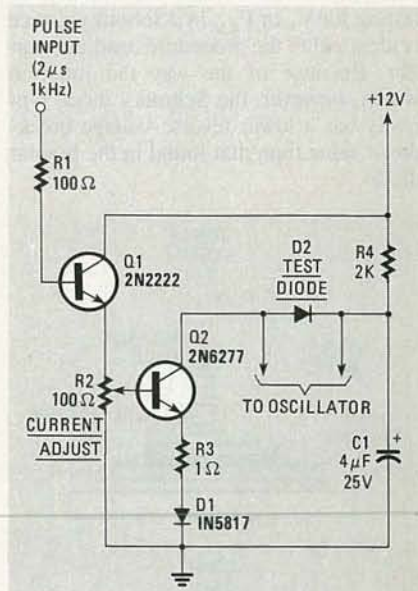

FIG. 3— P_{RV} IS NORMALLY MEASURED using pulsed voltages.

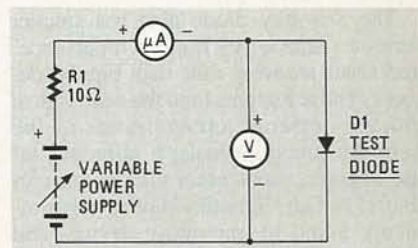

FIG. 4—FORWARD VOLTAGE DROP is measured using the same basic circuit as shown in Fig. 1. However, the polarity of the diode is reversed, and the resistor's value is reduced.

bulk resistance of the junction affects current flow. Higher currents also increase power dissipation, which in turn increases junction temperature, which increases the voltage drop, which results in greater power dissipation . . . and so on.

It is not unusual to find a two- or three-volt drop across a high-power rectifier operating near its rated current limit. And, in low-voltage designs, the power lost due to V_F can be appreciable.

The Schottky diode

One way to reduce V_F losses is to alter the construction of the junction. The Schottky-junction diode, named for its inventor, is just such a device.

As shown in Fig. 5, the Schottky diode consists of a junction made of metal on one side and a semiconductor on the other. The junction forms a barrier that acts like a one-way valve. The forward conduction mechanism uses hot-carrier electrons, as opposed to hole migration in bipolar junctions, to bridge the gap. That mechanism has led to the nickname *hot-carrier diode*.

Since the diode is composed of a single

semiconductor material, its quantum voltage gap is very small: typically on the order of 0.3 volts or less. The method of testing for V_F or P_{RV} in a Schottky device is identical to the procedures outlined earlier. Because of the way the junction works, however, the Schottky diode typically has a lower reverse-voltage breakdown value than that found in the bipolar diode.

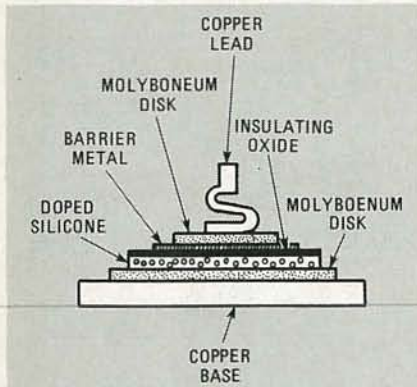

FIG. 5—THE SCHOTTKY DIODE is built from a single semiconductor material, unlike typical PN-junction diodes.

The Schottky diode also has smaller series resistance (V_F/I_F), less inductance, and faster recovery time than bipolar devices. Those features (and the nearly ideal voltage-current characteristics of the Schottky junction) make it attractive for use in applications other than power rectifiers. In fact, Schottky diodes are commonly found in microwave devices and TTL integrated circuits.

The Zener diode

The avalanche effect characteristic of bipolar semiconductor junctions is the basis of the Zener diode. Basically, it is a bipolar diode that operates in the reverse-breakdown mode. Breakdown voltage is largely independent of current, temperature, and age; therefore the Zener often replaces battery-resistor voltage-reference circuits.

The Zener diode is built much like a bipolar junction diode—with one difference. As we have noted throughout this series of articles, avalanche current often destroys a semiconductor junction because of the excessive heat that is generated. That problem is avoided in the Zener

diode by enlarging the junction and providing external heat sinking when necessary (usually for diodes with power ratings greater than one watt).

The Zener's breakdown voltage (V_Z) is measured using the same current-limited avalanche-producing procedures described several times in this series. There is one difference, however: the test current used. Until now we've been careful to maintain the avalanche current at a very low level to prevent damage to the junction. Zener diodes, however, need to be tested near the limits of their operating range—in other words, well beyond the knee—for the test to be accurate.

For 1/2- and 1-watt Zeners, that current is typically 20 mA. In other words, the test is performed with a constant-current power supply adjusted to provide 20 mA of current. Then, with the diode under test attached to the current source, voltage is measured across the diode. The voltage read is V_Z for that Zener.

Higher-powered Zeners are tested at higher currents, as defined by their data sheet. You will find, though, that V_Z is stable over a wide range of current values. Therefore, it is of little concern whether the diode is tested at 20 mA or at 24 mA—as long as the current remains within the safe operating limits of the Zener.

Dynamic resistance

Because Zener diodes frequently substitute for batteries, dynamic resistance (R_Z) is an important characteristic. Basically, dynamic resistance is the AC impedance of the diode; it is equivalent to the internal resistance of a battery.

R_Z is measured by first applying a DC current and then passing an AC current through the diode. The Zener's opposition to the passage of AC is its dynamic resistance.

Both V_Z and R_Z can be determined using the test circuit shown in Fig. 6. First the constant-current source is adjusted until the rated DC current flows through the Zener diode, as described above. At that point, V_Z may be read from the voltmeter.

R_Z is determined by measuring the peak-to-peak voltage (V_1) across the Zener, and that across R_1 (V_2). Then those values are inserted into the following equation:

MEASURING V_Z

A quick-and-easy way to measure a Zener's V_Z is to place a current-limiting resistor in series with any stable power source—it needn't be regulated—and measure the voltage across the diode. For

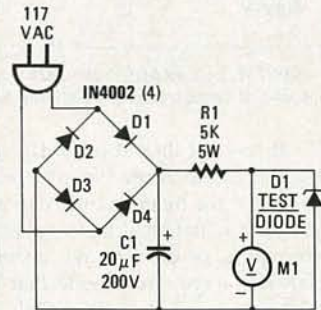

FIG. 1

Zeners with power ratings of less than one watt and voltage ratings less than 24, the circuit shown in Fig. 1 proves quite accurate. For safety, build the circuit in an insulated housing. And don't connect it to any line-powered equipment! R-E

$$R_Z = 100 \times V_1/V_2$$

Note that R_Z will vary as the DC current through the diode varies.

The tunnel diode

The last diode we'll examine this month is the tunnel diode. Although not as popular as it used to be, the tunnel diode is still used in high-frequency circuits.

The tunnel diode is a two-terminal device that differs from other diodes in the level of doping used in the semiconductor materials. The impurity concentrations in both the N-type and the P-type materials is 1000 times greater than that normally found. That high concentration results in an extremely thin depletion region at the junction—something on the order of 1 micron (0.000001 cm).

Normally, a forward voltage of a 0.5 or more is required to overcome the electrical barrier formed by the P-N junction. Quantum theory, however, predicts that upon occasion an electron will violate classical physics and sneak through the P-N barrier to appear mysteriously on the other side of the junction. That process is called tunneling. If the junction is made thin enough, as in the tunnel diode, the likelihood of tunneling increases.

Tunneling is important in that it occurs at very low voltages, typically 100 millivolts or less. Because the active region of a tunnel diode occurs at a much lower voltage than that of a conventional diode, the tunnel diode is an extremely low-power device. Such diodes have been used

continued on page 102

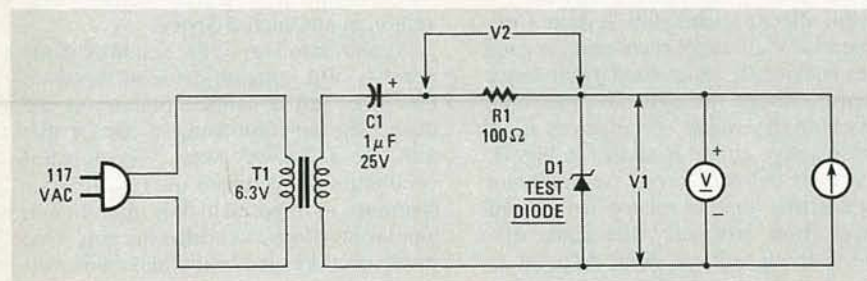

FIG. 6—DYNAMIC RESISTANCE (R_Z) and Zener voltage (V_Z) can be measured using this circuit.

PC SERVICE

BECAUSE THE CIRCUIT BOARD FOR THE robotics-control computer will not fit on the pages of Radio-Electronics, the component side is shown here half sized. The solder side of the board will be shown next month. For those interested in receiving full-size photostats of both sides of the board, simply send a self-addressed, stamped envelope to:

Radio-Electronics
Dept PC
500-B Bi-County Boulevard
Farmingdale, NY 11735

THE COMPONENT SIDE of the robotics-control computer is shown here half size. Note that it is not a mirror image, and it cannot be used to directly etch a board.

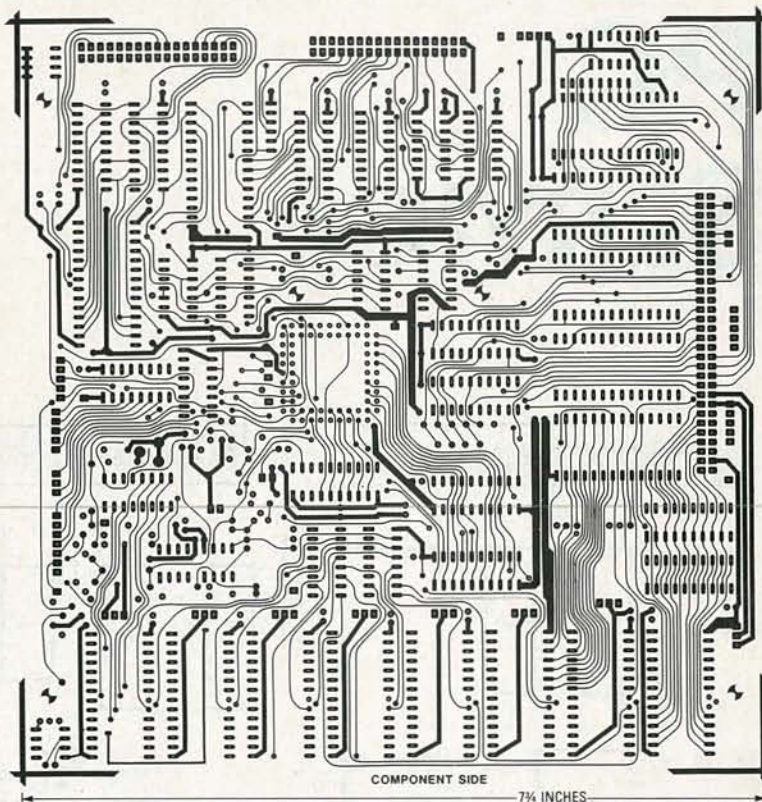

kePRO CIRCUIT MAKER

For art supplies, kits and economical equipment to produce at home professional quality print circuit boards...ask for the pro's - Kepro Circuit Systems, Inc. Kepro has been producing prototype and short run equipment, as well as providing PCB supplies to industrial companies for years. Their specialized experience and knowledge provides the home hobbyist an economical and convenient source of equipment and supplies for a professional, one-of-a-kind, printed circuit board.

Shears, etchers, sensitized and un-sensitized copperclad laminates, art supplies, kits and Keproclad...all you need to make a professional quality printed circuit board at home and at a cost you can afford.



Kepro Circuit Systems, Inc.

Kepro, your one stop source for at home PCB's.

Write or call Kepro for their catalog and price list:
1-800-325-3878 or 1-314-343-1630 (MO)
630 Axminister Drive, Fenton, MO 63026-2992.

ART SUPPLIES

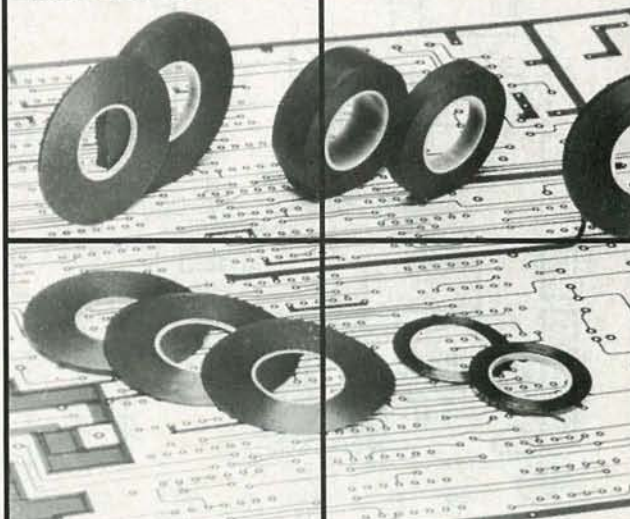

BENCHTOP ETCHER \$765.00



SHEAR \$390.00

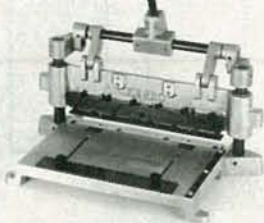

ART SUPPLIES from \$2.79



COPPER CLAD LAMINATES



Photosensitized
Pre-cut copper clad
Bulk packaged copper clad
Full sheets
Plate-thru copper clad

PC SERVICE

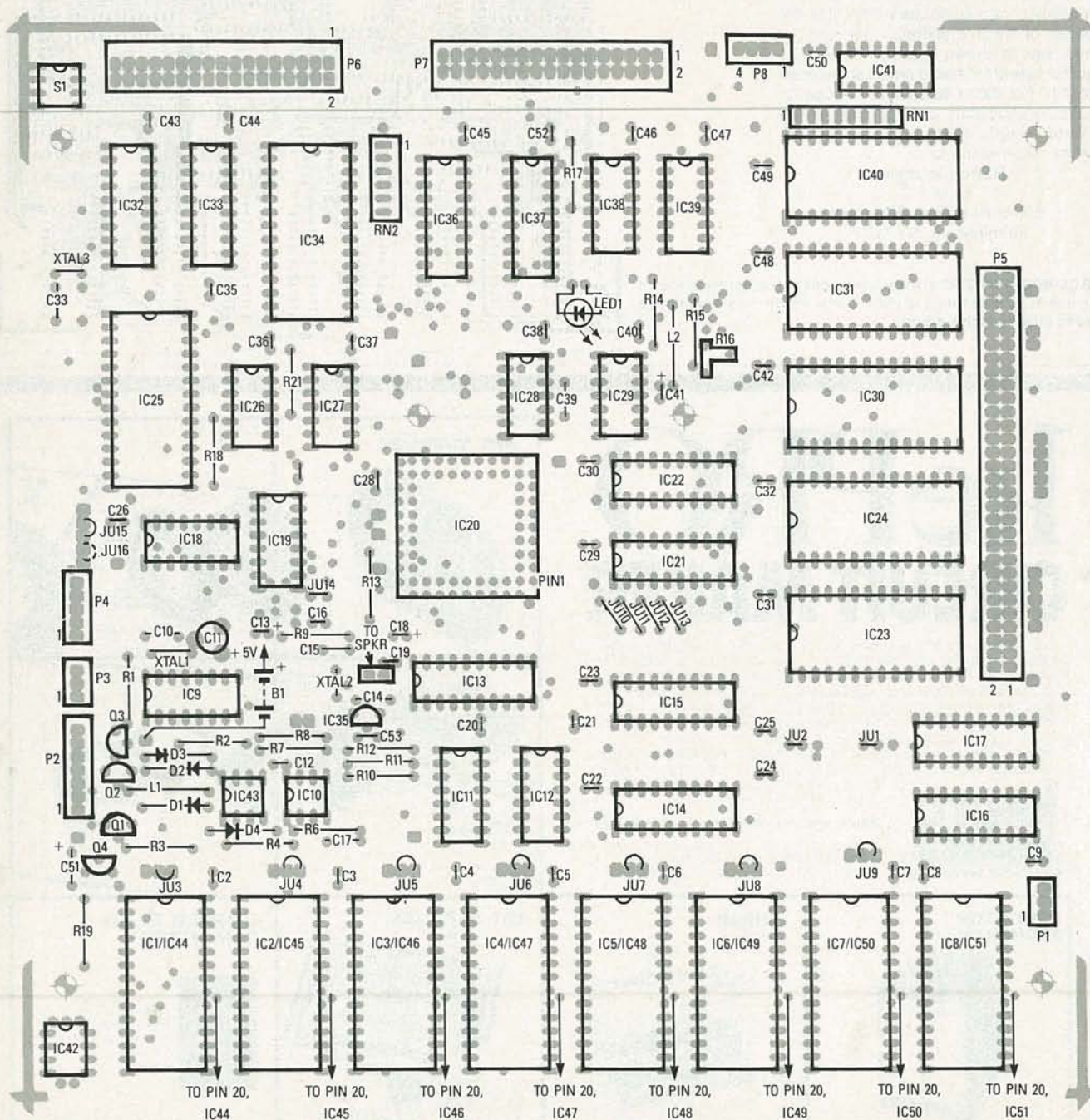

THE PARTS-PLACEMENT PATTERN for the robotic control computer. For clarity, the parts are shown over the board's pad master. The interconnecting traces are not shown.

NEW IDEAS

Headlight alarm

IT'S 5:00 P.M., AND YOU'VE JUST finished a long day at the office. You climb into your car, turn the ignition switch on, and nothing happens. That's when you suddenly realize the problem: You left your headlights on this morning. Unfortunately, the realization has come about eight hours too late and now your battery is dead.

The preceding incident has probably happened to you at least once; in my case it has happened more often than I care to remember. Or at least it used to. Now, I have installed the simple circuit shown in Fig. 1 in my car. Of course, the circuit is a headlight alarm. It has saved me from embarrassment and aggravation on several occasions.

The circuit

While many cars are equipped with a headlight alarm, many more, unfortunately are not. For those cars, the circuit in Fig. 1 offers a low-cost way to add that valuable feature. Let's see how it works.

The base of Q1 is connected to the car's ignition circuit; the easiest point to make that connection is at the ignition switch fuse in the car's fuse panel. Also, one side of the piezoelectric buzzer is connected to the instrument-panel light fuse; remember that when the headlights or parking lights are on, the instrument panel is lit too. When the headlights are off, no current reaches the buzzer and therefore nothing happens. What happens when the headlights are on depends on the state of the ignition switch. When the ignition switch is on, transistors Q1 and Q2 are biased on, effectively removing the buzzer and the LED from the circuit.

When the ignition switch is turned off but the headlight switch

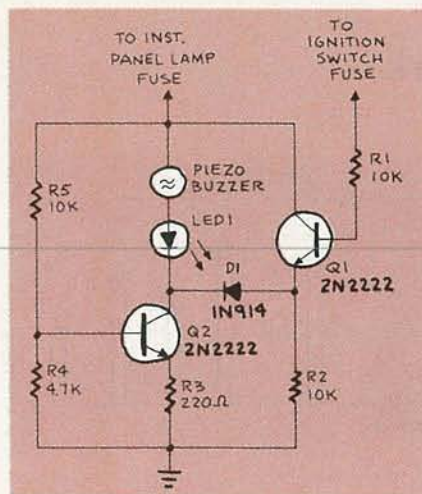

FIG. 1

remains on, transistor Q1 is turned off, but transistor Q2 continues to be biased on. The result is that the voltage across the piezoelectric buzzer and the LED is sufficient to cause the buzzer to sound loudly and the LED to light. Turning off the headlight switch will end the commotion quickly.

Construction

The circuit can be wired together on a piece of perforated construction board. The buzzer I used was a Radio-Shack 273-065 PC-board mounting type, but almost any similar buzzer will do. Circuit parameters are not critical, so feel free to make appropriate substitutions from your junk box to further reduce the cost.

When you are finished, house the circuit in a small, plastic experimenter's box and locate the unit on or under the dash of your car. You could also locate most of the unit behind the dash where it will be out of the way and mount only the LED where it can be seen easily. One good place would be next to the headlight switch on your dash; that will provide more of a custom look.—*Charlie Lowell*

NEW IDEAS

This column is devoted to new ideas, circuits, device applications, construction techniques, helpful hints, etc.

All published entries, upon publication, will earn \$25. In addition, for U.S. residents only, Panavise will donate their model 333—The Rapid Assembly Circuit Board Holder, having a retail price of \$39.95. It features an eight-position rotating adjustment, indexing at 45-degree increments, and six positive lock positions in the vertical plane, giving you a full ten-inch height adjustment for comfortable working.

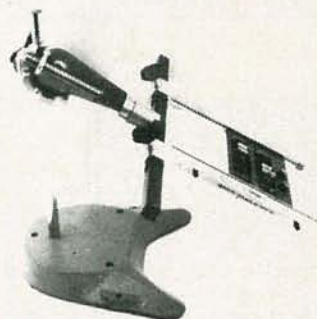

I agree to the above terms, and grant **Radio-Electronics Magazine** the right to publish my idea and to subsequently republish my idea in collections or compilations of reprints of similar articles. I declare that the attached idea is my own original material and that its publication does not violate any other copyright. I also declare that this material has not been previously published.

Title of Idea

Signature

Print Name

Date

Street

City

State

Zip

Mail your idea along with this coupon to:

New Ideas
Radio-Electronics,
500-B Bi-County Boulevard
Farmingdale, NY 11735

APRIL 1987

AUDIO UPDATE

Why stereo doesn't work



LARRY KLEIN,
AUDIO EDITOR

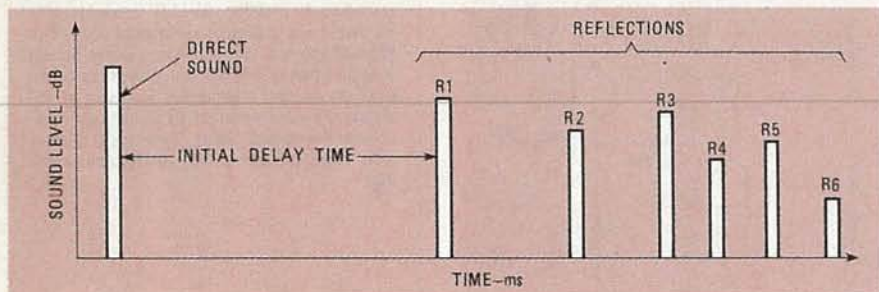

FIG. 1

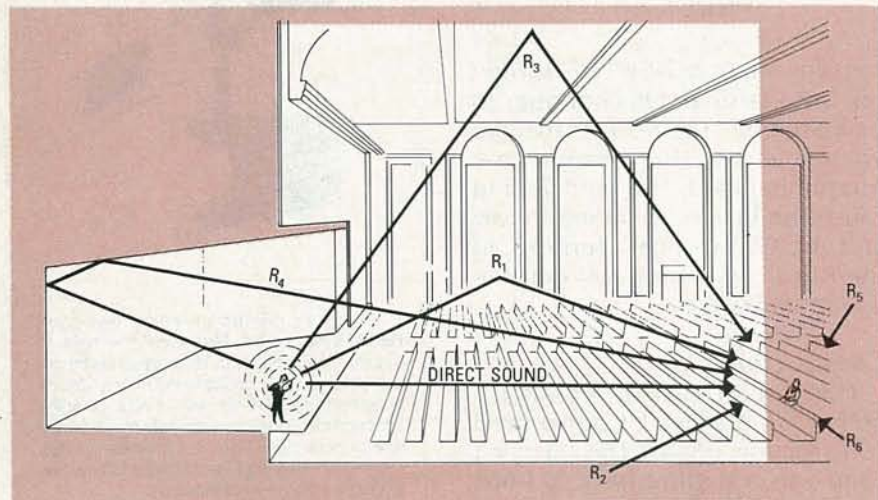

FIG. 2

DESPITE MORE THAN 35 YEARS IN PURSUIT of the "Holy Grail of Hi-Fi" (i.e. perfect sound reproduction), I've experienced it something less than a dozen times. By "perfect" I mean that with my eyes closed, I sonically seem to be in the same room or hall with the performers. Aside from a few impressive experiences with binaural headphone listening, which is another acoustic ballgame altogether, the only times I've experienced the "I am there/they are here" phenomena have been when there was specially recorded program material

and/or when two or more extra channels have been involved.

For some of us, quadraphonic sound reproduction, which was introduced in the early 1970's, had a potential that was never fully realized. A combination of bad marketing, bad engineering, and bad demonstrations condemned quadraphonic sound to an early demise, despite the fact that the basic concept was valid.

Live vs. reproduced sound

To appreciate the reasons why multichannel sound is, by its very

nature, far superior to the best that conventional stereo has to offer, it's necessary to understand the differences between live sound heard in a hall and recorded sound reproduced in a living room.

There are few acoustic similarities between the two listening environments. The sheer size of most live-performance venues means that the sound reflected and re-reflected from the boundary surfaces (walls, floor, ceiling) are going to reach a listener's ears substantially later than the sound coming directly from the performers. See Fig. 1. Since sound travels roughly 1,100-feet-per-second, or 1.1-feet-per-millisecond, time delays of more than 50 milliseconds between the direct and reflected sound are not uncommon. And when the sonic environment is both large and hard surfaced, such as in a church, the reflections multiply, blend, and take several seconds to die away. Furthermore, the reflected and reverberant energy, which can account for better than 80 percent of the total sound impinging on the audience, comes at the listeners from all directions. See Fig. 2.

Even when perfectly set up in a normal listening room, a conventional high-quality stereo system is functioning with a host of handicaps. First of all, the sound comes from a more or less flat plane whose area is roughly defined by the location of the two speakers. Whatever hall reverberation is captured by or synthesized into the recording is also coming from the same space.

Of course, there are reflections of the speaker sound taking place

Discover—Explore—Experience
Today's Electronics With ...

McGraw-Hill's Contemporary Electronics Series

Now you can meet the challenges of today's electronics quickly and easily. This professional level learning series is as innovative as the circuitry it explains and as fascinating as the experiments you build and explore! And it's for anyone who has an interest in electronics... from the hobbyist to the professional.

Thousands Have Already Experienced the Excitement!

Today's high-tech world demands an entirely new and innovative approach to understanding electronics. That's why McGraw-Hill has developed this unique "hands-on" learning method that brings to life the dynamics of the new electronics. It's a unique combination of interactive materials that gets you involved as you build and experiment with today's latest electronic circuitry.

Just how well this innovative learning approach meets the challenge of the new electronics is confirmed by those who have already completed the Series... "You have put me right into the middle of an extraordinary learning experience. With each lab exercise I have gained a new understanding of the intricacies of today's electronics." Or... "For me, the Series was just the answer. I felt confident within my specialty, but my grasp of other areas of electronics was slipping away. Your Series helped me upgrade my knowledge of the latest electronics concepts." Or this from a company director of training... "We manufacture sophisticated electronic products, with a lot of people in sales, assembly and purchasing. McGraw-Hill has answered a real need in helping our employees see the total picture. They now communicate with customers and each other more effectively."

Your Involvement in the New Electronics Begins Immediately.

You master one subject at a time with 15 McGraw-Hill *Concept Modules*, sent to you one

every 4 to 6 weeks. You waste no time on extraneous materials or outdated history. It's an entertaining, lively, nontraditional approach to the most modern of subject matter.

Your very first module takes you right to the heart of basic circuit concepts and gets you ready to use integrated circuits to build a digital oscillator. Then, you'll verify the operation of different electronic circuits using a light emitting diode (LED).

And each successive module brings you up to speed quickly, clarifying the latest advances in today's electronics... from digital logic and micro-processors to data communications, robotics, lasers, fiber optics, and more.

Unique Combination of Interactive Instruction Materials Makes Learning Easy.

Laboratory experiments, vividly illustrated text and interactive cassette tapes all blend together to give you a clear, simplified understanding of contemporary electronics.

With each module, you receive a McGraw-Hill *Action-Audio Cassette* that brings to life the facts and makes you feel as if you're participating in a lively dialogue with experts.

Your ability to quickly make this knowledge your own is further aided by strikingly *illustrated* texts that use diagrams, explanations, illustrations, and schematics to drive home and rein-

force the meaning of each important point. Carefully indexed binders conveniently house all this material, as well as the instructions that will guide you through your "hands-on" lab experiments.

Throughout your Series, *laboratory experiments* reinforce every significant concept. With this essential "hands-on" experience using actual electronic components, you master principles that apply all the way up to tomorrow's VLSI (Very Large Scale Integrated) circuitry.

Discover, Explore, Experience for Yourself—15-Day Trial.

In all ways, the Contemporary Electronics Series is an exciting learning experience that offers you the quickest and least expensive method available to master today's electronics... and the only one with "hands-on" experience.

To order your first module for a 15-day

trial examination, simply complete the card and send today! If the card is missing, write to us for ordering information.



McGraw-Hill
Continuing
Education Center

3939 Wisconsin Avenue, NW
Washington, DC 20016



With your first module, you'll build this solderless breadboarding system. As you add additional boards, you create increasingly complex circuits easily and quickly, bringing today's electronics concepts to life.

within the listening room, but compared to any live recording environment, the listening room walls are usually much too close. That means that the reflections arrive much too quickly (have too short a delay time), and the reverberant sounds that would normally be heard from the sides and rear essentially all come from the front. In fact, unless the chosen speaker systems are very carefully set up with due consideration for their specific dispersion charac-

teristics and their proximity to the adjacent room surface, early room reflections are likely to distort the stereo image and to introduce frequency-response irregularities through cancellation and reinforcement of the direct signal.

To my ears, most speakers sound best when at placed least three or four feet away from any reflecting surface, including the back wall, and are, in general, situated in a fairly absorptive part of listening room. Carpeting in front

of the speakers, wall hangings behind and between the speakers, and soft chairs flanking the speakers are all means to that end.

In my view, it is the audible, but usually only unconsciously perceived disparity between the acoustic environment embodied in the recording and the actual acoustic environment of the listening room that is primarily responsible for the lack of sonic realism of even the best stereo system.

My theory is supported by the fact that a good system almost always sounds more realistic when heard from an adjacent room, where you hear a blend of the two contradictory acoustic environments. A very large listening room can give rise to the same effect; when you listen far enough away from the speakers some of the same acoustic blending can take place. But in no case does the recorded early and late reflections (reverberations) surround the listener in the same way it does under live conditions.

The sound field

From the psychoacoustic viewpoint of a single listener, the complex acoustic interactions taking place throughout the concert hall or listening room don't really matter. What is significant is the ever-changing sound field occurring directly at the listener's two ears. Even an untrained listener hearing a well-recorded live performance for the first time has a sense of the size and the nature of the recording space. Assuming that the engineers were competent, the acoustic ambience of a recording of Orff's *Carmina Burana* performed in a church is going to sound quite different from that of a small jazz group playing in a night club. Our ear/brain computers are constantly analyzing the similarities and differences in phase, timing, amplitude, and frequency occurring in the sounds reaching our two ears. That information is used unconsciously to construct a mental image of the acoustic environment in which the sound is taking place. I say "unconsciously" because we are not talking about a deliberate mental process. But the fact that we are

continued on page 82

★ CABLE TV SPECIALS ★

CONVERTERS

JERROLD: JRX-3 DIC—36 Channel Corded Remote \$149.⁰⁰
 JSX-3 DIC—36 Channel Set Top \$129.⁰⁰
 SB-3—'The Real Thing' \$119.⁰⁰
 SB-3A-4 port \$99.⁹⁹

ZENITH: Z-TAC Cable Add-On \$199.⁰⁰

VIEW STAR: EVSC-2010—60 Channel Wireless—
 with Parental Lockout \$ 99.⁰⁰
 EVSC-2010 A-B—Same as above with
 A-B Switch \$109.⁰⁰
 View Star 2501—60 Channel Wireless
 with Volume \$119.⁰⁰

MISCELLANEOUS

OAK: N-12 Mini-Code \$ 89.⁰⁰
 N-12 Mini-Code Vari-Sync \$109.⁰⁰
 N-12 Mini-Code Vari-Sync Plus Auto On-Off . . \$165.⁰⁰

JERROLD: 400 & 450 Handheld Transmitters \$ 29.⁰⁰

HAMLIN: MLD-1200 \$ 99.⁰⁰

NEW ITEMS: Ripco Tape Copy Stabilizer \$149.⁹⁵

Scientific Atlanta **Call for Price**

OAK: E-13 Mini-Code Substitute \$ 79.⁹⁵
 E-13 Mini-Code W/Vari-Syn \$ 89.⁹⁵

ALL UNITS GUARANTEED. QUANTITY PRICES AVAILABLE.

UNITED ELECTRONIC SUPPLY

P.O. BOX 1206 • ELGIN, ILLINOIS 60121 • 312-697-0600

ACID RAIN

continued from page 49

points. Connect the circuit to a VOM, and adjust the potentiometer for a reading of 94 μ A. Then disconnect the sensor assembly from the main circuit and connect the battery-potentiometer combination in its place. Adjust R1 until the meter reads exactly 100 μ A, which corresponds to a pH of 2.5.

The other pH points are established by

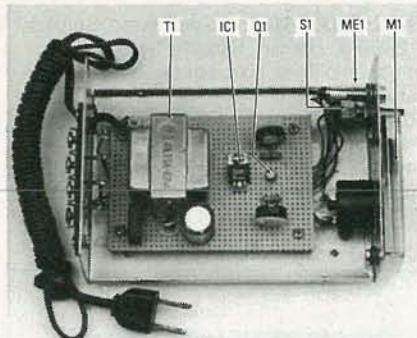

FIG. 5—THE ELECTRONIC COMPONENTS mount on a piece of perfboard; they are connected by point-to-point wiring. The terminal strip provides connections to the remote-mounted sensor and solenoid.

feeding a known current to the circuit and noting the position of the needle. Those positions correspond to the pH's shown in Table 1. If you want to interpolate in-between values, keep in mind the fact that the scale is not linear.

Installation and use

The best location for the sensor assembly is on a post, as shown in Fig. 6, away from trees and buildings. If it's mounted on the side of a house, be sure that the bracket you use is long enough to place the funnel beyond roof or eave run-off.

Don't be alarmed if the meter indicates some acidity. A pH of 6.0 to 6.5 is normal and unharmed. However, environmentalists warn of dire consequences for continuously higher readings.

For example, at continuous pH levels of 5.0 to 5.5, lawns and garden plants will

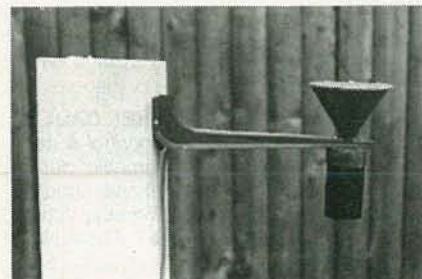

FIG. 6—THE SENSOR ASSEMBLY should be mounted on a long bracket that is screwed to a post. The post should be mounted away from overhanging eaves; and don't mount it under a tree.

begin to turn brown, and soil will need added lime. A pH of 4.5 in ponds and lakes will start killing fish, and, when pH reaches a level of 4.0, a clear blue appearance, although beautiful, will indicate a "dead" body of water. A pH of 3.5 will cause rapid deterioration of painted surfaces. A continuous pH of 3.0 will result in erosion of structural limestone, and entire forests will die. Last, if the meter indicates 2.5 or less, you may be living near an active volcano!

After taking readings from accumulated rainfall, the funnel should be

drained, leaving S1 in the DRAIN position only long enough to drain the funnel, as most inexpensive solenoid valves are not designed for continuous duty. Inspect the electrodes several times a year, and if any corrosion forms, swab it off with a weak ammonia-water solution, and then flush the electrodes with distilled water.

For studying the long-term effects of acidity, the output of the meter could be connected to a chart recorder. And the meter may also be used to test your local tap, pond, and stream water by pouring a sample into the funnel. **R-E**

ELENCO PRODUCTS AT DISCOUNT PRICES!



20 MHz DUAL TRACE OSCILLOSCOPE
\$349 MO-1251

TWO
100 MHZ
SWITCHABLE
PROBES
INCLUDED



35 MHz DUAL TRACE OSCILLOSCOPE
\$498 MO-1252

Top quality scopes at a very reasonable price. Contains all the desirable features. Elenco's 2 year guarantee assures you of continuous service. Two 1x, 10x probes, diagrams and manual included. Write for specifications.

MULTI METER with CAPACITANCE and transistor tester
\$65 Model CM-1500
Reads Volts, Ohms, Current, Capacitors Transistors & Diodes

TRUE RMS 4 1/2 DIGIT MULTIMETER
\$135 Model M-7000
.05% DC Accuracy
.1% Resistance with Freq. Counter & Deluxe Case

AUTO RANGING PLUS MANUAL RANGING 3 1/2 DIGIT METER 28 FUNCTIONS FULLY PROTECTED
M-1180 .7% ACY \$36.95
M-1182 .25% ACY \$39.95
M-1181 .1% ACY \$42.95

GF-8016 Function Generator with Freq. Counter
\$219
• Sine, Square, Triangle, Pulse, Ramp, .2 to 2 MHz
• Frequency .1 thru 10 MHz
GF 8015 without Freq. Meter \$169

10 MHz OSCILLOSCOPE
\$190 S-3000
10 MHz DC or AC Triggered Sweep
Calibrated Vert & Hor
Reads Volts & Freq

BREADBOARD
Shown 9436
9430 1,100 pins \$15
9434 2,170 pins \$25
9436 2,860 pins \$35

Triple Power Supply XP-660
\$14950
0-20V @ 1A
0-20V @ 1A
5V @ 5A
Fully Regulated, Short Circuit Protected with 2 Limit Cont. 3 Separate Supplies.

50 MHz LOGIC PROBE
\$23 LP-700
20 nec with memory

LOGIC PULSER
\$25 LP-600
2 us pulse @ 1A

3 Amp Power Supply XP-650
\$11950
0-40V @ 1.5A
0-20V @ 3A
Fully regulated, short circuit protected current limit control

DIGITAL LCR METER
Model LC-1800
Measures: Inductors Capacitors, Resistors
\$148
Inductors .1 μ H to 200 H
Capacitor .1pF to 200 μ F
Resistor .01 Ω to 20M Ω
Ranges 6 Ind, 7 cap, 7 res

C&S SALES, 8744 W. North Ter. Niles, IL 60648 800-292-7711 (312) 459-9040 **15 DAY MONEY BACK GUARANTEE** ASK FOR CATALOG
2 Year Limited Guarantee! Add 5% for Postage (\$10 max.), IL Res., 7% Tax

CIRCLE 109 ON FREE INFORMATION CARD

Radio-Electronics mini-ADS



CABLE TELEVISION CONVERTER, descrambler and wireless remote control video equipment accessories. Catalog free. **CABLE DISTRIBUTORS**, 116 Main Road, Washington, AR 71862.

CIRCLE 200 ON FREE INFORMATION CARD

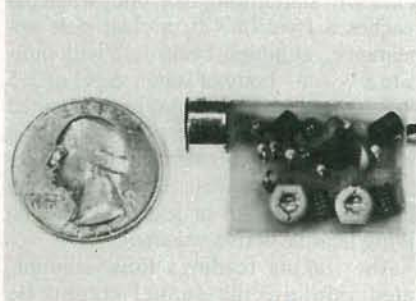

SIMPLY SNAP THE WAT-50 MINIATURE FM TRANSMITTER on top of a 9v battery and hear every sound in an entire house up to 1 mile away! Adjustable from 70-130 MHz. Use with any FM radio. Complete kit **\$29.95 + \$1.50 S + H**. Free shipping on 2 or more! COD add \$4. Call or send VISA, MC, MO. **DECO INDUSTRIES**, Box 607, Bedford Hills, NY 10507. (914) 232-3878.

CIRCLE 127 ON FREE INFORMATION CARD



ZENITH SSAVI \$169; reconditioned. Surplus N-12, SB-3, Hamlin. Satellite Systems, converters, amplifiers, accessories. Money-back guarantee. SSAVI project handbook **\$6.50** ppd. Radar speed timers for baseball, hockey, car/boat racing, bowling. Professional models used by police. **AIS SATELLITE, INC.**, P.O. Box 1226-E, Dublin, PA 18917. 215-249-9411.

CIRCLE 81 ON FREE INFORMATION CARD



SCIENTIFIC ATLANTA super Spring sale. Now available Scientific Atlanta 8500 and 8550 cable converters. Perfect reception on all channels. Sale price 8500 or 8550 **\$225.00** Hand remotes **\$20.00**. Call now to insure your order. Sale ends Apr. 30, 1987. Also, the original CM-04 for 8500 converter. Sale price only **\$69.95**. CM-04 kits **\$39.95!** Dealers welcome. C.O.D. accepted. **V.I.P. ELECTRONICS**, P.O. Box 628, Forestdale, R.I. 02824, (617) 755-9778.

CIRCLE 202 ON FREE INFORMATION CARD



TUNABLE NOTCH FILTER—for elimination of any TV, FM, or VHF signal. Can be tuned precisely to ANY signal within these ranges: *MODEL 26-Ch's. 2-6 plus FM [54-108 Mhz] *MODEL 1422-Ch's. 14(A)-22(I) [120-174 Mhz] *MODEL 713-Ch's. 7-13 [174-216 Mhz] Highly selective 60dB notch. Send **\$30** each. Quantity prices as low as **\$14**. **STAR CIRCUITS**, P.O. Box 8332, Pembroke Pines, FL. 33084

CIRCLE 94 ON FREE INFORMATION CARD



NEW: PANASONIC VIDEO SWITCHER. Record a cable channel while viewing any one of your 4 video options, another cable channel, 2nd VCR, TV games, video camera, etc. No need to use your cable converter for channel selection VCS-1 gives your cable ready TV or VCR full control of your viewing. Compatible with all scrambled and one way addressable systems. **\$85.00** Guaranteed. Free Catalog. (402) 331-4957 **M.D. ELECTRONICS**, 5078 So. 108th #115, Omaha, NE 68106. We accept MC. Visa. C.O.D.

CIRCLE 195 ON FREE INFORMATION CARD

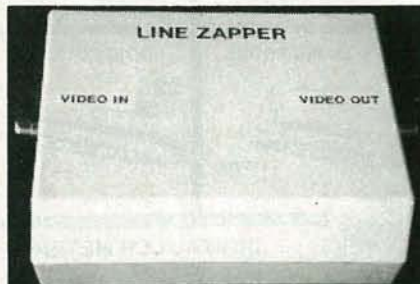

DECODE THE NEW VIDEO TAPE COPY PROTECTION SCHEME. Bothered by brightness changes, vertical jumping and jittering while watching recent movie releases? Stop it with the **LINE ZAPPER**. New kit detects and removes selected lines of video that have been modified and often interfere with normal television operation. Order your KIT today only **\$69.95** plus **\$2.00 S & H**. **ELEPHANT ELECTRONICS**, Box 41865-L, Phoenix, AZ 85080. Visa/MC orders (602) 581-1973. Allow 6 weeks for delivery.

CIRCLE 120 ON FREE INFORMATION CARD

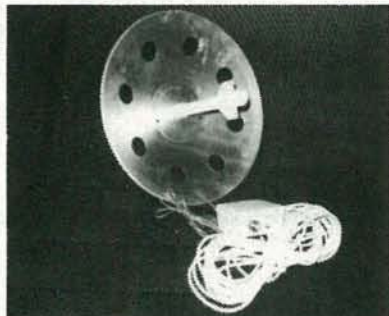

MICROWAVE ANTENNAS \$69.95. Now including shipping and Lifetime warranty. We Repair all types of Downconverters. Cable Converters and equipment available! **Panasonic 450 MHz** wireless converter **\$79.95** plus shipping. Coax cable, T.V. parts, accessories, connectors, T.V. amplifiers. Write for free information or call for prices. **BLUE STAR IND.**, Dept. 105-RE 4-87, 4712 Ave. N, Brooklyn, N.Y. 11234 (718) 258-9495 Ext. RE

CIRCLE 85 ON FREE INFORMATION CARD

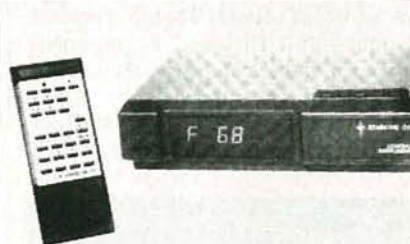

NEW JERROLD CS 68 CHANNEL CABLE TV CONVERTER with volume control & descrambler loop (Port). Programmable clock turns TV on/off & changes channel. Audio mute kills commercials. Programmable channel scan. Instant channel recall. Automatic fine tuning with manual override. Video & audio outputs. Friendly to all descramblers. Specify output. 1 year warranty. **\$129, \$105** ea./case lot of 10. Free delivery. Dealers wanted. (514) 739-9328. **CROSLY ELECTRONICS**, Box 840, Champlain, N.Y. 12919.

CIRCLE 177 ON FREE INFORMATION CARD

Radio-Electronics mini-ADS



WORLD'S FINEST CABLE TV NOTCH FILTERS. 60dB positive type noise and interference elimination filter **\$29.95** each. Negative type for total channel blocking **\$29.95**. We can supply any channel from channel 2 to 62. Add **\$4** per order for UPS and handling. COD phone orders accepted. Quantity discounts. Dealers wanted. **GENIE ELECTRONICS, PO Box 276, Alburg, Vermont 05440. (514) 739-9328**

CIRCLE 176 ON FREE INFORMATION CARD



A CAREER START FOR THE 21ST CENTURY. Since 1905, National Technical Schools has helped people build successful careers. Enter the 21st Century through home study courses in Robotics, Computer Technology and Servicing, Microprocessors, Video Technology, Basic Electronics, Transportation Technology, Climate Control Technology or TV and Radio Servicing. For a FREE catalog, call 1-800-B-BETTER. Or write **NTS/INDEPENDENT TRAINING GROUP, 456 West M. L. King Jr. Blvd. L.A., CA 90037.**

CIRCLE 187 ON FREE INFORMATION CARD



THE MODEL WTT-20 IS ONLY THE SIZE OF A DIME, yet transmits both sides of a telephone conversation to any FM radio with crystal clarity. Telephone line powered - never needs a battery! Up to 1/4 mile range. Adjustable from 70-130 MHz. Complete kit **\$29.95** + **\$1.50** S + H. Free Shipping on 2 or more! COD add **\$4**. Call or send VISA, MC, MO. **DECO INDUSTRIES, Box 607, Bedford Hills, NY 10507. (914) 232-3878.**

CIRCLE 127 ON FREE INFORMATION CARD

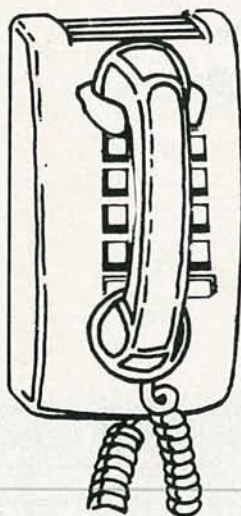

CALL NOW AND RESERVE YOUR SPACE

- 6 x rate \$745.00 per each insertion.
- Reaches 239,312 readers.
- Fast reader service cycle.
- Short lead time for the placement of ads.
- We typeset and layout the ad at no additional charge.

Call **516-293-3000** to reserve space. Ask for Arline Fishman. Limited number of pages available. Mail materials to: **mini-ADS, RADIO-ELECTRONICS, 500-B Bi-County Blvd., Farmingdale, NY 11735.**



CABLE TV CONVERTERS AND DE-SCRAMBLERS. Large selection of top quality merchandise. Low prices. Quantity discounts. We ship COD. Most orders are shipped within 24 hrs. Send **\$2.00** for catalog. **CABLETRONICS UNLIMITED, P.O. Box 266 Dept. R, S. Weymouth, MA 02190 (617) 843-5191**

CIRCLE 179 ON FREE INFORMATION CARD

COMMERCIAL ZAPPER

continued from page 47

maximize the number of comparator transitions during commercials. Begin by connecting the commercial killer to the stereo receiver's tape-monitor loop. Set the receiver to FM and select the tape-monitor mode. Because the audio level may vary from station to station, tune to the station of greatest intended use. And remember, the commercial killer works best with easy-listening formats. During commercials, adjust R41 to maximize attenuation by watching the FADE LED. Slight readjustment may be necessary to provide the fewest zapping errors without performance degradation.



FIG. 7—THE COMMERCIAL ZAPPER circuit is shown here assembled on a PC board.

If the commercial killer fails to work, make sure that the power supply is providing the correct voltage, and that V_{REF} is about 13.5 volts.

If the voltages are correct, then verify that you can obtain waveforms like those shown in Fig. 3—Fig. 5. If the peak signal level at the inverting input of IC2-b cannot be adjusted (via R41) to exceed 2.5 volts, the signal level out of the receiver may be unusually low, so the value of R41 may need to be increased.

If the rate of transitions at TP4 is low during music and high during commercials (but attenuation is not proportional to the rate of transitions), verify the following.

- When there is no signal present, the voltage at TP5 should be within 0.2 volts of the voltage at the non-inverting input of IC1-c.
- During a commercial, the voltage at TP5 should be at least three volts less than the voltage at the non-inverting input of A7.

If the first condition is not met, there will be attenuation during music. Diode D4 should be reverse-biased with no signal present. If it is not, and if the voltage at TP4 is about eight volts, it may be necessary to reduce R18.

If the second condition is not met, there will be insufficient attenuation during commercials. If TP4 is approximately eight volts with no signal present, it may be necessary to decrease R19 or R20.

Last, if fading occurs, but the LED does not light, it may be connected to the circuit backwards.

R-E

DRAWING BOARD

An output decoder



ROBERT GROSSBLATT

BELIEVE IT OR NOT, WE'RE ALMOST finished putting together our DTMF transmitter-receiver. All we have to do is add a few bits and pieces and we can start the easy part—looking around for some good applications for the circuit. As it stands now, we can point the transmitter at the receiver, push one of the transmitter's sixteen buttons, and see a DTMF tone pair at the outputs of the receiver's 3525, with the high and low group tones already conveniently separated for us. The last thing we have to do is translate the DTMF tones back into binary so we can do something with the output. Fortunately, that's the easiest part of the design.

As was the case with splitting the high and low groups, you could put together a circuit that converted DTMF data to binary using only standard parts. But then again, if you put your mind to it you could probably build a light bulb that way as well. This happens to be one of those times when it makes a lot of common sense to use an IC designed specifically for the job.

Although several companies make DTMF decoder IC's, we decided to use Mostek devices. That company makes a range of decoders, so you can pick an IC that really suits a particular application. Since we're not trying to do anything fancy, any of their decoder IC's will do. The MK5102 is a nice choice since it's easy to find and use. That IC is very similar to the MK5103, and the pinouts are identical, so one can be freely substituted for the other. The only difference between the parts is that the MK5103 is a slightly higher-

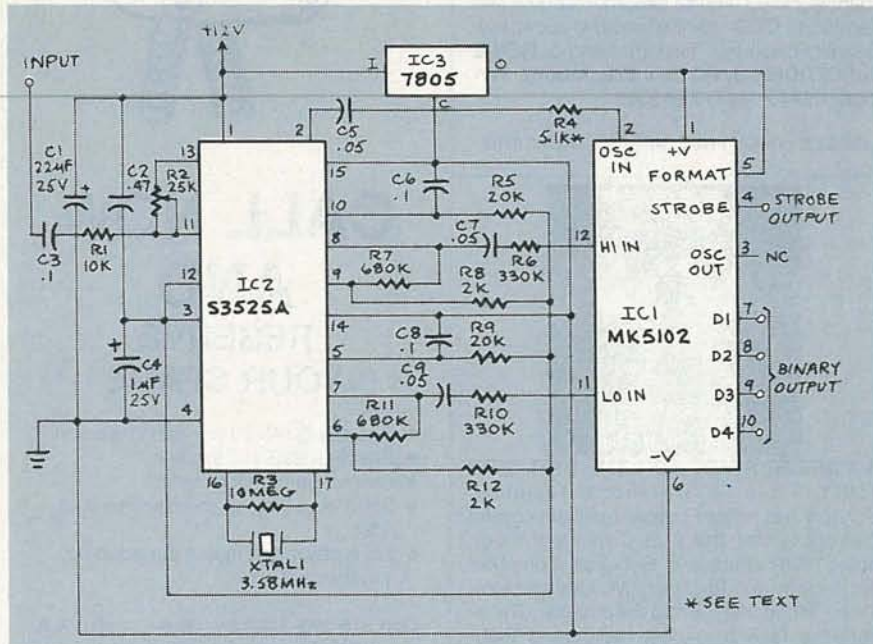

FIG. 1

grade device. The signal-to-noise ratio is 4 dB better, the tones can be detected 3 milliseconds faster, and it only uses about half the current when it's working (2 mA as opposed to 5 mA). But in many applications, those improvements will not make a difference.

Hooking it up

Getting the S3525 to talk to the MK5102 is simple. The only thing that might be the least bit tricky comes about because the two devices want different supply voltages: +5 volts for the MK5102 and +12 volts for the S3525. Since the MK5102 is a CMOS part it doesn't need a lot of current so the supply voltage can be chopped down to size with nothing more than a Zener.

Getting the signals from the S3525 outputs to the MK5102 inputs also takes a bit of thought since the voltage levels have to be translated there as well. That's because the CMOS outputs of the S3525 swing to within 1/2 volt of the supply voltage, which means that a

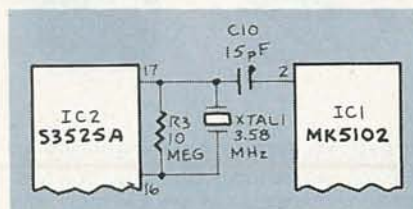

FIG. 2

high will be at about 12 volts. That's a definite no-no for the inputs of the MK5102. Figure 1 shows a circuit that takes care of the problem

and gets the two IC's talking to each other.

One thing you should notice right away is that we're making use of the buffered 3.58-MHz os-

MK5102 OUTPUT CODES

INPUT	OUTPUT							
	PIN 5 HIGH				PIN 5 LOW			
	D1	D2	D3	D4	D1	D2	D3	D4
1	φ	φ	φ	1	φ	1	φ	1
2	φ	φ	1	φ	φ	1	1	φ
3	φ	φ	1	1	φ	1	1	1
4	φ	1	φ	φ	1	φ	φ	1
5	φ	1	φ	1	1	φ	1	φ
6	φ	1	1	φ	1	φ	1	1
7	φ	1	1	1	1	1	φ	1
8	1	φ	φ	φ	1	1	1	φ
9	1	φ	φ	1	1	1	1	1
φ	1	φ	1	φ	φ	φ	1	φ
*	1	φ	1	1	φ	φ	φ	1
#	1	1	φ	φ	φ	φ	1	1
A	1	1	φ	1	φ	1	φ	φ
B	1	1	1	φ	1	φ	φ	φ
C	1	1	1	1	1	1	φ	φ
D	φ	φ	φ	φ	φ	φ	φ	φ

FIG. 3

cillator output that the folks at AMI have so conveniently put in the architecture of the S3525. (The buffered 3.58-MHz signal is exactly what we need to drive the MK5102.) Using one crystal for both IC's is a good idea since it eliminates one possible source of error. Of course we have to take care of the voltage differences there as well, but that's handled in the same manner as the outputs.

If you look at the outputs of the S3525, you'll see that C9 and C7 decouple each of them from the MK5102 inputs. Resistors R6 and R10 are there to do the level translation so the 12-volt outputs can safely drive the MK5102's 5-volt inputs. Much the same kind of level shifting is done at the crystal output as well with C5 and R4. The value you arrive at for R4 depends on the exact supply voltages at each IC but the value used in Fig. 1 should work as long as you're using supply voltages that are within 0.2 volts of 12 volts for the S3525 and of 5 volts for the

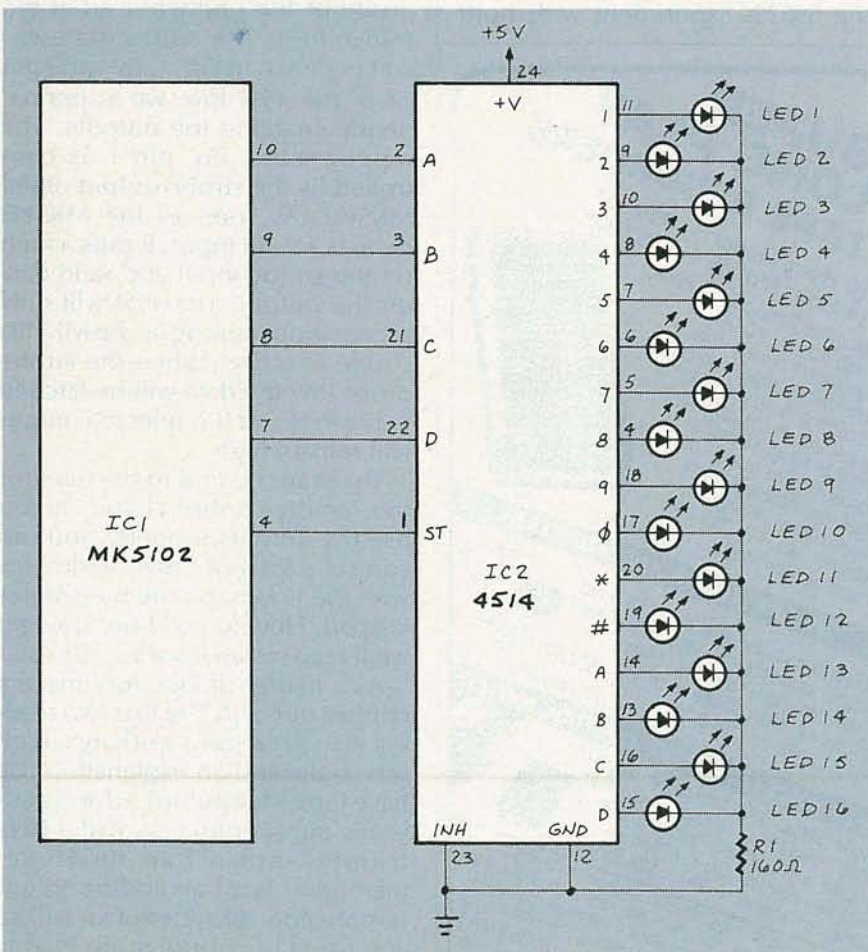

FIG. 4

COMB

Authorized Liquidator



COMMODORE®
VICMODEM™

- Use with the Commodore® C64™, the SX-64 or the VIC-20 Computer.
- Bell 103 Compatible.
- Full Duplex; 300 Baud.
- Manual Dial Direct Connecting.
- FCC Registered.

This Modem is **LOW liquidation priced** because it was closed out by Commodore®. Add it to your computer for access to timely financial information, news and reference libraries...as near as your phone! An affordable introduction to phone/computer services; and you can communicate with computer users who also own modems!

Use with data cassette (included), or with terminal program software, available at computer stores.

90-Day Limited Factory Warranty.

List: **\$59.00**

Liquidation
Priced At Only

\$19

Item H-2296-7041-072 Ship, handling: \$4.00 ea.
Commodore is a registered trademark of Commodore Electronics, Ltd.



Credit card members can order by phone, 24 hours a day, 7 days a week.

Toll-Free: 1-800-328-0609

Sales outside the 48 contiguous states are subject to special conditions. Please call or write to inquire.

SEND TO: Item H-2296
C.O.M.B. Direct Marketing Corp.
1405 Xenium Lane N/Minneapolis, MN 55441-4494

Send Modem(s) Item H-2296-7041-072 at \$19 each, plus \$4 each for ship, handling. (Minnesota residents add 6% sales tax. Sorry, no C.O.D. orders.)

My check or money order is enclosed. (No delays in processing orders paid by check.)

PLEASE CHECK: VISA MasterCard DISCOVER AMERICAN EXPRESS

Acct. No. _____ Exp. / _____
PLEASE PRINT CLEARLY

Name _____

Address _____

City _____

State _____ ZIP _____

Phone (____) _____
Sign Here _____

COMB COMB COMB

ELECTRONIC COMPONENTS



176 PAGE

FREE CATALOG

Manufacturers of Quality Electronic Components

Serving the Nation from Texas and California

- BATTERY HOLDERS & CLIPS • COILS
- CAPACITORS • CONNECTORS • FUSES
- JACKS • KNOBS • LAMPS • PLUGS
- MICROPHONES • POTENTIOMETERS
- RELAYS • RESISTORS • SWITCHES
- TRANSFORMERS • SPEAKERS • LEDS
- SEMICONDUCTORS • RF COILS

OVER 16,000 DIFFERENT ITEMS IN STOCK!
CATALOGS MAILED OUTSIDE USA SEND \$2.00

MOUSER ELECTRONICS

2401 HWY 287 NORTH MANSFIELD, TX 76063
PHONE 817-483-4422

CIRCLE 117 ON FREE INFORMATION CARD

Be an FCC LICENSED ELECTRONIC TECHNICIAN!



Earn up to \$30 an hour and more!

Learn at home in spare time. No previous experience needed.

No costly school. No commuting to class. The Original Home-Study course prepares you for the "FCC Commercial Radiotelephone License". This valuable license is your "ticket" to thousands of exciting jobs in Communications, Radio-TV, Microwave, Computers, Radar, Avionics and more! You don't need a college degree to qualify, but you do need an FCC License.

No Need to Quit Your Job or Go To School
This proven course is easy, fast and low cost! **GUARANTEED PASS** - You get your FCC License or money refunded. **Send for FREE facts now. MAIL COUPON TODAY!**

COMMAND PRODUCTIONS

FCC LICENSE TRAINING, Dept. 90
P.O. Box 2223, San Francisco, CA 94126

Please rush FREE details immediately!

NAME _____
ADDRESS _____
CITY _____ STATE _____ ZIP _____

MK5102. If your voltages are different, you'll have to adjust the value of the resistor.

That problem comes about because the S3525 will work over a wider supply voltage range than the MK5102. The S3525 is happy with anything from 9.5 to 13.5 volts while the MK5102 will choke if you don't stay within 1/2 volt of 5 volts. You can work out R4 with a lot of math, but this is one of those times when it's a lot easier (and a lot smarter) to measure the voltage at pin 2 of the MK5102. Using the appropriate DC range on your voltmeter or DMM, adjust the value of R4 until you've got a reading of 2.5 volts. That's not a super-accurate way to get the job done since the voltage at that point is actually AC, but it yields satisfactory results.

If you still have problems, you can modify the circuit as shown in Fig. 2. There, both C5 and R4 have been eliminated and the output of the oscillator on the S3525 is used to drive both IC's directly. Although that circuit appears simpler, it will put more of a load on the S3525. Experiment with both

circuit configurations and see which one works best for you. If there is no apparent difference, stay with the configuration shown in Fig. 1.

Believe it or not, that's just about all there is to connecting up the MK5102. The only other thing worth discussing is the format-control pin, pin 5. The MK5102 can output data two different ways: two-of-eight or straight binary. The difference between those outputs is shown in Fig. 3. When pin 5 is high, the output is straight binary; when pin 5 is low, the output is in two-of-eight format. Since we're feeding in binary in at the transmitter, we want binary out at the receiver and we can get that by tying pin 5 high.

Seeing the output

The last step in building our remote-control system is to devise some way of examining the binary output of the receiver. A simple way to look at it is to use a 4514 in a circuit setup that's exactly the opposite of the one we used at the transmitter. The appropriate circuit is shown in Fig. 4. By tying pin 23 of the 4514 low, we're permanently enabling the outputs. The input enable pin, pin 1, is controlled by the strobe output of the MK5102. As soon as the MK5102 detects a valid input, it puts a high on the strobe input and valid data on the output. The 4514 will only accept input as long as the MK5102 strobe is active. When the strobe drops low the data will be latched in the 4514 and the selected output will remain high.

There are no end to the uses for the remote-control circuit. If you use the outputs properly, you can control a lot more than 16 devices with the 16 keys on the transmitter keypad. How to go about doing it we'll leave as an exercise for you.

As a matter of fact, let's make a contest out of it. The first two readers who send me a working circuit schematic and an explanation will have their idea published and get a year's subscription to **Radio-Electronics**—not a bad deal! Remember, I want an add-on to our remote-control system that will let you use it to control more than 16 devices.

R-E

SUPER LONG PLAY TAPE RECORDERS

10 Hour Model - \$95.00*
14 Hour Model - \$159.00*

Modified Panasonic Slimline, high quality, AC-DC Recorders provide 5 or 7 continuous hours of quality recording & playback on each side of cassette for a total of 10 or 14 hours depending on model. Built-in features include • Voice level control • Digital counter, etc. TDK DC 180 Cassette Furnished.

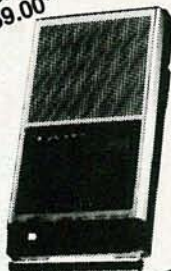

PHONE RECORDING ADAPTER

Records calls automatically. All Solid state connects to your telephone jack and tape recorder. Starts recording when phone is lifted. Stops when you hang up. **\$24.50***



VOX VOICE ACTIVATED CONTROL SWITCH

Solid state. Self contained. Adjustable sensitivity. Voices or other sounds automatically activate and control recorder. Uses either recorder or remote mike. **\$24.95***



*Add for ship & hdg. Phone Adapter & Vox \$1.50 ea. Recorders \$4.00 ea. Cal. Res. add tax. Mail order, VISA, M/C, COD's OK. Money Back Guarantee. Qty. disc. avail., Dealer Inquiries invited, Free data. © AMC SALES, Dept. A 9335 Lubec St., Box 928, Downey, CA (213) 90241 Phone 869-8519

CIRCLE 108 ON FREE INFORMATION CARD

DESIGNER'S NOTEBOOK

A battery backup for CMOS-based circuits



ROBERT GROSSBLATT
CIRCUITS EDITOR

ONE OF THE BIGGEST ADVANTAGES OF CMOS-based circuit design is the ability to run everything off batteries. Not only does that make the circuit completely portable, but it simplifies the overall design process as well. Powering a device from a wall socket means that you have to use transformers and rectifiers. It also means that you have to deal with ripple, regulation, and a lot of other stuff that has nothing to do with the circuit you're trying to build.

Of course, there are two sides to every story. Batteries simplify a lot of problems, but they also have one big one of their own: They go dead. And if power is drawn by a circuit to retain memory, those batteries will fail a lot sooner.

Memories like the 5101, 6116, 6264, and the other members of the CMOS low-power series require only about 10 μ A at 2 volts to retain their contents. That makes it possible to use a battery backup with those devices.

Battery backup circuit

If a battery backup is to be of any use, you need a circuit that will automatically switch from the main supply to the battery backup with an absolute minimum of glitching. That's the purpose of the circuit shown in Fig. 1. Designed for use with rechargeable Ni-Cd units, it charges the batteries whenever power is applied to the +V terminal, and supplies power from B1 when power is absent from that terminal. The circuit is easily modified for use with non-rechargeable batteries.

The first thing you should notice about the circuit is its simplicity.

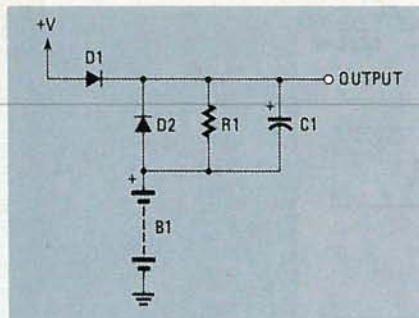

FIG. 1

The circuit's operation is straightforward. When power is supplied to +V, D1 conducts and, since D2 is reverse-biased, current flows into the batteries through current limiter R1. When the power is removed from +V, D2 is forward-biased and current flows from the battery to the output and on to the low-power voltage input of the CMOS device. Since D1 is reverse-biased at that time, no current can leak out via the +V terminal to the main part of the circuit. Capacitor C1 is included to filter out any glitches that may pop up during the change over from main power to battery backup, or when you replace the battery.

Component selection

Diode D2 can be a 1N914 unit since only small amounts of current will ever flow through it. Choosing a unit for D2 presents more of a problem; its selection depends on how much current is expected to flow through that diode. Chances are, if you're powering a CMOS IC, that the operating current is so low that you can use a 1N914 there as well. It is a simple matter to measure the current needs of the device to be

powered; that should be done before making a decision about which diode to use for D2.

Resistor R1 is the current limiter for the battery. Its value will depend on the battery's charging current and the voltage that's available from +V. The value can be found from:

$$R1 = (+V - 0.6 - V_B) / I_C$$

where +V is the voltage available at the +V terminal, 0.6 is the voltage drop across diode D1, V_B is the nominal voltage of the battery, and I_C is the charge current required by the battery. For I_C use the battery's 14-hour charge rate. The value of I_C might be different for batteries from different manufacturers. The value for the battery you will use may be marked on the battery itself. Otherwise it can be obtained from the battery's data sheet or from the manufacturer. You can modify the circuit for use with lithium or other non-rechargeable units by deleting R1.

Stabilizing control lines

One precaution you should take when using the circuit is to make sure that the memory control lines are stable before switching from main power to backup. If the control lines are enabled during the switch over, you stand a good chance of generating a write pulse and scrambling the data. In most cases, it's possible to three-state the appropriate inputs on the IC, which will take care of the problem. Otherwise, extra circuitry can be added that will perform the same function. If there's enough interest in that topic, we'll talk about it in more depth in a future column.

R-E

STATE OF SOLID STATE

Tone generator IC's



ROBERT F. SCOTT
SOLID STATE EDITOR

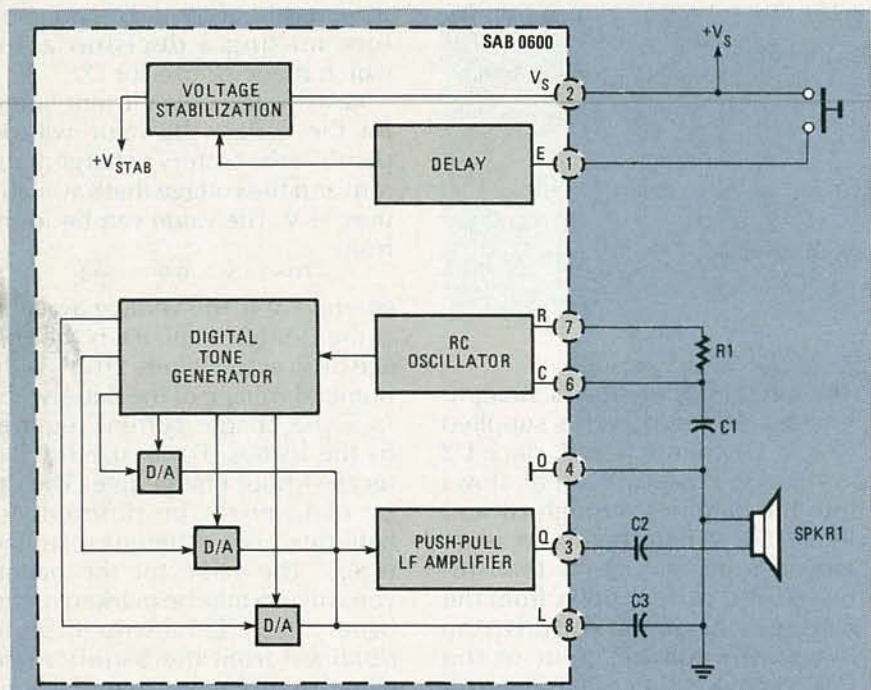

FIG. 1

THREE NEW IC TONE GENERATORS ARE available from the Integrated Circuits Division of Siemens Components. They are well suited for replacing the electromechanical gongs and doorbells in home installations and have countless applications as alarms and annunciators in timers, clocks, and automobiles. The devices are the SAB 0600, the SAB 0601, and the SAB 0602. The first develops a three-tone chime, the second generates a single tone, and the third produces two notes in succession. The SAB 0601 and the SAB 0602 are developed from the SAB 0600; the former by suppressing the last two tones, the latter by suppressing only the last note. Since all three IC's are simply vari-

ants of the SAB 0600, the circuits and discussion we will present will be centered on the latter.

A block diagram of the SAB 0600 is shown in Fig. 1. The SAB 0600 can be used to build a three-tone melodious chime, which in its simplest form requires only one resistor, three capacitors, and an 8-ohm speaker as external components as shown in the figure. The chime sequence is produced by three harmonically related frequencies: they are fed into a summing point and their amplitudes are allowed to decay individually.

The master oscillator generates a 13.5-kHz signal that is controlled by external components R1 and C1, which are connected to the R and C terminals of the tone gener-

ator. That 13.5-kHz signal is divided to produce the 660-, the 550- and the 440-Hz tones. One of those frequencies is divided down and used to control the timing and decay of the sequentially-produced tones. A 4-bit D/A (Digital-to-Analog) converter in each tone path acts on the three tones in such a way that they overlap as they decay.

The push-pull output stage can deliver approximately 160 mW to an 8-ohm speaker. The shrill tones produced by the squarewave voltages can be mellowed by shunting some of the higher harmonics to ground through a capacitor tied to pin 8 (C3 in Fig. 1); the value of that capacitor is typically 0.1 μ F. Volume can be controlled by inserting a 100-ohm potentiometer between the speaker and the output blocking capacitor (C2 in Fig. 1).

The chimes are sounded by momentarily applying a 1.5- to 11-volt (maximum) pulse to the trigger terminal, E. To at least somewhat protect against false triggering by interference on the control line, a trigger pulse shorter than 2 ms will not activate the circuit. The SAB 0600 requires a source of 7- to 11-volts DC for operation, but it can be triggered by either an AC or a DC voltage. For DC triggering, the switch or pushbutton is connected between pins 1 and 2.

An electronic doorbell

The fact that the electronic chime can be activated by an AC pulse simplifies using it as an add-on to conventional doorbell systems powered by a 16- to 25-volt bell transformer; it simply takes the place of an electromechanical

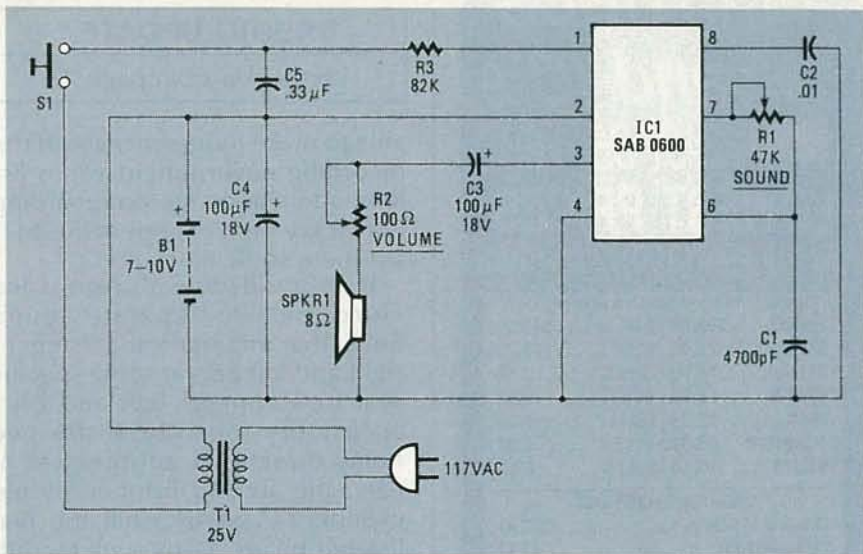

FIG. 2

sounder in the system. Figure 2 shows the required circuitry. An internal diode in the SAB 0600 shunts the negative half-cycles of the AC voltage to ground. The peak value of the positive half-cycles adds to the value of $+V_s$, so a resistor (R3) must be inserted in series with the trigger terminal to prevent the voltage at pin 1 from rising above the maximum level permitted for $+V_s$ (11 volts). Let's calculate its value.

The minimum permissible input current at pin 1 is 500 μ A. Resistor R3 must drop the AC peak voltage so that the voltage at pin 1 never exceeds 11 volts. Assuming that the bell transformer has a 25-volt secondary:

$$\begin{aligned}
 R3_{(MIN)} &= (V_{RMS} \times 1.41) / 500\mu A \\
 &= (25 \times 1.41) / 0.0005 \\
 &= 35 / 0.0005 \\
 &= 70,000 \text{ ohms}
 \end{aligned}$$

For reliable triggering, the maximum value of R3 is determined by the minimum value for V_s (6 volts) while applying 1.5 volts at 50 μ A to pin 1 for triggering. So:

$$\begin{aligned}
 R3_{(MAX)} &= (V_{S(MIN)} - 1.5) / 50 \\
 &= (6 - 1.5) / 0.00005 \\
 &= 90,000 \text{ ohms}
 \end{aligned}$$

The suggested value of 82,000 ohms shown in Fig. 2 will provide triggering by battery or AC-peak voltages up to 35.

Note well that no conventional electromechanical bell or chime can be connected in parallel with the electronic chime pushbutton. Otherwise the electronic chime

will sound continuously as the bell or gong will form an electrical connection between the V_s and the trigger terminals (pins 1 and 2).

The SAB 0600 and the others in the series are \$2.30 each, in lots of 1 to 24. Write to Siemens Components, Inc., Integrated Circuits Division, 186 Wood Avenue South, Iselin, NJ 08830. R-E

IS CET
CERTIFIED
ELECTRONICS TECHNICIAN

*You Can Be
One Of The
20,000 Technicians
Certified By IS CET*

The International Society Of Certified Electronics Technicians offers permanent certification by administering the CET exam with the FCC recognized communications option for \$20. A second exam on FCC regulations for a \$10 fee is required for a Radiotelephone License. Upon passing, technicians receive both a permanent Radiotelephone Operator Certificate and a CET Certificate issued by IS CET.

IS CET Offers License Renewal

IS CET has developed a program for registration of those who currently hold a valid Radiotelephone Operator License. By sending a completed application, a photocopy of your FCC License, and \$10 your license will be renewed with the assurance of a recognized national technicians association behind it.

For More Information Contact:
IS CET 2708 W. Berry, Ft. Worth, TX 76109. (817) 921 - 9101

ATTENTION! ELECTRONICS TECHNICIANS

EARN YOUR
**B.S.E.E.
DEGREE**

THROUGH HOME STUDY

Our New and Highly Effective Advanced-Placement Program for experienced Electronic Technicians grants credit for previous Schooling and Professional Experience, and can greatly reduce the time required to complete Program and reach graduation. No residence schooling required for qualified Electronic Technicians. Through this Special Program you can pull all of the loose ends of your electronics-background together and earn your B.S.E.E. Degree. Upgrade your status and pay to the Engineering Level. Advance Rapidly! Many finish in 12 months or less. Students and graduates in all 50 States and throughout the World. Established Over 40 Years! Write for free Descriptive Literature.



COOK'S INSTITUTE
OF ELECTRONICS ENGINEERING

347 RAYMOND ROAD
P.O. BOX 20345
JACKSON, MISSISSIPPI 39209

CIRCLE 193 ON FREE INFORMATION CARD

SEE YOUR DEALER TODAY



FROM

'Firestik'
ANTENNAS
ACCESSORIES

HERE'S A TIP
THAT'S PERFECT!
AM/FM AUTO RADIO
AND CB

'Firestik' II
GOLDEN SERIES

BARE-HANDS TUNABLE
"NO TOOLS NEEDED"
HIGH PERFORMANCE ANTENNAS

ALSO ANTENNAS FOR
CORDLESS TELEPHONES
MONITOR SCANNERS

Dealer & Distributor Inquiries Invited
SEND FOR FREE CATALOG

'Firestik' Antenna Company
2614 East Adams/Phoenix, AZ 85034

Name _____
Street _____
City _____
State _____ Zip _____

Serving the CB and
Communications Market Since 1962.

5-YEAR REPLACEMENT WARRANTY

CIRCLE 100 ON FREE INFORMATION CARD

LOOK SPECIAL INTRODUCTORY OFFER

Mention This Ad
And Take **15% OFF** PRICES LISTED BELOW
COMPLETE 1Mw LASER TUBE & POWER SUPPLY KIT



* Assembly Must Conform to Gov't Specs.
JUST \$129.90

- * 7 to 25 Watt Laser Diode \$14.88
- * 2Mw Laser Tube (uncased) \$139.95
- * 5 Mw Laser Tube (uncased) . . . \$159.95

*5-1/4" FLOPPY DISKS

Software excess, erraced,
Guaranteed. DSDD, with New labels
& sleeves. \$33.50/100
LARGE QTY. PRICES AVAILABLE

- * Infrared Goggles (AN/PAS5 . . . \$399.95
- * CHARZ-T Infrared Monocular \$1,999.00

- * 3" Solar Cells .75A, .45V . . . \$16.00/6
- \$65.00/30; \$190.00/100

- * 4" Solar Cells 1.5A, .45V . . . \$20.00/5
- \$70.00/20; \$273.00/100

- * 23x47x1-7/8" Solar Panel:
14V, 1.5A \$199.95

- * Jacobs Ladder/Tesla Coil Kit. . . \$19.88

BNF Enterprises

119r FOSTER St.
Peabody MA 01960 **Free!**
(617) 531-5774 **36 Page Catalog**
Customer Pays All Shipping Charges.

CIRCLE 196 ON FREE INFORMATION CARD



TUBES and IC's

FAST DELIVERY
LOWEST PRICES
call Toll Free (800) 221-5802

In-depth Inventory - Industrial & Receiving Tubes

3-500Z \$95.00	813 \$45.00
572-B 75.00	6LF6 8.26
811-A 15.00	6JS6C 7.46
6146-B 8.75	6CA7 6.91
8950 12.75	6MJ6 8.38
4CX250-B . . 85.00	8417 8.38
SG613 10.50	20LF6 8.26

CHEMTRONICS CHEMICALS

TUN-O-WASH-24 oz.	\$2.42
TUN-O-POWER	\$2.47
TUNER-RENU-16 oz. . \$2.65 . 6 oz. .	\$1.35
FREEZE IT	\$1.89

Major Manufacturers Factory Boxed and Full line of
Sylvania ECG Replacement Semiconductors



Minimum order \$25.00 Allow \$3 UPS charge

TRANSLERONIC INC.

Box R, 1365 39th Street, Brooklyn, NY 11218
Tel. 718-633-2800/Watts Line 800-221-5802
FAX # (718) 633-4375

CIRCLE 201 ON FREE INFORMATION CARD

AUDIO UPDATE

continued from page 72

able to make judgments about the recording environment when listening to a good stereo recording is a far cry from experiencing an I-am-there sonic illusion.

If we could perfectly record and store the two separate sound fields that impinge on a listener's right and left ears at some specific seat in a concert hall and then accurately reproduce the two fields directly at another set of ears, the second listener should experience exactly what the first listener heard. Many such recordings have been made using carefully constructed dummy heads with wide-range microphones implanted in the equivalent of their ear canals. Of course, the material has to be listened to through headphones to prevent the introduction of a confusing intervening acoustic environment. I've heard many such binaural recordings, and while they are a definite step towards realism, for obscure reasons they don't achieve quite the I-am-there perfection that theory seems to promise.

A practical approach

Late last year, I was asked by Yamaha to participate in the introduction of their *DSP-1* digital sound-field processor. I was particularly interested in the device because it used a completely new approach to recreating "concert-hall realism" in the home. It was neither an updated quadraphonic synthesizer nor a time-delay system, although in a sense it could be said to draw on both techniques in its digital manipulation of the signal.

After some discussion, Yamaha and I agreed on a presentation technique; I would first discuss the acoustic and psychoacoustic differences between the live musical experience and recordings reproduced at home—very much as I have done in my column. I would then introduce the *DSP-1* as one company's approach to enhancing the reality of home music reproduction. I'll discuss the specifics of Yamaha's digital processing techniques next time.

R-E

"Made in U.S.A."



Since 1965

We've been supplying quality crystals since 1965 — long before the flood of cheap imports.

We're still supplying quality crystals with

- Quick Turnaround
- Low Price
- High Quality

TO SOLVE CRYSTAL PROBLEMS, GET THIS CATALOG



JAN CRYSTALS

P.O. Box 06017
Ft. Myers, FL 33906
(813) 936-2397



CALL 1-800-237-3063
FREE (Except Florida)

MOVING?

Don't miss a single copy of **Radio - Electronics**. Give us:

Six weeks' notice

Your old address and zip code

Your new address and zip code

ATTACH LABEL HERE

name (please print)

address

city state zip code

Mail to: Radio-Electronics
SUBSCRIPTION DEPT., P.O. BOX 51866,
BOULDER, COLO. 80321-1866

COMPUTER DIGEST

VOL. 5 NO. 4 APR. 1987

A NEW KIND OF MAGAZINE FOR ELECTRONICS PROFESSIONALS

A
GERNSBACK
PUBLICATION

THE CAUZIN SOFTSTRIP SYSTEM

Paper goes digital

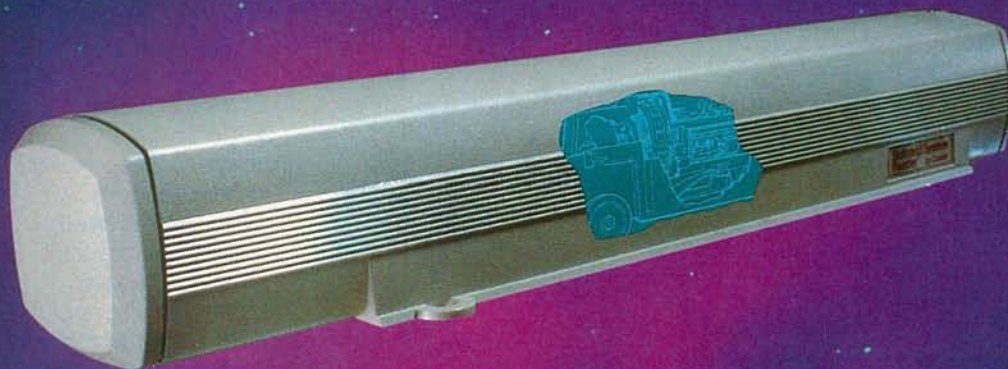

GROLIER'S
ELECTRONIC
ENCYCLOPEDIA

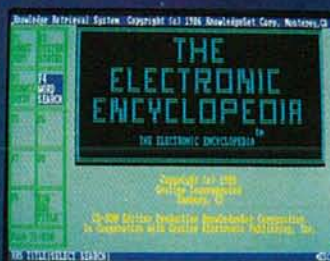

CONTENTS

APRIL 1987

Vol. 4 No. 4



- 93 THE CAUZIN SOFTSTRIP SYSTEM**
A new way to distribute software.

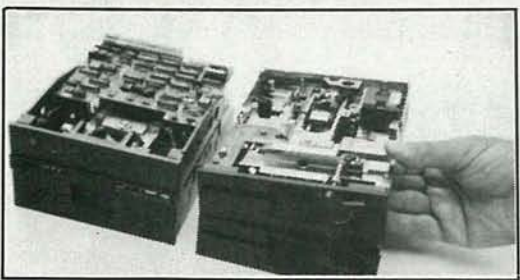

- 96 ADD A DISK DRIVE**
Increase your computing performance.



- 98 BUILD A PC INCOMPATIBLE**
Even better than the Timex Sinclair 1000!

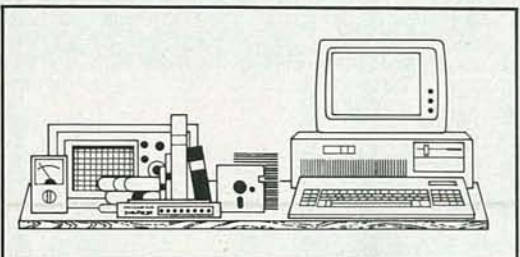

- 85 EDITOR'S WORKBENCH**
Hardware: The Hercules Graphics Card Plus
Software: Grolier's Electronic Encyclopedia
Etc.: New computer products

COMPUTER DIGEST

Larry Steckler,
EHF, CET: publisher & editor in chief

Art Kleiman,
editorial director
Brian C. Fenton,
managing editor
Byron G. Wels,
editor
Jeff Holtzman
technical editor
Carl Laron,
associate editor
Robert A. Young,
assistant editor
Teri Scaduto
editorial assistant
Ruby M. Yee,
production director
Karen Tucker,
production advertising
Robert A. W. Lowndes,
production associate
Geoffrey S. Weil,
production assistant
Andre Duzant,
technical illustrator
Jacqueline P. Cheeseboro
circulation director
Arline R. Fishman,
advertising director

ComputerDigest
Gernsback Publications, Inc.
500-B Bi-County Blvd.
Farmingdale, NY 11735

ADVERTISING SALES 516-293-3000

Larry Steckler
Publisher

NATIONAL SALES

Joe Shere
1507 Bonnie Doone Terrace
Corona Del Mar, CA 92625
714-760-8967

Cover Photo by Dan Muro

EDITOR'S WORK- BENCH

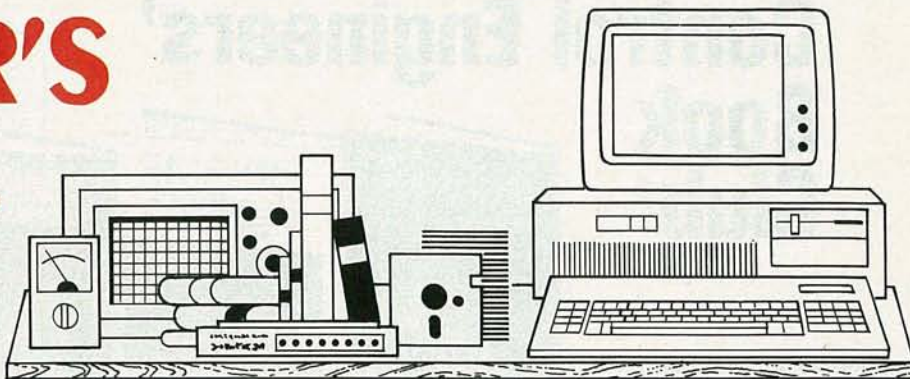

HERCULES GRAPHICS CARD PLUS

At a time when color-graphics systems for the IBM-PC are more prolific than ticks on a hound, one would hardly expect to see a monochrome graphics board squaring off with the competing color-graphics heavyweights. But into the midst of the fray comes the new Hercules card (Hercules Computer Technology 2550 Ninth St., Berkeley, CA 94710).

Like the old Hercules card, the new *Plus* supports both monochrome text and 720-by-348 pixel graphics on the IBM monochrome display monitor or its equivalent. The *Plus* is hardware and software compatible with all applications developed for the original card, including tough customers like Lotus 1-2-3, Flight Simulator, and Sub-Logic's Jet. Anything and everything that ran on the old card comes off without a hitch on the new one.

RamFont

What sets the *Plus* card apart from the original is something called RamFont, a hardware-based graphics mode that enables the PC to display multiple fonts and limited graphics on the screen as easily as older graphics cards displayed standard monochrome text. (See Fig. 1)

Actually, in addition to the original two modes, there are two RamFont modes: 4K RamFont and 48K RamFont. Each uses the indicated amount of display memory, and each serves a different purpose.

The 4K RamFont mode is essentially a superset of the standard text mode. Traditionally,

text screens have been limited to one type and style of displayed text; the patterns of which are indelibly etched into the BIOS ROM IC of the computer. With the *Plus*, Hercules provides a number of diskette-based fonts, including Bold, Greek, "Medieval," Sans Serif, "Future," and about 25 others, any one of which can replace the standard character set, thereby allowing you to customize the display to your liking. The selected font is accessible by any and all text-mode software in the normal fashion. Hercules provides a font editor so that you can create your own fonts, or modify theirs.

The 48K RamFont mode is completely new and totally revolutionary. In this mode, each character is defined by twelve bits, rather than the customary eight. So programs can display as many as 3,096 characters in different sizes, shapes and typefaces.

Using drivers supplied by Hercules, the 48K RamFont mode can also be used to display graphics screens from Lotus 1-2-3 (Version 2) and Symphony. (Lotus' new sci-

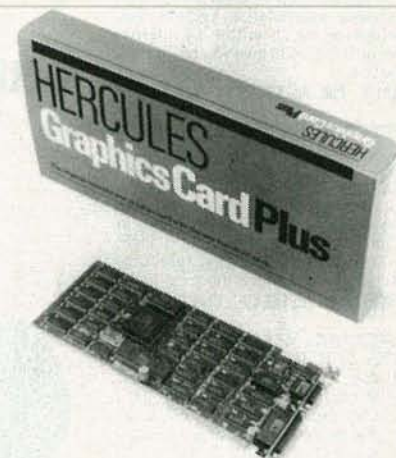

FIG. 2

entific word processor, Manuscript, makes use of the 48K RamFont mode; watch for a review in an upcoming issue.—*Editor*). The drivers actually replace the standard eight-

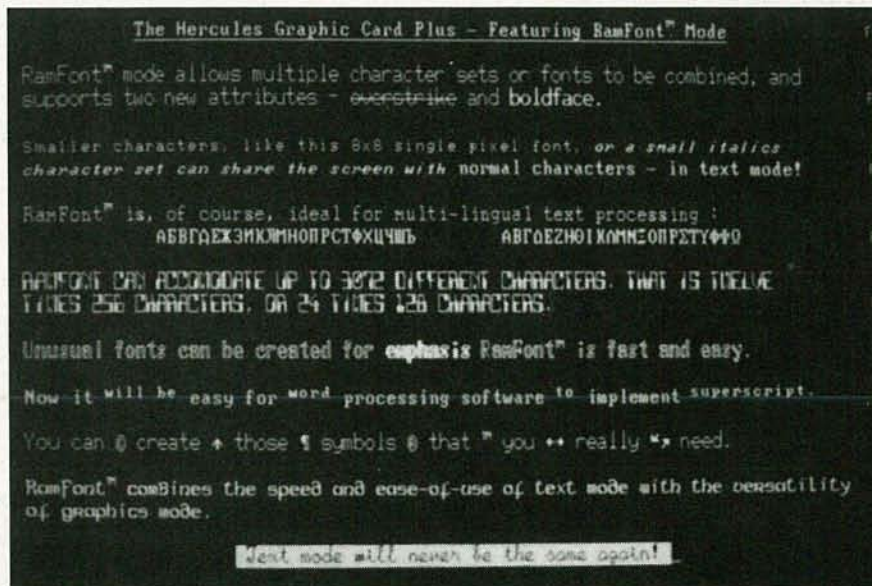
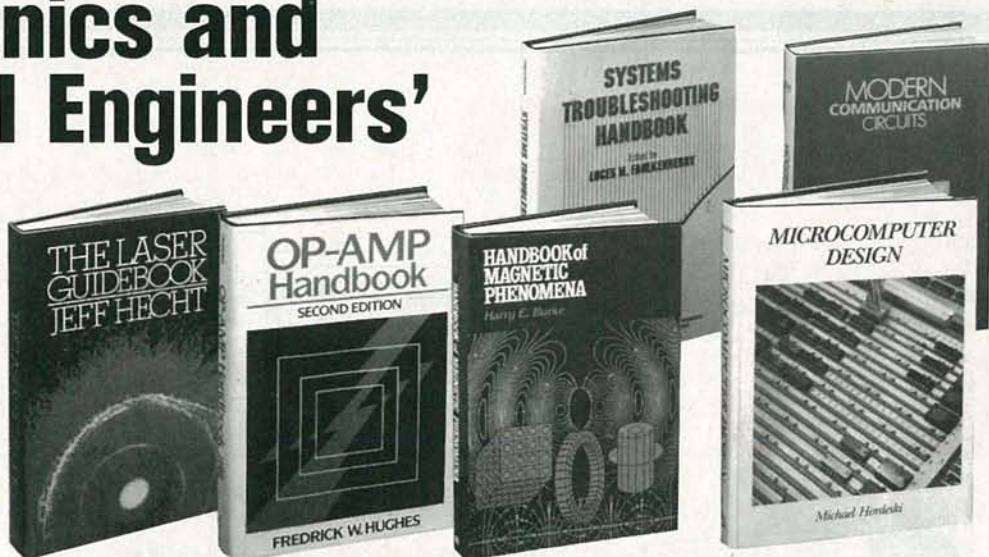

FIG. 1

Join the Electronics and Control Engineers' Book Club®



ADVANCED DIGITAL COMMUNICATIONS: Systems and Signal Processing. Edited by K. Feher. 768 pp., 436 illus. Emphasizes the newest advances and developments in telecommunications systems and networks. Chapters on subjects such as ISDN, speech coding algorithms, digital speech interpolation systems and interference are all written by international authorities to give you on-the-job expertise.

583801-X Pub. Pr., \$59.95 Club Pr., \$42.50

ELECTRONICS ENGINEERS' HANDBOOK, Second Ed. Edited by D. G. Fink & D. Christiansen. 2,272 pp., 2,189 illus. This updated and enlarged edition covers all the latest knowledge in the field, including new advances in integrated circuits, pulsed and logic circuits, laser technology, telecommunications, and much more.

209/812 Pub. Pr., \$89.00 Club Pr., \$61.50

DESIGNING ELECTRONIC CIRCUITS. By R. G. Middleton. 351 pp., 192 illus. Covers virtually every category of circuits commonly used. This practical manual provides the basic design procedures, tables and formulas vital to effective electronic circuit design. Plus over 60 start-to-finish procedures are featured along with scores of computer programs to help you design and analyze electronic circuits.

583673-4 Pub. Pr., \$36.95 Club Pr., \$27.50

THE LASER GUIDEBOOK. By J. Hecht. 368 pp., 109 illus. This book covers the operating principles, characteristics and applications of all commercially available lasers. It will help you find the specific laser that best meets your requirements.

277/338 Pub. Pr., \$49.50 Club Pr., \$37.50

MICROPROCESSOR HANDBOOK. Edited by J. D. Greenfield. 656 pp., 222 illus. This first-ever handbook helps you select the best microprocessor, enables you to understand the operation of a microprocessor you are now using and provides easily accessed coverage of the most popular 8 and 16-bit microprocessors currently available.

583636-X Pub. Pr., \$44.95 Club Pr., \$28.50

SYSTEMS TROUBLESHOOTING HANDBOOK. Edited by L. M. Faulkenberry. 415 pp., 282 illus. Ten leading experts share their most effective fault-isolation techniques as well as solutions to problems they commonly encounter when troubleshooting microprocessors, robotic control systems, PCs, fiber optics systems and other complex electronic systems and equipment.

583699-8 Pub. Pr., \$44.95 Club Pr., \$33.75

MICROCOMPUTER DESIGN. By M. Hordeski. 406 pp., illus. Emphasizes the most current, cost effective methods for developing, debugging and testing all types of microprocessor products, including software and hardware.

583683-1 Pub. Pr., \$29.95 Club Pr., \$20.95

Get the competitive edge with the newest and the best information in your field . . . with books from all the leading publishers

New Members!
Take any one of these great professional books for only **\$289** as a premium with your first selection!

Spectacular values up to **\$110.00**

ANTENNA ENGINEERING HANDBOOK, Second Ed. Edited by R. C. Johnson and H. Jasik, with contributions by 57 recognized authorities. 1,408 pp., 946 illus. This widely acclaimed Handbook gives you the guidance you need to solve problems in antenna design and application.

322/910 Pub. Pr., \$110.00 Club Pr., \$68.00

CONTEMPORARY ELECTRONICS CIRCUITS DESKBOOK Compiled by H. Helms. 272 pp., 442 circuit diagrams. Packed with clearly reproduced circuit diagrams, all proven-in-action, covering the entire spectrum of electronics technology. Each diagram includes a title, a brief description, type numbers or values for significant components and a citation of the original source.

279/802 Pub. Pr., \$31.50 Club Pr., \$23.50

POWER INTEGRATED CIRCUITS: Physics, Design, and Applications. Edited by P. Antognetti. 544 pp., 410 illus. This comprehensive book offers an exceptionally thorough overview of the state of the art in design and technology—including the latest design advances in voltage regulators, audio amplifiers, power MOS devices, BiMOS power ICs, and improved transistor structures.

021/295 Pub. Pr., \$49.50 Club Pr., \$35.50

AUTOMATIC CONTROL SYSTEMS, Fifth Ed. By B. C. Kuo. 736 pp., illus. Provides an overview of automatic control systems, including in-depth coverage of classical control techniques, optimal control theory, and analog and digital control system design. This updated edition discusses the latest ideas on the use of computers to design control systems and as components of such systems.

583706-4 Pub. Pr., \$44.95 Club Pr., \$33.50

OP-AMP HANDBOOK, Second Ed. By F. W. Hughes. 320 pp., 231 illus. Organized for on-the-job reference, this handbook covers all facets of op-amps, from stability and protection to signal processing using op-amps. Includes a collection of over 60 practical circuits for a variety of applications, procedures, and experiments.

583651-3 Pub. Pr., \$33.95 Club Pr., \$24.75

CHOOSING AND USING CMOS. By M. J. Walsh. 304 pp., 155 illus. Offers a comprehensive overview of the semiconductor technology used . . . gives practical advice on circuit techniques to make your job easier. Specifications, characteristics and applications are included.

679/576 Pub. Pr., \$35.50 Club Pr., \$24.95

MCGRAW-HILL CONCISE ENCYCLOPEDIA OF SCIENCE AND TECHNOLOGY. Editor-in-Chief S. P. Parker and the Staff of the McGraw-Hill Encyclopedia of Science and Technology. 2,065 pp., 1,600 illus. This volume serves every need for understanding today's science and technology. Written by over 3,000 of the world's topmost experts, including 19 Nobel Prize winners, it covers 75 disciplines from Acoustics to Zoology.

454/825 Pub. Pr., \$98.50 Club Pr., \$49.25

MICROPROCESSORS IN INSTRUMENTATION AND CONTROL. By S. A. Money. 246 pp., 148 illus. Provides the design procedures and applications data you need to create effective, high quality microprocessor-based systems. There is thorough coverage of programming, arithmetic and logic operations, parallel input-output, serial input-output, hardware design, analog/digital conversion and much more.

427/070 Pub. Pr., \$39.50 Club Pr., \$29.50

MODERN COMMUNICATION CIRCUITS. By J. Smith. 557 pp., 434 illus. Using realistic examples, this book presents time-saving approximation techniques for analyzing and designing virtually every kind of communications circuit imaginable. Includes particularly thorough coverage of the phase-lock loop.

587/302 Pub. Pr., \$45.95 Club Pr., \$32.50

HANDBOOK OF MAGNETIC PHENOMENA. By H. E. Burke. 423 pp., 221 illus. A straightforward guide to over 60 magnetic phenomena. Topics include Ampere's Law, Biot-Savart and toroidal fields, spinning electric charges, magnetic hysteresis, magnetic field measurement, magnetic resonance, galvanomagnetic effects, and more.

583760-9 Pub. Pr., \$49.50 Club Pr., \$37.50

MODERN ELECTRONIC CIRCUITS REFERENCE MANUAL. By J. Markus. 1,264 pp., 3,666 circuit diagrams. Complete with values of components and suggestions for revisions—plus the original source of each circuit in case you want additional performance or construction details.

404/461 Pub. Pr., \$82.50 Club Pr., \$61.50

TELEVISION ENGINEERING HANDBOOK.—By K. B. Benson. 1,478 pp., 1,091 illus. Packed with the technical information and know-how you need to design, operate and maintain every type of TV equipment in current use.
047/790 Pub. Pr., \$89.50 Club Pr., \$62.50

OPERATIONAL AMPLIFIERS AND LINEAR INTEGRATED CIRCUITS, Third Ed. By R. F. Coughlin and F. F. Driscoll. 450 pp., illus. A detailed practical guide to the op amp and its successor, the linear IC. A variety of applications and design procedures are covered.
583754-4 Pub. Pr., \$34.95 Club Pr., \$25.95

THE ENCYCLOPEDIA OF ELECTRONIC CIRCUITS. By R. Graf. 760 pp., 1,256 illus. This large volume provides circuits for virtually every type of application in 98 different categories. Each has a clear and concise explanatory text accompanying it.
583265-8 Pub. Pr., \$50.00 Club Pr., \$39.95

CONTROL SYSTEM DESIGN: An Introduction to State-Space Methods. By B. Friedland. 513 pp., illus. Covers feedback control, dynamics of linear systems, frequency-domain analysis, linear observers, linear, quadratic optimum control, random processes, and many other topics.
224/412 Pub. Pr., \$44.95 Club Pr., \$33.50

INTRODUCTION TO RADAR SYSTEMS. By M. I. Skolnik. 2nd Ed., 698 pp., 244 illus. Covering every radar fundamental and all important changes, this EE text exposes you fully to the systems themselves—and to their applications! Topics include radar equation, CW and frequency-modulated radar, MTI, pulse-doppler, tracking radar, receivers, displays, duplexers, noise, and more.
579/091 Pub. Pr., \$51.95 Club Pr., \$38.95

TROUBLESHOOTING ELECTRONIC EQUIPMENT WITHOUT SERVICE DATA. By R. G. Middleton. 303 pp., 162 illus. and tables. Packed with charts, diagrams, and case histories, this practical handbook shows you how to pinpoint defective electronic circuitry when no service data is available.
583134-1 Pub. Pr., \$27.95 Club Pr., \$19.95

STANDARD HANDBOOK OF ENGINEERING CALCULATIONS. T. G. Hicks, Editor in Chief. 2nd Ed., 1,468 pp., 1,292 illus. and tables. Now revised, updated, and considerably expanded, this huge handbook provides more than 5,100 step-by-step procedures for solving the kinds of engineering problems you encounter most frequently in your work.
287/35X Pub. Pr., \$64.50 Club Pr., \$49.50

Be sure to consider these important titles as well!

FUNDAMENTALS OF LOGIC DESIGN & SWITCHING THEORY. By A. D. Friedman.
583601-7 Pub. Pr., \$26.95 Club Pr., \$21.50

68000 MICROPROCESSOR: ARCHITECTURE, SOFTWARE & INTERFACE TECHNIQUES. By W. A. Triebel & A. Singh.
583613-0 Pub. Pr., \$34.95 Club Pr., \$26.95

DESIGNING DIGITAL FILTERS. By C. S. Williams.
583627-0 Pub. Pr., \$36.95 Club Pr., \$27.95

APPLICATIONS IN ARTIFICIAL INTELLIGENCE. By S. J. Andriole.
583715-3 Pub. Pr., \$49.95 Club Pr., \$37.50

ILLUSTRATED ENCYCLOPEDIA OF SOLID-STATE CIRCUITS AND APPLICATIONS. By D. R. Mackenroth & L. G. Sands.
583719-6 Pub. Pr., \$34.95 Club Pr., \$26.50

THE FOURIER TRANSFORM AND ITS APPLICATIONS, Second Ed., Revised. By R. N. Bracewell.
070/156 Pub. Pr., \$48.95 Club Pr., \$33.95

DIGITAL FILTERS AND SIGNAL PROCESSING. By L. B. Jackson.
583710-2 Pub. Pr., \$32.95 Club Pr., \$26.50

MICROPROCESSOR SUPPORT CHIPS. By TJ Byers.
095/183 Pub. Pr., \$44.50 Club Pr., \$35.25

ILLUSTRATED HANDBOOK OF ELECTRONIC TABLES, SYMBOLS, MEASUREMENTS AND VALUES. By R. H. Ludwig.
583705-6 Pub. Pr., \$34.95 Club Pr., \$25.95

INDUSTRIAL ROBOTICS. By M. P. Groover; R. N. Nagel and N. G. Odrey.
249/89X Pub. Pr., \$39.95 Club Pr., \$28.95

THE MCGRAW-HILL COMPUTER HANDBOOK. By H. Helms.
279/721 Pub. Pr., \$86.50 Club Pr., \$54.50



Why YOU should join now!

- **BEST AND NEWEST BOOKS IN YOUR FIELD** — Books are selected from a wide range of publishers by expert editors and consultants to give you continuing access to the best and latest books in your field.
- **BIG SAVINGS** — Build your library and save money too! Savings ranging up to 40% or more off publishers' list prices — usually 20% to 30%.

BONUS BOOKS—You will immediately begin to participate in our Bonus Book Plan that allows you savings up to 70% off the publishers' prices of many professional and general interest books!

■ **CONVENIENCE**—12-14 times a year (about once every 3-4 weeks) you receive the Club Bulletin FREE. It fully describes the Main Selection and Alternate Selections. A dated Reply Card is included. If you want the Main Selection, you simply do nothing—it will be shipped automatically. If you want an Alternate Selection—or no book at all—you simply indicate it on the Reply Card and return it by the date specified. You will have at least 10 days to decide. If, because of late delivery of the Bulletin you receive a Main Selection you do not want, you may return it for credit at the Club's expense.

As a Club member you agree only to the purchase of three books (including your first selection) during your first year of membership. Membership may be discontinued by either you or the Club at any time after you have purchased the first selection plus two additional books.

Other McGraw-Hill Book Clubs:
Architects' Book Club • Byte Book Club • Chemical Engineers' Book Club
• Civil Engineers' Book Club • Mechanical Engineers' Book Club

For more information, write to:
McGraw-Hill Book Clubs, P.O. Box 582, Hightstown, New Jersey 08520-9959

MAIL THIS COUPON TODAY

McGraw-Hill Book Clubs Electronics and Control Engineers' Book Club®

P.O. Box 582, Hightstown, New Jersey, 08520-9959

Please enroll me as a member and send me the two books indicated, billing me for the \$2.89 premium and my first selection at the discounted member's price, plus local tax, shipping, and handling charges. I agree to purchase a minimum of two additional books during my first year of membership as outlined under the Club plan described in this ad. A shipping and handling charge is added to all shipments.

Write Code No. of
\$2.89 selection here

Write Code No. of
first selection here

Signature _____

Name _____

Address/Apt. # _____

City _____

State _____ Zip _____

This order subject to acceptance by McGraw-Hill. All prices subject to change without notice. Offer good only to new members.

E33841

bit ASCII character codes with the 12-bit character codes required by RamFont. And through careful definition and manipulation of the character patterns involved (lines and solids included), complex graphic images can be created on-screen. Vendor software support for the new 48K RamFont mode is expected.

A point to consider, however, is that none of the 4K or 48K RamFont characters can be printed on paper. They are screen images only, and remain that way. Calls to the printer result in standard ASCII characters.

Printer port

Overshadowed by RamFont's glitter is a unique parallel-printer port. It's unique in that it is controlled by a single, proprietary IC that replaces about 18 standard TTL IC's. It is configured to function only as LPT1; to disable it, you must remove the IC.

Priced at \$299—a full \$200 less than the original Hercules card—the Hercules Graphics Card Plus is a winner. If you're in the market for a monochrome graphics card, check this one out first. 



GROLIER'S ELECTRONIC ENCYCLOPEDIA

What is the value of information? The answer to that question depends on the kind of information—and on whether it's accessible. If it's inaccessible, it's worth just about what it would be if it didn't exist at all: Nothing. That may seem obvious, but there's more to the idea than may appear at first glance. Our age has already been called the Information Age, but technologies that are here now, albeit in rather primitive form, promise to eclipse previous advances in both the storage and processing of information.

In fact, it's already happening in several areas. Almost everyone is familiar with optical storage technology, because the audio compact disk is one example of that technology. You may have heard of the CD-ROM—it's physically the same as an audio CD, but it usually carries information that is to be processed by computer.

We discussed the organization of the audio compact disk in the August 1986 issue; an upcoming issue in 1987 will discuss CD-ROM technology. Meanwhile, we've been discussing CD-ROM products as they've been released. For example, see our review

of the PC-SIG CD-ROM in the March issue. That CD-ROM contains the equivalent of more than 600 diskettes of programs and data files for the IBM-PC.

Another CD-ROM product, *The Electronic Encyclopedia*, has been released by Grolier Electronic Publishing, Inc. (Sherman Turnpike, Danbury, CT 06816), in cooperation with Activenture Corp. (Monterey, CA). If you've ever used a computer with the CP/M operating system, you may be interested to know that its inventor, Gary Kildall, is head of Activenture.

The encyclopedia is contained on a single CD-ROM; an auxiliary diskette contains Activenture's Knowledge Retrieval System (KRS), installation software, and drivers for several popular CD-ROM drives (Hitachi, Phillips, and Sony models). Unlike some CD-ROM products, KRS does not require the hardware drivers to be included in your

CONFIG.SYS file, so there is little possibility for conflict with other programs or devices. The program requires 256K of RAM, and it can run on any monochrome or color IBM-PC display.

What is it?

The encyclopedia itself is based on Grolier's *Academic American Encyclopedia*, which was first published in 1980. The text of *The Electronic Encyclopedia* has been available electronically through on-line networks since 1982. The CD-ROM contains a two-part 110-megabyte database. One part, comprising about 60 megabytes, contains the text of the encyclopedia; the other, comprising about 50 megabytes, is an index that pinpoints every occurrence of every word in the main database. The database contains about nine million words and thirty thousand entries. In

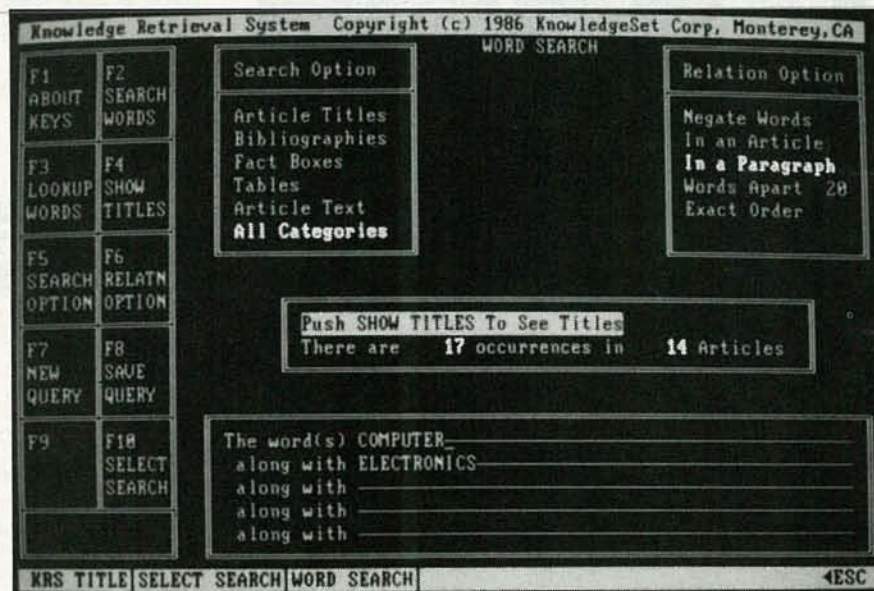

FIG. 3

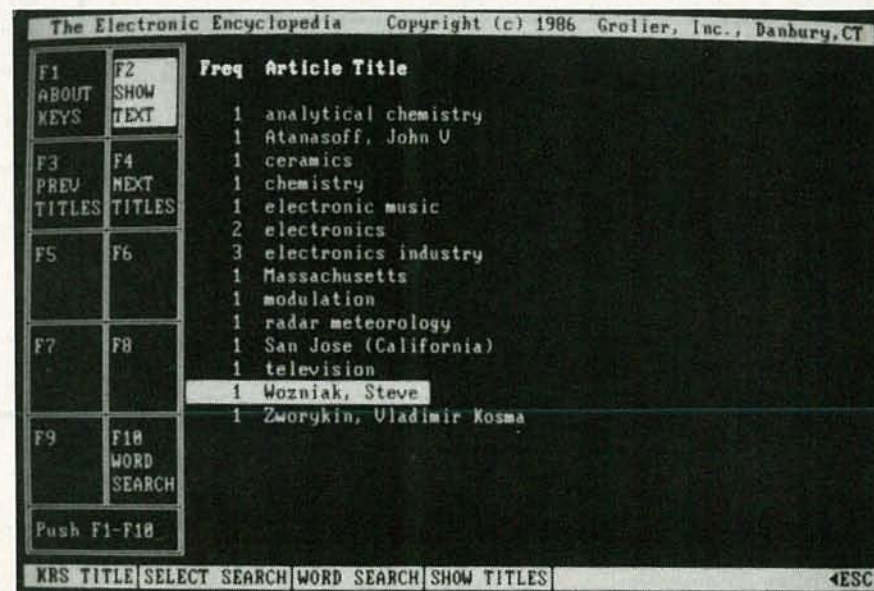

FIG. 4

printed form it takes ten thousand pages, or about two feet of shelf space, to hold the entire encyclopedia. About 35% of the entries concern science and technology; about 36% concern the humanistic disciplines; the remainder concern the social sciences, geography, sports, and contemporary life.

Enough statistics—what's it like to use the encyclopedia, and how is the encyclopedia itself?

Purpose and implementation

To begin with the latter, let's quote Grolier's three stated purposes for *The Electronic Encyclopedia* as they appear in the *User's Guide*:

- To provide quick access to definitive, factual information.
- To provide a readily intelligible general overview of a subject that does not compel

the reader to grasp intricate subtleties or wade through drawn-out historical analysis.

• To provide a starting place for further research by isolating key concepts, outlining the structure of the subject, and directing the reader to more specialized primary and secondary sources of information.

Does *The Electronic Encyclopedia* meet those goals? In general, yes. If you wanted graduate-level information on computer science or Shakespearean drama, the encyclopedia wouldn't help. In fact, as encyclopedias go, *The Electronic Encyclopedia* is rather weak; it's certainly no *Britannica*. But if you need a quick overview of a subject, or simply a place to start, it can be valuable.

The real strength of *The Electronic Encyclopedia* arises from its electronic form and from the indexing and collating abilities that form provides. It would be extremely difficult with any printed encyclopedia to find

all articles containing both the words *computers* and *electronics*. But with *The Electronic Encyclopedia* it's simple, as shown in Fig. 3.

After choosing a search topic, you're presented with a list of articles, as shown in Fig. 4, which you may examine one by one. You do so by moving the highlight bar with the cursor keys, and then pressing F2. The text display appears as shown in Fig. 5. In addition, complicated articles can be viewed in outline format.

When you find an interesting article, you can print the text or save it to a standard ASCII text file, for inclusion in a word-processing document.

A separate KRS screen allows you to set the screen colors, type of CD-ROM drive, and operating parameters. See Fig. 6.

Evaluation

The KRS software works fairly well in helping you to extract information from the encyclopedia, but it does have a few rough edges. For example, we wanted to open a file and collect all information on a topic in that file for perusal later. It turns out that you must assign a new output file name each time you enter a new article. Doing so requires you to traverse several levels of menus and to wait an appreciable amount of time.

In addition, some menu choices are not obvious, and it takes either some experimentation or a close study of the manual to learn how to accomplish simple tasks.

Last, although it's obvious that *The Electronic Encyclopedia* was designed not for the power user, but for the masses, a command-driven mode that bypasses the menus would have been nice, especially if it could be run from DOS in batch mode.

However, we think the real importance of *The Electronic Encyclopedia* lies not in what it itself can do, but in the avenues of design it opens for those to follow. KRS has become a standard by virtue of being first; others will emulate its good points and correct its faults.

The situation reminds us of what happened to Kildall's earlier brainchild, CP/M. Indeed, we would be surprised if some product didn't surpass KRS just as MS-DOS surpassed CP/M. We just hope that Kildall will gain the recognition and rewards he deserves for being a true pioneer, not just another copy-cat imitator.

Our methods of dealing with information are going to have a drastic effect on how we work, on the way we live, and even on the way we play. KRS and *The Electronic Encyclopedia* provide us a glimpse into the kind of information-processing systems our children will take for granted while wondering how earlier ages managed to accomplish anything.

Thanks to Amdek Corporation (2201 Live-ly Blvd., Elk Grove Village, IL 60007) for use of their *Color 722* EGA monitor, which was used for our color cover shots. 

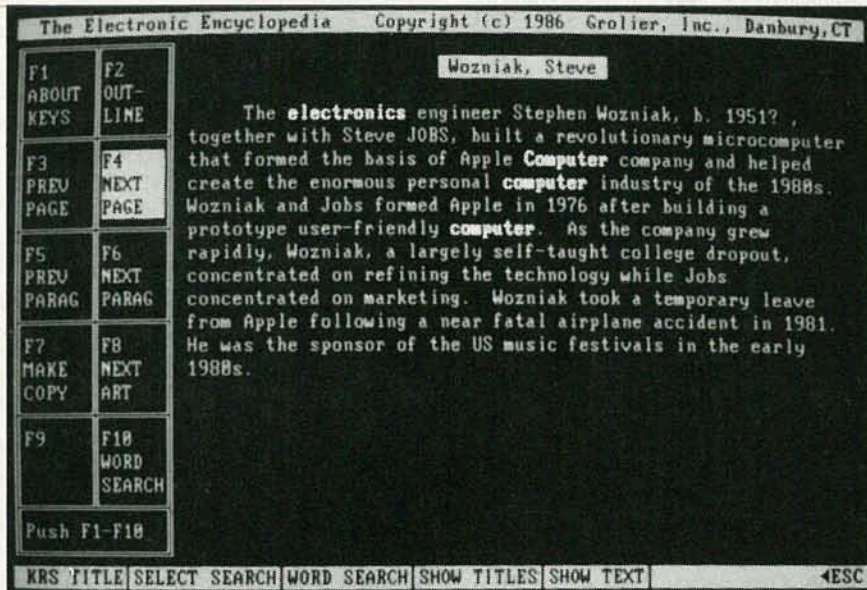

FIG. 5

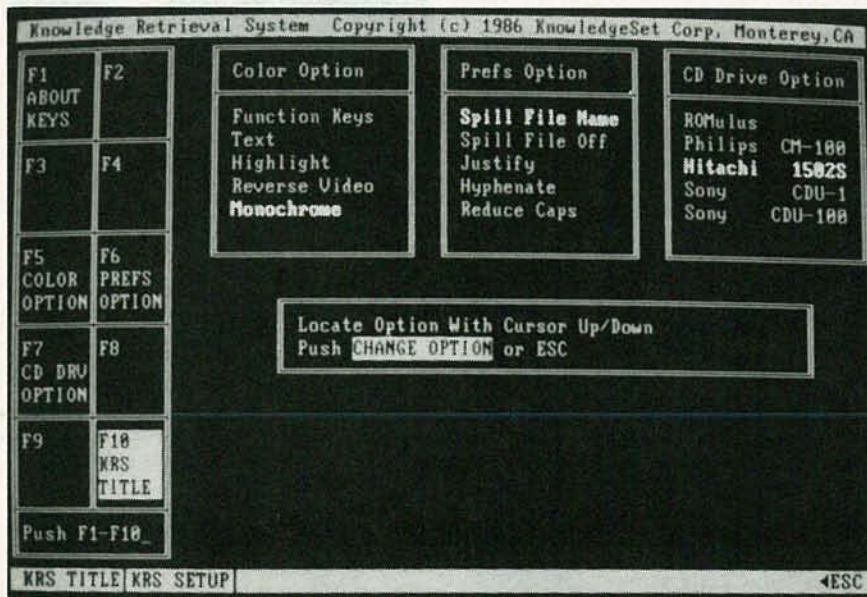

FIG. 6



HALL-COMSEC'S WIRETAP, HAYES' TRANSET 1000, DISC INSTRUMENTS' μLYNX TRACKBALL, AND FINOT GROUP'S KEEP TRACK

If you've ever connected any two pieces of computer gear together, you know that the so-called RS-232 standard is really just a myth. Many companies manufacture devices designed to help you conquer a troublesome RS-232 hook-up, but a device called the *WireTap*, from Hall-Comsec, Inc. (901 Sandy Cove Lane, Ft. Collins, CO) is inexpensive (\$37.50), and it can save you much grief. It's shown in Fig. 7.

The *WireTap* is a module with male and female DB-25 connectors on either end. Between them is a nine-position DIP switch, two rows of socket connectors, and two

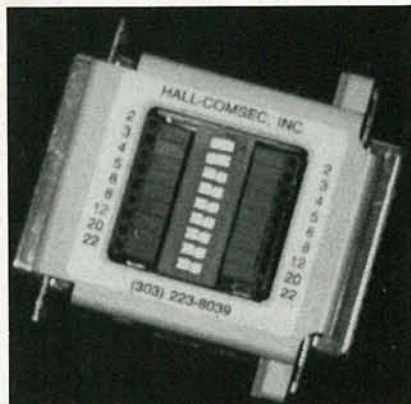

FIG. 7

rows of LED's. Near the male end, and connected to pins 2-8, 12, 20, and 22, are red LED's; at the female end, and connected to the same pins, are green LED's. The red LED's light on high signals; the green on low. Pin 7 is connected straight through; no other pins are accessible.

To connect a pin on one end to the pin opposite it (pin 2 to pin 2, for example), just close the appropriate switch. To connect a pin to a different pin (pin 2 to pin 3, for example) use the appropriate socket connectors and a short length of solid wire. Hall-Comsec has thoughtfully provided several such wires.

The *WireTap* is small enough to tuck away in a corner of your briefcase and carry with you wherever you go. It's helped us out of more than one jam.

KeepTrack Plus

Maintaining the files on a hard disk can be a real pain; many programs on the market profess to help ease the task. One of the better ones is called *KeepTrack Plus*. In operation, the program gives a tree-structured view of your directories and files. You can tag files across multiple directories, and then view, copy, delete, and back them up. You can copy an entire directory (with all subdirectories, if desired) by a single key-press. *KeepTrack Plus* will create the appropriate tree structure in the target drive, if necessary. You can back up files to two diskettes simultaneously, and create lists of files not to back up. The screen shot in Fig. 8 should give you an idea of how easy it is.

KeepTrack Plus comes with two manuals. One teaches the fundamentals of DOS, including filenames, directory structure, batch files, etc. The other manual is for users who are ready to start using *KeepTrack Plus* without training. At only \$79 (plus \$5 shipping), it's a real bargain. Contact The Finot Group, 2390 El Camino Real, Suite 3, Palo Alto, CA 94306.

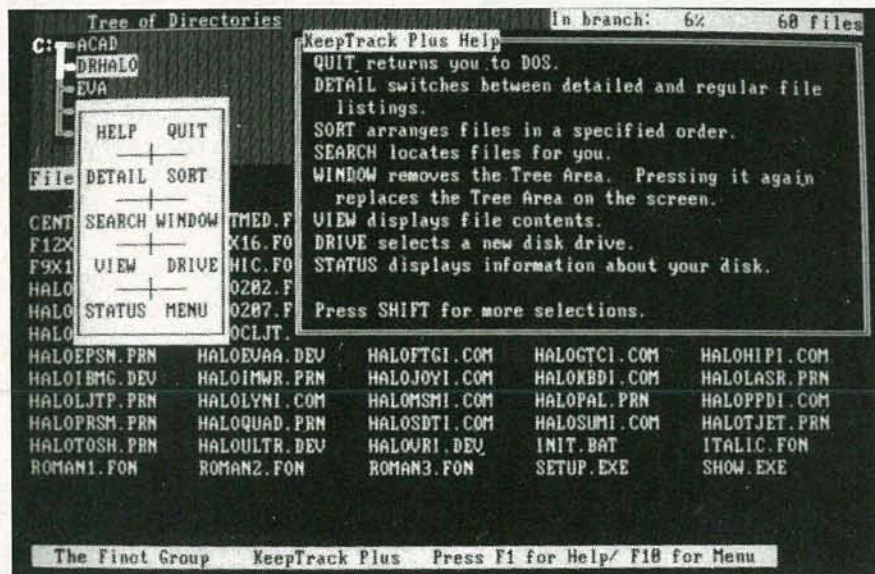

FIG. 8



FIG. 9

Hayes Transet 1000

There are printer buffers and then there are printer buffers like the one shown in Fig. 9. The *Transet 1000* from Hayes Microcomputer Products, Inc. (5923 Peachtree Industrial Blvd., Norcross, GA 30092) is a printer buffer—but it's also a whole lot more. You can use it to buffer data from a computer to a printer while simultaneously (or separately) buffering data from a modem. You can use it to connect two computers to one printer, or one computer to two printers. You can even design your own "communication paths" through it.

The *Transet 1000* has two bi-directional serial ports and an output-only parallel port. It comes in two versions: with 128K and 512K of RAM, which have suggested retail prices of \$399 and \$549, respectively, and many dealers discount both versions.

As a printer buffer, you can set it to print multiple copies, as well as to format raw ASCII text as well as most word processing programs.

Disc Instruments μLynx

Around the computer shack bugs are bad, but rodents can be good. Some peo-

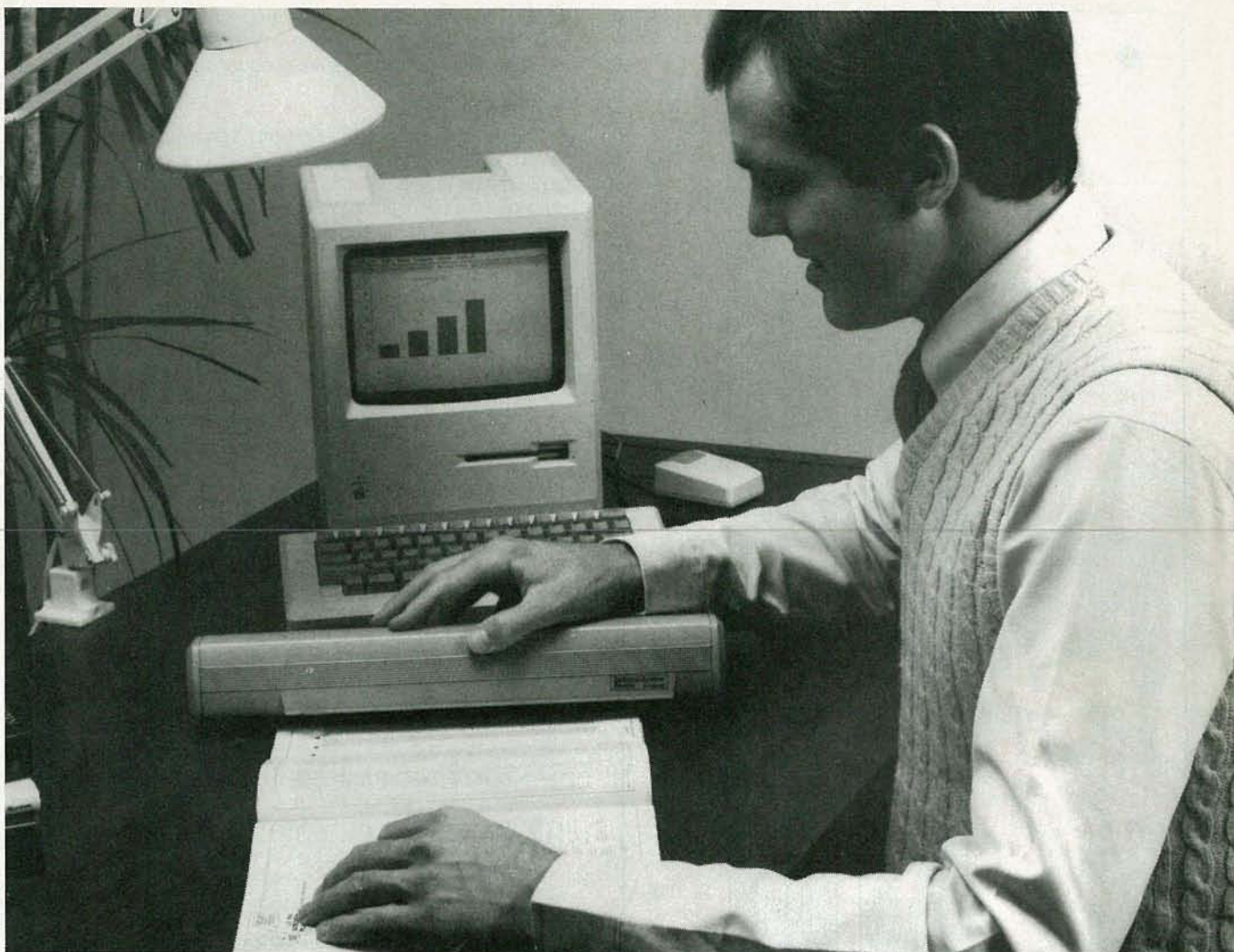

FIG. 10

ple swear by mice; others hate them. A compromise, and a good one, is sold by Disc Instruments (102 East Baker Street, Costa Mesa, CA 92626), a subsidiary of Honeywell. It's called the μLynx (pronounced microlynx), and it provides the convenience features of a mouse without the hassle.

Its biggest selling point is that you don't need to clean your desk—a rolling ball in the top of the unit performs the "mouse" functions. In addition, you don't need to dedicate a serial port to it; through a special dual connector, it hooks up between your keyboard and your computer. No separate power supply is necessary.

In operation, it greatly speeds cursor movements in programs like AutoCAD, Dr. Halo, etc. And it should be compatible with most programs, because it emulates operation of the Microsoft mouse. ▶◀



THE CAUZIN SOFTSTRIP SYSTEM

A new storage technology promises to revolutionize the way computer programs and all sorts of other data are distributed.

JEFF HOLTZMAN, TECHNICAL EDITOR

Personal computers have proven themselves extremely valuable to scientists, engineers, students, office workers, writers, musicians, artists and many others. But one problem that has often plagued personal computer users is the dissemination of information. Typing program listings (from **ComputerDigest** and other magazines) into a computer is time consuming and prone to error. Not only is time wasted in typing, but time is also wasted in debugging one's typing errors.

The Cauzin system is what the publishing industry has been looking for: an inexpensive yet reliable means of printing the software programs that eat up so much valuable page space. Bar codes were touted several years back as a possible solution. But bar codes never caught on because of their low data density, and because no low-cost, reliable bar-code reader became generally available for personal computers. However, a new technology that is similar, but vastly superior, to bar codes hopes to revolutionize the way that computer programs and other data are distributed.

Cauzin Systems, Inc. (a division of Kodak) has devised this new

technology. Long narrow strips called Datastrips are the heart of this technology.

As shown in Fig. 1, each strip is about 0.78 inches wide; the length depends on the amount of data a strip contains. The maximum length of a strip is about 9 inches. Different strips can contain different amounts of data, depending on the printing process, and on the paper and ink used for printing. Low-density strips, which can be printed on any Epson *MX* or *FX* printer, contain about 1500 bytes; high-density strips, which must be reproduced photographically, can contain as many as 5500 bytes.

High-density strips printed on good paper with the proper ink can hold 60,000 bytes on a single 8-1/2 × 11 inch sheet of paper. Each strip can hold as many as 10 files; conversely, a long file can extend across as many as 255 strips. A file can contain anything that can be represented in eight-bit bytes: program code, ASCII text, graphic images, spreadsheet workfiles, data bases, etc.

The reader required by the system contains a highly-integrated mechanical, optical and electronic system, all under control of a

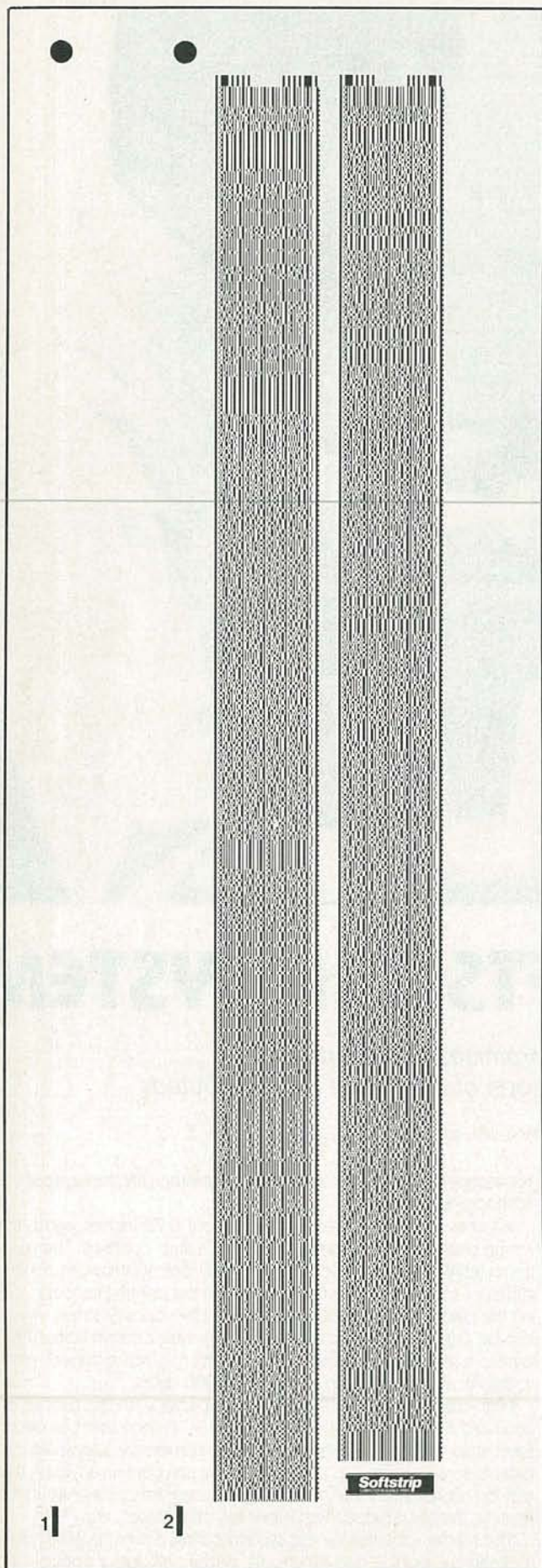

custom microprocessor (a TMS7040) and a custom VLSI IC. An internal view of the reader is shown in Fig. 2. In addition to the eight scanning lenses, 160 lenses are used for speed control.

The Softstrip

The physical makeup of a Softstrip is shown in Fig. 3. As you can see in Table 1, each strip contains 20 fields comprising a header area and a data area. Every strip contains fields 1 through 10; only the first strip of a file (or a group of files that extends across two or more strips) contains fields 11 through 18. Field 19 is the data area, and field 20 is an optional two-byte CRC (Cyclic Redundancy Check) code for error checking.

Each strip may contain from 2 to 6 bytes horizontally, plus one parity bit at each end of a line. Each line can be between ten and 40 mils high. Since each scan covers an area 2.5 mils high, the maximum resolution of the reader is 400 lines per inch. And since the thinnest data line is ten mils high, each data line is scanned a minimum of four times. Low-density strips with 40-mil lines are scanned 16 times.

Communicating with the reader

Cauzin has written communications programs for several popular microcomputers: the Apple IIe, the Apple IIc, the Macintosh, and the IBM-PC. Those programs can be used to read data strips automatically. However, if you want to read a data strip into a computer for which Cauzin has written no communications program, or if you're interested in getting at data strip files directly, here's some information that will help.

All you need is an interface cable, a computer with a serial port, and a communications program that can run at 4800 baud with 1

TABLE 1—CAUZIN SOFTSTRIP™ FIELD LAYOUT

Field	Length	Contents
1: Horizontal Sync		
2: Vertical Sync		
3: Data Sync	1	\$00
4: Expansion Bytes	2	\$00 See
5: Length	2	\$00 Extended Description
		Two byte Hex length of total bytes following this field
6: Checksum	1	Binary Add with carry
7: Strip I.D.	6	A mandatory 6 byte ID field (preferably ASCII)
8: Sequence No.	1	Binary
9: Strip Type	1	Binary
10: Software Expansion	2	\$0000 Binary (reserved)
11: Op. Sys. Type	1	Binary
12: Number Files	1	Binary
13: Cauzin Type	1	Binary
14: O.S. File Type	1	Binary
15: File Length	3	Binary lsb, nsb, msb order
16: Filename	Var.	ASCII Variable length name
17: Terminator	1	\$00/FF Filename Terminator
18: Block Expand	Var.	\$00 defaults 1 byte no info.
19: Data	Var.	File data information in consecutive blocks based on previous file lengths.
20: CRC	2	optional at strip end

NOTES: Fields 1 thru 10 occur on every strip
Fields 11 thru 18 are contained on Strip 1 only
File Directory Repeated Fields 13 thru 18
End of repeated file directory fields

FIG. 1—SAMPLE DATA STRIP contains a 6K BASIC program for printing a calendar for any year with a custom message. The program is also available on RE-BBS.

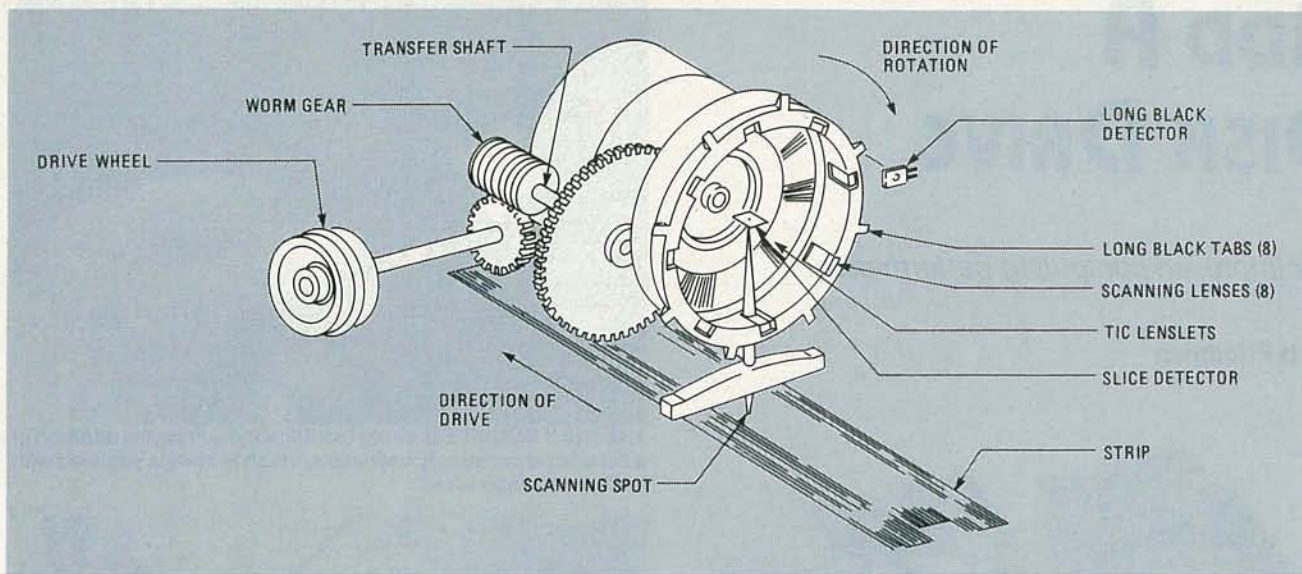

FIG. 2—INTERNAL VIEW OF THE READER: the eight black tabs provide horizontal-sync-like pulses for synchronizing the reader. All operations are controlled by a custom microprocessor.

start bit, 1 stop bit, and no parity bits.

The pinout of Cauzin's 6-pin modular plug is shown in Fig. 4. The reader can provide two-kinds of outputs: ± 5 -volt RS-232, and 25-mv Apple II cassette compatible. Pin 3 of the output connector determines whether RS-232 or cassette mode is active. The reader has a built-in pull-up to enable cassette mode; to enable RS-232 mode, just ground pin 3 (by connecting it to pin 6). Pin 1 provides a separate ground for the data input line in cassette mode; pin 4 provides a special signal we'll discuss below. To connect the reader to an IBM-PC, a *Macintosh*, or an *Apple*, follow the wiring diagrams shown in Fig. 5.

To read a Softstrip into a non-supported computer, you'll use the **TERMINAL** mode. Position the reader by aligning the circle and the bar by the Softstrip with the corresponding points on the reader. Then use your communications program to send the reader a "T" or a "t." The reader does not transmit an acknowledgement; rather the reader goes directly into the read mode. Use your communications program to capture the contents of the file in memory and then write the file to disk when transmission is complete. You can capture a file that extends across more than one strip simply by reading each strip in turn.

The Terminal mode is most useful for ASCII file transfers, because some file-header "garbage" may end up in the file. That garbage could create havoc in a binary object-code file. The communications program supplied by Cauzin transfers files cleanly, makes sure you read the strips in proper order, and performs other error checking.

Hacker mode

Notice in Fig. 4 that pin 4 of the reader's connector is labeled "Slice." Slice is a direct digital representation of the output of the scanner. By capturing the output of slice, you can digitize a rectangular region measuring about 0.78 by 0.5 inches. Possible applications include fingerprint analysis, digitization of musical scores, and handwriting analysis.

Note that the reader provides only the digitized signal; it's up to you to write the appropriate pattern-recognition software. However, Cauzin has written a special demonstration program that captures a digitized image in the memory of an Apple II computer. After an image has been captured, it can be saved to disk, printed, or displayed on screen. The hacker demo program is available from Cauzin.

The signal provided by Slice is purely digital: When the scanner is focused on a black spot, slice will be high (+5.0 volts). When the

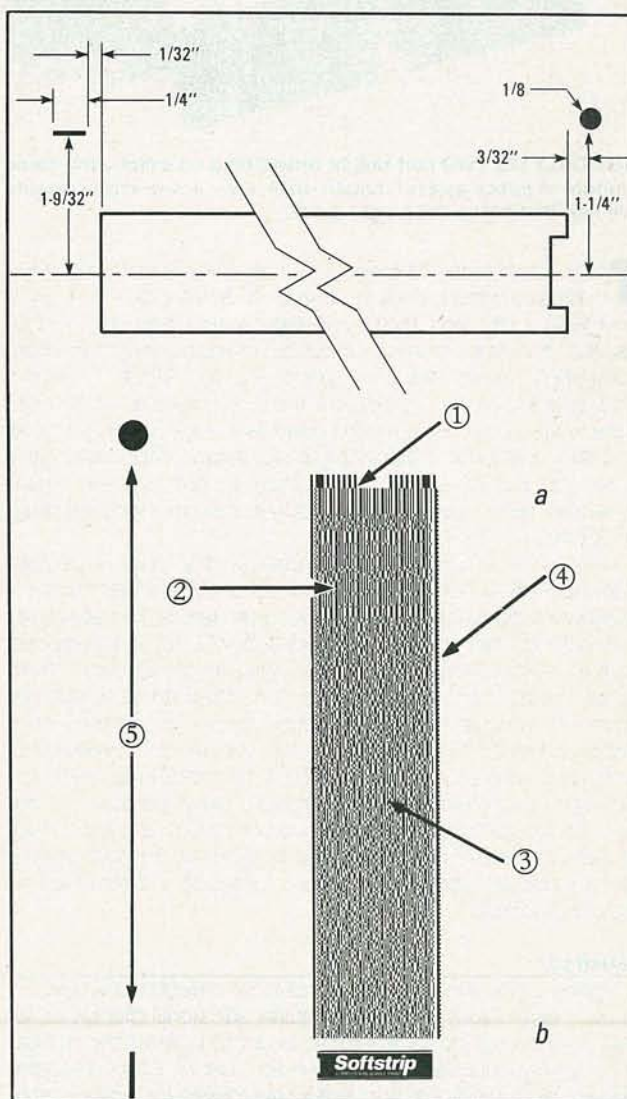
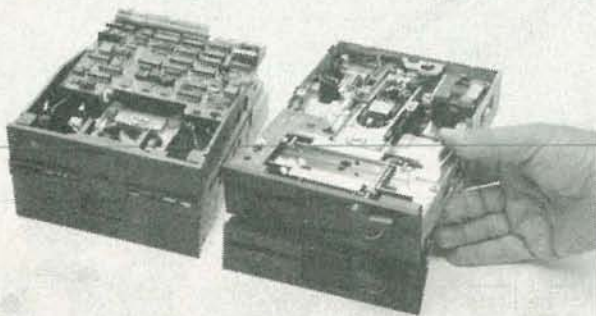

FIG. 3—THE SOFTSTRIP DIMENSIONS are shown in a. Its major areas are shown in b: (1) the header, which indicates paper and ink quality, number of bytes per line, and alignment; (2) the data section, which contains directory information; (3) the file section, which contains all data; (4) boundary lines, which keep the reader aligned and synchronized; (5) alignment marks.

ADD A DISK DRIVE

For improved computing performance.

Herb Friedman



NOT ONLY DO TWO half-height drives take up exactly the same amount of space as a full-height drive, their power requirements are half that of the full-height drive.

There are so many "surplus" 5-1/4 inch disk drives flooding the marketplace that a modern fast-access drive which sold for well over \$200 a little more than a year ago can now be purchased for less than \$60. Many of these surplus drives are half-height and IBM-compatible, which means they are dual-sided with 40 tracks per side, so that two will fit in exactly the same space as a full-height drive while using only as much power as a single full-height drive, and they will work in IBM-compatible, Radio Shack, Heath, and Zenith computers, as well as any other computer whose original drive was mechanically and electrically compatible with the Shugart SA-400 5-1/4 drive.

Although a half-height IBM-compatible disk drive is double-density, 40 tracks per side, with a track access of 6 milliseconds, it is downward-compatible with earlier single-density, 35 track drives having 30 ms. track access. If the original drive(s) for your computer, such as a Radio Shack Model I, use single-density, 35 track, single-sided drives, the IBM-compatible dual-sided 40 track half-size drive will work just fine. The computer simply ignores the extra 5 tracks per side and the second side. If your computer is a Heath H8, which uses hard-sectored single-sided, 40-track 20-ms drives, you can again substitute an IBM-compatible drive because a drive having faster track access can replace one of slower access. Also, an IBM-compatible drive automatically works in the hard or soft-sectored mode. (The hard or soft sector mode is determined by the disk controller.)

Satisfied?

Maybe you're satisfied with your present drive(s) but would like to use modern software which requires additional disk drives for maximum throughput, or maybe you want to increase the number of drives without installing outboard accessories. Either is accomplished by substituting two half-height drives for one or more internal full-height drives. If you have a Color Computer disk drive accessory it has 35 tracks, and 20- or 30-ms track access. The same cabinet and cable will accommodate two 40-track 6-ms drives. Since much modern software for this computer allows the user to select both the number of tracks and the track access time, you can

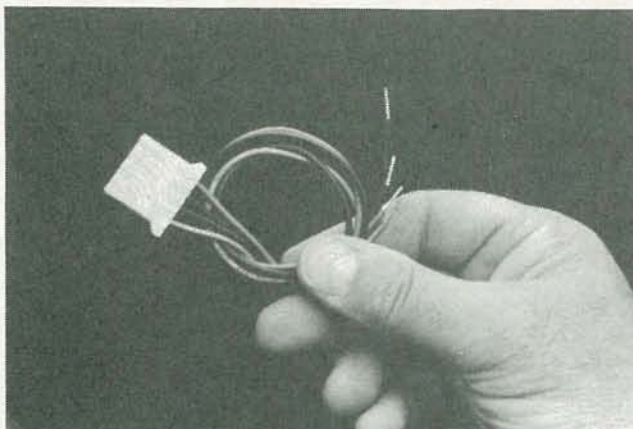

THE ONLY REQUIRED wiring modification will be the addition of a second power supply connector, which is always supplied with factory-installed wires.

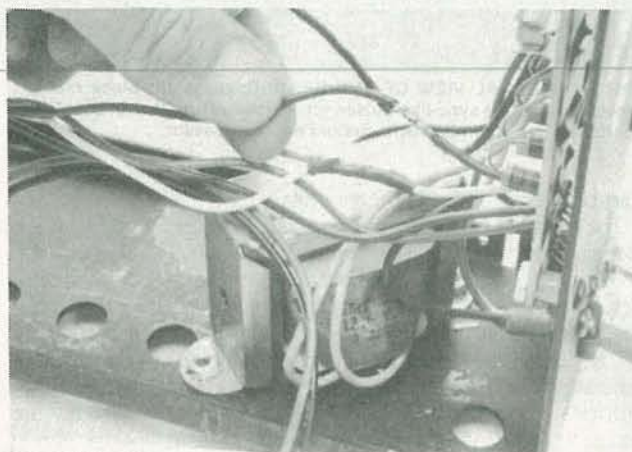

YOU WILL AVOID the possibility of damage to the power supply's printed circuit board if you splice the new power connector to the original wiring. Cut the tape to 3/16 inch so you can wrap several turns around the splice.

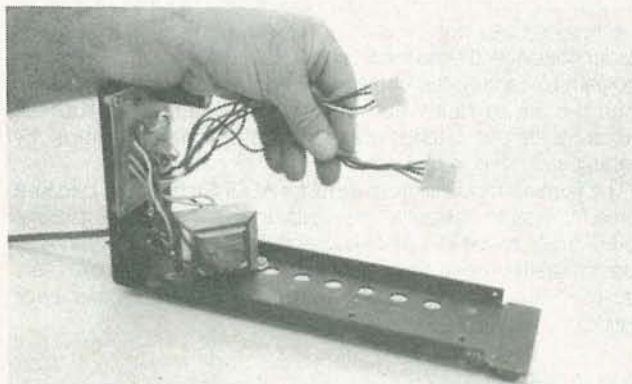

THE COMPLETED SUPPLY looks the same, but now there are two power connectors. Solder neatly, and don't remove unnecessary insulation.

almost double the track access speed. If you have an IBM PC-compatible computer you could replace the A: drive with two half-height drives (A: and B:) and use the space (from the original drive B:) for an internal hard disk drive.

The physical installation of two half-height drives presents no problems because the power and signal connectors are "standard." You might have to drill new holes in the cabinet for the half-height's connectors. Simply flip the drive over so the connections are in the clear—there are mounting holes on both sides of the drive.

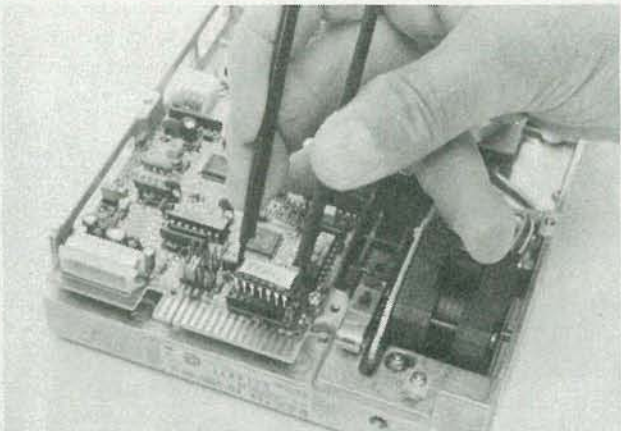

NEXT TAG and remove the resistor block from all drives except the one that uses the last connector on the signal cable. Then mark the block.

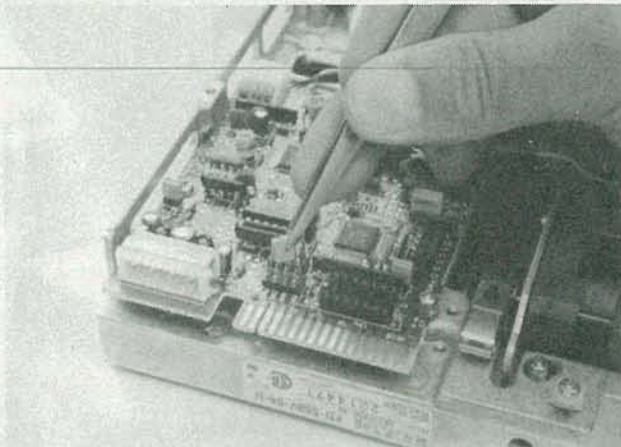

USING TWEEZERS or needle-nose pliers, set each drive's DS drive select jumper to correspond to the jumper of the older drive being replaced, or to the required jumper pair if you're just adding an extra drive.

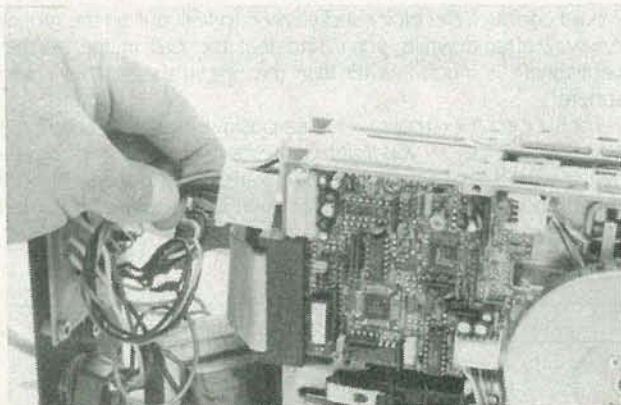

INSTALL THE DRIVE(S) and the signal and power connections. Make sure that matching power connector terminals are spliced together. One or more drives will probably be damaged if you reverse the end wires of a single connector.

Power connections

You will need to install an extra power connector for the extra drive. Do not remove the power supply assembly and drill new holes in the printed circuit board for the extra power wires because you can end up damaging the printed circuit board or one of the heat-sinked voltage regulators. A better way is to splice the wires for the new power connector into the wires leading to the original power connector. Don't attempt to match color-coded leads because there is no color standard for a disk drive's power connector:

Every color in the rainbow has been used. Since the connector is polarized, orient the old and new connectors in the same direction and then match the individual connections. To splice in the new wires, scrape about $\frac{3}{4}$ inch of insulation off an original wire, wrap the new wire around the old, solder, and cover with tape. If you offset each splice about one inch there will be no possibility of a short if a strand of wire slips out from under the tape.

Since it's almost impossible to program one of the half-heights when two are substituted for a full-height drive, make sure you program the drive before it's installed in the cabinet. Programming means setting the drive select jumper and possibly pulling a termination resistor block. Older drives programmed drive selection through pins shorted by a jumper plug. Also, most no longer have HS and HL head-loading programming, nor a MUX connection. If

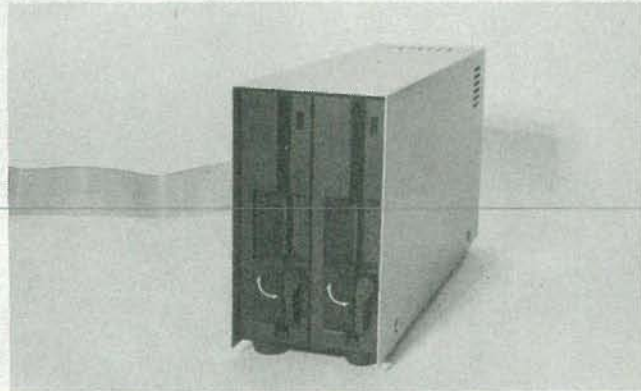

SECURE THE CABINET COVER and you now have two drives that occupy the space of one, both using the original cabinet and power supply.

they exist they are factory set at other pin-jumper terminals—which should never be changed by the user. If you don't know what a jumper is for, don't touch it.

The drive select programming for any 5- $\frac{1}{4}$ inch disk drive is almost always located adjacent to the card-edge signal connections, which are easy to locate because they are labeled DS0, DS1, DS2, and DS3. To program a half-height, look at your old drive and determine which one of the drive select jumpers isn't cut open. Then move the half-height's jumper to the same set of terminals, but keep in mind that the physical location might be different; on your old drive DS1 might be the third set of terminals, on the half-height it might be the first or second set of terminals. You are only interested in matching the DS connections, not their physical location. If your old drive also has HS, HL or MUX jumpers forget them. If your old drive has all DS jumpers set (Radio Shack does this for some computers because the selection is actually made by the pins of the signal cable's connector), you either must determine which is the one that's actually used, or short all DS pairs on the half-height drive.

Finally, there is the terminating resistor block. All drives are supplied with a terminating resistor, which resembles a socketed integrated circuit. It is generally located near the drive select jumpers. (If you can't locate the terminator block, phone the store that sold you the drive.) Only one drive per set of drives on a signal cable—usually the one at the end of the signal cable from the computer—can have the terminator; often, drives won't work if two or more drives are terminated. Pull the unwanted resistor block, but use an IC extractor tool so you don't damage the pins. You might need the block in the future. Not all resistor blocks are alike; a Brand X drive won't necessarily work with a resistor block from a Brand Y drive, so place a small label on each block before it's pulled so you know which block goes into which drive.

Basically, it takes longer to describe how to swap or retrofit half-height disk drives than it takes to do the job. The photographs show how easy it is to do a 2-for-1 half-height retrofit. If you plan your work carefully and solder neatly, soon you'll enjoy the convenience of dual disk storage. 



BUILD THIS IBM INCOMPATIBLE

Build your own fully functional computer from discrete components.

JEFF HOLTZMAN

Like the early settlers of this country, the pioneers of the personal-computer revolution built their own. Legendary machines like the Altair 8800 and the SWTPC 6800 were built, like settler's houses, from whatever materials were at hand. There was no going into the local Computerland and saying "Yea, I wanna buy a machine to do the bills and maybe play a few games—just for the kids, you know. . . ." If one of those pioneers wanted to balance his checkbook, he had to write a program to do it—and in assembly language at that!

Nowadays people say that that pioneering spirit is dead, and that no one in his right mind would attempt to build his own computer. Well we think differently. We think that you can learn an enormous amount about computers (and, possibly, about psychiatry) by building your own computer. In fact, we think that, for the engineering or technical student interested in digital design, there is no better way to learn than by building your own computer.

So, in this 463-part series, we are going to teach you everything you need to know—from the ground up—about building your own computer. With the information we'll provide, you'll be able to put together a fully functional version of anything from an Apple II to an IBM-PC to a Cray I. So stay tuned.

Basic electricity

To begin our foray into the world of computers, let's discuss the basics of electricity. As everyone knows, there are two basic kinds of electricity, positive and negative. (See Fig. 1.) Due to the nature of the Earth's orientation with respect to the sun, electricity in the northern hemisphere is positive. If you're from "down unda," you have negative electricity. You can see for yourself how the two types of electricity differ by standing on the equator, extending your arms from your sides, and holding a large plastic pail in each

hand. (See Fig. 2.) You must use a plastic pail, because a metal one would conduct electricity and allow it to leak out on the ground. Anyway, after a while, you'll find that the pail in the northern hemisphere is much heavier than the one in the southern hemisphere.

For our circuit examples we'll use positive electricity. Later on (in part 367) we'll show you a simple means of converting positive to negative (and negative to positive) electricity. But for now, if you live down unda, just reverse the orientation of all polarized components (diodes and capacitors), and substitute PNP for NPN transistors.

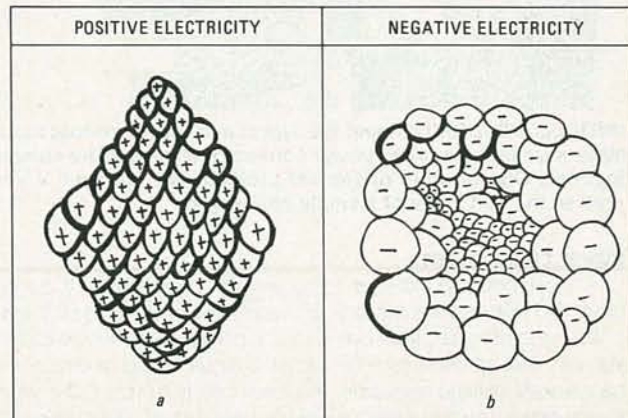

FIG. 1—THE TWO MAJOR KINDS OF ELECTRICITY. Other less-common types are not shown.



FIG. 2—POSITIVE ELECTRICITY falls on the northern hemisphere; negative electricity falls on the southern hemisphere.

Basic logic

Just as there are two basic kinds of electricity, there are two basic kinds of logic. Your choice of positive or negative logic, however, depends not on which hemisphere you live in, but on how obscure you want your circuit designs and programs to be. Due to the nature of the human mind, positive logic is inherently more comprehensible than negative logic. Positive logic is used more often than negative logic, but negative logic certainly has its uses. Sometimes, for example, if you're having trouble resolving a circuit into its proper logic elements, merely thinking about it in the opposite set of terms may suggest a solution. Or, if you're a student, you may be able to impress your professor by casting a circuit with negative logic elements. Or you may be able to confuse him so much that he'll have to admit you're a genius and place you on the dean's list. As we said, negative logic does have its uses.

There are three basic kinds of logic operations; it has been shown that many logic problems can be solved by combining them in various ways. The operations are the NOT, the AND, and the NAND. Their truth tables are shown in Fig. 3-a-Fig. 3-c.

NOT		AND			NAND		
INPUT	OUTPUT	A	B	OUTPUT	A	B	OUTPUT
1	0	0	0	0	0	0	1
0	1	0	1	0	0	1	1
		1	0	0	1	0	1
		1	1	1	1	1	0

FIG. 3—TRUTH TABLES OF THE MAJOR LOGIC ELEMENTS. The NOT and the AND combine to form the NAND..

The NOT gate

The operation of the NOT gate will be familiar to anyone who is married. For lack of anything better to do, couples often take up opposite sides of an argument. It doesn't matter which side each

person takes; in fact, often, the partners may in fact agree, or each may actually believe in the point of view the other represents. The important point is that for every "yes" there is a corresponding "no," and for every "no" there is a corresponding "yes." That is the essence of the NOT gate.

The AND gate

By contrast, the operation of the AND gate will be totally unfamiliar to anyone who is married. A two-input AND gate has the following property: for the output to be "yes," both inputs must be yes. Just as the two partners of a marriage almost never agree on the same thing at the same time, the AND gate is seldom used in practical circuits.

The NAND gate

The operation of the NAND gate should be somewhat more familiar. It is a combination of a NOT gate and an AND gate. For the output of a NAND gate to be "no," both inputs must be "yes." However, the output will be "yes" if either input is "yes." That is a very useful property.

Let's consider an example: suppose you want to buy a new computer, and your wife says no. If you had signed a marriage

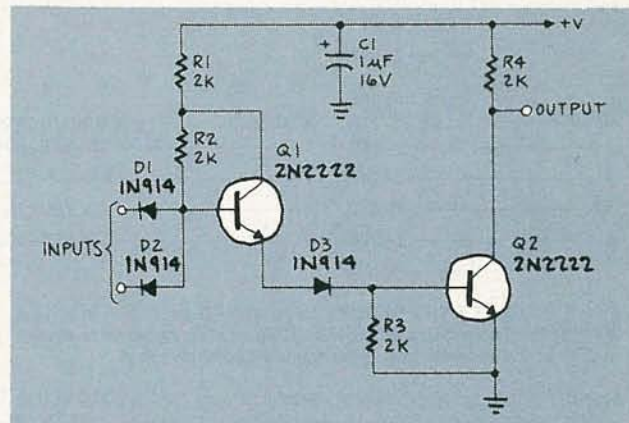

FIG. 4—A DISCRETE-COMPONENT NAND GATE. Build several hundred for next time.

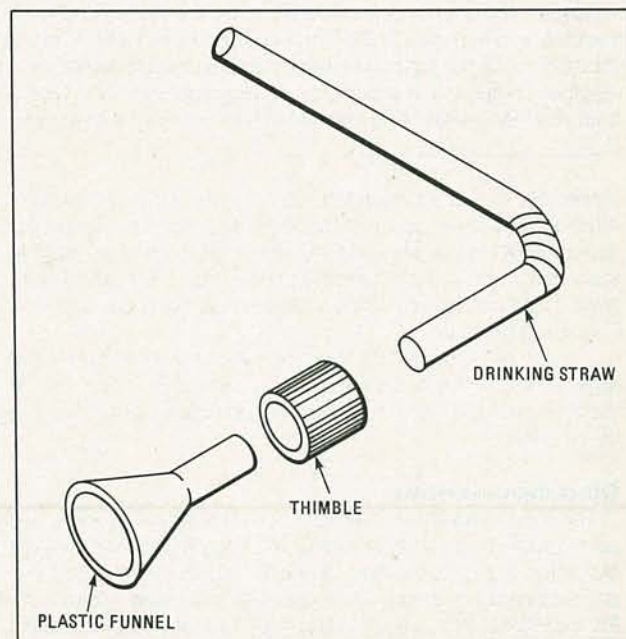

FIG. 5—POSITRON CATCHER. To decrease loss due to leakage, all components should be non-metallic. Use non-conductive epoxy to attach the parts together.

THE CAUZIN SOFTSTRIP SYSTEM

continued from page 95

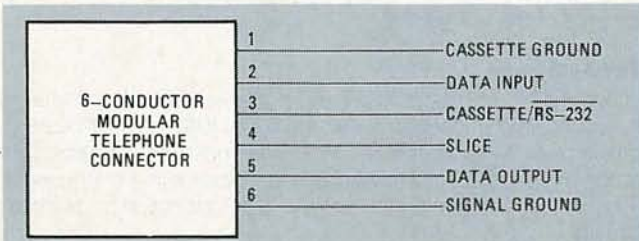

FIG. 4—READER PINOUT: A six-conductor telephone cord provides all connections. See Fig. 5 for connections to typical computers.

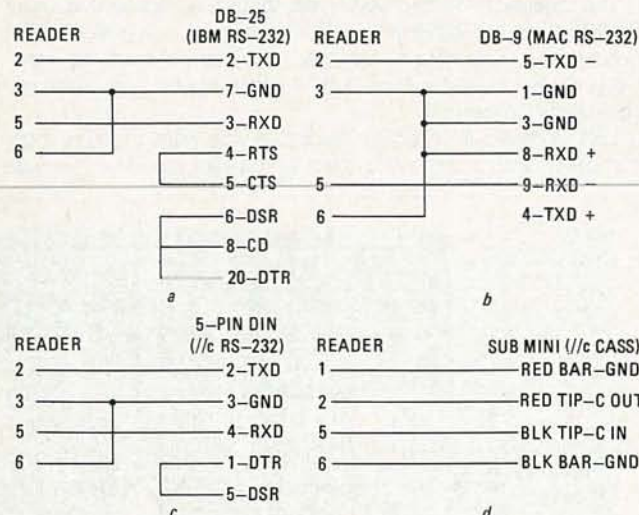

FIG. 5—CONNECT THE READER to an IBM-PC as shown in a, to a Macintosh as shown in b, to the RS-2323 port of an Apple IIc as shown in c, or to the cassette port of an Apple IIe as shown in d.

scanner is focused on a white spot, slice will be low (0.0 volts). To use slice, you'll also have to monitor pin 5, data out. Valid data appears at slice only when data out is high. In Hacker Mode, data out carries the signal that Cauzin calls Long Black. Long Black is similar to a TV's horizontal-sync signal.

To get into hacker mode, send an "H" to the reader, and wait for the reader to transmit a CTF (Command To Follow) followed by an "H." CTF is Cauzin's designation for a BREAK-type signal, not an ASCII character; CTF is a single pulse that goes low for 74 ms and then high for 74 ms. After receiving the "H," your program must

agreement with her stating that both of you would abide by the rules of NAND logic, you would be able to buy the computer. Of course, simple NAND logic can be detrimental, too. For example, if she wants to buy a new hair dryer, you're stuck. But by combining several logic elements, you could develop an equation like this: $\bar{T} = H \text{ AND } (W \text{ OR } \bar{W})$.

The equation shows that T will be "yes" only when H says "yes," regardless of what W says. If you think that the term $(w \text{ OR } \bar{w})$ is irrelevant, then you don't understand completely the psychology of marriage.

Other logic elements

There are many other logic functions (OR, NOR, XOR, XNOR, MAYBE, SORT-OF, KIND-OF, YES BUT, and so on), but, in order to reach our goal of building our own computer, we needn't discuss them here. Consult any elementary textbook on digital logic for more information. In the meantime, let's turn to something of a more practical nature.

Basic NAND circuit

A two-input NAND gate is shown in Fig. 4. As we stated above,



FIG. 6—HOSPITAL ADMISSIONS INFORMATION is contained in a Datastrip on a credit-card size piece of plastic. A special reader reads the data.

send three 0E characters, at which point the reader will begin scanning. From that point on, it's up to you to capture and analyze the data.

Other Uses

Datastrips can be printed in other forms. For example, they can be printed on credit card-like pieces of plastic and used for emergency-room admissions and other applications. For instance, all of a patient's relevant medical statistics could be printed on a small card. Use of the card, rather than a lengthy interview, can speed the admission process, and could mean the difference between life and death for a critically ill patient. A card and a special reader are shown in Fig. 6.

Softstrip datastrips can also be used to archive any sort of information. They are ideal for long-term storage because paper and ink are much more secure over long periods of time than magnetic media (disks and tape) and microfilm.

Conclusions

As you can see, Cauzin has packed a lot of smarts into a very small package. Whether the Softstrip system will catch on remains to be seen. However, many book publishers (Addison-Wesley, Houghton Mifflin, McGraw Hill, and many others) and many newspapers and magazines (including *The Village Voice*, *Byte*, *Keyboards*, *Computers and Software*, *MacUser*, *Nibble*, *Nibble Mac*, *Dr. Dobbs*, and many others) have already begun to print software in strip form, and we're considering it too. Let us know what you think. If reader response warrants it, you'll soon see much of our software in that form. **▶◀**

both inputs must be "yes" for the output to be "no." We're using positive logic, so a "yes" corresponds to a high, and a "no" corresponds to a low (ground). The values of the resistors will depend on the voltage you use to power the circuit. We'll show you how to build your own positron catcher (for generating positive electricity) below. But for experimental purposes, you could use a nine-volt battery and 2K resistors.

Project goals

The NAND gate is the basic building block of many digital computers. Whatever kind of computer you want to build, you can be certain of one thing: you'll need many NAND gates. You can start building now, and, if you change your mind later on, that's OK. Provided you use a reliable interconnection scheme, you can always reuse the gates you build. Of course, if you're sure you want to build, say, a Cray, you can get much better prices for the parts you buy, by buying in large quantities. Here are our estimates for the number of gates you'll need to build various computers. To build a Cray supercomputer, about 10^{50} gates. To build an IBM-PC, about 10^{10} gates. To build an Apple II, three or four dozen gates should

R-E Computer Admart

Rates: Ads are 2 1/4" x 2 7/8". One insertion \$825. Six insertions \$800 each. Twelve insertions \$775. each. Closing date same as regular rate card. Send order with remittance to **Computer Admart**, Radio Electronics Magazine, 500-B Bi-County Blvd., Farmingdale, NY 11735. Direct telephone inquiries to Arline Fishman, area code-516-293-3000. **Only 100% Computer ads are accepted for this Admart.**

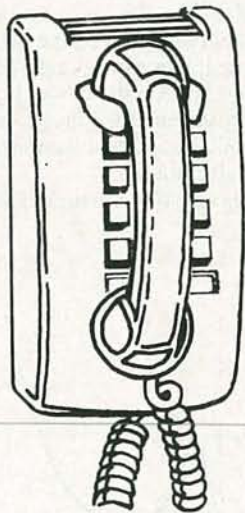

CALL NOW AND RESERVE YOUR SPACE

- 6 x rate \$800.00 per each insertion.
- Reaches 239,312 readers.
- Fast reader service cycle.
- Short lead time for the placement of ads.

Call 516-293-3000 to reserve space. Ask for Arline Fishman. Limited number of pages available. Mail materials to: **Computer Admart, RADIO-ELECTRONICS, 500-B Bi-County Blvd., Farmingdale, NY 11735.**

ICs PROMPT DELIVERY!!!

SAME DAY SHIPPING (USUALLY)
QUANTITY ONE PRICES SHOWN FOR JAN. 25, 1987

OUTSIDE OKLAHOMA: NO SALES TAX

DYNAMIC RAM			
1Mbit	1000Kx1	100 ns	\$33.00
51258	*256Kx1	100 ns	8.50
4464	64Kx4	150 ns	3.29
41256	256Kx1	100 ns	3.84
41256	256Kx1	120 ns	2.69
41256	256Kx1	150 ns	2.49
4164	64Kx1	150 ns	1.30
EPROM			
27512	64Kx8	200 ns	\$11.25
27C256	32Kx8	250 ns	5.15
27256	32Kx8	250 ns	4.96
27128	16Kx8	250 ns	3.77
27C64	8Kx8	150 ns	4.85
2764	8Kx8	250 ns	3.25
STATIC RAM			
62256	32Kx8	120 ns	\$14.95
6264LP-15	8Kx8	150 ns	2.85

OPEN 6 1/2 DAYS, 7 AM-10 PM: SHIP VIA FED-EX ON SAT.

SUNDAYS & HOLIDAYS: SHIPMENT OR DELIVERY, VIA U.S. EXPRESS MAIL

SAT DELIVERY INCLUDED ON FED-EX ORDERS RECEIVED BY:

Th: 5:00 AM \$5.4 lbs

Fr: P-One 5:13 2 lbs

MasterCard VISA or UPS CASH COD

Factory New, Prime Parts

MICROPROCESSORS UNLIMITED, INC.

24,000 S. Peoria Ave. (918) 267-4961

BEGGS, OK. 74421 No minimum order

Please call for current prices because prices are subject to change. Shipping & insurance extra \$1.00 for factory materials. Orders received by 9 PM CST can usually be delivered the next morning, via Federal Express Standard Air - \$6.00, or Priority One - \$13.00!

CIRCLE 61 ON FREE INFORMATION CARD

COMPUTER ASSEMBLY MANUALS



Eliminate Guesswork!
Build with Confidence!

BIG BLUE SEED for IBM™ BUILDERS
Parts list, placement diagrams & instructions for assembling over 75 IBM-compatible bare cards. Latest version includes guides for 640K, Turbo, & AT MthBds. \$17.95

APPLE SEED II for APPLE™ BUILDERS
Instructions for assembling over 85 Apple-compatible bare cards including II+ & IIe MthBds. For all Apple enthusiasts .. \$14.95

Both for \$30.00! Also bare cards in stock!
Check/money-order, VISA/MasterCard to:

NuScope Associates*, Dept RE
P.O. Box 790 • Lewiston, NY • 14092

*A Division of Kosmic MicroTech Inc.

CIRCLE 199 ON FREE INFORMATION CARD

GETTING THE MOST FROM YOUR PRINTER

Getting The Most From Your Printer



BP181—It is probable that 80% of dot-matrix printer users only ever use 20% of the features offered by their printers. This book will help you unlock the special features and capabilities that you probably don't even know exist. To order your copy send **\$6.95 plus \$1.50 for shipping** in the U. S. to **Electronic Technology Today Inc., P.O. Box 240, Massapequa Park, NY 11762-0240.**

A Z-80 WORKSHOP MANUAL



Starting with a review of computer principles, this book describes typical machine-code instructions followed by a detailed description of the Z-80 instruction set. Assembly language programming is also discussed with examples. Z-80 hex machine-code and assembler instructions are given in tabular form, along with in-our connections for the Z-80 and te associated devices.... Order your copy from **Electronic Technology Today Inc., PO Box 240, Massapequa Park, NY 11762. Price is \$6.95 plus \$1.00 for shipping.**

suffice.

If you have a different computer in mind, that's just great. We encourage experimentation, and would welcome design details. Send your ideas to the Managing Editor.

Construction

After verifying that your circuit works, you'll want to start duplicating it. Each gate could be built on a separate piece of perfboard, using spring-loaded terminals for connections. You'll need five terminals per gate (two for inputs, one for the output, and two for power and ground). However, if you're planning to build one of the larger computers, you may want to build many circuits (hundreds, or even thousands) on each card. The connections between the gates on each card could be soldered, and the cards might be interconnected via spring-loaded terminals.

The size of the positron catcher you'll need also depends on the computer you'll build. A filled household bucket will provide several hours of experimentation using several hundred gates. You can use a funnel, a thimble, and a drinking straw, as shown in Fig. 5. Drill a 1/8-inch hole in the thimble, and then use epoxy to glue the

thimble to the funnel, and the straw to the thimble. Be careful not to clog the straw!

If you're planning to build a Cray, try to obtain a 10,000-gallon fiberglass tank. You may be able to buy one cheaply from an out-of-business gasoline station. For the sake of efficiency, you should use something larger than a household funnel to catch positrons. If you can locate your catcher on top of a mountain, you'll avoid the dissipating effect the atmosphere has on positron energy.

Conclusion

The power of simple digital logic elements can be surprising at times. And that is the goal of our series—to show you just how much you can do with a few (or many) simple gates. For next time, start building gates. You should have at least several hundred on hand so that we can start building the most important part of any computer: the ALU (Arithmetic Logic Unit).

One problem you may run into is time. While the gates are easy to build, it's tough to build several hundred in just a month. So that we don't leave anyone behind, we'll delay publishing Part 2 until April, 1988. See you then. ♦♦♦

R-E ROBOT

continued from page 44

stall the watchdog timer (IC43) and JU15, and set the timeout for approximately 1 second (by substituting a 1-megohm resistor for R19). Do not install any other IC's. Apply power and confirm that the oscillator is operating by observing the signal at pin 56 of the microprocessor. Pin 24 of the microprocessor should go low each time S2 is pressed and each time IC43 times out. If those operations appear normal, remove power and install a ROM with a simple JMP -1 instruction where the reset vector normally goes (F000:FFF0). Now, if all is well, you should see a nice tight loop by observing the address bus on an oscilloscope.

You can trigger your scope easily on that signal and actually use your scope as a poor-man's bus analyzer. Observe the RD line and select a cycle for analysis. Note the exact position of the RD strobe on your scope. Now probe the D0 line. Is it high or low when RD is low? Write it down. Do the same for all of the data and address lines. You have just decoded the entire state of the microprocessor for that RD cycle: the address being read and the next instruction in the ROM.

Next, fill a ROM with NOP's (090h) and execute a jump to the beginning of the ROM. Scope the address lines. You should see a 0101 sequence on A0, a 0011 sequence on A1 and so on. Each address line will appear at half the frequency of the preceding line.

What if things are not as they should be? This is where the watchdog timer (IC43) comes to our rescue. Set it for a timeout of a few milliseconds, trigger your scope on the reset pulse from the microprocessor (pin 57), and observe the first few RD cycles at the ROM. Here are a few things to look for:

1. Is the chip select line to the ROM (pin 20) active? If not, there could be a problem in the address-decoding circuitry or the address latches. Perhaps one or more of the microprocessor signals ALE, DEN, DT/R, RD, or WR are lost.
2. Are the address lines correct? They should all be high except for A0-A3; those lines will toggle. Watch for voltage levels that are neither high nor low; two lines may be shorted, or the address decoder may not be functioning correctly.
3. Decode the first few instructions on the data bus. Do they accurately represent the contents of the ROM? Are the voltage levels correct? Incorrect voltage levels are caused by bus contention, shorted traces, ungrounded IC's, unpowered IC's, capacitors attached to data lines, and many others we have not (yet) had the pleasure of encountering.

continued on page 108

EARLY RADIO

continued from page 61

The end of spark

Another important milestone in the development of radio was the development of a generator capable of producing a high-frequency, continuous-wave carrier. That is, a carrier that could be modulated by sound.

Early radio transmitters were of the spark type. They could produce only a damped wave, which is very broadband and electrically noisy. Because of those characteristics, spark was suitable only for wireless telegraphy.

In 1889, Elihu Thomson of General Electric produced a high-frequency dynamo. Later, Nikola Tesla also produced such a dynamo. However, both had a maximum frequency of only about 5,000 cycles.

By 1903, Charles Steinmetz had built a 10,000-cycle alternator. In 1904, Reginald A. Fessenden conceived the idea of an alternator that would be capable of reaching a frequency of 100,000 cycles. Assigned to the project by General Electric, Ernst F. W. Alexanderson attempted to build such a device. He was eventually successful, although only after repeated failures.

The first transmission of a human voice took place on Christmas Eve, 1906. The continuous-wave carrier was generated by an alternator with an operating frequency of 50,000 Hz and a power of 1 kW. The microphone was a water-cooled unit. The historic event was not accompanied by much publicity, and 14 years would elapse before the beginning of scheduled radio broadcasting in the U.S. in 1920.

Tuned circuits

Spark did have one advantage: receivers did not need any type of tuning mechanism. For continuous-wave signals to be useful, some means of tuning would be required. Sir William Crookes' article, "Some Possibilities of Electricity" published in the *Fortnightly Review* in 1892, called attention to the need for tuned circuits. He wrote, "What remains to be discovered is a means of generating waves of any desired wavelength, and receivers which will respond to wavelengths between certain defined limits and be silent to all others."

That idea was put into action by Sir Oliver Lodge, who started experimenting with tuned receivers and transmitters in 1897. He called his method "syntonized tuning achieved through the use of capacitors." With the development of continuous-wave transmitters, and tuned receivers that could receive their signals, the first stage of the electronics revolution was complete.

SEMICONDUCTOR TESTING

continued from page 64

as high-current rectifiers in low-voltage applications.

As the forward bias on the tunnel diode is increased, however, something interesting happens. As shown in Fig. 7, the current peaks and then drops into a deep valley, only to increase exponentially in traditional fashion.

The dip constitutes a region of negative

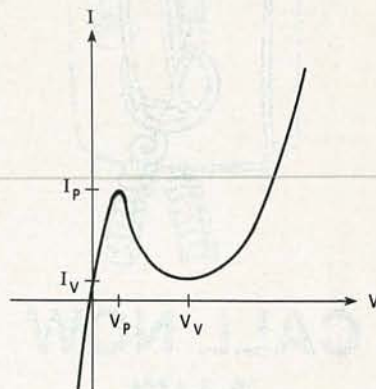

FIG. 7—THE TUNNEL DIODE is characterized by a rapid rise in current followed by a dip; when operated in the latter region, the diode can function as an oscillator.

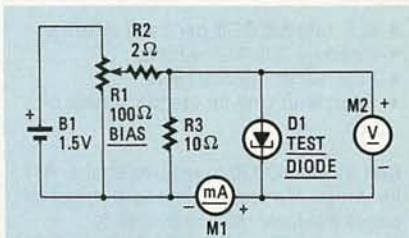

FIG. 8—MEASURE TUNNEL-DIODE characteristics using this circuit.

resistance, i.e., increased voltage leads to decreased current. By exploiting that characteristic, the tunnel diode can be made to oscillate in the relaxation mode. The small physical size of the tunnel diode permits oscillation into the hundreds of megahertz with simple circuitry and minimum power dissipation.

Tunnel-diode characteristics can be measured easily with a voltmeter and a current meter, as shown in Fig. 8. Bias voltage is increased with R1, and the rise in current noted. At some point (V_P), current will plunge suddenly, and voltage will increase by several hundred millivolts. Those characteristics represent valley current (I_V) and valley voltage (V_V), respectively. Typical readings are 100 mV at 1 mA for the peak values, and 350 mV to 1 V for the valley values. The I_P to I_V ratio should be no less than 6 to 1.

That's it for this month; next time we'll look at thyristors.

MARKET CENTER

FOR SALE

TUBES new, unused. Send self-addressed, stamped envelope for list. **FALA ELECTRONICS**, Box 1376-2, Milwaukee, WI 53201.

RESTRICTED technical information: Electronic surveillance, schematics, locksmithing, covert sciences, hacking, etc. **Huge selection. Free brochure MENTOR-Z**, 135-53 No. Blvd., Flushing, NY 11354.

TV tunable notch filters, free brochure. **D.K. VIDEO**, Box 63/6025, Margate, FL 33063. (305) 752-9202.

LASERS, components and accessories. Free catalog. **M.J. NEAL COMPANY**, 6672 Mallard Ct., Orient, OH 43146.

CLASSIFIED AD ORDER FORM

To run your own classified ad, put one word on each of the lines below and send this form along with your check to:

Radio-Electronics Classified Ads, 500-B Bi-County Boulevard, Farmingdale, NY 11735

PLEASE INDICATE in which category of classified advertising you wish your ad to appear. For special headings, there is a surcharge of **\$23.00**.

() Plans/Kits () Business Opportunities () For Sale
() Education/Instruction () Wanted () Satellite Television

Special Category: \$23.00

PLEASE PRINT EACH WORD SEPARATELY, IN BLOCK LETTERS.

(No refunds or credits for typesetting errors can be made unless you clearly print or type your copy.) Rates indicated are for standard style classified ads only. See below for additional charges for special ads. **Minimum: 15 words.**

1	2	3	4	5
6	7	8	9	10
11	12	13	14	15 (\$42.75)
16 (\$45.60)	17 (\$48.45)	18 (\$51.30)	19 (\$54.15)	20 (\$57.00)
21 (\$59.85)	22 (\$62.70)	23 (\$65.55)	24 (\$68.40)	25 (\$71.25)
26 (\$74.10)	27 (\$76.95)	28 (\$79.80)	29 (\$82.65)	30 (\$85.50)
31 (\$88.35)	32 (\$91.10)	33 (\$94.05)	34 (\$96.90)	35 (\$99.75)

We accept MasterCard and Visa for payment of orders. If you wish to use your credit card to pay for your ad fill in the following additional information (Sorry, no telephone orders can be accepted.):

Card Number

Expiration Date

Please Print Name

Signature

IF YOU USE A BOX NUMBER YOU MUST INCLUDE YOUR PERMANENT ADDRESS AND PHONE NUMBER FOR OUR FILES. ADS SUBMITTED WITHOUT THIS INFORMATION WILL NOT BE ACCEPTED.

CLASSIFIED COMMERCIAL RATE: (for firms or individuals offering commercial products or services) \$2.85 per word prepaid (no charge for zip code)...**MINIMUM 15 WORDS.** 5% discount for same ad in 6 issues; 10% discount for same ad in 12 issues within one year; if prepaid. **NON-COMMERCIAL RATE:** (for individuals who want to buy or sell a personal item) \$2.30 per word, prepaid...no minimum. **ONLY FIRST WORD AND NAME** set in bold caps at no extra charge. Additional bold face (not available as all caps) **50¢ per word additional (20% premium).** Entire ad in boldface, add **20% premium** to total price. **TINT SCREEN BEHIND ENTIRE AD:** add **25% premium** to total price. **TINT SCREEN BEHIND ENTIRE AD PLUS ALL BOLD FACE AD:** add **45% premium** to total price. **EXPANDED TYPE AD:** \$4.30 per word prepaid. All other items same as for STANDARD COMMERCIAL RATE. **TINT SCREEN BEHIND ENTIRE EXPANDED TYPE AD:** add **25% premium** to total price. **TINT SCREEN BEHIND ENTIRE EXPANDED TYPE AD PLUS ALL BOLD FACE AD:** add **45% premium** to total price. **DISPLAY ADS:** 1" x 2 1/4"—\$320.00; 2" x 2 1/4"—\$640.00; 3" x 2 1/4"—\$960.00. **General Information:** Frequency rates and prepayment discounts are available. **ALL COPY SUBJECT TO PUBLISHERS APPROVAL. ADVERTISEMENTS USING P.O. BOX ADDRESS WILL NOT BE ACCEPTED UNTIL ADVERTISER SUPPLIES PUBLISHER WITH PERMANENT ADDRESS AND PHONE NUMBER.** Copy to be in our hands on the 12th of the third month preceding the date of the issue. (i.e., August issue copy must be received by May 12th). When normal closing date falls on Saturday, Sunday or Holiday, issue closes on preceding working day.

FREE power supply with Assortment #103 PCB, TOKO coils 144LY-120K, 520HN-3000023, BKAN-K555AXX(2), 2N3904(2), BFQ85, 7812, 74123, MC1330A1P, 1N914, 1N5231B. Only \$25.00. **Assortment #201** MC1330, LM1458, MC1358, NE565, LM386, 2N3563, MPN3404, IN4002. Only \$10.00. **Assortment #301** PCB with all IC's, transistors, and diodes for Telease-Maast Satellite-TV project (Oct. 86 article) only \$25.00. 10% discount for 5 or more. Service charge \$3.00/order. **1(800) 821-5226 Ext. 426.** MC/VISA, COD, check or M.O. Or write **JIM RHODES INC., P.O. Box 3421, Bristol, TN 37625.**

TUBES, name brands, new, 80% off list. **KIRBY**, 298 West Carmel Drive, Carmel, IN 46032.

INDIVIDUAL Photofact-folders #1 to #1400. \$3.00 postpaid. **LOEB**, 414 Chestnut Lane, East Meadow, NY 11554.

WHOLESALE car-radio computer telephone audio video accessories antenna catalog (718) 897-0509 **D&WR**, 68-12 110th St., Flushing, NY 11375.

DESCRAMBLER catalog. Cable and satellite. SB3 \$99. Special combination Jerrold 400 and SB3 \$165. New cable descrambler kit \$49.00 (assembles in half hour). Send \$1.00. **MJ INDUSTRY**, Box 531, Bronx, NY 10461.

TUBES! 59¢. Year guarantee. Free catalog. Tube tester \$8.95. **CORNELL**, 4215 University, San Diego, CA 92105.

Ti-99/4A software/hardware bargains. Hard-to-find items. Huge selection. Fast service. Free catalog **DYNA**, Box 690, Hicksville, NY 11801.

VIDEO scrambling techniques. The original "secret manual" covers sinewave, gatedpulse, and SSAVI systems. 56 pages of solid, useful, legible information. Only \$14.95. **ELEPHANT ELECTRONICS, INC.**, Box 41865-J, Phoenix, AZ 85080. (602) 581-1973.

THE BEST PLACE to BUY, SELL or TRADE NEW and USED EQUIPMENT

NUTS & VOLTS MAGAZINE
BOX 1111-E • PLACENTIA, CA 92670
(714) 632-7721

Join Thousands of Readers Nationwide Every Month

ONE YEAR U.S. SUBSCRIPTIONS
\$10.00 - 3rd Class • \$15.00 - 1st Class

\$35.00 - Lifetime - 3rd Class

NUTS & VOLTS

HAM GEAR
COMPUTERS
SOFTWARE
SCANNERS • OPTICS
TEST EQUIPMENT
MICROWAVE
SATELLITE
AUDIO VISUAL
NEW PRODUCTS
COMPONENTS • KITS
ANTIQUE ELECT.
PUBLICATIONS
PLANS • SERVICES

PIONER-Scientific Atlanta-Jerrold Panasonic-Hamlin—Wireless converters all new original manufacturers warranted. Try our new converter repair facility we are the best. **(718) 459-5088.**

CABLE TV converters. Scientific Atlanta, Jerrold, Oak, Zenith, Hamlin. Many others. "New" **VIDEO HOPPER** "The Copy Killer". Visa, M/C, & Amex accepted. Toll free **1(800) 826-7623.** **B&B INC.**, 10517 Upton Circle, Bloomington, MN 55431.

CABLE TV EQUIPMENT. All major brands. Specializing in Scientific Atlanta, Jerrold, and Zenith. **Add-ons.** Our units have worked where others have failed. CODs accepted. Send \$2.00 for catalog to **K.D. VIDEO**, P.O. Box 29538, Mpls., MN 55429.

CABLE-TV converters and descramblers. Low prices, quality merchandise, we ship C.O.D. Send \$2.00 for catalog. **CABLETRONICS UNLIMITED**, P.O. Box 266, South Weymouth, MA 02190. (617) 843-5191.

A SINGER'S DREAM!



REMOVES VOCALS FROM RECORDS!
Now You can sing with the world's best bands! The Thompson Vocal Eliminator can remove most or virtually all of a lead vocal from a standard stereo record and leave the background!
Write or call for a free brochure and demo record.
LT Sound, Dept. R-1, P.O. Box 338, Stone Mountain, GA 30086 (404) 493-1258

WIREWRAPE labels. Identify IC's, pins. Easier, errorless wrapping. All DIP's 8-40 pins. Inexpensive, 363 labels \$6.00. **PAUL'S LABELS**, 7320 Embassy, Miramar, FL 33023.

IS it true...Jeeps for \$44 through the government? Call for facts! 1 (312) 742-1142, ext. 4673.

OLDTIME radio programs on high quality tapes. Comedy! Adventure! Music! Free catalog. **CARL F. FROELICH**, Heritage Farm, New Freedom, PA 17349.

LINEAR PARTS—transistors: MRF454 \$15, MRF455 \$12, MRF477 \$11, MRF492 \$16.75, MRF421 \$22.50, SRF2072 \$13, SRF3662 \$25, 3800 \$18.75, 2SC2290 \$19.75, 2SC2879 \$25. **Tubes:** 6KD6 \$10.50, 6LQ6 \$9.75, 6LF6 \$9.75, 8950 \$16.75. Best prices on Palomar road noise mics, Ranger AR3300. New 16 page catalog listing radio/amplifier tricks—channel modification, PLL-sliders, peaking for range, hard-to-find linear parts—mail \$1.00 to: **RFPC**, Box 700, San Marcos, CA 92069. For same day parts shipment, call (619) 744-0728.

CHANNEL 3—60db notch filter, 63.5MHz. \$19.95. All other channels \$29.95. Cable converter and accessory catalog \$1. (514) 739-9328. **CROSLY(A)**, Box 840, Champlain, NY 12919.

CABLE Dealers—Get your free catalog for the best buys on quality cable equipment. Most prices too low to print. N-12 Mini Code \$100.00. S.B. 2 or 3 \$99.00. Trimodes are the special of the month \$100.00. Hamlin Mid 1200 \$89.00. Extra remotes, cable converters, Pioneer, Jerrold, Viewstar, Starcom, Video Switcher. All products guaranteed 90 days. We accept M.C., VISA, COD's. Call or write for your free catalog today. (402) 331-4957. **M.D. ELECTRONICS**, 5078 South 108th, Suite 115, Omaha, NE 68137.

INTEL, RCA, National, OKI, SGS, and more. Factory prime and surplus parts catalog. **LYNBAR INDUSTRIES**, 205 Main, Box 822, St. Joseph, MI 49085-0822.

TUBES: "Oldest", "latest". Parts and schematics. SASE for list. **STEINMETZ**, 7519 Maplewood Ave., RE. Hammond, IN 46324.

TEST equipment, reconditioned. For sale. \$1.25 for catalog. **WALTER'S**, 2697 Nickel, San Pablo, CA 94806. (415) 724-0587.

SURPLUS MS-DOS software, hardware, audio kits, solar cells, lots of bargains. Free catalog. **GIL ELECTRONICS**, Box 1628-X, Soquel, CA 95073.

ELECTRONICS projects, components, PCB supplies, test instruments. Oscilloscopes \$219.00, multimeters \$7.95, power supplies \$69.95. Resistors 1 cent. 2 year guarantee. Call or send SASE for free catalog—**T.O.R.C.C.C.**, 1131 Tower, Schaumburg, IL 60195. (312) 490-1374.

BRAND new Oak vari-sync descramblers \$45.00 each; Oak automatic on/off \$75.00; SB-3 \$89.00; Tri-mode \$125.00; Bi-state \$125.00; Scientific Atlanta \$125.00; Hamlin \$75.00; Zenith cable \$175.00; Starcom VI \$125.00; Oak Sigma \$175.00; also schematics, service manuals, descrambler information booklets; catalog \$3.00; call us, we ship units UPS COD. **PONDEROSA COMPANY**, (303) 634-6666.

Quality Microwave TV Antennas

Multi-Channel 1.9 to 2.7 GHz
40dB Gain True Parabolic 20 Inch Dish
Complete System \$79.95 (plus shipping)
Dealerships, Qty. Pricing, Replacement Parts

Phillips-Tech Electronics
P.O. Box 8533 • Scottsdale, AZ 85252
(602) 947-7700 (\$3.00 Credit all phone orders!)

LIFETIME WARRANTY
MasterCard • Visa • COD's

ATTENTION looking for surplus test equipment signal generator voltmeter oscilloscope. **J.B. ELECTRONICS**, 9518 Grand, Franklin Park, IL 60131.

DECODE nearly any gated pulse signal with our new super simple circuit. Works on In-band, Out-band, AM or FM pilot tone—use with Hamlin, Jerrold, Sylvania. Complete plans and theory only \$13.50 plus \$1.50 P&H. **ELEPHANT ELECTRONICS INC.**, Box 41865-J, Phoenix, AZ 85080. (602) 581-1973.

NOTICE! light controllers, rope lights, etc. Flyer \$1.00 **DESIGN SPECIALTY**, 2213 Chesley Dr., San Jose, CA 95130.

TOOLS: soldering irons, coax strippers, pliers, test equipment, solder and more. Send for product and price list to: **JARRAND ELECTRONICS**, 39-32 Brookside Ave., Fairlawn, NJ 07410.

TUNABLE notch filters. Channels 2, 3, and 4 available. Send \$15 for sample. Specify channel. Money back guarantee. **DB ELECTRONICS**, P O Box 8644, Pembroke Pines, FL 33084.

SPEAKERS, factory over-runs, most sizes, SASE for list. **ELCOM**, 1190 Bluff, Guttenberg, IA 52052.

OLD radio TV schematics. Send \$1.00, make, model. **RADIO MAPS**, P O Box 791, Union City, CA 94587.

JERROLD cable descrambler closeout SB3's, 450/LCC58's \$69.95, both \$129.95, JRX3DIC's \$89.95. Quantity pricing SASE for order form. **CAD**, P O Box 486, Bunkerhill, IN 46914.

Parts Express

INTERNATIONAL INC. **HARDWARE AND ELECTRONICS**

CHECK OUT OUR HARDWARE SELECTION!



We stock wood screws, machine screws, sheet metal screws, nuts, bolts, and fasteners. All are available in either convenient package sizes or bulk for large quantity users. And best of all, our prices are truly low!

COPPER CLAD PC BOARD



9" x 8" Double Sided #055-300 \$150
18" x 12" Double Sided #055-320 \$395

RS-232 DATA SWITCH



• 2 position, rotary type. • Fully shielded, FCC approved.
#130-010 \$2795

REPLACEMENT POWER CORDS



• 18 gauge, 2 conductor. • 6 foot, bulk.
#110-010 (White) 29¢
#110-020 (Brown) (10-up)
#110-030 (Black) (1-9) 40¢

12" PIONEER WOOFER



• Power: 65W RMS • 11 oz. magnet
• 25 to 2500 Hz response • 1 1/2" voice coil
#290-100 \$1550 (1-3) \$1395 (4-10)

500 PIECE RESISTOR KIT



• 1/2 watt • Popular resistance values ranging from 2.7-ohms-3.3 Meg ohms.
#010-010 \$1295

FREE CATALOG

Our new 56 page catalog contains thousands of items that you need every day for do-it-yourself projects, product engineering, electronics repair and more. Call us today for your free copy and start saving!



OUTLET STRIP



• Heavy duty four outlet box. • All outlets switched w/circuit breaker. • UL approved.
#130-210 \$995

CALL TOLL FREE 1-800-255-3525

In Ohio: 1-800-322-3525
Local: (513) 222-0173

• 15 day money back guarantee. • \$10.00 minimum order. • COD orders accepted. • 24 hour shipping.
• Shipping charge - UPS chart rate (\$2.50 minimum charge). Hours 8:30 a.m. - 6 p.m. EST M-F.

PARTS EXPRESS INTL. INC.
340 East First St.
Dayton, Ohio 45402



CALL FOR FREE CATALOG

TEXT TO SPEECH BOARD!

PC/XT COMPATIBLE. MAKE YOUR COMPUTER TALK!

A VERY POWERFUL AND AMAZING SPEECH CARD. USES THE NEW GENERAL INSTRUMENTS SPO256-AL2 SPEECH CHIP AND THE CTS256A-AL2 TEXT TO SPEECH CONVERTER.

THIS BOARD USES ONE SLOT ON THE MOTHERBOARD AND REQUIRES A COM SERIAL PORT. BOARD MAY ALSO BE USED IN A STAND ALONE ENVIRONMENT WITH ALMOST ANY COMPUTER THAT HAS A RS232 SERIAL PORT. FEATURES ON BOARD AUDIO AMP OR MAY BE USED WITH EXTERNAL AMPS. DEMONSTRATION SOFTWARE AND A LIBRARY BUILDING PROGRAM ARE INCLUDED ON A 5 1/4" INCH PC/XT DISKETTE. FULL DOCUMENTATION AND SCHEMATICS ARE ALSO INCLUDED.



\$89.95
ASSEMBLED & TESTED

NEW!

CANON 80 COLUMN PRINTER - \$39.95

ORIGINALLY MANUFACTURED FOR THE PC JR. BUT WITH OPTIONAL CONNECTOR WILL WORK WITH PC, XT, OR AT. REQUIRES SERIAL I/O. THIS THERMAL PRINTER IS QUIET AND USES EASY TO GET 8 1/2" IN. ROLLS OF PAPER. 50 C.P.S., UPPER AND LOWER CASE, PLUS GRAPHICS. ORIGINAL LIST PRICE \$199.00. ADD \$3.00 FOR PC/XT CONNECTOR. ADD \$5.00 UPS.

PC/XT EPROM PROGRAMMER

\$199

NEW!

• LATEST DESIGN • PROGRAMS UP TO 4 DEVICES AT ONE TIME • FEATURES EASY TO USE MENU DRIVEN SOFTWARE THAT RUNS UNDER PC OR MS-DOS. • USES AN INTELLIGENT PROGRAMMING ALGORITHM FOR SUPER FAST (8X) EPROM BURNING. • THIS PLUG-IN BOARD ATTACHES TO AN EXTERNAL MINI CHASSIS CONTAINING 4 TEXTOL Z.I.F. SOCKETS. • NO PERSONALITY MODULES REQUIRED • AUTOMATIC VPP SELECTION: 12.5V, 21V, OR 25V. • EPROM DATA CAN ALSO BE LOADED FROM OR SAVED TO A DISKETTE. • PROGRAMMING SOFTWARE SUPPORTS: 2716, 2732, 2732A, 2764, 2764A, 27128, 27128A, 27256, 27256A, 27512, AND 27512A. • ASSEMBLED AND TESTED, BURNED. IN WITH MANUAL. \$199 WITH SOFTWARE.

Digital Research Computers

(OF TEXAS)
P. O. BOX 381450B • DUNCANVILLE, TX 75138 • (214) 225-2309

TERMS: Add \$3.00 postage. We pay balance. Orders under \$15 add 75¢ handling. No C.O.D. We accept Visa and MasterCard. Texas Res. add 6-1/4% Tax. Foreign orders (except Canada) add 20% P & H. Orders over \$50 add 85¢ for insurance.



**SCIENTIFIC
ATLANTA
UNITS**

**LOWEST
PRICES
ANYWHERE!**



CABLE-TV



BONANZA!



**WE'LL MATCH OR BEAT ANYONE'S
ADVERTISED RETAIL OR WHOLESALE PRICES!**

ITEM	SINGLE UNIT PRICE	DEALER 10-UNIT PRICE
RCA 36 CHANNEL CONVERTER (CH. 3 OUTPUT ONLY)	29.95	18.00 ea.
PIONEER WIRELESS CONVERTER (OUR BEST BUY)	88.95	72.00 ea.
LCC-58 WIRELESS CONVERTER	92.95	76.00 ea.
JERROLD 450 WIRELESS CONVERTER (CH. 3 OUTPUT ONLY)	105.95	90.00 ea.
SB ADD-ON UNIT	109.95	58.00 ea.
BRAND NEW — UNIT FOR SCIENTIFIC ATLANTA	<i>Call for specifics</i>	
MINICODE (N-12)	109.95	58.00 ea.
MINICODE (N-12) VARISYNC	119.95	62.00 ea.
MINICODE VARISYNC W/AUTO ON-OFF	179.95	115.00 ea.
M-35 B (CH. 3 OUTPUT ONLY)	139.95	70.00 ea.
M-35 B W/AUTO ON-OFF (CALL FOR AVAILABILITY)	199.95	125.00 ea.
MLD-1200-3 (CALL IF CH. 2 OUTPUT)	109.95	58.00 ea.
INTERFERENCE FILTERS — CH. 3	24.95	14.00 ea.
JERROLD 400 OR 450 REMOTE CONTROLLER	29.95	18.00 ea.
ZENITH SSAVI CABLE READY (DEALER PRICE BASED ON 5 UNITS)	225.00	185.00 ea.
SPECIFY CHANNEL 2 or 3 OUTPUT <i>Other products available — Please Call</i>		

Quantity	Item	Output Channel	Price Each	TOTAL PRICE
SUBTOTAL				
Shipping Add \$3.00 per unit				
COD & Credit Cards — Add 5%				
TOTAL				

California Penal Code #593-D forbids us from shipping any cable descrambling unit to anyone residing in the state of California.
Prices subject to change without notice.

PLEASE PRINT

Name _____
 Address _____ City _____
 State _____ Zip _____ Phone Number () _____
 Cashier's Check Money Order COD Visa Mastercard
 Acct # _____ Exp. Date _____
 Signature _____

FOR OUR RECORDS:

DECLARATION OF AUTHORIZED USE — I, the undersigned, do hereby declare under penalty of perjury that all products purchased, now and in the future, will only be used on cable TV systems with proper authorization from local officials or cable company officials in accordance with all applicable federal and state laws.

Dated: _____ Signed: _____

Pacific Cable Company, Inc.

7325½ RESEDA BLVD., DEPT. R-04 • RESEDA, CA 91335
 (818) 716-5914 • No Collect Calls • (818) 716-5140

IMPORTANT: WHEN CALLING FOR INFORMATION
 Please have the make and model # of the equipment used in your area. *Thank You*

APRIL 1987

\$45 MORROW CP/M ENGINE

- Over 15,000 of these single board computers installed.
- Free copy of the "MORROW OWNERS REVIEW". The national magazine devoted just to the MORROW computer.
- We have over 1500 in stock
- 4 mhz Z80A CPU, 64K RAM
- 16/32K ROM (32k rom rev 2 supplied)
- 2 RS232 serial ports (300→19.2k baud with db25 connectors installed)
- Centronics printer port (cable \$9)
- Power requirements—+12vdc -12vdc +5vdc
- Floppy disk controller up to 4 drives. SSDD standard. Rom for DSDD 48tpi or 96tpi \$12 extra including assembled bios
- CP/M bios, Newword and Bazic included.
- Schematic, bios.asm, maint manual and users guide included
- Copy program to read/write non morrow formats such as Kaypro, Osborne, Xerox, & IBM
- Optional rs232 terminal pcb, TTL monitor pcb, and display tube \$59 (with purchase of cpu, a 30% savings from separate price)

Call our bbs at 415-261-4513

Call to a copy of 15 day trial agreement. Tax & friesht extra. Send check or add 1.90 for COD. Price may change. Store Price may differ. While supplies last. No P.O.s, terms, or credit cards

Silicon Valley Surplus
415-261-4506
4401 OAKPORT OAKLAND CA, 94601
(RE FEB)

OPEN 10am-6pm
CLOSED SUN & MON

CIRCLE 197 ON FREE INFORMATION CARD

DPM LCD 3 1/2-.5" digits. 9V powered, specify input 2V or 200mV. \$29.00. Minnesota add 6%, shipping \$1.50. VISA/MC. RAHTEC, Box 36064, Minneapolis, MN 55435.

VIDEO copier (\$69.95) connects between two VCR's (stereo) and makes copies as good as the original. For info/order write or call VIDEO VIBES, 657 Allerton Ave., Bronx, NY 10467. Tel. (212) 653-4644.

PLANS AND KITS

BUILD this five-digit panel meter and square wave generator including an ohms, capacitance and frequency meter. Detailed instructions \$2.50. BAGNALL ELECTRONICS, 179 May, Fairfield, CT 06430.

CABLE TV converters: Jerrold Products include "New Jerrold Tri-Mode," SB-3, Hamlin, Oak VN-12, M-35-B, Zenith, Magnavox, Scientific Atlanta, and more. (Quantity discounts) 60 day warranty. Service converters sold here. For fast service C.O.D. orders accepted. Send SASE (60 cents postage) or call for info (312) 658-5320. Midwest Electronics, Inc., HIGGINS ELECTRONICS, 5143-R W. Diversey, Chicago, IL 60639. MC/Visa orders accepted. No Illinois orders accepted.

WRITE FOR
McGEE'S
SPEAKER & ELECTRONICS CATALOG

1001 BARGAINS IN SPEAKERS
toll free 1-800-346-2433 for ordering only.
1901 MCGEE STREET KANSAS CITY, MO. 64108

JERROLD gated pulse theory. Twelve information-packed pages covering DI & DIC converter operation. Includes introduction to trimode system. \$6.95 plus \$1.50 postage and handling. ELEPHANT ELECTRONICS, INC., Box 41865-J, Phoenix, AZ 85080. (602) 581-1973.

PROJECTION TV...Convert your TV to project 7 foot picture. Results comparable to \$2,500 projectors...Total cost less than \$30.00 plans and 8" lens \$21.95...Illustrated information FREE...MACROCOMA-GH, Washington Crossing, PA 18977. Creditcard orders 24hrs. (215) 736-3979.

TOP QUALITY imported, domestic kits, surplus, discount electronics, computer components. FREE catalog. TEKTRASONIX, 1120 Avenue of the Americas, 11th suite 4038, New York, NY 10036.

VERIFY before you buy. Write for free introductory list of authentic blueprints of master circuits and accessories. CANPLAN (division FORTEBEC INC.), 4690-A Clark, Montreal, Quebec, Canada H2T2T4.

TV-STEREO kit—easily converts your TV/VCR to receive the new MTS stereo sound. True stereo not simulation. \$43.95 information—SASE. DPI, Box 150, Elmont, NY 11003.

DIGITAL audio recorder Commodore-64. Excellent Sound! Plans, P.C.B., & drum software: \$19.95. Kit \$49.95. Postpaid, order now!! TAD PAINTER, P.O. Box 166055, Irving, TX 75016.

SCHEMATIC and theory for third brake light. Send \$2.00 to BILL SHAFER, Box 107, Gas City, IN 46933.

SAVE 75% build your own 68000 or IBM compatible computer—easy. Free details. DIGATEK CORPORATION, Suite 175, 2723 West Butler Drive, Phoenix, AZ 85051.

DESCRAMBLING, new secret manual. Build your own descramblers for Cable and Subscription TV. Instructions, schematics for SSAVI, gated sync, sine wave. (HBO, Cinemax, Showtime, etc.) \$8.95. For immediate delivery add \$1.00. CABLETRONICS, Box 30502R, Bethesda, MD 20814.

Pay TV and Satellite Descrambling All New 6th Edition!

100 pages. 13 cable and 7 satellite systems. Schematics. Cable Co. countermeasures. \$14.95. Experiments with Videocipher, Bypasses, Turnons, Schematics. \$12.95 Cable TV. Two-way systems, security. \$12.95 MDS/MMDS Handbook. For microwave hackers \$9.95 Build Satellite Systems Under \$600. \$11.95. Any 3/\$26 or 2/\$19.95. New Spring catalog \$1.

Shojiki Electronics Corp., 1327R Niagara St., Niagara Falls, NY 14303. COD's 716-284-2163

SATELLITE descrambling manual, Video Cypher II. Schematics and thorough explanation of digital audio encoding. (HBO, Cinemax, Showtime, Fantasy, Extasy) \$10.95. For immediate delivery add \$1.00 CABLETRONICS, Box 30502R, Bethesda, MD 20814.

CRYSTAL radio sets, plans, parts, kits, catalog \$1.00. MIDCO, 660 North Dixie Highway, Hollywood, FL 33020.

CORDLESS phone monitor. Simple instructions to modify cheap AM radio to receive entire 1.7 Mhz cordless phone band. No parts required, only a screwdriver. Also instructions how to monitor the new 46/49 Mhz frequencies. Only \$5.95 complete. ADVANTAGE INC., Box 1086, Edgewater, FL 32032.

CLOCK for IBM-PC and compatibles. Complete module, no slots required, 10 year battery life, easy installation, software included, \$29. ADVANCED ELECTRONICS, 3778 NW Wisteria, Corvallis, OR 97330.

AMPLIFIER breakthrough—The current amplifier drives loads push-pull without internal voltage gain. Fastest, quietest circuit in transistor electronics. Op amps now drive speakers. Plans for quieter, easier to construct audio amplifiers, all wattages, \$15. AMPLIFIERS UNLIMITED, Rt 2, Box 139, Highmore, SD 57345.

STRANGE STUFF. Plans, kits, new items. Build satellite dish \$69. Descramblers, bugs, adult toys. Informational photo package \$3.00 refundable. DIRIJO CORPORATION, Box 212, Lowell, NC 28098.

DESCRAMBLE the latest video cassette copy protection scheme. Our simple Line Zapper circuit takes the jitter out of your picture. Complete plans and theory only \$13.95 plus \$1.50 postage and handling. PC board and complete kits also available. ELEPHANT ELECTRONICS, INC., Box 41865-J, Phoenix, AZ 85080. (602) 581-1973.

HI-FI speaker systems, kits and speaker components from the world's finest manufacturers. For beginners and audiophiles. Free literature. A&S SPEAKERS, Box 7462R, Denver, CO 80207. (303) 399-8609.

VOICE disguisers! FM bugs! SWL active antenna, receivers, more! Send stamped envelope: XANDI ELECTRONICS, Box 25647, Dept. 60K, Tempe, AZ 85282.

FREE SAMPLE COPY

Write for your free copy of the most accurate satellite tv guide



p.o. box 308(H2502) Fortuna CA 95540

SATELLITE TV

CABLE TV Secrets—the outlaw publication the cable companies tried to ban. HBO, Movie Channel, Showtime, descramblers, converters, etc. Suppliers list included \$8.95. CABLE FACTS, Box 711-R, Pataskala, OH 43062.

SATELLITE systems \$349 up. VISA/MC available. Catalog \$3.00. STARLINK, INC., 2603-16R Artie, Huntsville, AL 35805.

SATELLITE TV receiver kits! LNA's! instructions, schematics! Send stamped envelope: XANDI ELECTRONICS, Box 25647, Dept. 21M, Tempe, AZ 85282.

OAK Orion "Turn-On" modifications: "Chip kit" or "Remote keypad." details—\$1.00. NAS-SAT, Box 5261, Long Beach, CA 90805. (213) 631-3552.

Get First Class Bench Equipment!



4.5 Digit Portable/ Bench Multimeter

This versatile instrument is suitable for use in general electronic maintenance production and laboratory. It features 0.05% DCV accuracy, integrated circuit electronics, solid-state LCD display, and push-button switch selection. Other features include: DC voltage, AC voltage, DC current, AC current, resistance, diode test, continuity test, full auto-polarity operation, overrange indication, dual slope integration, easy calibration (1 year stability), and 6000 continuous hours battery operation. Comes with probes.

Specifications: DCV-10uV to 1000V in 5 ranges with $\pm(0.05\% \pm 2 \text{ digits})$ accuracy, 10M ohm input impedance on all ranges except 11M ohm on 2V • ACV-10uV to 750V in 5 ranges with accuracy from $\pm(0.5\% \pm 10)$ to $\pm(5\% \pm 30)$, 10M ohm in parallel with $<100\text{pF}$, except 11M ohm on 2V • DC current-10nA to 10A in 6 ranges with accuracy from $\pm(0.05\% \pm 10)$ to $\pm(2\% \pm 10)$ • AC current-10nA to 10A in 6 ranges with accuracy from $\pm(0.75\% \pm 10)$ to $\pm(2\% \pm 10)$ • Resistance-10M Ohm to 20 Ohm in 6 ranges with accuracy from $\pm(0.02\% \pm 20)$ to $\pm(2\% \pm 2)$ • Size-8.4" W x 10.4" H x 3.9" D • Weight-67 oz.

\$179
Q-1550

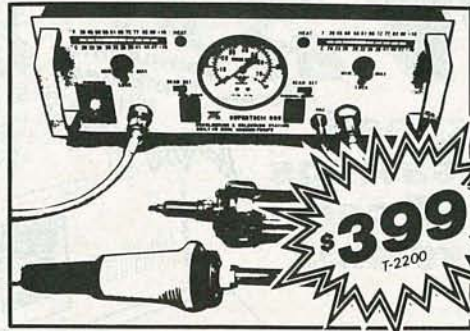

Soldering/Desoldering Station

Professional rack-mounting station with excellent desoldering facilities, backed by our exclusive 12 month warranty. Check it out!
Soldering features: Adjustable temperature-controlled iron (light weight for fatigue-free work); grounded tip; LED bar graph of tip temperature; LED "heating" indicator; lockable control knob; fast pre-heat & tight temperature control.

De-soldering: Rapid, "damage-free" desoldering of any size joint; adjustable desoldering temperature with LED bargraph readout; grounded tip; LED "heating" indicator, fingertip control vacuum gauge; filtered vacuum line; easy to clean.

Iron-clad, Nickel-plated Accessory Tips

Desoldering Tips \$4.95 each
1/16" (T-2201), 3/32" (T-2202), 1/8" (T-2203)

Soldering Tips \$2.50 each
Fine Wedge 1/32" (T-2204), Medium conical 1/32" (T-2205), Fine Conical 1/64" (T-2206), Medium Wedge 1/16" (T-2207), Wedge 1/8" (T-2208), Long Nose Wedge 3/64" (T-2209), Short Wedge 3/64" (T-2210).

NOTE: These tips fit both T-2200 and T-2000 soldering stations!



NEW IMPROVED MODEL

Economy Solder Station

\$59.95
T-2000

For hobbyist or technician: temperature-controlled station with fully adjustable heat up to 900°F (temp readout in both °C and °F) UL listed, grounded tip, heat-sensing for instant compensation. Ideal for anything from fine track PCB's to production work!

Resistance Substitution Wheel

Values from 5 ohms to 1M ohms in 36 steps using most common divisions. 2 1/2" dia. easy to read. Includes leads and insulated alligator clips. Maximum power .25W.

\$7.95
Q-1410



CRT Probe Set

\$29.95
Q-1245

Versatile probe suits virtually any scope. It features built in x1/x10 switch, 4' of SHIELDED cable with BNC connector, and wandering earth lead with alligator clip, insulating shroud.
Specification: Working voltage-600V Pk (or 600V DC) • Bandwidth-x1: DC-10MHz; x10: DC-100MHz • input resistance-x1: 1M ohm; x10: 10M ohm • Input capacitance-x1: 40pF \pm 0.50pF; x10: 10-60pF • REF position-probe grounded via 9M resistor.

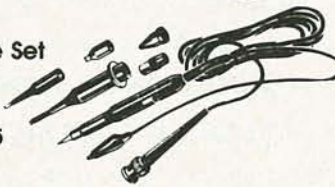

OSCILLOSCOPE

Portability & performance make this scope ideal for field service maintenance of telecommunication, computer, marine, airborne, industrial & other equipment. It offers 2mV/DIV sensitivity, automatic selection of chopped or alternate mode, automatic selection of TV line or frame display, and choice of DC, battery, or AC line operation (2 hrs. continuous ni-cad battery operation). Comes with two probes and schematic.

Specifications: VERTICAL DEFLECTION DC: to 15 MHz (-3dB) / AC: 10Hz to 15MHz (-3dB); 24 nsec risetime; $<3\%$ overshoot; input impedance 1M ohm shunted by 20pF \pm 3pF • TIME BASE- auto triggered; 0.5 usec to 0.5 sec sweep • TRIGGERING- Int.: 1 DIV or more/Ext. 1V p-p; 20Hz to 15MHz • HORIZ. DEFLECT- DC to 1 MHz; input impedance 1M ohm shunted by 20 pF \pm 3pF • Approx. 10 lbs., 4.5" H x 8 3/4" W x 12 1/2" D.

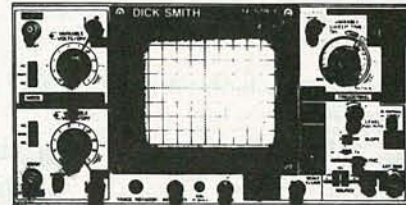

50 MHz Dual Trace

\$899
Q-1243

A premium scope for computer & general purpose work. It has a high grade CRT for a full 10cm x8 internal graticule, and comes complete with 2 probes and schematic.

Specifications: VERTICAL FREQUENCY & DEFLECTION- DC: DC to 50 MHz (-3dB) / AC: 10Hz to 50MHz (-3dB); 5mV to 1mV/div on 10 ranges in 1-2-5 step • RISE TIME- 7.7 nsec • overshoot • MODES- CH-A, CH-B, DUAL, ADD, x-y • INPUT IMPEDANCE: 1m/20pF \pm 3pF • MAX INPUT-600 V p-p or 300V (DC \pm AC peak) • CHOP FREQUENCY-200KHz • CHANNEL SEP- \pm 70dB at 1 KHz • TIME BASE- Auto or triggered (In Auto mode, trace is on without input signal) • SWEEP TIME- 0.2 to 0.5 sec/div on 20 ranges in 1-2-5 step; x5 mag. • TRIGGERING- sensitivity: Int. 1 div. or more/Ext. 1V p-p or more; Source: Int. CH1, CH2/Ext. Pos-Neg pull for Auto range • CALIBRATION- 0.5V p-p \pm 5%; • Power-120V \pm 10%; 50/60Hz • 21.6 lbs., 5.7" H x 11" W 16.6" D.

35 MHz Dual Trace

\$599
Q-1241

With high brightness CRT; includes 2 probes & schematic
Specifications: NORMAL, AUTO, & SINGLE sweep modes with 5x mag. ($\pm 10\%$) • TIME BASE-0.1 us- 0.5s/div ($\pm 3\%$); 21 ranges • 3% LINEARITY Delayed trigger: INTEN'D: Delay, time become dim/Delay: sweep starts at time delayed. Delayed time: 10 msec to 1 usec • TRIGGERING- Sensitivity: Int. $<1 \text{ Div/Ext } <100\text{mV p-p}$ for 10MHz, $<0.2\text{V p-p}$ for 35 MHz; Source: INT (CH-A, CH-B,ALT), LINE,EXT, 1/10 EXT TV LINE, FRAME).

20 MHz Dual Trace

\$399
Q-1240

Includes 2 probes & schematic
Specifications: VERTICAL FREQUENCY & DEFLECTION- AC 10 Hz/ DC to 202 MHz; 5mV to 20V/div on 12 ranges in 1-2-5 step (-3dB) 28 MHz (-6dB) • 17.5 nsec RISE TIME • 3% OVERSHOOT • MODES CH1, CH2, DUAL ADD x-y • INPUT IMPEDANCE- 1M/20pF \pm 3pF; MAX INPUT- 600V p-p or 300V DC \pm peak AC • CHOP FREQUENCY-200KHz • CHANNEL SEP-180dB at 1 KHz • TIME BASE- Auto or triggered • SWEEP TIME- 0.2 to 0.5 sec/div • TRIGGERING- Sensitivity: Int. $<1 \text{ div/Ext } <1\text{V p-p}$.

FREE BOOK with any oscilloscope!
Knowing Your Oscilloscope 192pp. (B-2003) **\$11.95 value!**
Great introduction to the use of oscilloscopes.
Specially extended to 4/30/87

Stores in BERKELEY, CA (415) 486-0755; REDWOOD CITY, CA (415) 368-8844; SAN JOSE, CA (408) 241-2266

Order Toll Free
1-800-332-5373
Pre-paid & Credit Card Orders Only!

Mon. - Fri 10a.m. - 6p.m. Pacific Time
In California call 415-368-1066

DICK SMITH ELECTRONICS
EVERYTHING FOR THE ELECTRONICS ENTHUSIAST

To receive your copy of our colorful 148 page catalog, circle Reader Service 188



3.5 Digit MM with Temp Sensor

A whole workshop in a handy portable multimeter. Easy-to-read LCD displays volts, current, impedance, capacitance, conductance, and temperature. Includes transistor, diode, & continuity tests and overload protection on all ranges. Comes with probes and battery. Includes leads plus temperature sensor.

Specifications: DCV - 5 ranges from 200mV to 1000V • ACV - 5 ranges from 200mV to 750V • DC/AC amps- 6 ranges from 200uA to 10A • Resistance - 6 ranges from 200 ohm to 20M ohm • Capacitance - 3 ranges from 200pF to 20u • Conductance - V display x 10000M ohm • Temperature-OF to 2000F.

\$99.95
Q-1512

Economy Digital Multimeter

Features full overload protection & diode check!
Comes with probes and battery.

Specifications: DCV -0.20, 100, 200V • ACV -0.20, 500V (RMS) • DC current-0.2, 20, 200mA • Resistance-0.2K, 20K, 200K, 2M ohms • 200 hour battery life.

\$21.95
Q-1440

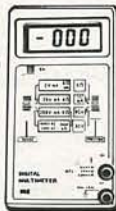

R-E Reader's Special



Type-right™

was \$34.95
\$24.95
Y-1021

Everyone should know how to type and anyone can learn with Type-right™! You get a full-sized 47-key color coded keyboard with an 8 character LCD screen and a 56-page course manual. The instructional program leads students step-by-step from basic finger positions to 45 w.p.m. proficiency. Speed & accuracy readouts after each lesson.

Offer good from 3/1/87 thru 4/30/87 or while supplies last.

14-Day Satisfaction Guarantee
1 Year Test Equipment Warranty

MAIL ORDERS

DSE, P.O. BOX 8021, Redwood City, CA 94063

We ship UPS Ground unless otherwise requested. Add 5% of order total (min \$1.50) for shipping. Outside USA and 20% (min \$4). There is an additional \$1.50 handling fee. California residents please add sales tax. VISA and MASTERCARD welcome.

NEW!

Get more power & speed at substantial cost savings with this fully IBM AT compatible computer system!

The superior engineering of this system ensures reliability and performance as well as full compatibility with the IBM AT. Like the IBM, it is based on the Intel 80286 microprocessor, but the stable, 4-layered main system board gives better reliability than the IBM. The AT Turbo's efficient design uses fewer chips but packs all the AT power onto a smaller board to fit XT systems as well. All boards and components are available individually to upgrade your current system, but you'll get even greater savings by buying our custom kit. Complete instructions are included, so you'll have the satisfaction of building your own superb AT computer.



Monitor optional (see below)

AT Compatible Computer Kit

AT Turbo Computer System

(See below for complete component descriptions)

80286 AT Baby Motherboard-6/10MHz	(X-1050)	\$499.00
2x 256K Upgrade Kit	(X-1190)	69.90
Hard/Floppy Disk Controller Card	(X-1052)	199.00
1.2MB Floppy Disk Drive	(X-7502)	135.00
200W Power Supply	(X-1111)	99.00
84-key Keyboard	(X-1122)	59.95
Heavy-duty Steel Case	(X-1120)	39.95

Individual Components Total \$1101.80

\$975

X-1152

SAVE \$125

off individual component prices



IBM PC XT AT are trademarks of International Business Machines Corporation
Intel 80286, 80287 are trademarks of Intel Corp.
Hercules Graphics Card is a trademark of the Hercules Graphics Corporation.

More AT-compatible Accessories

MONOPAK Card \$169

- IBM AT/XT PC compatible • Hercules compatible X-1054
- Monochrome graphic adapter with 80 x 25 text mode; 720 x 348 graphic mode & 64 KB buffer
- Parallel printer port with Centronic compatible interface **NEW!**
- Serial & game ports; light pen interface

Monographics Card \$89.95

- IBM AT/XT/PC compatible X-1012
- 80 x 25 text mode; 720 x 348 graphic mode
- Parallel printer port

Enhanced Graphics Card \$209.00

- IBM AT/XT compatible X-1008
- 256K Video RAM • Light pen interface
- RAM-loadable character generator
- Full 16-color support for 640 x 350 graphics

Color Graphics Adaptor Card \$69.95

- IBM AT/XT compatible • 40/80 col x 25 rows X-1007
- 320 x 200 med-res color; 640 x 200 hi-res b&w

2MB Memory Expansion Card \$139.00

- IBM AT compatible X-1056
- Fully socketed memory with parity check
- Select/split among Conventional, Extended or Expanded Memory
- Use up to 4 cards for up to 8MB expansion memory
- Includes software to enhance system performance

3MB Multifunction Card \$159.95

- IBM AT compatible X-1058
- Fully socketed memory with parity check
- True 16-bit architecture for memory
- RS-232 serial port; parallel printer port; game adapter port
- Includes serial & joystick interface cables

Amber Monitor \$119.00

- IBM AT/XT compatible X-1133

Green Monitor \$99.95

- IBM/AT/XT compatible X-1132

80286 AT Baby Motherboard \$499

- Intel 80286 CPU/80287 Math Coprocessor Socket X-1050
- 24 bit addressing; 16 bit data path; 16 level interrupts; 7 channel DMA
- Socketed for up to 1MB memory
- Speed 6/10 MHz, software switchable
- Real clock timer; built-in battery
- Standard speaker, keyboard, & power connectors
- 7 expansion slots
- (4 dual 62/36 pin; 3x62 pin for PC/XT adapter cards)
- BIOS made in USA - legal and 100% IBM AT compatible

256K Upgrade Kit \$34.95

- IBM AT compatible • 120 nsec X-1190
- contains 9 x 256K D/RAM (Z-9315)

Hard/Floppy Drive Controller Card \$199

- IBM AT compatible X-1052
- Supports two hard disk drives
- Supports two 1.2 MB floppy drives

360 KB/ 1.2 MB Floppy Drive Controller Card \$79

- IBM AT compatible X-1051

I/O Card \$79

- IBM AT compatible X-1060
- RS-232 & Parallel Game ports

1.2 MB Floppy Disk Drive \$135

- IBM AT compatible • 15 sectors/track X-7502

200W Power Supply \$99

- IBM AT compatible X-1111
- Input: 117V AC, 50Hz
- Output: 200W DC

84-key Keyboard \$59.95

- IBM AT/XT compatible X-1122
- Keyboard angle adjusts from 7-15°
- Mechanical key switch with strike rate 20 million
- LED indicator shows lock key status
- Ergonomic design: adjustable height, tactile feel

Heavy-Duty Steel Case \$39.95

- IBM XT/AT Baby Board Compatible X-1120
- Easy internal access
- Includes hardware for expansion slots & power supply mounting
- Weight approximately 17 lbs.

IBM AT-style case \$79

- IBM AT compatible X-1121

Dynamic RAMs (IBM AT compatible) \$1.29 \$1.19

64K 150 nsec (Z-9312)	\$1.29	\$1.19
64K 120 nsec (Z-9313)	1.95	1.75
256K 150 nsec (Z-9314)	2.99	2.89
256K 120 nsec (Z-9315)	4.29	3.99

Get great values on Computer Accessories at Dick Smith Electronics



\$129 **NEW!**
X-4020
PEPswitch
Electronic Printer Switch

Tired of messing with cables and juggling hardware? PEP switch is the smart printer switch that lets you switch between printers from your keyboard! Use it to select between draft and final copy printers, between printers with different paper types (e.g. invoices and picking slips), etc.

PEPswitch is compatible with any printing device with a Centronics parallel interface. The desired printer can be selected from your keyboard by a simple ASCII command sequence or by a mechanical switch on the PEPswitch cover. Multiple PEPswitches may be used to select from as many as five printers attached to one P.C.

It's so good, we use PEPswitch on our office system!

GENDER CHANGERS

Centronic M/M (X-4006)	\$9.95	RS-232 M/M (X-4009)	\$4.95
Centronic M/F (X-4010)	\$9.95	RS-232 M/F (X-4002)	\$4.95

Multiport RS-232 Gender Changer \$14.95
(X-4003)

MODEM SALE SAVE UP TO 27%!

Voyager 1200B was \$140	X-1100	\$109
• Plug-in card • 0-300 & 1200 bps		
Challenger 1200 was \$169	X-1102	\$129
• Free-standing • 0-300 & 1200 bps		
Discovery Hi-Speed was \$379	X-1104	\$299
• 0-300,600,1200,2400 bps		

25 Pin Adapter \$9.95 Null \$4.95
RJ-11 to RS-232 X-4005 Modem X-4007

Keyboard Extension Cable \$4.95
5 pin to 5 pin DIN; 10' length X-3597

PRINTER CABLES

Parallel Printer Interface (X-3595)	\$9.95
For use on a large range of computers	
IBM Parallel Interface (X-3590)	\$9.95
Fully RFI and EMI shielded; 6' length	
IBM Parallel Interface (X-3591)	\$11.95
Fully RFI and EMI shielded; 10' length	
IBM Serial Interface (X-3592)	\$9.95
25 pin Male/Male; 10' length	
25 pin Male/Female; 10' length (X-3593)	
Macintosh Serial Interface (X-3594)	\$7.95
6 foot length	

Try Dick Smith Electronics' fantastic Mail Order Service!

Electronics hobbyists & professionals all over the world have relied on DSE for more than 18 years!



Now! Custom cables are quick & easy!

IDC BENCH ASSEMBLY PRESS
\$139
 T-5260



Mass terminate up to 64-conductor cable in seconds without wire stripping or soldering! This quarter-ton manual press is a rugged, practical installation tool for low volume, mass termination of various IDC connectors on flat (ribbon) cable. Interchangeable base plates accommodate a broad range of IDC connectors.

PRESS ACCESSORIES

- Cutters**
 ● Flat (Ribbon) Cable (T-5261) **\$54.95**
 ● Strip Header (IDC) (T-5262) **\$49.95**

- Base Plates \$29.95 each**
 ● Female Socket Transition Connectors (T-5263)
 ● Card Edge Connectors (T-5264) ● DIP Plugs (T-5265)
 ● D-Sub Connectors (T-5266)

Make Your Own Professional Quality PCB's!

Photo-Etch™ PRINTED CIRCUIT KIT **\$37**
 H-5700

All the chemicals necessary to make any circuit up to 5" x 6" - from original or magazine art! For larger circuits, we carry a range of PCB-making accessories - check our catalog or call to inquire!

Contains: 5" x 6" steel frame; Pos-Neg film; film processing pack; yellow filter; 4oz. negative-acting etch resist; 16oz. resist developer; blank copper circuit boards; dry concentrated etchant; 1:1 resist patterns & tapes; complete instructions.

Developing trays & exposure light not included. Trays available at camera supply houses. DSE exposure light (S-3905) \$11.95.

Precision work is easy with the right tools!

Mini-Drill Stand **\$12.95**
 T-4753

NEW! Drill not included (see below)

Clean, accurate holes are a cinch with this sturdy mini-drill stand. It's a perfect accessory for the mini-drill kit below.

Mini-Drill Set **\$9.95**
 T-4751

For hobbyist, toolmaker, technician.
Contains: 4 high-speed twist drills with 3 collets, grinding bit, wrench, tommy bar, and DC power cable (for 12-35V DC) in a plastic case.

C Substitution Manual (B-4001) \$29.95 NEW!

Hard to find TORX screwdrivers?

We have 'em!

SIZE	CAT. NO.	SINGLE PRICE	10 & UP
#08	T-4208	\$2.70	\$2.60
#10	T-4210	3.15	3.05
#12	T-4212	3.40	3.30
#14	T-4214	3.60	3.50

INSTRUMENT CASES

\$6.95 NEW SIZE!
 H-2506
 6" W x 6 1/4" D x 2 1/2" H
 Includes mounting slots & posts.

Try these other useful sizes:
 10" W x 7 1/2" D x 3 3/4" H **\$9.95** H-2507
 8" W x 6 1/4" D x 2 1/2" H **\$7.95** H-2505

DIGITAL PANEL METERS

1.5 Digit LCD **\$29.95**
 High input impedance; 9V battery required
 Q-2200

1.5 Digit LCD **\$59.95**
 Low power dissipation, guaranteed zero reading or 0 volts input on all scales; 9V battery required.
 Q-2202

POCKET LIGHT METER **\$8.95**
 Q-1050

NEW!

0-3000 lux, accurate ±15%.
 For incandescent, fluorescent.
 No batteries required.

POCKET BATTERY TESTER **\$7.95**
 Q-1052

For all sizes: D, C, AA, AAA, N, 9V & Button

PHONE BUG ALERT **\$14.95**
 F-1008

NEW!

Alerts you to eavesdropping on any phone system. Easy to install. No batteries required.

ATTENTION AUSTRALIS 1 OWNERS!

The AUSTRALIS STEREO **\$29.95**
 UPGRADE Kit is NOW IN STOCK!
 K-6317

NEW

Jetset AIRDAPTER **\$34.95**
 C-4125

Frequent Fliers, Take Note!

Why rent lo-fi, uncomfortable airline earphones when you can own your own high quality stereo headphones to tune into inflight entertainment any time? Comfy & convenient, Airdapter works on all aircraft with standard airpore connectors or in personal stereo jacks in club & 1st class. Latest circuitry filters out hiss and amplifies signal.

Get a whole new source of TV!

Dual polarity, multi-channel wideband microwave-TV-tuner receives 1.9-2.7 GHz. System includes 19" parabolic dish, DC, LNC, cable, transformers & 90 day warranty. Use with any TV!

MICROWAVE Receiver System **\$99.95**
 D-6350

WARNING! Although this system receives descrambled pay TV signals (like HBO), such usage is ILLEGAL! DSE offers this product with the express understanding that it will be used for lawful purposes only!

Cordless Remote for ANY TV!

These stylish video components install easily in minutes & replace the existing tuner with 139 channel cable-ready capability controlled by a 19-button cordless remote with many features.

TV Remote Scan **\$139** Y-8530
MTS Stereo Remote Scan **\$199** Y-8531

VIDEOTAPE REWINDERS **\$39.95 each**

VHS C-3813
 Beta C-3814

Musicians! Make Notes!!

AUDIO MIXER **\$129** **NEW!**
 F-3050

Here's a pro-quality mixing board in a compact package at an incredible low price! Mix 2 mics and up to 4 other stereo inputs (from 8 separate sources) and output to a recorder or amplifier. Features include 5-band graphic equalizer, VU meters, Master, Fader & Monitor Controls; Talkover, Headphone Jack.

Specifications: Input sensitivity: 1mV-150mV; Output 0.775V at 1KHz sinewave; Distortion <0.05%; S/N ratio >60dB; Frequency response 20-20000KHz ±2dB; Equalizing frequencies: 60Hz, 250Hz, 1KHz, 3.5KHz, 12KHz ±5%; Control range ±12dB; Headphone power: 100mW (max) at 32 ohm; Power source: 220V AC, 50Hz; Size: 13 1/2" W x 9 1/2" D x 2 1/2" H (1) x 1 1/2" H (2)

Turn the page for **MORE GREAT VALUES!**

Order Toll Free 1-800-332-5373
 CIRCLE 95 ON FREE INFORMATION CARD
 In California call 1-415-368-1066

★ QUALITY PARTS ★ DISCOUNT PRICES ★ FAST SHIPPING!

SEND FOR FREE 1987 CATALOG... 48 PAGES!

ALL ELECTRONICS CORP.

EDGE CONNECTORS

ALL ARE .156" SPACING.

22 **EDGE CONNECTOR** \$1.25 ea
solder lug style 10 for \$11.00
22/44 **EDGE CONNECTOR**
\$2.00 ea PC style 10 for \$18.00
22/44 **EDGE CONNECTOR**
solder lug style \$2.50 each
28/56 **EDGE CONNECTOR**
PC style \$2.50 ea
36/72 **EDGE CONNECTOR**
PC style \$3.00 each
43/86 **EDGE CONNECTOR**
PC style \$4.50 each

TRANSISTORS

2N706 4 for \$1.00
2N2222A 3 for \$1.00
PN2222A 4 for \$1.00
2N2904 3 for \$1.00
2N2905 3 for \$1.00
MJ2955 \$1.00
2N3055 \$1.00
PMD 10K40 \$1.00
TIP 121 75¢
TIP 125 75¢

TRANSFORMERS

120 volt primaries

5.6 volts @ 750 ma.	\$3.00
6.3 volt @ 600 ma.	\$1.75
12 V.C.T. @ 200 ma.	\$2.00
12 V.C.T. @ 400 ma.	\$3.00
12 V.C.T. @ 1 amp.	\$4.00
12 V.C.T. @ 2 amp.	\$4.85
12 V.C.T. @ 4 amp.	\$7.00
18 volts @ 650 ma.	\$2.00
24 V.C.T. @ 200 ma.	\$2.50
24 V.C.T. @ 1 amp.	\$4.85
24 V.C.T. @ 2 amp.	\$6.75
24 V.C.T. @ 3 amp.	\$9.50
24 V.C.T. @ 4 amp.	\$11.00

WALL TRANSFORMERS

all plug directly into 120 vac outlet

4 VDC @ 70 ma.	\$2.00
6 VDC @ 500 ma.	\$3.50
6 VDC @ 750 ma.	\$4.50
9 VDC @ 500 ma.	\$5.00
12.5 VDC @ 265 ma.	\$3.00
18 VAC @ 18 VA and	
85 VAC @ 1.28 VA	\$3.50
24 VAC @ 250 ma.	\$3.00
MULTI-VOLTAGE @ 500 ma.	
3, 4.5, 6, 7.5, 9 or 12 VDC	\$7.50

MINI-BOX

Heavy-duty black phenolic project box with cover and screws. 2 1/4" X 1 1/2" X 1 1/2"

FUSES

3AG (AGC) SIZE
1, 1 1/2, 2, 2 1/2, 3, 4, 5, 6 AMP
GMA SIZE
1, 2, 3, 4, 5 AMP
5 of any ONE amperage 75¢

ALL ELECTRONICS CORP.
LOS ANGELES, CA STORE
905 S. Vermont Ave.
213 380-8000

VAN NUYS, CA STORE
6228 Sepulveda Blvd.
818 997-1806

COMPUTER GRADE CAPACITORS

1,400 mfd 200 Vdc
3" x 2" dia. \$2.00
6,400 mfd 60 Vdc
4 1/4" x 1 3/8" dia. \$2.50
7,500 mfd 200 Vdc
5 3/4" x 3" dia. \$4.00
12,000 mfd 40 Vdc
4 1/4" x 2" dia. \$2.50
22,000 mfd 25 Vdc
4 3/4" x 2" dia. \$2.50
48,000 mfd 10 Vdc
3" x 2 1/2" dia. \$2.50
66,000 mfd 15 Vdc
3 3/4" x 3" dia. \$3.00
72,000 mfd 15 Vdc
4" x 2" dia. \$3.50
100,000 mfd 10 Vdc
6" x 2 1/2" dia. \$1.00

PHOTO-FLASH CAPACITORS

170 MFD 330 Volt
CAT# PPC-170
75¢ each
400 MFD 330 Volt
CAT# PPC-400 \$1.00 ea

LIGHT ACTIVATED MOTION SENSOR

This device contains a photocell which senses sudden changes in ambient light. When an object or person passes within it's field of view (about 15') it keeps for several seconds then resets. Could be used as a door annunciator or modified to trigger other devices. 5 1/2" X 4" X 1". Operates on 6 Vdc. Requires 4 AA batteries (not included).
Catalog # LSMD \$5.75 per unit

TI SWITCHING POWER SUPPLY

Compact, well-regulated switching power supply designed to power Texas Instruments computer equipment.
INPUT: 14-25 vac @ 1 amp
OUTPUT: +12 vdc @ 350 ma.
+ 5 vdc @ 1.2 amp
- 5 vdc @ 200 ma.
SPECIAL PRICE
\$3.50 each

13.8 VDC REGULATED POWER SUPPLY

These are solid state, fully regulated 13.8 vdc power supplies. Both feature 100% solid state construction, fuse protection, and L.E.D. power indicator. U.L. listed.
2 amp constant, 4 amp surge \$20.00 each
3 amp constant, 5 amp surge \$27.50 each

8" 15 WATT SPEAKER

C.T.S Model 8B3079
Full range speaker.
100-10,000Hz.
Ideal for PA systems.
Mounting holes for line-matching transformer.
CAT#SK-815
\$3.50 ea. Case of 8 pcs.
\$25.00 per case



COMMODORE PRINTER/PLOTTER

Commodore Model # 1520
Four color X-Y plotter. Standard VIC serial interface allows easy connection to Commodore 64 computers. Up to 80 characters per line in four sizes.
4 inch paper
CAT # COM-1520
\$49.95 each
EXTRA pen sets \$1.50 per set.

MICRO-CASSETTE MECHANISM

Micro-cassette tape transport for standard MC60 or MC15 micro-cassettes. 3 Vdc operation. Contains: drive motor, belt, head, capstan, pinch wheel and other components. 3 1/2" X 2 1/4" X 5/8"
CAT# MCMC \$3.00 each 10 for \$27.50

3rd TAIL LIGHT ?

Sleek high-tech lamp assembly. Could be used as a third auto tail light, emergency warning light, or special-effects lamp. Red reflective lens is 2 3/4" x 5 1/2" is mounted on a 4" high pedestal with up-down swivel adjustment. Includes 12v replaceable bulb.
CAT# TLB \$3.95 each.

RELAYS

10 AMP SOLID STATE

CONTROL: 3-32 vdc
LOAD: 140 vac 10 amp
SIZE: 2 1/2" x 3/4" x 7/8"
\$9.50 EACH 10 FOR \$90.00

ULTRA-MINIATURE 5 VDC RELAY

Fujitsu # FBR21NED005M20
High sensitivity
COIL: 120 ohms
CONTACTS: 1 amp
Mounts in 14 pin DIP socket
\$1.25 each 10 for \$10.00

MINIATURE 6 VDC RELAY

Aromat #RSD-6V
Super Small S.P.D.T. relay
Gold colbalt contacts rated 1 amp @ 30 vdc. Highly sensitive. TTL direct drive possible. 120 ohm coil.
Operate from 4.3-6 vdc.
COIL: 120 ohms \$1.50 each
1 1/16" x 1/2" x 7/16" 10 for \$13.50

13 VDC RELAY

CONTACTS: S.P.N.C.
10 amp @ 120 vac
Energize coil to open contact.
COIL: 13 vdc 650 ohms
SPECIAL PRICE \$1.00 each

4PDT RELAY

14 pin KH style...
3 amp contacts...
USED but fully tested... \$1.70 each
Specify coil voltage desired
Either 24 vdc or 120 vac
LARGE QUANTITIES AVAILABLE
SOCKETS FOR KH RELAY 75¢ each

RECHARGEABLE NI-CAD BATTERIES

AAA SIZE 1.25V 500mAh \$1.85
AA size 1.25V 500mAh \$1.85
AA with solder tab \$2.00
C SIZE 1.2V 1200mAh \$3.50
SUB-C SIZE solder tab \$3.50
D SIZE 1.2V 1200mAh \$3.50

NI-CAD CHARGER

Will charge most every size Ni-cad battery available.
Cat# UNCC-N \$12.50

2K 10 TURN MULTI-TURN POT

SPECTROL #MOD 534-7161
\$5.00 EACH

SOLID STATE BUZZER

Star #SMB-06L
6 vdc
TTL compatible.
\$1.00 each
10 for \$9.00

POLARITY SWITCH

Designed to control an external coaxial relay on a satellite TV system. IDEAL FOR THE EXPERIMENTOR AS PARTS. Heavy chassis box containing a 5 Vdc relay, CA 358 op amp and other parts.
Catalog # RDP5 \$1.75 each 10 for \$15.00

48 KEY ASSEMBLY FOR COMPUTER OR HOBBYIST

NEW T.I. KEYBOARDS. Originally used on computers, these keyboards contain 48 S.P.S.T. mechanical switches. Terminates to 15 pin connector. Frame 4" x 9"
CAT # KP-48 \$3.50 each

WALL TRANSFORMER

11.5 Vdc 1.95 Amp.
INPUT: 120 Vac
SIZE: 3 3/4" X 2 7/8" X 2 5/8"
CAT # DCTX-11519 \$6.50 each

TELEPHONE COUPLING TRANSFORMER

Stancor # TTPC-8 or Triad # TY-304 P
600 ohms c.t. to 600 ohms c.t.
P.C. board mount
3/4" x 5/8" x 3/4"
\$1.25 each

3 1/2" SPEAKER

8 ohm impedance, Full range speaker. 8 oz magnet 4" diagonal mounting centers.
\$2.50 each 10 for \$20.00

XENON FLASH TUBE

3/4" long X 1/8" dia. Flash tube designed for use in compact camera flash units. Ideal for experimentors.
CAT# FLT-1 2 for \$1.00

SPRING LEVER TERMINALS

Two color coded terminals on a sturdy 2 3/4" x 3 3/4" bakelite plate. Great for speaker enclosures or power supplies.
75¢ EACH 10 for \$6.00

MINIATURE TOGGLE SWITCHES

ALL ARE RATED 5 AMPS @ 125 VAC

S.P.D.T. (on-on)
PC style non-threaded bushing.
75¢ each
10 for \$7.00

S.P.D.T. (on-off)
Solder lug terminals.
\$1.00 each
10 for \$9.00
100 for \$80.00

S.P.D.T. (on-off-on)
Solder lug terminals.
\$1.00 each
10 for \$9.00
100 for \$80.00

S.P.D.T. (on-off-on)
PC style non-threaded bushing.
75¢ each
10 for \$7.00

D.P.D.T. (on-on)
Solder lug terminals.
\$2.00 each
10 for \$19.00
100 for \$180.00

LED'S STANDARD JUMBO DIFFUSED T 1-3/4

RED 10 for \$1.50
100 for \$13.00
GREEN 10 for \$2.00
100 for \$17.00
YELLOW 10 for \$2.00
100 for \$17.00

D.P.S.T. LIGHTED ROCKER SWITCH

115 vac lighted rocker, snap mounts in 3/8" x 1 1/8" hole. Orange lens. 16 amp contact.
\$1.50

FLASHER LED

5 volt operation red jumbo T 1 1/4 size \$1.00 each
NEW GREEN FLASHER
CAT # LED-4G \$1.00

MINI-PUSH BUTTON

S.P.S.T. momentary normally open 1/8" bushing. Red button.
35¢ each
10 for \$3.00

BI-POLAR jumbo T 1 1/4 size

2 for \$1.70

SNAP ACTION SWITCH

Cherry elect. #E-21. N.O. or N.C. 0.1A contacts. Suitable for alarms and other low energy circuits. 1 1/8" lever.
45¢ EACH 10 FOR \$4.20

LED HOLDERS

Two piece holder for jumbo LED
10 for 65¢ 100 for \$5.00
CLEAR CLIPPER LED HOLDER
Make LED a fancy indicator. Clear.
4 for \$1.00

S.P.S.T. TOGGLE SWITCH

CARLING (on-off)
RATED: 10 amp @ 125 Vac.
All plastic body and toggle.
CAT# STS-1
\$1.00 ea.
10 for \$8.50
100 for \$7.50
LARGE QUANTITIES

MAIL ORDERS TO:
P.O. BOX 20406
Los Angeles, CA 90006
TWX - 5101010163 ALL ELECTRONIC
EASYLINK MBX - 62887748

TOLL FREE ORDERS ONLY
1-800-826-5432
(ORDER ONLY)
(IN CALIFORNIA: 1-800-258-6666)
ALASKA, HAWAII, OR INFORMATION
(213) 380-8000 NO C.O.D.!

QUANTITIES LIMITED
MINIMUM ORDER \$10.00
USA: \$3.00 SHIPPING
FOREIGN ORDERS:
INCLUDING SUFFICIENT SHIPPING
CALIF RES. ADD 6 1/2%

1-800-344-4539

DIKEY CORPORATION
NATIONAL SEMICONDUCTOR • PANASONIC MACHINE • EWC. INC. • INTERSIL • AD EAC. INC. • J. W. MILLER • AAVI ENGINEER E. F. JOHNSON • ATLANTIC SEMICONDUCTOR

256K (262,144 x 1) DRAM 150NS \$5.70/1; \$39.95/9
Factory Firsts

DIODES • DIAMOND TOOL • UNGAR • ES • CW INDUSTRIES • AMDEK • G.E. • YAGAR • YAGOR • J. W. MILLER • LUXO • SC CHEMICALS • ARIES • PLESSEY

INTEGRATED CIRCUITS

Part No.	Description	Fig.	1	10	100	1,000
7400 TTL	74LS100N	1.00	1	10	100	1,000
7400 TTL	74LS100N	1.00	1	10	100	1,000
7400 TTL	74LS100N	1.00	1	10	100	1,000
7400 TTL	74LS100N	1.00	1	10	100	1,000
7400 TTL	74LS100N	1.00	1	10	100	1,000
7400 TTL	74LS100N	1.00	1	10	100	1,000
7400 TTL	74LS100N	1.00	1	10	100	1,000
7400 TTL	74LS100N	1.00	1	10	100	1,000
7400 TTL	74LS100N	1.00	1	10	100	1,000
7400 TTL	74LS100N	1.00	1	10	100	1,000
7400 TTL	74LS100N	1.00	1	10	100	1,000
7400 TTL	74LS100N	1.00	1	10	100	1,000
7400 TTL	74LS100N	1.00	1	10	100	1,000

T.I.C. SOCKETS

Part No.	Description	Fig.	1	10	100	1,000
C8008	8 pin solder tail, tin	1.3	15	1.45	12.00	
C8014	14 pin solder tail, tin	1.5	1.45	12.00		
C8018	18 pin solder tail, tin	1.5	1.45	12.00		
C8022	22 pin solder tail, tin	1.5	2.25	21.00		
C8026	26 pin solder tail, tin	1.5	2.25	21.00		
C8030	30 pin solder tail, tin	1.5	2.25	21.00		
C8034	34 pin solder tail, tin	1.5	2.25	21.00		
C8038	38 pin solder tail, tin	1.5	2.25	21.00		
C8042	42 pin solder tail, tin	1.5	2.25	21.00		

5% Carbon Film Resistors

Part No.	Description	Fig.	1	10	100	1,000
NR10	10 ohm standard value in series	1.0	10	100	1,000	10,000
NR15	15 ohm standard value in series	1.0	10	100	1,000	10,000
NR20	20 ohm standard value in series	1.0	10	100	1,000	10,000
NR25	25 ohm standard value in series	1.0	10	100	1,000	10,000
NR30	30 ohm standard value in series	1.0	10	100	1,000	10,000
NR35	35 ohm standard value in series	1.0	10	100	1,000	10,000
NR40	40 ohm standard value in series	1.0	10	100	1,000	10,000
NR45	45 ohm standard value in series	1.0	10	100	1,000	10,000
NR50	50 ohm standard value in series	1.0	10	100	1,000	10,000

DISC CAPACITORS

Part No.	Cap. Value	Tolerance	Price	100	1,000
PA000	10 pF	±5%	6.49	48.71	1.89
PA002	15 pF	±5%	6.49	48.71	1.89
PA004	22 pF	±5%	6.49	48.71	1.89
PA006	33 pF	±5%	6.49	48.71	1.89
PA008	47 pF	±5%	6.49	48.71	1.89
PA010	68 pF	±5%	6.49	48.71	1.89
PA012	100 pF	±5%	6.49	48.71	1.89
PA014	150 pF	±5%	6.49	48.71	1.89
PA016	220 pF	±5%	6.49	48.71	1.89
PA018	330 pF	±5%	6.49	48.71	1.89
PA020	470 pF	±5%	6.49	48.71	1.89
PA022	680 pF	±5%	6.49	48.71	1.89
PA024	1000 pF	±5%	6.49	48.71	1.89
PA026	1500 pF	±5%	6.49	48.71	1.89
PA028	2200 pF	±5%	6.49	48.71	1.89
PA030	3300 pF	±5%	6.49	48.71	1.89
PA032	4700 pF	±5%	6.49	48.71	1.89
PA034	6800 pF	±5%	6.49	48.71	1.89
PA036	10000 pF	±5%	6.49	48.71	1.89

TANTALUM CAPACITORS

Part No.	Cap. Value	Tolerance	Price	100	1,000
TA002	2.2 uF	±10%	31	230	22.00
TA004	4.7 uF	±10%	31	230	22.00
TA006	10 uF	±10%	31	230	22.00
TA008	22 uF	±10%	31	230	22.00
TA010	47 uF	±10%	31	230	22.00
TA012	100 uF	±10%	31	230	22.00
TA014	220 uF	±10%	31	230	22.00
TA016	470 uF	±10%	31	230	22.00
TA018	1000 uF	±10%	31	230	22.00
TA020	2200 uF	±10%	31	230	22.00
TA022	4700 uF	±10%	31	230	22.00
TA024	10000 uF	±10%	31	230	22.00

7400 TTL

Part No.	Description	Price	100	1,000
7400	74LS100N	1.00	10	100
7401	74LS101N	1.00	10	100
7402	74LS102N	1.00	10	100
7403	74LS103N	1.00	10	100
7404	74LS104N	1.00	10	100
7405	74LS105N	1.00	10	100
7406	74LS106N	1.00	10	100
7407	74LS107N	1.00	10	100
7408	74LS108N	1.00	10	100
7409	74LS109N	1.00	10	100
7410	74LS110N	1.00	10	100
7411	74LS111N	1.00	10	100
7412	74LS112N	1.00	10	100
7413	74LS113N	1.00	10	100
7414	74LS114N	1.00	10	100
7415	74LS115N	1.00	10	100
7416	74LS116N	1.00	10	100
7417	74LS117N	1.00	10	100
7418	74LS118N	1.00	10	100
7419	74LS119N	1.00	10	100
7420	74LS120N	1.00	10	100
7421	74LS121N	1.00	10	100
7422	74LS122N	1.00	10	100
7423	74LS123N	1.00	10	100
7424	74LS124N	1.00	10	100
7425	74LS125N	1.00	10	100
7426	74LS126N	1.00	10	100
7427	74LS127N	1.00	10	100
7428	74LS128N	1.00	10	100
7429	74LS129N	1.00	10	100
7430	74LS130N	1.00	10	100
7431	74LS131N	1.00	10	100
7432	74LS132N	1.00	10	100
7433	74LS133N	1.00	10	100
7434	74LS134N	1.00	10	100
7435	74LS135N	1.00	10	100
7436	74LS136N	1.00	10	100
7437	74LS137N	1.00	10	100
7438	74LS138N	1.00	10	100
7439	74LS139N	1.00	10	100
7440	74LS140N	1.00	10	100
7441	74LS141N	1.00	10	100
7442	74LS142N	1.00	10	100
7443	74LS143N	1.00	10	100
7444	74LS144N	1.00	10	100
7445	74LS145N	1.00	10	100
7446	74LS146N	1.00	10	100
7447	74LS147N	1.00	10	100
7448	74LS148N	1.00	10	100
7449	74LS149N	1.00	10	100
7450	74LS150N	1.00	10	100
7451	74LS151N	1.00	10	100
7452	74LS152N	1.00	10	100
7453	74LS153N	1.00	10	100
7454	74LS154N	1.00	10	100
7455	74LS155N	1.00	10	100
7456	74LS156N	1.00	10	100
7457	74LS157N	1.00	10	100
7458	74LS158N	1.00	10	100
7459	74LS159N	1.00	10	100
7460	74LS160N	1.00	10	100
7461	74LS161N	1.00	10	100
7462	74LS162N	1.00	10	100
7463	74LS163N	1.00	10	100
7464	74LS164N	1.00	10	100
7465	74LS165N	1.00	10	100
7466	74LS166N	1.00	10	100
7467	74LS167N	1.00	10	100
7468	74LS168N	1.00	10	100
7469	74LS169N	1.00	10	100
7470	74LS170N	1.00	10	100
7471	74LS171N	1.00	10	100
7472	74LS172N	1.00	10	100
7473	74LS173N	1.00	10	100
7474	74LS174N	1.00	10	100
7475	74LS175N	1.00	10	100
7476	74LS176N	1.00	10	100
7477	74LS177N	1.00	10	100
7478	74LS178N	1.00	10	100
7479	74LS179N	1.00	10	100
7480	74LS180N	1.00	10	100

WIRE WRAP DIP SOCKETS

Part No.	Description	Fig.	1	10	100	1,000
W8008	8 pin wire wrap, gold	1.1	18	18.00		
W8014	14 pin wire wrap, gold	1.1	34	34.00		
W8018	18 pin wire wrap, gold	1.1	34	34.00		
W8022	22 pin wire wrap, gold	1.1	40	40.00		
W8026	26 pin wire wrap, gold	1.1	40	40.00		
W8030	30 pin wire wrap, gold	1.1	40	40.00		
W8034	34 pin wire wrap, gold	1.1	40	40.00		
W8038	38 pin wire wrap, gold	1.1	40	40.00		
W8042	42 pin wire wrap, gold	1.1	40	40.00		
W8046	46 pin wire wrap, gold	1.1	40	40.00		
W8050	50 pin wire wrap, gold	1.1	40	40.00		

7400 TTL

Part No.	Description	Price	100	1,000
7400	74LS100N	1.00	10	100
7401	74LS101N	1.00	10	100
7402	74LS102N	1.00	10	100
7403	74LS103N	1.00	10	100
7404	74LS104N	1.00	10	100
7405	74LS105N	1.00	10	100
7406	74LS106N	1.00	10	100
7407	74LS107N	1.00	10	100
7408	74LS108N	1.00	10	100
7409	74LS109N	1.00	10	100
7410	74LS110N	1.00	10	100
7411	74LS111N	1.00	10	100
7412	74LS112N	1.00	10	100
7413	74LS113N	1.00	10	100
7414	74LS114N	1.00	10	100
7415	74LS115N	1.00	10	100
7416	74LS116N	1.00	10	100
7417	74LS117N	1.00	10	100
7418	74LS118N			

7400

Part No.	1-9	10+	Part No.	1-9	10+
7400	29	19	7485	65	55
7402	29	19	7486	45	35
7404	35	25	7489	2.05	1.95
7405	39	29	7490	49	39
7406	39	29	7493	45	35
7407	39	29	74121	45	35
7408	35	25	74123	59	49
7410	35	25	74125	55	45
7411	45	35	74126	75	65
7416	45	35	74143	4.05	3.85
7417	45	35	74150	1.35	1.25
7420	35	25	74154	1.35	1.25
7430	35	25	74158	1.59	1.49
7432	39	29	74173	85	75
7438	39	29	74184	65	55
7442	55	45	74175	65	55
7445	79	69	74176	99	89
7446	89	79	74181	1.95	1.85
7447	89	79	74189	2.05	1.95
7448	2.05	1.95	74193	79	69
7472	65	55	74198	1.85	1.75
7473	45	35	74221	99	89
7474	45	35	74273	2.05	1.95
7475	49	39	74365	69	59
7476	45	35	74367	69	59

74LS

Part No.	1-9	10+	Part No.	1-9	10+
74LS00	29	19	74LS165	75	65
74LS02	29	19	74LS166	99	89
74LS04	35	25	74LS173	59	49
74LS05	35	25	74LS174	49	39
74LS06	1.09	99	74LS175	49	39
74LS07	1.09	99	74LS189	4.59	4.49
74LS08	29	19	74LS191	59	49
74LS10	29	19	74LS193	79	69
74LS14	49	39	74LS211	69	59
74LS27	35	25	74LS240	79	69
74LS30	29	19	74LS243	79	69
74LS32	35	25	74LS244	79	69
74LS42	49	39	74LS245	89	79
74LS47	99	89	74LS259	99	89
74LS73	39	29	74LS273	89	79
74LS74	35	25	74LS279	89	79
74LS75	39	29	74LS322	4.05	3.95
74LS76	55	45	74LS365	49	39
74LS85	59	49	74LS366	49	39
74LS86	35	25	74LS367	49	39
74LS90	49	39	74LS368	49	39
74LS93	49	39	74LS373	79	69
74LS123	59	49	74LS374	79	69
74LS125	49	39	74LS393	89	79
74LS138	49	39	74LS590	6.05	5.95
74LS139	49	39	74LS624	2.05	1.95
74LS154	1.09	99	74LS625	2.29	2.19
74LS157	45	35	74LS640	1.09	99
74LS158	45	35	74LS645	1.09	99
74LS163	59	49	74LS670	1.09	99
74LS164	59	49	74LS688	2.05	1.95

74S/PROMS*

Part No.	1-9	10+	Part No.	1-9	10+
74S00	29	19	74S188	1.29	
74S04	35	25	74S189	1.69	
74S08	35	25	74S198	2.49	
74S10	35	25	74S240	1.49	
74S32	35	25	74S244	1.49	
74S74	45	35	74S253	1.79	
74S85	1.79	1.49	74S287	1.49	
74S86	1.79	1.49	74S288	1.49	
74S124	2.95	2.35	74S373	1.49	
74S174	79	69	74S374	1.49	
74S175	79	69	74S472	2.95	

74ALS

Part No.	1-9	10+	Part No.	1-9	10+
74ALS00	35	25	74ALS138	89	
74ALS02	35	25	74ALS174	89	
74ALS04	39	29	74ALS175	89	
74ALS08	39	29	74ALS240	1.49	
74ALS10	39	29	74ALS245	1.49	
74ALS27	39	29	74ALS273	1.49	
74ALS30	39	29	74ALS373	1.69	
74ALS32	39	29	74ALS374	1.69	
74ALS74	49	39	74ALS573	1.69	

74F

Part No.	1-9	10+	Part No.	1-9	10+
74F00	39	29	74F139	89	
74F04	39	29	74F157	395	
74F08	39	29	74F183	395	
74F10	39	29	74F240	1.39	
74F32	39	29	74F244	1.39	
74F74	49	39	74F253	99	
74F86	59	49	74F373	1.39	
74F138	89	79	74F374	1.39	

CD - CMOS

Part No.	1-9	10+	Part No.	1-9	10+
CD4001	19	13	CD4076	65	55
CD4008	89	79	CD4080	25	25
CD4011	19	13	CD4082	25	25
CD4013	29	19	CD4093	35	35
CD4016	29	19	CD4094	89	
CD4017	55	45	CD40103	2.49	
CD4018	59	49	CD40107	69	
CD4020	59	49	CD40109	1.49	
CD4024	49	39	CD40510	69	
CD4027	39	29	CD4511	69	
CD4030	29	19	CD4520	75	
CD4040	65	55	CD4522	79	
CD4049	29	19	CD4523	79	
CD4050	29	19	CD4541	69	
CD4051	59	49	CD4543	79	
CD4052	59	49	CD4553	4.95	
CD4053	59	49	CD4555	79	
CD4059	3.95	2.49	CD4566	2.49	
CD4063	1.95	1.35	CD4572 (MC14572)	39	
CD4066	29	19	CD4583	89	
CD4069	25	25	CD4584	89	
CD4070	25	25	CD4585	39	
CD4071	25	25	MC14411P	8.95	
CD4072	25	25	MC14490P	4.49	

COMMODORE CHIPS

Part No.	Price	Part No.	Price	Part No.	Price
WD1770 Disk Cont.	19.95	6545-1 CRTC	2.49	8701 Clock Chip	9.95
SI-3052P 5V Pos. Reg. 2A	5.95	6551 ACIA	3.29	*8721 PLA	14.95
6504A CPU	1.95	6560 CPU	10.95	8722 MMU	9.95
6507 CPU	4.95	6567 VIC-II	14.95	*825100PLA	24.95
6510 CPU	9.95	6569 VIC PAL	14.95	251104-04 Kernel ROM	10.95
6520 PA	1.75	6572 VIC PAL-N	14.95	*82S100PLA (8085114-01)	13.95
6522 VIA	2.95	6581 SID	14.95	901225-01 Char. ROM	11.95
6525 TR	7.95	8360 Text Edtng.	10.95	901226-01 BASIC ROM	11.95
6526 CIA	14.95	8501 MPU	10.95	901227-03 Kernel ROM	11.95
6529 SP	4.95	8502 MPU	7.95	901229-05 Upgrad. ROM	15.95
6532 128x8 RAM I/O Tim & 6.49		8583 CRT Contrl	15.95	No spec available	
		8564 VIC	15.95		

NEC V20 & V30 CHIPS

Replace the 8086 or 8088 in Your IBM-PC and Increase Its Speed by up to 40%!

Part No.	Price
UPD70108-5 (5MHz) V20 Chip (Replaces the 8088)	\$ 9.95
UPD70108-8 (8MHz) V20 Chip (Replaces the 8088-2)	\$11.95
UPD70116-8 (8MHz) V30 Chip (Replaces the 8086 or 8086-2)	\$14.95
UPD70116-10 (10MHz) V30 Chip (Replaces the 8086 or 8086-2)	\$34.95

MICROPROCESSOR COMPONENTS

MISCELLANEOUS CHIPS		6500/6800/68000 Cont.		8000 SERIES Cont.	
Part No.	Price	Part No.	Price	Part No.	Price
D785AC	4.49	6840	3.95	8228	2.49
WD1770	19.95	6800	2.95	8237-5	4.95
CDP1802CE	4.95	6845	2.95	8243	2.25
2661-3	5.95	6850	1.49	8250A	5.49
WD9216	9.95	6852	3.95	8250B (For IBM)	6.95
		6875	8.95	8251A	1.75
		68000L8	11.95	8253-5	1.95
		68661PB	5.95	8254	2.95
				8255A-5	1.59
		8000 SERIES		8257-5	2.49
		8031	2.95	8279-5	2.95
		80C31BH	14.95	8282	19.95
		90335	1.49	8289-5	1.95
		8080A	2.49	8272	4.49
		8085A	2.29	8279-5	2.95
		8088-2	6.95	8748	7.95
		8088-2	8.95	8749	9.95
		8087 (5MHz)	125.00	8751	39.95
		8087 (8MHz)	159.95	8755	14.95
		8088	6.49		
		8092	4.95	DATA ACQUISITION	
		8116	4.95	ADC0804CN	3.19
		8155-2	1.95	ADC0808CCN	5.95
		8155-2	2.49	ADC0809CCN	3.95
		8156	2.49	ADC0816CCN	14.95
		8202	3.95	ADC0808LCN	8.95
		8203	14.95	DAC0808LCN	1.95
		8212	1.49	DAC1008LCN	6.49
		8224	2.25	AY-3-1015D	4.95
				AY-5-1013A	3.95

DYNAMIC RAMS

Part No.	Function	Price
4116-15	16,384 x 1 (150ns)	.89
4128-20 (Piggyback)	131,072 x 1 (200ns)	4.49
4164-150	65,536 x 1 (150ns)	1.15
4164-200	65,536 x 1 (200ns)	95
TMS4416-12	16,384 x 4 (120ns)	4.25
8116	16,384 x 1 (120ns)	.69
41256-150	262,144 x 1 (150ns)	4.95
50464-15	65,536 x 4 (150ns) (4464) (41464)	4.95

STATIC RAMS

Part No.	Function	Price
2016-12	2048 x 8 (120ns)	1.69
2102	1024 x 1 (350ns)	.89
2102-2L	1024 x 1 (250ns) Low Power (91L02)	1.95
2114N	1024 x 1 (450ns)	.99
2114N-2	1024 x 1 (200ns) Low Power	1.05
2114N-2L	1024 x 1 (200ns) Low Power (CMOS)	1.49
2149	1024 x 4 (45ns)	4.95
5101	256 x 4 (45ns) CMOS	1.95
6116LP-2	2048 x 8 (120ns) Low Power CMOS	2.95
6116LP-3	2048 x 8 (150ns) CMOS	1.89
6116LP-3	2048 x 8 (150ns) Low Power CMOS	2.95
6264P-12	8192 x 8 (120ns) CMOS	3.89
6264P-12	8192 x 8 (120ns) Low Power CMOS	4.25
6264P-15	8192 x 8 (150ns) CMOS	3.59
6264P-15	8192 x 8 (150ns) Low Power CMOS	3.75
6514	1024 x 4 (350ns) CMOS (UPD444C)	4.49
43256-15L	32,768 x 8 (150ns) Low Power	24.95

PROMS/EPROMS

Part No.	Price	
1702A	256 x 8 (1 jus)	6.95
TMS2616	2048 x 8 (450ns) 25V	4.95
TMS2532	4096 x 8 (450ns) 25V	5.95
TMS2564	8192 x 8 (450ns) 25V	8.95
2708	1024 x 8 (450ns)	4.95
TMS2716	2048 x 8 (450ns) 3 voltage	9.95
2716	2048 x 8 (450ns)	3.75
2716-1	2048 x 8 (350ns) 25V	4.95
27C16	2048 x 8 (450ns) 25V (CMOS)	6.49
27C32	4096 x 8 (450ns) 25V	4.95
2732A-20	4096 x 8 (200ns) 21V	3.25
2732A-25	4096 x 8 (250ns) 21V	3.95
2732A-45	4096 x 8 (450ns) 21V	3.75
27C32	4096 x 8 (450ns) 25V (CMOS)	6.49
2764-20	8192 x 8 (200ns) 21V	4.25
2764-25	8192 x 8 (250ns) 21V	3.75
2764A-25	8192 x 8 (250ns) 12.5V	4.25
2764-45	8192 x 8 (450ns) 21V	3.49
27C64	8192 x 8 (450ns) 21	

Worldwide • Since 1974

• QUALITY COMPONENTS • COMPETITIVE PRICING
• PROMPT DELIVERY

Mail Order Electronics - Worldwide
Jameco
ELECTRONICS

COMMODORE COMPATIBLE ACCESSORIES



HESWARE 300 Baud Modem
For VIC-20 and C-64
• Connects directly to User Port • Manual Answer/Dial • Function keys defined for convenience • Includes Midwest Micro Associates communication software.
CM-1 (For VIC-20 and C-64) ~~\$34.95~~ **\$24.95**

Four-Slot Cartridge Expander
Singly or in any combination!
Aprospand-64 (For C-64 & C-128) **\$29.95**

External Power Supply
CPS-10 (For C-64) **\$39.95**

Parallel Printer Interface
2K Buffer, Expandable to 10K!
MW-350 (For VIC-20, C-64 & C-128) **\$54.95**

Input/Output Card
16-Channel Analog Multiplexer
MW-611 (For C-64 and C-128) **\$199.95**

TRS-80/TANDY COMPATIBLE ACCESSORIES

E-X-P-A-N-D TRS-80 MEMORY
All kits come complete with documentation

TRS-80 MODEL 4, 4P, & 4D 64K/128K EXPANSION
TRS-64K-2 **\$7.95**
Expands Model 4 from 16K-64K or Model 4 (Gate Array Version), 4P and 4D from 64K-128K

TRS-64K-2PAL **\$14.95**
Expands Model 4 (Non-Gate Array Version) from 64K to 128K

TRS-80 MODEL 100 8K EXPANSION
M1008K **\$19.95 ea. or 3 for \$54.95**

ZUCKERBOARD

TANDY 1000 Expansion Memory Half Card
Expand the memory of your Tandy 1000 (128K Version) to as much as 640K. Also includes DMA controller chip.
TAN-EM256K Includes 256K RAM **\$ 99.95**
TAN-EM512K Includes 512K RAM **\$119.95**

Options for TAN-EM256K/512K
TAN-C Plug-in Clock option chip (only) **\$39.95**
TAN-D RAM Disk Printer Spooler Software (only) **\$39.95**

TANDY 1000 Multifunction Board with Clock Calendar
Expand the memory on your Tandy 1000 (128K Version) to as much as 640K. Complete with an RS232 port, clock/calendar, RAM Disk Printer Spooler and on-board DMA controller chip.
MTAN-256K Includes 256K RAM **\$179.95**
MTAN-512K Includes 512K RAM **\$199.95**

UV-EPROM ERASER

Erases all EPROMs. Erases up to 8 chips within 21 minutes (1 chip in 15 minutes). Maintains constant exposure distance of 1". Special conductive foam liner eliminates static build-up. Built-in safety lock to prevent UV exposure. Compact - 9.00" L x 3.70" W x 2.60" H. Complete with holding tray for 8 chips.
DE-4 UV-EPROM Eraser. **\$69.95**
UVS-11EL Replacement Bulb. **\$19.95**
NCF-2 Cond. Foam 12x24x1/4 Hard Blk. **\$ 8.95**

NOW YOU CAN BUILD AN IBM PC/XT COMPATIBLE!



IBM-Special (Includes 9 items above) \$499.95

ADDITIONAL ADD-ONS AVAILABLE!

IBM-KB	83-Key Keyboard.	\$ 59.95
IBM-ENH	Enhanced Keyboard.	\$ 79.95
IBM-ICB	Integrated Color Board w/Printer Port.	\$ 99.95
IBM-EGA	Enhanced Graphics 256K RAM.	\$259.95
IBM-MGA	Monochrome Graphics Adapter.	\$149.95
IBM-MULTI	Multifunction 0-384K RAM (without RAM).	\$149.95
IBM-20MBK	20MB Hard Disk Drive, Controller & Cable.	\$449.95
EM-100	Expansion Memory Half Card (without RAM)	\$ 59.95
TTX-1410	14" RGB Color Monitor.	\$299.95

IBM is a registered trademark of IBM Computers

IBM Compatible Kit

IBM-64K(2)	64K RAM Chips (18) . . .	\$ 19.90
KB83	83-Key Keyboard	\$ 29.95
IBM-FCC	Floppy Controller Card . . .	\$ 34.95
IBM-Case	Case.	\$ 39.95
IBM-MCC	Monochrome Card	\$ 69.95
IBM-PS	Power Supply	\$ 69.95
FD55B	Disk Drive.	\$109.95
IBM-MON	Monochrome Monitor	\$ 99.95
IBM-MB	Motherboard.	\$109.95

FREE! QUICKSOFT PC WRITE WORD PROCESSING SOFTWARE INCLUDED!

Regular List **\$584.50**

NEW PRODUCTS!



ProModem 1200/300 Baud Half-Card Modems

For IBM PC, XT, AT & Compatibles
• Auto-answer/Auto-dial • Extensive diagnostics • Built-in speaker/vol. control • Auto redial on busy • Ability to access Com-port 3 • Hayes compatible • 2 yr. warranty

PM1200B-2	without software	\$129.95
PM1200B-2S	w/Mirror™ Software	\$159.95

2 yr. warranty! ZOOM 300 Baud Modem for Apple II, II+ and IIe



• Auto-dial/Auto-answer • Hayes compatible • Includes call progress monitor, speaker, Zoom Communications software and manual • Made in U.S.A.

ZM300 **\$89.95**



ProModem 1200/300 for Apple II, II+, IIe and II GS

Fully Compatible with the NEW APPLE II GS!

• NEW, single card version • Built-in software in ROM • Comes with ProCom-A disk-based communications software • Hayes compatible • Compatible with ProDOS • Auto-dial/Auto-answer • Auto redial on busy • Built-in speaker and volume control • 2 phone jacks with exclusion switching • 2-yr warranty

PM1200A-2 **\$199.95**

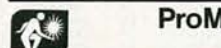

ProModem 2400/1200/300 Baud Modems

For Any Computer w/RS232 Serial Port

• Hayes command compatible • Call progress tone detection • Auto redial on busy • Internal power supply • Voice/data switching • Second phone jack for voice handset • Auto-answer/Auto-dial • Touch tone and pulse dialing • Speaker with volume control • 8 LED status lights • 1-yr warranty

PM1200G	(1200/300 baud).	\$199.95
PM2400G	(2400/1200/300 baud).	\$379.95
ProCom-B	(Communication Software	\$34.95

For IBM PC and Compatibles

APPLE COMPATIBLE ACCESSORIES

Jameco Parallel Printer Card for Apple II, II+ and IIe



• Intelligent interface to most dot matrix graphics printers
• Centronics standard
• Advanced text printing

JE880	Parallel Printer Card.	\$49.95
JE883	64K Buffer for JE880	\$69.95 \$59.95

Jameco Extended 80-Column Card for Apple IIe



• 80 Col / 64K RAM • Doubles amount of data your Apple IIe can display as well as its memory capacity • Ideal for word processing • Complete with instructions

JE864 **\$59.95**

Apple II, II+ and IIe Compatible Products

APF-1	Cooling Fan.	\$ 29.95
KHP4007	Switching Power Supply	\$ 34.95
JE860	16K RAM Card (II & II+ only)	\$ 39.95
JE875	Disk Controller Card.	\$ 49.95
JE877	Diagnostic Disk Controller Card	\$59.95 \$ 49.95
AMON	Monochrome Monitor	\$ 99.95
SMARTERM II	80-Col. Card.	\$139.95
Big Board-256K	256K RAM Card	\$189.95
Big Board-512K	512K RAM Card	\$219.95
Big Board-1M	1 Meg RAM Card	\$289.95

Universal 64K/256K Printer Buffer



• Four possible combinations: 1) Serial to Serial, 2) Serial to Parallel, 3) Parallel to Parallel, 4) Parallel to Serial • Cut sheet feeding • Software selectable output • Modem support • Selectable baud rates • Manual included

UB64K	\$199.95
UB256K	\$239.95

IBM Compatible! DISK DRIVES

FD55B	Teac 5 1/4" DS 1/2-Height	\$109.95
JU-455	Panasonic 5 1/4" DS 1/2-Height	\$109.95
TM100-2	Tandon 5 1/4" DS Full-Height.	\$119.95

DATA BOOKS

30003	National Linear Data Book (82).	\$14.95
30009	Intersil Data Book (86).	\$ 9.95
30013	Zilog Data Book (85).	\$14.95
30032	National Linear Supplement (84).	\$ 6.95
210830	Intel Memory Handbook (86).	\$17.95
230843	Intel Microsystem Hndbk. Set (86).	\$24.95

MUFFIN/SPRITE-STYLE FANS

MUF60	\$9.95
Torn Industries	(4.68" sq., 60 cfm)	
SUZAI1	\$8.95
EGAG Rotron	(3.125" square, 20 cfm)	

\$20 Minimum Order - U.S. Funds Only California Residents: Add 6%, 6 1/2% or 7% Sales Tax Spec. Sheets - 50¢ each Shipping: Add 5% plus \$1.50 Insurance Prices Subject to Change

Send stamped, self-addressed envelope to receive a Sales Flyer - FREE!
4/87



Send \$1.00 Postage for a FREE 1987 JAMECO CATALOG

1355 SHOREWAY ROAD, BELMONT, CA 94002 • PHONE ORDERS WELCOME 415-592-8097 Telex: 176043

1200 BAUD MODEM FOR IBM WITH PC TALK III SOFTWARE \$10995

STATIC RAMS			
2101	256x4	(45Ons)	1.95
5101	256x4	(45Ons)(CMOS)	3.95
2102L-4	1024x1	(45Ons)(LP)	.99
2112	256x4	(45Ons)	2.99
2114	1024x4	(45Ons)	.99
2114L-4	1024x4	(45Ons)(LP)	1.09
2114L-2	1024x4	(20Ons)(LP)	1.49
2114L-15	1024x4	(15Ons)(LP)	1.95
TMS4044-4	4096x1	(45Ons)	1.95
TMM2016-150	2048x8	(15Ons)	1.49
TMM2016-100	2048x8	(10Ons)	1.95
HM6116-4	2048x8	(20Ons)(CMOS)	1.95
HM6116-3	2048x8	(15Ons)(CMOS)	1.95
HM6116LP-4	2048x8	(20Ons)(CMOS)(LP)	1.95
HM6116LP-3	2048x8	(15Ons)(CMOS)(LP)	2.95
HM6116LP-2	2048x8	(12Ons)(CMOS)(LP)	2.95
HM6264P-15	8192x8	(15Ons)(CMOS)	3.89
HM6264LP-15	8192x8	(15Ons)(CMOS)(LP)	3.95
HM6264LP-12	8192x8	(12Ons)(CMOS)(LP)	4.49

LP=Low power

DYNAMIC RAMS			
4116-250	16384x1	(25Ons)	.49
4116-200	16384x1	(20Ons)	.89
4116-150	16384x1	(15Ons)	.99
4116-120	16384x1	(12Ons)	1.49
MK4332	32768x1	(20Ons)	1.19
4164-200	65536x1	(20Ons)(5v)	1.19
4164-150	65536x1	(15Ons)(5v)	1.29
4164-120	65536x1	(12Ons)(5v)	1.95
MCM6665	65536x1	(20Ons)(5v)	1.95
TMS4164	65536x1	(15Ons)(5v)	1.95
4164-REFRESH	65536x1	(15Ons)(5v)(REFRESH)	2.95
TMS4416	16384x4	(15Ons)(5v)	4.95
41128-150	131072x1	(15Ons)(5v)	5.95
TMS4464-15	65536x4	(15Ons)(5v)	6.95
41256-200	262144x1	(20Ons)(5v)	2.95
41256-150	262144x1	(15Ons)(5v)	2.95

5v=Single 5 Volt Supply REFRESH=Pin 1 Refresh

★ ★ ★ ★ HIGH-TECH ★ ★ ★ ★
NEC V20 UPD70108 \$1195
 REPLACES 8088 TO SPEED UP IBM PC 10-40%
 * HIGH-SPEED ADDRESS CALCULATION
 IN HARDWARE
 * PIN COMPATIBLE WITH 8088
 * SUPERSET OF 8088 INSTRUCTION SET
 * LOW POWER CMOS
8MHZ V20 UPD70108-8 \$13.95
8MHZ V30 UPD70116-8 \$19.95
 ★ ★ ★ ★ SPOTLIGHT ★ ★ ★ ★

EPROMS			
2708	1024x8	(45Ons)	4.95
2716-1	2048x8	(45Ons)(5V)	3.49
TMS2532	4096x8	(45Ons)(5V)	3.95
2732	4096x8	(45Ons)(5V)	3.95
2732A	4096x8	(25Ons)(5V)(21V PGM)	3.95
2732A-2	4096x8	(20Ons)(5V)(21V PGM)	4.25
27C64	8192x8	(25Ons)(5V)(CMOS)	5.95
2764	8192x8	(45Ons)(5V)	3.49
2764-250	8192x8	(25Ons)(5V)	3.95
2764-200	8192x8	(20Ons)(5V)	4.25
MCM68766	8192x8	(35Ons)(5V)(24 PIN)	17.95
27128	16384x8	(25Ons)(5V)	4.25
27C256	32768x8	(25Ons)(5V)(CMOS)	10.95
27256	32768x8	(25Ons)(5V)	7.49

5V=Single 5 Volt Supply 21V PGM=Program at 21 Volts

ORDER TOLL FREE
800-538-5000

SPECTRONICS CORPORATION EPROM ERASERS

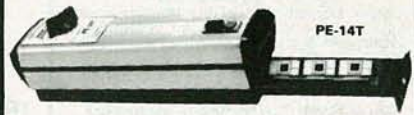

Model	Timer	Capacity Chip	Intensity (uW/Cm ²)	Unit Price
PE-14	NO	9	8,000	\$83.00
PE-14T	YES	9	8,000	\$119.00
PE-24T	YES	12	9,600	\$175.00



8000	
8035	1.49
8039	1.95
8080	2.95
8085	2.49
8087-2	169.95
8087	128.00
8088	6.95
8088-2	9.95
8155	2.49
8155-2	3.95
8748	7.95
8755	14.95
80286	129.95
80287	199.95

6500 1.0 MHZ	
6502	2.69
65C02(CMOS)	12.95
6507	9.95
6520	1.95
6522	4.95
6526	26.95
6532	6.95
6545	6.95
6551	5.95
6561	19.95
6581	34.95

CRT CONTROLLERS	
6845	4.95
68B45	8.95
6847	11.95
HD46505SP	6.95
MC1372	2.95
8275	26.95
7220	19.95
CRT5027	12.95
CRT5037	9.95
TMS9918A	19.95

CRYSTALS	
32.768 KHz	.95
1.0 MHZ	2.95
1.8432	2.95
2.0	1.95
2.097152	1.95
2.4576	1.95
3.2768	1.95
3.579545	1.95
4.0	1.95
4.032	1.95
5.0	1.95
5.0688	1.95
6.0	1.95
6.144	1.95
6.5536	1.95
8.0	1.95
10.0	1.95
10.738635	1.95
12.0	1.95
14.31818	1.95
15.0	1.95
16.0	1.95
17.430	1.95
18.0	1.95
18.432	1.95
20.0	1.95
22.1184	1.95
24.0	1.95
32.0	1.95

74LS00	
74LS00	.16
74LS01	.18
74LS02	.17
74LS03	.18
74LS04	.16
74LS05	.18
74LS08	.18
74LS09	.18
74LS10	.16
74LS11	.22
74LS12	.22
74LS13	.26
74LS14	.39
74LS15	.26
74LS20	.17
74LS21	.22
74LS22	.22
74LS27	.23
74LS28	.26
74LS30	.17
74LS32	.18
74LS33	.28
74LS37	.26
74LS38	.38
74LS42	.39
74LS47	.75
74LS48	.85
74LS51	.17
74LS73	.29
74LS74	.24
74LS75	.29
74LS76	.29
74LS83	.49
74LS85	.49
74LS86	.22
74LS90	.39
74LS92	.49
74LS93	.39
74LS95	.49
74LS107	.34
74LS109	.36
74LS112	.29
74LS122	.45
74LS123	.49
74LS124	2.75
74LS125	.39
74LS126	.39
74LS132	.39
74LS133	.49
74LS136	.39
74LS138	.39
74LS139	.39
74LS145	.99
74LS147	.99
74LS148	.99
74LS151	.39
74LS153	.39
74LS154	1.49
74LS155	.39
74LS156	.49
74LS157	.35
74LS158	.29
74LS160	.29
74LS161	.39
74LS162	.49
74LS163	.39
74LS164	.49

74LS165	
74LS165	.65
74LS166	.95
74LS169	.95
74LS173	.49
74LS174	.39
74LS175	.39
74LS191	.49
74LS192	.69
74LS193	.69
74LS194	.69
74LS195	.69
74LS196	.59
74LS197	.59
74LS221	.59
74LS240	.69
74LS241	.69
74LS242	.69
74LS243	.69
74LS244	.69
74LS245	.79
74LS251	.49
74LS253	.49
74LS256	1.79
74LS258	.49
74LS259	1.29
74LS260	.49
74LS266	.39
74LS273	.79
74LS279	.39
74LS280	1.95
74LS283	.59
74LS290	.89
74LS293	.89
74LS299	1.49
74LS322	3.95
74LS323	2.49
74LS364	1.95
74LS365	.39
74LS367	.39
74LS368	.39
74LS373	.79
74LS374	.79
74LS375	.95
74LS377	.79
74LS378	1.19
74LS390	1.19
74LS393	.79
74LS541	1.49
74LS624	1.95
74LS640	.99
74LS645	.99
74LS669	1.29
74LS670	.89
74LS682	3.20
74LS683	3.20
74LS684	3.20
74LS688	2.40
74LS783	22.95
81LS95	1.49
81LS96	1.49
81LS97	1.49
81LS98	1.49
25LS2521	2.80
25LS2569	2.80
26LS31	1.95
26LS32	1.95

74HC00	
74HC00	.59
74HC02	.59
74HC04	.59
74HC08	.59
74HC10	.59
74HC14	.79
74HC20	.59
74HC27	.59
74HC30	.59
74HC32	.69
74HC51	.59
74HC74	.75
74HC85	1.35
74HC86	.69
74HC93	1.19
74HCT107	.79
74HCT109	.79
74HCT112	.79
74HCT125	1.19
74HCT135	1.19
74HCT133	.69
74HCT138	.99
74HCT139	.99

74HCT00	
74HCT00	.69
74HCT02	.69
74HCT04	.69
74HCT08	.69
74HCT10	.69
74HCT11	.69
74HCT27	.69
74HCT30	.69
74HCT32	.79
74HCT74	.85
74HCT75	.95
74HCT138	1.15
74HCT139	1.15
74HCT154	2.99
74HCT157	.99
74HCT158	.99
74HCT161	1.29
74HCT164	1.39

8200	
8203	24.95
8205	3.29
8212	1.49
8216	1.49
8224	2.25
8237	4.95
8237-5	5.49
8250	6.95
8251	1.69
8251A	1.89
8253	1.89
8253-5	1.95
8255	1.69
8255-5	1.89
8259	1.95
8259-5	2.29
8272	4.95
8279	2.49
8279-5	2.95
8282	3.95
8284	2.95
8286	3.95
8288	4.95

2.0 MHZ	
6502A	2.95
6520A	2.95
6522A	5.95
6532A	11.95
6545A	7.95
6551A	6.95

DISK CONTROLLERS	
1771	4.95
1791	9.95
1793	9.95
1795	12.95
1797	12.95
2791	19.95
2793	19.95
2797	29.95
6843	19.95
8272	4.95
UPD765	4.95
MB8876	12.95
MB8877	12.95
1691	6.95
2143	6.95

CRYSTAL OSCILLATORS	
1.0MHZ	5.95
1.8432	5.95
2.0	5.95
2.4576	5.95
2.5	4.95
3.0	4.95
3.2768	4.95
4.0	4.95
4.032	4.95
5.0	4.95
6.0	4.95
6.144	4.95
8.0	4.95
8.032	4.95
10.0	4.95
12.0	4.95
18.432	4.95
20.0	4.95
24.0	4.95

BIT RATE GENERATORS	
MC14411	9.95
BR1941	4.95
4702	9.95
COM8116	8.95
MM5307	4.95

UARTS	
AY5-1013	3.95
AY3-1015	4.95
TR1602	3.95
68B45	6.95
68B50	6.95
68B54	7.95

74HCT00	
74HCT00	.69
74HCT02	.69
74HCT04	.69
74HCT08	.69
74HCT10	.69
74HCT11	.69
74HCT27	.69
74HCT30	.69
74HCT32	.79
74HCT74	.85
74HCT75	.95
74HCT138	1.15
74HCT139	1.15
74HCT154	2.99
74HCT157	.99
74HCT158	.99
74HCT161	1.29
74HCT164	1.39

2400 BAUD MODEM FOR IBM WITH PC TALK III SOFTWARE \$259!

CMOS

4001	.19	14419	4.95
4011	.19	14433	14.95
4012	.25	4503	.49
4013	.35	4511	.69
4015	.29	4516	.79
4016	.29	4518	.85
4017	.49	4522	.79
4018	.69	4526	.79
4020	.59	4527	1.95
4021	.69	4528	.79
4024	.49	4529	2.95
4025	.25	4532	1.95
4027	.39	4538	.95
4028	.65	4541	1.29
4035	.69	4553	5.79
4040	.69	4555	.75
4041	.75	4702	12.95
4042	.59	74C00	.29
4043	.85	74C14	.59
4044	.69	74C74	.59
4045	1.98	74C83	1.95
4046	.69	74C85	1.49
4047	.69	74C95	1.99
4049	.29	74C150	5.75
4050	.29	74C151	2.25
4051	.69	74C161	.99
4052	.69	74C163	.99
4053	.69	74C164	1.39
4056	2.19	74C192	1.49
4060	.69	74C193	1.49
4066	.29	74C221	2.49
4069	.19	74C240	1.89
4076	.59	74C244	1.89
4077	.29	74C374	1.99
4081	.22	74C905	10.95
4085	.79	74C911	8.95
4086	.69	74C917	12.95
4093	.49	74C922	4.49
4094	2.49	74C923	6.95
14411	3.95	74C926	7.95
14412	6.95	80C97	.95

7400/9000

7400	.19	74147	2.49
7402	.19	74148	1.20
7404	.19	74150	1.35
7406	.29	74151	.55
7407	.29	74153	.55
7408	.24	74154	1.49
7410	.19	74155	.75
7411	.25	74157	.55
7414	.49	74159	.65
7416	.25	74161	.69
7417	.25	74163	.69
7420	.19	74164	.85
7423	.29	74165	.85
7430	.19	74166	1.00
7432	.29	74175	.89
7438	.29	74177	.75
7442	.49	74178	1.15
7445	.69	74181	2.25
7447	.89	74182	.75
7470	.35	74184	2.00
7473	.34	74191	1.15
7474	.33	74192	.79
7475	.34	74194	1.65
7476	.35	74196	.79
7483	.50	74197	.75
7485	.59	74199	1.35
7486	.35	74221	1.35
7489	2.15	74246	1.35
7490	.39	74247	1.25
7492	.59	74248	1.35
7493	.35	74249	1.95
7495	.55	74251	.75
7497	2.75	74265	1.35
74100	2.29	74273	1.95
74121	.29	74278	3.11
74123	.49	74367	.65
74125	.45	74368	.65
74141	.65	9369	3.95
74143	5.95	9602	1.50
74144	2.95	9637	2.95
74145	.60	96S02	1.95

74S00

74S00	.29	74S163	1.29
74S02	.29	74S167	3.95
74S03	.29	74S174	.79
74S04	.29	74S175	.79
74S05	.29	74S188	1.95
74S08	.35	74S189	1.95
74S10	.29	74S195	1.49
74S15	.49	74S196	2.49
74S30	.29	74S197	2.95
74S32	.35	74S226	3.99
74S37	.69	74S240	1.49
74S38	.69	74S241	1.49
74S74	.49	74S244	1.49
74S85	.95	74S257	.79
74S86	.35	74S253	.79
74S112	.50	74S258	.95
74S124	2.75	74S280	1.95
74S138	.79	74S287	1.69
74S140	.55	74S288	1.69
74S151	.79	74S299	2.95
74S153	.79	74S373	1.69
74S157	.79	74S374	1.69
74S158	.95	74S371	4.95
74S161	1.29	74S571	2.95

VOLTAGE REGULATORS

TO-220 CASE

7805T	.49	7905T	.59
7808T	.49	7908T	.59
7812T	.49	7912T	.59
7815T	.49	7915T	.59

TO-3 CASE

7805K	1.59	7905K	1.69
7812K	1.39	7912K	1.49

TO-93 CASE

78L05	.49	79L05	.69
78L12	.49	79L12	1.49

OTHER VOLTAGE REGS

LM323K	5V 3A TO-3	4.79
LM338K	Adj. 5A TO-3	6.95
78H12K	12V 5A TO-3	8.95

LINEAR

TL066	.99	LM733	.98
TL071	.59	LM741	.29
TL072	1.09	LM747	.69
TL074	1.95	LM748	.59
TL081	.59	MC1330	1.69
TL082	.99	MC1350	1.19
TL084	1.49	MC1372	6.95
LM301	.34	LM1414	1.59
LM309K	1.25	LM1458	.49
LM311	.59	LM1488	.49
LM311H	.89	LM1489	.49
LM317K	3.49	LM1496	.85
LM317T	.95	LM1812	8.25
LM318	1.49	LM1889	1.95
LM319	1.25	ULN2003	.79
LM322	see 7900	XR2206	3.95
LM323	1.95	XR2211	2.95
LM323K	4.79	XR2240	1.95
LM324	.49	MPO2907	1.95
LM331	3.95	LM2917	1.95
LM334	1.19	CA3046	.89
LM335	1.79	CA3081	.99
LM336	1.75	CA3082	.99
LM337K	3.95	CA3086	.80
LM338K	6.95	CA3089	1.95
LM339	.59	CA3130E	.99
LM340	see 7800	CA3146	1.29
LM350T	4.60	CA3160	1.19
LF353	.59	MC3470	1.95
LF356	.99	MC3480	8.95
LF357	.15	XR2487	2.95
LM358	.59	LM3900	.95
LM380	.89	LM3909	.98
LM383	1.95	LM3911	2.25
LM386	.89	LM3914	2.39
LM393	.45	MC4024	3.49
LM394H	5.95	MC4044	3.99
TL434	4.20	RC4136	1.25
TL497	3.25	CA3086	.69
NE555	.29	LM13600	1.49
NE556	.49	75107	1.49
NE558	1.29	75110	1.95
NE564	1.95	75150	1.95
LM565	.95	75154	1.95
LM566	1.49	75188	1.25
LM567	.75	75189	1.25
NE570	2.95	75451	.39
NE590	2.50	75452	.39
NE592	.98	75453	.39
LM710	.75	75477	1.29
LM723	.49	75492	.79
H-TO-5 CAN, K-TO-3, T-TO-220			

EDGECARD CONNECTORS

100 PIN ST	S-100	.125	3.95
100 PIN WW	S-100	.125	4.95
62 PIN ST	IBM PC	.100	1.95
50 PIN ST	APPLE	.100	2.95
44 PIN ST	STD	.156	1.95
44 PIN WW	STD	.156	4.95

36 PIN CENTRONICS

IDCEN36	RIBBON CABLE	6.95
CEN36	SOLDER CUP	4.95
IDCEN36/F	RIBBON CABLE	7.95
CEN36PC	RT ANGLE PC MOUNT	4.95

DATA ACQ INTERFACE

ADC0800	15.55	8T26	1.29
ADC0804	3.49	D5833	2.25
ADC0809	4.49	8T95	.89
ADC0816	14.95	8T96	.89
ADC0817	9.95	8T97	.59
ADC0831	8.95	8T98	.89
DAC0800	4.49	DM8131	2.95
DAC0806	1.95	DP8304	2.29
DAC0808	3.95	D5833	2.25
DAC1020	8.25	D5835	1.99
DAC1022	5.95	D5836	.99
MC1408L8	2.95	D5837	1.65

IC SOCKETS

8 PIN ST	.11	100-	.10
14 PIN ST	.11	.11	.09
16 PIN ST	.12	.10	.10
18 PIN ST	.15	.13	.10
20 PIN ST	.18	.15	.10
22 PIN ST	.15	.12	.10
24 PIN ST	.20	.15	.10
28 PIN ST	.22	.16	.10
40 PIN ST	.30	.22	.10
64 PIN ST	1.95	1.49	.10

ST-SOLDERTAIL

8 PIN WW	.59	.69
14 PIN WW	.69	.52
16 PIN WW	.65	.58
18 PIN WW	.99	.90
20 PIN WW	1.09	.98
22 PIN WW	1.39	1.28
24 PIN WW	1.49	1.35
28 PIN WW	1.69	1.49
40 PIN WW	1.99	1.80

WW-WIREWRAP

16 PIN ZIF	4.95	CALL
24 PIN ZIF	5.95	CALL
28 PIN ZIF	6.95	CALL
40 PIN ZIF	9.95	CALL



ZIF-TEXTTOOL
(ZERO INSERTION FORCE)

DIP CONNECTORS

DESCRIPTION	ORDER BY	8	14	16	18	20	22	24	28	40	
HIGH RELIABILITY TOOLED ST IC SOCKETS	AUGATxxST	.62	.79	.89	1.09	1.29	1.39	1.49	1.69	2.49	
HIGH RELIABILITY TOOLED WW IC SOCKETS	AUGATxxWW	1.30	1.80	2.10	2.40	2.50	2.90	3.15	3.70	5.40	
COMPONENT CARRIES (DIP HEADERS)	ICCxx	.49	.59	.69	.99	.99	.99	.99	1.09	1.49	
RIBBON CABLE DIP PLUGS (IDC)	IDPxx	---	.95	.95	---	---	---	---	1.75	---	2.95

FOR ORDERING INSTRUCTIONS SEE D-SUBMINIATURE BELOW

36 PIN CENTRONICS

ICCN36/F RIBBON CABLE
CEN36PC RT ANGLE PC MOUNT

DIODES/OPTO/TRANSISTORS

1N751	.25	4N26	.69
1N759	.25	4N27	.69
1N4148	25/1.00	4N28	.69
1N4004	10/1.00	4N33	.89
1N5402	.25	4N37	1.19
KBPO2	.55	MCT-2	.59
KBUBA	.95	MCT-6	1.29
MDA990-2	.35	TL111	.99
N2222	.25	2N3906	.10
PN2222	.10	2N4401	.25
2N2905	.25	2N4402	.25
2N2907	.25	2N4403	.25
2N3055	.79	2N6045	1.75
2N3904	.10	TIP31	.49



D-SUBMINIATURE

DESCRIPTION	ORDER BY	9	15	19	25	37	50
SOLDER CUP	MALE DBxxP	.82	.90	1.25	1.25	1.80	3.48
	FEMALE DBxxS	.95	1.15	1.50	1.50	2.35	4.32
RIGHT ANGLE PC SOLDER	MALE DBxxPR	1.20	1.49	---	1.95	2.65	---
	FEMALE DBxxSR	1.25	1.55	---	2.00	2.79	---
WIRE WRAP	MALE DBxxPWW	1.69	2.56	---	3.89	5.60	---
	FEMALE DBxxSww	2.76	4.27	---	6.84	9.95	---
IDC	MALE IDBxxP	2.70	2.95	---	3.98	5.70	---
	FEMALE IDBxxS	2.92	3.20	---	4.33	6.76	---
HOODS	METAL MHOODxx	1.25	1.25	1.30	1.30	---	---
	GREY HOODxx	.65	.65	---	.65	.75	.95

FOR ORDERING INSTRUCTIONS: INSERT THE NUMBER OF CONTACTS IN THE POSITION MARKED "xx" OF THE "ORDER BY" PART NUMBER LISTED.
EXAMPLE: A 15 PIN RIGHT ANGLE MALE PC SOLDER WOULD BE DB15PR.

Mounting Hardware \$1.00

DIP CONNECTORS

DESCRIPTION	ORDER BY	10	20	26	34	40	50
SOLDER HEADER	IDHxxS	.82	1.29	1.68	2.20	2.58	3.24
RIGHT ANGLE SOLDER HEADER	IDHxxSR	.85	1.35	1.76	2.31	2.72	3.39
WW HEADER	IDHxxW	1.86	2.98	3.84	4.50	5.28	6.63
RIGHT ANGLE WW HEADER	IDHxxWR	2.05	3.28	4.22	4.45	4.80	7.30
RIBBON HEADER SOCKET	IDSxx	.79	.99	1.39	1.59	1.99	2.25
RIBBON HEADER	IDMxx	---	5.50	6.25	7.00	7.50	8.50
RIBBON EDGE CARD	IDExx	1.75	2.25	2.65	2.75	3.80	3.95

FOR ORDERING INSTRUCTIONS SEE D-SUBMINIATURE ABOVE

LED DISPLAYS

FND-357(359)	COM CATHODE	.362"	1.25
FND-500(503)	COM CATHODE	.5"	1.49
FND-507(510)	COM ANODE	.5"	1.49
MAN-72	COM ANODE	.3"	.99
MAN-74	COM CATHODE	.3"	.99
MAN-8940	COM CATHODE	.8"	1.99
TIL-313	COM CATHODE	.3"	.45

TIL-311 4x7 HEX W/LOGIC .270" 9.95

DIFFUSED LEDS

1200 BAUD MODEM FOR IBM WITH PC TALK III SOFTWARE \$109.95

BARGAIN HUNTERS CORNER

KEY TRONIC™ \$49.95

- 5150 STYLE OEM KEYBOARD**
 * IMPROVED KEYBOARD LAYOUT
 * 83 KEYS, FULLY IBM COMPATIBLE
 * LED INDICATORS FOR CAPS & NUMBER LOCK

MITSUBISHI \$129.95

- HIGH DENSITY DRIVE**
 * IBM PC/AT COMPATIBLE
 * 1.2 MEGABYTE, 1/2 HEIGHT FDD
 * READS DS/DD OR DS/DH DISKETTES
 * QUIET & RELIABLE

SPECIALS ENDS 4/30/87

PAGE WIRE WRAP WIRE PRECUT ASSORTMENT IN ASSORTED COLORS \$27.50

- 100ea: 5.5", 6.0", 6.5", 7.0"
 250ea: 2.5", 4.5", 5.0"
 500ea: 3.0", 3.5", 4.0"
SPOOLS
 100 feet \$4.30 250 feet \$7.25
 500 feet \$13.25 1000 feet \$21.95

Please specify color: \\
 Blue, Black, Yellow or Red

EMI FILTER \$4.95

- * MANUFACTURED BY CORCOM
 * LOW COST
 * FITS LC-HP BELOW
 * 6 AMP 120/240 VOLT

- 6 FOOT LINE CORDS**
 LC-2 2 CONDUCTOR .39
 LC-3 3 CONDUCTOR .99
 LC-HP 3 CONDUCTOR W/ STD FEMALE SOCKET 1.49

- MUFFIN FANS**
 3.15" SQ ROTRON 14.95
 3.63" SQ ETRI 14.95
 3.18" SQ PAPT 16.95

WIRE WRAP PROTOTYPE CARDS FR-4 EPOXY GLASS LAMINATE WITH GOLD-PLATED EDGE-CARD FINGERS

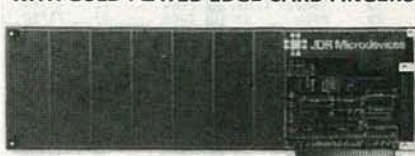

- IBM-PR2 **IBM**
 BOTH CARDS HAVE SILK SCREENED LEGENDS AND INCLUDES MOUNTING BRACKET
 IBM-PR1 WITH +5V AND GROUND PLANE . . . \$27.95
 IBM-PR2 AS ABOVE WITH DECODING LAYOUT \$29.95

- S-100**
 P100-1 BARE - NO FOIL PADS . . . \$15.15
 P100-2 HORIZONTAL BUS . . . \$21.80
 P100-3 VERTICAL BUS . . . \$21.80
 P100-4 SINGLE FOIL PADS PER HOLE . . . \$22.75

- APPLE**
 P500-1 BARE - NO FOIL PADS . . . \$15.15
 P500-3 HORIZONTAL BUS . . . \$22.75
 P500-4 SINGLE FOIL PADS PER HOLE . . . \$21.80
 7060-45 FOR APPLE IIe AUX SLOT . . . \$30.00

SOCKET-WRAP I.D.™

- * SLIPS OVER WIRE WRAP PINS
 * IDENTIFIES PIN NUMBERS ON WRAP SIDE OF BOARD
 * CAN WRITE ON PLASTIC, SUCH AS IC #
 PINS PART# PCK. OF PRICE
 8 IDWRAP 08 10 1.95
 14 IDWRAP 14 10 1.95
 16 IDWRAP 16 10 1.95
 18 IDWRAP 18 5 1.95
 20 IDWRAP 20 5 1.95
 22 IDWRAP 22 5 1.95
 24 IDWRAP 24 5 1.95
 28 IDWRAP 28 5 1.95
 40 IDWRAP 40 5 1.95
 PLEASE ORDER BY NUMBER OF PACKAGES (PCK. OF)



FRAME STYLE TRANSFORMERS

- 12.6V AC CT 2 AMP 5.95
 12.6V AC CT 4 AMP 7.95
 12.6V AC CT 8 AMP 10.95
 25.2V AC CT 2 AMP 7.95

25 PIN D-SUB GENDER CHANGERS \$7.95



SWITCHING POWER SUPPLIES

- PS-IBM \$69.95**
 * FOR IBM PC-XT COMPATIBLE
 * 135 WATTS
 * +5V @ 15A, +12V @ 4.2A
 * -5V @ .5A, -12V @ .5A
 * ONE YEAR WARRANTY



- PS-IBM-150 \$79.95**
 * FOR IBM PC-XT COMPATIBLE
 * 150 WATTS
 * +12V @ 5.2A, +5V @ 16A
 * -12V @ .5A, -5V @ .5A
 * ONE YEAR WARRANTY



- PS-130 \$99.95**
 * 130 WATTS
 * SWITCH ON REAR
 * FOR USE IN OTHER IBM TYPE MACHINES
 * 90 DAY WARRANTY



- PS-A \$49.95**
 * USE TO POWER APPLE TYPE SYSTEMS, 79.5 WATTS
 * +5V @ 7A, +12V @ 3A
 * -5V @ .5A, -12V @ .5A
 * APPLE POWER CONNECTOR



- PS-1558 \$34.95**
 * 75 WATTS, UL APPROVED
 * +5V @ 7A, +12V @ 3A
 * -12V @ 250ma, -5V @ 300ma



CAPACITORS

TANTALUM

1.0µf	15V .35	47µf	35V .45
6.8	15V .70	1.0	35V .45
10	15V .80	2.2	35V .65
22	15V 1.35	4.7	35V .85
22	35V .40	10	35V 1.00

DISC

10µf	50V .05	680	50V .05
22	50V .05	.001µf	50V .05
27	50V .05	.0022	50V .05
33	50V .05	.005	50V .05
47	50V .05	.01	50V .07
68	50V .05	.02	50V .07
100	50V .05	.05	50V .07
220	50V .05	.1	12V .10
560	50V .05	.1	50V .12

MONOLITHIC

.01µf	50V .14	1µf	50V .18
.047µf	50V .15	.47µf	50V .25

ELECTROLYTIC

RADIAL		AXIAL	
1µf	25V .14	1µf	50V .14
2.2	35V .15	10	50V .16
4.7	50V .15	22	16V .14
10	50V .15	47	50V .20
47	35V .18	100	35V .25
100	16V .18	220	25V .30
220	35V .20	470	50V .50
470	25V .30	1000	16V .60
2200	16V .70	2200	16V .70
4700	25V 1.45	4700	16V 1.25

DATARASE EPROM ERASER \$34.95

- * ERASES 2 IN 10 MINUTES
 * COMPACT-NO DRAWER
 * THIN METAL SHUTTER PREVENTS UV LIGHT FROM ESCAPING



1/4 WATT RESISTORS

- 5% CARBON FILM ALL STANDARD VALUES FROM 1 OHM TO 10 MEG. OHM
 10 PCS same value .05 100 PCS same value .02
 50 PCS same value .025 1000 PCS same value .015

RESISTOR NETWORKS

- | | | | |
|-----|--------|-------------|------|
| SIP | 10 PIN | 9 RESISTOR | .69 |
| SIP | 8 PIN | 7 RESISTOR | .59 |
| DIP | 16 PIN | 8 RESISTOR | 1.09 |
| DIP | 16 PIN | 15 RESISTOR | 1.09 |
| DIP | 14 PIN | 7 RESISTOR | .99 |
| DIP | 14 PIN | 13 RESISTOR | .99 |

SPECIALS ON BYPASS CAPACITORS

- | | |
|---------------------|-------------|
| .01 µf CERAMIC DISC | 100/\$5.00 |
| .01 µf MONOLITHIC | 100/\$10.00 |
| .1 µf CERAMIC DISC | 100/\$6.50 |
| .1 µf MONOLITHIC | 100/\$12.50 |

WISH SOLDERLESS BREADBOARDS

PART NUMBER	DIMENSIONS	DISTRIBUTION STRIP(S)	TIE POINTS	TERMINAL STRIP(S)	TIE POINTS	BINDING POSTS	PRICE
WBU-D	.38 x 6.50"	1	100	---	---	---	2.95
WBU-T	1.38 x 6.50"	---	---	1	630	---	6.95
WBU-204-3	3.94 x 8.45"	1	100	2	1260	2	17.95
WBU-204	5.13 x 8.45"	4	400	2	1260	3	24.95
WBU-206	6.88 x 9.06"	5	500	3	1890	4	29.95
WBU-208	8.25 x 9.45"	7	700	4	2520	4	39.95



LITHIUM BATTERY AS USED IN CLOCK CIRCUITS

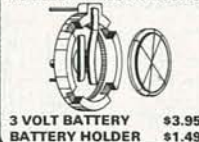

3 VOLT BATTERY \$3.95
 BATTERY HOLDER \$1.49

NEW EDITION!

1986 IC MASTER
 THE INDUSTRY STANDARD
\$129.95

PLEASE USE YOUR CUSTOMER NUMBER WHEN ORDERING

TERMS: Minimum order \$10.00. For shipping and handling include: \$2.50 for UPS Ground and \$3.50 for UPS Air. Orders over 1 lb. and foreign orders may require additional shipping charges - please contact our sales department for the amount. U.S.A. residents must include applicable sales tax. All merchandise is warranted for 90 days unless otherwise stated. Prices are subject to change without notice. We are not responsible for typographical errors. We reserve the right to limit quantities and to substitute manufacturer. All merchandise subject to prior sale.

COPYRIGHT 1987 JDR MICRODEVICES

THE JDR MICRODEVICES LOGO IS A REGISTERED TRADEMARK OF JDR MICRODEVICES. JDR INSTRUMENTS AND JDR MICRODEVICES ARE TRADEMARKS OF JDR MICRODEVICES. IBM IS A TRADEMARK OF INTERNATIONAL BUSINESS MACHINES. APPLE IS A TRADEMARK OF APPLE COMPUTER.

2400 BAUD MODEM FOR IBM WITH PC TALK III SOFTWARE \$259!

DISK DRIVES FOR APPLE COMPUTERS

AP-150
\$99.95

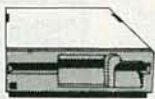

- 1/2 HT, DIRECT DRIVE
- 100% APPLE COMPATIBLE
- SIX MONTH WARRANTY

BAL-500
\$129.95

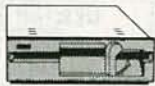

- TEAC MECHANISM-DIRECT DRIVE
- 100% APPLE COMPATIBLE
- FULL ONE YEAR WARRANTY

AP-135
\$129.95



- FULL HT SHUGART MECHANISM
- DIRECT REPLACEMENT FOR APPLE DISK II
- SIX MONTH WARRANTY

DOUBLE SIDED!

MAC535
\$249.95

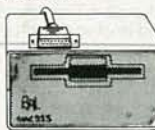

- 3.5" ADD-ON DISK DRIVE
- 100% MACINTOSH COMPATIBLE
- DOUBLE SIDED 800K BYTE STORAGE
- HIGH RELIABILITY DRIVE
- HAS AUTO-EJECT MECHANISM
- FULL ONE YEAR WARRANTY

AD-3C
\$139.95

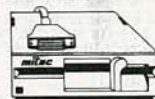

- 100% APPLE IIc COMPATIBLE, READY TO PLUG IN, W/SHIELDED CABLE & MOLDED 19 PIN CONNECTOR
- FAST, RELIABLE SLIMLINE DIRECT DRIVE
- SIX MONTH WARRANTY

- DISK DRIVE ACCESSORIES**
- FDD CONTROLLER CARD \$49.95
 - IIc ADAPTOR CABLE \$19.95
 - ADAPTS STANDARD APPLE DRIVES FOR USE WITH APPLE IIc

KB-1000

\$79.95

- CASE WITH KEYBOARD FOR APPLE TYPE MOTHERBOARD**
- USER DEFINED FUNCTION KEYS
 - NUMERIC KEYPAD WITH CURSOR CONTROL
 - CAPS LOCK
 - AUTO-REPEAT



KEYBOARD-AP

\$49.95

- REPLACEMENT FOR APPLE II KEYBOARD
- CAPS LOCK KEY, AUTO-REPEAT
- ONE KEY ENTRY OF BASIC OR CP/M COMMANDS



EXTENDER CARDS

IBM-PC	\$45.00
IBM-AT	\$68.00
APPLE II	\$45.00
APPLE IIe	\$45.00
MULTIBUS	\$86.00

APPLE COMPATIBLE INTERFACE CARDS

EPROM PROGRAMMER \$59.95

MODEL RP525



- DUPLICATE OR BURN ANY STANDARD 27xx SERIES EPROM
- EASY TO USE MENU-DRIVEN SOFTWARE IS INCLUDED
- MENU SELECTION FOR 2716, 2732, 2732A, 2764 AND 27128
- HIGH SPEED WRITE ALGORITHM
- LED INDICATORS FOR ACTIVITY
- NO EXTERNAL POWER SUPPLY NEEDED
- ONE YEAR WARRANTY

16K RAMCARD \$39.95



- FULL TWO YEAR WARRANTY
- EXPAND YOUR 48K APPLE TO 64K
- USE IN PLACE OF APPLE LANGUAGE CARD
- BARE PC CARD W/INSTRUCTIONS \$9.95

IC TEST CARD \$99.95



- QUICKLY TESTS MANY COMMON ICs
- DISPLAYS PASS OR FAIL
- ONE YEAR WARRANTY
- TESTS: 4000 SERIES CMOS, 74HC SERIES CMOS, 7400, 74LS, 74L, 74H & 74S

300B MODEM \$49.95

- FOR APPLE OR IBM
INCLUDES ASCII PRO-EZ SOFTWARE



- FCC APPROVED
- BELL SYSTEMS 103 COMPATIBLE
- INCLUDES AC ADAPTOR
- AUTO-DIAL
- DIRECT CONNECT
- CABLE FOR APPLE IIc \$14.95

JOYSTICK CR-401 \$7.95

- FOR ATARI 400, 800, 2600,
VIC 20/64 AND APPLE IIe

DISKFILE

- HOLDS 70 5 1/4" DISKETTES



3.5" DISKFILE HOLDS 40 \$9.95

POWER STRIP

- UL APPROVED
- 15A CIRCUIT BREAKER



2 WAY SWITCH BOXES

- AVAILABLE IN SERIAL OR PARALLEL
- CONNECTS 2 PRINTERS TO ONE COMPUTER OR VICE VERSA
- ALL LINES SWITCHES
- PUSH-BUTTON SWITCHES MOUNTED ON PCB
- 3 FEMALE GOLD-PLATED CONNECTORS

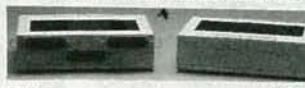

AB-P CENTRONICS PARALLEL \$39.95
AB-S RS232 SERIAL \$39.95

MOLDED INTERFACE CABLES

- 6 FOOT, 100% SHIELDED, MEETS FCC
- IBM PARALLEL PRINTER CABLE 9.95
 - CENTRONICS MALE TO FEMALE 15.95
 - CENTRONICS MALE TO MALE 14.95
 - MODEM CABLE FOR IBM 7.95
 - RS232 SERIAL MALE TO FEMALE 9.95
 - RS232 SERIAL MALE TO MALE 9.95
 - KEYBOARD EXTENSION (COILED) 7.95
 - APPLE II JOYSTICK EXTENSION 4.95

G. ITOH RITEMAN II PRINTER



- 160 CPS DRAFT MODE, 32CPS NLQ MODE
- 9 x 9 DOT MATRIX
- SUPPORTS EPSON/IBM GRAPHICS
- FRICTION AND TRACTOR FEEDS
- VARIABLE LINE SPACING AND PITCH

\$219.95

IBM PRINTER CABLE \$9.95
REPLACEMENT RIBBON CARTRIDGE \$7.95

NASHUA DISKETTES DEALS

- 5 1/4" SOFT SECTOR
DS/DD WITH HUB RINGS

\$9.90 69¢_{ea} 59¢_{ea}
BOX OF 10 BULK QTY 50 BULK QTY 250

- NASHUA DISKETTES WERE JUDGED TO HAVE THE HIGHEST POLISH AND RECORDED AMPLITUDE OF ANY DISKETTES TESTED ACCORDING TO "COMPARING FLOPPY DISKS", BYTE 9/84

DISKETTES

NASHUA 5 1/4"

N-MD2D	DS/DD SOFT	\$9.90
N-MD2F	DS/QUAD SOFT	\$19.95
N-MD2H	DS/HD FOR AT	\$24.95

NASHUA 8"

N-FD1	SS/DD SOFT	\$27.95
N-FD2D	DS/DD SOFT	\$34.95

NASHUA 3.5"

N-3.5SS	3.5" SS/DD FOR MAC	\$24.95
---------	--------------------	---------

VERBATIM 5 1/4"

V-MD1D	SS/DD SOFT	\$16.95
V-MD2D	DS/DD SOFT	\$17.95
V-MD110D	SS/DD 10 SECTOR HARD	\$19.95

BUILD STEVE GIARCIA'S INTELLIGENT EPROM PROGRAMMER

AS SEEN IN BYTE, OCT. 86

- STAND-ALONE OR RS-232 SERIAL OPERATION
- MENU SELECTABLE EPROM TYPES—NO CONFIGURATION JUMPERS
- PROGRAMS ALL 5V 27XXX EPROMS FROM 2716 TO 27512
- READ, COPY OR VERIFY EPROM
- UPLOAD/DOWNLOAD INTEL HEX FILES
- PROGRAMMER DRIVER USER MODIFIABLE

ONLY \$199

- KIT INCLUDES PCB AND ALL COMPONENTS EXCEPT CASE AND POWER SUPPLY

5 1/4" FLOPPY DISK DRIVES

TEAC FD-55B	1/2 HT DS/DD (FOR IBM)	\$109.95
TEAC FD-55F	1/2 HT DS/QUAD (FOR IBM)	\$124.95
TEAC FD-55GFV	1/2 HT DS/HD (FOR IBM AT)	\$154.95
TANDON TM100-2	DS/DD (FOR IBM)	\$119.00
TANDON TMS0-2	1/2 HT DS/DD (FOR IBM)	\$79.95
MPI-852	DS/DD (FOR IBM)	\$79.95

8" FLOPPY DISK DRIVES

FD 100-8	SS/DD (SA/801 EQUIV)	\$119.00
FD 200-8	DS/DD (SA/851R EQUIV)	\$159.00

DISK DRIVE ACCESSORIES

TEAC SPECIFICATION MANUAL	\$5.00
TEAC MAINTENANCE MANUAL	\$25.00
1/2 HT MOUNTING HARDWARE	\$2.95
MOUNTING RAILS FOR IBM AT	\$4.95
"Y" POWER CABLE FOR 5 1/4" FDDs	\$2.95
5 1/4" FDD POWER CONNECTORS	\$1.19



DISK DRIVE ENCLOSURES

CAB-1FH5	FULL HT 5 1/4" BEIGE CABINET W/POWER SUPPLY	\$69.95
CAB-2SV5	DUAL SLIMLINE 5 1/4" CABINET W/POWER SUPPLY	\$49.95
CAB-2SV8	VERTICAL DUAL SLIMLINE 8" CABINET W/POWER SUPPLY	\$209.95
CAB-2FH8	HORIZONTAL DUAL FULL HT 8" CABINET W/POWER SUPPLY	\$219.95

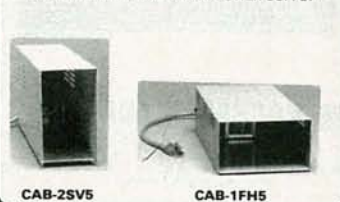

TEST EQUIPMENT FROM JDR INSTRUMENTS

DIGITAL MULTIMETER PEN DPM-1000
AUTO RANGING, POLARITY AND DECIMAL!

\$54.95

- LARGE 3.5 DIGIT DISPLAY
- DATA HOLD SWITCH FREEZES READING
- FAST, AUDIBLE CONTINUITY TEST
- LOW BATTERY INDICATOR
- OVERLOAD PROTECTION



20MHZ DUAL TRACE OSCILLOSCOPE	MODEL 2000	\$389.00
35MHZ DUAL TRACE OSCILLOSCOPE	MODEL 3500	\$549.00

FOR MORE INFORMATION ON THE OSCILLOSCOPES, CALL US FOR FREE PRODUCT BRIEFS.

CALL FOR VOLUME QUOTES COPYRIGHT 1987 JDR MICRODEVICES

CIRCLE 191 ON FREE INFORMATION CARD

1.2 MB MITSUBISHI DRIVE HALF HEIGHT FOR AT \$129.95

QUALITY IBM COMPATIBLE MOTHERBOARDS

FROM MODULAR CIRCUIT TECHNOLOGY

TURBO 4.77 / 8 MHZ \$129.95

JDR PART #: MCT-TURBO

- 4.77 OR 8 MHZ OPERATION WITH 8088-2 AND OPTIONAL 8087-2 CO-PROCESSOR
- DYNAMICALLY ADJUSTS SPEED DURING DISKETTE OPERATION FOR MAXIMUM THROUGHPUT AND RELIABILITY
- CHOICE OF NORMAL / TURBO MODE OR SOFTWARE SELECT PROCESSOR SPEED

STANDARD 4.77 MHZ \$109.95

JDR PART #: MCT-XTMB

- 8088 CPU, OPTIONAL 8087 CO-PROCESSOR
- 8 EXPANSION SLOTS
- 0K RAM INSTALLED, EXPANDABLE TO 640K ON-BOARD MEMORY
- ALL ICs SOCKETED-HIGHEST QUALITY PCB
- ACCEPTS 2764 OR 27128 ROMS

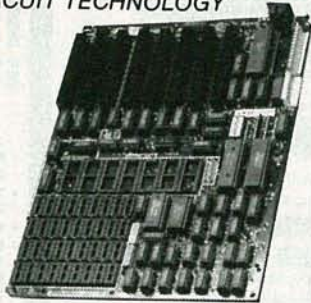

NOW WITH FREE MCT BIOS!

IBM COMPATIBLE INTERFACE CARDS

ALL WITH A ONE YEAR WARRANTY

MULTI I/O FLOPPY CARD

\$89.95

PERFECT FOR THE 640K MOTHERBOARD



- 2 DRIVE FLOPPY DISK CONTROLLER
- 1 RS232 SERIAL PORT; OPTIONAL 2nd SERIAL PORT
- PARALLEL PRINTER PORT
- GAME PORT
- CLOCK / CALENDAR
- SOFTWARE: CLOCK UTILITIES, RAMDISK, SPOOLER

OPTIONAL SERIAL PORT \$15.95

MULTIFUNCTION CARD

\$84.95

ALL THE FEATURES OF AST'S 6 PACK PLUS AT HALF THE PRICE



- CLOCK / CALENDAR
- 0-384K RAM
- SERIAL PORT
- PARALLEL PORT
- GAME PORT
- SOFTWARE INCLUDED

PRINTER CABLE \$9.95

64K RAM UPGRADE 9/\$11.61

COLOR GRAPHICS ADAPTOR

\$69.95

FULLY COMPATIBLE WITH IBM COLOR CARD



- 4 VIDEO INTERFACES: RGB, COMPOSITE COLOR, HI-RES, COMPOSITE MONOCHROME, CONNECTOR FOR RF MODULATOR
- COLOR GRAPHICS MODE: 320 x 200
- MONO GRAPHICS MODE: 640 x 200
- LIGHT PEN INTERFACE

MONOCHROME GRAPHICS CARD

\$79.95

FULLY COMPATIBLE W/IBM MONOCHROME ADAPTOR & HERCULES GRAPHICS



- LOTUS COMPATIBLE
- TEXT MODE: 80 x 25
- GRAPHICS MODE: 720 x 348
- PARALLEL PRINTER PORT; OPTIONAL SERIAL PORT
- STANDARD TTL COMPATIBLE OUTPUT

OPTIONAL SERIAL PORT \$19.95

MONOCHROME ADAPTOR

\$49.95

ANOTHER FANTASTIC VALUE FROM JDR!

- IBM COMPATIBLE TTL OUTPUT
 - 720 x 350 PIXEL DISPLAY
- PLEASE NOTE: THIS CARD WILL NOT RUN LOTUS GRAPHICS AND DOES NOT INCLUDE A PARALLEL PORT

FLOPPY DISK DRIVE ADAPTOR

\$34.95



- INTERFACES UP TO 4 STANDARD FDDs TO IBM PC OR COMPATIBLES
- INCLUDES CABLE FOR TWO INTERNAL DRIVES
- STANDARD DB37 FOR EXTERNAL DRIVES
- RUNS QUAD DENSITY DRIVES WHEN USED WITH JFORMAT

1200 BAUD MODEMS BY EASYDATA

HAYES COMPATIBLE, AUTO-DIAL, AUTO-ANSWER, AUTO RE-DIAL ON BUSY, POWER-UP SELF TEST, FULL ONE YEAR WARRANTY

MODEL 1200B*

- INTERNAL DESIGN
- 10 INCH CARD
- SERIAL PORT INCLUDED

\$119.95

*FOR IBM, INCLUDES PC TALK III COMMUNICATIONS SOFTWARE

MODEL 1200H*

- INTERNAL DESIGN
- HALF LENGTH (5") CARD
- INCLUDES SPEAKER

\$109.95

EASYDATA-12

- EXTERNAL DESIGN
- WITH POWER SUPPLY
- LED STATUS INDICATORS

\$119.95

CRT MONITORS FOR ALL APPLICATIONS



HITACHI RGB MONITOR

MODEL 1020

- MADE FOR ERICSSON BY HITACHI
- DIGITAL RGB-IBM COMPATIBLE
- 12" SCREEN
- RESOLUTION: 640H x 200V
- 38mm DOT PITCH
- CABLE FOR IBM PC INCLUDED

\$289.95



SAMSUNG MONOCHROME

MODEL SM-125F

- IBM COMPATIBLE TTL INPUT
- 12" NON-GLARE AMBER, LOW DISTORTION SCREEN
- RESOLUTION: 720H x 350V
- ATTRACTIVE CASE WITH SWIVEL BASE
- ONE YEAR WARRANTY

\$119.95



CENTER SYSTEMS MONOCHROME

MODEL KLM-1211

- IBM COMPATIBLE TTL INPUT
- 12" NON-GLARE SCREEN
- VERY HIGH RESOLUTION: 1100 LINES (CENTER)
- 25 MHz BANDWIDTH
- CABLE FOR IBM PC INCLUDED

\$99.95

AMBER OR GREEN AVAILABLE

ATTRACTIVE TILT & SWIVEL MONITOR STAND \$129.95

HALF HEIGHT HARD DISK SYSTEMS

Includes half height hard disk drive, hard disk drive controller, cables and instructions. All drives are pre-tested and are backed with a full one year warranty.

10 MEGA BYTE HDD

MMI 212

\$289.95

20 MEGA BYTE HDD

SEAGATE ST-225

\$369.95

BUILD YOUR OWN 256K XT COMPATIBLE SYSTEM

XT MOTHERBOARD \$109.95

PRO-BIOS (A \$20 VALUE) FREE!

256K RAM \$26.55

130W POWER SUPPLY \$69.95

FLIP-TOP CASE \$39.95

MCT-5150 KEYBOARD \$59.95

1/2 HT TANDON DRIVE \$79.95

FDD CONTROLLER \$34.95

MONOCHROME ADAPTOR \$49.95

CENTER MONITOR \$99.95

TOTAL: \$571.15

IBM STYLE COMPUTER CASE

AN ATTRACTIVE STEEL CASE WITH A HINGED LID FITS THE POPULAR PC/XT COMPATIBLE MOTHERBOARDS



- SWITCH CUT-OUT ON SIDE FOR PC/XT STYLE POWER SUPPLY
- CUT-OUT FOR 8 EXPANSION SLOTS
- ALL HARDWARE INCLUDED

\$39.95

IBM COMPATIBLE KEYBOARDS



MCT-5150 \$59.95

- "5150" STYLE KEYBOARD
- FULLY IBM COMPATIBLE
- LED STATUS INDICATORS FOR CAPS & NUMBER LOCK
- LARGE, EASY TO REACH SHIFT & RETURN KEYS
- 83 KEY TYPEWRITER LAYOUT

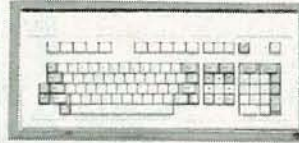

MCT-5151 \$79.95

- REPLACEMENT FOR KEYTRONICS KB-5151™
- SEPARATE CURSOR & NUMERIC KEYPAD
- CAPS LOCK & NUMBER LOCK INDICATORS
- IMPROVED KEYBOARD LAYOUT



MCT-5060 \$59.95

- IBM AT STYLE LAYOUT
- SOFTWARE AUTONSENSE FOR XT OR AT COMPATIBLES
- EXTRA LARGE SHIFT & RETURN KEYS
- LED INDICATORS FOR SCROLL, CAPS & NUMBER LOCK
- AUTO REPEAT FEATURE



MCT-5339 \$89.95

- IBM ENHANCED STYLE LAYOUT
- SOFTWARE AUTONSENSE FOR XT OR AT COMPATIBLES
- 12 FUNCTION KEYS
- EXTRA LARGE SHIFT & RETURN KEYS
- LED INDICATORS FOR SCROLL, CAPS & NUMBER LOCK
- AUTO REPEAT FEATURE
- SEPARATE CURSOR PAD

JDR Microdevices

110 Knowles Drive, Los Gatos, CA 95030
Toll Free 800-538-5000 • (408) 866-6200 • FAX (408) 378-8927 • Telex 171-110

MARK V ELECTRONICS INC.,
248 EAST MAIN STREET, SUITE 100,
ALHAMBRA, CA 91801.
TELEX: 3716914 MARK 5.



TOLL FREE
1-800-423-3483
Only for order paid by Master or Viscard
IN CAL.: 1-800-521-MARK



INFORMATION: 1-818-282-1196
MAIL ORDER: P.O. BOX 6610
ALHAMBRA, CA91802

CALL OR WRITE FOR A FREE CATALOG — OVER 60 HOT & WELL-QUALIFIED ITEMS FOR YOUR SELECTION!

TALKING CLOCK



1. Talk: push button for voice announcement of time.
2. Read out: twelve hours system display for hour, minute, second (by color flash), AM & PM.
3. Display: three display modes of time, alarm time & date.
4. Alarm: on/off switch with thirty seconds voice alarm.
5. Snooze: reminder voice alarm of thirty seconds after 4 minutes of first voice alarm.
6. Volume: two level of voice output.
7. Language available: English.

PARROT 8501\$17.75
COCKATOO 8502\$15.90 NOT A KIT!
MYNAH 8504\$16.90

TA-1500 100W + 100W NEW CLASS 'A' DC STEREO PRE-MAIN AMPLIFIER

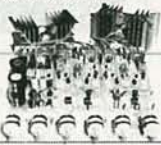

KIT\$ 67.00
METAL CABINET/X'FORMER\$ 26/\$ 16.80

CORDLESS SOLDERING IRON RECHARGEABLE



Each set\$22.80

0-50V/3A POWER SUPPLY W/SHORT CIRCUIT BREAK



Kit\$12.30

60W VERSATILE STEREO POWER BOOSTER

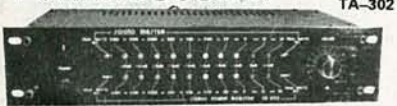

KIT\$ 50.00
ASS. with tested\$ 60.00

150MC Universal Digital Frequency Counter SM-100



FREE AC ADAPTOR *AVAILABLE UNTIL STOCK LAST*

Frequency Range: 10Hz - 150MHz
Event Counter: 0 to 99999999 counts. (8 Digit)
Input sensitivity: KHz range 10Hz - 10MHz 50mVrms.
MHz range 1MHz - 150MHz 40mVrms.
Response time: 0.2 second.
Hold Function: Hold the last input signal.
Power Supply: DC6V Battery or DCGV 250MA Adaptor.
Dimension: 9 7/8" x 6 1/16" x 2 3/4"
Assembled with tested\$99.00

TY-45 BAR/DOT AUDIO LEVEL DISPLAY



Kit\$34.95

100W DYNAMIC CLASS "A" MAIN POWER AMPLIFIER

TA-1000A



KIT\$ 51.95
METAL CABINET/X'FORMER\$26/\$16.80

NF-CR BI-FET PRE-AMP TA-2800



Kit\$44.50

STEREO SIMULATOR

TA-3000



SPECIAL KITS OFFER!

KIT ONLY \$25.00

You can own a stereo TV from today! This simulator is a special design of using the most advanceable monoipolised L.S.I. It produced a superior analog stereo effect since the L.S.I. is equalled 60 pcs. of LOW NOISE FET & TRANSISTOR. The simulator can even help you to promote your television from a normal one to a special one with a Hi-Fi STEREO function. Our simulator is also applicable to any other 'mono sources' in covering it to ANALOG STEREO. Undoubtedly, it is the most advanced equipment for every family, while it should contribute to your listening pleasure.
Ass. with tested\$30.00

PROFESSIONAL COLOR LIGHT CONTROLLER SM-328

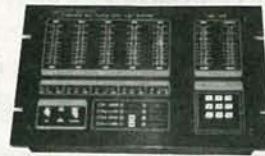

NEW FOR '87'

FEATURES:

1. FOUR GROUPS OF INDEPENDENT OUTPUT SYSTEM 1000W/CH. MAX. 4680W (100-117V)
 2. PROFESSIONAL COLOR CONTROL SYSTEM (KEYBOARD TYPE)
 3. INDEPENDENT INPUT SIGNAL ADJUSTMENT
 4. FOUR GROUPS OF INDEPENDENT DIMMER CONTROL
 5. SPEED CONTROL CHASER
 6. AUTOMATIC CHASING CONTROL SYSTEM
 7. FOUR KINDS OF SPECIAL CHASING PROGRAM
 8. COMBINATION OF PROGRAM AND MUSIC CHASING EFFECT
 9. FORWARD/BACKWARD CHASING CONTROL
- SM-328 color light controller is specialized for bedroom, night club, disco and advertisement lighting. It concurs with several color characteristics, which employ professional color control system and keyboard program selection. Therefore, it is capable of producing lighting effects by using chasing program and fluctuating music signal.
There are two kinds of lighting effects. The first type is controlled by 'music' signal. In order to adjust the brightness of four groups of lightings, each music signal will be separated into high, medium low A, and low B frequency range. Furthermore, each group of lightings is incorporated with an independent signal adjustment.
The second kind is composed of electrical circuits and this is the main part for creating a special lighting effect. It has four chasing programs.
DIMENSION: 14 5/16" X 8 15/16" X 3 1/16"
Ass. with tested\$120.00

TA-2400A ELECTRONIC ECHO AND REVERBERATION AMPLIFIER

REMIX records yourself!



Ass. with tested\$99.85

HIGH QUALITY MULTIPURPOSE PRE-AMPLIFIER

TA-2500 GREAT VALUE



Assembled with tested\$82.00

80W + 80W DC LOW TIM PRE-MAIN AMPLIFIER



Kit\$ 49.85
METAL CABINET/X'FORMER\$ 26/\$ 16.80

Model No.	Description	Kit/Assembled	Unit Price	TR-100	0-15V 2A REGULATED DC POWER SUPPLY	Kit/Ass.	\$59.50/89.50
TA-001	1W Mini Amplifier	Kit	\$3.90	TY-1A MK4	BATTERY FLUORESCENT LIGHT	Kit	\$3.95
TA-006	8W Mini Amplifier	Kit	\$4.92	TY-7	ELECTRONIC TOUCH SWITCH	Kit	\$5.50
TA-007	12W Stereo Power Booster	Kit	\$8.00	TY-11A	MULTI-FUNCTIONAL CONTROL RELAY	Kit	\$3.99
TA-008	AC/DC SHOULDER AMPLIFIER	Ass.	\$48.00	TY-12	DIGITAL CLOCK WITH TWO TIMER	Kit	\$13.88
TA-10	STEREO PRE-AMPLIFIER WITH MAGNETIC MIC AMP	Kit	\$6.00	TY-13	COLOR LED VU METER	Kit	\$17.50
TA-50 A, B	MULTI-PURPOSE MELODY GENERATOR	Kit	\$10.76	TY-14	ELECTRONIC SHOCK	Kit	\$3.00
TA-120	PURE CLASS "A" MAIN POWER AMPLIFIER	Kit	\$25.00	TY-18	HIGH PRECISION SOUND CONTROL SWITCH	Kit	\$7.68
TA-202	20W AC/DC STEREO AMPLIFIER	Ass.	\$60.00	TY-20	SUPER SENSITIVE COLOR POWER LEVEL INDICATOR	Kit	\$19.50
TA-300	30W Multi-Purpose Single Channel Amp.	Kit	\$11.07	TY-23B	COLOR LIGHT CONTROLLER	Kit/Ass.	\$65.00/75.00
TA-302	60W Stereo Power Booster	Kit/Ass.	\$50.00/60.00	TY-25	SPEAKER PROTECTOR	Kit	\$9.50
TA-323A	High Quality 30W-30W Stereo Amplifier	Kit	\$24.60	TY-35	FM WIRELESS MICROPHONE	Kit	\$7.88
TA-322	60W IC Stereo Pre-Amplifier & Power Amplifier	Kit	\$29.50	TY-38	AC/DC QUARTZ DIGITAL CLOCK	Kit	\$16.82
TA-400	40W TRANSISTORIZED MONO-AMPLIFIER	Kit	\$13.84	TY-41 MKIII	SOUND OR TOUCH CONTROL SWITCH	Kit	\$10.00
TA-477	120W MOSFET POWER AMPLIFIER	Kit	\$61.28	TY-42	INFRARED REMOTE CONTROL UNIT	Kit/Ass.	\$25.00/30.00
TA-800	80W+80W DC LOW TIM PRE-AMPLIFIER & POWER AMP.	Kit	\$55.38	TY-45	BAR/DOT LEVEL METER	Kit	\$21.00
TA-802	80W+80W PURE DC STEREO POWER AMP. (W/SPEAKER)	Kit	\$39.95	TY-47	BAR/DOT AUDIO LEVEL DISPLAY	Kit	\$34.95
TA-820A	60W+60W DCL DC PRE-MAIN & STEREO AMPLIFIER	Kit	\$43.00	TY-47	SUPERIOR ELECTRONIC ROULETTE	Kit	\$16.92
TA-1500	100Wx2 NEW CLASS "A" MAIN POWER AMP (MONO)	Kit	\$51.95	YAMATO 4001	3 1/2 DIGITAL MULTIMETER	0 SET	\$33.80
TA-1500	100Wx2 NEW CLASS "A" DC STEREO PRE-MAIN AMP	Kit	\$67.00	T1	LCD THERMOMETER CLOCK W/IN/OUT DOOR SENSOR	0 SET	\$20.00
TA-2400A	ELECTRONIC ECHO AND REVERBERATION AMP	Ass.	\$99.85	T2	LCD THERMOMETER CLOCK W/F5°C MEASURING	0 SET	\$18.00
TA-2500	HIGH QUALITY MULTI-PURPOSE PRE-AMPLIFIER	Ass.	\$90.00	8501	TALKING CLOCK (PARROT)	0 SET	\$17.75
TA-2200	DC FET SUPER CLASS "A" PRE-AMPLIFIER	Kit	\$38.00	8502	TALKING CLOCK (COCKATOO)	0 SET	\$15.90
TA-2800	NF-CR BI-FET PRE-AMP (WITH SWAY TONE CONTROL)	Kit	\$44.50	8504	TALKING CLOCK (MYNAH, GOLDEN DR BLACK)	0 SET	\$16.90
TA-3000	STEREO SIMULATOR	Kit/Ass.	\$25.00/30.00	NO 620	CORDLESS SOLDERING IRON RECHARGEABLE	0 SET	\$22.80
SM-43	3 1/2 MULTI-FUNCTIONAL LED D.P.M.	Kit/Ass.	\$29.23/35.00				
SM-48	4 1/2 HI-PRECISION D.P.M.	Kit/Ass.	\$38.00/43.00				
SM-100	8 DIGIT 150MC FREQUENCY COUNTER	Ass.	\$99.00				
TY-43	3 1/2 DIGIT PANEL METER	Kit	\$28.00	METAL CABINETS WITH ALUMINIUM PANEL			
TR-355 A, B	3-5A REGULATED DC POWER SUPPLY	Kit	\$8.90	LG1273	3" x 12" x 7"	0 SET	\$18.00
TR-603	0-15V/2A POWER SUPPLY WITH SHORT CIRCUIT BREAK & OVERLOAD PROTECTOR	Kit	\$10.25	LG1684	4" x 16" x 8"	0 SET	\$22.00
				LG1924	4" x 19" x 11.5"	0 SET	\$24.00
				LG1925	5" x 19" x 11.5"	0 SET	\$25.00

WE CAN SUPPLY HIGH POWER TRANSFORMERS FOR OUR KITS, PLEASE REFER TO OUR CATALOG!

TERMS: Minimum order: \$10.00. Charge card order \$20.00. No C.O.D.! Check & Money order, phone order accept. CA. residents must include 6.5% sales tax. Prices are subject to change without notice. All merchandise subject to prior sale. Shipping & handling: Inside L.A. 5% of total order (Min. \$1.50). Outside L.A. 10% of total order (Min. \$2.50). Outside U.S.A. 20% of total order (Min. \$5.00). Shipped by UPS ground. **HOURS:** Mon-Fri 9:30 to 5:00, Sat 9:30 to 1:00 (PACIFIC TIME)

NATION-WIDE DISTRIBUTORS WANTED FOR OUR PRODUCTS, QUANTITY DISCOUNTS AVAILABLE!



CIRCLE 93 ON FREE INFORMATION CARD

What's New at AMERICAN DESIGN COMPONENTS . . . ?

We warehouse 60,000 items at American Design Components — expensive, often hard-to-find components for sale at a fraction of their original cost!

You'll find every part you need — either brand new, or removed from equipment (RFE) in excellent condition. But quantities are limited. Order from this ad, or visit our retail showroom and find exactly what you need from the thousands of items on display.

Open Mon. — Sat., 9-5

THERE'S NO RISK.

With our full 90-day warranty, any purchase can be returned for any reason for full credit or refund.

PC 8300 HOME COMPUTER

(Advanced version of the Timex 1000)



42-key mechanical keyboard (not membrane). Contains 2K of RAM. ** Reverse video, Z80A, 6.5 MHz processor, ROM 8K BASIC. Graphics capability/sound—music, TV or monitor. Joystick input operates on 115 VAC. Includes: AC adapter, TV cable, and pair of cassette cables. Will run all prerecorded tapes for Sinclair/Timex 1000-ZX81. Mfr — Power 3000.

Item #10336 **\$29.95** New
(in orig. boxes)

**** 16K RAMPACK upgrade**
(1 available per each customer.)
Item #10337 **\$10.00** New

ADAM COMPUTER KIT!

(Less printer & w/o cabinet)



Build it yourself from subassemblies. No wiring necessary (just plugs together). Hook-up diagram included. Includes: Keyboard, 1 cassette digital data drive, 2 game controllers, power supply, all memory boards, and one cassette. Is capable of running CP/M, has built-in word processor.

Item #7410 **\$99.00** (complete)

ADAM PRINTER

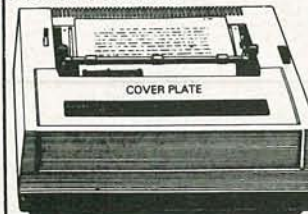

Complete, less top cover plate. Friction feed. Takes standard paper 8 1/2" x 11". (Customer returns; tested — operational.)

Item #8839 **\$69.50**

3 1/2", 10Mb HARD DISK DRIVE

(IBM® Compatible)

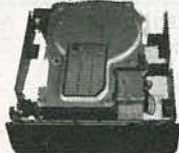

Fits standard 5 1/4" spacing. Shock mounted. High speed, low power. Mfr — MMI #MM212
Item #9217 **\$179.00** New
Controller Card for above
Item #9984 **\$99.00**

5 1/4", 1.2 Mb. AT HALF HT. DISK DRIVE



48/96 TPI
(IBM® Compatible)
Double sided, single/double density; 80 track.
Mfr — Panasonic #JU-475
Item #10005 **\$129.00** New

5 1/4" FULL HT. DISK DRIVE



48 TPI
(IBM® Compat.)
Double sided/double density, full height drive. 48 T.P.I., 80 tracks.
Mfr — MPI-52S
Item #7928 **\$79.95**
2 for **\$150.00**

5 1/4" FULL HT. DISK DRIVE



96 TPI DS/QUAD DENSITY
Mfr — CDC #9409T
Item #1893 **\$99.00**

3 1/4" DISK DRIVE EXPANSION MODULES . . .



IBM PC/XT



IBM PC Jr.
Side-by-side mounting (PC Jr. mounts on top). With floppy disk drive controller board. Contains: 2 Tabor TC-500 3 1/4" disk drives. Total capacity 360K. Item #8825
~~\$199.00~~ **\$99.00** New

APPLE
Side-by-side mtg. with disk storage space in front. Floppy disk controller board capable of handling 4 disk drives. Contains: 2 Tabor TC-500 3 1/4" disk drives. Total cap. 360K. Item #8826
~~\$199.00~~ **\$99.00** New

Stacked mounting, replaces old-fashioned 5 1/4" disk drives. Contains: 2 Tabor TC-500 3 1/4" disk drives. Total capacity 360K. Plugs right into your controller. Item #8827
~~\$169.00~~ **\$99.00** New

Each unit supplied with two 3 1/4" flexible diskettes.

IBM® COMPATIBLE 3 1/4" DISK DRIVE



Tabor TC-500 drive. Single-sided, quad density. Capacity: 164K bytes. Will work with any 5 1/4" disk controller.
Item #8824 **\$79.95**
~~\$49.95~~ New

* Total cap. 500K bytes with special software.
3 1/4" DISKETTES (Pack of 5)
Item #9495 **\$9.95** New

12 VDC SPRINT® FAN 27 CFM



Polarity protected. Can be mounted for cooling or exhaust. Dim.: 3 1/4" sq. x 1 1/4" deep
Mfr — Rotron — DAYNA
Item #9218 **\$12.95** New

12/24 VDC, 1" THIN MUFFIN-TYPE FAN



8W. Can be mounted for blowing or exhaust. 5 plastic blades with feathered edges, aluminum housing. Brushless, ball-bearing type. Dimen.: 4 1/8" sq. x 1" deep
Mfr — Centaur CUDDC24K4-601
Item #8541 **\$19.95** New

HI-POWER SWITCHING POWER SUPPLY



Output: +5.15V @ 70A
+12V @ 4A
+12V @ 4A
+5.2V @ 5A
Input: 115/230V nominal, .725KW cont. 47-63Hz. Enclosed in metal housing.
Dim.: 15"W x 2 1/2"H x 6" deep.
Mfr — Todd Prod. #4XS8151A
Item #9749 **\$29.95** New

PUMPS — COMPRESSORS — BLOWERS — MOTORS — POTENTIOMETERS — COUNTERS TIMERS — RELAYS — VOLTAGE REGULATORS — POWER SUPPLIES — SWITCHES

ADAM COMPUTER TAPE DRIVE



Serial format. Search 80IPS — Read/Write 20IPS. 12V motor, 5V logic, 8 & 9 pin connector cables. Originally designed for the Adam. Dim: 5"W x 3 3/4"H x 4" deep
Item #6641 **\$9.95** New

ADAM CASSETTES

(Assorted)



Consists of *Smart Basic*, *Buck Rogers*, and blank cassettes (all can be easily erased).
Item #7786 — Bakers Dozen
13 for **\$19.95** New

ADC KITS . . .

ROBOTICS KIT

(Springs, Belts, Pulleys & Gears)

Consists of:
9 Timing Belts (7.5" to 13")
2 Round Belts (12" to 15")
15 Nylon & Plastic Spur & Drive Gears
22 Torsion Springs
6 Compression Pulleys
19 Tension Springs

Item #5306 **\$14.95** New

IC SOCKET KIT

100 Ass't. Sockets — Consisting of 100 assorted IC sockets. From 14 to 40 Pin.

Item #5309 **\$9.95** New

COMPONENTS PARTS KIT

Hundreds of components! — Consisting of Heat Sinks, Capacitor, Trim pots, Resistors, and MORE!
Item #7230 **\$15.00** New

SWITCH KIT

35 Ass't. Switches — Consisting of 35 assorted: Dip, Toggle, Slide, and Sensitive Miniature and Standard Size Switches.
Item #5307 **\$9.95** New

RELAY KIT

15 Assorted Relays — Consisting of 15 ass't. AC & DC Relays, 5V, 12V, 24V, & 115V. All types.
Item #5308 **\$9.95** New

TOY MOTOR KIT

For Robotics — Consists of: 18 assorted toy motors, from 1.5V to 12VDC.
Item #7229 **\$9.95** New

COMPUTER GRADE POWER SUPPLY



Other uses—runs CB & car radios. Comes ready to plug in!

DC Output: -5V @ .5 amp.
+5V @ 3 amp.
+12V @ 6 amp.

Input 115V/60Hz. Dim.: 9 1/2"W x 3 3/4"H. (Rubber ft. incl.)

Item #9501 **\$24.95** New

SWITCHING POWER SUPPLY



115 & 230V, 47-440 Hz.
Input: 90-135V/180-270V
Output: 5VDC @ 5.5A
+12VDC @ .4A
-12VDC @ .3A

Perforated metal case enclosure. Dim.: 9 1/2"L x 3 3/4"W x 2"H.

Mfr — General Instrument

Item #7983 **\$14.95** New

COLECOVISION TO ADAM EXPANSION KIT



This expansion module just plugs into your ColecoVision. With Printer Power Supply and data drive (both included), you will have a working Adam Computer. Adam Keyboard, one Smart basic cassette and hook-up diagram also included.

Item #9918 **\$59.50**

ADAM ACCESSORIES . . .

ASCII KEYBOARD

Item #6643 **\$19.95**

PRINTER POWER SUPPLY

Item #6642 **\$14.95**

CONTROLLERS (set of 4)

Item #7013 **\$9.95**

LOGIC BOARD*

Item #7231 **\$9.95**

GAME BOARD*

Item #7679 **\$6.95**

*Parts Only

"The First Source" — for electromechanical & electronic equipment and components — AMERICAN DESIGN COMPONENTS!

15" COMPOSITE VIDEO MONITOR



15", green phosphor, high resolution (12 lines center) and bandwidth from 10Hz to 30Hz ± 3dB. Operating volt.: 120/240VAC, 50/60Hz., 65VA max.
Mfr — Motorola — Alpha Series
Item #10044 **\$34.95** New

MECHANICAL KEYBOARDS . . .



48-KEY — Timex Z81/1000
Item #6712 **\$5.95** New
66-KEY — Commodore C-16
Item #9394 **\$5.95** New
75-KEY — Timex or Adam
For computer upgrade . . .
Item #7429 **\$5.95** New

NS 87P50D-11 MICROCOMPUTER



8-bit single chip microcomputer units; emulates: 8048/49/50. Piggy-back configuration allows you to plug in an eprom 2758 and 2716, 2732. Features: XAMOS, 5V, 8-16 bit, 4K directly accessible memory. 256 bits on chip ROM, 11 MHz. max. freq.
Item #8899 **\$24.95** New

INTEGRATED CIRCUITS . . .

Linear . . .

LH0002CN	\$5.35
LM100CLH	2.65
LH0070-OH	3.55
TL071CP	.53
TL072CP	.71
LM301N	.32
LM307N	.41
LM310N	1.16
LM311N	.41
LM317K	2.65
LM317LZ	.62
LM317MP	.80
LM317F	.90
LM318N	1.07
LM319N	1.07
LM324N	.35
LM334Z	1.07
LM336Z	.98
LM337MP	1.03
LM337T	1.34
LM338K	3.55
LM339N	.44
LF347N	.90
LM348N	.62
LM350K	3.55
LF353N	.53
LF356N	.80
LM358N	.44
LM380N	.80
LM380N-8	.98
LM381N	1.16
LM383T	1.34
LM385Z	1.70
LM386N-4	.80
LM389N	.90
LM393N	.41
LF398N	2.15
LF411CN	.71
TL494CN	1.75
TL496CP	1.34
TL497ACN	1.97
NE555V	.26
XR-L555	.62
LM556N	.53
NE558N	1.07
NE564N	1.75
LM565N	.90
LM566CN	1.25
LM567V	.80
NE570N	2.24
NE571N	1.75
NE592N	.80
LM709N	.44
LM709CH	.80
LM710N	.62
LM711N	.62
LM723CN	.41
LM725CN	2.24
LM733CN	.62
LM739N	2.30
LM741CN	.26
LM741CH	.53
LM741-14N	.53
LM747CN	.53

LM748CN	\$.53
DS8T28N	1.57
LM1456V	1.75
LM1458N	.44
LM1488N	.62
LM1496N	.90
LM1899N	1.43
ULN2003A	.90
DS26LS31CN	1.34
DS26LS32CN	1.34
LM2901N	.53
LM2903N	.53
LM2907N	1.75
LM2917N	1.39
LM2917-14N	1.34
LM2931CT	1.07
MC3346P	.90
MC3486	1.34
MC3487	1.34
SG3524	1.75
LM3900N	.53
LM3914N	1.75
RC4136N	.80
RC4151NB	.90
RC4193NB(DE)	2.65
7805K	1.21
7812K	1.21
7815K	1.21
7818K	1.21
7824K	1.21
7805T	.44
7812T	.44
7815T	.44
7818T	.44
7824T	.44
78S40	1.75
7905K	1.21
7906K	1.21
7912K	1.21
7915K	1.21
7918K	1.21
7924K	1.21
7905T	.53
7912T	.53
7915T	.53
7918T	.53
7924T	.53
79L12AC	.53
79L15AC	.53
LF13201N	2.33
LM13600N	1.07
LM1889	1.85
75107N	.90
75108N	.90
75110A	1.34
75115	1.07
75123N	1.34
75124N	1.34
75138N	2.65
75154N	1.25
75450N	.53
75451CN	.44
75452CN	.44
75453CN	.44
75463N	.53
75472	.80
75492N	.71
76477	3.55

12" COMPOSITE VIDEO MONITOR (Controls front panel mtd.)



12", green phosphor, high resolution (12 lines center) and bandwidth from 10Hz to 30Hz ± 3dB. Operating voltage: 120/240VAC, 50/60Hz., 65VA max.
Mfr — Motorola — Alpha Series
Item #10043 **\$29.95** New

115 CFM MUFFIN® FAN



SPECIAL!
115 VAC/60 Hz., 21W., 28A., 3100 RPM; 5-blade model, aluminum housing. Can be mounted for blowing or exhaust.
Dim.: 4 1/4" sq. x 1 1/2" deep.
Item #5345 **\$5.95** RFE
With Speed Control
Item #5345S **\$8.95**

150 CFM SUPER VENTURI FAN



Ball bearing; 115 VAC, 60 Hz.; 195/178 amps. Has 2 sets of mtg. holes (fits standard rack or larger). Can be mtd. for blowing or exhaust. Dim.: 5" sq. x 1 1/2" deep.
Mfr — Rotron
Item #1866 **\$19.95** New

CORDLESS TELEPHONE



700 ft. Range
Wall or Base Mount
Full duplex: talk & listen simult. Auto redial: last number dialed recall. Comes with attachments for both types of mtg.; incl. AC power adaptor & battery indicator light. Color: brown w/cream. Famous make mfr.
Item #9997 **\$29.95** New

Rechargeable NICAD BATTERY BACKUPS



12V @ 450 ma
Contains 10 AA cells. Recharge rate: 45 ma. 16-18 hours. Case with tab output connections.
Dim.: 2 1/4" H x 1 1/4" W x 2 1/8" L
Mfr — GE #123233 or equiv.
Item #5443 **\$5.95** New
13.2V @ 1.65 AH
Contains 11 C cells.
For model boats, toys, etc.
Mfr — GE #418035B800101
Item #5444 **\$15.95** New

GEL-CELL BATTERIES (Rechargeable)



For use with model cars, trains, boats, planes, etc.—
6V @ .9 AH
Dim.: 2" W x 2" H x 1 1/2" D. Mfr — Globe GC610.
Item #9304 **\$3.95** New
6V @ 9.5 AH
Dim.: 5 1/2" H x 4 1/4" W x 2 1/4" deep. Mfr — Elpower #695
Item #7039 **\$14.95** New

NE555V	.26
XR-L555	.62
LM556N	.53
NE558N	1.07
NE564N	1.75
LM565N	.90
LM566CN	1.25
LM567V	.80
NE570N	2.24
NE571N	1.75
NE592N	.80
LM709N	.44
LM709CH	.80
LM710N	.62
LM711N	.62
LM723CN	.41
LM725CN	2.24
LM733CN	.62
LM739N	2.30
LM741CN	.26
LM741CH	.53
LM741-14N	.53
LM747CN	.53

COMPUTER & GAME EQUIPMENT — ACCESSORIES — MODULES — ELECTRONIC COMPONENTS — INTEGRATED CIRCUITS — OPTICS

STEPPING MOTORS for ROBOTICS

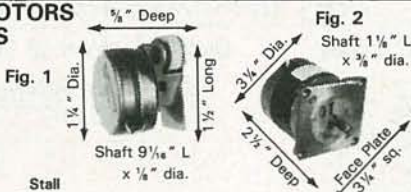

Fig. 1: 1 1/4" Dia., 1 1/2" Long, Shaft 9/16" L x 1/8" dia.
Fig. 2: 3/4" Dia., 2 1/2" Deep, Shaft 1 1/4" L x 3/8" dia., Face Plate 3/4" sq.
Precision steppers with increments from 1 to 7.5 degrees. Speeds up to 5,000 steps.

Item No.	Step Angle	Volts DC	Stall Torque oz/in	Type	Mfr. & Part No.	Fig	Price
5431	1	5	17	PM	N.A. Phillips A82310-M2	1	\$9.95 ea.
					Superior Electric M092-FT-402	2	\$34.50 ea.
7630	1.8	3.0	200	PM	Superior Electric M092-FT-402	2	\$59.50
5275	1.8	1.8	72	PM	Superior Electric M061-FF-6201B	2	\$19.95 ea.
						2/	\$37.50

RECORDING TAPE



7 1/2" Reel, 2400 ft.
Bulk erased. Major mfrs.: Ampex, Scotch, etc.
Item #6711 — 1/4 Mil.
79¢ ea.; 3 for \$2.00

Z800 Series . . .	
Z80	\$1.57
Z80-CTC	1.61
Z80-DART	4.45
Z80-DMA	4.45
Z80-PIO	1.61
Z80-SIO/1	4.45
Z80A	1.66
Z80A-DART	4.72
Z80A-DMA	5.35
Z80A-PIO	1.75
Z80B	3.55
Z80B-CTC	4.45
Z80B-PIO	4.45

Eproms . . .	
2708	\$3.55
2716	2.24
2732A-4	2.95
2764-25	2.95
68701	9.95
68766	16.25

MINI MICRO-COMPUTER REGULATOR



140 VA
Provides voltage regulation and ultra-isolation for microprocessor-based equipment. Contains less than 3% harmonic distortion, better than 60 dB traverse noise rejection. Contains dual outlet for CPU & monitor, and 6 ft. line cord.
Input: 95 — 130V, 60Hz.
Output: 120V @ 1.17A
Dimensions: 11 1/4" L x 4 1/4" H x 5 1/4" W
Mounted on metal base with rubber feet.
Mfr — Sola #63-13-114
Item #9999 **\$99.00** New

AMERICAN DESIGN COMPONENTS, 62 JOSEPH STREET, MOONACHIE, N.J. 07074

YES! Please send me the following items:

Item No.	How Many?	Description	Price	Total

Shipping & handling, we ship UPS unless otherwise specified. Add \$3 plus 10% total. Canadian: \$3 plus P.O. cost. Charge only. Sales Tax (N.J. residents only, please add 6% of total)

FREE 1987 CATALOG sent with every order.

ORDER TOTAL _____

All inquiries and free catalog requests call 201-939-2710.

For all phone orders, call TOLL-FREE 800-524-0809. In New Jersey, 201-939-2710.

My check or money order is enclosed.

Charge my credit card.

Visa Master Card Amex

Card No. _____

Exp. Date _____

Signature _____

Telephone: Area Code _____ Number _____

Name _____

Address _____

City _____

State _____ Zip _____

MINIMUM ORDER \$15.
RE-47

Radio Shack Parts Place™

PROJECT PARTS AT EVERYDAY LOW PRICES!

Low-Voltage DC Motors



Low As **79¢** Each

Add action to hobby projects and models. 1.5 to 3 VDC. #273-223 79¢ 3.5 to 9 VDC. #273-229 Pkg. of 2/1.49

Tri-Sound Siren

5⁹⁵

Attention Getter!



Contains an IC, driver circuit and 8-ohm speaker in a compact case. Wiring options permit three different sounds with extra-loud 80 db output. 3 VDC. #273-072

Melody Synthesizer

Only **2⁹⁹**

Preprogrammed With 12 Popular Tunes



UMC 3482. Ideal for musical doorbells, telephone music-on-hold. Tunes include Happy Birthday, Clementine, London Bridge and other favorites. 16-pin DIP with data and circuit examples. 1.5 VDC. #276-1797

Mike Connectors



(1) 8-Pin Mike Plug. #274-025 2.19
(2) 4-Pin Mike Plug. #274-001 1.59
(3) 4-Pin Chassis Socket. #274-002 99¢

LED Bonanza

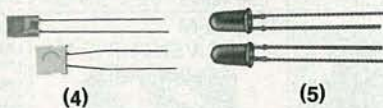

(4) 10 Assorted Rectangular LEDs. Various colors and sizes. #276-1655 Pkg. of 10/1.98
(5) 20 Assorted LEDs. Various colors and sizes. May include IR types. #276-1622 Pkg. of 20/1.98

Quality Memory Chips



Upgrade Your Computer With the Best!

Manufacturer's prime memory ICs with 150 ns access time and low-power design. 4164 64K Dynamic RAM. #276-2506 ... 3.95 4256 256K Dynamic RAM. #276-1252 ... 6.95

IC Inserter and Extractor

6⁹⁵

Handle ICs The Safe Way

Helps you remove or install DIP ICs without bending pins. Both inserter and extractor are groundable to protect static-sensitive MOS devices. #276-1574



Lighted AC Switches

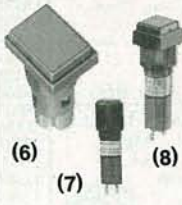

(6) 120 VAC SPDT Push-On/Off. Rated 3 amps at 120 VAC. Lamp requires 12 volts, AC or DC. Mounts in 1/2"-diameter hole. #275-676 4.95

(7) Round Button Version of Fig. 6. #275-677 4.95

(8) SPST Normally Open or Normally Closed. 5 amps at 250 VAC. 12-volt lamp. 5/8" mtg. hole. #275-678 5.95

12-Volt Flashing Lamps

Pkg. of 3 Only

99¢



Add sparkle to hobby projects and model train layouts. Includes one each: yellow, red, green. 95 mA. 4" wire leads. #272-1097

Wire-Wrapping Sockets



0.025" posts accept 3 levels of wire.

Pins	Cat. No.	Pkg. of 2	Pins	Cat. No.	Each
8	276-1988	1.19	28	276-1983	1.39
14	276-1993	1.29	40	276-1984	1.99
16	276-1994	1.39	—	—	—

Breadboarding System

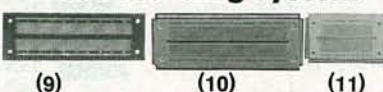

The fast and efficient way to build! Solderless modular breadboards accept DIP ICs and a wide variety of components. When your circuit is working properly, it's easy to transfer to the matching PC board.

(9) Experimenter's PC Board. Layout matches modular breadboard sockets. 2 1/16 x 5 7/16 x 1/16". 276-170 ... 2.69
(10) Modular Breadboard Socket. Two bus strips and 550 indexed connection points. #276-174 11.95
(11) Modular Breadboard Socket. Smaller version of Fig. 10 with 270 connection points. #276-175 6.95

Color-Coded Jumper Cables

3⁷⁹ Each

(12) Set of 10 Test Cables. 14" long with insulated mini alligator clip on each end. #278-1156

(13) Set of 6 Heavy-Duty Cables. 40" long. Claw-type clip at ends. #278-002



Semiconductor "Hotline"

Radio Shack Can Replace Almost Any Popular Semiconductor!

More Than 200,000 Substitutions

- No Minimum Order
- No Postage Charge



If the device you need for a project or repair job is not part of our regular stock, we'll special-order a replacement from our warehouse. Radio Shack also offers this convenient service on selected tubes, quartz crystals, phono cartridges and styli. Come in and give us a try!

Benchtop Digital Multitester



- LCD Display
- Memory Storage
- Full Autoranging
- Transistor Checker

99⁹⁵

Our Best Ever!

Compares with meters costing much more! Features an easy-to-read digital display plus a 31-position bargraph to show peaks and trends. Built-in transistor H_{FE} and semiconductor junction test modes. Buzzer continuity test. With probes, manual. Batteries extra. #22-195

Dual DC Power Supply



59⁹⁵ Independent or Tracking Operation

- Adjustable From 0 to 15 VDC
- Switchable Volt/Amp Meter

Quality and features you wouldn't expect at this low price! Output is adjustable 0 to 15 volts, and series mode provides up to 30 VDC. Front-panel meter and 4-position switch permit current/voltage monitoring. Has fuse protection, deluxe vented steel cabinet. Maximum current: 1 amp per channel. UL listed AC. Illustrated owner's manual. #22-121

Over 1000 items in stock: Binding posts, Books, Breadboards, Buzzers, Capacitors, Chokes, Clips, Coax, Connectors, Fuses, Hardware, ICs, Jacks, Knobs, Lamps, Multitesters, PC Boards, Plugs, Rectifiers, Relays, Resistors, Switches, Tools, Transformers, Transistors, Wire, Zeners, more!

Radio Shack®

A DIVISION OF TANDY CORPORATION

Prices apply at participating Radio Shack stores and dealers

**Tenma 15MHz Dual Trace
Portable Oscilloscope**

■ Internal rechargeable battery ■ Built-in battery charger ■ Two 10:1 probes included ■ 5x horizontal magnifier ■ Front panel electrical trace rotation ■ High brightness CRT with internal graticule ■ For additional specifications see MCM Catalog #14

Two Year
Limited Warranty

#72-335
\$489⁹⁰
(ea.)

Tenma LCR Meter

■ Measures inductance from 1μH-200H in six ranges ■ Measures capacitance from .1pF-200μF in seven ranges ■ Measures resistance from .01ohm-20Mohm in seven ranges ■ Carrying case included

One Year
Limited Warranty

#72-370
\$149⁹⁵
(ea.)



Tenma Regulated Power Supply

■ Output: Regulated 13.8V ■ Input: 120VAC ■ Fuse protected ■ With easily accessible fuse holder ■ Neon light indicator ■ Heavy duty binding posts ■ Effective heat sinks for more power dissipation ■ 90 day warranty

3.5 Amp
(5 Amp Surge)
#72-280 **\$29⁹⁵**
(ea.)

7 Amp
(10 Amp Surge)
#72-290 **\$59⁹⁵**
(ea.)

Tenma Resistance Selector Box

■ This device allows the user to quickly substitute a resistor in a circuit with any value between 1ohm and 11Mohm ■ Constructed entirely of ½ watt resistors with 1% tolerance ratings ■ 90 day warranty

#72-405
\$28⁵⁰
(ea.)

**The Name You Can
Trust In Electronic Test Equipment**

Tenma Anti-Static Work Mat

■ A must for the modern service shop ■ Used in conjunction with our #21-660 wrist strap to help eliminate static related problems ■ 18" x 26"

#21-655
\$37⁶⁰
(1-4) **\$33⁴⁵**
(5-up)

Tenma Anti-Static Wrist Strap

■ Silver-plated monofilament fibers are woven into a comfortable elastic wrist strap, that gently conforms to the user's wrist for reliable contact to ground

#21-660
\$10²⁵
(1-9) **\$9⁴⁵**
(10-up)

Tenma Soldering Station

■ Adjustable temperature range of 150° - 420° (300° - 790° F) ■ Grounded tip for soldering static sensitive devices ■ LED power, heater and temperature indicators ■ See MCM Catalog #14 for additional information

#21-147
\$49⁹⁵
(1-3) **\$44⁸⁰**
(4-up)



TENMA

Tenma Logic Probe

■ Working voltage: 4-16VDC ■ Frequency response: Maximum 20MHz ■ Detectable pulse width: Longer than 25nsec ■ Input impedance: 1Mohm minimum ■ Input overload protection: ±250V DC/AC ■ 90 day warranty

#72-415
\$14⁹⁵
(ea.)

Tenma RS-232 Break Out Box

■ Monitors individual communication interface lines ■ Detects the presence or absence of activity ■ Rewire RS-232 interfaces ■ Line powered ■ Dual-state LEDs monitor both positive and negative signal levels ■ 48 test points ■ For additional information see MCM Catalog #14

#72-440
\$49⁸⁰
(ea.)

Call Toll Free 1-800-543-4330 (In Ohio 1-800-762-4315
(In Alaska and Hawaii 1-800-858-1849))

Terms:



- \$10 minimum order. \$1.00 charge for orders under \$10.
- \$20 minimum charge card order.
- Orders shipped UPS C.O.D.
- Most orders shipped within 24 hours.
- Sales office open 8:30 am to 7:00 pm Saturdays 10:00 am to 3:00 pm EST.
- For prepaid orders add \$2.75 for shipping and handling.
- Should shipping and handling charges exceed \$2.75, the balance due will be sent C.O.D.



MCM ELECTRONICS
858 E. CONGRESS PARK DR.
CENTERVILLE, OH 45459
A PREMIER Company

CIRCLE 87 ON FREE INFORMATION CARD

**Be Sure To Call For
Your FREE Catalog!
Over 7,000 Items!**

SOURCE NO. RE-31

APRIL 1987

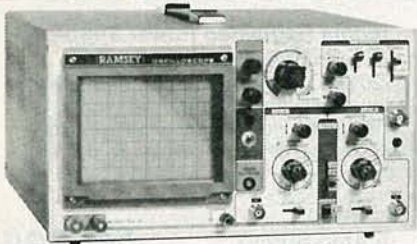

\$369.95*
20 MHz DUAL TRACE
 Features component testing circuit for resistors, capacitors, digital circuits and diodes—TV sync filter—high sensitivity—Z axis—XY mode—built-in calibrator—5X horizontal magnifier

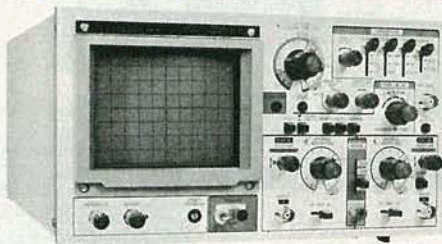

\$499.95*
35 MHz DUAL TRACE
 wide frequency bandwidth—optimal sensitivity—delayed triggering sweep—hold off—ALT trigger—single sweep TV sync 5X magnification—XY or XYZ operation—HF/LF noise reduction



NEW \$449.95*
15 MHz DUAL TRACE PORTABLE
 Field/bench applications—built-in charger and battery pack—up to 2 hours operation per charge—5X horizontal magnification—high brightness CRT—front panel trace rotator

RAMSEY OSCILLOSCOPES

All Ramsey oscilloscopes feature unsurpassed quality at an unbeatable price. Of heavy duty construction, they are suitable for hobby, service and production applications.

MODEL	BAND WIDTH	# TRACES	CRT SIZE	VERTICAL SENSITIVITY	MAXIMUM TRIG FREQ	USEABLE MAXIMUM BANDWIDTH
2200	20 MHz	(2)	8x10CM	5 mV per div	35 MHz	30 MHz
2500	15 MHz	(2)	3.5 inch	2 mV per div	30 MHz	25 MHz
3500	35 MHz	(2)	8x10CM	1 mV per div	50 MHz	60 MHz

*Add an additional \$10.00 for each unit for shipping.

All include high quality 1:1, 10:1 hook on probes, instruction/service manual with schematic and component layout, 1 year warranty.

MINI-100 COUNTER



\$119.95 CHARGER, NICAD BATTERIES, AC ADAPTER INCLUDED

CT-70 7 DIGIT 525 MHz



\$139.95 WIRED, INCLUDES AC ADAPTER

CT-90 9 DIGIT 600 MHz



\$169.95 WIRED INCLUDES AC ADAPTER

CT-50 8 DIGIT 600 MHz



\$189.95 WIRED INCLUDES AC ADAPTER

CT-125 9 DIGIT 1.2 GHz



\$189.95 WIRED INCLUDES AC ADAPTER

MODEL	FREQ RANGE	SENSITIVITY	ACCURACY	DIGITS	RESOLUTION	PRICE
MINI-100	1-500 MHz	Less than 250mv	1 PPM	7	100 Hz, 1 KHz	119.95
CT-70	20 Hz-550 MHz	< 50mv to 150 MHz	1 PPM	7	1Hz, 10Hz, 100Hz	139.95
CT-90	10 Hz-600 MHz	< 10mv to 150 MHz < 150mv to 600 MHz	1 PPM	9	0.1Hz, 1Hz, 10Hz	169.95
CT-50	5 Hz-600 MHz	LESS THAN 25 mv	1 PPM	8	1Hz, 10Hz	189.95
CT-125	10 Hz-1.25 GHz	< 25mv @ 50 MHz < 15mv @ 500 MHz < 100 mv @ 800 MHz	1 PPM	9	0.1Hz, 1Hz, 10Hz	189.95
CT-90 WITH DV-1 OPTION	10 Hz-600 MHz	< 10mv to 150 MHz < 150mv to 600 MHz	0.1 PPM	9	0.1Hz, 1Hz, 10Hz	229.90

RAMSEY FREQUENCY COUNTERS

Ramsey Electronics has been manufacturing electronic test gear for over 10 years and is recognized for lab quality products at breakthrough prices. Our frequency counters have features and capabilities of counters costing twice as much.



RAMSEY D-4100 COMPACT DIGITAL MULTITESTER
\$2495
 test leads and battery included



Compact sized reliability and accuracy. This LCD digital multimeter easily fits in your pocket, you can take it anywhere. It features full overload protection • 3 1/2 digit LCD readout • recessed input jacks • safety probes • diode check function • 2000 hours battery life



RAMSEY D-5100 HANDHELD DIGITAL AUTORANGING METER
\$49.95
 Includes Probes 1 Year Warranty

Has TOUCH-HOLD feature to allow readings to be logged or referred to before making the next reading. Up to 10 AMP current capability and a continuity function which beeps on zero Ohms.



\$4495
 wired includes AC adapter
 PR-2 kit \$39.95

PR-2 COUNTER PREAMP
 The PR-2 is ideal for measuring weak signals from 10 to 1,000 MHz • flat 25 db gain • BNC connectors • great for sniffing RF • ideal receiver/TV preamp



\$6995
 wired
 PS-2 kit \$49.95

PS-2 AUDIO MULTIPLIER
 The PS-2 is handy for high resolution audio resolution measurements, multiplies up in frequency • great for PL tone measurements • multiplies by 10 or 100 • 0.01 Hz resolution & built-in signal preamp/conditioner



\$8995
 wired includes AC adapter

PS-10B 1 GHz PRESCALER
 Extends the range of your present counter to 1 GHz • 2 stage preamp • divide by 1000 circuitry • super sensitive (50 mV typical) • BNC connectors • 1 GHz in, 1 MHz out • drives any counter

MINI KITS—EASY TO ASSEMBLE—FUN TO USE—FOR BEGINNERS, STUDENTS AND PROS

tone decoder
 A complete tone decoder on a single PC board. Features: 400-5000 Hz adjustable range via 20 turn pot, voltage regulation, 567 IC. Useful for touch-tone burst detection, FSK, etc. Can also be used as a stable tone encoder. Runs on 5 to 12 volts.
 Complete kit, TD-1 **\$5.95**

COLOR ORGAN
 See music come alive! 3 different lights flicker with music. One light each for high, mid-range and lows. Each individually adjustable and drives up to 300 W. runs on 110VAC.
 ML-1 Kit, **\$8.95**

VIDEO MODULATOR
 Converts any TV to video monitor. Super stable, tunable over ch 4-6. Runs on 5-15V accepts std. video signal. Best unit on the market! Complete kit, VD-1 **\$7.95**

LED BLINKY KIT
 Alternately flashes 2 jumbo LEDs. Use for name badges, buttons, warning panel lights. Runs on 3 to 15 volts.
 BL-1 Kit, **\$2.95**

MAD BLASTER
 Produces LOUD ear shattering and attention getting siren like sound. Can supply up to 15 watts of obnoxious audio. Runs on 6-15 VDC
 MB-1 Kit **\$4.95**

FM WIRELESS MIKE
 Transmits up to 300' to any FM broadcast radio, uses any type of mike. Runs on 3 to 9V. Type FM-2 has added sensitive mike preamp stage.
 FM-1 Kit **\$3.95**
 FM-2 Kit **\$4.95**

SUPER SLEUTH
 A super sensitive amplifier which will pick up a pin drop at 15 feet! Great for monitoring baby's room or as general purpose amplifier. Full 2W rms output, runs on 6 to 15 volts, uses 8-45 ohm speaker.
 BN-9 Kit **\$5.95**

TELEPHONE TRANSMITTER
 Low cost with professional performance. Features include: self phone line powered, tunable from 76 to 100 MHz, polarity antisensitive, compact size (1/2" x 1/4"). easily installs anywhere on the phone line or inside the instrument itself.
 PB-1 KIT **\$14.95**

FM RECEIVER
 For built-in applications or hobby experimentation. Full fledged super-heterodyne receiver. microvolt sensitivity, 10.7 MHz IF, integrated circuit detector, 50 mw audio amplifier, 9V external power source, operation on standard FM broadcast band as well as large portions on each side, compact (6" square), for bug detection or reception
 FR-1 KIT **\$14.95**

FM MINI MIKE
 A super high performance FM wireless mike kit! Transmits a stable signal up to 300 yards with exceptional audio quality by means of its built in electret mike. Kit includes case, mike, on-off switch, antenna, battery and super instructions. This is the finest unit available.
 FM-3 Kit **\$14.95**
 FM-3 Wired and Tested **19.95**

40 WATT 2 mtr PWR AMP
 Simple Class C power amp features 8 times power gain 1 W in for 8 out, 2 W in for 15 out, 5 W in for 40 W out. Max output of 50 W. Incredible value, complete with all parts, less case and T-R relay.
 PA-1, 40 W pwr amp kit **\$22.95**
 TR-1, RF sensed T-R relay kit **6.95**

VOICE ACTIVATED SWITCH
 Voice activated switch kit provides switched output with current capability up to 100 mA. Can drive relays, lights, LED or even a tape recorder motor. Runs on 9VDC.
 VS-1 KIT **\$6.95**

UNIVERSAL TIMER
 Provides the basic parts and PC Board required to provide a source of precision timing and pulse generation. Uses S55 timer IC and includes a range of parts for most timing needs.
 UT-5 Kit **\$5.95**

WHISPER LIGHT
 An interesting kit, small mike picks up sounds and converts them to light. The louder the sound, the brighter the light. Includes mike, controls for up to 300 W, runs on 110 VAC.
 WL-1 Kit **\$6.95**

SIREN
 Produces upward and downward wail. 5 W peak audio output, runs on 3-15 volts, uses 3-45 ohm speaker.
 Complete kit, SM-3 **\$2.95**

60 Hz TIME BASE
 Low current (25ma) 1 min/month accuracy
 TB-6 Kit **\$5.50**
 TB-6 Assy **\$9.95**

ACCESSORIES FOR RAMSEY COUNTERS

- Telescopic whip antenna—BNC plug \$ 8.95
- High impedance probe, light loading 16.95
- Low pass probe, audio use 16.95
- Direct probe, general purpose use 13.95
- Tilt bail, for CT-70, 90, 125 3.95

PHONE ORDERS CALL 716-586-3950



TELEX 466735 RAMSEY CI
 FAX 716-586-4754

CIRCLE 70 ON FREE INFORMATION CARD

TERMS: • satisfaction guaranteed • examine for 10 days; if not pleased, return in original form for refund • add 6% for shipping and insurance to a maximum of \$10.00 • foreign add 15% for surface mail • CDD add \$2.50 (CDD in USA only) • orders under \$15.00 add \$1.50 • NY residents add 7% sales tax • 90 day parts warranty on all kits • 1 year parts & labor warranty on all wired units.

RAMSEY ELECTRONICS, INC.
 2575 Baird Rd, Dept. RE
 Penfield, N.Y. 14526

CrackTheCode

TRI-MODE CABLE TV DESCRAMBLER PARTS

We stock the exact parts, PC board and AC adaptor for *Radio Electronics* February 1987 article on building your own TRI-MODE CABLE TV DESCRAMBLER.

#301 PARTS PACKAGE \$39.⁹⁵
Includes all the original resistors, capacitors, diodes, potentiometers, transistors, integrated circuits, LED's, Toko coil (E520HN-3000023) and Plessey SAW filter (SY323).

#302 PC BOARD \$12.⁹⁵
Original 5 X 8.8 etched & drilled silk-screen PC board used in article.

#304 AC ADAPTOR \$12.⁹⁵
Original (14 to 18 volt DC @ 200ma) AC adaptor used in article.

SPECIALS

Add \$2.50 shipping & handling — \$4.50 for Canadian orders.
We also offer quantity discounts on 5 or more units.

BOTH #301 and #302 \$49.⁰⁰
ALL THREE #301, #302, and #304 \$59.⁰⁰

FREE

Reprint of *Radio Electronics* Article (February 1987) on building your own TRI-MODE CABLE TV DESCRAMBLER.

60-CHANNEL CABLE CONVERTER \$69.⁹⁵
WITH INFRARED REMOTE CONTROL **SC-60R CONVERTER**



Add \$3.50 Shipping and Handling
\$4.50 on Canadian Orders

Thousands of these converters sold nationally for \$119.95. We offer you this same type of converter for only \$69.95. All converters are NEW, with Full manufacturer's WARRANTY.
FEATURES:
■ Full 60 Channel Capability ■ Cordless Infrared remote control
■ Ultra-Stable Synthesized tuning ■ Microprocessor controlled PLL
■ Works on all TV models. Specify channel 3 or channel 2 output.
■ Standard/HRC Switch for compatibility with all Cable Systems
■ Will work with all types of external descramblers

ORDER TOLL FREE
1-800-227-8529

Inside MA: 617-695-8699
VISA, MASTERCARD OR C.O.D.



Not available to Massachusetts residents due to state law.

J & W
ELECTRONICS, INC.

P.O. BOX 800 • MANSFIELD, MA 02048

© Copyright 1986 by J & W Electronics, Inc.

APRIL 1987

Saratoga Electronics

12380 SARATOGA-SUNNYVALE RD. SARATOGA, CA 95070



INTEGRATED CIRCUITS

D RAMS

4164-150NS \$.89 41256-150NS \$2.45

EPROMS

2716-450NS \$2.95 2764-250NS 3.75
2764-450NS 3.00 27256-300NS 6.75

TTL LOGIC

74LS00 SERIES		74S SERIES	
74LS00	\$.12	74S08	\$.35
74LS02	.12	74S51	.20
74LS04	.12	74S64	.30
74LS09	.12	74S138	.50
74LS14	.25	74F SERIES	
74LS107	.25	74F151	.95
74LS153	.29	74F158	.95
74LS155	.39	7400 SERIES	
74LS155	.39	7408	.20
74LS156	.39	7411	.25
74LS158	.25	7453	.20
74LS163	.30	74199	.15
74LS241	.49		

MISC.

MSM5832 (clock chip) \$1.49
WD2413M-03 (FDC) 2.49
FD1797A-02 (FDC) 2.49
LF347 (Bi-Fet) 1.29
MC10231 (10K ECL Dual Flip-Flop) .49
MC1489 .39

MICROS

8087-3 (5mHz) \$125.00
80287 (6mHz) 165.00
8749-H 7.95
Z80A DMA 3.00
Z80B CPU 4.00

ELECTROLYTIC CAPACITORS

5 for 99¢

10,000 mf @ 35v
2" (ht.) x 1" (diameter)

PCB's \$3.95 ea.

Surplus boards loaded with
MANY components!

PC/XT COMPATIBLE SYSTEM BOARD \$115.00

640KB w/o Bios & Ram

408/446-4949

TOLL FREE
800/621-0854 ext. 245

PRICES SUBJECT TO CHANGE
\$25 MIN. ORDER



ADVERTISING INDEX

RADIO-ELECTRONICS does not assume any responsibility for errors that may appear in the index below.

Free Information Number	Page	
—	"2001"	CV3 71 New-Tone Electronics
81	A.I.S. Satellite	75 199 NuScope Associates
108	AMC Sales	78 110 Omnitron
76	AP Products Brand of 3M	12 — Pacific Cable
107	All Electronics	112 198 Parts Express
—	Amazing Devices	106 101 Pomona Electronics
178	American Design Components	122, 123 — RCA D&SP
196	B N F Enterprises	82 78 Radio Shack
77	B&K Precision	20 70 Ramsey
98	Beckman Industrial	CV4 185 Regency
85	Blue Star Industries	75 97 Saratoga Electronics
109	C & S Sales	73 180,181 Sencore
—	C.O.M.B.	77 182,183 Sencore
60	CIE	34 197 Silicon Valley Surplus
200	Cable Distributors	75 74 Solid State Sales
179	Cabletronics	74 94 Star Circuits
—	Command Productions	78 92 Tektronix
79	Communications Electronics	38 123 Test Probes
193	Cook's Institute	81 201 Transleteronic
176,177	Crosley	74,75 186 United Electronic Supply
127	Deco Industries	74,75 202 VIP Electronics
95,188	Dick Smith Electronics	109,110,111 103 Wm B Allen
82	Digi-Key	113
—	Digital Research Computers	104
203	E-Z Hook	11
120	Elephant Electronics	75
100	Firestik II	81
121	Fluke Manufacturing	10
—	Fordham Radio	25
—	GRE America	32
—	Grantham College of Engineering	23
86	Heath	6,13
—	ICS	108
—	ISSET	81
—	Imtronics Industries	24
65	J & W	127
59	JDR Instruments	3
113,189	JDR Microdevices	116,117
190,191	JDR Microdevices	118,119
192	JDR Microdevices	120
114	Jameco	114,115
104	Jan Crystals	82
—	Joseph Electronics	15
184	Kepro Circuit Systems	65
87	MCM Electronics	125
195	M.D. Electronics	75
93	Mark V. Electronics	121
—	McGraw Hill Book Club	86
—	McGraw Hill Cont. Education Series	71
194	Mercer	9
63	Micro-Mart	107
61	Microprocessors Unltd.	101
117	Mouser	78
—	NRI	16
187	NTS	74

Gernsback Publications, Inc.
500-B Bi-County Blvd.
Farmingdale, NY 11735
(516) 293-3000
President: Larry Steckler
Vice President: Cathy Steckler

For Advertising ONLY 516-293-3000
Larry Steckler
publisher
Arline Fishman
advertising director
Shelli Weinman
advertising associate
Lisa Strassman
credit manager
Christina Estrada
advertising assistant

SALES OFFICES

EAST/SOUTHEAST
Stanley Levitan
Eastern Sales Manager
Radio-Electronics
259-23 57th Avenue
Little Neck, NY 11362
718-428-6037, 516-293-3000

MIDWEST/Texas/Arkansas/Okla.
Ralph Bergen
Midwest Sales Manager
Radio-Electronics
540 Frontage Road—Suite 339
Northfield, IL 60093
312-446-1444

PACIFIC COAST/ Mountain States
Marvin Green
Pacific Sales Manager
Radio-Electronics
15335 Morrison St.—Suite 227
Sherman Oaks, CA 91403
818-986-2001

2001 IS COMING IN MAY



An electronics revolution is in the making, but you don't have to wait until 2001 to find out how it will change your life in the 21st century. Radio-Electronics will forecast the coming changes and how they will affect you in the May 1987 issue!

Created by a special editorial task force—two years in preparation—this unique issue, 2001, takes you into the research laboratories of Westinghouse, Texas Instruments, Ford and Bell Labs where the future is being invented today!

You'll get an advance look at what's coming in artificial intelligence... new cars and highways (cleaner, quieter and more efficient)... futuristic energy sources like magneto-hydrodynamic and particle-beam generators... personal communications systems that will give you instant access to anyone anywhere... super computers and teaching breakthroughs that will multiply your capacity to learn!

Arthur Clarke introduces 2001. Isaac Asimov explores the marvels of robotics. But it is not science fiction. Rather it is

emerging technology with a solid foundation in current research and development.

And its impact will be enormous. It will change the way you work... the way you think... the way you live!

2001 is the kind of special publishing event that can only happen once in any magazine's lifetime and it will happen to Radio-Electronics in May, 1987.

With extra features and extra pages, 2001 will bear a premium cover cost, but you can reserve your copy now at less than the regular cover cost by mailing any one of the subscription orders in this issue.

2001 is coming in May. Make sure now that you don't miss it!

Radio-Electronics®

Oops Proof. Now Even Better.

*Industry's Most Popular Heavy-Duty DMMs...
Now Even Better With Dual-Fuse Protection
And A Tougher Case.*

The tough just got tougher. When Beckman Industrial introduced heavy-duty DMMs tough enough to withstand accidental drops, input overloads and destructive environments, they quickly became the industry's most popular.

Now they're even tougher, thanks to the best dual-fuse protection you can buy and a new case. Covered by a one-year, no-fault guarantee against damage to the meter other than gross abuse.

For overloads, all voltage ranges can withstand transients up to 6kV. Resistance ranges are protected to 600 volts. Current ranges are protected by a 2 amp/600 volt fuse. The 10 amp range is protected by a 15 amp, 600 volt high energy fuse with 100,000 amp interrupt rating.

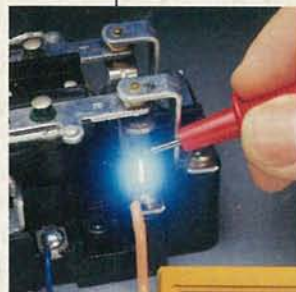

Our heavy-duty DMMs can withstand accidental drops, literally bouncing back for more, thanks to a new case made of Valox[®], one of the most impact and corrosive chemical resistant thermoplastics around. Sensitive components are shock mounted for impact protection.

Even oil, water and industrial grime can't keep our heavy-duty DMMs away from the action. *Everything* is sealed with o-rings for maximum protection.

Of course, even the toughest DMM isn't much good if it can't deliver accuracy and the right combination of capabilities at the right price.

Check the HD DMM specs for yourself: Maximum voltage rating of 1500 volts DC, 1000 volts AC; tested to 10KHz; diode test function; and exclusive Insta-Ohm[®] capability, now with an audible beeper, to make your HD even easier to use.

What's more, you can select just the model you need without paying extra. Whether it's the economical HD-100 at \$169.00 for solid, all-around meter performance, the HD-110, or the HD-110T that lets you select Fahrenheit or Celsius temperature measurement with a simple field adjustment, accurately measures from -4°F to -1999°F, works with any K-type thermocouple, and measures a range of 32°F to 392°F with the thermocouple provided.

You can even get true RMS capability (AC coupled) with a 4 1/2 digit display required by the HD-140's accuracy.



HEAVY DUTY DMMS	HD100	HD110	HD110T	HD140
Digits	3 1/2	3 1/2	3 1/2	4 1/2
Accuracy (Vdc)	0.25%	0.25%	0.25%	0.05%
Input Impedance	22 Megohms			10 Megohms
AC Conversion Type	Average			True RMS
Open Circuit Voltage (In OHMS Range)	500mV			4V
Voltage Burden (DC Amps)	250mV			
Current Ranges	200µA			
	2A	10A		
Beeper		✓	✓	✓
Battery Life (Av. Hrs.)	2000			100

Visit your local Beckman Industrial distributor today. Compare. And discover why the toughest are tougher than ever.

*In Service
Instruments,
We're The One.*

Beckman Industrial™

Beckman Industrial Corporation, Instrumentation Products Division
A Subsidiary of Emerson Electric Company
630 Puente Street, Brea, CA 92621
(714) 671-4800 • FAX: (714) 671-4874 • TLX: 188790
© 1986 Beckman Industrial Corporation

CIRCLE 98 ON FREE INFORMATION CARD