

ISSN 0893-1003

Radio- CAMCORDER BUYER'S GUIDE

\$2.25 MAR. 87
IN CANADA \$2.75

Electronics®

TECHNOLOGY - VIDEO - STEREO - COMPUTERS - SERVICE

BUYER'S GUIDE TO CAMCORDERS

8mm? VHS-C? How to decide.

A GERNSBACK PUBLICATION

NEW TECHNOLOGY
Very high speed integrated circuits

SEMICONDUCTOR TESTING
Field-effect transistors

BUILD THE R-E ROBOT
Building the base unit

PIEZOELECTRIC PLASTIC FILM
It's fun to experiment with

TV DESCRAMBLING
Build an outband decoder



PLUS:

- ★ **Satellite TV**
- ★ **Video News**
- ★ **COMPUTER DIGEST**
- ★ **Build a clock for your PC**



NOW GET SCOPE, COUNTER AND DMM INPUT ALL AT ONCE THROUGH ONE PROBE!

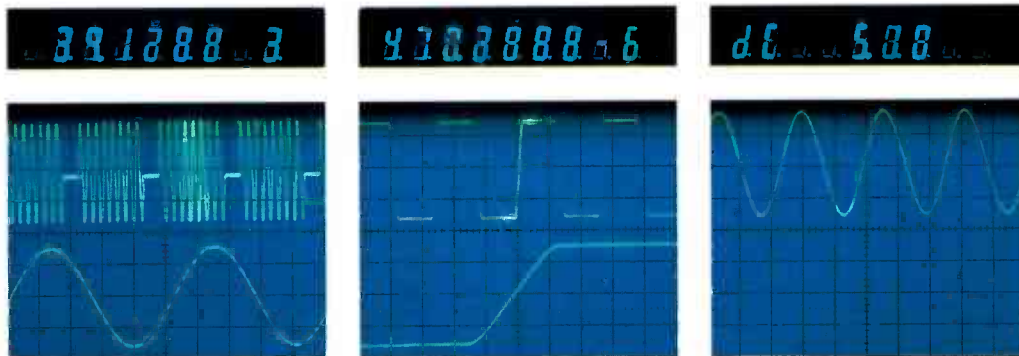

Gated frequency measurement. B sweep triggering during the intensified portion of the A sweep. Intensified portion frequency is measured with the counter/timer/DMM.

Delay time measurement. Delay time from the start of A sweep to the start of the B sweep is measured with *crystal accuracy*.

Channel 1 dc volts measurement. The average dc component of a waveform is measured directly through channel 1 with direct digital fluorescent readout.

The Tek 2236 combines 100 MHz, dual timebase scope capability with counter/timer/DMM functions integrated into its vertical, horizontal and trigger systems. For the same effort it takes to display a waveform you can obtain digital readout of frequency, period, width, totalized events, delay time and Δ -time to accuracies of 0.001%.

The same probe is used to provide input for the CRT display and the digital measurement system, resulting in easy set-up, greater measurement confidence and reduced circuit loading. Probe tip volts can also be measured through the Ch 1 input.

Precision measurements at the touch of a button.

Auto-ranging frequency, period, width and gated measurements are push-button-simple. And the 2236 offers an independent floating 5000 count, auto-ranging multimeter with side inputs for DC voltage mea-



surements to 0.1%.

A built-in, auto-ranging ohmmeter provides resistance measurements from 0.01 Ω to 2G Ω —as well as audible continuity. Automatic diode/junction detection and operator prompts serve to simplify set-up and enhance confidence in your measurements.

The 2236: scope, counter, timer, DMM plus a 3-year warranty—all for just \$2,650.

Contact your nearest distributor or call Tek toll-free. Technical personnel on our direct-line will answer your questions and expedite delivery. Orders include probes, 30-day free trial and service worldwide.

Call Tek direct:

1-800-433-2323 for video tape or literature,

1-800-426-2200 for application assistance or ordering information.

In Oregon, call collect: **1-627-2200**

Bandwidth	100 MHz
No of Channels	2 + Trig. View
Max. Sweep Speed	5 ns/div
Digital Readout Features	Direct Ch 1 Voltage Meas. 0.5% DC; 2.0% AC RMS Resistance: .01 Ω to 200 Meg Ω Continuity/Temp: Audible/C $^{\circ}$ or F $^{\circ}$ Totalizing Counter: — 1 counts to 8,000,000 Direct Freq. Meas: 100 MHz to 0.001% acc. Period, Width Meas: 10 ns with 10 ps max. resolution
Timing Meas. Accuracy	.001% (delay and Δ -time with readout)
Trigger Modes	P-P Auto, Norm, TV Field, TV Line, Single Sweep
Weight	7.3 kg (16.2 lb)
Price	\$2650
Warranty	3-year including CRT (plus optional service plans to 5 years)

Tektronix
COMMITTED TO EXCELLENCE

**SPECIAL
FEATURE**

47 A BUYER'S GUIDE TO CAMCORDERS
We explore the options and explain what you need to know to make an intelligent choice when you're ready to buy a camcorder.
Frank Vizard

BUILD THIS

52 R-E ROBOT
How to build the roving base unit for your robot. **Steven E. Sarns**

73 PC SERVICE
Use our exclusive direct-etch patterns to make circuit boards for the outband decoder, the gated pulse decoder we discussed in January, and the add-on clock board for your PC.

TECHNOLOGY

6 VIDEO NEWS
Inside the fast-changing video scene.
David Lachenbruch

57 PIEZOELECTRIC PLASTIC FILM
A versatile material for which you'll have fun finding new uses. **John Iovine**

59 THE EVOLUTION OF VHSIC
Very High Speed Integrated Circuits cram more circuitry in less space. **Bob Grossblatt**

63 TV SIGNAL DESCRAMBLING
How to build a decoder for the outband scrambling system.
Rudolf F. Graf and William Sheets

78 SATELLITE TV
Why Videocipher is dead. **Bob Cooper, Jr.**

81 AUDIO UPDATE
Psychoacoustics and stereo imagery.
Larry Klein

**CIRCUITS AND
COMPONENTS**

42 NEW IDEAS
An amplifier for broadcast band signals.

66 FINDING CABLE FAULTS
How time-domain reflectometry can help solve cable problems. **Vaughn D. Martin**

71 TESTING SEMICONDUCTORS
Part 2. FET characteristics and how to test them. **TJ Byers**

86 STATE OF SOLID STATE
A temperature transducer. **Robert F. Scott**

RADIO

44 COMMUNICATIONS CORNER
Noise bridges.
Herb Friedman

88 ANTIQUE RADIOS
A look at early portables.
Richard D. Fitch

COMPUTERS

93 COMPUTER DIGEST
You can build a 68000-based computer, add a clock board to your PC, and read reviews of the PC-SIG library, memory upgrades, and more!

**EQUIPMENT
REPORTS**

28 Fluke Line Current Test Adapter

32 TI/P-Cad PAL Starter Kit

DEPARTMENTS

128 Advertising and Sales Offices

128 Advertising Index

14 Ask R-E

129 Free Information Card

16 Letters

107 Market Center

36 New Products

4 What's News

COVER 1

Radio- CAMCORDER BUYER'S GUIDE Electronics

TECHNOLOGY - VIDEO - SIGHTS - COMPUTERS - SERVICE
**BUYER'S GUIDE
TO CAMCORDERS**
Recent VHS-C Model Introduces

NEW TECHNOLOGY
Very high speed Hi8magical circuitry

**SEMICONDUCTOR
TESTING**
7-band Hi-Mag translator

**BUILD THE
R-E ROBOT**
Building the new kit

**PEZOELECTRIC
PLASTIC FILM**
The fun for electronics with

TV DESCRAMBLER
Build an outdoor decoder

PLUS:

- * Hi8magical TV
- * Hi-Mag Hi-Mag
- * Hi-Mag Hi-Mag
- * Hi-Mag Hi-Mag
- * Hi-Mag Hi-Mag



If you're considering buying a video camcorder, you have a lot of decisions to make. Do you go for a 8mm system or for a VHS-C model? Perhaps even a full-sized VHS camcorder would serve your purposes better with its long recording time and compatibility with your present VCR. We've taken an in-depth look at the video camcorder market. We explain all you need to know to make an intelligent choice. A price and feature roundup is included.

Our model is holding a Sharp VC-C50UA VHS-C camcorder with features such as HQ circuitry, automatic focus, 6X power zoom with macro focus, and more.

NEXT MONTH

THE APRIL ISSUE IS
ON SALE MARCH 3

BUILD A ROBOT CONTROL COMPUTER

Now you can give your robot some smarts.

BUILD AN ACID-RAIN MONITOR

You may be surprised at what you find.

SPREAD-SPECTRUM COMMUNICATIONS

What it's all about.

BUILD A COMMERCIAL ZAPPER

Now you can enjoy only the music you want to hear!

As a service to readers, RADIO-ELECTRONICS publishes available plans or information relating to newsworthy products, techniques and scientific and technological developments. Because of possible variances in the quality and condition of materials and workmanship used by readers, RADIO-ELECTRONICS disclaims any responsibility for the safe and proper functioning of reader-built projects based upon or from plans or information published in this magazine.

Since some of the equipment and circuitry described in RADIO-ELECTRONICS may relate to or be covered by U.S. patents, RADIO-ELECTRONICS disclaims any liability for the infringement of such patents by the making, using, or selling of any such equipment or circuitry, and suggests that anyone interested in such projects consult a patent attorney.

Radio- Electronics

Hugo Gernsback (1884-1967) founder
M. Harvey Gernsback,
editor-in-chief, emeritus

Larry Steckler, EHF, CET, editor-in-chief
and publisher

EDITORIAL DEPARTMENT

Art Kleiman, editorial director
Brian C. Fenton, managing editor
Carl Laron, WB2SLR, associate editor
Jeffrey K. Holtzman,
assistant technical editor
Robert A. Young, assistant editor
Julian S. Martin, editorial associate
Byron G. Wels, editorial associate
M. Harvey Gernsback,
contributing editor
Jack Darr, CET, service editor
Robert F. Scott,
semiconductor editor
Herb Friedman,
communications editor
Bob Cooper, Jr. satellite-TV editor
Robert Grossblatt, circuits editor
Larry Klein, audio editor
David Lachenbruch,
contributing editor
Richard D. Fitch,
contributing editor
Teri Scaduto, editorial assistant

PRODUCTION DEPARTMENT

Ruby M. Yee, production director
Robert A. W. Lowndes,
editorial production
Andre Duzant, technical illustrator
Karen Tucker, advertising production
Geoffrey S. Weil, production traffic

CIRCULATION DEPARTMENT

Jacqueline P. Cheeseboro,
circulation director
Wendy Alanko,
circulation analyst
Theresa Lombardo,
circulation assistant

Cover photo by Herb Friedman

Typography by Mates Graphics

Radio-Electronics, Gernsback Publica-
tions, Inc., 500-B Bi-County Blvd.,
Farmingdale, NY 11735.
516-293-3000

Radio-Electronics is indexed in
Applied Science & Technology Index
and *Readers Guide to Periodical Literature*.

Microfilm & Microfiche editions are
available. Contact circulation depart-
ment for details.

Advertising Sales Offices listed
on page 126.



Make your home into something special!

That's exactly what your home will be when you fill it with Heathkit electronic products - products that make your life easier and more enjoyable. Within our diverse line are kit and assembled products sure to enhance each room in your home.



1. Make your entryway more secure and easy to use with the Keyless Doorlock. You'll never again be locked out because of lost or forgotten keys. All it takes is a simple fingertip entry of a four-digit code, and the Keyless Doorlock unlocks your door.

2. Add a new dimension to your living room with your own Computerized Weather Station. This Digital Weather Station displays up-to-the-minute temperature, wind, and barometric pressure readings, along with time and date.



3. Give your kitchen a unique blend of style and efficiency with our Digital Wall Clock. This easy-to-build kit keeps time with quartz-crystal accuracy. And with its simulated oak wood-grain finish cabinet, you'll have a timepiece that fits into almost any decor.



4. Put your den to greater use with this IBM PC AT Compatible Computer. Do word processing, personal accounting and more when you run exciting IBM-compatible software on your fast and powerful HS-241. And you can build it yourself in just a few hours.

5. Bring the latest in digital technology to your bathroom. This Digital Scale lets you closely monitor your weight with electronic precision. And, it's battery operated so it's safe to use right out of the shower.



6. Add a video entertainment center to your bedroom. Our 19"-diagonal stereo TV set gives you an extra-sharp color-corrected picture with full stereo sound, and convenient viewing that you can control from your bed. Comes in a simulated walnut cabinet that complements your room.



7. Transform your rec room into a haven for hobby fun. Put our Deluxe QRP CW Transceiver in this room and enjoy superb HAM radio operation that excels in performance and features. It offers expandable transmission and reception capabilities.

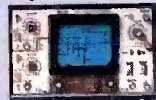

8. Give your workbench a touch of professionalism with this oscilloscope. Whether you're a service technician or a hobbyist, you'll love the wide range of measurement capability our laboratory-grade Dual Trace 10 MHz Oscilloscope gives you.

9. Add practicality to the utility room and save money, too. Avoid expensive food spoilage with our Freezer Alarm that



warns you when the inside temperature of your freezer rises too high. Prevent water damage with our Food Alarm that warns you of water that's where it shouldn't be.



10. Make your coming and going easier than ever.

Your garage door will open with incredible ease and dependability with our Deluxe Garage Door Opener. Easy to install, this opener is durable and includes a handy security light.

You'll find fun and excitement with every Heathkit product. Whether they're in kit form or already assembled, our products will help you enjoy your home more than you ever dreamed possible.

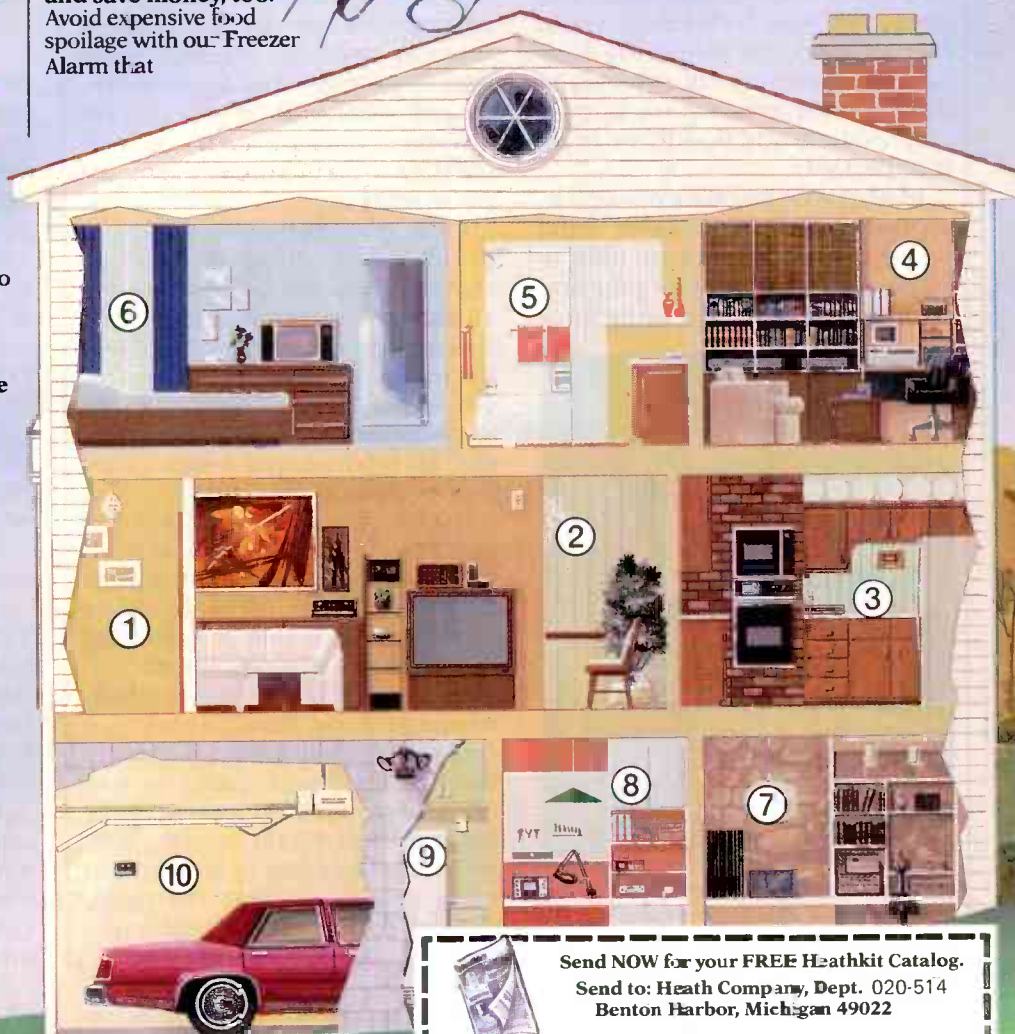

Heathkit[®]
Heath
Company

Send NOW for your FREE Heathkit Catalog.
Send to: Heath Company, Dept. 020-514
Benton Harbor, Michigan 49022

Name _____

Address _____

City _____ State _____ Zip _____

A subsidiary of Zenith Electronics Corporation CL-789A

CIRCLE 206 ON FREE INFORMATION CARD

WHAT'S NEWS

New technique checks brain's blood supply

Scientists at the General Electric Research & Development Center, Schenectady, NY, have demonstrated that a new magnetic-resonance computer-imaging technique, called projection angiography, can be used to make noninvasive measurements of blood flow through the veins and arteries of the human head and neck. The new technology could play an important role in the diagnosis and treatment of strokes and other conditions where knowledge of the blood flow to the brain is important.

In magnetic resonance imaging, a powerful magnetic field, radio waves, and computers are used to inspect internal body organs and structures. In the imaging pro-

cedure, the patient is positioned within the 1-meter bore of a 5-ton, doughnut-shaped superconducting magnet whose magnetic field is 30,000 times stronger than that of the earth's. The patient is then probed with high-frequency radio signals. Under the magnetic field's influence, those signals "excite" hydrogen atoms in the blood and other body organs, causing them to resonate. The resonance signals are picked up by an antenna and retransmitted to a special-purpose computer that converts the data into a picture of the object being imaged.

GE's new technique makes it possible to distinguish between signals given off by the moving atoms in the bloodstream and those given off by the motionless hydrogen atoms in body organs. The signals from the moving atoms are highlighted so that the intensity of the displayed image varies proportionally with speed.

If a blood vessel is not as bright as it should be, the blood is flowing sluggishly, indicating the presence of a disease such as arteriosclerosis that is narrowing the passage. Arteriosclerosis can clog a major blood vessel, interrupting blood flow, which can cause severe and permanent brain damage, resulting in paralysis, loss of speech, impaired reasoning, or death. Early detection by magnetic resonance imaging could prevent many deaths and limit the tissue damage due to such conditions.

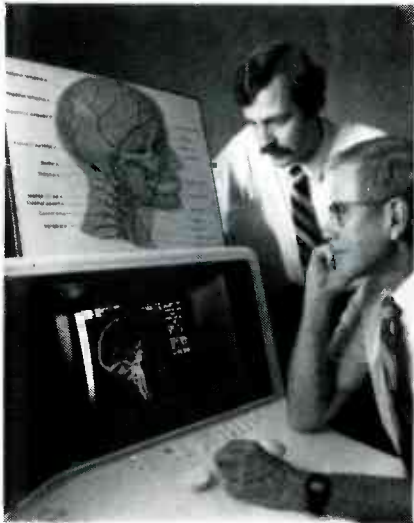

A FORM OF MAGNETIC RESONANCE scanning, projection angiography, makes it possible to measure blood flow to the brain.

Electromagnetic shielding a billion-dollar business

"Shielded room" took on a new meaning in 1978, when the State Department put up aluminum screens to shield the U. S. Embas-

sy in Moscow from electronic invasion by Soviet agencies. Now the White House, the FBI Building, and such facilities as data processing centers are shielded routinely.

The urge for shielding is creat-

ing a new business, electromagnetic compatibility, says Frost & Sullivan, a market research company that is based in New York and London.

Reasons other than the fear of political or economic espionage are behind much shielding, of course. In the computer field especially, shielding is often necessary to protect sensitive equipment and data from harmful outside radiation.

New liquid-level sensor can be used in harsh environments

An extremely sensitive liquid-level sensor that operates in severe temperature and/or radiation environments has been developed at Sandia National Laboratories (Albuquerque, NM 87185-5800).

Developed for use in a nuclear energy research program, the sensor can be adapted for a wide range of applications in which liquid-level changes ranging from a fraction of an inch to several feet need to be monitored.

Its inventors say that it could be used in nuclear power plants that typically use water to cool fuel. There also may be ways to use sensors operating on that principle in the chemical and petroleum processing industries, where high temperatures and corrosive environments are common.

The basic system includes a coaxial cable probe, partially submerged in a liquid, and associated electronics and equipment, which combine to provide continuous information.

The sensor determines liquid level by comparing certain features of the electromagnetic signals that are sent simultaneously through transmission lines contained in the probe and in a reference line.

R-E

One-Stop Component Center

JE232CM RS232 Interface (Commodore™ VIC-20 & C-64)

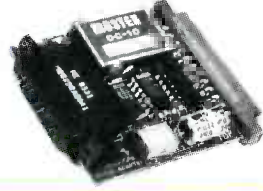

National/TI/Motorola/Intel/SAMS Data Books



Fans, Finger Guards and Plug Cords



Integrated Circuits (E)EPROMs, RAMs, MPUs, etc.

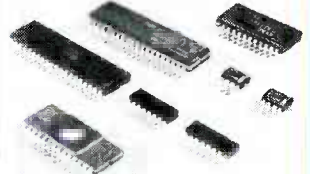

Linear Taper Potentiometers



Wire Wrap Sockets/ Header Plugs/Covers

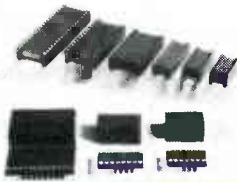

RS232 25 Contact D-Subminiature Connectors

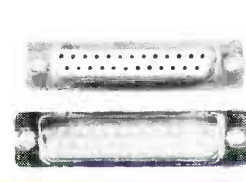

JE215 Adjustable Power Supply Kit



YOUR NEIGHBORHOOD JIM-PAK AUTHORIZED DISTRIBUTOR

<p>ALABAMA Birmingham, Huntsville, Mobile, Montgomery, J.L.S. Electronics, W&W Electronics, ATM Electronics, Handey's Elect. Center</p> <p>ALASKA Anchorage, Homer, Electric Supply Center, A.COM of Alaska</p> <p>ARIZONA Sierra Vista, Tucson, Yuma, B&S Electronics, Electronic City, Yuma Electronics</p> <p>ARKANSAS Little Rock, Arkansas Electronic Supply</p> <p>CALIFORNIA Anaheim, Atascadero, Berkeley, Carpinteria, Chico, Chico, Chula Vista, Concord, Costa Mesa, Covina, Cucamonga, Dublin, Eureka, Fontana, Fresno, Fresno, Glendale, Goleta, Half Moon Bay, Harbor City, Hawaiian Gardens, Hollywood, Inglewood, Lompoc, Los Osos, Merced, Modesto, Monterey, Morro Bay, National City, Oakland, Oakland, Oceanside, Orange, Palo Alto, Pasadena, Redding, Roseville, Sacramento, Sacramento, Sacramento, Sacramento, San Carlos, San Francisco, San Jose, San Jose, San Luis Obispo, San Luis Obispo, San Rafael, San Ysidro, Santa Cruz, Santa Cruz, Santa Maria, Santa Rosa, Scotts Valley, Stockton, Stockton, Torrance, Torrance, *Vallejo, Westminster, Willow, JK Electronics, CDBC Electronics, *1ST JIM-PAK DISTRIBUTOR 9/6/77</p>	<p>COLORADO Colorado Springs, Denver, Centennial Electronics, Fistell's Microelectronics</p> <p>CONNECTICUT Wallingford, Tron Town USA</p> <p>DELAWARE Newark, Wilmington, Computerland, Wholesale Electronics</p> <p>FLORIDA Clearwater, Daytona Beach, Del Ray Beach, Fort Walton Beach, Gainesville, Hialeah, Miami, Oakland Park, Orlando, Pensacola, Tampa, Amateur Electronic Supply, C&S Electronics, Electronic Parts Outlet, Palm Electronics, Skipper Electronics, Health/Zenith, Dharamidas Sons, Lafayette Radio, C&S Electronics, Pensacola Electronics, Leader Electronics</p> <p>GEORGIA Atlanta, Dalton, Stone Mountain, A.C.M. Computer Mart, A.C.M. Computer Mart, Coleman's Electronics</p> <p>HAWAII Honolulu, Honolulu, Industrial Electronics, Integrated Circuit Supply</p> <p>IDAHO Boise, Boise, Pocatello, Kimball Electronics, R.J.M. Electronics, Kimball Electronics</p> <p>ILLINOIS Addison, Berwyn, Carbondale, Downers Grove, Mount Prospect, Niles, Peoria, South Holland, Digital World, B.B.&W. Electronics, Pick's Electronics, Suburban Electronics, Tri-State Elect., Union Electronic Dist.</p> <p>INDIANA Angola, Bloomington, Chesterton, Evansville, Gary, Indianapolis, Lakeland Electronics, Stansifer Radio, Chesterton Electronics, Hutch & Son, Calumet Electronics, Warren Radio Co.</p> <p>IOWA Ames, Clinton, Davenport, Des Moines, Des Moines, Iowa City, Union Supply Co., R.J.S. Electronics, Union Supply Co., Warren Radio, Radio Trade Supply, Union Supply Co.</p> <p>KANSAS Overland Park, Salina, Wichita, Wichita, Burstein & Assoc. Electronics Inc., Amateur Radio Equipment, Lloyd's Radio & Elec., R.S.C. Electronics</p> <p>KENTUCKY Lexington, Paducah, Radio Electronic Equip. Co., Peerless Electronic Equip. Co., Warren Radio Co.</p> <p>LOUISIANA Baton Rouge, Baton Rouge, Bossard, Gretna, Industrial Elect. Supply, Menard Electronics, Menard Electronics, Pelican Electronics</p>	<p>LOUISIANA (Continued) Houma, Lake Charles, Metairie, Shreveport, Shreveport, Shreveport, Pelican Electronics, Wholesale Radio & Equip., Pelican Electronic Supply, Electronic Supply of Shreveport, Industrial Electronic Supply, Southern Electronics</p> <p>MARYLAND Aberdeen, Baltimore, Beltsville, College Park, Glen Burnie, Laurel, Lovaie, Towson, Harco Electronics, BCT Electronics, Mark Electronics, Electronics Plus, Revaco of Maryland, Maryland Radio Center, J&M Electronics, Baynesville Electronics</p> <p>MASSACHUSETTS Pittsfield, Springfield, Pittsfield Radio Equipment, Sydlie Electronic Supply</p> <p>MICHIGAN Ann Arbor, Bay City, Detroit, East Detroit, Farmington, Flint, Grand Rapids, Grand Rapids, Grand Rapids, Jackson, Lansing, Lansing, Livonia, Madison Heights, Niles, Saint Clair Shores, Taylor, Traverse City, Warren, Westland, Wedemeyer Elect. Supply, Kinde Distributing, Electronic Parts Co., Health/Zenith, Tri County Electronics, Shand Electronics, Radio Parts Inc., T&W Electronics, Warren Radio, Fulton Radio Supply, Fulton Radio Supply, Wedemeyer Elect. Supply, Norwest Electronics, Warren Radio, Niles Radio Supply, Shand Electronics, Bell Electronics Co., Tel Van Electronic Supply, Traverse City Elect. Supply, K-40 Electronics, The Electronic Connection</p> <p>MINNESOTA Duluth, Minneapolis, Northwest Radio of Duluth, Acme Electronics</p> <p>MISSISSIPPI Biloxi, Jackson, Pascagoula, Hooper Electronic Supply, Elington Electronic Supply, Hooper Electronic Supply</p> <p>MISSOURI Cape Girardeau, Flat River, Jefferson City, Jefferson City, Kansas City, Rolla, Redalia, Springfield, St. Louis, Show Me Electronics, Show Me Electronics, Central Missouri Dist. Co., Show Me Electronics, Electronic Supply Co. Inc., Eagle Electronic Dist., Show Me Electronics, Show Me Electronics, Show Me Electronics</p> <p>MONTANA Bozeman, Great Falls, Electronic Service & Dist., Electric City Radio</p> <p>NEBRASKA Grand Island, Lincoln, Omaha, G.I. Electronics, Scott Electronic Supply, Scott Electronics</p> <p>NEVADA Las Vegas, Sparks, Century 23 Computer House</p>	<p>NEW JERSEY Camden, Fairlawn, Mantua, Ocean, Trenton, Vineland, General Radio, Health/Zenith, Electronic World, Health/Zenith, Laraco Radio, Laraco/Vineland</p> <p>NEW MEXICO Albuquerque, Electronic City</p> <p>NEW YORK Amherst, Amherst, Bethpage, Buffalo, Commack, Jamestown, Johnson City, Kingston, Middleton, Newburgh, New York, N. White Plains, Plattsburgh, Poughkeepsie, Rochester, Troy, Utica, Audio Center, Health/Zenith, Electronic No. 24 Inc., Radio Equipment Corp., Spartan Electronics, Warren Radio, Unicorn Electronics, Greylock Electronics, Greylock Electronics, Action Audio Inc., Iaft Electronics, Health/Zenith, Champlain Electronics, Greylock Electronics, Health/Zenith, Trojan, Central Electronics</p> <p>NORTH CAROLINA Greensboro, Health/Zenith</p> <p>NORTH DAKOTA Bismarck, Fargo, Fargo, Mandan, Holden Electronics, Digital Hospital, S/S Electronics, John Iverson Company</p> <p>OHIO Akron, Bryan, Canton, Cleveland, Lancaster, Parma, Toledo, Toledo, Wickliffe, Youngstown, Warren Radio, Bernie's Electric, Electronic Center Inc., Health/Zenith, Electronic Supply Co., Superior Electronics, Health/Zenith, Warren Radio, Amateur Electronic Supply, Ross Radio Co.</p> <p>OKLAHOMA Bartlesville, Oklahoma City, Oklahoma City, Tulsa, All-State Electronics, Radio Supply, Trice Electronics, Trice Electronics</p> <p>OREGON Beaverton, Corvallis, Eugene, Portland, Norvac Electronics, Zero Gee Electronics, Norvac Electronics, Portland Radio Supply</p> <p>PENNSYLVANIA Chambersburg, Drexel Hill, Erie, Erie, Frazer, Philadelphia, Philadelphia, Phoenixville, York, Sunrise Electronic Dist., Kass Electronic Dist., Warren Radio, Health/Zenith, Health/Zenith, Jan Industrial, Steven's Radio Shack, Computer Center of York</p> <p>RHODE ISLAND Cranston, Pawtucket, Jabbour Electronics, Jabbour Electronics</p> <p>TENNESSEE Bristol, Chattanooga, Knoxville, Shield's Electronic Supply, Shield's Electronic Supply</p>	<p>TENNESSEE (Continued) Memphis, Memphis, Nashville, Nashville, Smyrna, Bluff City Electronics, Warren Radio, Eddie Warners Inc., Electra Dist. Co., Delker Electronics</p> <p>TEXAS Brownsville, Dallas, Dallas, Houston, Houston, McAllen, McAllen, Odessa, Richardson, George's Electronic Mart, Health/Zenith, George's Electronic Mart, Angie Electronics, George's Electronic Mart, Valley Wide Electronics, Whitlock Instrument, Martin Wholesale Electronics</p> <p>UTAH Cedar City, Midvale, Ogden, Salt Lake City, I & C Electronics, Health/Zenith, Ogden, Kimball Electronics</p> <p>VERMONT Burlington, Greylock Electronics</p> <p>VIRGINIA Annandale, Arlington, Blacksburg, Bristol, Charlottesville, Charlottesville, Hampton, Lynchburg, Norfolk, Norfolk, Norfolk, Norfolk, Richmond, Roanoke, Roanoke, Springfield, Vienna, Virginia Beach, Winchester, Woodbridge, Arcade Electronics, Arlington Electronic Wholesalers, Scotty's Radio & TV, Shield's Electronic Supply, E.I.R. Electronics, Grave's Electronics, Cain Electronics, Electronic Service Co., Avc Electronics, Cain Electronics, People's Electronics, A.B.S. Corp., Electronic Equipment Bank, Cain Electronics, Stinson Electronics Inc., E.G.E.</p> <p>WASHINGTON Bellevue, Bellingham, Cheney, Gig Harbor, Pullman, Seattle, Seattle, Spokane, Tacoma, A.B.C. Communications, Cascade Electronics, Long's Electronics, Northwest Electronics, H&D Electronics, A.B.C. Communications, Amateur Radio Supply, Electronic Supply Co., Bits, Bytes & Nibbles, C&G Electronics</p> <p>WEST VIRGINIA Farmont, Morgantown, Wheeling, TPS. Electronics, Electro Dist. Co., Industronics</p> <p>WISCONSIN Kenosha, Chester Electronic Supply</p> <p>FOREIGN Canada: British Columbia/Victoria, Ontario/Mississauga, El Salvador, P.R.E.I.S.A., Guam: Agana, Marianas Electronics, Guatemala: Electronica Pan Americana, Panama: Sonitex S.A., Panama: Topelco S.A., Puerto Rico: Hato Rey, Microcomputer Store, Saudi Arabia: Jeddah, Hisham Nwailati Establishment, Jeddah, Technical Computer Service</p>
---	---	---	--	--

• Quality Components • Competitive Pricing • Instant Delivery

JIM-PAK • 1355 SHOREWAY ROAD • BELMONT, CALIFORNIA 94002 • TELEPHONE (415) 595-5936 • FAX (415) 592-2503 • TELEX 176043 • DISTRIBUTOR INQUIRIES WELCOME

CIRCLE 222 ON FREE INFORMATION CARD

www.americanradiohistory.com

VIDEO NEWS



DAVID LACHENBRUCH,
CONTRIBUTING EDITOR

• **CD's go video.** The digital audio Compact Disc, or CD, was originally an offshoot of Philips' development of the laser videodisc. The audio CD itself has given birth to several offspring. Perhaps the most prominent of those is the CD-ROM, which provides vast amounts of storage for computer data. Also on the way is an interactive CD, called CD-I.

But the latest development will bring the CD full circle. It's called *Compact Disc-Video*, or CD-V, for short, and contains video as well as audio material.

Philips recently held private demonstrations of their CD-V for movie and record-company officials in New York and Los Angeles. The CD-V shown provided five minutes of analog video and up to 20 minutes of digital audio on a 4.75" CD. The video is recorded on the outside part of the disc; the audio is recorded toward the center. The CD-V is compatible with the all-audio CD—that is, the CD-V player can play an all-audio CD. In addition, Philips is preserving compatibility with videodisc players. The company says it plans to issue 8- and 12-inch CD-V's that, in effect, will be the same as Laserdiscs but with digital sound tracks. Analog audio tracks will also be retained to preserve compatibility with existing Laservision players. Pioneer is already selling players that can play standard audio CD's as well as 8- and 12-inch discs with digital audio; therefore, Philips, in effect, has invented something that is on the market already.

Although there have been discussions on setting standards for CD-V, Philips apparently chose to go ahead on its own with the demonstrations. Publicly, the company said they were for informational purposes only, but observers at the demonstrations were told that machines and discs were due in late 1987 or early 1988.

Philips' efforts have met with some criticism. A highly placed Sony Corporation of America official said that no standards had been adopted for CD-V and that Sony opposed the Philips system because, unlike the other CD systems, it was not compatible with the three international television standards (NTSC, PAL, and SECAM).

Therefore, CD-V's developed for one standard could not be used with players of the other two. The same official charged that Philips' system represented an attempt to "recoup its enormous investment in Laservision." Sony indicated that the development of true standards for a CD-V system would take more than a year.

• **8mm video's potential.** Although companies backing the VHS format officially oppose the adoption of the new 8mm video format, most Japanese companies are doing quiet research on the potential of the 8mm system. Because the system was developed by a committee of engineers from a large number of companies in the video industry, it was designed with built-in flexibility and potential for improvement.

For instance, although the new VHS-C camcorders are just about as compact as the 8mm versions, the latter have potential for startling further size reduction. VHS-C, on the other hand, probably has gone about as far as it can go in miniaturization. The reduction in the size of the VHS-C transport was accomplished largely by reducing the size of the head drum by almost half and increasing its speed. Further reductions in size appear not to be feasible. On the other hand, the full-size 8mm head drum starts out considerably smaller than that of the VHS system. Those exploring 8mm's potential point out that its head drum could be reduced in the same way as VHS's. Further, because of the design of the 8mm cassette, a reduced-size head drum virtually could be fitted inside the cassette itself.

Other future 8mm developments can only be hinted at. The system, of course, has an option for a digital-audio track, and some 8mm VCR's can be used as digital-audio recorders by recording sound on six tracks, with no video. What if one or more of those audio tracks were used for digital-video information? One result could be still pictures with sound. Another possibility is up to six simultaneous digital still-video tracks, with the user switching from one to any other by means of a wireless remote control.

R-E

Easier Testing. By Comparison.

*Scopemate 2.™ With Your Scope Or Ours,
Still The Best Price Solution
For Good/Bad IC and Component Testing.*

Now you can economically test all types of analog, digital and hybrid components—including resistors, capacitors, diodes and ICs with up to 40 pins—using a simple X-Y oscilloscope. In the field or on the bench, in-circuit or out-of-circuit. Without tedious pin-by-pin or contact-by-contact testing.

It's made possible by Scopemate 2™ from Beckman Industrial. All it does is plot voltage vs. current. Just a lot easier. A lot faster.

Scopemate 2 compares components known to be good with those to be tested, giving you a very accurate and fast way to identify bad devices. The voltage vs. current plot from a known good device is compared to the device under test. In fact, since there's no complex numerical test data to interpret, Scopemate 2 is ideal for less experienced personnel.

And, at \$495 it doesn't take too long to figure that Scopemate 2 may pay for itself in saved testing time. Real soon. Scopemate 2 comes with a simple yet comprehensive operator's manual, a complete set of leads, interconnect cables and plug-in transformer.

Although Scopemate 2 will work with just about any X-Y oscilloscope,

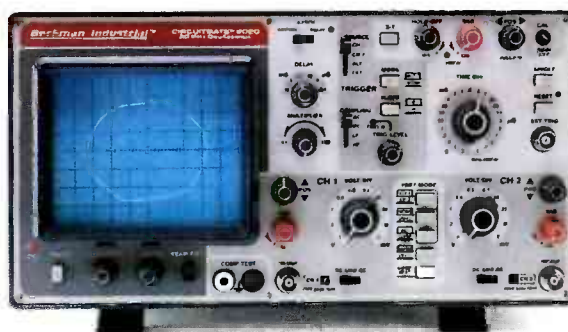

9020 20MHz Delayed Sweep Oscilloscope \$495.00

Vertical Accuracy: ±3%
Time-based accuracy: ±3%
Input Impedance: 1M ohm 35pF (2%)
Input Max. Voltage: 400V (DC+ pos. peak AC)
Sweep Delay Ranges: 10, 1.0, 1ms; 10, 1.0, 1μs
Mode: Normal, search, delay

Beckman Industrial Circuitmate™ Model 9020 offers capabilities seldom found on other scopes costing less than \$500.

Proven capabilities such as **delayed sweep** for easy bandwidth analysis, zoom-in for short-duration events, a variable holdoff function for a stable display of non-periodic signals—even beam finding to

Scopemate 2™ IC/Component Tester \$495.00

Test Method: Direct Visual Comparison (known good vs. device under test)

Test Sockets/Interface: 20 and 40-pin ZIF IC sockets; banana jacks

Power: 120 or 220VAC, 50/60Hz, 5VA max. (Specify)

Circuit Test Voltage/Current: 14VAC RMS (voltage, approx.); 300μA AC RMS (current, approx.)

Pin Test selection: Push-button switch per pin.

locate and return trace to view regardless of control settings. And switchable X1/X10 probes give you more sensitivity for low frequency measurements, less circuit loading for high frequency measurements.

For real value, combine the 9020 and Scopemate 2 for performance and flexibility unmatched by systems costing \$1,500 or more. For less than \$1,000.

Both Scopemate 2 and our Circuitmate Model 9020 illustrate a simple commitment by Beckman Industrial—to provide service test instruments that meet your needs. Whether through advanced technology or value-oriented applications of proven technology, Beckman Industrial gives you the right features at the right price, with service test instruments built to rigorous standards of quality and reliability.

Visit your Beckman Industrial distributor today and find out how the ruggedly reliable Scopemate 2 and the 9020 Oscilloscope can meet your needs. And why they offer the best value around. By comparison.



*In Service
Instruments,
We're The One.*



Beckman Industrial™

Beckman Industrial Corporation, Instrumentation Products Division
A subsidiary of Emerson Electric Company
630 Puente Street, Brea, CA 92621
(714) 671-4800 • FAX: (714) 671-4874 • TLX: 188790
© 1986 Beckman Industrial Corporation

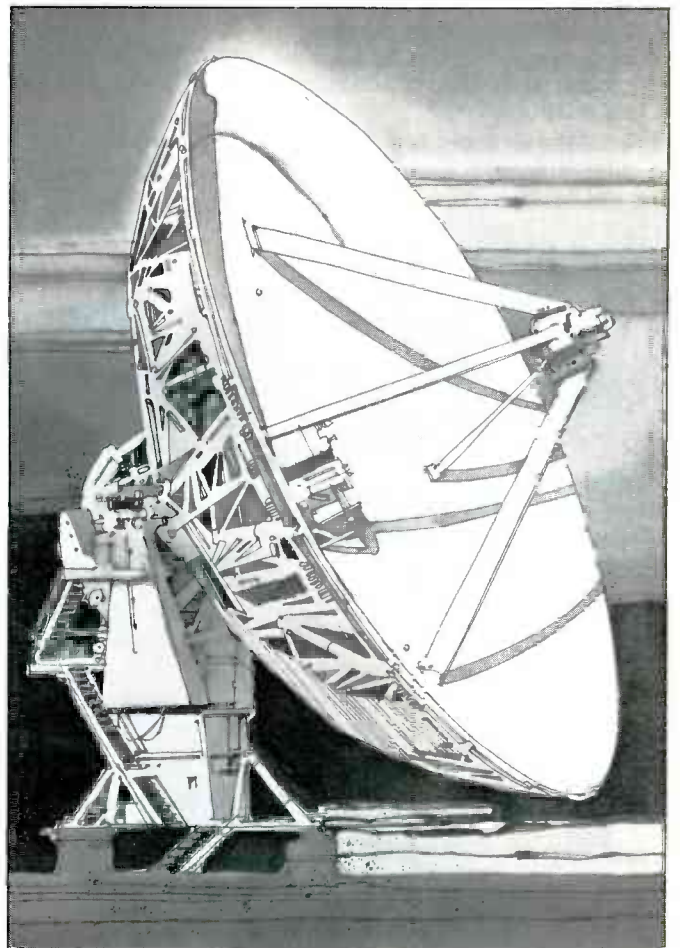
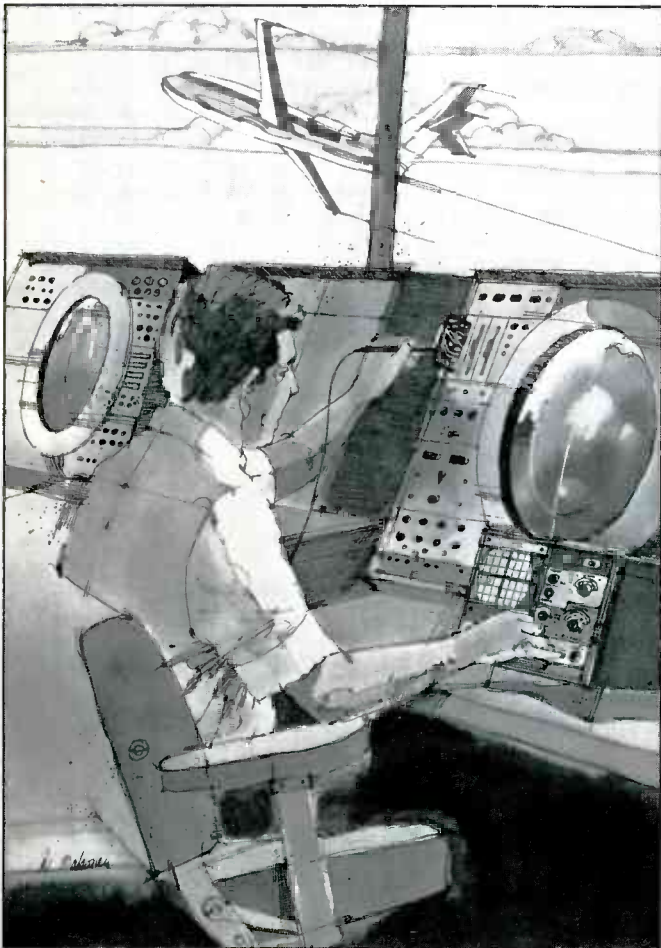
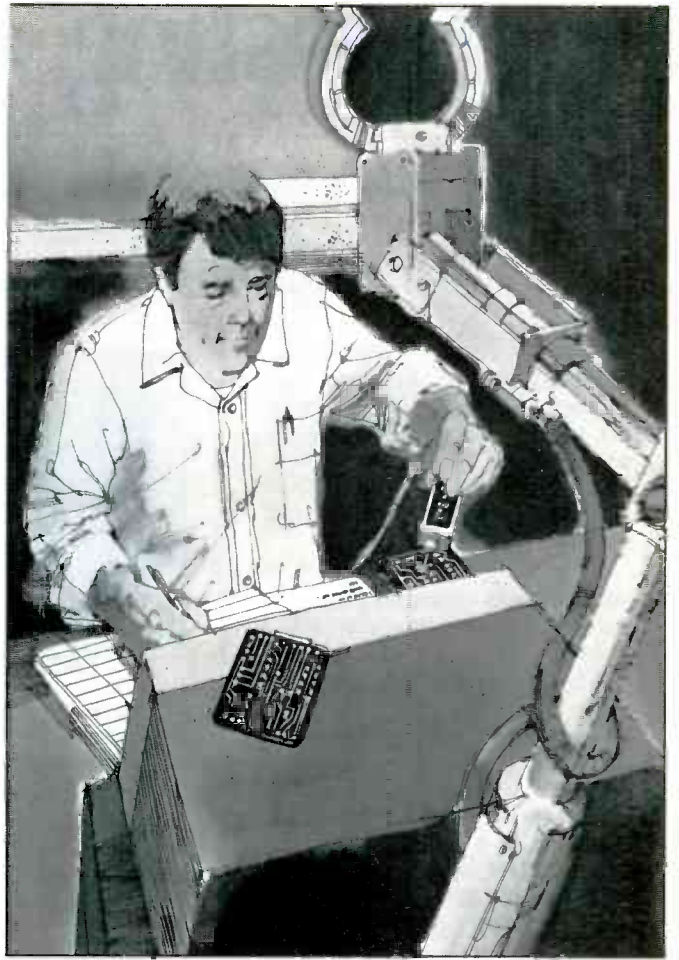

CIE MAKES THE WORLD OF ELECTRONICS YOURS.

Today's world is the world of electronics. To be part of it, you need the right kind of training, the kind you get from Cleveland Institute of Electronics, the kind that can take you to a fast growing career in business, aerospace, medicine, science, government, communications, and more.

Specialized training.

You learn best from a specialist, and that's CIE. We're the leader in teaching electronics through independent study, we teach only electronics and we've been doing it for over 50 years. You can put that experience to work for you just like more than 25,000 CIE students are currently doing all around the world.

Practical training.

You learn best with practical training, so CIE's Auto-Programmed® lessons are designed to take you step-by-step, principle-by-principle. You also get valuable hands-on experience at every stage with sophisticated electronics tools CIE-designed for teaching. Our 4K RAM Microprocessor Training Laboratory, for example, trains you to work with a broad range of computers in a way that working with a single, stock computer simply can't.

Personalized training.

You learn best with flexible training, so we let you choose from a broad range of courses. You start

with what you know, a little or a lot, and you go wherever you want, as far as you want. With CIE, you can even earn your Associate in Applied Science Degree in Electronics Engineering Technology. Of course, you set your own pace, and, if you ever have questions or problems, our instructors are only a toll-free phone call away.

The first step is yours.

To find out more, mail in the coupon below. Or, if you prefer, call toll-free **1-800-321-2155 (in Ohio, 1-800-523-9109)**. We'll send a copy of CIE's school catalog and a complete package of enrollment information. For your convenience, we'll try to have a representative contact you to answer your questions.

CIE	Cleveland Institute of Electronics 1776 East 17th St., Cleveland, Ohio 44114
YES! I want to get started. Send me my CIE school catalog including details about the Associate Degree Program. I am most interested in:	
<input type="checkbox"/> computer repair	<input type="checkbox"/> television/high fidelity service
<input type="checkbox"/> telecommunications	<input type="checkbox"/> medical electronics
<input type="checkbox"/> robotics/automation	<input type="checkbox"/> broadcast engineering
<input type="checkbox"/> other _____	
Print Name _____	
Address _____ Apt. _____	
City _____ State _____ Zip _____	
Age _____ Area Code/Phone No. _____	
Check box for G.I. Bulletin on Educational Benefits ARE-56	
<input type="checkbox"/> Veteran	<input type="checkbox"/> Active Duty
MAIL TODAY!	

ASK R-E

UNDERSTANDING CATV LINGO

Please translate the hodge-podge of terms used by the American cable-TV industry to describe their bands and frequency allocations. Here in West Germany, the CATV channels are 7 MHz wide, and the allocations are 118 to 174 MHz, Channels S3 through S10, 130 to 300 MHz, Channels S11 through S20.

I'd like to have the same type of information on American cable TV. Some of the terms used are Mid-band, MID A5-A1, Super J-W, Hyper AA-ZZ, 105-channel cable-ready, and 137-channel cable-ready.—H. N., APO New York.

Many channels are available to the CATV companies; they're located above and between the channels usually used for our off-the-air fare. In all but the simplest CATV systems, a converter must be used to process the incoming cable-TV signals so they can be fed to the TV set. Usually, cable converters provide output signals on standard TV channels 2, 3, or 4. Most companies have "premium" channels that cannot be viewed unless additional fees, above the standard monthly rental, are paid.

In some cases, the program is scrambled at the source and a decoder or descrambler is needed to view the program. In other cases, the premium channel is filtered out in the "drop" line feeding the cable subscriber's home.

In addition to the low VHF (Channels 2 through 6, 54 to 88 MHz), FM broadcast band (88 to 108 MHz), high VHF (Channel 7 through 13, 174 to 216 MHz), and UHF (Channels 14 through 83, 470 to 890 MHz), cable companies have available several bands of frequencies, including:

- Mid-band—frequencies be-

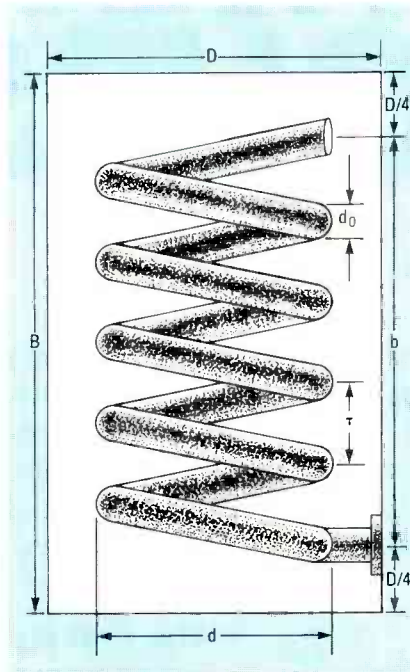

FIG. 1

tween 88 and 174 MHz. The nine channels are usually designated A through I.

- Super-band—includes frequencies between 216 and 300 MHz. The fourteen channels are usually designated J through W.

- Hyper-band—several channels between 300 and 402 MHz.

In most cases, the cable company supplies the converter box (and descrambler, when needed) to feed the cable signal into either channel 2, 3 or 4; channels are selected by controls on the front panel of the converter.

A cable-ready set does not require a converter to receive the basic CATV service. The set has an electronic tuner that can be switched to receive all, or nearly all the channels likely to be used by a CATV company. A 105-channel cable-ready set covers twenty-two channels, in addition to the eighty-

WRITE TO:

ASK R-E
Radio-Electronics
500-B Bi-County Blvd.
Farmingdale, NY 11735

two available for off-the-air telecasts. The 137-channel sets provide fifty-four additional channels of programming.

The CATV system in my area offers "Super-Basic" for \$13.25 a month. Their line-up includes twenty-nine channels, including four premium channels. "Home Box Office" (HBO, a movie service) is trapped out at the "drop" feeding the subscriber's home. "Premium Movies," "The Movie Channel," and "The Disney Channel" are scrambled; to receive them, the subscriber must rent a descrambler for an additional \$9.00 per month.

HELICAL RESONATOR TRAP

I enjoyed the article on TV descrambling in the June 1986 issue and became particularly interested in the method of scrambling by introducing a RF carrier as deliberate interference. Our local cable company uses that method of scrambling HBO on Channel 4. Following the author's suggestion, I can obtain a reasonably good picture by connecting a quarter-wave section of 300-ohm twin-lead across the line. The author also mentioned using a helical resonant cavity made from a coffee can and a few feet of copper tubing. Now I'm totally confused. The interfering signal has a wavelength of about 4.2 meters, so the dimensions of either a cylindrical or a rectangular resonator should be similar. Evidently, the key word is "helical." Can you refer me to any literature describing the design of that type of resonator?—T. J. K., Columbia, SC.

Figure 1 shows the physical details of a helical resonator. When the inner conductor is wound into a helix, a resonator with a Q ranging into the thousands can be

Authorized



Liquidator

XEROX® COMPUTER FOR BUSINESS, AND PERSONAL USE!

XEROX®... The Name You Can Trust!

For over 20 years, Xerox® has been the world leader in office automation and copying equipment. They have set standards that others can only imitate. The Xerox® 6064 Personal Computer was designed to meet the demands of business, professional, and personal computing today, and into the future! We are proud to offer this complete Xerox® System at a remarkably **LOW price**. Compare for yourself... then buy your Xerox® 6064 from C.O.M.B.!

Get the Xerox® Advantage! The Xerox® PC offers you the advantage of running IBM™ compatible MS™-DOS, so you can run the hundreds of business and professional software programs available today! And the Xerox® PC is easy to use! It's designed to get you up and running as quickly as possible with computer-aided instruction and superior documentation covering all aspects of personal computing.

Xerox®... Service You Can Count On! If you're considering an IBM™-compatible, don't be misled by price alone! The system we are offering is a **complete system**... very easy to hook up and use... and very affordable. But more than that, each system we sell is backed by Xerox® service and support. When you buy this system, your name and computer's serial number is automatically registered with Xerox®. Should you need service or advice, a network of over 150 service centers stands ready to help you. Before you buy... compare! Xerox® is your best value! Check all these features:

- IBM™-PC Compatibility.
- Standard 83-Key PC Keyboard with Mouse Interface (Mouse Not Included).
- High-Resolution Monochrome Monitor, with 10" Diagonal Non-Glare Screen, Swivel and Tilt Housing.
- Two 5 1/4" Floppy Disk Drives.
- 256KB Memory. 8MHz Intel 8086-2 Microprocessor for Faster Speed, Less Waiting Time.
- Seven Expansion Slots, Serial Port for Communications or Printer, and Parallel Printer Port.
- Comes with ScreenMate™, a User Friendly Guide to the Functions of the MS™-DOS Operating System.
- Menu Driven... No Need to Remember Complicated Commands! ScreenMate™



Lets You Select from a Menu and Provides Clear On-Line Instructions If You're Confused About Your Next Step.

Complete Tutorial Software and Manuals Included:

- "Getting Started" Booklet.
- Four Reference Guides.
- Four Software Programs: Two X-Cel™ Training Disks, Two Diagnostic Disks, GW™-BASIC Interpreter, and MS™-DOS/ScreenMate™ Operator's Guide.
- Twenty Blank Disks.

Over 150 Service Centers Nationally.

Manufacturer's Limited 90-Day Warranty on Parts/Labor.

List Price \$2764.80

\$999

Liquidation Priced At Only

Item H-2178-7118-557 Shipped Freight Collect Ship Wt.: 79 lbs.

Xerox® and the identifying numbers herein are trademarks of XEROX® CORPORATION.

Toll-Free: 1-800-328-0609

Credit Card customers can order by phone, 24 hrs. a day, 7 days a week.



SEND ME THE ITEMS I HAVE LISTED BELOW

Sales outside 48 contiguous states are subject to special conditions. Please call or write to inquire.

Item No.	Qty.	Item	Price	S/H

TOTAL (Products plus ship, handling)

SEND TO:
C.O.M.B. Direct Marketing Corp.
1405 Xenium Lane N/Minneapolis, MN 55441-4494
Item H-2178

Send the items indicated at left. (Minnesota residents add 6% sales tax. Sorry, no C.O.D.)

My check or money order is enclosed. (No delays in processing orders paid by check.)

Charge: VISA® MasterCard® DiscoverSM American Express®

Acct No. _____ Exp. / _____

PLEASE PRINT CLEARLY

Name _____

Address _____

City _____

State _____ ZIP _____

Phone (_____) _____

Sign Here _____



achieved. During developmental studies on the device, resonators were built that operated at frequencies ranging from approximately 2 MHz (in a 7-inch diameter shield) to 1000 MHz (in a 0.7-inch diameter shield). Unloaded Q ranged from 400 to 2000.

Unloaded Q is about 50 times the shield diameter (in inches) times the square of the resonant frequency (in MHz). Shield length (B) is about 30% greater than diameter (D).

Other variables involved in the design of a helical resonator are:

- b—axial length of coil in inches
- d—mean diameter of coil
- d_0 —conductor diameter
- τ —center-to-center spacing of turns
- Z_0 —characteristic impedance
- δ —skin depth

Skin depth is a frequency-dependent factor that is the depth below the surface of a conductor where the current density has diminished to 1 neper of the current

density on the surface.

Because of the complexity of the way those variables interact, we cannot give complete design details here. But, for example, using rough calculations from available data, the inside diameter of a shield for a Channel-4 helical-resonator trap can range from 6 inches (for an unloaded Q of 2000) to 0.4 inch (for an unloaded Q of about 180).

For complete helical resonator design data, see one or more of the following:

- "Coaxial Resonators with Helical Inner Conductor," W. W. Macalpine and R. O. Schildnecht, *Proceedings of the IRE*, December 1959, pp 2099-2103.
- "Helical Resonator Design Chart," W. W. Macalpine and R. O. Schildnecht, *Electronics*, August 12, 1960, pp 141-144.
- "Helical Resonator Design," Lawrence E. Stoskopf, *73 Magazine*, Dec. 1973, pp 49-52.
- "Taking Out the 2-Meter Garbage," Donald R. Molen, *QST*, June 1972, pp 48-50.
- "A Review of Transmission Lines As Circuit Elements," Wilfred Jensby, *QST*, Nov. 1966, pp 34-39.
- "Coaxial Tank VHF Filters," Edward Tilton, *QST*, Oct. 1964, pp 11-15.
- "Two-Stage Cavity Filter for Two Meters," Stirling M. Olberg, *Ham Radio*, Dec. 1973, pp 22-25.
- "Lines and Resonators with Helical Inner Conductor," *Reference Data for Radio Engineers*, 4th Edition, pp 600-603.

MORE ON PEST REPELLERS

An article in your July 1985 issue discussed ultrasonic pest repellers. The author mentioned several devices and their prices. Can you publish the addresses of sources of these devices?—T. A., Nicolet, AZ.

The author says that he saw the three devices mentioned in the article advertised recently, but did not note names or addresses. Recently, however, a repeller called *Super Bug-Away* has been advertised on stations carrying CNN programs in the early morning hours. The *Bug-Away* costs \$29.95 plus \$2.00 postage and handling. Call 1-800-367-2400 for information and literature.

continued on page 89

★ CABLE TV SPECIALS ★

CONVERTERS

JERROLD: JRX-3 DIC—36 Channel Corded Remote \$149.⁹⁹
 JSX-3 DIC—36 Channel Set Top \$129.⁹⁹
 SB-3—'The Real Thing' \$119.⁹⁹
 SB-3A-4 port \$99.⁹⁹

ZENITH: Z-TAC Cable Add-On \$199.⁹⁹

VIEW STAR: EVSC-2010—60 Channel Wireless—
 with Parental Lockout \$ 99.⁹⁹
 EVSC-2010 A-B—Same as above with
 A-B Switch \$109.⁹⁹
 View Star 2501—60 Channel Wireless
 with Volume \$119.⁹⁹

MISCELLANEOUS

OAK: N-12 Mini-Code \$ 89.⁹⁹
 N-12 Mini-Code Vari-Sync \$109.⁹⁹
 N-12 Mini-Code Vari-Sync Plus Auto On-Off . . \$165.⁹⁹

JERROLD: 400 & 450 Handheld Transmitters \$ 29.⁹⁹

HAMLIN: MLD-1200 \$ 99.⁹⁹

NEW ITEMS: Ripco Tape Copy Stabilizer \$149.⁹⁵

Scientific Atlanta **Call for Price**

OAK: E-13 Mini-Code Substitute \$ 79.⁹⁵
 E-13 Mini-Code W/Vari-Syn \$ 89.⁹⁵

ALL UNITS GUARANTEED. QUANTITY PRICES AVAILABLE.

UNITED ELECTRONIC SUPPLY

P.O. BOX 1206 • ELGIN, ILLINOIS 60121 • 312-697-0600

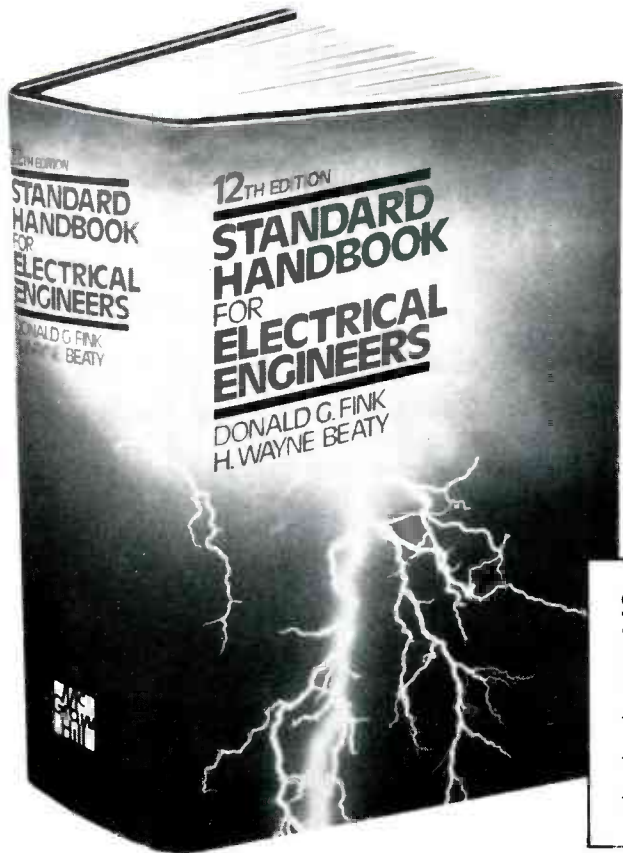

TAKE THIS GIANT \$86.50 HANDBOOK FOR ONLY \$14.95...

When you join the **Electronics and Control Engineers' Book Club®**

You simply agree to buy 3 more books — all at substantial discounts — within the next 12 months.

STANDARD HANDBOOK FOR ELECTRICAL ENGINEERS, 12th Edition.

Edited by Donald G. Fink and H. Wayne Beaty.

- ★ 2248 pages, 1863 illustrations and tables
- ★ Fully updated to cover all recent advances and developments
- ★ Written and compiled by 115 leading experts

The essential reference for Electrical Engineers!

Why you should join today:

THE BEST AND NEWEST BOOKS FROM ALL PUBLISHERS — Books are chosen from a wide range of publishers, by expert editors and consultants, to give you the best selection of books in your field.

BIG SAVINGS — Build your professional library at savings of usually 20-30% and often as much as 40% off publishers' list prices.

BONUS BOOKS — You will immediately begin to participate in our Bonus Book Plan that allows you savings of up to 70% off publishers' prices of many professional and general interest books.

CONVENIENCE — 14-16 times a year (about once every 3-4 weeks) you will receive the Club Bulletin FREE. It fully describes the Main Selection and a variety of alternate selections. A dated Reply Card is included. If you want the Main Selection, simply do nothing — it will be shipped automatically. If you want an alternate selection or no book at all, indicate it on the Reply Card and return it by the date specified. You will have at least 10 days to decide. If because of late delivery of the Bulletin you receive a Main Selection you do not want, you may return it for credit at the Club's expense.

As a Club member you agree only to the purchase of three additional books, from over 300 different titles that will be offered, during the first year of membership. Membership may be cancelled by either you or the Club at any time after you have purchased the three additional books.

The Twelfth Edition of this classic handbook provides up-to-the-minute information in such rapidly changing areas as nuclear power generation, high-voltage transmission systems, and alternative energy sources. It also covers such essentials as basic circuits, magnetism, power distribution, telecommunications, industrial electronics and electrical standards. All information is geared toward the practicing engineer and organized for quick on-the-job reference.

Take advantage of this outstanding limited-time offer — join the Electronics and Control Engineers' Book Club today and get your Handbook for only \$14.95!

FILL OUT THIS COUPON AND MAIL TODAY



McGraw-Hill Book Clubs

Electronics and Control Engineers' Book Club®

P.O. Box 582, Hightstown, NJ 08520-9959

Please enroll me as a member and send me the STANDARD HANDBOOK FOR ELECTRICAL ENGINEERS, 12th Edition (209/758) for just \$14.95, plus local tax, shipping and handling charges. I agree to purchase a minimum of three additional books during my first year of membership as outlined under the Club plan described in this ad. I understand that a shipping and handling charge is added to all shipments.

Signature _____

Name _____

Address/Apt. # _____

City _____

State _____ Zip _____

This order subject to acceptance by McGraw-Hill. All prices subject to change without notice. Offer good only to new members. Foreign member acceptance subject to special conditions.

E33838

LETTERS



MASZOTA TOOL ORGANIZER

Two years after opening Austin-Belmont TV in Chicago, IL, after having worked for 10 years as a Field Engineer for Zenith, the frustration of trying to find tools on a cluttered workbench forced me to seek a better method of organization. We had tried conventional organizers—magnetic tool holders, bars with rounded metal loops to hold individual tools, etc. They didn't work for us! Service technicians were still wasting time looking for tools on their benches. Also, there was no organization of any kind for the many odd-sized

tools and service accessories used daily by our men.

I decided to solve the problem and created the organizer described below. Our problem was solved immediately. We have used the organizer since 1971, and it has proven to be the best organizer that we have ever seen or used—far surpassing what was then and is now on the marketplace. The organizer differs from other organizers by the fact that tools are contained by resting against a pegboard wall at odd angles inside a drum of chicken wire.

Although it can be built in dif-

ferent sizes, we use an 18-inch square piece of chicken wire. The wire is rolled to form a drum, and the drum is secured by tying the short, cut ends of the wire, or by sewing them together by weaving a single strand of copper wire through both ends of the roll.

Using conventional pegboard hooks, the drum is hung on a pegboard in a visible area, within easy reach of the normal standing (or sitting) position by the workbench. Tools of any size and shape can literally be thrown into the organizer. The technician does not have to think consciously about

Small Outlines. No Problem.

With A P Products™ brand SOIC Test Clips.

- Allows safe, convenient, fast and easy testing of normally hard-to-access Small Outline Integrated Circuits (SOICs).
- Eight sizes available for .30" and .15" package sizes.
- Helical compression springs and insulating contact combs ensure contact integrity during testing.
- Permits devices stacked as close as .025" end-to-end to be tested simultaneously.
- Standard .025" square contacts on .10" centers at the probe end of the clip easily accept test probes or single row female socket connectors.
- Steel hinge pin and acetal thermoplastic body provide long service life.
- Available with alloy 764 unplated and gold plated leads.

For immediate response contact a local authorized A P Products Prototype & Test Devices distributor. Or telephone 800-321-9668 or (216) 354-2101 in Ohio for further information.

We Solve Problems.

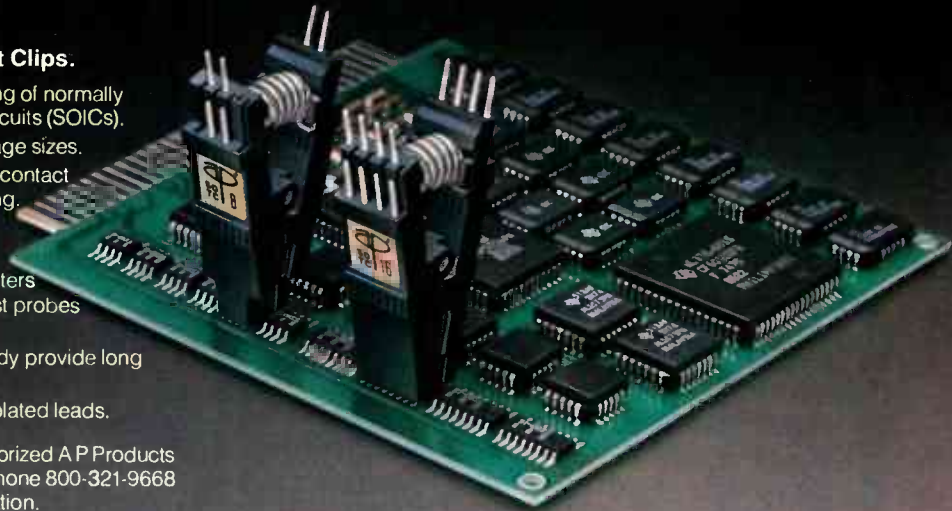

Associated Electronics/3M

A P Products Prototype & Test Devices
9325 Progress Parkway, P.O. Box 540
Mentor, Ohio 44060.

CIRCLE 76 ON FREE INFORMATION CARD

HITACHI OSCILLOSCOPES



V-212

20 MHz Dual Channels

Convenient 0, 10, 90 and 100% amplitude markings, vertical mode triggering, 1mV/div. sensitivity & ±3% accuracy, TV sync separation circuit, X-Y mode, low drift.

\$429.



V222

20MHz Dual Channels

Same as above with DC offset to measure signals having DC components, CH1 output and DC offset voltage monitor outlet available for external counter or DVM*, alternate magnify function provides x1 and x10, sweep waveforms to be simultaneously displayed.

\$511.

*The purchase of a Model V222 oscilloscope entitles you to purchase a Revere Model RDMT10 3 1/2 digit, 10 amp. scale digital multi-meter for \$39.95! Regular price is \$49.95. Offer applies only to Hitachi Model V222.

ALLEN

INDUSTRIAL ELECTRONICS GROUP

"The ALLEN INDUSTRIAL ELECTRONICS GROUP highly recommends these fine Industrial Quality

 Hitachi Oscilloscopes"

Richard S. Vialton MSEE
Sales Manager
ALLEN
INDUSTRIAL ELECTRONICS GROUP

 **HITACHI**
SAVE UP TO \$850.00!

V1100A

100MHz/Quad Channels, 8-trace, delayed sweep, CRT readout, digital measurement.

\$2260.

V1070A

100MHz/Quad Channels, 8-trace, delayed sweep, CRT readout.....

\$1610.

V1050F

100MHz/Quad Channels, 8-trace, delayed sweep.

\$1395.

V650F

60MHz/Triple Channels, delayed sweep.....

\$1057.

V-422

40MHz, Dual Channels.

\$785.

VC6041UG

40MHz, sampling, dual channels, 1mV dual trace, 6" CRT, 4k words per channel. GPIB option.

\$5180.

VC6041UX

40MHz, digital storage, 1mV dual trace, 6" CRT, 4k words per channel.

\$4380.

V509

50MHz, dual channels, mini portable, delayed sweep.

\$1199.

V134

10MHz, dual trace, bi-stable storage.....

\$1395.

V209

20MHz, dual channels, AC-DC, mini portable.....

\$815.



WM. B. ALLEN SUPPLY COMPANY, INC.

ALLEN SQUARE

THE 300 BLOCK • NORTH RAMPART STREET
NEW ORLEANS • LOUISIANA 70112-3106
LOUISIANA TOLL FREE 800 462 9520 • NEW ORLEANS (504) 525 8222

CALL NATIONWIDE TOLL FREE

800 535 9593

24 HOURS A DAY!

ALL MAJOR
CREDIT CARDS
HONORED



CIRCLE 103 ON FREE INFORMATION CARD

NRI Trains You At Home—As You Build Your Own IBM PC Compatible Computer

GET THE KNOW-HOW TO SERVICE EVERY COMPUTER ON THIS PAGE... AND MORE!

Learn the Basics the NRI Way— and Earn Good Money Troubleshooting Any Brand of Computer

The biggest growth in jobs between now and 1995, according to Department of Labor estimates, will occur in the computer service and repair business, where demand for trained technicians will actually double.

You can cash in on this opportunity—either as a full-time corporate technician or an independent service-person—once you've learned all the basics of computers the NRI way. NRI's practical combination of "reason-why" theory and "hands-on" building skills starts you with the fundamentals of electronics, then guides you through advanced electronic circuitry and on into computer electronics. You also learn to program in BASIC and machine language, the essential languages for troubleshooting and repair.

Total Computer Systems Training, Only From NRI

No computer stands alone... it's part of a total system. To really service computers, you have to understand computer *systems*. And only NRI includes a powerful computer system as part of your training, centered around the new, fully IBM PC compatible Sanyo 880 Series computer.



IBM is a Registered Trademark of IBM Corporation.
Epson is a Registered Trademark of Epson America, Inc.
Apple and the Apple logo are Registered Trademarks of Apple
Computer, Inc.
Compaq is a Registered Trademark of COMPAQ Computer Corporation.
© 1985 AT&T Technologies, Inc.

NEW!

Train with the newest Sanyo 880 Series Computer—it's fully IBM-compatible and runs almost twice as fast as the IBM PC!

You start with the step-by-step assembly of the new, highly-rated, Sanyo computer. You install and troubleshoot the "intelligent" keyboard. Then you assemble the power supply, install the disk drive, and add extra memory to give you a powerful 256K RAM system. The new 880 computer has two operating speeds: standard IBM speed of 4.77 MHz and a remarkable turbo speed of 8 MHz, making it almost twice as fast as the IBM PC. Next, you'll interface the high-resolution monitor and begin to use the valuable software included with your complete computer system.

It all adds up to confidence-building, real-world experience that includes training in programming, circuit design, and peripheral maintenance. You'll be learning about, working with, servicing, and troubleshooting an entire computer system—monitor, keyboard, computer, disk drive, power



supply—to ensure that you have all the essential skills you need to succeed as a professional computer service technician.

No Experience Needed, NRI Builds It In

This is the kind of practical, hands-on experience that makes you uniquely prepared, with the skills and confidence you need for success. You learn at your own convenience in your own home. No classroom pressures, no night school, no need to quit your present job until you're ready to make your move. Your training is backed by your personal NRI instructor and the NRI technical staff, ready to answer your questions and help you when you need it. You get it all with NRI at-home training.

100-Page Free Catalog Tells More

Send the postage-paid reply card today for NRI's big, 100-page, color catalog on NRI's electronics training, which gives you all the facts about NRI courses in Microcomputers, Robotics, Data Communications, TV/Audio/Video Servicing, and other growing, high-tech career fields. If the reply card is missing, write to the address below.

Your NRI total systems training includes:
 • NRI Discovery Lab™ to design and modify circuits
 • Your four-function, digital multimeter with walk-you-through instructions on audio tape
 • Digital logic probe for visual examination of keyboard circuits
 • The newest Sanyo 880 Series Computer with "intelligent" keyboard and 360K double-density, double-sided disk drive
 • High resolution monochrome monitor • 8K ROM, 256K RAM
 • Bundled software including GW BASIC, MS-DOS, WordStar, CalcStar
 • Reference manuals, schematics, and bite-size lessons.

SEND COUPON TODAY FOR FREE NRI CATALOG!

NRI SCHOOLS

McGraw-Hill Continuing Education Center
 3939 Wisconsin Avenue, NW, Washington, DC 20016

We'll give you tomorrow.

For Career courses approved under GI Bill
 check for details.

CHECK ONE FREE CATALOG ONLY

- | | |
|--|---|
| <input type="checkbox"/> Computer Electronics | <input type="checkbox"/> Basic Electronics |
| <input type="checkbox"/> TV/Audio/Video Servicing | <input type="checkbox"/> Electricians |
| <input type="checkbox"/> Satellite Electronics | <input type="checkbox"/> Small Engine Repair |
| <input type="checkbox"/> Robotics & Industrial Control | <input type="checkbox"/> Air Conditioning, Heating, & Ref. |
| <input type="checkbox"/> Industrial Electronics | <input type="checkbox"/> Locksmithing & Electronic Security |
| <input type="checkbox"/> Telephone Servicing | <input type="checkbox"/> Photography |
| <input type="checkbox"/> Digital Electronics Servicing | <input type="checkbox"/> Bookkeeping & Accounting |

Name (Please print) _____

Age _____

Street _____

City/State/Zip _____

Accredited by the National Home Study Council

000-000

where to place the tool. Also, odd-sized supplies, such as tape, rules, small instruments, etc., can be stored by inserting them so that they lie safely in the drum of the organizer. There is no searching for tools. They stay put, and are easily retrievable when needed.

We are pleased to offer the above description to the readers of **Radio-Electronics** for their own use (not for sale) as a token of appreciation for the wealth of information provided by the magazine readership to us over the years.

Anyone interested in mass production of the organizer for profit is welcome to get in touch with us concerning a transfer of the rights to this invention.

RICHARD "DICK" MASZOTA
A-B Television
3 North Melbourne Street
Beverly Hills, FL 326665.

SCHEMATIC ERROR

I have spotted an error in Fig. 2 in the October 1986 "Ask-RE" department. I think that readers will be able to build more satisfactory

baluns if they will shorten the longest dimension shown in the drawing slightly. It should be about 50", depending on the formula you use to calculate length, rather than the 53 3/4" shown.

MICHAEL CHEDIAK
Sherman Oaks, CA

KUDOS FOR JACK DARR

After reading you for many years, I finally felt the urge to tell you how much I have enjoyed your column, "Service Clinic," and your answers to service questions. While I am not a TV repair man, I still read your material, because you are teaching the most important thing of all: *how to think*.

That may sound absurdly simple, but you do it better than anyone else I have come across. For me, you are 75% psychological and 25% the best repairman in the business. It is something like the case of the wise old sage who tried to teach hungry people how to plant and grow grain, not how to eat it.

I would like to pass along my

thoughts on what were my own stumbling blocks. Every time I ran into a problem that should have taken five minutes to solve, but ended up taking five hours, I would look back and carefully examine what made it take so long. The answer almost always boiled down to one simple phrase: *I took something for granted*.

I looked at the glass fuse and it looked good.

I put in a brand new part; it just came from the factory, so it must be good.

This is a brand new part; it must be within company specs.

There is an insulated wire. I can see the wire coming out of each end of the insulation. There must be something in the middle. (It was burnt up.)

I can see solder sitting on the top; it must be soldered.

The relay turns on and off; it must be OK. (It had a magnetized core and would not release.)

This company just told me that they make the best part in the business. Would they lie?

Send Purchase Order
Check, Money Order, or C.O.D.
or Call Toll Free
800-223-0826
In N.Y. State (212) 865-5580

#1 IN CABLE BOXES
SPECIAL!

JERROLD CORDLESS CABLE TV CONVERTER

MODEL STARCOM-460

\$99.95

ANY QUANTITY

- Volume control
- 68 channels
- Mute control
- Automatic fine tuning
- Instant channel recall
- Programmable to go on at a particular channel and off automatically
- Compatible with descramblers



JERROLD CORDLESS CABLE TV CONVERTERS



MODEL DRX3-105/400

\$69.95

- 58 channels
- Remote channel changing
- Remote on/off switch
- Remote fine tuning

JERROLD CORDLESS CABLE TV CONVERTER

MODEL DRZ/450

\$69.95/

\$79.95 ea. / 10 lot

- 66 channels
- Automatic fine tuning
- A/B switch option



"THE RABBIT" VIDEO MULTIPLYING SYSTEM

TR-7000

\$51.95

\$59.95/6-11
\$69.96/1-5

12 up



IT'S LIKE HAVING A VCR IN EVERY ROOM

OMNITRON

ELECTRONICS

770 Amsterdam Ave., New York, NY 10025

SHIPPING CHARGES

For Orders	Add
\$25-100	\$6.50
\$100-500	\$8.50
\$500-750	\$10.50
\$750 and up	\$20.00

Write for
FREE CATALOG
1-30 1-2-308

MASTER CARD VISA

AN OUNCE OF PREVENTION.



The complete line of Flameproof Resistors from NTE Electronics.

NTE Flameproof Resistors are designed to provide you with a premium quality replacement device... that won't flameout or short even under the most severe overloads.

Our resistors range in capability from 1/8 Watts to 25 Watts with resistance values from 10 to 2.2 Megohms.

They're totally noncombustible with a metallic resistance material between a nonresistant core and a special ceramic outer cover.

NTE Flameproof Resistors are the ideal replacement components for electronic games, telecommunications, medical, data processing, military, broadcast and home entertainment equipment.

Don't take chances with your expensive equipment. Use NTE Flameproof Resistors... they handle the current.

LOOK FOR THE FULL LINE OF QUALITY NTE REPLACEMENT PARTS AND PRODUCTS:

- Transistors
- Thyristors
- Integrated Circuits
- Rectifiers and Diodes
- High Voltage Multipliers and Dividers
- Optoelectronic Devices
- Zeners
- Microprocessors and Support Chips
- Memory ICs
- Thermal Cut-Offs
- Bridge Rectifiers
- Unijunctions
- RF Transistors
- Microwave Oven Rectifiers
- Selenium Rectifiers
- Flameproof Resistors
- Wire Ties
- Electrolytic Capacitors
- Static Control Products



For more information or the name of your local distributor, call or write NTE.



NTE ELECTRONICS, INC.

44 Farrand Street, Bloomfield, New Jersey 07003
(Outside N.J.) 1-800-631-1250 • (N.J. only) 1-800-624-2624

CIRCLE 71 ON FREE INFORMATION CARD

Those are just a few of our stumbling blocks. The fellows who work for me think that I must be an old hard-head whenever I bring such things up to them. However, every time that they run into a problem that takes all day to solve, it usually comes back, of course, to having taken something for granted.

Our primary business is the custom-building of electronic flash units that are used in many ways other than taking pictures. We design the flashtubes and have them custom-made, and we design the power supplies to fire the flashtubes. Our two primary house rules are: (1) *Don't take it for granted.* (2) *Test that new part before you put it in.* Those two rules save us more time than anything else. I would be lost without my curve tracer and special condenser tester.

Thanks again, Jack, and please keep up the good work for many more years!
DEVON RENO
Country Club Hills, IL

INFORMATION REQUESTED

My previous requests for information have never failed to produce results from other readers—sometimes six months later, but always a response. I am most grateful.

Now I need information on tuning and base-end assembly details of a 50's model, Webster Band Spanner (ham) mobile antenna. I hope that someone can help.

MICK McDANIEL
*940 Temple Street
 San Diego, CA 92106*

HELP WANTED

For lack of anywhere else to turn, I am writing to you. I hope that you can help.

A friend of mine owns a Hewlett Packard model 130-B 100-MHz oscilloscope. The scope is inoperable, and we cannot find any service manuals, schematics, or even operating manuals for it. We have, of course, tried to get information from HP, but they claim to no longer have any information on that scope. We would appreciate any

help readers could give us in this matter.

JAY BECKETT, JR.,
*10804 Porter Street
 Crown Point, IN 46307*

HAM RADIO PRIVACY

Herb Friedman's November 1986 column is somewhat misleading. Mr. Friedman interprets the ability to electronically screen incoming transmissions as privacy. Readers may assume that such "privacy" means that others do not hear the subject transmissions. The only privacy afforded by those systems is similar to the privacy achieved by closing one's eyes in a crowded room. None of the various call-screening systems (sub-audible tones, RTTY selcall, Packet Radio, Digital Coded Squelch, etc.) prevent any listening station from hearing any transmission.

The Amateur Radio Service has always been careful to avoid encryption or privacy in amateur transmissions: Amateur Teletype Over Radio (AMTOR) is a variation of the commercial SITOR teletype

EASY LISTENING

- FOR 810 TO 912 MHz BAND SUPER CONVERTER 8001
- FOR YOUR UHF SCANNING RECEIVER AND OTHERS

A super-converter 8001 has been certified by FCC part 15 regulation.

HOW TO ORDER

Name: _____

Address: _____

City: _____ State: _____

Zip: _____ Phone () _____

Make Check or Money Order payable to

GRE AMERICA, INC.

Mail to: GRE AMERICA, INC.

425 Harbor Blvd., Belmont, CA 94002

Unit Cost @ \$59.94 x _____ = _____ Total

CA. Residents Add 6.5% Tax

Shipping & Handling @ \$4.00/

Unit x _____ = _____

Qty. _____

PAYMENT METHOD TOTAL ▶

Check Money Order

Mastercard Visa

Card No. _____

Expiration Date _____

Signature _____

**PHONE ORDER: 800-233-5973
 or 415-591-1400**



The Super Converter 8001 Features:

- Listening to 810–912 MHz Band on a UHF Scanner and /or Other Monitor Receivers
- Easy Connections to Your Receiver
- 9 Volts Battery Operation Power Source and Power On Indicator by LED Display
- External Power Jack Size: 79(w) x 30(H) x 100(D)mm

Warranty

- 180 Days From Date of Purchase

Unit Cost

- \$59.94 plus \$4.00 Shipping and Handling Charge

system that was developed to eliminate the encryption inherent in SITOR; Transmission in ASCII was not allowed in the Amateur Radio Service until only a few years ago. Section 97.117 of the FCC rules prohibits the use of codes or abbreviations where the intent is to obscure the meaning of communications. In fact, privacy in communications is counter to both the spirit and the regulations of the Amateur Radio Service.

Digital or sub-audible-tone squelch and selective receiving systems do let the listener refuse those transmissions outside his or her interest. That ability is useful to Amateur Radio operators in many situations. For example, an operator who is part of a storm-watch network can set the radio so that only transmissions from others in the network will open the squelch. That does not prevent operators outside the network from hearing those transmissions, but it allows our hypothetical ham to pursue his or her normal household chores with a minimum of interruptions from the radio. 73. BOB SCHETGEN, KU7G
Assistant Technical Editor
American Radio Relay League

NOT TRUE

Part 3 of the article "How to Design Oscillator Circuits" by Joseph J. Carr (*Radio-Electronics*, September 1986) is incorrect where the author states: "For example, a squarewave with a fundamental frequency of 200 Hz would be composed of a 200-Hz sinewave, plus 400-Hz, 600-Hz, 800-Hz ... sinewaves."

That isn't true. A squarewave is composed only of the fundamental and *odd* harmonics having progressively smaller amplitudes. For example, the amplitude of the third harmonic (600 Hz) is 1/3 that of the fundamental, the fifth is 1/5, etc.

Maintaining correct basic knowledge of electronics is hard enough without having to correct such misleading statements.

L. M. MORRISH
Hendersonville, NC

We made the error in attempting to amplify Mr. Carr's point. We apologize to him and to our readers.—Editor

ERRORS AND OMISSIONS

I am writing primarily about "Inside the Telephone," which appeared in the October, 1986 issue of *Radio-Electronics*. While generally informative, it does contain some errors and omissions.

In Fig. 5 the contacts in the dial network are shown open. At all times but the instant of sending a pulse the contacts are closed. The labels on the hook switch are reversed; the telephone circuitry is connected to the line while off-

hook, not while on-hook. The ringing signal is not connected to the line toward the instrument through a transformer, as shown, but rather, during ringing, the 20-Hz is connected to the line through the windings of a ringing trip relay (or equivalent) so as to be able to determine when the instrument goes off-hook.

There is an important omission regarding description of the ringing signal. Typically, it is 86 volts of 20-Hz superimposed on -49-volts

ELENCO PRODUCTS AT DISCOUNT PRICES!

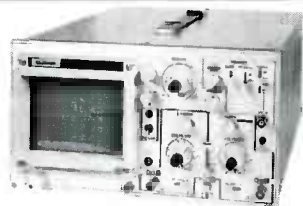

20 MHz DUAL TRACE OSCILLOSCOPE

\$349 MO-1251

TWO
100 MHZ
SWITCHABLE
PROBES
INCLUDED

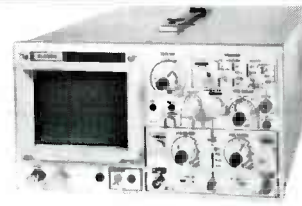

35 MHz DUAL TRACE OSCILLOSCOPE

\$498 MO-1252

Top quality scopes at a very reasonable price. Contains all the desirable features. Elenco's 2 year guarantee assures you of continuous service. Two 1x, 10x probes, diagrams and manual included. Write for specifications.



MULTI METER with
CAPACITANCE and
transistor tester

\$65 Model
CM-1500

Reads Volts, Ohms,
Current, Capacitors
Transistors & Diodes



**TRUE RMS 4 1/2
DIGIT MULTIMETER**

\$135 Model
M-7000

.05% DC Accuracy
.1 % Resistance
with Freq. Counter
& Deluxe Case



**AUTO RANGING
plus
MANUAL RANGING
3 1/2 DIGIT METER
28 FUNCTIONS
FULLY PROTECTED**

M-1180 .7% ACY \$36.95
M-1182 .25% ACY \$39.95
M-1181 .1% ACY \$42.95



**GF-8016 Function Generator
with Freq. Counter**

\$219

- Sine, Square, Triangle,
- Pulse, Ramp, .2 to 2 MHz
- Frequency .1 thru 10 MHz

GF 8015 without Freq. Meter \$169

10 MHz OSCILLOSCOPE

\$190
S-3000

10 MHz DC or AC
Triggered Sweep
Calibrated Vert & Hor
Reads Volts & Freq

BREADBOARD

Shown
9436



9430 1,100 pins \$15
9434 2,170 pins \$25
9436 2,860 pins \$35

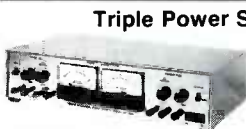

Triple Power Supply XP-660

\$14950

0-20V @ 1A
0-20V @ 1A
5V @ 5A

Fully Regulated, Short Circuit Protected with 2
Limit Cont. 3 Separate Supplies.

50 MHz LOGIC PROBE

\$23



20 nec with memory

LOGIC PULSER

\$25



2 us pulse @ 1A

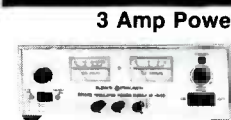

3 Amp Power Supply XP-650

\$11950

0-40V @ 1.5A
0-20V @ 3A

Fully regulated, short circuit protected current
limit control



DIGITAL LCR METER

Model LC-1800
Measures: Inductors
Capacitors, Resistors

\$148

Inductors .1µH to 200 H
Capacitor .1Pf to 200µf
Resistor .01Ω to 20MΩ
Ranges 6 Ind, 7 cap, 7 res

C&S SALES, 8744 W. North Ter. Niles, IL 60648
800-292-7711 (312) 459-9040



**15 DAY MONEY
BACK GUARANTEE**

ASK FOR CATALOG

2 Year Limited Guarantee! Add 5% for Postage (\$10 max.), IL Res., 7% Tax

CIRCLE 109 ON FREE INFORMATION CARD

SEE YOUR DEALER TODAY



FROM



HERE'S A TIP THAT'S PERFECT!

AM/FM AUTO RADIO AND CB

'Firestik' II

GOLDEN SERIES

BARE-HANDS TUNABLE "NO TOOLS NEEDED" HIGH PERFORMANCE ANTENNAS

ALSO ANTENNAS FOR CORDLESS TELEPHONES MONITOR SCANNERS

Dealer & Distributor Inquiries Invited SEND FOR FREE CATALOG

'Firestik' Antenna Company 2614 East Adams/Phoenix, AZ 85034

Name _____

Street _____

City _____

State _____ Zip _____

Serving the CB and Communications Market Since 1962.

5-YEAR REPLACEMENT WARRANTY

CIRCLE 100 ON FREE INFORMATION CARD

DC. The DC is needed to operate the ringing trip relay when the call is answered.

The description of dial pulses needs to be revised. The state of the circuit during the time one would dial is closed, with normal line current of 20 to 120 mA. When a digit is dialed, the dial-pulse contacts open the circuit once for a 1, twice for a 2, etc. The pulse rate is required to be in the range of 8 to 11 pulses per second, and the percent break time must be in the range of 58% to 64%. The interval of high (normal) current between breaks is consequently 36% to 42%.

Those times have absolutely nothing to do with conserving battery power, but rather they are established by the operating and releasing times of several responding relays and other electro-mechanical devices in the step-by-step switching system. That switching system is a descendant of the Stowager system that is mentioned in the article.

KENNETH E. STONE
Cherryvale, KS

THE REASON BEHIND RFI

Finally someone has come out on the side of amateurs and other radio operators and stated the real reason behind RFI. (See "Communications Corner" in the September 1986 issue.) Most of the time, it's not the fault of the radio operator (although it is sometimes), but rather the fault of a poorly designed piece of equipment. With all the products on the market that have little or no filtering, and little or no shielding, it's no wonder that we've seen the number of problems we have.

If we wish to do something about it, we do have an alternative: We must educate the average person as to the real causes of the problem. If the consumer demands a well-built product, some manufacturer will produce one. Then, perhaps, we will no longer have to explain how it could be the fault of our neighbor's sound system, and not our CB or ham transmitter.

JOSEPH A. CONSUGAR, KC3XM
Annapolis, MD

continued on page 35

SCOPE PRICE BREAKTHROUGH!

New B&K-PRECISION Dual-Trace 20MHz Scope... \$440!!

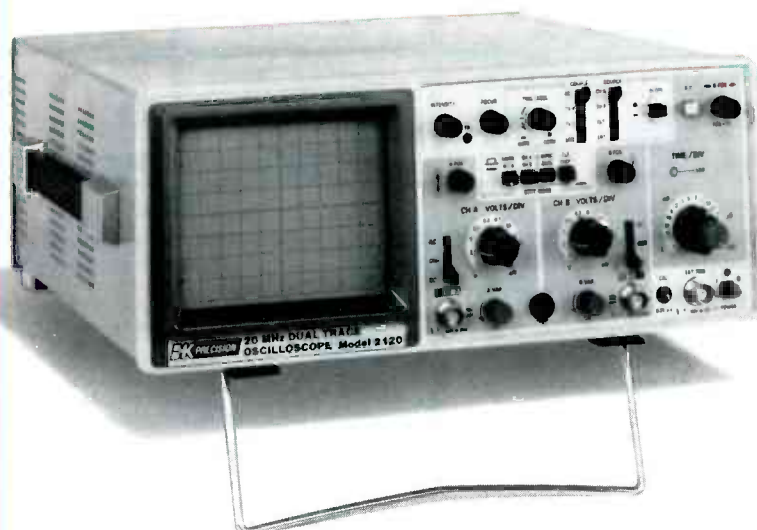

Now you can own a professional quality 20MHz, dual-trace scope for under \$450. Best of all, it's a full featured instrument, from B&K-PRECISION—famous for quality, dependable products.

- Compare these outstanding features, then compare price!
- Dual or single trace operation • 1mV/div sensitivity
 - 20MHz response at a true -3dB • AUTO/NORM triggered sweep operation with AC, TVH, TVV and Line coupling
 - Calibrated 18 step timebase with x10 magnifier • X-Y operation
 - Bright, sharp rectangular CRT with P31 phosphor
 - Front-panel trace rotation control • Tilt stand and soft handle
 - Selectable +/- slope • Built-in calibration source
 - Compact low-profile design.

For immediate delivery, contact your local B&K-PRECISION distributor or call B&K-PRECISION today.

B&K PRECISION DYNASCAN CORPORATION

6460 West Cortland Street • Chicago, Illinois 60635 • 312/889-9087
International Sales, 6460W Cortland St., Chicago, Illinois 60635 • Canadian Sales, Atlas Electronics, Ontario
South and Central American Sales, Empire Exporters, Plainview, NY 11803
CIRCLE 77 ON FREE INFORMATION CARD

Not all RCA modules are re-created equal.

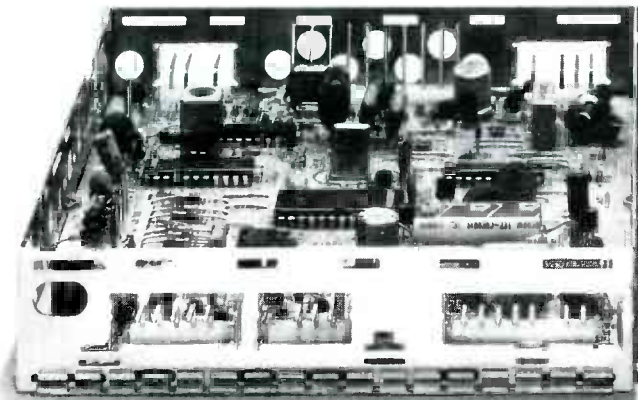

Competitor's rebuilt RCA module

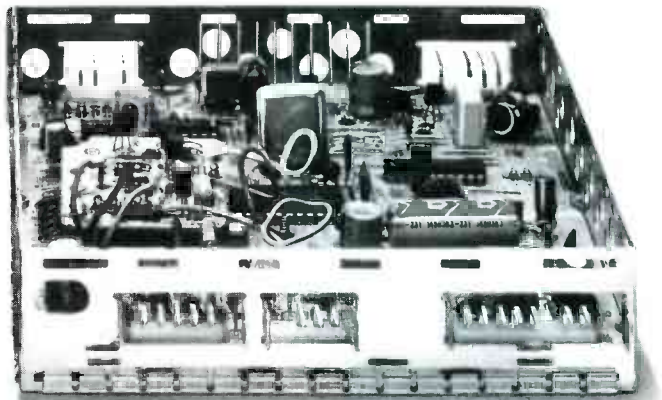

RCA rebuilt RCA module

Only modules rebuilt by RCA guarantee RCA quality.

Recently, one of our competitors slashed prices on their rebuilt RCA modules by up to 40%. Sounds good, until you review their products' performance. Then you'll wonder why they didn't do it sooner.

To demonstrate, we selected a random cross-section of their "bargain" boards for inspection. Using the same stringent testing methods RCA applies to its remanufactured boards, more than an incredible 70% of their rebuilt modules were rated unacceptable.

Some simply didn't work. Others lacked design updates, or had a wrong or missing component. The rest suffered from problems in

workmanship, such as the use of wire to bridge broken circuit board etchings, which could affect both reliability and performance.

Which all goes to show, RCA modules remanufactured by RCA remain your best bet. Ours are re-created to perform as well as, if not better than, the RCA original. Each contains the latest design updates. And all are thoroughly tested, inspected, and covered by warranty.

Their rebuilt modules may cost less, but the quality just isn't equal. So do it right the first time. Insist on RCA. Because the quality and performance are built in.



RCA Distributor and
Special Products Division

CIRCLE 225 ON FREE INFORMATION CARD

Our
guaranteed
savings plan.



Fluke 70 Series Analog/Digital multi-meters are like money in the bank. Buy one, and you're guaranteed to save both time and money.

Money, because you get longer battery life and longer warranty coverage — 3 years vs. 1 year or less on others.

And time, because 70 Series meters are easier to operate and have more automatic measurement features.

So before buying any meter, look beyond the sticker price. And take a closer look at the new low-priced \$79 Fluke 73, the \$99 Fluke 75, and the deluxe \$139 Fluke 77. In the long run, they'll cost less, and give higher performance, too.

And that, you can bank on.

For a free brochure, and your nearest distributor, call toll-free **1-800-227-3800, ext. 229.**

FROM THE WORLD LEADER
IN DIGITAL MULTIMETERS.



© 1985 Fluke
CIRCLE 121 ON FREE INFORMATION CARD

EQUIPMENT REPORTS

Fluke LCA-10 Line Current Test Adapter

*This multimeter accessory
makes measuring line
current a snap!*

CIRCLE 9 ON FREE INFORMATION CARD



IF YOU'VE EVER WANTED TO MEASURE the amount of current used by a line-powered device, you've had a couple of choices: you could break the leads and use a standard multimeter, or—if you were lucky enough to have one—you could use a clamp-on ammeter. But now there's a much cheaper and easier way: use your multimeter along with the *LCA-10* line-current test adapter from John Fluke Manufacturing Company, Inc. (P.O. Box C9090, Everett WA 98206).

If you need to make line-current measurements often, then perhaps a clamp-on ammeter is worth the investment. If you don't need to make line-current measurements often, then you probably end up breaking the leads to put your ammeter in-line with the device under test when it's necessary. But the hassle of doing that is probably too much of an annoyance if, for example, you just want to determine how much current your old refrigerator uses so you'll know whether a new model is a worthwhile investment.

The *LCA-10* allows you to use your multimeter to easily measure the amount of current being used by a line-powered device. It's certainly not a complex piece of equipment; it's so simple that we

were inclined to ask, "Why didn't we (or anyone else) ever think of that before?" Basically, the *LCA-10* is a convenient way to put an ammeter in series with a line-current-carrying wire. On one end is a three-wire line plug, and a three-wire receptacle. However, while the ground and neutral conductors run straight-through, the hot conductor is broken. The two ends of the break are brought out through a five-foot, heavy-duty, insulated wire that's terminated in shrouded banana plugs.

Fluke	LCA-10									
OVERALL PRICE	[Red bar]									
EASE OF USE	[Red bar]									
INSTRUCTION MANUAL	[Red bar]									
PRICE/VALUE	[Red bar]									
	1	2	3	4	5	6	7	8	9	10
	Poor			Fair			Good			Excellent

Using the *LCA-10*

To use the *LCA-10*, you simply connect the plugs into the common and 10-amp inputs of your multimeter, and set your multimeter according to its instructions. You then plug the other end into a line receptacle, and plug the

LETTERS

continued from page 26

FURTHER REFINEMENT IN ORDER

I just glanced through Mr. Grossblatt's department, "Drawing Board," in the September, 1986 **Radio-Electronics**, in which he corrects some problems from errors in a previous installment, and laments that only three readers had written in to point them out. I'll bet that he gets more letters on this one.

Although the correction noted regarding the infinite DE loop will work in a fashion, I think that further refinement is in order.

The textual explanation is a little misleading in that it implies that D and E are directly OR-ed in line 13. That is made even more deceptive by the fact that the OR comes right after the DEC DE. As you know, the E register is actually being OR-ed with A, the contents of which should have been loaded from D. The first time through the loop, A will have been loaded from H prior to entering the delay loop. That means that the first OR will not really be a valid one, but as E is not initialized to 01 at entry, it is really a moot point, as A will assume the correct value in line 14, and things will be OK thereafter. If the delay constant should have been 5101 instead of 5161, however, that could have been a problem if entering the loop with A=0.

You might point out that this is the classic Z80 double-register decrement and test for zero situation, and that the A register is usually loaded from one of the registers *before* the OR is done.

Another possible source of confusion to assembly-language novices in the routine as presented is that the test for the zero flag comes right after the LD A,D. That can leave the wrong impression—that the zero flag is set by the LD instruction group, when in fact it was the OR instruction that was responsible for setting the flag.

Keep up the good work. I find your column to be in line with the kind of noodling that I like to do.
CHUCK BRILLOWSKY
Southgate, MI

R-E

Analyze defective waveforms faster, more accurately, and more confidently — every time or your money back

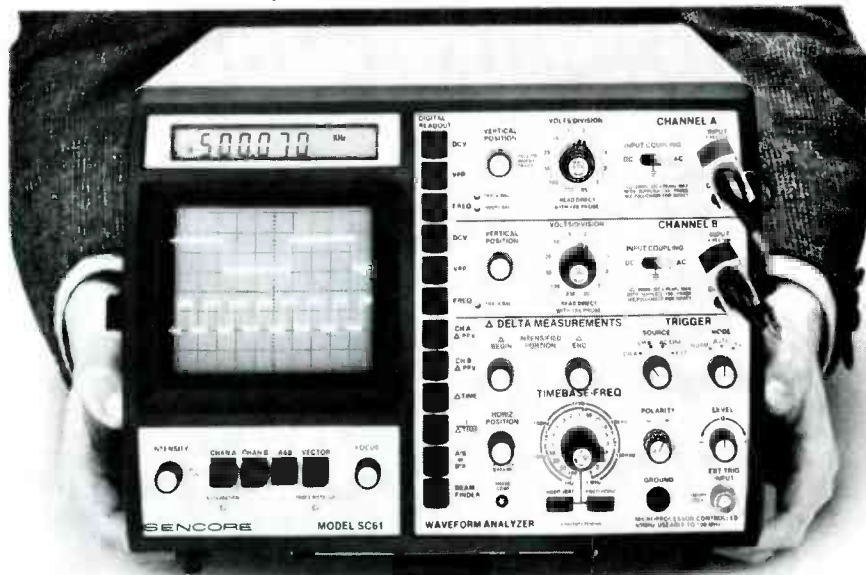

with the SC61 Waveform Analyzer
Patented \$2,995

If you value your precious time, you will really want to check out what the exclusively patented SC61 Waveform Analyzer can do for you. 10 times faster, 10 times more accurate, with zero chance of error.

End frustrating fiddling with confusing controls. Exclusive ultra solid ECL balanced noise cancelling sync amplifiers, simplified controls, and bright blue dual trace CRT help you measure signals to 100 MHz easier than ever.

Accurately and confidently measure waveforms from a tiny 5 mV all the way to a whopping 3,000 V without hesitation with patented 3,000 VPP input protection — eliminates expensive "front end" repairs and costly equipment downtime.

Make only one circuit connection and push one button for each circuit parameter test: You can instantly read out DC volts, peak-to-peak volts and frequency 100% automatically with digital speed and accuracy. It's a real troubleshooting confidence builder.

Confidently analyze complex waveforms fast and easily. Exclusive Delta measurements let you intensify any waveform portion. Analyze glitches, interference signals, rise or fall times or voltage equivalents between levels; direct in frequency or microseconds.

Speed your digital logic circuit testing. Analyzing troublesome divide and multiply stages is quicker and error free — no time-consuming graticule counting or calculations. Simply connect one test lead to any test point, push a button, for test of your choice, for ERROR FREE results.

To see what the SC61 can do for your troubleshooting personal productivity and analyzing confidence, CALL TODAY, WATS FREE, 1-800-843-3338, for a FREE 15 day Self Demo.



Call Today Wats Free 1-800-843-3338

SENCORE

3200 Sencore Drive

Sioux Falls, SD 57107

605-339-0100 In SD Only

*innovatively designed
with your time in mind.*

CIRCLE 201 ON FREE INFORMATION CARD

Get A Complete Course In

ELECTRONIC ENGINEERING

8 volumes, over 2000 pages, including all necessary math and physics. 29 examinations to help you gauge your personal progress. A truly great learning experience.

Prepare now to take advantage of the growing demand for people able to work at the engineering level.

Ask for our brochure giving complete details of content. Use your free information card number, or write us directly. **\$89.95**, Postage Included. Satisfaction guaranteed or money refunded.



**Banner
Technical
Books, Inc.**

1203 Grant Ave.
Rockford, IL 61103

CIRCLE 199 ON FREE INFORMATION CARD

ATTENTION! ELECTRONICS TECHNICIANS

EARN YOUR
**B.S.E.E.
DEGREE**

THROUGH HOME STUDY

Our New and Highly Effective Advanced-Placement Program for experienced Electronic Technicians grants credit for previous Schooling and Professional Experience, and can greatly reduce the time required to complete Program and reach graduation. No residence schooling required for qualified Electronic Technicians. Through this Special Program you can pull all of the loose ends of your electronics background together and earn your B.S.E.E. Degree. Upgrade your status and pay to the Engineering Level. Advance Rapidly! Many finish in 12 months or less. Students and graduates in all 50 States and throughout the World. Established Over 40 Years! Write for free Descriptive Literature.

**COOK'S INSTITUTE
OF ELECTRONICS ENGINEERING**

CI 347 RAYMOND ROAD
P.O. BOX 20345
JACKSON, MISSISSIPPI 39209

CIRCLE 212 ON FREE INFORMATION CARD

NEW PRODUCTS



CIRCLE 30 ON FREE INFORMATION CARD

PORTABLE POWERPACK, the *SideKick*, is built around a sealed, lead-acid battery that ensures maintenance-free service. Because the battery is sealed, it cannot leak or spill, even if punctured. It can be operated, stored, and charged in any position, even upside down.

With a full charge, the unit will run a 12-watt camcorder or VCR for nearly five hours, a portable television monitor for up to four hours, or a 100-watt portable light for 45 minutes.

Recharging the powerpack is simple, using the built-in charging

unit. Normal recharge time is 24 hours, but, unlike NiCd rechargeables, the unit will accept a "top-up" charge easily and quickly if needed, and can still accept a full recharge overnight. The *SideKick's* circuit is protected by a resettable thermal breaker. The entire package, which includes a charger, a plug-in unit, and a battery is tucked into a shoulder pack with adjustable straps.

The *SideKick* has a suggested retail price of \$89.95.—**Gates Energy Products, Inc.**, 1050 South Broadway, P. O. Box 5887, Denver, CO 80217.

EDITING SYSTEM consists of five components that are mounted together in a black metal frame to give the user complete studio capacity at consumer prices. The five products are: the *Creator*—a Special Effects Generator (SEG); the *Colorizer*; the *Gensync*—a combination genlock/power supply;

the model 7010 audio-visual processor, and the model 7100 color processor. The components may also be purchased individually, to enable users to expand their systems as their needs grow.

The heart of the system is the *Creator*, a microprocessor-controlled SEG. The user can create

special effects such as polarization, posterization, and monochrome, and get more pattern wipes than on any other similarly priced SEG. Its suggested retail price is \$499.95.

The *Colorizer* puts a full-range of color magic at the user's fingertips when combined with the *Creator*. It can also be used with just a VCR. There are nine different patterns: color bars and gray-scale generator; crosshatch/grid; color posterization; dots; art patterns/mosaic-look; psychedelic blending, and movement of color patterns. Its price is \$299.95.



CIRCLE 31 ON FREE INFORMATION CARD

The *Gensync* synchronizes signals from different sources to enhance the *Creator's* ability to perform like an expensive studio SEG. With it, the *Creator* can produce such special effects and mix functions as super (superimpose one image on another), dissolve, or cut. It has a suggested retail price of \$299.95.

The model 7010 audio-visual processor includes features such as a delay control that lets the user split the screen into four parts for instantaneous comparison when adjusting; an image enhancer that lets the user control sharpness and detail; a noise-reduction circuit, and an automatic stabilizer with LED that indicates when the picture is rock-steady. The suggested retail price is \$478.95.

The model 7100 color processor has controls for flesh tone, chroma, color saturation/intensity, fade, video gain, and delay for split-screen comparison. A black-reference setup control lets the user fine-tune from black for accurate color reproduction. The suggested retail price is \$379.95.

The price of the assembled *Editing System* is \$2699.00.—*Showtime Video Venture*, 2715 Fifth Street, Tillamook, OR 97141.

Now test and restore every CRT on the market . . . without ever buying another adaptor socket or coming up embarrassingly short in front of your customer . . . or your money back



with the new improved CR70 "BEAM BUILDER"™
Universal CRT Tester and Restorer
Patented \$995

Have you ever?

Thrown away a good TV CRT, data display CRT, or scope CRT that could have been used for another two or three years because you had no way to test or restore it?

Lost valuable customers because you advised them that they needed a new CRT when another technician came along and restored the CRT for them?

Lost the profitable extra \$35 or more that you could have gotten for restoring a CRT while on the job and locked in the profitable CRT sale later?

Avoided handling profitable trade-ins or rentals because you were afraid you'd have to replace the picture tube when you could have restored it?

Had a real need to test a CRT on the job, but didn't have the right adaptor socket or setup information in your setup book?

If any of these things have happened to you, **CALL TODAY, WATS FREE, 1-800-843-3338**, for a FREE 15 day Self Demo.

"BEAM BUILDER" is a trademark of Sencore, Inc.



Call Today Wats Free 1-800-843-3338

SENCORE

3200 Sencore Drive
Sioux Falls, SD 57107
605-339-0100 In SD Only

*innovatively designed
with your time in mind.*

CIRCLE 202 ON FREE INFORMATION CARD

R-E Engineering Admart

Rates: Ads are 2 1/4" x 2 7/8". One insertion \$825. Six insertions \$800 each. Twelve insertions \$775 each. Closing date same as regular rate card. Send order with remittance to **Engineering Admart**, Radio Electronics Magazine, 500-B Bi-County Blvd., Farmingdale, NY 11735. Direct telephone inquiries to Arline Fishman, area code-516-293-3000. *Only 100% Engineering ads are accepted for this Admart.*

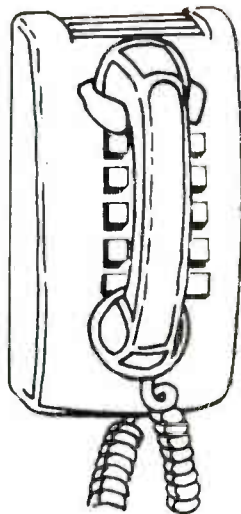

CALL NOW AND RESERVE YOUR SPACE

- 6 x rate \$800.00 per each insertion.
- Reaches 239,312 readers.
- Fast reader service cycle.
- Short lead time for the placement of ads.

Call 516-293-3000 to reserve space. Ask for Arline Fishman. Limited number of pages available. Mail materials to: Engineering Admart, RADIO-ELECTRONICS, 500-B Bi-County Blvd., Farmingdale, NY 11735.

IBM-PC Schematic Design

A professional package enabling you to design, edit, print & plot electronic schematics. Supports "A" through "E" size sheets, over 2000 Unique Library Parts, Part Rotation, Unlimited Hierarchy, Grids, Auto Panning, 5 Zoom Levels, Rubberbanding, Powerful Macros, Hi-Res Color & Monochrome Graphics, Much More! \$495 Includes Everything.

Call or Write for Free Demo Disk.

OrCAD Systems Corporation
1049 S.W. Baseline St. Suite 500
Hillsboro, OR 97123
(503) 640-5007



CIRCLE 220 ON FREE INFORMATION CARD

CONTROL YOUR DESTINY KNOWLEDGE IS POWER

HOME SATELLITE TV INSTALLATION & TROUBLESHOOTING MANUAL (Spanish or English)
"The acknowledged industr. home TVRO bible" \$29.95

HOME SATELLITE TV INSTALLATION VIDEOTAPE
"Install & tune up your TVRO" (Spanish or English) \$39.95

THE HIDDEN SIGNALS ON SATELLITE TV
"Your TVRO can detect much more" \$19.95

—New Book Releases—

KU-BAND SATELLITE TV—THEORY, INSTALLATION AND REPAIR *The Ku-Band Bible—386 pages* \$19.95

SATELLITE & CABLE TV SCRAMBLING & DESCRAMBLING *Understand the VideoCipher and Qik Orion Decoders* \$19.95



—ORDER NOW—

Send cost plus \$2 shipping for each item to:
BAYLINGALE PRODUCTIONS
1905 Mariposa — Suite 105
Boulder, CO 80302
TO ORDER ONLY
1-800-634-2255 EXT. 330 (NATIONAL)
1-800-847-4663 EXT. 330 (CALIF.)
FOR ANY OTHER INFORMATION
(303) 449-4551
Add \$1 per item when using
VISA/MASTERCARD

CIRCLE 221 ON FREE INFORMATION CARD

117 PRACTICAL IC PROJECTS BUILD YOU CAN

2645T—117 PRACTICAL IC PROJECTS YOU CAN BUILD.....

\$10.95. Dozens of fully-tested, ready-to-build circuits you can put together from readily-available, low cost IC's! There are a total of 117 IC circuits ranging from an audio mixer and a signal splitter to a tape-deck amplifier and a top-octave generator organ! From TAB Books. To order your copy send \$10.95 plus \$2.75 shipping to Electronic Technology Today Inc., P.O. Box 240, Massapequa Park, NY 11762-0240

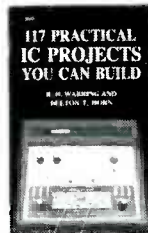

LINEAR IC EQUIVALENTS & PIN CONNECTIONS

Linear IC
Equivalents
and Pin
Connections



BP141—Shows equivalents & pin connections of a popular user-oriented selection of European, American and Japanese linear IC's 320 pages, 8 x 10 inches. \$12.50 Plus \$2.75 shipping. ELECTRONIC TECHNOLOGY TODAY INC., PO Box 240, Massapequa Park, New York 11762-0240.

EARTH STATION RECEIVER, the model *ESR2240*, is designed for CATV, SMATV, hotel/motel, broadcast, and teleconferencing applications. It mounts in a standard 19-inch rack panel and has the following features, designed with the commercial operator in mind: block down-conversion with



CIRCLE 32 ON FREE INFORMATION CARD

Drake's *BCDC-24* weatherproof lockdown converter or LNB; dual signal inputs with automatic or

manual polarity changeover for dual-feed installations; a 950–1459 MHz IF loop-through output that allows the stacking of multiple receivers per polarity without splitters; a saw filter for maximum adjacent-channel and interference rejection with minimum signal distortion; and optional dual audio outputs for control tones or second audio-subcarrier output.

The model *ESR2240* is priced at \$899.00.—**R.L. Drake Company**, P.O. Box 112, Miamisburg, OH 45342.

FREQUENCY STANDARD, the *Counter-Mate*, provides stable 1-MHz and 10-MHz signals to im-

prove the accuracy of counters and other instruments. A precision third-overtone 10-MHz crystal, mounted in a proportionally controlled copper oven, ages less than $\pm 3 \times 10^{-8}$ Hz per month and drifts



CIRCLE 33 ON FREE INFORMATION CARD

less than $\pm 5 \times 10^{-8}$ Hz from 0 to 40°C. A 50-turn frequency trimmer has a settability of 1×10^{-9} Hz and

is mechanically stable. Both outputs will drive TTL or 50 ohms with -5-ns rise and fall time square-waves. The output impedance properly matches power splitters for generating isolated signals to operate several instruments.

The *Counter-Mate* is priced at \$350.00.—**Wenzel Associates, Inc.**, 11124 Jollyville Road, Austin, TX 78759.

DIGITAL PANEL METER, the model *HY6300*, is a 3½" digital panel meter with 0.4" LCD digits and balanced differential analog inputs in a compact watertight package (less than ½" deep.)

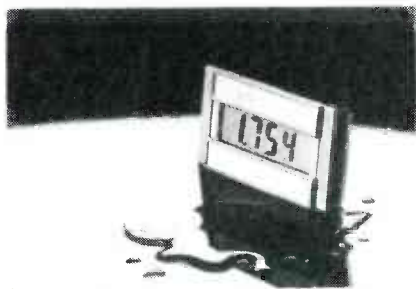

CIRCLE 34 ON FREE INFORMATION CARD

It is capable of operating in harsh environments where it is exposed to moisture and temperature levels from 0 to 50°C. The model *HY6300* contains a custom hybrid circuit that is capable of measuring voltages from 100 millivolts to 200 volts, current from 100 nA to 2 A, and resistance from 1 ohm to 20 megohms. The meter can be powered by either a 9-volt battery or a single 5-volt supply.

The model *HY6300* is priced at \$39.95.—**Hytek Microsystems, Inc.**, 980 University Ave., Los Gatos, CA 95030.

VIDEO-HEAD CLEANER, the model *CJ-51*, comes with a bottle of cleaning fluid that is stored in a compartment in the cartridge. The user removes the bottle, unscrews



CIRCLE 35 ON FREE INFORMATION CARD

Walk "tough dog" troubles out of any TV & VCR in half the time . . . or your money back



with the exclusive, patented,
VA62 Universal Video Analyzer . . . \$3,295

Would you like to?

Reduce analyzing time: Isolate any problem to one stage in any TV or VCR in minutes, without breaking a circuit connection, using the tried and proven signal substitution method of troubleshooting?

Cut costly callbacks and increase customer referrals by completely performance testing TVs & VCRs before they leave your shop? Own the only analyzer that equips you to check all standard and cable channels with digital accuracy? Check complete, RF, IF, video and chroma response of any chassis in minutes without taking the back off the receiver or removing chassis plus set traps dynamically right on CRT too? Simplify alignment with exclusive multiburst pattern?

Reduce costly inventory from stocking yokes, flybacks, and other coils and transformers, for substitution only, with the patented Ringing Test. Run dynamic proof positive test on any yoke, flyback, and integrated high voltage transformer . . . in- or out-of-circuit?

Protect your future by servicing VCRs for your customers before they go to your competition? Walk out "tough dog" troubles in any VCR chrominance or luminance circuit — stage-by-stage — to isolate problems in minutes? Have proof positive test of the video record/play heads before you replace the entire mechanism?

Increase your business by meeting all TV and VCR manufacturers' requirements for profitable warranty service work with this one universally recommended analyzer?

To prove it to yourself, CALL TODAY, WATS FREE, 1-800-843-3338, for a FREE Self Demo . . . or learn how the VA62 works first by calling for your free simplified operation and application instruction guide, worth \$10.00.



Call Today Wats Free 1-800-843-3338

SENCORE

3200 Sencore Drive
Sioux Falls, SD 57107
605-339-0100 In SD Only

*innovatively designed
with your time in mind.*

CIRCLE 203 ON FREE INFORMATION CARD

Radio-Electronics mini-ADS

the cap, and pours 10 drops of fluid onto the cleaning tape. The cartridge is inserted in the VCR and the PLAY button is pressed. The STOP button is pressed after 10 seconds to end the cleaning process.

The model *CJ-51* uses a residue-free mixture of Freon and alcohol, plus a non-abrasive, spun-bound polyester tape to clean the VCR heads. It is priced at \$11.95.—**Video Dynamics, Inc.**, 6525 Oxford St., St. Louis Park, MN 55426.

CELLULAR TELEPHONE, the model *500/555*, allows users to talk on the telephone even when they are not in their cars.

A lightweight rechargeable battery pack powers the system. Two different batteries are available: the 60-minute and the 140-minute



CIRCLE 36 ON FREE INFORMATION CARD

talk-time batteries. With the battery, the entire unit weighs only 7.5 or 10.25 pounds, respectively.

The system has a 50-number memory that can be recalled by pushing three buttons, a timer to keep track of how long each call is, and an electronic volume control. An electronic lock is provided to restrict outgoing calls.

A large digital display allows users to view the numbers in the memory at the push of a button. The display is also back-lighted.

The model *500/555* is priced at \$2216.00 with the 60-minute battery; \$2374.00 with the 140-minute battery.—**Mitsubishi International Corporation**, 879 Supreme Drive, Bensenville, IL 60601. **R-E**



THE MODEL WTT-20 IS ONLY THE SIZE OF A DIME, yet transmits both sides of a telephone conversation to any FM radio with crystal clarity. Telephone line powered - never needs a battery! Up to 1/4 mile range. Adjustable from 70-130 MHz. Complete kit **\$29.95 + \$1.50 S+H**. Free Shipping on 2 or more! COD add \$4. Call or send VISA, MC, MO. **DECO INDUSTRIES, Box 607, Bedford Hills, NY 10507. (914) 232-3878.**

CIRCLE 127 ON FREE INFORMATION CARD



APPLIANCE REPAIR HANDBOOKS—13 volumes by service experts; easy-to-understand diagrams, illustrations. For major appliances (air conditioners, refrigerators, washers, dryers, microwaves, etc.), elec. housewares, personal-care appliances. Basics of solid state, setting up shop, test instruments. **\$2.65 to \$5.90 each**. Free brochure. **APPLIANCE SERVICE, PO Box 789, Lombard, IL 60148. 1-(312) 932-9550.**

CIRCLE 84 ON FREE INFORMATION CARD



A CAREER START FOR THE 21ST CENTURY. Since 1905, National Technical Schools has helped people build successful careers. Enter the 21st Century through home study courses in Robotics, Computer Technology and Servicing, Microprocessors, Video Technology, Basic Electronics, Transportation Technology, Climate Control Technology or TV and Radio Servicing. For a FREE catalog, call 1-800-B-BETTER. Or write **NTS/INDEPENDENT TRAINING GROUP, 456 West M. L. King Jr. Blvd. L.A., CA 90037.**

CIRCLE 219 ON FREE INFORMATION CARD



THERMOPROBE—QUICKLY IDENTIFIES DEAD PC BOARD COMPONENTS. Locates dead resistors, transistors, IC's, diodes, and transformers without direct contact, in seconds. Operating active components radiate heat, dead components don't. **Thermoprobe** is sensitive to 1/25°F change in temperature. A must for your workbench or field service. Order #209TM. **ONLY \$21.95 + \$3.00 shipping, NY Res. add tax (no COD's).** **BUYUS, INC., Dept. RE387 10 White Birch Dr., Ossining, NY 10562, Visa or Mastercard (914) 762-4799.**

CIRCLE 53 ON FREE INFORMATION CARD



ARD-35 DIGITAL AUTORANGE MULTITESTER with case. 3 1/2 digit LCD under **\$59**. • **DMR-45**, 4 1/2 digit multimeter, 32 ranges with case; .5 LCD under **\$116**. • **DM-3520 CF** oversize 3 1/2 digit LCD with case, frequency capacity 20 amps **\$85**. **EMCO ELECTRONICS, P.O. Box 327, Plainview, NY 11803.** Send for your free catalog.

CIRCLE 213 ON FREE INFORMATION CARD

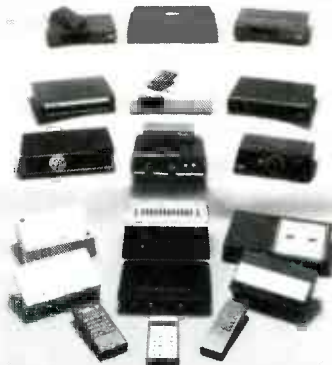

CABLE TV CONVERTERS AND DESCRAMBLERS. Large selection of top quality merchandise. Low prices. Quantity discounts. We ship COD. Most orders are shipped within 24 hrs. Send \$2.00 for catalog. **CABLETRONICS UNLIMITED, P.O. Box 266 Dept. R, S. Weymouth, MA 02190 (617) 843-5191**

CIRCLE 209 ON FREE INFORMATION CARD

Radio-Electronics mini-ADS

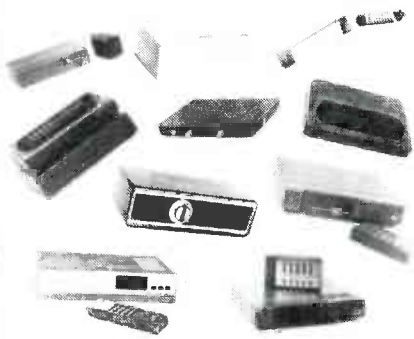

CABLE TELEVISION CONVERTER, descrambler and wireless remote control video equipment accessories. Catalog free. **CABLE DISTRIBUTORS UNLIMITED**, 116 Main Road, Washington, AR 71862.

CIRCLE 204 ON FREE INFORMATION CARD

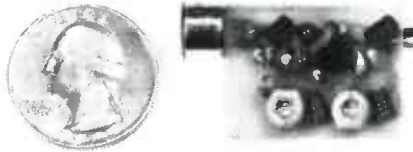

SIMPLY SNAP THE WAT-50 MINIATURE FM TRANSMITTER on top of a 9v battery and hear every sound in an entire house up to 1 mile away! Adjustable from 70-130 MHz. Use with any FM radio. Complete kit **\$29.95 + \$1.50 S + H**. Free shipping on 2 or more! COD add \$4. Call or send VISA, MC, MO. **DECO INDUSTRIES**, Box 607, Bedford Hills, NY 10507. (914) 232-3878.

CIRCLE 127 ON FREE INFORMATION CARD



ZENITH SSAVI \$169; reconditioned. Surplus N-12, SB-3, Hamlin. Satellite Systems, converters, amplifiers, accessories. Money-back guarantee. SSAVI project handbook **\$6.50** ppd. Radar speed timers for baseball, hockey, car/boat racing, bowling. Professional models used by police. **AIS SATELLITE, INC.**, P.O. Box 1226-E, Dublin, PA 18917. 215-249-9411.

CIRCLE 81 ON FREE INFORMATION CARD

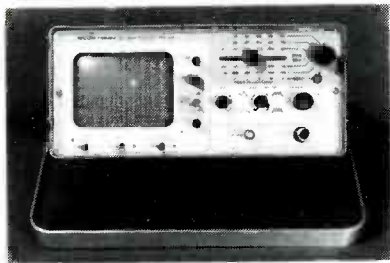

AVCOM's PSA-35A PORTABLE SPECTRUM ANALYZER for TVRO installation and service offers frequency coverages of 10 to 1750 MHz and 3.7 to 4.2 GHz. Features: built-in DC block with +18 VDC for powering LNA's and BDC's, calibrated signal amplitude display, and internal battery with charger. The PSA-35A, at **\$1965** is the most cost effective spectrum analyzer available. **AVCOM OF VIRGINIA, INC.**, 500 Southlake Boulevard, Richmond, VA 23236. Phone 804-794-2500/FAX 804-794-8284/TELEX 701-545

CIRCLE 224 ON FREE INFORMATION CARD



TUNABLE NOTCH FILTER—for elimination of any TV, FM, or VHF signal. Can be tuned precisely to ANY signal within these ranges: *MODEL 26-Ch's. 2-6 plus FM [54-108 Mhz] *MODEL 1422-Ch's. 14(A)-22(I) [120-174 Mhz] *MODEL 713-Ch's. 7-13 [174-216 Mhz] Highly selective 60dB notch. Send **\$30** each. Quantity prices as low as **\$14**. **STAR CIRCUITS**, P.O. Box 8332, Pembroke Pines, FL 33084

CIRCLE 94 ON FREE INFORMATION CARD



NEW: PANASONIC VIDEO SWITCHER. Record a cable channel while viewing any one of your 4 video options, another cable channel, 2nd VCR, TV games, video camera, etc. No need to use your cable converter for channel selection VCS-1 gives your cable ready TV or VCR full control of your viewing. Compatible with all scrambled and one way addressable systems. **\$85.00** Guaranteed. Free Catalog. (402) 331-4957 **M.D. ELECTRONICS**, 5078 So. 108th #115, Omaha, NE 68106. We accept MC. Visa. C.O.D.

CIRCLE 207 ON FREE INFORMATION CARD

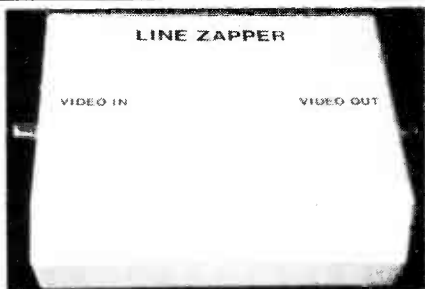

DECODE THE NEW VIDEO TAPE COPY PROTECTION SCHEME. Bothered by brightness changes, vertical jumping and jittering while watching recent movie releases? Stop it with the **LINE ZAPPER**. New kit detects and removes selected lines of video that have been modified and often interfere with normal television operation. Order your **KIT** today only **\$69.95** plus **\$2.00 S & H**. **ELEPHANT ELECTRONICS**, Box 41865-L, Phoenix, AZ 85080. Visa/MC orders (602) 581-1973. Allow 6 weeks for delivery.

CIRCLE 120 ON FREE INFORMATION CARD

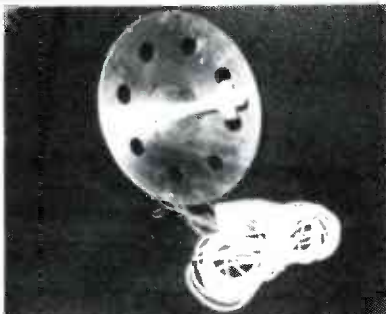

MICROWAVE ANTENNAS \$69.95. Now including shipping and Lifetime warranty. We Repair all types of Downconverters. Cable Converters and equipment available! Panasonic 450 MHz wireless converter **\$79.95** plus shipping. Coax cable, T.V. parts, accessories, connectors, T.V. amplifiers. Write for free information or call for prices. **BLUE STAR IND.**, Dept. 105-RE 3-87, 4712 Ave. N, Brooklyn, N.Y. 11234 (718) 338-8318 Ext. 105.

CIRCLE 85 ON FREE INFORMATION CARD



FREE CATALOG OF HARD-TO-FIND TOOLS is packed with more than 2000 quality items. Your single source for precision tools used by electronic technicians, engineers, instrument mechanics, schools, laboratories and government agencies. Also contains Jensen's line of more than 40 tool kits. Send for your free copy today! **JENSEN TOOLS INC.**, 7815 46th St., Phoenix, AZ 85044. (602) 968-6231.

CIRCLE 115 ON FREE INFORMATION CARD

NEW IDEAS

Broadcast-band RF amplifier

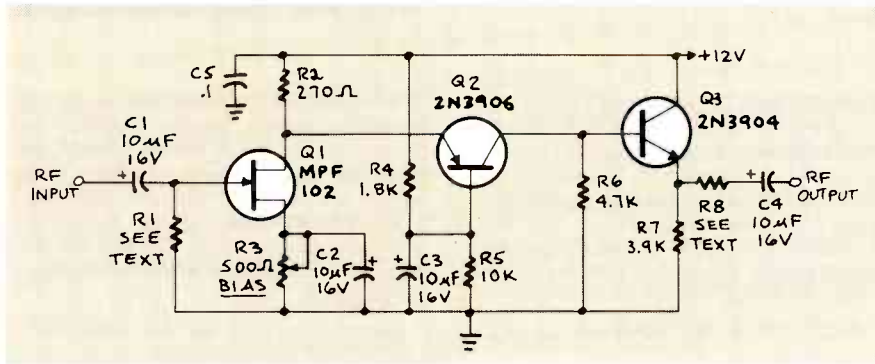

FIG. 1

UNLESS YOU OWN A TOP-OF-THE-LINE receiver or car radio, your AM reception may not be as good as it should be. The reason is that few low- to mid-price receivers and radios include RF amplifiers. By adding one yourself, however, you can improve reception at minimal cost. The RF amp shown here uses readily available parts, has wide bandwidth, and is very stable. In addition, by varying the values of several resistors, you can match the amplifier's input impedance to your antenna, and its output impedance to your radio.

How it works

The complete schematic is shown in Fig. 1. The circuit has a frequency response ranging from 100 Hz to 3 MHz; gain is about 30 dB.

Field-effect transistor Q1 is configured in the common-source self-biased mode; optional resistor R1 allows you to set the input impedance to any desired value. Commonly, it will be 50 ohms.

The signal is then direct-coupled to Q2, a common-base circuit that isolates the input and output stages and provides the amplifier's exceptional stability.

Last, Q3 functions as an emitter-follower, to provide low output impedance (about 50 ohms). If you need higher output impedance,

include resistor R8. It will affect impedance according to this formula: $R8 \approx R_{OUT} - 50$. Otherwise, connect output capacitor C4 directly to the emitter of Q3.

Construction

The circuit can be wired up on a piece of perfboard; a PC board is not necessary, although one can be used. However you build the circuit, keep lead lengths short and direct, and separate the input and output stages. You may have space to install the amplifier in your receiver. Otherwise, installing it in a metal case will reduce stray-signal pickup. You'll have to provide appropriate connectors on the case. Connect the amplifier to the antenna and radio using short lengths of coax.

The circuit has only one adjustment. Connect a source of 12-volt DC power to the circuit, and adjust R3 so that there is a 1.6-volt drop across R2.

If you're not sure of the impedance of your antenna, connect a 500-ohm potentiometer for R1, and adjust it for best reception. Then substitute a fixed-value resistor for the potentiometer.

You may want to follow the same procedure with the output circuit (R8), if you're not sure of your receiver's input impedance. Common impedances are 50, 75, and

NEW IDEAS

This column is devoted to new ideas, circuits, device applications, construction techniques, helpful hints, etc.

All published entries, upon publication, will earn \$25. In addition, for U.S. residents only, Panavise will donate their model 333—The Rapid Assembly Circuit Board Holder, having a retail price of \$39.95. It features an eight-position rotating adjustment, indexing at 45-degree increments, and six positive lock positions in the vertical plane, giving you a full ten-inch height adjustment for comfortable working.

I agree to the above terms, and grant Radio-Electronics Magazine the right to publish my idea and to subsequently republish my idea in collections or compilations of reprints of similar articles. I declare that the attached idea is my own original material and that its publication does not violate any other copyright. I also declare that this material has not been previously published.

Title of Idea

Signature

Print Name

Date

Street

City

State

Zip

Mail your idea along with this coupon to:

New Ideas
Radio-Electronics,
500-B Bi-County Boulevard
Farmingdale, NY 11735

300 ohms, so the same 500-ohm potentiometer can be used.

You can connect an external antenna through the amplifier to a receiver that has only a ferrite rod antenna. Connect the amplifier's output to a coil composed of 10–15 turns of #30 hookup wire wound around the existing ferrite core, near the existing winding. To obtain best reception, experiment with the number of turns and their placement. You may need to reverse the connections to the coil if output is weak.—D. J. Housley

Now electronics technicians can get into VCR Servicing quickly and easily

Learn professional VCR servicing at home or in your shop with exclusive videotaped demonstrations

Today, there are more than 10 million VCRs in use, with people standing in line to have them serviced. You can bring this profitable business into your shop with NRI professional training in VCR servicing. This top-level training supports the industry's claim that the best technicians today are those who service VCRs.

Integrated Three-Way Self-Teaching Program

In one integrated program, NRI gives you a study guide, 9 instructional units, 2 hours of video training tapes accompanied by a 32-page workbook that pulls it all together. At home or in your shop, you'll cover all the basic concepts of video recording, mechanical and electronic systems analyses, and the latest troubleshooting techniques. Your workbook and instructional units also contain an abundance of diagrams, data, and supplementary material that makes them valuable additions to your servicing library.

The "How-To" Videotape

Your NRI Action Videocassette uses every modern communications technique to make learning fast and easy. You'll enjoy expert lectures and see animation and video graphics that make every point crystal-clear. You'll follow the camera eye into the heart of the VCR as step-by-step servicing techniques are shown. Both electronic and mechanical troubleshooting are covered . . . including everything from complete replacement and adjustment of the recording heads to diagnosing micro-processor control faults.

Plus Training On All The New Video Systems

Although your course concentrates on VCRs covering Beta, VHS, and $\frac{3}{4}$ " U-Matic commercial VCRs, NRI also brings you up to speed in other key areas. You'll get training in capacitance and optical video disc players, projection TV, and video cameras. All are included to make you the complete video technician. There's even an optional final examination for NRI's VCR Professional Certificate.

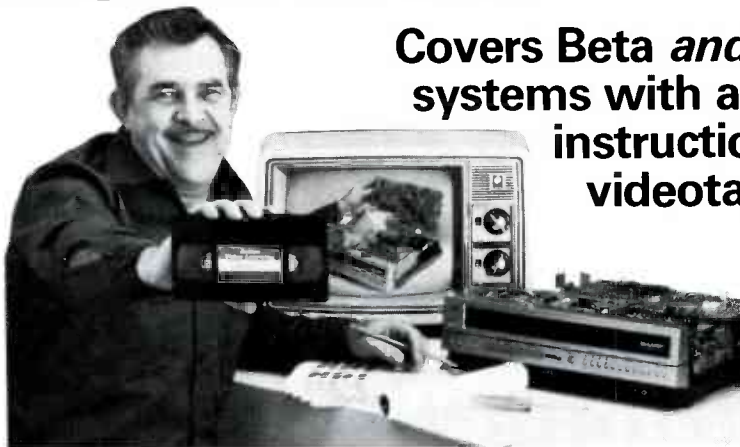

Covers Beta and VHS systems with actual instruction on videotape.

The Best Professional Training

This exclusive self-study course has been developed by the professionals at NRI. NRI has trained more television technicians than any other electronics school! In fact, NRI has consistently led the way in developing troubleshooting techniques for servicing virtually every piece of home entertainment equipment as it appears in the marketplace.

Satisfaction Guaranteed . . . 15-Day No-Risk Examination

Send today for the new NRI Self-Study Course in VCR Servicing for

Professionals. Examine it for 15 full days, look over the lessons, sample the videotape. If you're not fully satisfied that this is the kind of training you and your people need to get into the profitable VCR servicing business, return it for a prompt and full refund, including postage. Act now, and start adding new business to your business.

Special Introductory Offer

This complete VCR training course with two hour videotape is being offered for a limited time only, on orders received from this ad, at our low introductory price of \$179.95. Save \$20 by acting now!

NRI Training For Professionals
McGraw-Hill Continuing Education Center
3939 Wisconsin Avenue Washington, DC 20016

YES! Get me started in profitable VCR servicing. Rush me my NRI self-study course in VCR Servicing for Professionals. I understand I may return it for a full refund within 15 days if not completely satisfied.

PLEASE SPECIFY TAPE FORMAT DESIRED VHS BETA

Name (please print) _____

Company _____

Street _____

City/State/Zip _____

Enclosed is my check money order for \$179.95 (D.C. residents add 6% tax) Make check payable to NRI

Charge to VISA MasterCard _____

Interbank Number _____

Card Number _____ Expiration Date _____

Signature _____

(required for credit card sales)



NRI Training For Professionals
McGraw-Hill Continuing
Education Center
3939 Wisconsin Avenue
Washington, DC 20016

2600-037

COMMUNICATIONS CORNER



HERB FRIEDMAN,
COMMUNICATIONS EDITOR

Noise isn't always bad

OVER THE YEARS I HAVE HANDLED MANY transmitters—everything from flea-powered QRP's to 20-kW FM blockbusters—and, with the exception of the QRP's, you were warned to tune most of them fast—or else.

You had to tune up fast in order to keep heat dissipation in the final amplifier to a minimum, because excessive heat dissipation can damage or destroy an amplifier, be it a vacuum-tube or a solid-state device.

I tuned UHF TV-relay transmitters by literally opening the door of the cabinet; I dipped (resonated) finals by tuning until the color of an amplifier's plate changed from deep red to orange; and I sent many finals up in smoke in the early days of solid-state RF power amplifiers. In most instances my hand was quicker than the eye, or at least the heat, so I could tune up faster than the gremlins could destroy the final.

But when it came to antenna tuners, particularly those for long-wire antennas, the heat may outpace the fingers, because it can take much fiddling with two or three knobs before the input impedance of the tuner is within the range of the transmitter's adjustments. In fact, I often wondered how much damage I caused a transmitter when it took a long time to adjust an antenna tuner.

Of course, until recent times I didn't have the luxury of a Palomar Engineers (Box 455, Escondido, CA 92025) model *PT-340 Tuner-Tuner*, shown in Fig. 1. The *Tuner-Tuner* is a noise bridge that's specifically designed for pre-adjusting the antenna tuner before the transmitter is ever keyed (turned on).

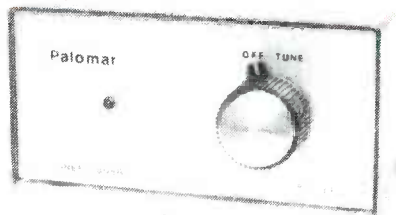

FIG. 1

The Noise Bridge

For those of you who have never used a noise-bridge, fear not; this will not be a three-part tutorial on noise-bridge design. We'll stick with the *Tuner-Tuner*.

To understand how it works, examine the simplified bridge circuits shown in Fig. 2-a and Fig. 2-b. In Fig. 2-a, the T1 and T2 connections may appear unusual, but the

ohms, the bridge is balanced. Therefore, no signal will flow through the headphones.

Now imagine that we unbalance the bridge by changing R2's value to something other than 50 ohms. The arms of the bridge are no longer balanced, so a signal will be heard in the headphones. In actual practice, a single transformer would replace T1 and T2; the circuit would resemble the one shown in Fig. 2-b.

Now let's show how the *Tuner-Tuner* works. Rather than a 1000-Hz tone, the signal source will be a white-noise generator that produces a range of signals at frequencies throughout the VHF spectrum. Also, T3 (in Fig. 2-b) will be replaced by an RF transformer; the headphones will be replaced

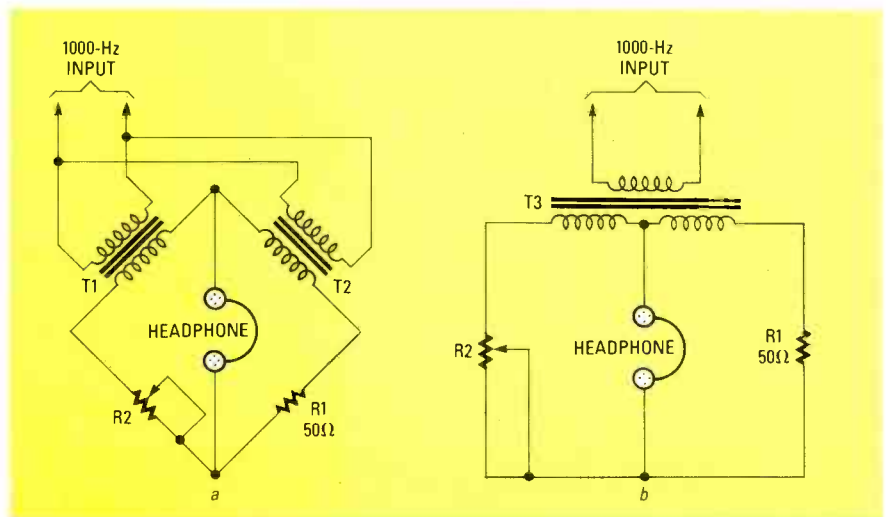

FIG. 2

circuit simply shows how to couple a 1000-Hz signal into the bridge so that both "arms" of the bridge conduct equal current. Resistor R1 is 50 ohms, so, if R2 is set for 50

by the receiver section of a transmitter; and R2 will be replaced by the input to an antenna tuner. Figure 3 shows the circuit that results.

continued on page 122

KENWOOD

...pacesetter in Amateur radio

NEW

Hear it All!



R-5000

High performance receiver

THE high performance receiver is here from the leader in communications technology—the Kenwood R-5000. This all-band, all mode receiver has superior interference reduction circuits, and has been designed with the highest performance standards in mind. Listen to foreign music, news, and commentary. Tune in local police, fire, aircraft, weather, and other public service channels with the VC-20 VHF converter. All this excitement and more is yours with a Kenwood R-5000 receiver!

- Covers 100 kHz-30 MHz in 30 bands, with additional coverage from 108-174 MHz (with VC-20 converter installed).
- Superior dynamic range. Exclusive Kenwood DynaMix™ system ensures an honest 102 dB dynamic range. (14 MHz, 500 Hz bandwidth, 50 kHz spacing.)

R-2000

- 150 kHz-30 MHz in 30 bands
- All modes • Digital VFOs tune in 50 Hz, 500 Hz, or 5 kHz steps • 10 memory channels
 - Programmable scanning • Dual 24-hour digital clocks, with timer • 3 built-in IF filters (CW filter optional) • All mode squelch, noise blanker, RF attenuator, AGC switch, S meter • 100/120/220/240 VAC operation • Record, phone jacks
 - Muting terminals • VC-10 optional VHF converter (118-174 MHz)

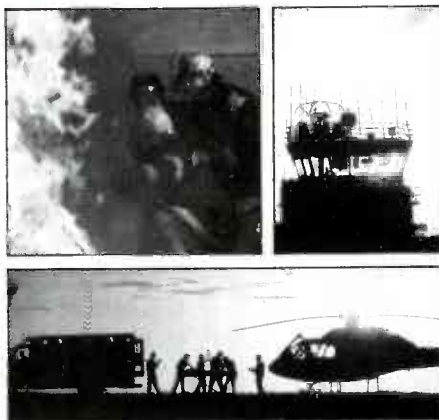

- 100 memory channels. Store mode, frequency, antenna selection.
- Voice synthesizer option.
- Computer control option.
- Extremely stable, dual digital VFOs. Accurate to ± 10 ppm over a wide temperature range.
- Kenwood's superb interference reduction. Optional filters further enhance selectivity. Dual noise blankers built-in.
- Direct keyboard frequency entry.



- Versatile programmable scanning, with center-stop tuning.
- Choice of either high or low impedance antenna connections.
- Kenwood non-volatile operating system. Lithium battery backs up memories; all functions remain intact even after lithium cell expires.
- Power supply built-in. Optional DCK-2 allows DC operation.
- Selectable AGC, RF attenuator, record and headphone jacks, dual 24-hour clocks with timer, muting terminals, 120/220/240 VAC operation.

Optional Accessories:

- VC-20 VHF converter for 108-174 MHz operation
- YK-88A-1 6 kHz AM filter
- YK-88S 2.4 kHz SSB filter • YK-88SN 1.8 kHz narrow SSB filter • YK-88C 500 Hz CW filter • YK-88CN 270 Hz narrow filter
- DCK-2 DC power cable • HS-5, HS-6, HS-7 headphones • MB-430 mobile bracket
- SP-430 external speaker • VS-1 voice synthesizer • IF-232C/IC-10 computer interface.

More information on the R-5000 and R-2000 is available from Authorized Kenwood Dealers.

KENWOOD

TRIO-KENWOOD COMMUNICATIONS
1111 West Walnut Street
Compton, California 90220

CIRCLE 102 ON FREE INFORMATION CARD

Specifications and prices are subject to change without notice or obligation

MAKE MORE MONEY

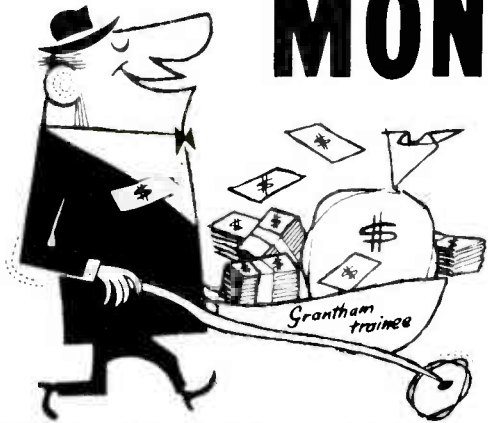

TRAIN FOR ELECTRONICS

You say you're *already* trained in electronics but that you're *not* making enough money??? Well then, maybe you don't have an accredited bachelor's degree to prove that your education is *up to snuff!* Check out the Grantham Independent-Study B. S. Degree Program. It could make a *dollars and sense difference* in your electronics career.

Grantham offers this program, complete but without laboratory, to electronics technicians whose objectives are to upgrade their level of technical employment. Since the field of electronics is so enormous, opportunity for advancement is always present. Promotions and natural turnover make desirable positions available to the man who is ready to *move up*.

Grantham College of Engineering
10570 Humbolt Street
Los Alamitos, California, 90720

This booklet FREE!

This free booklet explains the Grantham B.S. Degree Program, offered by independent study to those who work in electronics.

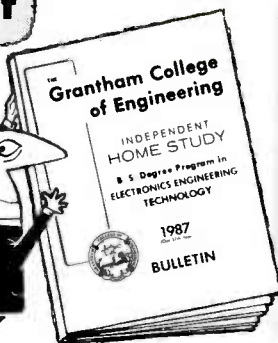

for **FREE Booklet CLIP COUPON** and mail in envelope or paste on postal card.

Do You REALLY Want to Make More Money?

Yes it does take *work* and a few sacrifices to climb up the electronics ladder to where the bigger money is. But, if that's where you want to be, then that's what you must do — *work* harder at learning and getting the right credentials, even if it takes a few sacrifices. A *B. S. degree* and the knowledge that rightly goes along with it can give you powerful ladder-climbing equipment in your search for *success in electronics*.

The accredited Grantham non-traditional B.S. Degree Program is intended for mature, fully-employed workers who want to upgrade their electronics careers.

Put Professional Knowledge and a COLLEGE DEGREE in your Electronics Career through Independent Home Study

Study materials, carefully written by the Grantham College staff for independent study at home, are supplied by the College. Your technical questions related to these materials and the lesson tests are promptly answered by the Grantham home-study teaching staff.

Recognition and Quality Assurance

Grantham College of Engineering is accredited by the Accrediting Commission of the National Home Study Council, as a degree-granting institution.

All lessons and other study materials, as well as communications between the college and students, are in the English language. However, we have students in many foreign countries; about 80% of our students live in the United States of America.

Grantham College of Engineering R-3-87
10570 Humbolt Street, Los Alamitos, CA 90720

Please mail me your free catalog which explains your B.S. Degree independent-study program.

Name _____ Age _____

Address _____

City _____ State _____ Zip _____

A Buyer's Guide to Camcorders

VHS-C, VHS, 8mm, 4mm, or Beta? Find your way through the camcorder maze with this up-to-date buyer's guide.

FRANK VIZARD

TWENTY-SEVEN YEARS AGO, AMERICANS ELECTED John F. Kennedy President of the United States. Television and film captured most of the public events of his presidency, but much of what we know regarding his personal life comes from home movies made on the beaches of Cape Cod and around the family home.

The technology has changed since Kennedy's day. Increasing numbers of people are capturing the personal highlights of their lives for viewing on their home TV screen. Videotape has superseded film.

At the start of the so-called video revolution, a few pioneers turned to portable videocassette recorders and, with a separate video camera, began recording their own home videos. That two-piece approach was inconvenient because of the entanglement of wires, bulky weight, and limited mobility. Manufacturers, responding to consumer demand, dispensed with the two-piece approach and created a smaller and lighter piece of equipment that combined the recording ability of the VCR and the picture-taking ability of the video camera into one product. The result was called a *camcorder*.

Choosing a format

While the camcorder was a straightforward technological development, buying a camcorder is far from simple. If you thought the format war between VHS and Beta videocassette recorders was a dispute that led only to confusion, then consider the formats available in camcorders.

There are, of course, camcorders that use VHS or Beta videotape. Unfortunately for proponents of the Beta system, that format is still supported only by its originator, Sony (Sony Drive, Park Ridge, NJ 07656). If you already own Beta equipment and would like to purchase a compatible camcorder, you have only one choice: Sony's model *BMC-660K*, which carries a list price of \$1495. Unless you are completely devoted to Beta, it appears that the selection of another format is in order.

However, eliminating Beta does not significantly simplify the



selection process. The VHS format itself has a stepchild called VHS-C. Unrelated to either VHS format, or to Beta, is yet another format, called 8mm. Finally, we may be seeing a 4mm format before long.

Smaller is better

All those competing formats are basically a multitude of solutions to a single problem—how to reduce the camcorder to a comfortable size. A standard VHS cassette is seven inches long. Any camcorder that uses such a cassette is unwieldy, although some of the latest models have shown some remarkable progress in downsizing. VHS camcorders do have several significant advantages. One is that the cassettes can be played back on any home VHS player without an adapter. Second, they offer relatively long recording times. Most VHS camcorders allow you to record for up to two hours at standard speed. Many VHS camcorders can also record at a slower speed, effectively lengthening the available recording time. The maximum recording time on Goldstar's (1050 Wall St. West, Lyndhurst, NJ 07071) *GVM-70A*, for example, is 240 minutes. A maximum recording time of 160 minutes is more common, however.



SONY CCD-V3

Despite that, the race for miniaturization goes on unabated. It has given rise to VHS-C, 8mm, and now, due sometime this summer from Samsung (301 Mayhill St., Saddle Brook, NJ 07662), 4mm.

Early reports indicate that while the 4mm camcorder itself will be about the same size as a VHS-C camcorder, the tape itself will be even smaller than the 8mm cassette, which is now the smallest on the market. Recording time will be up to 80 minutes. The 4mm camcorder will also have a built-in VHF/UHF tuner and a 2½-inch monitor. The built-in tuner means that the 4mm camcorder could double as a home deck, although the limited recording time would hamper its effectiveness in such a role. The monitor is reportedly an LCD type, which would make it a first in camcorders. The image created by those devices is not as sharp as that created by a



OLYMPUS VX-403

CRT. However, the image is acceptable for use in a camcorder, and the LCD's flat profile helps reduce the overall size of the unit.

The list price for the new 4mm camcorder will reportedly be about \$1300. Presumably a model without a tuner would cost much less. If Samsung's 4mm model meets with any success, there's little doubt that others would produce models using the format.

For the moment, though, the miniaturization battle is being waged between the VHS-C and 8mm formats. The VHS-C cassette is less than four inches in length, roughly the size of a pack of playing cards. A typical VHS-C camcorder is about 11 inches long by 8 inches high—about the dimensions of the magazine you are reading. VHS-C camcorders are also lighter than their full sized counterparts, averaging about three pounds, compared to about 5½ pounds for a standard-sized model.

The tape's small size is largely responsible for the VHS-C camcorder's size. The tradeoff, as we previously mentioned, is that the smaller cassette holds less tape, and therefore provides reduced recording time.

Standard recording time is 20 minutes, although newer VHS-C camcorders increase recording time to 60 minutes. The small size of the VHS-C cassette also means there is a hidden cost. VHS-C cassettes cannot be played back on a standard VHS videocassette recorder without the use of an adapter. The price of the adapter is about \$70.

A number of companies offer VHS-C camcorders, but the genre was started by JVC (41 Slater Drive, Elmwood Park, NJ 07407), and any new developments in the format are likely to come from that company. Just recently, for example, JVC unveiled the smallest VHS-C camcorder yet.

The *GR-C9* weighs only 1.7 pounds and lists for about \$1000. Considering the discounts available from many retailers, the *GR-C9* is perhaps the most affordable camcorder ever offered for sale.

Its affordability and small size are due principally to the fact that the *GR-C9* is a record-only device. Most other camcor-

ders have a built-in black-and-white video monitor that allows you to play back what you have recorded immediately. With the *GR-C9*, you'll have to postpone gratification until you get home to a VCR. The lack of a playback feature also means you'll be unable to dub from the camcorder to a VCR. To make copies or to edit your tape you'll need two VCR's. If you intend to direct your own video movie you may be better off with a more sophisticated machine, but from the standpoint of just taking video snapshots, the *GR-C9* is a suitable choice.

The *GR-C9*, incidentally, also features an interesting design innovation. Most camcorder battery packs attach to the rear of the unit. The battery pack for the *GR-C9* doubles as the camera's grip, reducing the overall size of the unit even more.

While the VHS-C camcorder initially had the edge as far as lightness and small size were concerned, 8mm camcorders are narrowing the gap fast. For the most part, early 8mm camcorders were as heavy and large as their full-size VHS competition, even though the tape used in 8mm camcorders is smaller in size than even the VHS-C cassette. However, recent models have put the 8mm camcorder into the flyweight class with VHS-C.

Sony's *CCD-V3 Handycam* cam-

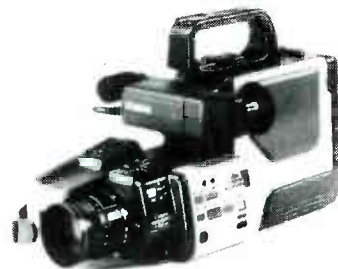

CANON VM-E1

recorder, for instance, weighs only three pounds, two ounces. The *CCD-V3* is an upgraded version of the *CCD-M8U* roundly knocked by JVC last fall in a nationwide television-advertising campaign.

Unlike the *CCD-M8U*, the *CCD-V3* incorporates built-in playback capability, automatic focus, and a zoom lens. There's also a difference in price; the *CCD-M8U* listed for \$1250 while the *CCD-V3* now carries a \$1500 price tag.

Sony is aggressively leading the push for 8mm, but it is not alone in making 8mm camcorders smaller and lighter. The Olympus (Crossways Park, Woodbury, NY 11797) *VX-80J*, for example, weighs in at 3.3 pounds and features a full complement of features at a list price of \$1850.

The major advantage the 8mm format has over the VHS-C format, however, is the amount of recording time. Its 120-

TABLE 1—CAMCORDER SPECIFICATIONS

Company	Model	Format	Min. ill. (lux)	Pickup device	Max length (min.)	Aperture	Zoom ratio	Hq	Price
Aiwa	CV-80	8mm	19	CCD	120	f/1.4	6:1	NA	\$1795
Canon	VM-E1	8mm	19	Saticon	120	f/1.2	6:1	NA	\$1695
Chinon	CV-T60	VHS	7	Newvicon	160	f/1.2	6:1	Yes	\$1995
	CV-T60G	VHS	7	Newvicon	160	f/1.2	6:1	Yes	\$1895
	C8-C60	8mm	NA	NA	120	NA	NA	NA	NA
Curtis Mathes	AV800	VHS	7	Newvicon	160	f/1.2	6:1	No	NA
Fuji	P100	8mm		CCD	NA	NA	NA	NA	NA
	Z600AF	8mm		NA	120	NA	NA	NA	NA
General Electric	9-9606	VHS	7	Newvicon	160	f/1.2	6:1	Yes	\$1499
	9-9608	VHS	7	Newvicon	160	f/1.2	6:1	Yes	\$1599
	9-9610	VHS	7	CCD	160	f/1.2	8:1	Yes	\$1799
Goldstar	GS-8AF	8mm	19	CCD	120	f/1.4	6:1	NA	\$1695
	GVM-70AF	VHS	19	CCD	240	f/1.4	6:1	Yes	\$1695
Hitachi	VM2100A	VHS	7	Saticon	160	f/1.2	6:1	Yes	\$1595
	VM5000A	VHS	7	MOS	160	f/1.2	6:1	Yes	\$1695
Instant Replay	Handycam	8mm	20	CCD	120	f/1	NA	NA	\$1295
	92IT3	VHS	7	Newvicon	120	f/1.2	6:1	Yes	\$1895
	66IT3	VHS	10	Newvicon	160	f/1.2	6:1	No	\$1995
	93IT3	VHS	20	CCD	120	f/1.2	8:1	Yes	\$1995
JC Penney	686-5335	VHS	10	Newvicon	160	f/1.2	6:1	Yes	\$1700
JVC	GR-C7	VHS-C	15	CCD	60	f/1.2	6:1	Yes	\$1495
	GR-C9	VHS-C	10	CCD	60	NA	NA	Yes	\$995
Kyocera	KD-200K	8mm	19	CCD	120	f/1.4	6:1	NA	\$1745
Magnavox	VR8292	VHS	7	Newvicon	160	f/1.2	6:1	Yes	\$1799
	VR8293	VHS	7	CCD	160	f/1.2	8:1	Yes	\$1899
	Video Escort	VHS-C	7	NA	60	f/1.2	6:1	NA	\$1899
Minolta	CR1200SAF	VHS	7	MOS	160	f/1.2	6:1	Yes	\$2085
	CR3000SAF	VHS-C	15	Saticon	60	f/1.2	6:1	No	\$1667
	CR8000SAF	8mm	7	MOS	120	f/1.2	6:1	NA	NA
Mitsubishi	HS-F10ur	VHS	7	Saticon	NA	f/1.2	6:1	No	\$1550
NEC	EMA8U	8mm	7	CCD	NA	f/1.2	6:1	NA	NA
	V-20	VHS	10	CCD	NA	f/1.2	NA	Yes	\$1795
Nikon	VN-800	8mm		CCD	120	NA	6:1	NA	\$1850
Olympus	VX403	VHS	7	CCD	160	f/1.2	8:1	No	\$1950
	VX801	8mm	7	CCD	120	f/1.2	6:1	NA	\$1850
Panasonic	PV210	VHS	7	Newvicon	160	f/1.2	6:1	Yes	NA
	PV220	VHS	7	Newvicon	160	f/1.2	6:1	Yes	NA
	PV300	VHS	7	CCD	160	f/1.2	8:1	Yes	NA
Pentax	PVC33A	VHS	7	Saticon	160	f/1.2	6:1	Yes	\$1699
	PVC55A	VHS	7	MOS	160	f/1.2	6:1	Yes	\$1799
	PVC800A	8mm	7	MOS	120	f/1.2	6:1	NA	NA
Philco	VCR801	VHS	7	Newvicon	160	f/1.2	6:1	Yes	\$1799
Quasar	VM-11	VHS	7	Newvicon	160	f/1.2	6:1	Yes	\$1650
	VM-20	VHS	7	CCD	160	f/1.2	8:1	Yes	\$1800
RCA	CRM200	VHS	7	Saticon	160	f/1.2	6:1	Yes	\$1299
	CMR300	VHS	7	MOS	160	f/1.2	6:1	Yes	\$1499
Sanyo	VM8	8mm	19	CCD	120	f/1.4	6:1	NA	\$1595
	VM-800	8mm	18	CCD	120	f/1.4	6:1	NA	\$1750
Sears	53721	VHS	7	Saticon	160	f/1.2	6:1	Yes	\$1290
Sharp	VC-10UAH	VHS	10	Newvicon	160	f/1.4	6:1	Yes	\$1900
	VC20UA	VHS	10	MOS	160	f/1.2	6:1	Yes	\$1799
	VC-C50UA	VHS-C	10	CCD	60	f/1.6	6:1	Yes	\$1599
Sony	BMC-66oK	Beta	25	CCD	200	f/1.4	6:1	NA	\$1495
	CCD-M8U	8mm	25	CCD	120	f/1.6	NA	NA	\$1250
	CCD-M9U	8mm	25	CCD	120	f/1.4	6:1	NA	\$1350
	CCD-V8FU	8mm	19	CCD	120	f/1.4	6:1	NA	\$1795
	CCD-V110	8mm	NA	CCD	120	NA	NA	NA	\$1995
	CCD-V3	8mm	NA	CCD	120	NA	NA	NA	\$1500
Sylvania	VC151	VHS	7	Newvicon	160	f/1.2	6:1	Yes	\$1799
Teknika	C6010	VHS	7	Newvicon	160	f/1.2	6:1	Yes	NA
Toshiba	SK-60	VHS-C	15	CCD	60	f/1.6	6:1	NA	NA
Zenith	VM6200	VHS-C	5	CCD	60	f/1.6	6:1	NA	NA

Camcorder Manufacturers

Aiwa

35 Oxford Drive
Moonachie, NJ 07074
CIRCLE 250 ON FREE INFORMATION CARD

Canon

One Canon Plaza
Lake Success, NY 11042
CIRCLE 251 ON FREE INFORMATION CARD

Chinon

43 Fadem Road
Springfield, NJ 07081
CIRCLE 252 ON FREE INFORMATION CARD

Curtis Mathes

1 Flat Creek Rd.
Athens, TX 75751
CIRCLE 253 ON FREE INFORMATION CARD

Fuji

350 5th Ave.
New York, NY 10118
CIRCLE 254 ON FREE INFORMATION CARD

Goldstar

1050 Wall St.
West Lyndhurst, NJ 07071
CIRCLE 255 ON FREE INFORMATION CARD

Hitachi

401 W. Artesia Blvd.
Compton, CA 90220
CIRCLE 256 ON FREE INFORMATION CARD

Instant Replay

2951 South Bayshore Drive
Miami, FL 33133
CIRCLE 257 ON FREE INFORMATION CARD

JVC

41 Slater Drive
Elmwood Park, NJ 07407
CIRCLE 258 ON FREE INFORMATION CARD

Kodak

Rochester, NY 14650
CIRCLE 259 ON FREE INFORMATION CARD

Kyocera

7 Powder Horn Drive
P.O. Box 4227
Warren, NJ 07060-0227
CIRCLE 260 ON FREE INFORMATION CARD

NAP Consumer Electronics

(Magnavox, Philco, Sylvania)
I-40 and Straw Plains Pike
Knoxville, TN 37914-1810
CIRCLE 261 ON FREE INFORMATION CARD

Minolta

101 Williams Drive
Ramsey, NJ 07446
CIRCLE 262 ON FREE INFORMATION CARD

NEC

1255 Michael Drive
Wood Dale, IL 60191
CIRCLE 263 ON FREE INFORMATION CARD

Nikon

623 Stewart Ave.
Garden City, NY 11530
CIRCLE 264 ON FREE INFORMATION CARD

Olympus

Crossways Park
Woodbury, NY 11797
CIRCLE 265 ON FREE INFORMATION CARD

Panasonic

One Panasonic Way
Secaucus, NJ 07094
CIRCLE 266 ON FREE INFORMATION CARD

Pentax

35 Inverness Drive East
Englewood, CO 80112
CIRCLE 267 ON FREE INFORMATION CARD

Quasar

9401 Grand Ave.
Franklin Park, IL 60131
CIRCLE 268 ON FREE INFORMATION CARD

RCA

30 Rockefeller Plaza
New York, NY 10020
CIRCLE 269 ON FREE INFORMATION CARD

Sanyo

1200 W. Artesia Blvd.
Compton, CA 90220
CIRCLE 270 ON FREE INFORMATION CARD

Sharp

Sharp Plaza
Mahway, NJ 07430
CIRCLE 271 ON FREE INFORMATION CARD

Sony

Sony Drive
Park Ridge, NJ 07656
CIRCLE 272 ON FREE INFORMATION CARD

Teknika

353 Rt. 46 W
Fairfield, NJ 07006
CIRCLE 273 ON FREE INFORMATION CARD

Toshiba

82 Totawa Rd.
Wayne, NJ 07470
CIRCLE 274 ON FREE INFORMATION CARD

Zenith

1000 Milwaukee Ave.
Glenview, IL 60025
CIRCLE 275 ON FREE INFORMATION CARD

Choosing a camcorder

Critics may disagree over which format offers the best picture, but VHS, VHS-C, and 8mm all provide satisfactory performance. Therefore, choosing a camcorder is mostly a question of convenience and features.

For those that want simply to be able to remove a cassette from their camcorder and drop it into their home deck, without the need for adapters, etc., VHS offers an obvious advantage (although it is important to remember the size trade-off). True, now there are also 8mm home decks, but the library of prerecorded material currently available is very limited. Until that changes, if it ever does, few will choose to go with 8mm home systems.

On the other hand, any camcorder that has a playback feature, and most do, can be directly connected to any television or monitor/receiver for tape viewing. Some camcorders, in fact, are sophisticated enough to serve as a household's primary VCR. Also keep in mind that images can be dubbed from one format to another by feeding your camcorder's output to your home VCR.

Features, specifications, and price

No matter which format you choose, your final selection will be guided by three factors. Those factors are the same ones that determine the selection of almost any product: features, specifications, and price.

Of course, to a large degree features and specifications determine price. As with everything else in life, there are tradeoffs to be made. Unless you are wealthy, the task of selecting a camcorder is one of finding the combination of features and performance you want (or can "get by with") at a price you can afford.

Manufacturers provide a wealth of specifications in their advertising literature, but for most users the most important one is likely to be the minimum required illumination. That specification tells you the least amount of light required to produce acceptable results. To add to the confusion, some manufacturers provide that specification in lux (which is Latin for light), while others provide the specification in foot-candles. A foot-candle is equal to the amount of illumination provided by a candle over a one foot-square spherical area, with every point of the area located exactly one foot from the light source. That light level has, of course, been standardized. One lux equals 0.0929 foot-candle. Normal living room illumination is between 60 and 120 lux, while a sunny day at the beach will measure about 100,000 lux.

If you're planning to record under low light conditions then you'll require a camcorder with a better-than-average minimum illumination rating. That rating is dependent on several factors, but the most

minute maximum is twice the recording time of VHS-C.

The split in the market for the two formats is even evident in the type of stores in which the two formats tend to be sold. VHS-C units are sold principally through consumer-electronics stores. 8mm camcorders are sold mostly in photographic

specialty stores; since Kodak (Rochester, NY 14650) introduced the format, that mode of distribution probably was inevitable. (Interestingly, though, Kodak does not offer a true camcorder. Instead they offer a modular system consisting of separate but dockable video recorders and video cameras).

Choosing a Tape

IF YOU OWN OR USE A VIDEOCASSETTE RECORDER, you are undoubtedly aware of the variety of brands and formulations of videotape on the market. Basically, most manufacturers sell tapes in 3 or 4 grades. Each grade is suitable for almost any taping chore, although some grades are better for certain chores than others. For instance, it makes little sense to use an expensive professional-grade tape for time shifting soap operas. On the other hand, you would not want to entrust a copy of a movie or TV classic to a standard- or economy-grade tape.

When it comes to tapes for camcorders, if you use a unit that accepts standard

As with home decks, the quality of the image recorded by a camcorder degrades as tape speed decreases. Therefore, if you are extending recording time by shooting in the EP or 60-minute mode, a higher tape grade is required for best results. JVC's grade of better tape is called *Super HG*.

Premium- or "professional"-grade videotape, such as JVC's *Super Pro* is used when top recording quality is essential. For instance, you would use premium-grade tape when the original recording is to be dubbed to a second tape; a top-quality original is necessary to minimize the picture degradation that always oc-



NIKON VN-800

If you are purchasing a VHS or VHS-C unit, you may want to look for one with HQ (*High Quality*) circuitry. Beta has always enjoyed a technical edge over VHS in the area of horizontal resolution. To the viewer, that means that a Beta picture will usually appear somewhat sharper than a VHS one. JVC, the originator of VHS and VHS-C, developed the HQ system to combat that superiority. HQ actually consists of three separate circuits, but many units call themselves HQ while using only one or two. The most commonly found HQ circuit is white-clip extension. That circuit reduces the amount of white clip by about 20%, resulting in crisper outlines between light and dark areas of a scene. Another circuit boosts high-frequency signals (which contain the picture details) during recording. The third circuit boosts high-frequency picture details during playback. Note that the three circuits are completely independent and that any combination of them may be found in a particular model. Also, HQ and non-HQ tapes and equipment are completely compatible.

Most camcorders are completely automatic, offering such bells and whistles as automatic aperture setting, automatic white balance (the white balance setting is used to adjust for proper color fidelity), and autofocus. If you like more control over your recording, be sure that the model you select allows you to override those automatic features. On the other hand, bear in mind that a camcorder that lacks one or more of those features can be more difficult to use.

Camcorders are designed to be light and comfortable, but eyeglass wearers may have to look harder to find a comfortable viewfinder. Likewise, left-handed people will find that most models have admittedly been designed for right-handed users.

As you can see, there are many things to consider when choosing a camcorder. To make the job a little easier, we've compiled a list of models available at press time; it is found in Table I. Bear in mind that the table is only a guide; specifications, list prices, etc., are always subject to change. Also, new models are introduced from time to time, and old ones are discontinued. **R-E**



TDK 8mm VIDEOTAPE

VHS or beta tapes, the same tapes you use in your home deck are used in those units. Now, however, different grades of tape are becoming available in the smaller VHS-C format.

For users of VHS-C camcorders, there are basically three grades of tape available. It is perhaps most convenient to think of them in terms of good, better, and best. Let's look at the tape grades offered by one manufacturer, JVC, and see how each is best used.

HG Super is JVC's "good" tape. It is designed for general use and is most effective when you're shooting in the SP or 20-minute mode.

curs during dubbing. Premium tape used at SP speeds yields the closest thing to professional results available to the consumer.

Currently, manufacturers are offering just one tape grade for 8mm users. However, because 8mm standard requires tapes that have either a metal-particle or evaporated-metal formulation (currently only metal-particle formulations are available), all 8mm tapes are outstanding performers. But quality is not cheap; prices for 8mm blank tape vary between about \$17 and \$24, depending on tape length. By contrast, VHS-C blank tape costs between \$7 and \$10 per cassette. **R-E**

significant of those is the camcorder's pickup.

Initially, consumer video cameras all used vacuum-tube pickups. Those devices, which go under tradenames such as Newvicon and Saticon, generally perform well in low-light conditions. On the other hand, if a vacuum-tube video camera were panned past a relatively bright light source, streaking or "comet-tailing" would occur. If such a video camera were pointed at a bright light for any length of time, the unit would be damaged.

Many newer camcorders and video cameras use solid-state CCD (Charge Coupled Device) or MOS (Metal Oxide Semiconductor) pickups. Those pickups are less susceptible to streaking and to damage from bright lights. They also produce a sharper image than that produced by a vacuum-tube pickup. But they require higher light levels than vacuum-tube pickups for satisfactory performance.

The camcorder's lens is the window through which it sees the world. Therefore, lens quality and features play a large

role in determining which images eventually wind up on tape.

All camcorders are supplied with lenses of solid, though not spectacular quality. Most are of the zoom variety, with focal lengths variable between 9mm and 54mm (a 6:1 zoom ratio). Some manufacturers, such as Panasonic (One Panasonic Way, Secaucus, NJ 07094), Quasar (9401 W. Grand Ave., Franklin Park, IL 60131), and General Electric (Portsmouth, VA 23705), offer units with 8:1 zoom ratios.

When comparing lenses, two features to watch for are *macro* and *maximum aperture*. A macro setting allows the lens to be used to tape items at extremely close range (as close as 1 inch). Maximum aperture (which is sometimes referred to as lens *speed*) tells you the maximum width of the lens aperture or opening. The larger the diameter of the lens opening, the more light will be admitted.

Some models have removable lenses. Those most often use C-mounts and allow you to use wide-angle, telephoto, or any lens that accepts that mount.

R-E ROBOT

This month, we show you how to build the robot's body. We'll also tell you about an updated drive system that will dramatically increase the robot's hauling power.

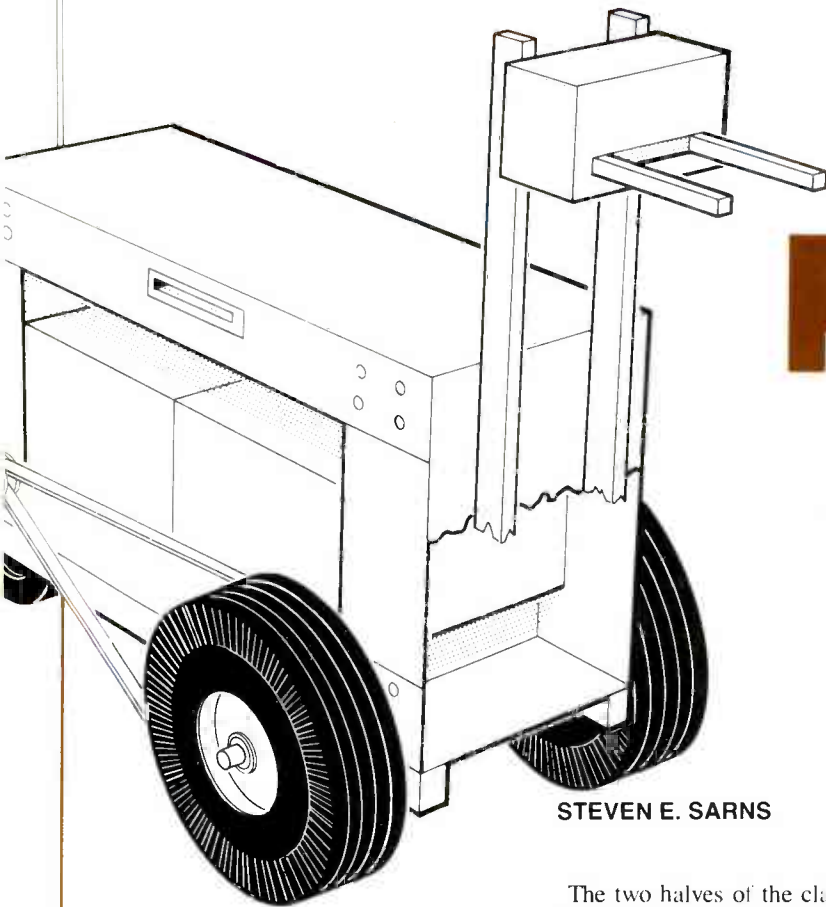

STEVEN E. SARNS

Part 4 ONCE THE DESIGN PROCESS is complete, it is time to begin building your robot. This month, we will start by showing you how to build the base unit that we designed. Remember that the procedures, dimensions, etc. will vary if you chose to use a different design.

Body construction

Our base-unit design is easy to manufacture and assemble. It consists of a "unitized-construction" body that is composed of four pieces of 0.090-inch 5051T-6 or 6065T-6 aluminum, plus two end caps (one of which is optional) formed from the same material. See Fig. 1. A chassis fabricated from 5051T-6 aluminum is available from Vesta Technology (see Sources Box); contact them directly for pricing and other details.

The upper and lower clamshells are formed from identical pieces of aluminum. See Fig. 2-a. Once the pieces are cut, they are bent as shown in Fig. 2-b to form a channel. Make the 90° bends using a 0.18-inch radius to prevent cracking the aluminum. Note that while Fig. 2-b shows right-hand bends, one of the pieces requires left-hand bends if the body clamshell is to fit together.

The two halves of the clamshell body are joined with the internal bulkheads. A cutting and bending guide for the bulkheads is shown in Fig. 3. Because of the thickness of the aluminum used, the notching shown at the four corners is required to allow the bulkheads to seat correctly inside the upper and lower clamshells. Form one bulkhead with left-hand bends; the other is formed with right-hand bends.

The bulkheads are the major strengthening component in the robot's chassis. When assembled, the resulting chassis is strong enough to carry a person without flexing, yet it weighs less than ten pounds. Further, the forward bulkhead serves as the mounting surface for the electronics package; the rear bulkhead holds the motors in their own compartment.

The four body components are fastened together with 6-32 × 3/8-inch machine screws. The holes are drilled in the outer shell, then each bulkhead is clamped in place and the bulkhead is drilled using the outside hole as a centering hole. Several precautions must be observed. First, securely clamp the bulkhead in place so that it cannot move during the drilling process. Second, ensure that the bottom of the bulkhead is in direct and flat contact with the bottom of the bottom clamshell. Third, use a carpenter's square to ensure that the chassis is assembled squarely.

A cutting and bending guide for the end covers is shown in Fig. 4. As with the bulkheads, the corners must be notched as shown. The front end-cover will be used to mount the robotic arm assembly. The rear end-cover is optional and should *not* be used with the specified motors (more on those in a moment) unless plenty of ventilation holes are provided. The end covers are mounted to the body during the last step of assembly using sheet-metal screws.

Mounting the axle

The axle is an 18-inch long, 1/2-inch diameter steel rod. The rod is modified by drilling a small hole 1/4-inch from each end. Once the wheel/axle assembly is complete, a cotter pin is placed through each hole to keep everything in place.

The axle is mounted to the lower clamshell with a 1-1/2-inch U-bolt. See Fig. 5. A hardwood or a hard-rubber block is shaped to fit inside the U-bolt. A 1/2-inch hole then is drilled in the block to accept the axle. The centerline of that hole should be placed so that the robot's body sits level when the rear caster is attached. The dimension in our case was 3/4-inch below the lower body. The U-bolt is placed around the block and inserted into two holes drilled into the lower clamshell just behind the forward bulkhead. To achieve maximum stability, it is important

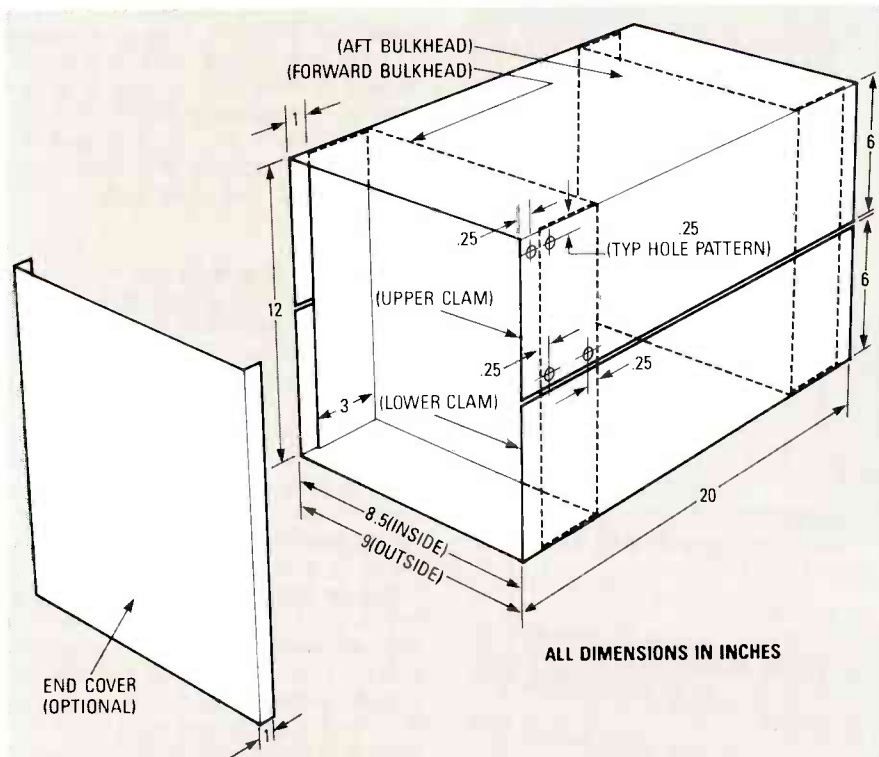

FIG. 1—THE ROBOT'S BODY consists of two "clamshells" joined together by two bulkheads. The bulkheads are the major strengthening component of the assembly.

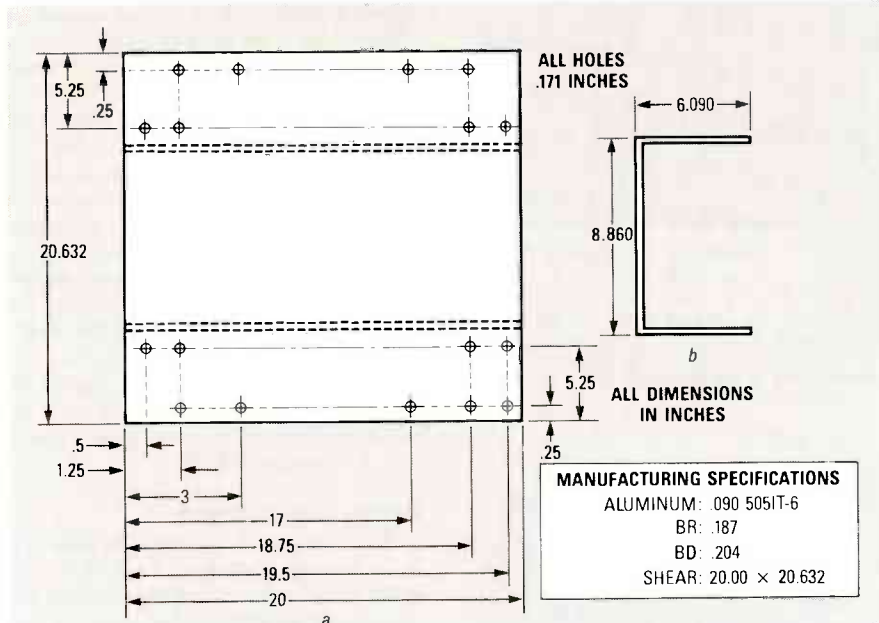

FIG. 2—USE THIS GUIDE to cut, drill and bend the clamshells. Cutting and drilling information is provided in a; bending dimensions are shown in b.

to keep the forward axle as far forward as possible without interfering with the electronics compartment.

The U-bolt approach is only one possible solution to the problem of fastening the axle to the chassis. Another approach is to use a piece of angle material at least 1.5-inches long, drilled to accept the 0.5-inch axle.

Wheel assembly

A diagram of our wheel assembly is shown in Fig. 6. The tires are 10.5- × 4-inch go-kart tires with 1/2-inch ball bearings. Those tires allow the robot to navigate rough terrain, like shag carpets. They are available from Spadel Tire and Wheel (2440 S. Tejon St., Englewood, CO 80110, phone: 303-935-1972); ask for part

Sources

Can you imagine what a robot we could build with a staff of 250,000 (the entire readership of **Radio-Electronics**)? One key to the success of the **R-E Robot** is the collective development capability of that readership. In an effort to encourage the exchange of software, sources of parts, hardware enhancements, and any other items of general interest, **Radio-Electronics** will open a special section of its new remote bulletin-board system (RE-BBS) to builders of the **R-E Robot**. You can reach the bulletin board by calling 516-293-2283.

To help simplify the mechanical aspects of building the robot, Vesta Technology (7100 W. 44th Avenue, Suite 101, Wheatridge, CO 80033, 303-422-8088) will offer an aluminum chassis similar to the one discussed in these articles. Vesta also will offer the RPC, its PC board, and the source code for testing the robot and implementing the RCL. For pricing and availability information, contact Vesta Technology directly. Complete construction details for the RPC, including schematics and PC board patterns, will be presented in a future installment of this series.

A complete description of a modified drive-train system for the robot is shown this month. For those that have difficulty finding appropriate drive-train components for the robot, a good source is Stock Drive Products (55 S. Denton Ave, New Hyde Park, NY 11040, 516-328-0200). Contact them directly for pricing and availability information.

Additional sources for various sub-systems and parts for the robot will be provided as appropriate in future installments of this article. **R-E**

number 51354. Contact the company directly for cost, shipping charges, or other information.

The tires are assembled with 4 bolts holding the two wheel halves together. That provides us with a convenient means of mounting the pulleys. Replace two of the bolts with 3/16- × 1/2-inch machine bolts. Be sure that the bolts protrude through the side opposite the tire's air valve. Re-establish the force on the wheel by installing a nut and lockwasher as shown in Fig. 6. Then using the wheel/machine-bolt assembly as a guide, drill 3/16-inch holes in two spokes of the pulley. If the center hubs of the wheel and the pulley are aligned properly, those holes should be 1.41 inches from the pulley's center hub. To ensure proper alignment, use the axle as a guide. Install the pulley on the wheel using nuts. Do not over-tighten the nuts or you may crack the pulley spokes. Once the pulley is installed, re-check the alignment of the center hubs to be sure that there will be no friction on the

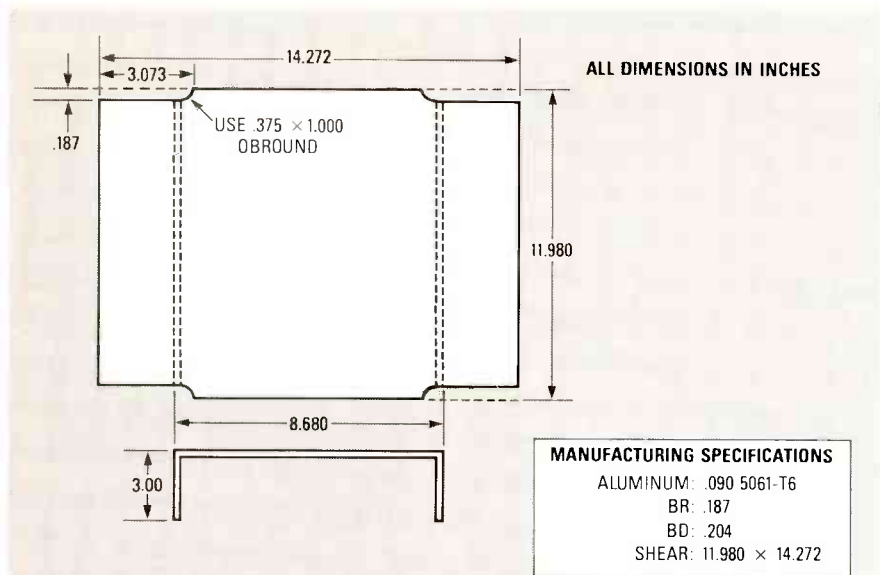

FIG. 3—THE BULKHEADS must be notched as shown if they are to fit squarely within the clamshell body.

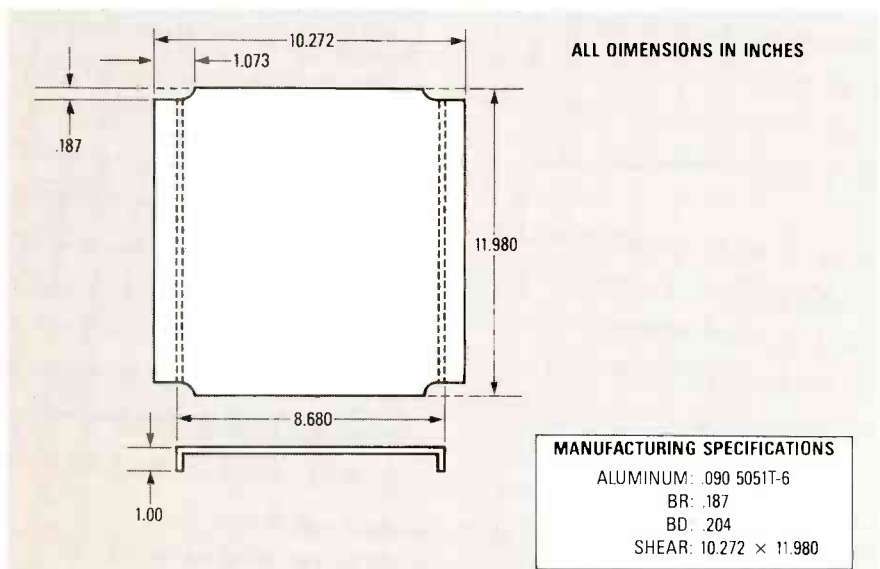

FIG. 4—CUTTING AND BENDING GUIDE for the end covers. Due to the thickness of the aluminum used, the covers must also be notched for proper fit.

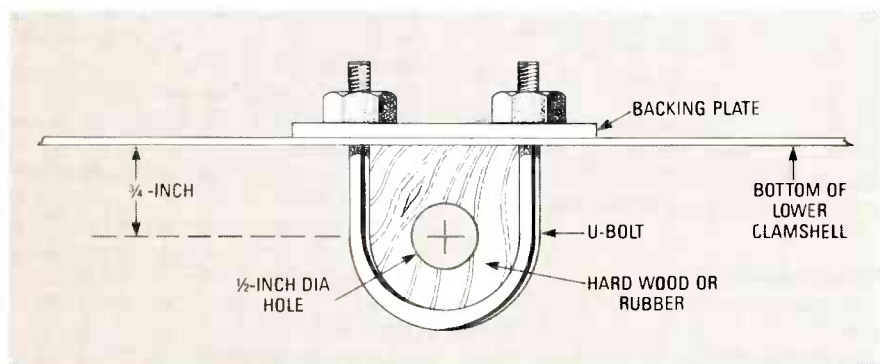

FIG. 5—USE THIS SIMPLE SCHEME to mount the wheel axle on the robot's body. Other schemes can also be used with satisfactory results.

axle when the wheel turns. A photograph of the assembly is shown in Fig. 7.

The rear caster is a 5-inch diameter hard-rubber unit on a ball-bearing swivel.

The single rear caster is located on the centerline of the robot, as close to the rear edge as possible to obtain the longest wheelbase. However, if the robot is going to carry heavy loads, such as a person, another scheme must be used to prevent flexing. One alternative would be to locate the caster under the rear bulkhead; another would be to use two casters, each located at one edge of the body.

Finish

The outer clamshells can be anodized for a hard, insulating finish in the color of your choice. Anodizing the robot's body should cost about \$50, provided that you can find someone willing to do such a small job.

Alternately, if you carefully degrease the aluminum with turpentine or another solvent, paint will produce an excellent finish. Careful spray painting will produce a finish that's as smooth that as produced by anodizing. An added advantage is that the finish can easily be touched up as needed. However, don't paint the unit until all systems have been completely tested. Otherwise the finish will undoubtedly be scratched during the assembly/disassembly procedures that go hand-in-hand with testing and troubleshooting.

Wiring channels

The wires that interconnect the electronics package, motors, shaft encoders, batteries, etc., are run along the bottom of the chassis. To prevent coupling between the motor-drive lines and the shaft encoder lines, those wires must be physically separated as much as possible.

To facilitate that separation, a 1-inch diameter hole or cutout is made in the left and right lower corners of both bulkheads. Later, when you wire the robot, motor-control, battery, and common lines should be bundled and passed through either the left or the right set of holes. The shaft-encoder lines (and any other signal lines your design might call for) should be bundled and passed through the other set of holes. Be sure to select heavy-gauge wire for the power leads.

Battery compartment

The battery compartment is accessed by removing the upper clamshell. To make installation and replacement of the two 12-volt utility batteries easier, a battery holder similar to the one shown in Fig. 8 should be built. The battery holder is a wooden platform that is cut so that it fits snugly within the battery compartment. The end pieces are then attached securely using nails or glue. Those end pieces hold the batteries in place by friction. To make installing and removing the platform easier, handles should be made by drilling holes in the end pieces through which short lengths of nylon cord are looped. Cushion the batteries and plat-

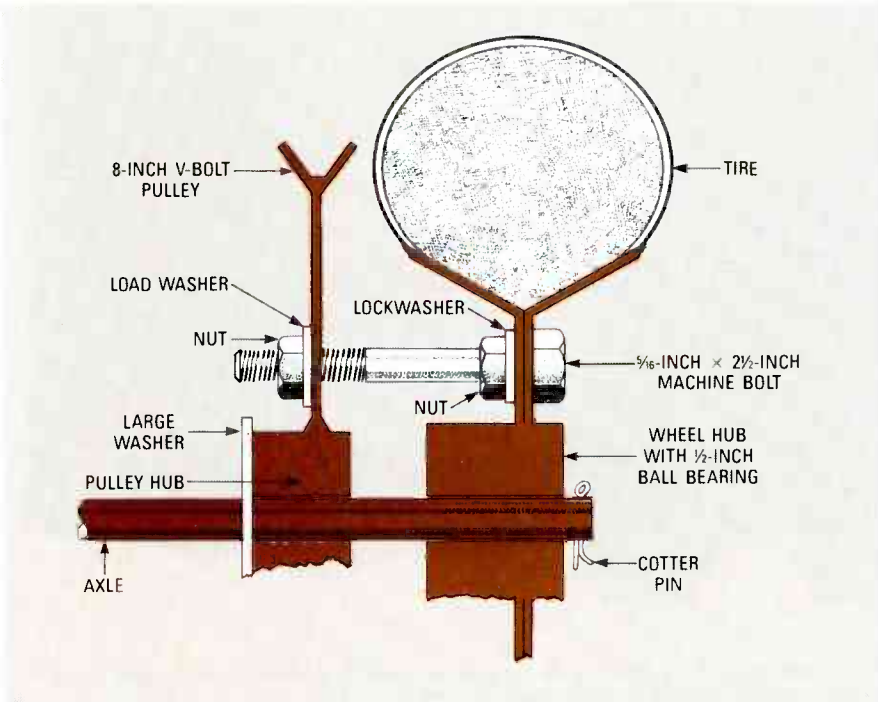

FIG. 6—THE WHEEL AND PULLEY are bolted together and mounted on the wheel axle. The assembly is held in place with a cotter pin.



FIG. 7—IF BOLTED TOGETHER PROPERLY, the wheel and pulley assembly will resemble the one shown here.

form by placing about two inches of packing material in the bottom of the battery compartment.

Electronics compartment

We'll deal with the robot's electronics (control board, RPC, etc.) in depth in future installments. Full details, including schematics, foil patterns, construction details, and more will be presented then. However, in designing and building your robot's body, it would be useful to have some idea of how the boards are mounted. Here, we'll see how the control board and RPC are installed in our version of the robot.

The electronics are located within the forward compartment and are mounted on the forward bulkhead, as shown in Fig. 9. We mounted the control board on the bulkhead using 3/4-inch by 6-32 standoffs (the height is not critical, however). The

RPC is stacked on top of the control board using 1-inch hinged standoffs. We located the hinge at the top edge rather than the bottom edge of the board. Although that requires a considerable amount of slack in the connecting wires, hinging the board makes testing and troubleshooting much easier.

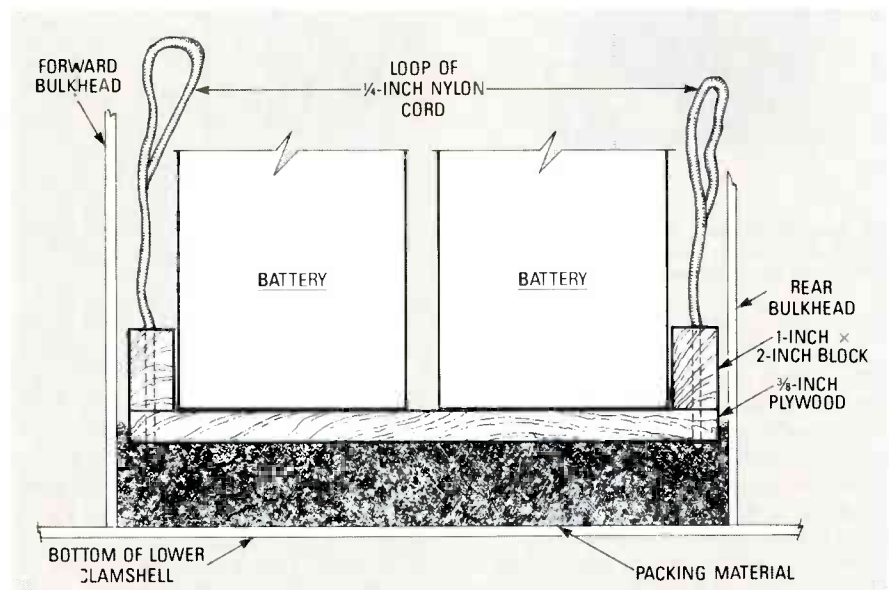

FIG. 8—USING A BATTERY HOLDER will make installing and removing the batteries easier.

The control board's foil pattern (which, once again, will be presented in a future installment) contains provisions for mounting two power transistors used to control drive-motor operation. However, the heatsinking on the board is minimal.

If you plan on having the unit carry particularly heavy loads, or to be in motion for extended periods of time, we suggest that those transistors be mounted on the bulkhead instead, using TO-3 sockets and insulators. Drill two TO-3 footprints near the top edge of the bulkhead. Mount the sockets under the control board so that they are in the electronics compartment, and the transistors, when installed, are in the battery compartment. The sockets are then wired to the appropriate points on the control board.

Motors

When we started the design of the drive train, our expected power requirements were calculated at 1/20 HP. It soon became evident, however, that there were many useful tasks that the robot could not perform without more power. Consequently, we had a special motor designed for our robot.

Our aim, as always, was to obtain maximum utility at minimum cost. That aim was achieved. The motors deliver 1/4 HP with a stall torque of 2.5 foot-pounds. With such a motor, the robot is capable of carrying a 150-pound load, while towing another 150-pound load! The cost was a relatively modest \$65 each, plus shipping. To aid readers, Vesta Technology (see Sources box for address) will collect orders (prepaid only) and have the motors made. When they're ready, the motors will be shipped and shipping charges will be invoiced.

The two motors are mounted in the

lower half of the rear compartment as shown in Fig. 10. Mounting them there allows the upper clamshell to be removed without also removing the motors. Due to the length of the motors, they are offset, with one motor mounted higher than the

other, as shown in the figure. The mounting and drive-shaft holes must be drilled through both the rear bulkhead and the clamshell. The drive-shaft diameter is $\frac{5}{16}$ -inch. Use a piece of scrap aluminum or PC-board material to create a drilling template for the motor-mounting holes. The template is used to mark the positions for the holes on the robot's body.

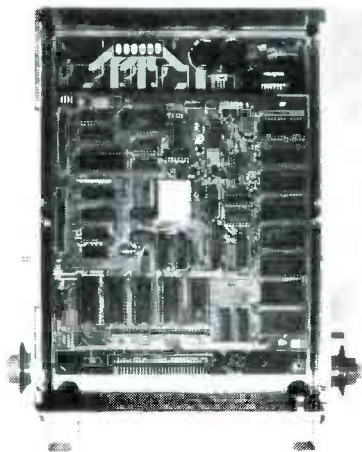

FIG. 9—THE CONTROLLER BOARD and the RPC are stacked and mounted on the forward bulkhead.

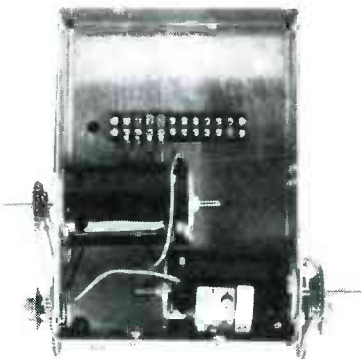

FIG. 10—THE MOTORS ARE MOUNTED in the lower half of the rear compartment. Because of their length, they must be staggered as shown.

Drive-train update

The original drive train used a $\frac{1}{2}$ -inch V-belt pulley to link the motor and the wheels directly. That arrangement did not provide sufficient pulling force. Ideally, the 4:1 reduction of that arrangement would have provided about 8 foot-pounds of torque at the wheel. Of course, the actual torque provided would be less.

We have designed a new speed-reducing system that provides a 12:1 reduction ratio. That results in a calculated torque at the wheel of 24 foot-pounds. (Of course, once again, the actual torque delivered will be somewhat less.) Our test system achieved a top speed of four miles per hour when connected to a single 12-volt battery. With a 150-pound payload, the system reached a speed of about two miles

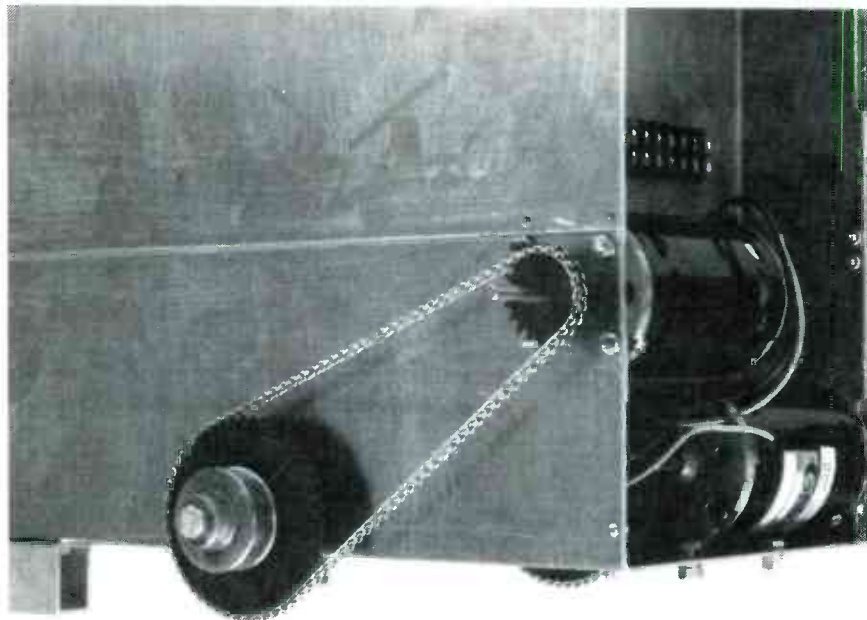

FIG. 11—UPDATED DRIVE SYSTEM. The motors are linked to a jackshaft via a ladder chain. The jackshaft will be linked to the wheels, when installed, via a V-belt.

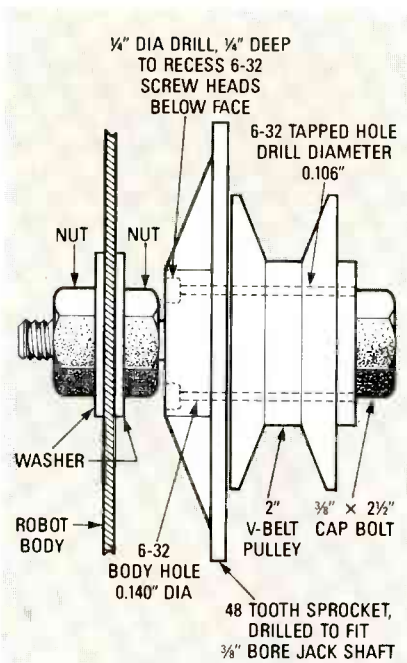

FIG. 12—JACKSHAFT DETAILS. Be sure that the unit is assembled so that the chain and the pulley are as close as possible.

per hour over a deep carpet. When connected to 24 volts, speed increases of about 50% are expected.

The modified reduction system is shown in Fig. 11. An 18-tooth sprocket is mounted on each motor. The sprocket bore must be drilled out to match the motor's $\frac{5}{16}$ -inch drive shaft.

The motor sprocket is linked to a jackshaft assembly via a chain drive. The details of the jackshaft are shown in Fig. 12. A 2-inch V-belt pulley is drilled to accommodate two 6-32 screws. A 48-tooth

sprocket is drilled for a $\frac{3}{8}$ -inch bore. Temporarily mount the 48-tooth sprocket and the 2-inch pulley on a $\frac{3}{8}$ -inch bolt and drill the sprocket to match the hole pattern on the pulley. Tap the pulley holes and bolt the pulley and the sprocket together so that when the jackshaft is assembled there will be a minimum distance between the sprocket and the V belt.

A $\frac{3}{8}$ × 2.5-inch cap bolt is used as the jackshaft axle. The pulley/sprocket assembly slides onto the bolt in such a way that when the jackshaft is mounted on the robot, the pulley will be on the outside and the sprocket will be on the inside. Using a 37-inch V belt to link the jackshaft to the robot's wheels, determine the proper mounting point on the robot's body by observing the tension on the belt. Drill the robot's body and mount the jackshaft using nuts and washers as shown. Link the sprocket on the jackshaft with the sprocket on the motor using an appropriate length of $\frac{1}{4}$ -inch ladder chain. Finish up by removing the set screws from the pulley and sprocket hubs (typically, those are supplied with such screws installed) and place a few drops of oil on each jackshaft for lubrication.

Before we finish up, let's pass along a word of caution. Although we have not reached the point in our series of articles where the motor controllers are driving our robot, the robot is now at a stage where it could be energized. **Do not do so!** Even at four miles-per-hour, a runaway robot could cause considerable damage. Do not energize the robot until the motor-controller board is built, tested, and installed. We will cover the controller board in depth, including schematics, PC patterns, etc. **R-E**

Piezoelectric Plastic Film

JOHN IOVINE

Learn about PVDF, a piezoelectric plastic whose uses are limited only by imagination.

WHILE EXPERIMENTING WITH QUARTZ crystals, French physicists Jacque and Pierre Curie discovered that when such a crystal was exposed to an electric voltage, it would deform. Further, they found that when a quartz crystal was mechanically deformed, it would generate a voltage. They named the phenomenon *piezoelectricity*, which literally means pressure electricity.

Quartz crystal is the best known piezoelectric material, but it is by no means the only one. Other naturally occurring piezoelectric materials include Rochelle salts and tourmaline. Further, many piezoelectric materials have been synthesized. While most of those materials are ceramics, one of the more interesting ones is nothing more than a specially processed plastic sheet or film. Made from *PolyVinylidene Fluoride*, or PVDF for short, piezoelectric film has properties that make it useful in a variety of applications. In addition, PVDF film is *pyroelectric*; that is, it is capable of transforming thermal energy into electrical energy. That property makes the film useful in applications such as intrusion alarms and proximity switches.

In this article, we are going to explore the uses and advantages of PVDF film. Included will be several experiments that you can perform. But first, let's learn a bit more about piezoelectricity, and what gives some materials that property.

The piezoelectric effect

A piezoelectric material is one in which all of the movable electric dipoles are oriented in the same direction. The condition can occur naturally, or it can be induced.

In nature, piezoelectricity occurs in crystals that have a high degree of symmetry. Of the 32 possible crystal structures, 20 are sufficiently symmetrical to give rise to piezoelectric properties. Despite that, relatively few crystal substances have been used in piezoelectric applications. Quartz, the most popular natural piezoelectric material, forms what is termed a trigonal trapezohedral crystal. It has threefold symmetry around its Z or optic axis, which means that if one measures a property at one point around the axis, the same property will repeat at 120° intervals.

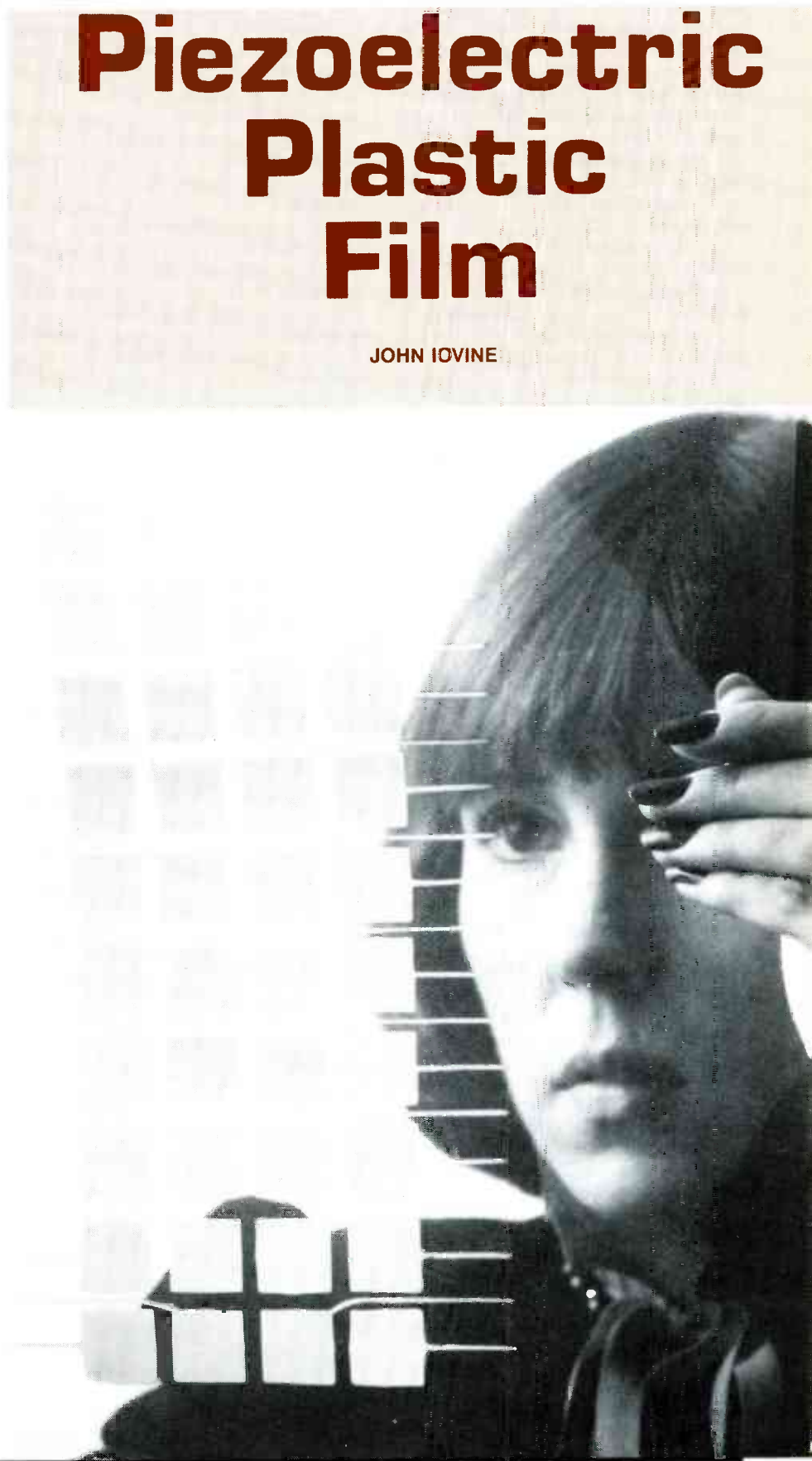

In a crystal with strong piezoelectric properties, such as quartz, the electrical dipoles spontaneously align in the same direction; that is, the crystal is naturally polarized. The effect is similar to the alignment of magnetic dipoles in magnetic material. The electrical dipoles are formed by the positive and negative ions (charged atoms) that make up the crystal's molecules. When the crystal is placed under mechanical pressure or stress, the physical distance between the positive and negative ions is altered, causing a voltage to be generated.

Similarly, placing a piezoelectric crystal in an electric field can cause the physical distance between the positive and negative ions to change. Depending on the nature of the piezoelectric material and the external electric field, the material will expand along one axis and contract along the others.

One of the first applications of the piezoelectric effect was in sonar. The Curies experimented with using the piezoelectric effect to locate submerged solid objects. During World War II, the supply of quartz for military sonar could not be guaranteed (most was imported from South America). As a result, researchers began looking for other piezoelectric materials. They found that some ceramics, though not naturally piezoelectric, could be made so by placing them in a strong electric field.

Piezoelectric ceramics do have some drawbacks, however. They are brittle, stiff, and dense, making it impractical to manufacture the ceramics in large sizes or to cut them to complex shapes. Because of that, researchers continued to search for other piezoelectric materials. In the late 1960's, they turned their attention to polymers. By 1969, it was determined that PVDF exhibited the highest degree of piezoelectricity of any known polymer.

Piezoelectricity and PVDF

Polyvinylidene fluoride is a semi-crystalline, high-molecular-weight polymer chain made up of carbon, hydrogen, and fluorine atoms arranged in repeating CH₂-CF₂ units. In its normal, unpolarized state, PVDF thermoplastic has many applications. PVDF pipes, valves, etc., are routinely used to route corrosive chemicals. Extruded PVDF tubing is used to insulate telephone-terminal and computer wiring. PVDF film is used for the "unleaded gasoline only" stickers found on automobiles and for automotive "racing stripes." PVDF resins form the base of a group of premium metal finishes used to beautify and protect metal buildings and structures.

To give the film piezoelectric properties, the electrical dipoles formed by the hydrogen and fluorine atoms of the polymer are aligned in the same direction (through the thickness of the film.) The

process includes controlled stretching of the film to achieve the proper mechanical orientation. The film is then polarized by placing it in an intense electric field.

There are many potential applications for PVDF film. Those range from heat and impact detectors, to sound generators, to acoustical pickups for musical instruments. In the remainder of this article, we are going to look at a few but interesting simple applications for the film. We will include several circuits that you can build yourself. If you wish to try some of the circuits but have difficulty locating PVDF film, Pennwalt, which manufactures PVDF piezoelectric film under the brand name of *KYNAR*, offers a small sample of the material and an accompanying 88-page technical manual for \$45. To order, contact Pennwalt at: *KYNAR* Piezo Film Department, P.O. Box C, King of Prussia, PA 19406.

Experimenting with PVDF

PVDF film is normally supplied with metallized electrodes. That gives it the appearance of aluminum foil. What you see is a "sandwich" with the PVDF film located between layers of aluminum.

The material can easily be cut to any desired shape using a pair of scissors. However, care must be taken to prevent shorting the electrodes. To be safe, check with an ohmmeter; the resistance between the electrodes should be close to infinite.

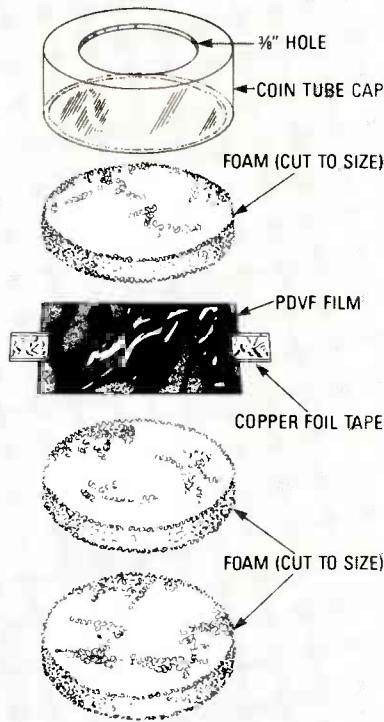

FIG. 1—THIS SIMPLE MICROPHONE uses a plastic coin-tube cap as a form. While performance is satisfactory, frequency response could be improved by curving the surface of the PVDF film.

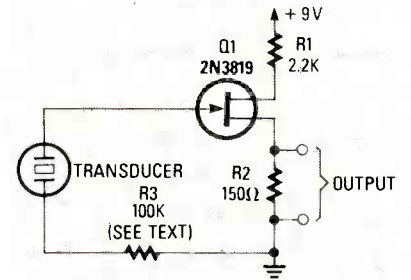

FIG. 2—A VOLTAGE FOLLOWER is used to buffer the output of the microphone for input to an audio amplifier.

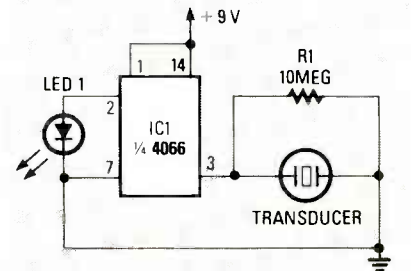

FIG. 3—PVDF FILM will generate a voltage when subjected to mechanical stress. That property can be demonstrated using the circuit shown here. When the PVDF film is tapped, the LED will light.

You'll need to devise some means of making connections to the metallized electrodes. One way is to use short lengths of copper-foil tape; that tape is normally used to make or repair PC boards. The tape uses an electrically conductive adhesive, making connection to the foil simple. If you purchase your sample from Pennwalt, the material is supplied with a set of special connectors.

We made a simple microphone using the scheme shown in Fig. 1. The "form" was an end cap from a plastic coin tube. A 3/8-inch hole was drilled in the center of the cap. The PVDF film was sandwiched between pieces of lightweight foam as shown. Using shielded cable to reduce noise, the copper tape leads were then connected to the voltage follower of Fig. 2; that circuit was used to buffer the output voltage of the film for input to an audio amplifier.

Note that that design is extremely simple and is intended only to demonstrate how the film could be used as a microphone. While performance is acceptable, the frequency response of the flat film is not very good. However, frequency response could be improved by curving the film's surface. In fact, it is possible to design a PVDF microphone that has a flat frequency response over an extremely wide range. PVDF film itself is an extremely broad-band material that will respond to frequencies from near DC to the GHz range.

continued on page 90

THE EVOLUTION OF VHSIC

What's VHSIC? A technique for cramming more circuitry that operates faster in less space.

ROBERT GROSSBLATT, CIRCUITS EDITOR

EVER SINCE THE EARLY SIXTIES WHEN THE first IC was put together, designers have been working with one major goal in mind: to cram more stuff into less space. There are two major benefits to be had by shrinking the size of components on the IC's substrate: more powerful IC's and faster operating speeds.

In the early days, the component count in an IC was an understandable number. One of the first commercially available IC's, for example, was a flip-flop made from only four transistors. Although later SSI (Small Scale Integration) devices contained as many as several hundred transistors, the relatively small number of com-

ponents was really the result of problems in two separate areas, one practical and the other philosophical.

The practical problem regarded materials and fabrication technology. In a very real sense the physical process of making an IC is similar to that of making a printed-circuit board. The topographic layout has to be designed and a mask has to be made. Then the mask is reduced in size and the pattern is transferred to the IC wafer. It's the last two parts of the process that cause the problem. Although the same procedure is used to make a transistor, there's a huge difference in the scale of reduction used in making transistors and that used in making IC's.

For example, the substrate of a transistor in the familiar TO-92 package is about the same as that in a simple IC, but the IC may contain hundreds or even thousands of transistors. In order for component density to increase in that way, there had to be corresponding advances in the fields of photolithography, resist and etching methods,

and materials technology.

The philosophical problem had to do with approaches to design. Although the transistor had become a standard replacement for the vacuum tube (those big glass things that got hot, remember them?), most other components remained unchanged. Resistors were still resistors, capacitors were still capacitors, and so on. The general rule of thumb in the days before the IC was to use as many passive components as you wanted, but to keep the number of active devices as low as possible. That same idea was carried over to the early days of IC circuit design.

The problem that arose then was that passive components took up a great deal of room on the substrate, and space was limited. The greater the number of passive components, the less room there was for active ones. And passive components were needed (in the early years) to couple the transistors in the chip.

Various schemes were developed to overcome the problem. Resistor Transistor Logic (RTL) was slow, and Diode Transistor Logic (DTL) was difficult to fabricate consistently. Direct-coupling methods were also tried, but they were unsuccessful at first. It wasn't until James Buie came up with a way to use transistors to perform coupling that the problem was solved. His method, Transistor Transistor Logic (TTL), marked the start of real increases in component density.

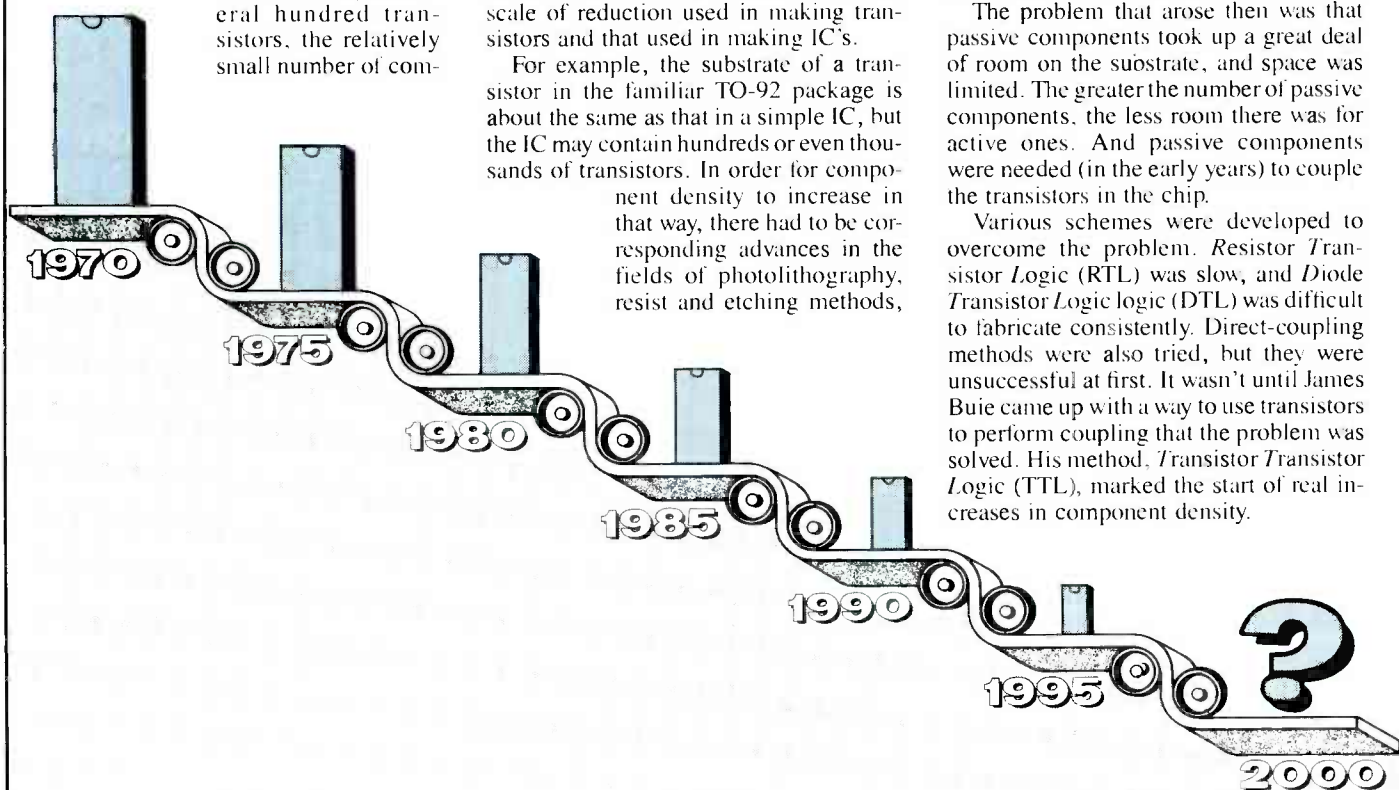

As more and more transistors were packed onto the substrate, IC's became more and more powerful. SSI gave way to MSI (*Medium Scale Integration*), and MSI gave way to LSI (*Large Scale Integration*). LSI technology was capable of component density so high that IC's dedicated to doing specific jobs started to appear. Microprocessors, TV subsystems, and even complete radios were produced on a single substrate.

VLSI (*Very Large Scale Integration*) made its debut in the memory market with the appearance of 64K RAM IC's. The emphasis of those RAM's was function, not speed. And Motorola's 68000 microprocessor placed many transistors on the substrate, but the substrate size increased as well.

The point is that solving the philosophical problem of circuit design led directly to the development of VLSI, but any further increases in IC technology could only come about by addressing the practical problems we mentioned earlier. Now that IC manufacturers knew how to get more components into an IC, the next step was to do the same thing in less space.

VLSI techniques were made possible by advances in materials and fabrication technology. Trace width had shrunk drastically throughout the 1970's. The decade began with 20-micron line widths and ended with 4-micron widths. By that time, the government had to get involved.

Enter the DOD

In 1978 the *Department Of Defense* (the DOD) started the VHSIC (*Very High Speed Integrated Circuit*), pronounced vee-sick, program. It was designed to occur in two phases. The first phase was to achieve IC's with line widths of 1.25 microns by the year 1985. IBM's CMAC (*Complex Multiply ACcumulate*) chip is built with 1.25-micron trace widths. The 3.2-inch silicon wafer shown in Fig. 1 contains a number of CMAC and test chips. Each CMAC chip contains more than 100,000 devices and can perform more than 100,000,000 multiplications per second.

The second phase of the DOD program, to be completed in 1990, aimed at trace widths of 0.5 micron. Why is reduced trace width so important, and what does it have to do with IC design? Trace width is important because it directly affects both component density and maximum operating speed.

In order to understand the relationship between trace width and maximum operating speed, let's put a few things in perspective. At the time the VHSIC program was started, several manufacturers were developing ways to make IC's reliably and consistently with trace widths of 3 microns. If that number doesn't mean anything to you, consider the fact that a human hair is about 100 microns wide. You can get

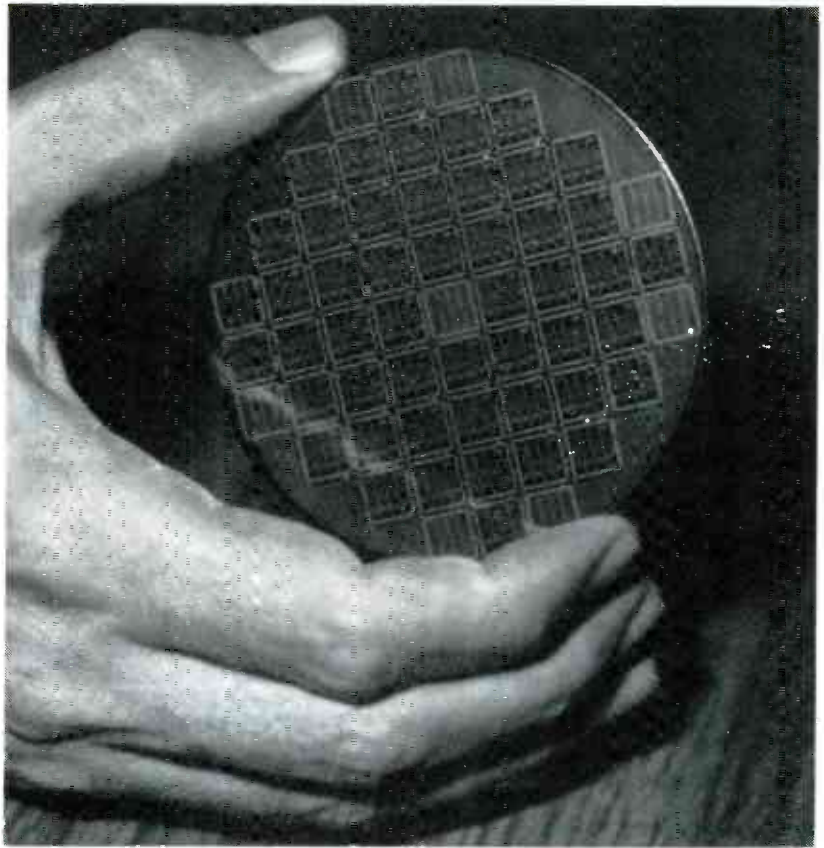

FIG. 1—IBM'S CMAC (*Complex Multiply ACcumulate*) chips each contain more than 100,000 devices and can perform more than 100,000,000 multiplications per second.

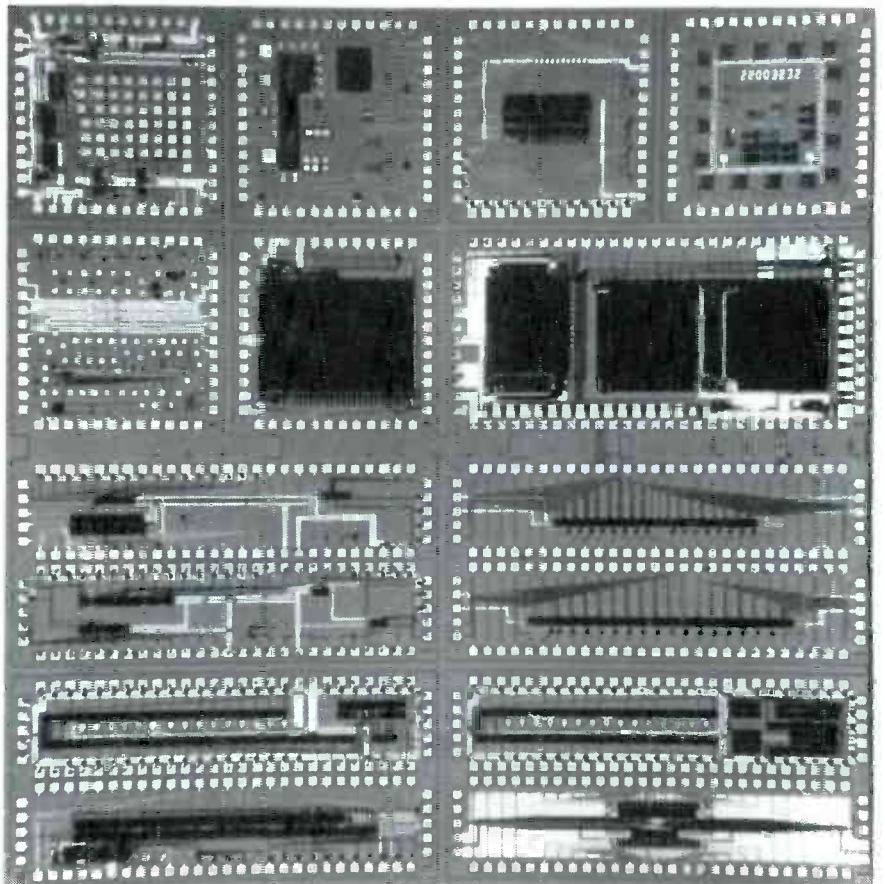

FIG. 2—HONEYWELL BUILDS VHSIC CHIPS FROM MACROCELLS containing RAM, ROM, and various dedicated logic functions.

TABLE 1—PHASE-ONE VHSIC PRODUCTION

Manufacturer	Function	Density	Type
Motorola	Four Port Memory	60,000	CMOS
	Arithmetic Logic Unit	36,000	Bipolar
	Convolver	74,000	CMOS
	Fast Fourier Arithmetic Unit	50,000	CMOS
	Fast Fourier Control Unit	50,000	CMOS
	Configurable Gate Array	26,000	CMOS
TRW	Window Addressable Memory	58,000	Bipolar
	Content Addressable Memory	66,000	Bipolar
	Matrix Switch	13,500	Bipolar
	Multiplier-Accumulator	42,000	Bipolar
	Microcontroller	25,000	Bipolar
	Address Generator	34,000	Bipolar
	Convolutional Decoder	73,000	Bipolar
Westinghouse	64K Static Ram	400,000	CMOS
	Pipeline Arithmetic Unit	133,000	CMOS
	Extended Arithmetic Unit	92,000	CMOS
	General Purpose Controller	79,000	CMOS
	Configurable Gate Array	40,000	CMOS
	Enhanced Arithmetic Unit	NA	CMOS
Texas Instruments	72K Static RAM	460,000	NMOS
	Multiplier Switch	30,000	Bipolar
	Array Controller/Sequencer	120,000	Bipolar
	Vector Arithmetic Logic Unit	85,000	Bipolar
	Vector Address Generator	130,000	Bipolar
	Data Processor Unit	190,000	Bipolar
	General Buffer Unit	130,000	Bipolar
Honeywell	Parallel Pipeline Processor	142,000	Bipolar
	Arithmetic Unit	121,000	Bipolar
	Sequencer	136,000	Bipolar
Hughes	Digital Correlator	72,000	CMOS/SOS
	Algebraic Encoder/Decoder	NA	CMOS/SOS
	Signal Tracker	NA	CMOS/SOS
	Electro-Optical Signal Control	NA	CMOS/SOS
	Gate Array	NA	CMOS/SOS
IBM	Complex Arithmetic Unit	100,000	NMOS

some idea of what half-micron spacing means when you realize that if a map of the United States were printed with line widths that fine, a twenty-inch map would show every street in the country.

The upper limit of an IC's speed is a direct function of its trace width. Electrons move through the IC at the speed of light; so, the closer that components can be packed together, the faster that signals can get from one element to another. The idea behind the VHSIC program was to combine the advances that had already been made in VLSI with new materials and methods of fabrication. The result would be more powerful IC's (because of the high component density) that operate at much higher speeds (due to reduced trace width).

The government awarded VHSIC development contracts to eight semiconductor manufacturers: Hughes, National Semiconductor, IBM, Motorola, TRW, Honeywell, Texas Instruments, and Westinghouse. As a point of interest, even though the first phase of the program had a target completion date of late 1985, breakthroughs in materials technology allowed 1.25-micron prototypes to be produced in the laboratory in late 1983.

As you can see in Table 1, although several contractors were working on CMOS implementations of the VHSIC design goals, bipolar MOS and NMOS IC's actually were the first to be delivered. The reason for this was that, besides the inherent speed of bipolar devices, they are less susceptible to damage by static discharge than CMOS. Reliability is very important, because VHSIC IC's are intended almost entirely for the military market.

Even so, the disadvantages of bipolar IC's (high power consumption and heat dissipation) caused Motorola, Hughes, and other contractors to concentrate their efforts on meeting the design goals with CMOS parts. Since the beginning of the VHSIC program, considerable advances had been made in CMOS fabrication technology. Little by little the major drawbacks of CMOS-based IC design—low component density and relatively slow speed being chief among them—were being overcome.

Areas that traditionally were dominated by bipolar and NMOS IC's began to see an influx of CMOS replacements. CMOS versions of both high-density static and dynamic RAM's appear on the market

regularly, and now even EPROM's and EEPROM's are produced in CMOS. The IC's being produced for the VHSIC program are all designed to do specific jobs, and contractors are trying to use CMOS for as many of those IC's as possible.

Honeywell, however, decided to go with bipolar design, and opted for three different types of bipolar devices, because each has specific benefits for different applications. Standard Schottky TTL was chosen for I/O, because that would be easier to interface the VHSIC IC's to regular TTL logic. In addition, CML (Current Mode Logic) and ISL (Integrated Schottky Logic) were chosen because each has better speed, component-density, and power-consumption figures than other bipolar schemes. Three VHSIC IC's were planned: a parallel pipeline processor containing 142,000 transistors, an arithmetic unit with 121,000 transistors, and a sequencer unit with 136,000 transistors.

Honeywell's approach to designing those IC's reflects the trend in VLSI and VHSIC design. Emphasis is placed on developing a library of functional elements, called "macrocells," that can be combined on the substrate to produce an IC optimized for a specific job. The size of those macrocells ranges from a few gates to as many as 2000 gates, depending on function. A macrocell test chip is shown in Fig. 2; it contains various building blocks including 2K RAM's, 29K ROM's, barrel shifters, ALU's, etc.

The macrocell approach to custom-IC design results in a higher production yield, because each element is thoroughly debugged before manufacture. The advantage of that sort of step-by-step approach is that Honeywell obtained completely functional IC's on the first production run.

With an eye to the commercial use of that technology, Honeywell formed a marketing division called Solid State Electronics and built one of the first plants devoted exclusively to the production of VHSIC IC's. The physical requirements for the plant are far and away the most demanding for any IC-fabrication facility.

VHSIC manufacture calls for a class-10 clean room, in which there can be only 10 particles per cubic foot of air. That is ten times cleaner than traditional clean-room standards. The inner surfaces of the pipes that carry gas are micropolished to ensure that the product they deliver is 99.9999% pure, and, as shown in Fig. 3, workers must wear bubble suits. Those suits are all custom fitted and have portable air-circulating units on the waist. The clean-room environment must be controlled so that temperature stays within ± 2 degrees and humidity within $\pm 5\%$.

Honeywell recently began offering a three-IC set as an electro-optical signal processor to be used for video signal and real-time image processing. The 1.25-mi-



FIG. 3—ULTRA-CLEAN AIR is required in VHSIC manufacturing. A single air-borne particle could ruin one of the 240 VLSI and VHSIC chips on the 6-inch wafer.

ron spacing of those IC's allows clock speeds greater than 25 MHz and a component density of more than 30,000 gates per IC. This means that the IC set is capable of throughput greater than 800 million operations per second per processor stage. It's also possible to design custom IC's using that technology by combining different macrocells. In addition, Honeywell has developed software that runs on Digital's VAX that turns the computer into a dedicated VHSIC design center.

Technological trickle-down

VHSIC's are produced for the Department of Defense, so there's little public information on the materials and fabrication technology used. But, as with other advances in the semiconductor industry, VHSIC has been trickling down to the commercial market. Motorola, for example, has been one of the leading lights in adapting VHSIC to CMOS. They successfully produced a four-port memory using 1.25-micron CMOS technology. The chip's size is 290 by 313 mils. it

contains some 60,000 transistors, and it operates at speeds as high as 25 MHz.

Most of the leading semiconductor manufacturers currently feature standard IC's and custom gates with trace widths of 2 microns. In light of recent developments in the VHSIC program, it's an obvious conclusion that 1.25-micron CMOS technology will soon become the *de facto* standard for the industry. Honeywell has already already announced the HC20,000, a 1.25-micron gate array whose fabrication technology is a direct result of VHSIC development work.

In addition, Honeywell's CMOS III program uses the same double-level metal, N-well, single-polysilicon process, and self-test features found in the VHSIC-CMOS products being produced for the government. The HC20,000 integrates some 18,000 gates using 238 CMOS or low-power Schottky TTL user-programmable I/O pins. As with any gate array, users specify how they want the gates connected; Honeywell then produces a mask to make the interconnections on the chip.

The resulting product is a dedicated IC produced at close to standard prices.

Analog and VHSIC

The speed and power available from the first wave of VHSIC IC's pushes the frontiers of digital processing even further into areas traditionally dominated by analog designs. Standard 2-micron digital IC's can handle AM radio and voice synthesis easily. Although the new 1.25-micron VHSIC IC's were designed for military applications, their 25-MHz speed will go a long way toward extending digital technology into the areas of CAD (Computer Aided Design), video processing, real-time image handling, and so on.

When second-phase VHSIC IC's start appearing around 1990, their half-micron geometries will enable them to run at operating speeds exceeding 100 MHz. And there's no doubt that they will appear, because Motorola has already announced the successful fabrication of a 1K CMOS static RAM featuring half-micron trace widths. That astounding achievement was done by using both direct-write electron beam and optical lithography.

VHSIC IC's and custom gate arrays eventually will be used by the commercial market. VLSI IC's are already being used for digital video processing, but due to their relatively low operating speeds (compared to video), considerable compromise is made in image quality. Incoming frequencies must be divided down to be handled by currently available digital processors. And every time you divide the frequency, there's a loss in quality.

The government initiated the VHSIC program because it wanted more powerful IC's with higher operating speeds. Because their applications were almost exclusively military, they were looking for advantages in processing capability and in weight. The commercial market is, of course, a completely different story. It may be some time before you can rush down to your local electronics store and pick up a handful of VHSIC hardware. Even the commercial units that are available now are aimed at OEM's, so prices are prohibitive for hobbyists and experimenters. But it's only a matter of time until a single-IC TV appears.

To wrap up, we've seen that IC's started out with 20-micron trace widths and a handful of transistors, and that component density has increased tremendously in the last twenty years. Motorola's 68000 has more than 13,000 gates, but those gates are built with 3-micron geometry, and the substrate is almost one quarter inch square. Compare that with the phase-one VHSIC's that, using 1.25-micron geometry, can pack more than 30,000 gates into an area less than a third that size. And when phase-two VHSIC's become available, you'll find more than 250,000 gates in the same space!

R-E

TV SIGNAL DESCRAMBLING

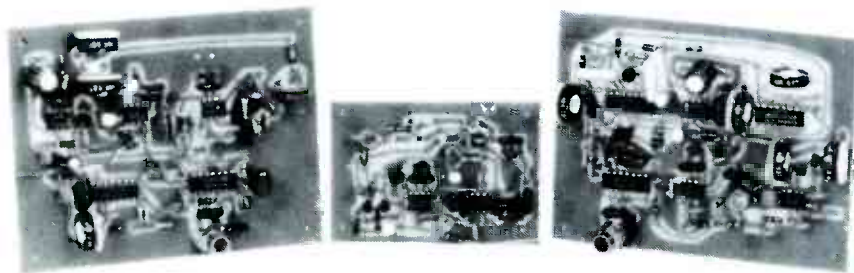

This month we show you how to build and align a gated-pulse decoder.

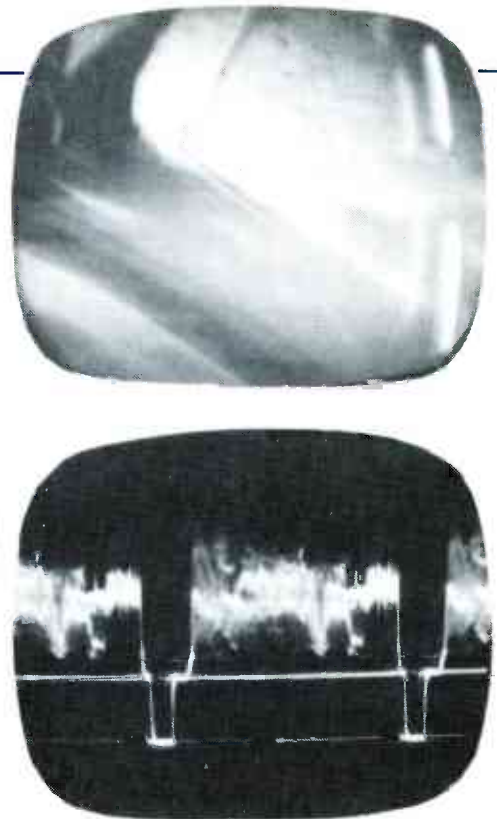

WILLIAM SHEETS and RUDOLF F. GRAF

Part 8 THIS MONTH, WE'LL look at a decoder for the outband system. Also, the PC board for January's gated sync descrambler is included in this month's PC Service.

Outband decoder

The outband system is used exclusively by cable-TV programmers. In it, the video signals, minus the horizontal sync pulses, are sent out over the assigned cable channel. The horizontal-sync is placed on another carrier, which can be located at just about any unused frequency within the cable system's bandwidth. The job of an outband decoder is to tune in the hidden carrier, extract the sync pulses, and recombine them with the video signal. In the following discussion, we will assume that the scrambled video has a center frequency of 150 MHz, and that the sync is located on a 100-MHz carrier.

If the circuit shown in Fig. 6 is to work properly, the cable must present a 75-ohm impedance and deliver a signal level of at least 1 millivolt. The cable lead is, of course, connected to the input, J1. A lowpass filter composed of C1, C2 and L1 passes the 100-MHz sync signal but blocks the 150-MHz video signal. Likewise, L2, C3, and C6 form a high pass filter that blocks the 100-MHz sync signal but allows the 150-MHz video signal to pass. We'll get to where that video signal goes in a moment. That circuitry allows

only the sync information to reach IC1, an MC1350 IF amplifier. Note that while that IC is designed for 60-MHz operation, its performance is more than adequate at 100 MHz (gain is greater than 30 dB). The 100-MHz signal is fed to pin 4.

An amplified sync signal appears at pin 8 of IC1 and is coupled to pin 7 of IC2, an MC1330 video detector. That IC is tuned to 100 MHz by the C5-L4 network. Complementary outputs are available at pins 4 and 5. In our application, the detected signals available at those points consist of the sync pulses only. One output (pin 4) is used only as a test point.

Normally, a 30-millivolt input should produce an output on the order of one volt. But since the circuit is designed for 45-MHz operation, and we are using it at 100 MHz, the gain of the IC is somewhat reduced. In our experiments, we have seen outputs on the order of 300 millivolts. That is sufficient for our needs.

From IC2, the sync signal is fed to a differential amplifier made up of Q2 and Q3. The base of Q3 should be biased at 7 volts. If needed, the value of R7 can be changed to achieve that bias level.

Under normal conditions (no sync pulse received) Q3 is nearly cut off and Q2 is conducting heavily. That means that Q1 is also cut off and a DC current is flowing from the collector of Q2 through the L7-R9-D2-R12-L6 circuit to ground. The voltage at the collector of Q3 is prac-

tically zero, and very little current flows through the R8-R10-L5-D1 circuit. Therefore, D1 is cut off and the 150-MHz video signal from the L2-C3 network must flow through the R11-C16-R12 circuit. Since D2 is biased on, some of the 150-MHz energy is shunted to ground by R9. In essence, R9, R11, and R12 form a "T" pad, attenuating the signal by about 6 dB.

When a sync pulse is received, the voltage at pin 5 of IC2 rises. That cuts off Q2 and biases Q3 on, which in turn biases Q1 on (through R8). Transistor Q1 now conducts heavily, grounding the collector of Q2. At the same time, current flows through R10, L5, and D1, biasing it on, and grounds L6. Since D1 is now on, it offers a low-impedance path to the 150-MHz signal, allowing it to bypass the "T" pad circuit previously described and to reach the output jack, J2, with relatively little attenuation. In essence, the 150-MHz signal is boosted during the sync intervals, restoring the proper sync-to-video relationship and decoding the signal.

Building the circuit

A parts-placement diagram of the circuit is shown in Fig. 7. The corresponding PC pattern can be found in PC Service. Note that the values of several of the capacitors and inductors will vary with different sync channel frequencies. Table 1 gives the appropriate values for two popu-

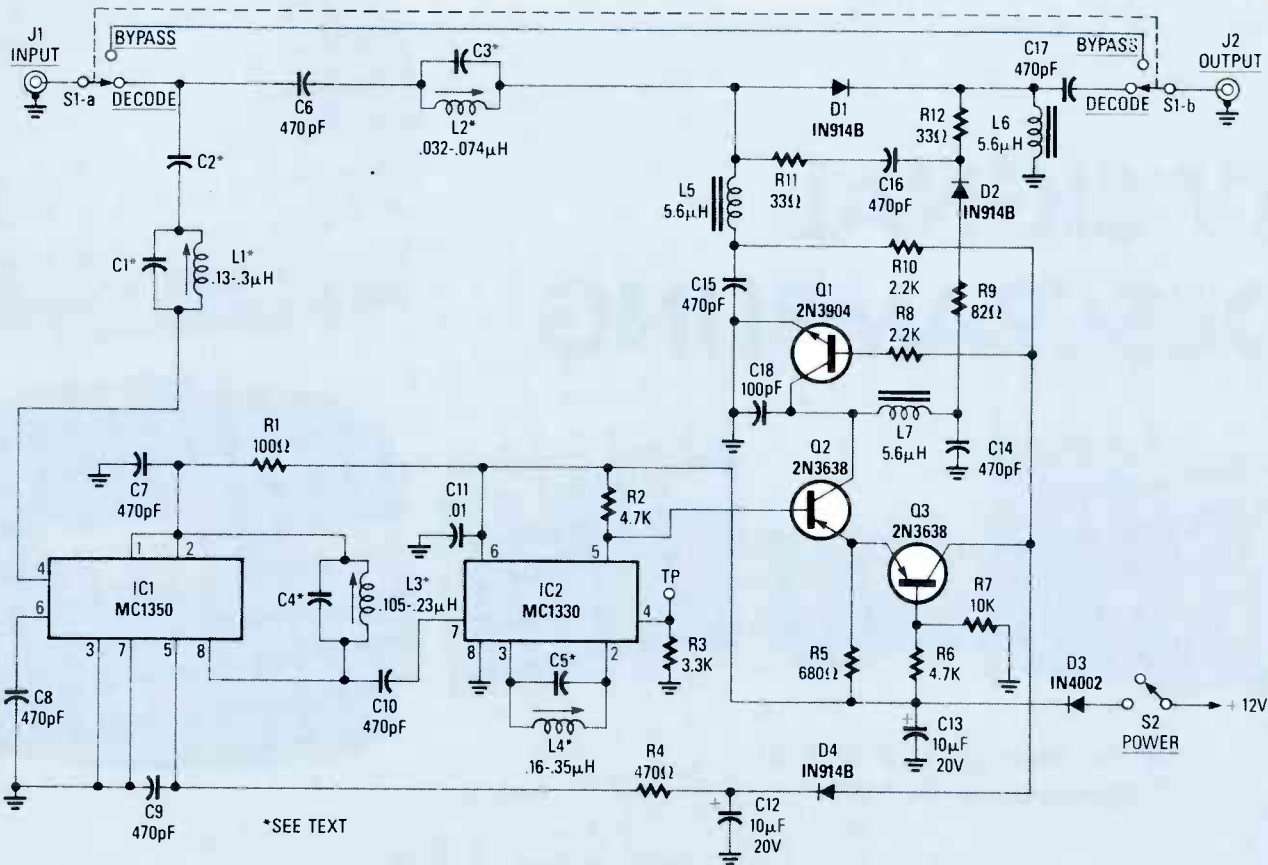

FIG. 6—FOR THE OUTBAND DECODER shown here to work, the cable company must provide at least a 1 millivolt signal. Values for C1–C5 and L1–L4 are found in Table 1.

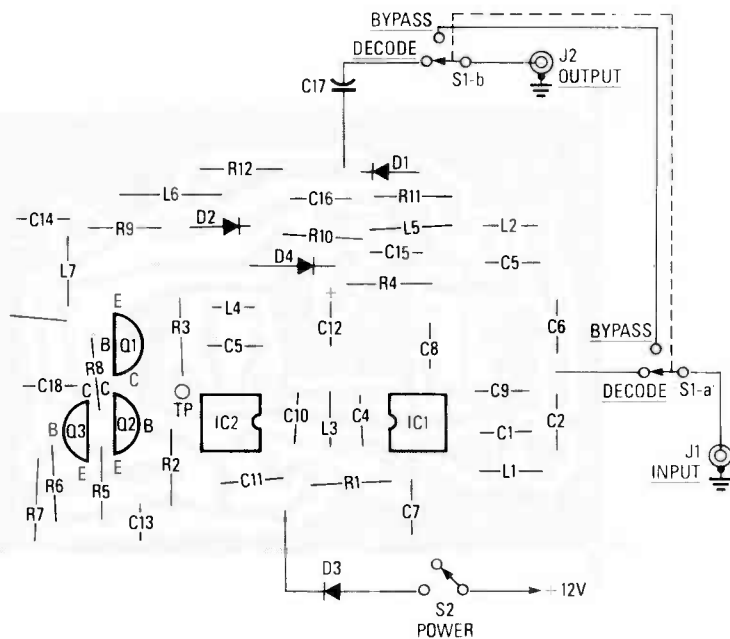

FIG. 7—IF YOU USE THE PC PATTERN shown in PC service, use this diagram when mounting the components.

far sync-channel frequencies: 50 MHz and 90–114 MHz.

Also, if you do not order the kit from the supplier mentioned in the parts list,

you will need to wind four of the inductors (L1–L4) yourself. All are wound using No. 22 enameled wire on an 8-32 screw. Coil L1 consists of 7½ turns, L2 consists

of 2½ turns, L3 consists of 6½ turns, and L4 consists of 8½ turns. Once each coil is wound, remove the screw and replace it with an iron core. Cores can be salvaged from coils removed from an old TV or radio as previously discussed. Also, an appropriate core is manufactured by Midland-Ross, Cambion Division; its part number is 515-3225-06-21-00. If wound properly, the coils can be adjusted to the inductances indicated in Table 1.

Once the board is built, check your work for poor solder joints, solder bridges, proper component alignment, etc. Correct any errors you spot. A photograph of the completed outband decoder board is shown in Fig. 8.

TABLE 1—CAPACITOR AND COIL VALUES

	50 MHz	90–114 MHz
C1	5 pF	5 pF
C2	47 pF	12 pF
C3	200 pF	82 pF
C4	56 pF	12 pF
C5	56 pF	10 pF
L1	0.2 μH	0.2 μH
L2	0.05 μH	0.03 μH
L3	0.175 μH	0.2 μH
L4	0.175 μH	0.24 μH

PARTS LIST OUTBAND DECODER

All resistors 1/4 watt, 10% unless noted

R1—100 ohms
R2, R6—4700 ohms
R3—3300 ohms
R4—470 ohms
R5—680 ohms
R7—10,000 ohms
R8—22,000 ohms
R9—82 ohms
R10—2200 ohms
R11, R12—33 ohms

Capacitors

C1—C5—see text and Table 1, NPO
C6—C10, C14—C17—470 pF, ceramic disc
C11—0.01 μ F, ceramic disc
C12, C13—10 μ F, 16 volts, electrolytic
C18—100 pF, ceramic disc

Semiconductors

IC1—MC1350 video IF (Motorola)
IC2—MC1330 video detector (Motorola)
Q1—2N3904 NPN transistor
Q2, Q3—2N3638 PNP transistor
D1, D2, D4—1N914B diode
D3—1N4001 diode

Other components

L1—L4—see text and Table 1
L5—L7—5.6 μ H, RF choke
S1—DPST switch, slide or toggle
S2—SPST switch, slide or toggle
J1, J2—phono jacks

Miscellaneous: PC board, wire, solder, etc

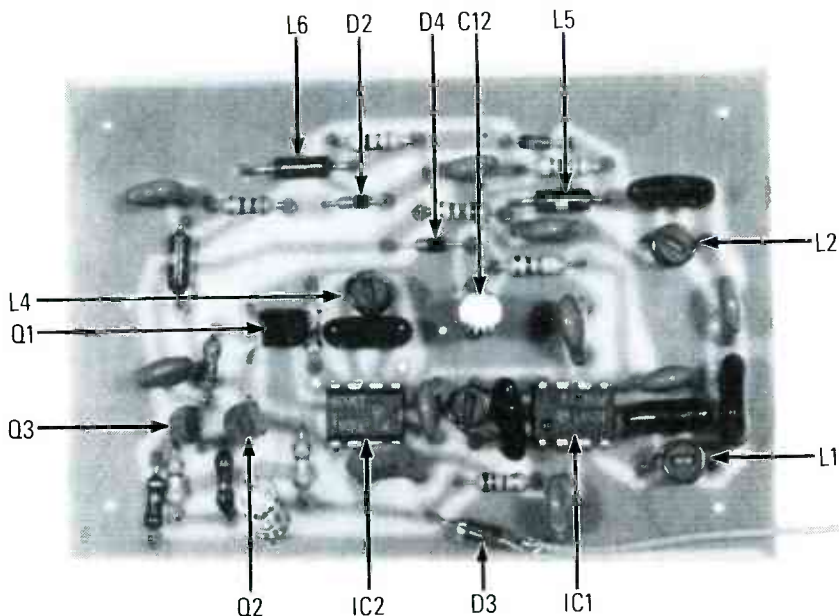

FIG. 8—THE FINISHED OUTBAND DECODER is shown here.

Aligning the unit

Begin by measuring the resistance between the power supply and ground rails. If it's less than a few hundred ohms, recheck IC1 and IC2 and the transistors for correct orientation. Once you've found and corrected the error, you can proceed.

Next, connect a VHF signal generator to the junction of C2 & C6 (input) and apply voltage to the power-supply rail. Connect a wideband (5 MHz), low-capacitance (1 megohm shunted by 10 pF, or less) scope between pin 4 of IC2 (use the convenient test point provided) and ground. Any modern TV-service scope should be able to meet those criteria.

Set the generator to the carrier frequency used for sync pulses on your cable system. Sometimes, an unused cable-channel frequency is used for that. If you find a channel that displays a clean white raster, you have likely found the sync channel. Otherwise, you'll need to ask your cable operator for that information when you request permission to use the circuit. **The circuit should never be used to decode cable signals without such permission.** For the purposes of our discussion, we will assume that the sync-channel frequency is 100 MHz. Modulate the generator's output 80% with a 10-millivolt, 1-kHz signal. Adjust L3 and L4 for maximum output. At that power level, some distortion is likely. If the output is reduced to 1 millivolt, it should be possi-

ble to obtain a 0.2–0.5-volt, 1-kHz sine-wave. Note that if the cable company uses a frequency around 50 MHz for the sync channel, the gain will be higher.

Next attach a TV or FM-radio receiver to the output, J2, and adjust L2 so that the sync frequency is blocked. That is indicated on the TV by the white raster dissolving into snow or on an FM radio by a null in the signal. This adjustment is broad, and hence not critical.

Next, tune the generator to the center

frequency of the scrambled channel (150 MHz in our case) and increase its output again to 10 millivolts, or more, until some response is seen at the test point. Adjust L1 for minimum response.

Now, connect the scope probe between the collector of Q3 and ground. With a 1-millivolt input, a 2-kHz squarewave should be seen. That indicates Q1, Q2, and Q3 are switching. If that squarewave is missing, check to be sure that there is 0.5–1 volt positive pulse at pin 5 of IC2. If everything else has checked out to this point and that pulse is missing, the IC is probably defective. Also check Q2, Q3 and their associated components. If you cannot locate any errors, try changing the value of R7 to 8.2K or 12K or replace the resistor with a 20K potentiometer.

Next, check R33 for the presence of a pulse. It should be 0.1 volts, or more, indicating that sufficient current is flowing to bias D1 and D2 on.

If you have trouble getting the circuit to work, try experimenting with the values of R9, R11, and R12. If you find that the insertion loss caused by the circuit is excessive, try replacing D1 and D2 with Motorola MPN3404 PIN diodes.

That completes the alignment of the decoder. Obviously, not all cable systems will use our example frequencies; in fact it is likely that none will. However, it is a simple matter to adjust the circuit for operation for a particular frequency pair. Before performing those adjustments, however, be sure to contact your cable-system operator and obtain authorization in writing. Using the outband decoder for unauthorized descrambling of a cable signal may be illegal. It is up to the user to determine what the requirements are for legal use and to meet them.

Ordering Information

The following are available from North Country Radio, P.O. Box 53, Wykagyl Station, New Rochelle, NY 10804: Complete sinewave decoder kit, including PC board (metal box for interface circuit not included), item SW-1, \$52.95 plus \$2.50 postage and handling; Pulse decoder kit, including PC board, item PD-1, \$54.95, plus \$2.50 postage and handling; Outband decoder kit, including PC board, item OB-1, \$34.95 plus \$2.50 postage and handling. All three kits can be purchased together for \$129.95 plus \$3.50 postage and handling. The LX10-33 coil is available separately for \$4.00, plus \$1.75 for postage and handling. NY residents please add appropriate sales tax.

The authors of this series on television scrambling and descrambling have written a comprehensive book on the topic. Entitled *Video Scrambling and Descrambling for Satellite and Cable TV*, it is available as book no. 22499 from Howard W. Sams & Co., Indianapolis, IN 46268.

FINDING CABLE FAULTS

Never heard of time-domain reflectometry? Find out what it's all about right here.

VAUGHN D. MARTIN

FAULTS IN TRANSMISSION LINES CAN SEVERELY disrupt the operation of radio transmitters, local-area networks, telephone systems, and many other high-power, high-speed devices. Without proper test equipment, locating faults can be extremely difficult—if not impossible. Simple DC-resistance tests seldom are able to reveal the location of a fault, not to mention its type.

Special test instruments do exist, however, that aid diagnosis of many types of cable faults—not just clean breaks. The Time Domain Reflectometer (TDR) relies on AC impedance measurements to diagnose both the type and the location of many types of cable faults.

TDR overview

The basic idea behind time-domain reflectometry is this: Send a high-speed pulse (or pulse train) with well-defined characteristics down a transmission line. Eventually it will be reflected back to the source, where the original and the reflected signals may be compared in phase, frequency, and amplitude. Depending on the quality of the cable, its impedance, and any faults (which may include clean breaks, frayed shields, etc.), the reflected

signal will have a “signature” that may be analyzed to reveal fault location and type.

Aside from discontinuities (opens), the transmission line itself has a number of relevant properties, including a characteristic impedance, which may or may not change with frequency, and which may vary with length. It also has its own velocity of propagation, and a characteristic attenuation per unit length, which varies with frequency. The TDR can provide quantitative and qualitative information on those characteristics in a single measurement.

The theory behind TDR's has been known for years, but it wasn't until about 20 years ago, when sub-nanosecond pulse generators and oscilloscopes with equivalent bandwidths became available, that time-domain reflectometry became practical.

With the new equipment, distance resolution shrank from hundreds of yards to fractions of an inch. Further, the new generation of sampling oscilloscopes permitted accurate measurements of reflected signals in the millivolt range.

By the way, the sampling scope is not to be confused with the storage scope. A sampling scope (like HP's early 140A and

its accompanying 1415A TDR plug-in) is used to obtain a prolonged view of a repetitive waveform. The sampling scope actually measures the instantaneous voltage of a waveform at various points, so the waveform must be periodic, or else the whole trace will not appear on the screen. Each sample is displayed as a single dot on the scope's CRT; after a number of successive samples are taken, the waveform is “filled out” and appears as a complete trace on the screen.

A storage scope, by contrast, captures the entire portion of the desired signal at once, not just a small portion of it, and then displays it when desired.

Principles of operation

In some industries the TDR is called a “wire radar,” because radar and time-domain reflectometry operate on similar principles. A block diagram of a typical TDR is shown in Fig. 1-a. As shown in Fig. 1-b, an ultra-fast (sub-nanosecond) voltage step is sent down the cable under test. The cable's propagation velocity is known, so the time for the reflected signal to bounce back can be measured, and the distance to the fault calculated. The faster the step, the greater the distance resolu-

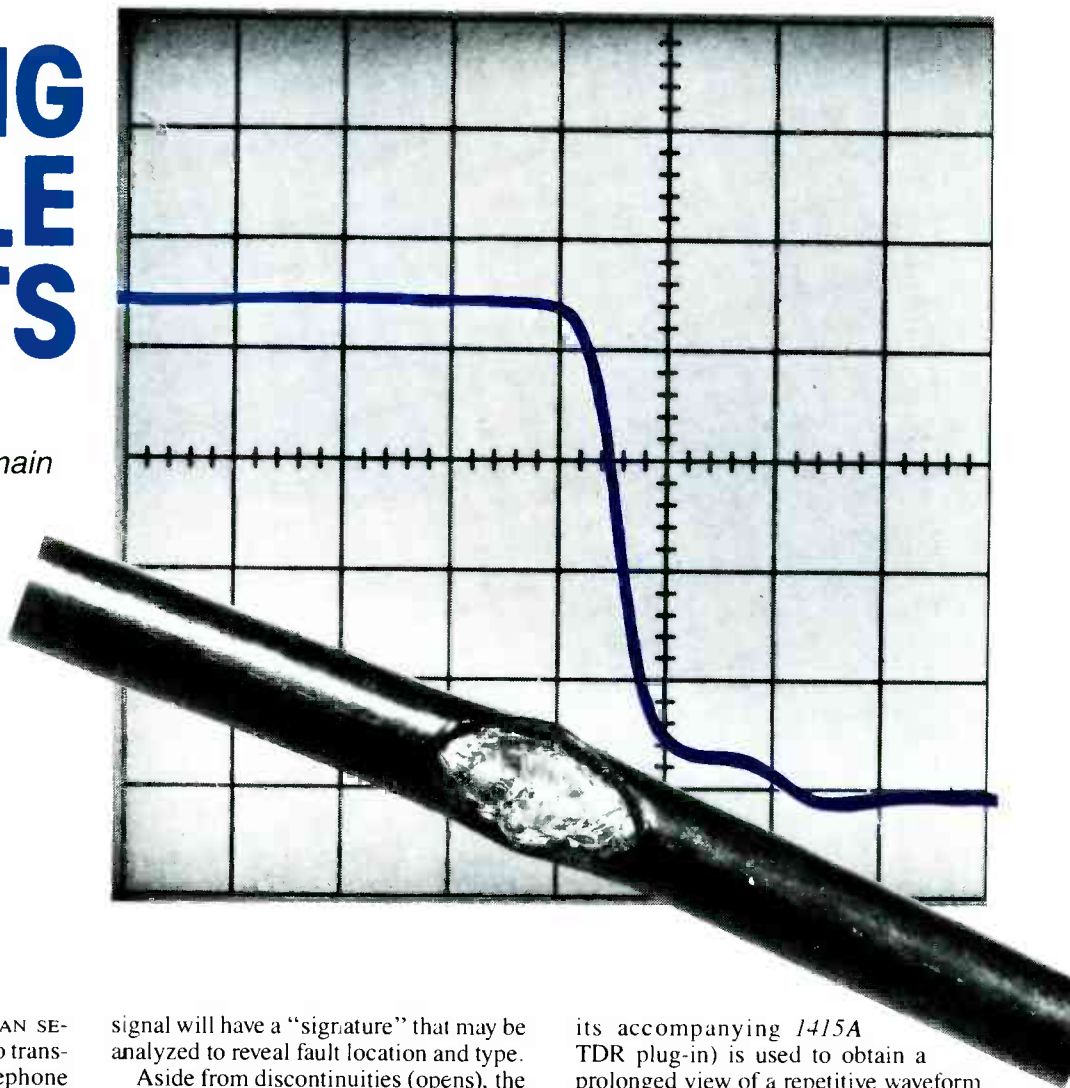

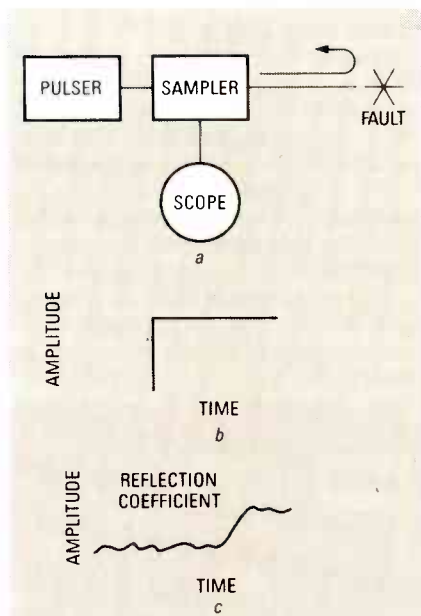

FIG. 1—THE TIME-DOMAIN REFLECTOMETER works by sending a very fast pulse down a transmission line, and then comparing the original with its reflection.

tion. The HP 140A mentioned earlier had a response of 2.3 GHz, which corresponds to 150 picoseconds.

The reflected signal is shown in Fig. 1-c. The shape of the reflection is related to the impedance of the cable and other factors, as we'll see shortly. Any deviation from the initial signal can be recorded and analyzed. The effects, therefore, of cables, connectors, baluns, strip lines, tapered sections, and other broadband devices can be analyzed with a TDR.

Generally, the reflected signal is superimposed on the original signal, which results in a step-up or a step-down transition on the display. The step-up condition results when an inductive fault (or a fault with resistance higher than the cable's nominal impedance) causes an in-phase reflection with the initial pulse. The signals add, and the effect is the step-up transition manifested on the CRT display.

Conversely, the step-down transition results when a capacitive fault (or a fault with resistance lower than the cable's nominal impedance) causes an out-of-phase reflection with the initial pulse. Those signals subtract, and the result is the displayed step-down transition.

Real TDR's

With the basic theory in mind, let's take a look now at several real-world TDR's, namely, Tektronix' 1502 and 1503, which are moderate- and long-range devices, respectively. The 1502 has shorter range but better resolution (2000 feet and 0.6 inches, respectively) than the 1503 (50,000 feet and 3 feet, respectively). The stated resolutions for both models are the-

oretical ideals, not real-world figures. The reason ideal figures are cited is that the resolution/accuracy issue is fraught with qualifiers to the extent that it is nearly impossible to make a blanket statement concerning both accuracy and resolution. We'll see why momentarily.

Reflected voltages

If we let $E+$ represent the initial pulse and $E-$ the reflected signal, then the reflection coefficient ρ is given as follows:

$$\rho = E-/E+$$

The 1502 displays the fault-reflection coefficient ρ on the CRT; that value is referenced to the transmitted voltage by the vertical amplifier, which is directly calibrated in milli- ρ per division, for a 50-ohm system. If ρ is very small, then the cable's impedance would approach the reference impedance per this formula:

$$Z = Z_{REF} \cdot (1 + \rho) / (1 - \rho)$$

The reference impedance (Z_{REF}) is 50 ohms; it is set by a precision 50-ohm cable supplied by Tektronix. ρ may assume any value between -1 and $+1$. -1 corresponds to a short circuit, which appears as shown in Fig. 2; $+1$ corresponds to an open circuit, as shown in Fig. 3. A positive ρ corresponds to a rise on the CRT screen, and a negative ρ to a dip.

The 1502 TDR actually displays the reflection coefficient ρ versus the distance

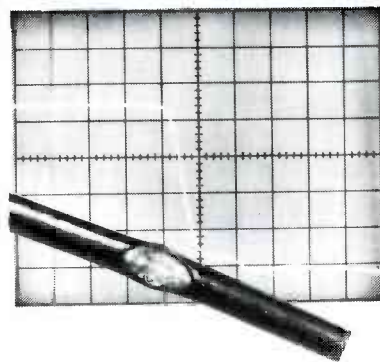

FIG. 2—A TEKTRONIX 1502 displays a short circuit.

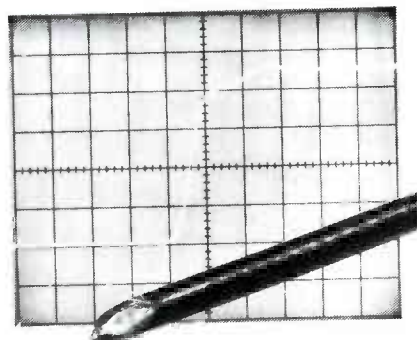

FIG. 3—A TEKTRONIX 1502 displays an open circuit.

to the detected fault. You can think of that as impedance versus distance. The time delay between the initial signal and its reflection from the fault identifies the distance to the fault.

Interpretation

Faults occur in even the best high-frequency transmission systems, and they can cause substantial losses of power, or severely distort the transmitted signal. Faults come in many forms: The dielectric may deteriorate and change; water may leak into cables or connectors; contacts may corrode; conductors may open or short; the cable may be cut or damaged; or a clamp may be fastened too tightly. The TDR treats all such occurrences as discontinuities, abrupt transitions in the otherwise-constant characteristic impedance of a transmission system.

The ideal cable should appear as a resistive load, with no reflections occurring except at the beginning and the end of the cable.

In practice, reflections do occur, and they indicate changes in impedance. Reflections may appear as steps or pedestals, which generally indicate that a cable of different impedance has been spliced into the line. Reflections might also appear as small bumps, which indicate a fault or discontinuity. Further, the profile might show a slowly rising or falling characteristic, which indicates a series or shunt loss in the cable.

If the overall loss in a transmission line is less than about 0.25 dB, and if the total impedance variation along the line is less than about ± 10 ohms, the impedance profile is valid. Therefore, the trace displayed on the screen is an accurate representation of the impedance at all points along the line, within the accuracy limits of the system.

As stated earlier, the CRT of the 1502 is calibrated in ρ per division; ρ is related to impedance by this formula:

$$\rho = (Z - 50) / (Z + 50) \\ = 50 \cdot (1 + \rho) / (1 - \rho)$$

Signatures

The nature of a fault may be discerned because the height and the shape of a reflection may be observed as a signature. With experience the operator becomes accustomed to interpreting signatures.

Figure 4 shows a number of TDR-detected cable faults with their resultant fault signatures.

As shown in in Fig. 4-a, a sharp pulse applied to a line with an inductive fault gives a pulse with a slowly falling output. The remaining parts of that figure show how pulses of different shapes appear after being fed through a line with the indicated type of fault.

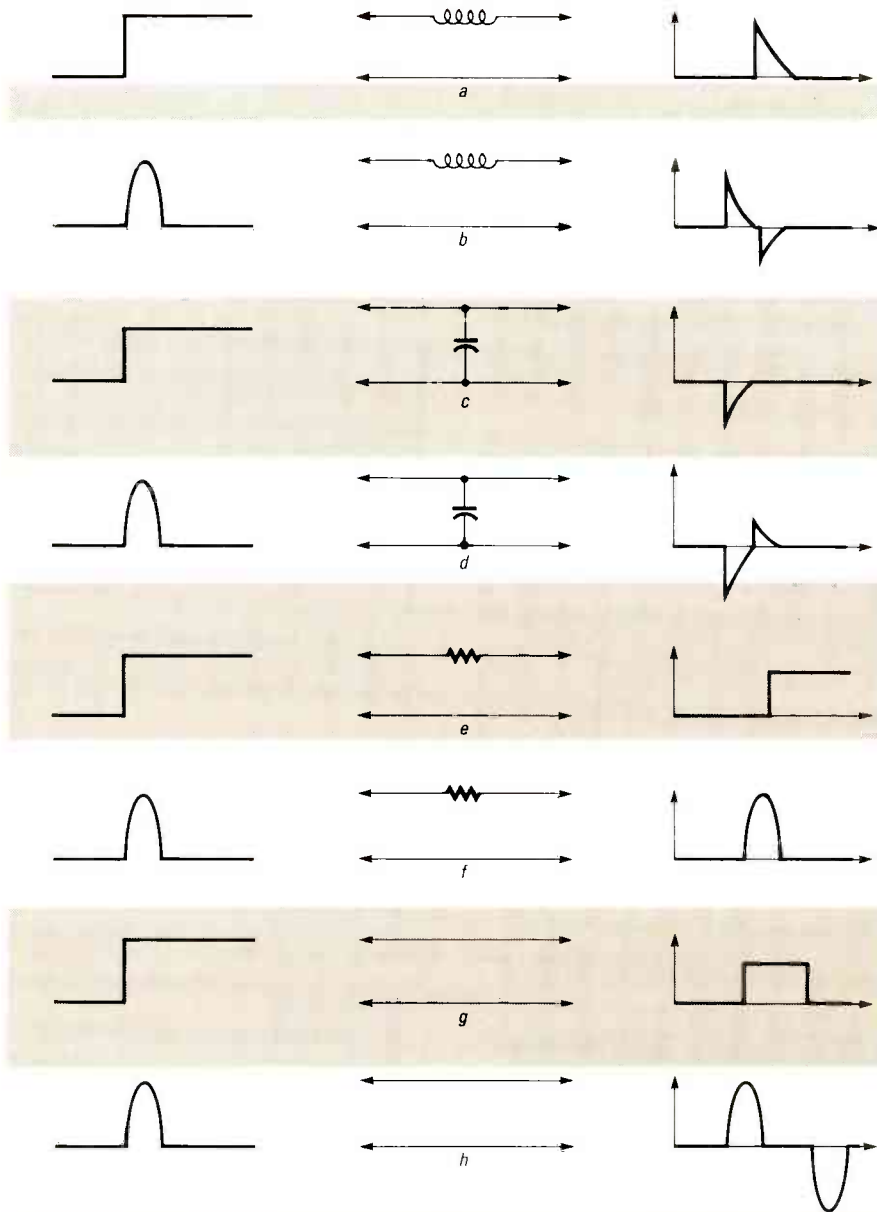

FIG. 4—SHARP PULSES are fed to inductive (a), capacitive (c), resistive (e), and straight-through (g), conductors. Half-sinewaves are fed to corresponding circuits in b, d, f and h.

As in any measurement technique, there are limitations imposed both by the state of present-day technology and by the technique itself. The TDR relates time to distance, so the risetime of the incident or the reflected pulse limits maximum distance resolution. It also limits system bandwidth—the frequency range over which measurements are valid. For example, reflections generated in waveguide systems, unlike coaxial systems, travel at various propagation velocities, depending upon the mode of propagation. Therefore, analysis of waveguide reflections is complex; it is further compounded by the inherent low-frequency cutoff of those systems. Hence the analysis is inherently narrow-band.

TDR and SWR

Whereas TDR measurements isolate a transmission line's characteristics in time (location), Standing Wave Ratio (SWR) measurements provide an immediate overall indication of a transmission line's performance. A TDR can be used to calculate worst-case VSWR (Voltage Standing Wave Ratio) by using the following formula:

$$VSWR = (1 + |\rho|) / (1 - |\rho|)$$

However, the TDR cannot predict the frequency at which that VSWR will occur. The equation is useful in verifying specifications on connectors or splices; however, since reflections combine in a complex manner, it is necessary to use frequency-

domain techniques to determine a system's overall VSWR.

A long-range TDR

Tektronix' model 1503 is a TDR that is designed for long-range measurements of twisted-pair and other low-bandwidth cables. A block diagram illustrating basic operation is shown in Fig. 5-a. Because of the low bandwidth, it is necessary to use high-energy signals of controlled bandwidth. The 1503 uses 10-volt 1/2-sinewave-shaped pulses, as shown in Fig. 6-b; depending on the type of fault, the reflected signal will be a reduced-amplitude, time-delayed version of the original signal, as shown in Fig. 6-c.

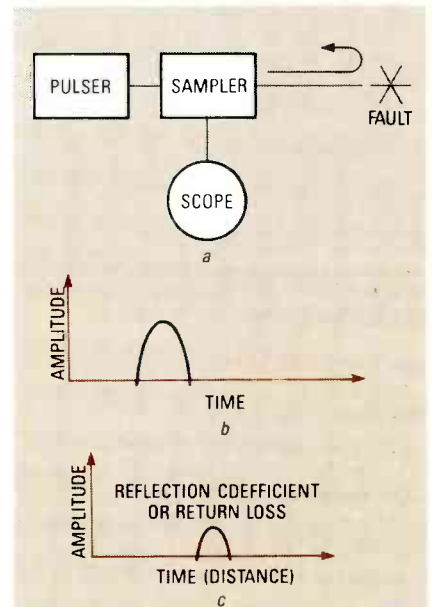

FIG. 5—BLOCK-DIAGRAM OF THE 1503 (a) is similar to the 1502, shown in Fig. 1. However, the 1503 uses half-sinewave signals (b) whose shape and amplitude (c) can be interpreted to diagnose cable faults.

The 1503 also has a precision log amplifier to amplify weak signals. Unlike the 1502, which reads in ρ , the 1503 reads in return loss. Return loss may be related to ρ as follows:

$$\text{Return loss} = 20 \log \rho$$

or

$$|\rho| = 10^{-X}$$

where

$$X = \text{Return loss} / 20$$

As shown in Fig. 6, the 1503 has controls to calibrate the CRT display. Usually, the original pulse is adjusted to occupy two CRT divisions, and so is the reflected pulse. Then return loss may be read directly from the front-panel control.

Length problems

A long cable can yield erroneous readings. The reason is that, due to cable loss, a major fault at a great distance will yield reflections that appear similar to a minor

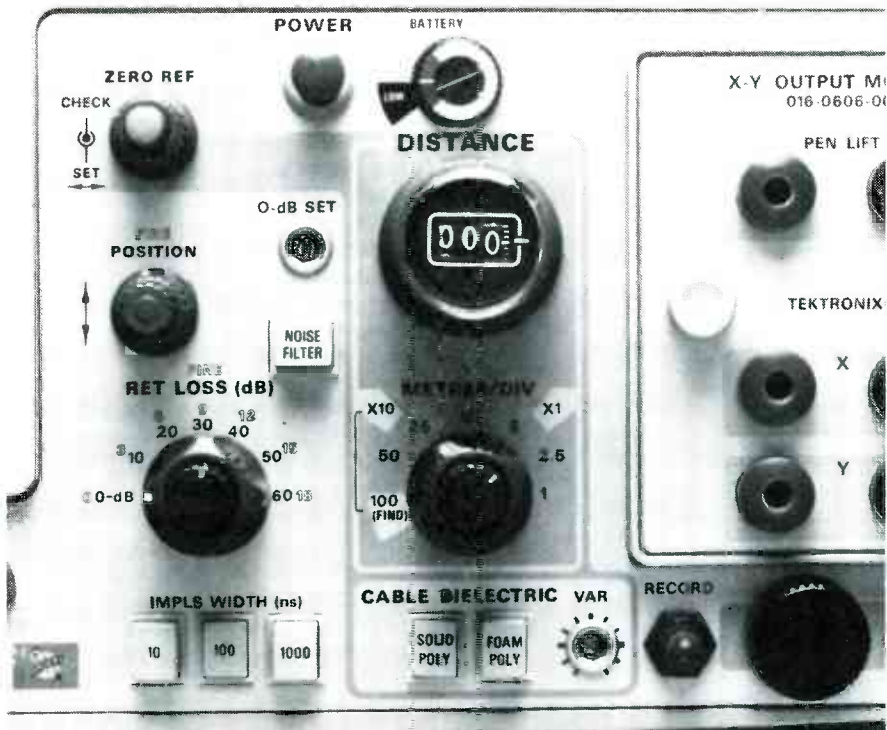

FIG. 6—FRONT PANEL OF TEKTRONIX' MODEL 1503 TDR has controls that calibrate the CRT for direct distance display.

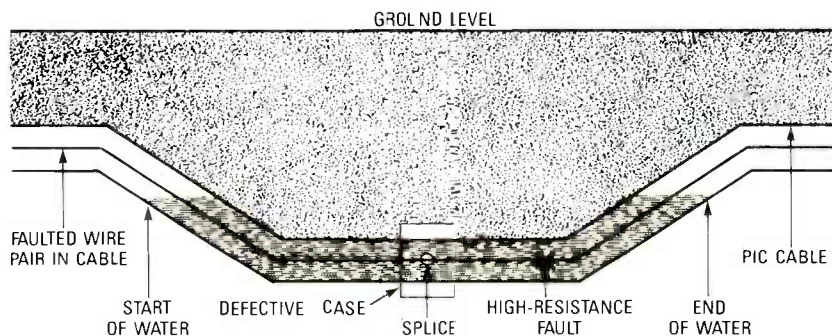

FIG. 7—A MOISTURE-LADEN TELEPHONE CABLE can fool a TDR about the location of the fault. A bridge-type tester may be necessary for maximum accuracy.



FIG. 8—AN ISOLATION NETWORK is available for the 1503; the network improves noise immunity.

fault at a short distance. The cure is to include mathematical corrections that include the effect of pulse attenuation.

On a longer cable, the risetime t_R of the

reflected pulse is almost totally a function of the cable itself; t_R in seconds is expressed by the following equation:

$$t_R = (13.133 \times 10^{-6}) \frac{\alpha_0^2 L^2}{f_0}$$

In that equation, α_0 is cable attenuation in dB/1000 feet at f_0 (in Hz), and L is the cable's length in feet. When using that formula, you should double the value for length, because the pulse must travel down the cable and back. In practice, RG213 cable has a reflected risetime of 12 ns through 50 feet of cable; a 50-foot length of RG174 has a 120-nanosecond risetime.

The vertical accuracy (the accuracy with which ρ is displayed) of both the 1502 and the 1503 is specified at $\pm 3\%$. Accuracy can be improved (as outlined in MIL-C-17, a specification devised for military use) by making measurements with the 1502 using a precision air-line reference to determine characteristic cable impedance.

Length determination

When attempting to relate electrical length to physical length, it is important to take into account four sources of possible error:

- Cable snaking, twisting, and looping.
- Variation in propagation velocity in a given type of cable.
- Sections composed of different cables with different propagation velocities.
- Measurement accuracy of physical cable length.

Snaking refers to the loss caused by cable take-up. For example, it may take 1000 feet of cable to cover a distance of 990 feet.

Propagation velocity depends on the cable's insulation and on the geometry of its cross-section. Most cable manufacturers control propagation to within 0.5 percent; however, different manufacturers' makes of the same cable can vary by as much as two percent. For example, Belden specifies the propagation velocity of its Teflon dielectric coaxial cable (type PTFE) as 69.5 percent of that in air; however, the same cable from ITT has a velocity of 71 percent.

Those figures are quoted for coaxial cable, the most stringently controlled type of cable. Twisted-pair and other types of cables yield greater differences.

When cable types are mixed, determining length can be difficult. For example, older sections of pulp-dielectric telephone cables are being spliced to new Polyethylene Insulated Cables (PIC). The resultant change in propagation velocity when a signal moves from one to the other drastically alters a cable's signature.

The last problem of cable-length measurement is often brought about by the operator's inability to judge distance accurately. For example, to clear obstacles, a cable might snake around brush, go down into a ditch, around a torn-up sidewalk, etc.

There are several practices that can help minimize error. First, take multiple readings. Second, use known points on the

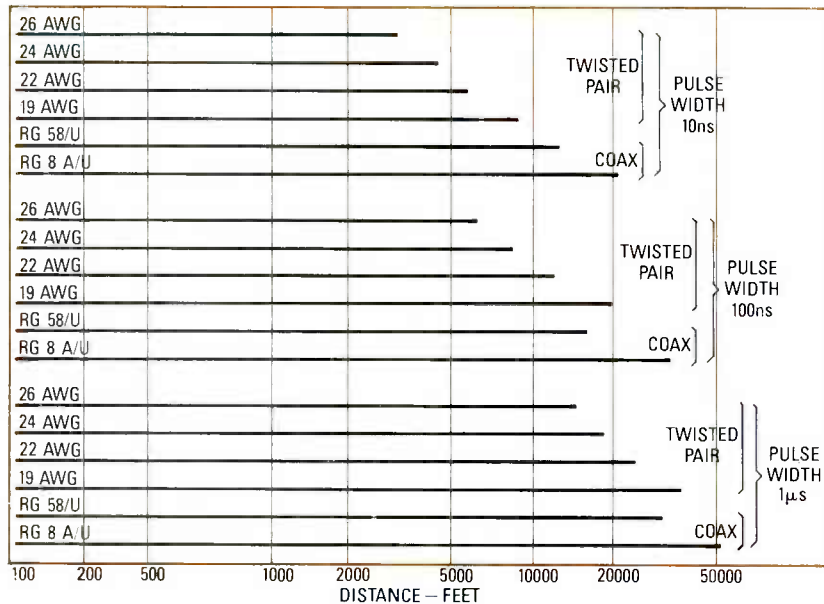

FIG. 9—COAX FAULTS CAN BE MEASURED at greater distances than twisted-pair faults.

Practical testing

First, it must be said that the TDR is not the only means by which cables may be tested; other methods may be used in some cases to obtain better results than with a TDR. For example, note the PIC cable in Fig. 7. Water has leaked into a below-ground telephone cable and will eventually cause insulation breakdown. That will place a resistance of several hundred thousand ohms across the cable. Further, through electrolysis, the cable's continuity will gradually be destroyed.

A TDR cannot detect the point where the insulation weakness begins, whereas a bridge-type fault locator can. On the other



FIG. 10—PERFORMANCE OF AN L-BAND antenna can be measured with a TDR.

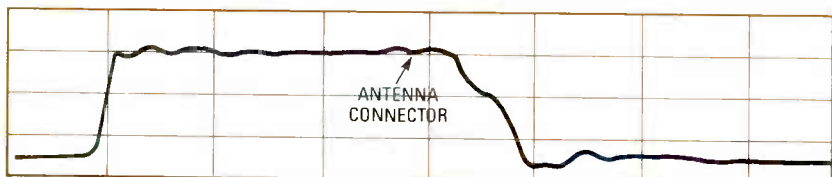

FIG. 11—THE TDR SIGNATURE of the L-band antenna pictured in Fig. 10 is shown here.

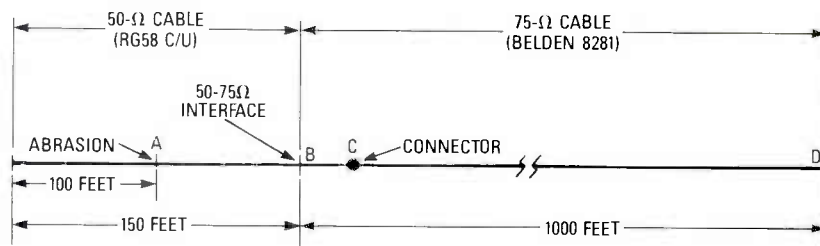

FIG. 12—TEST-JIG CABLE ASSEMBLY has two types of cables and several interconnections.

cable to calibrate the TDR. Last, take readings from both ends of the cable. The latter is a particularly good idea if the cable is composed of two spliced-together cables with different dielectrics.

hand, the TDR can detect water in the cable, but a bridge cannot. In summary then, the TDR can detect the problem and the bridge can detect the symptom.

Realizing another limitation of the

TDR will help preserve both the instrument and the well-being of the operator. The TDR cannot withstand any significant voltage on the cable under test. For example, with the 1502, a voltage-carrying cable should be disconnected from any powered equipment, and the ends of the cable should be terminated or shorted to bleed off static charge that may have built up.

The 1503 is more rugged; it can withstand up to 400 volts (DC + peak AC) at frequencies as high as 440 Hz. You can obtain a good signal even with more than 100 volts of 60-Hz AC. The 1503 also comes with an isolation network, shown in Fig. 8; that network is recommended for use with twisted-pair lines.

Both the 1502 and 1503 possess variable noise filters that enhance their S/N ratios. To test a noisy cable you may want to use the isolation network to provide a crisp, clean trace.

In practice, the first thing to do is to match the TDR's impedance to the impedance of the cable under test as closely as possible. The object of impedance matching is to put as much energy into the cable under test as is possible. However, if you're only interested in the distance to a cable fault or its signature, it may be unnecessary to calibrate the TDR.

The 1503 comes with a 50-ohm impedance standard, and the 1502 comes with impedance adapters of 75, 93, and 125 ohms; those same impedances may be set through front-panel pushbuttons. Most twisted-pair cables are tested with the 93-ohm setting or adapter; however, when the isolation network is used with the 1503, the 125-ohm setting should be chosen.

If an impedance adapter is unavailable, both the 1502 and the 1503 feature front-panel gain adjustments that allow precise recalibration for cables of any impedance. The effects of impedance mismatch are an invalid indication of ρ or return-loss calibration, reduced range, and re-reflections that appear as multiples of the distance to the actual fault.

It is very important to establish a good connection to the cable under test. Remember that the TDR contains high-frequency data that is not transmitted efficiently by pieces of lamp cord, battery clips, etc. In fact, low-quality cable substantially reduces the TDR's range and accuracy. Refer to Fig. 9 and note how large-diameter low-loss coax enables communications over a greater distance than small-diameter coax and twisted pair.

Antenna testing

In any kind of time-domain reflectometry, a chart recorder is useful for recording and preserving test data for later comparison with questionable equipment. For example, a chart recorder and a 1502 are

continued on page 90

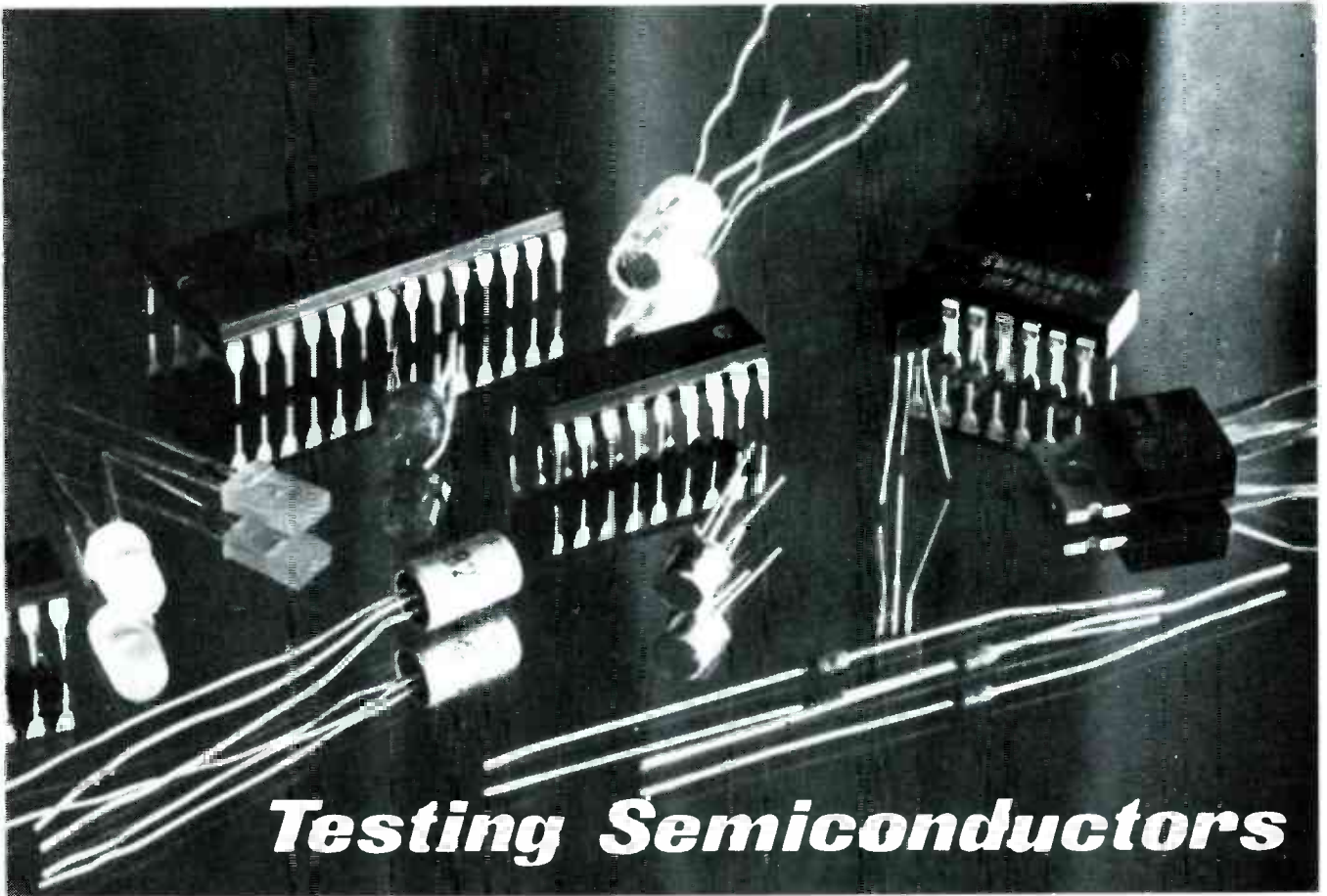

Testing Semiconductors

Our back-to-school series continues this month with a discussion of FET characteristics.

TJ Byers

Part 2 IN OUR LAST INSTALLMENT we investigated the static properties of the bipolar transistor. This time we'll turn our attention to the unipolar transistor, more commonly known as the *Field Effect Transistor*, or FET.

There are two basic types of FET: the *Junction FET (JFET)* and the *Metal-Oxide Semiconductor FET (MOSFET)*. Like bipolar transistors,

FET's comes in two "sexes:" N- and P-gate. In the test set-ups shown here, we'll use N-gate FET's. Those circuits can be adapted to P-gate types simply by reversing the polarities of voltage and current sources, and voltage and current meters.

JFET characteristics

The FET differs from the bipolar transistor in that it has only one junction. The FET is built as shown in Fig. 1. It is a bar

of semiconductor material with a diode junction formed around its center. One end of the bar is called the source; the other is called the drain. The connection to the diode junction is called the gate.

When voltage is applied across the semiconductor bar from source to drain, current flows unrestricted through that bar. If we reverse-bias the gate diode, however, an electric field forms within the bar. That field reduces the effective cross-sectional area of the semiconductor bar by forcing electrons from the voltage source toward the center of the semiconductor material. The smaller cross-sectional area represents an increase in resistance, which restricts the flow of electrons.

The strength of the field is proportional to the applied voltage. As the strength of the field increases, fewer electrons make their way through the tunnel, and current flow decreases proportionally. That phenomenon is called *the pinch effect*; it is what gives the FET its amplifying properties. As field strength increases, eventually it reduces the width of the tunnel so much that current ceases to flow. The voltage at which that occurs is called the *cut-off or pinchoff voltage (V_p)*.

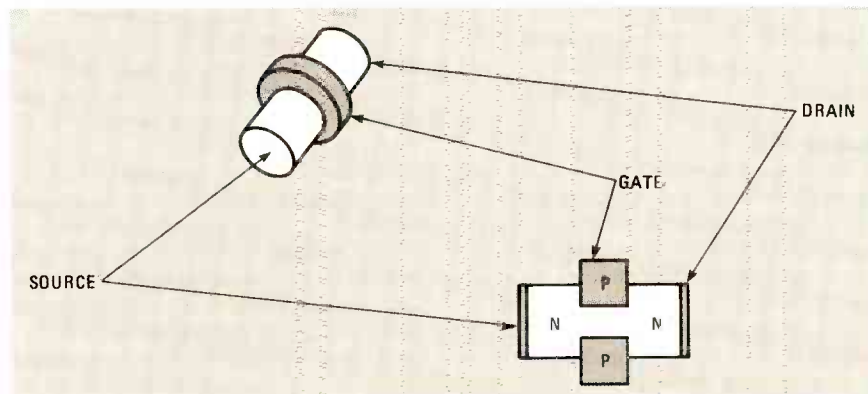

FIG. 1—THE JUNCTION FET is built from a bar of semiconductor material around which a diode junction is formed.

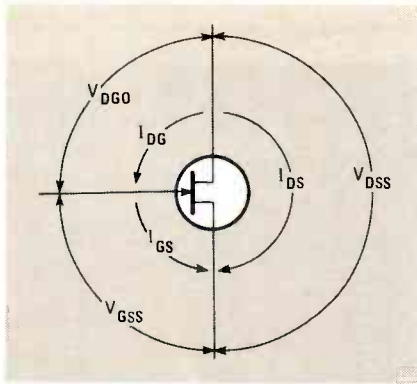

FIG. 2—IMPORTANT VOLTAGE AND CURRENT parameters of the JFET are shown here.

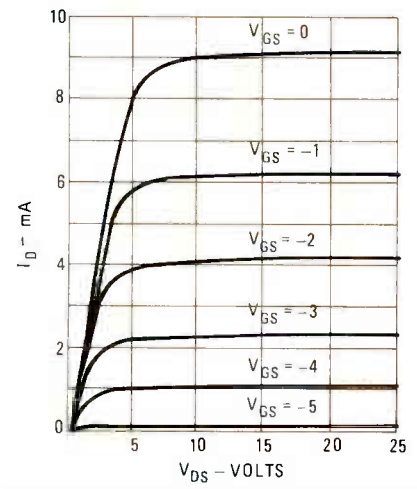

FIG. 3—CHARACTERISTIC CURVES of a typical JFET are shown here. In general, higher values of V_{DS} correspond to higher values of I_D .

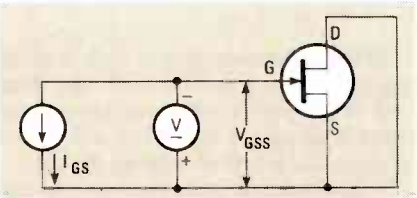

FIG. 4—TO MEASURE V_{GSS} , use this set-up. Gradually increase current (I_{GS}) to the point where further increase in current does not cause a corresponding increase in voltage.

Like the bipolar transistor, the FET has several important voltage and current characteristics; they are indicated in Fig. 2. The voltage characteristics each have three subscripted terms; the first two terms indicate the terminals between which the voltage is measured, and the third indicates the disposition of the third terminal. The third term is either O (for open) or S (for shorted). So, for example, V_{DGO} represents the voltage between the drain and the gate, with the source unconnected (open).

In Fig. 2 the subscripted terms representing current indicate the terminals through which that current flows. For example, I_{DG} represents the current that flows from drain to gate.

THE TERM FIELD-EFFECT TRANSISTOR IS GENERIC and covers several kinds of devices. But, basically, any semiconductor device whose operating characteristics are influenced by a controlled electric field qualifies as an FET. That generalization has led to the identification of three distinct FET types, labeled A, B, and C.

WHAT IS A FET?

creasing the negative gate voltage reduces I_{DS} to a very small amount. The type-C FET, on the other hand, is an enhancement-mode transistor. As shown in Fig. 1-c, it requires gate voltage before current will flow from source to drain. At zero gate volts, zero drain current flows.

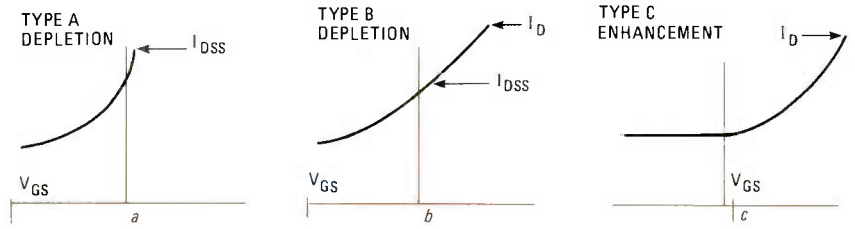

Fig. 1

The type-A FET is characterized as a depletion-mode transistor. As shown in Fig. 1-a, it operates only within the depletion-voltage section of the VI curve (quadrant II). In other words, with no voltage applied to the gate, current is free to flow between source and drain, restricted only by the lump resistance of the device. In-

A type-B FET is a hybrid of the A and C types. It is basically a depletion-mode transistor with enhancement features. As shown in Fig. 1-b, at zero gate volts, a current equal to about half the maximum I_{DS} flows. A depletion voltage on the gate reduces I_{DS} and a positive gate input increases it. **R-E**

The characteristic curves of a typical FET are shown in Fig. 3. Each curve shows how I_D varies with V_{DS} , when V_{GS} is held constant. In the lower part of each curve, as V_{DS} increases, I_D increases proportionally. In that more-or-less linear portion of the curve, the FET displays its amplifying properties.

As the voltage across the FET continues to increase, the width of the depletion region (the tunnel) increases until further increases in V_{DS} cause no increase in current, as depicted by the flat parts of those curves. That area of operation is called the constant-current mode; it occurs when the gate-depletion field saturates the drain-to-source path.

If V_{DS} increases further, eventually the device goes into avalanche current multiplication. That occurs at the breakdown voltage of the transistor, which is represented by the term V_{DSS} . The avalanche current, if allowed to continue unchecked, eventually would destroy the transistor.

Testing JFET's

The static parameters of the JFET are measured in much the same way as those of the bipolar transistor. Leakage current is measured with a milliammeter (or microammeter) and a constant-voltage source. Breakdown voltages are determined by allowing a limited amount of current to flow through the device in the avalanche mode and measuring the voltage across the transistor.

Figure 4, for example, represents the

setup for measuring V_{GSS} , the breakdown voltage of the gate-to-source junction. To make the measurement, apply a constant current to the diode junction in the reverse mode and measure the voltage across that junction.

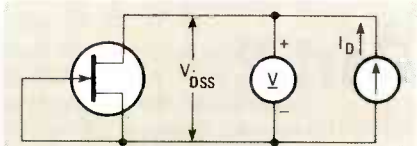

FIG. 5—TO MEASURE V_{DSS} , use this set-up. Gradually increase current (I_D) to the point where further current increase does not cause a corresponding voltage increase.

Note that that measurement is made with the drain shorted to the source. Many FET measurements require that several elements be tied together. Figure 5, for example, shows how to measure V_{DSS} . Generally, the values of V_{DSS} and V_{GSS} are identical, because in essence the gate is shorted to one end or the other of the semiconductor substrate.

In some cases it is necessary to apply a bias voltage to measure a particular parameter. V_{DS} , for example, is measured with a voltage applied to the gate. The voltage on the gate adds to the drain voltage, and that effectively lowers the breakdown voltage of the device. Sometimes a data sheet will identify that parameter as V_{DSSX} , where X represents the test voltage applied to the gate.

continued on page 88

PC SERVICE

One of the most difficult tasks in building any construction project featured in **Radio-Electronics** is making the PC board using just the foil pattern provided with the article. Well, we're doing something about it.

We've moved all the foil patterns to this new section where they're printed by themselves, full sized, with nothing on the back side of the page. What that means

for you is that the printed page can be used directly to produce PC boards!

Note: The patterns provided can be used directly only for *direct positive photoresist methods*.

In order to produce a board directly from the magazine page, remove the page and carefully inspect it under a strong light and/or on a light table. Look for breaks in the traces, bridges between traces, and in

general, all the kinds of things you look for in the final etched board. You can clean up the published artwork the same way you clean up your own artwork. Drafting tape and graphic aids can fix incomplete traces and doughnuts, and you can use a hobby knife to get rid of bridges and dirt.

An optional step, once you're satisfied that the artwork is clean, is to take a little bit of mineral oil and carefully wipe it

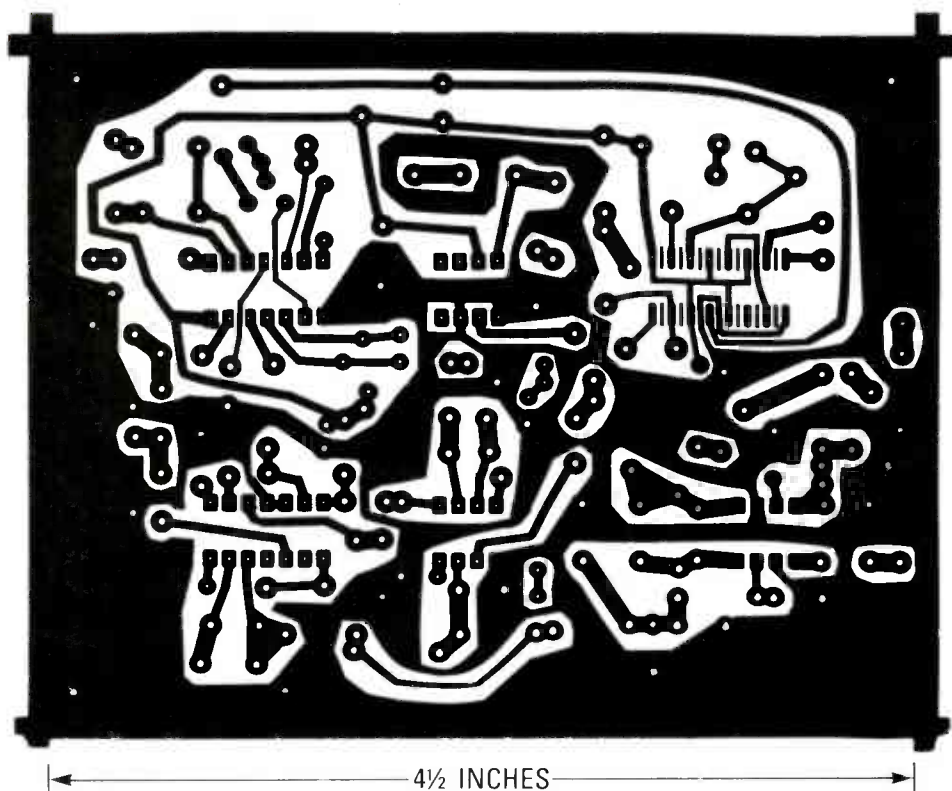

FOIL PATTERN FOR THE GATED-SYNC descrambler described in January is shown here.

4 1/2 INCHES

across the back of the artwork. That helps make the paper translucent. Don't get any on the front side of the paper (the side with the pattern) because you'll contaminate the sensitized surface of the copper blank. After the oil has "dried" a bit—patting with a paper towel will help speed up the process—place the pattern front side down on the sensitized copper blank, and make the exposure. You'll

probably have to use a longer exposure time than you are used to.

We can't tell you exactly how long an exposure time you will need as it depends on many factors but, as a starting point, figure that there's a 50 percent increase in exposure time over lithographic film. But you'll have to experiment to find the best method for you. And once you find it, stick with it.

Finally, we would like to hear how you make out using our method. Write and tell us of your successes, and failures, and what techniques work best for you. Address your letters to:

Radio-Electronics
Department PCB
500-B Bi-County Blvd.
Farmingdale, NY 11735

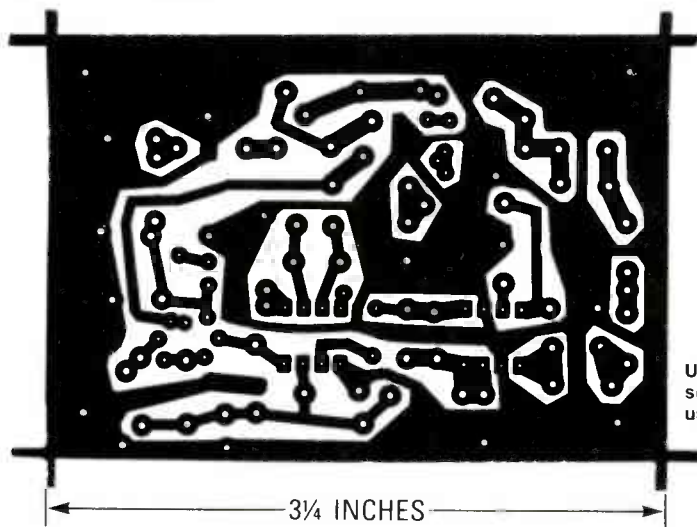

USE THIS PATTERN to build a de-scrambler for the outband system used by some cable-TV systems.

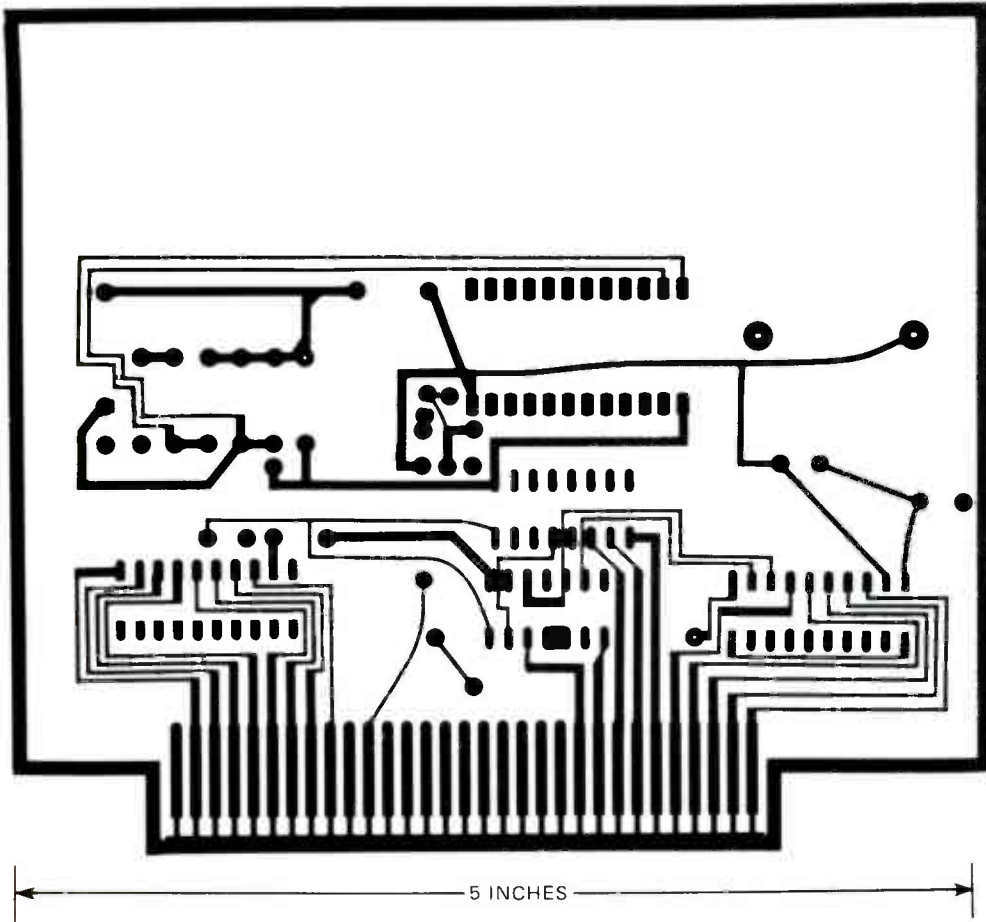

COMPONENT SIDE of the clock board. See Computer Digest for more information.

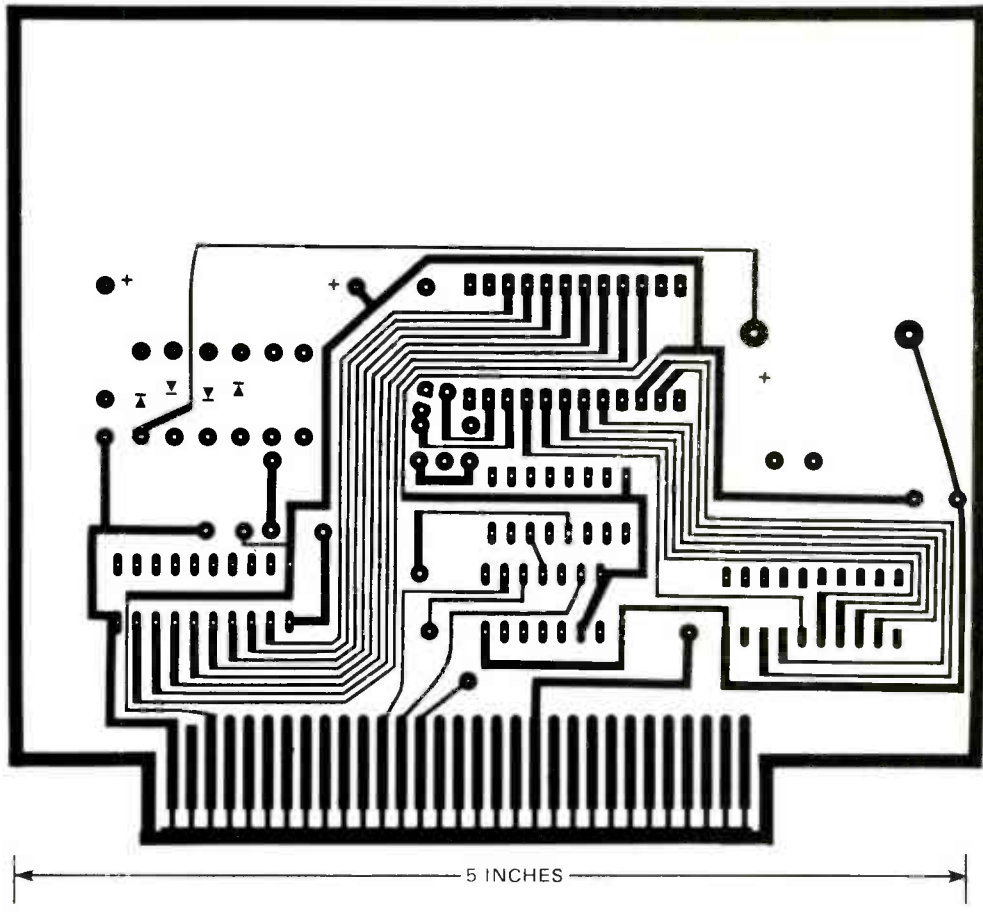

SOLDER SIDE of the clock board for IBM PC's and compatibles.

Increase your knowledge about all aspects of electronics

An absolutely no-risk guarantee.

Select 5 Books for only \$2⁹⁵ and get a Free Gift!

values to \$126.75

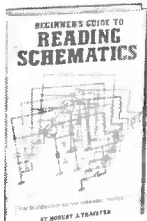
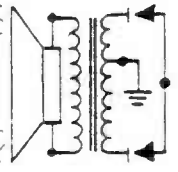

1536 \$14.95

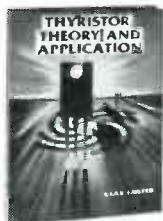

2665 \$17.95



1825 \$15.95



1553 \$15.95

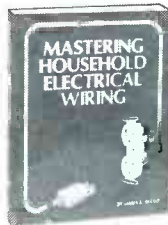

1587P \$13.95



1992 \$14.95



1277P \$15.95



1498P \$11.95

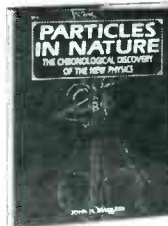

2616 \$23.95



1858 \$16.95



1909P \$14.95



1529P \$14.95

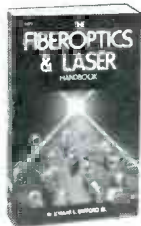

1671P \$16.95



1632P \$12.95



1665P \$17.95



1199P \$16.95

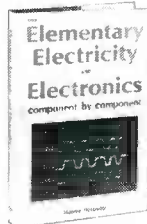

2753 \$23.95



2635 \$19.95



1604P \$15.95



1870 \$19.95



1532P \$14.95

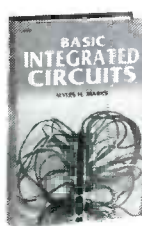

2609 \$26.95

TROUBLESHOOTING & REPAIRING



1977P. Troubleshooting and Repairing Satellite TV Systems Paper \$18.95

1503P. Maintaining and Repairing Videocassette Recorders Paper \$15.95

1897P. Beginner's Guide To TV Repair—3rd Edition Paper \$12.95

1250P. Digital Electronics Troubleshooting Paper \$14.95



EXCITING PROJECTS

1672P. Electronic Design and Construction of Alternate Energy Projects Paper \$12.95

1599P. GIANT Book of Easy-to-Build Electronic Projects Paper \$16.95

1586. 25 Silicon-Controlled Rectifier Projects \$17.95

AUDIO



1964P. Designing, Building and Testing Your Own Speaker System . . . with Projects—2nd Edition Paper \$10.95

2728. Demystifying Compact Discs: A Guide to Digital Audio \$15.95

2675. Microphones—3rd Edition—Covers equipment and techniques. \$22.95

2655P. The Complete Shortwave Listener's Handbook—3rd Edition Paper \$16.95

REFERENCE & THEORY



1625. Master Handbook of Electronic Tables & Formulas—4th Edition \$24.95

1370. The Master Handbook of IC Circuits \$26.95

(Publisher's Prices Shown)

Membership Benefits • Big Savings. In addition to this introductory offer, you keep saving substantially with members' prices of up to 50% off the publishers' prices. • **Bonus Books.** Starting immediately, you will be eligible for our Bonus Book Plan, with savings of up to 80% off publishers' prices. • **Club News Bulletins.** 14 times per year you will receive the Book Club News, describing all the current selections—mains, alternates, extras—plus bonus offers and special sales, with hundreds of titles to choose from. • **Automatic Order.** If you want the Main Selection, do nothing and it will be sent to you automatically. If you prefer another selection, or no book at all, simply indicate your choice on the reply form provided. • **Ironclad No-Risk Guarantee.** If not satisfied with your books, return them within 10 days without obligation! • **Exceptional Quality.** All books are quality publishers' editions especially selected by our Editorial Board.

FREE when you join
A Handy, Pocket-Sized
Resistor and Inductor
Color Code Calculator

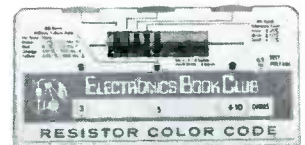

ELECTRONICS BOOK CLUB

P.O. Box 10, Blue Ridge Summit, PA 17214

Please accept my membership in the Electronics Book Club and send the 5 volumes circled below, plus my FREE Resistor & Inductor Color Code Calculator, billing me \$2.95 plus shipping and handling charges. If not satisfied, I may return the books within ten days without obligation and have my membership canceled. I agree to purchase at least 4 books at regular Club prices (plus shipping/handling) during the next 12 months, and may resign any time thereafter.

1199P 1250P 1277P 1370 1498P 1503P 1529P 1532P 1536 1553 1586
1587P 1599P 1604P 1625 1632P 1665P 1671P 1672P 1825 1858 1870 1897P 1909P
1964P 1977P 1992 2609 2616 2635 2655P 2665 2675 2728 2753

Name _____

Address _____

City _____

State/Zip _____ Phone _____

Valid for new members only. Foreign applicants will receive ordering instructions. Canada must remit in U.S. currency. This order subject to acceptance by the Electronics Book Club. RE-387

SATELLITE TV



BOB COOPER, JR.,
SATELLITE-TV EDITOR

Why Videocipher is dead

NOW THAT VIDEOCIPHER IS BROKEN and plug-in IC's are available "on the street" to break the Videocipher code, here are some words about the dangers involved in all of this.

First of all, if Section 705 of the Cable Communications Act of 1984 has any teeth at all, the sale or use of scramble-busting equipment or hardware—or even how-to information—is a federal crime. Be warned.

The reality is that, as this is written, dozens of people and firms are offering IC's for sale. There are three different approaches:

- **Cloning.** In the cloning approach, a working unit is designated as a "master." Its unique electronic address is extracted and stored in an external EPROM. Then the EPROM is used to rewrite the address code or identification number on other Videocipher VC-2000 units. In that way, two or more units end up sharing the same electronic address. That means that if one person, owning one of those units, subscribes to and pays for a number of services such as HBO, Cinemax, CNN, Showtime, and Disney, all other units sharing the same identification code will also receive those same programs. Only the first unit pays for those services.

- **Musketeering.** In musketeering, you sign up your Videocipher 2000 for one service, typically a low-cost service such as CNN/CNN Headline News, which sells for \$25 per year. The U30 EPROM is then replaced with a new EPROM, like the one shown in Fig. 1, which is specially rewritten for the occasion. When the new EPROM is in-



FIG. 1

serted, the VC-2000 receives, fully descrambled, all of the scrambled services. Figure 2 shows a screen display of a Cinemax program descrambled with a musketeer device. So for perhaps \$2 per month you receive \$60 or more in programming services.



FIG. 2

- **Clone-Tiering.** Clone-tiering is a variation of the basic cloning and musketeering approaches. A unit is first cloned with the authorization number from one master box, and then it is enhanced with a new U30 IC so that it receives all of the services up there. In other words, it is the best of both worlds.

Problems?

Alas, there are many problems. Several variations of the musketeering approach are in the mar-

INTERESTED IN SCRAMBLING?

Bob Cooper's *CSD Magazine* maintains a 24 hour per day *Scramble-Fax-Hotline* telephone service (305/771-0575) which you may call to obtain a 3-minute recorded update on the latest happenings in the satellite scrambling world. *Scramble-Fax Newsletter* is also published to keep you abreast of the latest events in descrambling, including sources for descrambling chips and equipment. For information, write *Scramble Fax*, P.O. Box 100858, Ft. Lauderdale, FL 33310 or telephone 305-771-0505.

If you have a dish of your own, tune in the Caribbean Super Station (Western 5, transponder 23) Tuesdays at 7 PM eastern for a special weekly Bob Cooper report. Also tune-in *Boresight* at 9 PM Thursday nights (Spacenet 1, transponder 9) for a weekly one-hour report on the activities in the home TVRO field.

ketplace. One group, based along the eastern seaboard but peddling their IC through a Nassau, Bahamas address, is selling an "unprotected" IC. In other words, a half-bright person with an EPROM burner can buy one of the IC's and then make up several dozen (hundred, thousand) copies for the price of a bare EPROM (typically under \$4). That is happening.

Other musketeering groups have taken steps to "protect" their IC's and have hidden the software routine they have created so it is not all present on a single IC, and is not directly copyable under any circumstances.

Meanwhile, in the cloning camp, there is another argument going on. In the cloning process, a master IC carries the authorization information from the master to the clones. The first sellers of cloning services insisted that those who

wished their boxes cloned bring the boxes to a center (outside of the USA) for the cloning operation. That slowed down commerce significantly. The next cloning groups decided that they would trust their customers to have control and possession of the magic cloning masters. So rather than tell a person to bring their boards to the cloning center, they began selling cloning masters. The going price as we write this report is between \$4,000 and \$6,000 for a cloning master. Most people buying these masters are then taking them as "cash-flow machines" and going out into their neighborhoods offering to clone people's units. The retail price to the consumer is around \$200 to \$300. Thus a person who pays \$6,000 for a clone master can clone 100 units and spread his \$6,000 cost into 100 equal units of \$60 each. When he collects \$300 for each unit he clones, he collects \$30,000 by doing 100 units. His \$6,000 investment just became \$30,000, a profit of \$24,000. As you might expect, business is brisk!

Could it be stopped?

All of this happened in November and December with lightning speed. In just a matter of days clone masters and musketeering techniques spread border to border and coast to coast almost overnight. The rapid spread of techniques and technology caught the cable programmers and scramblers totally unprepared.

Moreover, the wide distribution of the knowledge in such a short period of time made it virtually impossible to locate a core of this information to stamp it out. There was a time, perhaps a two week window back in early November, when the cable-programming trusts could have stopped all of this by dealing with a half dozen or so people who had that special scramble-busting knowledge. *And they had the opportunity to do so.* In fact, a meeting between a high executive of General Instruments and a representative of the scramble-busting "trust" was scheduled for October 19th and was in place until GI attorneys got into the act and forced their man to withdraw

from the meeting.

So the cable programmers blew the opportunity to stop the spread of underground hardware and software, and the rest is now history. Ahead are the "real" solutions to the Videocipher system.

The present systems are software oriented and take advantage of software programming "errors" that the originator of the system, M/A-Com, allowed to sneak into the system.

The next level of solution will be

a stand-alone descrambler box, not made by GI or any authorized source, that will allow a TVRO viewer to tune in any service at will, from anyplace within the footprint of the US domestic satellites. There will be no record that the individual owns a descrambler box and he will be totally untraceable. The marketing of that "ultimate" solution is anticipated around June 1st of this year.

Videocipher, for better or worse, is truly dead. R-E

SEND COOP \$20



and HE WILL SEND YOU \$63!

NOPE - not a new fangled 'chain letter'. TVRO pioneer Bob Cooper, Jr. has put together the most useful 'Data-pack' possible to bring you up to full speed on satellite television scrambling. It will cost you \$20 to receive all of the following valuable information:



1) YOU RECEIVE the 3 'current issues' of **CSD Magazine**; literally, 'the bible' of the home dish industry. The most complete insider look at the new equipment, scrambling strategies, worldwide satellite explosive growth anyplace. You receive 3 issues starting with the now-current issue. A great introduction to TVRO! This is an **\$18 value**.

2) YOU RECEIVE the current plus two recent back issues of **SCRAMBLE-FAX**, the hot-news 'Newsletter' that details the rapid changes taking place in scrambling, who is scrambling, how; who is working to break scrambling, their progress to date. This is a **\$30 value**.

3) YOU RECEIVE the special 180 page **COMMEMORATIVE EDITION OF Coop's Satellite Digest**, the full, unabridged history of home satellite television. This is the handiest, one-source reference recording the home dish industry; a **\$15 value**.

YOU RECEIVE all of the facts, all of the history, and all of the current, hard-to-find news about TVRO and scrambling. From Coop; the industry's most authoritative information source. Send your check or money order to the address below, or, with your Visa or Mastercharge card handy, call in your order to 305/771-0505 weekdays between 9 AM and 4 PM. Join the Coop team and learn ALL the facts today!

CSD/Coop's Satellite Digest

P.O. Box 100858/Ft. Lauderdale, Fl. 33310

- Telephone 305-771-0505 -

SCRAMBLE-FAX HOTLINE? Call 305-771-0575 for 3 minute update NOW!

AUDIO UPDATE

Psychoacoustics and Stereo Imagery



LARRY KLEIN,
AUDIO EDITOR



FIG. 1

IN MY LAST TWO COLUMNS I DISCUSSED the technologies and purposes of signal processors. I indicated that the major trouble areas in audio reproduction are noise, dynamic-range limitations, frequency balance, and spatial imaging. I covered the first three problems in past columns; now

let's take a brief look at the theory of stereo perception and the way that certain products can affect and enhance the stereo illusion.

Auditory localization

The human ear/brain's ability to localize sound sources is important for at least two reasons: It en-

abled our remote ancestors to determine the precise direction from which the saber-tooth tiger was coming (as a guide to the direction in which *they* should be going), and today it provides the ability to construct a stereo image psychoacoustically from two or more sound sources.

There are two differences between the sounds reaching our ears that we use to achieve localization: time-of-arrival differences and sound-pressure-level differences. In addition, there is some evidence that frequency-response differences between the ears due to head diffraction assist the localization process, but the present view is that the contribution is small, no matter how large the head. In general, differences in arrival times are used to localize lower-frequency sound sources, and differences in level are used for the higher frequencies; the brain's crossover point between the two is about 1200 Hz.

There's a good reason why your ear/brain mechanism uses (actually, needs) two different cuing mechanisms for localization. For wavelengths in the mid- to high-frequency ranges, your head is an acoustic barrier that partially blocks the sound reaching the ear most distant from the sound source. The difference between the ears is about 16 dB at 5,000 Hz, falling to about 7 dB at 1,000 Hz. When the frequency is low enough (i. e., the wavelengths long enough), the head ceases to be an adequate baffle and essentially the same signal *level* is heard by both ears.

However, your brain still senses

the differences in arrival time (*phase*) between the signals reaching your two ears—which is about 0.6 millisecond from a source located fully on one side of the head or the other—and that information provides the data needed for localization. Below 200 Hz or so, where wavelengths are very long, arrival-time differences begin to disappear and directionality begins to be lost. That, by the way, explains why the sound from subwoofers is non-directional.

Unnatural stereo

What I've just described is the way the ear localizes the source of *natural* sounds. Although stereo reproduction makes use of the same perceptual mechanisms to generate a spatial image, the process of stereo reproduction provides different and somewhat problematic raw material for the ear/brain to work with. Problems arise because part of the sound produced by each musical instrument and performer in a recording almost always appears in *both* channels and is reproduced by *two* widely spaced speakers.

So if you hear a centered soloist, both right and left speakers are contributing in equal measure to the illusion. But when a vocalist or musical instrument appears more to the left or to the right, the loudness/phase differences in the *two* signals reaching your ears have tilted your perception in one direction or another.

For example, when you are listening to a well-recorded jazz group, each performer (plus whatever reverberant hall sound might be captured) is represented by two signals, one in each channel. It should be obvious that stereo reproduction is a totally artificial (and, as you can see, surprisingly complex) process that works by manipulating—and misleading—the ear's normal sound-localization procedures.

Improving the image

An appreciation of the ear/brain's stereo spatial perception mechanism is helpful in understanding the techniques used by the various stereo enhancers, imagers, and synthesizers. Here are some commonly used techniques.

- In a normal stereo recording in which two speakers are used to reproduce each performer and instrument, there is a large amount of "inter-aural crosstalk." In other words, too much of the left-channel sound intended only for the listener's left ear reaches his right ear, and vice versa. Polk's SDA speakers, shown in Fig. 1, and Carver's electronic "Holographic" circuits achieve their effects by acoustically (Polk) or electronically (Carver) nulling the sound that reaches each ear from the opposite, unwanted channel. The enhancement that results from that procedure has to be heard to be believed. The sound stage is no longer confined to a narrowly defined space between the right and left speakers; depending upon the program material, it can form an arc of almost 180-degrees in front of the listener.
- Some imaging devices manipulate the phase of the two channels. Others extract the left-minus-right signal (which represents the difference between the two channels) and use it to enhance the "rightness" and the "leftness" of each channel. That technique, which has been used in several receivers, can substantially broaden the stereo sound stage.
- Mono-to-stereo synthesizers "comb-filter" the audio spectrum into three or more segments (the more, the better), putting alternate bands in each channel, and/or phase shifting each of the newly generated channels in opposite directions. Those circuits are found in some audio/video products; their intention is to provide a stereo effect from mono sound tracks and broadcasts.
- Several loudspeaker manufacturers have rearranged the sound-field propagation of their products (by the use of acoustical and electrical delays) to offset some of the spatial constrictions and artificialities introduced by normal stereo reproduction. AR's *Magic Speaker* and dbx's speaker systems embody that approach.
- Time-delay devices electronically delay a portion of both right and left channel signals separately and feed them into strategically placed rear speakers as a means of emulating the acoustic

time delays found in large concert halls.

I've probably neglected a few special techniques during my once-over-lightly treatment, but my purpose was to remove some of the technical mystery from the various products, not to create a catalog.

Four-channel revisited

A new breed of audio processor has come into prominence recently. To the audio old-timers among us, they may seem somewhat reminiscent of the quad decoders of the early seventies. To distinguish the new products from their multichannel predecessors, these new products are referred to as Sound Field or Surround Sound Processors, Home Theatre Sound Systems, or simply Dolby Surround Decoders. The processing in the more complex units is done mostly by digital means. We'll look at those units next month along with some of the reasons why stereo doesn't work right. R-E

SUPER LONG PLAY TAPE RECORDERS

10 Hour Model — \$95.00*
14 Hour Model — \$159.00*

Modified Panasonic Simitone. high quality, AC-DC Recorders provide 5 or 7 continuous hours of quality recording & playback on each side of 10 or 14 hours depending on model. Built-in features include: • Voice level control. • Digital counter, etc. TDK DC 180 Cassette Furnished.



PHONE RECORDING ADAPTER
Records calls automatically. All Solid state connects to your telephone jack and tape recorder. Starts recording when phone is lifted. Stops when you hang up. **\$24.50*** FCC APPROVED



VOX VOICE ACTIVATED CONTROL SWITCH
Solid state. Self contained. Adjustable sensitivity. Voices or other sounds automatically activate and control recorder. Uses either recorder or remote mike. **\$24.95***



*Add for ship & hdg. Phone Adapter & Vox \$1.50 ea. Recorders \$4.00 ea. Cal. Res. add tax. Mail order, VISA, M/C, COD's OK. Money Back Guarantee. Qty. disc. avail., Dealer Inquiries invited. Free data.

AMC SALES, Dept. A 9335 Lubec St., Box 928, Downey, CA (213) 90241 Phone 869-8519

CIRCLE 108 ON FREE INFORMATION CARD

STATE OF SOLID STATE



ROBERT F. SCOTT,
SEMICONDUCTOR EDITOR

Temperature transducer

THE MOST COMMONLY USED TEMPERATURE sensors and transducers include thermocouples, thermistors, temperature-dependent resistors, and biased diodes. The AD592 precision temperature transducer from Analog Devices provides output current that is proportional to absolute temperature; the IC is an ideal replacement or substitute for the types of transducers mentioned above. It is a two-terminal device that acts as a high-impedance temperature-dependent current source that yields $1 \mu\text{A}$ per degree Kelvin. It can operate from 4- to 30-volts DC.

The transducer can be used over a temperature range of -25°C to $+150^\circ\text{C}$ with typical calibration error of 2.0°C at 25°C . Over the 0°C to $+70^\circ\text{C}$ range, calibration error is 1.5°C . Typical applications include temperature measurement and control in automotive, home, and industrial environments, HVAC (Heating, Ventilating, and Air Conditioning) system monitoring, and temperature correction in precision electronics. A low parts-count per application makes the AD592 a cost-effective device because expensive linearization circuitry, precision voltage references, and cold-junction compensation are not required.

The design and operation of the AD592 temperature transducer comes from basic silicon transistor theory: When two identical silicon transistors are operated so that there is a constant ratio between their collector currents, the differences in their base-emitter voltages will be directly proportional to absolute temperature.

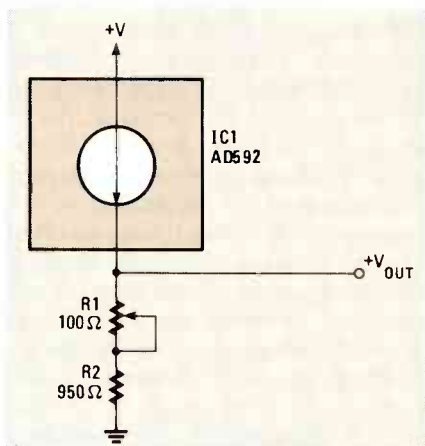

Fig. 1

In the AD592, the difference voltage is converted to a current that is proportional to absolute temperature by on-chip, low-temperature-coefficient thin-film resistors. The output current, when properly scaled, is equal to the absolute temperature (in degrees Kelvin) of the transducer.

During production, the on-IC scaling resistors are laser-trimmed to provide the $1 \mu\text{A}/^\circ\text{K}$ output with supply voltages ranging between $+3$ and $+30$ volts. The output current ranges from $248 \mu\text{A}$ at -25°C , to $298 \mu\text{A}$ at $+25^\circ\text{C}$, to $378 \mu\text{A}$ at $+105^\circ\text{C}$.

The transducer is packaged in a plastic TO-92 case and is available in three performance grades with maximum calibration errors ranging from 0.5°C to 2.5°C .

Figure 1 shows the basic circuit for using the AD592. Variable resistor R1 must be adjusted for the desired scale factor. To trim the circuit, a precisely known temperature must be measured by the transducer and the resistor ad-

justed for the desired output scale. For example, with the AD592 transducer at 0°C , adjust R1 so that $V_{\text{OUT}} = 0$. Doing so nulls the initial calibration error and shifts the output units from Kelvin to Celsius.

By using an op-amp, scale factor and calibration errors can be eliminated; consult the manufacturer's data sheet for the circuit. Another circuit shown in the data sheet allows output to be scaled in either degrees Celsius or Fahrenheit. The circuit uses an op-amp, and allows for easier calibration.

Further technical information on the AD592, and applications covering remote temperature multiplexing, a variable thermostat, and temperature-to-digital output can be found in the data sheet and in the *1986 Data Acquisition Databook Update and Selection Guide*. Contact an Analog Devices sales office in your area or write to **Analog Devices**, P. O. Box 280, Norwood, MA 20262.

Bridge motor driver

Sprague's new UDN-2998W, shown in Fig. 2, is a dual full-bridge motor driver that interfaces low-level logic to solenoids, brushless-DC and stepper motors. It can operate 50-volt inductive loads with continuous currents as high as two amps per bridge, and it can supply peak (start-up) current of as much as three amps per bridge. Control inputs are compatible with TTL, DTL, and five-volt CMOS logic.

The new device differs from similar motor drivers in several respects:

- Eight power diodes (four per

bridge) are included per IC. Those diodes, which are essential in motor-drive applications, are not provided on-IC by most other driver manufacturers.

- The 12-pin single-in-line power-tab package can dissipate 5.2 watts at +25°C—nearly 50% more than the 3.5 watts competitive devices can dissipate.

- An internal regulator allows operation from a single voltage power supply. Similar devices require an additional 5-volt supply.

- An internally generated turn-on delay prevents power-consuming, heat-producing crossover currents that would otherwise develop when switching phase (changing current direction).

Protection features include thermal-shutdown circuitry, crossover-current delays, and flyback and ground-clamp diodes. For PWM (Pulse Width Modulation) control, an OUTPUT ENABLE pin is provided for each bridge. Sink-driver emitters pins are brought out for connection to external current-sensing resistors.

The UDN-2998W costs \$4.16 each in 100-piece lots. For detailed information, request Data Sheet 29319.6 from Technical Literature Service, **Sprague Electric Co.**, 4 Hampden Road, P. O. Box 9102, Mansfield, MA 02048-9102

Quad auto-zero op-amp

Teledyne Semiconductor's new TSC914 is the first complete chopper-stabilized monolithic quad op-amp. Chopper-stabilized auto-zero amplifiers offer low offset voltage and drift by periodically sampling offset error, storing a correction voltage on a capacitor, and using that voltage to compensate for offset voltage and drift.

Earlier chopper-stabilized amplifiers have been packaged one to an IC, and earlier quad packages have been bipolar or low-performance CMOS types, neither of which can take advantage of chopper technology.

Unlike earlier chopper-stabilized op-amps, the TSC914's architecture makes possible the use of storage capacitors small enough to be included in the IC. The advanced chopper circuitry nulls offset voltage over time and with variations in temperature. Offset

voltage is 15 μ V maximum, drift is held to 0.15 μ V/°C, and supply current is 850 μ A maximum. Offset voltage is five times lower than the typical quad op-amp; offset voltage drift is eight times lower.

The TSC914's pinout matches that of the LM324. It is a drop-in replacement for the LM348, the OP-11, and the TL274, with \pm 5-volt operation. The TSC914 is available in two performance and two package versions. For more information, contact **Teledyne Semiconductor**, 1300 Terra Bella Ave., Mountain View, CA 94039-7267.

New transistors

The 2N7056 and 2N7059, shown in Fig. 3, are the first in a new series of transistors from Siliconix that utilize the company's MOSPOWER-6 technology in the electrically isolated TO-218 package. Those *ISOWATT218* devices provide 4000-volt isolation between internal electrical points and the heatsink or other mounting surface.

The new devices are produced jointly by Siliconix and SGS Semiconductor and will be offered independently by both firms.

The 2N7059 has a 500-volt breakdown rating, maximum continuous current rating of 8 amps, and a maximum on resistance of 0.45 ohm. The 2N7056 is similarly rated at 200 volts, 19 amps, and 0.1 ohm. Each can dissipate 75 watts continuously without derating. The transistors cost \$3.95 each in 10,000-piece lots, and \$5.00 each in lots of 1000.

For additional information on those devices, contact **Siliconix Inc.**, 2201 Laurelwood Rd., Santa Clara, CA 95054.

Reference guide

Data Converters and Voltage References is a new short-form brochure outlining Ferranti Semiconductor's wide range of A/D and D/A converters, along with its line of precision voltage references. The 10-page guide gives key parameters for the company's A/D and D/A converters, digital voltmeters, and fixed voltage references. Send requests for the brochure to **Ferranti Semiconductors**, 87 Modular Ave., Commack, NY 11725. R-E



TUBES and IC's

FAST DELIVERY

LOWEST PRICES

call Toll Free (800) 221-5802

In-depth Inventory - Industrial & Receiving Tubes			
3-500Z	\$95.00	813	\$45.00
572-B	75.00	6LF6	8.26
811-A	15.00	6JS6C	7.46
6146-B	8.75	6CA7	6.91
8950	12.75	6MJ6	8.38
4CX250-B	85.00	8417	8.38
SG613	10.50	20LF6	8.26

CHEMTRONICS CHEMICALS

TUN-0-WASH-24 oz.	\$2.42
TUN-0-POWER	\$2.47
TUNER-RENU-16 oz.	\$2.65
FREEZE IT	\$1.35
FREEZE IT	\$1.89

Major Manufacturers Factory Boxed and Full line of
Sylvania ECG Replacement Semiconductors





Minimum order \$25.00 Allow \$3 UPS charge

TRANSELETRONIC INC.



Box R, 1365 39th Street, Brooklyn, NY 11218
Tel. 718-633-2800/Watts Line 800-221-5802
FAX # (718) 633-4375

CIRCLE 211 ON FREE INFORMATION CARD



**You Can Be
One Of The
20,000 Technicians
Certified BY ISCET**

The International Society Of Certified Electronics Technicians offers permanent certification by administering the CET exam with the FCC recognized communications option for \$20. A second exam on FCC regulations for a \$10 fee is required for a Radiotelephone License. Upon passing, technicians receive both a permanent Radiotelephone Operator Certificate and a CET Certificate issued by ISCET.

ISCET Offers License Renewal

ISCET has developed a program for registration of those who currently hold a valid Radiotelephone Operator License. By sending a completed application, a photocopy of your FCC License, and \$10 your license will be renewed with the assurance of a recognized national technicians association behind it.

For More Information Contact:
**ISCET 2708 W. Berry, Ft. Worth, TX
76109. (817) 921 - 9101**

ANTIQUÉ RADIOS

Inventors and inventions

MANY MEN HAVE CONTRIBUTED DIRECTLY to the advancement of radio. Some, like Edison and Marconi, are well-known, even by the general public; others, like Tesla and de Forest, are known mostly in the technical community. Still others are almost totally unknown, yet they left their indelible marks on radio. Amos E. Dolbear is one such person.

Antique of the month

Professor Dolbear (1837–1916) was born in Norwich, CT; he was involved in many fields of physics, and he wrote books on many of them. In the year 1882 Professor Dolbear demonstrated a wireless telephone system in London. A reproduction of his system is shown in Fig. 1; the transmitter is shown in Fig. 1-a, the receiver in Fig. 1-b.

In the transmitter, a battery is connected in series with a carbon

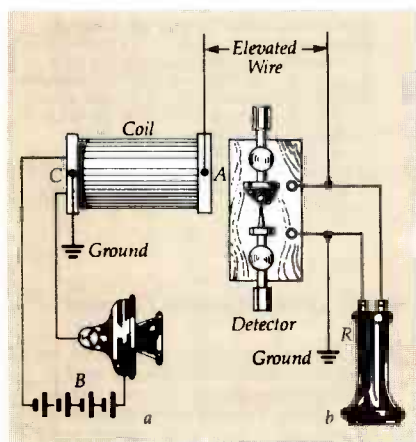

FIG. 1

mouthpiece and the primary winding of a coil. The secondary of the coil is connected to an antenna and to ground. In operation, the

diaphragm of the mouthpiece vibrates when you speak into it, and that causes changes in the resistance of the carbon, which thereby varies the current flowing through the coil. That current variation is passed on the transmitting antenna and then is picked up by the receiving antenna, which is connected to one side of the receiver. The other side of the receiver is grounded.

It's interesting to note that Professor Dolbear tried several schemes to increase transmission range. For example, he attached the antenna wires to kites, and also tried various schemes using pre-charged condensers (capacitors) raised to great heights.

Marconi

In the late 1800's a young man from Bologna, Italy was already at work in a little shack on the Southwest tip of England (in Cornwall). Guglielmo Marchese Marconi (1874–1937) was working on short-distance propagation.

In one early experiment, a group of experimenters including Marconi worked with a coherer tube (which we'll discuss momentarily). It was hoped that transmitters in Poldhu and Gibraltar would excite the coherer. When transmission began, lo and behold—the coherer responded. After some adjustment, it responded strongly. It was Gibraltar calling, and Marconi answered personally.

Of course, that was not the end of Marconi's career. Another emotional event happened on December 11, 1901, at Signal Hill, Newfoundland. A tall antenna stood atop the castle at Cabot tow-



RICHARD D. FITCH,
CONTRIBUTING EDITOR

er there; Marconi used that antenna to receive the first trans-Atlantic wireless telegraph message from Cornwall, England. By 1907 Marconi had established the trans-Atlantic wireless telegraph service for public use between the United States and the United Kingdom.

Marconi continued experimenting with wireless right into the 1930's. He received many awards and much recognition for his work, including a shared Nobel prize for physics in 1909.

He was successful because, among other things, he started at an early age and had adequate funding. His well-equipped yacht, *Elettra* (a former British mine sweeper), gave him a place to conduct many experiments. Part of the *Elettra* is preserved at an Italian museum near where Marconi lived. After he died in 1937, the yacht was sold and made some history of its own. Long before that, however, while anchored off Civitavecchia, Italy, the yacht was almost lost to a fire. Fortunately, the fire was in the engine room and not in the radio lab.

Marconi's floating lab had been the setting for many historic radio experiments, including early shortwave conversations from the Mediterranean to America and Australia. The yacht also figured in experimental wireless "beam" transmission, a system that concentrates radiated electricity in the form of a strong directional beam.

The coherer

In Marconi's wireless, the received electrical waves pass through a glass vial containing metal filings. The filings cling (or

cohere) to the inner plugs in the vial, thereby creating a path through which current can flow. A representation of the coherer appears in Fig. 2.

Marconi did not invent the coherer; a man named Branley did. Branley found that certain combinations of metallic flakes were affected by radio waves. Experiments showed that different combinations of flakes produce different resistances. After the wave passes, the coherer particles must be separated by jarring the tube.

Edison

Thomas Alva Edison (1847–1931) was a tireless and versatile inventor. He was born in Milan, Ohio, and spent his childhood years playing with a chemistry set. There

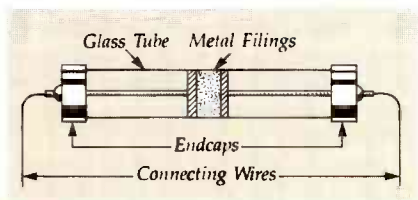

FIG. 2

seemed to be no end to his discoveries. Many of us in radio connect Edison with the "Edison effect," which was discovered in 1883 in conjunction with his work on the incandescent lamp.

The Edison effect describes what happens inside a charged glass bulb. Edison noted that carbon particles moved toward the positive end; later it was understood that electrons were being emitted by the heated filament.

One of the ironies of history is that when Edison discovered his effect, there was no thought that it might make something useful—such as a diode, which Fleming did not invent until some twenty years had passed. According to some authorities, Edison himself sent information about the effect to various experimenters who might want to work with it. That explains why working on the Edison effect was so popular.

Besides Edison's obvious accomplishments (including the incandescent light bulb and multiplex telegraphy), one pet project consumed much of his time: the phonograph. The book *From Tin*

Foil to Stereo by Oliver Read and Walter Welch, published by Howard W. Sams, documents many interesting facets of the history of the phonograph.

Tesla

Like Edison, many early inventors worked with electricity, but were not involved with wireless. Yugoslavian-born experimenter Nikola Tesla (1856–1943) was one such inventor. Tesla emigrated to the U. S. at the age of 28, after being educated in Paris and Prague, and working in Hungary.

Tesla went to work for Edison in Edison's New Jersey laboratory; later Tesla opened his own lab. He is credited with many electrical inventions, especially those related to AC power distribution. His most famous invention, probably, is the Tesla Coil, an air-core transformer used to create very high voltages. But Tesla was also one of the first to recognize how important the tuned circuit is for long-distance radio transmission.

De Forest

Another American inventor, Lee de Forest (1873–1961), was born in Council Bluffs, Iowa. De Forest was educated at Yale University, and fought in the Spanish-American war. Like Edison, he was another tireless inventor. He obtained more than 300 patents, the most famous of which is the audion, the first amplifying vacuum tube. In early experiments, de Forest used a gas flame to heat the tube so that electrons would be emitted. He was also first to broadcast phonograph records over the wireless in 1907.

In 1906 de Forest discovered that an element placed between the cathode and the plate of a tube could be used to control electron flow. The grid (so-called because it resembled a stove grid) was the link between the crude communications that preceded it and our modern systems. Early solid grids trapped all of the electrons going to the plate; de Forest's idea was to use a fine wire mesh. On December 30, 1915, a practical triode was demonstrated. A government radio station in Arlington, Virginia sent telephone messages via the airwaves to Hawaii and France. R-E

Be an FCC LICENSED ELECTRONIC TECHNICIAN!

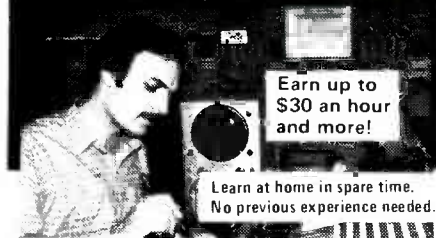

No costly school. No commuting to class. The Original Home-Study course prepares you for the "FCC Commercial Radiotelephone License". This valuable license is your "ticket" to thousands of exciting jobs in Communications, Radio-TV, Microwave, Computers, Radar, Avionics and more! You don't need a college degree to qualify, but you do need an FCC License.

No Need to Quit Your Job or Go To School This proven course is easy, fast and low cost! **GUARANTEED PASS** — You get your FCC License or money refunded. **Send for FREE facts now. MAIL COUPON TODAY!**

COMMAND PRODUCTIONS

FCC LICENSE TRAINING, Dept 90
P.O. Box 2223, San Francisco, CA 94126

Please rush FREE details immediately!

NAME _____
ADDRESS _____
CITY _____ STATE _____ ZIP _____



TRAIN TODAY for an exciting money-making career in:
• Electronics Engineering Technology
• Computer Programming • Data Processing
• Information Systems • Drafting with C.A.D.

NATIONAL EDUCATION CENTERS has 50 campuses nationwide, so there's a Center near you. In as little as 9 months, you can train for a high-tech career, in a state-of-the-art environment.

ASK ABOUT OUR BENEFITS! Day and Evening classes, Financial Aid to those who qualify, and Job Placement Assistance! Many of our schools are Approved for Veterans Training, and all are accredited members of either N.A.T.T.S. or A.I.C.S.

SO DON'T DELAY! For information send in the handy coupon today. Or call 7 days a week —

TOLL FREE:
1-800-722-7337
Ext. 210

National Education Centers

National Education Centers — Headquarters
1732 Reynolds • Irvine, CA 92714

The program I am interested in is:
Year of High School Graduation or G.E.D. _____

NAME: _____

ADDRESS: _____

CITY/STATE/ZIP: _____

PHONE: _____ RE-387

PIEZOELECTRIC FILM

continued from page 58

It is also simple to make a speaker using the film. Use a cardboard mailing tube as a form. Wrap the tube in a layer of lightweight foam. Then wrap the film around the tube/foam. Secure the ends of the film with ordinary cellophane tape. Be sure not to overlap the ends of the film or you will short out your "speaker." Connect the film to a signal source and listen. What you will hear is the higher audio frequencies of the signal.

The film will also respond, of course, to direct mechanical pressure. That means that the film can be used for applications ranging from a simple touch plate to impact monitors to tactile sensors for robots (R-E Robot builders take note!). PVDF can withstand impacts of up to several hundred G's without losing its piezoelectric characteristics.

The circuit in Fig. 3 shows how the film could be used in a touch-plate circuit. Tapping the film will cause the LED to light. For best results, mount the film in such a way that there is sufficient clearance for the film to flex. Perhaps the best approach would be to mount the film on a pair of 1/4-inch plastic spacers using ordinary contact cement.

As mentioned, in addition to its piezoelectric properties, PVDF is also pyroelectric. If the temperature of the film is raised, a voltage is produced. As the film cools, voltage reduces linearly. Note that at temperatures greater than 50°C, the pyroelectric activity is permanently reduced. At temperatures greater than 120°C, the film's piezoelectric properties are permanently impaired.

To demonstrate the film's pyroelectric properties, connect the film directly to the input of a high-impedance voltmeter or oscilloscope. Breathe on the film, and watch the response. For a more dramatic response, try shining a desk lamp on the film, or waving a lit cigarette in front of the film. PVDF is so sensitive that it can be used to detect the body heat of a person from as far as 50 feet away.

Applications

PVDF applications under investigation or showing potential include:

- a disposable blood-pressure cuff
- tone generators
- acoustic pickups for musical instruments
- engine noise/vibration sensors
- intrusion-detection systems
- signature-verification systems
- fluid-flow monitors
- and many, many others

Other applications are sure to be developed because PVDF film's use is limited only by human imagination. R-E

SEMICONDUCTORS

continued from page 72

The MOSFET

Developed after the FET, the MOSFET operates somewhat differently. Figure 6 shows the construction of an N-channel MOSFET. Fabrication begins with a slab of high-resistance P-type substrate. Two separate low-resistance N-type regions, called wells, are diffused into the substrate. Those islands represent the source and the drain. Next, a thin, high-resistance N-type region is created between the two wells.

Then a very thin layer of insulating metal oxide is deposited over the N channel separating the source and drain. On top of that layer is placed a metal contact, which becomes the gate of the transistor. Connections are then made to the drain and the source.

In operation, current flows between the source and the drain through the N channel. By applying a voltage to the gate, however, an electric field is created; it forces electrons to travel through the narrow part of the channel. As with the JFET, the field decreases the cross-sectional area of the path and increases its apparent resistance. That resistance decreases current flow in a manner that is proportional to the gate voltage. As gate voltage increases, eventually the electric field prevents the flow of electrons altogether.

That description applies to the depletion-mode MOSFET. However, if we replace the N channel with a high-resistance P-type semiconductor, we have an enhancement-mode MOSFET. The enhancement MOSFET requires an electric field in its channel before it can conduct current. The stronger the enhancement field, the larger the path's cross-sectional area, and the lower its effective resistance.

MOSFET testing

Although they are similar in many ways, a MOSFET cannot be treated like a JFET. In addition, not all tests performed on the JFET are applicable to the MOSFET.

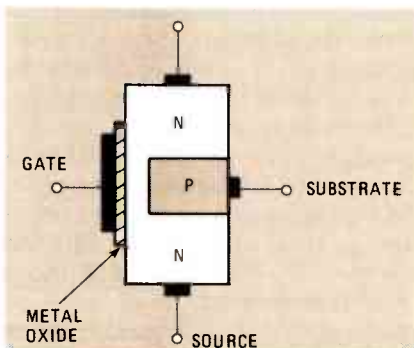

FIG. 6—MOSFET CONSTRUCTION is shown here. The oxide layer is usually silicon dioxide.

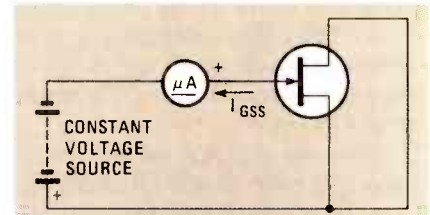

FIG. 7—MEASURE I_{GSS} OF A MOSFET only if it has protective input diodes!

Gate breakdown voltage (V_{GSS}), for example, is not a measurable quantity. The breakdown voltage of a MOSFET gate is determined by the thickness and the purity of the insulating layer. The thicker the layer, the more voltage it can withstand.

To properly measure a MOSFET's V_{GSS} , you must apply a gradually increasing gate voltage until the insulator fails. Unfortunately, when it does, the transistor becomes useless.

Manufacturers "measure" V_{GSS} by measuring the thickness of the insulating layer with sophisticated equipment, and then comparing the results to empirically derived failure curves. Tests of that type, however, are beyond the means of the experimenter.

Many MOSFETs, though, contain a diode in the gate junction that is intended to dissipate high-voltage spikes caused by static discharge. Those spikes could damage the transistor easily. The breakdown voltage of the protection diode is just below that of the gate.

So, if you are testing a protected-input MOSFET, you can measure V_{GSS} without damaging the transistor by simply applying enough voltage across the gate to force the diode into avalanche. Be sure to limit the current flow with a constant-current source so as not to destroy the protection diode. Now measure the voltage across the diode; it is close to the actual V_{GSS} .

Leakage current

Each breakdown-voltage parameter has a related leakage-current parameter. For example, I_{GSS} (Gate-to-Source leakage current with drain and source Shorted) is the term for input leakage of a FET; it is related to V_{GSS} .

Gate leakage is a very important characteristic of an FET because it is inversely related to input resistance. When leakage current is high, input resistance is low, and when input current is low, input resistance is high.

In many cases, you can measure leakage current with equipment similar to that used with bipolar transistors. A test circuit for measuring I_{GSS} , for instance, is shown in Fig. 7. I_{GSS} is normally measured at the V_{DSS} potential listed on the data sheet.

When measuring the I_{GSS} of a MOSFET, the measurement should be

continued on page 92

ASK R-E

continued from page 14

BOOSTER FOR SCANNER

I have two scanners and an all-band scanner antenna mounted about 75 feet above ground. I monitor local fire-department transmissions on 153.83 and 154.43 MHz. I have trouble receiving the transmissions from mobile units. Do you know of an appropriate booster?—P. K., Detroit, MI.

An inexpensive TV booster should work nicely. We recommend an inexpensive one, because some deluxe models have built-in traps and filters to eliminate all signals except those at TV frequencies. I have a bottom-of-the-line mast-mounted TV booster that works fine with my scanner. Don't expect 100% reception all the time; there will be times when a mobile unit may be in a dead spot. A booster that delivers 10 dB of gain and covers TV channels 2 through 13, FM, and mid- and superband cable channels is available for about \$10. R-E

Try the

**Radio
Electronics**

bulletin board
system

(RE-BBS)
516-293-2283

The more you use it the
more useful it becomes.

We support 300 and 1200
baud operation.

Parameters: 8N1 (8 data
bits, no parity, 1 stop bit) or
7E1 (7 data bits, even parity,
1 stop bit).

Add yourself to our user files
to increase your access.

Communicate with other R-E
readers.

Leave your comments on R-E
with the SYSOP.

RE-BBS
516-293-2283

New Precision Duster Ultra-Filtered To <0.2 Microns



ULTRAJET... a new generation high-purity duster with powerful jet action. A compact, portable tool for safe, non-abrasive cleaning of sensitive video heads and tape transport mechanisms, perfect for freeing oxide build-up and dust. Also useful for general purpose cleaning of all electronic equipment, optics, camera lenses and photographic film. Ultrajet system comes complete with surgical-grade chrome trigger valve, 12 oz. refill can and 36-inch extension hose. Refills available in 12 oz. and economical 20 oz. sizes. Send for more information today.

 **Chemtronics**
681 Old Willets Path
Hauppauge, NY 11788
800-645-5244
In NY 516-582-3322

CIRCLE 54 ON FREE INFORMATION CARD

HAMEG

Instruments

high quality at low cost

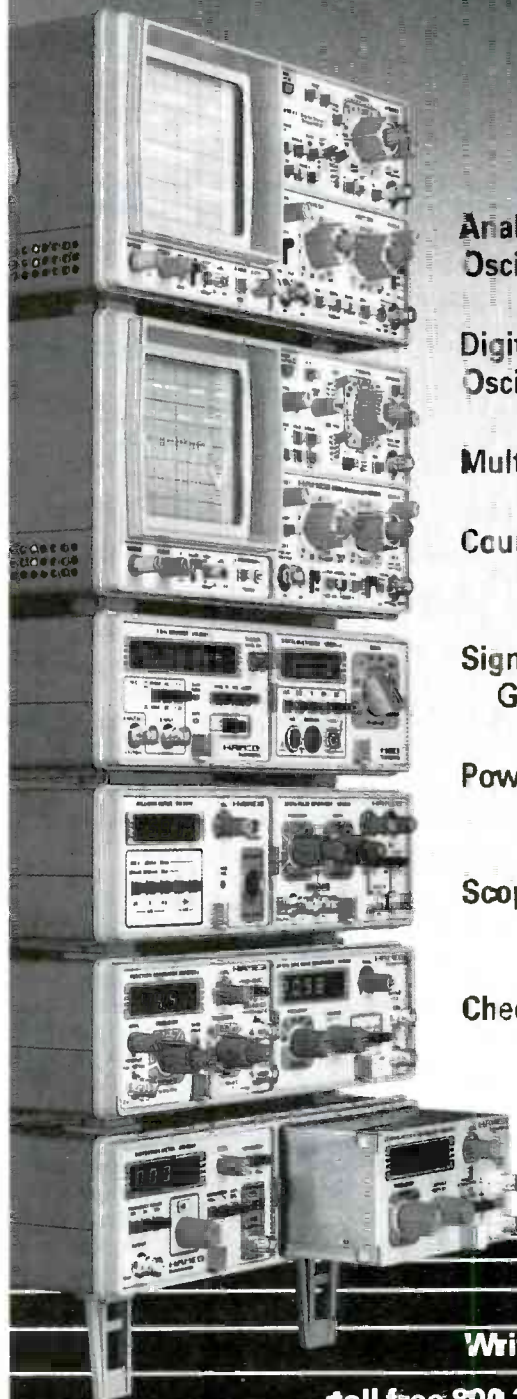

Analog
Oscilloscopes

Digital
Oscilloscopes

Multimeters

Counter
Timers

Signal
Generators

Power
Supplies

Scope
Testers

Checkpoint
Testers

Write or call

toll free 800.247.1241

HAMEG, INC.

88-90 Harbor Road · Port Washington N.Y. 11050
Phone (516) 883.3837 TWX (510) 223.0889

CIRCLE 62 ON FREE INFORMATION CARD

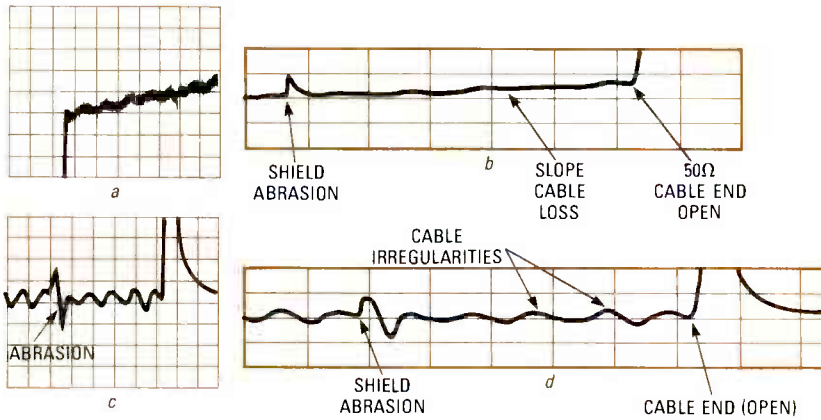

FIG. 13—CRT AND CHART-RECORDER outputs of the test assembly shown in Fig. 12 are illustrated here. Only the 150-foot section was measured; 1502 outputs are shown at *a* and *b*, and 1503 outputs at *c* and *d*.

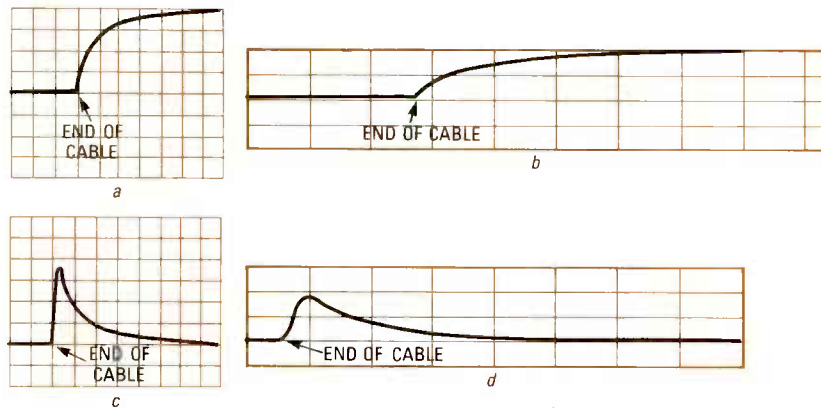

FIG. 14—AFTER CONNECTING THE 1000-FOOT TEST SECTION, outputs were again recorded. As before, 1502 outputs are shown at *a* and *b*, and 1503 outputs at *c* and *d*.

useful for measuring the signature of an antenna and its components. That type of comparison provides a quick yet accurate go/no-go indication.

Figure 10 shows an L-band aircraft antenna, and Fig. 11 shows its signature. The signature will vary depending on the length of the cable used, so the same length of cable should be used when testing a group of antennas. Remember that pulse risetime decreases on a long cable as a function of the length squared. Generally, it is best to use as short a cable as possible when using a TDR to test an antenna. If the antenna is to be tested with a cable in excess of 100 feet, or if the antenna resides in a strong RF environment, then a high-noise-immunity TDR (like the 1503) would be a good choice. Use of an isolation network will improve noise immunity further.

TDR coax signatures

Figure 12 shows a cable assembly composed of a 150-foot section of 50-ohm RG58C/U cable connected to a 1000-foot section of 75-ohm Belden 8281. An abrasion is present at point A, a 50/75-ohm interface at point B, and a connector at point C. The assembly ends at point D; it is not terminated.

First we disconnected the 150-foot section of RG58C/U and measured it with a 1502 and a 1503.

Figure 13-*a* shows a reproduction of the 1502's CRT, and Fig. 13-*b* shows the chart-recorder output. Note that the CRT trace shows little more than the general upward slope recorded by the chart recorder, which itself clearly displays both the abrasion at point A and the open circuit at point B. Figures 13-*c* and 13-*d* show the same setup as recorded by the 1503. Note that the chart recorder in effect gives a much-expanded view of the X axis, for better resolution.

Next, we reconnected point B (in Fig. 12) and readjusted both TDR's to view the signature at point D. Note how the curves shown in each section of Fig. 14 resemble each other closely in their depiction of the discontinuity at point D.

Conclusion

Time-domain reflectometry is a valuable technique, one that can significantly decrease the amount of time spent troubleshooting various types of faults in coax, twisted-pair, and other cables. We hope that this article has given you an understanding of the basic principles involved.

R-E

done in both the forward and the reverse directions, unless a protection diode is incorporated into the device. MOSFET's that have no protection diode should read the same in both directions. Because the insulating properties of the metal-oxide coating are far superior to those of a reverse-biased junction, the value of I_{GSS} in a MOSFET is considerably less than that of an FET.

Another current parameter often specified for FET's and MOSFET's is I_{DSS} , the drain-to-source leakage current with the gate shorted to the source. That test is often used to determine the amount of current flow in the constant-current mode.

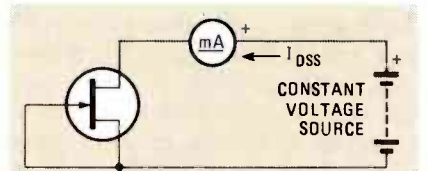

FIG. 8—MEASURE I_{DSS} by applying the manufacturer's stated value of V_{DSS} and reading the milli-ammeter.

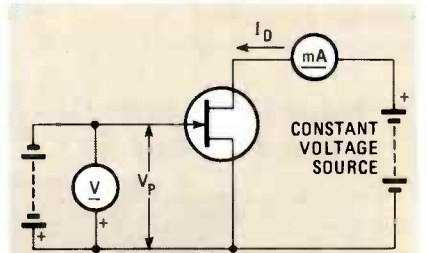

FIG. 9—MEASURE V_P by gradually increasing the gate voltage while monitoring I_D . When current stops increasing, V_P has been reached.

The circuit for measuring I_{DSS} is shown in Fig. 8. The drain voltage is maintained at the V_{DSS} value listed on the data sheet; then current is measured.

A circuit that combines both voltage and current measurements is shown in Fig. 9; that circuit is used to measure V_P . With no voltage on the gate, a normal depletion-mode transistor conducts current from source to drain. In order to halt that flow, a voltage must be applied to the gate. As stated earlier, the point at which source-to-drain current ceases to flow is called the pinchoff voltage. Sometimes you see that value listed as the cut-off voltage, which is a lingering term from our vacuum-tube past.

To measure V_P , gate voltage is gradually increased while drain current is monitored. When a change in gate voltage no longer produces a change in drain current, pinchoff voltage has been achieved. Ideally, current will drop to zero, but

continued on page 124

COMPUTER DIGEST

VOL. 4 NO. 3 MAR. 1987

A NEW KIND OF MAGAZINE FOR ELECTRONICS PROFESSIONALS

THE MC 68000

An in-depth look at a 68000-based computer you can build



BUILD A CLOCK BOARD FOR YOUR PC

Your computer will never forget what time it is!

THE PC-SIG LIBRARY

550 megabytes on a compact disc

A
GERNSBACK
PUBLICATION

CONTENTS

MARCH 1987

Vol. 4 No. 3

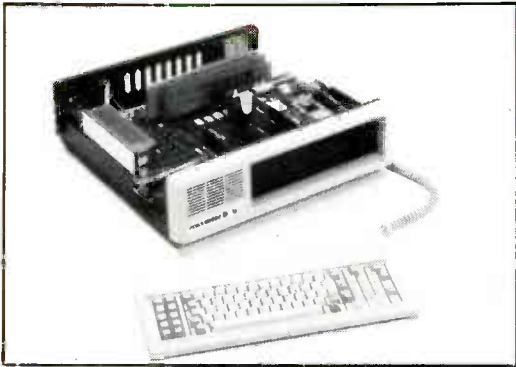

101 BUILD THE MC 68000

A powerful computer that's based on Motorola's 68000 microprocessor.

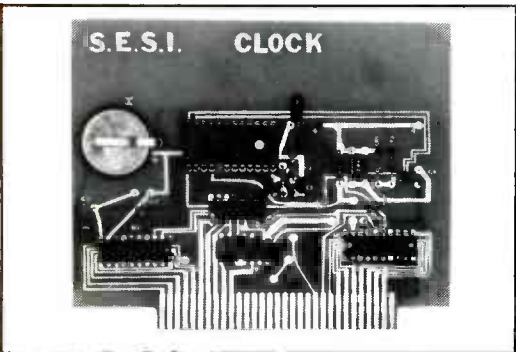

97 BUILD A CLOCK BOARD FOR YOUR PC

Now your computer will never forget what time it is.

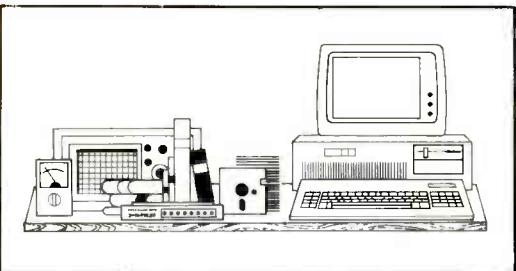

93 EDITOR'S WORKBENCH

Hardware: Increasing your PC's memory
Software: The PC-SIG Library
Etc.: New computer products

COMPUTER DIGEST

Larry Steckler,
EHF, CET: publisher & editor in chief

Art Kleiman,
editorial director

Brian C. Fenton,
managing editor

Byron G. Wels,
editor

Jeff Holtzman
technical editor

Carl Laron,
associate editor

Robert A. Young,
assistant editor

Teri Scaduto
editorial assistant

Ruby M. Yee,
production director

Karen Tucker,
production advertising

Robert A. W. Lowndes,
production associate

Geoffrey S. Weil,
production assistant

Andre Duzant,
technical illustrator

Jacqueline P. Cheeseboro
circulation director

Arline R. Fishman,
advertising director

ComputerDigest
Gernsback Publications, Inc.

ADVERTISING SALES 516-293-3000

Larry Steckler
Publisher

NATIONAL SALES

Joe Shere
1507 Bonnie Doone Terrace
Corona Del Mar, CA 92625
714-760-8967

EDITOR'S WORK- BENCH

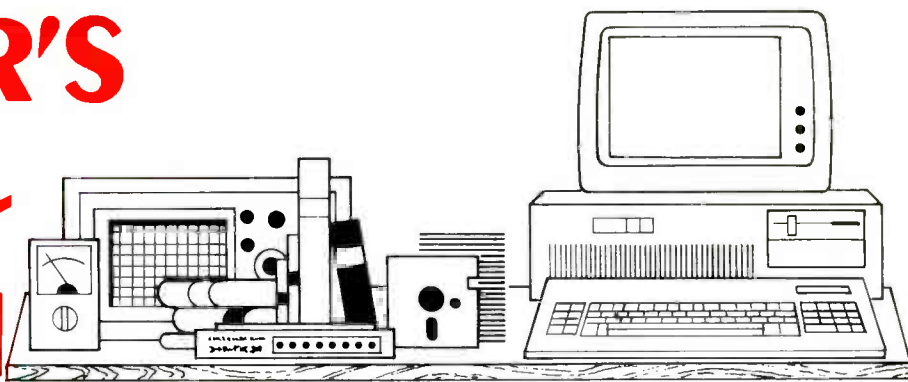

Welcome to the Editor's Workbench. In case you haven't noticed, **Computer Digest** is changing. How? We're going to be following the PC market much closer than we have been. We're going to review the latest hardware and software. And we're going to provide exciting articles on both construction and theory. We have a bias—IBM and CP/M systems—but if you're interested in others, let us know. When we find significant interest in a product or topic, we'll get on the manufacturers and authors for samples and articles. And don't worry—we're not abandoning C-64's, ZX-81's, etc. We'll publish quality articles on those computers, too.

This month in our Hardware section we're going to look at several excellent expansion boards for the IBM-PC. In the Software section, we'll examine the PC-SIG library on CD-ROM (which contains the equivalent of more than 600 floppy disks!). And be sure to take a look at the Etc. section—Zenith has an interesting new computer. And there's a Hayes-compatible modem that runs on a nine-volt battery and is smaller than a pack of playing cards.



MEMORY-EXPANSION AND MORE FROM ORCHID, APPARAT, AND VERICOMP

It wasn't long ago—perhaps two years—that a "fully-loaded" expansion board (with a serial port, a parallel port, a game adapter, a battery-powered clock/calendar, and as much as 384K of RAM) cost half a kilobuck, or more. These days, for the same cash

outlay, or less, you can get multi-function expansion cards that provide all the above, plus "productivity software," plus a megabyte or two of RAM.

More than a megabyte? How can an 8088 access that much memory? Besides, MS-DOS (and IBM's PC-DOS) can't access more than 640K of RAM—can it?

It can, and does. About a year and a half ago, Lotus Corporation (of spreadsheet fame) got together with Intel (of microprocessor and memory fame) and Microsoft (of operating-system and programming-language fame) and settled on an "interim" solution to the never-enough-memory problem suffered by all computer users. The big three came up with a hardware/software scheme for bank-switching up to eight megabytes of memory into a single, otherwise-unused 64K block of the 8088's address space. That type of expanded memory is variously called LIM (for Lotus, Intel, and Microsoft) or EMS (for Expanded Memory Specification). Whatever you call it, it can be tremendously useful—and not just for users of large spreadsheets. We'll discuss the technicalities of how it works in a future issue; for now, let's show how it can be put to use.

What's it good for? The same things that normal memory is useful for. You can, of course, use it with Lotus 123 to create larger spreadsheets. You can also use it to create RAM disks and printer buffers. The advantage of the RAM disk is that oft-used software can be downloaded from relatively slow disks (hard or soft) into EMS memory where it's available for instant use. And a printer buffer can store huge amounts of printer output in RAM and feed it the printer at its relatively slow rate. A modest printer buffer (64K) and a RAM disk can save you much time and aggravation.

In addition, more and more programs are able to take advantage of EMS memory for data and program storage, thereby allowing you more DOS memory (under 640K) for memory-resident programs and the like. In the memory-resident mode, for example, the Ready! outline processor leaves only a

small program kernel in DOS memory, and it swaps the main program code and your data in and out of EMS memory as required. AutoCAD 2.5 uses EMS memory for storage of drawing vectors, thereby allowing much faster screen re-draws and the like. Again, the time you save can be enormous.

By now you're convinced (or should be) of the value of EMS memory, but you might be wondering whether you can get a chunk of it without mortgaging your grandmother. The answer is yes—definitely! you can now get a fully expanded multifunction board for what a partially expanded board cost just a few years ago—or even less. If you need only memory and no ports, etc., you're in luck, too.

Orchid's Conquest

Orchid Technology (47790 Westinghouse Drive, Fremont, CA 94539) has a high-quality line of turbo boards, enhanced display adapters, and multifunction boards. (See, for example, our review of the *PCturbo 286e* in the February issue.) Their *Conquest* multifunction board is a high-quality example of the type of product now available.

The *Conquest* includes a serial port, a parallel port, and a clock/calendar. No game adapter is included. In addition, the board can hold one megabyte of memory (or two megabytes, using an optional daughterboard). The memory can be used as DOS RAM, EMS RAM, or both. An additional daughterboard is available for interfacing to Orchid's *PCnet* local-area-network system.

The board itself is full-length, and it occupies a single slot. The serial-port connector is attached to the mounting bracket; the parallel-port connector must be installed in a separate rear-panel slot, if it is used.

In addition, *Conquest* includes software for print spooling, RAM disk, disk caching, and a special memory-resident time/date display, with alarm. Disk caching is a special software technique for speeding up operation of hard- and floppy-disk drives.

Installing some Orchid boards is not a pleasant task, mainly because Orchid uses automated installation programs that modify your AUTOEXEC.BAT and CONFIG.SYS files in ways that may be incompatible with other software. And the manual may or may not spell out what the installation program does. However, by reading the manual carefully, you may be able to get an Orchid board running by doing the installation by hand. But if you're not intimately familiar with IBM system files, interrupts, and the like, you're likely to have trouble doing it that way.

Installing the *Conquest* is somewhat easier than installing other Orchid boards. To install it, you run a program that shows how to set the on-board jumpers. The jumpers show the *Conquest* whether some RAM is to be used for DOS or all for EMS, the 64K bank through which the EMS memory may be accessed, whether the ports and clock are enabled, and, if so, through which DOS communications channels (COM1 or COM2, LPT1 or LPT2), whether the ports may use interrupts, and, if so, which DOS RAM can only be filled from the 256K point.

After running the first set-up program, you install the board in your PC, and then run a second installation program. It allows you to allocate EMS memory for the RAM disk, the print spooler, etc. Orchid's memory-allocation scheme is a bit unusual in that the print spooler, if used, must go in DOS memory; the RAM disk and disk cache can go in either DOS or EMS memory. After running the program, your AUTOEXEC.BAT and CONFIG.SYS files have been modified. You can re-run the program at any time, but you must use the old versions of those system files (which have been renamed with the extension .OLD).

The manual and installation procedure give you few hints about how much memory to allocate to which functions. If you're unsure, you can experiment without hurting anything. A knowledgeable friend or someone from a local computer club may be able to help, as may your dealer. But don't look to Orchid for support—it's hard to get through to their technical-support department, and they don't return telephone calls.

When you do settle on the right configuration, you'll understand what the EMS fuss is about. The *Conquest* currently lists for \$395 with no RAM, \$445 with 256K, \$625 with one megabyte, and \$865 with two megabytes; at press time it could be found discounted for about \$220, without RAM. Adding a megabyte costs an additional \$100. For even more memory (up to the eight-megabyte EMS maximum), multiple *Conquest's* can be installed in one system.

The Apparat *Limbo II*

Apparat, Inc. (6801 South Dayton, Englewood, CO 80112) sells a pair of boards for expanding the IBM-PC. One, the *Limbo*, contains only a clock/calendar and as much

as two megabytes of memory; the other, the *Limbo II*, contains as much as 1.25 megabytes of memory, the clock/calendar, serial and parallel ports, and a game adapter. We evaluated the *Limbo II*.

The *Limbo II* is somewhat more versatile than the *Conquest* because its on-board memory can be used to fill DOS memory from a number of base locations (64K, 128K, 256K, 320K, 384K, 512K, and 576K).

A separate DIP switch allows you to enable and disable the clock, ports, and game adapter. Other jumpers and DIP switches allow you to set the RAM window, the I/O ports used by the card, and the serial and parallel port designations (COM1, COM2, and LPT1-LPT3). The board has connectors on the mounting bracket for the serial and game ports; the parallel-port connector must be attached through a separate cable to a vacant portion of the rear panel. You can connect an optional reset switch to a two-pin header block; especially useful to programmers, the switch works in conjunction with an optional RAM-resident program to provide a non-power-down reset for the time when a program goes astray.

Apparat's manual is not as well produced as Orchid's, but it is much easier to follow. Switch settings are shown clearly, the necessary changes to the system files are outlined clearly, and possible problems are anticipated. An appendix gives examples of using each of the supplied programs (the system drivers, several RAM-disk programs, several print spoolers, and several others.) No disk-cache program is supplied.

The board and supplied software worked with no hitches. With 256K of RAM the *Limbo II* lists for \$299; with 1.25 megabytes of RAM, it lists for \$499. The *Limbo* lists for \$199 with 64K, or \$549 with two megabytes of RAM.

Vericomp's *Breakthru/PC*

The *Breakthru/PC* from Vericomp (8825 Aero Drive, Suite 210, San Diego, CA 92123) is a full-length memory-only board; its RAM may be used only for EMS, not DOS, memory. However, it packs a wallop of two megabytes on a card that costs just \$398 with two megabytes of RAM, or \$150 with no RAM. It comes with RAM-disk, print-spooler, and disk-cache software, as well as a memory-test program. Its manual is sparse but clear.

Conclusions

Whether you're new to the world of the IBM-PC or an old hat, there's an economical way to expand your PC. A memory-only board like the *Breakthru/PC*, or even the *Limbo*, with its clock/calendar, may be the best solution if you already have a fully loaded PC. But if you're starting from scratch, or need extra ports, both the *Conquest* and the *Limbo II* are good buys. The *Conquest* has slightly better software, but the *Limbo II* is more versatile in its ability to fill DOS memory.

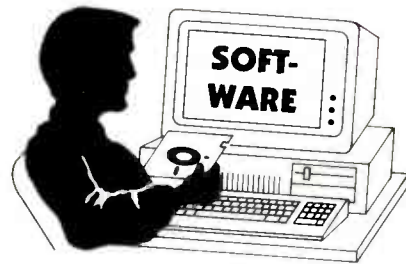

10,000 PUBLIC-DOMAIN AND USER-SUPPORTED PROGRAMS ON DISK.

For several years a company called PC-SIG (1030D East Duane Avenue, Sunnyvale, CA 94086) has been marketing public-domain and user-supported software for the IBM-PC. As of this writing, their carefully selected library consists of more than 600 double-sided double-density diskettes—and more are being added all the time.

Each disk sells for \$6; printed directories and a monthly newsletter are also available. Almost every conceivable type of program is included—everything from word processors and database managers to games to tutorials on various programming languages (BASIC, C, Pascal) to DOS tools to databases on structural-steel and magazine articles—and much more.

We thought it was time we took a look at the PC-SIG library, but that presented us with a problem. Normally we like to examine a single program, take it through its paces, find out its strong points, its weaknesses, its lovable quirks, and, if necessary, its not-so-lovable quirks. That procedure serves us most of the time—but not always. The usual program comes on a single floppy disk, or, at most, two or three. But what could we do when the software comes on more than 600 diskettes?

PC-SIG has had the intelligence to make their library available on CD-ROM. That 550-megabyte hunk of plastic made it possible for us to examine the PC-SIG library and extract many program and data files, some of which we've posted on the RE-BBS. (See the inside cover of Computer Digest for information on the RE-BBS.)

To access the disk, of course, you need a CD-ROM player. (Hitachi, Sony and Philips drives are supported.) In addition, you need an IBM-PC or compatible running PC-DOS (or MS-DOS) 3.1 or higher. After following the installation procedure, the CD-ROM appears as the next available logical drive. On our test PC-XT, that was drive D.

The new logical drive has several sub-directories, as shown in Fig. 1. The DOD (directory on disk) subdirectory contains search-and-retrieval information; the INFO subdirectory contains information about PC-SIG; and the BIBLE subdirectory contains the entire contents of the Bible. The other subdirectories each lead to separate sub-directories for each PC-SIG diskette. So, for example, the path to disk 432 would be:

```

Volume in drive D is PC-SIG
Directory of D:\

DOD      (DIR)   9-14-86  2:20p
INFO     (DIR)   9-14-86  2:20p
1-100    (DIR)   9-14-86  2:20p
101-200  (DIR)   9-14-86  2:20p
201-300  (DIR)   9-14-86  2:20p
301-400  (DIR)   9-14-86  2:20p
401-500  (DIR)   9-14-86  2:20p
501-600  (DIR)   9-14-86  2:20p
601-700  (DIR)   9-14-86  2:20p
DIRLE   (DIR)   9-14-86  2:20p
      10 File(s) 43745280 bytes free

D>_

```

FIG. 1

```

      (DIR)   9-14-86  2:20p
      (DIR)   9-14-86  2:20p
README  2830  2-09-86  10:00p
1-100   UPP  123662  1-27-86  4:12p
101-200 UPP  117056  1-27-86  4:19p
DFIND   BAT   85  2-09-86  10:00p
INDEX   TXT  30330  8-06-86  9:30a
QAA     TXT  5114  5-05-86  1:59p
PC-SIG  TXT  500  5-05-86  1:59p
ORDER   TXT  4049  9-13-86  3:23p
URESP   TXT  195  2-09-86  10:00p
SUBMIT  TXT  1750  2-09-86  10:00p
GO      BAT   20  2-09-86  10:00p
MORE    COM  384  2-09-86  10:00p
201-300 UPP  134596  1-27-86  4:26p
301-400 UPP  192800  1-27-86  4:37p
601-700 UPP  4071  1-27-86  4:55p
401-500 UPP  176150  5-27-86  4:46p
501-600 UPP  159300  5-27-86  4:54p
FILELIST TXT  443996  5-13-86  3:13p
F       BAT   22  5-13-86  3:17p
      21 File(s) 43745280 bytes free

D>_

```

FIG. 2

401-500\DISK432. Note in the photo that, even with all the above stored on the CD-ROM, there are still more than 43 megabytes of space remaining!

Scanning through 600 diskettes might seem to be a tedious job, especially when you consider that each diskette contains ten or twenty files, and often more. However, each "disk" contains a directory file (in ASCII), and the DOD subdirectory (shown in Fig. 2) contains a number of master catalog files (*.UPP) that can be searched with the MS-DOS FIND.COM program, or with several programs supplied by PC-SIG.

So locating programs of interest is not quite the chore it seems at first. However, the PC-SIG library is not completely indexed (as is another recent CD-ROM release, *Groliers' Electronic Encyclopedia*, a review of which will appear in these pages soon), so a fair amount of manual drudgework may be necessary if you want something specific, or if you want to make a thorough search.

Some people are skeptical about the quality of public-domain software; they wonder whether it is really as good as commercial software, and they may wonder whether it contains a "Trojan horse," a purposely destructive program.

To begin with the latter, PC-SIG checks all programs to make sure that no Trojan horses are distributed.

As for program quality, it varies enormously, but there is no doubt that the best

programs in the PC-SIG library are as good as or even better than their commercial counterparts. It's hard to provide examples because, with a library of perhaps 10,000 programs, choosing examples is hard. However, we will mention two programs, both of which we use every day, that have become part of our MS-DOS toolkit.

Outline processor

The first is called PC-OUTLINE. (See Fig. 3.) As the name suggests, it is an outline program. It features drop-down menus, a built-in keyboard macro processor, the ability to open nine different files at once, each in a window whose size and location can be set by the user, extensive document-formatting commands, the ability to remain RAM-resident, and in that mode to import and export text directly to a word-processing (or other) program. It can also print files, or save them in ASCII, WordStar, and "Structured" files. The latter is used to exchange files with other outline processors. Tutorial and other information is also included with the package.

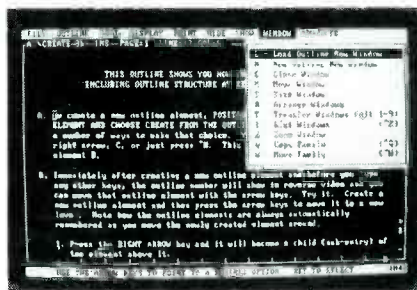

FIG. 3

In addition, PC-OUTLINE is fast—really fast—even on a standard 4.77-MHz PC clone. Its high speed proves that with proper programming techniques, a "lowly" 8088 really has enough power for word processing and similar applications—if the programmer knows what he (or she) is doing. If you've ever seen a program like Microsoft Word or Webster's New World Word Processor chugging along on a standard PC, you'll appreciate PC-OUTLINE's speed.

PC-OUTLINE is "user-supported," so the author expects you to send \$50 if you use it. At \$50, the program rivals or exceeds all the major commercially available outline processors. If you'd like to give PC-OUTLINE a try, order disk 480 from PC-SIG, or download PCO.ARC from the RE-BBS.

Command-line editor

Our other favorite program from the PC-SIG library is called CED, short for Command-line Editor. (We've also posted a copy of it on RE-BBS.) CED is a memory-resident program that, as its name suggests, allows you to edit commands at the DOS command line. To do so, you use keys in the cursor pad; the function keys no longer work. The left and right cursor keys move by the word; CNTL-Left moves left by the word; CNTL-Right moves right by the word;

Home takes you to the beginning of the line, and End takes you to the end; last, CNTL-End erases from the current position to the end of the line.

CED also keeps a stack of recently-performed DOS commands. Use the Up and Down arrow keys to move through the stack. When you find one you want, edit it in the usual fashion, and press Return when you're ready to execute it.

You may use CED to edit lines (and scroll through recently issued commands) anytime DOS is requesting input via function 0Ah. Other than the DOS command-line input routine, DEBUG and EDLIN also use 0Ah input.

You can also use CED to set up pseudo-DOS commands, or what CED calls a synonym. A synonym can be a single command (such as cd \letters\1987\march) callable by a short mnemonic ("M" for example).

A synonym can also be composed of several commands; CED thereby functions as a simple, but fast, batch processor. The advantage to using CED's batch synonym facility is that even short DOS batch files take up a great deal of space—4K on a standard PC-XT. With CED you can set up a single configuration file that contains your most-used DOS command strings arranged as CED synonyms and callable by a single letter, if desired. Letting CED do the work saves disk space and reduces clutter. And, because the disk is not accessed, synonym batch files run fast.

You can set the size of the command-stack buffer, the synonym buffer, and others. In addition, pressing CNTL-T (at the DOS prompt) will display buffer usage, defined synonyms, etc.

CED has a number of other advanced features, including the ability to add your own "internal" DOS commands, and complete documentation. It is available from PC-SIG on disk 535; we've posted a copy on the RE-BBS (download CED.ARC). The author of CED, Chris Dunford, has released the program into the public domain.

Conclusions

We started out talking about a CD-ROM that contains thousands of programs, and ended up focusing on several specific programs. Why? To show you that quality software really can be had for a reasonable price.

There are several methods of obtaining that software. Electronic bulletin boards across the country (including ours) carry those programs—you just have to find a BBS that has what you want, and then download it. For a large program, downloading can take some time, so the \$6 PC-SIG charges per disk may be less than your connect-time charges, especially if you're calling long distance.

The PC-SIG CD-ROM would be a good investment for a medium-to-large-sized computer club. The hardware cost could

be shared among the members, who would then have access to thousands and thousand of programs.

The PC-SIG CD-ROM sells for \$195; a CD-ROM player will set you back about \$1000 at the present time, although prices will continue to drop as competition heats up, and volume production increases.

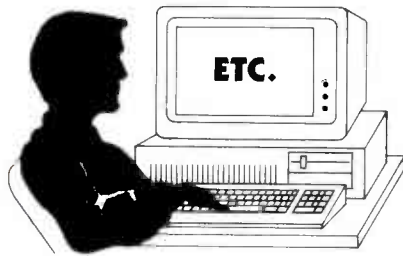

32-BIT MICROCOMPUTERS, the Z-386 model 80 and the Z-386 model 40, are part of Zenith's Z-300 Desktop PC series. Both models feature a 32-bit memory bus that operates at 16 MHz and offer the following speed enhancements:

Use of "memory paging" results in faster operation by accessing large blocks of memory—2000 and 4000 bytes of information—at once. That minimizes the use of wait states, which slow a PC's performance by inserting idle time that allows the microprocessor to wait for memory to "catch up."



CIRCLE 18 ON FREE INFORMATION CARD

"Burst-mode refresh" increases system speed by refreshing multiple rows of memory at once. That reduces the amount of time that the microprocessor is occupied in refresh functions, increasing the amount of available computing time.

An optional "cache controller" board stores frequently accessed data in extremely fast static RAM (Random Access Memory), thereby minimizing system wait states. The Z-386 PC's have three open 32-bit memory slots, allowing the use of the cache controller and memory cards.

The Z-386 model 80 (with an 80-mega-byte hard disk drive) is priced at \$7499.00;

the Z-386 model 40 (with 40 MB of storage) costs \$6499.00.—**Zenith Electronics Corporation**, 1000 Milwaukee Avenue, Glenview, IL 60025.

LASER PRINTER, the *Laserline 6*, features plug-in personality modules that enable up to three users to share a single printer. It also includes 15 resident, typeset-quality fonts and provides face-down, correct-order stacking of letter and legal paper.

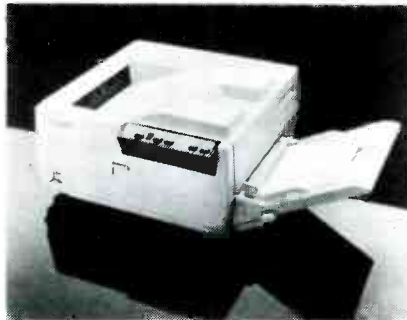

CIRCLE 19 ON FREE INFORMATION CARD

Three different personality modules are available. The basic personality module is a one-port HP *LaserJet*-compatible version; the advanced module is a one-port HP *LaserJet Plus* compatible module, and the multi-user module is a threeport HP *LaserJet Plus* compatible module.

The *Laserline 6* is fully compatible with a wide selection of applications software, including Microsoft Word, Wordstar 2000, and Lotus 1-2-3.

The *Laserline 6* has a suggested retail price of \$1995.00; the basic personality module has a list price of \$200, the advanced module, \$400, and the multi-user module, \$600.00.—**Okidata**, 532 Fellowship Road, Mt. Laurel, NJ 08054.

CD-ROM DRIVE, the model *CDR-2500S*, is a stand-alone version of Hitachi's built-in model, which is equipped with cable and interface board to connect to IBM PC's.

The model *CDR-2500* is designed to be incorporated into a personal computer, while the earlier models, the *CDR-1502S* and the *CDR-2500S*—both stand-alone models—have their own power supplies and can be connected as external components.

All three units offer 552 megabytes memory capacity, and a speed of 200 to 535 rpm (CLV) for single-sided disks. With high-



CIRCLE 20 ON FREE INFORMATION CARD

speed random access, the models have a capacity of more than 1500 floppy disks, and are especially useful for a variety of data and information-storage operations.

The model *CDR-2500S* is priced at \$1100.00, the model *CDR-1502S*, \$1000.00, and the model *CDR-1502S*, \$1050.00.—**Hitachi Sales Corporation of America**, 401 W. Artesia Blvd., Compton, CA 90220.

MODEM, the *WorldLink 1200*, is battery-powered and Hayes-compatible. Features include: 1200/300 bps operation, auto-dial, auto-answer, pulse and tone dialing, LED indication of call progress, carrier detect, speed, and low battery.



CIRCLE 21 ON FREE INFORMATION CARD

The *WorldLink 1200* supports both Bell 102/212A and CCITT V.21 and V.22 standards, so it is useful internationally. Optional acoustic cups allow full-duplex operation at both 300 and 1200 bps. List price is \$199.—**Touchbase Systems**, 16 Green Acre Lane, Northport, NY 11768.

3.5-INCH DRIVE KIT is designed to convert desktop PC's to the smaller, yet higher storage-capacity format of 3.5-inch software.

The new model *ND354A* disk drive and kit are also designed for easy installation into the IBM PC, XT, AT and compatible personal computers, including the AT&T model 6300, Compaq *Deskpro* and *Portable*. In addition, the drives are also fully compatible with the IBM *Convertible*, Toshiba's model *T1100*, *T1100 PLUS*, and *T3100* laptops.

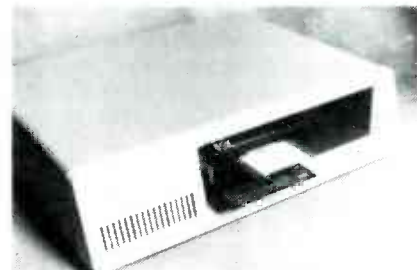

CIRCLE 21 ON FREE INFORMATION CARD

Both the 3.5-inch drive and installation kit for 5.25-inch form-factor drive PC's will be sold together at the suggested retail price of \$150.00.—**Toshiba America Inc.**, Information Systems Division, 2441 Michelle Drive, Tustin, CA 92680.

BUILD A CLOCK BOARD for YOUR PC

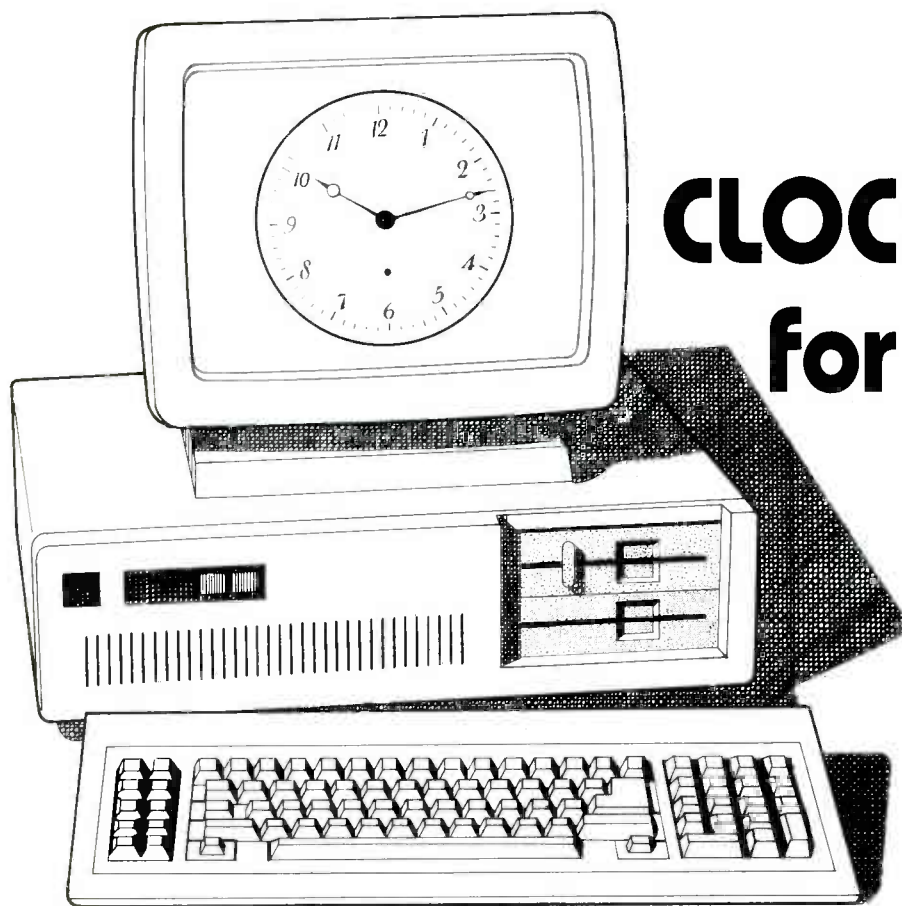

Build this inexpensive clock board and keep your IBM-PC (or compatible) on time and up to date—automatically!

VAUGHN D. MARTIN

The IBM-PC is a great machine, but it does have its quirks. For example, every time you turn it on, you have to enter the time and the date. That's no big deal—it's just a pain to have to do it every single time you use the computer.

Of course, you don't really have to enter the current time and date—you can just press the RETURN key. But then you won't be able to tell when you last worked on a file. And backup software may not work correctly, either.

However, there is a way to let the hardware do the drudge work for you—and that's what computers are for. All you need is a clock/calendar IC, a lithium battery, a few buffers and decoders, and a little software. The combination will take care of keeping your computer on time and up to date—you'll only have to enter the time and date when installing the clock.

The circuit was designed to work with the IBM-PC and compatibles; the PC board fits in the short slot. A kit of parts is available for under \$50; by doing some judicious shopping, you can build the circuit for even less. The cost is less than that of other boards that contain expensive I/O ports and other features that you may not really need or want.

Basic flowcharts of software operation will be presented here; the kit includes a disk with several programs (CLOCKSET.EXE and READCLOC.EXE) that allow you to set and read the clock, respectively. In addition, we'll post the source code (which is written in Lattice C) on the RE-BBS, so you can customize it to your heart's content.

How it works

The circuit is based on an MM58167A real-time clock IC, manufactured by National Semiconductor. It requires extremely low power, so a three-volt lithium battery should easily last a year or more. A block diagram of the MM58167A is shown in Fig. 1.

The IC has several data, control, and address lines. The address bus is five bits wide, allowing access to a total of 32 locations. The

contents of those locations are indicated in Table 1. The MM58167A also has a bi-directional eight-bit data bus.

Driving the IC is an oscillator, which requires two capacitors, a resistor, and a 32.768 kHz quartz crystal, which function together as

TABLE 1—CLOCK IC Contents

Address					Contents
A4	A3	A2	A1	A0	
0	0	0	0	0	Counter—Ten Thousandths of Seconds
0	0	0	0	1	Counter—Hundredths and Tenths of Seconds
0	0	0	1	0	Counter—Seconds
0	0	0	1	1	Counter—Minutes
0	0	1	0	0	Counter—Hours
0	0	1	0	1	Counter—Day of Week
0	0	1	1	0	Counter—Day of Month
0	0	1	1	1	Counter—Month
0	1	0	0	0	RAM—Ten Thousandths of Seconds
0	1	0	0	1	RAM—Hundredths and Tenths of Seconds
0	1	0	1	0	RAM—Seconds
0	1	0	1	1	RAM—Minutes
0	1	1	0	0	RAM—Hours
0	1	1	0	1	RAM—Day of Week
0	1	1	1	0	RAM—Day of Month
0	1	1	1	1	RAM—Months
1	0	0	0	0	Interrupt Status Register
1	0	0	0	1	Interrupt Control Register
1	0	0	1	0	Counters Reset
1	0	0	1	1	RAM Reset
1	0	1	0	0	Status Bit
1	0	1	0	1	GO Command
1	0	1	1	0	STANDBY INTERRUPT
1	1	1	1	1	Test Mode

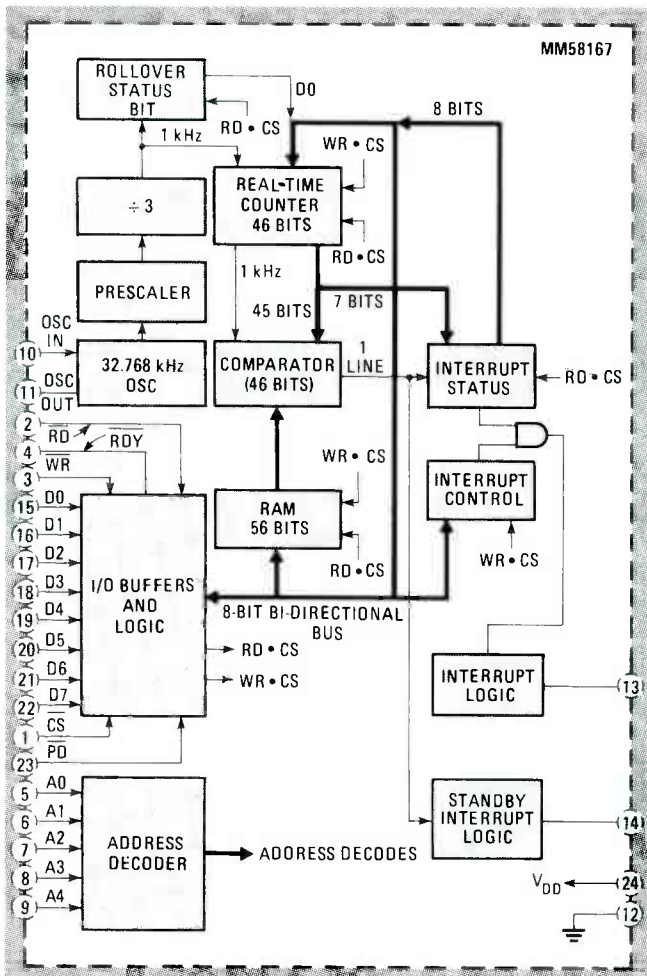

FIG. 1—BLOCK DIAGRAM OF THE MM58167 is shown here. The 56 bits of RAM can be used for generating alarm interrupts or as general-purpose storage.

a Pierce-type parallel-resonant circuit. The prescaler and the $\div 3$ sections provide a 1-kHz clock signal that drives the real-time counter, which consists of a 14-stage BCD counter. Each stage can be read from and written to; the counter keeps time in a 24-hour format.

A read-only rollover status bit signals when invalid data may have been read. Invalid data could be read if the counter incremented during a read (or between reads of successive locations.) A counter could increment because the counter chain is asynchronously clocked with respect to the system microprocessor (in this case, the IBM's 8088).

The clock IC's RAM contains fourteen four-bit nibbles that can be used for alarm interrupts or for general storage. In this project, the RAM is used for storage. The nibbles are accessed from the outside eight bits at a time; Table 2 shows how the nibbles are distributed in the MM58167's address space. Also note that some nibbles are not externally accessible: the low-order nibble at address D and the high-order nibble at address D. Note that the year is not available from the IC directly; it is tracked by the control software.

Referring back to Fig. 1, the comparator is a 46-bit device designed to compare values in RAM against the counters to provide an alarm interrupt. The alarm feature is not used in this project, but you could use it by writing the appropriate software, and by connecting the IC's interrupt output to one of the PC's interrupt lines.

Actually, the IC has two interrupt outputs: the main interrupt and the standby interrupt. The main interrupt is an active-high push-pull output. The standby interrupt is an active-low open-drain output. For the main interrupt, an eight-bit control register allows the user to select from one to seven interrupt rates (10 Hz, 1 Hz, etc.), as well as an alarm. The 8-bit status register (at address 10h) informs the user

TABLE 2—REGISTERS

Address	Upper nibble	Lower nibble
8	Milliseconds	No RAM Exists
9	Tenths of Seconds	Hundredths of Seconds
A	Tens of Seconds	Units of Seconds
B	Tens of Minutes	Units of Minutes
C	Tens of Hours	Units of Hours
D	No RAM exists	Day of Week
E	Tens Day of Month	Units Day of Month
F	Tens of Months	Units of Months

which one of the eight interrupts has occurred.

The IC's control lines include CHIP SELECT, POWER DOWN, READ, and WRITE. There is also a READY line that can be used to interface the IC to a microprocessor that has a wait-state capability.

The POWER-DOWN input functions similarly to the CHIP-SELECT signal, albeit one of opposite polarity. It differs, however, from CHIP SELECT in that it forces the main output into a high-impedance state, whereas CHIP SELECT does not.

The READY output is active low; it becomes active on the negative-going edge of either the system's READ or WRITE signals (assuming the CHIP-SELECT input is low). If the READY output is not used it may be left open-circuited.

In addition, the IC has a "GO" register (at address 15h), which is used to set the time. To do so, first the counters and the RAM are reset by writing FF into locations 12h and 13h. Then the correct time is written into the appropriate registers. Last, a write to address 15h loads the counters.

The circuit

Figure 2 shows the complete schematic of the clock's interface circuitry. NAND gates IC1-a, IC1-b, IC1-d, and 3-to-8 line decoder IC5 generate the MM58167's CHIP-SELECT signal. Any time an I/O address ranging from 2C0h to 2DFh is read or written, that signal will go low.

Integrated circuits IC3 and IC4 are bi-directional buffers that give the system access to the clock IC's address and control lines (IC3) and its data lines (IC4). The data-bus buffer (IC4) is also selected by the pin-9 output of IC5, and the direction of transfer is controlled by IC1-c, which combines the system's MEMORY-READ signal (at edge-conductor pin B12) with the I/O READ line (at pin B14).

The clock IC's READY signal is connected directly to the system's I/O READY line to inform the computer when valid data is available.

When the computer is turned off, the clock IC receives power from lithium battery B1 through diode D3, and diode D2 prevents battery power from trying to feed the computer's power supply. When the computer is turned on, five-volt power is supplied through diode D2 to the clock IC. Since that voltage is higher than the three volts supplied by the battery, D3 is reverse-biased, so no current is drawn from the battery. Therefore, the battery should last longer if the computer is used more. In any case, the battery is rated to supply power for a year before it needs to be replaced.

The network composed of D1, R3, and C5 ensures that the clock IC undergoes the correct power-up and power-down sequences. In particular, the POWER-DOWN line (pin 23) should be held low until all other lines are stable. The R3-C5 time constant is sufficient. Also, POWER-DOWN should go low as soon as possible after power is turned off. When power is turned off, the computer's five-volt supply begins to drop, so eventually the charge on capacitor C5 forward-biases diode D1, and that allows C5 to discharge through the computer's power supply. Diode D1 is a germanium type, to keep the voltage drop across it low.

Construction

Our prototype was built on a printed-circuit board, foil patterns for which are shown in PC Service. You can also purchase an etched

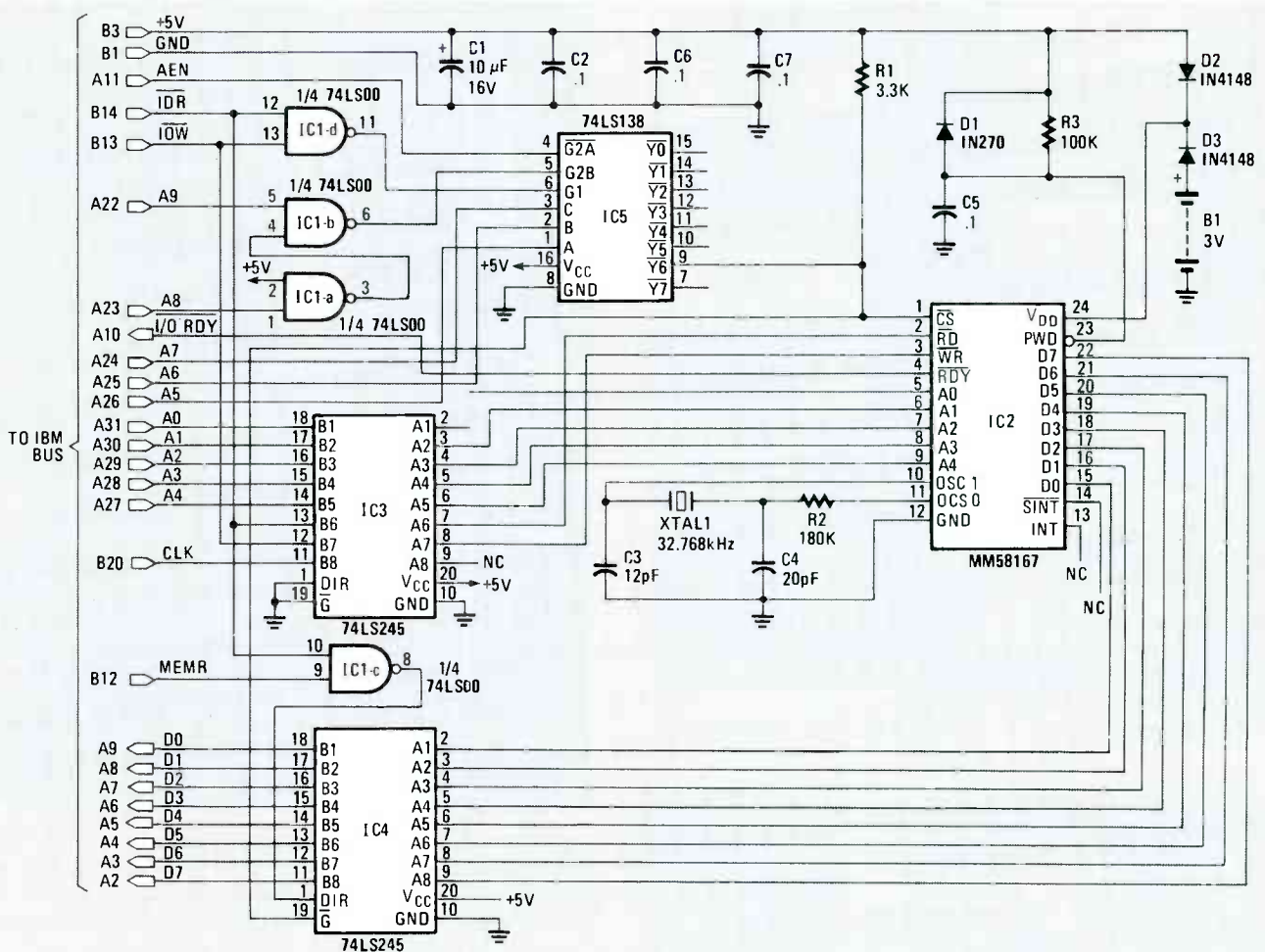

FIG. 2—COMPLETE CLOCK/CALENDAR SCHEMATIC is shown here. The clock IC's registers are accessed at the 32 locations beginning with 2C0h.

and drilled board (with gold-plated contacts) from the source mentioned in the Parts List. If you etch your own board, note that it is double-sided, so make sure that all feedthroughs are soldered on both sides of the board.

If you use our PC board, refer to Fig. 3, the parts-placement diagram, to stuff the board. Make sure that you mount the polarized capacitors correctly, as well as the diodes and the IC's. Check your work carefully.

Software

Two programs control operation of the clock board. The CLOCKSET program, outlined in Fig. 5, is used to set the clock (and to reset it when a time change occurs, or when the battery is changed.) When the program runs, it prompts the operator for the date, which is then checked. If the date is correct, the program prompts for the time, which is also checked. Entry of an invalid date or time causes the program to ask for the desired value again; the process repeats until a correct value is entered.

When the program has the correct values, it goes into a loop that consecutively sets the valid time and date values into the appropriate clock-IC registers.

The READCLOC program, outlined in Fig. 6, reads all the time and date registers from the clock IC. Because the IC's alarm feature is not used, several RAM locations (inside the MM58167) are used to keep track of the current year, as well as the month when the clock was last read. Then, each time the clock is read, the last month is compared to the current month. If the last month read is larger than the current month, it is assumed that the a new year has begun, so the year counter is incremented and saved.

The READCLOC program reads the status register each time to see

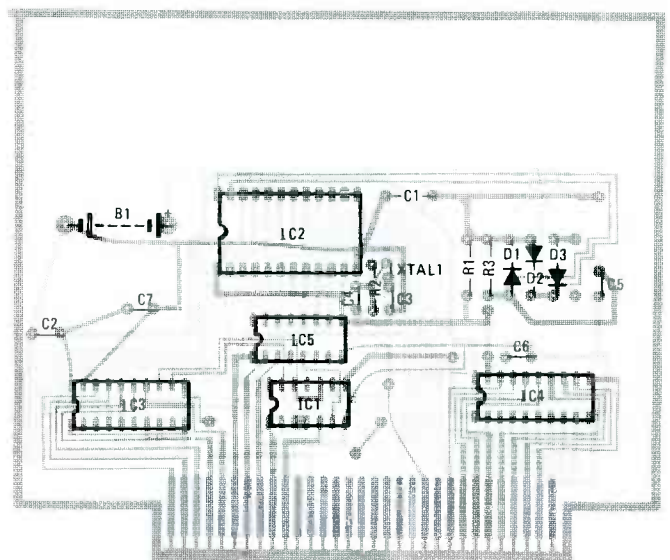

FIG. 3—STUFF THE PC BOARD as shown here. Make sure all IC's are inserted correctly, and that the polarity of the battery is also correct.

whether the clock changed while the registers were read. If so, the registers are read again. The process continues until the status register indicates that valid data has been read. Before display, both date and time are checked for validity. If either is invalid, then an error message and a default time and date are displayed.

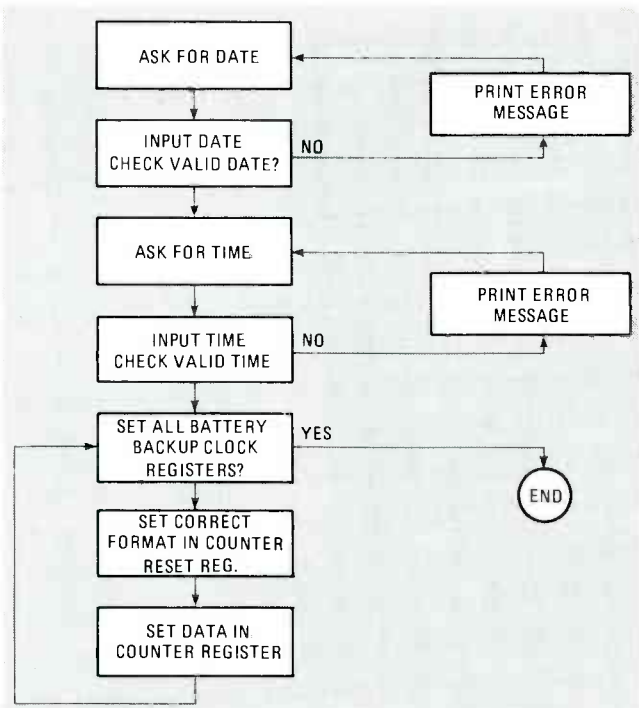

FIG. 4—TO SET THE CLOCK REGISTERS, the user is prompted for the time and date. The registers are loaded one by one.

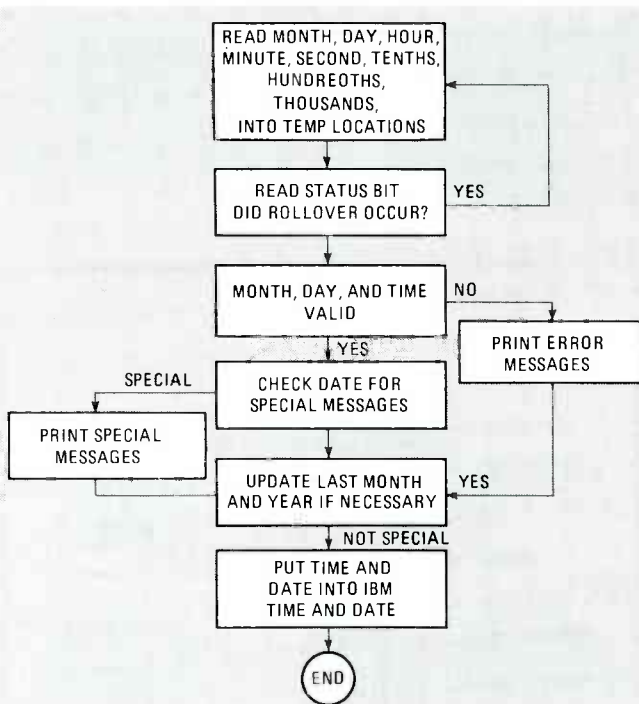

FIG. 5—TO DISPLAY THE TIME AND DATE, the clock registers are loaded one by one. If the current date is Christmas, New Year's, etc., a special message is displayed. Then the year register is updated, if necessary.

If time and date are valid, the program checks for a special date (New Year's Day, St. Valentine's Day, the 4th of July, Christmas, etc.). If the current date is one of those dates, an appropriate message ("Happy New Year," for example) is displayed, as are the time and date. Also the time and date are used to set the IBM-PC's time and date memory locations.

If you'd like more information about either program, or if you'd

PARTS LIST

All resistors are ¼-watt, 5% unless otherwise noted.

R1—3300 ohms
R2—180,000 ohms
R3—100,000 ohms

Capacitors

C1—10 µF, 16-volt, tantalum
C2, C5, C6, C7—0.1 µF, 25-volts, disc
C3—12 pF silver mica
C4—20 pF silver mica

Semiconductors

IC1—74LS00 quad NAND gate
IC2—MM58167A real-time clock
IC3, IC4—74LS245 eight-bit bi-directional buffer
IC5—74LS138 3-to-8 decoder
D1—1N270 germanium diode
D2, D3—1N4148 switching diode

Other components

XTAL1—32.768 kHz crystal (Digi-Key no. X32768)
B1—3-volt coin-type lithium battery (Digi-Key no. P142)
Miscellaneous: Battery holder (Digi-Key no. BH906-ND), PC board, wire, solder, etc.

Note: A disk containing driver software for this project is available for \$12 ppd from Specialty Electronics Services, Inc., P. O. Box 680712, San Antonio, TX 78268-0712. In addition, a PC Board is available (\$12), as is a complete kit of parts (\$49.95), and an assembled and tested version (\$59).

like to customize either for a special application, you can download the source code files from the RE-BBS. Call 516-293-2283 with your modem set for 300 or 1200 baud, 8 data bits, 1 stop bit and 1 start bit, and no parity. The file IBMLOCK.ARC contains both source files in compressed format.

Installation

There's nothing to installing the PC board physically. Just remove power and insert the board into an empty slot. Then run the program CLOCKSET, which will ask you for the current time and date, and last run READCLOC, which will set the time for DOS. You can include READCLOC in your AUTOEXEC.BAT file to set time and date automatically every time you boot up.

Chances are extremely slight that you'll experience any problems with the board, assuming you followed good construction techniques. If you do have a problem, remove the board, and make sure that the IC's and diodes are oriented correctly, and that all components are soldered well.

If the board appears to be OK, the clock board's I/O-port usage may be conflicting with some other board in your system. Remove all boards that aren't absolutely necessary and try again. If the clock board works now, you've begun to isolate the problem. To make the board compatible with your other hardware, you'll have to change the I/O port of one or the other. Most manufacturers provide jumper blocks or switch settings to change I/O ports. If you want to change the clock board's I/O ports, cut the trace leading from pin 9 of IC5 (the 74LS138), and connect another output of the IC to the cut trace. To accommodate the new port, you'll also have to recompile the operating software.

Before going to such drastic lengths, realize that it's possible, although unlikely, that the control software conflicts with some other software in your system. Try booting from a clean DOS diskette (one with no memory-resident programs), and then running CLOCKSET and READCLOC. If that solves the problem, experiment with your usual AUTOEXEC.BAT file. Try eliminating your RAM-resident programs one by one and rebooting until the problem goes away. Altering the loading order may solve the problem. ♦♦♦

Some people say that the day of the hacker is gone—that no one really wants to build his own computer—that people are content to plug keyboard and monitor into the back of a machine, insert a disk, and start computing.

We don't buy it. We think that there is more than one person interested in building his own computer from the ground up, learning every detail about it, customizing it, making it do what he wants it to do, not what IBM or Apple or Commodore says it should do. So, during the next few months, we'll be presenting a series of articles on building a 68000-based machine.

A 68000? Not an 8088? No—definitely not! We're developing Intel-itis! So we want to look at a different micro-processor family. Are we anti-Intel? Pro-Motorola? Neither. But we want to facilitate discussion.

In order to do so, we will present plans for building a computer that runs the CP/M-68K and OS-9 operating systems. Most people are familiar with CP/M from its long use with (ironically) Intel (8080) and Zilog (Z80) micro-processors. Fewer people are familiar with OS-9. It has been around nearly as long as CP/M; it was originally written for the 6809 microprocessor. The Radio Shack Color Computer runs OS-9, as do a number of proprietary systems. And the upcoming CD-I (Compact Disk Interactive) systems most likely will run OS-9.

Because of the amount of time and space required, we will not present complete construction plans for the computer. Rather, we will discuss its capabilities in depth, and describe a few of its more interesting hardware features in detail. That way we hope to entice you into building the machine and sharing your experiences with us and with your fellow readers.

The motherboard, EPROM's containing the system monitor and the BIOS for one operating system, and a thick handbook with complete construction plans, schematics, theory of operation, troubleshooting hints, monitor source listings, and sample programs are available at reasonable prices. We'll provide that information next time.

The computer's motherboard provides all necessary peripheral inter-

BUILD THE MC 68000

TIM AND HANS SCHRADER,
MANFRED KOENIG, HAGEN VOELZKE

faces (disk and video controllers, keyboard interface, serial and parallel ports, etc.) In addition, much expansion hardware is available, including RAM cards, an IEEE-488 interface, speech card, D/A and A/D converters, and more. Further, many professional programming languages are available, including BASIC, C Pascal, LISP, FORTRAN, etc.

Last, we've set up a special section of the R-E BBS (516-293-2283) for readers to share problems, hints, complaints, congratulations, etc. We've also posted several disks of public-domain software there, so you'll have a place to start learning about programming the 68000. From there on—it's up to you!—Editor.

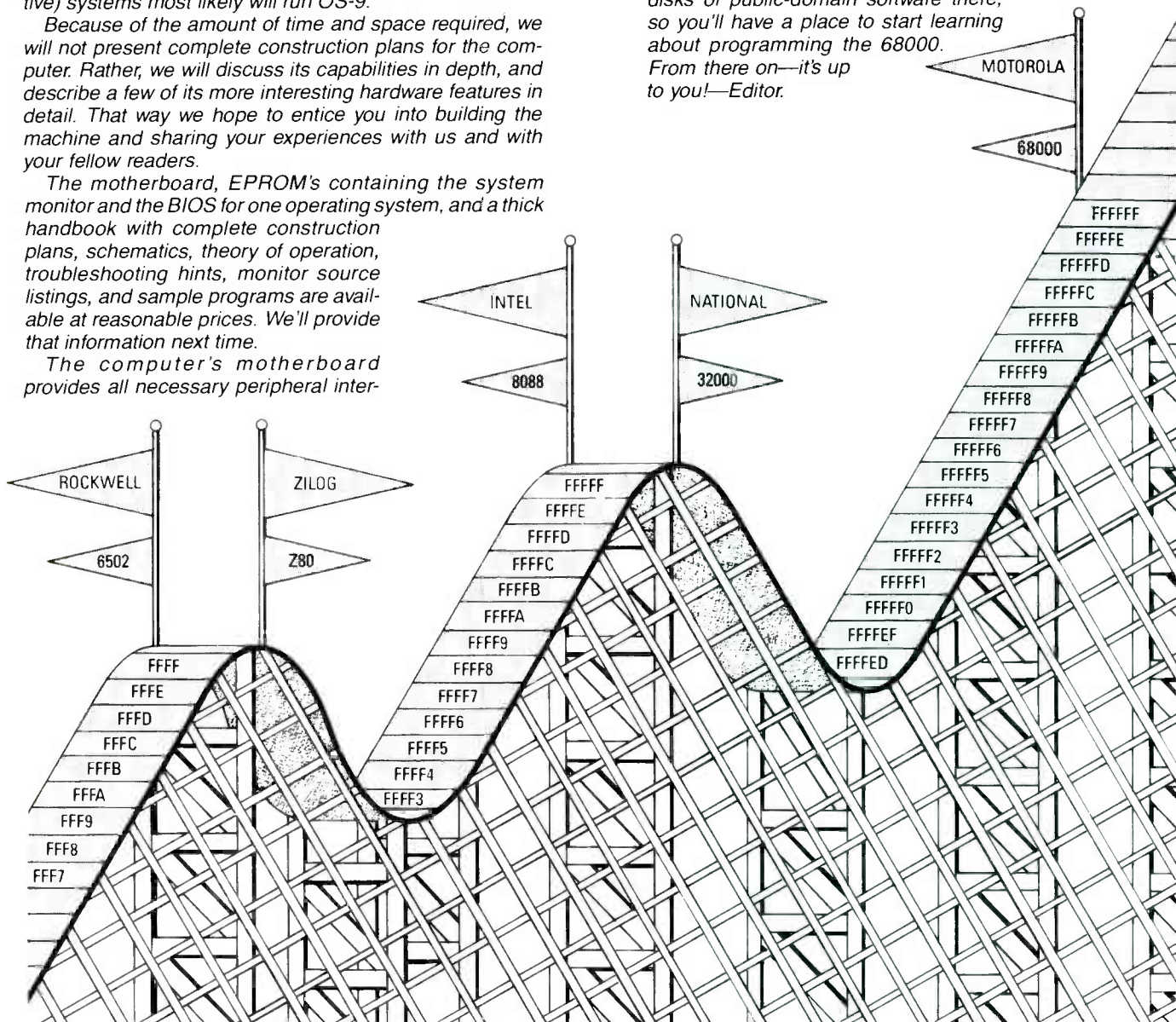

Apple's *Macintosh*, Commodore's *Amiga*, and Atari's *ST* all have one thing in common: the 68000 microprocessor that provides those computers with their smarts. Unfortunately, all three machines have closed architectures and proprietary hardware and software. That makes it hard to build add-on hardware, as well as software.

The IBM-PC family has one big advantage over all the 68000 machines: its open architecture. Every detail of every machine, adapter board, and even BIOS ROM listings have been published by IBM in a series of Technical Reference manuals.

So we felt that it was time to introduce a computer system with the best of both worlds: an open-architecture machine based on the 68000. In doing so, we had several design goals:

- The basic unit should provide all necessary hardware to get a system up and running, but the design should also be flexible enough to handle advanced operating systems and hardware.
- Assembly and testing should be simple enough that the amateur computerist would be able to get the system running without expensive test equipment.
- All components should be readily available; no expensive or hard-to-find parts should be used.
- The price of the computer should be competitive with that of the closed-architecture machines.

We believe that the computer described here meets or exceeds all those goals.

Design overview

Before we settled on the 68000, our first problem was to select an appropriate microprocessor. Should we use an 8- or a 16-bit device? A 16-bit microprocessor requires twice as many RAM's, ROM's and data buffers; those extra components increase cost and circuit-board complexity. On the other hand, a 16-bit micro-

WHAT, NO WORDSTAR?

This computer doesn't run WordStar, Lotus 123, dBASE, MacDraw, AppleWriter, or any other popular software. So what good is it?

To answer that question, let's take a brief look at some microcomputer history. About ten years ago the first personal computer kit was advertised in magazines including **Radio-Electronics**. The Altair 8800 was greeted at the time with smugness: "Cute, but what can it *do*?" History has since shown that the personal computer can do many things, very few of which were foreseen in 1976.

Many of today's leading engineers and programmers (and editors!) got their start on those early machines; the hardware and software tinkering they did has provided them with knowledge that has proven its worth again and again in working with other systems.

Times change, of course, and it wouldn't be worthwhile publishing information on building a computer with a few K of RAM and ROM, and only toggle switches for input, and discrete LED's for output. Ergo this 68000-based computer, several thousand of which are already live and well and operating in Europe.

The computer can be assembled for under \$1500, which is about what a maximally configured Altair cost in 1976. The lesser price, however, includes memory, peripheral support, and software that is several orders of magnitude better than what was available back then.

Although it doesn't run popular applications software, it's the kind of computer the serious student can learn much from, and it also has the expansion capacity and systems software that the scientist and engineer uses every day. Further, Phoenix Technologies (320 Norwood Park South, Norwood, MA 02062) recently announced an 8088 emulation program that runs on various 68000 machines, and allows them to run IBM-PC software. So building this machine is in no way a lesson in planned obsolescence.

processor can handle data twice as fast as an 8-bit device. Benchmark tests showed that an 8086 microprocessor would not satisfy our performance needs, but that a 68000 would, because it has a 32-bit internal data path.

After settling on the 68000, there were still many things to decide. We wanted the system to be able to accommodate as many different types of hardware as possible, so that users could avoid the anguish of accidentally buying incompatible equipment (keyboard, monitor, disk drives, etc.) Therefore our motherboard has many ports for interfacing a wide variety of peripherals, as shown in

TABLE 1—ON-BOARD HARDWARE

Hardware	Comments
CPU	8-MHz 68000 or 68010
RAM	128K or 512K, expandable to 16 megabytes
ROM	64K on board (32K monitor and 32K for BIOS)
BUS	Eight fully buffered expansion slots
Serial port	Up to 19,200 bps
Parallel port	Centronics standard
User port	16 bits (6522 VIA)
Joystick port	Standard analog
Keyboard ports	IBM-PC or parallel ASCII
Cassette port	3,600 bps, interface to standard recorder
Stereo sound port	Speech capability
Monochrome video port	16 MHz, 80 characters × 25 lines, 4 attributes
RGB video port	40 or 80 characters × 25 lines
Graphics	640 × 200 pixels (monochrome), 320 × 200 pixels in four of 16 colors Graphics and text can be mixed.
Disk controller	Eight simultaneous drives (8", 5-1/4", 3-1/2")
SASI port	For hard disk with up to 32 heads and 100 megabyte storage capacity

TABLE 2—EXPANSION HARDWARE

Device	Comments
RAM card	2 megabytes, no wait states with 120-ns 41256 at 8 MHz
RS-232 card	8 ports for MIDI, modems, printers, terminals
EPROM burner	Four ZIF sockets
Hard-disk controller	For SASI port
Mouse interface	With Mouse and software
Prototype card	
D/A and A/D	Several 10- and 12-bit cards
IEEE 488	Bus interface
Multifunction card	RAM, EPROM, I/O lines (28), clock, centronics port

MOTOROLA vs. INTEL

In the mid 1970's Intel Corporation quietly introduced the 8008 microprocessor. The device made it possible, for the first time, to build machine controllers that were programmable via electronic—not mechanical—means.

Shortly thereafter, MOS Technology and Motorola introduced microprocessors of their own: the 6502 and the 6800, respectively. Since that time, Motorola's original microprocessor has led to several generations of increasingly powerful devices, including several families of controllers, the general-purpose 6809, and the 68000 family, heart of the Apple *Macintosh*, the Commodore *Amiga*, and the Atari *ST*, as well as a number of UNIX-based systems, and other proprietary systems.

Of course, Intel didn't rest on its laurels. The 8008 soon gave way to the 8080, and then the 8088, heart of the IBM-PC. By some accounts the 8088, and its more powerful siblings, the 8086, the 80286, and the 80386, are the most powerful microprocessors in existence.

That's not the case, however. In fact, it can be argued that the 68000, and its more powerful siblings, the 68010, the 68020, and the 68030 are more versatile, easier to use, and more powerful than corresponding members of the 8088 family. So we chose the 68000 for this machine, rather than an Intel 8088-series device, and here are some of the reasons why.

For starters, the basic 68000 has equal access to all 16 megabytes (4 gigabytes for the 68020) of memory, whereas the 8088 family can address only 64K at a time through the use of segment registers that must be specially loaded by the programmer, the linker, or both. Later devices in the Intel family (the 80286 and the 80386) are not as restricted as the earlier devices in their ability to access large chunks of memory, but, as of this writing, software incompatibility has prevented widespread use of the expanded facilities.

In addition, the 68000 has a more highly integrated internal structure; that integration makes life much easier for the programmer. The 68000 has eight 32-bit data registers, any of which may be used as an accumulator, index counter, etc. The 68000 also has seven 32-bit address registers that, likewise, are truly general purpose.

The 8088 family, by contrast, has a dedicated accumulator and separate counting, index, and data registers. Different registers access different parts of memory, depending on the segment registers that modify them. The programmer must at all times keep track of both data and segment registers, and how the contents of those registers are affected by which instructions.

The 68000's instruction set is quite regular; the *MOVE* instruction, for example, can transfer values between any combination of CPU registers, memory, and peripheral devices. The 8088 family, by contrast, has separate *LOAD*, *STORE*, *IN*, and *OUT* instructions that are not all valid in all address modes—and that's one more "feature" that makes life difficult for the programmer.

Furthermore, successive generations of the 68000 family add facilities, but remain highly compatible with the earlier generations. Often a later-generation device can be inserted directly into the socket of an earlier device, and the user can immediately benefit from the added facilities.

Each generation of the Intel family, on the other hand, has introduced new modes that are incompatible with the original mode. So software developers are forced to re-develop applications from scratch, or to ignore the new modes altogether. The 80386 will remedy some of the problems mentioned, but control software that can make use of all its facilities is not likely to be seen before 1988. However, multi-user, multi-tasking operating systems (OS-9 and CRTX) are available for this machine right now.

TABLE 3—OPERATING SYSTEMS AND PROGRAMMING LANGUAGES

Software MONITOR	Comments
	32K, with editor, monitor, symbolic assembler, and debugger (contained in two on-board EPROMs).
CP/M-68K	Version 1.2, including C compiler
OS-9/68K	Realtime, multiuser, multitasking
CRTX	Realtime, multiuser, multitasking
MODULA 2	Pascal's control structures, C's power and speed
FORTH	Enhanced FORTH ('79 and '83 standards) with many 32-bit operations, editor and high-res graphics commands
C	Included with CP/M
XLISP	Public-domain interpreter
FORTRAN 77	Compiler
PASCAL	Compiler
BASIC PLUS	Interpreter
C	Whitesmith
FBASIC	Fast BASIC compiler, MBASIC compatible
GEDIT	Screen-oriented program editor, menu-driven
GRED	Joystick/mouse-controlled graphics program
PHO	Phoneme editor for speech card
CEDIT	Editor with built-in calculator
RAB	Memory-resident utility program with calculator, clock, memo pad, etc.
DU	Disk utility

Table 1. To keep the cost of the peripherals as low as possible, we made the system compatible with inexpensive IBM-PC clone components (keyboard, power supply, monitor, etc.).

We chose the 6845 (which, by the way, is used in the IBM-PC's color and monochrome display adapters) for video control. The screen can be switched, under software control, between text and high-res graphics displays. In monochrome text mode, 25 lines of 40 or 80 characters, each with a resolution of 8 × 10 pixels, can be displayed. The monochrome graphics mode has 640 × 200 freely programmable pixels; through hardware or software scrolling, a 1024 × 1024 matrix may be controlled. In color mode, you can display text as 40 characters × 25 lines, or graphics in 16 colors, from a 320 × 200 pixel matrix.

A DMA channel connected to the video RAM allows for super-fast graphics; up to 32 graphics pages can be defined. All important video signals (including the discrete RGB signals, SYNC and HSYNC, and their complements) are available at the video port, making it simple to interface just about any kind of monitor.

Seldom contained on any microcomputer motherboard is a floppy-disk controller. However, we have included a 1793 drive controller and a 9229 data separator. Just about any standard drive can be interfaced through one of two buses. Bus 1 is for 5¼" and 3½" drives; bus 2 is for 8" drives. As many as four drives, single or double sided, can be connected to each bus and configured via software as single or double density, with 35, 40, 77, or 80 tracks. The motherboard also has a SASI hard-disk controller.

R-E Computer Admart

Rates: Ads are 2 1/4" x 2 7/8". One insertion \$825. Six insertions \$800 each. Twelve insertions \$775. each. Closing date same as regular rate card. Send order with remittance to Computer Admart, Radio Electronics Magazine, 500-B Bi-County Blvd., Farmingdale, NY 11735. Direct telephone inquiries to Arline Fishman, area code-516-293-3000. **Only 100% Computer ads are accepted for this Admart.**

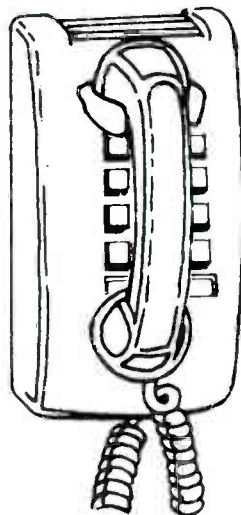

CALL NOW AND RESERVE YOUR SPACE

- 6 x rate \$800.00 per each insertion.
- Reaches 239,312 readers.
- Fast reader service cycle.
- Short lead time for the placement of ads.

Call 516-293-3000 to reserve space. Ask for Arline Fishman. Limited number of pages available. Mail materials to: Computer Admart, RADIO-ELECTRONICS, 500-B Bi-County Blvd., Farmingdale, NY 11735.

ICs PROMPT DELIVERY!!!

**SAME DAY SHIPPING (USUALLY)
QUANTITY ONE PRICES SHOWN FOR DEC. 21, 1985
OUTSIDE OKLAHOMA NO SALES TAX**

DYNAMIC RAM		
1Mbit	1000Kx1	100 ns \$38.50
51258	*256Kx1	100 ns 9.95
4464	64Kx4	150 ns 3.29
41256	256Kx1	100 ns 3.84
41256	256Kx1	120 ns 2.69
41256	256Kx1	150 ns 2.49
4164	64Kx1	150 ns 1.30
EPROM		
27512	64Kx8	200 ns \$14.95
27C256	32Kx8	250 ns 5.51
27256	32Kx8	250 ns 4.96
27128	16Kx8	250 ns 3.77
27C64	8Kx8	200 ns 4.52
2764	8Kx8	250 ns 3.27
STATIC RAM		
62256LP-1232Kx8	120 ns	\$14.95
6264LP-15	8Kx8	150 ns 2.95

640 Kbyte MOTHERBOARD KITS: Zenith 150, IBM PC/XT, Compaq Portable & Plus; hp Vectra

6087 6 MHz \$112.00
80287-8 8MHz \$270.00

OPEN 6 1/2 DAYS, 7 AM-10 PM. SHIP VIA FED-EX ON SAT. SUNDAYS & HOLIDAYS. SHIPMENT OR DELIVERY, VIA U.S. EXPRESS MAIL.

SAT DELIVERY INCLUDED ON FED-EX ORDERS RECEIVED BY: Th: 3:00 PM, Fr: 4:00 PM, Sa: 12:00 PM, Su: 12:00 PM. *No minimum order. Please call for current prices because prices are subject to change. Shipping & insurance extra. Cash discount prices shown. Orders received by 9 PM CST can usually be delivered to you the next morning via Federal Express Standard Air @ \$6.00, or Priority One @ \$13.00!

MasterCard VISA or UPS CASH COD
Factory New, Prime Parts MICROPROCESSORS UNLIMITED, INC. 24,000 S. Peoria Ave. (918) 267-4961 BEGGS, OK. 74421

CIRCLE 61 ON FREE INFORMATION CARD

COMPUTER ASSEMBLY MANUALS



*Eliminate Guesswork!
Build with Confidence!*

BIG BLUE SEED for IBM™ BUILDERS
Parts list, placement diagrams & instructions for assembling over 75 IBM-compatible bare cards. Latest version includes guides for 640K, Turbo, & AT MthBds. \$17.95

APPLE SEED II for APPLE™ BUILDERS
Instructions for assembling over 85 Apple-compatible bare cards including II+ & IIe MthBds. For all Apple enthusiasts .. \$14.95

Both for \$30.00! Also bare cards in stock!
Check/money-order, VISA/MasterCard to:

NuScope Associates*, Dept RE
P.O. Box 790 • Lewiston, NY • 14092

*A Division of Kosmic MicroTech Inc.

CIRCLE 214 ON FREE INFORMATION CARD

GETTING THE MOST FROM YOUR PRINTER

Getting The Most From Your Printer

By: [unreadable]

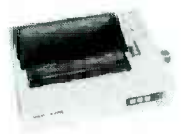

BP181—It is probable that 80% of dot-matrix printer users only ever use 20% of the features offered by their printers. This book will help you unlock the special features and capabilities that you probably don't even know exist. To order your copy send \$6.95 plus \$1.50 for shipping in the U.S. to Electronic Technology Today Inc., P.O. Box 240, Massapequa Park, NY 11762-0240.

A Z-80 WORKSHOP MANUAL



Starting with a review of computer principles, this book describes typical machine-code instructions followed by a detailed description of the Z-80 instruction set. Assembly language programming is also discussed with examples. Z-80 hex machine-code and assembler instructions are given in tabular form, along with in-our connections for the Z-80 and te associated devices.... Order your copy from **Electronic Technology Today Inc., PO Box 240, Massapequa Park, NY 11762. Price is \$6.95 plus \$1.00 for shipping.**

Assorted interfaces

For flexibility, several kinds of keyboards can be accommodated: serial ASCII, parallel ASCII, and IBM-PC. Both Centronics and RS-232C ports are included, as is a freely-programmable 16-bit user port. An analog joystick port and a stereo sound port are also included; the latter can be used for speech synthesis, with the addition of a speech/clock card.

For adding your own or commercial hardware, the system includes eight expansion slots. A sample of the commercially available hardware is shown in Table 2.

Software

You can get the system up and running simply by building the motherboard and adding a keyboard and a monitor (or an RS-232 terminal). The system attempts to boot from floppy disk, but if you push the ESC key during the boot process, you enter the ROM monitor. From there you can examine and change memory locations, use the built-in symbolic assembler, trace programs, etc.

Of course, eventually you'll want to add disk drives and write

programs in a high-level language. The CP/M-68K operating system comes with an assembler/editor/debugger package, and the Digital Research C compiler. Many other editors, programming languages, and utilities are available, as shown in Table 3.

General remarks

About 2000 systems have been assembled since the computer was introduced in Europe in fall 1984. Interest groups sprouted all over Germany, and, based on the experiences of users there, a new motherboard was designed that corrected several flaws in the original.

Building the motherboard and peripheral cards is straightforward. However, construction does require meticulous attention to numerous small details. The handbook that accompanies the motherboard and EPROM set contains instructions for novice kit builders, as well as step-by-step instructions for testing each sub-system as you bring the computer up.

Next time we'll discuss hardware features and construction; the final article will discuss software. ♦♦♦

MARKET CENTER

FOR SALE

TV tunable notch filters, free brochure. **D.K. VIDEO**, Box 63/6025, Margate, FL 33063. (305) 752-9202.

CHANNEL 3—60dB notch filter, 63.5MHz. \$19.95. All other channels \$29.95. Cable converter and accessory catalog \$1. (514) 739-9328. **CROSLLEY(A)**, Box 84C, Champlain, NY 12919.

CLASSIFIED AD ORDER FORM

To run your own classified ad, put one word on each of the lines below and send this form along with your check to:

Radio-Electronics Classified Ads, 500-B Bi-County Boulevard, Farmingdale, NY 11735

PLEASE INDICATE in which category of classified advertising you wish your ad to appear. For special headings, there is a surcharge of **\$23.00**.

() Plans/Kits () Business Opportunities () For Sale
() Education/Instruction () Wanted () Satellite Television
()

Special Category: \$23.00

PLEASE PRINT EACH WORD SEPARATELY, IN BLOCK LETTERS.

(No refunds or credits for typesetting errors can be made unless you clearly print or type your copy.) Rates indicated are for standard style classified ads only. See below for additional charges for special ads. **Minimum: 15 words.**

1	2	3	4	5
6	7	8	9	10
11	12	13	14	15 (\$42.75)
16 (\$45.60)	17 (\$48.45)	18 (\$51.30)	19 (\$54.15)	20 (\$57.00)
21 (\$59.85)	22 (\$62.70)	23 (\$65.55)	24 (\$68.40)	25 (\$71.25)
26 (\$74.10)	27 (\$76.95)	28 (\$79.80)	29 (\$82.65)	30 (\$85.50)
31 (\$88.35)	32 (\$91.10)	33 (\$94.05)	34 (\$96.90)	35 (\$99.75)

We accept MasterCard and Visa for payment of orders. If you wish to use your credit card to pay for your ad fill in the following additional information (Sorry, no telephone orders can be accepted.):

Card Number

Expiration Date

Please Print Name

Signature

IF YOU USE A BOX NUMBER YOU MUST INCLUDE YOUR PERMANENT ADDRESS AND PHONE NUMBER FOR OUR FILES. ADS SUBMITTED WITHOUT THIS INFORMATION WILL NOT BE ACCEPTED.

CLASSIFIED COMMERCIAL RATE: (for firms or individuals offering commercial products or services) \$2.85 per word prepaid (no charge for zip code)...**MINIMUM 15 WORDS.** 5% discount for same ad in 6 issues; 10% discount for same ad in 12 issues within one year; if prepaid. **NON-COMMERCIAL RATE:** (for individuals who want to buy or sell a personal item) \$2.30 per word, prepaid...no minimum. **ONLY FIRST WORD AND NAME** set in bold caps at no extra charge. Additional bold face (not available as all caps) **50¢ per word additional (20% premium)**. Entire ad in boldface, **add 20% premium** to total price. **TINT SCREEN BEHIND ENTIRE AD PLUS ALL BOLD FACE AD:** add 25% premium to total price. **TINT SCREEN BEHIND ENTIRE AD PLUS ALL BOLD FACE AD:** add 45% premium to total price. **EXPANDED TYPE AD:** \$4.30 per word prepaid. All other items same as for STANDARD COMMERCIAL RATE. **TINT SCREEN BEHIND ENTIRE EXPANDED TYPE AD PLUS ALL BOLD FACE AD:** add 25% premium to total price. **TINT SCREEN BEHIND ENTIRE EXPANDED TYPE AD PLUS ALL BOLD FACE AD:** add 45% premium to total price. **DISPLAY ADS:** 1" x 2 1/4"—\$320.00; 2" x 2 1/4"—\$640.00; 3" x 2 1/4"—\$960.00. **General Information:** Frequency rates and prepayment discounts are available. **ALL COPY SUBJECT TO PUBLISHERS APPROVAL. ADVERTISEMENTS USING P.O. BOX ADDRESS WILL NOT BE ACCEPTED UNTIL ADVERTISER SUPPLIES PUBLISHER WITH PERMANENT ADDRESS AND PHONE NUMBER.** Copy to be in our hands on the 12th of the third month preceding the date of the issue. (i.e., August issue copy must be received by May 12th). When normal closing date falls on Saturday, Sunday or Holiday, issue closes on preceding working day.

TUBES new, unused. Send self-addressed, stamped envelope for list. **FALA ELECTRONICS**, Box 1376-2, Milwaukee, WI 53201.

RESTRICTED technical information: Electronic surveillance, schematics, locksmithing, covert sciences, hacking, etc. **Huge selection. Free brochure MENTOR-Z**, 135-53 No. Blvd., Flushing, NY 11354.

LASERS, components and accessories. Free catalog. **M.J. NEAL COMPANY**, 6672 Mallard Ct., Orient, OH 43146.

FREE power supply with Assortment #103 PCB, TOKO coils 144LY-120K, 520HN-3000023, BKAN-K555AXX(2) 2N3904(2), BFQ85, 7812, 74123, MC1330A1P, 1N914, 1N5231B. Only \$25.00. **Assortment #201** MC1330, LM1458, MC1358, NE565, LM386, 2N3563, MPN3404, IN4002. Only \$10.00. **Assortment #301** PCB with all IC's, transistors, and diodes for Telease-Maast Satellite-TV project (Oct. 86 article) only \$25.00. 10% discount for 5 or more. Service charge \$3.00/order. **1(800) 821-5226 Ext. 426. MC/VISA, COD, check or M.O. Or write JIM RHODES INC., P.O. Box 3421, Bristol, TN 37625.**

TUBES, name brands, new, 80% off list. **KIRBY**, 298 West Carmel Drive, Carmel, IN 46032.

INDIVIDUAL Photofact-folders #1 to #1400. \$3.00 postpaid. **LOEB**, 414 Chestnut Lane, East Meadow, NY 11554.

WHOLESALE car-radio computer telephone audio video accessories antenna catalog (718) 897-0509 **D&WR**, 68-12 110th St., Flushing, NY 11375.

CATALOG and theory sheet: All models of converters and descramblers. Special combination 400 and SB3, \$165. Pulse descrambler kit assemblies in half hour \$69.00, built \$110.00. Satellite descrambler kit assemblies in one hour \$110.00, built \$180.00. Send \$1.00. **MJ INDUSTRY**, Box 531, Bronx, NY 10461.

TUBES! 59¢. Year guarantee. Free catalog. Tube tester \$8.95. **CORNELL**, 4215 University, San Diego, CA 92105.

TI-99/4A software/hardware bargains. Hard-to-find items. Huge selection. Fast service. Free catalog **DYNA**, Box 690, Hicksville, NY 11801.

VIDEO scrambling techniques. The original "secret manual" covers sinewave, gated pulse, and SSAVI systems. 56 pages of solid, useful, legible information. Only \$14.95. **ELEPHANT ELECTRONICS, INC.**, Box 41865-J, Phoenix, AZ 85080. (602) 581-1973.

WIREWAP labels. Identify IC's, pins. Easier, errorless wrapping. All DIP's 8-40 pins. Inexpensive, 363 labels \$6.00. **PAUL'S LABELS**, 7320 Embassy, Miramar, FL 33023.

IS it true...Jeeps for \$44 through the government? Call for facts! **1(312) 742-1142, ext. 4673.**

OLDTIME radio programs on high quality tapes. Comedy! Adventure! Music! Free catalog. **CARL F. FROELICH**, Heritage Farm, New Freedom, PA 17349.

Quality Microwave TV Antennas

Multi-Channel 1.9 to 2.7 GHz
40dB Gain True Parabolic 20 Inch Dish
Complete System \$79.95 (plus shipping)
Dealerships. Qty. Pricing. Replacement Parts

Phillips-Tech Electronics
P.O. Box 8583 • Scottsdale, AZ 85252
(602) 947-7700 \$3.00 Credit all phone orders!

LIFETIME WARRANTY MasterCard • Visa • COD's

CABLE-TV



BONANZA!



WE'LL MATCH OR BEAT ANYONE'S
ADVERTISED RETAIL OR WHOLESALE PRICES!



SCIENTIFIC ATLANTA UNITS

LOWEST PRICES ANYWHERE!



ITEM	SINGLE UNIT PRICE	DEALER 10-UNIT PRICE
RCA 36 CHANNEL CONVERTER (CH. 3 OUTPUT ONLY)	29.95	18.00 ea.
PIONEER WIRELESS CONVERTER (OUR BEST BUY)	88.95	72.00 ea.
LDC-58 WIRELESS CONVERTER	92.95	76.00 ea.
JERROLD 450 WIRELESS CONVERTER (CH. 3 OUTPUT ONLY)	105.95	90.00 ea.
SB ADD-ON UNIT	109.95	58.00 ea.
BRAND NEW — UNIT FOR SCIENTIFIC ATLANTA	<i>Call for specifics</i>	
MINICODE (N-12)	109.95	58.00 ea.
MINICODE (N-12) VARISYNC	119.95	62.00 ea.
MINICODE VARISYNC W/AUTO ON-OFF	179.95	115.00 ea.
M-35 B (CH. 3 OUTPUT ONLY)	139.95	70.00 ea.
M-35 B W/AUTO ON-OFF (CALL FOR AVAILABILITY)	199.95	125.00 ea.
MLD-1200-3 (CALL IF CH. 2 OUTPUT)	109.95	58.00 ea.
INTERFERENCE FILTERS — CH. 3	24.95	14.00 ea.
JERROLD 400 OR 450 REMOTE CONTROLLER	29.95	18.00 ea.
ZENITH SSAVI CABLE READY (DEALER PRICE BASED ON 5 UNITS)	225.00	185.00 ea.

SPECIFY CHANNEL 2 or 3 OUTPUT *Other products available — Please Call*

Quantity	Item	Output Channel	Price Each	TOTAL PRICE
			SUBTOTAL	
			Shipping Add	\$3.00 per unit
			COD & Credit Cards — Add 5%	
			TOTAL	

California Penal Code #593-D forbids us from shipping any cable descrambling unit to anyone residing in the state of California.
Prices subject to change without notice.

PLEASE PRINT

Name _____
 Address _____ City _____
 State _____ Zip _____ Phone Number () _____
 Cashier's Check Money Order COD Visa Mastercard
 Acct # _____ Exp. Date _____
 Signature _____

FOR OUR RECORDS:

DECLARATION OF AUTHORIZED USE — I, the undersigned, do hereby declare under penalty of perjury that all products purchased, now and in the future, will only be used on cable TV systems with proper authorization from local officials or cable company officials in accordance with all applicable federal and state laws.

Dated: _____ Signed: _____

Pacific Cable Company, Inc.
 7325½ RESEDA BLVD., DEPT. R-03 • RESEDA, CA 91335
 (818) 716-5914 • No Collect Calls • (818) 716-5140

IMPORTANT: WHEN CALLING FOR INFORMATION
 Please have the make and model # of the equipment used in your area. Thank You

Learn TV/VCR Repair

Now you can train at home in your spare time for a money-making career in TV/VCR Repair. No previous experience necessary. No need to quit your job or school. Everything is explained in easy-to-understand language with plenty of drawings, diagrams and photos. We show you how to troubleshoot and repair videocassette recorders and TV sets, how to handle house calls and shop repairs for almost any make of television or VCR. Tools are included with your course so you can get "hands-on" practice as you follow your lessons step by step. Send for free facts about the exciting opportunities in TV/VCR Repair and find out how you can start making money in this great career. **MAIL COUPON TODAY!**

ICS SCHOOL OF TV/VCR REPAIR, Dept. DEO27
(SINCE 1981) Scranton, Pennsylvania 18515

Please send me full information and color brochure on how I can learn TV/VCR Repair at home in my spare time. I understand there is no obligation and no salesman will visit me.

Name _____ Age _____
 Address _____ Apt. # _____
 City/State/Zip _____
 Phone () _____

MASTERCARD AND VISA are now accepted for payment of your advertising. Simply complete the form on the first page of the Market Center and we will bill.

CABLE TV

Zenith, Jerrold, Sci-Atlanta, Oak — many others.
 Avoid costly rentals of converters — buy direct —
Free illustrated catalogue — Call for wholesale pricing.

APARE INDUSTRIES 1-313-670-6009
 35552 Grand River, Suite 255, Farmington, MI 48024

CABLE TV converters: Jerrold Products include "New Jerrold Tri-Mode," SB-3, Hamlin, Oak VN-12, M-35-B, Zenith, Magnavox, Scientific Atlanta, and more. (Quantity discounts) 60 day warranty. Service converters sold here. For fast service C.O.D. orders accepted. Send SASE (60 cents postage) or call for info (312) 658-5320. Midwest Electronics, Inc., HIGGINS ELECTRONICS, 5143-R W. Diversey, Chicago, IL 60039. MC/Visa orders accepted. No Illinois orders accepted.

TELEPHONE bug, FM room bug schematics with detailed construction procedures using Radio Shack's numbered parts. Both, \$6.00. Receivers available. **SHEFFIELD ELECTRONICS**, 7223 Stony Island, Chicago, IL 60649.

STRANGE stuff. Plans, kits, new items. Build satellite dish \$69. Descramblers, bugs, adult toys. Informational photo package \$3.00 refundable. **DIRIJO CORPORATION**, Box 212, Lowell, NC 28098.

DESCRAMBLE the latest video cassette copy protection scheme. Our simple Line Zapper circuit takes the jitter out of your picture. Complete plans and theory only \$13.95 plus \$1.50 postage and handling. PC board and complete kits also available. **ELEPHANT ELECTRONICS, INC.**, Box 41865-J, Phoenix, AZ 85080. (602) 581-1973.

HI-FI speaker systems, kits and speaker components from the world's finest manufacturers. For beginners and audiophiles. Free literature. **A&S SPEAKERS**, Box 7462R, Denver, CO 80207. (303) 399-8609.

DESCRAMBLING, new secret manual. Build your own descramblers for **Cable and Subscription TV**. Instructions, schematics for SSAVI, gated sync, sinewave. (HBO, Cinemax, Showtime, etc.) \$8.95. For immediate delivery add \$1.00. **CABLETRONICS**, Box 30502R, Bethesda, MD 20814.

A SINGER'S DREAM!



REMOVES VOCALS FROM RECORDS!
 Now You can sing with the world's best bands!
 The Thompson Vocal Eliminator can remove most or virtually all of a lead vocal from a standard stereo record and leave the background!
 Write or call for a free brochure and demo record.
LT Sound, Dept. R-1, P.O. Box 338,
Stone Mountain, GA 30086 (404) 493-1258

TV-stereo kit—easily converts your TV/VCR to receive the new MTS stereo sound. True stereo not simulation. \$43.95 information—SASE. **DPI**, Box 150, Elmont, NY 11003.

LISTEN to hidden subcarriers on FM receiver. Plans \$6.95 with PC/brd \$15.95. **D&B**, Box 1258, Bruceville, TX 76630.

FREE microprocessors, memory chips, etc. Free electronics magazine subscriptions. Free education in computers. For information write **MICROSAT CORPORATION**, 2401 N.E. Cornell, Bldg. 133, Hillsboro, OR 97124.

DIGITAL audio recorder Commodore-64. Excellent Sound! Plans, P.C.B. & drum software: \$19.95. Kit \$49.95. Postpaid, order now!! **TAD PAINTER**, P.O. Box 166055, Irving, TX 75016.

SCHEMATIC and theory for third brake light. Send \$2.00 to **BILL SHAFER**, Box 107, Gas City, IN 46933.

SAVE 75%—build your own 68000 or IBM compatible computer—easy. Free details. **DIGATEK CORPORATION**, Suite 175, 2723 West Butler Drive, Phoenix, AZ 85051.

HOBBY, educational, industrial products. 70 kits. Amplifier, FM transistor, VU meter, door bell, alarm system, power supply. Send \$3.00 to **HOBBY ELECTRONIC**, P.O. Box 1339, Claremont, NH 03743, or call (603) 543-0033.

EDUCATION & INSTRUCTION

CASSETTE recorded home study for new general class FCC license examinations. Also broadcasting and cablevision courses. **BOB JOHNSON TELECOMMUNICATIONS**, 1201 Ninth, Manhattan Beach, CA 90266.

FCC commercial general radiotelephone license correspondence course. 60 individual lessons for \$89.50. Payment plan. Results guaranteed! Details free. **AMERICAN TECHNICAL INSTITUTE**, Box 201, Cedar Mountain, NC 28718.

HOME study course for class 1 license. Send \$12.00 to **KATHLEEN LAWSON**, 2024 Pine Ave., Niagara Falls, NY 14301.

WANTED

INVENTORS! AIM wants—ideas, inventions, new products, improvements on existing products. We present ideas to manufacturers. Confidentiality guaranteed. Call toll free 1 (800) 225-5800 for information kit.

INVENTIONS, ideas, new products wanted! Industry presentation/national exposition. Call free 1 (800) 528-6050. Canada, 1 (800) 528-6060. X831.

PRINTED CIRCUIT BOARDS

Low Quotes, High Quality, Quick Service. Single, Double sided, Multilayered Boards. Prototypes through Production Quantities. Design/Layout Capabilities. Board Assembly/Project Enclosures/Turnkey Facilities. Call or write for quotes and info. **T.O.R.C.C.C.**, 1131 Tower, Schaumburg, Illinois 60195, (312) 490-1374.

CALL FOR FREE CATALOG

TEXT TO SPEECH BOARD!

PC/XT COMPATIBLE. MAKE YOUR COMPUTER TALK!

A VERY POWERFUL AND AMAZING SPEECH CARD. USES THE NEW GENERAL INSTRUMENTS SPO256-AL2 SPEECH CHIP AND THE CTS256A-AL2 TEXT TO SPEECH CONVERTER.

THIS BOARD USES ONE SLOT ON THE MOTHERBOARD AND REQUIRES A COM SERIAL PORT. BOARD MAY ALSO BE USED IN A STAND ALONE ENVIRONMENT WITH ALMOST ANY COMPUTER THAT HAS A RS232 SERIAL PORT. FEATURES ON BOARD AUDIO AMP OR MAY BE USED WITH EXTERNAL AMPS.

DEMONSTRATION SOFTWARE AND A LIBRARY BUILDING PROGRAM ARE INCLUDED ON A 5 1/4 INCH PC/XT DISKETTE. FULL DOCUMENTATION AND SCHEMATICS ARE ALSO INCLUDED.



\$69.95
COMPLETE
KIT

NEW!

\$89.95
ASSEMBLED
& TESTED

HARD DISK CONTROLLER CARD
THE FANTASTIC KONAN KDC-230. WITH MANUAL. SUPER EASY TO CONFIGURE AND USE. FOR PC/XT.
 HALF SIZE PCB. '99 — ADD \$8.00 FOR CABLES

PC/XT EPROM PROGRAMMER

\$199



NEW!

* LATEST DESIGN * PROGRAMS UP TO 4 DEVICES AT ONE TIME * FEATURES EASY TO USE MENU DRIVEN SOFTWARE THAT RUNS UNDER PC OR MS-DOS. * USES AN INTELLIGENT PROGRAMMING ALGORITHM FOR SUPER FAST (8X) EPROM BURNING. * THIS PLUG-IN BOARD ATTACHES TO AN EXTERNAL MINI CHASSIS CONTAINING 4 TEXTOL Z.I.F. SOCKETS. * NO PERSONALITY MODULES REQUIRED * AUTOMATIC VPP SELECTION: 12.5V, 21V, OR 25V. * EPROM DATA CAN ALSO BE LOADED FROM OR SAVED TO A DISKETTE. * PROGRAMMING SOFTWARE SUPPORTS: 2716, 2732, 2732A, 2764, 2764A, 27128, 27128A, 27256, 27256A, 27512, AND 27512A. * ASSEMBLED AND TESTED. BURNED IN WITH MANUAL. \$199 WITH SOFTWARE.

Digital Research Computers

(OF TEXAS)

P. O. BOX 381450 • DUNCANVILLE, TX 75138 • (214) 225-2309

TERMS: Add \$3.00 postage. We pay balance. Orders under \$15 add 75¢ handling. No C.O.D. We accept Visa and MasterCard. Texas Res. add 5-1/8% Tax. Foreign orders (except Canada) add 20% P & H. Orders over \$50 add 85¢ for insurance.

One tree can make
3,000,000 matches.



One match can burn
3,000,000 trees.



A Public Service of This Magazine
 & The Advertising Council

ALL SALES SUBJECT TO THE TERMS OF OUR 90 DAY LIMITED WARRANTY. FREE COPY UPON REQUEST.

RADIO-ELECTRONICS

BUSINESS OPPORTUNITIES

MECHANICALLY inclined individuals desiring ownership of small electronics manufacturing business—without investment. Write: **BUSINESSES**, 92-R, Brighton 11th, Brooklyn, NY 11235.

YOUR own radio station! AM, FM, TV, Cable. Licensed/unlicensed. **BROADCASTING**, Box 130-F3, Paradise, CA 95969.

PROJECTION TV...Make \$\$\$s assembling projectors...easy...results comparable to \$2,500 projectors. Total cost less than \$30.00. **Plans, 8" lens and dealers information \$20.50.** Illustrated information **free.** **MACROCOMA-GGX**, Washington Crossing, PA 18977. Creditcard orders 24hrs. (215) 736-2880.

BIG PROFITS

ELECTRONIC ASSEMBLY BUSINESS

Start home, spare time. Investment knowledge or experience unnecessary. **BIG DEMAND** assembling electronic devices. Sales handled by professionals. Unusual business opportunity.

FREE: Complete illustrated literature
BARTA, RE-O Box 248
Walnut Creek, Calif. 94597

BUSINESS-residential burglar alarms. Booming business. Get in now. Information \$2.00. **DYNAMIC SECURITY**, P.O.B. 1456-K Grand Rapids, MI 49501.

EASY, lucrative. One man CRT rebuilding machinery. Free info: (815) 459-0666 **CRT**, 1909 Louise, Crystal Lake, IL 60014.

DO IT YOURSELF TV REPAIR

NEW...repair any TV...easy. Retired serviceman reveals secrets. Write, **RESEARCH**, Rt3, Box 601BR, Colville, WA 99114.

Multi-Channel Microwave T.V. Receivers

19-27 GHz Parabolic Dish 40+ dB Gain
LIFETIME WARRANTY
Complete System \$89.95 (Shipping Incl.)
Dealer Rates. Replacement Components & Expert Repairs Available

K & S ELECTRONICS Call now for same
P.O. BOX 34522 day shipping!
PHOENIX, AZ 85067 (602) 230-0640

VISA/MC/COD \$2 credit on phone orders!

SATELLITE TV

CABLE TV Secrets—the outlaw publication the cable companies tried to ban. HBO, Movie Channel, Showtime, descramblers, converters, etc. Suppliers list included \$8.95. **CABLE FACTS**, Box 711-R, Pataskala, OH 43062.

SATELLITE systems \$349 up VISA/MC available. Catalog \$3.00. **STARLINK, INC.**, 2603-16R Artie, Huntsville, AL 35805.

SATELLITE TV receiver kits, LNA's, instructions, schematics. Send stamped envelope: **XANDI**, Box 25647, Dept. 21L, Tempe, AZ 85282.

OAK Orion "Turn-On" modifications: "Chip kit" or "Remote keypad." details—\$1.00. **NAS-SAT**, Box 5261, Long Beach, CA 90805. (213) 631-3552.

VIDEOCIPHER II, descrambling manual \$10.00; offset printed set of schematics \$10.00; free set of DeSug members "special" video and audio "working schematics" with \$20.00 order; **PONDEROSA COMPANY**, (303) 634-6666.

PRINTED-CIRCUIT BOARDS

CIRCUIT boards, double and single sided with plated through holes. Cad/cam artwork design. SmArtwork and EE/designer supported. Competitive pricing. **EXPRESS CIRCUITS**, 314 Cothren Street, P.O. Box 58, Wilkesboro, NC 28697. (919) 667-2100.

Pay TV and Satellite Descrambling All New 6th Edition!

100 pages. The most complete source of descrambling information available. Theory and schematics for the most popular cable and satellite systems. Bypasses, detection of illegal decoders, pilotless, B-MAC etc. Free Videocipher update. Material not in magazines. **\$14.95.** Cable TV, 2 way systems, etc. for those interested in descrambling **\$12.95.** MDS/MMDS Handbook Terrestrial microwave hackers **\$12.95.** New edition. Experiments with Videocipher for hackers **\$12.95.** Build Satellite Systems under **\$600.** **\$11.95.** Any 3/\$26. New catalog \$1. Torx bits for cable boxes any size **\$9.95**

**Shojiki Electronics Corp., 1327R
Niagara St., Niagara Falls, NY
14303. COD's 716-284-2163**

INVENTORS

INVENTORS! Can you patent and profit from your idea? Call **AMERICAN INVENTORS CORPORATION** for free information. Over a decade of service. 1 (800) 338-5656. In Massachusetts or Canada call (413) 568-3753.

SCIENTIFIC ATLANTA & TOCOM

SCIENTIFIC Atlanta cable converters (original units), models—8500 and 8550, remote control...\$250.00. **Tocom** and **Zenith** descramblers available, **Guaranteed. N.A.S.,** (213) 631-3552.

TRI-MODE/BI-STATE

TRI-mode/bi-state interface for SB units. Complete kit includes PCB, 61.C.s., all parts and instructions. \$25.00 postpaid. **ARUS ELECTRONICS**, P.O. Box 662, Chappaqua, NY 10514.

TEST INSTRUMENTS

High Quality Lowest Prices Off-The-Shelf

New! **MINI-METERS w/MAXI-SPECS**

SCOPE 3 1/2 Digit LCD with 8 Full Functions
Model **DVM-632** \$449.95
Deluxe test leads included
• 0.5% accuracy • Transistor gain test • Audible continuity checking & diode test • 10 Amp measurement

SCOPE 3 1/2 Digit LCD Multimeter
Model **DVM-630** \$299.95
Test leads included • 0.5% accuracy • 6 functions, 19 ranges • Automatic zero adjust • Low battery indication • Measures 5" x 2 3/4" x 7/8"

B & K 20 MHz Dual Trace
Model **2120** \$379.95
Probes included • 20 and 26 MHz band widths • TVV and TVH • X-Y operation • Trace rotation: adjustable front panel • Channel 1 output

Zippered Carrying Case CC-30 \$4.50

SCOPE 3 1/2 Digit Capacitance
Model **DCM-602** \$699.95
Test leads included • 8 ranges with full scale values to 2000 uF • LSI circuit • Crystal time base • Frequency range 800 Hz to 8 Hz

SCOPE 3 1/2 Digital Multimeters
Model **DVM-638** \$799.95
Test leads included • 11 function, 38 ranges • Logic level detector • Audible visual continuity • capacitance and conductance measurement.

Model **DVM-634** \$487.50 Model **DVM-636** \$627.50
• 7 function, 32 ranges • 8 function, 37 ranges
• Transistor measurement • Capacitance measurement

SCOPE Pocket Sized Audio Signal Generator
Model **RC-555** \$699.95
Test leads & 9V battery included • Low distortion sine-wave signal • 46 step selected frequency • x1 range 20 Hz to 1.5 KHz/x100 range 2KHz to 150 KHz

HITACHI 35 MHz Dual Trace Oscilloscope
Model **V-355** \$599.95
(Reg. \$899.95)
Probes included • Thin, lightweight, compact • Large 6" rectangular, internal graticule CRT • Autofocus

FORDHAM Sweep Function Generator
Model **FG-801** \$219.95
(Reg. \$289.95)
Test leads included • 7 frequency ranges, 0.2 Hz to 2 MHz • Accuracy to ±5%

FORDHAM 550 MHz Frequency Counter
Model **FM-8** \$169.95
(Reg. \$249.95)
Completely assembled, pre-tested, precalibrated • High intensity 8-digit LED display

New! **SCOPE 4 1/2 Digit LCD Bench Digital Multimeter**
Model **DVM-6005** \$199.95
Test lead set & 6 "D" size batteries included • 0.4" high characters • Conversion period: 500 milliseconds • Automatic, negative polarity

Service & Shipping Charge Schedule Continental U.S.A.

FOR ORDERS	ADD	FOR ORDERS	ADD
\$25-100	\$4.50	\$751-1,000	\$12.50
\$101-250	\$6.00	\$1,001-1,500	\$16.50
\$251-500	\$8.00	\$1,501-2,000	\$20.00
\$501-750	\$10.50	\$2,001 and up	\$25.00

Ask for our **FREE Catalog**

TOLL FREE 800-645-9518
In New York State 800-832-1446

260 Motor Parkway, Hauppauge, NY 11788

TENMA

THE NAME YOU CAN TRUST IN ELECTRONIC TEST EQUIPMENT

© 1987, MCM Electronics

TENMA Combination Function Generator and Frequency Counter

- Six digit display ■ Output range: .2Hz-2MHz: seven ranges ■ Counter range: .1Hz-10MHz ■ 5-15V TTL and CMOS output
- Wave forms: sine, triangle, square, pulse, and ramp. For detailed specifications call for a complete Tenma catalog.

#72-380

\$21990
(ea.)

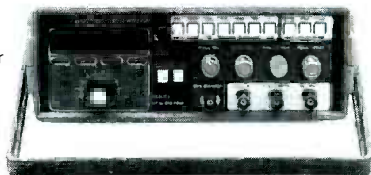

TENMA 3 1/2 Digit Bench Top DMM

- Performs eight functions: DCV, ACV, DCA, ACA, resistance, audible continuity, diode and capacitance test ■ Power: AC adaptor output 7.5VDC ■ Accessories: Test leads, spare fuse (2A), operator's manual and AC adaptor ■ For detailed specifications call for a complete Tenma catalog

#72-410

\$14980
(ea.)

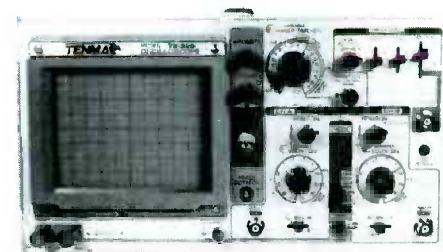
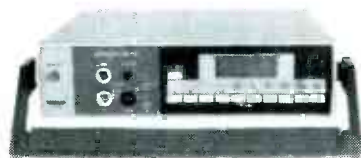

TENMA 20MHz Dual Trace Oscilloscope

- Two high quality 10:1 probes included. For detailed specifications call for a complete Tenma catalog.

#72-320

~~\$38995~~
\$36995
(ea.)



SPECIAL

TENMA Digital LCR Meter

- Measures inductance, capacitance and resistance ■ L = 1μH-200H, C = .1pF-200μF, R = .01ohm-20Mohm
- Carrying case included. For detailed specifications call for a complete Tenma catalog.

#72-370

\$14995
(ea.)



TENMA Combination DMM/ Capacitance Meter

- Measures voltage, AC and DC current up to 10A
- Resistance up to 20Mohm
- Capacitance up to 20μF
- Built-in transistor tester
- Test leads and carrying case included ■ For detailed specifications call for a complete Tenma Catalog

#72-045

\$7495
(ea.)

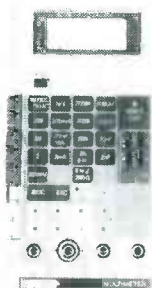

TENMA 4 1/2" Digit Multimeter

- True RMS AC voltage and current functions ■ Built-in frequency counter, 20KHz and 200KHz range ■ Data hold feature ■ Measures AC and DC voltage/current, resistance and frequency
- Carrying case included.

#72-430

\$15980
(ea.)

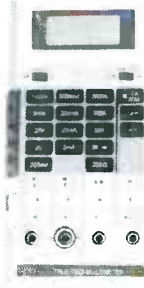

TENMA Compact DMM with Logic Probe

- Measures DCV, ACV, DCA, ACA and resistance
- Audible continuity tester, diode check and transistor hFe ■ Built-in logic tester compatible with DTL/TTL/HTL/CMOS ICs.
- Accessories: Test leads, spare 2A fuse and instruction manual ■ Call for complete specifications

#72-445

\$5980
(ea.)

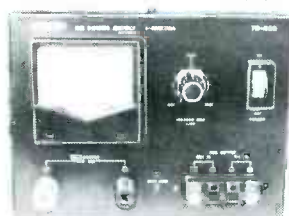

TENMA 30A Power Supply

- Output voltage: 1-15VDC ■ Lighted cross needle meter: Displays voltage, current and power simultaneously ■ Output current: 30A, 24A continuous ■ Fan cooled

#72-035

\$22780
(ea.)



Be Sure To Call For Your FREE Catalog! Over 6,000 Items!

We also have... a full line of test equipment, computer accessories, telephone accessories, speakers, television parts, flybacks, yokes, switches, fuses, lamps, capacitors, resistors, cartridges, styli, wire, CATV equipment, the largest selection of original Japanese semiconductors in the country and more.



- Terms:**
- \$10 minimum order. \$1.00 charge for orders under \$10
 - \$20 minimum charge card order
 - Orders shipped UPS C.O.D.
 - Most orders shipped within 24 hours.
 - Sales office open 8:30 am to 7:00 pm Saturdays 10:00 am to 3 pm EST.
 - For prepaid orders add \$2.75 for shipping and handling.
 - Should shipping and handling charges exceed \$2.75, the balance due will be sent C.O.D.



858 E. CONGRESS PARK DR. • CENTERVILLE, OH 45459
(513) 434-0031



MCM ELECTRONICS

A PREMIER Company

SOURCE NO. RE-30

CALL TOLL FREE 1-800-543-4330
In Ohio 1-800-762-4315 • In Alaska and Hawaii 1-800-858-1849

CIRCLE 87 ON FREE INFORMATION CARD

NATIONAL SEMICONDUCTOR • PANASONIC MACHINE • EWC, INC. • INTERSIL • AD EAC, INC. • J. W. MILLER • AAVID ENGINEER • F. JOHNSON • ATLANTIC SEMICONDUCTOR

256K (262,144 x 1) DRAM 150NS \$5.70/1; \$39.95/9 Factory Firsts

DIODES • DIAMOND TOOL • UNGAR • ES • CW INDUSTRIES • AMDEK • G.E. JGAR • YAGRO • J. W. MILLER • LUXO 3C CHEMICALS • ARIES • PLESSEY

INTEGRATED CIRCUITS

Table listing integrated circuits with columns for Part No., Description, Price, and Manufacturer.

TI IC SOCKETS

Diagram of a Solder Tail Dip Socket with dimensions and a list of pin configurations for various manufacturers.

DISC CAPACITORS

Table listing disc capacitors with columns for Part No., Cap., Volts, Price, and Manufacturer.

7400 TTL

Table listing 7400 TTL integrated circuits with columns for Part No., Description, Price, and Manufacturer.

WIRE WRAP DIP SOCKETS

Diagram of a Wire Wrap Dip Socket with dimensions and a list of pin configurations for various manufacturers.

TANTALUM CAPACITORS

Table listing tantalum capacitors with columns for Part No., Cap., Volts, Price, and Manufacturer.

7400TTL

Table listing 7400TTL integrated circuits with columns for Part No., Description, Price, and Manufacturer.

Micro

Table listing microprocessors with columns for Part No., Description, Price, and Manufacturer.

310 DISC CAPACITORS

Table listing 310 disc capacitors with columns for Part No., Description, Price, and Manufacturer.

7400TTL

Table listing 7400TTL integrated circuits with columns for Part No., Description, Price, and Manufacturer.

Micro

Table listing microprocessors with columns for Part No., Description, Price, and Manufacturer.

PANASONIC LS SERIES

Table listing Panasonic LS Series capacitors with columns for Value, Volts, Price, and Manufacturer.

7400TTL

Table listing 7400TTL integrated circuits with columns for Part No., Description, Price, and Manufacturer.

Micro

Table listing microprocessors with columns for Part No., Description, Price, and Manufacturer.

PANASONIC V-SERIES

Table listing Panasonic V-Series capacitors with columns for Value, Volts, Price, and Manufacturer.

7400TTL

Table listing 7400TTL integrated circuits with columns for Part No., Description, Price, and Manufacturer.

Micro

Table listing microprocessors with columns for Part No., Description, Price, and Manufacturer.

PANASONIC V-SERIES

Table listing Panasonic V-Series capacitors with columns for Value, Volts, Price, and Manufacturer.

7400TTL

Table listing 7400TTL integrated circuits with columns for Part No., Description, Price, and Manufacturer.

Micro

Table listing microprocessors with columns for Part No., Description, Price, and Manufacturer.

PANASONIC V-SERIES

Table listing Panasonic V-Series capacitors with columns for Value, Volts, Price, and Manufacturer.

THE DIGI KEY VOLUME DISCOUNT AND SERVICE CHARGES ARE SIMPLE TO APPLY. MOST ITEMS SOLD BY DIGI KEY MAY BE COMBINED FOR A VOLUME DISCOUNT. ITEMS THAT ARE NOT DISCOUNTABLE ARE IDENTIFIED BY THE SUFFIX 'ND' FOLLOWING THE PART NUMBER.

WHEN ORDERING BY PHONE CALL 1-800-344-4539 (CALL 218-681-6674), BY MAIL SEND YOUR ORDER TO: DIGI KEY, P.O. Box 677, Thiel River Falls, MN 55751.

CIRCLE 82 ON FREE INFORMATION CARD

120 RADIO-ELECTRONICS

www.americanradiohistory.com

Crack The Code

TRI-MODE CABLE TV DESCRAMBLER PARTS

We stock the exact parts, PC board and AC adaptor for *Radio Electronics* February 1987 article on building your own TRI-MODE CABLE TV DESCRAMBLER.

#301 PARTS PACKAGE \$39.⁹⁵

Includes all the original resistors, capacitors, diodes, potentiometers, transistors, integrated circuits, LED's, Toko coil (E520HN-3000023) and Plessey SAW filter (SY323).

#302 PC BOARD \$12.⁹⁵

Original 5 X 8.8 etched & drilled silk-screen PC board used in article.

#304 AC ADAPTOR \$12.⁹⁵

Original (14 to 18 volt DC @ 200ma) AC adaptor used in article.

SPECIALS

Add \$2.50 shipping & handling — \$4.50 for Canadian orders. We also offer quantity discounts on 5 or more units.

BOTH #301 and #302 \$49.⁰⁰

ALL THREE #301, #302, and #304 \$59.⁰⁰

FREE

Reprint of *Radio Electronics* Article (February 1987) on building your own TRI-MODE CABLE TV DESCRAMBLER.

60-CHANNEL

CABLE CONVERTER

WITH INFRARED REMOTE CONTROL

SC-60R CONVERTER

\$69.⁹⁵

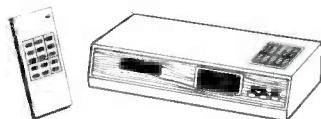

Add \$3.50 Shipping and Handling
\$4.50 on Canadian Orders

Thousands of these converters sold nationally for \$119.95. We offer you this same type of converter for only \$69.95. All converters are NEW, with Full manufacturer's WARRANTY.

FEATURES:

- Full 60 Channel Capability
- Cordless Infrared remote control
- Ultra-Stable Synthesized tuning
- Microprocessor controlled PLL
- Works on all TV models. Specify channel 3 or channel 2 output.
- Standard/HRC Switch for compatibility with all Cable Systems
- Will work with all types of external descramblers

ORDER TOLL FREE
1-800-227-8529

Inside MA: 617-695-8699
VISA, MASTERCARD OR C.O.D.



Not available to Massachusetts residents due to state law.

J & W
ELECTRONICS, INC.

P.O. BOX 800 • MANSFIELD, MA 02048

© Copyright 1986 by J & W Electronics, Inc.

MARCH 1987

SEMICONDUCTORS

continued from page 90

practically, however, there will always be a small amount of leakage current.

Enhancement-mode transistors, which require a voltage on the gate before they begin to conduct, do not have a pinchoff voltage. It is, obviously, zero. The counterpart to V_P is called the *threshold gate voltage*, or $V_{GS(TH)}$. The threshold voltage is defined as the voltage where I_D just starts to flow; it is measured by increasing the gate voltage until a perceptible increase in drain current is noted.

Whichever term is used (V_P or $V_{GS(TH)}$), the value represents the minimum operating current of the transistor.

Dual-gate MOSFET's

There is one more member of the FET family that we must look at: the dual-gate MOSFET. It's basically no different than other FET's, except for the addition of an extra control gate. That extra gate is useful for mixers, modulators, AGC circuits, and other applications.

All the test set-ups reviewed earlier are applicable to dual-gate MOSFETs—with one exception. Because there are two gates, the parameters of each gate must be

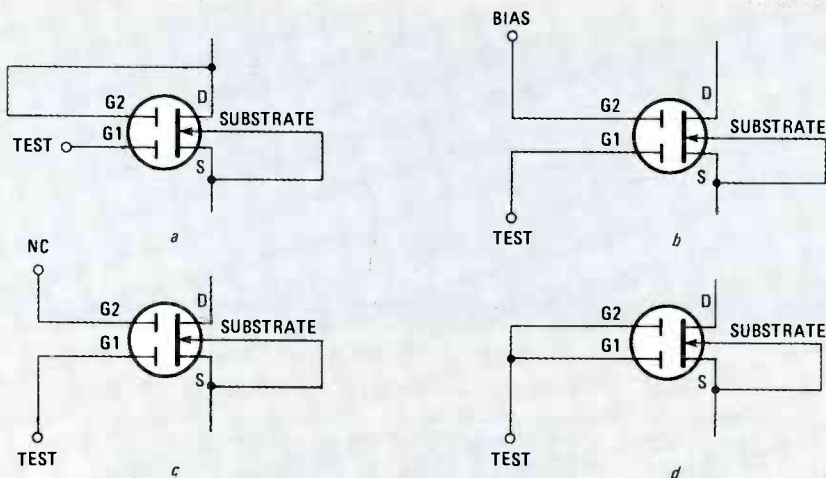

FIG. 10—CHARACTERISTICS OF THE DUAL-GATE MOSFET vary depending on how the gates are connected. The second gate can be connected to the drain (a), to the source (b), to nothing (c), or to the other gate (d).

measured separately. While one gate is being tested, the other gate can be configured in one of several ways.

First, as shown in Fig. 10-a, the unused gate could be tied to the drain.

Second, as shown in Fig. 10-b, the unused gate could be tied to the source, as it would be to measure V_{DSS} .

Third, and least desirable, as shown in

Fig. 10-c, the unused gate could be disconnected from the rest of the circuit.

Last, as shown in Fig. 10-d, the two gates could be tied together. Doing so effectively makes the dual-gate MOSFET act as a single-gate MOSFET.

That does it for this session. In our next segment we'll look at several types of special-purpose diodes. **R-E**

MOVING?

Don't miss a single copy of **Radio - Electronics**. Give us:

Six weeks' notice

Your old address and zip code

Your new address and zip code

ATTACH LABEL HERE

name (please print)

address

city state zip code

Mail to: Radio-Electronics
SUBSCRIPTION DEPT., P.O. BOX 51866,
BOULDER, COLO. 80321-1866

COMMUNICATIONS CORNER

continued from page 44

Tuning the tuner

The purpose of an antenna tuner is to convert the only-heaven-knows impedance of a non-

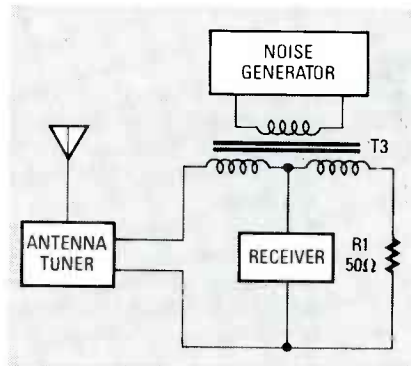

FIG. 3

standard antenna to about 50 or 72 ohms. We'll use 50 ohms for the sake of discussion.

Rather than keying the transmitter and trying to adjust the tuner before the RF power amplifier burns out, we can use the noise bridge shown in Fig. 3 and pre-

adjust the tuner before the transmitter is turned on.

To do so, first adjust the receiver to the desired operating frequency, and then turn on the noise generator. You'll hear a strong noise from the receiver, and the S-meter should indicate a moderate to strong signal. Next, tweak the antenna tuner's controls for minimum noise, as indicated by the S-meter reading. When the antenna tuner is adjusted precisely, its input appears to be 50 ohms, the same value as R_1 . The bridge will be in perfect balance, so the noise will "null out" and the S-meter reading will drop to its normal minuscule value, or to a very low value if the tuner cannot be adjusted to a precise 50-ohm resistive impedance. When the transceiver is keyed now, it will see the required 50-ohm load.

Naturally, you don't want to go through a connect-disconnect hassle every time you change frequency, so the Palomar unit contains internal on-off switching that controls the power from a 9-volt battery and also bypasses the *Tuner-Tuner*. **R-E**

Saratoga Electronics

12380 SARATOGA-SUNNYVALE RD. SARATOGA, CA 95070



INTEGRATED CIRCUITS

D RAMS

4164-150NS \$.89 41256-150NS \$2.45

EPROMS

2716-450NS \$2.95 2764-250NS 3.75
2764-450NS 3.00 27256-300NS 6.75

TTL LOGIC

74LS00 SERIES		74S SERIES	
74LS00	\$.12	74S08	\$.35
74LS02	.12	74S51	.20
74LS04	.12	74S64	.30
74LS09	.12	74S138	.50
74LS14	.25	74F SERIES	
74LS107	.25	74F151	.95
74LS153	.29	74F158	.95
74LS155	.39	7400 SERIES	
74LS155	.39	7408	.20
74LS156	.39	7411	.25
74LS158	.25	7453	.20
74LS163	.30	74199	.15
74LS241	.49		

MISC.

MSM5832 (clock chip) \$1.49
WD2413M-03 (FDC) 2.49
FD1797A-02 (FDC) 2.49
LF347 (Bi-Fet) 1.29
MC10231 (10K ECL Dual Flip-Flop) .49
MC1489 .39

MICROS

8087-3 (5MHz) \$125.00
80287 (6MHz) 165.00
8749-H 7.95
Z80A DMA 3.00
Z80B CPU 4.00

ELECTROLYTIC CAPACITORS

5 for 99¢

10,000 mf @ 35v
2" (ht.) x 1" (diameter)

PCB's
\$3.95 ea.

Surplus boards loaded with
MANY components!

PC/XT COMPATIBLE SYSTEM BOARD
\$115.00

640KB w/o Bios & Ram

408/446-4949

TOLL FREE
800/621-0854 ext. 245

PRICES SUBJECT TO CHANGE
\$25 MIN. ORDER



ADVERTISING INDEX

RADIO-ELECTRONICS does not assume any responsibility for errors that may appear in the index below.

Free Information Number

Page

—	"2001"	CV3	—	NRI	18,43
81	A.I.S. Satellite	41	219	NTS	40
108	AMC Sales	81	—	National Education Centers	87
76	AP Products Brand of 3M	16	71	New-Tone Electronics	23
107	All Electronics	125	214	NuScope Associates	104
—	Amazing Devices	106	110	Omnitron	22
—	Apare Industries	108	220	OrCad Systems	38
84	Appliance Service	40	—	Pacific Cable	107
224	Avcom of Virginia	41	225	RCA D&SP	27
77	B&K Precision	26	78	Radio Shack	124
53	BUYUS	40	97	Saratoga Electronics	126
199	Banner Technical Books	36	200,201	Sencore	33,35
221	Baylin/Gale Productions	38	202,203	Sencore	37,39
98	Beckman Industrial	7	223	Silicon Valley Surplus	106
85	Blue Star Industries	41	94	Star Circuits	41
109	C & S Sales	25	92	Tektronix	CV2
—	C.O.M.B.	13	211	Transletronic	85
60	CIE	8	102	Trio-Kenwood	45
204	Cable Distributors	41	208	United Electronic Supply	14
209	Cabletronics	40	103	Wm B Allen	17
54	Chemtronics	89			
—	Command Productions	89			
212	Cook's Institute	79			
—	Coop's Satellite Digest	79			
127	Deco Industries	40,41			
95	Dick Smith Electronics	123			
82	Digi-Key	120			
—	Digital Research Computers	108			
210	ESI	34			
227	Electronics Book Club	77			
120	Elephant Electronics	41			
213	Emco	40			
100	Firestik II	26			
121	Fluke Manufacturing	28			
—	Fordham Radio	109			
—	GRE America	24			
—	Grantham College of Engineering	46			
62	Hameg	89			
86,206	Heath	3,31			
—	ICS Computer Training	108			
—	ISET	85			
65	J & W	121			
59	JDR Instruments	CV4			
113,215	JDR Microdevices	112,113			
216,217	JDR Microdevices	114,115			
218	JDR Microdevices	218			
114	Jameco	118,119			
115	Jensen Tools	41			
222	Jim-Pak	5			
87	MCM Electronics	111			
207	M.D. Electronics	41			
93	Mark V. Electronics	117			
—	McGraw Hill Book Club	15			
63	Micro-Mart	110			
61	Microprocessors Unltd.	104			

Gernsback Publications, Inc.
500-B Bi-County Blvd.
Farmingdale, NY 11735
(516) 293-3000
President: Larry Steckler
Vice President: Cathy Steckler

For Advertising ONLY 516-293-3000
Larry Steckler
publisher
Arline Fishman
advertising director
Shelli Weinman
advertising associate
Lisa Strassman
credit manager
Christina Estrada
advertising assistant

SALES OFFICES

EAST/SOUTHEAST
Stanley Levitan
Eastern Sales Manager
Radio-Electronics
259-23 57th Avenue
Little Neck, NY 11362
718-428-6037, 516-293-3000

MIDWEST/Texas/Arkansas/Okla.
Ralph Bergen
Midwest Sales Manager
Radio-Electronics
540 Frontage Road—Suite 339
Northfield, IL 60093
312-446-1444

PACIFIC COAST/ Mountain States
Marvin Green
Pacific Sales Manager
Radio-Electronics
15335 Morrison St.—Suite 227
Sherman Oaks, CA 91403
818-986-2001

CIRCLE 97 ON FREE INFORMATION CARD

2001 IS COMING IN MAY



An electronics revolution is in the making, but you don't have to wait until 2001 to find out how it will change your life in the 21st century. Radio-Electronics will forecast the coming changes and how they will affect you in the May, 1987 issue.

Created by a special editorial task force—two years in preparation—this unique issue, 2001, takes you into the research laboratories of Westinghouse, Texas Instruments, Ford and Bell Labs where the future is being invented today!

You'll get an advance look at what's coming in artificial intelligence... new cars and highways (cleaner, quieter and more efficient)... futuristic energy sources like magneto-hydrodynamic and particle-beam generators... personal communications systems that will give you instant access to anyone anywhere... super computers and teaching breakthroughs that will multiply your capacity to learn!

Arthur Clarke introduces 2001. Isaac Asimov explores the marvels of robotics. But it is not science fiction. Rather it is

emerging technology with a solid foundation in current research and development.

And its impact will be enormous. It will change the way you work... the way you think... the way you live!

2001 is the kind of special publishing event that can only happen once in any magazine's lifetime and it will happen to Radio-Electronics in May, 1987.

With extra features and extra pages, 2001 will bear a premium cover cost, but you can reserve your copy now at less than the regular cover cost by mailing any one of the subscription orders in this issue.

2001 is coming in May. Make sure now that you don't miss it!

**Radio-
Electronics**®

TEST EQUIPMENT THAT MEASURES UP TO YOUR SPECIFICATIONS



DMM-300 \$79.95
3.5 DIGIT DMM / MULTITESTER

Our best model. A highly accurate, full function DMM loaded with many extra features. Audible continuity, capacitance, transistor, temperature and ohm accuracy all in one handheld meter. Temperature probe, test leads and battery included.

- Basic DC accuracy: plus or minus 0.25%
- DC voltage: 200mv — 1000v, 5 ranges
- AC voltage: 200mv — 750v, 5 ranges
- Resistance: 200 ohms — 20M ohms, 6 ranges
- AC/DC current: 200uA — 10A, 6 ranges
- Capacitance: 200pf — 20uf, 3 ranges
- Transistor test: hFE test, NPN PNP
- Temperature test: 0° — 2000° F
- Conductance: 200ns
- Fully over-load protected
- Input impedance: 10M ohm



DMM-200 \$49.95
3.5 DIGIT FULL FUNCTION DMM

High accuracy, 20 amp current capability and many range settings make this model ideal for serious bench or field work. Tilt stand for hands free operation. 2300 hour battery life with standard 9v cell. Probes and battery included.

- Basic DC accuracy: plus or minus 0.25%
- DC voltage: 200mv — 1000v, 5 ranges
- AC voltage: 200mv — 750v, 5 ranges
- Resistance: 200 ohms — 20M ohms, 6 ranges
- AC/DC current: 200uA — 30A, 6 ranges
- Fully over-load protected
- Input impedance: 10M ohm
- 80 x 86 x 57mm, weighs 320 grams



DMM-700 \$49.95
3.5 DIGIT AUTORANGING DMM

Autorange convenience or fully manual operation. Selectable LO OHM mode permits accurate in-circuit resistance measurements involving semi-conductor junctions. MEM mode for measurements relative to a specific reading. Probes and battery included.

- Basic DC accuracy: plus or minus 0.5%
- DC voltage: 200mv — 1000v, autoranging or 5 manual ranges
- AC voltage: 2v — 750v, autoranging or 4 manual ranges
- Resistance: 200 ohms — 20M ohms, autoranging
- AC/DC current: 20mA — 10A, 2 ranges
- Fully over-load protected
- Audible continuity tester
- Input impedance: 10M ohm
- 15C x 75 x 34mm, weighs 230 grams



DMM-100 \$29.95
3.5 DIGIT POCKET SIZE DMM

Shirt-pocket portability with no compromise in features or accuracy. Large, easy to read 5" LCD display. 2000 hour battery life with standard 9v cell provides over two years of average use. Probes and battery included.

- Basic DC accuracy: plus or minus 0.5%
- DC voltage: 2v — 1000v, 4 ranges
- AC voltage: 200v — 750v, 2 ranges
- Resistance: 2k ohms — 2M ohms, 4 ranges
- DC current: 2mA — 2A, 4 ranges
- Fully over-load protected
- Input impedance: 10M ohm
- 130 x 75 x 23mm, weighs 195 grams

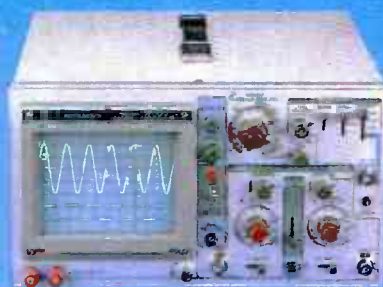

MODEL 2000 \$349.95
20 MHz DUAL TRACE OSCILLOSCOPE

Model 2000 combines useful features and exacting quality. Frequency calculation and phase measurement are quick and easy in the X-Y Mode. Service technicians will appreciate the TV Sync circuitry for viewing TV-V and TV-H as well as accurate synchronization of the Video Signal, Blanking Pedestals, VITS and Vertical: Horizontal sync pulses.

- Lab quality compensated 10X probes included
- Built-in component tester
- 110/220 Volt operation
- X-Y operation • Bright 5" CRT • TV Sync filter



MODEL 3500 \$499.95
35 MHz DUAL TRACE OSCILLOSCOPE

Wide bandwidth and exceptional 1mV/DIV sensitivity make the Model 3500 a powerful diagnostic tool for engineers or technicians. Delayed triggering allows any portion of a waveform to be isolated and expanded for closer inspection. Variable Holdoff makes possible the stable viewing of complex waveforms.

- Lab quality compensated 10X probes included
- Delayed and single sweep modes
- Z Axis intensity modulation
- X-Y operation • Bright 5" CRT • TV Sync filter



DPM-1000 \$54.95
3.5 DIGIT PROBE TYPE DMM

Autorange, pen style design for the ultimate in portability and ease of use. Custom 80 pin LSI chip increases reliability. Audible continuity tester and data hold feature for added convenience. Case, test leads and batteries included.

- Basic DC accuracy: plus or minus 1%
- DC voltage: 2v — 500v, autoranging
- AC voltage: 2v — 500v, autoranging
- Resistance: 2k ohms — 2M ohms, autoranging
- Fully over-load protected
- Input impedance: 11M ohm
- 162 x 28 x 17mm, weighs 75 grams

2 YEAR WARRANTY ON ALL MODELS



JDR INSTRUMENTS
110 Knowles Drive, Los Gatos, CA 95030
(408) 866-6200 • FAX (408) 378-8927 • Telex 171-110

COPYRIGHT 1986 JDR MICRODEVICES
THE JDR INSTRUMENTS LOGO IS A REGISTERED TRADEMARK OF JDR MICRODEVICES.
JDR INSTRUMENTS IS A TRADEMARK OF JDR MICRODEVICES.

ORDER TOLL FREE 800-538-5000

OR VISIT OUR RETAIL STORE
1256 SOUTH BASCOM AVE.
SAN JOSE, CA. (408) 947-8881
CIRCLE 59 ON FREE INFORMATION CARD