

**SPECIAL FEATURE:
TELETEXT DECODER**

Radio - BUILD A TELEPHONE LINE TESTER

Electronics

\$1.95 APR. 1986
IN CANADA \$2.50

TECHNOLOGY - VIDEO - STEREO - COMPUTERS - SERVICE

BUILD THIS TELETEXT DECODER

Find out what all the fuss is about!



FREQUENCY COUNTERS

How they work and how to use them.

MICROPROCESSORS

A decade of change.

ELECTRONICS IN MEDICINE

Speeding the healing
process.

ELECTROMAGNETIC INTERFERENCE

Design PC boards to fight EMI.

BUILD A GRAVITY-WAVE DETECTOR

You can prove a new theory!

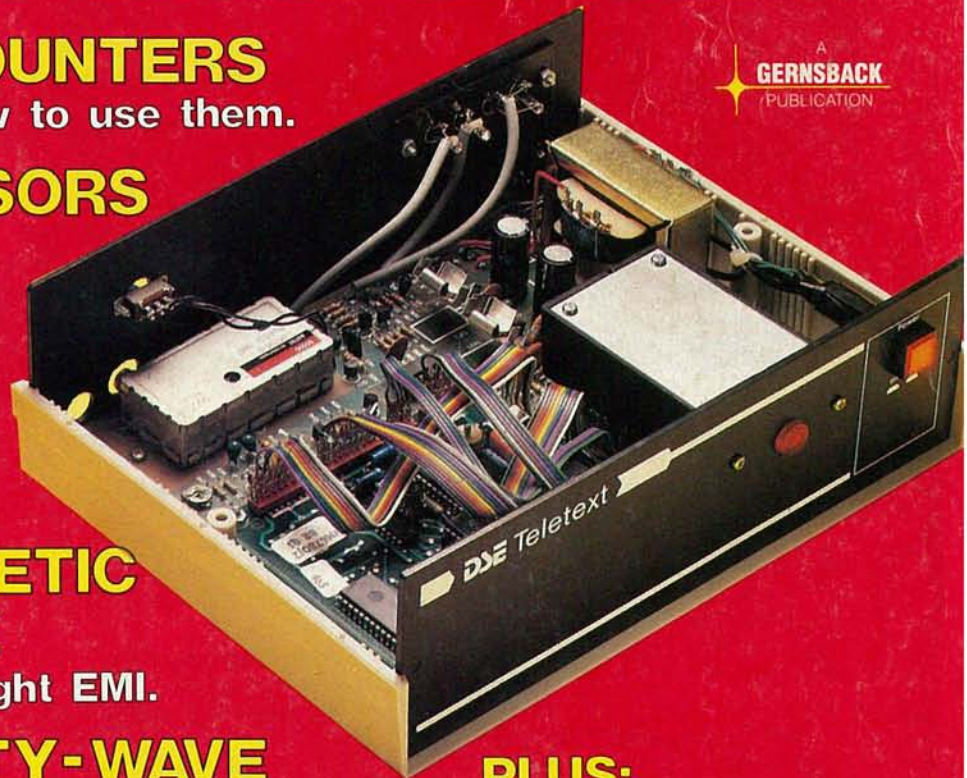

A
GERNSBACK
PUBLICATION

PLUS:

- ★ Ask R-E
- ★ Satellite TV
- ★ Antique Radios
- ★ Robotics
- ★ **COMPUTERDIGEST**

Now! Tek quality and expert advice are just a free phone call away!

The industry standard in CRT performance.

Crisp, easy-to-read, bright CRT; 14kV accelerating potential, provides high writing rate and small spot size. Full size 8x10 cm display for measurement accuracy.

Display controls are flexible and easy to use.

Separate intensity controls reduce blooming in alternate sweep mode. Focus tracking minimizes control adjustment and BEAM FIND eliminates confusion.

Vertical system provides measurement assurance.

Flat transient response and high accuracy ensures true reproduction of your signals. Fast risetime and high bandwidth is well suited for a variety of measurement.

Perform delayed sweep measurements accurately and easily.

Both sweeps can be displayed alternately making differential measurements easy and accurate (1%). An interlocking SEC/DIV control simplifies set-up.

Stable hands-off triggering.

P-P AUTO detects signal peaks, then sets the trigger level for you. Display asynchronous signals using VERT MODE triggering. Independent TV field and line selection.

Front panel laid out by function for ease of use.

Color coding aids the user in operation. Functions and modes are placed logically. All nomenclature is clearly labeled, and protected behind a scratchless Lexan surface.



Our direct order line gets you the industry's leading price/performance portables... and fast answers from experts!

The 60 MHz single time base delay 2213A, the 60 MHz dual time base 2215A and the 100 MHz dual time base 2235 offer unprecedented reliability and affordability, plus the industry's first 3-year warranty* on labor and parts, CRT included.

The cost: just \$1275 for the 2213A, \$1525 for the 2215A, \$1750 for the 2235.† Even at these low prices, there's no scrimping on performance. You

have the bandwidth for digital and analog circuits. The sensitivity for low signal measurements. The sweep speeds for fast logic families. And delayed sweep for fast, accurate timing measurements. All scopes are UL Listed and CSA approved.

You can order, or obtain literature, through the Tek National Marketing Center. Technical personnel, expert in scope applications, will answer your questions and expedite delivery. Direct orders include comprehensive 3-year warranty*, operator's

manual, two 10X probes, 15-day return policy and worldwide service backup.

Order toll free: 1-800-426-2200, Ask for Rick.

In Oregon, call collect: (503) 627-9000. Or write Tektronix, Inc. P.O. Box 1700 Beaverton, OR 97075

Tektronix®
COMMITTED TO EXCELLENCE

- BUILD THIS**
- 45 TELETEXT DECODER**
Teletext is here! Be among the first to tune in to this new information medium.
J. Daniel Gifford
 - 50 TELEPHONE-LINE TESTER**
Stop playing the telephone service guessing game with this easy-to-build line tester.
Herb Friedman
 - 60 TWO NIFTY PROJECTS**
Build these projects, perfect for this time of year, and be the talk of your neighborhood.
Lapri Oolf

- TECHNOLOGY**
- 16 VIDEO NEWS**
A review of the fast-changing video scene.
David Lachenbruch
 - 53 GRAVITY WAVES?**
A startling new theory explains the source of noise in electronic devices.
Gregory Hodowanec
 - 66 CURING ELECTROMAGNETIC INTERFERENCE**
Part 4. The final installment in our series shows you how to design EMI-free PC boards.
Michael F. Violette
 - 69 ALL ABOUT FREQUENCY COUNTERS**
Learn all about those useful instruments.
Vaughn D. Martin
 - 81 ROBOTICS**
Our mystery computer is revealed.
Mark J. Robillard
 - 82 SATELLITE TV**
Some dishes are harder than others.
Bob Cooper, Jr.

- CIRCUITS AND COMPONENTS**
- 61 A DECADE OF CHANGE: THE MICROPROCESSOR**
A look back at the history of the microprocessor, including the most recent versions of that device. **Robert Grossblatt**
 - 98 DESIGNER'S NOTEBOOK**
Voltage doublers. **Robert Grossblatt**
 - 100 NEW IDEAS**
A flood alarm.
 - 102 DRAWING BOARD**
Memory Expansion. **Robert Grossblatt**
 - 106 STATE OF SOLID STATE**
Temperature alarm IC's. **Robert Grossblatt**

RADIO

- 92 ANTIQUE RADIOS**
Back to the present.
Richard D. Fitch
- 105 COMMUNICATIONS CORNER**
Broadband amplifiers.
Herb Friedman

VIDEO

- 88 SERVICE CLINIC**
Hot resistors and shorted capacitors. **Jack Darr**
- 90 SERVICE QUESTIONS**
Answers to your TV-service questions.

COMPUTERS

- Following page 92
- COMPUTER DIGEST**
Packet radio, computer care, and more.

EQUIPMENT REPORTS

- 26 Huntron Instruments Tracker 2000**
- 34 Phot-On-Off Compact Disc Cleaner**

DEPARTMENTS

- 130 Advertising and Sales Offices**
- 130 Advertising Index**
- 6 Ask R-E**
- 131 Free Information Card**
- 22 Letters**
- 109 Market Center**
- 38 New Products**
- 4 What's News**

COVER 1



Teletext is here *now*, and here's your chance to get in on all the excitement. You can build a teletext decoder for under \$200, as long as you have some source of composite video available—a VCR, for example. Of course, a decoder is not much good if no one is broadcasting in your area. But if you have cable TV or a satellite dish, then the chances are that you can get Superstation WTBS, which broadcasts the *Electra* teletext magazine.

The decoder is easy to build, and is available as a complete kit from Dick Smith Electronics. The hard-to-get parts are available separately. What can you do when you finish building the decoder? The screen shots shown should give you a good idea. Turn to page 45.

NEXT MONTH

THE MAY ISSUE IS
ON SALE APRIL 3

CLICK AND POP SUPPRESSOR

Not ready for a compact disk player? Next month we'll show you a project to help you get the cleanest possible sound from your analog records.

TAKING KRILLIAN PHOTOGRAPHS

Learn all about Krillian photographs and see how you can make your own.

ALL ABOUT FREQUENCY COUNTERS

Learn more about that valuable test instrument in the concluding installment of this article.

TELETEXT DECODER

Next month we'll present the construction details.

CAPACITOR LEAKAGE TESTER

A handy instrument to have on your workbench.

SURFACE-MOUNT TECHNOLOGY

All about that revolution in package design.

As a service to readers, Radio-Electronics publishes available plans or information relating to newsworthy products, techniques and scientific and technological developments. Because of possible variances in the quality and condition of materials and workmanship used by readers, Radio-Electronics disclaims any responsibility for the safe and proper functioning of reader-built projects based upon or from plans or information published in this magazine.

Since some of the equipment and circuitry described in RADIO-ELECTRONICS may relate to or be covered by U.S. patents, RADIO-ELECTRONICS disclaims any liability for the infringement of such patents by the making, using, or selling of any such equipment or circuitry, and suggests that anyone interested in such projects consult a patent attorney.

Radio-Electronics

Hugo Gernsback (1884-1967) founder
M. Harvey Gernsback,
editor-in-chief, emeritus

Larry Steckler, EHF, CET, publisher

EDITORIAL DEPARTMENT

Larry Steckler, editor-in-chief

Art Kleiman, editorial director

Brian C. Fenton, managing editor

Carl Laron, WB2SLR, associate editor

Jeffrey K. Holtzman,
assistant technical editor

Robert A. Young, assistant editor

Julian S. Martin, editorial associate

Byron G. Wels, editorial associate

M. Harvey Gernsback,
contributing editor

Jack Darr, CET, service editor

Robert F. Scott,
semiconductor editor

Herb Friedman,
communications editor

Bob Cooper, Jr. satellite-TV editor

Robert Grossblatt, circuits editor

David Lachenbruch,
contributing editor

Richard D. Fitch,
contributing editor

Mark J. Robillard, robotics editor

Bess Isaacson, editorial assistant

PRODUCTION DEPARTMENT

Ruby M. Yee, production director

Robert A. W. Lowndes,
editorial production

Andre Duzant, technical illustrator

Karen Tucker, advertising production

Geoffrey S. Weil, production traffic

CIRCULATION DEPARTMENT

Jacqueline P. Cheeseboro,
circulation director

Rita Sabalis,
assistant circulation director

Jacqueline Allen, circulation assistant

Cover photo by Robert Lewis

Typography by Mates Graphics

Radio-Electronics is indexed in
Applied Science & Technology Index
and *Readers Guide to Periodical Literature*.

Microfilm & Microfiche editions are
available. Contact circulation department
for details.

Advertising Sales Offices listed
on page 130.



NEW! Lower Price Scanners

Communications Electronics™, the world's largest distributor of radio scanners, introduces new lower prices to celebrate our 15th anniversary.

Regency® MX7000-DA

List price \$699.95/CE price \$394.95/SPECIAL
10-Band, 20 Channel • Crystalless • AC/DC
Frequency range: 25-550 MHz. continuous coverage and 800 MHz. to 1.3 GHz. continuous coverage
The Regency MX7000 scanner lets you monitor military, F.B.I., Space Satellites, Police and Fire Departments, Drug Enforcement Agencies, Defense Department, Aeronautical AM band, Aero Navigation Band, Fish & Game, Immigration, Paramedics, Amateur Radio, Justice Department, State Department, plus thousands of other radio frequencies most scanners can't pick up. The Regency MX7000 is the perfect scanner for intelligence agencies that need to monitor the new 800 MHz. cellular telephone band. The MX7000, now at a special price from CE.

Regency® Z60-DA

List price \$379.95/CE price \$179.95/SPECIAL
8-Band, 60 Channel • No-crystal scanner
Bands: 30-50, 88-108, 118-136, 144-174, 440-512 MHz.
Hear Police, Aircraft and the FM Broadcast Bands. The Regency Z60 covers all the public service bands plus aircraft and FM music for a total of eight bands. The Z60 also features an alarm clock and priority control as well as AC/DC operation. Order today.

Regency® Z45-DA

List price \$329.95/CE price \$159.95/SPECIAL
7-Band, 45 Channel • No-crystal scanner
Bands: 30-50, 118-136, 144-174, 440-512 MHz.
The Regency Z45 is very similar to the Z60 model listed above however it does not have the commercial FM broadcast band. The Z45, now at a special price from Communications Electronics Inc.

Regency® RH250B-DA

List price \$613.00/CE price \$329.95/SPECIAL
10 Channel • 25 Watt Transceiver • Priority
The Regency RH250B is a ten-channel VHF land mobile transceiver designed to cover any frequency between 150 to 162 MHz. Since this radio is synthesized, no expensive crystals are needed to store up to ten frequencies without battery backup. All radios come with CTCSS tone and scanning capabilities. A monitor and night/day switch is also standard. This transceiver even has a priority function. The RH250 makes an ideal radio for any police or fire department volunteer because of its low cost and high performance. A UHF version of the same radio called the RU150B covers 450-482 MHz. but the cost is \$449.00. To get technician programming instructions, order a service manual from CE with your radio system.

NEW! Bearcat® 50XL-DA

List price \$199.95/CE price \$114.95/SPECIAL
10-Band, 10 Channel • Handheld scanner
Bands: 29-54, 136-174, 406-512 MHz.
The Uniden Bearcat 50XL is an economical, hand-held scanner with 10 channels covering ten frequency bands. It features a keyboard lock switch to prevent accidental entry and more. Also order part # **BP50** which is a rechargeable battery pack for \$14.95, a plug-in wall charger, part # **AD100** for \$14.95 and also order optional cigarette lighter cable part # **PS001** for \$14.95.

NEW! JIL SX-400-DA

List price \$799.95/CE price \$399.95/SPECIAL
Multi-Band, 20 Channel • No-crystal Scanner
Search • Lockout • Priority • AC/DC
Frequency range: 26-520 MHz. continuous coverage.
With optionally equipped RF converters 150KHz-3.7 GHz.
To celebrate our 15th anniversary, when you order the JIL SX-400 synthesized scanner before March 31, 1986, from CE, you'll get your choice of the RF-8014-DA or RF-5080-DA converter **free**. Or if you prefer, you can get the RF-1030-DA converter for only \$50.00 more with your SX-400 order. The JIL SX-400 is designed for commercial and professional monitor users that demand features not found in ordinary scanners. The SX-400 will cover from 150 KHz to 3.7 GHz. with RF converters. You may also order the following RF converters for your SX-400 scanners separately at these prices.
RF-1030-DA at \$234.95 each for frequency range 150 KHz. - 30 MHz. USB, LSB, CW and AM. (CW filter required for CW signal reception); **RF-5080-DA** at \$194.95 each for 500-800 MHz.; **RF-8014-DA** at \$194.95 each for 800 MHz.-1.4 GHz. Be sure to also order **ACB-300-DA** at \$99.95 each which is an antenna control box for connection of the RF converters. The **RC-4000-DA** data interface at \$259.95 each gives you control of the SX-400 scanner and RF converters through a computer. Add \$3.00 shipping for each RF converter, data interface or antenna control box. Add \$10.00 for shipping both the scanner and free converters. If you need further information on the JIL scanners, contact JIL directly at 213-926-6727 or write JIL at 17120 Edwards Road, Cerritos, California 90701.

SPECIAL! JIL SX-200-DA

List price \$499.95/CE price \$157.95/SPECIAL
Multi-Band - 16 Channel • No-Crystal Scanner
Frequency range 26-88, 108-180, 380-514 MHz.
The JIL SX-200 has selectable AM/FM receiver circuits, tri-switch squelch settings - signal, audio and signal & audio, outboard AC power supply - DC at 12 volts built-in, quartz clock - bright vacuum fluorescent blue read-outs and dimmer, dual level search speeds, tri-level scan delay switches, 16 memory channels in two channels banks, receive fine tune (RIT) ± 2KHz., dual level RF gain settings - 20 db pad, AGC test points for optional signal strength meters all for this special price.

NEW! Regency® HX1200-DA

List price \$369.95/CE price \$219.95/SPECIAL
8-Band, 45 Channel • No Crystal scanner
Search • Lockout • Priority • Scan delay
Sidelit liquid crystal display • EAROM Memory
New Direct Channel Access Feature
Bands: 30-50, 118-136, 144-174, 406-420, 440-512 MHz.
The new handheld Regency HX1200 scanner is fully keyboard programmable for the ultimate in versatility. You can scan up to 45 channels at the same time including the AM aircraft band. The LCD display is even sidelit for night use. Order **MA-256-DA** rapid charge drop-in battery charger for \$68.95 plus \$3.00 shipping/handling. Includes wall charger, carrying case, belt clip, flexible antenna and nicad battery.

NEW! Bearcat® 100XL-DA

List price \$349.95/CE price \$209.95/SPECIAL
9-Band, 16 Channel • Priority • Scan Delay
Search • Limit • Hold • Lockout • AC/DC
Frequency range: 30-50, 118-174, 406-512 MHz.
The world's first no-crystal handheld scanner now has a LCD channel display with backlight for low light use and aircraft band coverage at the same low price. Size is 1 3/4" x 7 1/2" x 2 1/4". The Bearcat 100XL has wide frequency coverage that includes all public service bands (Low, High, UHF and "T" bands), the AM aircraft band, the 2-meter and 70 cm. amateur bands, plus military and federal government frequencies. Wow...what a scanner!
Included in our low CE price is a sturdy carrying case, earphone, battery charger/AC adapter, six AA ni-cad batteries and flexible antenna. Order your scanner now.

Bearcat® 210XW-DA

List price \$339.95/CE price \$209.95/SPECIAL
8-Band, 20 Channel • No-crystal scanner
Automatic Weather • Search/Scan • AC/DC
Frequency range: 30-50, 136-174, 406-512 MHz.
The new Bearcat 210XW is an advanced third generation scanner with great performance at a low CE price.

NEW! Bearcat® 145XL-DA

List price \$179.95/CE price \$102.95/SPECIAL
10 Band, 16 channel • AC/DC • Instant Weather
Frequency range: 29-54, 136-174, 420-512 MHz.
The Bearcat 145XL makes a great first scanner. Its low cost and high performance lets you hear all the action with the touch of a key. Order your scanner from CE today.

NEW! Bearcat® 800XLT-DA

List price \$499.95/CE price \$317.95
12-Band, 40 Channel • No-crystal scanner
Priority control • Search/Scan • AC/DC
Bands: 29-54, 118-174, 406-512, 806-912 MHz.
The Uniden 800XLT receives 40 channels in two banks. Scans 15 channels per second. Size 9 1/4" x 4 1/4" x 1 1/2".

OTHER RADIOS AND ACCESSORIES

Panasonic RF-2600-DA	Shortwave receiver	\$179.95
Panasonic RF-B300-DA	Shortwave receiver	\$195.95
RD95-DA	Uniden Remote mount Radar Detector	\$128.95
RD55-DA	Uniden Visor mount Radar Detector	\$98.95
RD9-DA	Uniden "Passport" size Radar Detector	\$239.95
BC 210XW-DA	Bearcat 20 channel scanner SALE	\$209.95
BC-WA-DA	Bearcat Weather Alert*	\$49.95
DX1000-DA	Bearcat shortwave receiver SALE	\$349.95
PC22-DA	Uniden remote mount CB transceiver	\$99.95
PC55-DA	Uniden mobile mount CB transceiver	\$59.95
R1060-DA	Regency 10 channel scanner	\$98.95
MX3000-DA	Regency 30 channel scanner	\$198.95
XL156-DA	Regency 10 channel scanner SALE	\$129.95
UC102-DA	Regency VHF 2 chan. 1 Watt transceiver	\$124.95
RH250B-DA	Regency 10 ch. 25 Watt VHF transceiver	\$329.95
RH600B-DA	Regency 10 ch. 60 Watt VHF transceiver	\$459.95
RU150B-DA	Regency 10 channel UHF transceiver	\$449.95
RPH410-DA	10 ch. handheld no-crystal transceiver	\$399.95
P1405-DA	Regency 5 amp regulated power supply	\$69.95
P1412-DA	Regency 12 amp regulated power supply	\$119.95
BC10-DA	Battery charger for Regency RPH410	\$79.95
MA256-DA	Drop-in charger for HX1000 & HX1200	\$68.95
MA257-DA	Cigarette lighter cord for HX1200	\$19.95
MA917-DA	Ni-Cad battery pack for HX1200	\$34.95
EC10-DA	Programming tool for Regency RPH410	\$24.95
SMRH250-DA	Service man. for Regency RH250	\$24.95
SMRU150-CA	Service man. for Regency RU150	\$24.95
SMRPH410-DA	Service man. for Regency RPH410	\$24.95
SMMX7000-DA	Svc. man. for MX7000 & MX5000	\$19.95
SMMX3000-DA	Service man. for Regency MX3000	\$19.95
B-4-DA	1.2 V AAA Ni-Cad batteries (set of four)	\$9.00
A-135C-DA	Crystal certificate	\$3.00
FB-E-DA	Frequency Directory for Eastern U.S.A.	\$12.95
FB-W-DA	Frequency Directory for Western U.S.A.	\$12.95
TSG-DA	"Top Secret" Registry of U.S. Govt. Freq.	\$14.95
TIC-DA	Techniques for Intercepting Comm.	\$14.95
RRF-DA	Railroad frequency directory	\$10.95
CIE-DA	Covert Intelligenc. Elect. Eavesdropping	\$14.95
A60-DA	Magnet mount mobile scanner antenna	\$35.00
A70-DA	Base station scanner antenna	\$35.00
USAMM-DA	Mag mount VHF/UHF ant. w/ 12' cable	\$39.95
USAK-DA	3/4" hole mount VHF/UHF ant. w/ 17' cable	\$35.00
USATLM-DA	Trunk lip mount VHF/UHF antenna	\$35.00

Add \$3.00 shipping for all accessories ordered at the same time.
Add \$12.00 shipping per shortwave receiver.
Add \$7.00 shipping per scanner and \$3.00 per antenna.

BUY WITH CONFIDENCE

To get the fastest delivery from CE of any scanner, send or phone your order directly to our Scanner Distribution Center. Michigan residents please add 4% sales tax or supply your tax I.D. number. Written purchase orders are accepted from approved government agencies and most well rated firms at a 10% surcharge for net 10 billing. All sales are subject to availability, acceptance and verification. All sales on accessories are final. Prices, terms and specifications are subject to change without notice. All prices are in U.S. dollars. Out of stock items will be placed on backorder automatically unless CE is instructed differently. A \$5.00 additional handling fee will be charged for all orders with a merchandise total under \$50.00. Shipments are F.O.B. Ann Arbor, Michigan. No COD's. Most products that we sell have a manufacturer's warranty. Free copies of warranties on these products are available prior to purchase by writing to CE. Non-certified checks require bank clearance.

Mail orders to: Communications Electronics™ Box 1045, Ann Arbor, Michigan 48106 U.S.A. Add \$7.00 per scanner for U.P.S. ground shipping and handling in the continental U.S.A. For Canada, Puerto Rico, Hawaii, Alaska, or APO/FPO delivery, shipping charges are three times continental U.S. rates. If you have a Visa or Master Card, you may call and place a credit card order. Order toll-free in the U.S. Dial 800-USA-SCAN. In Canada, order toll-free by calling 800-221-3475. Telex CE anytime, dial 810-223-2422. If you are outside the U.S. or in Michigan dial 313-973-8888. Order today.

Scanner Distribution Center™ and CE logos are trademarks of Communications Electronics Inc.

* Bearcat is a registered trademark of Uniden Corporation.

† Regency is a registered trademark of Regency Electronics Inc.

AD #021586-DA

Copyright © 1986 Communications Electronics Inc.

**For credit card orders call
1-800-USA-SCAN**

**COMMUNICATIONS
ELECTRONICS INC.**

Consumer Products Division

P.O. Box 1045 □ Ann Arbor, Michigan 48106-1045 U.S.A.
Call 800-USA-SCAN or outside U.S.A. 313-973-8888



MX4000

HX2000

MX7000

CIRCLE 79 ON FREE INFORMATION CARD

WHAT'S NEWS

Solid-state power switch can be built into HVIC's

General Electric scientists reported to the recent 31st International Electronic Devices Meeting in Washington on work with a new type of solid-state power switch that could be built right into high-voltage integrated circuits (HVIC's). That would make it possible to boost the current rating of such IC's to an ampere or more.

The new device—the lateral

Insulated Gate Transistor (IGT)—has much in common with the vertical IGT, a revolutionary power device pioneered in the early 1980's. Like the earlier development, the new experimental device merges power MOSFET and bipolar technologies to achieve the best features of each—high current density and low drive current requirements.



A WAFER OF INSULATED gate transistor power switches about to be tested by G.E. scientist Dr. Eric Wildi. The new devices are so designed that it may be possible to build them right into high-voltage integrated circuits, making it possible for such high-voltage IC's to handle ten times as much power as they do now.

International standard on subjective speaker tests

The International Electrotechnical Commission (Geneva, Switzerland), has announced that it has

issued Part 13 of its Publication 263: "Sound System Equipment." Part 13 deals with a difficult subject: listening tests on loudspeakers.

The standard includes recommendations for the dimensions and acoustic characteristics of the listening room, descriptions of test procedures that have proved satisfactory, and considerable information on statistical methods for analysis of results. Particularly important are the statistical tests that show whether the results are reliable, and the confidence level at which they are significant.

Objective measurements—dealt with in Part 5 of the same publication—are important, but often do not predict actual performance. While subjective tests are difficult, the new standard indicates how all significant variables can be controlled, leading to reliable and reproducible results.

NEMA opposes protectionism, urges deficit reduction

The National Electrical Manufacturers Association (NEMA) has issued a 12-point Declaration of Trade Principles. Important points in a national trade policy, it states, are reduction of the budget deficit and opposition to protectionism.

NEMA believes that protectionist actions not aimed at achieving market access "could have serious negative consequences on American economic growth and the international trading system." (Resistance to protectionism is not to apply when such actions are intended to force open foreign markets.)

Other important points are "balanced administration of export controls," improvement of export credit facilities, and the use of government executive and legislative measures to assist in bringing about equivalent access to world markets.

R-E



ELECTRONICS, INC.

*New and Used Electronic Test Equipment
Sales • Service • Rental • Leasing*

HITACHI 3.5 Digit DMM *Free* With Scope Purchase



FEATURES:

- AC DC voltage
- AC DC current
- Resistance
- Diode test
- Audible Continuity check
- Temperature (Type K, 3510 & 3525)
- Data hold
- Manual or autoranging
- Overload protection
- LCD display
- Built-in stand
- Battery included
- Test leads included

Special!

MODEL	BASIC DC VOLTAGE ACCURACY	QTY 1 PRICE	QTY 3+ PRICE	One With Any Scope Purchased From RAG
3550	±.5% ±2 digits	\$49.00	\$42.00	FREE
3525	±.25% ±2 digits	\$64.00	\$54.00	\$19.95
3510	±.1% ±2 digits	\$79.00	\$67.00	\$29.95

2 year warranty plus carrying case included!



Model V-422 shown

MODEL V-222 \$536.00

DC to 20 MHz, 1 mV/div, Dual Trace, D.C. offset for DMM Output, Vertical Mode Trigger, 6" CRT (w/two X1/X10 probes).

MODEL V-422 \$694.00

DC to 40 MHz, other features same as V-222 (w/two X1/X10 probe).

MODEL V-1050F \$1,276.00

DC to 100 MHz, 5 mV/div, Quad Trace, Delayed Sweep, Full T.V. Triggering, alternate time base (w/two X1/X10 probes).

MODEL V-212 \$461.00

DC to 20 MHz, 1 mV/div, Dual Trace, Features 6" Rectangular CRT (w/two X10 probes).

MODEL V-650 \$956.00

DC to 60 MHz, 1 mV/div, Triple Trace, Delayed Sweep, Full T.V. Triggering, variable trigger hold-off (w/two X1/X10 probes).

NEW! 3 year warranty parts and labor on above scopes!

RAG Electronics is a factory authorized Hitachi repair center.

CIRCLE 126 ON FREE INFORMATION CARD

CALL US TOLL FREE
1-800-732-3457
IN CALIFORNIA TOLL FREE
1-800-272-4225

- Master Charge
- VISA ■ COD
- Money Order
- Check



ADD FOR SHIPPING AND INSURANCE

\$0 to \$250.00	\$4.50
\$251.00 to \$600.00	\$6.50
\$601.00 to \$750.00	\$8.50
\$751.00 to \$1000.00	\$12.50
over \$1000.00	\$15.00

Prices subject to change without notice.

RAG ELECTRONICS, INC. / 21418 Parthenia Street / Canoga Park, CA 91304 / 1-818-998-6500

ASK R-E

PC-BOARD GROUND PLANE

I'm familiar with the term *ground plane* as applied to antennas, but not to PC boards. What is the significance and importance of ground planes on PC boards? Can you suggest additional reading on the subject?—A. M. W., Nathrop, CO.



FIG. 1

A ground plane, as shown in Fig. 1, is a continuous, un-etched area of copper that is connected to circuit ground. Ground planes are used to minimize stray inductive and capacitive coupling and to eliminate ground loops in low-level, low-noise audio circuits, in HF and VHF circuits, and in digital circuits.

The ground plane may be on the wiring side of a PC board, the component side, or both. When it is on the component side of the board, the ground plane is generally unbroken, except for clearance around the component-terminal holes. When the ground plane is on the plated wiring side of the board, sensitive circuit lines are run close by, and parallel to the ground plane; alternatively, signal lines may be routed through the ground plane.

Our illustration shows the PC board pattern for a filter used in a 2-meter transmitter. The ground plane is on the wiring side of the board.

For more information on using and designing ground planes, refer to *The Design & Drafting of Printed Circuits* by Darryl Lindsey, published by Bishop Graphics,

Inc., West Lake Village, CA. Also see *Generation of Precision Artwork for Printed Circuit Boards* by Preben Lund, published by John Wiley and Sons, New York, NY.

SPEAKERPHONE INFORMATION

I saw the article, "New All-In-One Speakerphone," in the November, 1978 issue of Radio-Electronics, but I've been unable to contact either the author, Mr. Camenzind, or Tridar Corporation, the maker of the phone. I'd like to get a complete diagram and parts list, if they're available. The Tridar phone appears to include circuits that overcome the switching problem that develops when both parties on the phone line speak at the same time.—M. L. A., Philadelphia, PA.

Telephone technology has advanced quite a bit in the eight or so years since the Tridar speakerphone was developed. I'm sure that you can find a satisfactory speakerphone in a well-stocked telephone-supply store.

By the way, Motorola recently announced a new IC: the MC34018 Voiceswitch Speakerphone. That IC incorporates all necessary amplifiers, attenuators, and control functions to produce a hands-free speakerphone system. For a data sheet and circuit application diagrams, contact Mr. Ron Hlavinka, Motorola Semiconductor Products, P.O. Box 20912, Phoenix, AZ.

MEASURING SPEAKER IMPEDANCE

I am in auto-sound servicing and installation, and I have accumulated quite a few speakers. I don't know the impedance of many of those speakers. I know that I can't measure impedance with just a multimeter, but I don't know which instruments

WRITE TO:

ASK R-E
Radio-Electronics
500-B Bi-County Blvd.
Farmingdale, NY 11735

to use. I have most of the usual audio service instruments. Can you help me?—R.H., Hartsville, SC.

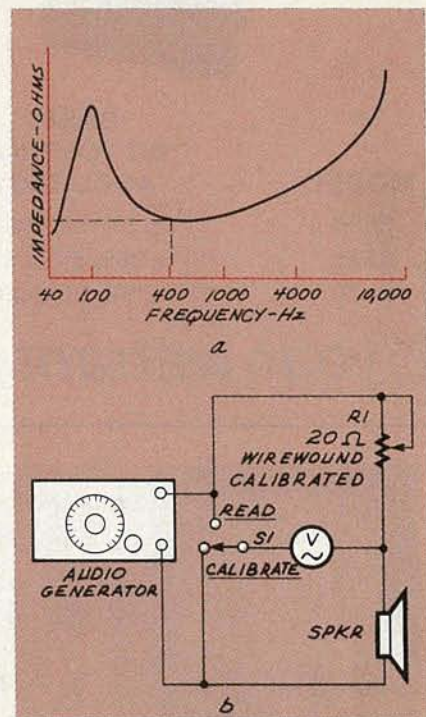

FIG. 2

The impedance of a loudspeaker varies with frequency along a curve like that shown in Fig. 2-a. The speaker's impedance can be measured with an audio generator, a variable resistor, and a high-impedance AC voltmeter. Wire the equipment as shown in Fig. 2-b, and set the generator's output for 400 Hz. With S1 in the CALIBRATE position, adjust the generator's output attenuator to give a full-scale reading on the meter. Then throw the switch to READ and adjust R1 until the meter reads the same in that position. The speaker's impedance then equals R1.

continued on page 12

How to beat the high cost of cheap meters.



You get what you pay for.
So get the Fluke 70 Series.

You'll get more meter for your money, whether you choose the affordable 73, the feature-packed 75 or the deluxe 77.

All of them will give you years of performance, long after cheaper meters have pegged their fishhook needles for the last time.

That's because they're built to last, inside and out. So they're tough to break. They don't blow fuses all the time. You don't even have to replace batteries as often.

And they're backed by a 3-year warranty. Not the usual 1-year.

Of course, you may only care that the world-champion 70 Series combines digital and analog displays with more automatic features, greater accuracy and easier operation than any other meters in their class.

You may not care that they have a lower overall cost of ownership than all the other "bargain" meters out there.

But just in case, now you know.

For a free brochure or your nearest distributor, call toll-free **1-800-227-3800, ext. 229.**

FROM THE WORLD LEADER
 IN DIGITAL MULTIMETERS.



FLUKE 73

\$79*

Analog/digital display
 Volts, ohms, 10A, diode test
 Audible continuity
 Autorange
 0.7% basic dc accuracy
 2000+ hour battery life
 3-year warranty



FLUKE 75

\$99*

Analog/digital display
 Volts, ohms, 10A, mA, diode test
 Audible continuity
 Autorange/range hold
 0.5% basic dc accuracy
 2000+ hour battery life
 3-year warranty



FLUKE 77

\$139*

Analog/digital display
 Volts, ohms, 10A, mA diode test
 Audible continuity
 "Touch Hold" function
 Autorange/range hold
 0.3% basic dc accuracy
 2000+ hour battery life
 3-year warranty
 Multipurpose holster

* Suggested U.S. list price, effective November 1, 1985
 ** Patent pending.

FLUKE

IN THE U.S. AND NON-EUROPEAN COUNTRIES: John Fluke Mfg. Co., Inc., P.O. Box C9090, M/S 250C, Everett, WA 98206, Sales: (206) 356-5400, Other: (206) 347-6100.
 EUROPEAN HEADQUARTERS: Fluke (Holland) B.V., P.O. Box 2269, 5600 CD Eindhoven, The Netherlands, (040) 458045, TLX: 51846.
 © Copyright 1985 John Fluke Mfg. Co., Inc. All rights reserved. Ad No. 4714-70

CIRCLE 261 ON FREE INFORMATION CARD

APRIL 1986

7

NEW!

Satellite Communications Training from NRI!



Move into commercial satellite communications and home satellite TV with NRI's latest training breakthrough!

Explore Every Aspect of Satellite Transmission and Reception As You Assemble, Install, and Train With the Complete TVRO System Included in Your Course

Back in 1964, great excitement surrounded the launching of Syncom 2, the true forerunner of today's satellites. But not even the most hopeful of scientists believed that in less than 25 years, communications satellites would have such a tremendous impact on the professional and personal lives of millions of people around the globe.

Today, thanks to the rapid development of satellite technology, a call to Paris is as clear and as easy to make as a call to your next door neighbor . . . executives from multi-national corporations and even small businesses use video conferencing to "meet" without leaving their offices . . . simultaneously a billion people witness a single event (a soccer game, an inauguration, a benefit rock concert) . . . global weather maps transmitted from satellites allow meteorologists to forecast weather trends weeks

in advance . . . and scientists now explore and investigate the mysteries of outer space without leaving their labs.

And, not surprisingly, these amazing applications of satellite technology have opened up exciting new opportunities for the technician trained to install, maintain, troubleshoot and repair satellite communications equipment.

Home Satellite TV Is Just at the Start of Its Explosive Future

You've seen them in suburban backyards and alongside country farmhouses. Home satellite TV systems are springing up all across the country.

Already there are over a million TVRO (Television Receive-Only) systems in place in the U.S. alone, and experts predict that by 1990, a remarkable 60% of U.S. homes will have a satellite dish. Contributing to the field's phenomenal growth are the support of the FCC and Congress, steady improvement in product quality, the development of smaller dishes, and a growing consumer enthusiasm for satellite TV.

New Jobs, New Careers for the Trained Technician

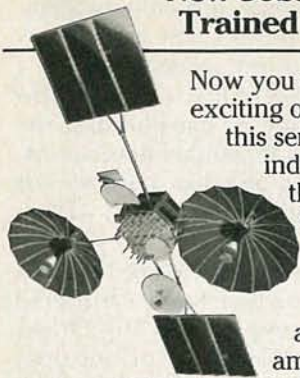

Now you can take advantage of the exciting opportunities opening up in this service- and support-intensive industry. NRI's new breakthrough training prepares you to fill the increasing need for technicians to install, adjust, and repair earth station equipment, such as dishes, antennas, receivers, and amplifiers.

As an NRI-trained technician, you can concentrate your efforts on consumer-oriented TVRO equipment. Or you can use your NRI training to build a career servicing larger commercial or military equipment used both to transmit and receive voice, data, and video signals. You'll also find opportunities in sales and system consulting, a role some expect to increase tenfold within the next five years on both the corporate and consumer levels.

NRI Brings Satellite Technology Down to Earth

Only NRI has the resources and the skills necessary to transform today's most sophisticated technology into understandable, step-by-step training.

NRI's new course in Satellite Communications gets you in on the ground floor of this booming technology. You are thoroughly trained in the necessary basic electronics, fundamental communications principles, and television transmission and operation.

Using the remarkable NRI Discovery Lab[®], you demonstrate first-hand many important points covered in your lessons. You perform critical tests and measurements with your digital multimeter. And, using your NRI Antenna Applications and Design Lab, you assemble and test various types of antennas and matching sections.

Then you concentrate on both commercial and consumer satellite earth station equipment, putting theory to practice as you assemble and install the 5' parabolic dish antenna system included in your course.

Your Home Satellite TV System Brings Theory to Life!

The Wilson TVRO system included in your course comes complete with 5' parabolic dish antenna system, low-noise amplifier (LNA), down converter, receiver, low-loss coaxial cable, and even a permanent polar mount.

By training with an actual TVRO system, you'll come to understand the function and operation of a satellite earth station—knowledge that you can apply to both consumer and commercial equipment. And once you have completed your TVRO system, you'll have access to the best television entertainment available—direct from the satellite to your home.



At-Home Training the Uniquely Successful NRI Way

It's hands-on training, at home. . . designed around the latest state-of-the-art electronic equipment you work with as part of your training. You start from scratch and "discover by doing" all the way up to the level of a fully qualified professional. You conduct key experiments. . . perform vital tests. . . install your own system. . . and you do it at the pace that suits you best.



But, most important to your success, you don't do it alone. Built into your NRI training is the enormous experience of our development specialists and instructors, whose long-proven training skills and personal guidance come to you on a one-to-one basis. They are always available for consultation and help.

Make Your Move Into the Future Today! Send for Your FREE NRI Catalog

Only NRI can train you at home for an exciting and rewarding career as a satellite communications technician. The knowledge and know-how you gain from your NRI training provide you with the soundest possible foundation for further growth with the industry. But now is the time to act. Return the post-paid card to us today. You will receive your 100-page catalog free. It's filled with all the details you'll want to know about our training methods and materials and our more than 70 years of successful

innovation in at-home, hands-on career training—the kind of experience that enables NRI to provide the most effective training possible to prepare you for today's, and tomorrow's, high-tech opportunities. (If the card is missing, write to us at the address below.)



NRI SCHOOL OF ELECTRONICS

McGraw-Hill Continuing Education Center
3939 Wisconsin Avenue, NW
Washington, DC 20016

We'll give you tomorrow.



ASK R-E

continued from page 6

NEEDS TUNING CAPACITOR

I want to build the antenna tuner described in "Hobby Corner" in the April, 1985 issue of Radio-Electronics. I also have a couple of other projects that I'd like to build, but I am unable to find a component that prevents me from completing any of them. In all cases, that component is a 365-pF variable capacitor. Where can I obtain one? I've tried several local parts distributors, but none have been able to help me.—H. M. H., San Antonio, TX.

A 365-pF single-gang "broadcast receiver type" variable capacitor is carried by Mouser Electronics. The stock number is 524-A1-227, and the price is \$10.95. Mouser has a \$20.00 minimum order, otherwise add \$5.00 for handling. The Mouser distribution center in areas east of the Montana-Wyoming-Colorado-New Mexico borders is 2401 Gughway, 287-North, Mansfield, TX 76063.

A cheaper way to go would be to use a capacitor from an old radio. If you have an old table-model AC-DC radio in the attic or basement, take a look at the tuning capacitor. Most likely, you'll see two separate sections or "gangs." One gang has larger plates or a greater number of plates than the other. The larger section has a nominal range of 10 to 365 pF. The smaller section has a range of about 0 to 110 pF, and it could be used in place of a 100-pF variable capacitor in a "classic" regenerative-type shortwave radio.

PARTS FOR CRYSTAL RADIO

I teach high-school physics and I'd like to develop a laboratory experiment on LC circuits that uses a crys-

tal radio. While present-day semiconductor diodes can work wonders, I'd like my students to see a radio as it was in the "old days." Do you know where I can purchase the galena-and-catswhisker detector assemblies? I'd also like a source for the old-fashion phone tips.—D. E. W., Columbus, OH.

The parts you want are listed in catalog No. 823 from Philmore Manufacturing Co., 40 Inip Drive, Inwood, NY 11696. The phone tips, part No. 2181 are on page 36. A complete crystal-and-catswhisker assembly is part No. 7003, and a galena crystal alone is part No. 7005. Both of those are listed on page 60. Write Philmore or call them at (516) 239-6161 for information on price and availability. Also, Calectro lists phone tips (part No. F2-872) in a recent catalog. For more information, call Calectro at (815) 968-9661.

In the early 1930's many of us couldn't afford to purchase crystal detectors, so we made our own. As I recall, we melted a pea-sized lump of pure lead in a spoon over

GOT A QUESTION? ASK R-E!

We welcome your questions in any area of electronics. Send them to Ask R-E, Radio-Electronics, 500-B Bi-County Boulevard, Farmingdale, NY 11735. We regret that we cannot answer your questions individually, but those of widest interest to our readers will be published.

CABLE TV SPECIAL!

General Instrument/Jerrold Cordless Cable TV Converter

MODEL DRZ-450

(66 CHANNELS)



NEW
SPECIAL!

• With Automatic Fine Tuning

\$69.95
ANY QUANTITY

TEKNIKA WIRELESS REMOTE CONTROL TV TUNER CABLE CONVERTER



SPECIAL!
WITH VOLUME
CONTROL
140
CHANNEL
\$139.95

RG-59/U 75 OHM
Co-Axial Cable
Copper Braided
Shield
White or Black
Bare copper
conductor
Braided bare
copper shield
\$44.50/1000 ft.

CONNECTORS

F-59
separated ferrule

6c/1000 LOT
11c/100 LOT

F-59ALM
with attached 1/2" grip ring

7c/1000 LOT
12c/100 LOT

F 56 AVAILABLE UPON REQUEST

MATCHING TRANSFORMER

21c/100 Lot

2 WAY-75OHM U/V SPLITTER

49c/100 LOT
89c/50 LOT
99c/EA.

OMNITRON

ELECTRONICS
770 Amsterdam Ave., New York, NY 10025

■ Write for FREE 136 page Catalog ■

SHIPPING CHARGES

For Orders	ADD
\$25 - 100	\$6.50
\$100 - \$500	\$8.50
\$500 - \$750	\$10.50
\$750 and up	\$15.00

MASTER CARD • VISA

Send Purchase Order, Check,
Money Order or C.O.D.

or Call Toll Free

800-223-0826

in N.Y. State (212) 865-5580

FORDHAM WILL BEAT ANY ADVERTISED

B&K LEADER HITACHI AW SPERRY NON-LINEAR BBC

OSCILLOSCOPE PRICE by \$25⁰⁰

No ifs, ands or buts.

Copyright © Fordham 1985

Must be a currently advertised price.
This offer may be withdrawn at any time without prior notice.

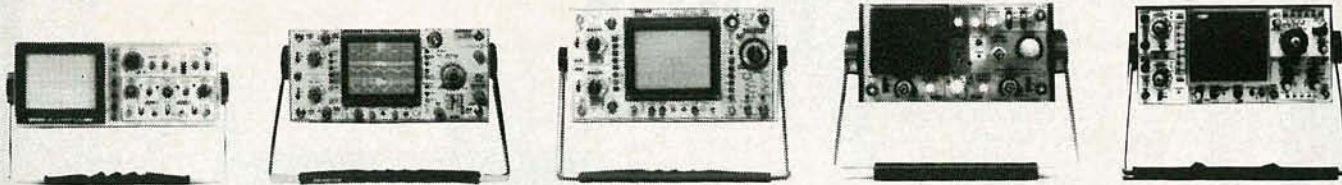

ASK FOR FREE CATALOG.
Money orders, checks accepted. C.O.D.'s require 25% deposit.



Fordham

Toll Free
800-645-9518
In NY State 800-832-1446

260 Motor Parkway, Hauppauge, NY 11788

Service & Shipping Charge Schedule Continental U.S.A.

FOR ORDERS	ADD
\$25-\$100	\$4.50
\$101-\$250	\$6.00
\$251-500	\$8.00
\$501-750	\$10.50
\$751-1000	\$12.50
\$1,001-1500	\$16.50
\$1,501-2000	\$20.00
\$2,001 and up	\$25.00

an alcohol lamp.

After the lead melted we sprinkled it with powdered sulphur. The sulphur flamed and combined with the lead to form lead sulfide (PbS), a hard crystalline mass. You and your class could experiment with different mixes until you got a "hot" crystal. We used to mount the crystal in Wood's metal that was salvaged from a blown fuse cartridge or plug. Don't forget that the crystal set works best when its coil is wound around a genuine Quaker Oats oatmeal box.

SIMPLE RF FIELD MONITOR

I enjoy flying radio-controlled

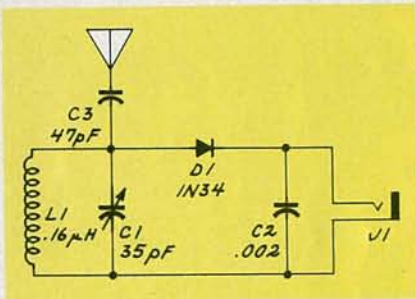

FIG. 3

model airplanes. I use AM digital/proportional control on Channel 44 (72.670 MHz). I need to know if someone is using that channel before I put my plane in the air. Can you give me the circuit of a simple monitor for that frequency?—B. G., Evergreen Park, IL.

A simple crystal receiver should do the trick. The circuit in Fig. 3 shows a suitable circuit. Coil L1 should be wound from eight turns of 18-gauge enameled wire spaced two inches apart on a 1/2-inch form. Use high-impedance phones (2000 ohms or more) for best sensitivity.

FM NOTCH FILTER

I want to notch-out a local FM station at 103.9 MHz so that I can pick up a distant station at 103.7 MHz. I feel that the solution lies in using using op-amp active filters. Can you help me?—N. F., Clifton Heights, PA.

I don't feel that using op-amp active filters is the most practical way to go.

As an alternative, an inexpensive and highly effective notch filter can be built merely from a section

of coaxial transmission line that is connected across the lead-in at, or

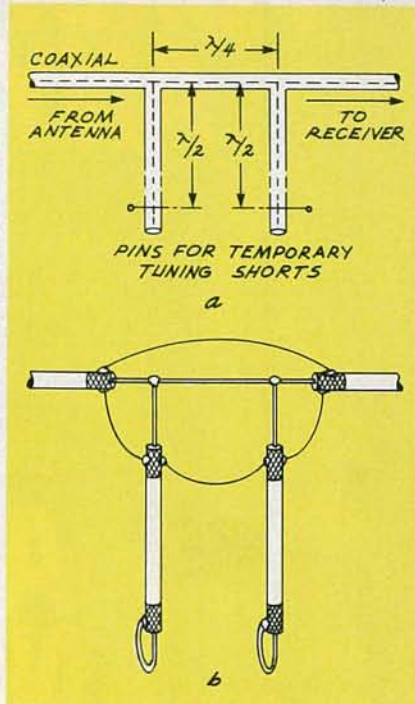

FIG. 4

close to, the receiver's antenna input. With careful measurement continued on page 99

WAVETEK®

Our 2 MHz Function Generator has an unlimited range.

Model 20 not only covers the .002 Hz to 2.1 MHz frequency range, it covers the world. With internal NiCad batteries,* you can take Model 20 anywhere and get triggered, gated or continuous waveforms—sines, squares, and triangles up to 20 volts peak to peak. It recharges from wall transformer (included) or external source from 12 to 25 VDC or 10 to 18 VAC. Model 20 also has many of the features you would expect from the industry leader in function generators, including VCG input connector for external sweep or FM, step attenuator to -80dB, and a TTL pulse output. The price is just \$395. For a data sheet or to order, call or write Wavetek San Diego, P.O. Box 85265, 9045 Balboa Ave., San Diego, CA 92138. Phone (619) 279-2200; TWX (910) 335-2007. *Batteries not included.



CIRCLE 262 ON FREE INFORMATION CARD

PERFORMANCE THAT IS OUT OF THIS WORLD...



\$389⁰⁰
MODEL 2000 20MHz
DUAL TRACE

\$549⁰⁰
MODEL 3500 35MHz
DUAL TRACE DELAYED SWEEP

...AT A DOWN TO EARTH PRICE

At last! Truly affordable test equipment with no compromise in design, and features you would expect to find only on oscilloscopes costing hundreds of dollars more! JDR Instruments presents two, new, high-performance models backed by a two year warranty and technical support which is only a phone call away. Perfect for the technician or advanced hobbyist, both models feature Dual Trace capability and a variety of operating and triggering modes, including CH-B Subtract and X-Y operation.

MODEL 2000 has a 20 MHz bandwidth and 20 calibrated sweeps ranging from .2s to .2 μ s. A convenient built-in component tester provides additional diagnostic power.



INCLUDES TWO HIGH QUALITY
1x, 10x TEST PROBES

MODEL 3500 features a 35 MHz bandwidth and exceptional 1mV/DIV sensitivity. Delayed sweep and variable holdoff allow stable viewing of complex waveforms.

CIRCLE 59 ON FREE INFORMATION CARD

ORDER TOLL FREE
800-538-5000
800-662-6279 (CA)

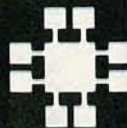

JDR INSTRUMENTS
1224 South Bascom Avenue
San Jose, California 95128 (408) 995-5430

VIDEO NEWS



DAVID LACHENBRUCH
CONTRIBUTING EDITOR

● **Polaroid drops VCR's.** After a lengthy market test, Polaroid, the originator of instant photography, has decided against entering the field of instant video photography, at least for the time being. Polaroid, one of the first companies to announce an interest in 8mm video camcorders, in 1984 demonstrated a model made for it by Toshiba with great fanfare. But instead of putting it on the nationwide market, the company decided on a test in the Tampa-St. Petersburg-Sarasota area. After a long test, Polaroid said: "We will not pursue expansion nationally with that model." A spokesman said there were no plans to market any VCR's now, but that decision was subject to change in the future. Polaroid remains active in video, however, by continuing to market a line of videocassettes.

● **TV "blue boxes."** The coming generation of digital TV-sets is designed for easy servicing by reprogramming them. Access for servicing, in the case of sets using ITT digital IC's, is provided via a rear-panel connector or by dialing up a special code on the wireless remote-control unit. In both cases, that gives the repair technician access to the set's control bus. From there, it would be an easy matter to defeat the sync-suppression decoding used by most cable-TV systems for their premium channels, according to engineers of the National Cable TV Association. The NCTA fears that the introduction of digital TV sets will lead to a flood of "blue boxes" to let cable subscribers decode pay-TV programs without paying for them. The NCTA has written to all major TV-set manufacturers urging them to "take the necessary steps to make it impossible to externally force" one of ITT's VLSI chips to defeat pay-TV encoding.

● **Home word-processing.** Several manufacturers are betting that the next major consumer-video product will be the home word-processor. They shrug off the 1985 slowdown in home-computer sales, arguing that word processing is the most significant true home use for a computer and that a dedicated word-processor can make inroads in virtually any

home where a lot of typing is done, as well as among college students. Two such dedicated home machines have now been introduced.

North American Philips Co., in a joint venture with parent N.V. Philips of the Netherlands, has introduced the Magnavox *Videowriter* (it will be called the Philips *Videowriter* in other countries), an easy-to-use replacement for the typewriter, consisting of a console with a 4-by-9-inch amber CRT, a single 3.5-inch disk drive with a built-in dot-matrix thermal printer on top. It has a separate keyboard with standard typewriter-key layout and 17 special-function keys, plus a cluster of four keys for cursor control. Nationwide marketing is planned this year at a suggested list price of \$800.

SCM, the typewriter company, has introduced its own *Personal Word Processor* consisting of a 12-inch monitor screen with a wafer-tape memory system and keypad to control special functions. A compatible SCM electronic typewriter must be used by the system; that typewriter provides the keyboard and printer functions. The *Personal Word Processor* is priced at \$500, compatible SCM electronic typewriters at about \$300 to \$500.

● **Another VHS victory.** The ranks of companies putting their brand names exclusively on Beta VCR's in the half-inch field now have thinned to two—Sony and its affiliate, Aiwa. Sanyo, which recently has claimed to sell more Beta VCR's than any other brand, has now decided to field VHS as well as Beta recorders under its own brand name. The recorders will be made by a subsidiary, Tokyo Sanyo, which has been manufacturing VHS recorders for sale under the Fisher brand, owned by Sanyo. Sony's recent repositioning of Beta to a high-priced enthusiasts' line with the SuperBeta system and Beta Hi-Fi made it necessary for Sanyo to add VHS to keep its price-conscious mass-market status. Among brands originally in the Beta camp, four have added VHS (NEC, Toshiba, Radio Shack, and Sears Roebuck), and four others have switched from Beta to VHS (Fisher, Marantz, Teknika, and Zenith).

R-E

Heathkit®



Robotics technology comes to life in building HERO® 1 and teaching it movement, speech and object manipulation.

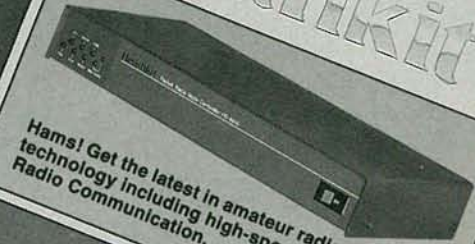

Hams! Get the latest in amateur radio technology including high-speed Packet Radio Communication.



Build from our full line of precision test instruments and see how they can increase your troubleshooting effectiveness.



Powerful new IBM-PC compatible Heathkit computers are yours to build easily and save with, or to buy assembled.



New Digital Rain Gauge records rainfall accurately and reads out inside your home in 100ths of an inch.

Your guide to everything that's new in electronics, computers and technical education. Over 400 items. Discover fascinating kits to build, enjoy and learn with, as well as assembled high tech products for home, business and hobby.

Get our famous High Tech Catalog

FREE

Heathkit®
Heath
Company

Heath Company
Dept. 020-406
Benton Harbor, Michigan 49022

MAIL COUPON TODAY and receive the latest issue of the Heathkit Catalog free of charge

Name _____

Address _____

City _____ State _____

CL-783DR2 Zip _____

A subsidiary of Zenith Electronics Corporation

CIRCLE 277 ON FREE INFORMATION CARD

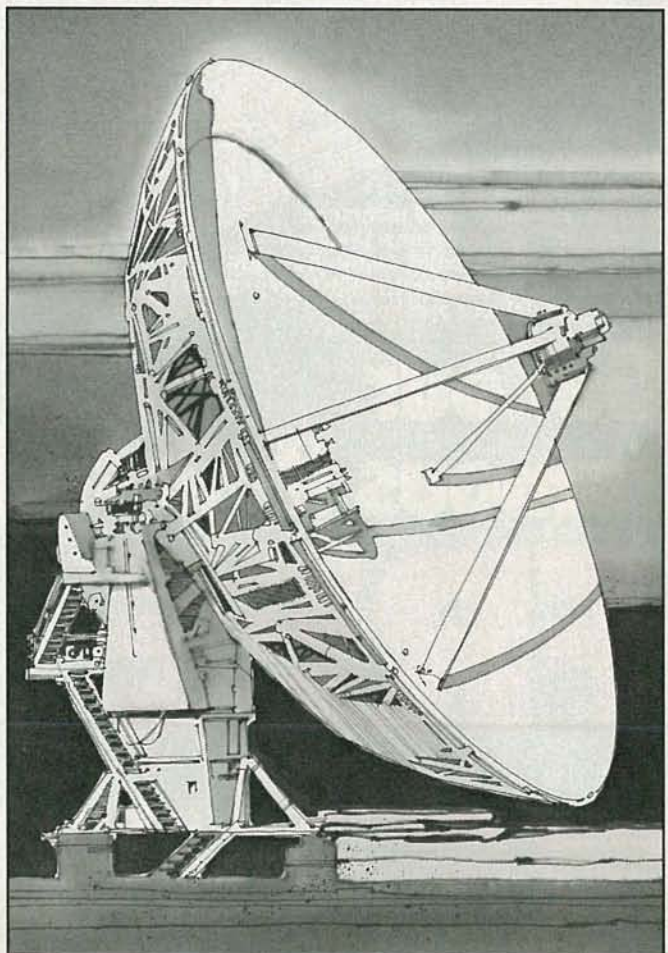
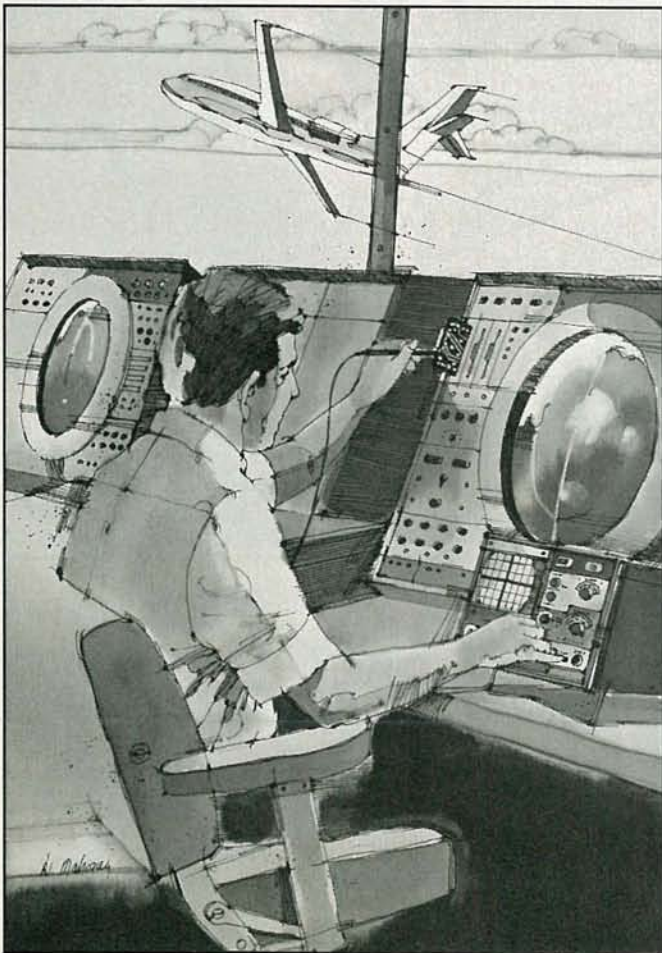
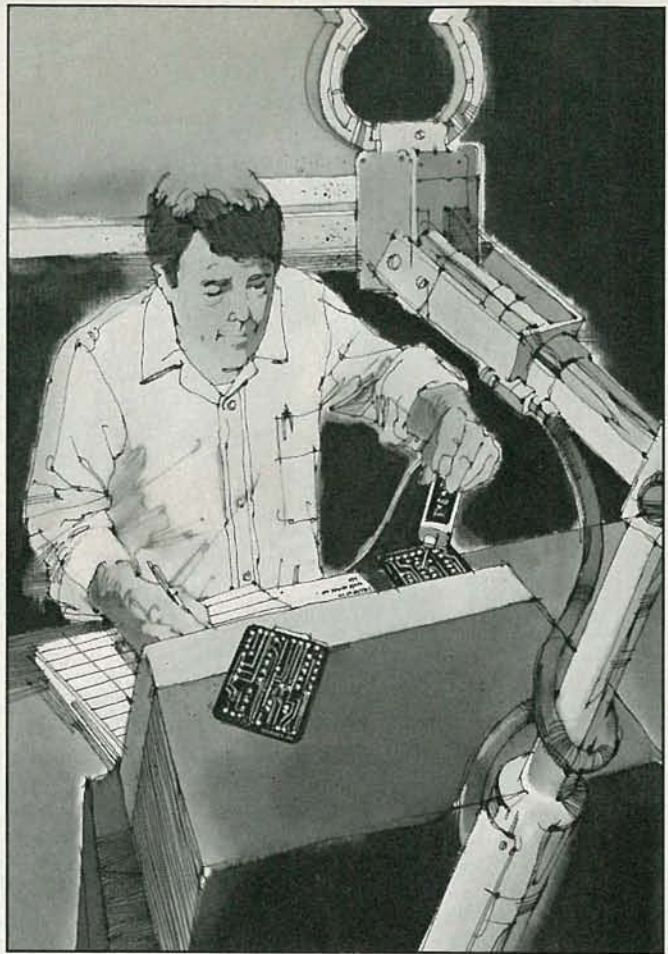
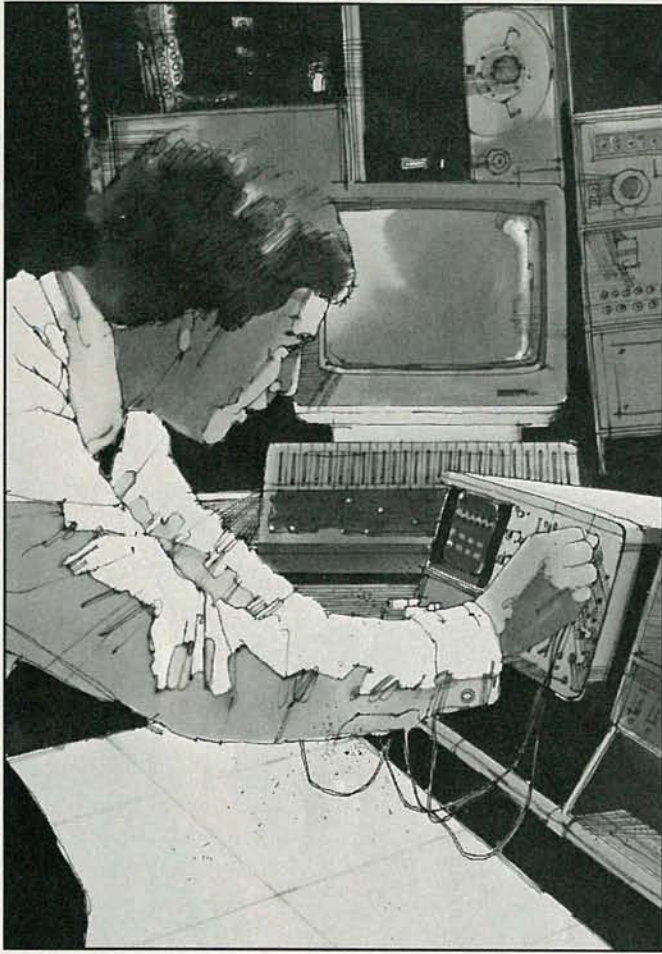

CIE MAKES THE WORLD OF ELECTRONICS YOURS.

Today's world is the world of electronics. To be part of it, you need the right kind of training, the kind you get from Cleveland Institute of Electronics, the kind that can take you to a fast growing career in business, aerospace, medicine, science, government, communications, and more.

Specialized training.

You learn best from a specialist, and that's CIE. We're the leader in teaching electronics through independent study, we teach only electronics and we've been doing it for over 50 years. You can put that experience to work for you just like more than 25,000 CIE students are currently doing all around the world.

Practical training.

You learn best with practical training, so CIE's Auto-Programmed® lessons are designed to take you step-by-step, principle-by-principle. You also get valuable hands-on experience at every stage with sophisticated electronics tools CIE-designed for teaching. Our 4K RAM Microprocessor Training Laboratory, for example, trains you to work with a broad range of computers in a way that working with a single, stock computer simply can't.

Personalized training.

You learn best with flexible training, so we let you choose from a broad range of courses. You start

with what you know, a little or a lot, and you go wherever you want, as far as you want. With CIE, you can even earn your Associate in Applied Science Degree in Electronics Engineering Technology. Of course, you set your own pace, and, if you ever have questions or problems, our instructors are only a toll-free phone call away.

The first step is yours.

To find out more, mail in the coupon below. Or, if you prefer, call toll-free **1-800-321-2155 (in Ohio, 1-800-523-9109)**. We'll send a copy of CIE's school catalog and a complete package of enrollment information. For your convenience, we'll try to have a representative contact you to answer your questions.

CIE Cleveland Institute of Electronics

1776 East 17th St., Cleveland, Ohio 44114

YES! I want to get started. Send me my CIE school catalog including details about the Associate Degree Program. I am most interested in:

- | | |
|--|---|
| <input type="checkbox"/> computer repair | <input type="checkbox"/> television/high fidelity service |
| <input type="checkbox"/> telecommunications | <input type="checkbox"/> medical electronics |
| <input type="checkbox"/> robotics/automation | <input type="checkbox"/> broadcast engineering |
| <input type="checkbox"/> other _____ | |

Print Name _____

Address _____ Apt. _____

City _____ State _____ Zip _____

Age _____ Area Code/Phone No. _____

Check box for G.I. Bulletin on Educational Benefits

- Veteran Active Duty

MAIL TODAY!

OR CALL TOLL FREE
1-800-321-2155
(In Ohio, 1-800-523-9109)

RE-34

It's about JOBS It's about MONEY

The U.S. Labor Department, in their 1984 Occupational Projections and Training Data report, predicts that 589,000 positions will need to be filled by 1995.

Isn't it about TIME

To prepare for an interesting and rewarding career in
**COMPUTER TECHNOLOGY
TELECOMMUNICATIONS
OR ROBOTICS?**

Isn't it about time to invest in YOU?

We Offer:

- Training that keeps pace with each new advancement
- Facilities that are modern, attractive and comfortable
- Amenities and services to promote your success
- Financial assistance is available
- And once you graduate, placement assistance is also available

**Phoenix Institute
of Technology**

2555 E. University Drive
Phoenix, Arizona 85034
(602) 244-8111

For more information about careers in Electronics Technology, address inquiries to Admissions Department

Name _____
Address _____
City _____
State _____ Zip _____
Phone () _____

LETTERS



BAD IDEA?

I must take exception to the "New Idea" presented in the October, 1985 issue of *Radio-Electronics* (page 46). The article specified a 74L04 inverter. A TTL Databook gives the following data for that inverter:

- High-level output current: 200 μ A
- Low-level output current: 3.6 mA
- High-level output voltage: 2.4 V (min)

For a best-case situation when the output of the 74L04 is high (2.4 volts) the current flowing through LED is given by $(2.4 - 0.7 \text{ volts}) / 270 \text{ ohms} = 6.3 \text{ mA}$. (0.7 volts assumed for the LED). According to the data sheet, the 74L04 can not supply that current.

One should never drive current into an LED directly from a TTL out-

put. A better solution is to use the TTL output to sink current as shown in Fig. 1-a.

A little math shows that if the 74L04's output is at zero volts, the current it must supply is $(5 - 0.7 \text{ volts}) / 270 \text{ ohms} = 16 \text{ mA}$ —still an unacceptable value for the 74L04!

The solution is to use a 7404 inverter. It can sink 16 mA, although sinking that much current would leave nothing with which to drive another gate. The preferred solution would be to use a 7404 inverter with a 510-ohm resistor in series with each LED. To be consistent, the 555 should also sink current to light the LED. A correct circuit is shown in Fig. 1-b.

MIKE PETROSKI
West Palm Beach, FL

OOPS!

I don't know if any other readers caught it, but I would like to point out a rather dramatic error in the November, 1985 issue of *Radio-Electronics*.

On page 72, in the article "Medical Uses of Electric Shock," by Dr. Ray Fish, concerning the use of electric shock for patient care, you show an ECG of a patient with ventricular fibrillation. The strip is mounted backward as compared to the text definition. The area labelled "D" is the heart in fibrillation, and just to the left of "D" is a rather large square wave. That wave represents the defibrillator discharging. "C" shows the heart in a post-shock recovery phase, and "A" shows the heart starting to pump again. I have no idea what "B" is supposed to represent as the arrow points to the heart in a resting "repolarization" phase.

Also, you point out that the defibrillator is charged to 1,000 volts.

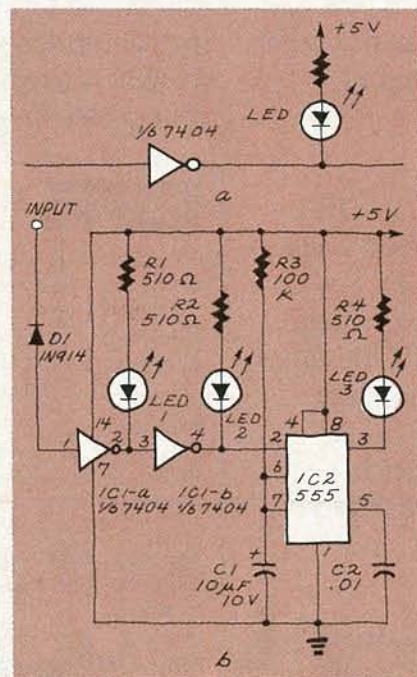

FIG. 1

It is more important to point out that the current delivered will be about 62 amps into a non-inductive load of approximately 52 ohms. It is the current that causes the heart to contract firmly and then relax, and wait for the sinoatrial node to start firing again. Unfortunately, many of those popular medical television programs have fed us the myth that the heart will spring back into a normal rhythm after defibrillation. That is not the case. It usually takes a lot of CPR and medical treatment to bring the heart back into a life-sustaining rhythm.

STEVE HOPF

Olympic Memorial Hospital
Port Angeles, WA

PRINTER BUFFER ROM LISTING

Concerning the recent controversy about the Printer Buffer and the ROM listing, I can well appreciate the author's not wanting to divulge the ROM listing so that anyone could steal the fruits of his labor. On the other hand, as a purchaser of the ROM, I would like to know if a replacement is available for the one I bought should it fail in the future. Even the best businesses have been known to fail. If the maker of my ROM should fail, where would I be?

What I propose is that the author make available to **Radio-Electronics** a copy of the ROM listings. The magazine would agree to keep them confidential as long as the replacements were available from the author or his distributor. If for any reason ROM's were no longer available from those sources, **Radio-Electronics** would be free to distribute the listings publicly. That would serve to protect the interests of both the author and consumer.

CLARENCE VRANISH
Evanston, WY

NEEDS EICO MANUAL

I have been a newsstand buyer of **Radio-Electronics** for a number of years. However, space limitations have prevented me from retaining back issues except for articles of special interest.

Recently a friend of mine retired to Florida and gave me an EICO 427

scope. However, the instruction manual had been lost. I do remember ads with EICO products, but I haven't seen any in recent issues.

Is EICO still in business? If not, where can I purchase a manual for the scope?

WESLEY E. JOHNSON
Vandalia, OH

We are pleased to report that EICO is still in business and is located at 108 New South Road, Hicksville, NY 11801.

WAYS TO PROTECT AGAINST EMI

In Mr. Violette's article, "Electromagnetic Interference," (**Radio-Electronics**, November 1985) there was no mention of a new option that is now available to the hobbyist. I refer to my own invention, which is described in U.S. Patent #4326179. I call it a *Lossy Line Filter*. It consists of one step-up transformer (to about 10,000-volts AC) and one step-down transformer (to 115-volts AC). The transformers are connected by two lengths of distributed resistance.

STUN GUN



Free holster with purchase.



EQUALIZER

- The ultimate non-lethal defense weapon.
- In five seconds can immobilize your attacker, even through heavy clothing.
- Discharges over forty thousand volts of electricity from a nine volt nickel-cadmium battery.
- \$49.95, Mass 5% sales tax, \$3.00 shipping and handling.

1-800-522-2636
FOR ORDERS ONLY
617-871-5611
FOR INFORMATION

Cameo Enterprises, Inc.
P.O. Box 63, Accord, MA 02018

CIRCLE 267 ON FREE INFORMATION CARD

OK Test Equipment



Function Generators

- MODEL 205 FUNCTION GENERATOR**
- .005Hz to 5MHz • Sine, Square, Triangle, Haversine, Pulse and Ramp Waveforms. • Run, Trigger, Gate & One Shot Modes
 - Variable start/stop phase $\pm 90^\circ$ • Continuously variable symmetry to 19:1 • Variable amplitude, DC offset, and attenuation
 - 20V p-p and TTL outputs • External Sweep
- MODEL 206 SWEEP/FUNCTION GENERATOR**
- All Model 205 features plus: • Linear and Log Sweep to 10,000:1 both internal and external • Marker with variable duration plus hold • Continuous and single sweep plus hold • Dial-and-enter sweep limits • Additional 600 Ω sweep output
- MODEL 207 PULSE/FUNCTION GENERATOR**
- All Model 205 features plus: • Variable Pulse Frequency .005Hz to 5MHz • Normal, Square, Double, and delayed pulse modes
 - Variable pulse width and delay 5ns to 50ms • Symmetrical, complement, low clamped, and high clamped wave forms.

AFFORDABLE EXCELLENCE

3455 Conner Street, Bronx, New York, 10475, U.S.A
Telex 125091 OK NYK Telex 232395 OK NY UR
Phone (212) 994-6600
Fax (212) 994-4755



CIRCLE 272 ON FREE INFORMATION CARD

\$ 339.00 LOGIC ANALYZER

Add-on for your
Oscilloscope

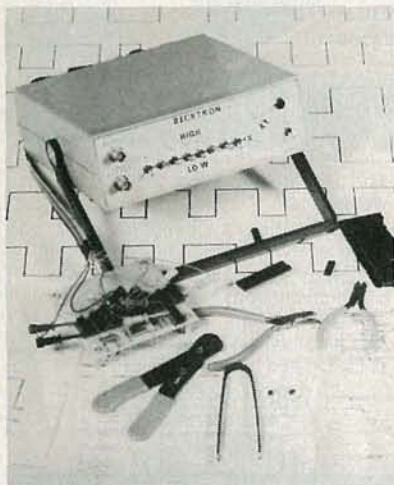

**8 Channel Logic
Analyzer To Be Used
With Your Scope As
The Display Media**

- Featuring -

**Pre-settable Triggering
Sample Rate
200 Nano Seconds
2K Memory Per Channel
Displaying 1K
Before Trigger And
1K After Trigger
Trigger Centered On
Screen**



Orders
1-800-592-4141

For Information:
1-307-856-0771

Becktron
P.O. Box 528
Riverton, Wyo. 82501

CIRCLE 281 ON FREE INFORMATION CARD

The transformers can be neon-sign transformers or even oil-burner transformers. The resistors can be made by coating vulcanized fiber strips (fish paper) with conducting latex paint.

A simple calculation shows that the resistors can be as high as several thousand ohms without seriously limiting the amount of 60-Hz power that can be supplied. Damaging line spikes don't get through at all.

In my opinion, most, if not all, of the devices currently sold to suppress voltage spikes are based upon fallacious premises. EMI is, in any particular case, an exceedingly complicated problem, involving Maxwell's equations in a three-dimensional, time-varying way; they involve reflections and all the other complications that electromagnetic theory presents. To an EMI spike all capacitors, inductors, shields, and grounds look like metallic surfaces along which they travel on the way to your gates. The only thing guaranteed to blunt the killing power of a spike is a long, exhausting trip through a distributed resistor.

Make the "hand-drill test" with a Lossy Line Filter and any other you can build or buy. You will find that there is no contest.

THEODORE LASAR
New York, NY

ELECTRONIC WALL GAME

I have a commercial arcade-type (coin-operated) electronic wall-game called SUPER BOWLER MODEL 100A that is in need of some troubleshooting. The game is approximately 10 years old and was manufactured by the now defunct Sunbird Electronics Corporation of Minneapolis, MN.

I need a schematic and circuit description or any other information on the Sunbird Corporation's new name and owner.

I am willing to pay any reasonable fee for reproduction and postage costs.

CARL CICIORA
3815 Fee Fee
Bridgeton, MO 63044.

FIGHT AGAINST CANCER

Back in 1979 I was fortunate to find and read your editorial "The Fight Against Cancer—A Turn To-

wards Electronics," **Radio-Electronics**, September 1979. You described hydrothermia, an experimental medical electronic treatment using RF energy to heat and selectively destroy cancerous tissue. I was inspired by your pride at realizing the extent to which medical research is turning toward electronics.

Well, recently I again found and read your editorial. Again I was inspired and this time enough to write and tell you about recent enlightening developments in the field.

As you earlier described, hydrothermia consists of RF energy ranging in frequency from several megahertz to the microwave area that causes a heating effect upon the exposed cells. But the effects are observed to be quite different when the RF field is in broadcast resonance with the frequency of the living cell's own electrical system.

Pulsed RF signals that cause broken bones to mend effectively, that stimulate the re-growth of lost limbs, and that also arrest cancer growth have led scientists to discover a biological waveband within the 0- to 0.003-MHz range of the electromagnetic spectrum. That waveband makes possible cellular communications in a language that cells understand. It is a way of altering the behavior of cells by delicately directing cell growth and repair.

That practical method holds great promise toward revolutionizing all of medicine. But despite early advances, important questions remain. Investigators now seek to understand the bio-electrochemical interface mechanism—or, chiefly, to find out what is the sequence of events that are involved with the coupling of the electromagnetic field with the various biological processes. Knowledge of that fundamental interaction will serve in part as the theoretical framework of the science of electrophysiology.

The sweeping turn toward electronics to solve biological problems is appropriate because most of the forces that concern humans in this world are electromagnetic. All of the ordinary chemical and biological effects are due to the

interaction of electric charges and the fields they produce. Electrophysiology represents our most nearly perfect understanding of the hierarchy of electrical activity that we call life.

GLENN M. ALEXANDER
New York, NY.

DEFECTIVE RESIST

Our records indicate that many readers of R-E have purchased bottles of ER-71 etch resist spray. We have found that some ER-71 etch resist spray, lot #900 (may appear to be 006 if read upside down) does not flow properly; it has a tendency to "crawl" even though the circuit board has been properly cleaned.

If you have one of these defective bottles, please do the following:

1. Empty the bottle.
2. Replace the original black plastic cap
3. Return to The Datak Corporation, 65 71st Street, Guttenberg, New Jersey, 07093. A no-charge replacement will be shipped to you within the next five weeks.

We are sorry for any problems you may have had.
CATHERN PFLUEGER
The Datak Corporation

PC SERVICE

I cannot respond directly to your request for comments on using your new PC Service since I haven't tried it, though I think it is a great idea with much merit and promise. However, I think my experience making PC boards in the last couple of years bears directly on what you are attempting to do.

Robert Grossblatt's fine, three part article "Etch Your Own PC Boards" beginning in December 1982 *Radio-Electronics* came at exactly the right time for me, and I immediately set out to make boards. Having a photographic darkroom and years of photographic experience gave me a head start, and I was immediately able to produce very good Kodolith masks.

The "fun" started when I sallied forth to acquire sensitizer and developer for the boards. Grossblatt's article talked of "several companies" making sen-

continued on page 90

ELECTRONIC COMPONENTS



176 PAGE
FREE CATALOG

Manufacturers of Quality
Electronic Components

- BATTERY HOLDERS & CLIPS • COILS
- CAPACITORS • CONNECTORS • FUSES
- JACKS • KNOBS • LAMPS • PLUGS
- MICROPHONES • POTENTIOMETERS
- RELAYS • RESISTORS • SWITCHES
- TRANSFORMERS • SPEAKERS • LEDS
- SEMICONDUCTORS • RF COILS

OVER 15,000 DIFFERENT ITEMS IN STOCK!

MOUSER ELECTRONICS

11433 WOODSIDE AVE. SANTEE, CA 92071
PHONE: (619) 449-2222 TWX 910-331-1175

CIRCLE 117 ON FREE INFORMATION CARD

Learn micro-processing with the new MICRO-PROFESSOR 1P



Students, engineers or technicians—
upgrade your micro-processing skills
with the new Micro-Professor 1P.

The MPF-1P features:

- extensive software support
- more built-in memory
- improved keyboard
- larger display

Three tutorial guides help cover all capabilities. The ideal training tool! MPF-1P will deliver you into the growing world of micro-processing. Invest now!

Plus—FREE GIFT Only \$199.95

Check this box for FREE

Z-80 Microprocessor
Programming and
Interfacing textbook when
you order within 7 days.
\$12.95 value. (Include
\$5.00 postage &
handling)

ETRONIX

Dept. RE0486
5326 9th Ave. N.E.
Seattle, WA 98105-3617

For immediate action call TOLL FREE:

1-800-426-1044

Full money back guarantee.



CIRCLE 111 ON FREE INFORMATION CARD

OK Test Equipment

OK
Electronics
Division



The Bench Rack

MODEL 2324-R

- Model 203 - 2MHz Function Generator
- Model 510 - 200MHz Multi-Function Counter
- Model 1010 - 10MHz Miniature Oscilloscope
- Model 601 - 3-1/2 Digit DMM
- Model 58150 - Bench rack mounting system

AFFORDABLE EXCELLENCE

3455 Corner Street, Bronx, New York, 10475, U.S.A.
Telex 125091 OK NYK. Telex 232395 OK NY UR.
Phone (212) 994-6600.
Fax (212) 994-4755.



CIRCLE 273 ON FREE INFORMATION CARD

APRIL 1986

**Check
Digital IC's
in-circuit
Fast!**

**In the field or
on the bench.
B&K-PRECISION
gives you the
answers for
TTL or CMOS**



Model 550 (for TTL) \$395
Model 552 (for CMOS) \$395

New B&K-PRECISION IC Comparator Testers/Logic Monitors put you on the fast track to digital troubleshooting. IC's are tested by comparison to a known good device, allowing you to test hundreds of types with one simple operation.

As logic monitors, they simultaneously indicate the logic states of up to 20 IC pins. No need to check pins singly with a logic probe.

Tests most 14 to 20 pin, 54 and 74 Series TTL (Model 550) or 4000 and 74C Series CMOS (Model 552) devices.

- Convenient one button testing
- Reverse polarity and overvoltage protection
- Uses power from equipment under test
- Memory stores short duration pulses and intermittent events
- Zero insertion force reference IC socket
- LED at each IC pin identifies where fault exists
- Includes 16 and 20 pin DIP clips
- Compact hand-held size

Available from stock at your local B&K-PRECISION distributor. For more information contact your distributor or:

BK PRECISION
DYNASCAN
CORPORATION

6460 West Cortland Street
Chicago, Illinois 60635 • 312/889-9087

International Sales: 6460 W. Cortland St., Chicago, IL 60635
Canadian Sales: Atlas Electronics, Ontario

South and Central American Sales,
Empire Exporters, Plainview, NY 11803

EQUIPMENT REPORTS

Huntron Instruments Tracker 2000

*Troubleshoot those
defective circuits at a
"glance."*



CIRCLE 9 ON FREE INFORMATION CARD

TRACING THE SOURCE OF A FAILURE back to a particular section or stage of a system will usually present few problems to a technician with decent troubleshooting skills. Finding which component in that stage caused that failure is a different matter. Often, even the best technician is reduced to trial-and-error substitutions to restore proper operation.

Now there's an easier way. The Huntron Instruments (15123 Highway 99 North, Lynnwood, WA 98037) *Tracker 2000* allows you to test almost any component (analog or digital semiconductors, resistors, capacitors, inductors, etc.) for shorts, opens, leakage, or noise. And it can do all of that even for components that are still in circuit.

How it works

To test a component, the unit applies a sinewave test signal across two terminals of the suspected defective device. The resultant current flow, voltage drop, and the phase difference between the two are used to generate a "signature," which is displayed on the *Tracker 2000's* CRT. Each type of component has a distinct signature when it is working normally, and a very different sig-

nature when it is not. Knowing those signatures is the key to using this instrument. We'll talk more about that in a moment.

At first glance, the *Tracker 2000* looks like an ordinary oscilloscope. Its most prominent feature is a 2.8-inch (diagonal measure) CRT. Rather than having the crosshatch graticule that is commonly found on modern oscilloscopes, it has a simple crosshair; that crosshair is marked at regular intervals along the X (horizontal) axis. If this were an oscilloscope, such a graticule would render it unsatisfactory for a number of applications. However, in using the *Tracker 2000* we are primarily interested in qualitative measurement, not quantitative. The graticule is quite satisfactory for such use.

Otherwise, the unit is laid out in an attractive and functional manner. Most controls are situated on the front panel and are grouped by function. All pushbutton controls are momentary and have an LED indicator so that the operator can tell at a glance which functions have been selected. Two seldom-used slide switches, as well as screwdriver adjustments used to control the quality of the display, are located on the back panel.

**United States
Instrument Rentals, Inc.**



A U.S. Leasing Company

2988 Campus Drive
San Mateo, CA 94403

Call for Special Prices and

Free Catalog

800-824-2873



Hitachi Denshi America, Ltd.

Beckman Industrial™



SCOPES

Iwatsu

- All 14 models in stock
- 2-3 year warranties
- 20-250 MHz

Model 5702—\$ 535
5705—\$ 899
5710—\$1245
5711—\$1695
7506—\$ 749

Hitachi

- All 20 models in stock
- 2-3 year warranties
- 20-100 MHz

Model 1050—\$1299
509—\$1199
VC 6041—\$5499
422—\$ 690
1100—\$1999
650—\$ 930
V209—\$ 725
1070—\$1595
1100A—\$2490



Hitachi V-222

SALE \$535
List \$715

Hitachi V-222

Portable Dual Trace Scope

- DC-20 MHz
- 3-Way Power Supply
- Lightweight
- High Sensitivity and Fast Sweep Timer

DIGITAL MULTIMETERS

Beckman

- All 300, HD, and circuitmate series
- All accessories in stock

HD100—\$169 320—\$179
HD110—\$189 330—\$219
HD130—\$239 350—\$229
HD140—\$259 360—\$289
300—\$120 4410—\$239
310—\$145

Fluke

- Autorange • Analog display
- Touchhold function
- 0.3% accuracy • Heavy duty

Model 73—\$ 79 8010A—\$279
75—\$ 99 8012A—\$359
21—\$ 99 8020B—\$199
23—\$145 8022B—\$154
25—\$229 8024B—\$249
27—\$259 8050A—\$389

SALE \$114
List \$139

Fluke 77

Analog/Digital Multimeter



POWER SOURCES

POWER DESIGNS

- Low and high voltage power sources
- 1-5 year warranties

2020B—\$750
2K20—\$695
4050—\$660
6150—\$725

TW5005W—\$595
TW6050A—\$880
TW347—\$695
TP340—\$750
TP343A—\$795

Used Test Equipment, too!—Over 3,000 Models Available at Huge Discounts with Warranties!

- Quantity Discounts Available
- Dealers Welcome
- Freight and Tax extra
- Immediate Availability of Equipment

Call

800-824-2873

Include work address and phone #
for Free Catalog.

IF YOU WANT TO GET YOU HAVE TO GET INTO

Learn PC Servicing By Building Your Own NTS/HEATH HS-15 Desk-Top Computer, Circuit-By-Circuit

NTS Intrinsic Home Training Takes You Below The Surface

NTS gets you right down into the heart of computer circuitry. You learn how microprocessors function, how they are designed, how they operate and are used to solve problems. Your program includes a wide variety of tests and projects, as you assemble your PC. You experience the excitement of seeing your own skills grow, the security of knowing you really understand what makes a computer tick.

A Career in PC Servicing

The world of computers is constantly expanding. Applications have spread from business to manufacturing, from industry to medical and scientific fields. Computer-aided design, engineering, and production have revolutionized drafting, graphics, and prototyping. Computer sales figures point to a continuing need for service technicians as well as installation and maintenance specialists. The type of training you receive will largely determine your ability to take advantage of these opportunities and nothing beats the practical, down-to-earth training you get from NTS.

The NTS/HEATH 16-Bit HS-151

This desk-top PC is the most powerful and versatile ever offered in any home training program. Check the advanced features listed below:

1. 128 KB RAM user memory on board, expandable to 640 KB
2. 16-bit 8088 Microprocessor accepts advanced software, speeds word processing; also allows selection from the huge library of IBM software.
3. 5.25-inch floppy disk drive, double density, IBM formatted, stores up to 360 KB. (Expandable to dual disk drive, and optional 10.5 MB hard-disk drive.)
4. MS-DOS operating system, IBM compatibility, make a wide choice of software programs available.
5. Four open IBM-compatible slots provide for future expansion, printer, modem, etc. Will accept most peripheral boards designed for IBM-PC.
6. Two video outputs for color or monochrome display monitor. Your NTS course includes a high resolution monitor displaying 80 characters by 25 lines, or graphics.
7. Editing capabilities help you insert or delete characters and lines, erase, jump or smooth scroll, etc.

Your NTS training course will teach you to program on this outstanding PC, using lessons, texts, and diagrams to make full use of its capabilities. Catalog contains complete details.

**IBM
Compatible**



Learning circuitry through the construction of this equipment offers practical training for which there is no substitute. Test equipment is included.

Field servicing is interesting and rewarding. Technicians may work for a service company, manufacturer, or major users.

The NTS/HEATH HS-151 PC completed, includes monitor and full-function keyboard with calculator keypad, and typewriter format.



NTS PC SERVICING A MICROCOMPUTER

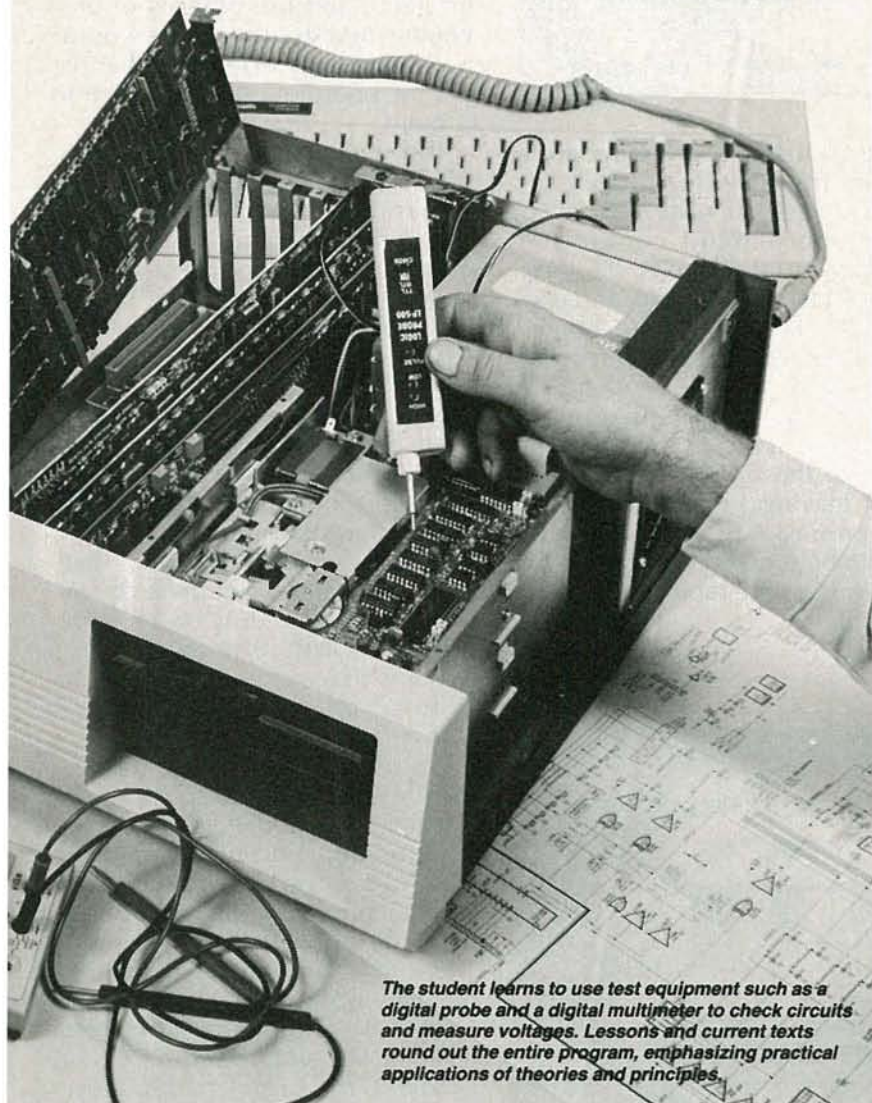

The student learns to use test equipment such as a digital probe and a digital multimeter to check circuits and measure voltages. Lessons and current texts round out the entire program, emphasizing practical applications of theories and principles.

Installing the disk-drive in the PC is one of the final stages in the assembly of the microcomputer. Learning the use of test equipment to check circuits is an integral part of the training which, with field experience, develops invaluable career skills.

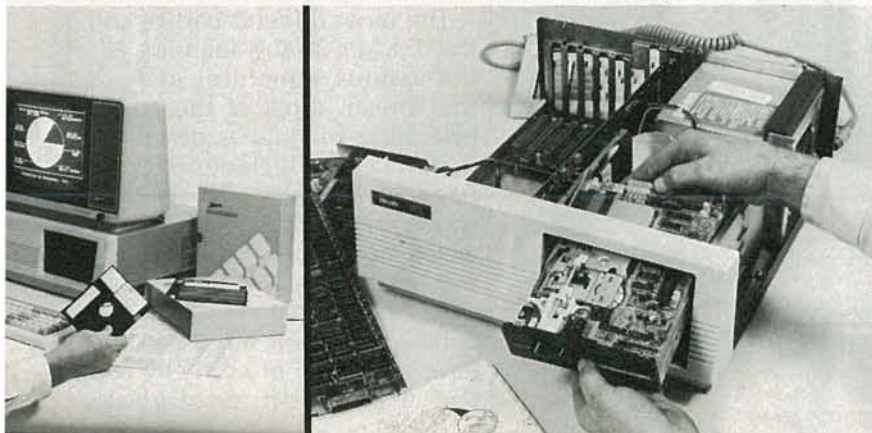

NTS COURSES COVER MANY AREAS OF SPECIALIZATION IN ELECTRONICS:

Robotics: Build the NTS/HEATH Hero 1 Robot as you learn robotic programming. Robot is complete with arm and gripper, voice synthesizer. Robotics is becoming increasingly important in industry as almost daily news features attest.

Video Technology: Build one of the most advanced Color TV sets in America as you learn circuit diagnostics, and the use of digital test instruments. Course covers color TV, video tape recorders, computer fundamentals, solid-state devices.

Industrial and Microprocessor Technology covers circuit analysis, microprocessors and automation applications, lasers, and basic industrial robotics.

TV & Radio Servicing is a specialized course offering an excellent foundation in the use and application of both analog and digital test equipment as applied to the TV servicing field. Learn circuits, adjustments, trouble-shooting, and servicing of Color and monochrome monitors.

Digital Electronics offers the student the opportunity to get involved with computer concepts, computer technology fundamentals, and digital equipment by training on the NTS Compu-Trainer.

Basic Electronics is a course designed for those wishing to have an over-view of electronics in many of its aspects including radio receivers, solid state devices, and electronic components.

NTS Intrinsic training programs include a variety of superb equipment, most of which is classified as field-type, making the training practical and career oriented. Texts and lessons have been tested in our Resident School in Los Angeles to assure home study students their courses of training are easy to understand. NTS, now in its 80th. year, continues to be at the leading edge in Electronics home training.

* IBM is a trademark of International Business Machines Corp.
* MS is a trademark of Microsoft Corp.

If card is missing, simply write to the address shown below stating the course you are interested in. A FREE color catalog with all details will be sent to you by return mail.

**NTS NATIONAL
TECHNICAL
SCHOOLS**

TECHNICAL TRADE TRAINING SINCE 1905
Resident and Home-Study Schools

4000 So. Figueroa St., Los Angeles, CA 90037

SEND FOR THIS
FREE CATALOG NOW



**SAVE MONEY
HIGH QUALITY
FAST DELIVERY**
We are utilizing the latest
equipment and technology to
maintain our quality at
reasonable prices.

**JAN
CRYSTALS**
Since 1958

- General Communication
- Industry
- Marine VHF
- Scanners
- Amateur Bands
- CB Standard
- CB Special
- Microprocessor

Call or Write
JAN CRYSTALS
P.O. Box 06017
Fort Myers
FL 33906-6017
(813) 936-2397



CIRCLE 104 ON FREE INFORMATION CARD

	Huntron	Tracker 2000
OVERALL PRICE	1 2 3 4 5 6 7 8 9 10	1 2 3 4 5 6 7 8 9 10
EASE OF USE	1 2 3 4 5 6 7 8 9 10	1 2 3 4 5 6 7 8 9 10
INSTRUCTION MANUAL	1 2 3 4 5 6 7 8 9 10	1 2 3 4 5 6 7 8 9 10
PRICE/VALUE	1 2 3 4 5 6 7 8 9 10	1 2 3 4 5 6 7 8 9 10
	Poor	Fair
		Good
		Excellent

The unit has four impedance ranges. Those are HIGH (open-circuit voltage 120 volts p-p, maximum short-circuit current 0.6 mA), MEDIUM 2 (40 volts, 0.6 mA), MEDIUM 1 (30 volts, 9 mA), and LOW (20 volts, 135 mA). Those ranges can be selected manually, or can be stepped through sequentially using an AUTO mode. That mode allows the user to see the signature at the various impedances while leaving his hands free to hold probes. A HIGH LOCKOUT switch can be pressed to prevent the HIGH impedance range from being entered.

The unit has two display channels. Either channel can be used, or the unit can be made to alternate between the two. Among other things, that is useful for comparing the signatures at identical points on identical PC boards. If one of those boards is known to be good, and the other is of unknown quality, that gives you a quick way to ascertain whether or not the board of unknown quality is good.

The unit has three test-signal frequencies: 50/60, 400, and 2000 Hz. Generally, most measurements are made using the 50/60-Hz frequency. The others are used for viewing small amounts of capacitance or large amounts of inductance.

Normally, circuits are tested either in or out of circuit while they are in an inactive (power off) state. The *Tracker 2000* does have a built-in pulse generator to allow in-circuit, active-state (power-on) testing of certain components. That generator can output pulses from 0 to 5 volts, with duty cycles from near 0% to 100%. Among the components that can be tested in that manner are optocouplers, thyristors, and transistors.

One reservation about using the instrument is the fear that its output signal might damage sensitive components, particularly CMOS IC's. To soothe those fears, the manufacturer had the unit tested by two separate laboratories. Those tests are summarized in the manual. In short, those tests, performed by Component Concepts (Everett, WA 98201) and MTL Microtesting Limited (Alton, Hampshire, England), found that the *Tracker 2000* in no way adversely affected the normal operation of CMOS devices.

The most difficult part of using the *Tracker 2000* is learning all of the various signatures and what they mean. Most of the copious operating manual is devoted to that subject. It includes page after page of devices and their signatures when working properly as well as when they've failed. Until you become very familiar with the *Tracker 2000*, that manual must be constantly at your side if you are to have any hope of correctly using the unit. With enough use

PROBES FOR SALE

FROM THE BEST SOURCE FOR OSCILLOSCOPE
PROBES AND DMM/VOM TEST LEAD SETS.

- Low Cost
- High Quality
- Excellent Performance
- Slender, Flexible Cable
- Wide Range of Choice
- Switchable X1 and X10 Attenuation Factor
- 100 MHz Bandwidth

MODEL SP100

\$43



**TEST
PROBES, INC.**

TPI

Your Probe
Specialists

COLINE U.S. SALES & STOCKING SOURCE

P.O. BOX 2113, LA JOLLA, CALIFORNIA 92038 (714) 459-4197

CIRCLE 123 ON FREE INFORMATION CARD

FLUKE 70

SERIES MULTIMETERS



- 77**
- 0.3% Accuracy
 - Manual or Autorange
 - 10A + mA Range
 - Beeper
 - "Touch-Hold" Function

Sale
\$129⁹⁵
 75 89⁹⁵
 73 69⁹⁵

WE CARRY A FULL LINE OF FLUKE MULTI-METERS. IN STOCK NOW

SALE ENDS April 30

BK PRECISION DYNASCAN CORPORATION

BREAKS THE PRICE BARRIER WITH THESE HIGH PERFORMANCE OSCILLOSCOPES

100 MHz Dual Trace/ Dual Time Base

- 1 mV/div sensitivity
- 23 calibrated sweeps
- Rectangular CRT with internal graticule and scale illumination
- Signal Delay Line

\$995

Does not include probes (\$60.00 a pair when purchased with scope)

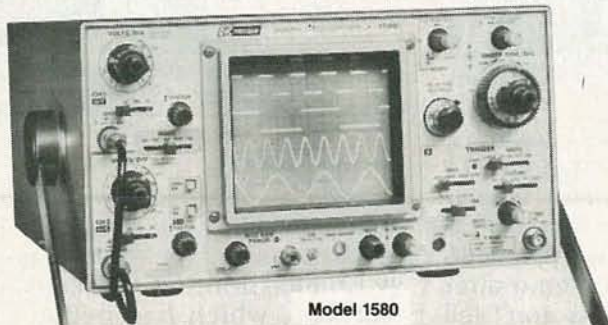

Model 1580

QUANTITIES ARE LIMITED

BECKMAN'S CIRCUITMATE[®] ALL UNDER \$100

AVAILABLE NOW...



\$64⁹⁵

Circuitmate DM 20—3½-digit, pocket-size multimeter; 0.8% Vdc accuracy, diode test, hFE test, conductance, 10 amps AC and DC ranges, auto-polarity, auto-zero, auto-decimal



\$79⁹⁵

Circuitmate DM-25—3½ digit, pocket-size multimeter; 0.5% Vac accuracy, diode test, capacitance, continuity beeper, conductance, 10 amps AC and DC ranges, auto-polarity, auto-zero, auto-decimal



\$69⁹⁵

Circuitmate DM-40—3½-digit multimeter; 0.8% Vdc accuracy, diode test, auto-polarity, auto-zero, auto-decimal



\$89⁹⁵

Circuitmate DM 45—3½-digit multimeter; 0.5% Vdc accuracy, diode test, continuity beeper, 10 amps AC and DC ranges, auto-polarity, auto-zero, auto-decimal

BK PRECISION

100 MHz Dual Time Base SCOPE

MODEL 1590



\$1395⁰⁰

PRICE DOES NOT INCLUDE PROBES

BK PRECISION

INDUSTRIAL TRANSISTOR TESTER



\$219⁹⁵

MODEL 520B

- Now with HI/LO Drive
- Works in-circuit when others won't
- Identifies all three transistor leads
- Random lead connection
- Audibly and visually indicates GOOD transistor

- 1mV/division sensitivity to 70 MHz
- 500 μV/division cascade sensitivity
- Four-input operation provides trigger view on 4 separate inputs
- Alternate time base operation
- Switching power supply delivers best efficiency and regulation at lowest weight



TOLL FREE HOT LINE
800-223-0474

212-730-7030

ADVANCE ELECTRONICS

26 WEST 46th STREET, NEW YORK, N.Y. 10036

Be an FCC LICENSED ELECTRONIC TECHNICIAN!



Learn at home in spare time. No previous experience needed.

No costly school. No commuting to class. The Original Home-Study course prepares you for the "FCC Commercial Radiotelephone License". This valuable license is your "ticket" to thousands of exciting jobs in Communications, Radio-TV, Microwave, Computers, Radar, Avionics and more! You don't need a college degree to qualify, but you do need an FCC License.

No Need to Quit Your Job or Go To School
This proven course is easy, fast and low cost! **GUARANTEED PASS** - You get your FCC License or money refunded. **Send for FREE facts now. MAIL COUPON TODAY!**

COMMAND PRODUCTIONS

FCC LICENSE TRAINING, Dept. 90
P.O. Box 2223, San Francisco, CA 94126

Please rush **FREE** details immediately!

NAME _____
ADDRESS _____
CITY _____ STATE _____ ZIP _____

SUPER LONG PLAY TAPE RECORDERS

10 Hour Model - \$95.00*
14 Hour Model - \$159.00*

Modified Panasonic Slimline, high quality, AC-DC Recorders provide 5 or 7 continuous hours of quality recording & playback on each side of cassette for a total of 10 or 14 hours depending on model. Built-in features include • Voice level control. • Digital counter, etc. TDK DC 180 Cassette Furnished.



PHONE RECORDING ADAPTER

Records calls automatically. All Solid state connects to your telephone jack and tape recorder. Starts recording when phone is lifted. Stops when you hang up. **\$24.50***



VOX VOICE ACTIVATED CONTROL SWITCH

Solid state. Self contained. Adjustable sensitivity. Voices or other sounds automatically activate and control recorder. Uses either recorder or remote mike. **\$24.95***



*Add for ship & hdlg. Phone Adapter & Vox \$150 ea. Recorders \$4.00 ea. Cal. Res. add tax. Mail order. VISA, M/C, COD's OK. Money Back Guarantee. Qty. disc. avail. Dealer Inquiries invited. Free data. © **AMC SALES INC.** Dept. A 9335 Lubec St., Box 928, Downey, CA 90421 (213) 869-8519

CIRCLE 108 ON FREE INFORMATION CARD

however, eventually you will be able to tell the state of a component at a glance, greatly increasing the speed and efficiency of your troubleshooting.

Our unit was supplied with two manuals. The previously mentioned operating manual contains detailed information on the *Tracker 2000's* use, and some details of the unit's theory of operation, but little on maintenance or the circuit itself. That information was contained in a second manual. There, complete schematics, parts lists, and parts-placement diagrams, as well as troubleshooting and maintenance information on the unit could be found. What was curious, however, was that most of that manual was devoted to a far less detailed rehash of some of the material contained in the larger operating manual.

To speed up the necessary period of acclimation, Huntron offers a demonstration board that features both good and bad versions of a number of common components. By seeing what the signatures of those components actually look like, it is much easier to master the basic workings of the unit.

The Huntron *Tracker 2000* is covered by a one-year warranty. It sells for \$1895.00. Pricing for the demonstration board was unavailable at press time; for more information, contact the manufacturer. **R-E**

Melville Technologies Phot-On-Off Compact Disc Cleaner

Rid your compact disk of those bothersome excess photons forever.

CIRCLE 3.14159 ON YOUR FREE INFORMATION CARD

ONE OF THE ADVANTAGES CLAIMED OF compact discs over standard LP records is their quietness. Because they are insensitive to the effects of dirt and dust, they will play without pops or crackles time after time. Their proponents don't tell you, however, that CD's do suffer from a form of contamination known as photon pollution.

Photon pollution comes about because not all the photons from a CD player's laser beam are reflected back to its photodiode "pickup." Some become trapped beneath the CD's clear plastic surface so they accumulate in the microscopic pits that carry the digital information. At first those "dead" photons do not affect playback quality, but after repeated playings of a disc the read errors they cause become noticeable as a deterioration in sound quality.

Melville Technologies' *Phot-On-Off* CD cleaner claims to eliminate the effects of photon pollution by providing a way to remove unwanted photons from CD's.

How it works

The device consists of an open-ended lead box that is connected to a user-supplied source of high-energy gamma rays. In use, a contaminated disc is placed face down in a bracket mounted inside the box, which itself is positioned with its open end down over a square of black velvet. According to the manufacturer, impacts from the high-energy gamma rays cause the disc substrate containing the contaminated pits to vibrate violently at the molecular level. That loosens the photons and dislodges them from the pits where they have stuck. The liberated photons fall into the black velvet, which can be taken outside and shaken clean.

Melville Tech	Phot-On-Off									
OVERALL PRICE	1	2	3	4	5	6	7	8	9	10
EASE OF USE	1	2	3	4	5	6	7	8	9	10
INSTRUCTION MANUAL	1	2	3	4	5	6	7	8	9	10
PRICE/VALUE	1	2	3	4	5	6	7	8	9	10
	Poor		Fair			Good			Excellent	

Performance

After some initial set-up difficulties, which were settled with the assistance of the Atomic Energy Commission, we subjected a test disc, which had begun to show signs of audio distortion (due, no doubt, to photon pollution) to a thorough *Phot-On-Off*

CALL TOLL FREE

CALIFORNIA 800-772-1519
OTHER STATES 800-854-1519

IN SAN DIEGO CALL
619-560-9676

FREE CATALOG!



PROBE MASTER

YOUR SINGLE SOURCE FOR PROBES AND ACCESSORIES

**HIGH PERFORMANCE
MINIATURE SCOPE PROBES
60 MHz TO 250 MHz**

\$30 TO \$55

**REPLACEMENT PROBES & TEST LEADS
FOR FLUKE, TEKTRONIX, H.P. & OTHERS**

OTHER PRODUCTS

- TEST LEADS
- TERMINATIONS
- ATTENUATORS
- BNC CABLES
- BNC ADAPTERS
- RUGGED AND RELIABLE
- REPLACEABLE TIP & GROUND LEAD
- ADJUSTABLE LF & HF RESPONSE
- COMPENSATION FOR MOST SCOPES

READOUT ACTUATOR (RA) OPTION



SWITCHES READOUT ON TEKTRONIX
465, 475, 485 & 7000 SERIES
SCOPES. (FOR 10x probes only.)



STANDARD BNC

REPLACEABLE TIP

ACTUAL SIZE

CHARACTERISTICS

MODEL	ATTENUATION	CABLE TERMINATION	BAND WIDTH (MHz)	RISE TIME (NS)	LOADING CAP. (PF)	*RES. (M-OHM)	DC MAX.	PRICE
-------	-------------	-------------------	------------------	----------------	-------------------	---------------	---------	-------

FIXED ATTENUATION

2903	1X	STD	25	11	40	1	600V	\$25.00
2960	10X	STD	60	5.8	16	10	500V	\$30.00
2960 RA	10X	RA	60	5.8	16	10	500V	\$40.00
2904	10X	STD	100	3.5	17	10	600V	\$35.00
2904 RA	10X	RA	100	3.5	17	10	600V	\$45.00
2905	10X	STD	250	1.5	17	10	600V	\$45.00
2905 RA	10X	RA	250	1.5	17	10	600V	\$55.00
2906	100X	STD	70	5.0	6	100	1.2KV	\$55.00

SWITCHED

2901	10X, 1X, GND	STD	10X/1X	10X/1X	10X/1X	10X/1X	600V	\$39.00
2902	10X, 1X, GND	STD	100/5	3.5/70	17/100	10/1	600V	\$49.00
1064	Engineers Accessory Kit							\$12.00

* RA = Readout Actuator, STD = Standard BNC • Cable length 5 1/2 ft.
• On switched probes, probe tip is grounded thru a 9 Meg OHM resistor, when switch is in the GND position • 10X compensation range, 15 to 50 PF

**IMMEDIATE DELIVERY
CALL FOR NEAREST DISTRIBUTOR**



4898 RONSON CT.
SAN DIEGO, CA 92111

treatment. We left it in the device for the full two hours specified in the instructions. And indeed, when we pried up the lead box, removed the velvet cloth, and then shook it out outside we did notice that something was released into the air. (Reviewer's wife's note: That may have been dust; I'd recently used that rag to clean off his collection of antique transistors.)

We have not yet been able to determine exactly how well the device worked; the disc is still glowing from the gamma ray treatment and we have been advised by the AEC that it would be unwise to handle it for a period of several years. We will present the results of our listening tests in a followup report early in 1989.

The *Phot-On-Off* comes with detailed instructions, including plans for pouring the required cast-concrete base and a pamphlet full of hints for lifting heavy objects. Price is \$9495.00. For more information contact Melville Technologies, 79 "O" St., Oh, OH, 00000. R-E

Save the clouds.

When you lose your vision, you lose the clouds. You lose the sunsets. The seashells. The moonlight and snowflakes.

This year 50,000 Americans will lose all that and more. Forever.

Yet with your help half of all blindness can be prevented.

We're the National Society to Prevent Blindness. We fight to save all the things people lose when they lose their eyesight.

Help us save the clouds.

Give to Prevent Blindness.



National Society to Prevent Blindness
Box 2020, Madison Square Station New York, N.Y. 10159

Call us **FREE 1-800-626-6343**
or write for **FREE** Flyer.

COPPER ELECTRONICS

4200 PRODUCE ROAD - LOUISVILLE, KENTUCKY 40218

MIDLAND
Model 76-300
AM - BASE STATION CB.



Retail \$149.95
\$79.95

WESTPORT
WCB40



40 CHANNEL
CB TRANSCEIVER
Retail \$89.95 **29.95**

AV-261
Permanent Mount
1/2" hole mount

26.95

AV-261M
Magnet Mount

29.95

AV-261T No-Hole
Trunk Mount

26.95



BEARCAT 20/20



Retail \$299.95

\$199.95

Aircraft, marine and public service-all within pushbutton reach.



uniden
Bearcat
300

Retail \$399.95 **269.95**

Limited Quantities

THE LOWEST PRICES IN THE COUNTRY

We have a national factory warranty service on many brands, and we service **All** CB, Amateur, and Commercial Equipment.

Put Your Electronic Skills to Work UNDERWATER!

BECOME A ROBOT VEHICLE PILOT/TECHNICIAN

Accredited by NATTS
Approved for Training
of Veterans
Approved for Various
Loan & Grant Programs

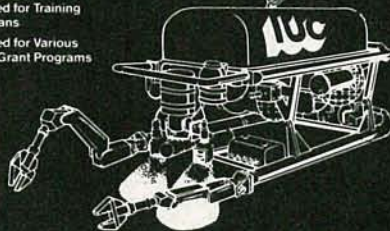

HIGH PAY—WORLDWIDE TRAVEL
Call or Write Today for **FREE BROCHURE**
CALL (212) 885-0600

UNDERWATER VEHICLE TRAINING CENTER
10046 CHICKASAW, HOUSTON, TX 77041
IN TEXAS CALL: 713-690-0405, TELEX 4620684

CIRCLE 283 ON FREE INFORMATION CARD

Electricity and water don't mix. At least not in our Heavy Duty Digital Multimeters. Because these Oops Proof™ instruments are protected by a system of seals to ensure contamination-free dependability in even the cruddiest conditions.

Other abuse-proof features include the best mechanical protection ever built into a precision Digital Multimeter. In fact, every one of our Oops Proof multimeters will survive a drop from ten feet onto a concrete surface!

All the Heavy Duty series meters measure up to 1000 volts AC and 1500 volts DC, with full overload protection to those maximum voltages even on the lowest range settings. Overload circuitry also provides transient protection to 6KV on all voltage ranges and up to 600 volts on all resistance ranges.

We also invented a unique, long-life rotary switch for our Digital Multimeters. You can actually feel the difference just by

rotating the function selector knob.

You'll find these features in a full line of Heavy Duty DMMs that offer a 4½ digit readout, 0.05% VDC accuracy, a 10-amp current range, a 2000-hour battery life, diode test, true RMS and temperature measurement. All this and a no-questions, one-year warranty.

You'll want to try one out, of course, so drop into your nearest electronics distributor and drop one.

Our lips are sealed.



LOWEST EVER

SMART BUY

from
MEGURO
(JAPAN)

20 MHz Dual Trace Oscilloscope

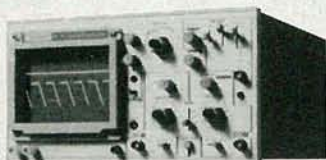

\$339⁰⁰

2-FREE Probes Included

- Built-in Component Tester
- 6" Square Internal Graticule CRT
- Sensitivity: 5mV ~ 10V/div ±3%
- Rise Time: 17ns or less
- Sweep Time: 0.2µs ~ 0.5s/div ±3%
- X-Y and Z Axis Operation
- 110/220 Volt Operation
- One Year Parts & Labor Warranty

35 MHz Scope/Delay Trigger \$499.⁰⁰

Add 12.⁰⁰ Per Unit for UPS & C.O.D. Charges

TO ORDER CALL COLLECT:

(213) 624-3757

Diplomat International, 453 South Spring St.,
Suite 1224 Los Angeles, CA 90013

CIRCLE 285 ON FREE INFORMATION CARD

SEE YOUR DEALER TODAY



FROM

'Firestik'
ANTENNAS
ACCESSORIES

HERE'S A TIP
THAT'S PERFECT!

AM/FM AUTO RADIO
AND CB

'Firestik' II

GOLDEN SERIES

BARE-HANDS TUNABLE
"NO TOOLS NEEDED"
HIGH PERFORMANCE ANTENNAS

ALSO ANTENNAS FOR
CORDLESS TELEPHONES
MONITOR SCANNERS

Dealer & Distributor Inquiries Invited
SEND FOR FREE CATALOG

'Firestik' Antenna Company
2614 East Adams/Phoenix, AZ 85034

Name _____
Street _____
City _____
State _____ Zip _____

Serving the CB and
Communications Market Since 1962.

5-YEAR REPLACEMENT WARRANTY

CIRCLE 100 ON FREE INFORMATION CARD

NEW PRODUCTS

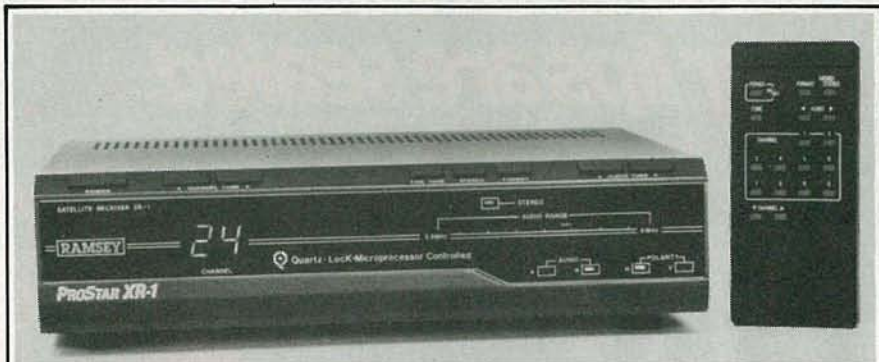

CIRCLE 21 ON FREE INFORMATION CARD

BLOCK RECEIVER, for satellite TV, the ProStar model XR-1, features quartz-lock frequency synthesized tuning, with microprocessor-controlled video fine tune circuitry—specifically designed to trap out terrestrial interference; weatherproof DRO (Dielectric Resonator Oscillator) block downconverter; matrix ster-

eo audio; dual-polarity capability with electronic switching; full-function infrared remote control with random channel access; electronic TV antenna changeover, and high video quality.

The ProStar model XR-1 has a suggested retail price of \$600.00.—**Ramsey Electronics**, 2575 Baird Road, Penfield, NY 14526.

RADAR MOUNT, the Radar Ready, attaches to any windshield with strong suction cups, which absorb many road jolts and vibrations. Special release tabs allow the Radar Ready to quickly detach from the windshield. It is completely portable and easily transferred from vehicle to vehicle.

The Radar Ready is available in two styles: A1, for automobiles, mini-trucks, and mini-vans, and T1, for RV's, full-sized trucks, and

full-sized vans. Both are priced at \$19.95, plus \$2.00 P&H when ordered from the manufacturer.—**Nob Industries**, PO Box 43444, Tucson, AZ 85733.

LINE-DISTURBANCE ANALYZER, model 646-3, is designed for both single- and three-phase circuits. It provides four AC channels for monitoring and recording impulses, sags, surges, undervoltages, overvoltages, and frequency variations. A separate channel monitors neutral-to-ground voltage disturbances, while another channel provides time-related measurements of DC-voltage disturbances.

The model 646-3 is designed for pre-installation site surveys and maintenance of computers and related peripherals, as well as power



CIRCLE 22 ON FREE INFORMATION CARD

MASTER THE NEW ELECTRONICS WITH MCGRAW-HILL'S

Contemporary Electronics Series

The fast, easy and low cost way to meet the challenges of today's electronic innovations. A unique learning series that's as innovative as the circuitry it explains, as fascinating as the experiments you build and explore.

From digital logic to the latest 32-bit microprocessor, the McGraw-Hill Contemporary Electronics Series puts you into the electronic picture one easy step at a time. Fifteen unique Concept Modules, sent to you one every 4-6 weeks, give you a handle on subjects like optoelectronics, robotics, integrated circuits, lasers, fiber optics and more.

Each Concept Module goes right to the heart of the matter. You waste no time on extraneous material or outdated history. It's a fast, efficient, and lively learning experience...a non-traditional approach to the most modern of subject matter.

Unique Interactive Instruction

With each module, you receive a McGraw-Hill Action Audio Cassette. Each tape is a dynamic discussion that drives home the key facts about the subject. Your learning

With your first module, you get this solderless breadboarding system. You'll use it throughout the series to build electronic circuits and bring concepts to life.

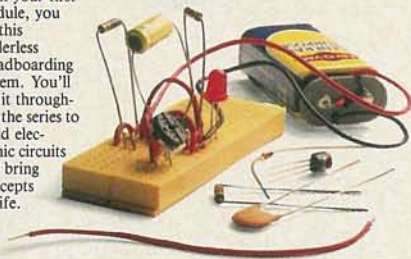

experience is reinforced through interaction with vividly illustrated text, audio cassettes, and actual electronic experiments. Indexed binders preserve backup material, notes, and tapes for convenient referral.



Perform Experiments in Contemporary Electronics

Throughout your series, laboratory experiments reinforce every significant point. This essential experience...dynamic, hands-on demonstrations of theory in practice... will help you master principles that apply all the way up to tomorrow's latest VLSI (Very Large Scale Integrated) circuitry.

In your very first module, you'll use integrated circuits to build a digital oscillator, verifying its operation with a light emitting diode (LED). You'll learn to identify passive and active components, understand concepts common to all electronic circuits.

For Anyone Interested in Electronics

The Contemporary Electronics Series is designed for anyone from hobbyist to professional. It's for you if you're looking for new fields of interest...if you're a teacher who

wants an update in contemporary circuits...a manager or supervisor in an electronics plant...a doctor, an engineer, a chemist who finds electronics playing an increasingly important role in your work. It's even for electronics engineers or technicians who feel their training needs freshening up. It's the quickest,

most convenient, probably least expensive way to do it. And the only one that gives you hands-on experience.



15-Day No-Risk Trial

To order your first module without risk, send the postage-paid card today. Examine it for 15 days under the terms of the order form and see how the Contemporary Electronics Series gets you into today's electronics. If card has been used, write us for ordering information.



McGraw-Hill
Continuing Education Center
3939 Wisconsin Ave.
Washington, D.C. 20016

surveys and troubleshooting of sensitive industrial or commercial equipment. Disturbances that fall outside user-selected thresholds



CIRCLE 23 ON FREE INFORMATION CARD

are recorded with full description of all events, their magnitude, and the exact times of occurrence. A convenient, statistical and worst-case summary report is also available.

The model 646-3 is priced at \$3690.00.—**Dranetz Technologies, Inc.**, PO Box 4019, Edison, NJ 08818-4019.

TELEPHONE-LINE TEST SET, model 96, is a lightweight, battery-operated, hand-held comprehensive analog test set that conforms to Bell Specifications. It is capable of transmitting and receiving signals to test dial-up, dedicated, or leased 2- or 4-wire lines. The model 96 can measure noise, background noise, and round-trip loss, determine AC continuity, and test channel loss. Data can be received with or without filters for use in a variety of testing applications. Dial-up capability is provided by an RJ45 jack and butt-in studs. Connection to the line

under test is provided by a second RJ45 jack or two 310 jacks. Received signal levels are displayed on a 4-digit LCD; they are audibly monitored on a speaker with volume control.

The model 96 is housed in a plastic case and comes with a leatherette carrying case. It is priced at \$1295.00.—**International Data Sciences, Inc.**, 7 Wellington Road, Lincoln, RI 02865.

TUNER, the Deluxe Versa Tuner II, model *MFJ-949C*, has a cross-needle meter that reads forward power, reflected power, and SWR simultaneously in ranges of 30 and 300 watts. For quick operation, no SWR sensitivity adjustment is needed. The model *MFJ-949C* provides maximum power transfer from your transmitter to nearly any antenna, and can handle up to 300 watts RF output from the transmitter on bands ranging from 160 through 10 meters.

The 6-position antenna switch allows the user to feed his signal to the antenna directly, or through



CIRCLE 24 ON FREE INFORMATION CARD

SEMI-
CONDUCTORS

FLAMEPROOF
RESISTORS

WIRE
TIES

ANTI-STATIC
FOAM



CIRCLE 25 ON FREE INFORMATION CARD

the tuner via two different coax lines, a random wire, a balanced line; or the signal may be fed to a dummy load. For connection to balanced lines, a 1:4 balun is built into the unit. It also includes a 50-ohm dummy load for easy transmitter tuning, 1000-volt capacitors, and SO-239 connectors and binding posts for the balanced line, random wire, and ground.

The model MFJ-949C is available from the manufacturer for \$149.95 (plus \$5.00 S&H).—**MFJ Enterprises, Incorporated**, PO Box 494, Mississippi State, MS 39762.

DMM, model DM50, has 28 ranges and features peak hold, the ability to detect, store, and display transient voltage or current peaks

(with a minimum duration of 6 ms.) That differs from typical data-hold functions that merely freeze the current reading.

Ease-of-use is a key feature of the model DM50. A single range/function switch allows measurements to be made quickly and efficiently. A 3½-digit liquid-crystal display provides high-contrast viewing, even in bright sunlight. Other features include 0.5% DC-volt accuracy, 10-megohm input impedance, diode test function, continuity beeper, 10-amp current range, a tilt bail, and safety-designed test leads.



CIRCLE 26 ON FREE INFORMATION CARD

The model DM50 is priced at \$99.95.—**Beckman Industrial Corporation**, 630 Puenta Street, Brea, CA 92621.

LASER PUMP, FBN marketing's *Lase-O-Whoosh* is a manually operated laser pump for use in areas where electricity is scarce or the supply is erratic. The pump consists of a heavy walled hollow glass tube with a plunger assembly within. At the exterior end of the plunger rod is a wooden handle by means of which it can be moved up and down inside the tube. A flexible hose at the bottom of the tube connects the device to the laser to be pumped.

In use, the pump is taken outdoors, preferably into bright sunlight, and the plunger moved vigorously up and down. This excites, or at least arouses a mild interest among, the photons that enter the tube through its transparent walls and those stimulated photons are pumped into the laser rod through the flexible tube,

continued on page 108

ONCE AGAIN, WE'RE EXTENDING OUR PRODUCT LINE.

STATIC
FIELD SERVICE
KIT

ELECTROLYTIC
CAPACITORS

Introducing the newest addition to NTE's expanding replacement line — Aluminum Electrolytic Capacitors. These NEV and NEH series subminiature capacitors are designed for demanding applications requiring high capacitance and small size, such as precision medical electronics, automobiles and the newest personal computers and disk drives. NTE's quality electrolytic capacitors operate over a broad temperature range and are available in blister pack or bulk at your local NTE distributor.

NTE

NTE ELECTRONICS, INC.

44 Farrand Street, Bloomfield, New Jersey 07003
(Outside N.J.) 1-800-631-1250 • (In N.J.) 1-800-624-2624



CIRCLE 271 ON FREE INFORMATION CARD

New
800 MHz models

Regency Scanners

*Bring you the Excitement of Police,
Fire, Emergency Radio, and more.*



MX5000



MX4000



MX3000

Our radios deliver the local news. From bank hold-ups to three alarm fires. It's on-the-scene action. While it's happening from where it's happening . . . in your neighborhood.

You can also listen to weather, business and marine radio calls. Plus radio telephone conversations that offer more real life intrigue than most soap operas. And with our new models, there's even more.

Unique Capabilities

Introducing two all new Regency scanners. First, there's the MX7000, a 20 channel, no-crystal unit that receives continuously from 25 to 550 MHz and 800 MHz to 1.2 GHz. That's right! Continuous coverage that includes VHF and UHF television audio, FM Broadcast, civil and military aircraft bands and 800 MHz communications. Next in line is the new MX4000. It's eight band coverage includes standard VHF and UHF ranges with the important addition of 800 MHz and aircraft bands. Both units feature keyboard entry, a

multifunction liquid crystal display and selectable search frequency increments.

Practical Performance

If you don't need the 800 MHz range coverage, Regency offers two exciting new units. The MX5000 is a 20 channel, no-crystal scanner that receives continuously from 25 to 550 MHz with all the same features as the MX7000. Then there's the 30 channel MX3000. It's digitally synthesized so no crystals are necessary, and the pressure sensitive keyboard makes programming simple. What's



more, it has a full function digital readout, priority, search and scan delay, dual scan speed, and a brightness switch for day or night operation.

At Home Or On The Road

With compact design, easy access front panel and mounting bracket these Regency scanners are ideal for mobile* use. But we also supply each radio with a plug-in transformer and a telescoping antenna so you can stay in touch at home. The MX4000 even has a rechargeable battery pack so it's fully portable.

See your Regency Scanner Authorized Dealer for a free demonstration on these and other new Regency Scanners. Or, write Regency Electronics, 7707 Records Street, Indianapolis, IN 46226.

ELECTRONICS, INC.®
7707 Records Street
Indianapolis, IN 46226-9989

*Mobile use subject to restriction in certain localities.

BUILD THIS

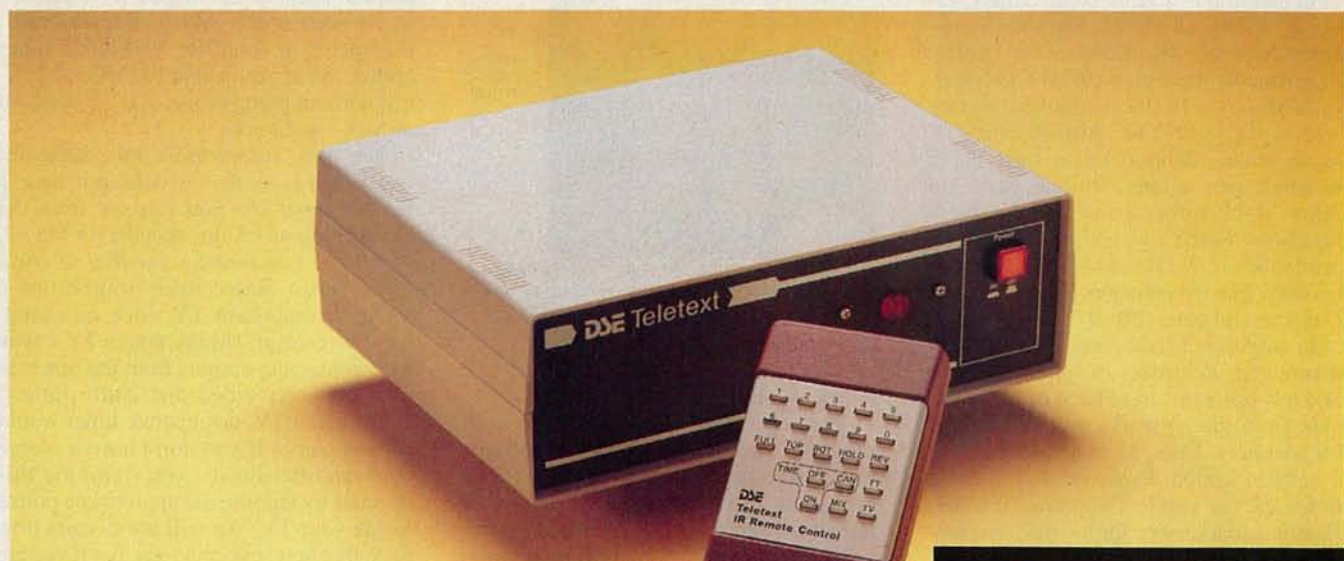

Teletext Decoder

Get all that you can from TV!
Decode those "hidden signals"
with this World System Teletext decoder

J. DANIEL GIFFORD

ARE YOU GETTING ENOUGH FROM TELEVISION? If you're not getting teletext, then you're not getting it all! But we'll show you how easy it is to build a World System Teletext decoder that will let you tune into a new world of information.

With this decoder, you can get—at the touch of a button—news, sports scores, weather forecasts, stock-market prices, and more. Teletext is expected to become very popular during the next few years. But you can get in on the action *now* by building your own decoder.

What is teletext?

Teletext is no longer just an experiment in the U.S.—the FCC authorized the use of lines 10-18 for teletext transmission in 1983. But even so, teletext has been slow to catch on, mainly because the necessary decoders have been very expensive. But, of course, that's no longer a problem. This decoder is available in kit form for under \$200.

Unlike videotext (which is an interactive system requiring phone lines or a two-way cable-TV net for operation), teletext is a one-way data transmission system that is sent out as part of a TV signal, whether that signal is sent out via satellite, cable, or regular broadcast TV. And best of all, it's available free of charge to viewers—advertisers will eventually pick up the tab for this service.

Teletext services

Although teletext services are in their infancy in the U.S., there are a number of systems operating right now, and one or more should be available to you no matter where you live. As we'll soon see, however, if you have cable TV or a TVRO dish, your chances of having a service available increases dramatically.

If you don't have cable or a TVRO, you may not be out of luck. One of the largest broadcast-TV services is the agriculturally-oriented *Infotext* service, produced by the University of Wisconsin and available on television stations throughout that state. Close behind is the general-interest *Electra* service produced by Taft Broadcasting of Cincinnati, available there on WKRC, Channel 12; the similar *Keyfax* service on WFLF, Channel 32 in Chicago; and the *Metrotext* service on KTTV, Channel 11, in Los Angeles.

Electra is the current giant of the teletext world in the U.S. because, in addition to being broadcast in the Cincinnati area, it is also linked by Satellite Syndicated Systems to Superstation WTBS-Atlanta and SPN. That makes *Electra* (a 100-page magazine that contains fast-breaking news, sports scores, headlines, and statistics, financial information, and features such as weather, a trivia page, and a sports quiz) available to over 9,000 cable-TV systems serving some 32 million homes,



plus an unknown number of TVRO owners.

In addition to simply connecting *Electra* to WTBS and SPN, Satellite Syndicated Systems also produces a teletext magazine of their own called *Cabletext*. *Cabletext* is a business-oriented service with 11 pages of NYSE, AMEX, and OTC stock prices, delayed by as little as 15 minutes, plus a long "rolling page" of other stock information and business headlines. Both *Cabletext* and *Electra* are available on WTBS and SPN simultaneously, *Electra* on pages 100 to 199, and *Cabletext* on pages 201-212.

In addition to the services we have mentioned, a number of others services and test programs have been or are available from the networks and some local broadcasters. CBS, for example, has had a service called *Extravision* for some time, and the public TV station WGBH-Boston had a service for a while, but neither used the World System Teletext standard. Instead, both used the NABTS (North American Basic Teletext Specification) system, which requires an expensive decoder. While the capabilities of NABTS teletext are more powerful than those of World System Teletext, the expense of the decoders has kept it from becoming popular. NBC, which had been broadcasting a NABTS service for almost 2 years, discontinued its participation in teletext service in early 1985. The reason given was that teletext technology for the consumer—namely the availability of affordable decoder—had not progressed as quickly as had been anticipated, and that there was little chance of affordable NABTS decoders becoming available in the foreseeable future.

How teletext works

Teletext text and graphics are transmitted as digital data squeezed into a broadcast television signal in the VBI, or Vertical Blanking Interval (which is the time at the end of each television field when the cathode-ray beam is cut off while it returns to start the next field.)

You can see the VBI as a black bar when the picture rolls vertically. And by looking at the VBI, you can see if a particular TV signal is carrying teletext data. Of course, you won't be able to see the actual teletext data in a readable form, but you can see the presence of teletext by rolling the TV picture until you can see the VBI. If it's smooth and steady, there's no teletext. But if teletext data are present, you will see—as you can in Fig. 1—several lines of dancing white dots in the VBI.

Teletext isn't the only information that the VBI is used to transmit. Other uses for the VBI include closed-caption information (which is another form of teletext), VIR (Vertical Interval Reference) automatic color-balance information, and VITS (Vertical Interval Test Signal)

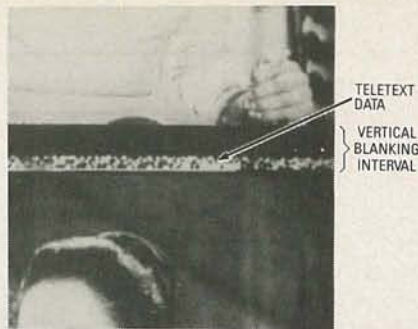

FIG. 1—YOU NEED A DECODER to view teletext, but not to detect the presence of teletext, which can be clearly seen in a TV signal's VBI.

broadcast test data.

Teletext is sent as an endless loop of "pages." The data for the pages are transmitted serially at the rate of 13,500 bits per second per VBI line used. The total rate of transmission, therefore, is dependent on the number of lines (up to 8) used to transmit the data.

At the user end, a decoder is used to convert the teletext data to a regular video signal that can be displayed on a TV screen. Any of the pages in the loop can be accessed at random. However, because of the endless-loop format, it takes time for each page to come around in the loop. The rate averages about 1.75 pages per second per VBI line used. So there is a slight delay between the time the page number is entered and the time that page appears on the screen. That imposes a practical limit to the number of pages a teletext service (or magazine) can offer. Most teletext services offer from 100 to 200 pages, which translates to an average delay of about 4 seconds. Some pages, such as indexes, are transmitted more than once within the loop so that they will come up faster.

Set-top decoders—whether NABTS or World System Teletext—have been expensive because the market for them has so far been small. Also, a decoder must incorporate a complete VHF/UHF tuner circuit. So if you wanted to receive teletext without going broke, you've been out of luck—until now.

The only compromise this \$200 decoder makes is that it does not have a built-in tuner. As you can see from the block diagram of the decoder in Fig. 2, you'll need an outboard source of composite video. Some likely sources are a VCR, a component-TV tuner, or a satellite TV receiver. (Many newer TV's even have composite outputs from the tuner, as well as direct video and audio inputs. With such a TV, no separate tuner would be necessary.) If you don't have a source of composite signals, you could use this decoder by tapping the appropriate points inside your TV. We will not discuss how to do that here, except to say that if you are not sure of what you're doing, don't even attempt it—it could be dangerous.

The decoder has two sets of outputs: composite video and audio jacks for connection to a monitor or a direct-input TV, and a Channel 3 or 4 RF output for connection to a TV's regular antenna input.

The heart of the decoder is a VM6780-2 teletext decoder module manufactured by Mullard Limited of Britain, one of the oldest and foremost manufacturers of teletext IC's and equipment. A block diagram of the module is shown in Fig. 3. The module contains 5 special-purpose IC's developed by Mullard, along with two 2114 RAM IC's that store the data for the current page. Although the module comes preassembled and is, for all practical purposes, an oversized 29-pin IC, a brief discussion of its operation is in order.

The module is connected to its input,

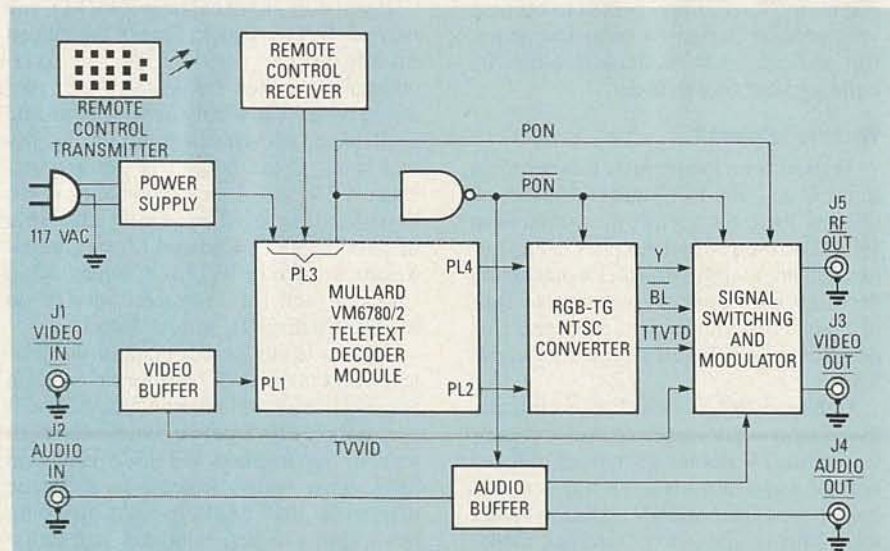

FIG. 2—THE TELETEXT DECODER BLOCK DIAGRAM. To make the Mullard decoder module a complete set-top decoder, you need to add a power supply, video and audio buffers, and an RGB-to NTSC converter so that it can be used with U.S. TV's. A signal switcher and modulator are needed so that both TV pictures and teletext data can be displayed at the same time.

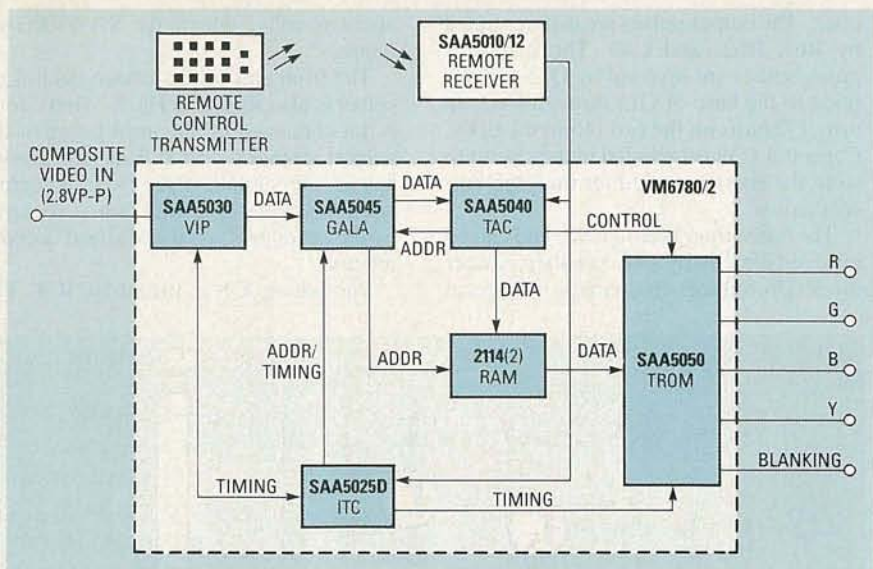

FIG. 3—THE DECODER MODULE contains all the actual teletext decoding circuitry. This simplified block diagram does not show many of the specialized control outputs of the module.

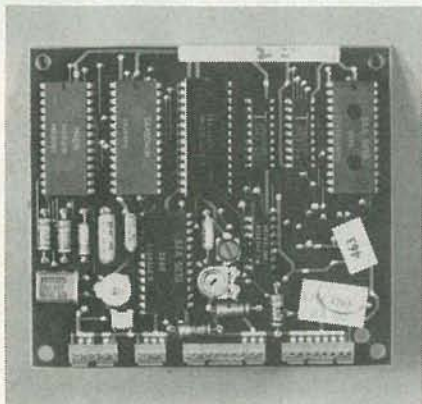

FIG. 4—THE TELETEXT DECODER MODULE comes pre-assembled from Mullard Limited of Britain.

output, and control circuitry by 29 pins that are arranged as four connectors, which can be seen in the photo of the module in Fig. 4. A 2.8 volt p-p composite-video signal is sent first to the SAA5030 Video Input Processor (VIP) IC, which locks onto the timing signals of the video signal and extracts the teletext data from the VBI. The data is sent to the module's master control IC, the SAA5040B Teletext Acquisition and Control (TAC) IC. The TAC separates the character data from the address data and stores each character in its correct place in RAM. Almost all functions of the module are controlled by the TAC, which, in turn, is controlled by an external remote-control input.

Because the teletext chip set was originally developed for 625-line, PAL-standard TV, the data from the VIP must be modified slightly before they are sent to the TAC. That's done by the SAA5045 Gearing and Address Logic Array (GALA) IC.

Once the data are stored in the two

RAM IC's, they are read out by the SAA5050 Teletext Read-Only Memory (TROM) IC, which produces an RGB video signal from the data. All timing information and signals for the module are produced by the fifth IC, the SAA5025D Timing Chain (TIC).

In addition to the RGB outputs, the Mullard module has several specialized outputs that are used to simplify its interface to a TV or other outlying circuitry. Only two of those, *After Hours Sync* (AHS) and *Picture ON* (PON) are used in this decoder.

The decoder circuit

The Mullard module was developed primarily to be used in "teletext-ready" TV sets. But as we saw in the block diagram in Fig. 2, it can be used as the heart of an excellent set-top decoder. All we

need to do is add a power supply, video and audio input buffers, a remote-control circuit, an RGB-composite video encoder, and a video switching and output circuit. We'll look at each of those circuits separately.

The schematic for the power supply is shown in Fig. 5. The supply has a conventional design that uses LM7805T and LM7812T regulators to produce the +5 and +12 outputs that are required by the rest of the decoder circuit. Since those regulators must be able to supply about 250 milliamps each, you must use heat-sinks with them.

The audio buffer (Fig. 6) and video buffer (Fig. 7) are also conventional in design. Their primary purpose is to provide signals of the proper level and polarity to the module and output circuitry. They also protect the decoder against excessive input voltages. Note that the AUDIO IN and AUDIO OUT jacks are simply connected together to form a built-in "Y" connector; that simplifies hookup to some tuner/monitor combinations. The audio signal plays no part in the decoder's operation. (Remember—the teletext information is transmitted in the vertical-blanking interval.) However, an audio input is provided so that it can be modulated on the RF output. If the decoder's composite video output is used instead, the audio connection can be made directly from the tuner to the monitor.

One very convenient feature of the decoder is that it offers wireless (infrared) remote control. The schematics for the remote-control transmitter and receiver are shown in Fig. 8.

The transmitter circuit is based around the Signetics SAA5000 transmitter-encoder IC. The SAA5000 requires very few external components—all that's needed for the keyboard are normally open push-button switches and pull-down resistors.

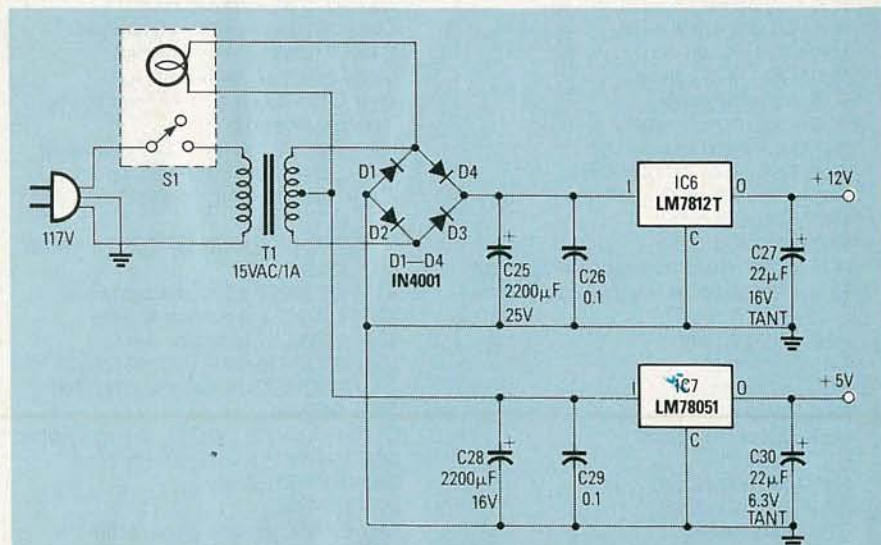

FIG. 5—THE POWER SUPPLY for the decoder uses a conventional design. Note that heat sinks are needed for the regulators, which must supply about 250 milliamps each. The power switch used in the prototype had a built-in pilot lamp.

All the decoding is handled inside the IC. The output circuit is also simple. The R-C network (R59 and C37) that is connected to pins 2 and 3 determines the output bit rate.

The output at pin 16 is a 24-bit serial

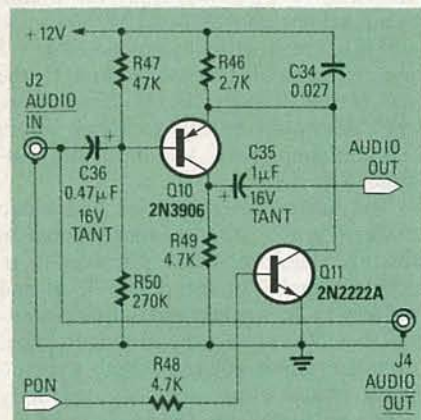

FIG. 6—THE AUDIO BUFFER. Note that decoder has no need for audio, so the input goes straight through to the output. However the sound is modulated for the RF output of the decoder. The PON signal is used to blank the sound when the decoder is in its teletext mode.

code. The output pulses are differentiated by R61, R62, and C40. The negative-going spikes are inverted by Q12 and applied to the base of Q13 through R63. In turn, Q2 turns on the two infrared LED's. Capacitor C39 is included in the circuit to store the energy needed for the high-current pulses.

The transmitter is handheld, and can be powered directly by a 9-volt battery. Zener diode D6 reduces the battery voltage to

about 6 volts, which the SAA5000 requires.

The front end of the remote control receiver is also shown in Fig. 8. That circuit is not contained on the main board of the teletext decoder, and it does not decode any of the signals it receives. It merely amplifies them to a level that is required by the decoder IC on the Mullard decoder module.

Photodiode D8 is biased by IC9. The

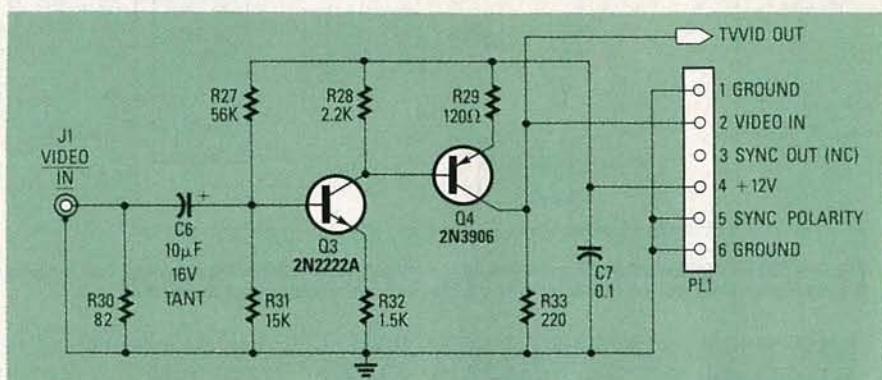

FIG. 7—THE VIDEO BUFFER. The buffered signal is sent to the video switch for TV display and to the module for teletext decoding of the VBI data.

PARTS LIST

All resistors ¼ watt, 5%, unless otherwise noted.

R1—4.7 ohms, ½ watt
 R2—R4, R6, R10, R14—R16, R37, R38, R60, R62—10,000 ohms
 R5, R34—100 ohms
 R7, R8—470 ohms
 R9—27,000 ohms
 R11—1 megohm
 R12, R32, R40—1500 ohms
 R13, R24, R48, R49—4700 ohms
 R17, R26, R28—2200 ohms
 R18—3300 ohms
 R19—R23, R66, R71—1000 ohms
 R25—10 megohms
 R27—56,000 ohms
 R29—120 ohms
 R30—82 ohms
 R31—15,000 ohms
 R33—220 ohms
 R35, R46—2700 ohms
 R36, R43—68 ohms
 R39—180 ohms, ½ watt
 R41, R42—2400 ohms
 R44, R53—R58—33,000 ohms
 R45—1800 ohms
 R47—47,000 ohms
 R50—270,000 ohms
 R51—1000 ohms, trimmer potentiometer
 R52—50,000 ohms trimmer potentiometer
 R59—220,000 ohms
 R61—560 ohms
 R63—47 ohms
 R64—27 ohms
 R65—2.2 ohms, ½ watt
 R67—22 ohms
 R68—150,000 ohms
 R69—100,000 ohms
 R70—6800 ohms

Capacitors

C1—100 µF, 16V electrolytic
 C2—C4, C7, C8, C16, C17, C24, C26, C29—0.1 µF, ceramic disc

C5—33 pF, ceramic disc
 C6, C38, C41, C43, C45—10 µF, 16 volts, tantalum
 C9, C20—100 pF, ceramic disc
 C10—C12—15 µF, 16 volts, tantalum
 C13—47 pF, ceramic disc
 C14, C23, C40—0.001 µF, ceramic disc
 C15, C18—0.01 µF, ceramic disc
 C19—10 pF, ceramic disc
 C21—5—70 pF, trimmer capacitor
 C22—not used
 C25, C28—2200 µF, 25 volts, electrolytic
 C27, C30, C31—22 µF, 16 volts, tantalum
 C32, C33—33 µF, 10 volts, tantalum
 C34—0.027 µF, dipped mylar
 C35—1 µF, 16 volts, tantalum
 C36—0.47 µF, 16 volts, tantalum
 C37—270 pF, ceramic disc
 C39—330 µF, 16 volts, electrolytic
 C42—0.0033 µF, ceramic disc
 C44—0.047 µF, ceramic disc
 C46, C47—47 µF, 16 volts, electrolytic

Semiconductors

IC1—SAA5010 remote-control receiver
 IC2—CD4013B dual D-type flip-flop
 IC3—74HC00 high-speed CMOS quad NAND
 IC4—MC1377 RGB-NTSC/PAL Video Encoder
 IC5—CD4066B quad analog switch
 IC6—LM7812T regulator, 12 volts
 IC7—LM7805T regulator, 5 volts
 Q1—Q3, Q7—Q9, Q11—BC548 (2N2222A)
 Q4—Q6, Q10, Q12—BC558 (2N3906)
 Q13—2N2094
 D1—D4—1N4001, 50 PIV, 1 amp rectifier
 D5—1N4735 6.2 volts, 1 watt, Zener
 D6—3.3 volts, Zener
 D7—1N4148
 D8—BPW50 infrared photodiode
 LED1, LED2—LD271 infrared LED
 LED3—standard, red

Other components

L1—chroma coil (TOKO16NNF/10624AG)

L2—400 nS delay line
 L3—5 mH
 S1—SPST push-on/push-off, illuminated
 S2—SPST miniature slide
 S3—S23—SPST normally open pushbutton
 T1—117 volts to 15 volts, center tapped, 1A transformer
 XTAL1—3.579545 MHz
 RF modulator—Astec UM1285-8 RF video modulator
 Module—Mullard VM6780-2 teletext decoder module
Miscellaneous: Case, power cord, strain relief, ribbon cable and connector plugs (4, 6, 9, and 10-pin), Mullard module, RCA jack, 5-pin DIN socket, clip-on heatsinks, IC sockets, hardware, heatshrink tubing, etc.

A complete kit of parts (No. K-6315), including PC board, case, and all parts—except those for the wireless remote control circuit in Fig. 8 (a wired remote control unit is substituted—is available for \$199.00 plus \$10.00 shipping from Dick Smith Electronics, Inc., P.O. Box 8021, Redwood City, CA 94063; 800-332-5373 (orders) 415-368-8844 (inquiries). The following parts are also available separately: Case (No. H-2507), \$12.95; Transformer T1 (No. M2155), \$5.95; PC board (H-7001) \$29.95; IC1 (No. Z-6900), \$12.95; IC4 (No. Z-2500), \$1.90; XTAL1 (K-6031), \$1.19; L1 (No. L-0521), \$1.50; L2 (No. L-0520), \$4.95.

A complete kit of parts for the infrared remote control (No. K-3425) is available for \$34.95 plus \$2.75 shipping.

California residents must add 6.5% sales tax. Orders outside U.S. must include U.S. funds and add 15% of merchandise total for shipping.

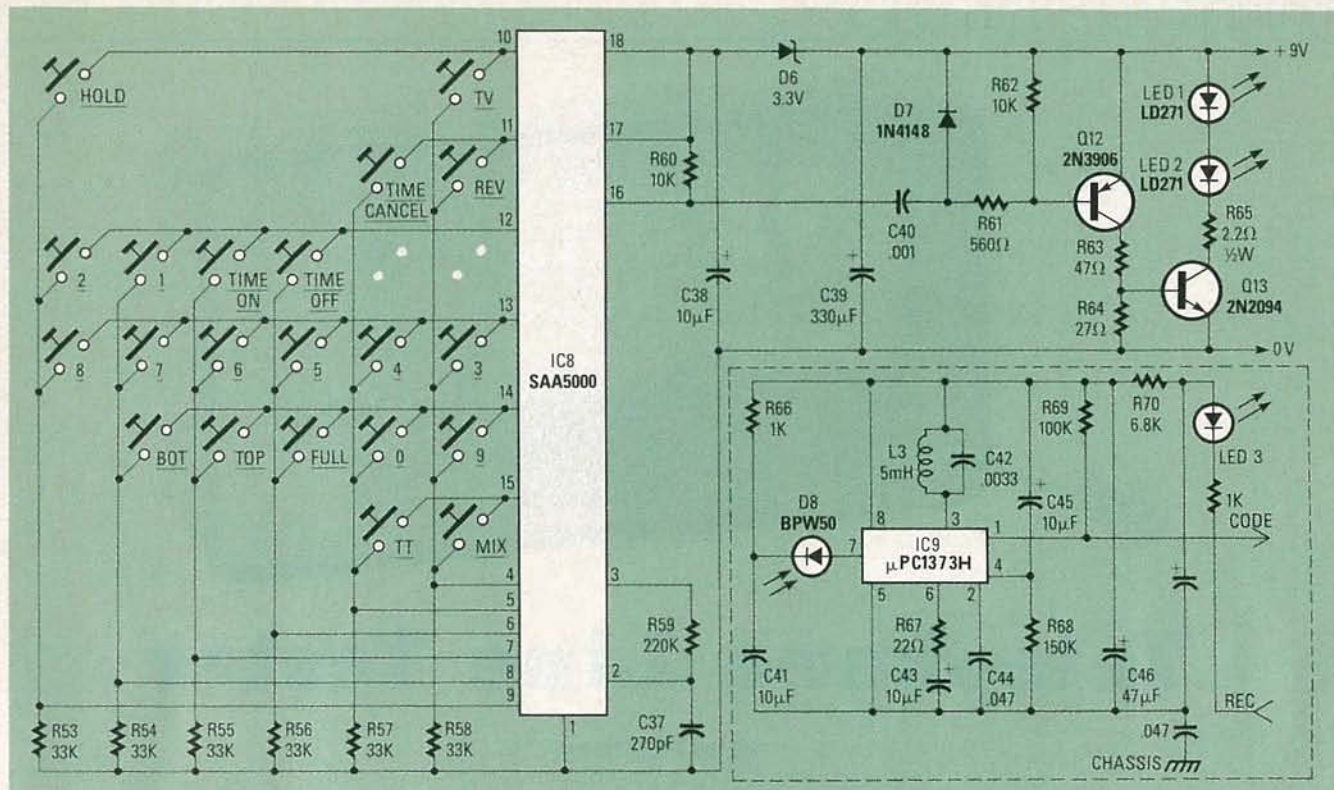

FIG. 8—THE WIRELESS REMOTE CIRCUIT controls all the functions of the decoder except power. IC8 handles all the keyboard-decoding and code generation functions for the transmitter. The front end of the receiver circuit is shown inside the dashed box.

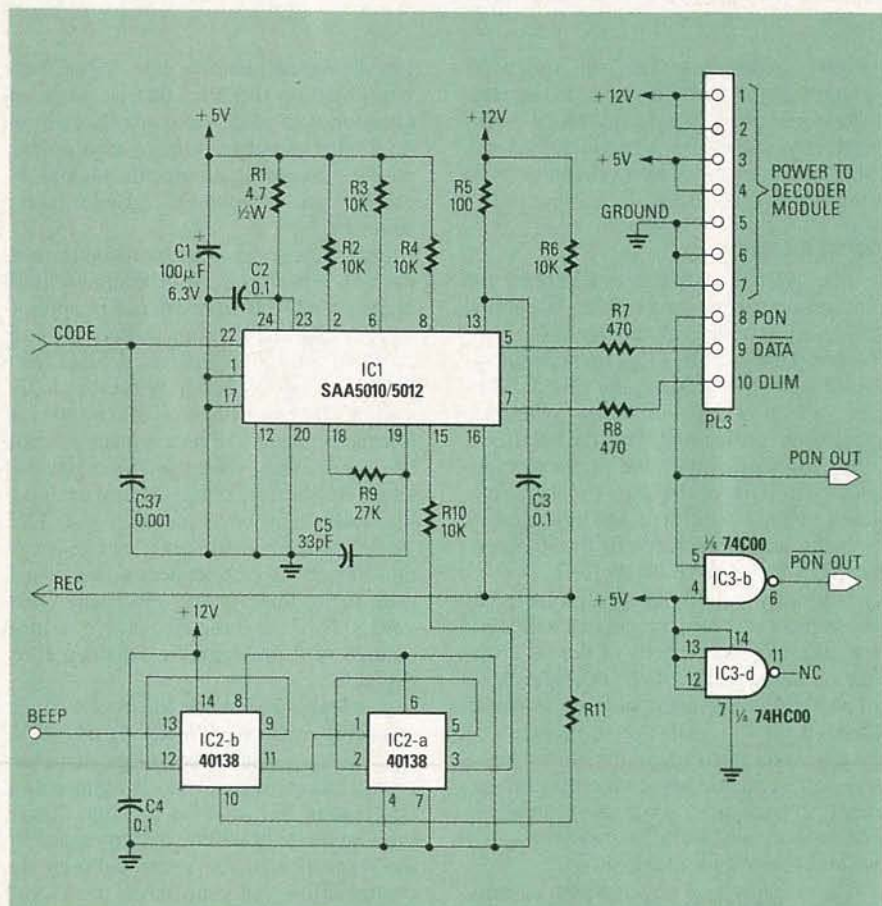

FIG. 9—THE REMOTE CONTROL DECODING CIRCUIT. IC1 decodes the signals that are sent from the receiver front-end to pin 22. It sends back a "message-received" signal on pin 16. IC2 provides a 2400 Hz signal that can be used to drive a piezoelectric transducer for an audible signal that a message has been received.

gain of the IC is determined by the ratio of the impedance at pin 3 to that at pin 6. The tuned circuit connected to pin 3 is resonant at the transmitter's frequency.

The preamplifier IC also limits and level-shifts the output of the preamplifier stage to reduce the effects of noise and poor transmission conditions. The IC also contains a peak detector that extracts the data from the bit stream and sends it out on pin 1. Note that LED3, which lights to acknowledge the receipt of a message, is not part of the preamplifier circuit. However, it's shown with the preamp because it is also mounted off the main board.

Other than power and ground, there are two connections from the preamp to the main board. One is the message-received signal from the Mullard module, and the other is the serial control data that are sent to the module's remote-control decoder circuit, which is shown in Fig. 9.

The heart of the decoder is IC1, the SAA5010/5012 remote control receiver. We won't discuss the control format here except to say that the system uses a doubly-redundant 24-bit data stream for each command, making it virtually error-proof. We will cover the various commands in detail next time.

One of the IC1's control frequencies is divided down by IC2, a 4013 dual flip-flop, and the resulting 2400 Hz tone can be sent to a transducer to provide an audible message-received signal.

Next time, we'll finish up with the circuit and show you how to build the unit.

R-E

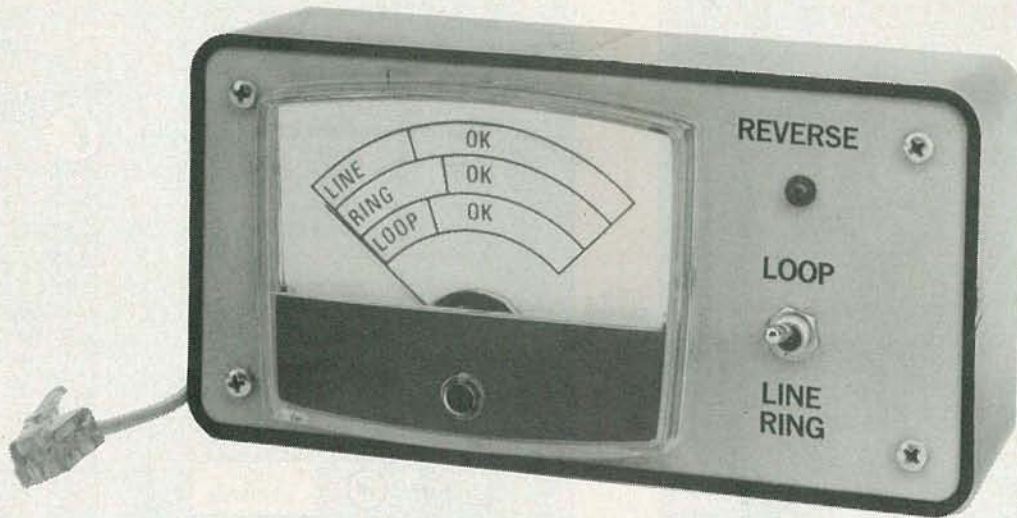

Telephone Line Tester

HERB FRIEDMAN

Beat the telephone service guessing game with this simple yet effective telephone-line tester.

EVER SINCE THE BREAKUP OF AT&T, THE odds of getting a telephone circuit repaired on the first attempt are only 50-50. The problem is that now the telephone lines are the responsibility of your local telephone company, while the receiver itself is the responsibility of its supplier, most often AT&T. If you contact the supplier, and the problem is not in the telephone, they won't help you. Similarly, if you call the local telephone company, and the problem is in the telephone, you are also out of luck. But this time there's a kicker—you can be billed \$50.00 or more for a "service" call. And you still won't have a working phone.

One of the ways to avoid playing the telephone-service guessing game, and thus any unnecessary and unconscionable service charges, is to first, conduct your own line tests, using the telephone-line tester shown in Fig. 1. If the telephone line passes its tests, any problems must be the fault of the receiver itself. If the line doesn't pass its tests, you can call in the local telephone company secure in the knowledge they won't—or can't—stick you for a service charge.

The telephone-line tester is intended for the commonly used modular connector system. To use the device you simply unplug the telephone from its modular connector and substitute the tester's connector. If for some reason you want both the tester and telephone to be simulta-

neously connected, you can use a Y-adaptor at the modular jack. If the telephone uses the older 4-pin "block" connector, you can use a modular-to-4 pin block adapter; those are available in both single and Y versions.

What it tests

The telephone-line tester checks the operating parameters of the telephone company's wiring at the modular connector. That includes the open circuit or "on-hook" line voltage; the "loop" voltage, which is the line voltage when the telephone is off hook (when the handset is lifted from its cradle); the ringer voltage, and the polarity of the line. The telephone line's voltage conditions are indicated by a meter, and the polarity of the line connections is indicated by an LED.

Normally, polarity is not a problem because most standard telephones will work regardless of the polarity of the DC voltage on the telephone line. (The purchase of any telephone that is polarity sensitive should be seriously questioned.) However, reversed line polarity can interfere with certain kinds of switching equipment, in particular, some of the low-cost conference and multi-use switchers, so we've provided for that test.

The voltage-level on telephone circuits is 48-volts DC. The wires in the telephone cables are color-coded, with the *green* wire being the positive side, and the *red*

wire being the negative side. When there is no load on the line, that is, when all telephones in your home or office are *on hook*, the measured voltage at your telephone's modular connector should be greater than 40-volts DC, give or take a smidgen.

Depending on your particular telephone's repeat coil, your telephone will represent a DC load resistance of approximately 190 to 250 ohms when it goes *off hook*, meaning the handset is lifted from the cradle. Since there is resistance in the wiring between the central office and your telephone, there will be a substantial drop in voltage when your telephone goes off hook. At that time, the voltage at the modular jack might be as low as 5-volts DC. (A Bell System instrument, such as one of the 500 series of telephones, will work even if the line voltage approaches zero volts.) For conventional service a loop voltage of 5 or higher is considered acceptable.

A telephone is made to ring by superimposing a 90-volt, 20-Hz signal on the line. Since a telephone ringer is always connected across the line it represents a continuous AC load on the line. Thus, once again there will be a drop caused by the resistance in the wires between the central office and your phone. A 45-volt RMS equivalent voltage at your telephone is considered acceptable, although 40 volts is sufficient to ring the phone.

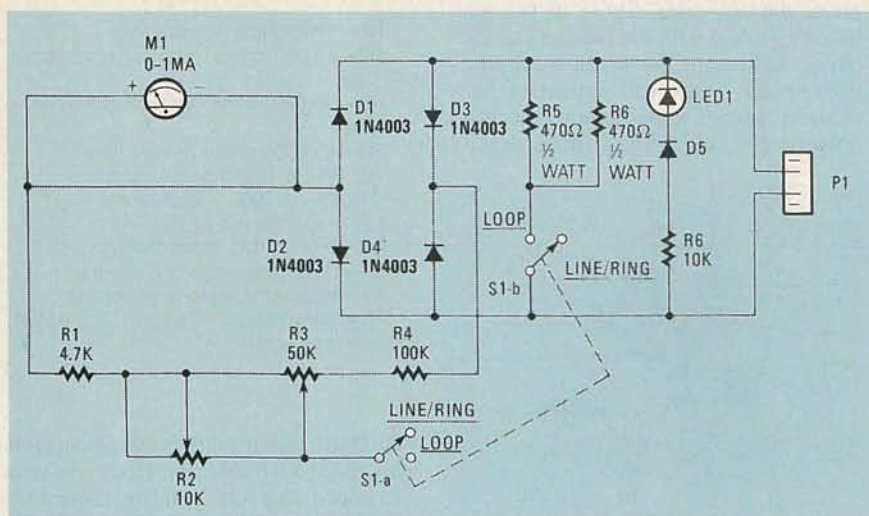

FIG. 1—BY PREVENTING UNNECESSARY SERVICE CALLS, this simple yet effective circuit can save you quite a bit of money.



FIG. 2—THE SMALL PC BOARD can be secured to the front panel of the cabinet via S1's mounting nut. The board shown here is the author's prototype.

How it works

The telephone-line tester shown in Fig. 1 is connected to the telephone line through modular connector P1. Although a conventional telephone modular-plug has four connectors, the tester uses only the two inside ones—the red and the green. The yellow and black connectors are not used for normal, single-instru-

ment, two-wire service. Since the tester's LED polarity indicator is always connected when the tester is plugged in, the instant the unit is connected you will have an indication of the polarity. If it is correct—that is, if the green wire is the positive side—and the red wire is the negative side, nothing will happen. If the situation is reversed, the LED will light.

With switch S1 set for LINE/RING, both S1-a and S1-b are open and the meter indicates the condition of the line-voltage. Any line voltage reading in the LINE OK range (more on the meter in a moment) indicates a line voltage higher than 40-volts DC. If the telephone is caused to ring, either by using a ringback number or by dialing from another phone, the meter will indicate RING OK, and the LED will pulse (indicating AC), if the ringing voltage/current is correct. The actual position

of the meter's pointer depends on how many ringers are connected across the line. (Three or more of the old-fashioned ringers can excessively load the ringing voltage if the local telephone company has not corrected for your ringer load.)

When S1 is closed the voltage range of the meter is changed and a nominal load resistance of 230 ohms (R5 and R6) is connected across the line to emulate the off hook load of the telephone. If the meter indicates LOOP OK, you can be certain that you have sufficient loop voltage for satisfactory telephone operation. If you place another load on the line, perhaps by taking an extension telephone off hook, the meter reading will almost invariably drop below the LOOP OK range. That is perfectly normal; the line is operating properly when a single loop load results in a LOOP OK meter reading. That, by the way, is how to test telephones for proper connection. If lifting the handset causes the meter reading to drop, you can at least be certain that the telephone's hook switch is working and that the repeat coil is connected to the line.

Building the unit

The unit is assembled on the metal front panel of a 1½ × 2½ × 5½-inch plastic utility box. Except for the meter, all components are installed on a 2 × 2¼-inch printed circuit board that is self-mounting to the panel through S1's mounting nut (see Fig. 2). An appropriate foil pattern for this project is shown in Fig. 3; the parts-placement diagram for that board is shown in Fig. 4. Note that the size of the PC board and its layout aren't really critical as long as the board fits inside the cabinet without interfering with the installation of the meter or the cabinet's internal panel-support posts.

While it is usually best to make circuit boards using the photographic method, because of its small size, this board is an exception. It is probably best to do this layout by hand, using resist tape and resist donuts. That's because the board's small size and relative simplicity make the photographic method too expensive to justify. That's why we've shown the layout here, rather than in our PC service section as usual.

There's just one catch to that—very thin resist tape is getting harder to find in stores all the time. If you can't find the proper tape, we suggest you replace the trace that sweeps around the S1 contacts with a length of No. 24 or No. 26 solid insulated wire. That substitution has been made in the author's prototype to show you the proper routing of the wire. See Fig. 2.

Potentiometers R2 and R3 are installed on the foil side of the board so that they

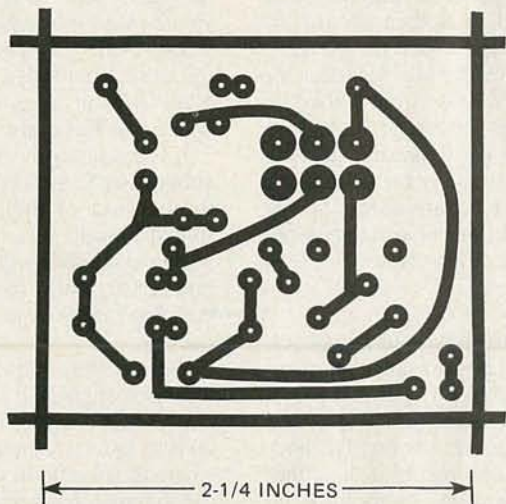

FIG. 3—BECAUSE OF IT'S SMALL SIZE and relative simplicity, the foil pattern for the telephone-line tester is shown here.

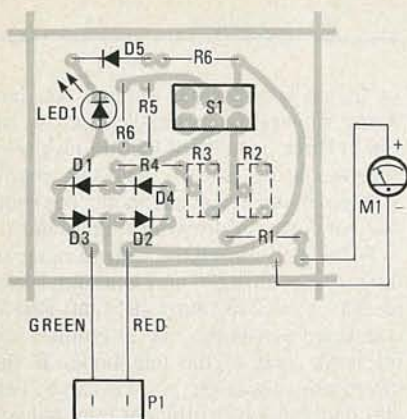

FIG. 4—PARTS-PLACEMENT DIAGRAM for the telephone-line tester. The foil pattern can be found in our PC service section, elsewhere in this issue.



FIG. 5—IF YOU WANT to dress-up the meter, a new scale, similar to the one shown here, can be made. If you choose to do that, be sure that the LINE OK and LOOP OK reference lines fall at the 0.3 mA mark; the RING OK range begins at 0.4 mA.

can be accessed without dismantling the project. All other components are mounted conventionally on the "component" side of the PC-board. To ensure that the LED passes through the panel when the printed-circuit assembly is installed, position the LED so that there is $\frac{1}{8}$ -inch between the printed circuit board and the bottom of the LED before you solder its leads. When the assembly is secured with S1's mounting nut, $\frac{1}{4}$ to $\frac{1}{2}$ of the LED will protrude through the front panel.

You might be tempted to substitute a single 230-ohm resistor for R5 and R6. Don't do that! The loop load must be rated for 1 watt, and that is most easily accomplished by using two parallel-connected half-watt standard-value resistors.

Meter M1 in our project is a 0-1-mA DC meter; those are available from almost any electronics supplier. If you want to dress up your project, you can create a meter scale similar to the one shown in Fig. 5. If you do that, the LINE OK and LOOP OK ranges should begin at 0.3 mA. The RING OK range should begin at 0.4 mA. Once you've drawn the scale, remove the meter's plastic cover. Then, taking care not to bend or otherwise damage the meter's needle, glue the new scale in place.

The modular connecting cord can be salvaged from some old telephone gear, or you can get a replacement cord at your local telephone store. With rare exceptions, the cord will have four wires; you will use only the green and red ones, as

previously mentioned. Cut the cord to the length you want and then carefully trim the insulation from the free end of the green and red wires. Those of you who haven't worked with old headsets or telephone equipment are in for a surprise, because the wires will appear to be a strand of copper wound around a cotton, polyester or silk thread. That's exactly

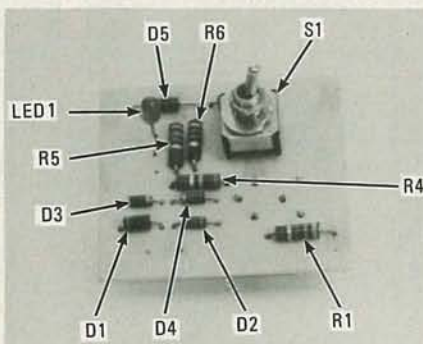

FIG. 6—THE COMPLETED PC board is shown here.

what it is. That type of wire is called "Litz" wire; it is very flexible, but it is almost impossible to solder because the fibers actually burn up before the connection is made. To install the Litz wires on the printed-circuit board, lightly tin the wire using a low-wattage (about 25 watts) soldering iron. Then clip off the very end of the wire so there's no loose strand and pass the wire(s) through its hole in the printed-circuit board. Fold the wire flat against the foil and then quickly solder it in place. If you use too large an iron, or too much heat (you keep the iron on the connection too long), the wire will burn up (turn black) and you'll have to repeat the whole thing until the Litz wires are properly soldered to the printed-circuit foils.

Once you've assembled the board (see Fig. 6), install the meter in the panel, solder the two pieces of wire that will be used to connect the circuit and the meter to the PC board, and then secure the printed-circuit board to the panel, using S1's mounting nut. Finally, connect the free ends of the wire you previously installed to the meter; be sure to observe the proper meter polarity. To prevent the modular cord from eventually breaking at the soldered Litz-wire connections, secure the cord with a plastic cable clamp at one of the meter's mounting screws.

Calibration

Set R2 and R3 to about mid-range, set S1 to the LINE/RING position and then connect a small variable DC power source across the telephone line input. Adjust the power supply for about 40-volts DC and see if the LED turns on. If it does the power supply connections are reversed. If it does not turn on, check its operation by reversing the power connections. If the

PARTS LIST

- R1—4700 ohms, $\frac{1}{4}$ watt, 5%
- R2—10,000 ohms, trimmer potentiometer.
- R3—50,000 ohms, trimmer potentiometer.
- R4—100,000 ohms, $\frac{1}{4}$ watt, 5%
- R5, R6—470 ohms, $\frac{1}{2}$ watt, 5%
- D1-D5—1N4003 silicon diode
- LED1—jumbo red LED
- M1—0-1-mA DC panel meter
- S1—DPST, miniature, PC mount
- P1—Modular telephone connector.
- Miscellaneous**—Cabinet, PC board, wire, solder, etc.

LED still doesn't turn on you have probably made a wiring error. Once you've determined that the polarity indicator is working normally, return the power-supply connections to normal (LED off).

Next, set the power supply to 5-volts DC, flip S1 to the LOOP position, and adjust R2 until the meter's needle moves to the LOOP OK reference line (reads 0.3 mA). Next, flip S1 back to the LINE/RING position, adjust the power supply for 40-volts DC, and adjust R3 until the meter pointer is on the LINE OK reference line.

Testing the line

To test a telephone line simply set S1 to the LINE/RING position and connect the tester to the telephone line. If the LED lights, the telephone company's wiring to the connector is reversed (it does happen). Note the meter reading—the pointer should rest anywhere in the ok range (read 0.3 mA or greater). Next, flip S1 to the LOOP position; again, the meter should read in the ok area. Finally, once again set S1 to the LINE/RING position and cause the line to ring (perhaps by dialing from another phone). The meter should read in the RING OK range (greater than 0.4 mA) and the LED should blink because the voltage applied to the polarity-tester circuit is AC. If any of the tests produces anything but the expected results, the problem most likely lies in the telephone lines rather than in the phone itself.

If you want to check out extension telephones, set S1 for a LOOP test and then lift the handset of any phone; the meter should indicate less than the OK reading when the telephone goes off hook. As we said earlier, that is normal and shows that the telephone is at least connected to the line.

The telephone-line tester we've described is limited; it can not tell you precisely what's wrong with your telephone service. But it can at least tell you roughly where the trouble lies, and hence who to call to have repairs done. Considering the high cost of an unnecessary service call, that puts you way ahead in the game. **R-E**

Gravitational Waves???

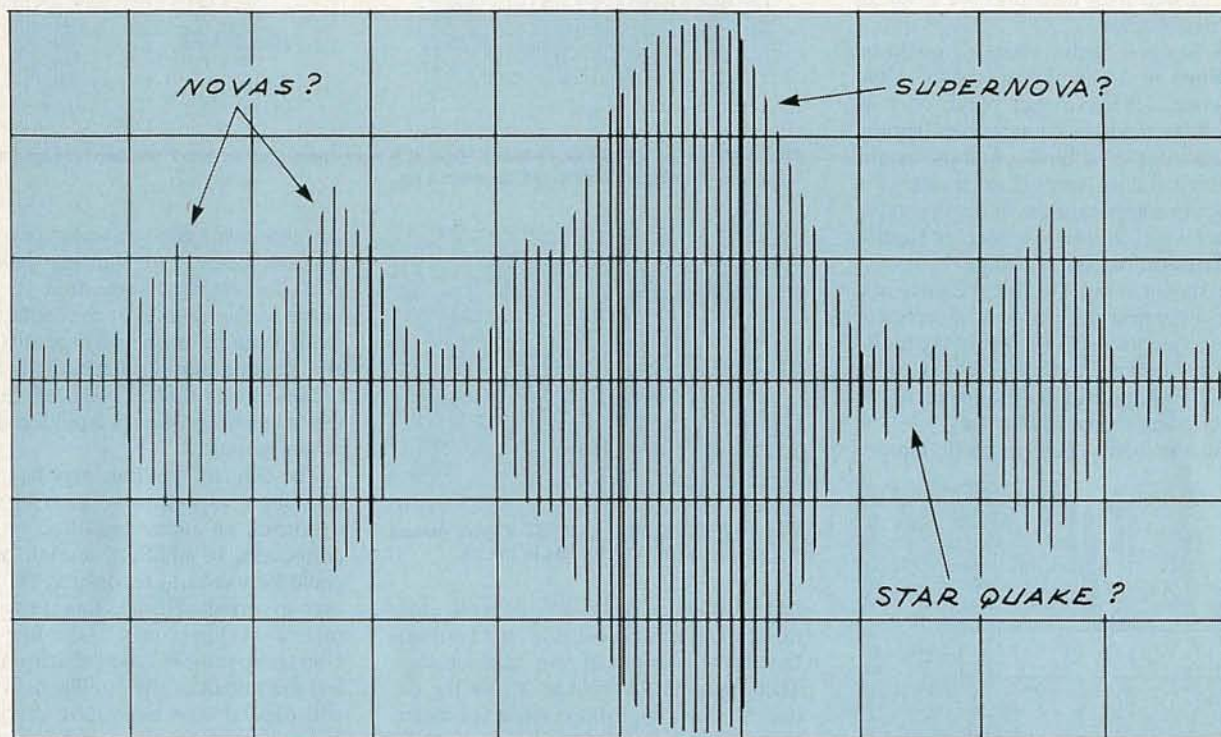

Are gravitational waves the source of noise in electronic devices?

The author believes so, and describes a simple circuit to detect the waves.

GREGORY HODOWANEC

EINSTEIN PREDICTED THE EXISTENCE OF gravity waves—the counterpart of light and radio waves—many years ago. However, he predicted the existence of quadrature-type gravity waves. Unfortunately, no one has been able to detect quadrature-type gravity waves.

Consequently, the author developed, over the years, a new cosmology, or theory of the universe, in which monopole gravity waves are predicted. The author's theory does not preclude the existence of Einsteinian gravity waves, but they are viewed as being extremely weak, very long in wavelength, and therefore very difficult to detect unequivocally. Monopole signals, however, are relatively strong, so they are much more easily detected.

Monopole gravity waves have been detected for many years; it's just that we're used to calling them $1/f$ "noise" signals or flicker noise. Those noise signals can be seen in low-frequency electronic circuits. More recently, such signals have been called *Microwave Background Radiation* signals (MBR); most scientists believe that to be a relic of the so-called "big-bang" that created the universe.

In the author's cosmology, the universe is considered to be a finite, spherical, closed system; in other words, it is a black body. Monopole gravity waves "propagate" any distance in Planck time, which is about 10^{-44} seconds; hence, their effects appear everywhere almost instantaneously. The sum total of background flux in the universe gives rise to the observed microwave background temperature, in our universe, of about 3°K .

Sources of monopole gravity waves include common astrophysical phenomena like supernovas, novas, starquakes, etc., as well as earthly phenomena like earthquakes, core movements, etc. Those sorts of cosmic and earthly events cause detectable temporary variations in the amount of gravitational-

The author has developed a new cosmology that predicts the existence of a new type of gravitational signal. We are publishing the results of some of his experiments that back up his theories in the hope that it will foster experimentation as well as alternate explanations for his results.

impulse radiation present in the universe.

Novas, especially supernovas (which are large exploding stars), are very effective generators of oscillatory monopole gravity waves. Those signals have a Gaussian waveshape and a lifetime of only a few tens of milliseconds. They can readily impart a portion of their energy to free particles like molecules, atoms, and electrons.

The background flux, in general, is fairly constant. Variations in the background flux are caused by the movements of large mass concentrations like galaxies, supergalaxies, and black holes. Those movements create gravitational "shadows," analogous to optical shadows. When the Earth-moon-sun alignment is just right, the gravitational shadow of a small, highly concentrated mass—a black hole, for example—can be detected and tracked from the Earth. So, keeping those facts in mind, let's look at several practical methods of detecting gravitational energy.

Electrons and capacitors

As stated above, gravity-wave energy can be imparted to ordinary objects. Of

special interest to us are the loosely-bound electrons in ordinary capacitors. Perhaps you have wondered how a discharged high-valued electrolytic capacitor (say 1000 μF at 35 volts) can develop a charge even though it is disconnected from an electrical circuit.

While some of that charging could be attributed to a chemical reaction in the capacitor, I believe that much of it is caused by gravity-wave impulses bathing the capacitor at all times. And the means by which gravity waves transfer energy is similar to another means of energy transfer that is well known to readers of **Radio-Electronics**: the electric field.

As shown in Fig. 1-a, the presence of a large mass near the plates of a capacitor causes a polarized alignment of the molecules in the capacitor, as though an external DC voltage had been applied to the capacitor, as shown in Fig. 1-b.

You can verify that yourself: Drop a

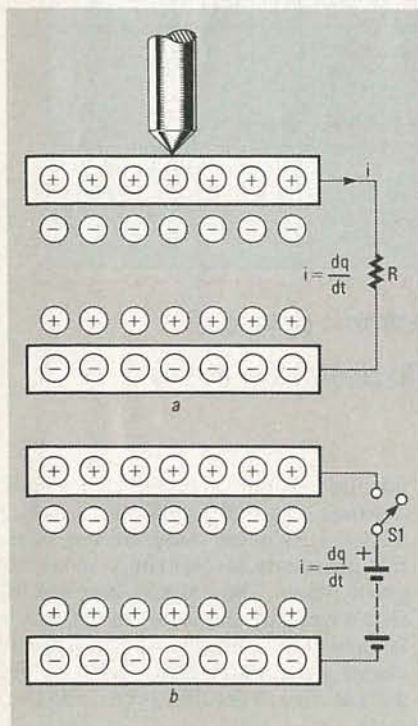

FIG. 1—A CAPACITOR CAN BE CHARGED by a gravitational impulse (a), just as it may by a DC voltage (b).

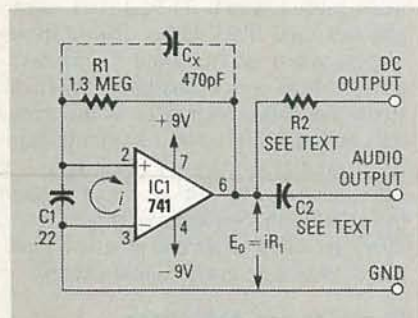

FIG. 2—A BASIC GRAVITY-WAVE DETECTOR is very simple. The charge build-up on capacitor C1 due to gravity-wave impulses is amplified by IC1 for output.

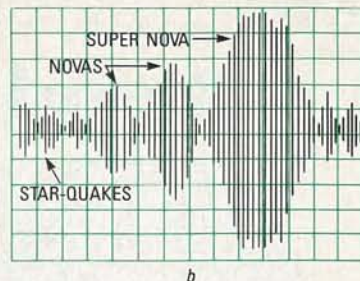
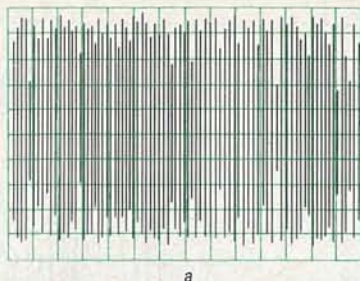

FIG. 3—DISPLAY OF GRAVITY-WAVE SIGNALS from the circuit in Fig. 2 reveals 1/f signals (a) and amplitude-modulated astrophysical events (b).

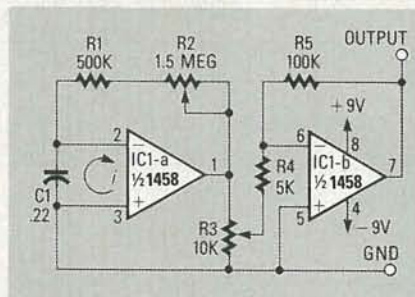

FIG. 4—A BUFFERED OUTPUT STAGE makes the gravity-wave detector easier to use.

fully-discharged 1000- μF , 35-volt electrolytic capacitor broadside on a hard surface from a height of two or three feet. Then measure the voltage across the capacitor with a high-impedance voltmeter. You will find a voltage of about 10 to 50 mV. Drop the capacitor several times on opposite sides, don't let it bounce, and note how charge builds up to a saturation level that may be as high as one volt.

In that experiment, the energy of free-fall is converted to polarization energy in the capacitor. The loosely-bound electrons are literally "jarred" into new polarization positions. In a similar manner, gravitational impulses from space "jar" electrons into new polarization positions.

Here's another experiment: Monitor a group of similar capacitors that have reached equilibrium conditions while being bathed by normal background gravitational impulses. You'll observe that, over a period of time, the voltage across all those open-circuited capacitors will be equal, and that it will depend only on the average background flux at the time. Temperature should be kept constant for that experiment.

I interpret those facts to mean that a capacitor develops a charge that reflects the monopole gravity-wave signals existing at that particular location in the universe. So, although another device could be used, we will use a capacitor as the sensing element in the gravity-wave detectors described next.

The simplest detector

Monopole gravity waves generate small impulse currents that may be coupled to an op-amp configured as a current-to-voltage converter, as shown in Fig. 2. The

current-to-voltage converter is a nearly lossless current-measuring device. It gives an output voltage that is proportional to the product of the input current (which can be in the picoampere range) and input resistor R1. Linearity is assured because the non-DC-connected capacitor maintains the op-amp's input terminals at virtual ground.

The detector's output may be coupled to a high-impedance digital or analog voltmeter, an audio amplifier, or an oscilloscope. In addition, a chart recorder could be useful to record the DC output over a period of time, thus providing a record of long-term "shadow-drift" effects. Resistor R2 and capacitor C2 protect the output of the circuit; their values will depend on what you're driving. To experiment, try a 1K resistor and 0.1 μF capacitor.

The output of the detector (E_O) may appear in two forms, depending on whether or not stabilizing capacitor C_X is connected. When it is, the output will be highly amplified 1/f noise signals, as shown in Fig. 3-a. Without C_X , the circuit becomes a "ringing" circuit with a slowly-decaying output that has a resonant frequency of 500–600 Hz for the component values shown. In that configuration, the circuit is a Quantum Non-Demolition (QND) circuit, as astrophysicists call it; it will now actually display the amplitude variations (washes) of the passing gravitational-impulse bursts, as shown in Fig. 3-b.

An interesting variation on the detector may be built by increasing the value of sensing capacitor C1 to about 1000–1600 μF . After circuit stability is achieved, the circuit will respond to almost all gravity-wave signals in the universe. By listening carefully to the audio output of the detector you can hear not only normal 1/f noise, but also many "musical" sounds of space, as well as other effects that will not be disclosed here.

An improved detector

Adding a buffer stage to the basic circuit, as shown in Fig. 4, makes the detector easier to work with. The IC used is a common 1458 (which is a dual 741). One op-amp is used as the detector, and the other op-amp multiplies the detector's

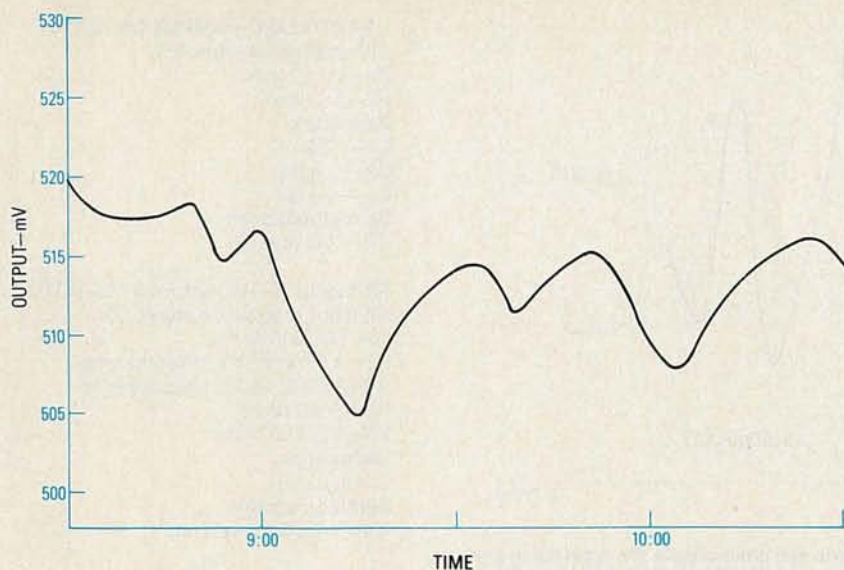

FIG. 5—THE SAME GRAVITATIONAL "SHADOW" passed the author's monitor location on two consecutive days at approximately the same time.

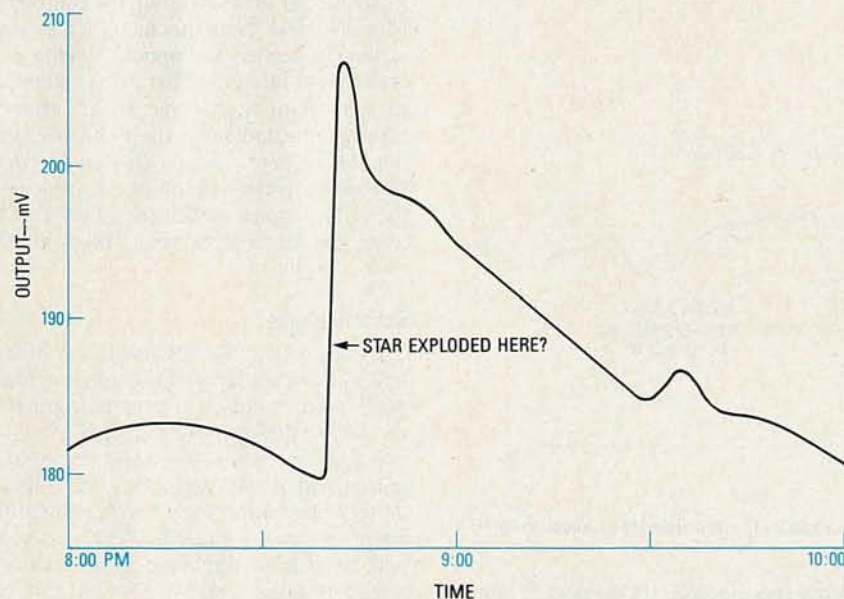

FIG. 6—THE EXPLOSION OF A SUPERNOVA just after 8:30 pm produced the sharp slope in this curve.

output by a factor of 20. Potentiometer R3 is used to adjust the output to the desired level.

When used unshielded, the circuits presented here are not only sensitive detectors of gravitational impulses, but also of *electromagnetic* signals ranging from 50–500 GHz! Hence, these circuits could be used to detect many types of signals, including radar signals.

To detect only gravity waves, and not EMI, the circuit should be shielded against all electromagnetic radiation. Both circuits are low in cost and easy to build. Assembly is non-critical, although proper wiring practices should be followed. Initially, you should use the op-amps specified; don't experiment with other devices until you attain satisfactory results with the devices called for. Later you can experiment with other compo-

nents, like low-power op-amps, especially CMOS types, which have diodes across their inputs to protect them against high input voltages. Those diodes make them much less sensitive to electromagnetic radiation, so circuits that use those devices may be used to detect gravity-waves without shielding.

The circuit in Fig. 4 is the QND or ringing type, but the feedback resistance is variable from 0.5 to 2 megohms. That allows you to tune the circuit to the natural oscillating frequency of different astrophysical events. Huge supernova bursts, for example, have much larger amplitudes, and lower frequencies of oscillation than normal supernovas and novas. Hence you can tune the detector for the supernova burst rate that interests you. With the component values given in Fig. 4, the resonant frequency of the circuit

RHYSMONIC COSMOLOGY

Ancient and Renaissance physicists postulated the existence of an all-pervasive medium they called the *ether*. Since the advent of sub-atomic physics and relativity, theories of the ether have fallen into disuse. Rhythmic cosmology postulates the existence of rhyssons, which are the fundamental particles of nature, and which pervade the universe, as does the ether.

Each rhysson has the attributes of size, shape, position, and velocity; rhyssons are arranged in space in a matrix structure, the density of which varies according to position in the universe. The matrix structure of rhyssons in free space gives rise to the fundamental units of length, time, velocity, mass, volume, density, and energy discovered by physicist Max Planck.

Fundamental postulates of the Rhythmic Universe can be summarized as follows:

- The universe is finite and spherical.
- Euclidean geometry is sufficient to describe Rhythmic Space.
- The edge of the universe is a perfect reflector of energy.
- Matter forms only in the central portion of the universe.

The matrix structure of rhyssons allows the instantaneous transmission of energy along a straight line, called an energy vector, from the point of origin to the edge of the universe, where it would be reflected according to laws similar to those governing spherical optics.

In Rhythmic Cosmology, mass, inertia, and energy are treated as they are in classical mechanics. Mass arises, according to the author, because "particles in rhythmic cosmology must be the result of changes in the 'density' of the rhythmic structure, since the universe is nothing more than rhyssons and the void."

In a "dense" area of the universe, such as the core of a particle, a number of rhyssons are squeezed together. This means that every particle has a corresponding anti-particle, or an area of correspondingly low density. In addition, a particle has an excess of outward-directed energy vectors, and an anti-particle has an excess of inward-directed energy vectors. Those vectors are what we usually call electric charge.

Gravity is not a force of attraction between objects; rather, two objects are impelled towards each other by energy vectors impinging on the surfaces of those objects that do not face each other. Newton's laws of gravitation hold, although their derivation is different than in Newton's system.

Gravitational waves arise in various ways, but, in general, a large astronomical disturbance, such as the explosion of a supernova, instantaneously modulates the rhythmic energy vectors. That modulation might then appear, for example, superimposed on the Earth's gravitational-field flux—and it would be detectable by circuits like those described here.

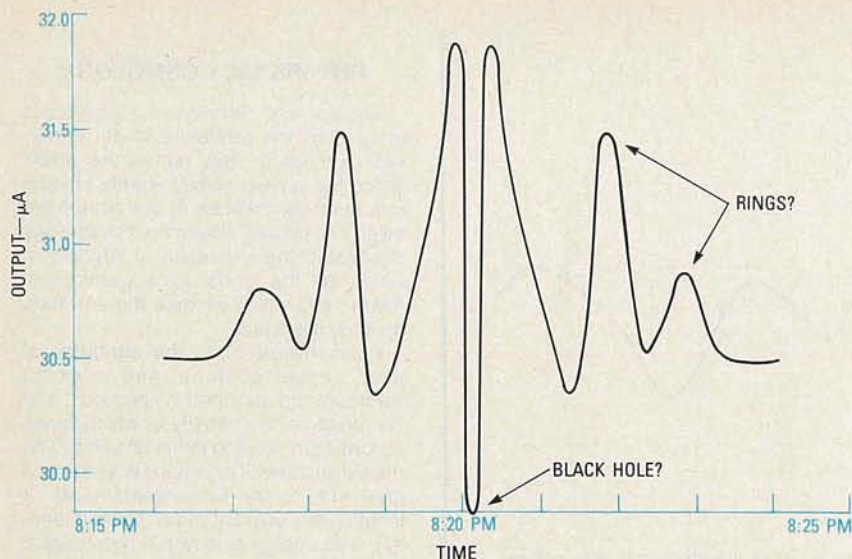

FIG. 7—THE SHADOW OF A BLACK HOLE passed the Earth and produced the dip in the curve just after 8:20 pm. That occurred four days after the explosion of a supernova that was detected on July 1, 1983.

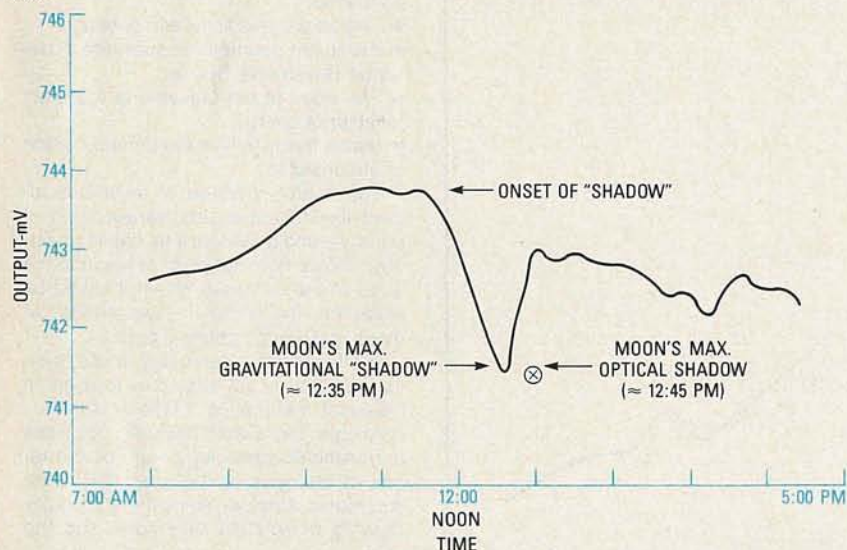

FIG. 8—ECLIPSE ON MAY 30, 1984 produced a gravitational shadow that preceded the optical shadow by about eight minutes.

can be varied between 300–900 Hz. The circuit of Fig. 4, or a variant thereof, was used to obtain all the experimental data discussed below.

In addition, the circuits that we've described in this article were built in an aluminum chassis and then located within an additional steel box to reduce pickup of stray EMI. Power and output connections were made through filter-type feedthrough capacitors.

In the QND mode, coupling the detector's output to an audio amplifier and an oscilloscope gives impressive sound and sight effects. Fluctuations generally result from passing gravitational shadows. The author has taken much data of the sort to be discussed; let's examine a few samples of that data to indicate the kind of results you can expect, and ways of interpreting those results.

Sample scans

Shown in Fig. 5 is an unusual structure

that was repeated exactly the next day, but four minutes earlier. The pattern was followed for several weeks, moving four minutes earlier per day. That confirms the observation that the burst response of the detector was related to our location on earth with respect to the rest of the universe. The change of four minutes per day corresponds with the relative movements of the earth and the body that was casting the "shadow."

The plot of Fig. 6 appears to be a supernova, probably in our own Galaxy, caught in the act of exploding. The plot of Fig. 7 was made four days after another supernova explosion; that plot reveals that that supernova left a well-developed black hole and "ring" structure. You may find it interesting to consider that visual indications of those supernovas will not be seen for several thousand years! As such, it might be "quite a while" before we get a visual confirmation of our suspected supernova!

PARTS LIST—SIMPLE DETECTOR

All resistors ¼-watt, 5%.

R1—1.3 megohm

R2—see text

Capacitors

C1—0.22 μF

C2—see text

C_x—see text

Semiconductors

IC1—741 op-amp

PARTS LIST—BUFFERED DETECTOR

All fixed resistors ¼-watt, 5%.

R1—500,000 ohms

R2—1.5 megohms, potentiometer

R3—10,000 ohms, potentiometer

R4—5000 ohms

R5—100,000 ohms

Capacitors

C1—0.22 μF

Semiconductors

IC1—1458 dual op-amp

Last, Fig. 8 shows a plot of the moon's gravitational shadow during the eclipse of May 30, 1984. Note that the gravitational shadow preceded the optical shadow by about eight minutes! That gives credence to our claim that gravitational effects propagate instantaneously. Relatedly, but not shown here, a deep shadow is consistently detected whenever the center of the galaxy appears on the meridian (180°), hinting of the existence of a "black hole" in that region.

Conclusions

In this article we discussed the highlights of a new theory of the universe that predicts the existence of monopole gravity waves. We then presented details of a circuit that can be used to detect monopole gravity waves. The author has monitored those signals for ten years with many different circuits, so is confident that you will be able to duplicate those results. Needless to say, the subject of gravity waves is a largely unexplored one, and there is much yet to be learned. Perhaps this article will inspire you to contribute to that knowledge. In your experiments, you might consider trying the following: Operate several detector circuits at the same time and record the results. Separate the detectors—even by many miles—and record their outputs. In such experiments, the author found that the circuits' outputs were very similar. Those results would seem to count out local EMI or pure random noise as the cause of the circuit response.

For more information on the subject of gravity you might consult *Gravitation*, by C. Misner, K. Thorne, and J. Wheeler, published by W. H. Freeman and Co., 1973. Also, the article, "Quantum Non-Demolition Measurements" in *Science*, Volume 209, August 1, 1980 contains useful information on the QND type of measurement used here.

R-E

the fourth law of robotics

A robot shall make learning fun for man and thereby improve the quality of life for mankind.



A robot is a robot is a robot... was a robot. Until HERO 2000.

HERO 2000 is much more than a robot. It's a walking, talking 16-bit computer. With 64K ROM and 24K RAM expandable to more than half a megabyte. And a fully articulated arm with five axes of motion. Yours to program. Command. Modify and expand. Total system access and solderless experimenter boards provide almost limitless possibilities. Its remote RF console with ASCII keyboard gives total control. Available with three self-study courses. Backed by Heath Company, world leader in electronic kits.

Build your own HERO 2000. Or buy it assembled. Have fun learning skills that translate directly to the world of work.



HERO[®] 2000

the
knowledge
builder

FREE. Send today for latest Heathkit Catalog.

Heathkit[®]
Heath
Company

A subsidiary of Zenith Electronics Corporation.



Mail coupon today to receive a **FREE** Heathkit Catalog featuring HERO 2000.

Mail to: Heath Company
Dept. 020-404
Benton Harbor, Michigan 49022

Name _____

Address _____

City _____ State _____

Zip _____

RO-141

CIRCLE 86 ON FREE INFORMATION CARD

TWO (2) NIFTY PROJECTS

Here are two nifty projects that are just perfect for this time of year!

LAPRI OOLF

FOR DECADES, MANKIND HAS BEEN BOTHERED by the question: "What happens to the light in my refrigerator when I close the door? Does it go out, or does it stay on all the time?" Those claiming to be in the know will tell you that, "You know, it goes the same place your lap does when you stand up," or that it's controlled by the-little-man-who-wasn't-there.

Don't you believe them! After all, how did *they* find out? Well, now you can learn once and for all just what does happen to your refrigerator light when you close the door by building the Frid-O-Matic (pronounced "fridgeomatic"). This simple-to-use device, easily built from widgets, thingamabobs, and whatchamacallits found around the house, will give you the definitive answer and make you the talk of the neighborhood.

The Frid-O-Matic works on the principle that "what you see is what you get," which can also be stated as "never give a sucker an even break." As shown in Fig. 1, a DASC (Dark Activated Silicon Controlled Rectifier), aimed at the refrigerator's interior light, monitors that device's state at all times. As long as that light is on the Frid-O-Matic remains inactive, but when (and if) the interior light goes off the DASC latches, conducting voltage to normally closed relay RY1, which is wired in series with the interior light's power source. If the light goes on, the relay is energized, causing it to go off.

The Frid-O-Matic can be built using point-to-point, perforated construction board, or PC board techniques. A five- or twelve-volt power supply can be used, depending on the coil voltage of RY1. The entire device can be housed in an empty milk or orange juice container so as to blend inconspicuously with the usual contents of your refrigerator (see Fig. 2).

Using your Frid-O-Matic is easy. With the side of the juice or milk container containing the DASC facing the refrigerator's interior light, carefully close the refrigerator door. The next time you open it, if the interior light goes on, that is an indication it was never off. If, however, it does not light, that is an indication that it did go off when the door was closed (aha!), or when you weren't looking. Or



FIG. 1—BLOCK DIAGRAM of the Frid-O-Matic. Schematic is behind blocks.



FIG. 2—WHICH ONE is the Frid-O-Matic? Only your wife knows for sure.

maybe it just picked that time to burn out.

The Frid-O-Matic can be disconnected by ripping out the wires to RY1.

Build the CheapModem

Computer-to-computer communication can be an expensive proposition, and sometimes it isn't worth the investment in equipment. Here's a short-haul modem you can build. It's almost free!



FIG. 3—AFTER MUCH TRIAL-AND-ERROR experimentation, it was found that the best resonator is usually determined by what happened to be on sale at the supermarket this week. Several good resonators can be found in this photograph.

The operation of the CheapModem is quite straightforward. The output from the computer's serial port is fed to two amplifiers—a straight-through one and an inverting one, and coupled from each to a small buzzer. The buzzers have different pitches and correspond to the logic highs and logic lows that are output by the serial port.

Both buzzers are mounted inside a resonating chamber, which is connected by a flexible conductor to a similar resonator at the receiving computer. A phono cartridge or other suitable pickup is mounted in that resonator and connected through a pair of 567 tone decoders to that computer's serial port.

The electronic part of this project is elementary, and the circuits can be found in almost any project book. The real secret of the CheapModem is in the resonators and in the selection of the correct flexible conductor. Both rigid and semirigid resonators have been tried, and each type has its own advantages. Semirigid resonators, in the form of waxed or plasticized cardboard containers are more efficient than the rigid, or tin-can, sort, but are not as durable. They are, however, easier to open and empty, and for that reason may be preferred. The final choice is up to you, and may well be based on your eating habits or just on what's on sale at the supermarket. Several suitable resonators are shown in Fig. 3.

The flexible conductor is perhaps the most important part of this project. A number of materials were evaluated, among them wirewrap wire, UHF hard line, and a slinky. The last worked well, but was found to be prone to interference from ambient noise, which led to transmission errors. In the end, the most effective in terms of its price/performance ratio was found to be dental floss. Dental floss is also easy to knot, and a good knot is vital to the proper performance of the CheapModem.

A maximum reliable transmission rate of 1.25 baud was achieved in the author's prototype. While a higher speed would have been more useful, for the price you can't argue. And you get to eat what was in the cans or containers. **R-E**

A Decade of Change:

The Microprocessor

Today, microprocessors are used in everything from microwave ovens to automobiles to home computers. They've come a long way in a few short years.

ROBERT GROSSBLATT, CIRCUITS EDITOR

NAMES LIKE UNIVAC AND ENIAC HAVE MYSTICAL connotations for some of us. Visions of huge rooms filled with glowing tubes and punched cards dance before our eyes, and our ears fill with the all-pervading murmur of massive air-conditioning systems. We remember staring awestruck as those giant computers flexed their electronic muscles to produce printed portraits of George Washington. (Wow!—*Editor*)

Those machines aren't really part of microcomputer history—they're part of its pre-history. Microcomputer history really began one day in the early 1960's when Jack Kilby of Texas Instruments made the first integrated circuit. After it was shown that an entire circuit could be fabricated from a single solid chunk of semi-conductor material, the stage was set for the development of the microprocessor. But things didn't really take off until the early 1970's.

Several important events occurred in 1970:

- The development of *Large Scale Integration* (LSI) techniques made it possible to fabricate a complete circuit on a single piece of silicon.
- Memory technology matured to the point that standard products became widely available.
- A huge market opened up for hand-held calculators.

A year later Intel introduced a general-purpose IC that did just about everything necessary needed to support calculator-type operations. Intel called that IC the 4004; it had a four-bit data path, and it was the first microprocessor.

First generation microprocessors were designed for specific applications. The 4004 was designed to handle calculator logic, and the eight-bit 8008, introduced a year later, was designed to control an intelligent terminal.

Intel's IC's were designed at a time when memory was very expensive. Consequently, from the beginning, their microprocessors relied heavily on internal registers to store and transfer data. As shown in Fig. 1, the 8008's six storage registers are eight bits wide, and the program counter is fourteen bits wide. That limited the 8008 to 16K of directly addressable memory. Further, the internal stack is only seven words deep. That's fine for a controller, but it really limits use of the 8008 as a computer.

The microcomputer industry really came into its own with the second generation of microprocessors: Intel's 8080 and Motorola's 6800. Although both are microprocessors, their design philosophies are radically different.

Intel increased power in the 8080 by moving the stack itself to external memory, and by giving it a sixteen-bit stack pointer. As shown in Fig. 2, the 8080 also

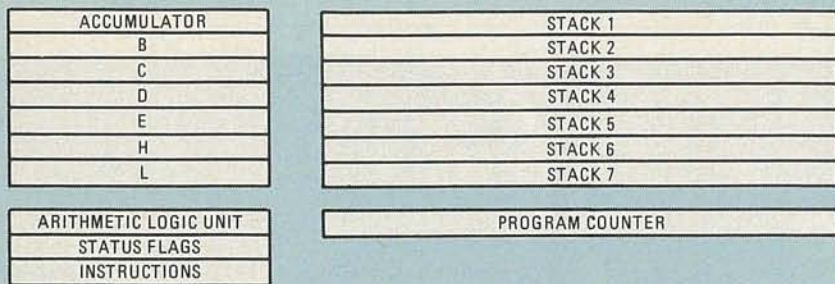

FIG. 1—THE FIRST 8-BIT MICROPROCESSOR, Intel's 8008, had an internal seven-byte stack, and it was limited to 16K bytes of memory.

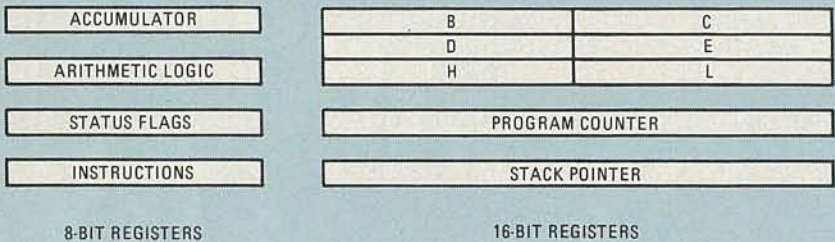

FIG. 2—THE FIRST GENERAL-PURPOSE MICROPROCESSOR, Intel's 8080, features an eight-bit accumulator and three general-purpose sixteen-bit registers.

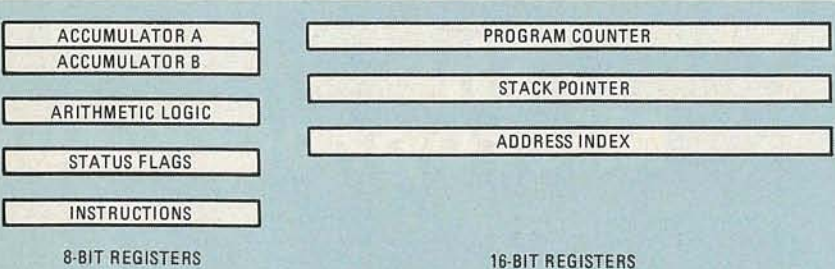

FIG. 3—MOTOROLA'S 6800 emphasizes quick memory access at the expense of few internal registers.

has three sixteen-bit registers in addition to the program counter, which was itself increased to sixteen bits. That gave the 8080 the capability of addressing the now-familiar 64K of external memory.

Motorola's 6800 was designed along different lines altogether. Instead of emphasizing internal registers, temporary data storage occurs in external memory, and the microprocessor has only enough registers to keep track of where things are. Other than the primary and secondary accumulators, the only "data" register in the 6800 is an index register that is used as a counter, and to do indexed memory addressing. The 6800's internal structure is shown in Fig. 3.

There are advantages and disadvantages to both design philosophies. For example, the 6800 must access memory much more often than the 8080, but it can do that much more rapidly than the 8080 can. But by far the most important consequence of the difference in those IC's is in overall memory organization.

To the 8080, all addresses are the same—it takes the same amount of time to access any location in its 64K range.

Also, the processor goes to location 0000 for its first instruction after power up and after reset.

The 6800, on the other hand, has a special set of two-byte "zero page" addressing instructions that allow page zero—the first 256 bytes of memory—to be accessed rapidly. All other address instructions are three bytes long. That makes zero-page real estate valuable—the microprocessor can address page zero locations in two-thirds the time it can address locations in other pages. Since zero-page addresses are, in a sense, the 6800's substitute for registers, the operating system is put at the top of memory. When a 6800 is first powered up, it goes to address FFFE for its first instruction.

The Motorola and Intel design philosophies have shaped the architectures of just about all microprocessors that have followed, down to the latest sixteen- and thirty-two bit microprocessors.

CP/M

In 1973 the microcomputer industry was rather limited. First-generation micros like the Altair and the Imsai stored

data on paper tape or cassettes. Floppy disk drives had just begun to appear when Gary Kildall, a consultant working for Intel, developed CP/M, a Disk Operating System (DOS) for Intel's 8080. When Imsai licensed CP/M and began distributing it, the home computer market exploded. Since CP/M was just about the only DOS available, the 8080 became the microprocessor of choice for most home computers.

Because of the popularity of CP/M, any heir to the 8080's throne would have to have an instruction set compatible with that microprocessor. Since most of the software available for home computers was coded in the 8080's native tongue, microprocessor manufacturers realized that it was a matter of simple economic survival to make sure that such software would run on any new microprocessor.

By the time that the second generation of microprocessors began winding down, the home-computer market was an economic reality. CP/M gave birth to a variety of sophisticated systems-programming languages, and user-oriented application programs began to fill the market. That caused more CP/M computers to be sold and more programs to be written for them. Then, when major manufacturers like IBM and Xerox began adopting CP/M for use in their products, the stage was set for the birth of the third generation of microprocessors.

Intel introduced the 8085, an improved version of its 8080, and then upgraded that with the 8085A. The old 8080 required *three* voltages to operate: +12, +5 and -5. The 8085A required only +5 volts, and a much simpler clock circuit now sufficed. In addition, a series of new interrupt and I/O signals were tied to various pins on the IC—in an attempt, perhaps, to simplify the complex I/O set-up of the 8080.

Unfortunately, Intel paid a high price for that increased flexibility. Because they dedicated so many pins to I/O, and because they remained locked to a standard forty-pin package, the data bus had to be multiplexed with the lower eight bits of the address bus. And that meant that the 8085 would always need external latching. A big gripe with the 8080 was that it needed extra support IC's (an 8224 Clock Generator and an 8228 System Controller); and since the 8085 also needed at least an eight-bit latch and some decoding, the 8085 never became as popular as Intel had hoped. However, a CMOS version became available relatively early; Tandy used it in their portable computers, and that prevented it from becoming totally obscure. But perhaps the real reason for its lukewarm reception was that it was introduced three years after the Z80.

Zilog's Z80

From the moment it appeared, the Z80

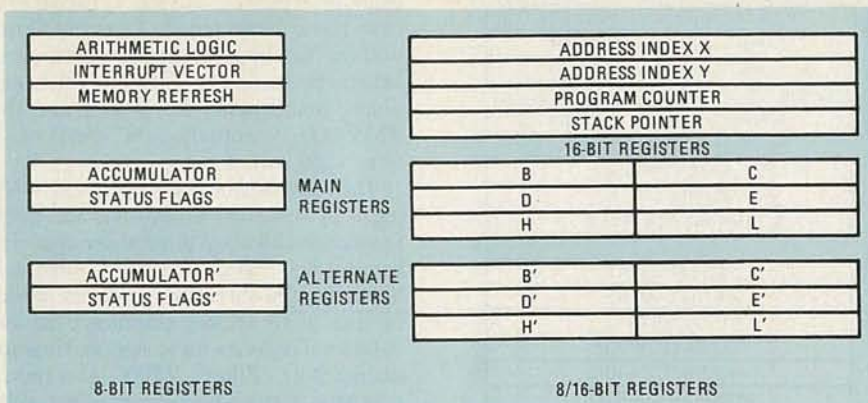

FIG. 4—ZILOG'S Z80 has the same registers as the 8080, but it provides a duplicate register set for quick response to interrupts.

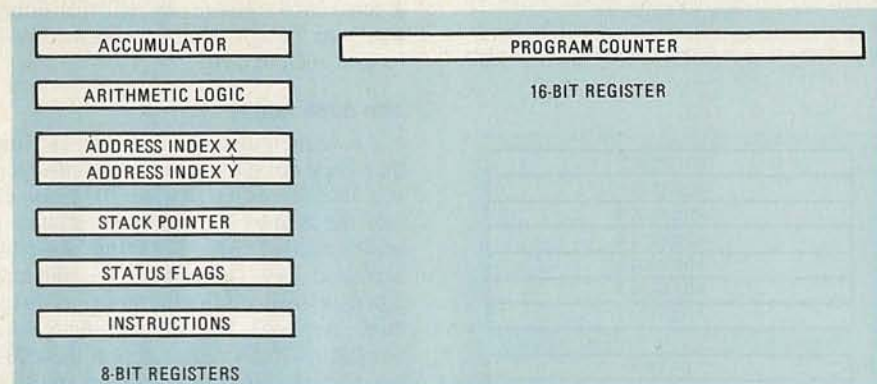

FIG. 5—MOS TECHNOLOGY'S 6502 has no general-purpose 16-bit registers, but it has the most flexible addressing schemes of all the early eight-bit processors.

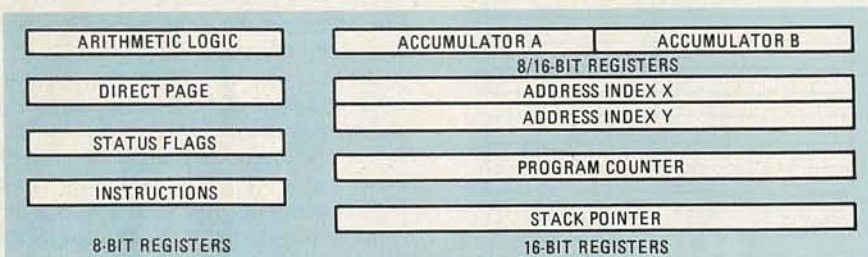

FIG. 6—MOTOROLA'S 6809 was intended to bridge the 8/16-bit gap; but it never really caught on, in spite of its having some really powerful features.

was a winner. It incorporated all the 8080 instructions as a subset of its own greatly-expanded instruction set. And that allowed it to run all the existing 8080-based software. In terms of hardware, the Z80 was designed according to the Intel philosophy. Zilog maintained the register structure of the 8080, but also added a set of alternate registers that duplicated the main set, as shown in Fig. 4. The alternate registers allow an increase in processing speed because, during an interrupt, the main registers can be swapped with the alternates by using a fast one-byte instruction.

Combined with the other advantages it had over the 8080—a single supply-voltage and a simple clock—the Z80 became the upgrade for the 8080. It had built-in features that required extra IC's in an 8080-based system. The Z80, for exam-

ple, can refresh dynamic RAM IC's automatically.

One interesting point about the Z80 is that, when it was first introduced, Zilog believed that the huge new instruction set would be responsible for most sales of the IC. As it turned out, 8080 code had become the standard, and the Z80's extra instructions were, for the most part, ignored. Intel, on the other hand, showed awareness of that need for compatibility, because the 8085 added only two instructions to the 8080's repertoire.

The 6502

In 1975 MOS Technology introduced the 6502. Just as the Z80 is a high-performance version of the 8080, the 6502 is a souped up 6800—but with differences. You can run 8080 code on a Z80, but 6800 code is gibberish to a 6502. What the

Microprocessor Speed

How fast a program runs on your computer depends on more than just its clock speed. The clock frequency determines microprocessor speed, but the instruction set, as well as the way a program is written, determine how fast a program runs.

Most of a microprocessor's time is spent accessing locations in your computer's memory, and the instruction that tells the microprocessor to do that can be two, four or even more bytes long. The overall speed of your computer is a function of how many cycles of the system clock it takes to complete a particular instruction.

A computer running at 8 Mhz will complete a four-byte instruction in exactly the same length of time that it takes a 2-MHz computer to complete a one-byte instruction. Overall program execution speed, therefore, depends on how much the microprocessor has to do and how quickly it can do it. The same program running on two computers with different microprocessors will undoubtedly run at two different speeds. Which runs faster depends on what the program is asking the microprocessor to do.

Some microprocessors have instruction sets that are quick at number crunching, while others are better at memory access. In general, microprocessors with internal registers, like the Z80, are better at number crunching because they have one-byte commands to manipulate register data. Microprocessors like the 6502, on the other hand, which do most things in memory, access that memory quicker than the register-oriented type of microprocessor.

R-E

6502 got from the 6800 was its design philosophy. The 6502 is a top-down processor; its strength is in powerful addressing modes, rather than a lot of internal registers. Among its advantages over the 6800 were: on-IC clock generator, an improved instruction set, new addressing modes, faster access to the stack, and built-in BCD arithmetic.

At first glance, the 6502's architecture might look like a step backward. As shown in Fig. 5, the sixteen-bit index register of the 6800 was split into two eight-bit registers, and the stack pointer is only eight bits wide. That limits the stack to 256 bytes, but the designers of the 6502 decided that a 256-byte stack is more than adequate for most applications. By limiting its length, it could be placed in a dedicated area of memory (100 to 1FF). And that allowed the stack to be accessed very quickly, which increased overall execution speed. Splitting the index register allows both halves to be used independently for some very powerful indexed addressing modes.

What saved the 6502 from obscurity was being chosen as the microprocessor for the Apple, Atari, and Pet computers. The huge successes enjoyed by those ma-

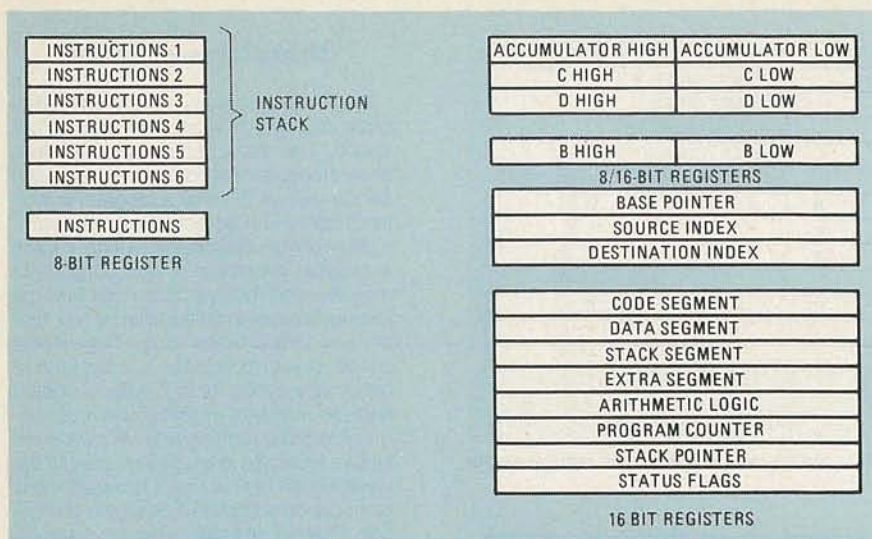

FIG. 7—INTEL'S 8088/86, workhorse of the IBM PC, provides one-megabyte memory addressing through the use of segment registers.

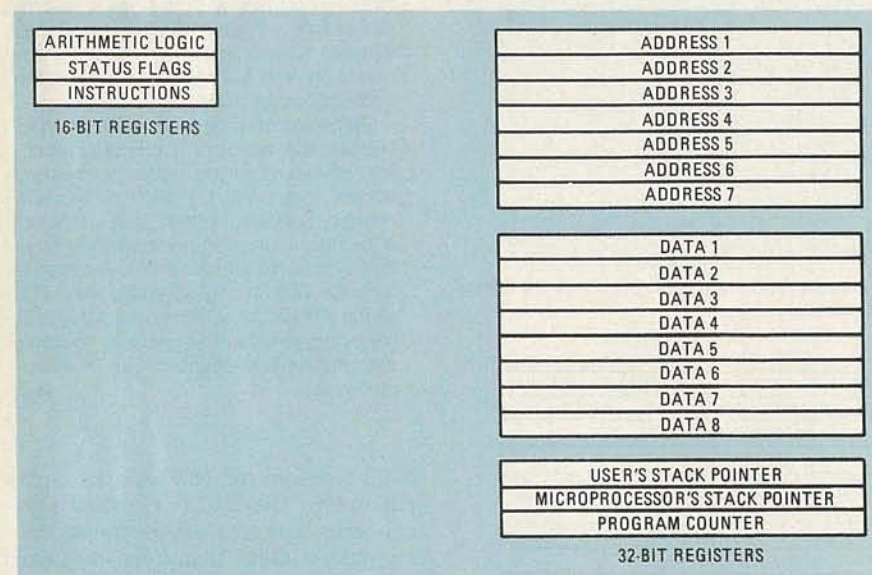

FIG. 8—MOTOROLA'S 68000, heart of Apple's Macintosh, is probably the most powerful sixteen-bit microprocessor on the market.

chines transformed the 6502 into one of the few silicon superstars.

The fourth generation of microprocessors began to emerge around 1980. The home-computer market was a mammoth economic reality by that time, and IC manufacturers were selling microprocessors as fast as they could make them. The third generation's last gasp was Motorola's 6809. It included advanced addressing and a multiply instruction. That instruction was innovative, unique, and it allowed a substantial increase in program execution speed. The 6809's structure is shown in Fig. 6.

Unfortunately for Motorola, the 6809 came late in the history of microcomputing, so few machines were designed around that IC. (Radio Shack's *Color Computer* is a notable exception.—*Editor*) One interesting footnote to computer history is that Apple was so impressed

with the 6809 that they used it in early *Macintosh* designs.

Fourth-generation microprocessors came about through refinements in IC technology. The advent of Very Large Scale Integration (VLSI) vastly increased on-IC component density. Results include sixteen-bit microprocessors, 64K (and larger) dynamic RAM's, as well as performance upgrades for the previous generation of microprocessors.

Sixteen bit microprocessors weren't really new. For example, TI's TMS9900, was a second-generation, top-down, sixteen-bit microprocessor with two sixteen-bit registers: a stack pointer and a program counter. All other data storage occurred in external memory. The TMS9900 has separate address and data buses because it comes in a 64-pin package. The TMS9900 is a powerful microprocessor, and the way it was marketed is a perfect

example of how *not* to do it. TI used the IC in its home computer, the *T199*, but TI did nothing to support outside developers. When the computer failed to catch on, Texas Instruments let it die, and the TMS9900, essentially an IC ahead of its time, died with it.

The second-generation design philosophies of the 8080 family and the 6800 family showed up in third generation sixteen-bit IC's. Intel released the 8086 and 8088; they're direct descendents of the original 8080, so they emphasize the use of internal registers for storing and manipulating data. Zilog's Z8000 is a more-powerful, sixteen-bit version of the well-established Z80. Motorola's 68000, a muscular, sixteen-bit version of the neglected 6809, is more powerful than either Intel's or Zilog's microprocessors. We'll look at each in turn.

The 8086 family

As we mentioned earlier, it takes more than good design to make a silicon superstar. Intel struck it rich when IBM jumped into the home-computer market with a machine based on the 8088. Intel was a bit surprised, as well. The 8088 is a watered-down version of Intel's more powerful 8086. As shown in Fig. 7, the 8086 has a number of 16-bit registers, but the 8088 has an eight-bit-wide data bus, and that means that sixteen-bit data must be loaded into the microprocessor eight bits at a time. That's why it's called an 8/16 bit IC. The 8086, on the other hand, is a true sixteen-bit microprocessor.

IBM's choice of the 8088 was a serious miscalculation of both their marketing ability, and the viability of the market. One of the forgotten oddities of the IBM PC is that it originally showed up in the market with only 16K of RAM. The incredible popularity of the PC led to the development of huge amounts of applications software, and much mainstream eight-bit software was rewritten to operate on the 8088. Once again, Intel had produced the microprocessor that became the industry standard.

Several new features showed up in the new sixteen-bit series that had no counterpart in their eight-bit predecessors. A multiply instruction was added (as Motorola had done with the 6809), but it could be used effectively only in the 8086. The 8088 had a tough time handling thirty-two bit results, so most IBM-PC programmers do multiplication with the traditional shift and add approach, and that slows the PC down drastically.

Although the 8086 and 8088 are stand-alone microprocessors, Intel has some support IC's that can speed things up. The 8087 Math Co-Processor, for example, does high-speed number crunching, and it substantially increases the computing speed of the 8086. Note that the eight-bit data bus of the IBM PC restricts the

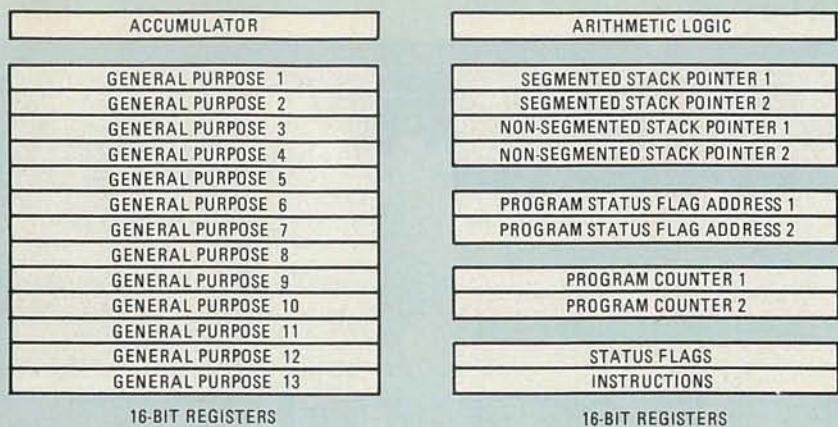

FIG. 9—ZILOG'S Z8000 has not been very popular, in spite of powerful register and memory-addressing structures.

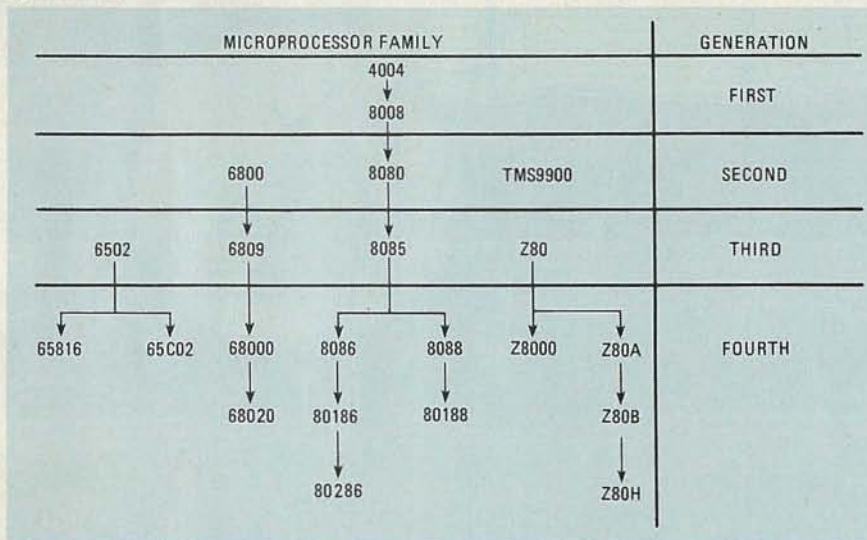

FIG. 10—THE GENEALOGY OF THE FIRST FOUR GENERATIONS OF MICROPROCESSORS is indicated here. What will be next? Stay tuned . . .

usefulness of the 8087 in that computer.

The 80186 and 80188 were introduced by Intel in 1983 as upgrades of the 8086 and the 8088, respectively. Those two IC's took advantage of new VLSI techniques, but didn't really represent any advance in performance. However, they include a lot of the support circuitry for timing and bus control that had to be done externally with the earlier IC's.

Intel's 80286, which IBM uses in its PC/AT, is a major enhancement of the 8086. Besides having an on-IC memory-management system, it has a "virtual memory" mode in which the internal registers can generate 24-bit addresses. In practical terms, this means that the 80286 can directly address as much as sixteen megabytes of memory. By contrast, the 8086 can generate only 20-bit addresses, and that allows it to address "only" one megabyte of memory directly.

The 68000

Motorola's 68000 is probably the most-powerful sixteen-bit microprocessor to show up on the market; Apple chose to use it for the ill-fated Lisa and for the

MacIntosh. Because its design is similar to that of the 6800, it has a variety of powerful addressing modes. Motorola learned a few things from Intel, apparently, because they added sixteen thirty-two-bit registers, as well as two stack pointers—one for the user and one for internal housekeeping. Unlike most other microprocessors, the 68000 doesn't have a dedicated accumulator. Rather, any of the data registers can be used as an accumulator. The 68000's organization is shown in Fig. 8.

Motorola designed the instruction set so that there could be as many as 64,000 instructions. The Intel IC's, by way of comparison, continued the 8080's practice of limiting the IC to a maximum of 256 instructions. In fact, the 68000 has only 56 basic instructions, but the IC's addressing flexibility makes it easy for programmers to access the full power of the IC without having to remember separate instructions for each special case.

One strength of the 68000 is the width of its registers. If the 8088 is an 8/16 bit microprocessor, then the 68000 should be called a 16/32 bit microprocessor. It has,

like the 80286, a "virtual memory" scheme, but its wider registers allow some versions of the 68000 to manage more than 4 gigabytes of memory.

The Z8000

The Z8000 from Zilog is a sixteen-bit version of the Z80. It is a well-designed, true sixteen-bit microprocessor with thirteen general-purpose sixteen-bit registers, several stack pointers, and the ability to address as much as sixteen megabytes of memory. The Z8000's organization is shown in Fig. 9.

In spite of its potential, however, the Z8000 has not enjoyed the popularity of its eight-bit predecessor. When the Z80 hit the market, it was successful because it was compatible with the 8080. Unfortunately, the 8086 and the Z8000 are totally incompatible.

Other improvements

The last major advance of the fourth generation had to do with IC technology. Faster versions of popular eight- and sixteen-bit microprocessors began to appear. The Z80, whose original operating speed was a mere 2.5 MHz, became available in 4- and 6-MHz versions (the Z80A, and Z80B, respectively). The original 6502 ran at 1 MHz; its upgrade, the 6502C, runs at 4 MHz. Rockwell, NCR, and GTE each came out with CMOS versions of the 6502, the 65C02, that uses less power, runs faster, and has a larger instruction set than the original.

The 65816

New microprocessors like Western Design Center's 65816 aim at higher speeds, better memory handling, and increased compatibility. The 65816 has a software-selectable mode in which it can emulate a 6502, and it's the first sixteen-bit microprocessor to use the mainframe technique of "cache memory," which is similar to the virtual memory modes we've already mentioned. In a cache system, intermediate data and program information are stored in high-speed memory, and less-important data is stored in a slower memory system such as a disk.

Conclusions

The overall genealogy of the important microprocessor families is outlined in Fig. 10. As you can see, the trend in new products is toward wider buses, higher speeds, and more flexibility. True 32-bit microprocessors are now showing up.

When the 8080 first appeared, it cost over \$250. Today you can buy one for less than three dollars. And when you hold one of those twelve-year-old IC's in your hand, keep in mind that you're looking at more computing power and speed than was ever dreamed of in the pre-historic days of the Univac—all of twenty-five years ago.

R-E

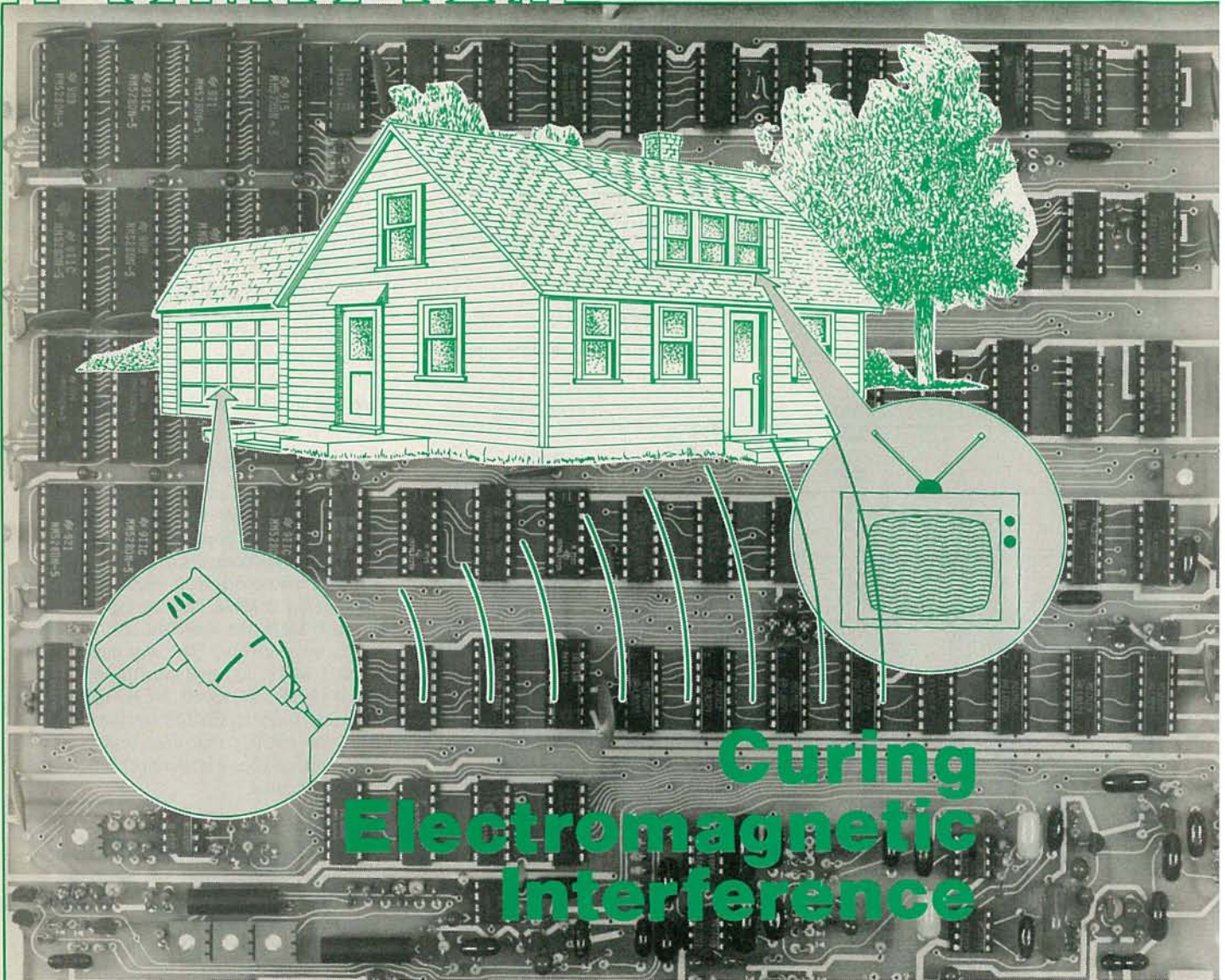

Curing Electromagnetic Interference

*The time to eliminate EMI in your PC boards is during their design.
These guidelines can help you do just that.*

MICHAEL F. VIOLETTE

Part 4 HAVE YOU EVER DESIGNED and bread-boarded a project, only to find that the circuit doesn't work properly once transferred to a PC board? The cause might be a faulty component or poor soldering, or it might be electromagnetic interference.

Often board layouts are done without any thought of the possible consequences of EMI. When the circuitry involved is either high-speed or high-frequency, at least *some* EMI problems are likely.

In this article we'll look at ways to reduce the chances that EMI will plague your PC-board designs. We'll also look at how to solve EMI problems after the fact; that is, interference to or from boards that are already in existence.

Note that we will not talk about actual circuit-board design. That topic is beyond the scope of this article, but has been presented in this magazine in the past; for instance, see "Designing Double-Sided PC Boards" in the September and October 1985 issues of **Radio-Electronics**. What we will show you are things to consider when doing your own design.

Component selection

Many EMI problems can be avoided if the consequences of selecting a particular component for an application are considered. For instance, when designing digital-logic circuits, most of us would first consider the fastest possible logic family for the job. But increased speed can lead

to increased EMI problems. Let's see why.

For one thing, increased speed means increased frequency, and faster rise times. Consider Fig. 1-a, which shows one half-cycle of a squarewave. Take particular note of the fact that the "square"-wave is not square at all; rather, is shaped like a trapezoid—the leading and trailing edges of the pulse are not perpendicular to the baseline. That's because no high-low transition is instantaneous; there is always some *rise time*. If you were to examine any squarewave on an oscilloscope with a sufficient bandwidth, you would see that that waveform also is trapezoidal.

The amplitude of the squarewave is A. The rise time, t_r , is defined as the transi-

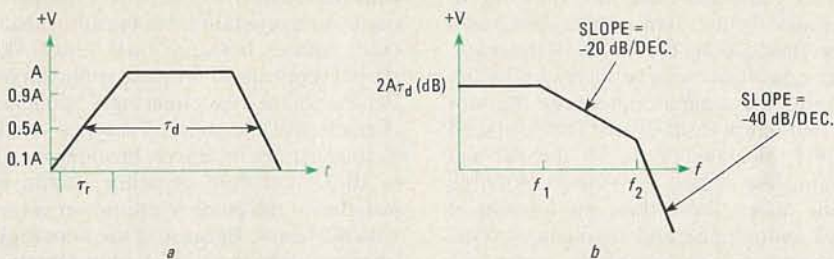

FIG. 1—THE FASTER THE RISE TIME of a squarewave, one half of which is shown in a, the wider the bandwidth. The frequency spectrum of the half-cycle is shown in b.

tion time between 0.1A and 0.9A (or between 10% and 90% of the peak amplitude). The pulse duration, t_d , is the interval between 0.5A on the leading edge and 0.5A on the trailing edge.

The frequency spectrum of the half-cycle of the squarewave is shown in Fig. 1-b. Note that any periodic waveform, such as a squarewave, ramp, triangular wave, etc., can be represented as a series of sinewaves. In that way, a time-domain signal, such as a squarewave, can be represented as a frequency-domain signal, as we have done.

Actually, the waveform in Fig. 1-b is the envelope of the frequency spectrum; it is the upper limit on all the frequency components contained in the half-cycle of the squarewave. Note that there are two frequency "breakpoints" where the amplitude of the frequency components change. Those breakpoints are determined by the speed of the logic and are found from:

$$f_1 = 1/\pi\tau_d$$

$$f_2 = 1/\pi\tau_r$$

At f_1 the amplitude of the spectrum "rolls off" (at or, has a negative slope of) 20-dB-per-decade (3-dB-per-octave), and at f_2 the amplitude rolls off at 40-dB-per-decade (6-dB-per-octave). The f_2 frequency is of particular importance because it determines the bandwidth of the logic; f_2 is the upper frequency limit of that band. That is important because EMI can be generated at any frequency up to that limit. At low frequencies EMI is relatively harmless, but at higher frequencies, radiation can be more of a problem. For instance, a rise time of 2 nanoseconds results in a bandwidth of $1/\pi\tau_r = 1/(3.14 \times 10 \times 10^{-9}) = 32$ MHz. That is definitely RF, and at that frequency it doesn't take a very long wire to create an efficient radiator. Table 1 lists some common logic families, their rise and fall times, and the bandwidth (in MHz) that results.

By the same token, high-speed logic is very susceptible to interference from external sources. The reason, of course, is that the same wide bandwidth allows for interference from a wide variety of sources. In the case of ECL logic, consider how many sources emit radiation that

falls within the range of 0 to 160 MHz.

Of course, the selection of a logic family might be dictated by an existing design, or, perhaps the operation of the circuit requires high-speed clocking. But if you can get by with clock speeds of a few MHz or less, why use high-speed logic and increase the chances of EMI problems occurring?

Circuit layout

After the logic family is chosen and the schematic drawn, usually the next step is to work up a prototype of the circuit. After the prototype stage, a PC-board layout is created. In the discussion that follows, the location and layout procedures apply to both breadboarding and the final design. Also, while we are discussing PC-board layout here, wirewrapped projects should also be built following these guidelines.

Digital signals can wreak havoc if they get into an analog circuit. Always keep analog and digital circuits and signals separate and electrically isolated. As a rule, analog circuits are much more sensitive than digital circuits. Consider, for example, a TTL gate where the swing between a logic high and a logic low is approximately 3.5 volts. However, many analog circuits have sensitivities in the millivolt or even microvolt range. If a TTL circuit that is adjacent to an analog circuit is happily switching away, and even mild coupling exists between the circuits, the digital signals could very easily swamp the analog circuit.

One of the most likely routes for such coupling is via the returns. The return traces in digital signals can be very noisy; and if analog circuits make use of the same returns, that noise can be coupled into them easily. There are two ways to reduce that coupling. One is to use separate analog and digital returns. The only common point should be the ground terminal of the circuit's power supply.

The other way to reduce coupling would be to use very thick traces, or ground planes, for the commons.

When laying out digital circuitry, if the fastest logic is slower than 10 ns (TTL), the layout of the board is unimportant from an EMI standpoint. Otherwise, follow the general scheme shown in Fig. 2.

Group the circuitry by function, then locate the fastest logic as near the I/O connector as possible. Slower circuitry is located progressively farther from the connector. It is also good common sense to locate any I/O circuitry as physically close to the connector as possible.

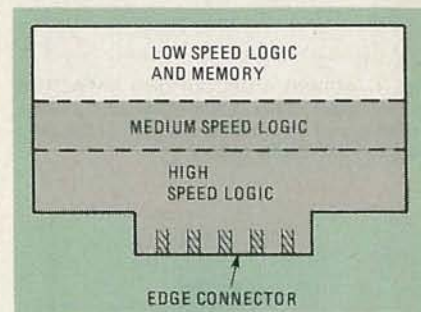

FIG. 2—DIGITAL PC BOARDS should be laid out so that the fastest logic is located nearest the I/O connector. Progressively slower logic is located progressively farther away from that connector.

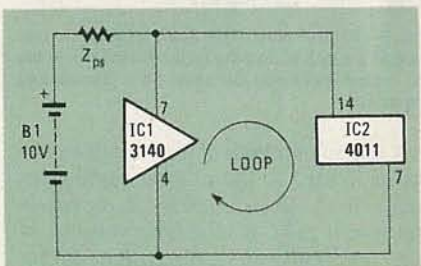

FIG. 3—WHEN THE LOGIC GATE (IC2) switches states, the increased current-draw will cause a noise voltage to disrupt the operation of the op-amp (IC1).

Power-distribution design

The key to a successful EMI-proof power-distribution system is to keep the impedance of the system as low as possible. A low-impedance supply provides enough current without an intolerable drop in the voltage of the supply system. A low-impedance supply is especially important when supplying the transient current to a component. That is the current that a single gate draws from the power supply when switching from low to high.

The importance of low power-distribution impedance is illustrated in Fig. 3. There, an analog op-amp, such as a 3140, is sharing the same power-supply rail with a digital gate, such as a 4011. There is an impedance, Z_{ps} , associated with the power-supply rail (due to trace inductance and resistance). During a switching operation, the gate, IC2, draws a transition current from the supply and a noise voltage develops across the power-distribution impedance. That voltage will appear at the input of the analog amp, IC1, and, if large enough, can disrupt its operation.

Another problem exists in the circuit of Fig. 3: There is a large loop between IC2

and the power supply. That loop can and will act like a radiating and/or pickup loop.

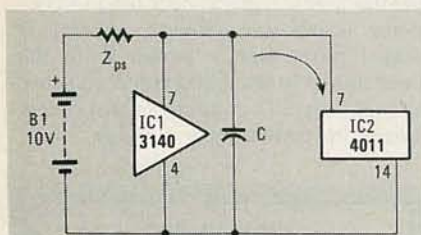

FIG. 4—ADDING A DECOUPLING CAPACITOR to the circuit of Fig. 3 will eliminate the noise problem and also reduce the size of the loop between IC2 and its supply.

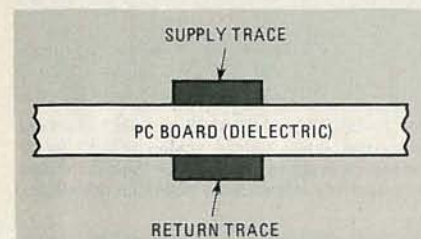

FIG. 5—BY RUNNING THE SUPPLY RAIL on one side of the board, and the return on the other, the PC board itself can be used as a decoupling capacitor.

A remedy for both of those problems is shown in Fig. 4. There, a decoupling capacitor has been installed across the power and return rails to IC2. The purpose of that capacitor is to supply current during the low to high transitions of the gate. As shown in Fig. 4, that capacitor also reduces the size of the loop between the "supply" and the gate.

It is important that the leads of decoupling capacitors are kept as short as possible. Otherwise, lead inductance could cause the capacitor to self-resonate and behave as an inductor.

Looking at the arrangement of power and ground pins on most digital IC's, it becomes obvious that EMI was not considered when pin 7 was established as ground and pin 14 as V_{CC} . That places the ground and power inputs at opposite corners of a 14-pin DIP, which is just about the farthest apart they can be. As a result, the job of keeping capacitor leads short is made just that much harder. For situations where lead inductance is particularly troublesome, it may be possible to use decoupling capacitors that have been designed to fit under the IC itself.

When designing digital circuits, the inclusion of decoupling capacitors is almost mandatory. But there is an alternative to using discrete capacitors. That is to use the board itself as the capacitor. That is done by running the positive rail on one side of the dielectric board and the negative or return rail on the other side as is shown in Fig. 5.

When that scheme is used, the supply

and return traces act like the electrodes of a capacitor that are separated by a dielectric (the board material). The total capacitance is the sum of the distributed capacitance along the length of the trace. That capacitance can be increased by decreasing the separation between the supply and return (usually that is determined by the thickness of the PC board) and making the traces as wide as possible (wide traces also reduce the amount of trace inductance and resistance). One technique that is sometimes used, especially in crowded designs, is to leave as much copper as possible on one side of the board. That copper ground plane is used as the return trace. Of course, putting traces on both sides of the board means, by definition, that you will be making a double-sided board. Such boards can be more difficult and costly to produce than single-sided ones. On the positive side, double-sided boards allow you to reduce the physical size of the layout.

If the circuit is laid out on a single-sided board, then the power-supply rails should be routed as close to each other as possible, and decoupling capacitors should be used where required. Figure 6 shows two ways that the power and return rails could be routed. In Fig. 6-a we see one common layout. From our discussion thus far, you should now be able to see why that is a poor scheme from an EMI perspective. The relatively long distance between the rails can give rise to excessive lead inductance in the decoupling capacitor, as well as larger than necessary loops. The layout shown in Fig. 6-b is far better as it minimizes both problems.

Selecting decoupling capacitors

As a general rule, a good design will provide for one decoupling capacitor for

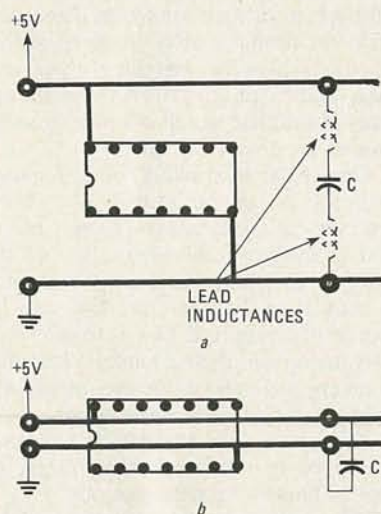

FIG. 6—THE RELATIVELY LONG distances between the supply rails in a can cause excessive EMI. Routing the rails as shown in b is more satisfactory from an EMI perspective.

every two IC's. That capacitor should be capable of supplying the maximum expected transition current of the logic being used. As a general rule of thumb, capacitance values between 0.01 and 0.001 should be adequate for most applications. Because of their excellent high-frequency characteristics, ceramic disc types should be used in most instances. In addition, a 1- to 10- μ F tantalum capacitor should be installed at the point where power comes onto the board. Because of the poor high-frequency characteristics of a tantalum capacitor, it should be installed in parallel with a 0.01- μ F ceramic disc.

Routing signal traces

The final step is the routing of signal traces. Input/output lines should be routed first to minimize their length.

Clock circuits are one of the prime sources of EMI on digital boards. In many cases, as the clock signals are routed to the various components that require them, long traces and one or more loops result. Such traces make good radiators and can give rise to crosstalk problems.

One way to minimize that problem is to lay out the board in such a way that components are grouped together by function. Attention should also be paid to the location of the oscillator. Place it as near the circuitry that requires clock pulses as possible, but away from any sensitive analog circuitry. Finally, use ground planes to minimize any radiation from those traces.

Trace routing should also be designed to prevent common impedance coupling. That coupling occurs when two circuits share a common wire or bus, and the current from one circuit induces a voltage across the common impedance of the wire. To prevent common impedance coupling, ground returns should be isolated.

Wirewrap boards

As you can well imagine, all those individual wires used on wirewrap boards can create a great deal of EMI. To eliminate EMI, a wirewrap board should be designed to reduce wire bundling, with everything connected point-to-point.

The first step in laying out the signal and power runs is to create an X-Y grid of ground lines. Those lines should be placed about 10 pins apart. Doing that creates a ground plane for the board.

Over those, you should connect all runs of wire that are greater than $d/2$ long, where d is the diagonal measure of the board. If the circuit uses high-speed components, the next step is to lay out a second X-Y grid of ground wires; that step is most likely unnecessary for home projects. Finally, connect all remaining lines.

With that procedure, and by following the layout recommendations we presented earlier, and with the proper use of decoupling capacitors, it is possible to build an EMI-immune wirewrap board. **R-E**

All About FREQUENCY COUNTERS

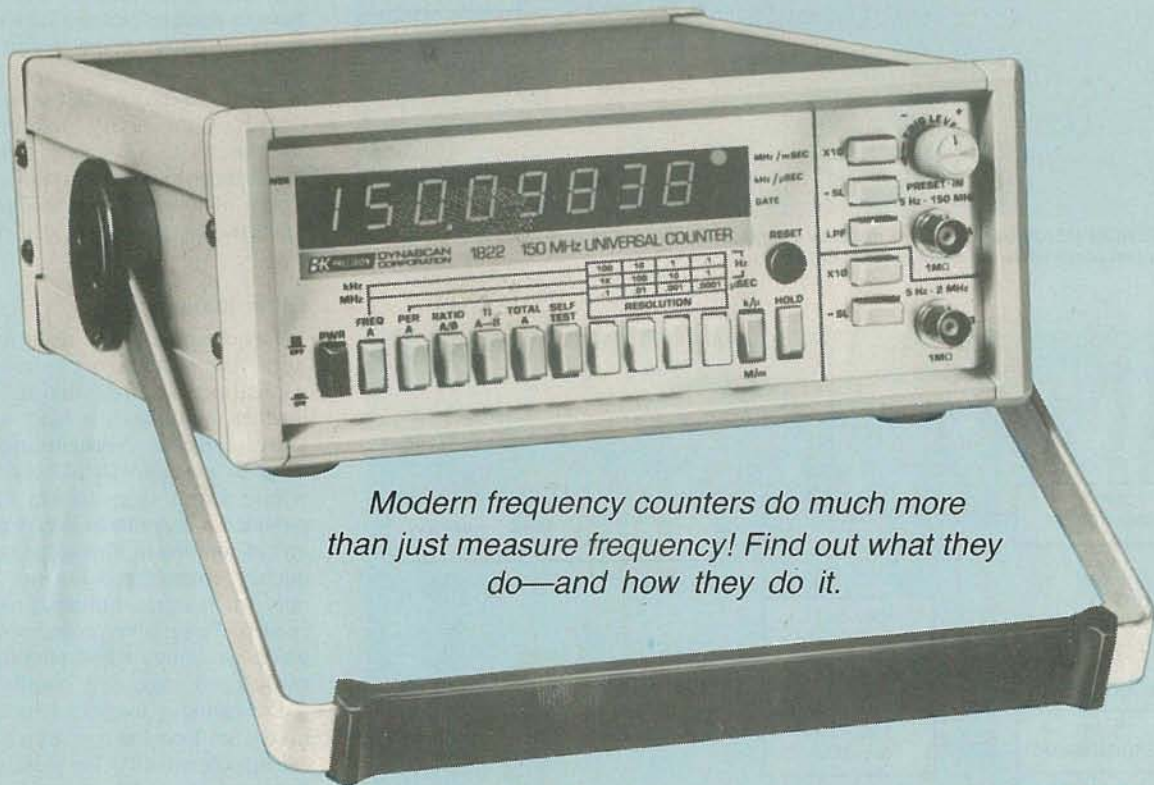

Modern frequency counters do much more than just measure frequency! Find out what they do—and how they do it.

VAUGHN D. MARTIN

IF YOU'VE CONSIDERED ADDING A FREQUENCY counter to your test bench, but weren't sure whether the cost would be justified, you may be in for a pleasant surprise. Modern frequency counters do much more than merely measure frequency. In this article we'll talk about what they do, how they work, the circuits that compose them, and sources of measurement error. We'll also discuss several unusual applications of frequency counters, and how special instruments like reciprocal and microwave frequency counters work.

The frequency counter

In addition to frequency (f), most frequency counters these days can measure period (T), the frequency ratio of two signals, and the elapsed time between two events. Some frequency counters can count the number of pulses in a period of time defined by the user or the system under test. As we'll see, the circuitry used for each of those measurements is quite similar.

A simplified block diagram of a frequency counter is shown in Fig. 1. An input signal is first conditioned so that the digital processing circuitry can handle that signal. We'll have quite a bit to say

about that input circuitry a little later, but for now let's just concentrate on the major functions.

The timebase oscillator is usually a very accurate crystal oscillator. The timebase divider scales the output of the timebase oscillator and provides a pulse train whose frequency is switch-selectable, usually in steps of a factor of ten (10, 100, 1000, etc.). The main gate opens for a period of time that is determined by the timebase divider. While the gate is open, pulses are counted and then scaled for

output by the display circuitry. For example, if 45,500 counts accumulate in the counting register, and if the gate time is one second, then the frequency is 45.5 kHz. The same number of pulses in 0.1 second would correspond to a frequency of 455 kHz.

Period measurements are made by determining the amount of time a signal takes to complete one cycle of oscillation. In this mode, as shown in Fig. 2, the counting register counts pulses from the timebase oscillator, and the input signal

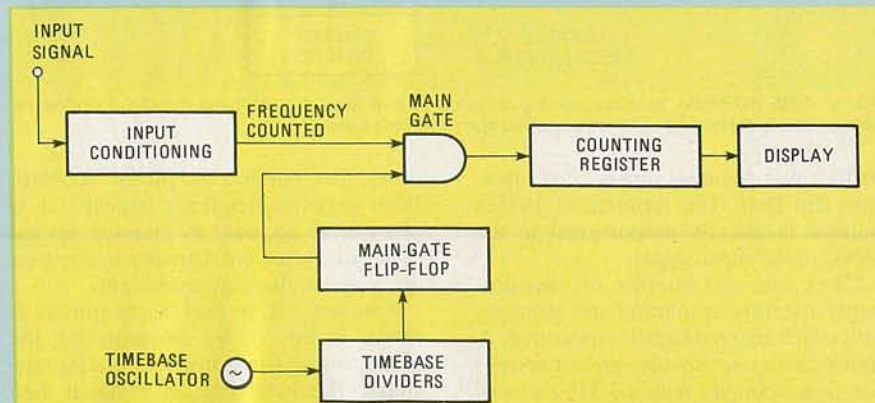

FIG. 1—FREQUENCY MEASUREMENTS are made by counting the number of pulses that occur in a period of time that is determined by the timebase divider.

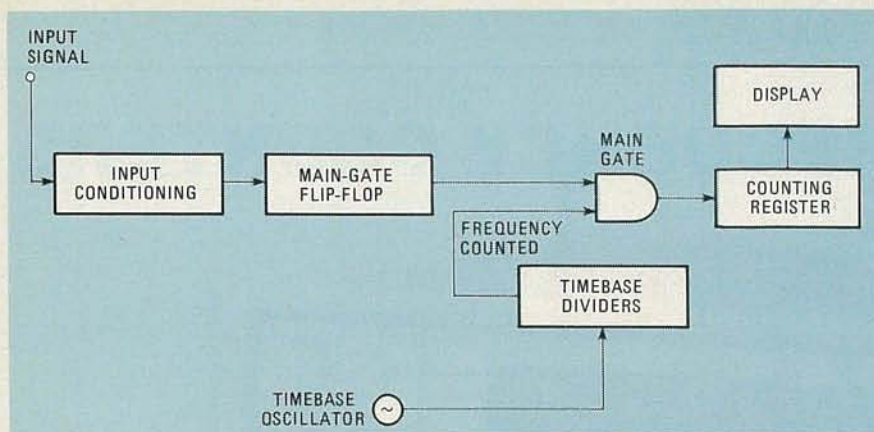

FIG. 2—PERIOD MEASUREMENTS are made by counting the number of pulses from the timebase oscillator that occur while the input pulse is active.

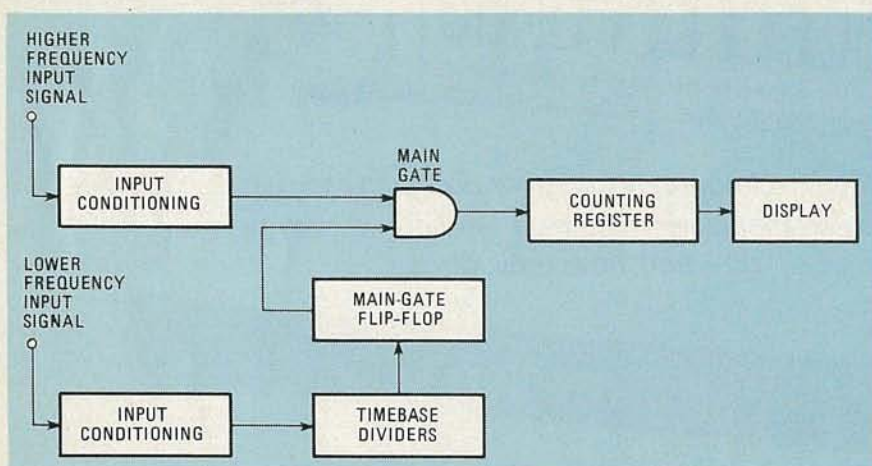

FIG. 3—RATIO MEASUREMENTS are made by disconnecting the timebase oscillator from the main gate. One signal is applied to the regular input, and the second is fed through the timebase signal path.

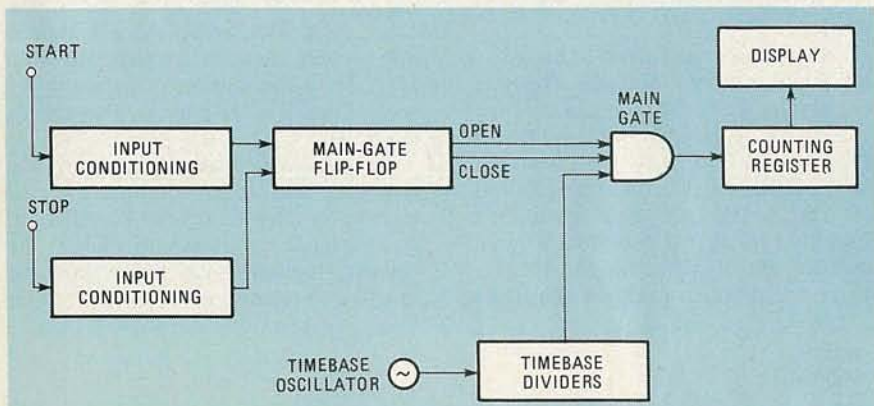

FIG. 4—TIME INTERVAL is measured by counting pulses from the timebase oscillator during an interval that is defined by externally-applied start and stop pulses.

enables that counting through the main-gate flip-flop. The number of pulses counted is directly proportional to the period of the input signal.

Clock rate and number of measurements affect the resolution and accuracy with which an input signal is measured. A higher clock rate provides greater resolution. For example, with a 1-MHz clock, one million pulses would be counted in one second, but with a 10-MHz clock, ten

times that number would be counted. With very-low-frequency signals, it is often more accurate to measure several complete cycles and then display the average value of those measurements.

Frequency ratio may be measured, as shown in Fig. 3, by disconnecting the timebase oscillator from the gating circuitry. The lower-frequency signal then controls the gate, and the higher frequency signal is counted by the counting regis-

ter. Accuracy can be improved by using the averaging technique we mentioned above.

Time interval is measured by using two control signals, START and STOP, to control the main gate, as shown in Fig. 4. The counting register then counts pulses from the timebase oscillator. Counting commences upon receipt of a START pulse, and counting ceases upon receipt of a STOP pulse.

Pulse counting is similar to measuring frequency, except that an external signal, such as an SPST toggle switch, determines the gate's time interval—that is, the length of time the gate is able to accept input pulses. The basic idea is shown in Fig. 5.

Other features

Frequency counters often include features like normalizing, presetting, and prescaling. A normalizing frequency counter multiplies the input signal by a preset constant. Normalization is often used to measure RPM and flow rate, where input transducers commonly provide more (or less) than one pulse per unit of rotation or flow. A presettable frequency counter provides an indication only when a preset number has been exceeded. Presettable counters are used in batch counting, RPM monitoring, and cardiac and respiratory monitoring.

Prescaling is useful for increasing the maximum frequency at which a counter can operate reliably. The prescaler divides the input signal by a factor of n before applying it to the main gate, as shown in Fig. 6. The tradeoff is that, to keep resolution from decreasing by n , the main gate must remain open for a period of time equal to n . However, that allows a slower, less expensive gate and counting register to be used.

That should give you some of idea of what frequency counters can do. Now let's look at how they do it. We'll begin at the beginning—the input-conditioning circuitry.

Input processing

The major components of the signal-processing block we have referred to in previous diagrams as "input conditioning" are shown in Fig. 7. First we notice a switch to select AC- or DC-coupling. Then we see an attenuator that is used to reduce the amplitude of the input signal if it is too great. Next there is a limiting circuit composed of a fuse and diodes D1 and D2. Then we see an impedance-matching network that is followed by a wide-band amplifier.

An optional AGC (Automatic Gain Control) circuit provides feedback from the amplifier to the input attenuator, and then the Schmitt trigger conditions any signal with a slow rise-time, a slow fall-time, or both (like a sine wave), to provide

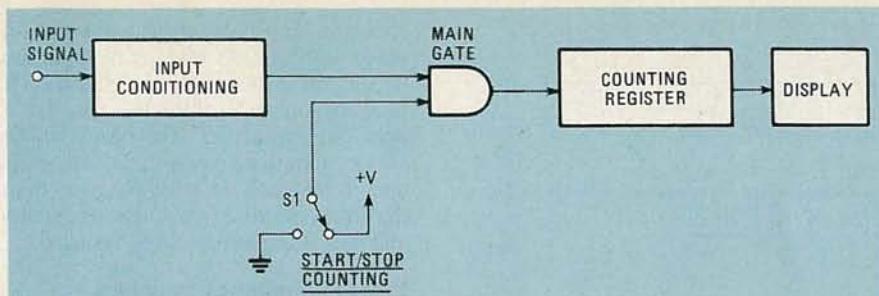

FIG. 5—PULSES ARE COUNTED by using a manual START/STOP switch to control the main gate. The input signal is applied to the regular input.

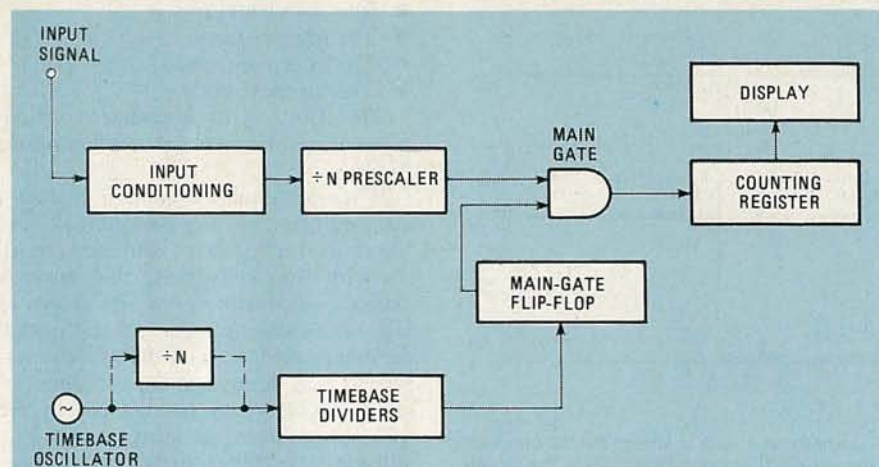

FIG. 6—A PRESCALER may be used to measure frequency higher than usual. For proper display, the output of the timebase oscillator may also be divided.

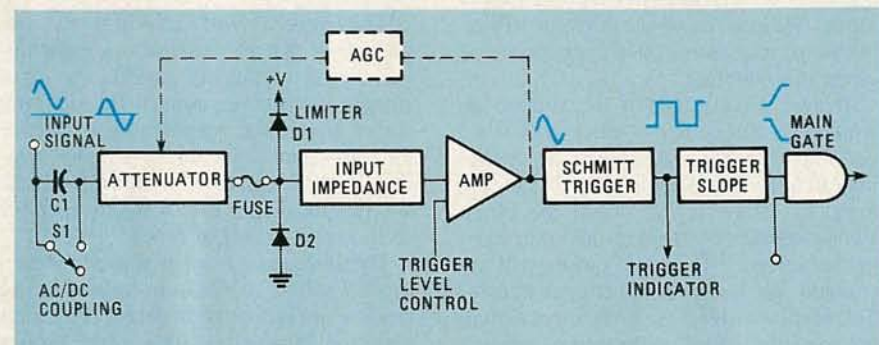

FIG. 7—THE INPUT-CONDITIONING CIRCUIT of a typical frequency counter is shown here. The circuit shapes signals to a digital form that is acceptable to the main gate.

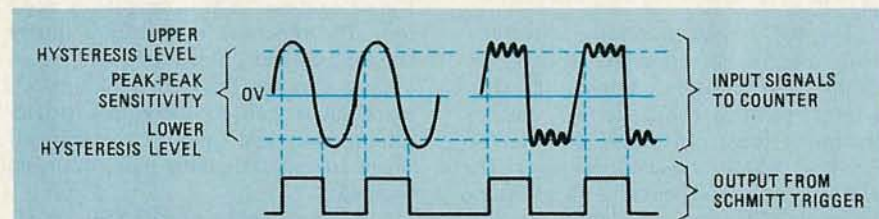

FIG. 8—NOISE RIDING AN INPUT SIGNAL can cause false triggering of a frequency counter's counting circuit.

a more rectangular output with fast risetimes and fast falltimes. Next we find a trigger-slope selector, and then the properly-conditioned input signal is fed to the digital counting and display circuitry.

While keeping those input components in mind, let's talk a bit about the sort of

input signal that is required, and then look at each stage of that signal-processing circuit in more detail.

Sensitivity may be defined as the smallest input signal that can be counted reliably. Sensitivity is usually specified in terms of the rms value of a sinewave input.

In general, pulses must have an amplitude exceeding $2\sqrt{2}$ (2.82) times the rms value of the specified trigger voltage.

It may appear that a more sensitive frequency counter is a better frequency counter. However, frequency counters usually have broadband input amplifiers, so high sensitivity can cause false triggering to occur. That is why a Schmitt trigger is used. As shown in Fig. 8, the peak-to-peak sensitivity, or hysteresis, of the frequency counter should prevent noise riding the input signal from triggering the counting circuit. Now let's look at the input circuitry.

Input-signal conditioning

Input coupling may be either DC or AC. As shown in Fig. 9-a, an AC signal with a large DC component can shift the level of the signal outside the usable range of hysteresis. By coupling the input signal through a capacitor, the DC is blocked, and the signal falls within the usable range of hysteresis.

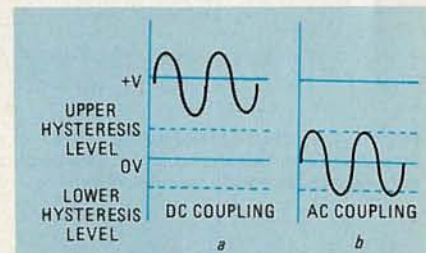

FIG. 9—A DC-COUPLED SIGNAL, as shown at a, can shift a signal completely out of the hysteresis range. AC-coupling, as shown at b, brings the signal in range.

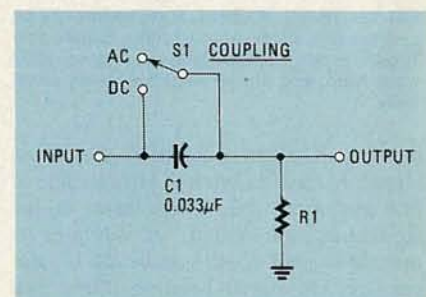

FIG. 10—THIS RC NETWORK is used with different values of R1 to generate the waveforms shown in Fig. 11.

AC coupling is of little value if the duty cycle—the ratio of the *on* time to the period of a waveform—is low, because the time constant of the input network may exceed the width of the input pulse. For the same reason, AC-coupling should not be used on variable duty-cycle signals.

Let's see what effect the input network can have on narrow pulses. The effects of the RC network (shown in Fig. 10) that we used are shown in Fig. 11. Trace a in Fig. 11 shows the input signal; trace b shows the output signal when S1 is closed—i.e., when the input is DC-coupled to the output. The remaining traces (c-f) show how

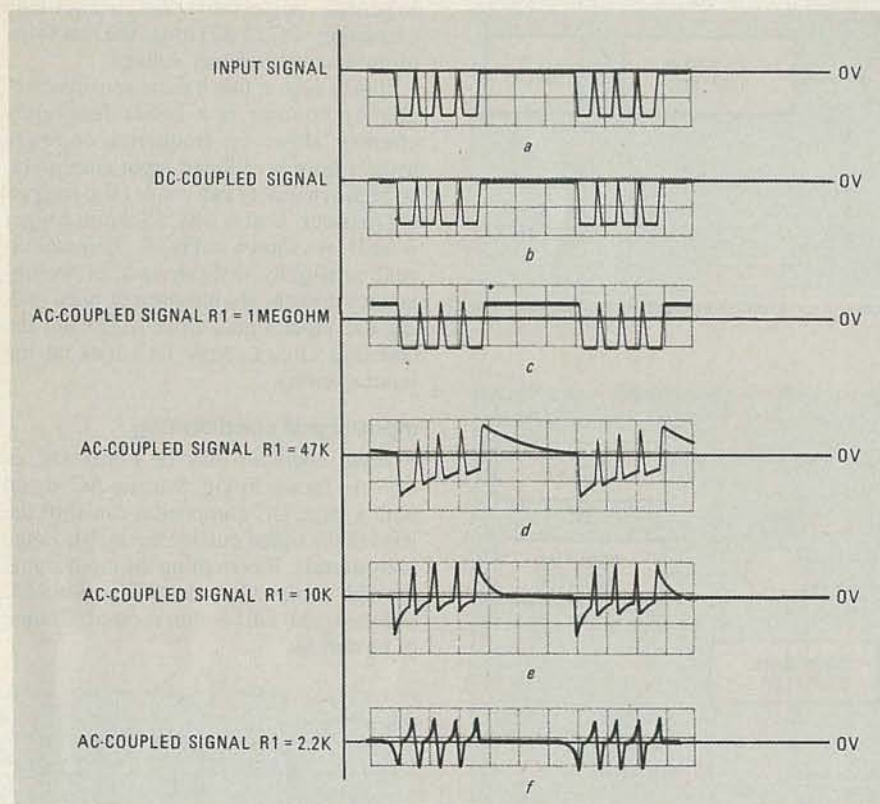

FIG. 11—THE INPUT SIGNAL to the network in Fig. 10 is shown at a. At b is shown the DC-coupled output, and at c-f are shown AC-coupled outputs with the value of R1 varying as indicated. The signal at f would cause drastic counting errors.

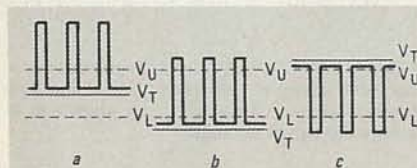

FIG. 12—TRIGGER LEVEL, if set improperly (a), can cause a pulse-train to pass undetected. Trigger level is set properly at b, a positive-going wave-train, and at c, a negative-going wave-train.

decreasing values of R1 affect the output signal. In trace c (where R1 has a value of one megohm), the voltage level of the signal has been shifted, but it retains its overall shape. As the value of R1 decreases, the signal becomes more and more distorted, until, as shown in trace f, (where R1 has a value of 2.2K), the circuit becomes a differentiating network, so erratic counting would result.

The attenuator is a voltage-dividing RC network that typically provides switch-selectable division by 1, 10, or 100. Variable attenuators are also commonly used. The attenuator is often followed by a limiting network which ensures that sensitive amplifier inputs are not overloaded. That could easily happen with a low-impedance, high-speed input signal like a glitch.

The input to the amplifier is generally high impedance (one megohm), but some frequency counters allow you to choose either high (one megohm) or low (50 ohms) input impedance. You can often get

a sensitivity of 20 to 25 mV with a 50-ohm input. A sensitivity of one mV is possible, but noise may cause false triggering and erroneous counting.

Trigger level refers to the voltage at which the frequency counter will trigger—that is, deliver a pulse to the counting circuitry. If the trigger level is set too high, as shown in Fig. 12-a, the input signal will never fall below the lower hysteresis voltage, V_L , so no pulses will be counted. By lowering the trigger threshold, as shown in Fig. 12-b, the input signal will traverse the complete hysteresis range, so each input pulse will be counted. The trigger level must be set correctly for negative input voltages too, as shown in Fig. 12-c.

The AGC circuit adjusts the sensitivity of the amplifier to accommodate inputs of different magnitudes. A tradeoff exists between the response of the AGC and the minimum frequency signal that can be counted, which is usually about 50 Hz with common AGC circuits. In addition, common AGC circuits are also limited in their ability to respond to high-frequency AM (Amplitude Modulated) signals. The reason is that the AGC circuit tends to respond to the peak voltage levels and ignore the valleys, and that can cause erroneous counting.

Now let's look at how circuits like those described have been implemented in a real-world frequency counter. The frequency-compensated input attenuator

shown in Fig. 13 can reduce an input signal as high as 100 volts by a factor of ten, depending on the setting of switch S1. The network composed of R6, R7, C4, and C5 does the attenuating. The block labeled MARKER GENERATOR will be discussed later. But for now, let's find out how counting errors can arise in frequency counters, and how those errors can be reduced.

Error in frequency counters

The major sources of error in a frequency counter may be classified in four categories:

- The ± 1 count error
- The trigger error
- The systematic error
- The timebase error

The effects of those errors on various types of measurements are summarized in Table 1.

When a frequency counter makes a measurement, a ± 1 count ambiguity exists in the LSD (Least Significant Digit). As with A/D converters, that error is called a *quantizing error*. As shown in Fig. 14, depending on the precise instant the main gate opens and allows input signals to pass through to the counting circuits, a pulse may be missed. In the middle trace, the gate opens for time T_M , and one pulse passes. In the bottom trace, the gate also opens for time T_M , but it opens a little later, so a second pulse passes through.

The *trigger error* is caused by the random noise that accompanies an input signal. When measuring period, the input signals themselves control the opening and closing of the main input gate. Therefore noise can cause the hysteresis "window" to be crossed too soon (or too late), and that means the gate will stay open for an incorrect period of time.

The *systematic error* is caused by even the slightest mismatch between the risetimes or propagation delays of the start and stop channels. Mismatched probes and cable lengths can cause that type of error.

The *timebase error* is the greatest source of error in most frequency counters. The timebase is usually a quartz-crystal oscillator. Since the timebase oscillator controls the period of time the main gate is open, its importance in determining accuracy cannot be overstated. There are basically three types of crystal oscillator:

1. Room-temperature (RTXO)
2. Temperature-compensated (TCXO)
3. Oven-controlled (both switched- and proportional-oven types).

Oscillator type 1 simply ignores the effect of temperature; oscillator type 2 attempts to compensate for temperature drift by using components that drift in the direction opposite that of the crystal. The net effect is, hopefully, no drift with temperature.

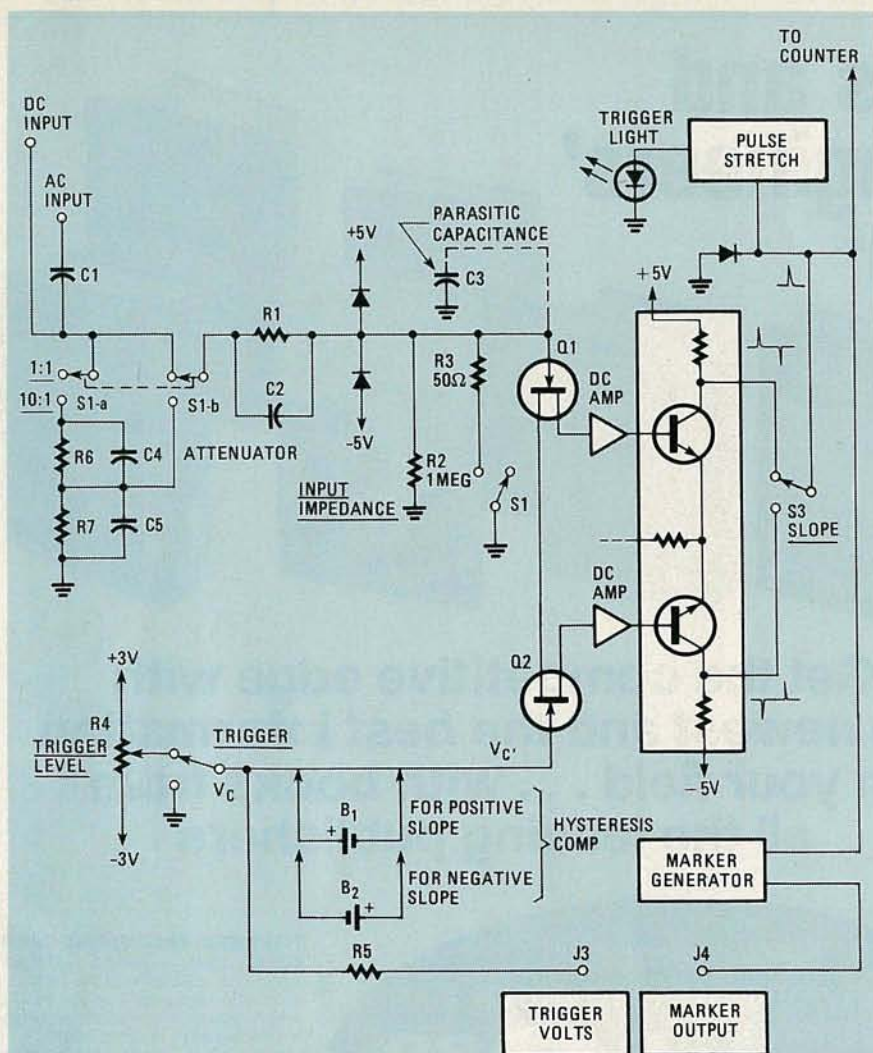

FIG. 13—INPUT-CONDITIONING CIRCUITRY serves to produce a clean digital output for the counting circuitry that follows.

TABLE 1—ERROR SUMMARY

Source of errors	Frequency measurement	Period measurement	Time interval measurement	Remarks
± 1 Count	Yes	Yes	Yes	A Random error
± Time Base	Yes	Yes	Yes	A Random error
± Trigger	No	Yes	Yes	
± Systematic	No	No	Yes	

TABLE 2—CRYSTAL OSCILLATOR ERROR

	Room temperature crystal oscillators	Temperature compensated crystal oscillators	Simple switching oven oscillators	Proportional oven oscillators
Temperature (0°C - 50°C)	$<2.5 \times 10^{-6}$	$<5 \times 10^{-7}$	$<1 \times 10^{-7}$	$<7 \times 10^{-9}$
Line Voltage (10% change)	$<1 \times 10^{-7}$	$<5 \times 10^{-8}$	$<1 \times 10^{-9}$	$<1 \times 10^{-10}$
Aging	$<3 \times 10^{-7}/\text{mo}$	$<1 \times 10^{-7}/\text{mo}$	$<1 \times 10^{-7}/\text{mo}$	$<1.5 \times 10^{-8}/\text{mo}$ or $<5 \times 10^{-10}/\text{day}$
Short Term (1 sec. avg.)	$<2 \times 10^{-9}\text{rms}$	$<1 \times 10^{-9}\text{rms}$	$<5 \times 10^{-10}\text{rms}$	$<1 \times 10^{-11}\text{rms}$

Oscillator type 3 doesn't attempt to compensate for variations in temperature; it attempts to control that temperature completely. It usually takes 24 hours after turn-on for an oven to attain its maximum specified accuracy, but an oven can usually attain an accuracy of 7 parts in 10^{-9} in 20 minutes. Precision frequency counters usually keep their ovens turned on constantly, whatever the state of the ON/OFF switch, so that maximum accuracy is always attainable at the instant that the instrument is turned on.

Besides temperature, there are three additional sources of error in a crystal oscillator: line-voltage variations, aging rate or long-term stability, and short-term stability.

The effect of line-voltage variation on crystal frequency is usually specified in terms of a 10% change in voltage. The effects of line-voltage variation can be minimized by careful power-supply design.

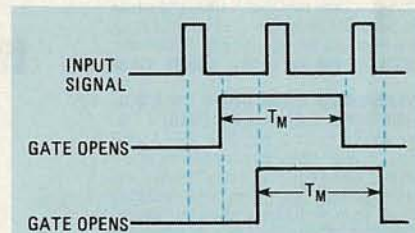

FIG. 14—A ONE-COUNT ERROR can occur if a frequency counter's main gate opens at the wrong time.

The physical properties of the crystal gradually change with time. That shift results in a cumulative frequency drift called aging. Aging is usually specified in terms of frequency change per month, since a factor like temperature would mask the small amount of aging that would occur in such a short period of time.

Short-term stability, also referred to as time-domain stability and fractional frequency deviation, results from noise (random frequency and phase fluctuations) generated in the crystal itself. The effect of each type of crystal-oscillator error is summarized in Table 2.

Now that we've discussed the basic theory of frequency counters, and sources of error therein, let's look at several interesting and unusual real-world applications for a frequency counter. In addition to basic frequency, time and counting measurements, you can use any frequency counter with adjustable START and STOP trigger-level controls to measure phase and risetime.

Unfortunately, that discussion will have to wait until next time as we've run out of space for this issue. At that time, we'll also look at some rather sophisticated counters and accessories, and how they are used.

R-E

From McGraw-Hill . . . the professionals' publisher

Join the Electronics and Control Engineers' Book Club®



SWITCHED CAPACITOR CIRCUITS
By P. E. Allen and Edgar Sanchez-Sinencio. 759 pp., 558 illus. and tables. Covering the latest developments in design, analysis, and implementation, this is the first guide to switched capacitor (SC) circuits—an economical way of combining analog sampled data techniques with MOS technology.
583239-9 Pub. Pr., \$56.50 Club Pr., \$39.45

TROUBLESHOOTING ELECTRONIC EQUIPMENT WITHOUT SERVICE DATA By R. G. Middleton. 303 pp., 162 illus. and tables. Packed with charts, diagrams, and case histories, this practical handbook shows you how to pinpoint defective electronic circuitry when no service data is available.
583134-1 Pub. Pr., \$24.95 Club Pr., \$18.50

STANDARD HANDBOOK OF ENGINEERING CALCULATIONS T. G. Hicks, Editor in Chief. 2nd Ed., 1,468 pp., 1,292 illus. and tables. Now revised, updated, and considerably expanded, this huge handbook provides more than 5,100 step-by-step procedures for solving the kinds of engineering problems you encounter most frequently in your work.
287/35X Pub. Pr., \$59.50 Club Pr., \$44.50

POWER CONTROL WITH SOLID-STATE DEVICES By Irving M. Gottlieb. 372 pages, 218 illustrations. This comprehensive book discusses every type of solid-state device and circuitry now available for power electronics. It covers both the proven-in-practice power control systems and the avant garde—as well as some promising combinations of the older and newer devices and circuitries.
583240-2 Pub. Pr., \$28.95 Club Pr., \$21.95

CONTROL SYSTEM ENGINEERING By Mohamed E. El-Hawary. 583 pages, 373 illustrations. This up-to-the-minute guide gives you the latest techniques for the design, analysis, and compensation of today's increasingly complex and sophisticated control systems. All the systems covered are closed-loop time-invariant feedback control systems.
583224-0 Pub. Pr., \$32.95 Club Pr., \$24.75

DIGITAL LOGIC DESIGN. By B. Holdsworth. 338 pp., 192 illus. All of the recent advances in digital design techniques are presented here in depth. It's both a text covering basic concepts and a practical guide to design techniques for combinational, clock-driven, and event-driven circuits.
582852-9 Pub. Pr., \$39.95 Club Pr., \$27.50

INTRODUCTION TO RADAR SYSTEMS. By M. I. Skolnik. 2nd Ed., 698 pp., 244 illus. Covering every radar fundamental and all important changes, this EE text exposes you fully to the systems themselves—and to their applications! Topics include radar equation, CW and frequency-modulated radar, MTI, pulse-doppler, tracking radar, receivers, displays, duplexers, noise, and more.
579/091 Pub. Pr., \$47.95 Club Pr., \$35.75

Get the competitive edge with the newest and the best information in your field . . . with books from all the leading publishers

New members!
Any one of these great professional books for only . . . **\$2⁸⁹** as a premium with your 1st selection!

Spectacular values up to **\$105.00**

HANDBOOK OF PRACTICAL ELECTRICAL DESIGN. By J. F. McPartland. 416 pp., 300 illus. This volume provides a step-by-step explanation of designing electrical systems for industrial, commercial, and residential applications.
456/95X Pub. Pr., \$44.50 Club Pr., \$30.95

INTRODUCTION TO MICROWAVE ELECTRONICS. By T.C. Edwards. 76 pp., illus., softbound. Eliminating unnecessary theory and mathematics, this book provides you with a lucid overview of microwave engineering and the devices and circuits being used today.
583030-2 Pub. Pr., \$14.95 Club Pr., \$10.95

ELECTRONICS ENGINEERS' HANDBOOK, 2/e. Edited by D. G. Fink & D. Christiansen. 2,272 pp., 2,189 illus. This updated and enlarged edition covers all the latest knowledge in the field, including new advances in integrated circuits, pulsed and logic circuits, laser technology, telecommunications, and much more.
209/812 Pub. Pr., \$83.50 Club Pr., \$63.95

ANTENNA ENGINEERING HANDBOOK, 2/e. Edited by R. C. Johnson and H. Jasik, with contributions by 57 recognized authorities. 1,408 pp., 946 illus. This widely acclaimed Handbook gives you the guidance you need to solve problems in antenna design and application.
322/910 Pub. Pr., \$105.00 Club Pr., \$62.50

TRANSDUCERS: Theory and Applications. By J.A. Allocca and A. Stuart. 497 pp., 328 illus. Thoroughly describes and illustrates the theory and operation of all important transducers used in industrial, communication, medical, and other applications.
582997-5 Pub. Pr., \$29.95 Club Pr., \$24.95

ELECTRONIC COMMUNICATIONS SYSTEMS. By W. D. Stanley. 566 pp., illus. Emphasizing the signal-processing functions of modulation and demodulation operation, this book presents the essentials of electronic communications in a logical, step-by-step sequence.
582834-0 Pub. Pr., \$32.95 Club Pr., \$22.50

TELEVISION ENGINEERING HANDBOOK.—By K. B. Benson. 1,478 pp., 1,091 illus. Packed with the technical information and know-how you need to design, operate and maintain every type of TV equipment in current use.
047/790 Pub. Pr., \$89.50 Club Pr., \$62.50

THE ENCYCLOPEDIA OF ELECTRONIC CIRCUITS. By R. Graf. 760 pp., 1,256 illus. This large volume provides circuits for virtually every type of application in 98 different categories. Each has a clear and concise explanatory text accompanying it.
583265-8 Pub. Pr., \$50.00 Club Pr., \$39.95

GATE ARRAYS: Design Techniques and Applications. Edited by J. W. Read. 349 pp., 146 illus. Written by a team of specialists, this book describes the fundamental principles, design techniques, and uses of gate arrays.
512/868 Pub. Pr., \$35.00 Club Pr., \$24.75

PRACTICAL DIGITAL DESIGN USING ICs, 2/e. By J. D. Greenfield. 717 pp., illus. This revised and expanded Second Edition of a popular guide shows how to get the most out of a wide range of popular integrated circuits. What's more, it contains the specialized know-how today's designer needs to interface ICs with microprocessors.
582853-7 Pub. Pr., \$31.95 Club Pr., \$22.95

McGRAW-HILL CONCISE ENCYCLOPEDIA OF SCIENCE AND TECHNOLOGY. Editor-in-Chief S. P. Parker and the Staff of the McGraw-Hill Encyclopedia of Science and Technology. 2,065 pp., 1,600 illus. This volume serves every need for understanding today's science and technology. Written by over 3,000 of the world's topmost experts, including 19 Nobel Prize winners, it covers 75 disciplines from Acoustics to Zoology.
454/825 Pub. Pr., \$95.00 Club Pr., \$66.50

MICROWAVE SEMICONDUCTOR CIRCUIT DESIGN. By W.A. Davis. 416 pp. heavily illus. Provides in-depth coverage on microwave circuit analysis, passive microwave components, impedance transformers and circuits, broadband directional couplers, mechanical realization of selected transmission lines, CAD, CAM and CAT, characteristics of amplifiers and oscillators, noise, statistical thermodynamics and PN junction theory.
583044-2 Pub. Pr., \$47.50 Club Pr., \$35.50

INTRODUCTION TO RADIO FREQUENCY DESIGN. By W. H. Hayward. 383 pp., illus. This comprehensive volume prepares you to actually design HF, VHF, and UHF equipment and enables you to follow much of the current literature. Structured equation sets make it easy to write programs for small computers or calculators.
582748-4 Pub. Pr., \$32.95 Club Pr., \$27.25

McGraw-Hill Encyclopedia of Electronics and Computers. By S. P. Parker, Editor-in-Chief. 960 pp., 1,266 illus., outsized 8 1/2 x 11 format. It's a single-volume library that covers the entire world of electronics from Edison's pioneering work in electricity right up to optical fiber communications, control systems, lasers, radar, TV receivers, artificial intelligence, and computer storage technology.
454/876 Pub. Pr., \$67.50 Club Pr., \$41.50

ELECTRONICS ENGINEERING FOR PROFESSIONAL ENGINEERS' EXAMINATIONS. By C. R. Hafer. 336 pp., more than 200 illus. Actually two books in one—a quick preparation manual to help you pass your P.E. exams on the first try and a rich source of practical electronics engineering information and know-how.
254/303 Pub. Pr., \$32.50 Club Pr., \$25.50

COMPUTER METHODS FOR CIRCUIT ANALYSIS AND DESIGN. By J. Vlach and K. Singhal. 656 pp., 148 illus. Computational methods have become an integral part of circuit analysis and design. And a solid understanding of the basics of computer-aided design is a must for engineers who want to achieve their career objectives.
582855-3 Pub. Pr., \$42.50 Club Pr., \$33.95

MODERN ELECTRONIC CIRCUITS REFERENCE MANUAL. By J. Markus. 1,264 pp., 3,666 circuit diagrams. Complete with values of components and suggestions for revisions—plus the original source of each circuit in case you want additional performance or construction details.
404/461 Pub. Pr., \$79.50 Club Pr., \$57.95

STANDARD HANDBOOK FOR ELECTRICAL ENGINEERS, 11/e. By D. G. Fink and H. Beaty. 2,448 pp., 1,414 illus. Today's most widely used source of electrical engineering information and data serves you as no other single work when you need detailed, timely, and reliable facts.
209/74X Pub. Pr., \$79.95 Club Pr., \$62.95

Be sure to consider these important titles as well!

DESIGN OF FEEDBACK CONTROL SYSTEMS. By G. H. Hostetter, C. J. Savant, and R. T. Stefani.
583206-2 Pub. Pr., \$41.95 Club Pr., \$31.45

VLSI SYSTEM DESIGN. By S. Muroga.
582823-5 Pub. Pr., \$34.95 Club Pr., \$26.50

MICROPROCESSOR SUPPORT CHIPS: Theory, Design, and Applications. By T. J. Byers.
095/183 Pub. Pr., \$43.50 Club Pr., \$35.25

DATA COMPRESSION: Techniques and Applications. By T. J. Lynch.
583267-4 Pub. Pr., \$44.50 Club Pr., \$31.25

PRINCIPLES OF ACOUSTIC DEVICES. By V. Ristic.
583248-8 Pub. Pr., \$46.95 Club Pr., \$31.50

ANALYSIS AND DESIGN OF DIGITAL INTEGRATED CIRCUITS. By D. A. Hodges and H. G. Jackson.
291/535 Pub. Pr., \$40.00 Club Pr., \$32.50

HANDBOOK OF OPERATIONAL AMPLIFIER CIRCUIT DESIGN. By D. E. Stout & M. Kaufman.
617/97X Pub. Pr., \$48.50 Club Pr., \$34.95

ENGINEERING MATHEMATICS HANDBOOK, 2/e. By J. J. Tuma.
654/298 Pub. Pr., \$41.50 Club Pr., \$31.00

DIGITAL COMMUNICATIONS. By J. Proakis.
509/271 Pub. Pr., \$42.95 Club Pr., \$31.50

CRYSTAL OSCILLATOR CIRCUITS. By R. J. Matthys.
583251-8 Pub. Pr., \$37.95 Club Pr., \$26.95

MAINTAINING AND REPAIRING VIDEOTAPE RECORDERS. By R. L. Goodman.
582895-2 Pub. Pr., \$15.95 Club Pr., \$12.50

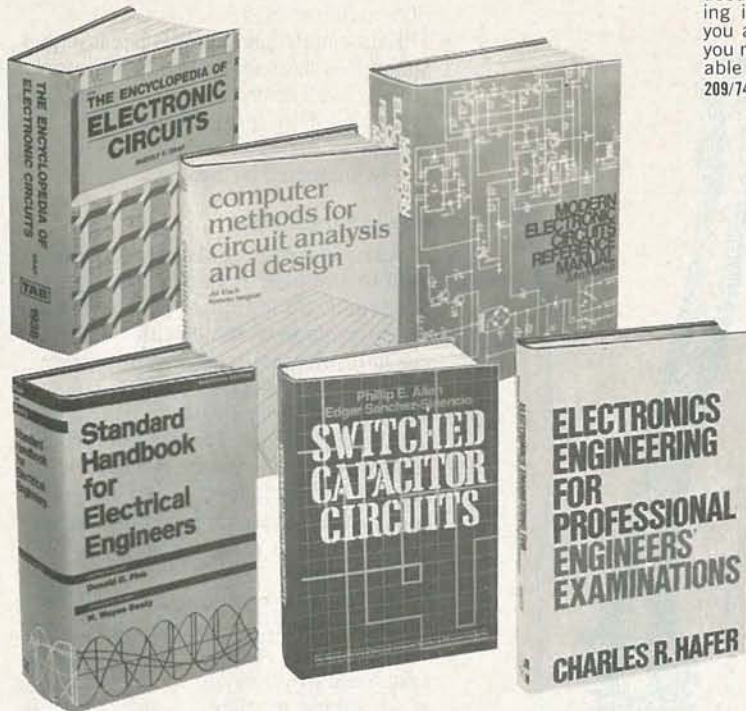

Why YOU should join now!

- **BEST AND NEWEST BOOKS IN YOUR FIELD** — Books are selected from a wide range of publishers by expert editors and consultants to give you continuing access to the best and latest books in your field.
- **BIG SAVINGS** — Build your library and save money too! Savings ranging up to 30% or more off publishers' list prices — usually 20% to 25%.

BONUS BOOKS—You will immediately begin to participate in our Bonus Book Plan that allows you savings up to 70% off the publishers' prices of many professional and general interest books!

- **CONVENIENCE**—12-14 times a year (about once every 3-4 weeks) you receive the Club Bulletin FREE. It fully describes the Main Selection and Alternate Selections. A dated Reply Card is included. If you want the Main Selection, you simply do nothing—it will be shipped automatically. If you want an Alternate Selection—or no book at all—you simply indicate it on the Reply Card and return it by the date specified. You will have at least 10 days to decide. If, because of late delivery of the Bulletin you receive a Main Selection you do not want, you may return it for credit at the Club's expense.

As a Club member you agree only to the purchase of three books (including your first selection) during your first year of membership. Membership may be discontinued by either you or the Club at any time after you have purchased the first selection plus two additional books.

Other McGraw-Hill Book Clubs:
Architects' Book Club • Byte Book Club • Chemical Engineers' Book Club
• Civil Engineers' Book Club • Mechanical Engineers' Book Club

For more information, write to:
McGraw-Hill Book Clubs, P.O. Box 582, Hightstown, New Jersey 08520-9959

MAIL THIS COUPON TODAY

McGraw-Hill Book Clubs
Electronics and Control Engineers'
Book Club®
P.O. Box 582, Hightstown, New Jersey, 08520-9959

Please enroll me as a member and send me the two books indicated, billing me for the \$2.89 premium and my first selection at the discounted member's price, plus local tax, shipping, and handling charges. I agree to purchase a minimum of two additional books during my first year of membership as outlined under the Club plan described in this ad. A shipping and handling charge is added to all shipments.

Write Code No. of
\$2.89 selection here

Write Code No. of
first selection here

Signature _____

Name _____

Address/Apt. # _____

City _____

State _____ Zip _____

This order subject to acceptance by McGraw-Hill. All prices subject to change without notice. Offer good only to new members.

E33783

Healing with Electronics

Although the concept is over a hundred years old, electrical stimulation of the body to promote healing has only recently been accepted. Here, we look at the techniques that are currently used, and some of the problems that had to be overcome to develop those techniques.

EACH YEAR, ABOUT THREE PERCENT OF the population of the United States suffers some type of bone break. In fact, that type of injury is the third leading cause of hospitalization in this country.

Normally, a broken bone heals. But in about 5% of the cases the bone either doesn't heal at all, or the healing process takes an abnormally long time. In recent years, those problem cases have been treated with electronics.

The idea of using electronics to promote healing is not new. In the 1840's, it was discovered that electric currents could sometimes cause healing in fractures that were not healing on their own. In more modern times the phenomenon came under closer scrutiny, and in 1979, the U.S. Food and Drug Administration (FDA) approved the use of weak-pulsed magnetic fields to promote healing.

Since then, weak-pulsed electromagnetic fields have been used to treat over 15,000 patients in this country alone. Although the patients selected for such treatment generally had fractures that failed to heal normally over a period of months or years, a success rate of 80% has been achieved with electronically stimulated healing.

In addition to causing a fractured bone, such as that shown in Fig. 1, to heal, electromagnetic fields may be helpful in stimulating the healing of skin ulcers and other defects in soft tissues. It is even felt by some people that electromagnetic fields may also prove to be useful in reducing the growth of cancers.

Electric fields and healing

Electric fields can interact with body tissues in a number of ways. One of those ways is heating. When the energy put into a tissue is greater than one-watt-per-kilogram of tissue, significant heating occurs.

There are several possible ways that heat-producing electric currents can promote healing. Thermal stimulation of blood vessels causes blood flow to increase because such stimulation dilates those vessels. It also makes it easier for nutrients in the blood to pass through blood-vessel walls to the tissues. Finally, it increases the metabolic rate of tissues.

Heating can also relax muscles, reducing muscle spasms and pain. Connective tissues may be softened by heat, allowing

Dr. RAY FISH, PhD, MD

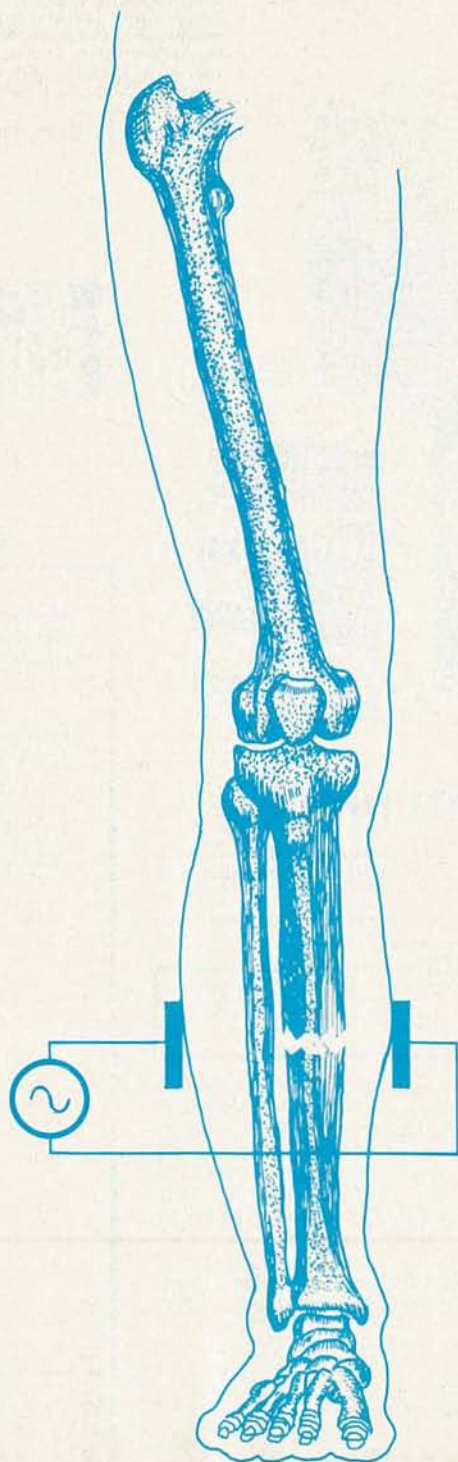

for less painful movement. For those reasons, deep heating usually plays an important part in the treatment of orthopedic injuries, such as injuries to joints, tendons, and muscles.

Heat can damage tumors because they sometimes have a marginal blood supply, which is overloaded when the metabolism is increased by local heating. Also, the uptake of toxins (chemotherapy drugs) can be increased by heating.

Healing fractures

Weak electric fields are sometimes used to stimulate bone healing. The applied fields try to imitate the distribution and magnitude of the electric fields that are naturally generated within bones. Bone is a piezoelectric material; voltages are produced when bone is stressed or bent. The growth and shaping of bones is controlled by the voltages caused when the bones are loaded. With exercise, bones generate electric fields; the strength of those fields is usually a few millivolts-per-centimeter.

The fields are part of a natural feedback system that changes the shape of bones as they grow and repair themselves after injury. Naturally, bone grows in such a way as to reduce mechanical stress on the bone. When compressive forces are applied to bone, a negative potential results, leading to bone growth; when tension is applied to bone, a positive potential results, leading to absorption of bone. Also, bone grows in such a way that the shape is one that can handle the load placed upon it with the least strain.

Although many other factors contribute to bone growth and shaping, there is no doubt that weight bearing strengthens bones. Decreased weight bearing causes loss of bone mass. In extreme cases, such as when astronauts do not exercise in space, the loss of calcium from bones can be significant.

A bone injury alters the natural electrical fields. That is, the field strength at such sites increases markedly. Although researchers are not certain of the mechanisms involved, one theory is that the increased field strength attracts certain types of "healing" cells.

If healing is not proceeding satisfactorily, or has stopped, it is possible to assist the natural process by applying an



FIG. 1—THE BONE THAT most often fails to heal is the tibia, the large bone between the knee and ankle. Here are two x-rays of the same leg taken at different angles to show more detail. The smaller bone next to the tibia, the fibula, is also broken. The knee and ankle joints are just out of the picture.

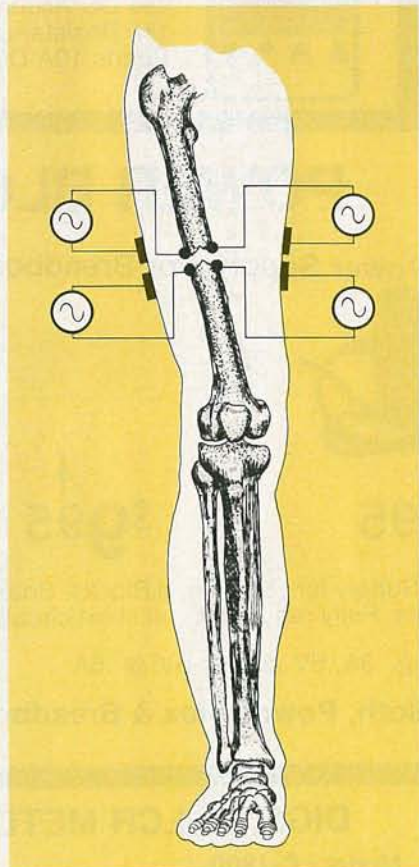

FIG. 2—HERE, THE NEGATIVE ELECTRODES are implanted directly on the bone. The positive electrodes are located on pads on the surface of the skin.

electrical field to the injury. Such non-healing can be caused by several factors. A fracture may not heal if its ends are too far apart (half the diameter of the bone) or if certain types of tissues have grown between the fracture fragments. The latter causes a "false joint" (in medical terms, a

synovial pseudarthrosis) to form.

A field can be applied to the injury site in several ways. One of those is direct application. In that method, shown in Fig. 2, electrodes are implanted directly in the bone. With implanted electrodes, bone formation (osteogenesis) is stimulated at the negative electrode (cathode). Bone-cell death (necrosis) often occurs at an implanted anode. Thus, the cathode is implanted in the bone while the anode is placed on or implanted in the skin.

A variety of different electrode materials have been tried. The most common are stainless steel and titanium, but platinum alloys and silver/silver-chloride electrodes also have been used. The voltage used to drive the electrodes can be DC, pulsed DC, symmetric AC, or asymmetric AC (usually under 3 kHz).

In the case of large, weight-bearing bones, it is not uncommon to use four electrodes, each carrying up to 20 microamperes to the fracture site.

One thing that must be guarded against is the possibility of wires coming loose. To prevent that from happening, the fracture site is covered by a cast. To aid in mobility, the power supply may be made part of that cast.

It is of course possible to deliver a current to the fracture site without physically locating electrodes there. One such method is induction. In the method shown in Fig. 3, pulsed magnetic fields are generated by a pair of coils that are placed so that they share a common axis, which passes through the fracture site. An AC voltage of 10 to 100 is applied to the coils, which in turn sets up a time-varying magnetic field at the fracture site. The magnitude of the magnetic field is between 0.1 and 20 gauss. Experiments have shown that such magnetic fields induce current densities of 1 to 20 microamperes-per-centimeter. The corresponding peak voltage density is about one millivolt-per-centimeter. To aid healing, the magnetic field is applied continuously for 10 or more hours a day, over a period of several months.

Finally, a current can be induced via capacitive coupling. As shown in Fig. 4, the electrodes are placed on the skin on opposite sides of the fracture site. Potentials of 1 to 10 volts at 20 to 200 kHz are then applied to the electrodes.

Another application of electric fields in healing is in the treatment of skin ulcers. Those ulcers are caused by poor circulation, leading to the loss of skin and most commonly occur on the leg. To treat such ulcers, currents of 200 to 1,000 microamperes have been used. In one study, a negative electrode made of a copper mesh embedded in saline-soaked gauze was first placed on the wound for about a week

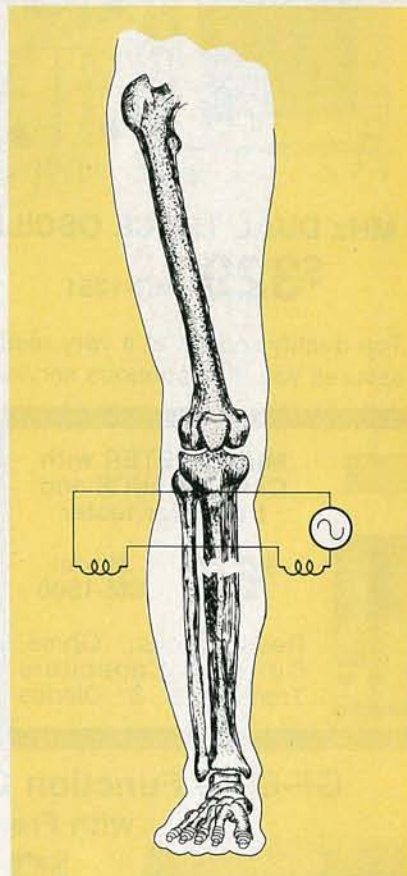

FIG. 3.—CURRENT CAN BE DELIVERED to the fracture site via induction. Here, the two coils share a common axis, and that axis passes through the fracture site.

to inhibit infection. Then a positive electrode was applied to stimulate growth.

Although the use of electrical stimulation to promote healing seems promising, there are a number of complications that can arise when such stimulation is carried out for prolonged periods of time.

Medical-electronics research

The clinical success of bringing fracture healing to thousands of people with otherwise hopeless cases leaves no doubt that electronically-assisted bone healing works. However, finding the right current levels, electrode placements, and other parameters was not easy.

Proving the value of a treatment method does not usually come easily because one does not try unproven methods on large numbers of subjects. If tried on small numbers of subjects at first, something often goes wrong, making the method look worthless. In general, years of initial research are done on animals to define the types of conditions (e.g. fracture types) that might respond to treatment, the treatment methods that might work, and the safety of the methods. It did take well over 100 years for electrically stimulated frac-

continued on page 86



20 MHz DUAL TRACE OSCILLOSCOPE
\$329 MO-1251

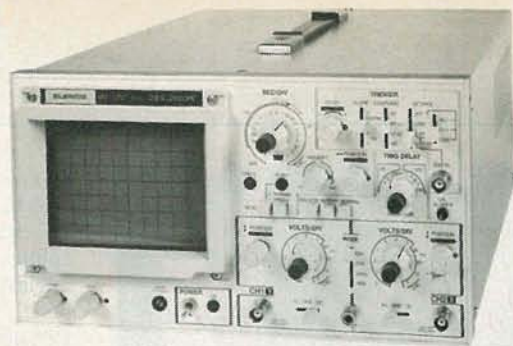

35 MHz DUAL TRACE OSCILLOSCOPE
\$545 MO-1252

Top quality scopes at a very reasonable price. Contains all the desirable features. Elenco's 2 year guarantee assures you of continuous service. Two 1x, 10x probes, diagrams and manual included. Write for specifications



MULTI METER with CAPACITANCE and transistor tester
\$65 Model CM-1500

Reads Volts, Ohms, Current, Capacitors Transistors & Diodes



TRUE RMS 4 1/2 DIGIT MULTIMETER
\$135 Model M-7000

.05% DC Accuracy
 .1 % Resistance with Freq. Counter & Deluxe Case



3 1/2 DIGIT MULTIMETER
\$25 Model M-1600

1% DC Accuracy
 1% Resistance
 Reads 10A DC

GF-8016 Function Generator with Freq. Counter
\$219



- Sine, Square, Triangle,
- Pulse, Ramp, .2 to 2 MHz
- Frequency .1 thru 10 MHz

GF 8015 without Freq. Meter \$169

Triple Power Supply XP-660
\$149.50

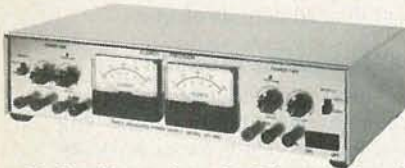

0-20V @ 1A
 0-20V @ 1A
 5V @ 5A

Fully Regulated, Short Circuit Protected with 2 Limit Cont. 3 Separate Supplies.

3 Amp Power Supply XP-650
\$119.50

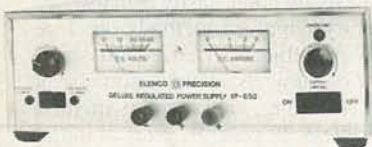

0-40V @ 1.5A
 0-20V @ 3A

Fully regulated, short circuit protected, current limit control

NEW

POWER BLOX

The Power Supply For Breadboards

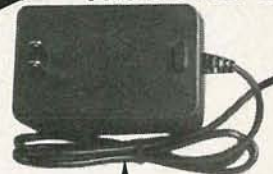

\$14.95

\$9.95

Now a Power Supply for your Bread Blocks. Snaps into existing units. Fully regulated and short circuit protected.

12V @ .3A, 5V @ 1A, -5V @ .5A

\$22.95 for Both, Power Blox & Breadboard



DIGITAL LCR METER
 Model LC-1800
 Measures: Inductors Capacitors, Resistors
\$14.95

Inductors .1μH to 200 H
 Capacitor .1Pf to 200μf
 Resistor .01Ω to 20M Ω
 Ranges 6 Ind, 7 cap, 7 res

C&S SALES, 8744 W. North Ter. Niles, IL 60648
 800-292-7711 (312) 459-9040



15 DAY MONEY BACK GUARANTEE ASK FOR CATALOG

2 Year Limited Guarantee! Add 5% for Postage (\$10 max.), IL Res., 7% Tax

CIRCLE 279 ON FREE INFORMATION CARD

ROBOTICS



MARK J. ROBILLARD,
ROBOTICS EDITOR

Mystery computer revealed

LAST MONTH WE DISCUSSED SOME OF the requirements of a portable robot controller. We found that a CMOS microprocessor, plenty of RAM, and a flexible I/O structure were among the most important of those requirements. I also dropped a few hints about a super controller that meets those requirements and that needs only four AA cells to operate. This month I'll let the cat out of the bag—it's Radio Shack's *Model 100*. Before I talk more about it, let's examine some alternatives.

The portable-computer market is filled with battery-operated machines. Some are IBM-compatible, and some aren't. Prices for today's portables split into two corresponding ranges. The IBM-compatibles generally go for about \$2000, while the non-compatibles go for about \$1000, or less, and sometimes much less. A robot needs a good processor, good I/O (Input/Output), and a flexible control language that's easy to learn and apply; but that doesn't necessarily mean it needs to be IBM-compatible.

So, in my opinion, Radio Shack's *Model 100* is the computer to use for robot control, especially since prices for both models (8K and 24K RAM) have been dropping almost monthly.

The *Model 100* was the first laptop computer to hit the scene, and it was truly revolutionary. NEC and Olivetti followed with machines that were based on the same design; and, if you shop around, you can pick up either an NEC or an Olivetti for about \$200.

The *Model 100* has an 80C85 microprocessor, parallel and serial

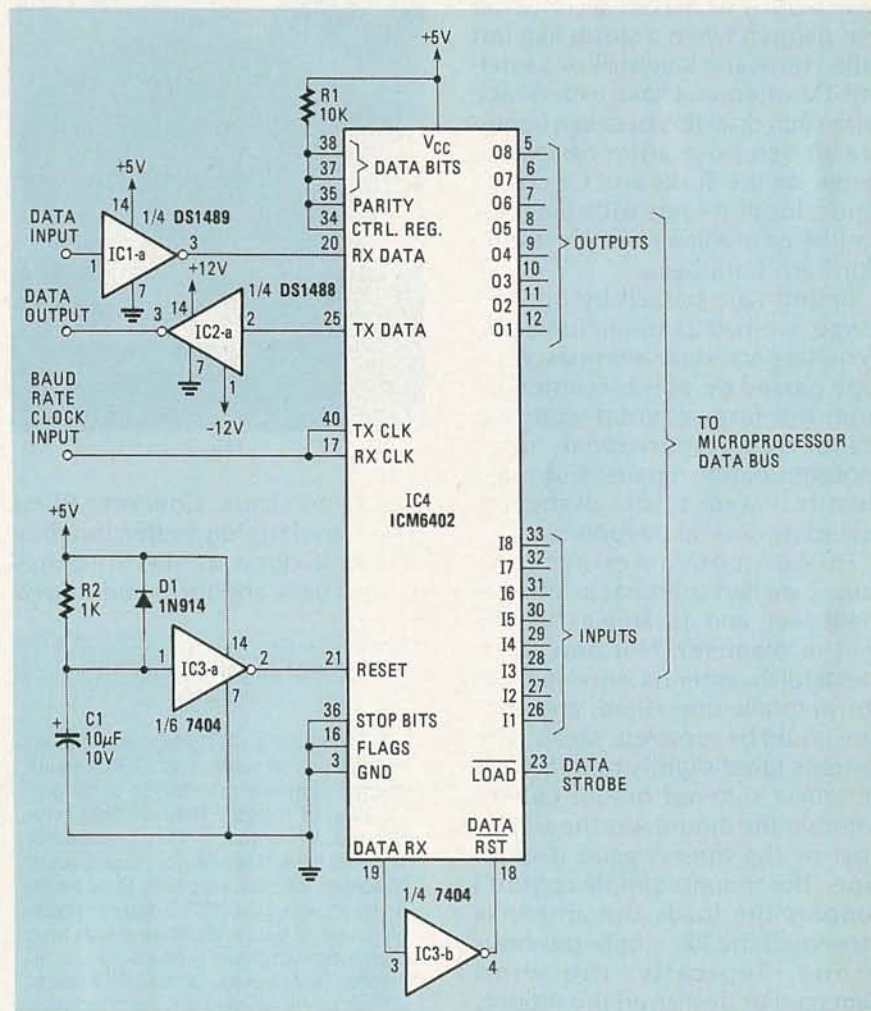

FIG. 1

interfaces, provision for a barcode reader, and RAM that can be expanded on-board to as much as 32K. Third-party vendors even sell add-ons that allow as much as ½-megabyte of (bubble) memory! If those features sound familiar, it's because they perfectly match the requirements we've been discussing the past couple of months.

A serial connection

How do you interface a computer to a robot? You can use the parallel interface, the RS-232 interface—or both, if necessary. What do you do if you have no serial interface? The circuit shown in Fig. 1 could be used with just about any computer with an 8-bit data bus.

continued on page 104

SATELLITE TV



BOB COOPER, JR.
SATELLITE-TV EDITOR

The "Kate" test

LAST MONTH WE TALKED ABOUT WHAT can happen when a storm like last fall's Hurricane Kate strikes a satellite-TV antenna. I have experience with such disasters because I operate an extensive antenna-testing range on the Turks and Caicos Islands, located some 650 miles east southeast of Miami in the extreme northern Caribbean.

Before Kate passed by our test range, we had 25 operational and 15 non-operational antennas. After Kate passed by, only two antennas from the former group were still standing and operational. Some required minor repairs, but more than half were totally destroyed, including several 20-footers.

In our consumer-antenna range, we had antennas as small as eight feet, and as large as sixteen feet in diameter. Not one solid-metal dish antenna survived the storm totally unscathed, and only one could be repaired. Mesh-type designs fared slightly better. Most antennas suffered mount failure, whether the mount was the single-post or the three-legged (tripod) type. The mounts simply couldn't support the loads the antennas presented the 100+ mile-per-hour winds. Typically, the wind damaged or destroyed the mount, the antenna broke free, and the wind slammed the antenna into the ground and other nearby objects.

No solid fiberglass antenna survived, either. Again, the mounts bent and collapsed because they simply couldn't handle the winds. Five-inch steel pipes that supported twelve-foot fiberglass dishes simply bent under the stress. Smaller pipes split open and shat-

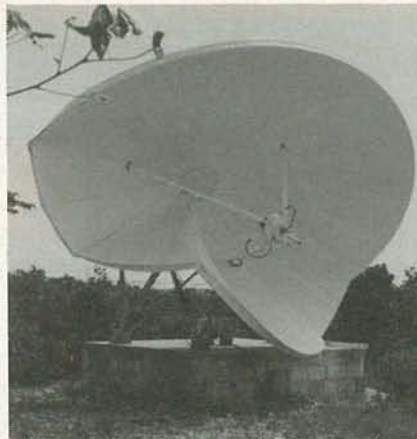

FIG. 1

tered into strips. Concrete-filled pipes fared slightly better, but they still split open as the antennas twisted back and forth and ripped

TVRO dealer "Starter Kit" available

Bob Cooper's *CSD Magazine* has arranged with a number of TVRO equipment suppliers to provide a single-package of material that will help introduce you to the world of TVRO dealership. A short booklet written by Bob Cooper describes the start-up pitfalls to be avoided by any would-be TVRO dealer, in addition, product data and pricing sheets from prominent suppliers in the field are included. That package of material is free of charge and is supplied to firms or individuals in the electronics service business as an introduction to the 1984/85 world of selling TVRO systems retail.

You may obtain your *TVRO Dealer Starter Kit* free of charge by writing on company letterhead, or by enclosing a business card with your request. Address your inquiries to: *TVRO STARTER KIT*, P.O. Box 100858, Fort Lauderdale, FL 33310. That kit *not* available to individuals not involved in some form of electronics not involved in some form of electronics sales and service.

the pipes into bent-spaghetti shapes.

Of the 40 antennas under our direct care, those that survived with either minor damage or no damage at all were of special interest. As we reported last month, the two that survived unscathed were both Paracclipse horizon-to-horizon driven antennas. Eight other antennas survived with relatively minor damage: broken ribs, broken drives, feed supports that snapped loose. One of those was an eleven-foot Harris Delta Gain antenna, known for its very-heavy-duty construction. The other seven were all mesh antennas. What follows is a breakdown of what happened, by manufacturer.

1. Conifer's twelve-foot screen-mesh is supplied by the manufacturer with the mesh already attached to the panel sections. Three antennas were involved in the Kate Test and all had relatively minor damage. The damage sustained was typically related to the motor-drive units (which are separate from the antennas proper), although one antenna was significantly damaged when a chunk of a nearby house plowed into (and through) about one third of the screen mesh surface. Obviously, we can't blame Conifer for that.

2. Ranger's eleven-foot screen-mesh dish (of relatively lightweight construction, by the way) broke loose from its pipe mount and free-wheeled in the winds. Damage was confined to the support structure and amounted to about 25% of the antenna's original cost.

3. Uniden's 10.5-foot screen-mesh antenna with slide-in pan-

Super Disk™ Diskettes

Now...Diskettes you can swear by, not swear at.

Lucky for you, the diskette buyer, there are many diskette brands to choose from. Some brands are good, some not as good, and some you wouldn't think of trusting with even one byte of your valuable data. Sadly, some manufacturers have put their profit motive ahead of creating quality products. This has resulted in an abundance of low quality but rather expensive diskettes in the marketplace.

A NEW COMPANY WAS NEEDED AND STARTED

Fortunately, other people in the diskette industry recognized that making ultra-high quality diskettes required the *best* and newest manufacturing equipment as well as the best people to operate this equipment. Since most manufacturers seemed satisfied to give you only the everyday quality now available, an assemblage of quality conscious individuals decided to start a new company to give you a new and better diskette. They called this product the *Super Disk* diskette, and you're going to love them. Now you have a product you can swear by, not swear at.

HOW THEY MADE THE BEST DISKETTES EVEN BETTER

The management of *Super Disk* diskettes then hired all the top brains in the diskette industry to make the *Super Disk* product. Then these top bananas (sometimes called floppy freaks) created a new standard of diskette quality and reliability. To learn the "manufacturing secrets" of the top diskette makers, they've also hired the remaining "magnetic media moguls" from competitors around the world. Then all these world class, top-dollar engineers, physicists, research scientists and production experts (if they've missed you, send in your resume to *Super Disk*) were given one directive...to pool all their manufacturing know-how and create a new, better diskette.

HOW SUPER DISK DISKETTES ARE MANUFACTURED

The *Super Disk* crew then assembled the newest, totally quality monitored, automated production line in the industry. Since the manufacturing equipment at *Super Disk* is new, it's easy for *Super Disk* to consistently make better diskettes. You can always be assured of ultra-tight tolerances and superb dependability when you use *Super Disk* diskettes. If all this manufacturing mumbo-jumbo doesn't impress you, we're sure that at least one of these other benefits from using *Super Disk* diskettes will:

- TOTAL SURFACE TESTING** - For maximum reliability, and to lessen the likelihood of disk errors, all diskettes must be totally surface tested. At *Super Disk*, each diskette is 100% surface tested. *Super Disk* is so picky in their testing, they even test the tracks that are in between the regular tracks.
- COMPLETE LINE OF PRODUCTS** - For a diskette to be useful to you and your computer, it must be compatible physically. *Super Disk* has an entire line of 5¼-inch and 3½-inch diskettes for your computer.
- SPECIALLY LUBRICATED DISK** - *Super Disk* uses a special oxide lubricant which is added to the base media in the production of their diskettes. This gives you a better disk drive head to media contact and longer head and disk life.
- HIGH TEMPERATURE/LOW-MARRING JACKET** - A unique high temperature and low-marring vinyl jacket allows use of their product where other diskettes won't work. This special jacket is more rigid than other diskettes and helps eliminate dust on the jacket.
- REINFORCED HUB RINGS** - Standard on all 48 TPI *Super Disk* mini-disks, to strengthen the center hub hole. This increases the life of the disk to save you money and increase overall diskette reliability.
- DISK DURABILITY** - *Super Disk* diskettes will beat all industry standards for reliability since they will give you more than 75% of the original signal amplitude remaining even after an average (Weibull B-50) of 30 million passes. They are compatible with all industry specifications as established by ANSI, ECMA, ISO, IBM and JIS.
- CUSTOMER ORIENTED PACKAGING** - All *Super Disk* disks are packaged 10 disks to a carton and 10 cartons to a case. The economy bulk pack is packaged 100 disks to a case without envelopes or labels.
- LIFETIME WARRANTY** - If all else fails, remember, all disks made by *Super Disk* Inc., have a lifetime warranty. If any *Super Disk* diskette fails to meet factory specifications, *Super Disk* Inc. will replace them under the terms of the *Super Disk* warranty.
- SUPERB VALUE** - With *Super Disk's* automated production line, high-quality, error-free disks are yours without the high cost.

Order toll free 800-USA-DISK

NOW...NAME BRAND QUALITY AT SUPER CE PRICES

Now, you can buy *Super Disk* brand diskettes directly from Communications Electronics at prices less than "unbranded" generic diskettes. Your data is valuable, so why take chances using a diskette that could be so unreliable that the manufacturer refuses to put their name on it. To save you even more, we also offer *Super Disk* bulk product where 100 diskettes are packed in the same box without envelopes or labels. Since we save packaging costs, these savings are passed on to you. 5¼" diskette envelopes are also available from us. These super strong and tear resistant envelopes are only \$10.00 per pack of 100. Use order # CV-5 for a 100 pack of 5¼" diskette envelopes.

39¢ per disk Quantity One

Our diskettes are packed 10 disks to a carton and 10 cartons to a case. The economy bulk pack is packaged 100 disks to a case without envelopes or labels. For best value, you should order in increments of 100 diskettes. Almost all diskettes are immediately available from *Super Disk*. With our efficient warehouse facilities, your order is normally shipped in less than a day.

SAVE ON SUPER DISK™ DISKETTES

Product Description	Part #	Super Disk Price per disc (\$)
5¼" SSSD Soft Sector w/Hub Ring	6431-FA	0.64
5¼" Same as above, but bulk pack w/o envelope	6437-FA	0.39
5¼" SSDD Soft Sector w/Hub Ring	6481-FA	0.68
5¼" Same as above, but bulk pack w/o envelope	6487-FA	0.43
5¼" DSDD Soft Sector w/Hub Ring	6491-FA	0.74
5¼" Same as above, but bulk pack w/o envelope	6497-FA	0.49
5¼" DSQD Soft Sector (96 TPI)	6501-FA	1.09
5¼" Same as above, but bulk pack w/o envelope	6507-FA	0.84
5¼" DSHD for IBM PC/AT - bulk pack	6667-FA	2.07
3½" SSDD (135 TPI) - bulk pack	6317-FA	1.67
3½" DSDD (135 TPI) - bulk pack	6327-FA	1.99

SSSD = Single Sided Single Density; SSDD = Single Sided Double Density; DSDD = Double Sided Double Density; DSQD = Double Sided Quad Density; DSHD = Double Sided High Density; TPI = Tracks per inch.

BUY YOUR DISKETTES FROM CE WITH CONFIDENCE

To get the fastest delivery of your diskettes, phone your order directly to our order desk and charge it to your credit card. Written purchase orders are accepted from approved government agencies and most well rated firms at a 10% surcharge for net 10 billing. For maximum savings, your order should be prepaid. All sales are subject to availability, acceptance and verification. All sales are final. All prices are in U.S. dollars. Prices, terms and specifications are subject to change without notice. Out of stock items may be placed on backorder or substituted for equivalent product unless we are instructed differently. A \$5.00 additional handling fee will be charged for all orders with a merchandise total under \$50.00. All shipments are F.O.B. CE warehouse in Ann Arbor, Michigan. COD terms are available, in U.S. UPS areas for \$5.00 extra, and are payable with cash or certified check. Michigan residents add 4% sales tax or supply tax ID number.

For shipping charges add \$6.00 per 100 diskettes and/or any fraction of 100 5¼-inch or 3½-inch diskettes for U.P.S. ground shipping and handling in the continental U.S. For 1,000 or more disks shipped to the continental U.S., shipping charges are \$4.00 per hundred diskettes. UPS 2nd day air rates are three times continental U.S. rates. For Canada, Puerto Rico, Hawaii, Alaska, or APO/FPO delivery, shipping is three times the continental U.S. rate.

Mail orders to: Communications Electronics Inc., Box 1045, Ann Arbor, Michigan 48106-1045 U.S.A. If you have a Visa or Master Card, you may call and place a credit card order. Order toll-free in the U.S. Dial 800-USA-DISK. In Canada, order toll-free by calling 800-CA1-DISK. If you are outside the U.S. or in Michigan dial 313-973-8888. Telex anytime 810-223-2422. Order your *Super Disk* diskettes now.

Copyright © 1986 Communications Electronics Inc.

Ad #031386-FA



**Now
39¢
a disk**

els: We had three of those antennas, and, to our surprise, none lost their panels. Before the Kate Test, we suspected that, when slide-in panels were beaten by strong winds, the panels would pop out, and that, though the user might lose panels, the dish's super-structure would remain intact. The feeds on those antennas were damaged where the feed inserts into a sleeve at the hub of the dish. Damage amounted to about 20% of the original cost.

4. Hero's thirteen-foot screen-mesh antennas bent their five-inch steel pipe mounts, but only after the mesh had been stripped from the surface of the dish by the wind. The screen mesh is fastened to the ribs of the those older-style antennas with metal screws. The wind simply yanked the screen mesh off the ribs by decapitating the screws. Both antennas were un-salvageable, so we cannot recommend any antenna whose mesh is fastened with screws.

5. ECI's eleven-foot screen-mesh antenna with slide-in panels: The surface made it through the storm but the mount bent over and pointed the antenna toward the ground. Steel plates attaching the dish-mount to the pipe-support bent badly and allowed the antenna to flip over and yank the motor drive out of its socket. The repairs were all mechanical, and the antenna probably would have survived had the steel in the mount been stronger and the pipe support larger—a 6-inch-thick wall, for instance.

6. AMD's eleven- and thirteen-foot all-aluminum solid-surface antennas: The mounts gave away, so the antennas free-wheeled and beat themselves into crumpled piles of useless junk.

7. We had ten of Paraclypse's nine- and twelve-foot screen-mesh antennas, only one of which was a total loss. That one was a very early design without something called a "hurricane strap," a safety cable designed to keep the antenna from whipping in the wind should the motor-drive breaking system fail. In our case, the motor-drive failed, and, since there was no hurricane strap, the antenna free-wheeled and beat itself to death, spraying parts over an area several hundred yards wide. The other nine Paraclypse antennas suffered minor panel or support-strut damage, and repairs typically amounted to about 10-15% of the original cost.

8. Three screen-mesh Aristocom antennas suffered rib and mesh-surface failures, but their mounts held. Repairs amounted to about 20% of original cost.

Failure trends

There were trends in the way those antennas failed that may escape casual reading. Virtually all mesh-antenna failures resulted from mount failures. When a mount fails, the antenna's dish area acts as a sail, and the wind drives that sail until something stops its forward motion. When that happens, the antenna disintegrates. But when the mounts do not give way, the antenna usually survives with minor damage.

The solid surface (metal or fiberglass) antennas had similar

SATELLITE TV/

The First Five Years!



THE MOST COMPLETE report on the mushrooming home 'TVRO' industry ever compiled, written as only the 'father of TVRO' could have prepared. More than **1000 pages** (!) tracing the complete story of home TVRO, lavishly illustrated with equipment photos, schematic diagrams, equipment analysis reports. **Bob Cooper**, the first private individual to own and operate a TVRO (1976) has collected and polished hundreds of individual reports into a unique 'collector's edition' which clearly explains the TVRO phenomenon in North America. From Coop's first 20 foot 'monster' dish to the present day 5 foot 'C-band' TVROs, the fascinating growth of TVRO equipment and its legal status unfolds for you.



THIS TWO VOLUME SET totaling more than 1,000 pages is available for the first time to readers of **Radio-Electronics** at special discount pricing. **Originally** sold at \$100 per two-volume set, a limited supply is now available **ONLY** through this advertisement. **PLUS**, you will also receive a special extraordinary bonus; the 200 page (+) **October 1984** edition of **CSD/Coop's Satellite Digest**. This very special edition of CSD is a best-seller in the TVRO industry, with the most comprehensive collection of TVRO facts and figures ever compiled. Combined with the 1,000 page 'CSD ANTHOLOGY' report, you have instant reference to **everything** you will ever need to know about the state of the home TVRO industry. It is **MUST** reading for every person in, or thinking about 'getting into,' **any** segment of the home TVRO world.

— **SEND CSD ANTHOLOGY/2 Vols. + CSD Bonus.**
 — **SEND CSD October '84 Special Issue ONLY.**

NAME _____ COMPANY _____
 ADDRESS _____
 CITY _____ STATE _____ ZIP _____

Payment: \$60 US funds (Anthology + Bonus), \$15 US funds CSD Oct. ONLY; payable "CSD ANTHOLOGY."
 Shipping charges prepaid. Enter order to: **CSD Anthology**, Radio-Electronics Magazine, 200 Park Av. S., New York, NY 10003; or call 305-771-0505 for credit card orders ONLY.





**Punch up a new program.
Profits by remote control.**



This program appeals to a vast audience. Millions of glued-to-the-recliner remote control transmitter addicts. When their RCT conks out, they get very impatient. They want it fixed or replaced right now. Waiting weeks for a new unit from the original manufacturer doesn't please them.

You've got them coming and going.

Philips ECG has replacements for RCTs that cover most TV/VCR manufacturers from A to Z. (AOC to Zenith). For example, five models replace 18 RCA models. In fact, over 170 OEM remote control transmitters can be covered by just 71 replacement RCTs. And like all Philips ECG products, they fit and they work.

Philips ECG has an express delivery plan that makes you a hero.

You don't commit to anything but ordering from your Philips ECG distributor. If it's a replacement for a popular OEM brand he might have it in stock. If not, Philips ECG guarantees express delivery. This

means you beat an OEM repair or replacement schedule by days or weeks. In fact, in a matter of days your customer is back on the recliner, pushing buttons and smiling contentedly. And you're a hero.

Contact your local Philips ECG distributor today for a free Cross Reference RCT catalog. Start making profit by remote control right away.



Time-Saving Money Maker! *Philips Remote Control Transmitter Tester*

On site or in shop, this tester quickly and positively verifies all remote control transmitting functions, including those for TV receivers, VCRs and cable converters . . . both infrared and ultrasonic types. It's a first from Philips ECG for the television industry. Put it to work saving time and making money for you. Battery-operated, weighs just four ounces.

If it's ECG, it fits. And it works.

PhilipsECG

A North American Philips Company

causes of failure: The mounts failed to hold the antenna upright, and once the mount bent or gave way, the antenna self-destructed.

Very large antennas (sixteen feet and greater) suffered extreme structural damage when their circumference rings collapsed and the dishes folded up like clams—see Fig. 1 for an example. Smaller dishes didn't "clam-shell" but their mounts did give way. Very small dishes (for our part of the world), in the eight- to nine-foot range, generally survived because their mounts were designed for eleven- and twelve-foot units.

The place where the linear-actuator drive attaches to the dish was the most common point of failure. Typically, a rotating ball-joint attachment connects the antenna end of the actuator arm to the dish's surface through a bracket attached to a strut. Those brackets failed on perhaps one-third of our antennas, and left them unsupported and at the mercy of the hurricane-force winds. **R-E**

MEDICAL ELECTRONICS

continued from page 79

ture healing to come into use after it was discovered.

Many types of electronic devices will be implanted in people in future years. There are already pacemakers, drug and hormone infusion pumps, arm and leg muscle stimulators, artificial hearts, heart-assist devices, defibrillators, brain-stimulation devices, and artificial ears. And more devices will be developed in the future, but electronics engineers will encounter many challenging problems before those new devices become successful and accepted.

One problem is that electronic devices must be shown to be safe and effective before being tried on people. Thus, almost all medical-electronics devices are tested on animals first. For instance, animal testing of artificial hearts was conducted for over a decade before approval was gained for a test on a human subject.

Another problem is that the course of a disease or injury can be greatly different in different people. One reason is that each patient is different. Each differs in his physical conditioning, ability to tolerate pain, adaptability to change, and motivation. Further, each injury or illness is unique. Each fracture is at least a little different from any other; each heart is

continued on page 94



THE WIRELESS TELEPHONE TRANSMITTER model WTT-20 is only the size of a dime, yet transmits both sides of a telephone conversation with crystal clarity. Completely automatic. Uses power from the telephone line itself. Never needs a battery! Up to ¼ mile range. Use with any FM radio. Complete kit only **\$29.95**. Tax included. VISA and MasterCard accepted. **FREE SHIPPING. DECO INDUSTRIES, Box 607, Bedford Hills, NY 10507. (914) 241-2827.**

CIRCLE 127 ON FREE INFORMATION CARD



NEED A STORAGE SCOPE? The Scope Memory attaches to your analog oscilloscope and converts it into a digital storage scope capable of storing and displaying transient signals and pulses. Features include selectable sampling rates, 2K memory, pre and post trigger capability. Single and Dual Channel models available from **\$575.00. SIBEX, INC. 3320 U.S. 19N, Suite 410, Clearwater, FL 33519, (813) 786-3001.**

CIRCLE 289 ON FREE INFORMATION CARD



SINGLE AND DUAL TRACE Scopes, Analog and Digital Multimeters, Power Supplies, High Voltage and Low Cap. Probes, RF and Sine/Square Wave Generators, Digital Capacity Meters. Available at your local distributor. **EMCO ELECTRONICS, P.O. Box 327, Plainview, NY 11803.** Send for your free catalog.

CIRCLE 284 ON FREE INFORMATION CARD



THERMOPROBE—QUICKLY IDENTIFIES DEAD PC BOARD COMPONENTS. Locates dead resistors, transistors, IC's, diodes, and transformers without direct contact, in seconds. Operating active components radiate heat, dead components don't. **Thermoprobe** is sensitive to 1/25°F change in temperature. A must for your workbench or field service. Order #209TM. **ONLY \$21.95 + \$3.00 shipping.** NY Res. add tax. **BUYUS, INC., Dept. RE486 10 White Birch Dr., Ossining, NY 10562. VISA or MASTERCARD (914) 762-4799.**

CIRCLE 53 ON FREE INFORMATION CARD

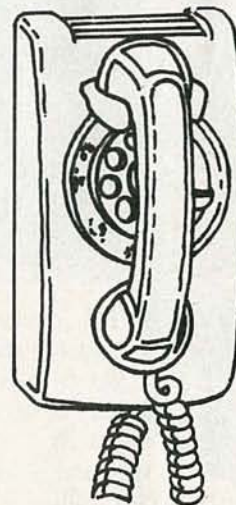

CALL NOW AND RESERVE YOUR SPACE

- 6 × rate \$745.00 per each insertion.
- Reaches 229,044 readers.
- Fast reader service cycle.
- Short lead time for the placement of ads.
- We typeset and layout the ad at no additional charge.

Call 516-293-3000 to reserve space. Ask for Arline Fishman. Limited number of pages available. Mail materials to: mini-ADS, RADIO-ELECTRONICS, 500-B Bi-County Blvd., Farmingdale, NY 11735.

Radio-Electronics mini-ADS

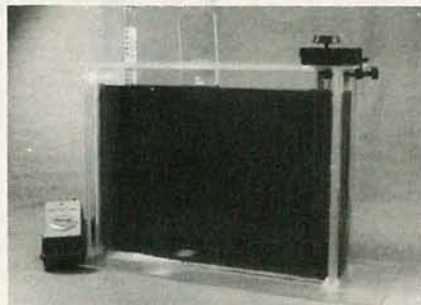

ETCH HIGH QUALITY PC BOARDS IN MINUTES with the Proto-Etch system. Replace time consuming manual etching with faster, Controlled Processing. Produces quality boards to 8 x 9 inches. The only self agitating, temp controlled tank in this price range. An incredible value at **\$74.95** (kit), or assembled for **\$104.95**. CA orders add **\$4.87** sales tax. Order today. **QUINTEC ELECTRONICS, 444 Lincoln Blvd., Dept 225C, Venice, CA 90291. Ph(213) 306-5354.**
CIRCLE 282 ON FREE INFORMATION CARD



DELTA DUAL TRACE OSCILLOSCOPES WITH PROBES. DX5020 20MHZ **\$355.00.** Built in component tester 5MV to 20V/Div 0.2 microsec. to 0.5s/DIV. Risetime less than 17ns. One year limited warranty. DX5035 35MHZ **\$525.00.** DX5045 45MHZ **\$669.00.** DX5015S 15MHZ A/C D/C **\$460.00.** DX1200 DMM **\$27.50;** DX1300 DMM 16 measurement Ranges **\$49.00.** CA add 6.5% tax plus shipping. **DELTA DYNAMIC INC., 20955 E. Lycoming St., Walnut, CALIF. 91789. Tel. (714) 594-7131 Telex: 503749 DELTAX.**

CIRCLE 251 ON FREE INFORMATION CARD



CORDLESS TV TRANSMITTER. This unit, a miniature video transmitter, conveniently transmits UHF signals to remote television locations within a 200' range. Signal inputs from VCR, Video Game, Satellite Receiver, Video Camera, or Micro Computer. When ordering select an open UHF channel for your area. CH 14, 19, 25, or 27. **\$89.95** plus **\$4.00** S&H. Visa/MasterCard call **1-800-522-2636** orders only, **617-871-5611** for information. **CAMEO ENTERPRISES, INC., P.O. BOX 63, Accord, MA 02018.**

CIRCLE 266 ON FREE INFORMATION CARD



NEW PUBLICATION, "5 Great Ways to Use the SSAVI": a complete guide for all uses, including conversion to a stereo TV decoder **\$6.50** ppd. ZENITH SSAVI Descramblers only **\$169.** Gated pulse **\$199.** Reconditioned original equipment for UHF chs. 48,50,51,54,60, etc. Quantity discounts. Surplus TV equipment: Oak N-12, Hamlin MLD-1200, etc. Warranty. Catalog **\$1.** **AIS SATELLITE, P.O. Box 1226-A, Dublin, PA, 18917. 215-249-9411.**

CIRCLE 288 ON FREE INFORMATION CARD



TV STEREO-SAP-ADAPTER: only **\$79.00** to modify your existing TV set as a Stereo-Second Audio Program-Function TV. It requires single line from TV and stereo amplifier. Detail instruction manual for modification is included. Allow 4-6 weeks delivery. **INTEK ELECTRONICS, P.O. BOX 76417, Los Angeles, CA 90076, (213) 739-1664.**

CIRCLE 265 ON FREE INFORMATION CARD

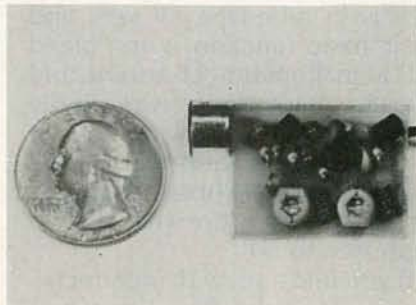

THE MOST EXCITING KIT YOU WILL EVER BUILD The model WAT-50 miniature FM transmitter uses a 4-stage circuit NOT to be confused with a simple wireless microphone. Up to 1 mile range. So sensitive, it will pick-up a whisper 50 feet away! Use with any FM radio. Complete kit only **\$29.95** tax incl. VISA and MasterCard accepted. **FREE SHIPPING. DECO INDUSTRIES, Box 607, Bedford Hills, NY 10507. (914) 241-2827.**

CIRCLE 127 ON FREE INFORMATION CARD

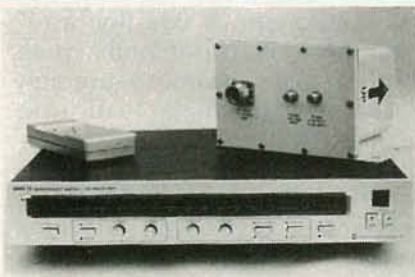

SATELLITE TELEVISION RECEIVER SEMIKIT with dual conversion downconverter. Features infrared remote control tuning, AFC, SAW filter, RF or video output, stereo output. Polorator controls, LED channel & tuning indicators. Install six factory assembled circuit boards to complete. **Semikit \$250.00.** Completed downconverter add **\$75.** Completed receiver and downconverter add **\$100.** **JAMES WALTER SATELLITE RECEIVER, 2697 Nickel, San Pablo, CA 94806. Tel. 415-724-0587.**

CIRCLE 124 ON FREE INFORMATION CARD



R&D SHEET METAL WORKER—New multipurpose Shear, Brake and Roll now with 6" male dies, removable and removable female dies. A complete in-house shop at 1/3rd the cost. Over 20 years development/sales worldwide in industry, government and education. Free literature or **\$2.00** for "Guide to Sheet Metal Working." **PACIFIC ONE CORPORATION, 513 Superior Ave., St. 53, Newport Beach, CA 92663 (714) 645-5962 Telex 4996168.**

CIRCLE 118 ON FREE INFORMATION CARD



SUBSCRIPTION TV MANUAL. This information packed book details the methods used by subscription TV companies to scramble and descramble video signals. Covers the Sinewave, Gated Pulse, SSAVI system, and the methods used by most cable companies. Includes circuit schematics, theory, and trouble shooting hints. **Only \$12.95** plus **\$2.00** first class P&H. **ELEPHANT ELECTRONICS INC., (formerly Random Access) Box 41770-R, Phoenix, AZ 85080**
CIRCLE 120 ON FREE INFORMATION CARD

SERVICE CLINIC

Hot resistors and shorted capacitors

OFTEN YOU RUN ACROSS A TV SET WITH one or more high-wattage *bleeder* resistors. We're not talking about the resistors that are used to discharge electrolytic capacitors when power is removed from a set, but those that are used to stabilize the power supply. They turn up mostly in tube-type TV sets, and their basic function is to "bleed off" a small amount of current, and thereby make the power supply less susceptible to variations in load current. Bleeder resistors usually run pretty hot—and sometimes they even do what they're supposed to do!

If you find a set with incorrect—or no—B+, the first thing you should check is the bleeder string, as shown in Fig. 1. One tool that is useful in checking high-wattage resistors is the WCFT (the Well-Calibrated Finger Tip). Just be careful; some resistors are supposed to run hot, and one could easily blister your WCFT! So bring it close, but don't touch. If you can feel some heat, but not too much, the resistor is probably OK. If the resistor is cold, it—or another in the bleeder string—may be open.

If it's too hot, you've got a short somewhere that's allowing too much current to flow through the bleeder string. That sort of short is often, but not always, caused by a bypass capacitor. Bypass capacitors in older sets are often made of paper, and they usually have values of about 0.25 or 0.5 μF . They're much more likely than today's plastic capacitors to become leaky, shorted, or open. You may have several bypass capacitors to check, because every resistor in a bleeder string may be bypassed individually.

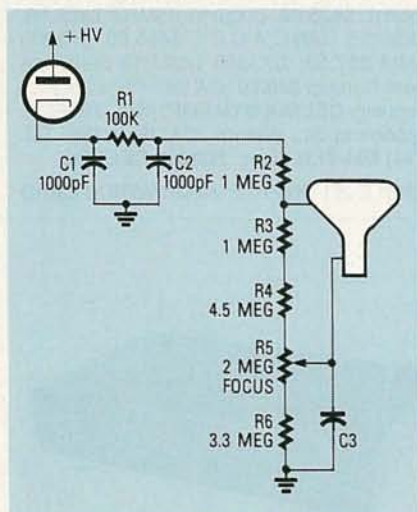

FIG. 1

When you find a leaky capacitor, replace it, and then check the rest of the capacitors in your circuit. You may find a marginally-functional capacitor that will fail soon—according to Murphy, as soon as you return the set to the customer! In general, a good paper capacitor will have resistance well over 50K; if you find one with a resistance of 50K or so, replace it on general principles.

Particularly watch out for the type of paper capacitor that has been rolled from a thick sheaf of paper, and that has the case folded over on the ends. That type is especially prone to leakage, and you can usually rely on one to fail once the set has been taken home! If, while servicing an older set, you see any rolled-paper capacitors, it's a good idea to replace them with modern capacitors. (As we used to say in the Air Force, CYA.)

We seldom have trouble with early "molded" capacitors or mica capacitors (of the original "sand-



JACK DARR,
SERVICE EDITOR

wich" type). They seldom, if ever, develop opens, because of their construction.

Oscillator problems

If a capacitor in an oscillator circuit develops an open, you'll get no feedback, and the oscillator won't work. So, if you find a set with a dead horizontal or vertical oscillator, look for an open capacitor.

A TV set that uses a switching power supply may appear to be totally dead because of a bad capacitor. If the switching circuit doesn't oscillate, there will be no output voltage at all.

A TV set with bad convergence may also be suffering from an open capacitor; that will prevent the convergence pulses from getting to the proper places, so the picture won't converge. To find the source of the trouble, just trace the pulses through the circuit until you find where they stop.

In short (no pun intended), start by troubleshooting the most logical component. If you find a resistor that looks burnt, or that runs very hot, that's an almost-sure sign that somewhere on its "load" side there is a shorted or leaky capacitor. Usually the fastest way of finding the problem is by making resistance checks with an ohmmeter. And remember to discharge any capacitor with a value greater than about 0.1 μF before trying to measure its resistance. Otherwise you may have to troubleshoot your ohmmeter!

If you find an open capacitor don't just replace it and turn the set on; measure the resistance of the circuit to ground. That resistance should always be high (50K

OPEN SATURDAYS 8 A.M. TO 1 P.M. WITH 24 HOUR ANSWERING TO TAKE YOUR ORDER ANYTIME

WM. B. ALLEN SUPPLY COMPANY

TEST EQUIPMENT SPECIALS

COMPLETE INVENTORY OF MULTIMETERS
AND SCOPES FROM 18 MANUFACTURERS

V-222

20MHz • Dual Trace
6" CRT



Reg. \$715

\$490

HITACHI

OSCILLOSCOPES

V-212

DC-20MHz • Dual Trace



Reg. \$615

\$425

V-422

DC-40MHz • Dual Trace



Reg. \$925

\$624

V-1100

100MHz • Quad Trace
CRT Readout • 1mV
6" PDA-CRT



Reg. \$2490

\$2190

V-1070

100MHz • Quad Trace
CRT Readout
6" PDA-CRT



Reg. \$2295

\$1249

V-650F

60MHz • Dual Trace
Delayed Sweep



Reg. \$1195

\$870

V-6041

40MHz/2 Channels • 4000
Words Per Channel



Reg. \$5855

\$4350

WM. B. ALLEN
ELECTRONICS
CATALOG
FREE
WITH EVERY
PURCHASE



\$15.00
VALUE

V-1050

100MHz • Quad Trace
Delayed Sweep



Reg. \$1595

\$1150

800 535-9593

LOUISIANA TOLL FREE 800 462-9520



WM. B. ALLEN
SUPPLY COMPANY
ALLEN SQUARE

300 BLOCK NORTH RAMPART, NEW ORLEANS, LA 70112

CIRCLE 103 ON FREE INFORMATION CARD

or more) if the circuit has no shorts. If you measure less than that, find out why before turning the TV set on. Just follow logic and common sense; you'll find the problem! **R-E**

SERVICE QUESTIONS

SONY STATIC CONVERGENCE

I had trouble with a Sony KX-2501 monitor. I fixed some intermittent "flagging" at the top of the screen by setting the horizontal hold. However, the horizontal static-convergence drifted badly. I checked DC voltages; they looked OK. Incidentally, the emitters of Q1502 and Q1503 should be at 147.7 volts, not 48.7 volts, as shown on some copies of the schematic.

So I finally gave up and ordered a new horizontal-voltage regulator control (for \$45!). When it came about three weeks later, I installed it, and lo and behold: perfect convergence. The adjustments were easy to make. My dealer told me that he had ordered several of those controls lately. I wonder why they fail like that—moisture? So, just for luck, I ran a bead of silicone around the shaft, hopefully sealing out dust and moisture. If future adjustments are needed, the silicone can be peeled off easily.—M. D. Chepko, M.D., Raleigh, NC.

Thanks for the useful hint, doc!

WHAT KIND OF SCOPE FOR TV?

I want to buy an oscilloscope for TV servicing. What's the best kind to get for that purpose?—M. R., Luther-ville, MD.

I've always said that it's easy to pick out a wife, a suit of clothes, etc., but you've got to be careful in choosing test equipment. Seriously, there are a lot of good scopes available. Heathkit, B & K, Hickok, Tektronix, and many others all make scopes, and you can't go too far wrong with any of them. I've got six of various makes, and they're all good. My suggestion would be to try the Old Professor's *Famous Test for Whisky*: Pour some in a glass and drink it! In other words, arrange for a demonstration in your shop and try different several models. **R-E**

LETTERS

continued from page 25

sitizens of positive and negative types, some with dyes to aid the user. However plentiful all those goodies are in New York, here in the hick city of Tulsa I found one spray can of GC positive sensitizer at the oldest electronics supply house in town and one bottle of developer for it at another supply house. I couldn't make them work, though I could get a faint image. I think one or both items had spent too many years on a shelf. I wrote to GC and they sent me a very nice handbook, but I had no idea where to order the materials then or now. Electronics supply houses are somewhat less than eager to special order \$10 items—especially if you don't know for sure what you want.

So I followed the advice you magazine people like to give—write to your advertisers—and came up with Datak ER-71 negative photo resist and ER-8 developer. Those products are very easy to use and appear to be a quality system, but my results have been spotty. I do single-side boards quite well, but have trouble with the resist standing up long enough on double-sided boards. I would like to try some of those potions that Grossblatt described, but still don't know where to get them. Some advertisers occasionally show materials, kits, and sensitized boards, but describe them so poorly, incompletely, and often erroneously that one must essentially buy blind. What I am getting at is that, although you obviously avoid mentioning brand names and such, you would be doing the neophyte board maker a beautiful service if you would list what's available, how it works, and where to get it.

As for my trying your method, I cannot try it with my Datak ER-71 because the ER-71 requires a negative mask.

While not precisely on the subject of exposing boards through a sheet of paper, I would like to briefly describe a method of board layout which way be of interest to you.

Ferric chloride is a convenient

etchant to use because it can be purchased at Radio Shack stores, where it presently costs \$2.50 a pint. I discovered the hard way that when it gets tired it suddenly stops etching, obviously due to absorbing all the copper it can accommodate. Just as obviously, boards with a few copper traces and large bare areas not only deplete the etchant rapidly, but tend to over-etch delicate areas while the etchant works on the large spaces. So, to make the etching quicker and more uniform, and to save etchant, I changed my board design to where, instead of running narrow copper connecting lines, I reversed the system and run etched lines to separate connected areas. The result is exactly as desired: boards etch quickly and uniformly and a minimum amount of copper is removed. I don't consider board layout any more difficult than the conventional way, though it does require getting one's mind working in the right direction.

H.C. DOENNECKE
Tulsa, OK

SERVICING B.I.C. TURNTABLES

I have gotten many inquiries from owners of B.I.C. turntables, and other B.I.C. audio equipment going back as far as the Garrard days. Those owners say that they are having a difficult time locating service and parts, and they have heard that B.I.C. has gone out of business. That distresses me because B.I.C. always supported its products with a strong service organization.

The good news is that a company called "South Street Service" has taken over all the service and parts for B.I.C. equipment. I have spoken to the owner, Alan Ruthkowski (former national service manager at B.I.C.), and he confirms that virtually all parts are still available through his company. In fact, they have re-manufactured many parts that previously were not available, such as grilles for speakers, turntable motors, head swells, etc.

The address of the South Street Service Company is 202 South Street, Oyster Bay, NY 11771.

ARTHUR M. GASMAN
Port Washington, NY

R-E

AP's newest series of A·C·E Boards is easy to spot. Just look for the boards with the bright blue backplates. Hobbyists and professionals alike will find these new A·C·E Boards offer more quality for less money than any other solderless breadboard on the market.

What makes the A·C·E Board™ 100 series so special?

First, they cost less. And that's always important.

Second, the backplate is blue to show that it's made of a heavier metal alloy than our A·C·E Board 200 series. That extra weight makes it a little more stable on a table. And that means it's a little faster and easier for a beginner to work with.

But most important of all, the A·C·E 100 series boards are made with the same high standards of quality that have been a part of A P PRODUCTS since our beginning in 1967. From our largest A·C·E Board with over 5000 tie points to a single tie point block, our spring clip terminals give you nothing but good solid contact on every connection. The 100 series has the same double-sided adhesive foam found in our 200 series. It insulates to prevent shorts and seals the bottom of the individual spring clip cells. And our A·C·E Board 100 series comes with our guarantee that if your A·C·E Board doesn't work perfectly, return it to your A P PRODUCTS distributor. He'll replace it, no hassles.

The economical All-Circuit Evaluators: ACE 109 and ACE 118.

The 100 series is starting off with two A·C·E Boards in the most popular size configurations. And look for announcements of other A·C·E 100 boards in the future.

Our ACE 109 gives you a total of 840 tie points with 8 buses and three binding posts. The ACE 118

gives you even more capacity with 1824 total tie points, 16 buses and 4 binding posts.

Now you don't have to settle for second rate boards to save money.

Now there's an A·C·E Board that's right for any application. Just look for the bright blue back-

plates on our A·C·E Board 100 series boards. And for all your circuit building needs, for any size project, look for the A P PRODUCTS name.

Suggested retail price:

ACE 109 \$20.95 ACE 118 \$39.95

For the name of the distributor nearest you, call TOLL FREE (800) 321-9668. (In Ohio, call collect: (216) 354-2101).



A P PRODUCTS INCORPORATED
9325 Progress Parkway
Box 540, Mentor, Ohio 44060
[216] 354-2101, TWX: 810-425-2250

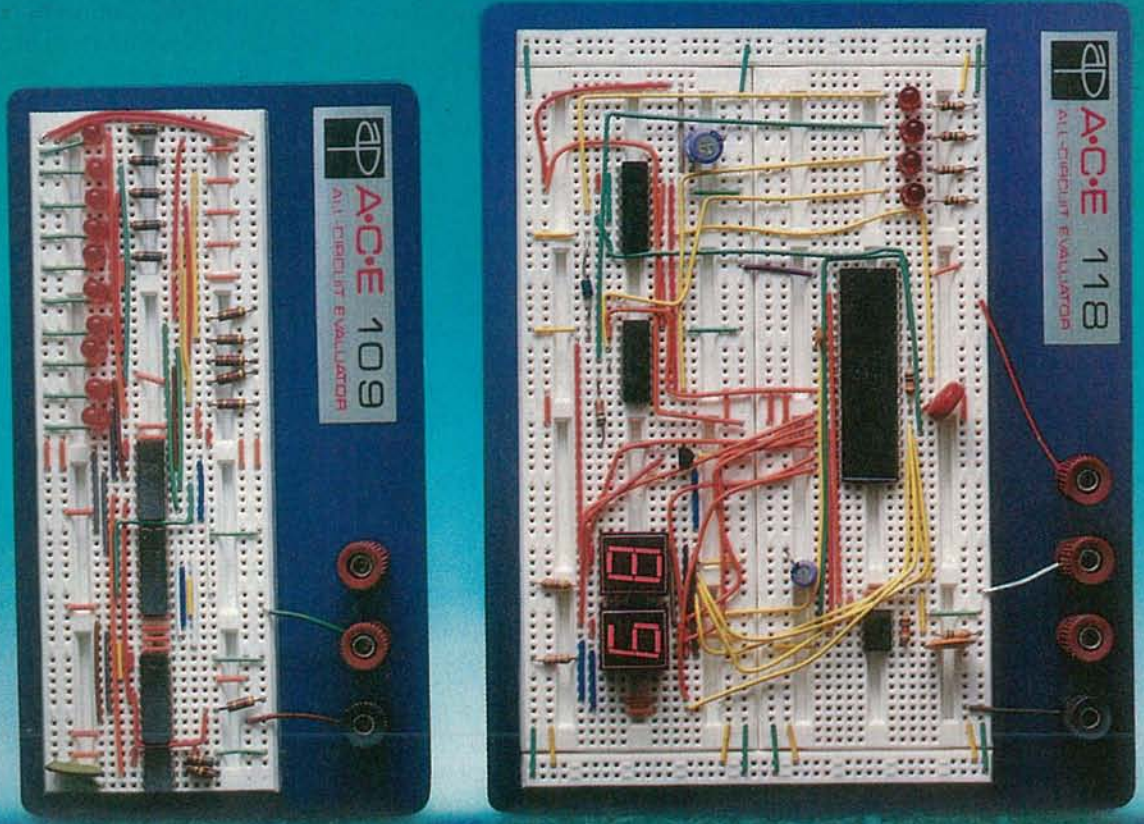

ANTIQUE RADIOS



RICHARD D. FITCH

Back to the present

WE'VE SPENT THE LAST COUPLE OF months looking at the overall history of the radio arts and sciences. Let's return now to the present—the 20th century. First we'll look at the Antique of the Month, then we'll go on to discuss the WW1 era and the 1920's.

A classic collectable

The Stewart Warner radio shown in Fig. 1 (serial number A399897) is interesting in that it has a molded, simulated wood-veneer cabinet. It also has seven pushbuttons, one of which can be used to tune in a police-band station. Although the radio doesn't really qualify as an antique, its classic appearance would make it a valuable member of any collection. The Stewart Warner belongs to Kerry Swanson of Ellensburg, Washington. I'd like to thank him for the fine photo.

WW1 and beyond

World War One was no exception to the rule that, during every national conflict, there is a surge of technical and economic progress. The slow but steady advancement of radio came to a standstill around 1915, at least as far as the civilian was concerned. For the next three years all research was directed toward the war effort. I hope to discuss, in a future column, some WW1 communications equipment for those of you who collect it. But for now, let's stick to civilian gear.

By the end of WW1, development of civilian gear again began to roll. In fact, it began to develop so fast that it was running over itself. By that time numerous broadcasts could be picked up by



FIG. 1

anyone with a working receiver. There were many receivers around, and most of them were home-made. The time was ripe for the appearance of regularly scheduled broadcasts.

All antique-radio buffs are familiar with the Westinghouse Station in Pittsburgh, KDKA. That station actually made the first pre-scheduled radio broadcast: the results of the Harding/Cox presidential election of November 1920. Although there were probably fewer than 1000 listeners, regularly scheduled broadcasting had gotten its start.

The apparatus used to receive radio waves in the early 1920's was usually housed in a square box with a hinged lid on top. Or it might simply have been mounted on a breadboard—and I don't mean one of those plastic jobs with a matrix of socket holes, but a real chunk of wood that bread was cut on! Receivers in that era were mostly powered by batteries, and we listened to those radios with earphones. Later those battery-

powered receivers were often adapted to operate from the AC lines and with a loudspeaker.

Receivers, radios, sets

For the many readers who are sexagenarians (those who are sixty years old, or older), the use of the terms receiver, radio, and set should be familiar. In that era, the receiving unit itself was never referred to as a *radio*. If the word radio was used at all it encompassed the entire wireless operation—transmitter, receiver, and everything in between.

A popular dictionary from 1924 doesn't even mention the word radio. Reference books as far back as 1910 also make no mention of the word radio. I don't know just when the ornate cabinet in the parlor became a *radio*; maybe one of you oldtimers can enlighten us about the origin of the term.

Portables

Radio had become so popular that people wanted to hear broadcast radio everywhere: at home, at camp, in boats, in automobiles, and even on vacation. The sets were still most often battery-powered, so both manufactured and homemade portables were in great demand.

Some manufacturers recognized the need for true portable receivers. Radiola offered a completely self-contained portable in a long, skinny box that resembled a suitcase. There were compartments in the ends for batteries and phones. That Radiola "portable" weighed a ton, and it had a totally inadequate handle on top for carrying it about. In spite of its limitations, though, the Radiola was

COMPUTER DIGEST

VOL. 3 NO. 4

April 1986

A NEW KIND OF MAGAZINE FOR ELECTRONICS PROFESSIONALS

PACKET RADIO

What Cellular Did For The Telephone...



A
GERNSBACK
PUBLICATION

COMPUTER CARE

Preventive Maintenance Extends
Computer Life

GRAFEX-32

Part 3, The Conclusion

CONTENTS

Vol. 3 No. 4

April 1986

6 Computer Care

Here's the lowdown on preventive maintenance for your entire computer system. Now you can keep it healthy and happy and extend its life. **Herb Friedman**

10 Packet Radio

It was bound to happen! The happy marriage of computer technology and amateur radio to create a new and meaningful advance. **Marc Stern**

12 Grafex-32, Part 3

And here's the conclusion of this three-part article on the high-resolution graphics board for the Apple Computer. **Ray Dahlby**

3 Editorial

4 Letters

4 Computer Products

5 Software Review



See Page 6

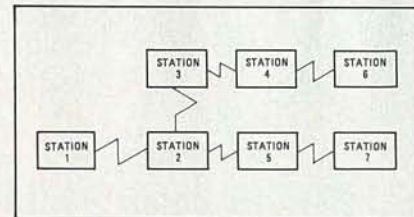

See Page 10

ON THE COVER

Sitting atop that beautiful Heath computer terminal, is their brand-new HD-4040 Packet Radio Adapter. For more detailed information, turn to page 10.

COMING NEXT MONTH

We're going to show you how to use a TI-99/4A keyboard with your Sinclair ZX-81, and we'll have an excellent program that lets you use your computer to select power supply components. To round things off, look for an article on power control with your Commodore-64 that lets you "automate" your home!



EDITORIAL

Wonderful idea #1275

■I've had another wonderful idea that I want to share with you, in the hope that it will be brought to the attention of some of the manufacturers in the computer business. I'm in the process of setting up a new computer system. It isn't an especially large or complex system, and should ordinarily pose no problems.

But this computer comes with—not one, but two large loose-leaf tomes. In order to get up-and-running, you've got to read both of these books which seem to have been written by engineers. Now engineers, as we all know, write to *impress*, not to *express*. The writing is confused and convoluted, hard to follow, full of digressions and fishbacks, and the books are laden with charts and diagrams, rife with "If..." "However..." "Refer to..."

The result is total frustration, utter confusion and complete disgust.

Oh, you can fight your way through the books if you have sufficient patience and a friend who knows a little more than you do. But Wonderful idea #1275 is going to solve the problem once and for all.

Each manufacturer should hire a *writer* to write his instruction books. I realize that this is an unheard-of concept, and one that no manufacturer thinks is viable. After all, a writer is liable to make *sense* out of the instructions. With an easy-to-understand book, the user might even wind up knowing what in heck he's doing. Surely, we wouldn't want *that* to happen!

Of course, this might lead to fewer service calls, saving the manufacturer a lot of money, but that is not important in the overall scheme of things. Then too, the engineers who now write these semi-literate instructions might get their noses out of joint.

So what is really needed, is an *additional* instruction book which will serve to translate the existing instruction books into more-readable (and understandable) prose.

Now take the books I'm currently fighting my way through. One volume deals with the hardware, the other with operating instructions. You can get just so far with the operations, when you learn that you've got a DIP switch set incorrectly. To *locate* that switch, you've got to put this manual down and pick up the *other*. The instructions for setting that switch are no easier to understand than the rest of the manual, with diagrams that just don't help. Now I'm not stupid. And I'm supposed to be computer-literate. But I keep thinking of the poor boob that has less knowledge than I do, and wonder how he's going to make out!

C'mon Wonderful idea #1275!

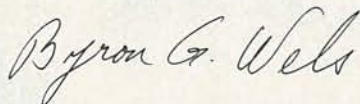

Byron G. Wels
Editor

COMPUTER DIGEST

M. Harvey Gernsback,
editor-in-chief, emeritus

Larry Steckler, EHF, CET: publisher &
editor in chief

Art Kleiman, editorial director

Byron G. Wels, editor

Brian C. Fenton, managing editor

Carl Laron, associate editor

Robert A. Young, assistant editor

Ruby M. Yee, production director

Karen Tucker,

production advertising

Robert A. W. Lowndes,

production associate

Geoffrey S. Weil,

production assistant

Andre Duzant, Technical Illustrator

Jacqueline P. Cheeseboro

circulation director

Arline R. Fishman,

advertising director

Gernsback Publications, Inc.
500-B Bi-County Blvd.,
Farmingdale, NY 11735
516-293-3000
President: Larry Steckler
Vice President: Cathy Steckler

ADVERTISING SALES 516-293-3000

Larry Steckler
Publisher

NATIONAL SALES

Joe Shere
1507 Bonnie Doone Terrace
Corona Del Mar, CA 92625
714-760-8967

ComputerDigest is published monthly as an insert in Radio-Electronics magazine by Gernsback Publications, Inc., 500-B Bi-County Blvd., Farmingdale, N.Y. 11735. Second-Class Postage Paid at New York, N.Y. and additional mailing offices. Copyright © 1986 Gernsback Publications, Inc. All rights reserved. Printed in U.S.A.

A stamped self-addressed envelope must accompany all submitted manuscripts and/or artwork or photographs if their return is desired should they be rejected. We disclaim any responsibility for the loss or damage of manuscripts and/or artwork or photographs while in our possession or otherwise.

LETTERS

Help!

I'd be happy to pay any costs for a service or theory manual for the Timex-Sinclair ZX81. I'm a beginner in the electronics field and any help would be appreciated. Write to Juan Bonilla, 42 Baldorioty St., Sabana Grande, PR 00747.

We don't usually print addresses Juan, but this seemed to be the best and fastest way to get aid to you.

Penance!

Yours is the only large-circulation magazine that has ever carried serious coverage of the Timex/Sinclair 1000. In a recent issue you told a reader that support for this wonderful machine had died. Tain't true! There are a lot of firms providing support to these units, and a lot of people still using them. Thanks for the best electronics magazine around. Keep

up the (almost always) good work!—B. C. T., Tucson, AZ.

Thank you sir. Humble pie can be delicious. We got lots of letters just like yours, so here's what we're going to do: Any firms out there that provide service, parts, literature, software, whatever for the TS/1000 and ZX-81, please write to the Editor. We'll compile a complete listing (on our own time, boss) and make the list available to all our readers at no charge. Are we friends again?

Noisy Printer

How can I reduce the noise level from my printer? It's working properly, but it does seem awfully loud.—S. K., Abilene, TX.

Start by placing a sound-absorbing pad under it. Often, the surface on which a printer is placed acts like a reverberator and amplifies the sound. If that doesn't help sufficiently, try using a

soundproof housing over the printer for air-transmitted noise.

Computer Chess?

Has anybody worked out a program that will enable me to play chess using a computer and a modem? I'm certain that a lot of people who are involved in both chess and computers would be interested.—R. C., Denver, CO.

Sounds fascinating. Can anybody help?

New Software

I've developed an interesting new software package that just about every computer user will want. What's the best way to market such a product?—L. W., St. Louis, MO.

Begin by writing to our advertising sales department who will be happy to send you a media file and rate card! ◀▶

COMPUTER PRODUCTS

For more details use the free information card inside the back cover

SPEECH SYNTHESIZER, the *Voice Master*, a hardware/software system for microcomputers that provides speech and music synthesis as well as voice-recognition capabilities, can use almost any spoken language for its operation. Unlike other speech devices for microcomputers, the *Voice Master* does not depend on a speech chip to create its vocabulary. The user digitally records his or her own voice to provide the vocabularies of up to 64 words or phrases for the unit. Those recorded vocabularies are then played back to reproduce the words or phrases as directed by the user in high-quality sound that closely resembles a tape recording of the user's voice and can record in any language.

The *Voice Master* is also capable of highly-accurate *voice recognition* and can recognize and store vocabularies of up to 32 words or phrases each on floppy disk. Vocabularies for both



CIRCLE 11 ON FREE INFORMATION CARD

speech and recognition may be instantly called and loaded from disk.

The *Voice Master* is available in models for the Commodore 64/128, Apple II series, and Atari computers for a suggested retail price of \$89.95, which includes the *Voice Master* module, program disk, headset/microphone, connecting cables, and a comprehensive documentation booklet.—**Covox, Inc.**, 675-D Conger Street, Eugene, OR 97402.

ADD-ON MEMORY BOARD, the *Cheetah Card™*, is designed for the IBM PC-AT and compatibles. It not only adds 2.5 megabytes of memory per card, but also allows the AT to run

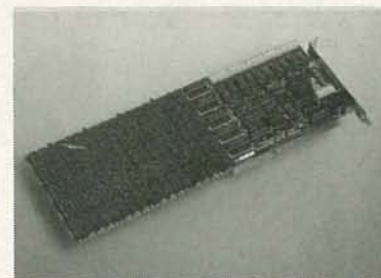

CIRCLE 17 ON FREE INFORMATION CARD

up to 30% faster with its *no-wait* state.

The *Cheetah Card™* comes with a full 3-year limited warranty and is priced at \$945.00.—**Cheetah International, Inc.**, 107 Community Boulevard, Suite 5, Longview, TX 75606. ◀▶

SOFTWARE REVIEW

Best Friend...\$84.95.



■When our company switched over from a CP/M system to MS-DOS, the *last thing* anybody wanted was to have to put down the instruction manuals and do a software review. After offering the package around to several of my co-workers, I found it back on my desk.

Let me tell you something. I'm glad it worked out like that. Best Friend, as the program is called, is precisely that and is worth all of the gibberish instruction manuals that ever came with *any* computer. I casually glanced through the brochure, flipped through the book, and then inserted the disk in my A: drive. Typed in A: and return, then (as the book told me to, I typed "BF" and enter. A menu appeared.

Using the function keys, you select any of the ten items on the menu or ESC to go back to your regular applications. Arbitrarily, we selected the calculator function and pressed that. The screen informed us that it was "being loaded," and then the calculator appeared. Knocked our socks off. This isn't a calculator any more than a Rolls Royce can be described simply as a "car." It's a full-function scientific *printing* calculator that will do anything you can expect any calculator to do.

The system provides six basic functions: File Services (copying, deleting, and renaming files), Disk Services (formatting, copying and comparing disks), I/O options (lets you specify printers to ports and set serial port parameters), Typewriter Emulation (gives you the equivalent of a full-featured electronic typewriter), Scientific/Business Calculator (many easy to use functions including "tape," printer control, ability to return results to a program), and finally, Output

Redirection (gets reports on disk that until now could only be output to the printer). And Best Friend can be run as a "stay resident" program so all its features can "pop-up" behind whatever else you are doing!

Suddenly, the sub-title on the instruction book, "Makes PC-DOS easy to use" had new meaning. We started playing with the other available files. I want to tell you something: I could sit here and fill up space talking about the different available functions, about how well thought-out this program is, and how it's probably the best thing to come down the pike since sliced bread. But you didn't just fall off the turnip truck either. Best Friend is available in a demo package for a mere \$14.95 or the full package for \$84.95. Since they have tailored systems to exactly suit the computer you have (Yes, even CP/M) it would be a good idea to send for their descriptive brochure first which contains an ordering coupon. There's no charge for that brochure.

Of equal importance in this day and age, is the fact that it is *not* copy protected.

The bottom line is that Best Friend has and continues to perform a valuable service here. It has made our new computer easier for me to use, thereby making me a more-valuable asset to my company. It has eased the transition into the new computer as well. But the fact is that even if I were an old hand at the new computer, I'd still value Best Friend, for it has been able to show me some features I didn't know existed. To order or send for a brochure (you should!) write to Elite Software, P. O. Drawer 1194, Bryan, TX 77806. If you're out that way, you can telephone. (409) 846-2340. ◀▶

COMPUTER CARE

It doesn't take much, and it pays off.

HERB FRIEDMAN

■The way it appears in the mail order catalogs of data processing supplies, at least 26 hours of each workday should be spent cleaning, checking or adjusting your personal computer. In fact, we are fast approaching the point when the different kinds of "computer care" products will outnumber the the books on personal computing.

The desktop personal computer and its peripherals are among the most reliable of consumer products, requiring a minimum of attention to keep them going. A quick pass with a brush now and then, a wipe with a cleaning pad, a check of frequently moved cables and connectors is all that's needed to insure years of trouble-free operation, assuming a "chip" doesn't break down. While a failure at the "chip level" generally is catastrophic, short of using common sense when you initially install and service the computer there is little you can do to avoid it.

Fresh air first

Assuming the power supply doesn't blow up and take a handful of components with it, it is primarily heat that destroys chip-level components, so the first step in computer care is to install the equipment in such a way that there is an air flow through the enclosure(s). Even when a computer (or a peripheral) is equipped with a cooling fan or blower it is assumed there will be

a known minimum rate of air exchange within the enclosure when the device is located on top of a table. Hiding the computer from view inside a cabinet or a desk restricts air flow, sharply elevating the operating temperature in the cabinet. Even if you employ an accessory fan or blower fan for a computer installed within a decorative cabinet it usually ends up recycling warm air (which gets even warmer) (Fig. 1).

An auxiliary fan is rarely required for computers as initially supplied by the manufacturer. But if you load the computer with several internal accessories the build-up of ambient heat can easily exceed the original design limits, and a cooling fan might be required to avoid shortening the life of the internal components, and reduce or eliminate intermittent glitches caused by heat overload. (It is not uncommon for socketed integrated circuits to develop intermittent contacts after a few years of cooking in the heat. The problem is usually due to the heat-sensitive metals used for contacts in cheap sockets.) Both the Apple and Radio Shack Color Computers are good illustrations of how accessory hardware raises internal ambient heat above safe limits. As initially equipped by the manufacturer neither computer needs a fan when located on a table, but both are known to "glitch out" when loaded with accessories if the "extra" heat isn't vented by an accessory fan.

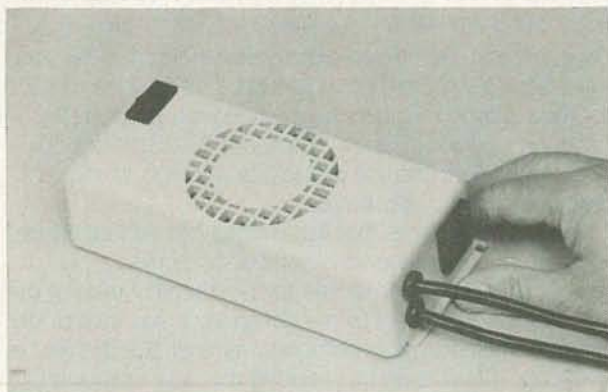

FIG. 1—IF YOU HAVE LOADED your computer with internal accessories beyond what the manufacturer originally supplied, or age is causing intermittent glitches after hours of operation, an accessory fan might be the cure for heat-caused glitches. A fan such as this for the Osborne computer is enclosed in a housing that either slides into place or is easily secured with sticky-tape or a few screws.



FIG. 2—AN UNSHARP, FUZZY SCREEN display is usually the result of dust on the face of the CRT rather than an electrical breakdown. You can save an expensive "overhaul" service charge if you simply clean the CRT with a common household glass cleaner. (Special CRT cleaning products don't justify their extra cost.)

Except for esthetic reasons, dust covers are rarely needed for modern personal computers. They might be needed to keep coffee and paper clips from falling into a printer, but that's about it. The modern keyboard uses sealed keyswitches so dust can't affect the keys, and no commonly-used personal computer puts a foam filter in front of a fan to catch dust, and thereby restrict the air flow as the filter gets clogged (one of life's dumber ideas). In fact, most internal computer fans and blowers simply pass the dust inside the cabinet where it settles out on the components—and causes no problems.

Dust creates problems only when it settles on the CRT or a disk, or gets picked up on a disk when the disk falls on the floor, or it takes the form of oxide flake-off from magnetic media and collects on the read/write head of a cassette recorder or a disk drive.

Dust on a CRT is insidious because it destroys the sharpness of the image: it's the reason why many terminal operators start to complain about tired eyes or blurred vision. The static charge on the face of a CRT attracts dust, and within days a relatively thick film can build across the face of the CRT. The dust in turn diffuses the screen display, causing the image to bloom. The heavier the film of dust the greater the bloom, and, therefore, the fuzzier the image. Blooming produces the same kind of tired eyes as looking through eyeglasses having the wrong prescription. As a general rule, the problem is avoided by cleaning the CRT every few days with a window cleaner such as Windex. (Fig. 2) Dust that settles out on a disk, or which adheres to a disk when the disk falls to the floor, is a problem not because it can ruin the mechanism, but because a "solid particle" can scratch the disk itself and destroy data bits. The way to get rid of the dust is to blow it off with either air or a neutral gas. While there are several pressurized products in the marketplace, some employ freon, which is a refrigerant. It not only chills the disk, possibly deforming the substrate (the disk itself), the change in temperature can cause moisture on the disk. The safest products are those used by photographers to clean negatives because they usually come out at room temperature. Two such products are OMIT, which is a neutral "gas," and Falcon, which is filtered air. Neither will chill a disk nor cause moisture. (Fig. 3)

The only dust that normally causes a problem in computers is the oxide flake-off from magnetic media: cassette tape and disks. Much of the low cost cassette tape is cheaply made and has excessive flake-off, which can cause an oxide build-up on the head that actually lifts the tape off the head. While "tape lift" generally interferes primarily with *reads*, if the lift is severe it can drop bits on a *write*.

There are many "head cleaning" chemicals which, as far as we know consist of denatured alcohol and some "magic" additive. The best head cleaner is a cotton Q-tip dipped in ordinary denatured alcohol. If you want to clean the entire tape path—which includes the tape guides and the capstan pinch roller—use a "cleaning cassette," a conventional cassette having a mildly abrasive cloth tape instead of magnetic recording tape.

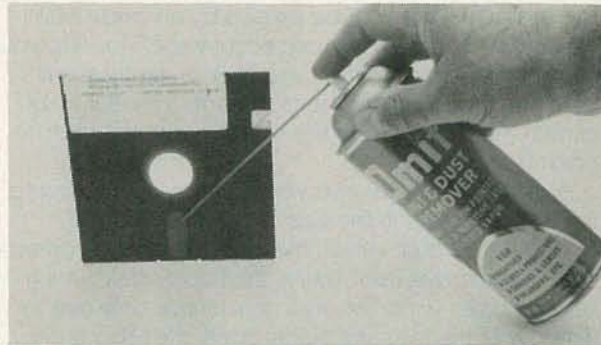

FIG. 3—IF YOU DROP A DISK on the floor, or dust has settled out, don't try to blow it away with your breath or a Freon-based aerosol product—either way you can cause moisture on the disk itself. Instead, blow the dust away with one of the "neutral" products photographers use to blow the dust off negatives.

You squirt a few drops of head cleaning fluid on the cloth tape and run the machine for a few seconds. The fluid loosens the accumulated oxide crud and the cleaning tape lifts it off and traps the particles. (The saturated cloth beats just about anything, no matter how expensive, when it comes to cleaning a cassette recorder.)

Disk drive read/write heads are something else. Regardless how it's packaged, the actual cleaning device comes down to a mildly abrasive disc (usually fiberglass) packaged in a sleeve that closely resembles a conventional disk. (Fig. 4) Generally, a cleaning chemical is squirted on the disk to loosen whatever has supposedly accumulated on the head(s). Running the drive causes the cleaning disk to scrub the head(s) clean. Since a cleaning disk is abrasive (otherwise it wouldn't clean the head), there is considerable debate whether the cleaning disk can do more damage than it cures. (The service department of at least one major disk drive manufacturer will tell you not to clean the head at any time.) In fact, it's questionable whether disk drives ever need cleaning because data disks do not usually shed excessive oxide; if there should be some flake-off it is usually trapped in the microscopic pockets of the liner inside the disk sleeve: That's why the liner is there in the first place. Cleaning of disk drive heads should only be done when you are certain there

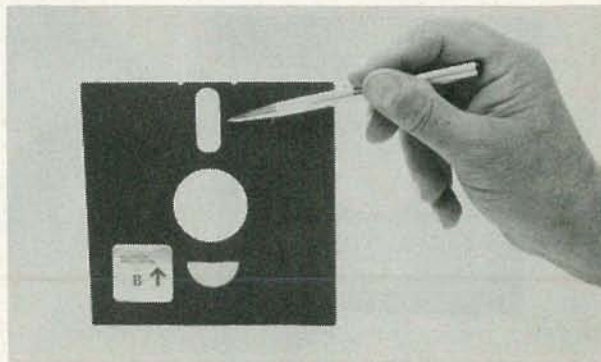

FIG. 4—A CLEANING DISK contains a mildly abrasive pad that contacts a disk drive's read/write head through a window in the sleeve. The pad is usually soaked with a "cleaning fluid."

is a problem that might be caused by an oxide build-up on the head—a really rare occurrence. How do you know when it happens? If you start to get frequent read errors cleaning the head is worth a try. But make certain the cleaning disk has the correct number of open “windows.”

A cleaning disk has two windows corresponding to the two windows in the sleeve of a conventional floppy disk through which the read/write head contacts the magnetic disk itself. Unlike the floppy disk, which has two open windows, as a general rule only one window of the cleaning disk is open, the other is covered by a peel-off tab. If you have dual-sided drives you peel off the tab so both heads get cleaned. If you have a single-sided drive you must leave the tape in place, else you end up scrubbing the small pressure pad that squeezes the disk against the read/write head, and this can cause trouble because it allows the cleaning disk to grind grime and dust into the pad; and the dust ground into the pad can cause the pad to drag and possibly slow the disk speed outside the normal tolerance range. (Fig. 5)

Don't clean the heads for too long. Entering DIR (for directory) will cause the drive to work for a few seconds, and that's all the cleaning that's needed. If that doesn't correct the read problem the trouble is probably in the hardware, and the most common problem is incorrect drive speed, which is usually checked with an “analyzer” disk that tells you the actual disk speed in rpm. If you don't have an analyzer disk you can check the speed by aiming a neon or fluorescent lamp at the small strobe pattern on the disk drive's motor. If the pattern doesn't appear rock steady the speed is off. Adjust the disk drive's motor speed trimmer screw until the pattern “freezes.” If the pattern is steady and you still get read errors it's time for an overhaul by a shop specializing in disk drives. (Fig. 6)

If a drive drops out suddenly, if you get messages such as “I/O ERROR,” or “DRIVE NOT AVAILABLE,” check the small drive select programming plug; it might have come loose or fallen out. Possibly, vibration worked it loose. (This is not an uncommon problem when an independent dealer starts pinching pennies. Some of

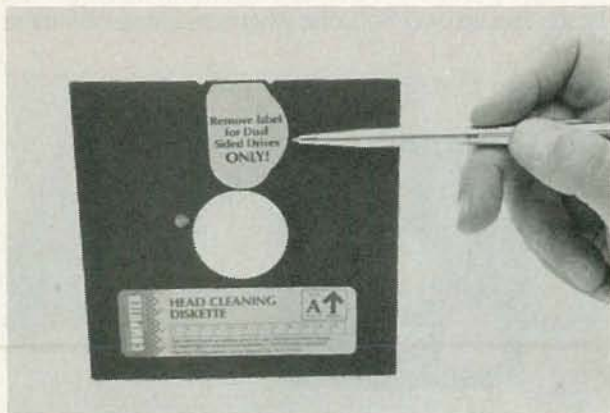

FIG. 5—THE WINDOW on the flip side of a cleaning disk is usually covered by a label. The label must not be removed if the drive is single-sided (one head). If the drive is double-sided (two heads) the label must be removed so both heads are cleaned at the same time.

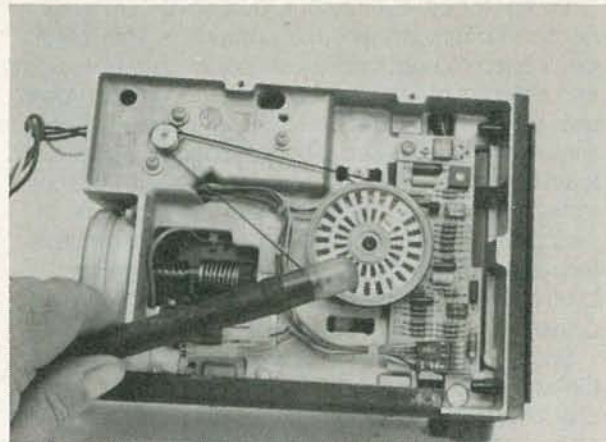

FIG. 6—IF A DISK DRIVE PRODUCES I/O errors after cleaning check its speed by holding a small neon or fluorescent test lamp near the strobe pattern “painted” on the drive's flywheel. If the speed is on-the-mark the strobe pattern will freeze. If the pattern's “bars” drift adjust the drive's speed control until the pattern freezes.

the dealers who put together their own “IBM computers” from conventional parts save .001 cent by using anything other than the proper programming plug. In the illustration shown, the jumper was one section cut from a conventional 4-section plug.) (Fig. 7.)

Many intermittent computer problems can be traced to card edge “fingers” and their connectors which aren't gold plated. Many card edge fingers are simply tinned with lead and they eventually develop an insulating oxide. All that's usually needed to get rid of the oxide is to simply remove and reapply the connector, whose contacts wipe the oxide from the card edge fingers. Unfortunately, the cheap sockets usually used for the unplated fingers aren't all that good either, and over a period of time will lose sufficient tension to clean the fingers. If just removing and restoring the connector doesn't provide a reliable contact wipe the oxide off the fingers with a “game cartridge” cleaning stick: A small stick with a mildly abrasive plastic pad at one end that is saturated with alcohol. The cleaning stick was originally intended for

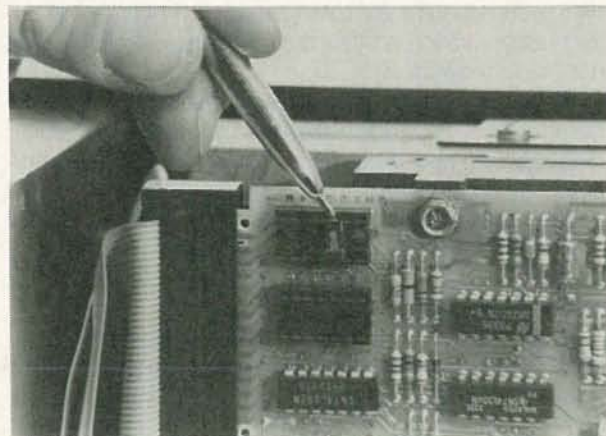

FIG. 7—SOME DISTRIBUTORS save a penny or two by shipping an “IBM type” drive with a “drive select jumper” cut from a larger DIP shunt. It's been known to work loose, so check that it's seated if the computer doesn't recognize a drive exists.



FIG. 8—SOME COMPUTERS and peripherals don't use gold plated edge connectors. If the fingers are simply tinned with solder or even tin plated they can develop intermittent contacts. If you suspect the fingers, just scrub them clean with the same kind of cleaning wand or stick used to clean game cartridges (game cartridges use similar edge connector).

cleaning the contacts on game cartridges, many of which use the same cheap construction as "leaded" computer card edge connections. The stick usually works even better than scrubbing the contacts with a pencil eraser (Fig. 8)

Use the same procedure with intermittent cassette recorder connections. Usually, the recorder goes untouched for months, and plugs and jacks can develop the same kind of insulating oxide as finger contacts. As a general rule, moving a plug in and out of its jack a few times will wipe the oxide free. If it doesn't, dip the plug in alcohol and run it in and out of the jack a few times—that will usually get rid of the most stubborn dirt. (Fig. 9) If you still have an intermittent connection when you wiggle the plug it's more than likely the jack's "tip" connection has lost its tension (it happens to cheap jacks after a few years), which means the jack itself will have to be replaced because even if you bend the tip connection it will simply deform the next time the plug is inserted: You cannot restore tension to the cheap jacks used on cassette recorders. (Fig. 10)

The modern desktop printer can run for years with

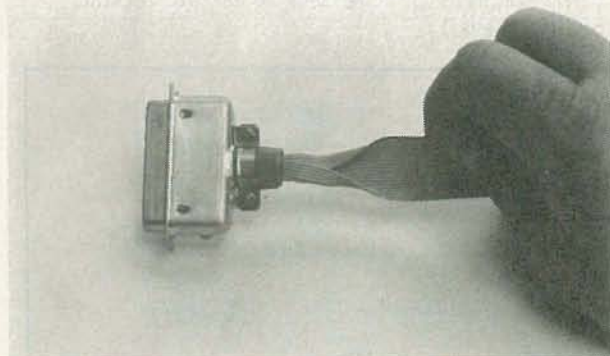

FIG. 9—FREQUENT REMOVAL of large insulation-displacement connectors, such as those used for Centronics-type printer connections, often cause the wire to pull loose inside the connector. If your cable develops intermittent connections replace the insulation displacement connector with a conventional solder-type connector. The ribbon will be firmly locked in place if you fold it on itself and wrap a heavy layer of tape where the wire passes through the connector's cable clamp.



FIG. 10—THE WEIGHT of the relatively heavy shielded hoods commonly used on monitor cables often works them free after several months. Simply tightening the hood's locking screws (if you didn't use them—which is not unusual) is often the cure for an intermittent monitor.

no maintenance other than cleaning a daisy wheel print element that's used with a fabric rather than a "one time" (polyethylene) ribbon. About the only required maintenance is an infrequent cleaning of the rubber platen of a letter quality printer. Over a long period of time just normal grime can cause a hard film to accumulate on the rubber, which can interfere with the character impression. Most stationary stores sell platen cleaners, which are small pads containing a crush-tube that releases a premeasured quantity of alcohol into the pad when squeezed. A few passes of the pad over the platen and the hard coating is removed. (Fig. 11)

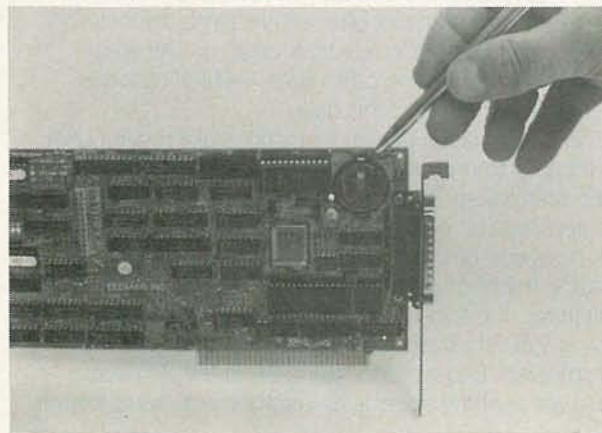

FIG. 11—ACCESSORY BOARDS powered by Mercury or Lithium batteries often develop intermittents not because the battery is dying but because it is leaking electrolyte: actually a microscopic film that gets between the battery and the socket's contact. Usually, a wipe with a cloth will restore operation, but the battery should be replaced immediately, before the electrolyte permanently damages some components.

In general, computer care is more common sense than anything else. If the system was installed properly, if all cables are secured and someone doesn't drop a jelly sandwich into the printer, it will probably keep going for years with the least amount of service and attention. Just remember the golden rule of personal computers: "If it ain't broke, don't fix it." ◀▶

PACKET RADIO

What cellular did for the telephone...

Marc Stern

■ One of the most exciting phenomena to hit Amateur Radio in the last 15 years is packet radio. It represents the marriage of the personal computer and communications technology.

The growing interest in packet radio is an outgrowth of the availability of small-computer systems as the Commodore VIC-20 or C-64; the desire to use the computer for communications, and the availability of interface software and hardware. It's a case of the right pieces being in place at the right time.

Over-the-air links

The result has been a rapidly spreading over-the-air computer network that is linking cities all over. When you think about this network, you begin to realize it has a great deal in common with packet-switched, local area networks (LAN). The difference is, that this network is linked via radio. (See Fig. 1)

Like a LAN, each outlet is called a node and special hardware is needed to enable the interface between the Amateur Radio station's computer, transceiver and the network.

In a LAN, special software is needed to enable the interface. Each piece of data entered into the network is preceded by special address coding—Amateur Radio callsigns, among other data—which tells the system where to send the data.

The packet radio network functions like a giant LAN. So it's easy to underestimate the importance of packet radio technology, but it represents an important step in the transmission of data.

It frees you of the constraints imposed by the wireline telephone system. Because of bandwidth limitations, the top speed that can be accommodated now is 9,600-bits per second (baud) of data transmission. Experiments going on in the Amateur realm are pushing speeds toward the 56K-baud barrier,

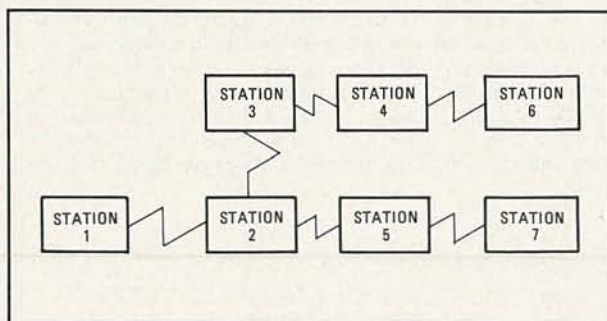

FIG. 1—PACKET RADIO is like an over-the-air computerized Local Area Network, each node communicating with only those it is seeking. Its attraction is high speed, secure communications.

or about a 600 percent increase in speed and a manifold increase in data density.

And this information is delivered free of errors thanks to the error-recovery nature of the packet radio network. Because of the unique packet data encoding, if the transceiver for which the information is destined doesn't receive the entire message or the checksum error-checking code is incorrect, the network will keep trying to get that information through until it receives an acknowledgement that it has been sent correctly, even if the error occurs mid-word or mid-sentence.

Finally, this system is secure and spectrum efficient. Because it depends on unique addressing, messages that aren't intended for your node go unread by your terminal program. You may see a record of activity on a frequency, but, unless a message is broadcast as a bulletin to many Amateur stations or nodes, you won't see its contents because the system will prevent it. Spectrum efficiency is ensured because it uses frequency modulation and digital packets.

One of the functions of FM radio is the capture effect. When a signal has captured or saturated the discriminator circuitry of an FM transceiver, that radio hears no other signal. With the distances involved between packet radio system nodes, it is unlikely that any transceiver will "capture" the system for more than a transmission or so and this will allow several stations to be on frequency at once, each using the system in turn. (Local stations working in packet, likewise, won't bother the overall network because they are unlikely to be transmitting with the amount of power needed to do it. Therefore, the overall network won't hear them and will continue to move data. Again, the capture effect is at work.)

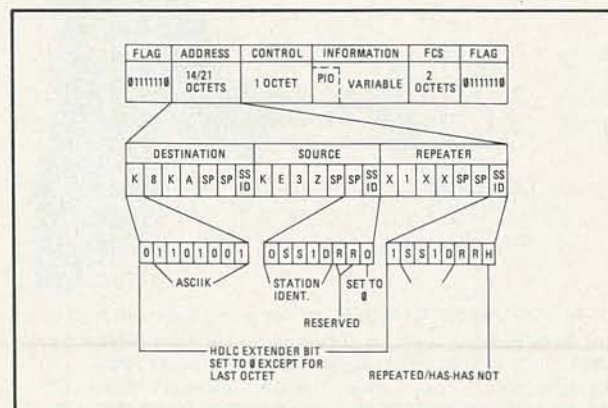

FIG. 2—OSI PROTOCOL is seven layers deep and was developed to promote compatible communications among devices. Solid lines are interfaces between layers, arrows indicate how like layers attract.

When two stations transmit simultaneously, part of the protocol which drives the packet network checks periodically to see if the network is busy or free. If it is busy, the node refrains from activity until it is free. When it is free, that station can slip its packets into the data stream and they will move along it until they arrive at their destination.

Seven layers

One of the plans which packet networks adopted early on was the Open Systems Interconnection (OSI) model on which to base network interaction. OSI, developed by the International Organization for Standardization (ISO), was developed to ensure compatibility between communications devices.

The OSI model specifies a seven-layer structure, each with its own protocol. Within each layer, the structure is modular, allowing differences in design and in the validation of protocols. (See Fig. 2.) Level 1 is the Physical layer which is concerned with bit-level data. The RS-232 and CCITT standards apply here. Hardware is impacted by this layer. Level 2 is the Link layer which arranges the bits into frames. At this level, the most common packet protocol is the ISO High-Level Data Link Control. This layer establishes a link (circuit) through supervisory frames and performs error checking and recovery. Level 3 is the Network layer which handles the addressing; routing; multiplexing, as well as flow control. At this layer, packet describes the message structure.

Level 3 can establish two types of network, virtual and datagram. The virtual circuit establishes a logical connection between the end points and then uses an abbreviated packet header. The datagram uses complete header information.

This layer can be further subdivided into internet or Sublayers A and B.

Level 4 is the Transport layer. It arranges the information in the correct order in the event that packets arrive out of order after traveling through a network. It also reassembles any packets scrambled as they move through the network.

Levels 5—Session layer, which handles log-on, logoff and authentication; 6—Presentation Level, which performs code conversion, control data structure and display formats and manages data interchange with peripheral storage devices, and 7 the Applications layer, which is user software and interface, handle various housekeeping and interface chores.

For our purposes, the important levels are 1, 2, 3, 4 and 7. They define the packet system.

Packet hardware, software

Although packeteers could have used the EIA RS-232 standard, they chose the CCITT V.24 and V.28, which specified the pinouts in the network connector. They also used the Bell 202, as opposed to the newer 212A modem standard, because there were some 202 models available on the surplus market. These modems use a 1200 Hz mark and 2200 Hz space.

Encoding in a packet radio system is predominantly a baseband technique. Called nonreturn to zero,

inverted, a 0 causes a change in signal level at the beginning of a bit interval, while a 1 causes no change.

This type of encoding is supported by such controller chips as the Intel 8273; Zilog 8530, and Western Digital 1933. All of this is housed and implemented by a device which is called a terminal node controller (TNC). A combination modem-computer, the TNC and its protocol senses when a network is free; turns digital information into analog data so it can be sent across the network, and takes analog information and turns it into digital information so it can be used at a node.

The Amateur packet network uses a version of CCITT standard X.25 called A(mateur)X.25 and it defines how digital information is framed into a packet. The frame consists of the beginning flag, address field, control field, information field, frame-check segment and ending flag. (This data are sent with 16 inversions so it can be synchronized with the network.)

The flags are always represented by 01111110, while the address field consists of two or three specially encoded ham call signs, the destination, source and, optionally, the repeating stations used to get the information from A to B. The last octet of each address element is reserved for a secondary station identifier. The control field is used to identify a frame's type and also signals a connection request, ready-not ready conditions, frame numbers and modes of operation. As you'd expect, the information field is used to convey the message and the frame-check sequence is the checksum.

As these frames and others move through a radio packet system they head for their designation nodes. It is up to each node to assemble or disassemble the information. The TNC not only acts, therefore, as the modem, but also as a special-purpose microcomputer. Software to handle the assembly or disassembly is stored in Programmable Read-Only Memory. It implements the HDLC.

Importance of system

Such is the reliability and security of the Amateur packet system that commercial manufacturers and the military are studying it closely. Amateurs have proved that it is possible to use radio to enable a high-speed, dense information flow. It also opens some interesting commercial possibilities.

Imagine using an FM station's SCA for data communication. Or using a business band frequency for secure, high-speed, close-of-business data transmission. In minutes an entire day's transactions can be reliably sent from point A to B, securely and without error. It's an interesting concept, especially as Amateurs work for higher speed levels, such as 19.2K-baud and 56K-baud. Further, it provides a cost-effective alternative to satellite or terrestrial links. In fact, it looks so attractive that commercial providers are already bringing their own TNCs to market.

So, once again, the Amateur Radio community is at the cutting edge of communications technology, making the inevitable marriage of computers, radio and communications work and work well, too. ◀▶

BUILD THE GRAFEX-32

PART 3

High-Resolution Graphics for your Apple II.

RAY DAHLBY

This article was begun two issues ago, continued in the last issue, and is concluded here. We'd recommend that you go back to the February, 1986 issue and re-read the entire story from beginning to end, and if you elect to build this unit, do so, knowing that you now have all of the required information.

A word about monitors

Before I set out to design this project, I went looking for a video monitor with two essential characteristics; a high video bandwidth and a long persistence phosphor screen. The Sanyo 9-inch B&W monitor I had been using with my Apple did a satisfactory job displaying the Apple's 40 column text and 280 by 192 graphics screens but blurred noticeably when displaying 80 column text, an indication of its rather poor video bandwidth of 5Mhz or so. In order to display 640 dots in a 40 μ s line, the required video bandwidth should be about equal to the dot clock frequency of 16 Mhz. Another characteristic of the Sanyo, which is common to all video monitors using a standard short persistence phosphor screen, is a flicker effect when displaying interlaced computer graphics images. This flicker is the result of the non-spatially limited bandwidth nature of computer generated images as compared to images from a video camera. Since interlace is necessary to get a vertical resolution above about 200 lines and still stay within NTSC television timing, (and thus retain monitor-compatibility with the Apple II), I had to find a screen with a longer persistence. Fortunately, Apple Computer Inc. came to my rescue when they introduced the Monitor III. This screen has the necessary combination of high bandwidth, long persistence, and modest price. I wondered if they anticipated my needs since the Apple II does not normally require these.

A peculiarity of the 7220 when generating interlaced video is a timing skew between sync pulses responsible for even and odd video fields. The effect on some monitors, is line-pairing which shows up as an

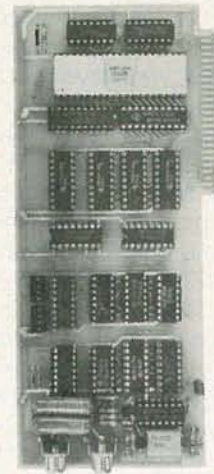

uneven spacing between horizontal lines. This effect can be eliminated on the Monitor III as well as other monitors by a slight adjustment of the vertical hold control.

The Grafex sub-interpreter software includes a command to switch the display from 640 by 400 interlaced video to 640 by 200 non-interlaced. This command can be useful for those users who do not have a long persistence screen. The 400 line vertical resolution can still be used by programs to address to complete bit-map and the display scrolled vertically to view it. In effect, the screen shows a window of 640 by 200 on a 640 by 400 "world." If 64K by 4 bit RAM chips are substituted for the 16K by 4 bit 4416's, this "world" will be 640 by 1600. The sub-interpreter has a command called "SCROLL" which accepts a parameter in the range of 0 to 1599 for this purpose.

Conclusion

The 7220 is the first graphics co-processor chip to become widely available in the microcomputer marketplace. Now in volume production, it has dropped in price to about \$40.00 in single units from over \$100.00 a year ago. The Grafex board serves as an evaluation and development tool for this chip, in addition to its main use as a graphics expander for the Apple II. As more sophisticated graphics co-processors and larger memories become available, the open-architecture of the Apple II will likely play host to these products as well, allowing Apple users the opportunity to stay abreast of the latest technology while expanding and enhancing the utility of their machines.

It was not the intention of this article to provide a complete tutorial on programming the 7220. Such a tutorial alone would take several times the size of this article. A software package has been written to facilitate the use of the Grafex circuit board from BASIC programs. This package is in the form of a sub-interpreter to Applesoft and adds about thirty commands relating to drawing points, lines, rectangles, arcs and circles as well as text, from within Applesoft BASIC programs. Please check the end of this article for

prices and ordering information. Those readers interested in writing their own drivers for the 7220 are urged to buy, borrow, or steal a copy of the "7220 DESIGN MANUAL." This 138 page book is an excellent source of information on both the hardware and software aspects of this chip. It is available for \$10.00 from NEC Electronics U.S.A., One Natick Executive Park, Natick, Massachusetts 01760.

The screen photos

The screen photos reproduced here were taken from an Apple Monitor and show text and graphics at 640 by 400 resolution. The displays were generated with a Grafex board installed in an Apple IIe running under Applesoft Basic with the Grafex sub-interpreter software. The text displayed in these examples comes from a software character set loaded into system RAM by the sub-interpreter. All Grafex displays are bit-mapped; there is no hardware character generator on the board. The character font stored in system RAM can be read into the 7220 GDC which then writes it into the screen bit-map in any of eight directions and 16 sizes. In addition, derived character sets can be displayed by

PARTS LIST

SEMICONDUCTORS

D1, D2—1N914 or 1N4148 diode
IC1—PD7220D graphic display controller
IC2, IC3—74LS00—Quad NAND gate
IC4—74LS02—Quad NOR gate
IC5—74LS86—Quad exclusive OR gate
IC6—74SO4—Hex inverting amplifier/buffer
IC7-IC9—74LS74—dual-D flip-flop
IC10, IC19—74LS174—Hex-D flip-flop IC11—
74LS245—Octal transceiver
IC12—74LS374—Octal D-type flip-flop
IC13-IC16—TMS4416-20NL Dynamic RAM
IC17, IC18—74LS166 Paralle-to-serial shift register
IC20—74LS163PNP Binary Counter
Q1—2N3906 PNP Silicon Transistor
Q2—2N3904 NPN Silicon Transistor
XTAL—16MHz quartz crystal

CAPACITORS

C1-C5—0,1+ microF, 50-volt ceramic disc

RESISTORS

(All resistors 1/4-watt 5%)

R1, R2, R9—100-ohm
R3, R10—1000-ohm
R4—1500-ohm
R5—3300-ohm
R6—2200-ohm
R7—5100-ohm
R8—200-ohm
R11—75-ohm

MISCELLANEOUS

J1, J2—PC-mount phono jac
RY1, RY2—SPST N.O. 5-volt reed relay

KITS AND SOFTWARE AVAILABILITY

The following kits and software packages are available for the Grafex-32: a) Printed circuit board (professionally made with plated-through holes, solder-mask and gold-plated edge connector) \$45.00. b) Kit of all parts for above \$125.00. c) Assembled and tested board \$195.00. d) Sub-interpreter software and demos on 5 1/4" diskette, Apple DOS 3.3 \$45.00. e) Color software package on 5 1/4" diskette. Apple DOS 3.3 (requires three Grafex-32 boards and RGB monitor) \$95.00. Please add \$4.00 per order for Air-mail postage and handling. Payment accepted by check or money order in U.S. funds to: Ray Dahlby Electronics, Dept. #255, Box C 34069, Seattle, Washington 98124-1069, or: Ray Dahlby Electronics, Dept. 255-810 West Broadway, Vancouver, B.C. V5Z 4C9, For technical inquiries, phone (604) 732-1080 (no phone orders please).

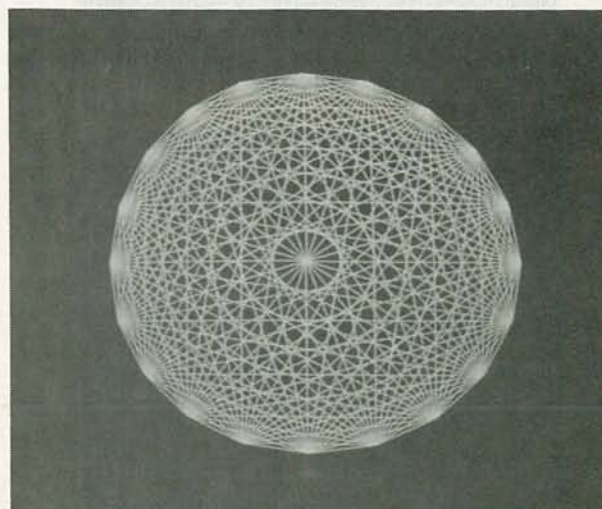
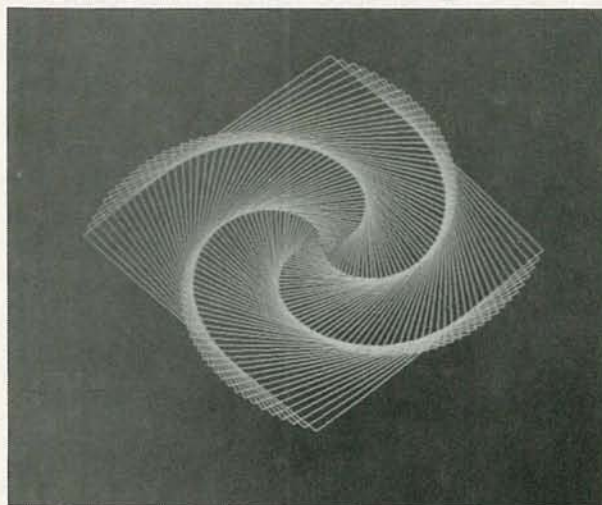

THE AVAILABLE DETAIL at 640 by 400 resolution . These are common examples of computer graphics. Start with a figure, and repeat at different rotations and sizes.

shifting the position of characters and writing them on top of themselves using the set, clear, and complement modes of the GDC.

Photograph #2 shows a barberpole effect of 80 columns by 50 rows of text. The character set used in this and the other examples, is made from a 5 by 7 dot matrix in an 8 by 8 box. This character set includes the complete 128 character ASCII set. The Monitor III screen displays highly readable text in this 80 by 50 format and, in fact, I find it to be preferable to the Apple 80 column display.

The 8 drawing directions are shown in photograph #3. The title for this display was produced by writing the string "DIFFERENT DIRECTIONS" at a magnification factor of 2, and then writing it again but with the x and y starting position shifted by 1 pixel and the mode set to complement.

Photographs 4, 5 and 6 show off the detail available at 640 by 400 resolution and are quite common examples used in computer graphics. Photos 4 and 5, for example, are simply the result of repeatedly drawing a triangle and a rectangle, at different rotations and sizes.

Photograph #7 is a good illustration of the detail available when graphing mathematical functions. The 3-D effect of the titling is again produced by writing a shifted text string on top of itself. Photograph #8 is the

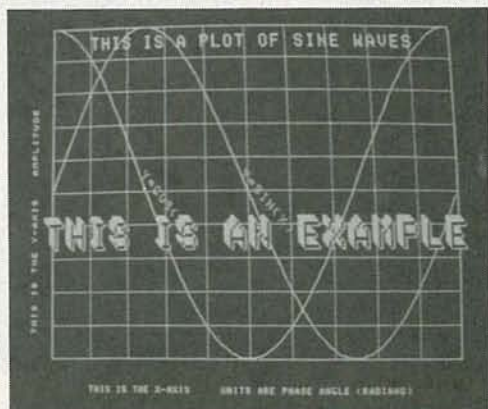

GOOD ILLUSTRATION OF THE DETAIL available when graphing mathematical functions. The 3-D effect of the titling results from a text string written on top of itself.

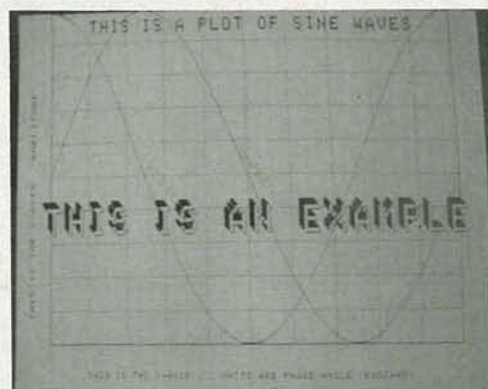

THE SAME SCREEN IMAGE COMPLIMENTED. The GDC can perform an exclusive-OR of this type on 32K-bytes of memory in under 16 ms.

same screen image complemented. The GDC can perform an exclusive-or of this type on 32K bytes of memory in under 16ms, obviating the need for hardware reverse video capability.

The last two pictures, #8 and #9, show a fanciful "video art" example I wrote by accident. This effect is produced by writing the letter "A" at different magnifications, rotations, and modes (set, clear, and complement). The program, written in Applesoft Basic, is just a few lines in length yet produces videotape-like animation.

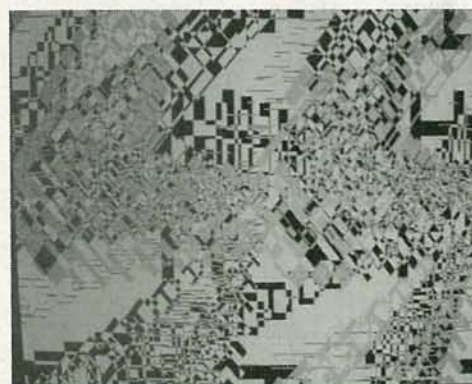
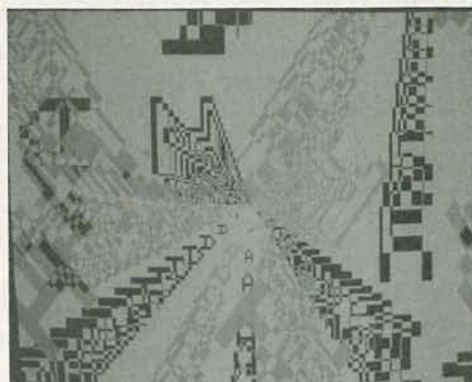

SOME VIDEO ART produced accidentally by writing the letter "A" at different magnifications, rotations and modes. The program, written in Applesoft BASIC, is just a few lines in length yet produces a videotape-like animation.

References

- 1—"High Resolution Sprite-Oriented Color Graphics:" Steve Ciarcia: Byte Magazine, August 1982.
 - 2—"Polish Your Apple With A Luminance Board:" Ray Dahlby: Computers and Electronics magazine, November 1982.
- Further Reading
- 1—"Display Controller Simplifies Design of Sophisticated Graphics Terminals:" Jeffery L. Wise and Henryk Szejnwald: Electronics magazine April 7, 1981.
 - 2—"Super Graphics Hardware from NEC : "Steve Levine: Byte magazine, April, 1983.
 - 3—"MOS Memory Data Book": Texas Instruments:1984.
 - 4—"Output-enable feature a must on fast common I/O memories": Al Reddy and Sherri Craig: Computer Systems Equipment Design magazine, January, 1985. ◀▶

quite advanced for its day, so it was very popular.

Home-built portables

Portable receivers could be built from instructions that appeared in radio papers and magazines. For example, my friend Daniel Hoffman II, who is quite a radio historian, sent information on the one-tube (UV199) Goodreau spiderweb portable. Instructions for building one appeared in a tabloid called *Radio In The Home* that was published by one Henry Neely. The Goodreau receiver appeared in the April 1924 issue, and complete instructions, a parts list, a schematic, and pictorial diagrams were included. Even a pattern for the coil form was provided.

The Goodreau receiver was typical of many homemade receivers that appeared in early radio publications. With the information provided, and the usual hobbyist's ground-floor knowledge of radio, there was little problem building one's own receiver.

Publications like *Radio In The Home*, as well as various early Gernsback publications, contributed much to the development of radio. And those early papers and magazines are as collectable as the equipment itself is.

Popular early receivers

Of course, station KDKA was not Westinghouse's only venture in the radio business; they were an early producer of quality receivers. For example, one early set uses three 01A tubes. The operating controls and output jacks are on the front panel, and binding posts for antenna, ground, and battery protrude from the back of the cabinet.

A good-looking receiver, the *Melody 5 Receiving Set*, was made by Better Radio Products of Muncie, Indiana. That receiver also uses 01A tubes—five of them. It could also use 201A's or 301A's. Like the Westinghouse, the controls and output jacks are on the front panel, but the seven binding posts for antenna, battery, etc., are concealed inside the box. For an antenna, the manufacturer recommended using 75 feet of insulated wire mounted as high as is convenient.

MUST LIQUIDATE! COMMODORE PLUS/4 COMPUTER SYSTEM

AT BELOW DEALER COST!



NOTE: Monitor not available. The Plus/4™ can hook up to your TV.

Factory new!

Factory warranted by Commodore®. Built-in software for word processing, data processing, spreadsheets and 128 color graphics!

Commodore® designed this Plus/4™ specifically for programmers and small businesses! And then they made it **VERY EASY** to learn and use for novices. Popular business software is available for a variety of purposes. For programmers, this machine has easy-to-use powerful commands and 60K of usable memory. Can hook up as many as four disk drives.

Team up the computer with our compatible units of famous brand, factory reconditioned and warranted **DISK DRIVE** and **DOT MATRIX PRINTER!** Sorry, we can't print the brand name of the disk drive and printer. But phone us Toll-Free and we can tell you. With Disk Drive for data storage and Printer for "hard copies", you'll have a complete system...at low liquidation prices. Order **TODAY!**

Units sold individually or in any combination you desire.

	Original List Price	YOUR COST
PLUS/4 COMPUTER Item H-1088-5035-001 Ship, hand: \$8.00	\$299.00	\$79
DISK DRIVE Item H-1088-3553-013 Ship, hand: \$8.00	\$269.00	\$149
PRINTER Item H-1088-3831-005 Ship, hand: \$7.00	\$200.00	\$119
TOTAL Ship, hand: \$23.00	\$768.00	\$347

COMPLETE SYSTEM WITH 20 FREE FLOPPY DISKS

Total Original List . . . **\$877.00**

Liquidation
Priced At Only . . . **\$339**

Item H-1088-5035-019 Ship, hand: \$19.00

Credit card customers can order by phone, 24 hours a day, 7 days a week.



Toll-Free: 1-800-328-0609

Your check is welcome! No delays in orders paid by check.

Sales outside continental U.S. are subject to special conditions. Please call or write to inquire.

C.O.M.B. Direct Marketing Corp.
Authorized Liquidator
14605 28th Avenue North
Minneapolis, Minnesota 55441-3397

Additional Features of COMMODORE PLUS/4

Data base of 999 records. Computer holds 99 lines of text before it must be transferred to disk drive. Excellent terminal for use with modem. 128 colors available for graphics. Split screen and windowing capabilities Compatible with all Commodore hardware except joystick and dataset. NOT compatible with C64 software.

DISK DRIVE

Intelligent, high-speed. External 5 1/4" floppy diskette recorder. 2K RAM, 16K ROM. Maximum storage of 170K formatted data: 35 tracks. Uses single sided, single density disk. Serial interface. Second serial port for chaining second drive or printer. Data transfer rate of 400 bytes per second.

DOT MATRIX PRINTER

Bi-directional 6 x 7 dot matrix impact printer. 60 characters per second. Has upper and lower case letters, numerals and symbols. All PET graphic characters. Standard friction feed. Maximum of 80 columns width, dot addressable. CBM, ASCII character codes. Original plus maximum of two copies. Paper width: 4.5" to 8.5". Size: 13" W x 8" D x 3 1/4" H. Weight: 6 1/2 lbs.

C. O. M. B. Direct Marketing Corp. Item H-1088
14605 28th Ave. N./Minneapolis, MN 55441-3397

Send the following items. (Minnesota residents add 6% sales tax. Allow 3-4 weeks for delivery. Sorry, no C.O.D. orders.)

Send COMPLETE SYSTEM(s) Commodore® Plus/4™, Disk Drive, Printer and Floppy Disks Item H-1088-5035-019 at \$339 each plus \$19 each for ship, handling.

Send COMMODORE® PLUS/4™ COMPUTER(s) Item H-1088-5035-001 at \$79 each plus \$8 each for ship, handling.

Send DISK DRIVE(s) Item H-1088-3553-013 at \$149 each plus \$8 each for ship, handling.

Send PRINTER(s) Item H-1088-3831-005 at \$119 each plus \$7 each for ship, handling.

My check or money order is enclosed. (No delays in processing orders paid by check, thanks to TeleCheck.)

Charge: MasterCard VISA

Acct. No. _____ Exp. _____

PLEASE PRINT CLEARLY

Name _____

Address _____

City _____

State _____ ZIP _____

Phone (____) _____

Sign Here _____

An old friend gave me one of the ever-popular Crosley 51's. He believes that that set was on the market before the 1920 KDKA broadcast. That Crosley may have received some of the phonograph music broadcasts that were sent out two months before the presidential returns. Dr. Frank Conrad also made his experimental transmissions at that time. Those who wanted to listen could purchase a receiver at a department store in Pittsburgh.

The pioneering activities of Dr. Conrad are well documented. He broadcast from his own station, 8XK, located in his two-story two-bay heated garage located in the Pittsburgh suburb of Wilkinsburg, as well as from station KDKA. In his home lab Dr. Conrad and others laid much of the foundation of broadcast radio.

Store-bought receivers

Home-made receivers continued to plague the budding radio industry for some years. The early hobbyists didn't need store-

bought receivers that they knew nothing about when their own receivers worked perfectly well. If maintenance was necessary, that was no problem for people who had built their set from the ground (no pun intended) up.

But, as the years passed, the old-timers began to fade away. Their faithful home-made sets were stored in attics or basements, or perhaps they were simply discarded. By the late 1920's broadcast receivers were being manufactured by the thousands. I guess that was when it became possible to go into a store and buy a *radio*.

Thanks

Let me say a few words to everybody who took time to write. I appreciate all those letters, and I will answer each one personally. I enjoyed hearing from everyone who relished the photos we've printed here. The Majestic model 70, the Crosley 51, and the Arvin 444 are very popular among collectors. My family-heirloom Silver-tone must have been one of the

most popular radios ever made. And thanks for the photos you've sent; I'll try to work them in as space permits.

Some of you "antiquers" had really difficult technical questions about restoring your antique apparatus. Those questions require considerable research. So, if you don't receive an answer from me right away, please have patience. And don't forget those stamped, self-addressed envelopes!

Have and needs

This section is a service for readers who have or need antique equipment, parts, or other information to share. Readers are asked to contact each other directly, as I have no way of evaluating items that are offered.

Schematics—3000 of them. Inquire with an SASE to Scaramella, 37 Earl Street, P. O. Box 1, Woonsocket, RI 02895-0001. Books, Magazines & Schematics—Send SASE with \$0.44 in stamps for list to Alvin Sydnor, 806 Meetinghouse Rd., Boothwyn, PA 19061. **R-E**

MEDICAL ELECTRONICS

continued from page 86

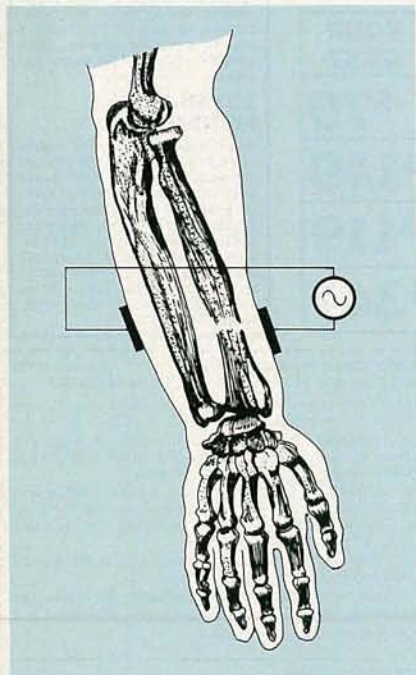

FIG. 4—CAPACITIVE COUPLING can also be used to deliver current to the fracture site.

weak in a different anatomical area, and each tumor grows and spreads differently.

There are a wide variety of problems

that have to do with technique and technology. Although some may appear simple or obvious at first, failure to properly deal with them can doom an otherwise promising treatment to failure.

Problems may arise during the implantation of the device itself. For instance, if certain ear structures are damaged during the implantation of a device to stimulate the inner ear, that device would appear to be useless. Thus, the surgical techniques required to properly insert a device or probe must be perfected and understood by all involved in the procedure.

Even if implantation is carried out correctly, later body movements may cause problems. For instance, an electrode implanted to stimulate bone growth may be pulled away from the bone.

Also, any implanted object is subject to "rejection" by the body's immune system. If that occurs, the result is an infectious or inflammatory reaction.

There are also problems in evaluating the effectiveness of a technique. Due to human nature, feedback from the patient himself is usually not reliable. People often want to please others who are trying to help them. It is common for people to say that a device is of assistance to avoid hurting the feelings of the investigator, even when the device developed is of no use. Further, the *placebo* effect must be considered. Current applied to the head may lessen depression or bring sleep because the impressive-looking equipment

convinces the person that a cure is at hand. The tissues with implanted electrodes may heal more quickly because the person is more careful about protecting the area from further injury.

When investigating the benefits of electrical stimulation, the researcher must deal with the number of different types of stimulation that might be effective. Thousands of different combinations of stimulation parameters may seem reasonable, yet only a certain combination of parameters may work. Finding that combination is made even more difficult by the response times involved. For instance, the healing of bone takes place over months. Among the parameters that can be varied are current level, waveform, polarity, coupling method, electrode material, and duration of the application.

Finally, there are problems that have little or nothing to do with medicine or technology at all. It is complicated, costly, time-consuming, and expensive to get any medical product approved for sale, or even human testing. And even if approval is received, and many lives are saved, if just a single person is harmed by a device a costly lawsuit is very probable. Companies have lost millions in such suits, even in cases where they've won.

Despite all of that, the area of electronic stimulation is most promising. In the years to come, researchers are sure to come up with even more applications for that technology. **R-E**

Two of the best HAMEG-Performers

2 year warranty

high quality at low cost

HM 205 an outstanding new Oscilloscope with Digital Storage

Realtime:

2 channels DC – 20 MHz
max. sensitivity 2 mV/div.
Timebase 0.2 s – 20 ns/div.
Trigger: DC – 35 MHz (0.5 div.)
Built-in Component Tester
1 kHz / 1 MHz calibrator (3 ns)
TV sync. separator

Digital Storage:

max. sampling rate 100 kHz
Refresh-, Single-Mode
Storage: 8 bit x 2048 points
Timebase: 5 s – 0.1 ms/div.

CRT 8x10 cm, int. graticule, 2 kV

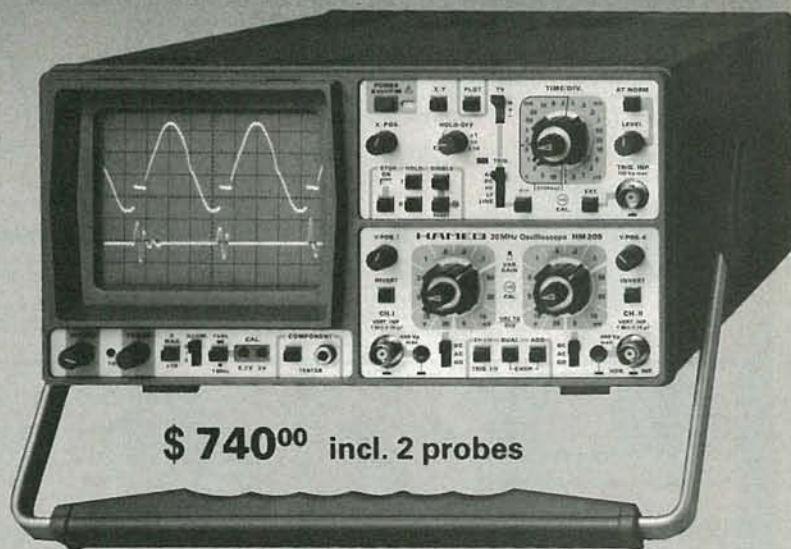

\$ 740⁰⁰ incl. 2 probes

HM 208 the high tech Digital Storage Scope with 20 MHz sampling rate

Realtime:

2 channels DC – 20 MHz
max. sensitivity 1 mV/div.
Timebase 0.1 s – 20 ns/div.
Trigger: DC – 40 MHz (0.5 div.)

Digital Storage:

max. sampling rate 20 MHz
Roll-, Refresh-, Single-, XY-Mode
Storage: 8 bit x 4096 points
Timebase: 50 s – 1 μ s/div.
Pretrigger: 0-25-50-75-100%

CRT 8x10 cm, int. graticule, 14 kV

IEEE-488 Interface Option

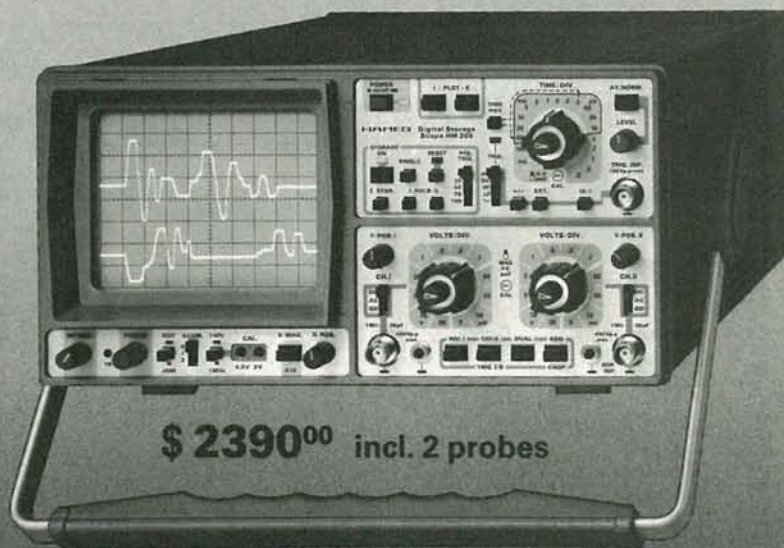

\$ 2390⁰⁰ incl. 2 probes

Write or call

HAMEG® Inc.

14 day full money back guarantee

88-90 Harbor Road · Port Washington, N.Y. 11050 · ☎ (516) 883.3837 · TWX (510) 223.0889

CIRCLE 269 ON FREE INFORMATION CARD



Don't Miss Our New
1986 CATALOG!
 Available in April.
 See Coupon Below
 to Reserve Your Copy.
GIANT 148 PAGES!

Dick Smith Security Center

This is the type of alarm system the professional installers could charge you \$500 - \$1000 for...and more! Suitable for homes, offices...you name it! With six individual sectors all fully controllable for instant or delayed alarm, each able to isolate and each triggerable by a huge range of sensors.

- ★ Resistive loop sensing suits both n/o & n/c alarm sensors will trigger alarm.
- ★ Any sector can be isolated while the rest of the alarm remains on.
- ★ Six different sectors, all with LED indication to show sector status.
- ★ Includes fire detector provision.

\$149



Cat L-5100

Do-It-Yourself & SAVE!

Satellite TV gives you better picture & sound and more viewing options!

Think you can't afford it? Think again! Dick Smith Electronics has satellite systems to fit every budget - just look!

DICK SMITH STEREO SATELLITE SYSTEMS

Features Rockdale CT-12 Stereo Receiver, Rockdale downconverter, feedhorn, LNA, cables, leads, connectors, & 6' antenna dish

Save over \$222 off component prices!
\$799

DSE DELUXE SATELLITE SYSTEM

Save over \$218 off component prices
\$999

Or build your own Satellite Receiver for only \$99.95!

The performance rivals commercial receivers costing hundreds of dollars more. The ease of assembly & field proven circuitry is fantastic. The quality is better than expensive commercial units.

The Australis 1 Satellite Receiver Kit can be assembled in just hours! Buy the complete system & save even more!

SYSTEM INCLUDES: Australis 1 Kit, Avantek downconverter, feedhorn, LNA cables, etc., & 6' dish. **\$699**

Richard Maddox, author of
Troubleshooting & Repairing Satellite TV Systems



Requires 18V AC Adaptor
 Cat M-9558 \$7.95

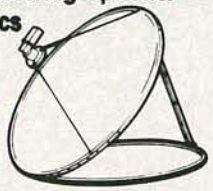

ALARM HOUSING

Creating your own alarm system? This sturdy steel case measures 8" x 10 1/2" x 3 1/2" deep - plenty of room to house your system, and rugged construction to resist tampering!

\$29.95

Cat H-2490

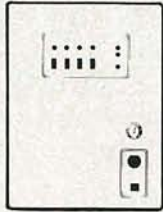

PUSH-BUTTON ALARM CONTROL PANEL

Improved flush mounts make this panel faster & easier to install. All connectors are gold-coated. 6-15V DC power operation. 900,000 possible 3 to 6-digit code combinations.

\$34.95



Cat L-5135



DIP METER

Cat G-1335

Frequency Range: 1.5-250 MHz in 6 plug-in coils
 Modulation: Approximately 2 KHz sinewave
 Crystal Oscillator: 1-15 MHz
 Power Supply: 9V DC
 Semiconductors: 2 transistors & 1 diode



\$59.95



Fully solid-state IC regulated
 Automatic fold back function
 Output short circuit protected
 Remote sensing circuit design
 RF filter-fitted
 1500V Hi-Pot tested

\$89

Cat M-9547

POWER SUPPLIES

3-6-9-12 VDC @ 1 amp



\$14.95

Cat M-9530

Invaluable around the home or workshop. It will give a maximum of 1 amp at 3.6, 9 and 12 volts DC. Simply plugs into 117 VAC power socket-DC connections. Ideal for use with alarm systems, intercoms, etc.

HEAVY-DUTY SOLID-STATE 13.8V/5A Peak



\$19.95

Cat M-9545

Regulated DC Power Supply, 13.8 VDC, 3A Cont. For home, lab service bench, CB stereo and auto radios, this is an extremely versatile unit. You'll wonder how you managed without it! Input is 117VAC@60Hz 100W, and the output is fully regulated low ripple up to 5 amp surge. The unit is fuse and double-short circuit protected with on/off switch and pilot light.



Learn About Integrated Circuits with Dick Smith's

FUNWAY 3 INTO ELECTRONICS

Volume 3

Dick Smith's FUNWAY INTO ELECTRONICS series is packed with projects designed to teach electronics while entertaining inquiring minds & busy hands. Volume 3 is for those who have worked their way through volumes 1 & 2 for the advanced hobbyist! It contains 10 fascinating projects based on integrated circuits. We also offer matching kits (like the two below) to make building these projects even easier!

\$6.95

Cat B-2610

MINI AMP KIT *

\$14.95

Want an amplifier for your walkie-stereo or radio? Don't be tied to phones; use this project and listen in comfort! Or you can build this into a mini PA Amplifier.



Cat K-2667

MINI SYNTH KIT *

\$19.95

It's a real beauty, this one: a real 'live' musical synthesiser - and it's live because it uses YIG as the note generator! you get an amazing range of control over the sound.



Cat K-2669

* Requires FUNWAY book Volume 3 (Cat B-2610) for complete construction details

* Requires FUNWAY book Volume 3 (Cat B-2610) for complete construction details



DSE SOLDERING STATION

\$49.95

Cat T-2100

When You're Ready For Some Serious Soldering...

Get this professional station at a hobbyist's price! Features fully variable temperature control; lightweight, detachable iron; iron holder & cleaning sponge.

CONNECT WITH SAVINGS

'D' TYPE

COMPUTER CONNECTORS PLUGS (SOLDER TAIL)

9 Pin	were \$1.25	Cat P-2684 10 up 75c	79c
15 Pin	were \$1.60	Cat P-2687 10 up 85c	89c
25 Pin	were \$1.85	Cat P-2690 10 up \$1.05	\$1.15

SOCKETS (SOLDER TAIL)

9 Pin	were \$1.25	Cat P-2685 10 up 85c	89c
15 Pin	were \$2.20	Cat P-2688 10 up 85c	\$1.09
25 Pin	were \$2.60	Cat P-2691 10 up \$1.35	\$1.45

BACKSHELLS

For P-2684, P-2685 were 80c	Cat P-2686 10 up 57c	63c
For P-2687, P-2688 were \$1.00	Cat P-2689 10 up 59c	65c
For P-2690, P-2691 were \$1.25	Cat P-2692 10 up 60c	65c

EVERYTHING FOR PROJECTS



\$29.95

Cat H-2481

19" Rack Mounting Case

Professional quality black instrument case fits standard 19" racks, overall they're 16.75" x 9.8" x 5.5". Supplied flat, assembly takes just a couple of minutes. Heavy gauge (0.12") front panel; top and bottom pre-punched for ventilation.

Cat H-2482 16.75" x 9.8" x 3.25" \$27.50
 Cat H-2483 16.75" x 9.8" x 1.5" \$24.95



Cat T-1820

12 Watt S30

\$19.95

Ideal for the hobbyist! This reliable iron has a high impact plastic handle and Tricoid 0.12" long life tip.

ROYEL SOLDERING IRONS



\$22.95

Cat T-1830

A professional quality, precision tool - 110V AC with 16W heating power. Push button control for dual temperature mode

PROJECT PARTS

For Remote Control

Z-6097 14457 TX IC	\$5.95
Z-6098 14458 RX IC	\$10.95
Z-1950 Photo diode	60c (10 up 55c)
FPT 100 Ultrasonic Transducer TX	\$2.95 (10 up \$2.75)
L-7050 Ultrasonic Transducer RX	\$2.95 (10 up \$2.75)

For Satellite Receiver

L-1620 SAW Filter	\$29.95
H-2507 Case	\$12.95
H-7000 PCB	\$29.95
M-9558 Power Supply	\$7.95
Z-1891 BFR 91	\$1.19
Z-3070 BB 119	\$2.20
Z-6095 MWA 120 RF Amp	\$12.50
Z-6000 MC 10116 ECC IC	\$7.79
Z-2323 HP 5082-2800 HP SCHOTTKY	\$2.00
L-1600 5-8 MHz Filter	\$3.95



DESIGNER BOARDS

Now designing is so simple! No soldering, no mess - and each board comes with a pad of layout paper!

Cat P-4614 3" x 2.4" x 3"	\$4.95
Cat P-4615 7" x 2.7" x 3"	\$9.95
Cat P-4616 8" x 6" x 8"	\$19.95
Cat P-4617 8" x 9.75" x 8"	\$29.95

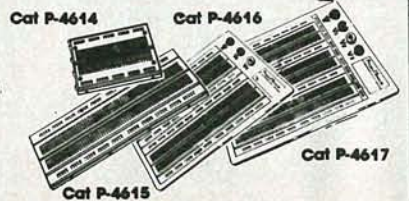

Cat P-4614

Cat P-4616

Cat P-4617



Heavy Duty Plastic INSTRUMENT CASES

Everything you could want in a case!
 Cat H-2505 7.9" x 6.3" x 2.5" \$9.95
 Cat H-2507 10" x 7.5" x 3.1" \$12.95

TAKE ADVANTAGE OF TELETEXT

Build this Low-Cost Decoder and SAVE A FORTUNE!

This Month's
**COVER
STORY**



Cat K-6315

ONLY
\$199

“This new teletext decoder... is the simplest and best performing world system teletext decoder that I have found to date.”

—Thomas Harrington, quoted from the best-selling *Hidden Signals on Satellite TV* (Cat B-1843)

Look at These Features!

Easy to build circuit board with screened overlay showing component layout for easy assembly • Comes with pre-adjusted and pre-assembled decoder module • Requires very little adjustment • Housed in attractive case with screened front and rear panels • You'll be proud to have it on your video shelf • Just wait until your friends ask what it is! • Comes complete with 21 button remote control • Teletext services are FREE — no user fees, no scrambled signals • Watch regular TV, view Teletext pages, or see the text over the regular TV picture • Decoder can be set to newflash page warning you of hot news stories.

A note about Teletext

Teletext refers to digital data transmitted in the Vertical Blanking Interval (VBI) between broadcast frames on your ordinary TV. Taft Broadcasting of Cincinnati produces the largest teletext service, ELECTRA, a 100 page magazine of news, information, & entertainment. It is carried by WTBS, along with CABLETEXT, 11 pages of stock & business data. Other services include the University of Wisconsin's INFOTEXT, Chicago's KEYFAX (WFLO) and METROTEXT in Los Angeles (KTTV). And this is only the beginning — we believe Teletext will be the hottest communications issue of the late '80's!

NOTE: This kit requires pre-tuned composite video & audio outputs from VCR, tuner, (some) cable-TV decoders, or TV (some newer models feature composite tuner outputs).



LATEST NEWS • BUSINESS HEADLINES • SPORTS SCORES • WEATHER • NYSE, AMEX AND OTC STOCK PRICES • COMMODITY REPORTS • STATISTICS • SPORTS QUIZ • NEWS FLASHES • AND MUCH MORE



Want to Learn More about Teletext!



The Hidden Signals on Satellite TV

The first book dedicated to the non-video services hidden in many domestic satellites, it covers radio, press & business services, etc., and this new edition contains 60 pages more info than the original bestseller!

240 pages

\$19.95
Cat B-1843

NEW
EXPANDED
1986
EDITION

Infra-red REMOTE CONTROL for your Teletext Decoder

No more messy leads & wires to trip over! This sleek remote is designed especially for our Teletext Decoder (K-6315), duplicating all its control keys. It requires only a handful of parts, so it's easy to build. At this low price remote control is not an option, it's a necessity!



NEW
KIT!

AMAZING!
ONLY **\$34.95**
Cat K-3425

In-Line Amp VCR Booster

Boost the signal level from your VCR or on long co-ax feed lines — you'll get clearer, crisper viewing. Also eliminates degradation when running more than one TV. Best of all, it plugs in to your existing system!

REQUIRES AC ADAPTER
Use M-9523 \$6.95

WAS \$13.95
NOW **\$8.95**

Cat L-4202

Cat L-4201



NEW

In-Line VHF Amp

This 10 dB video amp has a bandwidth of 50-450 MHz & output capability of 30 dBmV. Noise figure is 4 dB & impedance is 75 ohms.

\$8.95

Cat L-4201

NEW

VHF/UHF Masthead Amp

This high gain amp (XHF 25 dB, UHF 20 dB) boosts TV signals even in fringe areas. Its high input capability resists overload on strong signals, while a built-in FM trap cuts interference. Includes UL-listed AC adapter.

\$24.95

Cat L-4200

**NOW
OPEN
IN L.A.**

Orders Only — Call Toll Free:
1-800-332-5373
(Monday-Friday, 7am-6pm PACIFIC TIME)
IN CALIFORNIA CALL: 1-415-368-1066

STORES AT:
BERKELEY: 2474 Shattuck Ave. (415)486-0755
REDWOOD CITY: 390 Convention Way (415)368-8844
SAN JOSE: 4980 Stevens Creek Blvd (408)241-2266
LOS ANGELES: 1830 Westwood Blvd. (213)474-0626
HEAD OFFICE: 390 Convention Way, Redwood City, CA 94063

**Don't Miss Our
Brand-New
1986 Catalog!**

Available in April -
Reserve Your Copy Now!



Just send \$1.00 for postage & handling. We'll rush your copy to you — hot off the press!

WHERE THE ELECTRONIC ENTHUSIAST IS # 1!

**DICK SMITH
ELECTRONICS**

MAIL ORDERS

P.O. Box 8021 Redwood City CA 94063
14 DAY MONEY-BACK GUARANTEE
SHIPPING & HANDLING:

We ship UPS Ground unless otherwise requested.
Add 5% of order total (\$1.50 minimum) for shipping.
120% outside the U.S.A. - \$4.00 minimum.
There is an additional \$1.00 handling fee.
California residents please add sales tax.

YES! PLEASE RESERVE MY COPY of the 1986 DICK SMITH ELECTRONICS Catalog! Enclosed is \$1.00 for postage & handling.

NAME _____ ADDRESS _____ CITY _____ STATE _____ ZIP _____ 64E

DESIGNER'S NOTEBOOK



ROBERT GROSSBLATT,
CIRCUITS EDITOR

Voltage doublers

WE'VE TALKED A LOT ABOUT POWER SUPPLIES in past columns. We've presented handy circuits that do everything from generating a negative voltage from a (single-ended) positive supply to warning you when your batteries were ready to roll over and die. We even presented a circuit that monitors the charging of Ni-Cd cells. Since I still receive a lot of mail about the subject of power-supplies, this month's entry for our growing notebook also deals with power supplies.

Anybody who has ever designed a power supply knows that it is often difficult to find a transformer that can generate all the voltages needed by the circuit being powered. It's easy to use a voltage regulator to drop a higher voltage to a lower one, but it's not as easy to go the other way. There are some IC's that can do the job, but they're hard to find, and, as we all know, when a problem comes up we need a solution right away.

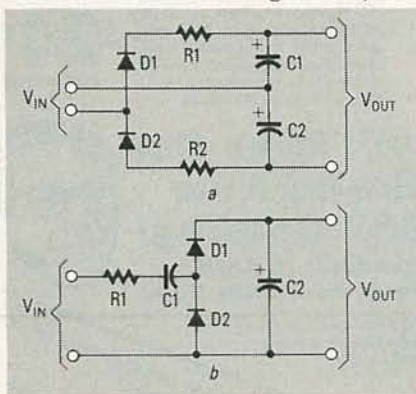

FIG. 1

How they work

As its name implies, the full-wave doubler uses both positive

and negative excursions of the incoming AC voltage, just as a full-wave *rectifier* does. During the positive half-cycle D1 is forward biased, so it charges C1. During the negative half-cycle D2 conducts, so it charges C2. Since the diodes alternately conduct and block the current on each half cycle, the voltage at the output of the circuit is (theoretically) twice the input voltage.

A couple of solutions to the step-up problem are shown in Fig. 1. Both circuits are standard voltage doublers. A full-wave doubler is shown in Fig. 1-a, and a half-wave doubler is shown in Fig. 1-b. You can use either to boost an AC input voltage, but each has unique advantages and disadvantages. Let's discuss how each circuit works, and then let's compare their performances.

Component values aren't critical. The capacitors should be at least 22 μF each, and each should have a voltage rating about twice the input voltage. The diodes must be able to handle the current passing through them and they must not break down when they're reverse-biased. Although you can use diodes that have a PIV equal to the output voltage, it's a lot safer to double that value.

The two resistors are optional

current limiters to protect the capacitors, diodes, and whatever you're powering. You can pick resistor values by applying Ohm's law. Use either the maximum current capability of the diodes or, preferably, the current requirements of the circuit you're powering. In any case, R1 and R2 should have the same values, as should C1 and C2, and D1 and D2.

The half-wave doubler works pretty much the same as its full-wave cousin. The diodes alternately conduct and block on each half-cycle of the incoming AC voltage. Output capacitor C2 charges to $\frac{1}{2} V_{\text{OUT}}$ during one half of the AC cycle, and its stored voltage is added to the AC input during the other half cycle. The result, of course, is a voltage across C2 that's approximately twice the input voltage.

You can calculate the values of the diodes and the resistors in the same way as for the full-wave doubler; however, the capacitor values have to be calculated differently. Since the entire doubled voltage appears across C2, its voltage rating should be at least *four* times the input voltage. And C2 is usually much smaller than C1—C2 might be 0.47 μF , and C1, 47 μF . Just be sure not to make C2 so

continued on page 116

TABLE 1—VOLTAGE DOUBLERS

	Half-wave	Full-wave
Output voltage	$< 2 V_{\text{IN}}$	$\approx 2 V_{\text{IN}}$
Ripple voltage	High noise	Low noise
Output current	Low	High
Connections	Common ground	Isolated output

R-E Engineering Admart

Rates: Ads are 2 1/4" x 2 7/8". One insertion \$825. Six insertions \$800. Twelve insertions \$775. each. Closing date same as regular rate card. Send order with remittance to **Engineering Admart**, Radio Electronics Magazine, 500-B Bi-County Blvd., Farmingdale, NY 11735. Direct telephone inquiries to Arline Fishman, area code-516-293-3000. *Only 100% Engineering ads are accepted for this Admart.*

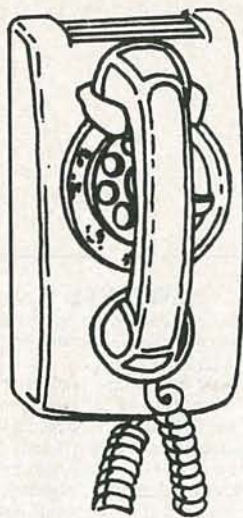

**CALL NOW
AND
RESERVE
YOUR SPACE**

- 6 x rate \$800.00 per each insertion.
- Reaches 229,044 readers.
- Fast reader service cycle.
- Short lead time for the placement of ads.

Call 516-293-3000 to reserve space. Ask for Arline Fishman. Limited number of pages available. Mail materials to: Engineering Admart, RADIO-ELECTRONICS, 500-B Bi-County Blvd., Farmingdale, NY 11735.

TOROIDAL POWER TRANSFORMERS

Small size • Low noise • Easy mounting

Made in U.S.A. UL-Recognized
50 standard transformers with
117V-60Hz primaries in stock
for 26VA, 45VA, 70VA, 120 VA,
180VA, 360VA, 600VA, 1000VA.
Custom sizes: 15VA-3,000VA
Call or write for data sheets



Size	Secondary Volts/Amps	Price each*		
		1	2-4	5-24
26VA	2x8.5V/1.47A	\$24.30	\$20.40	\$17.90
OD - 2.4"	2x12V/1.08A	24.30	20.40	17.90
H - 1.2"	2x15V/0.87A	24.30	20.40	17.90
Wt - 0.7 lb	2x18V/0.71A	24.30	20.40	17.90
	2x24V/0.54A	24.30	20.40	17.90
180VA	2x12V/7.50A	\$36.60	\$31.20	\$27.80
OD - 3.9"	2x15V/5.90A	36.60	31.20	27.80
H - 1.9"	2x18V/5.00A	36.60	31.20	27.80
Wt - 3.0 lb	2x24V/3.58A	36.60	31.20	27.80
1000VA	2x50V/10.00A	\$91.70	\$78.40	\$69.00
OD - 6.3"	2x65V/7.69A	91.70	78.40	69.00
H - 2.4"				
Wt - 12.1 lb				

Dual secondaries may be used in parallel or in series.
*FOB Factory, (includes mounting washer and rubber pads).
Terms: VISA, MasterCard, COD or money orders—UPS charges added.

301-464-2100 TOROID CORPORATION OF MARYLAND
6000 Laurel-Bowie Rd., Bowie, MD 20715-4037

CIRCLE 287 ON FREE INFORMATION CARD

WHITE'S RADIO LOG



An up-to-date directory of North American AM, FM and TV stations including special section on world-wide shortwave stations. 136 pages, 5 1/2 x 7 1/2 inches, soft cover. \$4.95 plus \$1 postage in USA. **ELECTRONIC TECHNOLOGY TODAY INC., PO Box 240, Massapequa Park, NY 11762-0240.**

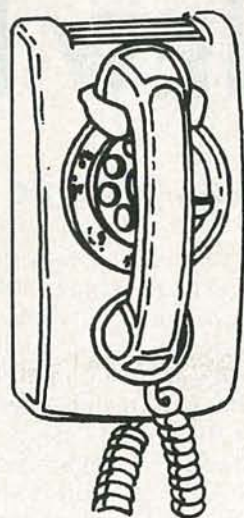

**CALL NOW
AND
RESERVE
YOUR SPACE**

- 6 x rate \$800.00 per each insertion.
- Reaches 229,044 readers.
- Fast reader service cycle.
- Short lead time for the placement of ads.

Call 516-293-3000 to reserve space. Ask for Arline Fishman. Limited number of pages available. Mail materials to: Engineering Admart, RADIO-ELECTRONICS, 500-B Bi-County Blvd., Farmingdale, NY 11735.

ASK R-E

continued from page 14

and assembly, it is possible to build a simple filter that provides as much as 30 dB of attenuation at the desired frequency. If you wish, two filter sections can be used to sharpen the notch and provide up to 80 dB of attenuation.

The operation of a transmission-line stub filter is based on some unique characteristics of a transmission line. A section of line that is one-half wavelength long and shorted at one end will appear as a short at the frequency of interest at the other end of the line. The basic idea is shown in Fig. 4-a. Purists

may insist that the spacing between stubs be 1/4 wavelength, but we have found through experimentation that, when using those filters to treat TVI problems, the stubs can be used as close together as is mechanically practical.

The physical length of a half-wave stub will be shorter than its electrical length because of the velocity factor, or propagation constant, of the cable from which the stub is built. The velocity factor, K, for RG-59/U 72-ohm coax is 0.66, and it's 0.83 for 300-ohm twin lead. The formula for a half-wave stub of coaxial line is:

$$L = (5906 \times K)/f$$

In that equation, L is the length in inches, K is the velocity factor of

the transmission line, and f is specified in MHz. So, to build a 103.9-MHz notch filter, $L = (5906 \times 0.66)/103.9 = 37.5$ inches.

Build the filter as shown in Fig. 4-b, with the stubs an inch or so longer than the calculated value. Connect the filter in the line between the antenna and the receiver, and then tune in the unwanted station. Now, starting at the far end of the stub, use a needle or a sharp pin to short the outer braid to the inner conductor in 1/4-inch steps until you find the point of maximum attenuation. Mark that point, increase the stub length about 3/4 inch and cut off the excess. Strip off 1/2 inch of insulation and solder the core to the braid. That should do it! **R-E**

NEW IDEAS

An easy-to-build flood alarm

IF YOU LIVE IN A LOW-LYING AREA, flooding can be a big problem. Indeed, awareness of rising water is sometimes a matter of life and death. (It's at least a matter of wet or dry items in the basement!) You can use the circuit described here to warn you of an impending flood condition. The circuit is very easy to build, and it's easy to modify to suit your application and the components in your junkbox. In addition, it can be adapted for use in other applications.

How it works

My circuit is a very simple switch that sets off a buzzer when the sensor shown in Fig. 1-a gets wet. The sensor is built from a salt-impregnated cloth sandwiched between two copper plates. When the sandwich gets wet, the salt provides a high-conductivity path for electricity to flow.

My circuit is shown in Fig. 1-b. I used a 2SC106 transistor because I happened to have one in my junkbox, but any medium- to high-power transistor will do. I used a variable resistor for R1, but a fixed resistor could be used. You can calculate the value that resistor should have from the following formulas, where I_B is the transistor's base current, h_{FE} is its DC current gain, I_C is the required load current, and V_{CC} is the supply voltage:

$$I_B = (2 \times h_{FE}) / I_C$$

$$R_B = (V_{CC} - 0.7) / I_B$$

My sensor has a resistance of 200-300 ohms; you'll have to take that resistance into account when calculating the value of the base resistor.

Construction

The sensor can be built from two pieces of PC-board material

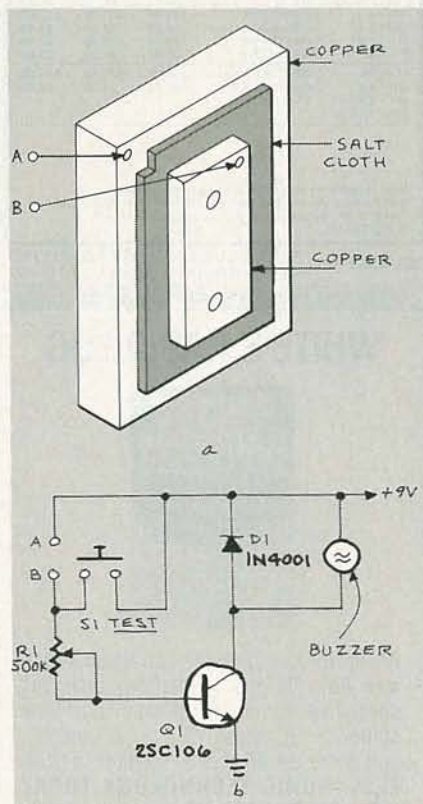

FIG. 1

about 1-1/2" on a side. Drill several holes through one piece to admit water. Soak a piece of cloth in a saturated salt solution, let it dry, and then sandwich it between the two pieces of PC board. Solder one wire to each inner face of the sandwich. Last, fasten the assembly together with nylon bolts or plastic electrical tape.

Run the wires from the sensor to the place where the circuit will be mounted, and connect them to the points marked A and B on the schematic. There is nothing at all critical about construction of the circuit, and you should feel free to experiment with different transistors and output devices.

For example, if you drive a small piezo-electric buzzer you may be able get by with a small transistor

NEW IDEAS

This column is devoted to new ideas, circuits, device applications, construction techniques, helpful hints, etc.

All published entries, upon publication, will earn \$25. In addition, for U.S. residents only, Panavise will donate their model 333—The Rapid Assembly Circuit Board Holder, having a retail price of \$39.95. It features an eight-position rotating adjustment, indexing at 45-degree increments, and six positive lock positions in the vertical plane, giving you a full ten-inch height adjustment for comfortable working.



I agree to the above terms, and grant **Radio-Electronics Magazine** the right to publish my idea and to subsequently republish my idea in collections or compilations of reprints of similar articles. I declare that the attached idea is my own original material and that its publication does not violate any other copyright. I also declare that this material has not been previously published.

Title of Idea

Signature

Print Name

Date

Street

City

State

Zip

Mail your idea along with this coupon to: **New Ideas Radio-Electronics, 500-B BI-County Blvd., Farmingdale, NY 11735**

BUY A SCOPE

GET A DMM FREE!

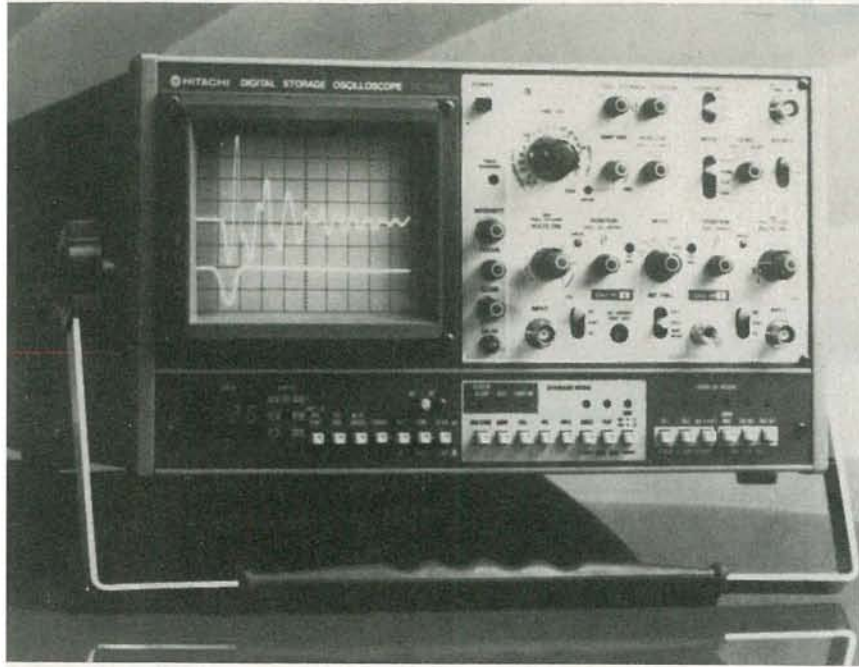

Joseph Electronics give you a **free 3½-digit DMM (Regularly: \$79.95)** with the purchase of any Hitachi Oscilloscope. For the best value on instrumentation for all your electronic needs CALL **JOSEPH ELECTRONICS TODAY!**

HITACHI VC-6041 UX Professional 40 MHz Digital Storage Oscilloscope. Features: Repeat Storage of Waveforms at 40 MHz • DC to 40 MHz range • 4000 words memory per channel • Storage of 10 MHz – One time events • Cursor Function • Probes • **Free! Midland DMM** Reg: \$4950 **\$4295**

HITACHI V-1100A 100 MHz Readout Oscilloscope for fast, easy and precise measuring. Features: Built-in computer • DC to 100 MHz range • Large 6 inch CRT • Quad channel • 8 Trace, delayed sweep • Digital Measurement • 5 Kv accelerating potential • Probes • **Free! Midland DMM** Reg: \$2490 **\$2195**

HITACHI V-222 High performance, lightweight 20 MHz portable oscilloscope: Features: Compact Design • 6 inch CRT with internal deflection • 1 Mv Sensitivity • Dual Trace • Auto Focus • DC to 20 MHz range • Vertical Trigger Mode • DC Offset • Probes • **Free! Midland DMM** Reg: \$715 **\$495**

HITACHI V-422 Same as Hitachi Model V-222 above, with range DC to 40 MHz • **Free! Midland DMM** Reg: \$925 **\$625**

HITACHI V-650F Best-selling Oscilloscope, 60 MHz, dual trace delayed sweep. Features: Large, bright state-of-the-art 6 inch CRT • High sensitivity of 10 V/div • Dual Trace • Delayed Sweep • Trigger View • Auto-Focus • Probes • **Free! Midland DMM** Reg: \$1195 **\$875**

HITACHI V-1050F Superb 100 MHz, Quad Trace Delayed Sweep Oscilloscope. Features: Large, bright 6 inch CRT • Quad Trace Operation (4 channels) • High Sensitivity • High Accuracy • Alternate Timebase Operation • 20 MHz bandwidth limiter • Full TV Triggering • 10x Magnification • Auto Focus • Probes • **Free! Midland DMM** Reg: \$1595 **\$1150**

Midland DMM 23-215 This pocket-sized DMM features: 3½ digit readout, .5% accuracy, 10 Meg input, and full overload protection to meet UL1244.

HURRY! SALE LIMITED TO QUANTITIES ON HAND

Call: 1 (800) 323-5925

In Illinois: (312) 297-4200



HANDLING CHARGES	
ORDER	ADD
\$0 - 999	\$10
\$1000 - 2499	\$15
\$2500 - up	\$20

Joseph Electronics

8830 N. Milwaukee Ave.,
Niles, IL 60648

Order for our new Joseph's Test Equipment Catalog, featuring 116 pages of tremendous savings on all 25 leading instrumentation lines. This catalog is free, too.

DRAWING BOARD



ROBERT GROSSBLATT,
CIRCUITS EDITOR

Memory expansion

A FEW MONTHS AGO WE DISCUSSED memory circuits, and our discussion generated a lot of mail. The most-often-asked question was how to put large amounts of memory together—how to organize it. Now how you go about managing large amounts of memory depends on what kind of memory you're going to use and what you plan on doing with it. In our demonstration circuit, management wasn't much of a problem because we only used one memory IC, and all we wanted was to see how it worked. But if you wanted to use more memory you would have to think about how to organize it.

A good example of memory management can be found inside a typical personal computer. In the usual 64K machine, eight 4164's will be put side by side to get a memory system that is eight bits (or one byte) wide. All kinds of great things can be done with that memory if it's managed properly. The video can be mapped directly into memory, soft switches can be set up than can be "thrown" one way or the other by accessing certain locations in memory. But before we get to the exotic stuff, let's take a look at the basics.

In Fig. 1 I've connected four 5101's (the IC we used in our original memory demonstration circuit) and arranged them in two different ways. Two IC's are placed side by side to widen the bus to eight bits, and two other IC's are put in parallel with the first two. That gives us a memory system that's 512 bytes long and eight bits wide. It should be obvious that that arrangement won't work if we simply leave the outputs of each pair-member connected together.

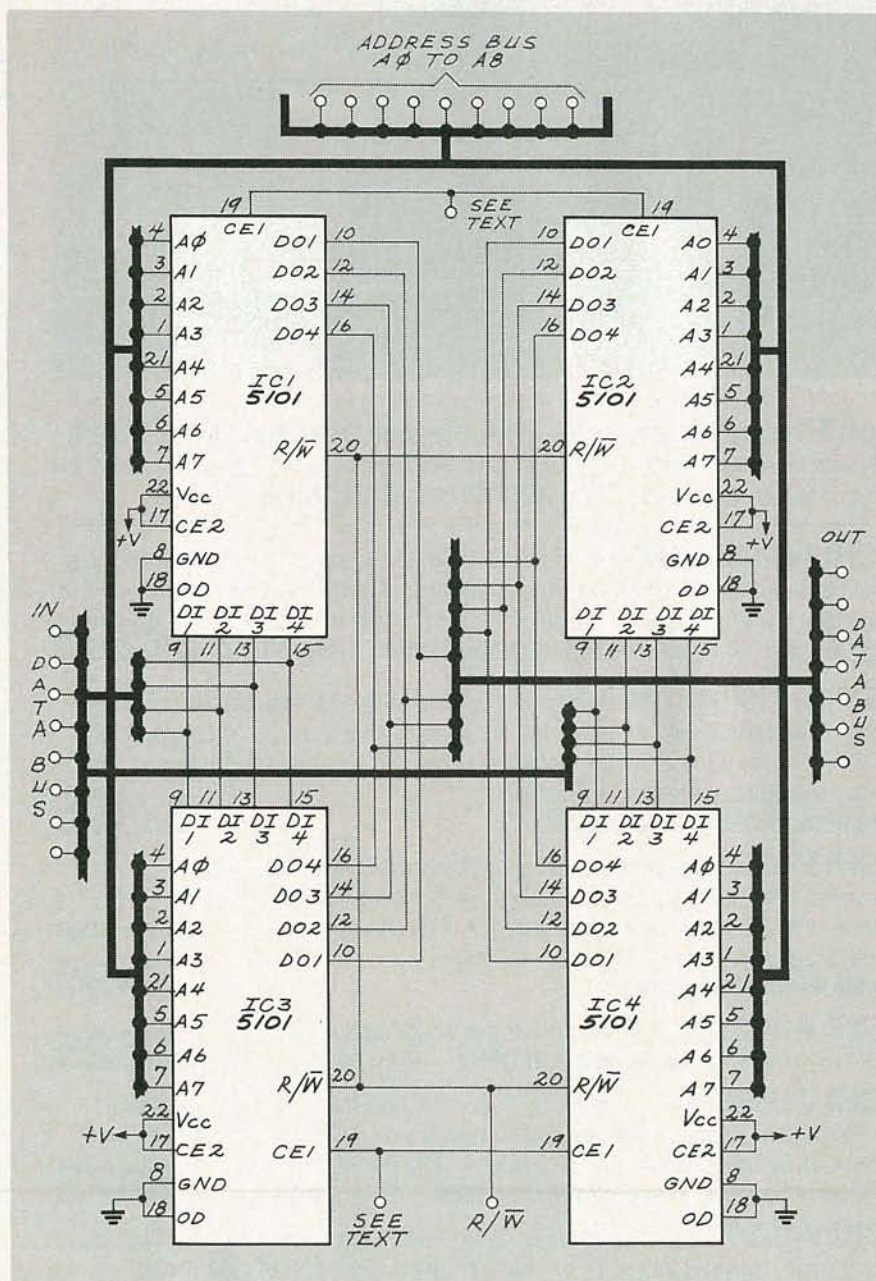

FIG. 1

Hence we need some circuitry to manage the system.

Memory management is really an old problem. In the early days

Which Way To YOUR Future?

Are you at a crossroads in your career? Have you really thought about it? Are you *planning* for your future, or perhaps refusing to face the subject? Which way will you go — down the same old road? Or are you ready for something else?

In electronics you can't stand still. If you are not moving ahead, then you're falling behind. At the crossroads of your career, various choices are available — and, yes, *decisions* have to be made.

Which road will you take — one that doesn't go where you want to be, or one that leads to hard work *but also* to the better life? Ah, decisions, decisions!

Career decisions are so important that you need all the *input* you can get before locking-in on one of them. Grantham College of Engineering offers you *one* source of input which may help you in making that decision. It's our free catalog.

Ask for our free catalog and you may be surprised to learn how it is easily possible to earn a B.S. degree in electronics without attending traditional classes. Since you are already in electronics (you are, aren't you?), you can complete your B.S. degree work with Grantham while studying at home or at any convenient place.

But don't expect to earn that degree without hard work. Any degree that's worth your effort can't be had without giving effort to the task. And of course it is what you learn in the process, as much as the degree itself, that makes you stand out above the crowd — that places you in an enviable position, prestige-wise and financially.

Grantham College of Engineering
10570 Humbolt Street
Los Alamitos, California, 90720

**This booklet
FREE!**

This free booklet explains the Grantham B.S. Degree Program, offered by independent study to those who work in electronics.



for
**FREE
Booklet
CLIP
COUPON**
and mail in
envelope or
paste on
postal
card.

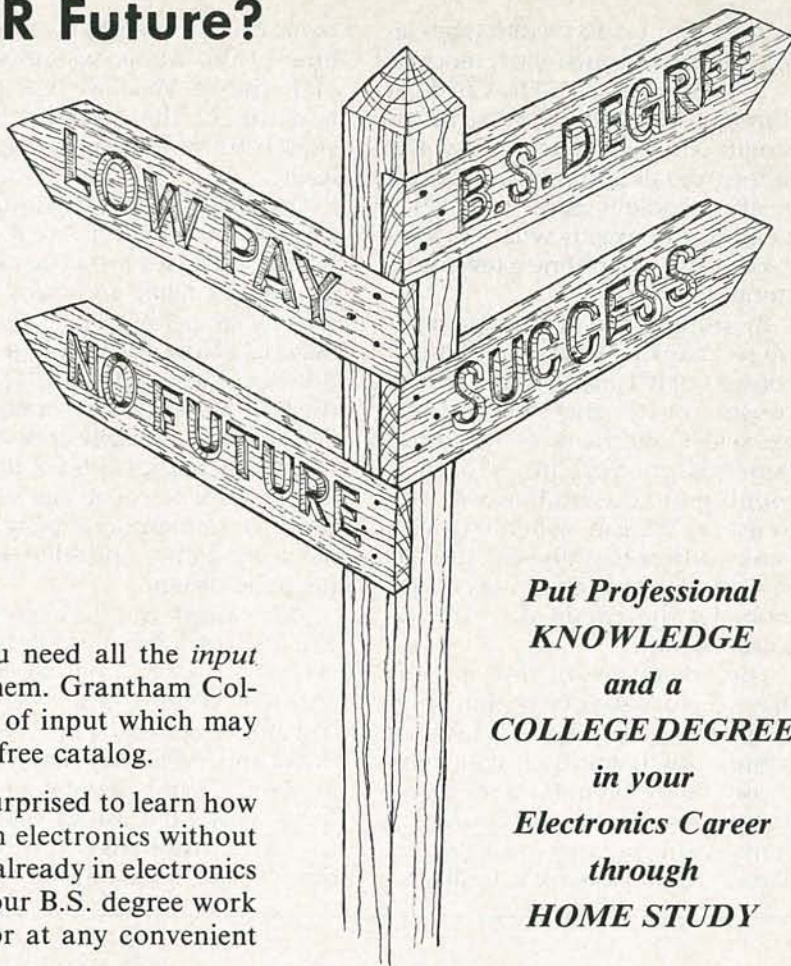

*Put Professional
KNOWLEDGE
and a
COLLEGE DEGREE
in your
Electronics Career
through
HOME STUDY*

Grantham offers this program, complete but without laboratory, to electronics technicians whose objectives are to upgrade their level of technical employment.

Recognition and Quality Assurance

Grantham College of Engineering is accredited by the Accrediting Commission of the National Home Study Council, as a degree-granting institution.

All lessons and other study materials, as well as communications between the college and students, are in the English language. However, we have students in many foreign countries; about 80% of our students live in the United States of America.

Grantham College of Engineering R-04-86
10570 Humbolt Street, Los Alamitos, CA 90720

Please mail me your free catalog which explains your B.S. Degree independent-study program.

Name _____ Age _____

Address _____

City _____ State _____ Zip _____

APRIL 1986

bus contention was avoided by OR-ing parallel outputs. Most modern IC's, including our 5101, can float (three-state) their outputs, so arranging the bus setup is easy. But before we talk about how we'd solve the problem here, let's get a clear idea of exactly what we want to do—and let's define a few terms along the way.

By putting the IC's in parallel, we're "banking" memory. Bank 1 consists of IC1 and IC2, and Bank 2 consists of IC3 and IC4. The way we select one bank or the other depends on what the system is supposed to do and how we want to use it. We can switch between banks with something as crude as a mechanical switch, or, as is common, let the circuit do it for us automatically.

The advantage of the latter is that we can make our system operate exactly as if we had 512 bytes of continuous memory. If you think about the problem for a moment, it becomes obvious that the key to banking the memory is careful use of each IC's enable pins. Only one

bank can be enabled at any one time or the whole system will go up in smoke. What we have to find is a trigger that we can use to switch between banks automatically.

The best trigger is the address of the desired location. We'll assign Bank 1 addresses from 000 to 0FF (0 to 255 decimal), and Bank 2 addresses from 100 to 1FF (256 to 511 decimal). Now our problem is well defined. Any address placed on the bus that's less than or equal to 0FF will automatically access Bank 1, and any address above that will access Bank 2. As you can see, our problem in memory management has turned into a problem in simple logic design.

The easiest way to accomplish the desired bank selection is shown in Fig. 2. Since we have a 512-byte system ($512 = 2^9$), there will be 9 address lines. Any address above 0FF will place a high level on the most significant bit, so that's what we'll use to select between our two banks. The 5101 has three Chip Enable pins (17, 18, and

19), but, as you'll remember from our last examination of that IC, they do different things to the IC.

Pin 17 switches between normal and low-power standby operation; pin 18 enables the outputs; and pin 19 enables the IC as a whole. In our circuit we want to control the entire IC, since when a bank is switched off we want to inhibit both reads and writes. A look at the IC's data sheet reveals that we have to keep pin 17 high, pin 18 low, and we must use the high address (A9) line to control pin 19.

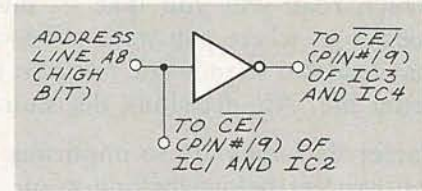

FIG. 2

The inverter in Fig. 2 does the bank switching for us. When bank 1 is selected, bank 2 is deselected. And it's all done automatically.

continued on page 108

Special Purchase
LAP COMPUTER
FULL FACTORY WARRANTY

BUILT IN 300 BAUD MODEM
Built in spread sheet, similar to Lotus Terminal Emulator to Communicate with Personal or Mainframe Computers

IT'S A HANDS FREE PHONE
Comes with Rechargeable Batteries and Charger.
Options Available: Serial or Parallel Port, Workslate Printer

workslate
BY CONVERGENT TECHNOLOGIES

THE MOST PORTABLE TERMINAL

OUR BEST PRICE EVER **\$295.00** ORIGINALLY \$195.00

INCLUDES FREE SOFTWARE WORTH \$88.00
Information and Consultant Services Software

OTHER SOFTWARE PACKAGES • WITH PURCHASE ONLY
Case Management \$25.00 Intelligence Analysis \$15.00
Financial Statements \$25.00 Real Estate \$25.00
Inventory Analysis \$15.00 Electronic Mail \$25.00
Marketing Management \$15.00 Loan Analysis \$15.00
Sales Responder \$15.00 Portfolio Analysis \$15.00
Travel

Keyboard: 60 keys • Typewriter-style keyboard and calculator pad.
Power: NiCad rechargeable battery, AC adaptor/recharger or 4AA alkaline batteries.
Software: Built in handles worksheets for Financial analysis, phone, calendar and communications management. Internal Memory up to 12 8" x 11" pages. Microcassettes store up to 10 worksheets or 45 minutes of audio information.

15 Day Money Back Guarantee

CEC 1745 Adrian Road, No. 1
Burlingame, CA 94010
415/342-4058
800/228-3411

PRINT™
Products International Inc.

8929 Brookville Road • Silver Spring, Maryland 20910

800-638-2020

Call Our Toll Free Number

In Maryland Call 301-587-7824

FREE CATALOG
Equipment, Tools & Supplies for Electronic Maintenance & Service.

- ▶ Pace Desoldering and Printed Circuit Board Repair Products
- ▶ 3M Static Control Products, Work Stations, Shielding Bags
- ▶ Huntron Test Instruments
- ▶ Lindstrom Hand Tools
- ▶ Print Tool Cases
- ▶ Cooper Tool Group, Weller, Crescent, Xcelite
- ▶ Brand Name Tools and Supplies for Repairs in the Field or Depot

NEW CATALOG

RAGE®
Systems for Development, Production, and Repair of Electronic Assemblies

MBT-100
Desoldering System

MBT-200
Desoldering and Soldering System

COMMUNICATIONS CORNER



HERB FRIEDMAN
COMMUNICATIONS EDITOR

Broadband amplifiers

IT'S AMAZING HOW MUCH WE TAKE FOR granted about tuned circuits nowadays because of the nature of modern solid-state devices. When I was an active experimenter, almost everything involving radio frequencies was done with tuned circuits; and that generally meant that extensive mounting, switching and shielding hardware had to be used. Today we can toss a 50-cent solid-state device, along with a few resistors and capacitors, into a plastic box, and we'll end up with a broadband amplifier with a gain that's more stable than I could ever hope to attain from an old-style tuned circuit.

In the good old days, receiver preselectors and outboard RF preamplifiers needed lots of extra gain to receive signals that today would be considered at least S7. And most of the legendary shortwave receivers in the old days were really dogs compared to modern transistorized shortwave radios.

Most of the gain in those circuits was provided by the tuned circuit rather than the amplifying device, a vacuum tube with an input impedance between 1 and 100 megohms. In the circuit shown in Fig. 1, L1 is supposed to match the impedance of the antenna system

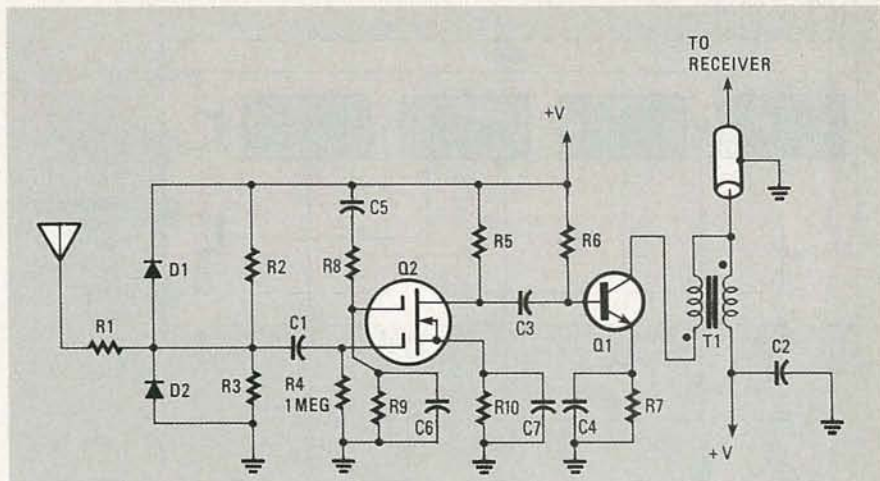

FIG. 2

to the impedance of the resonant circuit created by L2 and C1.

The turns ratio of L2 to L1 was often 60/1, 100/1, or even higher. That's called an "infinite-impedance matching transformer." In any case, since L2 and C1 are resonant, the effective voltage across C1, hence, the input to the amplifier, can easily be 20 to 40 dB greater than the voltage attained by a simple step-up transformer. You can see why RF preamplifiers were so popular with shortwave listeners!

What about L3 and L4? Their primary function is impedance transformation, rather than power transformation. They match the high-impedance output of the preamplifier to the low-impedance input of the receiver to which the preamplifier is connected. The point is that, especially in the less expensive and unsophisticated boosters used for shortwave listening, most of the signal gain came from the L2/C1 circuit.

For the experimenter, the major

problem with the tuned preamplifier was that the input and output coils interacted with each other. Since the overall stage gain was so high, the circuit became unstable and broke into self-oscillation if even the smallest amount of energy from the output coil fed back to the input coil.

Another problem with tunable preamplifiers was the tuning itself. The tuning range was limited by the values of the coils and capacitors, so an all-band HF preamplifier would require four, five, or even more band-switched coils to cover the frequency range from the broadcast band through 30 MHz. And every extra switch and coil increased overall circuit losses and made the device more susceptible to instability.

The broadband amplifier

Thanks to solid-state devices, today's shortwave preamplifiers can dispense with input coils and tuning circuits when used at frequencies as high as 30 MHz, and

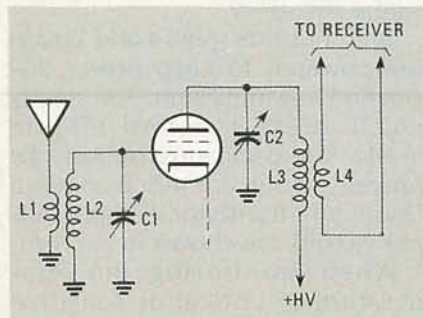

FIG. 1

STATE OF SOLID STATE

Temperature-alarm IC



ROBERT F. SCOTT,
SEMICONDUCTOR EDITOR

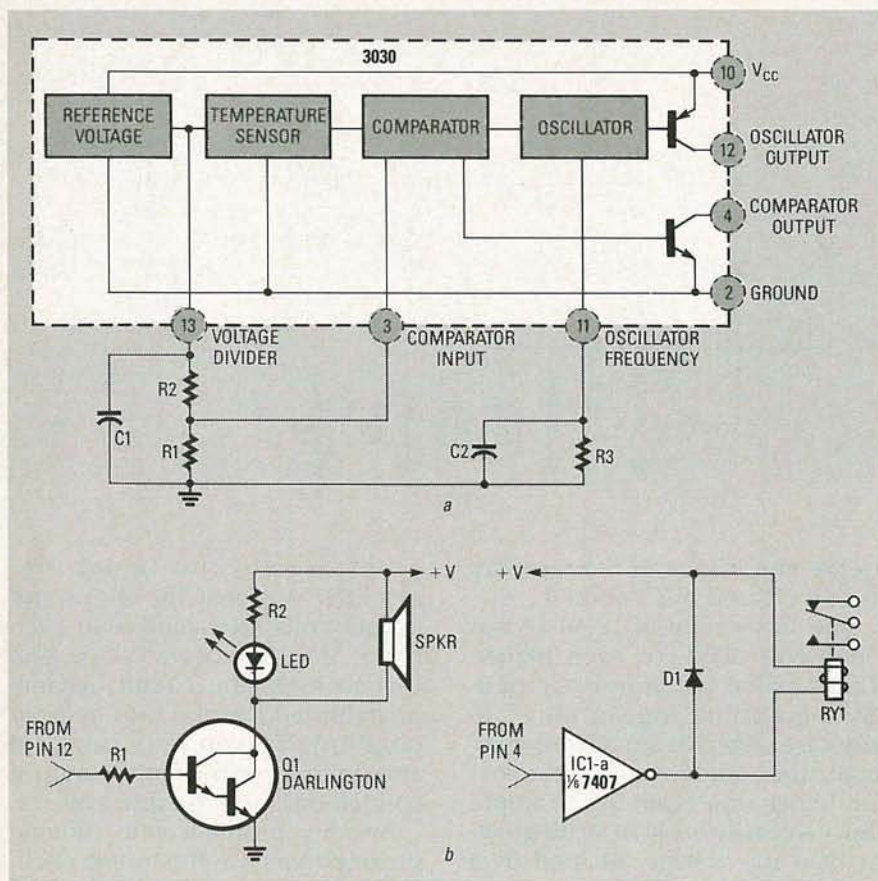

FIG. 1

DETECTORS, MONITORS, AND ALARMS make up an interesting line of monolithic devices from Intech. One of those is the 3030 temperature alarm that can flash a light, sound an alarm, or shut down equipment when the temperature of the IC's package exceeds a preset level. Features include a wide temperature range and excellent repeatability; an oscillating output tone that, with proper interface circuitry, can drive a speaker; a TTL-compatible

output; low current drain; and an accurate, externally-available, temperature-compensated reference voltage.

The 3030 may be used as a fire-alarm temperature sensor; in addition, it may be used to shut down power supplies or other equipment automatically; and it can be used as a temperature controller in heating and refrigerating appliances.

A block diagram of the 3030 is shown in Fig. 1-a, along with the

off-IC components that determine its mode of operation: R1-R3, C1, and C2.

The reference circuit develops a voltage that is independent of temperature and power-supply voltage. That voltage drives the off-IC voltage divider, composed of R1 and R2, and an on-IC temperature sensor that consists of two diodes. When the power-supply voltage drops below the reference voltage set by the voltage divider, the comparator activates the oscillator, which delivers an alternating signal to pin 12 of the IC; a steady-state output current is also delivered to pin 4. The comparator has a small amount of hysteresis to ensure positive snap action.

Resistor R3 and capacitor C3 control the oscillator's frequency and duty cycle. Capacitor C1 stabilizes the reference voltage and prevents transients, glitches, and spikes from interfering with the operation of the sensitive comparator.

Intech provides information on several methods of calibrating the alarm for the desired temperature trip-point. Accuracy is $\pm 4^\circ\text{C}$ when the recommended type of high-precision resistor is used.

Using the 3030

Both outputs (pins 4 and 12) are low-powered to keep power dissipation to a minimum. The steady output works at normal TTL-gate levels. The oscillating output can provide about 0.5 mA to drive a Darlington transistor. Sample output circuits are shown in Fig. 1-b.

When monitoring the temperature of critical or sensitive

components, you can mount the 3030 in direct contact with the component's heatsink. The steady output can be used to deactivate the circuit when it overheats, and to restore power later when temperature drops to a safe level.

The 4-page data sheet and application note for the 3030 temperature alarm contains full electrical specifications for the device, along with diagrams showing applications like a delayed alarm; a low-power temperature controller that turns a heater on when the temperature goes below the set point, and off when the temperature rises above the set point; and a cooler control to turn on a fan, a low-power compressor, or a refrigerator when the temperature rises above the trip point.

The 3030 costs \$19.00 in quantities ranging from 1 to 24. For data sheets and information on availability, write to **Intech Inc.**, Micro-Circuit Division, 2270 Martin Ave., Santa Clara, CA 95050.

Thyristor handbook

Thyristor Device Data is a comprehensive new book containing over 600 pages of data on SCR's, Triac's, GTO's (Gate Turn-Off thyristors), SIDAC's (Triac-like devices), and triggers. It includes sections on theory and applications, cross-reference tables, a device-selector guide, and a complete set of data sheets. It is available through all Motorola sales offices and distributors. For further information contact **Motorola Semiconductor Products**, P.O. Box 20912, Phoenix, AZ 85036.

R-E

COMMUNICATIONS CORNER

continued from page 105

sometimes even higher. What we use instead is a broadband (or wideband) preamplifier. An example of such a circuit is shown in Fig. 2; that schematic is a simplified version of MFJ's *Remote Active Antenna*.

First, notice that there is no tuned network at the input to the circuit. The antenna is coupled directly to the high-impedance input of the FET. The two diodes, D1 and D2, and resistor R1 serve only

to protect the FET against excessive input voltages. Direct coupling is possible because the solid-state devices used in modern shortwave radios provide sensitivity approaching $0.1 \mu\text{V}$, which is much more sensitive than that provided by tube receivers. Therefore, we don't need the extra gain provided by the tuned circuit to reach the theoretical sensitivity limits of such circuits.

Between the FET and Q1, which matches the medium-impedance output of the FET to the low-impedance of the associated receiver's antenna input, we can easily attain an overall untuned—wide-band—gain of 20 to 30 dB. And when that gain is added to the typical 0.1 or $0.25 \mu\text{V}$ sensitivity of modern shortwave receivers, it becomes easy to dig out signals that usually can't be heard.

And because there aren't any tuned circuits, the wideband solid-state preamplifier is much less susceptible to instability. In fact, modern homebrew RF preamps hardly ever break out into self-oscillation. If there is a problem with instability, it is generally caused by the antenna input of the shortwave radio radiating RF energy back to the preamplifier.

Although it is possible to design wideband preamplifiers for just about any frequency range without tuned circuits, in reality most preamps *do* require some form of tuned circuit, if only for impedance matching. For experimenters and hobbyists interested primarily in frequencies from 100 kHz to 30 MHz, it's possible to avoid tuned circuits and still get 10 to 20 dB of extra gain. More than 20 dB requires the use of tuned circuits.

You might be asking, "Why does a solid-state device provide greater gain at VHF frequencies than a tube?" One major reason is inter-electrode capacitance. In solid-state devices like the 40673 FET, which is used in many RF preamplifier circuits, the small amount of inter-electrode capacitance between gate and source is simply not enough to bypass much of the RF signal to ground. That small amount of capacitance also increases stability by reducing feedback between input (gate) and output (drain).

R-E

NEW IDEAS

continued from page 100

like a 2N2222, or perhaps no transistor at all. You could use a PNP transistor simply by reversing the polarity of the diode and the battery supply.

You could also drive a relay to provide a higher-current or more-isolated output. Just be sure to include a reverse-biased diode as shown.

I included a small momentary push-button switch as a battery test; unless you're prone to a lot of flooding, your battery should last its entire shelf life.

For use as a flood alarm, the sensor should be mounted horizontally near the floor of your basement. But the circuit can also be used in other applications. For example, the sensor could be mounted vertically in a sump-pump hole, horizontally on the floor of your freezer, or vertically as a boat's "bail-out" alarm.—*Jim Cook*

R-E

Imagine.

Imagine a life spent wondering if, and when, a disease that destroys your body, your mind, your life will strike. That's the shadow under which every child of a Huntington's Disease victim lives. But now there's hope. Real hope.

Your contributions helped us find the marker, now they can help us find a cure. Please give generously to the National Huntington's Disease Association.

NATIONAL HUNTINGTON'S DISEASE ASSOCIATION
National Huntington's Disease Association
1182 Broadway, Ste. 402, NY, NY 10001

THIS SPACE CONTRIBUTED BY THE PUBLISHER

APRIL 1986

NEW PRODUCTS

continued from page 43



CIRCLE 3.14 ON FREE INFORMATION CARD

where eventually enough of them accumulate for lasing to take place. Time-to-lase is given as between two and 14 hours, depending on weather, season, and latitude, and on the stamina of the operator.

The *Lase-O-Whoosh*, including manual, flexible hose, bicycle clamp, and adapter valves, is available for a limited time only for \$19.95 postpaid from **FBN Marketing**, Dead Letter Office, Josephson Junction, IC 68000 **R-E**

This publication is available in microform from University Microfilms International.



Please send information about these titles:

Name _____

Company/Institution _____

Address _____

City _____

State _____ Zip _____

Phone () _____

Call toll-free 800-521-3044. In Michigan, Alaska and Hawaii call collect 313-761-4700. Or mail inquiry to: University Microfilms International, 300 North Zeeb Road, Ann Arbor, MI 48106.

ROBOTICS

continued from page 81

The IM6402 is a CMOS UART (Universal Asynchronous Receiver/Transmitter). It converts parallel data from the microprocessor's data bus to serial data that can be transmitted according to RS-232 signal levels. Similarly, it converts incoming serial data to parallel data that is acceptable to the host microprocessor. Level translation is handled, in Fig. 1, by IC1-a, a 1489 line receiver, and by IC2-a, a 1488 line driver.

The parallel connection

Of course, you can connect devices like motors to the *Model 100's* parallel interface. Just be sure to provide appropriate interface circuitry—you can't control a 6-HP motor with a CMOS buffer! The power supply for the interface, the motor, and the sensors should be separate from the *Model 100's* internal supplies. Just connect the grounds of all circuits together. The *Model 100's* ground is available at pin 7 of the RS-232 connector.

More memory

The *Model 100* comes with 8K (or 24K) of battery-backed-up CMOS RAM. That means that, when the power switch is off, the RAM modules still receive power, so the contents of the RAM are not lost forever.

I say *modules* because the *Model 100's* RAM IC's are not industry-standard parts. The reason is that, when the *Model 100* was designed, the 8K × 8 RAM did not exist, so the *Model 100's* designers built small modules, each of which contained four 2K × 8 RAM's. You can get a 24K *Model 100* from Radio Shack for several hundred dollars more than the 8K unit, or you can buy extra RAM modules from third-party vendors for about \$30.00 each.

You could also build your own RAM expansion using several 6264 8K × 8 RAM IC's. Don't tackle that unless you know what you're doing. Radio Shack sells a technical reference manual for the *Model 100* that should help you figure out the proper address decoding for that computer.

Programming

For those of you who are familiar with BASIC, you may be surprised by some of the *Model 100's* control features. For example, the *Model 100* supports interrupts; in fact, several of the machine's I/O devices are treated as interrupts! You can write programs that will respond to interrupts from the communications port, the built-in MODEM, the built-in clock, and even the keyboard's eight function keys, using the following statements:

- ON COM GOSUB
- ON MDM GOSUB
- ON TIME\$ GOSUB
- ON KEY GOSUB

In case you're wondering, I don't work for Radio Shack. It's just that I am so impressed with the *Model 100* that I had to tell you about some of its special features. I am currently working on a number of intelligent interfaces for the machine, and I have interfaced it to a Heath *HERO-1*. If you are interested in learning more about that, drop me a line. **R-E**

DRAWING BOARD

continued from page 102

If you want to add memory to the system, you can build on that technique. The only limitation is the width of the address bus. We've got to have a spare address line around to do the switching for us. However, nothing stays simple forever.

Consider this scenario: You have a 64K memory system that's controlled by an eight-bit microprocessor. Consequently, all the address lines are used to do real addressing. Suppose you want to add some more memory to the system. There are several reasons for doing that:

- As an alternate 64K bank for data storage, etc.
- To increase continuous memory in the system to 128K.

The problem then is to control the memory when the address bus is limited to sixteen bits ($2^{16} = 65,536$), or 64K. And *that*, as you know, is a real-world problem. We'll show you how to tackle that problem next time. **R-E**

MARKET CENTER

SATELLITE TELEVISION

CONSUMER information package don't be ripped off! Get the facts about satellite TV before you buy. Covers such topics as equipment suppliers, buying at wholesale, installation and scrambling. This is information you can not afford to be without. Send \$12.95 to **BEST SATELLITE TV**, RD #3 Old Freedom Plains RD, Poughkeepsie, NY 12603.

SUPER LNA kits, dx tv preamps, microwave components, ir detectors. **LSI**, Box 7553 Jackson, MS 39204.

CABLE TV secrets - the outlaw publication the cable companies tried to ban. HBO, movie channel, showtime, descramblers, converters, etc. Suppliers list included. \$8.95. **CABLE FACTS**, box 711-R, Pataskala, OH 43062.

CLASSIFIED AD ORDER FORM

To run your own classified ad, put one word on each of the lines below and send this form along with your check to:

Radio-Electronics Classified Ads, 500-B Bi-County Boulevard, Farmingdale, NY 11735

PLEASE INDICATE in which category of classified advertising you wish your ad to appear. For special headings, there is a surcharge of **\$23.00**.

() Plans/Kits () Business Opportunities () For Sale
() Education/Instruction () Wanted () Satellite Television

Special Category: \$23.00

PLEASE PRINT EACH WORD SEPARATELY, IN BLOCK LETTERS.

(No refunds or credits for typesetting errors can be made unless you clearly print or type your copy.) Rates indicated are for standard style classified ads only. See below for additional charges for special ads. **Minimum: 15 words.**

1	2	3	4	5
6	7	8	9	10
11	12	13	14	15 (\$42.75)
16 (\$45.60)	17 (\$48.45)	18 (\$51.30)	19 (\$54.15)	20 (\$57.00)
21 (\$59.85)	22 (\$62.70)	23 (\$65.55)	24 (\$68.40)	25 (\$71.25)
26 (\$74.10)	27 (\$76.95)	28 (\$79.80)	29 (\$82.65)	30 (\$85.50)
31 (\$88.35)	32 (\$91.10)	33 (\$94.05)	34 (\$96.90)	35 (\$99.75)

We accept MasterCard and Visa for payment of orders. If you wish to use your credit card to pay for your ad fill in the following additional information (Sorry, no telephone orders can be accepted.):

Card Number _____ Expiration Date _____

Please Print Name _____ Signature _____

IF YOU USE A BOX NUMBER YOU MUST INCLUDE YOUR PERMANENT ADDRESS AND PHONE NUMBER FOR OUR FILES. ADS SUBMITTED WITHOUT THIS INFORMATION WILL NOT BE ACCEPTED.

CLASSIFIED COMMERCIAL RATE: (for firms or individuals offering commercial products or services) \$2.85 per word prepaid (no charge for zip code)...**MINIMUM 15 WORDS.** 5% discount for same ad in 6 issues; 10% discount for same ad in 12 issues within one year; if prepaid. **NON-COMMERCIAL RATE:** (for individuals who want to buy or sell a personal item) \$2.30 per word, prepaid...no minimum. **ONLY FIRST WORD AND NAME** set in bold caps at no extra charge. Additional bold face (not available as all caps) 50¢ per word additional (20% premium). Entire ad in boldface, add 20% premium to total price. **TINT SCREEN BEHIND ENTIRE AD:** add 25% premium to total price. **TINT SCREEN BEHIND ENTIRE AD PLUS ALL BOLD FACE AD:** add 45% premium to total price. **EXPANDED TYPE AD:** \$4.30 per word prepaid. All other items same as for STANDARD COMMERCIAL RATE. **TINT SCREEN BEHIND ENTIRE EXPANDED TYPE AD:** add 25% premium to total price. **TINT SCREEN BEHIND ENTIRE EXPANDED TYPE AD PLUS ALL BOLD FACE AD:** add 45% premium to total price. **DISPLAY ADS:** 1" x 2 1/4" - \$310.00; 2" x 2 1/4" - \$620.00; 3" x 2 1/4" - \$930.00. **General Information:** Frequency rates and prepayment discounts are available. **ALL COPY SUBJECT TO PUBLISHERS APPROVAL. ADVERTISEMENTS USING P.O. BOX ADDRESS WILL NOT BE ACCEPTED UNTIL ADVERTISER SUPPLIES PUBLISHER WITH PERMANENT ADDRESS AND PHONE NUMBER.** Copy to be in our hands on the 12th of the third month preceding the date of the issue. (i.e., August issue copy must be received by May 12th). When normal closing date falls on Saturday, Sunday or Holiday, issue closes on preceding working day.

SATELLITE TV VIEWERS

Get the most complete weekly listings. Send \$1 for sample copy.

Satellite TV Week

P.O. Box 308E, Fortuna, California 95540
800-358-9997 (U.S.) • 800-556-8787 (Calif.)
707-725-2476 (all others)

E.Z satellite kit complete system \$995.00 and \$1995.00 computer print-out of your location \$9.95. Master Card/Visa **IN-X-SALES**, Box 45, Tilton, NH 03276. (603) 286-3082.

THE LNA specialists! Brand name, lowest noise, lowest prices! We will not be undersold! Send for prices **LNA**, 201 E Southern, Suite 100, Tempe, AZ 85282

BUILD your own satellite TV receiving system and save! Instruction manuals, schematics, circuit boards, parts kits! Send stamped envelope for complete product listing: **XANDI**, Box 25647, Dept. 21Z, Tempe, AZ 85282.

SATELLITE systems \$449. Name brands. Quantity discounts. Information \$1.00. Catalog \$2.00. **STAR-LINK, INC.**, 2603-16R Artie, Huntsville, AL, 35805.

INVENTORS

INVENTORS can you profit from your idea? Call AMERICAN INVENTORS CORPORATION for free information. Over a decade of service. 1-800-338-5656. In Massachusetts call (413) 568-3753.

CABLE-TV

DEALERS wanted: Channel 2,3, and 4 notch filters. Money back guarantee. Send \$15.00 for sample and quantity price list. Specify channel(s). **GARY KURTZ**, Box 291394, Davie, FL 33329.

REEL-TO-REEL TAPES

AMPEX professional series open reel tape. 1800-or 2400-feet on 7-inch reels. Used once. Case of 40. \$45.00. 10 1/2 x 3600 feet and cassettes available. MasterCard Visa. **VALTECH ELECTRONICS**, Box 6-RE, Richboro, PA 18954. (215) 322-4866.

No previous experience necessary

LEARN PROGRAMMING



Master computers in your own home at your own pace in your spare time. Learn even before you decide on a computer.

BE YOUR OWN COMPUTER EXPERT

Programming is the best way to learn to use computers, and we can show you the best—and most economical—way to learn programming!

Send today for your free information package. No obligation. No salesman will call.

HALIX INSTITUTE
CENTER FOR COMPUTER EDUCATION DEPT. 49 4
1543 W. OLYMPIC, #226
LOS ANGELES, CA 90015-3894

YES! Send me free information on how I can learn about computers and programming at home!

Name _____
Address _____
City _____ State/Zip _____

APRIL 1986

MASTERCARD AND VISA are now accepted for payment of your advertising. Simply complete the form on the first page of the Market Center and we will bill.

FOR SALE

SELL blank video cassettes. Super high grade Olympia VHS T-120. Fully guaranteed. Only \$3.49 your cost. Add \$5.00 shipping and handling for any quantity. **STRANDBERG**, 1001 S. Elm Street, Greensboro, NC 27406. Telephone (919) 274-3775. Check, M. O., VISA or MasterCard account number & expiration date.

ELECTRONIC surveillance: Amazing reports reveal secret techniques used by professionals! **A.T.I.S.**, 61 Gatchell, Buffalo, NY 14212.

CABLE-TV converters—All major brands. Wireless remotes with volume. Wired remotes. Cable and video accessories. Cablemaster distributor. Lowest prices. Ship C.O.D. catalogs \$3.00, **SONE ASSOCIATES**, 5 Broadway, Suite 201, Troy, NY 12180. (518) 274-0608.

CABLE-TV filters for elimination of undesirable signals. (50 dB notch) channels available: 2 through 8; 14(A) through 22 (I). Send \$20. each. **money back guarantee**. Quantity discounts. **CATV**, Box 17621, Plantation, FL 33318.

CATALOG built cable converters, N12 Minicord \$98, MLD1200 \$98 more. Many microwave converters, satellite systems, pulse descrambler kits \$79. Built \$120, SYNC restorer kit \$99, built \$170 satellite

descrambler kit \$119, built \$190. Surge, RFI protectors from \$14. Hobby kits. \$1.00 **MINUTE KITS**, Box 531, Bronx, NY 10461

ELECTRONIC tubes—radio, TV & industrial types—huge inventory. Call toll free (800) 221-5802 or write Box **ESC TRANSLETRONIC, INC.** 1365 39th St., Brooklyn, NY 11218. (718) 633-2800.

BUGGED? Wiretapped? Find out fast. Countermeasures equipment catalog \$1. **CAPRI ELECTRONICS**, route 1R, Canon, GA 30520.

CABLE-TV converters and descramblers. Low prices, quality merchandise, we ship C.O.D.. Send \$2.00 for catalog. **CABLETRONICS UNLIMITED**, P.O. Box 266 South Weymouth, MA 02190. (617) 871-6500

WANTED: Western Electric RCA, McIntosh, Marantz, Levinson, Tannoy, Dynaco, Altec, JBL tubes speakers, amplifiers. (713) 728-4343. **MAURY** 11222 Atwell, Houston, TX 77096.

TEKTRONIX 500—series oscilloscopes either repairable or overhauled. SASE for test equipment specials. **RUBIYAT** (914) 937-2535, 117 N. Ridge St. Rye Brook, NY 10573

COMPUTER aided design of phase loops. Disk for Commodore 64. \$10. **KINGSBURY** 10426 Burned Oak Ln. Escondido, Calif. 92026

APPLE II logic analyzer card: 8 channels, 26 MHz. Upgradeable to 48 channels or 52 MHz. Microprocessor disassembly pads and complete systems available. Literature, send SASE **BETANCOURT**, 2331 Holly Spring Dr., Silver Spring, MD. 20904.

ANTIQUÉ Radio Classified—Published monthly—features articles, regular columns, photos and ads. Sample \$1.50. **A.R.C.**, 9511-23 Sunrise, Cleveland, Ohio 44133.

ELECTRONICS, exclusives, surplus and more. Send \$1.00 (refundable) for two discount catalogs. Add another \$1.00 and get 8 X-acto knife blades! **JELKINS**, 311 Shirley Street, Boston, MA 02152

DESCRAMBLER manuals, sinewave, gated pulse, SSAVI, \$4.00 each, all three \$10.00 **BNF**, 6690 7

Mile, S. Lyon, MI 48178

ASSORTMENT #103 - consisting of **Toko coils** 144LY-120K, 520 - HN-3000023, **BKAN-K5552AXX (2); PCB; transistors** 2N3904 (2), BFQ85 (Sub); **IC's** 7812, 74123, MC1330A1P; **Diodes** 1N914, 1N5231B. Only \$25.00. Coils (only) \$8.00/SET **AC Adapter** \$6.00. **Free shipping**. MC/Visa/COD. Toll free **1-800-821-5226 Ext. 426** (orders). **JIM RHODES, INC.** 1025 Ransome Lane, Kingsport, TN 37660.

DESCRAMBLER plans. New design decodes gated sync suppressed signals—newest pilotless method. Circuit boards. Most parts from Radio Shack. Detailed theory, drawings, schematics, instructions \$14.95 plus \$2.00 shipping. **DIRIJO CORP.**, Box 212, Lowell, NC 28098.

PICTURE flyer lists quality electronic surplus at low prices. Since 1970. Send for the last 3 issues. **STAR-TRONICS**, Box 683, McMinnville, OR 97128.

TUBES, name brands, new 80% off list, **KIRBY**, 298 West Carmel Drive, Carmel IN 46032.

TUBES, new, used. Send self-addressed, stamped envelope for list. **FALA ELECTRONICS**, Box 1376-2, Milwaukee, WI 53201.

CB'ERS only: antennas, radios, modulators, voice scramblers frequency expanders, modifications, goody boxes, professional repairs, much more! **free catalog**. **PRESIDENT C.B.SALES**, 101 W. Adams-12, Long Beach, CA 90805. (213) 631-3552.

DRAMS 41256 150ns for your PC memory expansion \$2.90. **COMPUSOURCE**, 34 Main Street, MA 02148.

RESISTORS - any value / quantity, 1/4 watt @\$0.1, 1/2 watt @\$1.15 (\$1.00 minimum). Quantity discounts, 1,000+ . Send wattage(s), value (s), quantity(s), and remittance—T.O.R.C.S. **ELECTRONICS**, Box 47148, Chicago, IL 60647 (312) 342-9171.

CB MODIFICATIONS

Increase channels, range, privacy! We specialize in frequency expanders, speech processors, FM converters, PLL & slider tricks, how-to books, plans, kits. Expert mail-in repairs & conversions. 16-page catalog \$2.

CBC INTERNATIONAL, P.O. BOX 31500RE, PHOENIX, AZ 85046 (602) 996-8700

MICRO MART



15 Pin Header & Mating Socket, Vert MT/PC

.156" Centers 5/1.00

Jumbo Green LEDs 15 \$1.100 \$6.00

3,300uF 35V AXIAL 1/2" x 78" Nich 2/95

Coils For Radio Elec's Feb. 84 TV Project, Toko #5 T-1, T-2, L-1 (12UH) & L-2 (.071UH) Complete Set Of All 4 Coils 8.50

MC1330—Prime (Moto) 2/1.00

BFO-85 Transistor 1.50

Disc Caps. 001uf 20/1.00

74123-Prime (Nat) 3/1.00

470uf 35V (Radial) 3/1.00

470uf 16V (Axial) 4/1.00

2N3904 10/1.00

2N3906 10/1.00

1N914 40/1.00

1N4148 40/1.00

1N5231B (5.1V Zener Diode) 5/1.00

Voltage Regulators (Prime TO-220) 7805, 7812, 7824, 7905, 7912—Mix or Match—3/1.00

Mica Insulators For TO-220 Pkg 20/1.00

Voltage Reg's (Unmarked, 60% Prime) May Include Positive Neg & Adjust 15/1.00

78L08 Voltage Reg (DM106 TO-92) 20/1.00

PN2222A 20/1.00

2N3055 50

Logic Probe (Pencil Type) 18.95

Logic Pulsar (Pencil Type) 18.95

Zoners (U-Short) 1N4735A & 1N4749A 30 \$1

Relay-SPST 12V Coil, Normally Closed Contacts Open When Energized 95

Edgecard Conn 15 30 Pin 156" Cir's 65

6-32 Screw-In Stand Off Terminal 20 \$1

LM509K (MC7805CK) Regulator 75

15 Cent (1.15) Per IC 74LSXX

74LS02 74LS32 74LS158

74LS08 74LS74 74LS174

74LS10 74LS86 74LS257

74LS20 74LS153 74LS273

20 Cent (1.20) Per IC CMOS

4001B, 4001B, 4050B, 4051B

MC838 (DTL) 10/1.00

01uF 100V Mylar Cap (AX) 20 \$1

2716 EPROM 1.45

2732 EPROM 1.95

2764 EPROM 2.45

27128 EPROM 4.95

256K Dram 150ns Prime Hitachi (Ideal For Mac Upgrades & Expansion Projects) 4.95

8243 (I/O Expander IC) W/Specs 2.95

UDN 6118 (Display Driver IC-Specs) 85

UDN 6128 95

UCN 4116B-Osc/Freq Div Clock IC-Specs-5/1

2N3643 (NPN TO-92) Plastic 10 \$1

LM339 45

LM380 (ULN2280) 45

555 Timers (T1) 4/1.00

NE555 (Dual Timer-Moto) 50

741 Op Amp 4/1.00

LM1310 (Unmarked, Tested Prime) 50

LM1889 95

LM3900 45

AM/FM Radio IC #2204 W/Specs-Hobby 15/1.00

IC Sockets

8 PIN/.07 14 PIN/.13 16 PIN/.15

18 PIN/.17 20 PIN/.19 22 PIN/.21

24 PIN/.22 28 PIN/.24 40 PIN/.39

7 Segment Display (3 Common Cath) 15

7 Segment Display (6 Common An) 65

Tri State LEDs 3/1.00

40 Pin Red LEDs-Diffused Lens, Prime (TI) All 100% Prime 15 \$1.100 \$6.100 \$57.50

LED Mounting Clips & Rings 15/1.00

1uf 200V Mylar Film (AX) 15 \$1

UDN7180 (Segment Driver IC Data) 65

Dip Switch-12 Position 2/1.00

Dip Switch-8 Position 4/1.00

Keyboard Push Button Tops 30/1.00

Audio Cable 30 Feet/1.00

22AWG Wire 50 Feet/1.00

27AWG Wire 50 Feet/1.00

Mini Lubricant (& Lubricant) 1/00

Molex Pins (7 Pin/Strip 100/\$2.500/\$4.1K) 1.56

MC1458 (Dual 741) 4/1.00

ULN2274 (Dual Audio Power AMP) 75

Rotary Switch (5 Position, SA 125V-3/1.00

Giant Alpha Numeric Display 1-1/2" X 2" 7X5 (35 Total) Red LED Matrix/Specs-4.95

11 LED Bar Graph Display-2-3/4" Rect LED's (Specify Red, Grn, Ambi) Specs 2.89

Seven Amp (7) Tapped Transformer-Can Be Wired For (7.5V, 9V, 15V, 18V Reg Shog 8.95

Wall Plug Transformer-24V 525mA 1.20

6.3V 1.2A Transformer 1.20

12V Center Tap Transformer 2.95

8A/200V Bridge, Quick Disconnect (GI) 65

N4007 20/1.00

1N5059 (200V 1 Amp) 15/1.00

1N5060 (400V 1 Amp) 10/1.00

Zener Diodes-20V 1W 30/1.00

Zener Diodes-13V 1W Glass 30/1.00

2560.0K Crystal 50

3.579545 Color Burst Crystal (HC-18) 50

1.0 Mhz Crystal 1.95

6.0 Mhz Crystal 1.95

TO-5 Heat Sinks (Bern) 10/1.00

TO-18 Heat Sinks (Bern) 10/1.00

Super Sub-Mini Ceramic Caps (All 100V)

0015uf 100V (152) 30/1.00

0022uf 100V (182) 30/1.00

0027uf 100V (272) 30/1.00

0033uf 100V (332) 30/1.00

0047uf 100V (392) 30/1.00

005uf 100V (562) 10/1.00

0082uf 100V (822) 30/1.00

4.7uf 40V Lytic (Radial) 20/1.00

47uf 25V Lytic (Radial) 10/1.00

1000uf 165V Twp Load 1.00

3200uf 50V (Ideal For Power Supplies) 1.00

Super Sub-Mini Ceramic Caps (All 100V)

.1uf 50V Monolithics 10/1.00

.01uf 50V Monolithics 20/1.00

Chip Caps-Set of 4, 2 Each 2.7 & 3.3pf-1.00
33uf 100V Dip Mylar 10/1.00

1N4004 Diodes 30/1.00

Pots-1 Meg, Linear Taper 5/1.00

Motion Detector Bds (inc IC-S2) 7/10.00

Mot Det (IC Only-ULN2232A) 3/52-20/10.00

Project Box/Lid For Detector 1.95

Miniature Speaker For Detector65

Extensive Construction Article For Det. \$1

TV Knobs 4.95

Ammeter (0-15 A.C. Amperes) 15/1.00

Volt/OHM Meter MVMNT (0-1K OHM, 0-300V) 2.95

6V Miniature Gear Motor 50

RF Chokes-1, 5uh, 8.2uh, 12uh, 22uh-10/1.00

40 Pin Flat Cable Socket Connector-Head-40

50 Pin Flat Cable Socket Connector-Head-50

14 Pin Dip Header Plug/Mate (3M) 3/1.00

Mixed Connector Ass't 10/1.00

1.5AMP 50V Bridge (GI, TO-5 Pkg) 50

25AMP 200V Bridge (Solder Lug Term) 1.50

Zenith TV Replacement IC Special \$1 Each

221-42, 221-43, 221-45, 221-48, 221-69, 221-79, 221-87, 221-96, 221-104, 221-105, 221-106, 221-140

2SD901 (Horiz. Output W/Damper Diode)-2.95

2N1172B (Cath. Horiz. Output Trans)-1.95

Winograd 4 Bay Bowtie UHF Antenna-19.50

IC Storage (Bug) Box (Holds) 30 ICs-2.25

Precision (Multi-Turn) Trim Pots (Copal),

10 OHM, 500 OHM, 1K, 2K, 5K, 10K, 20K, 50K, 100K, 200K, 500K, 1M, 85 Each-3/\$2

Piper Pt-10V Hor Mt (Single Turn) Trimmers

100 OHM, 1K, 5K, 10K, 25K, 50K, 100K, 200K, 500K, 1M 25 Each

Mixed Coil Ass't 10/1.00

Buzzers 3/1.00

Chip Resistor (6.8K) 20/1.00

Chip Resistor (470K) 20/1.00

Chip Cap (330pf) 20/1.00

36 Pin RT. Angle Header Connector 50

MFR901 (Hobby Grade-60% Good) 10/1.00

IC Ass't (Hobby Grade, Some Marked)-30/\$1

20 Cent (.20) 74SCXX Series Special

- **Octal Interface Circuits**
- **Equivalent To 74LSXX Series**
- **Low Power ISO-CMOS Technology**
- **Short Propagation Delay**
- **Improved Noise Margins**
- **High Current, Sink/Source Capability**

745C137-1 Of 8 Inverted Decoder, Latched

745C138-1 Of 8 Inverted Decoder

745C139-1 Of 4 Inverted Decoder

745C237-1 Of 8 Non-Inverted, Latched

745C238-1 Of 8 Non-Inverted

745C239-1 Of 4 Non-Inverted

745C240-Octal Buffer/Line Driver-Inv

745C241-Octal Buffer/Line Driver-Inv

745C244-Octal Buffer/Line Driver-N/I

745C245-Octal Bus Transceiver-Non/I

745C373-Transoantet Latch-Non/Inv

Terms: MICRO-MART accepts Visa, MC and telephone COD's. Minimum order \$10.00. Shipping--U.S. orders, \$2.00. Canada and other countries \$3.50 (includes ins.). Shipping rate adjusted where applicable. NJ residents add 6% sales tax.

MICRO-MART • 508 CENTRAL AVE., WESTFIELD, NJ 07090 • (201) 654-8008

745C374-D Type Flip-Flop, Non/Inv	2.50
745C533-Transparent Latch-Inverted	
745C534-D Type Flip-Flop, Inverted	
745C540-Octal Buffer/Line Driver-Inv	
745C541-Octal Buffer/Line Driver-N/I	
745C563-Transparent Latch, Inverted	
745C564-D Type Flip-Flop, Inverted	
745C573-Transparent Latch, Non/Inv	
745C574-D Type Flip-Flop, Non/Inv	

Data Book For All Above #'s

Control IV Micro-Controller Kit- \$129.50

- 4 Mhz, 8-Bit Microprocessor (NAT 1NS8073)
- Control Basic Interpreter On-Chip
- Auto-Start Operation At Power-On
- Fast 16 Bit Multiply And Divide
- RS-232, Supports CRT & Serial Link
- 24 Bi-Directional I/O Lines (8255A)
- RAM Memory-2K Expandable To 16K
- EPROM Memory-Expandable To 16K
- Built In EPROM Programmer
- Parr (Centronics) Printer Interface
- Optional Real-Time Clock W/Backup

Pay TV Hardware Installation Kit Blow Out As Low As \$2.95 + \$3.50 Shipping Per Unit

All Kits Contain 5 F Connectors, 300 to 75 Ohm Balun, 300 OHM Terminal Block 2 Ft 75 Ohm Patch Cord 2 Ft 300 OHM Twin Lead, Nylon Cable Ties, And UHF Antenna

Model #4124-\$2.95 includes All Of The Above Plus 25 Feet Coaxial Cable And Mounting Hardware For Indoor Wall/Ceiling Installation

Model #4880-\$2.95 includes All Of The Above Plus 25 Feet Coaxial Cable And Attractive Expandable Pole-U-Bolt For Easy Indoor Installation

Model #4845-\$3.95 includes All Of The Above Plus 65 Feet Coaxial Cable And All Necessary U-Bolt Hardware

MODEL 705 Digital Multimeter

DC Voltage	1000v to 1000V
AC Voltage	100v to 750V
DC Current	0.1uA to 10A
AC Current	0.1uA to 10A
Hilo Resistance	0.12 to 20MΩ
Capacitance	1pF to 20uF
Diode Test	forward voltage testing
Hirt test	transistor testing

\$51.95

UHF-TV PREAMP
(As featured in Radio Electronics March/May articles, 1982)

This inexpensive antenna mounted pre-amp can add more than 25 dB of gain to your system. Lots of satisfied customers and repeat orders for this high quality kit, which includes all component parts, PC BD, Case, Power Supply and Balun \$34.50 Assembled Version \$57.50

RADIO-ELECTRONICS

110

CIRCLE 270 ON FREE INFORMATION CARD

TUBES: "Oldies", latest. Supplies, components, schematics. Send SASE, for catalog. **STEINMETZ**, 7519 Maplewood Ave., R.E., Hammond, IN., 46324.

LINEAR PARTS, TUBES TRANSISTORS - MRF 454 \$16, MRF455 \$12, MRF477 \$11, MRF492 \$18. Catalog. **RFPC** Box 700, San Marcos, CA 92069. (619) 744-0728.

DESCRAMBLERS for downconverters. High gain. Send \$2.00. **RB ELECTRONICS**, P.O. Box 643, Kalamazoo, MI 49005.

CONVERTER descrambler schematic, service manuals, cable and satellite, New Oak cable descrambler \$35.00, Varisync units \$45.00, no Colorado sales, call (303) 634-6666 for special wants, **POUDEROSY COMPANY**, 2408-A East Platte, Colorado Springs, CO 80909.

LASERS and nightvision surplus components free catalog **M.J. NEAL COMPANY**, 6672 Mallaro Ct. Orient, Ohio 43146.

RESTRICTED technical information: Electronic surveillance, schematic, locksmithing, covert science, hacking, etc. **huge selection. Free brochure: MENTOR-Z**, 135-53 No. Blvd., Flushing, NY 11354.

INDIVIDUAL photofact-folders #1 to #1400. \$3.00 postpaid. **LOEB**, 414 Chestnut Lane, East Meadow, NY, 11554.

RESISTORS 1/4W, 1/2W 5% C.F. 3 cents. 1% Metalfilms, custom wirewounds, capacitors and other components. **JR INDUSTRIES** 5834-H Swancreek, Toledo, OH 43614.

OLDTIME radio programs on high quality tapes. Comedy! Adventure! music! Free catalogue. **Carl F. Froelich**, Heritage Farm, New Freedom, PA 17349.

FREE importer accessories catalog, video audio, others. with business card write **17 Banner Court** East Brunswick, NJ 08816.

WHOLESALE audio video telephone accessories antennas cartridges. Free catalog (718) 897-0509. **D&WR** 68-12 110 St., Flushing, NY 11375.

TV tunable notch filters, free brochure. **D.K VIDEO**, Box 63/6025, Margate, FL 33063. (305) 752-9202.

LIGHT chaser, color organ controller, rope lights, triggerable neon power supply. **DESIGN SPECIALTY**, Box 1995, Huntington Beach, CA 92647.

MOBILE telephone using your 2-way radio, plans \$9.95, with PC/brds \$19.95, parts available. **CURRENT DEVELOPMENT CORP.**, Box 384, Westmoreland, NY 13490.

CORDLESS copy phone interference? We've got the answer. Have a radar speeding ticket? We can help. Home phone extension in your car? You can have it. 50-page color catalog airmailed \$3.00. **DBE**, P.O. Drawer G, Waikiki, HI 96830.

MICROWONDERLAND. Commodore computer's parts! KIM-1 computers, accessories! Thousands ICs by mail! Free 64KDRAM SETS! Discounts! Catalog - \$3.00! **K.BOUFAL—CONSULTING SERVICES**, 244 Fitzwater, Philadelphia, PA 19147. (215) 925-6469.

CATALOG: Electronic components at budget prices for students, hobbyists and industry. Send \$2.00 P & H (refundable) **BUDGET ELECTRONICS**, Box 1477, Moreno Valley, CA 92388.

KOSS headphones from \$7.00. Send \$1.00 for audio catalog, refundable **WSC**, RD#1 Box 172, Sicklerville, NJ 08081.

TEST equipment, reconditioned. For sale. \$1.25 for catalog. **WALTER'S**, 2697 Nickel, San Pablo, CA 94806 (415) 724-0587.

CAPACITORS—Ceramic disk—50 volts all values \$0.10 plus \$1.00 shipping per order. **T.O.R.C.C.C. ELECTRONICS**, Box 47148, Chicago, IL 60647. (312) 342-9171.

CIRCUIT boards, guaranteed lowest quotes and free twelve hour prototypes. Single and double sided boards. Small through large production quantities. Mail specifications. - **Hobbyists;** any schematic, 6"x9" maximum, etched on a 3"x4" board - \$1.75. (larger boards - \$2.75). - Send remittance and artwork; or, print your own circuit boards. Kits of all sizes. Guaranteed lowest prices.—Basic kit \$3.00; materials for two 3"x4" boards (included), or SASE for catalog—**T.O.R.C.C.C. ELECTRONICS**, Box 47148, Chicago, Illinois 60647, (312)-342-9171.

CABLE-TV

WE'LL MATCH OR BEAT ANYONE'S ADVERTISED RETAIL OR WHOLESALE PRICES!

BONANZA!

ITEM	SINGLE UNIT PRICE	DEALER 10-UNIT PRICE
RCA 36 CHANNEL CONVERTER (CH. 3 OUTPUT ONLY)	29.95	18.00 ea.
PIONEER WIRELESS CONVERTER (OUR BEST BUY)	88.95	72.00 ea.
LCC-58 WIRELESS CONVERTER	92.95	76.00 ea.
JERROLD 450 WIRELESS CONVERTER (CH. 3 OUTPUT ONLY)	105.95	90.00 ea.
SB ADD-ON UNIT	109.95	58.00 ea.
BRAND NEW — TRIMODE UNIT FOR JERROLD		
MINICODE (N-12)	109.95	58.00 ea.
MINICODE (N-12) VARISYNC	119.95	62.00 ea.
MINICODE VARISYNC W/AUTO ON-OFF	179.95	115.00 ea.
M-35 B (CH. 3 OUTPUT ONLY)	139.95	70.00 ea.
M-35 B W/AUTO ON-OFF (CALL FOR AVAILABILITY)	199.95	125.00 ea.
MLD-1200-3 (CALL IF CH. 2 OUTPUT)	109.95	58.00 ea.
INTERFERENCE FILTERS — CH. 3	24.95	14.00 ea.
JERROLD 400 OR 450 REMOTE CONTROLLER	29.95	18.00 ea.
ZENITH SSAVI CABLE READY (DEALER PRICE BASED ON 5 UNITS)	225.00	185.00 ea.
SPECIFY CHANNEL 2 or 3 OUTPUT <i>Other products available — Please Call</i>		

Quantity	Item	Output Channel	Price Each	TOTAL PRICE
California Penal Code #593-D forbids us from shipping any cable descrambling unit to anyone residing in the state of California. Prices subject to change without notice.			SUBTOTAL	
			Shipping Add	\$3.00 per unit
			COD & Credit Cards — Add 5%	
			TOTAL	

PLEASE PRINT

Name _____
 Address _____ City _____
 State _____ Zip _____ Phone Number () _____
 Cashier's Check Money Order COD Visa Mastercard
 Acct # _____ Exp. Date _____
 Signature _____

FOR OUR RECORDS:

DECLARATION OF AUTHORIZED USE — I, the undersigned, do hereby declare under penalty of perjury that all products purchased, now and in the future, will only be used on cable TV systems with proper authorization from local officials or cable company officials in accordance with all applicable federal and state laws.

Dated: _____ Signed: _____

Pacific Cable Company, Inc.
 7325 1/2 RESEDA BLVD., DEPT. # R-4 • RESEDA, CA 91335
 (818) 716-5914 • No Collect Calls • (818) 716-5140

IMPORTANT: WHEN CALLING FOR INFORMATION
 Please have the make and model # of the equipment used in your area. Thank You

Saratoga Electronics



ORDER TOLL FREE

800-621-0854
ext.245

DYNAMIC RAMS

4164 - 150NS \$1.25
41256 - 150NS \$3.25

I.C.'s

M58725 \$1.49
9114EPC \$.90
74S374 \$.39
74S280 \$.39
8237A-5 \$3.50

EPROMS

2716 - 450NS \$2.95
2732A - 450NS \$2.25
2764 - 450NS \$3.00
2764 - 250NS \$3.75
27256 - 300NS \$6.75

PC/AT COMPATIBLE SYSTEM BOARD

\$895

★ 1 Megabyte Installed

DRIVES

MIT 4853 QUAD/DS 96 TPI
1/2HT. \$69.95
TM848-2 8" DS/DD 1/2HT. \$99.95
SEAGATE 20MB 1/2HT. \$375.00
QUANTUM 40MB FULL HT. \$795.00
HARD DISK CONTROLLER
(OMTI 5510) \$139.00

PC/XT COMPATIBLE SYSTEM BOARD

★ 256/640 KB w/o Bios & Ram

\$160

Ask About Our PC/XT System Kit

\$895

**\$25 MINIMUM ORDER
PRICES SUBJECT TO CHANGE**

12380 SARATOGA - SUNNYVALE ROAD
SARATOGA, CA 95070
(408) 446 - 4949



FREE EVALUATION and ADVISORY SERVICE



A NON PROFIT ORGANIZATION

For professional electronic technicians by prestigious non-profit organization. Earn University Degree (Bachelors or Masters) through Home Study! Credit given for previous schooling and professional experience. Upgrade your earning power. Free Details!
CONTINENTAL EDUCATION ASSOCIATES
P.O. Box 1197 - Champlain, NY 12919-1197

PLANS & KITS

CATALOG: Hobby/broadcasting/1750 Meters/Ham/CB: Transmitters, amplifiers, antennas, scramblers, bugging devices, more! **PANAXIS**, Box 130-F4 Paradise, CA 95969.

UNCYPHERS American & Canadian satellite or cable latest technology available. Plans & boards kits or complete. Send \$5.00 for catalog. Refundable on order to **PILGRIM VIDEO PRODUCTS**, Box 203 Oak, Street, Pembroke, MA 02359. (617) 826-8704.

CABLE TV, converters: Jerroco products include "new Jerroco Tri-mode" SB-3, Hamlin, Oak VN-12, M-35-B, Zenith and more. UHF deluxe II kits. (Quantity discounts) 60 day warranty. Service converters sold here. For fast service C.O.D. orders accepted. Send SASE (60 cents postage) or call for info. (312) 637-4408, **HIGGINS ELECTRONICS** 5143-R W. Diversey, Chicago, IL 60639. No Illinois orders accepted.

PAY TV and Satellite Descrambling.

73 pages of theory and schematics for all major systems. Fantasy and Anik-D schematics included. Most complete reference available on satellite scrambling \$12.95. MDS Handbook \$10. Stungun schematics \$5. Satellite systems under \$600., \$11.95. Printed circuits, kits catalog \$1.

SHOJIKI ELECTRONICS CORP. 1327R Niagara Street, Niagara Falls, NY 14303 COD's **716-284-2163**

ALARM system complete kits, RF wireless, motion detecting, for home, auto, fire. **JGM LABS**, P.O. Box 62, Eola, IL 60519.

Hi-fi speaker kits, auto speaker systems and speaker components from the world's finest manufacturers. for beginners and audiophiles. Free literature. **A&S SPEAKERS**, Box 7462R, Denver, CO 80207. (303) 399-8609.

HOW to build 1,000 watt car stereo amplifiers send \$15.00 **MESCO** 1114 East Township, Fayetteville, AR 72703.

"ZX81 **mechanical** converted keyboard. Easy instructions for direct hookup. Send \$39.95 H.L. **SCOTT**, Box 1141, Canadian, TX 79014.

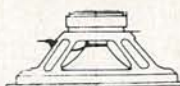

WRITE FOR **McGEE'S**

SPEAKER & ELECTRONICS CATALOG

1001 BARGAINS IN SPEAKERS
toll free 1-800-346-2433 for ordering only.
1901 MCGEE STREET KANSAS CITY, MO. 64108



REMOVES VOCALS FROM RECORDS!

Now You can sing with the world's best bands! The Thompson Vocal Eliminator can remove most or virtually all of a lead vocal from a standard stereo record and leave the background!
Write or call for a free brochure and demo record.
LT Sound, Dept. R-1, P.O. Box 338, Stone Mountain, GA 30086. (404) 493-1258

8" dish \$69 fabrication cost. Polar mount, attractive, easy construction. Stock hardware items used. **complete** instruction, plans, fabrication assembly, setup drawings, photos. \$14.95 plus \$2.00 shipping **DIRIJO DISH** Box 212, Lowell, NC 28098.

BUILD a microcomputer controlled robot. 200 page how-to book, 8 1/2" x 11". \$12 ppd. **BUDGET ROBOTICS**, Box 18616, Tucson, AZ 85731

FREE catalog 99-cent kits—audio, video, TV, computer parts. **ALLKIT**, 434 W. 4th St., West Islip, NY 11795.

CRYSTAL radio sets, plans, parts, kits catalog \$1.00. **MIDCO**, 660 North Dixie Highway, Hollywood, FL 33020.

VCR amplifier kit: transmits VCR output to any TV in your house, \$24.95. Includes PC board and all board mounted parts. CA residents add 6.5%. Catalog refundable with order. **CAS ELECTRONICS**, 1559-J Amar Rd. Suite 457, West Covina, CA 91792.

THE BEST PLACE to BUY, SELL or TRADE NEW and USED EQUIPMENT
NUTS & VOLTS MAGAZINE
BOX 1111-E • PLACENTIA, CA 92670
(714) 632-7721
Join Thousands of Readers Nationwide Every Month
ONE YEAR U.S. SUBSCRIPTIONS
\$10.00 - 3rd Class • \$15.00 - 1st Class
\$35.00 - Lifetime - 3rd Class

NUTS & VOLTS

HAM GEAR
COMPUTERS
SOFTWARE
SCANNERS • OPTICS
TEST EQUIPMENT
MICROWAVE
SATELLITE
AUDIO VISUAL
NEW PRODUCTS
COMPONENTS • KITS
ANTIQUE ELECT.
PUBLICATIONS
PLANS • SERVICES

PROJECTION TV...Convert your TV to project 7 foot picture...Results comparable to \$2,500.00 projectors...Total cost less than \$30.00...Plans and 8" lens \$19.95...Illustrated information free. **MACROCAMA-GH**, Washington Crossing, PA 18977. Creditcard orders 24 hours (215) 736-3979.

FILTER designer kit a variable gain state variable filter may be reconfigured to build most of the circuits in Don Lancaster's Book, active filter cook book, \$24.95 Indiana residents add 5% sales tax. **KEY ELECTRONICS** P.O. Box 1, Redkey, IN 47373.

ONE tube radio kit—complete with board, tube, all parts except batteries and headphones. \$19.95 prepaid. Includes 20 page tube, parts and books catalog. **ANTIQUÉ ELECTRONIC SUPPLY** 688 W. First St., Tempe, AZ 85281.

CONTROL up to 48 devices with your computer easily! Complete plans schematics, programs \$12.95. **B&W ELECTRONICS**, 3621 Lowden, Kalamazoo, MI 49008.

BUILD this five digit panel meter and square wave generator including an ohms, capacitance and frequency meter. Detailed instructions \$2.50 refundable plus .50 cents. **BAGNALL ELECTRONICS**, 179 May., Fairfield, CT 06430.

CABLE and subscription TV secret manual. Build your own **descramblers**, converters. Instructions, schematics for sine wave, inband/outband gated sync, SSAV1 - (HBO, showtime, cinemax, UHF, etc.) Send \$8.95 to **CABLETRONICS**, Box 30502R, Bethesda, MD 20814.

How Can You Help Prevent Birth Defects?

Support



THIS SPACE CONTRIBUTED BY THE PUBLISHER

★ QUALITY PARTS ★ DISCOUNT PRICES ★ FAST SHIPPING!

ALL ELECTRONICS CORP.

SEND FOR FREE NEW 1986 CATALOG... 48 PAGES!

EDGE CONNECTORS
ALL ARE 1.56" SPACING.

- 22/44 EDGE CONNECTOR PC style \$2.00 each 10 for \$18.00
- 22/44 EDGE CONNECTOR solder lug style \$2.50 each
- 28/56 EDGE CONNECTOR PC style \$2.50 each 10 for \$22.00
- 36/72 EDGE CONNECTOR PC style \$3.00 each
- 43/86 EDGE CONNECTOR PC style \$4.50 each

- TRANSISTORS**
- 2N706 4 for \$1.00
 - 2N2222A 3 for \$1.00
 - PN2222A 4 for \$1.00
 - 2N2904 3 for \$1.00
 - 2N2904 3 for \$1.00
 - 2N2905 3 for \$1.00
 - MJ2955 \$1.50
 - 2N3055 \$1.00
 - PMD 10K40 \$1.00
 - TIP 121 75¢
 - TIP 125 75¢

- TRANSFORMERS**
- 120 volt primaries
 - 5.6 volts @ 750 ma. \$3.00
 - 6 volts @ 150 ma. \$1.25
 - 6.3 volt @ 600 ma. \$3.00
 - 12 V.C.T. @ 200 ma. \$2.00
 - 12 V.C.T. @ 400 ma. \$3.00
 - 12 V.C.T. @ 1 amp \$4.00
 - 12 V.C.T. @ 2 amp \$4.85
 - 12 V.C.T. @ 4 amp \$7.00
 - 18 volts @ 650 ma. \$3.50
 - 24 V.C.T. @ 200 ma. \$2.50
 - 24 V.C.T. @ 1 amp \$4.85
 - 24 V.C.T. @ 2 amp \$6.75
 - 24 V.C.T. @ 3 amp \$9.50
 - 24 V.C.T. @ 4 amp \$11.00
 - 36 V.C.T. @ 135 ma. \$3.00

- WALL TRANSFORMERS**
- all plug directly into 120 vac outlet
 - 4 VDC @ 70 ma. \$2.00
 - 6 VDC @ 500 ma. \$3.50
 - 6 VDC @ 750 ma. \$4.50
 - 9 VDC @ 500 ma. \$3.00
 - 12.5 VDC @ 265 ma. \$3.00
 - 18 VAC @ 18 VA and 8.5 VAC @ 1.28 VA \$4.50
 - 24 VAC @ 250 ma. \$3.00
 - MULTI-VOLTAGE @ 500 ma. \$7.50
 - 3.4, 6.7, 12.5, 9 or 12 VDC \$7.50

- MINI-BOX**
Pomona #2104 \$1.00 EACH
Heavy-duty black phenolic project box with cover and crews. 2 1/2" X 1 1/2" X 1 1/2"

- FUSES**
- 3AG (AGC) SIZE 1, 1 1/2, 2, 2 1/2, 3, 4, 5, 6 AMP
 - GMA SIZE 1, 2, 3, 4, 5 AMP
 - 5 of any ONE amperage 75¢

SOUND AND VIDEO MODULATOR FOR T.I. COMPUTER
T.I. # UM1381-1. Designed for use with T.I. computers. Can be used with video sources. Built-in A/B switch. Channel 3 or 4 selection switch. Operate on 12 vdc. Hook-up diagram included.
CAT# AVMOD WERE \$10.00 REDUCED TO \$5.00 EACH

SLIM LINE COOLING FAN
Etri \$ # 99XM182 low noise fan. Measures 3 3/8" square x 1" deep. 21 cfm, 23 db, 1700 rpm.
SPECIAL PRICE .. \$12.50 each

2K 10 TURN MULTI-TURN POT SPECTROL #MOD 534-7161 \$5.00 EACH

SOLID STATE BUZZER
Star #SMB-06L 6 vdc TTL compatible. \$1.00 each 10 for \$9.00

± 12 Vdc or 24Vdc POWER SUPPLY
DELTRON MODEL QD12/15-1.7 Dual plus and minus 12Vdc open frame power supply. Can be used as 24Vdc @ 1.5 amp. INPUT: either 115 Vac or 230 Vac Fully regulated computer grade supply. 7" x 4 1/2" x 2 1/4"
\$12.50 each 10 for \$110.00

SPECIALS

1 AMP 50 VOLT DIODES
IN4001 TAPE AND REEL 100 for \$4.50 1000 for \$30.00

SOLDER TAIL I.C. SOCKETS
24 PIN 10 for \$2.50 100 for \$22.00 1000 for \$200.00

MICRO-CASSETTE MECHANISM
Micro-cassette tape transport for standard MC60 or MC60 micro-cassettes. 3 Vdc operation. Contains: drive motor, belt, head, capstan, pinch wheel and other components. 3 1/2" X 2 1/4" X 5/8"
CAT# MCMC \$3.00 each 10 for \$27.50

220 Vac COOLING FAN
ROTRON # MX77A3 Muffin XL 220 Vac 4.1/8" square metal frame fan.
CAT# CF-220 \$6.50 ea 10 for \$60.00 / 100 for \$500.00 QUANTITIES AVAILABLE

DELUXE CASSETTE MECHANISM
ALPINE #160295 New, high quality auto-reverse deck with pre-amp. Operates on 12-14 Vdc. Designed for "soft touch" operation of fast-forward, rewind, seek and repeat functions. Overall dimensions 5 1/4" X 3 9/16" X 2 1/2". Includes spec sheet and hook-up diagram.
CAT# DCMC \$12.75 each 2 for \$24.00

SPECIAL PRICE TRANSISTOR
plastic transistor PN3569 TO-92 N.P.N. 100 for \$8.00 1000 for \$60.00 LARGE QUANTITIES AVAILABLE

LINE CORDS

TWO WIRE
6' 18/2 SPT-1 flat 3 for \$1.00
6' 18/2 SPT-2 flat 2 for \$1.00
6' 16/2 SJT round \$1.25 each

THREE WIRE
6' 18/3 flat \$1.50 each
8' 18/3 round \$2.00 each
8' 16/3 round \$4.00 each

RELAYS

10 AMP SOLID STATE
CONTROL: 3-32 vdc LOAD: 140 vac 10 amp HIGH sensitivity. COIL: 2 1/2" x 1 1/4" x 1 1/8"
\$9.50 EACH 10 FOR \$90.00

ULTRA-MINIATURE 5 VDC RELAY
Fujiitsu # FBR211NED005M20 High sensitivity. COIL: 120 ohms. CONTACTS: 1 amp Mounts in 14 pin DIP socket
\$1.25 each 10 for \$10.00

3 1/2" SPEAKER
8 ohm impedance. Full range speaker. 8 oz magnet 4" diagonal mounting centers.
\$2.50 each 10 for \$20.00

SPRING LEVER TERMINALS
Two color coded terminals on a sturdy 2 1/4" x 3 3/8" bakelite plate. Great for speaker enclosures or power supplies.
75¢ EACH 10 for \$6.00

XENON FLASH TUBE
3/4" long X 1/8" dia. Flash tube designed for use in compact camera flash units. Ideal for experimenters.
CAT# FLT-1 2 for \$1.00

CASSETTE MIKE
Dynamic cassette mike with 3.5mm plug and on/off switch.
\$1.50 EACH 10 FOR \$13.50

TWIST-LOCK CONNECTOR
Same as Switchcraft #12CL5M. 5 conductor in-line plug and chassis mount jack. Twist-lock style.
\$2.50/SET

COMPUTER GRADE CAPACITORS

- 2,000 mfd. 200 VDC 1 1/4" DIA. x 5" HIGH \$2.00
- 3,600 mfd. 40 VDC 1 1/4" DIA. x 3 3/4" HIGH \$1.00
- 6,400 mfd. 60 VDC 1 3/4" DIA. x 4 1/4" HIGH \$2.50
- 9,700 mfd. 50 VDC 1 3/4" DIA. x 4 1/2" HIGH \$3.00
- 31,000 mfd. 15 VDC 1 1/4" DIA. x 4" HIGH \$2.50
- 72,000 mfd. 15 VDC 2" DIA. x 4 1/4" HIGH \$3.50
- 185,000 mfd. 6 VDC 2 1/2" DIA. x 4 1/2" HIGH \$1.50

MINIATURE 6 VDC RELAY
Aromat #RSD-6V Super Small S.P.D.T. relay Gold coil contact rated 1 amp @ 30 vdc. Highly sensitive. TTL direct drive possible. 120 ohm coil. Operate from 4.3-6 vdc. COIL: 120 ohms \$1.50 each 10 for \$13.50

13 VDC RELAY
CONTACTS: S.P.N.C. 10 amp @ 120 vac Energize coil to open contact... COIL: 13 vdc 650 ohms
SPECIAL PRICE \$1.00 each

MINIATURE TOGGLE SWITCHES
ALL ARE RATED 5 AMPS @ 125 VAC

- S.P.D.T. (on-on) PC style non-threaded bushing. \$1.00 each 10 for \$7.00
- S.P.D.T. (on-on) Solder lug terminals. \$1.00 each 10 for \$9.00
- S.P.D.T. (on-off-on) Solder lug terminals. \$1.00 each 10 for \$9.00
- S.P.D.T. (on-off-on) PC style non-threaded bushing. \$1.00 each 10 for \$7.00
- S.P.D.T. (on-on) PC lugs threaded bushing. \$1.00 each 10 for \$9.00
- D.P.D.T. (on-on) Solder lug terminals. \$2.00 each 10 for \$18.00

TI SWITCHING POWER SUPPLY
Compact, well-regulated switching power supply designed to power Texas Instruments computer equipment.
INPUT: 14-25 vac @ 1 amp OUTPUT: +12 vdc @ 350 ma +5 vdc @ 1.2 amp -5 vdc @ 200 ma
SIZE: 4 1/4" x 4 1/4" x 1 1/4" high \$5.00 each

4PDT RELAY
14 pin KH style... 3 amp contacts... USED but fully tested... \$1.70 each Specify coil voltage desired Either 24 vdc or 120 vac LARGE QUANTITIES AVAILABLE
SOCKETS FOR KH RELAY 75¢ each

STANDARD JUMBO DIFFUSED T 1 1/2
RED 10 for \$1.50 100 for \$13.00
GREEN 10 for \$2.00 100 for \$17.00
YELLOW 10 for \$2.00 100 for \$17.00

D.P.S.T. LIGHTED ROCKER SWITCH
115 vac lighted rocker, snap mounts in 1/2" x 1 1/4" hole Orange lens 16 amp contact \$1.50

MINI-PUSH BUTTON
S.P.S.T. momentary normally open 1/8" bushing. Red button. 35¢ each 10 for \$3.00

13.8 VDC REGULATED POWER SUPPLY
These are solid state, fully regulated 13.8 vdc power supplies. Both feature 100% solid state construction, fuse protection, and L.E.D. power indicator. U.L. listed.
2 amp constant, 4 amp surge \$18.00 each
3 amp constant, 5 amp surge \$25.00 each

RECHARGEABLE NI-CAD BATTERIES

- AAA SIZE 1.25V 500MAH \$1.85
- AA SIZE 1.25V 500MAH \$1.85
- AA with solder tab \$2.00
- C SIZE 1.2V 1200MAH \$3.50
- D SIZE 1.2V 1200MAH \$3.50

FLASHER LED
5 volt operation red jumbo T 1 1/4 size \$1.00 each

BI-POLAR
jumbo T 1 1/4 size 2 for \$1.70

LED HOLDERS
Two piece holder for jumbo LED 10 for \$5.00

CLEAR CLIPLITE LED HOLDER
Make LED a fancy indicator. Clear. 4 for \$1.00

D.C. CONVERTER
Designed to provide a steady ± 5 vdc @ 240 ma. from a battery supply of 3.5 to 6.25 volts. 2 1/8" x 1 1/8" x 1 1/8"
\$1.50 each

7 CONDUCTOR RIBBON CABLE
Spectra-strip red marker strip, 28 ga. stranded wire.
\$5.00 per 100 roll

UNIVERSAL CHARGER
Will charge 4-AA, C, D, or AAA ni-cads or one 9 volt ni-cad at one time...
\$11.00 per charger

SNAP ACTION SWITCH
Cherry elect. #E-21. N.O. or N.C. 0.1A contacts. Suitable for alarms and other low energy circuits. 1 1/4" lever.
45¢ EACH 10 FOR \$4.20

ROTARY ACTION MICRO
OMRON #C-5G3-C41 Clockwise action micro used in coin operated mechanisms and low torque operations. RATED: 5 amps @ 125 Vac \$1.25 each 10 for \$11.00 LARGE QUANTITIES AVAILABLE

ALL ELECTRONICS CORP.
LOS ANGELES, CA STORE
905 S. Vermont Ave.
213 380-8000

VAN NUYS, CA STORE
622B Sepulveda Blvd.
818 997-1806

MAIL ORDERS TO:
P.O. BOX 20406
Los Angeles, CA 90006

TWX - 5101010163 ALL ELECTRONIC
EASYLINK MBX - 62887748

TOLL FREE ORDERS ONLY
1-800-826-5432 (ORDER ONLY)
(IN CALIFORNIA: 1-800-258-6666)

ALASKA, HAWAII, OR INFORMATION
(213) 380-8000 NO C.O.D.

QUANTITIES LIMITED
MINIMUM ORDER \$10.00
USA: \$3.00 SHIPPING
FOREIGN ORDERS: INCLUDING SUFFICIENT SHIPPING
CALIF RES. ADD 6 1/2%

APRIL 1986

EDUCATION & INSTRUCTION

GET a better job. Learn electronics on T.V. All the basics on a two hour VHS or Beta video tape. Send \$49.95 or write for free details. **E.I.T. Co.,** P.O. Box 2891, Norman, OK 73070.

FCC commercial general radiotelephone license correspondence course. 60 individual lessons for \$89.50. Payment plan. Results guaranteed! Details free. **AMERICAN TECHNICAL INSTITUTE,** Box 201, Cedar Mountain, NC 28713.

UNSCRAMBLE satellite signals the easy way. Parts available from Radio Shack. Send \$19.95 for plans & catalog Board & Plans \$39.95, kits from \$99.95. **VIDEO RESEARCH,** P.O. Box 2, Kingsport, TN 37660.

Be a TV/VCR Repair Specialist

Now you can train at home in spare time for a money-making career as a TV/VCR Repair Specialist. No previous experience necessary. No need to quit your job or school. Everything is explained in easy-to-understand language with plenty of drawings, diagrams and photos. We show you how to troubleshoot and repair video-cassette recorders and TV sets, how to handle house calls and shop repairs for almost any make of television or VCR. Tools are included with your course so you can get "hands-on" practice as you follow your lessons step by step. Send for free facts about the exciting opportunities in TV/VCR Repair and find out how you can start making money in this great career. **MAIL COUPON TODAY**

ICS SCHOOL OF TV/VCR REPAIR, Dept. DE036
SINCE 1891 Scranton, Pennsylvania 18515

Please send me full information and color brochure on how I can learn TV/VCR Repair at home in my spare time. I understand there is no obligation and no salesman will visit me.

Name _____ Age _____
 Address _____
 City/State/Zip _____
 Phone (____) _____

BUSINESS OPPORTUNITIES

MECHANICALLY inclined individuals desiring ownership small electronics manufacturing business - without investment. Write: **BUSINESS,** 92-R, Brighton 11th, Brooklyn, NY 11235.

YOUR own radio station! AM, FM, TV, Cable. Licensed/unlicensed. **BROADCASTING,** Box 130-F4 Paradise, CA 95969.

PROJECTION TV...Make \$\$\$s assembling projectors...Easy...Results comparable to \$2,500 projectors...Your total cost less than \$20.00... **Plans, 8" Lens & Dealers** information \$17.50...Illustrated information **free...MACROCOMA -GHX,** Washington Crossing, Pennsylvania 18977. Creditcard orders 24 Hours (215) 736-2880.

BIG PROFITS **ELECTRONIC ASSEMBLY BUSINESS**

Start home. spare time. Investment knowledge or experience unnecessary. **BIG DEMAND** assembling electronic devices. Sales handled by professionals. Unusual business opportunity.

FREE: Complete illustrated literature
 BARTA, RE-O Box 248
 Walnut Creek, Calif. 94597

Hi-profit CRT rebuilding machinery. **ONE MAN. EASY. CRT,** 1909 Louise, Crystalake, IL. 60014. (815) 459-0666.

REPORT on 10 best business opportunities in 1986. **\$3.00 LOGICALIFE CAPITAL GROUP,** 3471 Tony Drive, San Diego, CA 92122.

PRINTED CIRCUIT BOARD

PRINTED circuit boards. Quick prototypes, production, design, reflow solder send print or description for quote to **KIT CIRCUITS,** Box 235 Clawson, MI 48017.

WANTED

JAPAN importer (to help reduce U.S. trade deficit). Interested in procuring for sale in Japan U.S. manufactured electronic products, e.g. satellite TV, IC's, telephone decramblers, etc. Desire establishing sole agent relationships with U.S. companies for sale of products. Contact: **TACSAN TRADING CO.** 18-6, 3-Chome Toranomon Minatoku, Tokyo 105 Japan.

INVENTORS! AIM wants—ideas, inventions, new products, improvements on existing products. We present ideas to manufacturers. Confidentiality guaranteed. Call toll free **1-800-225-5800** for information kit.

INVENTIONS, ideas, new products wanted! Industry presentation/national exposition. Call free **1-800-528-6050.** Canada, 1-800-528-6060. X831.

Quality Microwave TV Antennas

Multi-Channel 1.9 to 2.7 GHz
40dB Gain True Parabolic 20 Inch Dish
Complete System \$84.95 (Shipping incl.)
 Dealerships, Qty. Pricing, Replacement Parts
Phillips-Tech Electronics
 P.O. Box 34772 • Phoenix, AZ 85067
 (602) 947-7700 (\$3.00 Credit all phone orders!)

LIFETIME WARRANTY MasterCard • Visa • COD's

ELECTRO-MATH

NOW SOLVE THOSE ELECTRONIC AC AND DC MATH PROBLEMS ON YOUR COMMODORE 64

SOLVE FOR: Inductive reactance, capacitive reactance, total impedance, resonant frequencies, bandwidth, vector solutions R, P and P, R, decibel problems, Ohms law time constants, charge on capacitors, sine wave conversions, H.T and L pads, transformer relationships and much more

\$19.95 design those circuits today with Electro-Math \$19.95
 send check or money order today
Electro-Math • P.O. Box 5906, Sherman Oaks, Ca. 91413

HIGH VOLTAGE TRIPLERS/MULTIPLIERS

REPLACEMENT FOR

ECG®/GE®/SK®

500A/ GE527 & SK3304	8.75	6.95
523/ GE528 & SK3306	8.85	7.20
526A/ SK3306	8.85	7.20
528/ SK3906	10.70	8.70
529/ GE529 & SK3307	9.99 3 MIN.	7.95 100 MIN.

OUTPUT TRANSISTORS

165/ SK3115 & GE38	2.25	1.95	1.75
238/ GE37 & SK3710	2.25	1.95	1.75
283/ SK3467	2.75	2.35	1.80
2SD1341P	2.25	1.95	1.75
2SC1172B	2.25 5 MIN.	1.95 50 MIN.	1.55 100 MIN.

AUDIO POWER

TYPE	10 min	50 min	100 min	TYPE	10 min	50 min	100 min	TYPE	10 min	50 min	100 min
152/ SK3893	30	25	21	196/ SK3054	49	44	39	291/ SK3440	49	44	39
153/ SK3274	30	25	21	197/ SK3083	59	54	49	292/ SK3441	49	45	40

RECTIFIER DIODES

125 1000V/2.5A	7¢	6¢	5¢
156 1000V/5A	18¢	16¢	13¢
506 DAMPER/HI-VOLT—FAST RECOVERY	29¢	24¢	19¢

\$\$\$ ADDITIONAL SAVINGS \$\$\$

TYPE	10 min	50 min	100 min	TYPE	10 min	50 min	100 min
102A	35	32	29	171	49	44	38
123A	18	16	14	184	38	33	28
123AP	13	11	09	185	38	33	28
128	38	35	29	198	60	54	49
129	38	35	29	199	18	15	12
130	59	55	49	234	19	16	13
159	16	13	11	375	44	42	39
162	2.25	1.95	1.49	712	75	69	60
163A	2.35	1.99	1.55				

FOR A COMPLETE LIST CALL OR WRITE—C.O.D. Orders Welcome (Min. Order \$25)

DIGITRON ELECTRONICS

110 HILLSIDE AVENUE, SPRINGFIELD, NEW JERSEY 07081
 Toll Free 1-800-526-4928 In NJ 201-379-9016 Telex 138441
 PRICES SUBJECT TO CHANGE WITHOUT NOTICE. OFFER GOOD WHILE SUPPLY LASTS.
 ECG is a Trade Mark of Philips ECG, Digatron Etc. not associated with Philips ECG.

THE NEW 65/9028 VT ANSI VIDEO TERMINAL BOARD!

★ FROM LINGER ENTERPRISES ★

A second generation, low cost, high performance, mini sized, single board for making your own RS232 Video Terminal. Use as a computer console or with a MODEM for hook up to any of the telephone-line computer services.

FEATURES:

- * Uses the new SMC 9028 Video Controller Chip coupled with a 6502A CPU.
- * RS-232 at 16 Baud Rates from 50 to 19,200
- * On board printer port!
- * 24 X 80 format (50/60 Hz).
- * For 15,750 Hz (Horiz.) monitors.
- * 3 Terminal Modes: H-19, ADM3A, and ANSI X 3.64-1979
- * Wide and thin-line graphics.
- * White characters on black background or reversed.
- * Character Attributes: De-Inten, Inverse or Underline.
- * Low Power: 5VDC @ .7A, ± 12VDC @ 20MA.
- * Mini size: 6.5 X 5 inches.
- * Composite or split video.
- * 5 X 8 Dot Matrix characters (U/L case).
- * Answer back capability.
- * Battery backed up status memory.
- * For ASCII parallel keyboard.

MICRO SIZE!



\$99.95
 (Full Kit)

SOURCE DISKETTE:
 PC/XT FORMAT
 5 1/4 IN. \$15

ADD \$40 FOR A&T

Digital Research Computers

(OF TEXAS)

P.O. BOX 381450 • DUNCANVILLE TX 75138 • (214) 225-2309

Call or write for a free catalog on Z-80 or 6809 Single Board Computers, SS-50 Boards, and other S-100 products.

TERMS: Add \$3.00 postage. We pay balance. Orders under \$15 add 75¢ handling. No C.O.D. We accept Visa and MasterCard. Texas Res. add 5-1/8% Tax. Foreign orders (except Canada) add 20% P & H. Orders over \$50 add 85¢ for insurance.

cable tv

DESCRAMBLER PARTS!

We stock the exact parts, PC board and AC adaptor for Radio Electronics February 1984 article on building your own **Cable TV Descrambler**.

#701 PARTS PACKAGE..... **\$29.95**

Includes all the original resistors, capacitors, diodes, transistors, integrated circuits, coils, IF transformers (toko BKAN-K5552AXX).

#702 PC BOARD..... **\$12.95**

Original etched & drilled silk-screened PC board used in the article.

#704 AC ADAPTOR..... **\$12.95**

Original (14 volts DC @ 285ma) ac adaptor used in the article.

S □ P □ E □ C □ I □ A □ L □ S

BOTH #701 & #702..... **NOW \$39**

ALL THREE #701, #702 & #704 **NOW \$49**

Add \$2.50 shipping and handling — \$4.50 for Canadian orders
We also offer quantity Discounts on 5 or more units

FREE

Reprint of Radio Electronics article (February 1984) on Building Your Own **CABLE TV DESCRAMBLER** with any purchase of above.

**60-CHANNEL
CABLE
CONVERTER**
WITH INFRARED REMOTE CONTROL



SC-60R CONVERTER..... **\$69.95**

Thousands of these converters sold nationally for \$119.95
We offer you this same type of converter for only \$69.95
All converters are NEW, with Full manufacturer's WARRANTY.

FEATURES:

- Full 60 Channel Capability
- Cordless Infrared remote control
- Ultra-Stable Synthesized tuning
- Microprocessor controlled PLL
- Works on all TV models, channel 3 output
- Standard/HRC Switch for compatibility with all Cable Systems
- Will work with all types of external descramblers

Add \$3.50 Shipping and Handling
\$4.50 on Canadian Orders

**ORDER
TOLL FREE
1-800-227-8529**



inside MA 617-339-5372
VISA, MASTERCARD or C.O.D.



**J & W
ELECTRONICS, INC.**

P.O. BOX 800R • MANSFIELD, MA 02048

FORCED SALE!

Electronic Mail Order Parts & Equipment Business

CANADIAN OWNER UNABLE TO OBTAIN USA WORKING PAPERS. FORCED TO SACRIFICE BUSINESS IMMEDIATELY AT ANY COST! BUSINESS COMPLETELY PORTABLE AND CAN BE MOVED ANYWHERE.

Established 10 years! 80,000 USA buyers mailing list. Serving industry, schools, dealers & hobbyists. Very well known name with high customer and supplier acceptance both in the USA and Canada. All systems in place, time proven, operating smoothly and postured for immediate expansion.

This is an honest once in a lifetime opportunity to acquire an established, well organized business at a truly bargain price. Net assets exceed \$200,000. This is a superb opportunity for: (A) a motivated individual (or team) wishing to enter this exciting profitable field. (B) A Hong Kong or South American businessman wishing to establish in the USA or (C) an established importer, manufacturer or distributor looking to acquire synergistic activity. Owner can continue to act as advisor.

CONTACT OWNER TODAY;
(brokers protected)

Marvin Birnbom
ETCO ELECTRONICS
Plattsburgh, N.Y. 12901

1-518-561-8700 or
1-514-739-2808 (Montreal)

CIRCLE 268 ON FREE INFORMATION CARD

DESIGNER'S NOTEBOOK

continued from page 98

the 60-Hz input—or whatever the input frequency being fed to voltage doubler happens to be.

Now we know how diode-capacitor voltage doublers work—but which of the configurations should we use in a given circuit? Well, there are pros and cons to each. I've summarized them in Table 1 so that you can make an intelligent decision about which of the voltage doublers is best for your application.

You can cascade either circuit for an even higher output voltage. Just remember that the voltage ratings for the capacitors and diodes will have to increase accordingly. And be aware that a wimpy nine-volt input can easily produce a voltage high enough to be taken seriously. Even though the current is reduced considerably, it doesn't take a lot of juice to melt either a screwdriver tip, or the fingertip of an unwary hobbyist. **R-E**

This publication is available in microform from University Microfilms International.



Please send information about these titles:

Name _____

Company/Institution _____

Address _____

City _____

State _____ Zip _____

Phone () _____

Call toll-free 800-521-3044. In Michigan, Alaska and Hawaii call collect 313-761-4700. Or mail inquiry to: University Microfilms International, 300 North Zeeb Road, Ann Arbor, MI 48106.

AMAZING DEVICES

PERSONAL DEFENSE AND PROPERTY PROTECTION UTILIZE SPACE AGE TECHNOLOGY.
CAUTION THESE DEVICES CAN BE HAZARDOUS AND MAY SOON BE ILLEGAL.

PHASORS
POCKET PAIN FIELD GENERATOR — IPG50
Assembled.....\$64.50
IPG5.....Plans.....\$8.00 IPG5K.....Kit/Plans.....\$44.50
PHASOR PAIN FIELD CROWD CONTROLLER — PPF10
Assembled.....\$250.00
PPF1.....Plans.....\$15.00 PPF1K.....Kit/Plans.....\$175.00
BLASTER - Provides a plasma discharge capable of puncturing a can. Produces a 100,000 WATT PULSE.
BLS10.....ASSEMBLED.....\$89.50
BLS1.....PLANS.....\$10.00 BLS1K.....KIT/PLANS.....\$69.50
PLASMA STUN GUN - Very intimidating and affective 5 to 10 feet 100,000 VOLTS
ITM10.....ASSEMBLED.....\$99.50
ITM1.....PLANS.....\$10.00 ITM1K.....KIT/PLANS.....\$69.50

LASERS
RUBY LASER RAY GUN — Intense visible red beam burns and welds hardest of metals. **MAY BE HAZARDOUS.**
RUB3 All Parts Available for Completing Device \$20.00
CARBON DIOXIDE BURNING, CUTTING LASER — Produces a continuous beam of high energy. **MAY BE HAZARDOUS.**
LCS. All Parts Available for Completing Device. \$20.00
VISIBLE LASER LIGHT GUN — produces intense red beam for sighting, spotting, etc. Hand held complete.
LGU3.....Plans.....\$10.00 (Kit & Assembled Units Available)
IR PULSED LASER RIFLE — Produces 15-30 watt infra-red pulses at 200-2000 per sec.
LRG3.....All Parts & Diodes Available.....\$10.00
BEGINNERS LOW POWER VISIBLE LASER — Choice of red, yellow, green — provides an excellent source of monochromatic light.
LHC2.....Plans.....\$5.00 LHC2K.....Kit.....\$34.50

SECURITY
SNOOPER PHONE — Allows user to call his premises and listen in without phone ever ringing.
SNP20.....Assembled.....\$89.50
SNP2.....Plans.....\$9.00 SNP2K.....Plans/Kit.....\$59.50
LONG RANGE WIRELESS MIKE — Miniature device clearly transmits well over one mile. Super sensitive, powerful.
MFT1.....Plans.....\$7.00 MFT1K.....Plans/Kit.....\$49.50
WIRELESS TELEPHONE TRANSMITTER — Transmits both sides of phone conversation over one mile, shuts off automatically.
VWPM5.....Plans.....\$9.00 VWPM5K.....Plans/Kit.....\$39.50
PWM5 — LONG RANGE SUPER EAR WITH WIRELESS ATTACHMENT
PWM5.....Plans.....\$10.00 PWM5K.....Kit.....\$139.50
PWM50.....Assembled and Tested.....\$169.50

Our phone is open for orders anytime. Technicians are available 9-11 a.m., Mon-Thurs for those needing assistance or information. Send \$1.00 for catalog of hundreds more similar devices. Send check, cash, MO, Visa, MC, COD to: **INFORMATION UNLIMITED**
DEPT RB, P.O. Box 716, Amherst, N. H. 03031 Tel: 603-673-4730

CIRCLE 72 ON FREE INFORMATION CARD



SAVE THE STARS.

■ When you lose your vision, you lose the stars. ■ You lose the sunsets. The rainbows. The snowflakes and moonlight. ■ This year, 50,000 Americans will lose all that and more. Forever. ■ Yet in many cases, blindness can be prevented. ■ We're the National Society to Prevent Blindness. ■ We sponsor medical research to conquer eye diseases. We sponsor safety programs to eliminate eye injuries. ■ We fight to save all the things people lose when they lose their eyesight. ■ Help us save the stars. ■ Give to Prevent Blindness.



**National Society
to Prevent Blindness**

Box 2020, Madison Sq. Station, NY, NY 10159

Radio Shack Parts Place™

START YOUR NEXT PROJECT AT THE SHACK®

Build With the Best! Manufacturer's First-Quality ICs

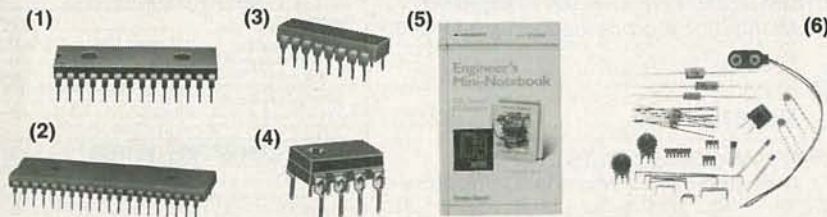

(1) **SPO256-AL2 Speech Synthesis IC.** This 28-pin MOS LSI device uses a stored program to produce natural sounding speech. With circuit examples and detailed data. Support parts are available through Radio Shack. #276-1784 **12.95**

(2) **CTS256-AL2 Text-to-Speech IC.** This 40-pin device translates standard ASCII characters into control data for the synthesizer above. Makes it a snap to add voice output to almost any computer or terminal. With data. #276-1786 **16.95**

(3) **4164 64K D-RAM.** Quality chip with 150 ns access. Upgrade your micro! #276-2506 . . . **3.95**

(4) **TLC555 CMOS Timer IC.** Super low-power version of standard 555. Ideal for battery-powered equipment. #276-1718 **1.39**

(5) **Timer IC Mini-Notebook.** By Forrest Mims III. Build 28 circuits! Large schematic diagrams help you learn to use the versatile 555 and 556 ICs. 32 pages. #276-5010 **99¢**

(6) **Timer Project Parts.** For above. Requires breadboard and 9V battery. #277-061 . . . **11.95**

Battery Guidebook

NEW! 1⁹⁹

Learn how batteries work, how to recharge and test them, and how to choose the best values. Also provides technical data on all Radio Shack ENERCELL batteries. 160 pages. #62-1396

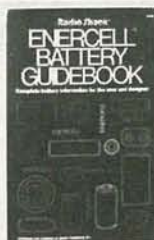

Heavy and Light-Duty Switches



(7) **Heavy-Duty DPDT.** Center off position. Rated 10 amps at 125 VAC. Screwdriver terminals. With on/off on label plate. Mounts in 7/16" dia. hole. #275-1533 **1.79**

(8) **Position DIP.** For digital/low-current use. Mounts in 16-pin DIP socket or PC board. #275-1301 . . **1.69**

Communicate With Light!



Optical Fiber Cable. This 5-meter length of high-quality 1000-micron plastic cable is ideal for experiments. Design your own lightwave link. #276-228 **5.99**

Emitter/Detector Pair. Use to send analog or digital signals through fiber optic cable. No special tools needed. With data and sample circuits. #276-225 **4.99**

Two Alarming Values



Piezo Buzzer. Steady or pulsed output, depending on hookup to screwdriver terminals. 4 to 28 VDC. Output is 90 dB at 12 VDC, only 10 mA. Easily panel mounted in 1 1/16" dia. hole. #273-068 **6.95**

XC-5491 Tri-Color LED. Glows red on DC, green on reverse DC, yellow on AC. T-1 3/4 size. #276-035 . . **1.29**

4000-Series CMOS ICs

- Highest Quality
- With Pin-Out, Specs

Low As **99¢**



Description	Type	Cat. No.	Each
Quad 2-Input NOR Gate	4001	276-2401	.99
Quad 2-Input NAND Gate	4011	276-2411	.99
Dual Type-D Flip Flop	4013	276-2413	1.19
Decade Counter/Divider	4017	276-2417	1.49
Inverting Hex Buffer	4049	276-2449	1.19
Quad Bilateral Switch	4066	276-2466	1.19

For Model Railroaders!



Mini Lamps. One red, one yellow, one green.

Volts	Cat. No.	Pkg. of 3
6	272-1098	.69
12	272-1099	.69

CdS Photoresistor. Rated 200 mW at 170 V, max. #276-116 . . **1.29**

Enclosure and PC Board

Only **2⁹⁹**



Small enclosure, big value! 1 3/16 x 3 7/16 x 2 5/16". Rugged, yet easy-to-drill molded plastic. Includes board with 483 DIP-spaced, solder-ringed holes, two labels, complete hardware, snap-in rubber feet. #270-291

PC-Mount 3/4-Watt 15-Turn Pots

1⁴⁹ Each



For critical, fine-control, trimming. 10% tolerance.

Ohms	1000	10k	20k
Cat. No.	271-342	271-343	271-340

New "Hotline" Service!

Your Local Radio Shack Can Replace Almost Any IC or Semiconductor



Over 200,000 Substitutions!

No Minimum ■ No Postage Charge

If the semiconductor or IC you need is not part of our regular stock, we'll check our new in-store substitution guide and special-order a replacement from our warehouse. Your order will be sent ASAP to your local Radio Shack store and you'll be notified when it arrives. We also offer this convenient service on selected tubes, crystals, phonograph cartridges and styli.

Digital Multimeter With Autoranging

Just Select The Function And it Does The Rest!



Only **34⁹⁵**

This accurate, extra-durable Micronta® DVM features an easy-to-read LC display plus fuse and overload protection. Measures to 1000 volts DC, 750 volts AC, DC current to 200 mills, resistance to 2 megs, and has a "diode-check" mode for semiconductor junctions. 4 7/8 x 2 13/16 x 1 1/4". With probes, manual and spare fuse. Requires 2 "AA" cells. #22-188

Prewired Car Clock Module

Special Purchase!

Only **4⁹⁵**



MA3003D-2. Detroit's goof, your gain! Fluorescent display with 1/4"-high digits is easy to read, night or day. Great for vehicles or stationary application—all you need is 12 volts DC. Approximately 1 3/8 x 2 1/8 x 1 1/2". #277-1021

Triple-Output DC Supply

Special Purchase!

Only **4⁹⁵**



Originally for Colecovision, it's ready to plug into AC and deliver +5 VDC to 900 mA, -5 VDC to 100 mA, and +12 VDC to 300 mA. UL listed. #277-1022

Over 1000 items in stock: Binding posts, Books, Breadboards, Buzzers, Capacitors, Chokes, Clips, Connectors, Fuses, Hardware, ICs, Jacks, Knobs, Lamps, Multimeters, PC Boards, Plugs, Rectifiers, Relays, Resistors, Switches, Tools, Transformers, Transistors, Wire, Zeners and more!

Radio Shack®
A DIVISION OF TANDY CORPORATION
Prices apply at participating Radio Shack stores and dealers

Worldwide • Since 1974

• QUALITY COMPONENTS • COMPETITIVE PRICING
• PROMPT DELIVERY

Mail Order Electronics • Worldwide
Jameco ELECTRONICS

COMMODORE COMPATIBLE ACCESSORIES



RS232 Adapter
for VIC-20 and
Commodore 64

The JE232CM allows connection of standard serial RS232 printers, modems, etc. to your VIC-20 and C-64. A 4-position switch allows the inversion of the 4 control lines. Complete installation and operation instructions included.

• Plugs into User Port • Provides Standard RS232 signal levels
• Uses 6 signals (Transmit, Receive, Clear to Send, Request to Send, Data Terminal Ready, Data Set Ready)

JE232CM.....\$39.95

Voice Synthesizer VIC-20 & C-64

JE520CM.....\$99.95

300 Baud Auto Modem

Mitey-Mo (For C-64).....\$74.95

Parallel Printer Interface

MW350 (For VIC-20, C-64 & C-128).....\$69.95

FREE 4K Buffer Included!

TRS-80 COMPATIBLE ACCESSORIES

E-X-P-A-N-D TRS-80 MEMORY

All kits come complete with documentation

TRS-80 MODEL I, III

TRS-16K3 200ns (Model III).....\$5.95

TRS-16K4 250ns (Model I).....\$5.49

TRS-80 COLOR AND COLOR II

TRS-64K-2.....\$9.95

TRS-80 MODEL 4, 4P

TRS-64K-2.....\$9.95

Expands Model 4 from 16K-64K or Model 4P from 64K-128K

TRS-64K-2PAL.....\$29.95

Expands Model 4 from 64K to 128K

TRS-80 Model 100 • NEC • Olivetti

M100BK.....\$29.95 ea. or 3 for \$79.95

TRS-80 Model 100 Expansion

NEC8KR.....\$29.95 ea. or 3 for \$79.95

NEC Model PC-8201A Expansion

OM10BK.....\$29.95 ea. or 3 for \$79.95

Olivetti Model M10 Expansion

TANDY 200

M200R.....\$99.95 ea. or 2 for \$189.95

Tandy Model 200 Expansion

PROMETHEUS MODEMS



Intelligent
1200/300 Baud
Modem with
Real Time
Clock/Calendar

The ProModem™ is a Bell 212A (1200/300) intelligent stand-alone modem • Hayes command set compatible plus an additional extended command set • Shown with alphanumeric display option. RS-232 Stand-Alone Unit:

PM1200.....\$299.95

Options for ProModem 1200

PM-COM.....\$79.95

ProCom Communications Software. Please specify Operating System - Apple: ProDOS or CP/M - IBM: PC DOS or MS DOS

PM-OP512K.....\$129.95

Communications Buffer Option

BUF512K.....\$54.95

512K Memory for PM-OP512K

PM-ALP.....\$79.95

Alphanumeric Display for ProModem 1200

PM-SPECIAL #2.....\$249.95

Includes PM-OP512K, BUF512K and PM-ALP

\$20 Minimum Order - U.S. Funds Only

Shipping: Add 5% plus \$1.50 Insurance

APPLE COMPATIBLE ACCESSORIES

All Apple Cards come complete with instructions. MADE IN THE USA!

16K RAM CARD
(Language Card)
For Apple II and II+*

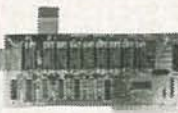

Expand from 48K-64K. Runs AppleSoft, DOS, CP/M and Pascal. (ARC-16K/MEM-1)

JE860..\$39.95**

CONTROLLER CARD
For Apple II, II+ and IIe*



Capable of handling up to two drives. Recommended drives: ADD-514 or ADD-12 (ACC-1)

JE875....\$49.95

80-COLUMN PLUS 64K RAM
For Apple IIe*



JE864 doubles the amount of data the Apple IIe can display, and memory capacity too.

JE864....\$69.95

Jameco ELECTRONICS



128K RAM CARD

For Apple II, II+ and IIe*

Five key software programs are included: Memory Management System, Utilities, Diagnostics, Demos, and RAM Disk Emulators for DOS 3.3, CP/M & Apple Pascal. Features DOS relocater. Expand-A-RAM:

JE868.....\$119.95**

PROMETHEUS



APPLESURANCE DIAGNOSTIC DISK CONTROLLER CARD

For Apple II, II+ and IIe*

PREVENTS CRASHES!

Test your RAM, ROM, CPU and Disk Drives. DRV-1/Applesurance II:

JE877.....\$69.95

PROMETHEUS

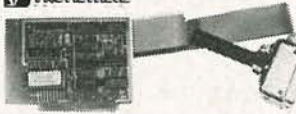

PARALLEL PRINTER CARD

For Apple II, II+ and IIe*

Fully compatible with Apple CP/M, Apple Pascal (or FORTRAN), and most other operating systems and software packages. Available for Apple II, II+ and IIe* PRT-1:

JE880.....\$59.95

PROMETHEUS



PARALLEL/SERIAL 64K BUFFER CARD

For Apple II, II+ and IIe*

Using the parallel jumper cable supplied, the JE883 will attach to the JE880 (above). Parallel Card needed for operation. The JE883 includes a standard parallel input with both parallel and serial (RS232) buffered outputs. P/S Buffer:

JE883.....\$79.95

*APPLE, APPLE II, II+ and IIe are registered trademarks of Apple Computers.
**When using CP/M, the JE860 and JE868 will only function with Version 2.20 or earlier: PASCAL (JE868) Version 1.1 or earlier.

ADDITIONAL APPLE COMPATIBLE PRODUCTS

Key: a=Apple II or II+ b=Apple IIe

APF-1 Cooling Fan with Surge Protection • Key: (a,b).....\$39.95

KHP4007 Switching Power Supply • Key: (a,b).....\$39.95

JE614 Numeric/Aux. Keypad - 11 accessible functions • Key: (b).....\$49.95

AMON 12" Green Monitor with Swivel Stand • Key: (a, b and IIe).....\$99.95

KB-EA1 Apple Keyboard and Case • Key: (a).....\$99.95

JE520AP Voice Synthesizer - Plug-In, User Ready • Key: (a,b).....\$119.95

ADD-12 5 1/4" Half-Height Disk Drive • Key: (a,b).....\$129.95

ADD-IIc 5 1/4" Half-Height Disk Drive • Key: (IIc).....\$129.95

ADD-514 5 1/4" Full Height Disk Drive • Key: (a,b).....\$139.95

PM1200A Prometheus Internal Modem - 2 Cards • Key: (a,b).....\$299.95

PM1200M Prometheus Macintosh Ext. Modem • Key: (Macintosh).....\$349.95

GENERAL APPLICATION POWER SUPPLIES

Power/Mate Corp. REGULATED POWER SUPPLY

• Input: 105-125/210-250VAC @ 47-63Hz • Line regulation: ±0.05% • 3 mounting surfaces • Overvoltage protection • UL recognized • CSA certified

Part No.	Output	Size (Inches)	Weight	PRICE
EMAS/6B	5V@3A / 6V@2.5A	4 1/4" x 4W x 2 1/4"H	2 lbs.	\$29.95
EMAS/6C	5V@6A / 6V@5A	5 1/4" x 4 1/4"W x 2 1/4"H	4 lbs.	\$39.95

4-CHANNEL SWITCHING POWER SUPPLY

• Microprocessor, mini-computer, terminal, medical equipment and process control applications • Input: 90-130VAC, 47-440Hz • Output: +5VDC @ 5A, -5VDC @ 1A; +12VDC @ 1A, -12VDC @ 1A • Line regulation: ±0.2% • Ripple: 30mV p-p

• Load regulation: ±1% • Overcurrent protection • Adjustment: 5V main output ±10% • Size: 6 3/4"L x 1 3/4"W x 4-15/16"H • Weight: 1 1/2 lbs.

FCS-604A.....\$59.95

IBM COMPATIBLE ACCESSORIES

Build an IBM PC/XT Compatible!



- 8 Card Slots
- Flip-Up Lid
- All necessary hardware for expansion is included
- Weight: 17 lbs.

IBM-Case.....\$59.95

Additional Add-Ons Available!

IBM-KB Keyboard.....\$79.95

IBM-FCC Disk Controller.....\$59.95

IBM-MCC Monochrome Card.....\$89.95

IBM-MON 12" Monochr. Monitor.....\$109.95

IBM-5151 Keyboard.....\$99.95

(Equivalent to Keytronics™ 5151)

IBM-ICB Color Card.....\$109.95

(With Printer Port)

IBM-E384K 384K RAM Card.....\$169.95

IBM-MB Motherboard.....\$269.95

IBM-10MBK 10MB HH Hard Kit.....\$499.95

IBM-20MBK 20MB HH Hard Kit.....\$599.95

IBM PC/XT Equivalent 130 Watt Power Supply

Upgrade Your PC!

• Input: 110V @ 60Hz • Output: +5VDC @ 15A, -5VDC @ 0.5A, +12VDC @ 4.2A, -12VDC @ 0.5A • Plug compatible connectors • Fits into IBM PC • Weight: 6 lbs.

IBM-PS.....\$99.95

IBM Compatible! DISK DRIVES

Documentation Included

FD55B Teac 5 1/4" DS 1/2-Height.....\$99.95

SA455 Shugart 5 1/4" DS 1/2-Height.....\$99.95

TM100-2 Tandon 5 1/4" DS Full-Height.....\$99.95

JMR 5 1/4" DISK DRIVE ENCLOSURES

Complete with power supply, switch, power cord, fuseholder and connectors.

DDE-1FH.....\$69.95

Houses 1 Full-Height 5 1/4" Floppy Drive.

DDE-2HH.....\$79.95

Houses 2 Half-Height 5 1/4" Floppy Drives - Vertical

HDDE-1FH.....\$199.95

Houses 1 Hard Disk Drive

UV-EPROM ERASER

Erases all EPROMs. Erases up to 8 chips within 21 minutes (1 chip in 15 minutes). Maintains constant exposure distance of one inch. Special conductive foam liner eliminates static build-up. Built-in safety lock to prevent UV exposure. Compact - only 9.00"L x 3.70"W x 2.60"H. Complete with holding tray for 8 chips.

DE-4 UV-EPROM Eraser.....\$74.95

UVS-11EL Replacement Bulb.....\$17.95

DATA BOOKS

30003 National Linear Data Book (82).....\$14.95

30009 Intersil Data Book (85).....\$9.95

30013 Zilog Data Book (85).....\$9.95

30022 Nat'l. Logic Data Book Set (84).....\$24.95

210830 Intel Memory Handbook (83/84).....\$19.95

230843 Intel Microsystem Hndbk. (83/84).....\$19.95

MUFFIN/SPRITE-STYLE FANS

MUF60 (SPN3-15-2462).....\$9.95

Howard Industries (4 6/8" sq, 60 cfm)

SU2C7.....\$9.95

EG&G Rotron (3.125" square, 20 cfm)



Mail Order Electronics • Worldwide
Jameco ELECTRONICS



Send \$1.00 Postage for a
FREE
1986 JAMECO CATALOG

1355 SHOREWAY ROAD, BELMONT, CA 94002 • PHONE ORDERS WELCOME 415-592-8097 Telex: 176043

GREAT PRICES! GUARANTEED 100%

★ ★ ★ CALL TOLL FREE (800) 245-8555 ★ ★ ★

74 SERIES		CMOS		DIGITAL IC SPECIALS			
74 xx	.20	74Sxx	.25	any 4000 series	.24	Your Choice .17 ea.	
741xx	.30	74S1xx	.35	any 4500 series	.45	74LS00	74LS02
742xx	.35	74S2xx	.40			74LS08	74LS10
743xx	.40	74S3xx	.45			74LS11	74LS20
						74LS74	74LS109
74LSxx	.20	74ALSxx	.30	Z80 Series			
74LS1xx	.30	74ALS1xx	.35				
74LS2xx	.40	74ALS2xx	.45	2.5 mhz			
74LS3xx	.45	74ALS3xx	.55	CPU, CTC, PIO	.75		
				DMA, DART, SIO	1.95		
74Fxx	.25	74HCxx	.35	4.0mhz (A)		Your Choice .22 ea.	
74F1xx	.35	74HC1xx	.45			74LS153	74LS157
74F2xx	.50	74HC2xx	.55	CPU, CTC, PIO	1.50	74LS139	74LS174
74F3xx	.55	74HC3xx	.65	DMA, DART, SIO	3.95		74LS161
							74LS138
74HCTxx	.30	74SCxx	.30	6.0mhz (B)			74LS175
74HCT1xx	.40	74SC1xx	.40			Your Choice .29 ea.	
74HCT2xx	.55	74SC2xx	.50			74LS240	74LS241
74HCT3xx	.65	74SC3xx	.60			74LS257	74LS273
						74LS283	74LS288
						74LS373	74LS374
							74LS377

64k DRAM

Set of 9

200ns \$8.99
150ns \$9.99

256k DRAM 150ns

Set of 9
29.95

6500 / 6800 Series				**RAMS**				E-Proms									
Any 65xx	1.50	Any 65xxA	2.00	2101	256x4	Static	450ns	.39	4044-2	4Kx1	Static	200ns	.75	2708	1Kx8	450ns	.55
Any 68xx	1.50	Any 65xxB	2.75	2102	1Kx1	Static	450ns	.39	MK4118	1Kx8	Static	250ns	.75	2716-	2Kx8	450ns	.95
Any 68Axx	2.25	Any 68Bxx	2.95	2016-20	2Kx8	Static	200ns	.95	TMS4027	4Kx1	Static	250ns	.25	2716-3	2Kx8	350ns	1.25
				2016-15	2Kx8	Static	150ns	1.45	UPD411	4Kx1	Static	300ns	.69	2716-2	2Kx8	250ns	1.55
				2111	256x4	Static	450ns	1.65	MMS280	4Kx1	Static	300ns	.45	2732	4Kx8	450ns	1.25
				2112	256x4	Static	450ns	.75	6116-4	2Kx8	Static	200ns	.95	2732-3	4Kx8	350ns	1.45
				2114-2	1Kx4	Static	200ns	.37	6116-3	2Kx8	Static	150ns	1.25	2764	4Kx8	250ns	1.75
				2114-3	1Kx4	Static	300ns	.35	4116-2	16Kx1	Dynamic	200ns	.29	2764-3	8Kx8	350ns	1.95
				2114-4	1Kx4	Static	450ns	.32	4116-25	16Kx1	Dynamic	250ns	.25	2764-2	8Kx8	250ns	2.25
				2118	16Kx1	Static	150ns	.49	6264LP-15	8Kx8	Static	150ns	4.75	27128	16Kx8	350ns	2.75
				2147	4x1	Static	55ns	1.49						27128-3	16Kx8	300ns	2.95
				2044-4	4Kx1	Static	450ns	.45						27128-2	16Kx8	200ns	3.15
														27256	32Kx8	250ns	7.95

CUT LEAD IC PROGRAM These IC's are cut lead types - Useable in PC Boards or Sockets***
* = Used in IBM Clone Mother Boards any @ .12 ea.

7400	7402	7403	7404	7406	*7407	7408	7410	74109	7411	74123	74125
7414	74148	74153	74157	7416	74160	74161	74163	74165	74166	7417	74173
74174	74175	7491	74193	74195	74221	7425	7426	7427	74276	74279	74298
7430	7432	74367	74368	74368	74393	7440	7442	7445	7451	7473	7474
7486	7475	7489	7493	7493	*LS02	LS03	*LS04	LS05	*LS08	*LS10	LS107
LS112	*LS138	LS139	*LS14	*LS14	LS153	LS155	LS156	LS157	LS158	LS161	LS163
LS164	LS165	LS166	LS169	LS169	LS175	LS191	LS193	LS194	LS195	*LS20	LS221
LS240	LS241	*LS244	*LS245	LS251	LS253	LS257	LS266	*LS27	LS273	LS279	LS280
LS283	LS298	*LS30	*LS32	LS365	LS367	LS37	*LS374	LS375	LS377	LS378	LS38
LS393	*LS670	*LS74	LS86	*S00	S04	*S138	*S157	S161	S240	S241	*S74

8000's	8200's	8255	8300's	DISC CONTROLLERS			
8031	3.95	8202	2.70	1691	5.95	2795	19.95
8035	2.95	8203	1.75	1771	4.50	2797	19.95
8039	2.45	8205	1.75	1791	4.95	6843	12.95
INS8060	9.95	8212	.90	1793	8.95	8272	3.95
INS8073	9.95	8214	.95	1795	9.95	MB8876	9.95
8080A	.70	8216	.90	1797	9.95	MB8877	9.95
8085	3.95	8224	1.90	2143	6.95	MC3470	1.50
8085A-2	9.95	8226	1.90	2791	12.95	UPD765	4.25
8086	4.50	8228	2.20	8741	7.95		
8086-2	5.25	8237	2.90	8748	7.95		
8087-3	129.95	8238	2.35	8749	7.95		
8087-2	169.95	8243	1.25	8755	16.95		
8088	6.95	8250	3.70				
8089	29.95	8251	1.75				
		8251A	1.85				
		8253	1.75				
8100's		8253-5	1.75				
8131	2.45	8292	9.95				
8155	2.45						
8155-2	2.75						
8156	5.90						
8185	19.95						
8185-2	29.95						

ALL ITEMS
SUBJECT
TO PRIOR
SALE!

SPEED UP YOUR IBM BY 33%
New V-20 CPU Mfg. by NEC replaces the 8088 in your system
No compatibility problem.



\$19.95

BIOS ROM FOR
\$9.97
IBM CLONE Mother Boards

IBM CLONE
MOTHER BOARD IC COMPLEMENT

Part No	ICs/B'd	Part No	ICs/B'd
8088	1	7407	1
8284	1	BIOS ROM	1
8288	1	74LS373	2
8255	1	74LS322	1
8237	1	74LS244	6
8253	1	74LS245	4
8259	1	74LS27	1
		74LS20	2
		74LS138	3
		74LS02	2
		74LS04	3
		74LS08	1
		74LS870	1
		74LS175	2
		74LS32	1
		74LS10	1
		74LS00	2

Digital 74 S#

When Purchase Individually \$99.00
SPECIAL \$79.95 for Entire Set of IC's

* * MISCELLANEOUS IC SPECIALS * *

TR1602	.95	2652	.65	CD4049	.19	75454	.19
WD1100	.65	D2817	.95	CD4077	.19	TL0-71	.19
MC1776CPI	.65	2901PC	.95	CD4081	.19	COM8017	.95
MC12002L	.65	2910PC	.95	MM5262	.19	N8T25	.19
AY5-1013	.95	D3232	.65	NE555	.19	P8254-2	.95
IMS1420-	.75	MK3887N	.95	NE556	.39	N825115T	.95
MC1458	.22	CD4008	.17	SY6520	.79	DP84244N	.95
MC1488	.26	CD4011	.17	HM6116	.75	8602	.29
MC1489	.26	CD4013	.19	HM6147	.29	Z8001ADC	.95
AM2167	.75	CD4019	.19	TL0-62	.19	CR19006	.95
MN27580	.55	CD4025	.19	SY6545	.95	CR19007	.95
26LS31	.19	TMS4027	.29	MC6810	.35	CR19212	.95
26LS32	.19	TMS4050	.19	MC6845	.79	MC10104P	.65
2651P2	.65	TMS4060	.19	UA709CP	.19	AM9602	.29
SCM2661A	.75	CD4042	.19	754518P	.19	TMS9937	.95
						AM95174A	.95

ELECTRONIC PARTS OUTLET
2515 N. Scottsdale Road
Scottsdale, AZ 85257 (602) 941-9357
(SEND FOR OUR FREE CATALOGUE)
TOLL FREE!!
CALL (800) 245-8555

In Phoenix, AZ
ELECTRONIC PARTS OUTLET
1921C W. Thunderbird
Phoenix, AZ 85023
602-374-0181, 2

In Florida Toll-Free 800-225-8663
ELECTRONIC PARTS OUTLET
2275 So. Federal Hwy
DelRay Beach, FL 33444
305-265-1206, 7

Please call for current prices. Prices subject to change. Please expect higher or lower prices on some parts due to supply and demand and our changing costs. Shipping and insurance extra. Orders received by 6 PM can usually be delivered to you by the next morning, via Federal Express Standard Air @ \$6.00, or Priority One @ \$11.50

NOW 3 RETAIL LOCATIONS AND MORE TO COME

CIRCLE 263 ON FREE INFORMATION CARD

TENMA

THE NAME YOU CAN TRUST IN ELECTRONIC TEST EQUIPMENT

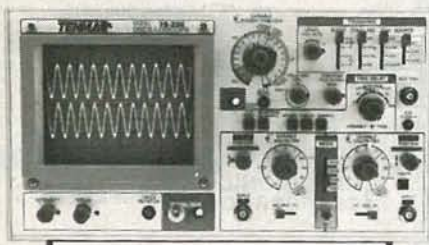

TENMA 35 MHz Dual Trace Oscilloscope

- Two high quality 10:1 probes included
- For additional specifications see MCM Catalog #11

#72-330
\$569⁰⁰ (ea)

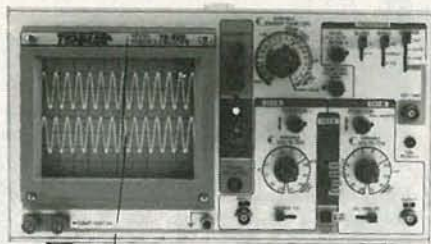

TENMA 20 MHz Dual Trace Oscilloscope

- Two high quality 10:1 probes included
- For additional specifications see MCM Catalog #11

#72-320
\$389⁹⁵ (ea)



NEW

TENMA Rotary Dial DMM

- 3½ digit LCD display
- Rotary dial for rapid selection of functions and ranges
- 20 amp AC-DC current
- .1ohm resolution
- Carrying case included

#72-075 **\$44.80** (ea)
\$41⁹⁵ (2-up)



TENMA Autoranging Digital Multimeter

- 3½ digit
- Auto polarity
- Low battery indicator
- 10 amp AC-DC current
- Continuity buzzer
- 2¼" x 5¾" x 1¾"
- Carrying case included

#72-058 **\$49.80** (ea)
\$44⁹⁵ (2-up)



TENMA Capacitance Meter

- Measures capacitors from 0.1pF to 19,999mfd
- Accuracy 0.5%
- Checks capacitors in and out of circuit
- Carrying case included

#72-040 **\$59.80** (ea.)
\$54⁹⁵ (2-up)



NEW

TENMA Digital LCR Meter

- Measures inductance, capacitance and resistance
- L = 1 micro H to 200H, C = .1pF to 200 micro F, R = .01ohm to 20Mohm
- Carrying case included.

#72-370
\$149⁹⁵ (ea)



TENMA Combination Function Generator and Frequency Counter

- 6 digit display
- Output range: .2Hz to 2MHz seven ranges
- Counter range: .1Hz to 10MHz
- 5-15 volt TTL and CMOS output
- Wave forms: sine, triangle, square, pulse, and ramp.

#72-380
\$219⁹⁰ (ea)



TENMA Frequency Counter

- 8 digit LED display
- Measurement range: 1Hz - 120MHz
- High input sensitivity of 20mV RMS

#72-375 **\$189⁹⁵** (ea)



Be Sure To Call For Your FREE Catalog! Over 6,000 Items!

We also have ... a full line of test equipment, computer accessories, telephone accessories, speakers, television parts, flybacks, yokes, switches, fuses, lamps, capacitors, resistors, cartridges, styli, wire, CATV equipment, the largest selection of original Japanese semiconductors in the country and more.

- Terms:**
- \$10 minimum order. \$1.00 charge for orders under \$10.
 - \$20 minimum charge card order.
 - Orders shipped UPS C.O.D.
 - Most orders shipped within 24 hours.
 - Sales office open 8:30 am to 7:00 pm Saturdays 10:00 am to 3 pm EST.
 - For prepaid orders add \$2.75 for shipping and handling.
 - Should shipping and handling charges exceed \$2.75, the balance due will be sent C.O.D.



MCM ELECTRONICS
 858 E. Congress Park Dr.
 Centerville, Ohio 45459-4072
 (513) 434-0031

SOURCE NO. RE-19

CALL TOLL FREE 1-800-543-4330
 In Ohio 1-800-726-4315 • In Alaska and Hawaii 1-800-858-1849

CIRCLE 87 ON FREE INFORMATION CARD

APRIL 1986

BUILD A COMPLETE XT SYSTEM—\$698

STATIC RAMS

2101	256x4	(450ns)	1.95
5101	256x4	(450ns)(CMOS)	3.95
2102L-4	1024x1	(450ns)(LP)	.99
2102L-2	1024x1	(250ns)(LP)	1.45
2112	256x4	(450ns)	2.99
2114	1024x4	(450ns)	.99
2114L-4	1024x4	(450ns)(LP)	1.09
2114L-2	1024x4	(200ns)(LP)	1.49
2114L-15	1024x4	(150ns)(LP)	1.95
TMS4044-4	4096x1	(450ns)	1.95
TMM2016-150	2048x8	(150ns)	1.49
TMM2016-100	2048x8	(100ns)	1.95
HM6116-4	2048x8	(200ns)(CMOS)	1.39
HM6116-3	2048x8	(150ns)(CMOS)	1.49
HM6116LP-4	2048x8	(200ns)(CMOS)(LP)	1.49
HM6116LP-3	2048x8	(150ns)(CMOS)(LP)	1.59
HM6116LP-2	2048x8	(120ns)(CMOS)(LP)	2.95
HM6264P-15	8192x8	(150ns)(CMOS)	3.89
HM6264LP-15	8192x8	(150ns)(CMOS)(LP)	3.95
HM6264LP-12	8192x8	(120ns)(CMOS)(LP)	4.49

LP-Low power

DYNAMIC RAMS

4116-250	16384x1	(250ns)	.49
4116-200	16384x1	(200ns)	.69
4116-150	16384x1	(150ns)	.89
4116-120	16384x1	(120ns)	1.49
MK4332	32768x1	(200ns)	6.95
4164-200	65536x1	(200ns)(5V)	1.19
4164-150	65536x1	(150ns)(5V)	1.29
4164-120	65536x1	(120ns)(CMOS)(5V)	1.95
MCM6665	65536x1	(200ns)(5V)	1.95
TMS4164	65536x1	(150ns)(5V)	1.95
4164-REFRESH	65536x1	(150ns)(5V)(REFRESH)	2.95
TMS4416	16384x4	(150ns)(5V)	4.95
41128-150	131072x1	(150ns)(5V)	5.95
41256-200	262144x1	(200ns)(5V)	2.95
41256-150	262144x1	(150ns)(5V)	2.95

5V-Single 5 Volt Supply REFRESH-Pin 1 Refresh

★★★★HIGH-TECH★★★★

NEC V20 UPD70108 \$14.95

REPLACES 8088 TO SPEED UP IBM PC 10-40%

- * HIGH-SPEED ADDRESS CALCULATION IN HARDWARE
- * PIN COMPATIBLE WITH 8088
- * SUPERSET OF 8086/8088 INSTRUCTION SET
- * LOW POWER CMOS

8 MHZ V20 UPD70108-8 \$24.95
8 MHZ V30 UPD70116-8 \$26.95

★★★★SPOTLIGHT★★★★

EPROMS

2708	1024x8	(450ns)	3.95
2716-6	2048x8	(650ns)	2.29
2716	2048x8	(450ns)(5V)	2.25
2716-1	2048x8	(350ns)(5V)	2.79
TMS2532	4096x8	(450ns)(5V)	3.95
2732	4096x8	(450ns)(5V)	2.45
2732A	4096x8	(250ns)(5V)(21V PGM)	2.75
2732A-2	4096x8	(200ns)(5V)(21V PGM)	3.95
27C64	8192x8	(250ns)(5V)(CMOS)	5.95
2764	8192x8	(450ns)(5V)	2.45
2764-250	8192x8	(250ns)(5V)	2.85
2764-200	8192x8	(200ns)(5V)	3.49
TMS2564	8192x8	(450ns)(5V)	8.95
MCM68766	8192x8	(350ns)(5V)(24 PIN)	17.95
27128	16384x8	(250ns)(5V)	2.79
27C256	32768x8	(250ns)(5V)(CMOS)	12.95
27256	32768x8	(250ns)(5V)	7.49

5V-Single 5 Volt Supply 21V PGM-Program at 21 Volts

SPECTRONICS CORPORATION EPROM ERASERS



Model	Timer	Capacity Chip	Intensity (uW/Cm ²)	Unit Price
PE-14	NO	9	8,000	\$83.00
PE-14T	YES	9	8,000	\$119.00
PE-24T	YES	12	9,600	\$175.00

ORDER TOLL FREE
800-538-5000
800-662-6279 (CA)



8000

8035	1.49
8039	1.95
8080	2.95
8085	2.49
8087-2	139.95
8087	109.00
8088	6.95
8088-2	9.95
8155	2.49
8155-2	3.95
8748	7.95
8755	19.95
80286	129.95
80287	185.00

6500

6502	2.79
65C02 (CMOS)	12.95
6507	9.95
6520	1.95
6522	4.95
6526	26.95
6532	6.95
6545	6.95
6551	5.95
6561	19.95
6581	34.95

2.0 MHZ

6502A	2.95
6520A	2.95
6522A	5.95
6532A	11.95
6545A	7.95
6551A	6.95

3.0 MHZ

6502B	6.95
-------	------

6800

6800	1.95
6802	4.95
6803	9.95
6809	5.95
6809E	5.95
6810	1.95
6820	2.95
6821	1.95
6840	6.95
6843	19.95
6844	12.95
6845	4.95
6847	11.95
6850	1.95
6883	22.95

2.0 MHZ

68B00	4.95
68B02	5.95
68B09E	6.95
68B09	6.45
68B21	3.50
68B45	6.75
68B50	3.95
68B54	7.95

6.0 MHZ

Z80B-CPU	3.75
Z80B-CTC	4.25
Z80B-PIO	4.25
Z80B-DART	14.95
Z80B-SIO/0	12.95
Z80B-SIO/2	12.95
Z8671 ZILOG	19.95

CLOCK CIRCUITS

MMS369	1.95
MMS369-EST	1.95
MMS167	12.95
MMS174	11.95
MMS5832	2.95

CRT CONTROLLERS

6845	4.95
6845A	8.95
6847	11.95
HD46505SP	6.95
MC1372	2.95
8275	26.95
7220	19.95
CRT5027	12.95
CRT5037	9.95
TMS9918A	19.95

DISK CONTROLLERS

1771	4.95
1791	9.95
1793	9.95
1795	12.95
1797	12.95
2791	19.95
2793	19.95
2797	29.95
6843	19.95
8272	4.95
UPD765	4.95
MB8876	12.95
MB8877	12.95
1691	6.95
2143	6.95

BIT RATE GENERATORS

MC14411	9.95
BR1941	4.95
4702	9.95
CM08116	8.95
MMS5307	4.95

UARTS

AY5-1013	3.95
AY3-1015	4.95
TR1602	3.95
2651	4.95
IM6402	6.95
IM6403	9.95
INS8250	6.95

SOUND CHIPS

76477	3.95
76489	8.95
SSI-263	39.95
AY3-8910	12.95
AY3-8912	12.95
SP1000	39.00

CRYSTALS

32,768 KHz	.95
1.0 MHz	2.95
1.8432	2.95
2.0	1.95
2.097152	1.95
2.4576	1.95
3.2768	1.95
3.579545	1.95
4.0	1.95
4.032	1.95
5.0	1.95
5.0688	1.95
6.0	1.95
6.144	1.95
6.5536	1.95
8.0	1.95
10.0	1.95
10.738635	1.95
12.0	1.95
14.31818	1.95
15.0	1.95
16.0	1.95
17.3430	1.95
18.0	1.95
18.432	1.95
20.0	1.95
22.1184	1.95
24.0	1.95
32.0	1.95

CRYSTAL OSCILLATORS

1.0MHz	5.95
1.8432	5.95
2.0	5.95
2.4576	5.95
2.5	4.95
4.0	4.95
5.0688	4.95
6.144	4.95
8.0	4.95
10.0	4.95
12.0	4.95
12.480	4.95
15.0	4.95
16.0	4.95
18.432	4.95
20.0	4.95
24.0	4.95

MISC.

TMS99531	9.95
TMS99532	19.95
ULN2003	.79
3242	7.95
3341	4.95
MC3470	1.95
MC3480	8.95
MC3487	2.95
11C90	13.95
2513-001 UP	6.95
AY5-2376	11.95
AY5-3600 PRO	11.95

74LS00

74LS00	.16	74LS165	.65
74LS01	.16	74LS166	.95
74LS02	.17	74LS169	.95
74LS03	.18	74LS173	.49
74LS04	.16	74LS174	.39
74LS05	.18	74LS175	.39
74LS08	.18	74LS191	.49
74LS09	.18	74LS192	.69
74LS10	.16	74LS193	.69
74LS11	.22	74LS194	.69
74LS12	.22	74LS195	.69
74LS13	.26	74LS196	.59
74LS14	.39	74LS197	.59
74LS15	.26	74LS221	.59
74LS20	.17	74LS240	.69
74LS21	.22	74LS241	.69
74LS22	.22	74LS242	.69
74LS27	.23	74LS243	.69
74LS28	.26	74LS244	.69
74LS30	.17	74LS245	.79
74LS32	.18	74LS251	.49
74LS33	.28	74LS253	.49
74LS37	.26	74LS256	1.79
74LS38	.26	74LS257	.99
74LS42	.39	74LS258	.49
74LS47	.59	74LS259	1.29
74LS48	.69	74LS260	.49
74LS51	.17	74LS266	.39
74LS73	.29	74LS273	.79
74LS74	.24	74LS279	.39
74LS75	.22	74LS281	1.95
74LS76	.29	74LS283	.59
74LS83	.49	74LS290	.89
74LS85	.49	74LS293	.89
74LS86	.22	74LS299	1.49
74LS90	.39	74LS322	3.95
74LS92	.49	74LS323	2.49
74LS93	.39	74LS364	1.95
74LS95	.39	74LS365	.39
74LS107	.34	74LS367	.39
74LS109	.36	74LS368	.39
74LS112	.29	74LS373	.79
74LS122	.45	74LS374	.79
74LS123	.49	74LS375	.95
74LS124	2.75	74LS377	.79
74LS125	.39	74LS378	1.18
74LS126	.39	74LS390	1.19
74LS132	.39	74LS393	.79
74LS133	.49	74LS541	1.49
74LS136	.39	74LS624	1.95
74LS138	.39	74LS640	.99
74LS139	.39	74LS645	.99
74LS142	.39	74LS669	1.29
74LS147	.99	74LS670	.89
74LS148	.99	74LS682	3.20
74LS151	.39	74LS683	3.20
74LS153	.39	74LS684	3.20
74LS154	1.49	74LS688	2.40
74LS155	.59	74LS783	22.95
74LS156	.49	74LS785	1.49
74LS157	.35	81LS96	1.49
74LS158	.29	81LS97	1.49
74LS160	.29	81LS98	1.49
74LS161	.39	25LS2521	2.80
74LS162	.49	25LS2569	2.80
74LS163	.39	26LS31	1.95
74LS164	.49	26LS32	1.95

HIGH SPEED CMOS

A new family of high speed CMOS logic featuring the speed of low power Schottky (Bsn typical gate propagation delay), combined with the advantages of CMOS: very low power consumption, superior noise immunity, and improved output drive.

74HC00

74HC: Operate at CMOS logic levels and are ideal for new, all-CMOS designs.

74HC00	.59	74HC148	1.19
74HC02	.59	74HC151	.89
74HC04	.59	74HC154</	

PARTIAL LISTING ONLY — CALL FOR A FREE CATALOG

CMOS

4001	.19	14419	4.95
4011	.19	14433	14.95
4012	.25	4503	.49
4013	.35	4511	.69
4015	.29	4516	.79
4016	.29	4518	.85
4017	.49	4522	.79
4018	.69	4526	.79
4020	.59	4527	1.95
4021	.69	4528	.79
4024	.49	4529	2.95
4025	.25	4532	1.95
4027	.39	4538	.95
4028	.65	4541	1.29
4035	.69	4553	5.79
4040	.69	4585	.75
4041	.75	4702	12.95
4042	.59	74C00	.29
4043	.85	74C14	.59
4044	.69	74C74	.59
4045	1.98	74C83	1.95
4046	.69	74C85	1.49
4047	.69	74C95	.99
4049	.29	74C150	5.75
4050	.29	74C151	2.25
4051	.69	74C161	.99
4052	.69	74C163	.99
4053	.69	74C164	1.39
4056	2.19	74C192	1.49
4060	.69	74C193	1.49
4066	.29	74C221	1.75
4069	.19	74C240	1.89
4076	.59	74C244	1.89
4077	.29	74C374	1.99
4081	.22	74C905	10.95
4085	.79	74C911	8.95
4086	.89	74C917	8.95
4093	.49	74C922	4.49
4094	2.49	74C923	4.95
14411	9.95	74C926	7.95
14412	6.95	80C97	.95

7400/9000

7400	.19	74147	2.49
7402	.19	74148	1.20
7404	.19	74150	1.35
7406	.29	74151	.55
7407	.29	74153	.55
7408	.24	74154	1.49
7410	.19	74155	.75
7411	.29	74157	.75
7414	.49	74159	1.65
7416	.25	74161	.69
7417	.25	74163	.69
7420	.19	74164	.85
7423	.29	74165	.85
7430	.19	74166	1.00
7432	.29	74175	.89
7438	.29	74177	.75
7442	.49	74178	1.15
7445	.69	74181	2.25
7447	.89	74182	.75
7470	.35	74184	2.00
7473	.34	74191	1.15
7474	.33	74192	.79
7475	.45	74194	.85
7476	.35	74196	.79
7483	.50	74197	.75
7485	.59	74199	1.35
7486	.35	74221	1.35
7489	2.15	74246	1.35
7490	.39	74247	1.25
7492	.35	74248	1.35
7493	.35	74249	1.95
7495	.55	74251	.75
7497	2.75	74265	1.35
74100	2.29	74273	1.95
74121	.29	74278	3.11
74123	.49	74367	.65
74125	.45	74368	.65
74141	.65	9386	3.95
74143	5.95	9602	1.50
74144	2.95	9637	2.95
74145	.60	96S02	1.95

74S00

74S00	.29	74S163	1.29
74S02	.29	74S168	3.95
74S03	.29	74S174	.79
74S04	.29	74S175	.79
74S05	.29	74S188	1.95
74S08	.35	74S189	1.95
74S10	.29	74S195	1.49
74S15	.35	74S196	1.49
74S30	.29	74S197	1.49
74S32	.35	74S226	3.99
74S37	.69	74S240	1.49
74S38	.69	74S241	1.49
74S74	.49	74S244	1.49
74S85	.95	74S257	.79
74S86	.35	74S263	.79
74S112	.50	74S258	.95
74S124	2.75	74S280	1.95
74S138	.79	74S287	1.69
74S140	.55	74S288	1.69
74S151	.79	74S299	2.95
74S153	.79	74S373	1.69
74S157	.79	74S374	1.69
74S160	.95	74S471	4.95
74S161	1.29	74S571	2.95

VOLTAGE REGULATORS

TO-220 CASE		
7805T	.49	7905T .59
7808T	.49	7908T .59
7812T	.49	7912T .59
7815T	.49	7915T .59
TO-3 CASE		
7805K	1.39	7905K 1.49
7812K	1.39	7912K 1.49
TO-92 CASE		
78L05	.49	79L05 .69
78L12	.49	79L12 .69
OTHER VOLTAGE REGS		
LM323K 5V 3A	TO-3	4.79
LM338K Adj 5A	TO-3	3.95
78H05K 5V 5A	TO-3	7.95
78H12K 12V 5A	TO-3	8.95
78P05K 5V 10A	TO-3	14.95

LINEAR

TL066	.99	LM733	.98
TL071	.69	LM741	.29
TL072	1.09	LM747	.69
TL074	1.95	LM748	.59
TL081	.59	MC1330	1.69
TL082	.99	MC1350	1.19
TL084	1.49	MC1372	6.95
LM301	.34	LM1414	5.95
LM305K	1.25	LM1458	.49
LM311	.59	LM1488	.49
LM311H	.89	LM1489	.49
LM317K	3.49	LM1496	.85
LM317T	.95	LM1812	8.25
LM318	1.49	LM1889	1.95
LM319	1.25	ULN2003	.79
LM320	7.99	XR2204	3.75
LM322	1.65	XR2211	2.95
LM323K	4.79	XR2240	1.95
LM324	.49	MPQ2907	1.95
LM331	3.95	LM2917	1.95
LM334	1.19	CA3046	.89
LM335	1.40	CA3081	.99
LM336	1.75	CA3082	.99
LM337K	3.95	CA3086	.80
LM338K	3.95	CA3089	1.95
LM339	.59	CA310E	.99
LM340	see 7800	CA3146	1.29
LM350T	4.60	CA3160	1.19
LF353	.59	MC3470	1.95
LF356	.95	MC3480	.95
LF357	.99	MC3487	2.95
LM358	.59	LM3900	.49
LM380	.89	LM3909	.95
LM383	1.95	LM3911	2.28
LM386	.89	LM3914	2.39
LM393	.45	MC4024	3.49
LM394H	4.60	MC4044	.99
TL494	4.20	RC4136	1.25
TL497	3.25	RC4558	.69
NE555	.29	LM13600	1.49
NE556	.49	75107	1.49
NE558	1.29	75110	1.95
NE564	1.95	75150	1.95
LM565	.95	75154	1.95
LM566	1.49	75188	1.25
LM567	.79	75189	1.25
NE570	2.95	75451	.39
NE590	2.50	75452	.39
NE592	.98	75453	.39
LM710	.75	75477	1.29
LM723	.49	75492	.79
H-TO-5 CAN, K-TO-3, T-TO-220			

IC SOCKETS

8 PIN ST	.13	.11
14 PIN ST	.15	.12
16 PIN ST	.17	.13
18 PIN ST	.20	.18
20 PIN ST	.29	.27
22 PIN ST	.30	.27
24 PIN ST	.30	.27
28 PIN ST	.40	.32
40 PIN ST	.49	.39
64 PIN ST	4.25	CALL
ST-SOLDER TAIL		
8 PIN WW	.59	.49
14 PIN WW	.69	.52
16 PIN WW	.69	.58
18 PIN WW	.99	.90
20 PIN WW	1.09	.98
22 PIN WW	1.39	1.28
24 PIN WW	1.49	1.35
28 PIN WW	1.69	1.49
40 PIN WW	1.99	1.80
WW-WIREWRAP		
16 PIN ZIF	4.95	CALL
24 PIN ZIF	5.95	CALL
28 PIN ZIF	6.95	CALL
40 PIN ZIF	9.95	CALL
ZIF-TEXT TOOL (ZERO INSERTION FORCE)		
8 PIN ST	1.99	100
14 PIN ST	.15	.12
16 PIN ST	.17	.13
18 PIN ST	.20	.18
20 PIN ST	.29	.27
22 PIN ST	.30	.27
24 PIN ST	.30	.27
28 PIN ST	.40	.32
40 PIN ST	.49	.39
64 PIN ST	4.25	CALL
8 PIN WW	.59	.49
14 PIN WW	.69	.52
16 PIN WW	.69	.58
18 PIN WW	.99	.90
20 PIN WW	1.09	.98
22 PIN WW	1.39	1.28
24 PIN WW	1.49	1.35
28 PIN WW	1.69	1.49
40 PIN WW	1.99	1.80
16 PIN ZIF	4.95	CALL
24 PIN ZIF	5.95	CALL
28 PIN ZIF	6.95	CALL
40 PIN ZIF	9.95	CALL
ZIF-TEXT TOOL (ZERO INSERTION FORCE)		
8 PIN ST	1.99	100
14 PIN ST	.15	.12
16 PIN ST	.17	.13
18 PIN ST	.20	.18
20 PIN ST	.29	.27
22 PIN ST	.30	.27
24 PIN ST	.30	.27
28 PIN ST	.40	.32
40 PIN ST	.49	.39
64 PIN ST	4.25	CALL
8 PIN WW	.59	.49
14 PIN WW	.69	.52
16 PIN WW	.69	.58
18 PIN WW	.99	.90
20 PIN WW	1.09	.98
22 PIN WW	1.39	1.28
24 PIN WW	1.49	1.35
28 PIN WW	1.69	1.49
40 PIN WW	1.99	1.80
16 PIN ZIF	4.95	CALL
24 PIN ZIF	5.95	CALL
28 PIN ZIF	6.95	CALL
40 PIN ZIF	9.95	CALL
ZIF-TEXT TOOL (ZERO INSERTION FORCE)		
8 PIN ST	1.99	100
14 PIN ST	.15	.12
16 PIN ST	.17	.13
18 PIN ST	.20	.18
20 PIN ST	.29	.27
22 PIN ST	.30	.27
24 PIN ST	.30	.27
28 PIN ST	.40	.32
40 PIN ST	.49	.39
64 PIN ST	4.25	CALL
8 PIN WW	.59	.49
14 PIN WW	.69	.52
16 PIN WW	.69	.58
18 PIN WW	.99	.90
20 PIN WW	1.09	.98
22 PIN WW	1.39	1.28
24 PIN WW	1.49	1.35
28 PIN WW	1.69	1.49
40 PIN WW	1.99	1.80
16 PIN ZIF	4.95	CALL
24 PIN ZIF	5.95	CALL
28 PIN ZIF	6.95	CALL
40 PIN ZIF	9.95	CALL
ZIF-TEXT TOOL (ZERO INSERTION FORCE)		
8 PIN ST	1.99	100
14 PIN ST	.15	.12
16 PIN ST	.17	.13
18 PIN ST	.20	.18
20 PIN ST	.29	.27
22 PIN ST	.30	.27
24 PIN ST	.30	.27
28 PIN ST	.40	.32
40 PIN ST	.49	.39
64 PIN ST	4.25	CALL
8 PIN WW	.59	.49
14 PIN WW	.69	.52
16 PIN WW	.69	.58
18 PIN WW	.99	.90
20 PIN WW	1.09	.98
22 PIN WW	1.39	1.28
24 PIN WW	1.49	1.35
28 PIN WW	1.69	1.49
40 PIN WW	1.99	1.80
16 PIN ZIF	4.95	CALL
24 PIN ZIF	5.95	CALL
28 PIN ZIF	6.95	CALL
40 PIN ZIF	9.95	CALL
ZIF-TEXT TOOL (ZERO INSERTION FORCE)		
8 PIN ST	1.99	100
14 PIN ST	.15	.12
16 PIN ST	.17	.13
18 PIN ST	.20	.18
20 PIN ST	.29	.27
22 PIN ST	.30	.27
24 PIN ST	.30	.27
28 PIN ST	.40	.32
40 PIN ST	.49	.39
64 PIN ST	4.25	CALL
8 PIN WW	.59	.49
14 PIN WW	.69	.52
16 PIN WW	.69	.58
18 PIN WW	.99	.90
20 PIN WW	1.09	.98
22 PIN WW	1.39	1.28
24 PIN WW	1.49	1.35
28 PIN WW	1.69	1.49
40 PIN WW	1.99	1.80
16 PIN ZIF	4.95	CALL
24 PIN ZIF	5.95	CALL
28 PIN ZIF	6.95	CALL
40 PIN ZIF	9.95	CALL
ZIF-TEXT TOOL (ZERO INSERTION FORCE)		

DATA ACQ INTERFACE

ADC0800	15.55	8T26	1.29
ADC0804	3.49	8T28	1.29
ADC0809	4.49	8T95	.89
ADC0816	14.95	8T96	.89
ADC0817	9.95	8T97	.59
ADC0831	8.95	8T98	.89
DAC0800	4.49	DM8131	2.95
DAC0806	1.95	DM8304	2.29
DAC0808	2.95	DS8833	2.25
DAC1020	8.25	DS8835	1.99
DAC1022	5.95	DS8836	.99
MC1408L8	2.95	DS8837	1.65

EDGE CARD CONNECTORS

100 PIN ST	S-100	.125	3.95
100 PIN WW			

BARGAIN HUNTERS CORNER FRANKLIN ACE-10 DISK DRIVE FOR APPLE II

- * RELIABLE, DIRECT DRIVE MECHANISM MADE FOR FRANKLIN-BY MITAC, A WORLD LEADER IN FDDs FOR APPLE
- * 100% COMPATIBLE WITH APPLE II, II+, AND IIe; USE W/STANDARD APPLE CONTROLLER OR OPTIONAL \$49.95 CONTROLLER
- * FULL HEIGHT BEIGE ENCLOSURE MATCHES APPLE; BAKED ENAMEL FINISH RESISTS SCRATCHES
- * SHIELDED CABLE WITH GROUNDING LUG FOR EMI-FREE OPERATION

ONE YEAR WARRANTY
ONLY \$79.95

HURRY — QUANTITIES ARE LIMITED!
SPECIALS END 3/31/86

PAGE WIRE WRAP WIRE PRECUT ASSORTMENT IN ASSORTED COLORS \$27.50

- 100ea: 5.5", 6.0", 6.5", 7.0"
250ea: 2.5", 4.5", 5.0"
500ea: 3.0", 3.5", 4.0"
- SPOOLS**
100 feet \$4.30 250 feet \$7.25
500 feet \$13.25 1000 feet \$21.95

Please specify color:
Blue, Black, Yellow or Red

EMI FILTER \$4.95

- * MANUFACTURED BY CORCOM
- * LOW COST
- * FITS LC-HP BELOW
- * 6 AMP 120/240 VOLT



6 FOOT LINE CORDS

- LC-2 2 CONDUCTOR .39
LC-3 2 CONDUCTOR .99
LC-HP 3 CONDUCTOR W/STD FEMALE SOCKET 1.49

MUFFIN FANS

- 3.15" SQ ROTRON 14.95
3.63" SQ ETRI 14.95
3.18" SQ MASUSHITA 16.95

WIRE WRAP PROTOTYPE CARDS FR-4 EPOXY GLASS LAMINATE WITH GOLD-PLATED EDGE-CARD FINGERS

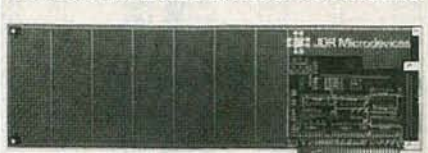

IBM-PR2 IBM

- BOTH CARDS HAVE SILK SCREENED LEGENDS AND INCLUDES MOUNTING BRACKET
- IBM-PR1 WITH +5V AND GROUND PLANE \$27.95
IBM-PR2 AS ABOVE WITH DECODING LAYOUT \$29.95

S-100

- P100-1 BARE - NO FOIL PADS \$15.15
P100-2 HORIZONTAL BUS \$21.80
P100-3 VERTICAL BUS \$21.80
P100-4 SINGLE FOIL PADS PER HOLE \$22.75

APPLE

- P500-1 BARE - NO FOIL PADS \$15.15
P500-3 HORIZONTAL BUS \$22.75
P500-4 SINGLE FOIL PADS PER HOLE \$21.80
7060-45 FOR APPLE IIe AUX SLOT \$30.00

SOCKET-WRAP I.D.™

- * SLIPS OVER WIRE WRAP PINS
 - * IDENTIFIES PIN NUMBERS ON WRAP SIDE OF BOARD
 - * CAN WRITE ON PLASTIC, SUCH AS IC #
- | PINS | PART# | PCK. OF | PRICE |
|------|-----------|---------|-------|
| 8 | IDWRAP 08 | 10 | 1.95 |
| 14 | IDWRAP 14 | 10 | 1.95 |
| 16 | IDWRAP 16 | 10 | 1.95 |
| 18 | IDWRAP 18 | 5 | 1.95 |
| 20 | IDWRAP 20 | 5 | 1.95 |
| 22 | IDWRAP 22 | 5 | 1.95 |
| 24 | IDWRAP 24 | 5 | 1.95 |
| 28 | IDWRAP 28 | 5 | 1.95 |
| 40 | IDWRAP 40 | 5 | 1.95 |
- PLEASE ORDER BY NUMBER OF PACKAGES (PCK. OF)



FRAME STYLE TRANSFORMERS

- | | | |
|-------------|-------|-------|
| 12.6V AC CT | 2 AMP | 5.95 |
| 12.6V AC CT | 4 AMP | 7.95 |
| 12.6V AC CT | 8 AMP | 10.95 |
| 25.2V AC CT | 2 AMP | 7.95 |

25 PIN D-SUB GENDER CHANGERS \$7.95

SWITCHING POWER SUPPLIES

PS-IBM \$99.95

- * FOR IBM PC-XT COMPATIBLE
- * 130 WATTS
- * +5V @ 15A, -12V @ 4.2A
- * -5V @ .5A, -12V @ .5A
- * ONE YEAR WARRANTY



PS-130 \$99.95

- * 130 WATTS
- * SWITCH ON REAR
- * FOR USE IN OTHER IBM TYPE MACHINES
- * 90 DAY WARRANTY



PS-A \$49.95

- * USE TO POWER APPLE TYPE SYSTEMS
- * +5V @ 4A, +12V @ 2.5A
- * -5V @ .5A, -12V @ .5A
- * APPLE POWER CONNECTOR



PS-SPL200 \$49.95

- * +5V @ 25A, -12V @ 3.5A
- * -5V @ 1A, -12V @ 1A
- * UL APPROVED
- * ALUMINUM ENCLOSURE



PS-TDK \$29.95

- * +5V @ 4A, +12V @ 2A
- * +12V @ 2.8A, -12V @ .30A
- * 6.2" x 7.4" x 1.7", 1.6 LBS.



PS-11951 \$29.95

- * MANUFACTURED BY ASTEC
- * +5V @ 6A, +12V @ 2A
- * +12V @ 1.5A, -12V @ 2A,
- * 5.0" x 8.0" x 2.0", 1.6 LBS.



NEW BOOKS BY STEVE CIARCIA

- | | |
|-----------------------------|---------|
| BIULD YOUR OWN Z80 COMPUTER | \$19.95 |
| CIRCUIT CELLAR VOL 1 | \$17.95 |
| CIRCUIT CELLAR VOL 2 | \$18.95 |
| CIRCUIT CELLAR VOL 3 | \$18.95 |
| CIRCUIT CELLAR VOL 4 | \$18.95 |

MICROCOMPUTER HARDWARE HANDBOOK FROM ELCOMP \$14.95

- OVER 800 PAGES OF DATA SHEETS ON THE MOST COMMONLY USED ICs. INCLUDES TTL, CMOS, 74LS00, MEMORY, CPUs, MPU SUPPORT, AND MUCH MORE!

CAPACITORS

TANTALUM

1.0μf	15V .35	.47μf	35V .45
6.8	15V .70	1.0	35V .45
10	15V .80	2.2	35V .65
22	15V 1.35	4.7	35V .85
.22	35V .40	10	35V 1.00

DISC

10pF	50V .05	680	50V .05
22	50V .05	.001μf	50V .05
27	50V .05	.0022	50V .05
33	50V .05	.005	50V .05
47	50V .05	.01	50V .07
68	50V .05	.02	50V .07
100	50V .05	.05	50V .07
220	50V .05	.1	12V .10
560	50V .05	.1	50V .12

MONOLITHIC

.01μf	50V .14	.1μf	50V .18
.047μf	50V .15	.47μf	50V .25

ELECTROLYTIC

RADIAL		AXIAL	
1μf	25V .14	1μf	50V .14
2.2	35V .15	10	50V .16
4.7	50V .15	22	16V .14
10	50V .15	47	50V .20
47	35V .18	100	35V .25
100	16V .18	220	25V .30
220	35V .20	470	50V .50
470	25V .30	1000	16V .60
2200	16V .70	2200	16V .70
4700	25V 1.45	4700	16V 1.25
COMPUTER GRADE 44,000μf		30V	3.95

DATARASE EPROM ERASER \$34.95

- * ERASES TWO EPROMS IN 10 MINUTES
- * COMPACT-NO DRAWER
- * THIN METAL SHUTTER PREVENTS UV LIGHT FROM ESCAPING



1/4 WATT RESISTORS

- 5% CARBON FILM ALL STANDARD VALUES FROM 1 OHM TO 10 MEG. OHM
- | | | | |
|-------------------|------|---------------------|------|
| 10 PCS same value | .05 | 100 PCS same value | .02 |
| 50 PCS same value | .025 | 1000 PCS same value | .015 |

RESISTOR NETWORKS

SIP	10 PIN	9 RESISTOR	.69
SIP	8 PIN	7 RESISTOR	.59
DIP	16 PIN	8 RESISTOR	1.09
DIP	16 PIN	15 RESISTOR	1.09
DIP	14 PIN	7 RESISTOR	.99
DIP	14 PIN	13 RESISTOR	.99

SPECIALS ON BYPASS CAPACITORS

- | | |
|---------------------|-------------|
| .01 μf CERAMIC DISC | 100/\$5.00 |
| .01 μf MONOLITHIC | 100/\$10.00 |
| .1 μf CERAMIC DISC | 100/\$6.50 |
| .1 μf MONOLITHIC | 100/\$12.50 |

WISH SOLDERLESS BREADBOARDS

PART NUMBER	DIMENSIONS	DISTRIBUTION STRIP(S)	TIE POINTS	TERMINAL STRIP(S)	TIE POINTS	BINDING POSTS	PRICE
WBU-D	.38 x 6.50"	1	100	---	---	---	2.95
WBU-T	1.38 x 6.50"	---	---	1	630	---	6.95
WBU-204-3	3.94 x 8.45"	1	100	2	1260	2	17.95
WBU-204	5.13 x 8.45"	4	400	2	1260	3	24.95
WBU-206	6.88 x 9.06"	5	500	3	1890	4	29.95
WBU-208	8.25 x 9.45"	7	700	4	2520	4	39.95



LITHIUM BATTERY AS USED IN CLOCK CIRCUITS

- | | |
|----------------|--------|
| 3 VOLT BATTERY | \$3.95 |
| BATTERY HOLDER | \$1.49 |

IC MASTER \$79.95



VISIT OUR RETAIL STORE LOCATED AT 1256 SOUTH BASCOM AVENUE IN SAN JOSE

JDR Microdevices

1224 S. Bascom Avenue, San Jose, CA 95128
800-538-5000 • 800-662-6279 (CA) • (408) 995-5430
FAX (408) 275-8415 • Telex 171-110

HOURS: M-W-F, 9-5 TU-TH, 9-9 SAT, 10-3
PLEASE USE YOUR CUSTOMER NUMBER WHEN ORDERING

TERMS: Minimum order \$10.00. For shipping and handling include \$2.50 for UPS Ground and \$3.50 for UPS Air. Orders over 1 lb. and foreign orders may require additional shipping charges - please contact our sales department for the amount. CA residents must include applicable sales tax. All merchandise is warranted for 90 days unless otherwise stated. Prices are subject to change without notice. We are not responsible for typographical errors. We reserve the right to limit quantities and to substitute manufacturer. All merchandise subject to prior sale.

PARTIAL LISTING ONLY — CALL FOR A FREE CATALOG

DISK DRIVES FOR APPLE COMPUTERS

AP-150
\$99.95

- 1/2 HT, DIRECT DRIVE
- 100% APPLE COMPATIBLE
- SIX MONTH WARRANTY

BAL-500
\$129.95

- TEAC MECHANISM-DIRECT DRIVE
- 100% APPLE COMPATIBLE
- FULL ONE YEAR WARRANTY

AP-135
\$129.95

- FULL HT SHUGART MECHANISM
- DIRECT REPLACEMENT FOR APPLE DISK II
- SIX MONTH WARRANTY

MAC535
\$249.95

- 3.5" ADD-ON DISK DRIVE
- 100% MACINTOSH COMPATIBLE
- SINGLE SIDED 400K BYET STORAGE
- HIGH RELIABILITY DRIVE
- HAS AUTO-EJECT MECHANISM
- FULL ONE YEAR WARRANTY

AD-3C
\$139.95

- 100% APPLE IIc COMPATIBLE
- READY TO PLUG IN, W/ SHIELDED CABLE & MOLDED 19 PIN CONNECTOR
- FAST, RELIABLE SLIMLINE DIRECT DRIVE
- SIX MONTH WARRANTY

DISK DRIVE ACCESSORIES
FDD CONTROLLER CARD \$49.95
IIc ADAPTOR CABLE \$19.95
ADAPTS STANDARD APPLE DRIVES FOR USE WITH APPLE IIc

KB-1000 \$79.95

- CASE WITH KEYBOARD FOR APPLE TYPE MOTHERBOARD
- USER DEFINED FUNCTION KEYS
 - NUMERIC KEYPAD WITH CURSOR CONTROL
 - CAPS LOCK • AUTO-REPEAT



KEYBOARD-AP \$49.95

- REPLACEMENT FOR APPLE II KEYBOARD
- CAPS LOCK KEY, AUTO-REPEAT
- ONE KEY ENTRY OF BASIC OR CP/M COMMANDS



EXTENDER CARDS

IBM-PC	\$45.00
IBM-AT	\$68.00
APPLE II	\$45.00
APPLE IIe	\$45.00
MULTIBUS	\$86.00

APPLE COMPATIBLE INTERFACE CARDS

EPROM PROGRAMMER \$59.95

MODEL RP525

- DUPLICATE OR BURN ANY STANDARD 27xx SERIES EPROM
- EASY TO USE MENU-DRIVEN SOFTWARE IS INCLUDED
- MENU SELECTION FOR 2716, 2732, 2732A, 2764 AND 27128
- HIGH SPEED WRITE ALGORITHM
- LED INDICATORS FOR ACTIVITY
- NO EXTERNAL POWER SUPPLY NEEDED
- ONE YEAR WARRANTY

16K RAMCARD \$39.95

- FULL TWO YEAR WARRANTY
- EXPAND YOUR 48K APPLE TO 64K
- USE IN PLACE OF APPLE LANGUAGE CARD

BARE PC CARD W/ INSTRUCTIONS \$9.95

IC TEST CARD \$99.95

- QUICKLY TESTS MANY COMMON ICs
- DISPLAYS PASS OR FAIL
- ONE YEAR WARRANTY
- TESTS: 4000 SERIES CMOS, 74HC SERIES CMOS, 7400, 74LS, 74L, 74H & 74S

300B MODEM \$49.95

FOR APPLE OR IBM
INCLUDES ASCII PRO-EZ SOFTWARE

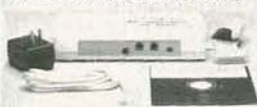

- FCC APPROVED
- BELL SYSTEMS 103 COMPATIBLE
- INCLUDES AC ADAPTOR
- AUTO-DIAL/ AUTO-ANSWER
- DIRECT CONNECT

CABLE FOR APPLE IIc \$14.95

JOYSTICK CR-401 \$7.95

FOR ATARI 400, 800, 2600,
VIC 20/64 AND APPLE IIe

DISKFILE

HOLDS 70 5 1/4" DISKETTES



\$895

3.5" DISKFILE HOLDS 40 \$995

POWER STRIP

- UL APPROVED
- 15A CIRCUIT BREAKER



\$12.95

BAL 3-WAY SWITCH BOXES

- SERIAL OR PARALLEL
- CONNECTS 3 PRINTERS TO ONE COMPUTER OR VICE VERSA
- ALL LINES SWITCHES
- HIGH QUALITY ROTARY SWITCH MOUNTED ON PCB
- GOLD CONTACTS
- STURDY METAL ENCLOSURE



SWITCH-3P CENTRONICS PARALLEL \$99.95

SWITCH-3S RS232 SERIAL \$99.95

BAL PRINTER BUFFERS

- FREES COMPUTER FOR OTHER TASKS WHILE PRINTING LONG DOCUMENTS
- STAND-ALONE DESIGN: WORKS WITH ANY COMPUTER OR PRINTER
- ALL MODELS FEATURE PRINT PAUSE MEMORY CHECK, GRAPHICS CAPABILITY

SP120P PARALLEL \$139.95

- 64K UPGRADABLE TO 256K
- LED INDICATOR SHOWS VOLUME OF DATA IN BUFFER

SP120S RS232 SERIAL \$159.95

- 64K UPGRADABLE TO 256K
- 6 SELECTABLE BAUD RATES, FROM 600B—19,200B

SP110P PARALLEL \$249.95

- 64K UPGRADABLE TO 512K
- SPOOLS OUTPUT OF UP TO 3 COMPUTERS
- LED BARGRAPH DISPLAYS AMOUNT OF DATA IN BUFFER
- RESET FUNCTION CLEARS DATA IN BUFFER
- REPEAT FUNCTION CAN PRODUCE MULTIPLE COPIES OF A DOCUMENT



NASHUA DISKETTES DEALS

5 1/4" SOFT SECTOR
DS/ DD WITH HUB RINGS

\$990 BOX OF 10
69c^{ea} BULK QTY 50
59c^{ea} BULK QTY 250

NASHUA DISKETTES WERE JUDGED TO HAVE THE HIGHEST POLISH AND RECORDED AMPLITUDE OF ANY DISKETTES TESTED ACCORDING TO "COMPARING FLOPPY DISKS", BYTE 9/84

DISKETTES NASHUA 5 1/4"

N-MD2D	DS/ DD SOFT	\$9.90
N-MD2F	DS/ QUAD SOFT	\$34.95
N-MD2H	DS/ HD FOR AT	\$49.95

NASHUA 8"

N-FD1	SS/ DD SOFT	\$27.95
N-FD2D	DS/ DD SOFT	\$34.95

NASHUA 3.5"

N-3.5SS 3.5" SS/ DD FOR MAC \$32.95

VERBATIM 5 1/4"

V-MD1D	SS/ DD SOFT	\$23.95
V-MD2D	DS/ DD SOFT	\$29.95
V-MD110D	SS/ DD 10 SECTOR HARD	\$23.95

Sakata 120 CPS DOT MATRIX PRINTER



MODEL SP-1200 \$169.95

- EPSON/ IBM COMPATIBLE
- 9-WIRE PRINTHEAD
- 120 CPS-BIDIRECTIONAL, 80 COL.
- FRICTION AND TRACTOR FEED
- PROPORTIONAL SPACING
- CENTRONICS PARALLEL INTERFACE
- 8 CHARACTER SETS AND GRAPHICS

6 FOOT IBM PRINTER CABLE \$9.95

REPLACEMENT RIBBON CARTRIDGE \$11.95

5 1/4" FLOPPY DISK DRIVES

TEAC FD-55B	1/2 HT DS/ DD (FOR IBM)	\$99.95
TEAC FD-55F	1/2 HT DS/ QUAD (FOR IBM)	\$99.95
TEAC FD-55GFV	1/2 HT DS/ HD (FOR IBM AT)	\$154.95
TANDON TM100-2	DS/ DD (FOR IBM)	\$99.95
TANDON TM50-2	1/2 HT DS/ DD (FOR IBM)	\$69.95
MPI-B52	DS/ DD (FOR IBM)	\$69.95
QUME QT-142	1/2 HT DS/ DD (FOR IBM)	\$69.95

8" FLOPPY DISK DRIVES

FD 100-8	SS/ DD (ISA/ 801 EQUIV)	\$119.00
FD 200-8	DS/ DD (ISA/ 851R EQUIV)	\$159.00

DISK DRIVE ACCESSORIES

TEAC SPECIFICATION MANUAL	\$5.00
TEAC MAINTENANCE MANUAL	\$25.00
1/2 HT MOUNTING HARDWARE	\$2.95
MOUNTING RAILS FOR IBM AT	\$4.95
"Y" POWER CABLE FOR 5 1/4" FDDs	\$2.95
5 1/4" FDD POWER CONNECTORS	\$1.19



TEAC FD-55 TANDON TM100-2

DISK DRIVE ENCLOSURES

CAB-APPLE	APPLE TYPE CABINET W/ OUT POWER SUPPLY	\$24.95
CAB-1FH5	FULL HT 5 1/4" BEIGE CABINET W/ POWER SUPPLY	\$80.95
CAB-2SV5	DUAL SLIMLINE 5 1/4" CABINET W/ POWER SUPPLY	\$49.95
CAB-2SV8	VERTICAL DUAL SLIMLINE 8" CABINET W/ POWER SUPPLY	\$209.95
CAB-2FH8	HORIZONTAL DUAL FULL HT 8" CABINET W/ POWER SUPPLY	\$219.95



CAB-2SV5 CAB-1FH5

TEST EQUIPMENT FROM JDR INSTRUMENTS

DIGITAL MULTIMETER PEN DPM-1000
AUTO RANGING, POLARITY AND DECIMAL!

\$54.95

- LARGE 3.5 DIGIT DISPLAY
- DATA HOLD SWITCH FREEZES READING
- FAST, AUDIBLE CONTINUITY TEST
- LOW BATTERY INDICATOR
- OVERLOAD PROTECTION



20MHZ DUAL TRACE OSCILLOSCOPE	MODEL 2000	\$389.00
35MHZ DUAL TRACE OSCILLOSCOPE	MODEL 3500	\$549.00

FOR MORE INFORMATION ON THE OSCILLOSCOPES, SEE OUR FULL PAGE AD. ON PAGE 15.

CALL FOR VOLUME QUOTES

© COPYRIGHT 1986 JDR MICRODEVICES

CIRCLE 255 ON FREE INFORMATION CARD

APRIL 1986

125

BUILD A COMPLETE XT SYSTEM—\$698

XT COMPATIBLE MOTHERBOARD \$169.00

- 4.77 MHz 8088 CPU, OPTIONAL 8087 CO-PROCESSOR
- 8 EXPANSION SLOTS
- 0K RAM INSTALLED, EXPANDABLE TO 640K ON-BOARD MEMORY
- ALL ICs SOCKETED-HIGHEST QUALITY PC BOARD
- ACCEPTS 2764 OR 27128 ROMS

PRO-BIOS \$29.95

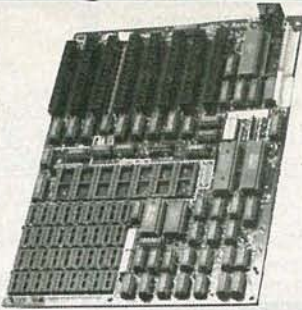

HARD DISK SYSTEMS

Includes short slot HD Controller, cables, mounting hardware and instructions. All drives are pre-tested and come with a one year warranty.

10 Mb \$389
20 Mb \$489

IBM COMPATIBLE INTERFACE CARDS ALL WITH A ONE YEAR WARRANTY

MULTI I/O FLOPPY CARD \$129.95

PERFECT FOR THE 640K MOTHERBOARD

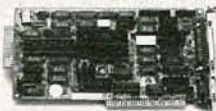

- 2 DRIVE FLOPPY DISK CONTROLLER
- 1 RS232 SERIAL PORT; OPTIONAL 2nd SERIAL PORT
- PARALLEL PRINTER PORT
- GAME PORT
- CLOCK / CALENDAR
- SOFTWARE: CLOCK UTILITIES, RAMDISK, SPOOLER

MULTIFUNCTION CARD \$119.95

ALL THE FEATURES OF AST'S 6 PACK PLUS AT HALF THE PRICE



- CLOCK / CALENDAR
- 0-384K RAM
- SERIAL PORT
- PARALLEL PORT
- GAME PORT
- SOFTWARE INCLUDED
- PRINTER CABLE \$9.95
- 64K RAM UPGRADE 9/\$11.61

COLOR GRAPHICS ADAPTOR \$99.95

FULLY COMPATIBLE WITH IBM COLOR CARD



- 4 VIDEO INTERFACES: RGB, COMPOSITE COLOR, HI-RES COMPOSITE MONOCHROME, CONNECTOR FOR RF MODULATOR
- COLOR GRAPHICS MODE: 320 x 200
- MONO GRAPHICS MODE: 640 x 200
- LIGHT PEN INTERFACE

MONOCHROME GRAPHICS CARD \$119.95

FULLY COMPATIBLE WITH IBM MONOCHROME ADAPTOR & HERCULES GRAPHICS



- LOTUS COMPATIBLE
- TEXT MODE: 80 x 25
- GRAPHICS MODE: 720 x 348
- PARALLEL PRINTER INTERFACE
- OPTIONAL SERIAL PORT \$19.95

MONOCHROME ADAPTOR \$49.95

ANOTHER FANTASTIC VALUE FROM JDR!

- IBM COMPATIBLE TTL OUTPUT
 - 720 x 350 PIXEL DISPLAY
- PLEASE NOTE: THIS CARD WILL NOT RUN LOTUS GRAPHICS AND DOES NOT INCLUDE A PARALLEL PORT

FLOPPY DISK DRIVE ADAPTOR \$49.95



- INTERFACES UP TO FOUR STANDARD FDDs TO IBM PC OR COMPATIBLES
- INCLUDES CABLE FOR TWO INTERNAL DRIVES
- STANDARD DB37 FOR EXTERNAL DRIVES
- RUNS QUAD DENSITY DRIVES WHEN USED WITH JFORMAT

EASYDATA 1200 BAUD MODEM FOR IBM

INCLUDES PC TALK III COMMUNICATIONS SOFTWARE



- HAYES COMPATIBLE
- AUTO DIAL / AUTO ANSWER
- AUTO RE-DIAL ON BUSY
- INCLUDES SERIAL PORT!
- ONE YEAR WARRANTY

\$169.95

CRT MONITORS FOR ALL APPLICATIONS



TAXAN RGB VISION III
MODEL 415

- MADE FOR TAXAN BY ACORN
- 640 x 262 PIXEL RESOLUTION
- 16 COLORS
- 18 MHZ BANDWIDTH
- 12" BLACK MATRIX
- IBM AND LOTUS COMPATIBLE
- CABLE FOR IBM \$15.95

\$289.95



SAKATA COMPOSITE COLOR
MODEL SC-100

- TOP RATED FOR APPLE
- 13" COMPOSITE VIDEO
- RESOLUTION: 280H x 300V
- INTERNAL AUDIO AMPLIFIER
- ONE YEAR WARRANTY

\$169.95



SAMWOO/ALPHA MONOCHROME
MODEL DM-216B

- PERFECT COSMETIC MATCH FOR IBM PC
- IBM COMPATIBLE TTL INPUT
- 12" NON-GLARE SCREEN
- P39 GREEN PHOSPHOR
- HI-RES 22 MHZ BAND WIDTH

\$99.95

BUILD YOUR OWN XT COMPATIBLE SYSTEM!

- XT MOTHERBOARD \$169.00
- PRO-BIOS \$29.95
- 64K RAM \$8.91
- 130 WATT POWER SUPPLY \$89.95
- FLIP-TOP CASE \$49.95
- DKM-2000 KEYBOARD \$79.95
- 1/2 HEIGHT DISK DRIVE \$69.95
- FLOPPY DISK CONTROLLER \$49.95
- MONOCHROME ADAPTOR \$49.95
- MONOCHROME MONITOR \$99.95

TOTAL: **\$697.51**

MONITOR STAND



TILTS AND SWIVELS

ONLY \$12.95

IBM PRINTER CABLE



- DB25 TO CENTRONICS
- SHIELDED CABLE \$9.95

IBM STYLE COMPUTER CASE

AN ATTRACTIVE STEEL CASE WITH A HINGED LID FITS THE POPULAR PC/XT COMPATIBLE MOTHERBOARDS

- SWITCH CUT-OUT ON SIDE FOR PC/XT STYLE POWER SUPPLY
- CUT-OUT FOR 8 EXPANSION SLOTS
- ALL HARDWARE INCLUDED

\$49.95



IBM COMPATIBLE KEYBOARDS

DKM-2000 \$79.95

KB-5151 \$99.95



- FULLY IBM COMPATIBLE
- LED STATUS INDICATORS FOR CAPS & NUMBER LOCK
- 83 KEY IDENTICAL TO IBM

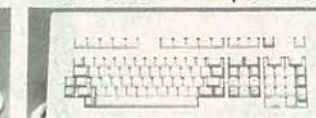

- ENHANCED IBM COMPATIBLE
- SEPARATE CURSOR & NUMERIC KEYPADS
- CAPS LOCK & NUMBER LOCK INDICATORS
- IMPROVED KEYBOARD LAYOUT

POWER SUPPLY



NOW ONLY **\$89.95**

- FOR IBM PC-XT COMPATIBLE
- 130 WATTS
- +5V @ 15A, +12V @ 4.2A
- -5V @ .5A, -12V @ .5A

150 WATT MODEL **\$99.95**

DISK DRIVES TANDON TM50-2

\$69.95

- 1/2 HT DS/DD
- IBM COMPATIBLE
- EXTREMELY QUIET!

- TEAC FD-55B DS/DD \$99.95
- TEAC FD-55F DS/QUAD \$99.95
- TEAC FD-55G DS/HD \$154.95
- QUME QT-142 DS/DD \$69.95
- MOUNTING HARDWARE \$2.95
- AT/RAILS \$4.95

JDR Microdevices

1224 South Bascom Avenue, San Jose, CA 95128

800-538-5000 • 800-662-6279 (CA) • (408) 995-5430 • FAX (408) 275-8415 • Telex 171-110

NATIONAL SEMICONDUCTOR • PANASONIC MACHINE • RAYCHEM • WESTINGHOUSE • EAC, INC. • W. MILLER • AVI ENGINEER • E. F. JOHNSON • ATLANTIC SEMICONDUCTOR

256K (262,144 x 1) DRAM 150NS \$5.70/1; \$39.95/9 Factory Firsts

JODES • DIAMOND TOOL • UNGAR • ES • CW INDUSTRIES • AMDEK • G.E. • IGAR • YAGEO • J. V. MILLER • LUXO • SO CHEMICALS • ARIES • PLESSEY

7400 TTL

Table listing 7400 TTL integrated circuits with part numbers and prices.

4000 CMOS

Table listing 4000 CMOS integrated circuits with part numbers and prices.

74HC00 CMOS

Table listing 74HC00 CMOS integrated circuits with part numbers and prices.

T I.C. SOCKETS

Table listing T I.C. sockets with part numbers and prices.

SOLDER TAIL DIP SOCKETS

Table listing solder tail dip sockets with part numbers and prices.

5% Carbon Film Resistors

Table listing 5% carbon film resistors with values and prices.

DISC CAPACITORS

Table listing disc capacitors with values and prices.

TANTALUM CAPACITORS

Table listing tantalum capacitors with values and prices.

74500 TTL

Table listing 74500 TTL integrated circuits with part numbers and prices.

74500 CMOS

Table listing 74500 CMOS integrated circuits with part numbers and prices.

74500 TTL

Table listing 74500 TTL integrated circuits with part numbers and prices.

WIRE WRAP DIP SOCKETS

Table listing wire wrap dip sockets with part numbers and prices.

1% Metal Film Resistors

Table listing 1% metal film resistors with values and prices.

3% Metal Film Resistors

Table listing 3% metal film resistors with values and prices.

PANASONIC LS SERIES

Table listing Panasonic LS series capacitors with values and prices.

330 DISC CAPACITORS

Table listing 330 disc capacitors with values and prices.

74LS00 TTL

Table listing 74LS00 TTL integrated circuits with part numbers and prices.

74LS00 CMOS

Table listing 74LS00 CMOS integrated circuits with part numbers and prices.

74LS00 TTL

Table listing 74LS00 TTL integrated circuits with part numbers and prices.

SILICON TRANSISTORS

Table listing silicon transistors with part numbers and prices.

5% Metal Oxide Film Resistors

Table listing 5% metal oxide film resistors with values and prices.

2 Watt Resistor Assortment

Table listing 2 watt resistor assortment with values and prices.

5% Wirewound Res. Resistors

Table listing 5% wirewound resistor assortment with values and prices.

1% Metal Film Resistors

Table listing 1% metal film resistor assortment with values and prices.

The Digi-Key volume discount and service charges are simple to apply. Most items sold by Digi-Key may be combined for a volume discount. Items that are not discountable are identified by the suffix -ND following the part number.

Table showing service charges and volume discount rates for different order amounts.

WHEN ORDERING BY PHONE, CALL 1-800-344-4531 (AK, call 218-681-6674). BY MAIL SEND YOUR ORDER TO: DIGI KEY, P.O. Box 677, Thief River Falls, MN 55781.

You may pay by check, money order, MasterCard, VISA or C.O.D. DIGI-KEY GUARANTEE: Any parts or products purchased from Digi-Key that prove to be defective will be replaced or refunded if returned within 90 days from receipt with a copy of your invoice.

CIRCLE 82 ON FREE INFORMATION CARD

THE MOST POPULAR PRODUCTS IN EUROPE & ASIA ARE COMING NOW! 50 HOT ITEMS FOR YOUR SELECTION. SEND \$1.00 FOR MARK V CATALOG, REFUND UPON ORDER

INFRARED REMOTE CONTROL UNIT

TY-41 MK3



Kit \$25.00
 Ass. with tested \$30.00

60W VERSATILE STEREO POWER BOOSTER

TA-302



Kit \$50.00
 Ass. with tested \$60.00

3-5A REGULATED DC POWER SUPPLY

(TR-355A) 0-15V/5A
 (TR-355B) 0-30V/3A



Kit \$10.00

PURE CLASS "A" MAIN POWER AMPLIFIER

TA-120

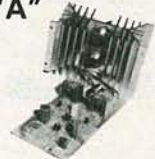

Kit \$25.00

NF-CR BI-FET IC PRE-AMPLIFIER

TA-2800

WITH 3 WAY TONE CONTROL!



Kit \$44.50

80W + 80W DC LOW TIM PRE-MAIN AMPLIFIER

TA-800



Kit \$55.38

0-50V/3A POWER SUPPLY W/SHORT CIRCUIT BREAK

TA-503



Kit \$12.00

SPEAKER PROTECTOR

TY-25



Kit \$11.00

UNIVERSAL DIGITAL FREQUENCY COUNTER

SM-100 150MC



SM-100 is an accurate, easy-operated digital frequency counter. Few pieces of advanced, high technical LSI integrated circuit are used, thus, circuit structure is reliable, SM-100 can give you up to 8 digits of resolution for a wide frequency range of 10Hz to 150MHz. Besides, a memorize system is available, the last input digits can be held on the panel, as compare to the other or even observation. Input sensitivity: KHz range 10Hz - 10MHz 50mVrms
 MHz range 1MHz - 150MHz 40mVrms

Response time: 0.2 sec.
 Hold: Hold the late input signal
 Power supply: DC6V Battery or DC9V 250MA Adaptor
Assembled with tested \$99.00

TR-100 0-15V 2A REGULATED DC POWER SUPPLY



- * Output voltage is adjustable from 0-15V DC, two current limit range are available for selection: 200mA or 2A.
- * An elaborated protection system is specially designed, a 'BB' sound and a sparkle light will appear when the output is overloaded.
- * High stability and reliable resulting from employing high quality voltage regulate IC.
- * Possessing king size meter makes the reading of voltage and current more clearly and accuracy.

A refined case, meter and all accessory are enclosed for both kit and assembly form. Most suitable for factory, professional or even amateur.

Kit \$59.50
 Ass. with tested \$69.50

3 1/2 DIGITAL MULTIMETER

YAMATO 4001



SPECIAL OFFER!

The YAMATO 4001 is a 3 1/2 DIGIT COMPACT DIGITAL MULTIMETER, it employs FE type LCD, with large figures. Its ADVANTAGES: High accuracy in measuring. High impedance assures min. measuring error. One rotary switch allows fast & convenient operation. 26 measurement range enable wider application. Over-input indication & low battery life appears on display. LSI-circuit use provides high reliability and durability. Measurement possible even under strong magnetic field.
Not a KIT, assembled with tested \$33.80

MULTIFUNCTIONAL LED D.P.M.

SM-43



6 different kinds of usages with only one meter, high accuracy ($\pm 0.1\%$) (± 1 digit), high input impedance, high anti-vibrating ability, the display reset to zero automatically when the input is 0V, and employs 100PPM/C temperature compensating zener diode which improves the accuracy and stationary of the meter.

MEASUREMENT RANGE:
 D.C. VOLTAGE: 1mV - 1000V
 A.C. VOLTAGE: 1mV - 1000V
 DIGITAL THERMOMETER: 0°C - 100°C
 D.C. CURRENT: 1uA - 2A
 CAPACITOR METER: 1pF - 2uF
 FREQUENCY COUNTER: 10Hz - 20KHz
 DIMENSION: 3 3/4" x 1 7/8" x 4 1/16"
 Kit \$29.23
 Assembled with tested \$35.00

WE CAN SUPPLY METAL CABINETS AND POWER TRANSFORMERS FOR OUR KITS! PLEASE REFER TO OUR CATALOG.

STEREO SIMULATOR

TA-3000



SPECIAL KITS OFFER!

KIT ONLY \$25.00

You can own a stereo TV, from today! This simulator is a special design of using the most advanceable monopolised L.S.I. It produced a superior analog stereo effect since the L.S.I. is equalled 60 pcs. of LOW NOISE FET & TRANSISTOR. The simulator can even help you to promote your television from a normal one to a special one with a Hi-Fi STEREO function. Our simulator is also applicable to any other 'mono sources' in covering it to ANALOG STEREO. Undoubtedly, it is the most advanced equipment for every family, while it should contribute to your listening pleasure.

Ass. with tested \$30.00

TA-2400A ELECTRONIC ECHO AND REVERBERATION AMPLIFIER

REMIX records yourself!



This unit combines the most advanced computer V.L.S.I. technique with high quality Japan Made component, so it has the following FEATURES:

It can generate various reflection and reverberation effect such as that in valley and music hall. It has a 3 section effect control which includes reverberation control, delay control and depth control. Special effect can be made in your record tapes by using this model. All kinds of infield sound effect can be obtained by skilful use of this control. It has LED display to show reflection and reverberation.

Ass. with tested \$99.85

HIGH QUALITY MULTIPURPOSE PRE-AMPLIFIER

TA-2500



This specially designed pre-amplifier includes a professional GRAPH EQUALIZER TONE control system and has a gain to 12dB. Frequency response extends from 5Hz to 20KHz, so even in bad listening condition it can improve well. It can accept input from various magnetic cartridge, record deck and tuner, its output can be connected to all kinds of power amplifier! The following combinations are good examples.
Assembled with tested \$90.00

COLOR LIGHT CONTROLLER

TY-23B



As a result of the advanced technology, this unit can control various colorful light bulbs, the visual effect of which is most suitable in places like party, disco, electronic game centre and also in lightings for advertisement. Total output power is 3000W (1000W/Ch.) which means that it can control 30 pieces of 100W or 600 pieces of 5W color light which is enough for most usages.

Kit \$65.00
 Ass. with tested \$75.00

120W MOSFET POWER AMPLIFIER

TA-477



This amplifier consists of three super low TIM differential stages, and Hitachi 2S349/2SK 134 match pair "MoSfet" as output component whose frequency response and transient response is superior to the other power transistor. Therefore this amplifier sounds clear and high fidelity and has superior analysis over whole Audio spectrum, so it is suitable for reproducing classic and modern music.

Kit \$61.28

TERMS:

Min order: \$10.00
 Charge card order: \$20.00
 NO C. O. D. Cashier's check, phone orders accept.
 Calif. Res Add 6.5% Sales Tax.
 Prices are subject to change without notice.

All merchandises are subject to prior sale.
 Shipping & Handling: Inside L. A. 5% of total order (Min 1.50). Outside L. A. 10% of total order (Min 2.50). Outside U.S.A. 20% of total order (Min 5.00).
 Shipped by UPS



MARK V ELECTRONICS INC.
 248 E. Main Street,
 Suite 100,
 Alhambra, CA91801

Information (818) 282-1130
 Orders (818) 282-1196
 P.O. BOX 7065 ALHAMBRA, CA 91802
 TELEX: 3716914 MARK 5

HOURS: MON - FRI 10:00 TO 5:00
 SATURDAYS 9:00 TO 12:00

RAMSEY

THE FIRST NAME IN ELECTRONIC TEST GEAR



\$30 OFF

Save \$30 on the RAMSEY 20MHz Dual Trace Oscilloscope

Unsurpassed quality at an unbeatable price, the Ramsey oscilloscope compares to others costing hundreds more. Features include a component testing circuit for resistor, capacitor, digital circuit and diode testing • TV video sync filter • wide bandwidth & high sensitivity • internal graticule • front panel trace rotator • Z axis • high sensitivity x-y mode • regulated power supply • built-in calibrator • rock solid triggering

Was \$399.95 NOW ONLY **\$369.95** high quality hook on probes included



NEW RAMSEY 1200 VOM MULTITESTER

Check transistors, diodes and LEDs with this professional quality meter. Other features include, decibel scale • 20K volt metering system • 3 1/2" mirrored scale • polarity switch • 20 measuring ranges • safety probes • high impact plastic case

\$19.95 test leads and battery included



NEW

RAMSEY D-4100 COMPACT DIGITAL MULTITESTER

Compact sized reliability and accuracy. This LCD digital multitester easily fits in your pocket, you can take it anywhere. It features full overload protection • 3 1/2 digit LCD readout • recessed input jacks • safety probes • diode check function • 2000 hours battery life

\$22.95 test leads and battery included

NEW 35 MHz DUAL TRACE OSCILLOSCOPE



A heavy duty and accurate scope for service as well as production use. Features include • wide frequency bandwidth • optimal sensitivity • extremely bright display • delayed triggering sweep • hold off • ALT trigger • single sweep • TV sync • 5X magnification • XY or XYZ operation • HF/LF noise reduction

3500 Dual Trace Oscilloscope \$499.95 includes 2 high quality probes

ALL OSCILLOSCOPES INCLUDE 2 PROBES

NEW 15 MHz DUAL TRACE PORTABLE OSCILLOSCOPE



Ideal for field/bench applications, this scope can display up to 15 MHz signals. Internal battery pack allows up to 2 hours operation on a single charge. Features include • built-in battery charger • 5X horizontal magnification • high brightness CRT • front panel trace rotator • internal rechargeable battery pack

2500 Portable Oscilloscope \$449.95 includes 2 high quality probes

MINI KITS—EASY TO ASSEMBLE, FUN TO USE BEGINNERS & PROS WILL HAVE A GREAT TIME WITH THESE KITS

FM MINI MIKE

A super high performance FM wireless mike kit! Transmits a stable signal up to 300 yards with exceptional audio quality by means of its built in electret mike. Kit includes case, mike, on-off switch, antenna, battery and super instructions. This is the finest unit available.

FM-3 Kit **\$14.95**
FM-3 Wired and Tested **19.95**

Color Organ

See music come alive! 3 different lights flicker with music. One light each for high, mid-range and lows. Each individually adjustable and drives up to 300 W, runs on 110VAC.

Complete kit, ML-1 **\$8.95**

Video Modulator Kit

Converts any TV to video monitor. Super stable, tunable over ch 4-6. Runs on 5-15V accepts std. video signal. Best unit on the market! Complete kit, VD-1 **\$7.95**

Super Sleuth

A super sensitive amplifier which will pick up a pin drop at 15 feet! Great for monitoring baby's room or as general purpose amplifier. Full 2W rms output, runs on 6 to 15 volts, uses 8-45 ohm speaker. Complete kit, BN-9 **\$5.95**

Led Blinky Kit

A great attention getter which alternately flashes 2 jumbo LEDs. Use for name badges, buttons, warning panel lights, anything! Runs on 3 to 15 volts. Complete kit, BL-1 **\$2.95**

CPO-1

Runs on 3-12 Vdc 1 wall out, 1 KHZ good for CPO, Alarm, Audio Oscillator. Complete kit **\$2.95**

Tone Decoder

A complete tone decoder on a single PC board. Features: 400-5000 Hz adjustable range via 20 turn pot, voltage regulation, 567 IC. Useful for touch-tone burst detection, FSK, etc. Can also be used as a stable tone encoder. Runs on 5 to 12 volts. Complete kit, TD-1 **\$5.95**

FM Wireless Mike Kit

Transmits up to 300' to any FM broadcast radio, uses any type of mike. Runs on 3 to 9V. Type FM-2 has added sensitive mike preamp stage.

FM-1 Kit **\$3.95** FM-2 Kit **\$4.95**

Whisper Light Kit

An interesting kit, small mike picks up sounds and converts them to light. The louder the sound, the brighter the light. Includes mike, controls up to 300 W, runs on 110 VAC. Complete kit, WL-1 **\$6.95**

Siren Kit

Produces upward and downward wail characteristic of a police siren. 5 W peak audio output, runs on 3-15 volts, uses 3-45 ohm speaker. Complete kit, SM-3 **\$2.95**

60 Hz Time Base

Runs on 5-15 VDC. Low current (25ma) 1 min/month accuracy TB-7 Kit **\$5.50** TB-7 Assy **\$9.95**

Siren Kit

Produces upward and downward wail characteristic of a police siren. 5 W peak audio output, runs on 3-15 volts, uses 3-45 ohm speaker. Complete kit, SM-3 **\$2.95**

Universal Timer Kit

Provides the basic parts and PC board required to provide a source of precision timing and pulse generation. Uses 555 timer IC and includes a range of parts for most timing needs.

UT-5 Kit **\$5.95**

Mad Blaster Kit

Produces LOUD ear shattering and attention getting siren like sound. Can supply up to 15 watts of obnoxious audio. Runs on 6-15 VDC. Complete kit, MB-1 **\$4.95**

Siren Kit

Produces upward and downward wail characteristic of a police siren. 5 W peak audio output, runs on 3-15 volts, uses 3-45 ohm speaker. Complete kit, SM-3 **\$2.95**

30 Watt 2 mtr PWR AMP

Simple Class C power amp features 8 times power gain, 1 W in for 8 out, 2 W in for 15 out, 4 W in for 30 out. Max output of 35 W, incredible value, complete with all parts, less case and T-R relay.

PA-1, 30 W pwr amp kit **\$22.95**
TR-1, RF sensitive T-R relay kit **6.95**

Power Supply Kit

Complete triple regulated power supply provides variable 6 to 18 volts at 200 ma and -5 at 1 Amp. Excellent load regulation, good filtering and small size. Less transformers, requires 6 3V (a 1 A and 24 VCT). Complete kit, PS-3LT **\$6.95**

CT-70 7 DIGIT 525 MHz COUNTER

Lab quality at a breakthrough price. Features • 3 frequency ranges each with pre amp • dual selectable gate times • gate activity indicator • 50mV @ 150 MHz typical sensitivity • wide frequency range • 1 ppm accuracy

\$119.95 wired includes AC adapter

CT-70 kit \$99.95
BP-4 nicad pack 8.95

CT-50 8 DIGIT 600 MHz COUNTER

\$169.95 wired

CT-50 kit \$139.95
RA-1 receiver adapter kit 14.95

CT-90 9 DIGIT 600 MHz COUNTER

The most versatile for less than \$300. Features 3 selectable gate times • 9 digits • gate indicator • display hold • 25mV @ 150 MHz typical sensitivity • 10 MHz timebase for WWV calibration • 1 ppm accuracy

\$149.95 wired includes AC adapter

CT-90 kit \$129.95
OV-1 0.1 PPM oven timebase 59.95
BP-4 nicad pack 8.95

CT-125 9 DIGIT 1.2 GHz COUNTER

\$169.95 wired includes AC adapter

BP-4 nicad \$8.95

DM-700 DIGITAL MULTIMETER

Professional quality at a hobbyist price. Features include 26 different ranges and 5 functions • 3 1/2 digit, 1/2 inch LED display • automatic decimal placement • automatic polarity

\$119.95 wired includes AC adapter

DM-700 kit \$99.95
MP-1 probe set 4.95

PR-2 COUNTER PREAMP

The PR-2 is ideal for measuring weak signals from 10 to 1,000 MHz • flat 25 db gain • BNC connectors • great for shifting RF • ideal receiver/TV preamp

\$44.95 wired includes AC adapter

PR-2 kit \$34.95

PS-2 AUDIO MULTIPLIER

The PS-2 is handy for high resolution audio resolution measurements, multiplies up in frequency • great for PL tone measurements • multiplies by 10 or 100 • 0.01 Hz resolution & built-in signal preamp/conditioner

\$49.95 wired

PR-2 kit \$39.95

PS-10B 1.5 GHz PRESCALER

Extends the range of your present counter to 1.5 GHz • 2 stage preamp • divide by 1000 circuitry • super sensitive (50 mV typical) • BNC connectors • 1 GHz in, 1 MHz out • drive any counter

\$79.95

PS 10-B Prescaler \$79.95
wired includes AC adapter

ACCESSORIES FOR RAMSEY COUNTERS

Telescopic whip antenna—BNC plug **\$ 8.95**
High impedance probe, light loading **16.95**
Low pass probe, audio use **16.95**
Direct probe, general purpose use **13.95**
Tilt bail, for CT-70, 90, 125 **3.95**

PHONE ORDERS CALL **716-586-3950**
TELEX 466735 RAMSEY CI

TERMS: • satisfaction guaranteed • examine for 10 days, if not pleased, return in original form for refund • add 6% for shipping and insurance to a maximum of \$10.00 • overseas add 15% for surface mail • CDD add \$2.50 (CDD in USA only) • orders under \$15.00 add \$1.50 • NY residents add 7% sales tax • 90 day parts warranty on all kits • 1 year parts & labor warranty on all wired units.

RAMSEY RAMSEY ELECTRONICS, INC.
2575 Baird Rd.
Penfield, N.Y. 14626

ADVERTISING INDEX

RADIO-ELECTRONICS does not assume any responsibility for errors that may appear in the index below.

Free Information Number	Page		Page		Page
288	A.I.S. Satellite	87	120	Elephant Electronics	87
108	AMC Sales	34	284	EMCO	86
76	AP Products	91	—	Engineering ADMart	99
—	Advanced Electronics	33	268	Etco	116
107	All Electronics	113	111,252	Etronix	25,107
72	Amazing Devices	116	100	Firestik II	38
77	B&K Precision	26	261	Fluke Manufacturing	7
98	Beckman Industrial	37	—	Fordham Radio	13, CV4
281	Becktron	24	—	Grantham College of Engineering	103
53	Buyus	86	—	Halix	109
279	C & S Sales	80	269	Hameg	95
—	CIE	18	86,277	Heath	17,57
267,266	Cameo Enterprises	23,87	265	Intek Electronics	87
—	C.O.M.B.	93	65	J & W	115
—	Command Productions	34	59	JDR Instruments	15
79,290	Communications Electronics	3,83	113,253	JDR Microdevices	122,123
—	Coop's Satellite Digest	84	254,255	JDR Microdevices	124,125
280	Copper Electronics	36	256	JDR Microdevices	126
—	Cost Effective Components	104	114	Jameco	118,119
127	Deco Industries	86,87	124	James Walter Satellite Rec.	87
251	Deltax Dynamic	87	104	Jan Crystals	32
95	Dick Smith Electronics	96,97	—	Joseph	101
82	Digi-Key	127	87	MCM Electronics	121
—	Digital Research Computers	114	257	Mark V. Electronics	128
57	Digitron	114	—	McGraw Hill	39,74
285	Diplomat International	38	270	Micro-Mart	110
263	Electronic Parts Outlet	120	117	Mouser	25
—			—	NRI	8
—			—	NTS	28
271	NewTone	42,43	272,273	O.K. Industries	23,25
274	Omnitron	12	—	Pacific Cable	111
118	Pacific One	87	68	Philips ECG	85
258	Phoenix Institute of Technology	22	101	Pomona	CV3
276	Print Products International	104	276	Print Products International	104
264	Probemaster	35	283	Prof. Diving School of N.Y.	36
282	Quintec	87	282	RAG Electronics	5
126	RAG Electronics	5	78	Radio Shack	117
70	Ramsey	129	278	Regency	44
278	Saratoga Electronics	112	259	Sibex	86
289	Spartan Electronics	130	75	Spartan Electronics	130
260	Tektronix	CV2	123	Test Probes	32
287	Toroid	99	287	U.S. Instrument Rentals	27
286	U.S. Instrument Rentals	27	262	Wavetek	14
103	Wm B. Allen	89			

**SPARTAN
PRICE
BUSTER**
(516) 499-9500
6094 Jericho Tpk.
Commack, N.Y. 11725

**WELLER Temperature
Controlled Soldering
Station**



\$97.95

- Control Ranges 600 F, 700 F, 800 F
- Change temperature by simply changing the heat sensing tip
- Safe for IC Soldering
- Storage Tray for extra tips and tip cleaning sponge with receptacle
- Comes with 1/8" screwdriver tip 700 F
- 3 wire 4.5' long cord

**SGL WABER DATAGARD
Spike & Noise
Suppressor**



\$37.95

PROTECT YOUR COM-
PUTER WITH DATAGARD

Datagard DG115S provides a single-stage spike filter and a single-stage noise filter to protect against moderate and catastrophic spikes and virtually all unwanted noise interference coming through the wall outlet

**NEW 12"
DIAGONAL
MONITOR**



Green
\$90.95
Amber
\$95.95

- Monochrome display
- Composite video
- 80 characters & 25 lines
- 700 line resolution at center
- Non-glare CRT

**HAYES
Smartmodem 1200**



\$390.95

- Full or Half Duplex
- 300 BPS or up to 1200 BPS operation
- Auto Answer and Auto Dial
- Connects directly to telephone lines

XCELITE \$33.00

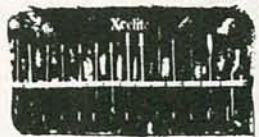

Multipurpose fourteen piece nut
and screwdriver set.

**RS232 TRANSMISSION
LINE TESTER**



\$18.95

Features: * Male to Female connector for easy insertion into RS232 Line * Test 7 Lines (TD, RD, RTS, CIS, DSR, CD, DTR) using LED's to indicate status of each * Directly powered by RS232 Line no AC power needed.

**GENERAL INSTRUMENT
58 Channel Remote
Controller**

LCC-58



\$75.95

- On/off fine tune
- Wireless
- Installs in minutes

**PHILIPS REMOTE CABLE
CONVERTER**



\$121.95

- Micro computer technology
- Quartz controlled IC's lock in picture & prevent drift
- 60 channel selection
- Programmable time on & off
- 24 hour LED digital clock
- Favorite channel memory & recall plus scan
- Wireless hand held "infra-red" transmitter system
- Automatic line tune
- Adaptable to any brand television
- One year warranty service

Dealers Welcome

Prices subject to change without notice. COD \$2.00 Extra

We accept MC, Visa, Amex. COD (w \$10 deposit) Shipping charges as follows:

to 75 00	\$2 50
76 00 to 250 00	\$4 50
251 00 to 500 00	\$6 00
501 00 to 750 00	\$8 50
751 00 to 1000 00	\$12 00
Over 1000 00	\$12 50

Store Hours:

Mon-Fri 9-6 Sat. 9:30-5

(516) 499-9500

TELEX: 551427 SPARTAN

Gernsback Publications, Inc.

500-B Bi-County Blvd.
Farmingdale, NY 11735
(516) 293-3000

President: Larry Steckler
Vice President: Cathy Steckler

ADVERTISING SALES 516-293-3000

Larry Steckler
publisher
Arline Fishman
advertising coordinator
Shelli Weinman
advertising associate
Lisa Strassman
credit manager
Donna Sala
credit associate
Naomi Matten
advertising assistant

SALES OFFICES

EAST/SOUTHEAST

Stanley Levitan
Eastern Sales Manager
Radio-Electronics
500-B Bi-County Blvd.
Farmingdale, NY 11735
718-428-6037, 516-293-3000

MIDWEST/Texas/Arkansas/Okla.

Ralph Bergen
Midwest Sales Manager
Radio-Electronics
540 Frontage Road—Suite 339
Northfield, IL 60093
312-446-1444

PACIFIC COAST/ Mountain States

Marvin Green
Pacific Sales Manager
Radio-Electronics
15335 Morrison St.—Suite 227
Sherman Oaks, CA 91403
818-986-2001

CIRCLE 75 ON FREE INFORMATION CARD

What Pomona knows about "Black Boxes" would fill a book.

The Pomona Electronics diversified line of "Black Boxes" can qualify as a true success story. Acceptance by our customers has been nothing short of overwhelming because they are so useful.

Design engineers have made their lives a little easier by using them to permanently package—and shield—voltage dividers, passive or active isolation or impedance-matching networks, attenuators and other custom test circuits.

In our 1986 General Catalog you'll find almost 100 models of high quality "Black Boxes" in phenolic, glass filled nylon and die-cast shielded metal; in an almost infinite selection of sizes and connector combinations to exactly suit your needs.

Here's how to get your copy of our 1986 General Catalog: Just circle the reader service number below; call us at (714) 623-3463; write us at ITT Pomona Electronics, a division of ITT Corporation, 1500 East Ninth Street, P.O. Box 2767, Pomona, California 91769.

Our products are available through your favorite electronics parts distributor.

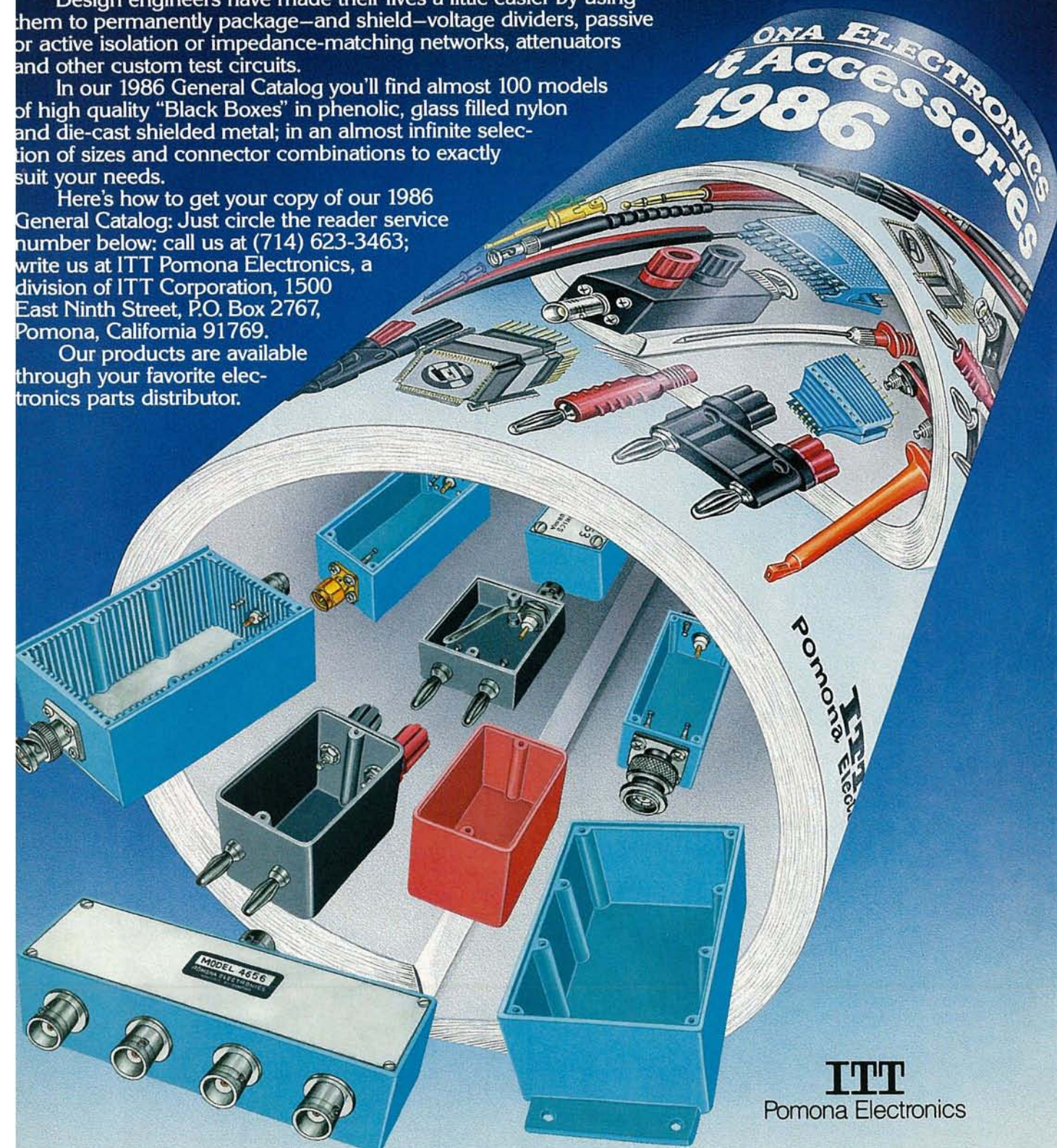

ITT
Pomona Electronics

CIRCLE 101 ON FREE INFORMATION CARD



SCOPE 3½ DIGIT LCD MINI-METER WITH THE MAXI-SPECS

Small enough to fit in your shirt pocket

\$29.95
ONLY Model DVM-630

Model CC-30 Deluxe
Zippered Carrying Case \$4.50

- 0.5% DC accuracy
- 6 Functions, 19 Ranges
 - DC Voltage, 0.1 mV to 1000 V • DC Current, 0.1 uA to 2A • Resistance, 0.1 ohm to 2 M ohm • Diode Test • Battery Test
- Measures approx. 5 x 2¾ x 7/8 in.
- 300 hour battery life
- Automatic zero adjust
- Low battery indication
- Test leads included



Model DCM-602
\$69.95

3½ Digit Capacitance Meter
8 ranges with full scale values to 2000 uF
FEATURES • Broad test range - 1 pF to 2000 uF • LSI circuit provides high reliability and durability • Lower power consumption • Crystal time base
• Protected from charged capacitors
• Frequency range - 800 Hz to 8 Hz

SCOPE HAND-HELD DIGITAL CAPACITANCE and MULTIMETERS

- 0.5% DC Accuracy
- Highest Quality
- Highest Performance
- Lowest Prices



Model DVM-634
\$48.75

7 functions, 32 ranges.
Transistor measurement included.

3½ Digital Multimeters

FEATURES • DC Voltage 100 uV - 1000 V • AC Voltage 100 uV - 750 V • AC/DC Current 200 uA - 10 Amps • Resistance 20 Megohms • Capacitance (DVM 636/638) 1 pF - 20 uF
• Overload Protection • Auto-decimal LCD readout • Polarity indication • 300 hour battery life with 9V transistor battery • Low battery indication

Model DVM-638
\$79.95

11 functions, 38 ranges.
Includes logic level detector, audible visual continuity, capacitance and conductance measurement.

Model DVM-636
\$62.75

8 functions, 37 ranges.
Capacitance measurement included.

ASK FOR FREE CATALOG.
Money orders, checks accepted. C.O.D.'s require 25% deposit.



Fordham

Toll Free
800-645-9518
In NY State 800-332-1446

Service & Shipping Charge Schedule Continental U.S.A.

FOR ORDERS	ADD
\$25-\$100	\$4.50
\$101-\$250	\$6.00
\$251-500	\$8.00
\$501-750	\$10.50
\$751-1000	\$12.50
\$1,001-1500	\$16.50
\$1,501-2000	\$20.00
\$2,001 and Up	\$25.00

260 Motor Parkway, Hauppauge, NY 11788