

48783

# Radio

## HOW TO ELIMINATE FM MULTIPATH DISTORTION

\$1.95 OCT. 1985  
IN CANADA \$2.50

# Electronics

TECHNOLOGY - VIDEO - STEREO - COMPUTERS - SERVICE

### BUILD THIS VARIABLE POWER SUPPLY FOR YOUR WORKBENCH.

It features dual-tracking outputs, current limiting and more.

### A SATELLITE-TV DISH MADE OUT OF PLYWOOD?

According to theory it can be done!

### ELECTRONICS IN MEDICINE

Fiber optics and lasers are the new medical tools.

### ADD REMOTE CONTROL TO JUST ABOUT ANYTHING

Two IC's make it easy to control up to 272 functions!



### BUILD AN IC TESTER.

It's a great teaching tool too.

A GERNSBACK PUBLICATION

### HOW TO DESIGN DOUBLE-SIDED PC BOARDS

It's easy if you follow our hints.

Special 16-page section:

## COMPUTER DIGEST

MR ROBERT DAHM  
997 GRAND AV  
IL 60506  
10#XS  
390736 DHM 09976053 14 A DEC85  
\*\*\*\*\*S-DIGIT 60506

★ Designers Notebook

State

★ Equipment Reports ★ Service Clinic





# Now! Tek quality and expert advice are just a free phone call away!

**The industry standard in CRT performance.**

Crisp, easy-to-read, bright CRT; 14kV accelerating potential, provides high writing rate and small spot size. Full size 8x10 cm display for measurement accuracy.

**Display controls are flexible and easy to use.**

Separate intensity controls reduce blooming in alternate sweep mode. Focus tracking minimizes control adjustment and BEAM FIND eliminates confusion.

**Vertical system provides measurement assurance.**

Flat transient response and high accuracy ensures true reproduction of your signals. Fast risetime and high bandwidth is well suited for a variety of measurement.

**Perform delayed sweep measurements accurately and easily.**

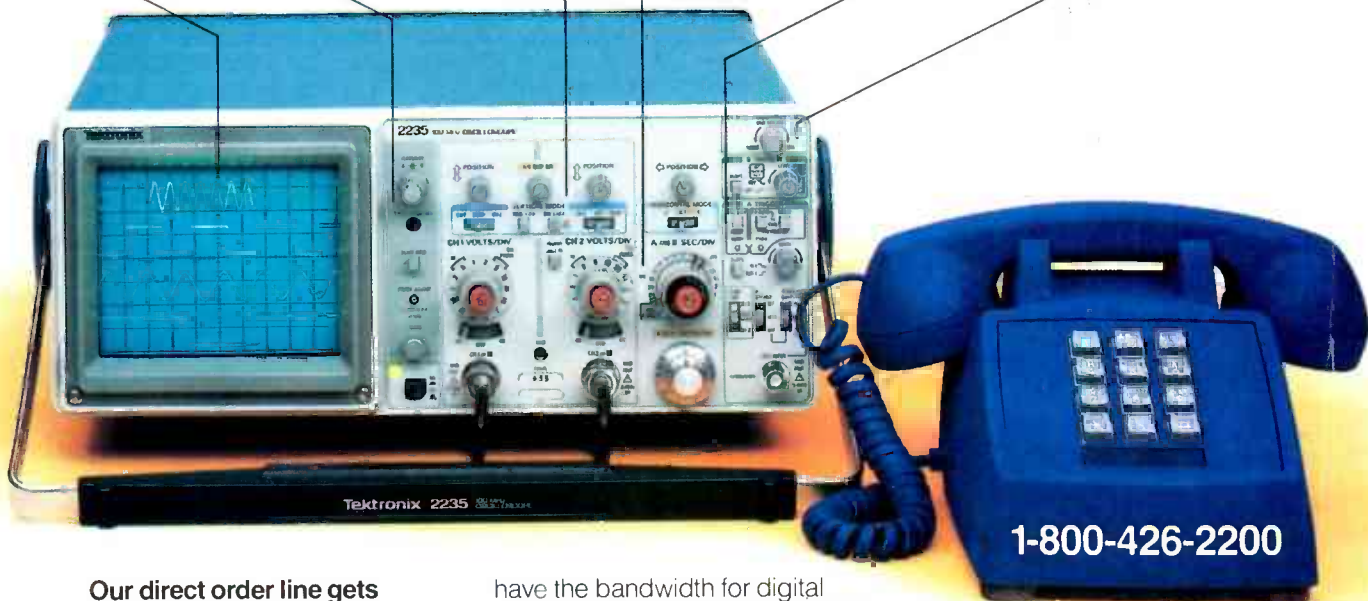
Both sweeps can be displayed alternately making differential measurements easy and accurate (1%). An interlocking SEC/DIV control simplifies set-up.

**Stable hands-off triggering.**

P-P AUTO detects signal peaks, then sets the trigger level for you. Display asynchronous signals using VERT MODE triggering. Independent TV field and line selection.

**Front panel laid out by function for ease of use.**

Color coding aids the user in operation. Functions and modes are placed logically. All nomenclature is clearly labeled, and protected behind a scratchless Lexan surface.



**1-800-426-2200**

**Our direct order line gets you the industry's leading price/performance portables... and fast answers from experts!**

The 60 MHz single time base delay 2213A, the 60 MHz dual time base 2215A and the 100 MHz dual time base 2235 offer unprecedented reliability and affordability, plus the industry's first 3-year warranty\* on labor and parts, CRT included.

**The cost: just \$1275 for the 2213A, \$1525 for the 2215A, \$1750 for the 2235.**† Even at these low prices, there's no scrimping on performance. You

have the bandwidth for digital and analog circuits. The sensitivity for low signal measurements. The sweep speeds for fast logic families. And delayed sweep for fast, accurate timing measurements. All scopes are UL Listed and CSA approved.

**You can order, or obtain literature, through the Tek National Marketing Center.** Technical personnel, expert in scope applications, will answer your questions and expedite delivery. Direct orders include comprehensive 3-year warranty\*, operator's

manual, two 10X probes, 15-day return policy and worldwide service backup.

**Order toll free: 1-800-426-2200, Ask for Rick.**

In Oregon, call collect: (503) 627-9000. Or write Tektronix, Inc. P.O. Box 1700 Beaverton, OR 97075

**Tektronix®**  
COMMITTED TO EXCELLENCE

# OCTOBER '85

## Radio- Electronics

Electronics publishers since 1908

Vol. 56 No. 10

- BUILD THIS**
- 53 VERSATILE BENCH POWER SUPPLY**  
This supply features six outputs including two precision voltage references.  
**Vaughn D. Martin**
  - 80 IC TESTER**  
Test your digital IC's and troubleshoot your digital circuits. **David H. Dage**
  - 83 PC SERVICE**  
Use the direct-etch foil patterns to make your power-supply and IC-tester circuit boards.

- TECHNOLOGY**
- 26 SATELLITE TV**  
Cable and satellite TV. **Bob Cooper, Jr.**
  - 58 A PLYWOOD SATELLITE-TV DISH**  
A satellite dish made out of plywood? According to theory, it's possible, and an experimental dish proves it.  
**David J. Sweetnam, C.E.T.**
  - 62 ELECTRONICS IN MEDICINE**  
Lasers and fiber optics are important medical tools that make new techniques possible.  
**Ray Fish, Ph.D, M.D.**
  - 88 ROBOTICS**  
Building a robot kit. **Mark J. Robillard**

- CIRCUITS AND COMPONENTS**
- 46 NEW IDEAS**  
A low-budget logic probe
  - 65 A VERSATILE REMOTE CONTROLLER**  
Two IC's make it easy to build a remote controller with 256-function capability.  
**J. Daniel Gifford**
  - 77 DESIGNING DOUBLE-SIDED PC BOARDS**  
Here are a few hints to help make the job easier. **Robert Grossblatt**
  - 94 DRAWING BOARD**  
The Z80's control signals. **Robert Grossblatt**
  - 102 DESIGNER'S NOTEBOOK**  
Award-winning one-gate design.  
**Robert Grossblatt**
  - 110 STATE OF SOLID STATE**  
Precision operational amplifiers.  
**Robert F. Scott**

### RADIO

- 69 ALL ABOUT MULTIPATH DISTORTION**  
Multipath distortion and how to fight it.  
**Robert F. Scott**
- 104 COMMUNICATIONS CORNER**  
Infrared communications for the hearing-impaired.  
**Herb Friedman**
- 108 ANTIQUE RADIOS**  
Cabinet restoration.  
**Richard D. Fitch**

### VIDEO

- 12 VIDEO NEWS**  
A review of the fast-changing video scene.  
**David Lachenbruch**
- 112 SERVICE CLINIC**  
An unusual servicing problem. **Jack Darr**
- 112 SERVICE QUESTIONS**  
Solutions to your TV problems.

### COMPUTERS

Following page 108 **COMPUTER DIGEST**  
Spike protection, CAD, printheads, and more!

### EQUIPMENT REPORTS

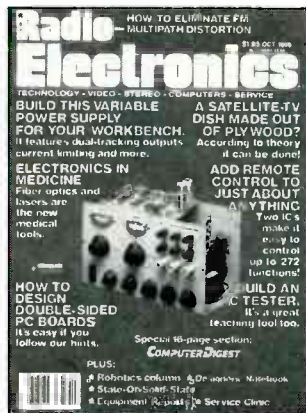
- 34 Kenwood 7390 2-Meter Transceiver**
- 42 Vidicraft CCU-120 Commercial Cutter**

### DEPARTMENTS

- 142 Advertising and Sales Offices**
- 142 Advertising Index**
- 143 Free Information Card**
- 16 Letters**
- 116 Market Center**
- 48 New Products**
- 4 What's News**

**Radio-Electronics, (ISSN 0033-7862)** Published monthly by Gernsback Publications, Inc., 200 Park Avenue South, New York, NY 10003. Second-Class Postage paid at New York, NY and additional mailing offices. Second-Class mail authorized at Ottawa, Canada. One-year subscription rate U.S.A. and possessions \$15.97, Canada \$20.97, all other countries \$23.47. subscription orders payable in US funds only, international postal money order or check drawn on a U.S.A. bank. Single copies \$1.95. © 1985 by Gernsback Publications, Inc. All rights reserved. Printed in U.S.A. **POSTMASTER:** Please send address changes to RADIO-ELECTRONICS, Subscription Dept., Box 2520, Boulder, CO 80322. A stamped self-addressed envelope must accompany all submitted manuscripts and/or artwork or photographs if their return is desired should they be rejected. We disclaim any responsibility for the loss or damage of manuscripts and/or artwork or photographs while in our possession or otherwise.

# COVER 1



Is there a variable power supply on your electronics workbench? Then consider building one like the one shown on our cover. It has three pairs of complementary outputs: the first pair is dual-tracking, while the outputs of the second pair are independently adjustable. The third pair is used as a precision voltage reference.

The supply is versatile and easy to build. We'll show you how to increase its current capacity, and how to build it with only the outputs you need. For more information, see page 53.

# NEXT MONTH

THE NOVEMBER ISSUE IS  
ON SALE OCTOBER 3

## BUILD A VIDEO TITLER

Now you can superimpose titles and symbols directly over video images!

## ALL ABOUT EMI

Electromagnetic interference, its causes, and its cures.

## BUILD A PULSE GENERATOR FOR YOUR WORKBENCH

It features external triggering, sync output, CMOS or TTL outputs and more!

## HOW TO SERVICE COMPACT-DISC PLAYERS

It will become increasingly important to know how.

## HOW TO DESIGN WITH DIGITAL IC'S

All about digital counters.

As a service to readers, Radio-Electronics publishes available plans or information relating to newsworthy products, techniques and scientific and technological developments. Because of possible variances in the quality and condition of materials and workmanship used by readers, Radio-Electronics disclaims any responsibility for the safe and proper functioning of reader-built projects based upon or from plans or information published in this magazine.

Since some of the equipment and circuitry described in RADIO-ELECTRONICS may relate to or be covered by U.S. patents, RADIO-ELECTRONICS disclaims any liability for the infringement of such patents by the making, using, or selling of any such equipment or circuitry, and suggests that anyone interested in such projects consult a patent attorney.

## Radio-Electronics

Hugo Gernsback (1884-1967) founder  
M. Harvey Gernsback, editor-in-chief  
Larry Steckler, EHF, CET, publisher

### EDITORIAL DEPARTMENT

Arl Kleiman, editor  
Brian C. Fenton, technical editor  
Carl Laron, WB2SLR, associate editor  
Jeffrey K. Holtzman, assistant technical editor  
Robert A. Young, assistant editor  
Julian S. Martin, editorial associate  
Byron G. Wels, editorial associate  
Jack Darr, CET, service editor  
Robert F. Scott, semiconductor editor  
Herb Friedman, communications editor  
Bob Cooper, Jr. satellite-TV editor  
Robert Grossblatt, circuits editor  
David Lachenbruch, contributing editor  
Richard D. Fitch, contributing editor  
Mark J. Robillard, robotics editor  
Bess Isaacson, editorial assistant

### PRODUCTION DEPARTMENT

Ruby M. Yee, production manager  
Robert A. W. Lowndes, editorial production  
Andre Duzant, technical illustrator  
Karen Tucker, advertising production  
Geoffrey S. Weil, production traffic

### CIRCULATION DEPARTMENT

Jacqueline P. Weaver, circulation director  
Rita Sabalis, assistant circulation director  
Jacqueline Allen, circulation assistant

Radio-Electronics is indexed in *Applied Science & Technology Index* and *Readers Guide to Periodical Literature*.

Microfilm & Microfiche editions are available. Contact circulation department for details.

Advertising Sales Offices listed on page 142.





# NEW!

# uniden®

# Bearcat®



## Scanners

Communications Electronics™, the world's largest distributor of radio scanners, introduces new scanners and scanner accessories from J.I.L., Regency and also Uniden/Bearcat. Chances are the police, fire and weather emergencies you'll read about in tomorrow's paper are coming through on a scanner today.

### NEW! Regency® MX7000-K

List price \$699.95/CE price \$429.00/SPECIAL 10-Band, 20 Channel • Crystalless • AC/DC Frequency range: 25-550 MHz. continuous coverage and 800 MHz. to 1.2 GHz. continuous coverage In addition to normal scanner listening, the MX7000 offers CB, VHF, and UHF TV audio, FM Broadcast, all aircraft bands (civil and military), 800 MHz communications, cellular telephone, and when connected to a printer or CRT, satellite weather pictures.

### NEW! Regency® MX5000-K

List price \$599.95/CE price \$329.00/SPECIAL Multi-Band, 20 Channel • No-crystal scanner Search • Lockout • Priority • AC/DC Selectable AM-FM modes • LCD display World's first continuous coverage scanner Frequency range: 25-550 MHz. continuous coverage. Never before have so many features come in such a small package. The Regency MX5000 mobile or home scanner has continuous coverage from 25 to 550 MHz. That means you can hear CB, Television audio, FM broadcast stations, all aircraft bands including military and the normal scanner bands, all on your choice of 20 programmable channels.

### NEW! Regency® MX4000-K

List price \$629.95/CE price \$299.00/SPECIAL Multi-Band, 20 Channel • No-crystal scanner Search • Lockout • Priority • AC/DC Selectable AM-FM modes • LCD display Bands: 30-50, 118-136, 144-174, 440-512, 800-950 MHz. The Regency MX4000 is gives coverage in the standard VHF and UHF ranges with the important addition of the 800 MHz. and aircraft bands. It features keyboard entry, multifunction liquid crystal display and variable search increments.

### NEW! Regency® Z60-K

List price \$379.95/CE price \$216.00/SPECIAL 8-Band, 60 Channel • No-crystal scanner Bands: 30-50, 88-108, 118-136, 144-174, 440-512 MHz. Cover your choice of over 15,000 frequencies on 60 channels at the touch of your finger.

### NEW! JIL SX-400-K

List price \$799.95/CE price \$469.00/SPECIAL Multi-Band, 20 Channel • No-crystal Scanner Search • Lockout • Priority • AC/DC Frequency range: 26-520 MHz. continuous coverage. With optionally equipped RF converters 150KHz-3.7 GHz. The JIL SX-400 synthesized scanner is designed for commercial and professional monitor users that demand features not found in ordinary scanners. The SX-400 will cover from 150 KHz to 3.7 GHz. with RF converters. Order the following RF converters for your SX-400 scanner. RF-1030-K at \$259.00 each for frequency range 150 KHz. - 30 MHz. USB, LSB, CW and AM. (CW filter required for CW signal reception); RF-5080-K at \$199.00 each for 500-800 MHz.; RF-8014-K at \$199.00 each for 800 MHz.-1.4 GHz. Be sure to also order ACB-300-K at \$99.00 each which is an antenna control box for connection of the RF converters. The RC-4000-K data interface at \$259.00 each gives you control of the SX-400 scanner and RF converters through a computer. Add \$3.00 shipping for each RF converter, data interface or antenna control box. If you need further information on the JIL scanners, contact JIL directly at 213-926-6727 or write JIL at 17120 Edwards Road, Cerritos, California 90701 U.S.A.

### SPECIAL! JIL SX-200-K

List price \$499.95/CE special price \$159.00 Multi-Band - 16 Channel • No-Crystal Scanner Frequency range 26-88, 108-180, 380-514 MHz. The JIL SX-200 scanner tunes military, F.B.I., Space Satellites, Police and Fire, Drug Enforcement Agencies, Defense Department, Aeronautical AM band, Aero Navigation Band, Fish & Game, Immigration, Paramedics, Amateur Radio, Justice Department, State Department, plus other thousands of radio frequencies most other scanners can't pick up. The SX-200 has selectable AM/FM receiver circuits, tri-switch squelch settings - signal, audio and signal & audio, outboard AC power supply - DC at 12 volts built-in, quartz clock - bright vacuum fluorescent blue readouts and dimmer, dual level search speeds, tri-level scan delay switches, 16 memory channels in two channels banks, receive fine tune (RT) ± 2KHz., dual level RF gain settings - 20 db pad, AGC test points for optional signal strength meters.

### Regency® HX1000-K

List price \$329.95/CE price \$209.00 6-Band, 30 Channel • No Crystal scanner Search • Lockout • Priority • Scan delay Sidelit liquid crystal display • Digital Clock Frequency range: 30-50, 144-174, 440-512 MHz. The new handheld Regency HX1000 scanner is fully keyboard programmable for the ultimate in versatility. You can scan up to 30 channels at the same time. When you activate the priority control, you automatically override all other calls to listen to your favorite frequency. The LCD display is even sidelit for night use. Order MA-256-K rapid charge drop-in battery charger for \$79.00 plus \$3.00 shipping/handling. Includes wall charger, carrying case, belt clip, flexible antenna and nicad battery. Order now.

### NEW! Bearcat® 100XL-K

List price \$349.95/CE price \$229.00 9-Band, 16 Channel • Priority • Scan Delay Search • Limit • Hold • Lockout • AC/DC Frequency range: 30-50, 118-174, 406-512 MHz. The world's first no-crystal handheld scanner now has a LCD channel display with backlight for low light use and aircraft band coverage at the same low price. Size is 1 3/8" x 7 1/2" x 2 1/8". The Bearcat 100XL has wide frequency coverage that includes all public service bands (Low, High, UHF and "T" bands), the AM aircraft band, the 2-meter and 70 cm. amateur bands, plus military and federal government frequencies. Wow...what a scanner! Included in our low CE price is a sturdy carrying case, earphone, battery charger/AC adapter, six AA ni-cad batteries and flexible antenna. Order your scanner now.

### NEW! Regency® HX2000-K

The World's First 800 MHz. Handheld Scanner List price \$569.95/CE price \$359.00 7-Band, 20 Channel • No-crystal scanner Priority control • Search/Scan • AC/DC Sidelit liquid crystal display • Memory backup Bands: 118-136, 144-174, 440-512, 800-950 MHz. The HX2000 scanner operates on 120V AC or 6 VDC. Scans 15 channels per second. Size 3" x 7" x 1 1/2". Includes wall charger, carrying case, belt clip, flexible antenna and nicad batteries. Selectable AM/FM modes.

### NEW! Bearcat® 800XL-K

List price \$499.95/CE price \$329.00 12-Band, 40 Channel • No-crystal scanner Priority control • Search/Scan • AC/DC Bands: 29-54, 118-174, 406-512, 806-912 MHz. The Uniden 800XL receives 40 channels in two banks. Scans 15 channels per second. Size 9 1/4" x 4 1/2" x 1 1/2".

#### OTHER RADIOS AND ACCESSORIES

- Panasonic RF-2600-K Shortwave receiver ..... \$179.00
  - Panasonic RF-B300-K Shortwave receiver ..... \$195.00
  - RD95-K Uniden Remotemount Radar Detector ..... \$139.00
  - RD55-K Uniden Visor mount Radar Detector ..... \$119.00
  - BC 20/20-K Bearcat 40 channel scanner ..... \$274.00
  - BC 210XW-K Bearcat 20 channel scanner ..... \$219.00
  - BC-WA-K Bearcat Weather Alert™ ..... \$39.00
  - DX1000-K Bearcat shortwave receiver ..... \$459.00
  - PC22-K Uniden remote mount CB transceiver ..... \$99.00
  - PC55-K Uniden mobile mount CB transceiver ..... \$59.00
  - Z10-K Regency 10 channel scanner ..... \$139.00
  - Z30-K Regency 30 channel scanner ..... \$154.00
  - Z45-K Regency 45 channel scanner ..... \$179.00
  - R1060-K Regency 10 channel scanner ..... \$98.95
  - MX3000-K Regency 30 channel scanner ..... \$189.00
  - C403-K Regency 4 channel scanner ..... \$69.00
  - R106-K Regency 10 channel scanner ..... \$99.00
  - RH250B-K Regency 10 channel VHF transceiver ..... \$329.00
  - RU150B-K Regency 10 channel UHF transceiver ..... \$449.00
  - RPH410-K 10 ch. handheld no-crystal transceiver ..... \$399.00
  - BC10-K Battery charger for Regency RPH410 ..... \$79.00
  - MA256-K Drop-in charger for HX1000 scanner ..... \$79.95
  - MA257-K Cigarette lighter cord for HX1000 ..... \$19.95
  - MA917-K Ni-Cad battery pack for HX1000 ..... \$24.95
  - EC10-K Programming tool for Regency RPH410 ..... \$20.00
  - SMRH250-K Service man. for Regency RH250 ..... \$20.00
  - SMRU150-K Service man. for Regency RU150 ..... \$20.00
  - SMRPH410-K Service man. for Regency RPH410 ..... \$20.00
  - SMMX7000-K Svc. man. for MX7000 & MX5000 ..... \$20.00
  - SMMX3000-K Service man. for Regency MX3000 ..... \$20.00
  - B-4-K 1.2 V AA Ni-Cad batteries (set of four) ..... \$9.00
  - A-135C-K Crystal certificate ..... \$3.00
  - FB-E-K Frequency Directory for Eastern U.S.A. .... \$12.00
  - FB-W-K Frequency Directory for Western U.S.A. .... \$12.00
  - TSG-K "Top Secret" Registry of U.S. Govt. Freq. .... \$15.00
  - TIC-K Techniques for Intercepting Comm. .... \$15.00
  - RRF-K Railroad frequency directory ..... \$10.00
  - CIE-K Cover Intelligenc, Elect. Eavesdropping ..... \$15.00
  - AB0-K Magnet mount mobile scanner antenna ..... \$35.00
  - A70-K Base station scanner antenna ..... \$35.00
  - USAMM-K Mag mount VHF/UHF ant. w/ 12' cable ..... \$39.95
  - USAK-K 3/4" hole mount VHF/UHF ant. w/ 17' cable ..... \$35.95
  - USATLM-K Trunk lip mount VHF/UHF antenna ..... \$35.95
- Add \$3.00 shipping for all accessories ordered at the same time. Add \$12.00 shipping per shortwave receiver. Add \$7.00 shipping per scanner and \$3.00 per antenna.

#### BUY WITH CONFIDENCE

To get the fastest delivery from CE of any scanner, send or phone your order directly to our Scanner Distribution Center™ Michigan residents please add 4% sales tax or supply your tax I.D. number. Written purchase orders are accepted from approved government agencies and most well rated firms at a 10% surcharge for net 10 billing. All sales are subject to availability, acceptance and verification. All sales on accessories are final. Prices, terms and specifications are subject to change without notice. All prices are in U.S. dollars. Out of stock items will be placed on backorder automatically unless CE is instructed differently. A \$5.00 additional handling fee will be charged for all orders with a merchandise total under \$50.00. Shipments are F.O.B. Ann Arbor, Michigan. No COD's. Most products that we sell have a manufacturer's warranty. Free copies of warranties on these products are available prior to purchase by writing to CE. Non-certified checks require bank clearance.

Mail orders to: Communications Electronics™ Box 1045, Ann Arbor, Michigan 48106 U.S.A. Add \$7.00 per scanner for U.P.S. ground shipping and handling in the continental U.S.A. For Canada, Puerto Rico, Hawaii, Alaska, or APO/FPO delivery, shipping charges are three times continental U.S. rates. If you have a Visa or Master Card, you may call and place a credit card order. Order toll-free in the U.S. Dial 800-USA-SCAN. In Canada, order toll-free by calling 800-221-3475. Telex CE anytime, dial 810-223-2422. If you are outside the U.S. or in Michigan dial 313-973-8888. Order today.

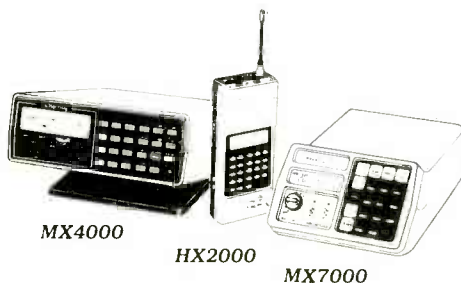
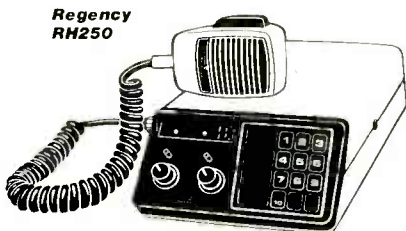
Scanner Distribution Center™ and CE logos are trademarks of Communications Electronics Inc. † Bearcat is a registered trademark of Uniden Corporation. ‡ Regency is a federally registered trademark of Regency Electronics Inc. AD #090385-K

Copyright © 1985 Communications Electronics

## For credit card orders call 1-800-USA-SCAN



Consumer Products Division  
P.O. Box 1045 □ Ann Arbor, Michigan 48106-1045 U.S.A.  
Call 800-USA-SCAN or outside U.S.A. 313-973-8888



CIRCLE 79 ON FREE INFORMATION CARD

www.americanradiohistory.com

# WHAT'S NEWS

## Phone-computer combination is a portable office

Comm 88, a Minneapolis manufacturer, has unveiled a complete portable office housed in a 6 × 13 × 18-inch briefcase. The case holds a Motorola cellular telephone, an Epson *Geneva* computer with flip-up 80-column screen, a Motorola *Datalink* cellular modem, an AC/DC rechargeable power system, and data communication, word processing, and electric spreadsheet software.



CELLULAR TELEPHONE, MODEM, computer and software make up a complete portable office, usable in a car or on the beach.

The *Portable Office* weighs 29 pounds and can be carried under any airplane seat. It is compatible with cellular telephone systems in more than 30 US cities. The user can send and receive calls or transmit data from taxicabs, boats, or even the golf course.

A built-in power system recharges in two hours from either AC or DC, and can even charge

when the equipment is in use. Options include an external ring-alert for noisy areas, high-gain antennas, and dual batteries for up to 16 hours between charges. Suggested list price is \$4,400.

## Spaceborne lasers may measure wind, humidity

Researchers at RCA Astro-Electronics (East Windsor, NJ) report that they are developing spaceborne equipment to measure wind, temperature, and humidity in the Earth's atmosphere. The system uses lasers to make the measurements, reports Fred Shashoua, manager of the project. The first flights of the system may be as early as 1989, he believes.

The lidar (*L*ight *D*etection *A*nd *R*anging) device uses a laser to measure wind. Directed at an angle to the approaching wind, reflection from the small particles always found in the atmosphere gives the wind speed in the same way that radar measures the speed of larger approaching objects.

Measuring temperature and humidity is more complicated, states Mr. Shashoua. Two lasers are required—one to act as a reference. To measure humidity, one laser is beamed at the area being checked. The wavelength of the light from that laser is that at which absorption varies most with changes in humidity. The other laser radiates at a frequency not greatly affected by changes in humidity.

The difference in the absorption of the two laser light beams is compared and used to determine humidity.

For temperature, the laser is set at a frequency at which the absorption by oxygen is greatest (a point in the infrared not far from the

boundary of visible light). Oxygen's absorption varies rapidly with temperature, so comparing the absorption of the light from that laser with that of a laser set at a frequency at which little oxygen absorption takes place, yields an indication of the temperature.

Information from the system is expected to be valuable in helping aircraft avoid undesirable headwinds, and to the military, because heat-seeking and optically-guided missiles are hindered by fog. It can also reduce aircraft fuel consumption and enhance weather forecasting.

## Software package simulates automatic factory layouts

Scientists of the General Electric Co. demonstrated to the 14th International Programmable Controllers Conference a software package that will enable manufacturing engineers to try out automated factories before they are built. The new software creates realistic representations of factories or parts of factories—complete with icons that resemble robots, forklift trucks, etc.—on the computer's video monitor. Techniques like those used in videogames bring the simulated factory to life: Work cells change color to indicate whether they are machining a part, waiting for material, or idled for maintenance or repair. Forklift trucks and automatic guided vehicles transfer parts from one machine to the next. Queues of parts build up in front of some machines, while others are waiting for parts.

With this installation in place and fed sufficient information, it is possible—by simply watching the simulated factory—to observe bot-

*continued on page 6*





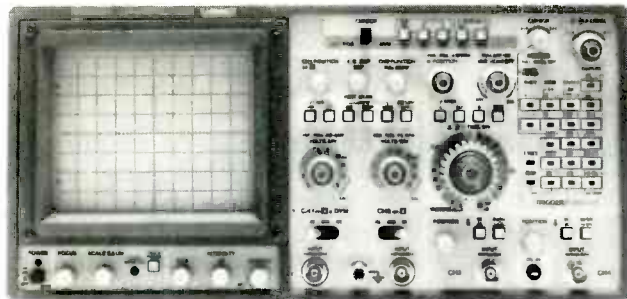
# ELECTRONICS, INC.

New and Used Electronic Test Equipment  
Sales • Service • Rental • Leasing



**HITACHI**  
Hitachi Denshi, Ltd.

## V1100A DC to 100 MHz Portable Readout Oscilloscope



### FEATURES

- Character display of set-up information on CRT (VOLTS/DIV, TIME/DIV, CAL or UNCAL, Delay Time, Trigger source, etc.)
- Cursor read-out function eliminates conventional calculation procedures (V, ΔV, ΔV%, ΔT, 1/ΔT, ΔT%, phase).
- Digital measuring function displays, DC voltage, AC voltage, and Frequency.
- Comment display function allows user's comments to be displayed on the CRT such as date and measurement data. Excellent for photo documentation.
- 4 channel, 8 trace, DC to 100 MHz, High sensitivity 1 mV/Div, Delayed sweep, Full TV triggering, Alternate triggering.

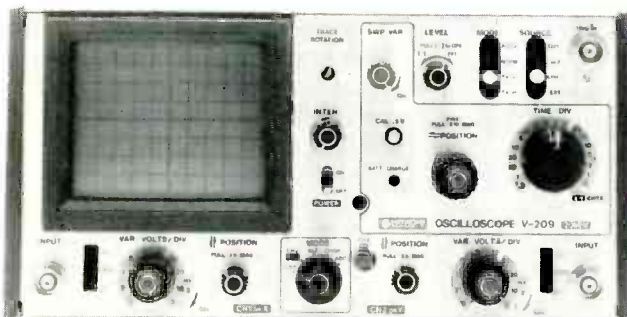
List Price \$2,490.00

**Sale Price \$2,250.00**



**HITACHI**  
Hitachi Denshi, Ltd.

## V-209 DC to 20 MHz Mini-Portable Dual-Trace Oscilloscope



- A three-way power supply takes the V-209 anywhere, anytime for speedy field measurements.
- High sensitivity (1 mV/div at 10MHz) and fast sweep times (50ns/div) make the V-209 a valuable tool in R&D as well as servicing in a wide variety of applications including computers and video equipment.
- A Built-in TV sync separation circuit with easily selectable TV-V and TV-H modes ensures stable observation of both vertical and horizontal TV signal waveforms.
- An auto focus feature maintains constant trace without the necessity of troublesome manual focus adjustments.
- The V-209 is just what it claims to be—a powerful field service tool in a compact, lightweight package.

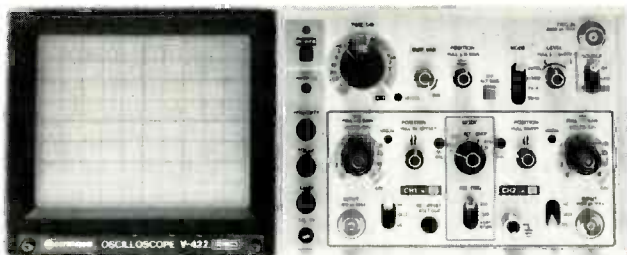
List Price \$945.00

**Sale Price \$708.00**



**HITACHI**  
Hitachi Denshi, Ltd.

## Portable Oscilloscopes



Model V-422 shown

CIRCLE 287 ON FREE INFORMATION CARD

### MODEL V-212

**\$461.00**

DC to 20 MHz, 1 mV/div, Dual Trace. Features 6" Rectangular CRT (w/two X10 probes).

### MODEL V-422

**\$694.00**

DC to 40 MHz, 1 mV/div, Dual Trace, D.C. offset for DMM Output, Vertical Mode Trigger 6" CRT (w/two X10 probes).

### MODEL V-1050F

**\$1,276.00**

DC to 100 MHz, .5 mV/div, Quad Trace, Delayed Sweep. Full TV Triggering, Alternate time base (w/two X10 probes).

Full 2 year parts and labor warranties on the above scopes.

HITACHI GSA CONTRACT NUMBER GS00S57322

CALL US TOLL FREE

**1-800-732-3457**

IN CALIFORNIA TOLL FREE

**1-800-272-4225**

- Master Charge
- VISA ■ COD
- Money Order
- Check



ADD FOR SHIPPING AND INSURANCE	
\$0 to \$250.00	\$4.50
\$251.00 to \$600.00	\$6.50
\$501.00 to \$750.00	\$8.50
\$751.00 to \$1000.00	\$12.50
over \$1000.00	\$15.00

Prices subject to change without notice.

RAG ELECTRONICS, INC. / 21418 Parthenia Street / Canoga Park, CA 91304 / 1-818-998-6500

---

---

# WHAT'S NEWS

tlenecks or other impediments to efficient production, and re-design to prevent them—add machine tools to help those that are overworked, install robots where needed, or to change layouts to bring the proposed facility to peak efficiency.

## Telephone subdivision announced by EIA

The Consumer Electronics Group (CEG) of the Electronic Industries Association (EIA) has formed a Telephone Subdivision. The purpose, according to Tom Friel, President of the CEG, is to “enable us to be more responsive to the needs of this fast-growing segment of the consumer electronics industry.”

Under an agreement between EIA's Consumer Electronics Group and the Information and Telecommunication Group (ITG), and approved by the EIA Board of Governors, CEG will coordinate state legislature activity, conduct consumer-affairs programs, gather and disseminate sales data on the retail telephone market, and continue the International Winter and Summer Consumer Electronics Shows (CES). ITG will be responsible for engineering standards, relations with the FCC, liaison with the Underwriters Laboratories, and marketing services related to the EIA statistical program covering telephones.

A Telephone Coordinating Committee consisting of companies from both CEG and ITG has been established. Membership on that committee entitles a company to full participation and voting rights in the telephone subdivisions of either group. That coordination is expected to eliminate duplication and permit EIA mem-

bers to take full advantage of both groups' resources.

## Newest programmable ROM has 15-ns access time

A new programmable read-only memory (PROM), with a 15-nanosecond access time—the fastest in the industry—has been developed by National Semiconductor of Santa Clara, CA. The new PL87X288B is a programmable logic device with five inputs, eight outputs, a fixed AND array generating all 32 product terms, and a programmable OR array. Typical power dissipation is 550 milliwatts. It operates over the commercial temperature range—0 to 70 degrees C. (A 20-ns military temperature range device is also available.)

Pricing in 100-up quantities is \$2.20 each in plastic DIP and \$3.10 each in ceramic.

## New 3-D laser tracking system will measure robot arm motion

A new study at the National Bureau of Standards aims to improve greatly the measurement of performance of a variety of industrial robots.

Robots are being used more and more in manufacturing operations, but there is no agreement as to how their performance should be measured. Most manufacturers quote figures for the “accuracy” and “repeatability” of their robot arms, but these are “quasi-static” figures. But in many operations, kinematic measures of accuracy and repeatability, that trace the robot arm's motion as it moves in a continuous path at a rapid rate, are necessary.

The prototype, developed by the NBS, consists of a single laser interferometer, a servo-controlled tracking mirror, a similar target

mirror mounted on the robot's wrist, and a computer to control the system. It makes continuous measurements of the position of the target mirror while the robot is moving at its normal working pace. The measurements include not only the three spatial dimensions, but also the pitch and roll of the robot's wrist.

In the finished device, precision transducers will measure the angular rotation of the mirrors and a standard interferometer will measure the path length of the beam. Such a device, NBS researchers say, would be able to measure the position of an industrial robot arm to an accuracy of 12 micrometers (0.0005 inch) over a 3-meter (9.8 foot) cube, an accuracy of about one part in 100,000.

## Videotape vending machine accepts credit cards

A vending machine that rents or sells pre-recorded video cassettes on the insertion of a credit card has been introduced by Credit Vending, Inc., of Phoenix, AZ.

To rent a cassette, the customer simply places the credit card in the machine and enters the tape's number on a calculator-type keyboard. The card is verified electronically, the tape dispensed, and a receipt is issued. When the tape is returned, another receipt is issued. If a customer fails to return a tape, the credit card is charged for the price of the cassette.

At present, the machine accepts Visa or MasterCard, and rents VHS and Betamax format tapes.

The machine, the *Creditron Video Center*, is computer-controlled and modularly constructed. Tapes can have variable rental prices based on titles or day of the week rented. **R-E**



# The best DMM in its class just got better.



## The Fluke 80TK. One innovation leads to another.

First there was the 70 Series, which set a new standard for low-cost, high-performance, Fluke-quality multimeters.

And now, another first. The Fluke 80TK K-type Thermocouple Converter. A temperature measurement device that adds instant temperature measurement capabilities to the 70 Series DMMs.

Or any DMM, for that matter.

Feature for feature, the versatile 80TK is the most affordable unit of its kind. For quick comparison readings, it can measure °C or °F at the flick of a switch. It includes a built-in battery test. And the availability of 3 Fluke probes give you the flexibility to measure any

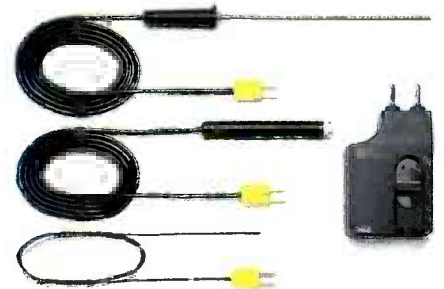
form of temperature, from freezer to furnace, with just one base unit.

No other thermocouple converter we know of offers DMM users so much for so little. Just \$59, including a general-purpose bead probe.

So even if you don't own a Fluke 70 Series multimeter, the 80TK will help the DMM you're now using measure up when things get hot. Or cold.

For your nearest distributor, call toll-free **1-800-227-3800, ext. 229**, day or night. Outside the U.S., call 1-402-496-1350, ext. 229.

FROM THE WORLD LEADER  
IN DIGITAL MULTIMETERS.



Surface, immersion and general-purpose probes with "mini" thermocouple connectors are available for the Fluke 80TK.

### 80TK SPECIFICATIONS

Temperature Measurement Range
-50 to 1000°C
-58 to 1832°F
Battery Life: 1600 Hours (9V)



IN THE U.S. AND NON-EUROPEAN COUNTRIES: John Fluke Mfg. Co., Inc., P.O. Box C9090, M/S 250C, Everett, WA 98206. Sales: (206) 356-5400. Other: (206) 347-6100.  
EUROPEAN HEADQUARTERS: Fluke (Holland) B.V., P.O. Box 2269, 5600 CG Eindhoven, The Netherlands. (040) 458045. TLX: 51946.  
© Copyright 1985 John Fluke Mfg. Co., Inc. All rights reserved. Ad No. 4709-70/80

CIRCLE 262 ON FREE INFORMATION CARD

**Only NRI gives you professional hands-on training and equipment to prepare you for today's high-tech video electronics servicing careers.**



**Become One of America's Most Sought-After Technicians... Put Your Talents and Spare Time To Work for You in the "Explosive-Growth" World of Home Entertainment Electronics**

Train in state-of-the-art video/audio servicing and become a fully qualified professional the uniquely successful NRI way. It's hands-on training, at home... designed around the latest state-of-the-art electronic equipment you build as part of your training. You start from scratch and "discover by doing." You conduct key experiments...

perform vital tests... build your own systems... and do it all at the pace that suits you best.

There's no stopping the incredible boom in consumer electronics. Soaring sales, new and improved products, entirely new technologies have opened up new opportunities for the trained technician as never before.

The \$25 billion consumer electronics industry is creating a whole new servicing and repair market at home. This year, TV sales alone are expected to hit 16.2 million units. That's \$5.5 billion dollars. Every day, sales of home VCRs, a product barely conceived of ten years ago, reach 20,000 units. Every day!



And the revolution has spread to the business sector as tens of thousands of companies are purchasing expensive high-tech video equipment used to train their employees and store important company data.

### The High-Tech Revolution Is Just Starting

Already, disc players can handle both audio CDs as well as laser video discs. And coming are machines that will accommodate laser computer discs. Camcorders are becoming smaller, lighter and more versatile, 8mm video cassettes will produce high resolution pictures. Soon, our TVs will become interactive computer terminals, giving us entertainment, information and communications in one sophisticated unit.

### Join the Future or Be Left Behind

Can you see the opportunity? The servicing and repair market that's there already . . . the enormous need created by the millions upon millions of electronic devices yet to come. If you're looking for a high-potential career in a clean, respected industry . . . if you'd like to get started in a field that's still wide open for the independent business person . . . even if you'd like to find a way to make extra money "moonlighting," now's the time to look into NRI at-home training.

### Start Right and There'll Be No Stopping You!

NRI training in Video/Audio Servicing is the perfect way for you to profit from the era of consumer electronics. You study at home in your spare time at your own pace. No classroom pressures, no night school grind.

Even if you've never had electronics training, NRI prepares you properly with a thorough grounding in the fundamentals. . . a

foundation that you build on to achieve advanced electronic skills. With this kind of understanding and practical bench experience built into NRI's exclusive training methods, you are on your way to take advantage of the new opportunities that are opening up every day.

### Totally Integrated Hands-On Training

The secret of NRI's training success lies in the unique way multimedia instructions are fully integrated with the equipment you use. NRI's Action Audio and Video cassettes combine with brilliantly illustrated and well thought out lesson materials to give you a thoroughly stimulating and productive learning experience.

Since NRI training is built around learning by doing, right from the start you conduct important experiments and tests with your professional digital multimeter.

You assemble the remarkable NRI Discovery Lab® and perform a complete range of

Only NRI's video training includes a state-of-the-art TV you build, the latest VCR, professional test equipment, and NRI Action Video tapes. All yours to keep as part of your training.

demonstrations and experiments in the process. You build your own 25" Heath/Zenith color TV and train with the latest model front-loading VCR, also included as part of your course.

NRI has purposely designed your training around equipment that has the same high-tech circuitry you'll encounter in commercial equipment. That means your training is real-world training. And *that's* unique.

### Inside Your TV

The 25" TV included with your training has an expanded 178 channel, cable-ready tuning system, microprocessor for complete computerized digital control, stereo audio system, electronic time display, wireless remote control, and a space phone that lets you answer the phone and make calls from your chair.



Only NRI trains you with Action Video tapes for step-by-step professional servicing skills reinforcement. You'll watch complicated troubleshooting techniques come to life!

### Your NRI Training Has Another Special Element

Also built into your NRI training is the enormous experience of our development specialists and instructors. Their long-proven training skills and personal guidance come to you on a one-to-one basis. They are always available for consultation and help.

### Step Into the Future Today

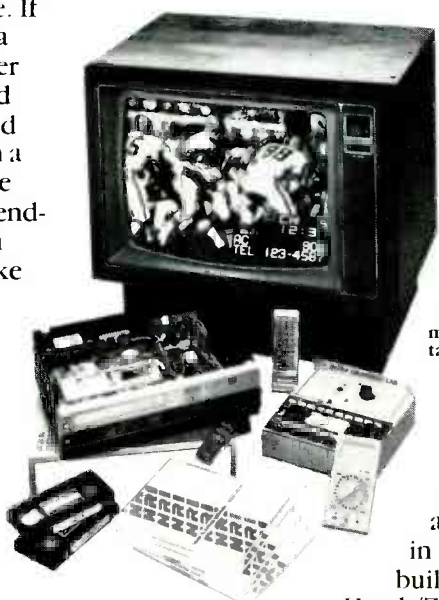
The richest reward you gain from your NRI Video/Audio training is a firm grip on the future. Your knowledge and know-how provide you with the soundest possible foundation for further learning and growth with the industry.

### Send For Free Catalog

But now is the time to act. Return the post-paid card to us today. You will receive our 100-page catalog free. It's filled with all the details you'll want to know about our training methods and materials and our more than 70 years of successful innovation in at-home, hands-on career training. (If someone has beaten you to the card, write to us at the address below.)

## **NRI** Schools

McGraw-Hill Continuing Education Center  
3939 Wisconsin Avenue, NW  
Washington, DC 20016



# VIDEO NEWS



**DAVID LACHENBRUCH**  
CONTRIBUTING EDITOR

• **Tubeless TV.** TV sets using LCD's instead of picture tubes are proliferating, and prices are coming down, although larger screen sizes are still not available. At the Summer Consumer Electronics Show in Chicago, four brands, with a total of 13 models, were shown; and manufacturers are promising plenty more to come. Among the biggest promises was Casio's pledge to introduce a 12-inch color picture-on-the-wall LCD TV early next year.



For the here and now, Casio chopped the price of its 2-inch black-and-white model with earphone sound to \$100, and added a version with FM and AM at \$130. Its 2.6-inch color model, with built-in loudspeaker and blacklight at \$300 has audio and video jacks to permit use as a field video monitor; a color set with FM-AM is \$350. Epson has two 2-inch color models at \$350 and \$399, and a tiny, black-and-white set, just the size of an audio cassette case at \$199. Epson's sister brand, Seiko, (see photo) showed a 2-inch color set with built-in alarm clock and flip-up screen, while Citizen has 2.7-inch models—color at \$299, and black-and-white with AM radio at \$100.

• **A Good Buy.** With competition among domestic TV manufacturers and increased imports from Korea and Taiwan, the prices of color TV's actually are going down while everything else is going up. An RCA study indicates that the average retail price of a color set in 1967 was \$568, while in 1984 it was \$524. Since 1967, the government's Consumer Price Index has increased by 211 percent. RCA uses the

government's figures to estimate that if color-TV sets had followed the inflationary trend of other consumer products, the average color set in 1984 would have cost \$1,630!

• **Digital VCR's join TV's.** The company that originated digital TV sets is now working on VCR's. ITT Semiconductors is developing two basic IC's that replace hundreds of components and sharply improve the picture in home VCR's. The video recording itself is analog, and the components are said to be adaptable to any VCR system. ITT claims the IC's will make low-cost multi-standard (PAL, SECAM, and NTSC) VCR's possible, and eventually VCR's with built-in standards converters, able to record in any of the world's color TV standards, and play back in any other. ITT is aiming at a cost of \$20 for the IC set, and availability in 1986.

ITT also says it now has a set of two IC's that provide multichannel TV sound, and that they will have a full-field memory IC next year that will allow TV sets with such features as freeze-frame, zoom, and interlace-free pictures that double the line rate of the incoming TV signal, providing 1,050 lines from a 525-line picture. ITT claims the same IC will also make possible an economical "multiple picture-in-picture" system, able to display nine different pictures on the same screen giving the viewer a sample of what's showing on all channels at the same time.

• **VHS Responds.** The VHS manufacturers are responding to Sony's new emphasis on 8mm by pushing hard on the virtues of the VHS format. Matsushita (Panasonic) and Hitachi have both developed camcorders taking full-sized VHS cassettes. JVC, the inventor of VHS, is pushing its *Video Movie*, using the small 20-minute VHS-C cassette that can be played back in a standard VHS deck by placing it in an adapter. JVC's top officials concede that while they are working toward a *Video Movie* machine with longer recording time, their top priority now is developing a new version considerably smaller than the existing model and with a better quality picture.

**R-E**



# NEW LIT

## Transistor data book

The *Super E-Line Transistor Technical Handbook* is Ferranti Semiconductor's 112-page guide to its *Super E-Line* transistors, which offer one-watt power dissipation in TO-92 packages. The *Handbook* contains five sections: a detailed description of the *Super E-Line* chip and packaging technology, a product index listing commercial and quality-assured products, a selector table showing device types by application group, a technical data section with full specifications for each device in the series, and application notes showing the use of E-line transistors in typical circuits. Copies of the handbook can be obtained by contacting Ferranti Electric, Semiconductor Div., 87 Modular Ave., Commack, NY 11725.

## Transistor Selection Guide.

Ferranti's 6-page *MOSFET Selection Guide and Cross Reference List* offers design data on complementary N- and P-channel transistors. Arranged as an easy-to-read chart, it provides data on key parameters of over 150 MOSFET-devices in TO-92, TO-39, TO-220, and TO-3 packages.

Included in the guide are low-voltage threshold devices for telecommunications, superfast (1-ns) switching devices, and high-voltage, low-leakage devices for use in test instruments. It also contains key parameters of the various devices covered, among those specifications are: continuous current,  $I_D$ ; breakdown voltage,  $BV_{DSS}$ , and on-resistance,  $R_{DS(on)}$ .

The guide also includes a cross-reference to help the user in selecting equivalent or near-equivalent devices.—**Ferranti Semiconductors**, 87 Modular Ave., Commack, NY 11725

R-E

BK PRECISION

FLUKE

# RAG

## ELECTRONICS, INC.

New and Used Electronic Test Equipment  
Sales • Service • Rental • Leasing

CIRCLE 285 ON FREE INFORMATION CARD

## ok Soldering & Desoldering Tools

### DESOLDERING STATIONS



**SA-150 Variable Temp.** \$395.00  
**SA-100 Fixed Temp** \$349.00

Compact, lightweight desoldering station with self-contained, high volume vacuum pump and variable heat control. Powerful enough for most difficult thru-hole and multi-layer applications. Features pistol-grip handpiece, trigger-actuated operation, no-clog, straight flow design, easy collector cleaning and handy, built-in tool holder. Easily disassembled for service. Supplied with a .039" conical tip, tip-cleaning pin and spare filters.

### SOLDERING STATION



**SA-3-115** \$89.95

Special tip-mounted sensor and sophisticated control circuitry. Temperature stability within 5% over the range of 100°C to 500°C (200°F to 930°F). For 115 VAC. 50/60 Hz operation; 230 VAC model also available. Lighted power and heater indicators, proportional temperature control and temperature indication meter, iron holder and tip cleaning sponge standard. Rugged, compact enclosure. Supplied with special 24 volt, 48 watt, low-leakage iron and SAT-3-01 (1/32 inch) conical tip.

\$29.90

### WB-104-1 WISHBOARD

- 3 bus strips
- 2 sockets
- 3 binding posts
- Mounted on a 5.9" x 8.7" Aluminum ground plate
- 18 14-pin DIP capacity



### WP-707A Dual Output



\$369.00

- Two DC power supplies, 0-25 V, 0-2 A full load each, or in series to provide 0-50 VDC.
- Two digital voltmeters with range of 99.9 VDC. May be used to measure DC source voltage or current (switch selectable).
- Load regulation .075% max. over full range.
- Ripple 5mV peak to peak max.
- Automatic short circuit shut down (current limiting)

### BK PRECISION TRIPLE OUTPUT POWER SUPPLY



**MODEL 1650** \$319.00

- Functions as three separate supplies
- Exclusive tracking circuit
- Fixed output 5 VDC, 5A
- Two 0 to 25 VDC outputs at 0.5A
- Fully automatic, current-limited overload protection
- + and - terminals of each output are fully isolated, in all modes
- All three outputs may be connected in series or parallel for higher voltage or current



**LICATEK DC POWER SUPPLY**  
**MODEL 30-3/0-30 VDC/0-3A**  
**\$135.00**

**LP-1** \$19.95

### DIGITAL LOGIC PROBE

- Use to 50 ns, 10 MHz
- Circuit powered, portable
- Compatible with most logic families

CALL US TOLL FREE  
**1-800-732-3457**  
IN CALIFORNIA TOLL FREE  
**1-800-272-4225**

Master Charge	ADD FOR SHIPPING AND INSURANCE
VISA	\$0 to \$250.00
Money Order	\$251.00 to \$600.00
Check	\$601.00 to \$750.00
	\$751.00 to \$1000.00
	over \$1000.00

Prices subject to change without notice.

RAG ELECTRONICS, INC. / 21418 Parthenia Street / Canoga Park, CA 91304 / 1-818-998-6500

HITACHI Hitachi Denshi, Ltd.

IWATEL

LEADER Instruments Corporation

POWER DESIGNS

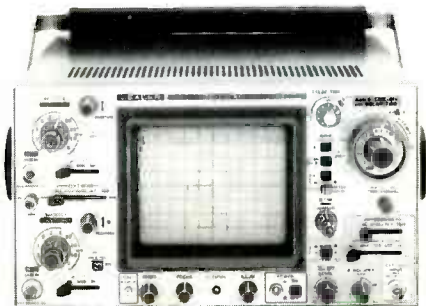
# RAG

## ELECTRONICS, INC.

New and Used Electronic Test Equipment  
Sales • Service • Rental • Leasing

**LEADER**  
Instruments Corporation

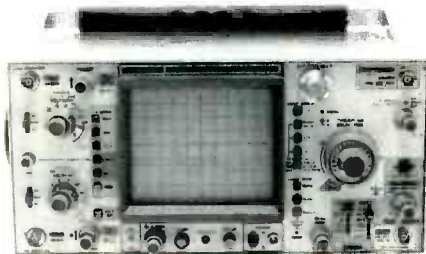
### SPECIAL SALE ON LEADER SCOPES



#### LBO 524L DC to 40 MHz

The LBO-524L is designed to meet a broad range of applications in design, testing and servicing of both analog and digital circuits and equipment. Its large 8x10 cm PDA CRT provides sharp, bright displays even at highest sweep rates. Comprehensive triggering controls including holdoff, alternate triggering and delayed sweep triggered functions permit stable displays for even the most complex signals. With 0.5 millivolt sensitivity, extremely low-level signals can easily be observed. A channel 1 output is available on the rear panel to drive other less sensitive instruments such as a frequency counter with an input level as low as 500 microvolts. The dual time base permits accurate observation and time interval measurements of complex waveforms.

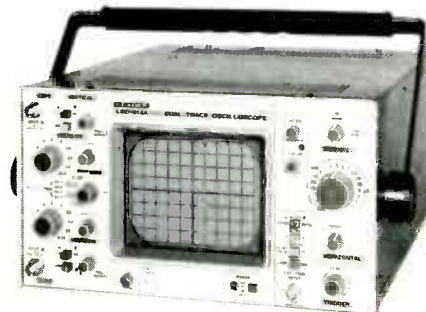
**\$749.00**



#### LBO-516 DC to 100 MHz

The LBO-516 is an economical 100-MHz, 3-channel, alternate time base oscilloscope. It has all of the important features that are expected in a 100-MHz oscilloscope such as full front panel operation, alternate triggering for simultaneous view of asynchronous signals and independent or simultaneous display of main and delayed time bases. The bright 20-kV PDA CRT and 0.5mV sensitivity permit sharp, bright displays of even those normally tough to see critical signals. Eight trace capability is possible by displaying main and delayed versions of CH-1, CH-2, CH-3, and CH-1+CH-2. Also included are comprehensive triggering facilities with video sync separators, variable trigger holdoff, excellent trigger sensitivity and more.

**\$1195.00**



#### LBO-514A DC to 15 MHz

The LBO-514A is a compact 5-inch oscilloscope that offers maximum performance at low cost. Equipped with both vertical and horizontal magnifiers, it has 1-mV sensitivity with X5 magnification and a maximum sweep speed of 0.1  $\mu$ s/cm (0.2 s/cm to 0.5  $\mu$ sec in 18 calibrated steps plus X5 magnification). The LBO-514A provides both chop and alternate dual trace displays.

**\$447.00**

Ask about Leader's Video and RF Generators

LOGICAL

### SHOOTER LOW-COST EPROM BLASTER



- Ideal for Hobbyists or Light Usage
- 128K RAM Buffer
- Build-In RS-232 Port
- Completely Assembled & Tested
- Programs 2716 through 27256
- Fast Intelligent Algorithm
- Works with Any Computer or Dumb Terminal
- Stand-Alone Mode. Copies and Verifies
- Upload/Download in Intel/Motorola/Binary Formats
- 90 Day Warrantee Parts & Labor

**\$395.00**



#### INDUSTRIAL MODEL WITH TIMER MODEL T8/2T

**\$97.50**

- Erases 15 EPROMs in 20-30 Minutes
- Rugged 60 Minute Auto Shut-Off Timer and Safety Interlock
- 5" x 8" Tray with Indicator
- Conductive Pad
- Attractive Steel Enclosure

#### MODEL T8/1

**\$49.95**

This is a Low Cost Unit Designed in a Two Part Plastic Case. This unit erases as many as 8 EPROMs in 15-20 minutes.

CALL US TOLL FREE

**1-800-732-3457**

IN CALIFORNIA TOLL FREE

**1-800-272-4225**

CIRCLE 126 ON FREE INFORMATION CARD

**RAG ELECTRONICS, INC.** / 21418 Parthenia Street/Canoga Park, CA 91304 / 1-818-998-6500

- Master Charge
- VISA ■ COD
- Money Order
- Check



ADD FOR SHIPPING AND INSURANCE	
\$0 to \$250.00	\$4.50
\$251.00 to \$600.00	\$6.50
\$501.00 to \$750.00	\$8.50
\$751.00 to \$1000.00	\$12.50
over \$1000.00	\$15.00

Prices subject to change without notice.



# GIANT 15th ANNIVERSARY SALE!

## FLUKE DMM Accessories



**\$99.00**

### 80I-600 AC Current Probe

±1000 transformer. Features large jaw opening for industrial use.  
Accuracy: ±3%  
Range: 1A to 600A 30 Hz to 1 kHz  
Jaw Opening: 2 inches (50 mm)



**\$59.00**

Fluke's 80TK plug-in thermocouple accessory converts virtually any DMM with standard banana plug inputs in a convenient, easy to use temperature measuring device.

80TK SPECIFICATIONS  
Temperature Measurement Range  
-50 to 1000°C  
-58 to 1832°F  
Battery Life: 1600 Hours (9V)



**\$219.00**

### Y8100 DC/AC Current Probe

Uses Hall-effect to measure dc or ac current without electrical contact. Battery powered. Two ranges, 20A and 200A  
Accuracy: ±2% of range (dc to 200 Hz)  
Range: to 200A and 1 kHz  
Jaw Opening: 0.75 inch (19 mm)



**\$85.00**

### 85 RF Probe

Accuracy: ±0.5 dB above 0.5V  
Range: 100 kHz to 500 MHz  
Input Level: 0.25V to 30V rms



**\$80.00**

### 80K-40 High Voltage Probe

(±1000 resistive divider).  
Accuracy: ±2%, 20 kV to 30 kV  
Range: to 40,000V dc or peak ac (60 Hz)

## LEADER Instruments Corporation

### Audio Sine/Square Wave Generator



- Distortion from <.05%
- 10 Hz to 1 MHz
- 3V 600Ω

**LAG-120B**

**\$259.95**



**5K PRECISION**

**FUNCTION GENERATOR**

**MODEL 3010**

**\$189.00**

- Sine, square and triangle output
- Variable and fixed TTL outputs
- 0.1 Hz to 1 MHz in six ranges
- Typical distortion under 0.5% from 1 Hz to 100 kHz
- Variable DC offset
- VCO input for sweep tests



**MULTI-FUNCTION COUNTER**



**MODEL WD-755**

**\$248.00**

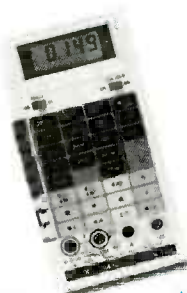
- 5 Hz to 125 MHz
- 8 Digit LED Display
- Period Measurement 5 Hz to 2 MHz
- Totalizes to 99,999,999 Plus Overflow
- Frequency Ratio Mode
- Time Interval Mode
- Switchable Attenuator & Low Pass Filter

## ESCORT DMM's & Capacitance Meter



**MODEL EDM 1116A \$89.00**

- 0.5 basic DC accuracy
- AC/DC 200mV, 2V, 200V, 1000V
- AC/DC 2mA, 20mA, 200mA, 10A
- 200Ω, 2kΩ, 200kΩ, 2MΩ, 20MΩ
- 2nF, 20nF, 200nF, 2μF, 20μF
- Diode Testing
- hFe Testing
- Audible Continuity Testing



**4 1/2-Digit Multimeter**

**MODEL EDM 1346A \$189.00**

- Audible Continuity Testing
- Diode Testing
- Data Hold

DC Voltage: 200mV-1000V ±(0.05%rdg + 3dgt)  
AC Voltage: (True RMS - 200 mV-200V @45Hz-1KHz ±(0.75%rdg + 10dgt)  
DC Current: 2A-10A ±(0.75%rdg + 3dgt)  
AC Current: (True RMS / 20mA - 200mA @45Hz-400Hz ±(0.75%rdg + 10dgt)  
Resistance: 2KΩ-200KΩ±(0.1%rdg + 3dgt)  
Frequency: 20KHz-200KHz ±(0.5%rdg + 3dgt)



**ESCORT**

**3 1/2-Digit Capacitance Meter**  
Range: 200PF - 20mF

**MODEL EDC110A \$89.00**

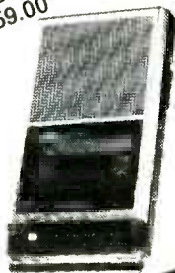
Accuracy:  
20PF-20uF ±(0.5%rdg+1dgt+0.5PF)  
200uF ±(1.0%rdg+1dgt)  
2000uF-20mF ±(2.0% rdg+ 1dgt)

CIRCLE 126 ON FREE INFORMATION CARD

# SUPER LONG PLAY TAPE RECORDERS

10 Hour Model — \$95.00\*  
14 Hour Model — \$159.00\*

Modified Panasonic Slimline. high quality, AC-DC Recorders provide 5 or 7 continuous hours of quality recording & playback on each side of cassette for a total of 10 or 14 hours depending on model. Built-in features include • Voice level control. • Digital counter, etc. TDK DC 180 Cassette Furnished.



## PHONE RECORDING ADAPTER

Records calls automatically. All Solid state connects to your telephone jack and tape recorder. Starts recording when phone is lifted. Stops when you hang up. **\$24.50\*** FCC APPROVED



## VOX VOICE ACTIVATED CONTROL SWITCH

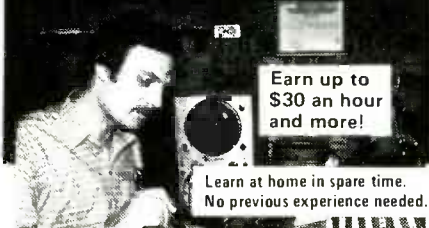
Solid state. Self contained. Adjustable sensitivity. Voices or other sounds automatically activate and control recorder. Uses either recorder or remote mike. **\$24.95\***



\*Add for ship & hdg. Phone Adapter & Vox \$1.50 ea. Recorders \$4.00 ea. Cal. Res. add tax. Mail order. VISA/M/C, COD's OK. Money Back Guarantee. Free data avail. Dealer Inquiries invited. Free data AMC SALES INC. Dept A 9335 Lubec St., Box 928, Downey, CA 90421 (213) 869-8519

CIRCLE 108 ON FREE INFORMATION CARD

# Be an FCC LICENSED ELECTRONIC TECHNICIAN!



Earn up to \$30 an hour and more!

Learn at home in spare time. No previous experience needed.

No costly school. No commuting to class. The Original Home-Study course prepares you for the "FCC Commercial Radiotelephone License". This valuable license is your "ticket" to thousands of exciting jobs in Communications, Radio-TV, Microwave, Computers, Radar, Avionics and more! You don't need a college degree to qualify, but you do need an FCC License.

**No Need to Quit Your Job or Go To School** This proven course is easy, fast and low cost! **GUARANTEED PASS** — You get your FCC License or money refunded. **Send for FREE facts now. MAIL COUPON TODAY!**

## COMMAND PRODUCTIONS

FCC LICENSE TRAINING, Dept 90  
P.O. Box 2223, San Francisco, CA 94126

Please rush FREE details immediately!

NAME \_\_\_\_\_  
ADDRESS \_\_\_\_\_  
CITY \_\_\_\_\_ STATE \_\_\_\_\_ ZIP \_\_\_\_\_

# LETTERS

WRITE TO:

## LETTERS

Radio-Electronics  
200 Park Ave South  
New York, NY 10003

### DISCRETE COMPONENTS LIVE!

I would like to congratulate you for the article "High Power FET Audio Amp", in the December 1984 issue. It is the first complex, all discrete project in your magazine (or any other electronics magazine) in quite a long time!

I'd almost forgotten how mind-stretching an exercise it is to analyze a circuit, component by component. In this world of LSI and VLSI circuits, it is refreshing to see that, for certain applications, discrete components are not completely useless.

RODOLFO GARZAS.  
Linares, N.L., Mexico

### AUTOMOTIVE ELECTRONICS

I'm writing in response to your invitation to readers to express our preferences regarding articles about "non-repairable" modules. Particularly where automobiles are concerned, I would be very eager to see as much material as possible explaining the operation of electronically controlled engine systems. It seems to me that many of those who are involved in electronics in one way or another are also car nuts to some degree. As such, I predict that such an article, or preferably a series of articles, would be quite successful.

I attended a seminar for engineering students conducted by a GM engineer, and received the distinct impression that GM considers their system to be absolutely proprietary. The engineer refused to answer any questions that could be regarded as technical in any detail. It was as if he were trying to sell cars to his audience instead of presenting a seminar. I have read the engineering press, as well as the automotive press, and have never seen

those systems discussed except in the broadest terms.

By the way, I am one of many who are ex-subscribers to *Popular Electronics*. Please don't change your basic format. I don't think your *ComputerDigest* adds much to the value of *Radio-Electronics*, but I congratulate you on keeping up your standards in the rest of the magazine. Keep up the good work and I'll keep recommending your magazine to students and associates.

JONATHAN SKEAN  
Lincoln, NE

### ADVERTISING RIP-OFF

In your January 1985 "Equipment Reports", you reviewed the TRS-80 Model 4. You mention the 64K RAM upgrade Radio Shack sells for that computer. After having it installed, however, I was informed that the upgrade can not be used to add memory to the machine, but only as a simulated disk drive. I was told that they think it can eventually be used as a memory add-on, but that they had not as yet figured out how. In light of that, I feel that Radio Shack's advertising is quite a rip-off.

HARRY L. DENMAN  
Richland Hills, TX

### MODULE REPAIR

I am a hobbyist in many areas of electronics: stereo, automotive electronics, TV, etc. I very much agree with Pete Kissa's letter ("Letters," *Radio-Electronics*, December 1984). I, too, would like to see more information concerning the troubleshooting and repair of electronics modules.

In your reply to Mr. Kissa's letter, you showed several examples of module replacement due to the failure of an inexpensive part. I





**ELECTRONICS, INC.**

New and Used Electronic Test Equipment  
Sales • Service • Rental • Leasing

know several years ago I had to buy a new electronic ignition module for my furnace. If the information and parts needed to do the repair were available, I am sure that the task would have required but a dollar or so of spare parts.

I agree that, at times, it may not be cost effective for a repair technician to troubleshoot and repair a module, etc. But certainly many times it is; and I believe that there are a very large number of people who would become more interested in the repair of such modules if the information needed to do so were available.

RICHARD V. WRIGHT  
Sanford, NC

**THE TESLA COIL**

Robert Golka's account (*Radio-Electronics*, March 1985) of his recent investigations into ball lightning was fascinating. One statement regarding the "12.5-million volt Tesla coil" needs attention.

The June, 1900, *Century Magazine* carried an article on that coil. On page 176 there is an internal view of the laboratory, showing the coil actively producing discharges stated to represent 12-million volts. That figure has been used by researchers in establishing the maximum potential for the coil, and has been quoted time and time again.

The truth of the matter is that Tesla undertook hundreds of experiments with that coil, and with others, not all of which required a maximum output. Obviously, the 12-million-volt quotation could not have been the maximum capability, because some of Tesla's experiments produced discharges longer than the building itself. In such instances, the coil had to be tuned to produce its maximum potential at some point external to the building. Tesla stated that he had achieved an absolute potential of "18-million volts."

One of those experiments was described in a lecture before the New York section of the National Electric Light Association. Tesla showed a slide of his laboratory, in which his coil was apparently under full power. A description of the address was carried in the May 20, 1911, issue of the *Electrical Review and Western Electrician*. I quote:

**HITACHI** Hitachi Denshi, Ltd. **CCTV Cameras & Monitors**



MODEL KP-120

Meet the new generation of TV cameras that brim with useful features, thanks to the MOS solid-state imaging devices.

- Compact size and light weight
- Long life and high reliability
- Extreme low-light handling capabilities
- No geometric distortion
- Reduced lag and no sticking
- Excellent immunity to vibration and shock
- No effects of magnetic fields
- Sensitive to near-infrared

**MODEL KP-120 Camera Head**  
Lenses available

**\$775.00**



MODEL HV-720

- Owing to the use of an automatic sensitivity adjusting circuit, the only necessary camera operation is focusing
- A white suppressor circuit ensures faithful reproduction on the video monitor, even for subjects with strong contrast.
- Camera mounting screws are provided at the top and bottom of the camera, facilitating mounting of the camera.
- Switchover to external synchronization takes place automatically when an external drive signal is input, hence no switch operation is necessary.\*
- Synchronizing System: Line-lock 2:1 interlace.
- Pick-up tube: Vidicon tube.
- Includes 16mm f1.6 lens

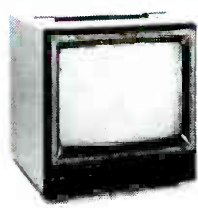
**MODEL HV-720**

**\$144.00**

\***MODEL HV-730**

**\$199.00**

**B&W MONITORS**



VM-900A	9"/500 line/video loop	<b>\$126.00</b>
VM-910	9"/500 line/video loop/ DC restoration/rack mountable	<b>\$164.00</b>
VM-906	9"/500 line/video loop/ DC restoration/rack mountable	<b>\$210.00</b>
VM-129	12"/700 line/video loop/ DC restoration	<b>\$276.00</b>
VM-173	17"/700 line/video loop/ DC restoration	<b>\$312.00</b>



**Used Equipment Sale List**

Manufacturer	Model	Description	Price
Hewlett Packard	141T/8552B	Display Storage W/8555A Plug-In	\$13,500.00
Hewlett Packard	141T/8552B	Display Storage W/8554B Plug-In	11,000.00
Hewlett Packard	141T/8552B	Display Storage W/8553B Plug-In	9,500.00
Tektronix	465B	Oscilloscope	2,100.00
Tektronix	2445	Oscilloscope	3,000.00
Tektronix	2215	Oscilloscope	1,300.00
Hewlett Packard	8640B	Signal Generator Option 001 & 003	9,000.00
Hewlett Packard	6268A	Power Supply	1,000.00
Hewlett Packard	8614A	Signal Generator	3,000.00
Hewlett Packard	100CD	Oscillator	250.00
AUL Instruments	ME 30/U	Milliterized HP 400 E	200.00
Hewlett Packard	608B	Signal Generator	1,000.00
Hewlett Packard	608E/F	Signal Generator	1,500.00
Hewlett Packard	1740A	Oscilloscope	1,500.00
Hewlett Packard	334A	Distortion Analyzer	1,300.00

Above equipment sold with 120 day warrantee parts and labor CIRCLE 286 ON FREE INFORMATION CARD

CALL US TOLL FREE

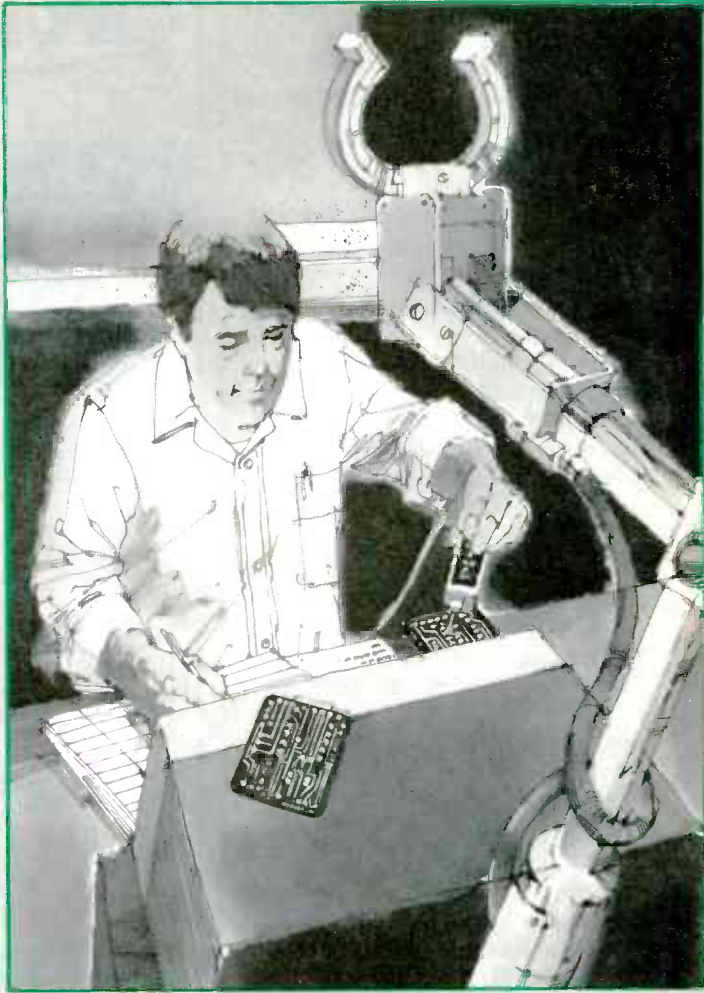
**1-800-732-3457**  
IN CALIFORNIA TOLL FREE  
**1-800-272-4225**

Master Charge	ADD FOR SHIPPING AND INSURANCE
VISA • COD	\$0 to \$250.00 ..... \$4.50
Money Order	\$251.00 to \$500.00 ..... \$6.50
Check	\$501.00 to \$750.00 ..... \$8.50
	\$751.00 to \$1000.00 ..... \$12.50
	over \$1000.00 ..... \$15.00

Prices subject to change without notice.

RAG ELECTRONICS, INC. / 21418 Parthenia Street / Canoga Park, CA 91304 / 1-818-998-6500





# What can you do Just about

## CIE can show you how.

Computer technology. Satellite communications. Cable television. Cellular radio. Digital electronics. Robotics. Just a few of the hottest career areas in electronics. The ones everybody is talking about. The ones that are changing the way we live, the way we do business, the way we entertain ourselves. The best way to start a career in any of them? By learning the basic electronics theory and principles of how they work from CIE.

## Join a leader.

Leading the world in specialized electronics training, CIE is the largest school of its kind with over 25,000 students at home and abroad. And with over 50 years of experience teaching electronics to thousands of men and women through proven

methods of independent study **without** classroom sessions.

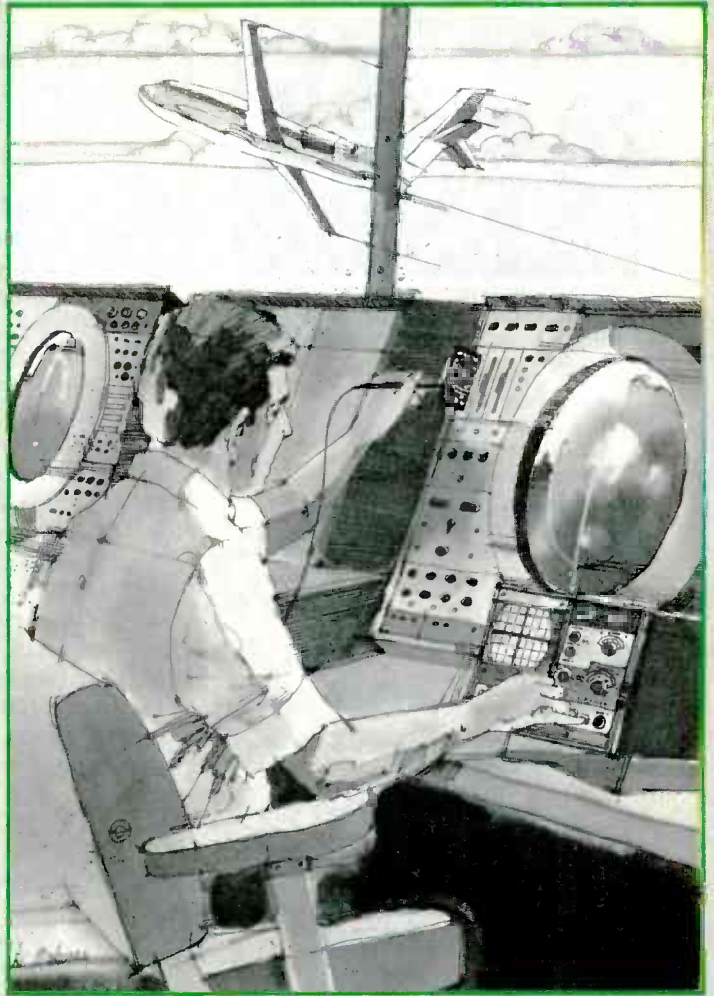
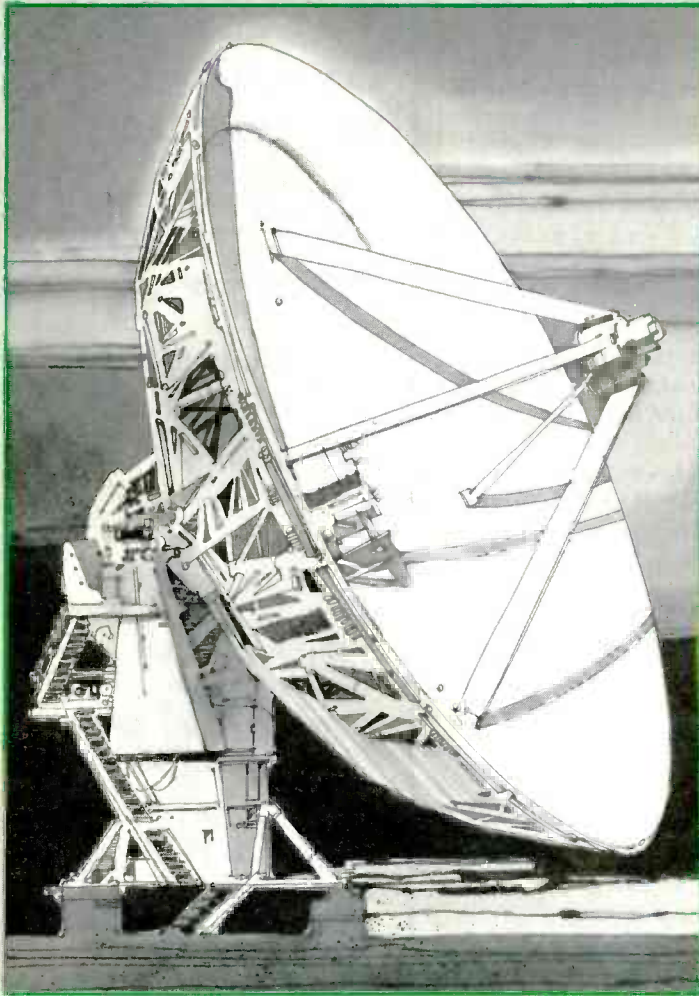
## Learn as much as you want, when you want.

Whether you're interested in learning new skills or upgrading old ones, earning a diploma or an A.A.S. degree, CIE can match your needs with courses and programs that let you start where you want, go as far as you want from a basic beginner course all the way to CIE's Associate in Applied Science Degree in Electronics – a comprehensive program that prepares you for advanced electronics careers.

## Custom training equipment helps you learn.

CIE believes in the importance of learning by





# with electronics? anything.

doing. So most of our courses include specialized training laboratories keyed to specific lessons for practical experience through teaching experiments. Our CIE Microprocessor, for example, comes fully assembled and ready to use to teach you how a computer CPU works through a series of experiments you perform on your own.

## Are you ready?

If you're ready to do something now about your future, there's no waiting to enroll with CIE. Get all the information you need to enroll simply by calling us toll-free at **1-800-321-2155** (in Ohio, 1-800-362-2105). Or mail in the handy reply coupon or card to Cleveland Institute of Electronics, 1776 East 17th Street, Cleveland, Ohio 44114.

### **CIE** World Headquarters

**Cleveland Institute of Electronics, Inc.**  
1776 East 17th Street • Cleveland, Ohio 44114

- Please send me your CIE Off-Campus Studies Catalog, including details about the Associate Degree program. I understand there is no cost for the catalog and a CIE representative may call, but there is no obligation.

Print Name \_\_\_\_\_

Address \_\_\_\_\_ Apt. No. \_\_\_\_\_

City \_\_\_\_\_ State \_\_\_\_\_ Zip \_\_\_\_\_

Age \_\_\_\_\_ Area Code/Phone No. \_\_\_\_\_ / \_\_\_\_\_

Check box for G.I. Bill bulletin on Educational Benefits

- Veteran  Active Duty

**MAIL TODAY!**

RE-19

Learn micro-processing with the new  
**MICRO-PROFESSOR 1P**



Students, engineers or technicians—  
upgrade your micro-processing skills  
with the new Micro-Professor 1P.

**The MPF-1P features:**

- extensive software support
- more built-in memory
- improved keyboard
- larger display

Three tutorial guides help cover all  
capabilities. The ideal training tool!  
MPF-1P will deliver you into the growing  
world of micro-processing. Invest now!

**Plus—FREE GIFT** Only **\$179.95**

Check this box for FREE  
Z-80 Microprocessor  
Programming and  
Interfacing textbook when  
you order within 7 days.  
\$12.95 value. (Include  
\$5.00 postage &  
handling)



Dept. RE1085  
5326 9th Ave. N.E.  
Seattle, WA 98105-3617

For immediate action call TOLL FREE:

**1-800-426-1044**

Full money back guarantee.



CIRCLE 211 ON FREE INFORMATION CARD

**ELECTRONIC  
COMPONENTS**



176 PAGE

**FREE CATALOG**

**MANUFACTURERS OF QUALITY  
ELECTRONIC COMPONENTS**

- BATTERY CLIPS & HOLDERS
- CABLE SETS • CONNECTORS • CAPACITORS
- DISPLAYS • LEDs • FUSES • JACKS & PLUGS
- KNOBS • LAMPS • POTENTIOMETERS
- RF COILS • RELAYS • RESISTORS
- SWITCHES • SEMICONDUCTORS • SPEAKERS
- TEST EQUIPMENT • TRANSFORMERS • TOOLS
- WIRE & CABLE

OVER 15,000 DIFFERENT ITEMS IN STOCK!

- Sales and Order Desk  
Open from 8:00a.m. (PST)
- Phone and Mail  
Orders Welcome
- TERMS: C.O.D., Visa,  
Master Charge  
(Open Accounts Available)
- Catalogs Mailed  
Outside USA  
Send \$2.00

**MOUSER ELECTRONICS**

11433 WOODSIDE AVE. SANTEE, CA 92071  
PHONE: (619) 449-2222 TWX 910-331-1175

CIRCLE 67 ON FREE INFORMATION CARD

"He next showed another effect of such a magnifying transmitter with a large ball, thirty-nine inches in diameter, which was placed just a little above the building, the roof of which was removable. Several of these streamers could be followed a hundred feet into the air; from a distance it looked as if the building was on fire, and the roar could be heard ten miles ..."

Another instance in which researchers have erred is in regard to an article which appeared in Hugo Gernsback's *Electrical Experimenter* for June 1919. In discussing the capability of his machine, Tesla stated that "100,000,000 volts are perfectly practicable." Writers have picked that up and quoted it as an achievement, rather than a prediction (see *Radio-Electronics* for August, 1983). Tesla did design his Wardenclyffe broadcasting station for potentials of "30-million volts;" but, unfortunately, the project was never put into operation.

HARRY GOLDMAN,  
Tesla Coil Builders' Association,  
Glen Falls, NY

**POWER METER**

The article, "Power Meter for Your Stereo," by Mark S. Cohen, in the May 1985 *Radio-Electronics*, missed the mark as a speaker protector. First of all, the delay of four stages of sensing/amplification would allow plenty of time for a good healthy power surge to blitz any speaker. The slowest element is the relay.

Another major consideration is: What happens to the stereo amplifier? Very few power amplifiers are designed to handle a large power surge with no load. The designer should have connected a resistive load to the normally open circuits of the relay to protect the amplifier.

A third factor to consider is the relay's contact resistance and power-handling capacity. The parts list says only: "DPDT 12V DC relay." The higher the power of the stereo amplifier, the more critical are those factors. A high contact resistance can cause distortion and even power loss. But it does look like a darn good power meter.  
HENRY M. TARFMAN  
Lawndale, CA

R-E

**Does your  
financial plan  
include the  
only investment  
that offers**

- high market-based interest
- guaranteed earnings
- tax advantages
- no risk
- automatic savings?

**Yes—if you buy  
U.S. Savings  
Bonds through the  
Payroll Savings  
Plan.**

Surprised? Find out  
how Bonds can  
bring some fortune  
into your future . . .  
ask about Payroll  
Savings where you  
work today.



**U.S. Savings Bonds ★**  
America's favorite  
way to save!



# ADVANCE ELECTRONICS

IS PROUD TO ANNOUNCE

**Beckman Industrial™ EASY B.O.B. SERIES**

OF PORTABLE

## Break Out Boxes



**EASY B.O.B.**  
Model 750, 770  
Breakout Box, RS 232C

**FEATURES:**

- Full RS 232C Breakout
- Line Powered (750) (not shown) or Self-Powered (770) (shown)
- 50 Pairs of Red and Green LED's
- Control Signal Simulation
- 2/3 Swap Switch
- Convenient Dual-Gender Connectors
- Cable Test Feature

*The Ultimate in Interface Testing—  
Four State signal status of all lines at  
a glance, null modem and loopback  
testing at the flip of a switch, dual  
gender connectors, switchable  
ground line, cable test feature,  
choice of powered (Model 770) or  
unpowered (Model 750) and more!*

### EASY CABLETESTER

Model 715  
RS 232C



**FEATURES:**

- Quickly Identifies Cable Wiring
- Scan and Single Step Test
- Convenient Dual-Gender Connectors
- Fits in the Palm of Your Hand
- Optional Remote Indicator for Analyzing Installed Cables (Model 716)
- No External Power Required
- Open, Continuity and Bridging Light Indicators



**EASY B.O.B.**  
Model 730  
Breakout Box, RS 232C

**FEATURES:**

- Full RS 232C Breakout
- Self-powered
- Sensitive, High Impedance Circuitry
- Dual Pulse Trap
- Control Signal Simulation
- Convenient Dual-Gender Connectors
- 49 Probe Points

**CALL FOR  
PRICES!**



TOLL FREE HOT LINE  
**800-223-0474**

212-730-7030

26 WEST 46th STREET, NEW YORK, N.Y. 10036

THE TEST EQUIPMENT SPECIALISTS

**ADVANCE  
ELECTRONICS**



- 77
- 0.3% Accuracy
  - Manual or Autorange
  - 10A + mA Range
  - Beeper
  - "Touch-Hold" Function

Sale (with holster)  
**\$11995**

**WE CARRY A FULL LINE OF FLUKE MULTI-METERS. IN STOCK NOW**

SALE ENDS OCT. 85

# FLUKE 70 SERIES MULTIMETERS

- Analog Display • Rotary Knob • Volts AC & DC • Resistance to • 32 MΩ • 10 Amps • Diode Test • 3200 Counts • Fast Autoranging • Function Annunciators in Display • Power-Up Self Test • 2000+ Hour Battery Life w/ Power Down "Sleep Mode" • New Test Leads • VDE & UL Approval



SALE  
**\$8995**

75

- 0.5% Accuracy
- Manual or Autorange
- 10A + 300 mA Range
- Beeper



SALE  
**\$7995**

and free C70 holster  
73

- 0.7% Accuracy
- Autorange Only
- 10 Amp Only



4 1/2 DIGIT MULTIMETERS

**\$349 00**

MODEL 8060A



- Frequency measurements to 200KHz
- dB measurements
- Basic dc accuracy 0.4%; 10 μV, 10 nA and 10 mΩ sensitivity
- Relative measurements
- True RMS
- High-speed Beeper

**BK PRECISION** DYNASCAN CORPORATION

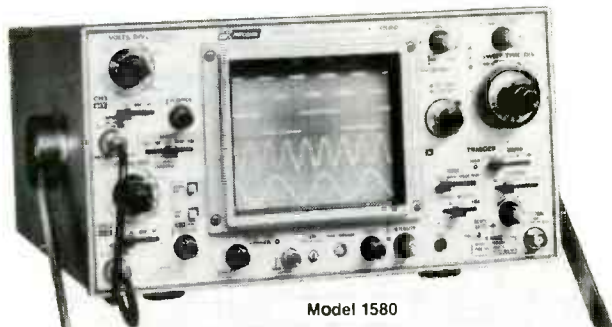
**BREAKS THE PRICE BARRIER WITH THESE HIGH PERFORMANCE OSCILLOSCOPES**

100 MHz Dual Trace/  
Dual Time Base

- 1 mV/div sensitivity
- 23 calibrated sweeps
- Rectangular CRT with internal graticule and scale illumination
- Signal Delay Line

**\$995**

Does not include probes (\$60.00 a pair when purchased with scope)



Model 1580

**QUANTITIES ARE LIMITED**

**BK PRECISION**



INDUSTRIAL TRANSISTOR TESTER

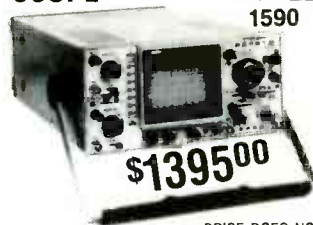
**\$21995**

MODEL 520B

- Now with HI/LO Drive
- Works in-circuit when others won't
- Identifies all three transistor leads
- Random lead connection
- Audibly and visually indicates GOOD transistor

**BK PRECISION**

100 MHz Dual Time Base SCOPE



MODEL 1590

**\$139500**

PRICE DOES NOT INCLUDE PROBES

- 1mV/division sensitivity to 70 MHz
- 500 μV/division cascade sensitivity
- Four-input operation provides trigger view on 4 separate inputs
- Alternate time base operation
- Switching power supply delivers best efficiency and regulation at lowest weight



CAPACITANCE METERS  
**\$20995**

MODEL 830

- Automatically measures capacitance from 0.1pF to 200mF
- 0.1pF resolution
- 0.2% basic accuracy
- 3 1/2 digit LCD display



**\$16995**

MODEL 820

- Resolves to 0.1pF
- 4 digit easy-to-read LED display
- Fuse protected against charged capacitors
- Overrange indication



# BECKMAN'S CIRCUITMATE<sup>®</sup> ALL UNDER \$100

AVAILABLE NOW...



**\$64<sup>95</sup>**

Circuitmate DM 20—  
3½-digit, pocket-size  
multimeter; 0.8% Vdc  
accuracy, diode test,  
hFE test, conductance,  
10 amps AC and DC  
ranges, auto-polarity  
auto-zero, auto-  
decimal



**\$69<sup>95</sup>**

Circuitmate DM-40 —  
3½-digit multimeter;  
0.8% Vdc accuracy,  
diode test, auto-  
polarity, auto-zero,  
auto-decimal



**\$89<sup>95</sup>**

Circuitmate DM 45 —  
3½-digit multimeter;  
0.5% Vdc accuracy,  
diode test, continuity  
beeper, 10 amps AC  
and DC ranges, auto-  
zero, auto-polarity,  
auto-decimal



**\$79<sup>95</sup>**

Circuitmate DM-25—  
3½ digit, pocket-size  
multimeter; 0.5% Vac  
accuracy, diode test,  
capacitance, continuity  
beeper, conductance,  
10 amps AC and DC  
ranges, auto-polarity,  
auto-zero, auto-  
decimal



The DM73 is the smallest digital  
multimeter on the market. Its  
probe-style design makes it ideal  
for taking measurements in hard-  
to-reach test areas.

**SALE**  
**\$59.95**

- Small Size
- Complete Autoranging
- "Touch Hold"
- Audible continuity checking

**\$76<sup>95</sup>**



The DM 77 gives you  
the convenience of  
autoranging plus 10  
amps ac/dc  
measurement  
capability. You simply  
select the function  
you want, and the  
DM 77 automatically  
sets the required  
range.

... Quality and Performance  
Beckman and 4½ Digits ...



True RMS

**\$239<sup>00</sup>**

AVAILABLE NOW!

BECKMAN does it  
again... a true RMS  
4½ DMM w/1 year  
calibrated cycle at  
a 3½ digit price.

MODEL 4410



**NEW**  
Beckman  
Circuit-mate  
DM10

**\$39<sup>95</sup>**

in stock now  
Model DM 10B  
with Beeper \$49<sup>95</sup>



POWER SUPPLIES



**\$319<sup>95</sup>** MODEL  
1601

- Isolated 0-50VDC, continuously variable; 0-2A in four ranges
- Fully automatic shutdown, adjustable current limit
- Perfect for solid state servicing



**\$339<sup>95</sup>** MODEL 1650

- Functions as three separate supplies
- Exclusive tracking circuit
- Fixed output 5VDC, 5A
- Two 0 to 25VDC outputs at 0.5A
- Fully automatic, current-limited overload protection



FUNCTION GENERATORS

**\$199<sup>95</sup>** MODEL  
3010 **\$329<sup>95</sup>** MODEL  
3020

- Sine, square and triangle output
- Variable and fixed TTL outputs
- 0.1 Hz to 1MHz in six ranges
- Push button range and function selection
- Typical sine wave distortion under 0.5% from 1 Hz to 100kHz

SWEEP FUNCTION

- Four instruments in one package — sweep generator, function generator, pulse generator, tone-burst generator
- Covers 0.02Hz-2MHz
- 1000:1 tuning range
- Low-distortion high-accuracy outputs



TOLL FREE HOT LINE  
**800-223-0474**

212-730-7030

26 WEST 46th STREET, NEW YORK, N.Y. 10036

THE TEST EQUIPMENT SPECIALISTS

**ADVANCE**  
**ELECTRONICS**

# SATELLITE TV



BOB COOPER, JR.\*

## Competition between home TVRO's and cable services

LAST MONTH WE EXAMINED THE REAL reasons HBO and other premium-program suppliers chose to scramble their satellite feeds. We came to the conclusion that, although unauthorized program viewing by home TVRO's was part of the problem, the real reason for scrambling was unauthorized distribution of program materials by local cable companies. We also pondered the likelihood that premium-program scrambling at 4 GHz might make it worthwhile for suppliers like HBO to serve private individuals.

There is one very emotional business conflict here. C-band premium programming was originally created for cable firms that affiliated themselves with premium-program suppliers. It was never intended for home TVRO's. Although a handful (numbering in the tens of thousands) of home TVRO's may have been a source of "amusement" to cable operators a few years ago, the home-TVRO industry of 1985 no longer amuses cable executives. Here's why:

- A recent national study showed that although 72.1% of all home-TVRO owners live where no cable TV service is available, 26.5% *do* have cable service available.
- Of the 26.5% who do have cable available, 48.7% of those are former cable subscribers.

That means that about 1 in 4 home-TVRO users could have cable if they wanted it, and that half of that number, or 1 in 8 overall, have discontinued cable in favor of TVRO. Those are rather sobering numbers. Suppose cable were to lose 1 subscriber in 8 nationwide to home-TVRO system ownership?

\* Publisher, CSD magazine



FIG. 1

### Cable and TVRO competition

Cable and home TVRO are, at the moment, competitors for consumers' entertainment dollars. From the perspective of the cable operator, the home-TVRO industry is feeding off the programming services created by cable, and paid for by cable. Because the majority of the most desirable satellite services are on satellite primarily to reach cable-service subscribers, it appears to the cable people that TVRO is getting a free ride at their expense. And if the present trend of TVRO sales continues into areas where cable is available, that 1-in-8 ratio may end up being 1-in-7 or 1-in-6 very soon. Cable doesn't like having to compete with itself!

### A possible solution

If all the most desirable cable programming on C-band were simply scrambled, ownership of a C-band TVRO would quickly become much less desirable. There are well-researched studies to back up that contention. For example, the recently completed 1985 CSD "Home Marketing Study" surveyed more than 4,800

randomly selected owners of TVRO systems. The result was more than 150 charts, tables, and demographic profiles that provided the home-TVRO industry with its first insightful look into the complex TVRO marketplace. Here are a few of the findings:

- 66% of all home-TVRO owners watch movies as their primary form of satellite-originated entertainment.
- 54.4% of all home-TVRO owners view HBO at least once every 24 hours.
- 36.9% of all home-TVRO owners view WTBS (Super Station Atlanta) at least once every 24 hours.
- 28.9% of all home-TVRO owners view ESPN (the Eastern Sports Network channel) at least once every 24 hours.

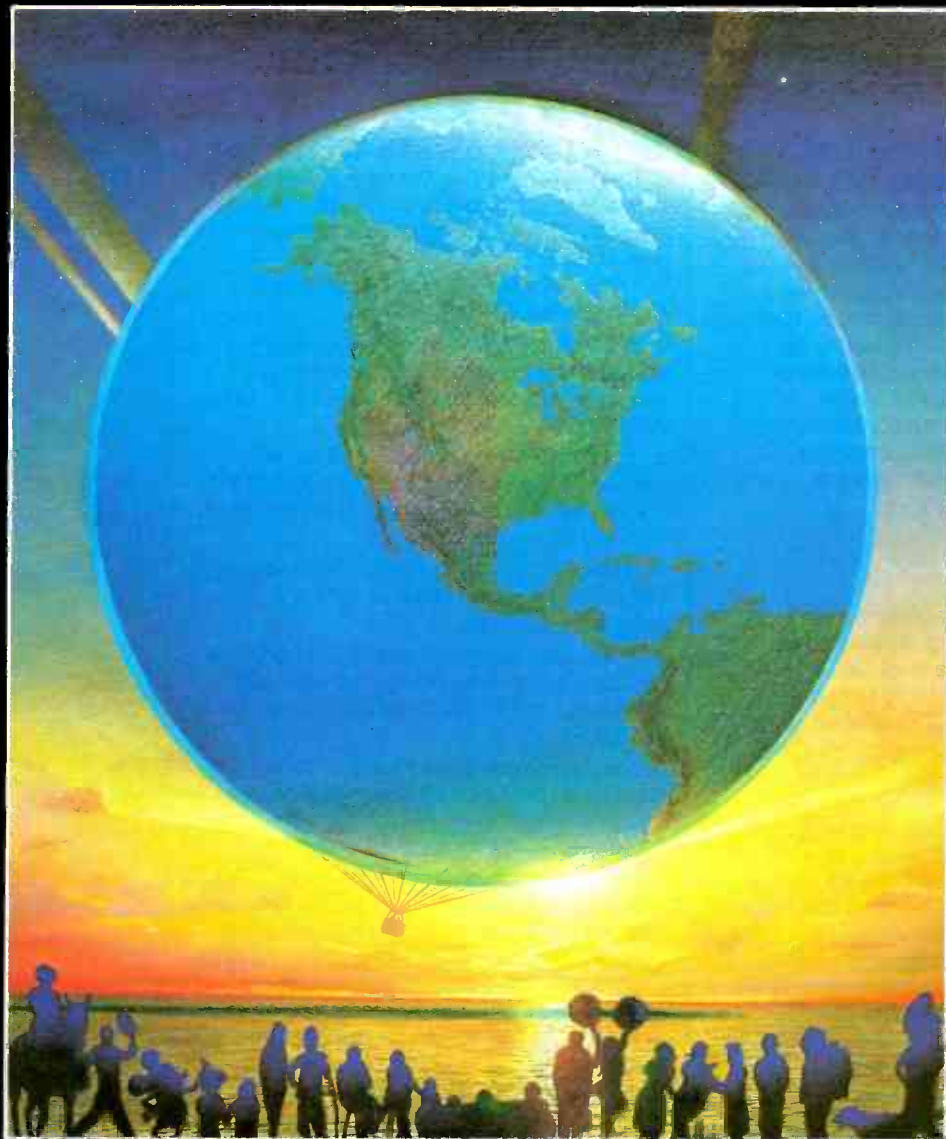
Those statistics clearly show that movies are the primary source of viewing entertainment, and that sports and news are well down the list. Now suppose the top three (movies, sports, and news) were moved to 12 GHz?

Arguments for a 12 GHz (Ku-band) service have been around for a long time. For one, the dishes are smaller than comparable C-band units—typically 4 feet or less (see Fig. 1). In addition, the equipment cost, ultimately, would be lower (\$500 per system when bought in volume). Further, interference with microwave links, which is a problem with C-band equipment, is eliminated. Most important, though, by moving home viewers to 12 GHz, the cable firms would feel less threatened, since 12-GHz feeds, from the beginning, would be designed solely for home viewers.

Showtime has shown interest in



**We Bring You the World™**



The fastest growing, most complete  
video programming log for satellite television.  
Satellite TV Week gets it straight —  
bringing information to  
industry, dealers and viewers.

## **Satellite TV Week.**

P.O. Box 308, Fortuna, California 95540  
800-358-9997 or in CA 800-556-8787  
707-725-2476

CIRCLE 260 ON FREE INFORMATION CARD

[www.americanradiohistory.com](http://www.americanradiohistory.com)

# IF YOU WANT TO GET YOU HAVE TO GET INTO

## Learn PC Servicing By Building Your Own NTS/HEATH HS-151 Desk-Top Computer, Circuit-By-Circuit

### NTS Intrinsic Home Training Takes You Below The Surface

NTS gets you right down into the heart of computer circuitry. You learn how microprocessors function, how they are designed, how they operate and are used to solve problems. Your program includes a wide variety of tests and projects, as you assemble your PC. You experience the excitement of seeing your own skills grow, the security of knowing you really understand what makes a computer tick.

### A Career in PC Servicing

The world of computers is constantly expanding. Applications have spread from business to manufacturing, from industry to medical and scientific fields. Computer-aided design, engineering, and production have revolutionized drafting, graphics, and prototyping. Computer sales figures point to a continuing need for service technicians as well as installation and maintenance specialists. The type of training you receive will largely determine your ability to take advantage of these opportunities .... and nothing beats the practical, down-to-earth training you get from NTS.

### The NTS/HEATH 16-Bit HS-151

This desk-top PC is the most powerful and versatile ever offered in any home training program. Check the advanced features listed below:

1. 128 KB RAM user memory on board, expandable to 640 KB
2. 16-bit 8088 Microprocessor accepts advanced software, speeds word processing; also allows selection from the huge library of IBM software.
3. 5.25-inch floppy disk drive, double density, IBM formatted, stores up to 360 KB. (Expandable to dual disk drive, and optional 10.5 MB hard-disk drive.)
4. MS-DOS operating system, IBM compatibility, make a wide choice of software programs available.
5. Four open IBM-compatible slots provide for future expansion, printer, modem, etc. Will accept most peripheral boards designed for IBM-PC.
6. Two video outputs for color or monochrome display monitor. Your NTS course includes a high resolution monitor displaying 80 characters by 25 lines, or graphics.
7. Editing capabilities help you insert or delete characters and lines, erase, jump or smooth scroll, etc.

Your NTS training course will teach you to program on this outstanding PC, using lessons, texts, and diagrams to make full use of its capabilities. Catalog contains complete details.

**IBM  
Compatible**



*Learning circuitry through the construction of this equipment offers practical training for which there is no substitute. Test equipment is included.*

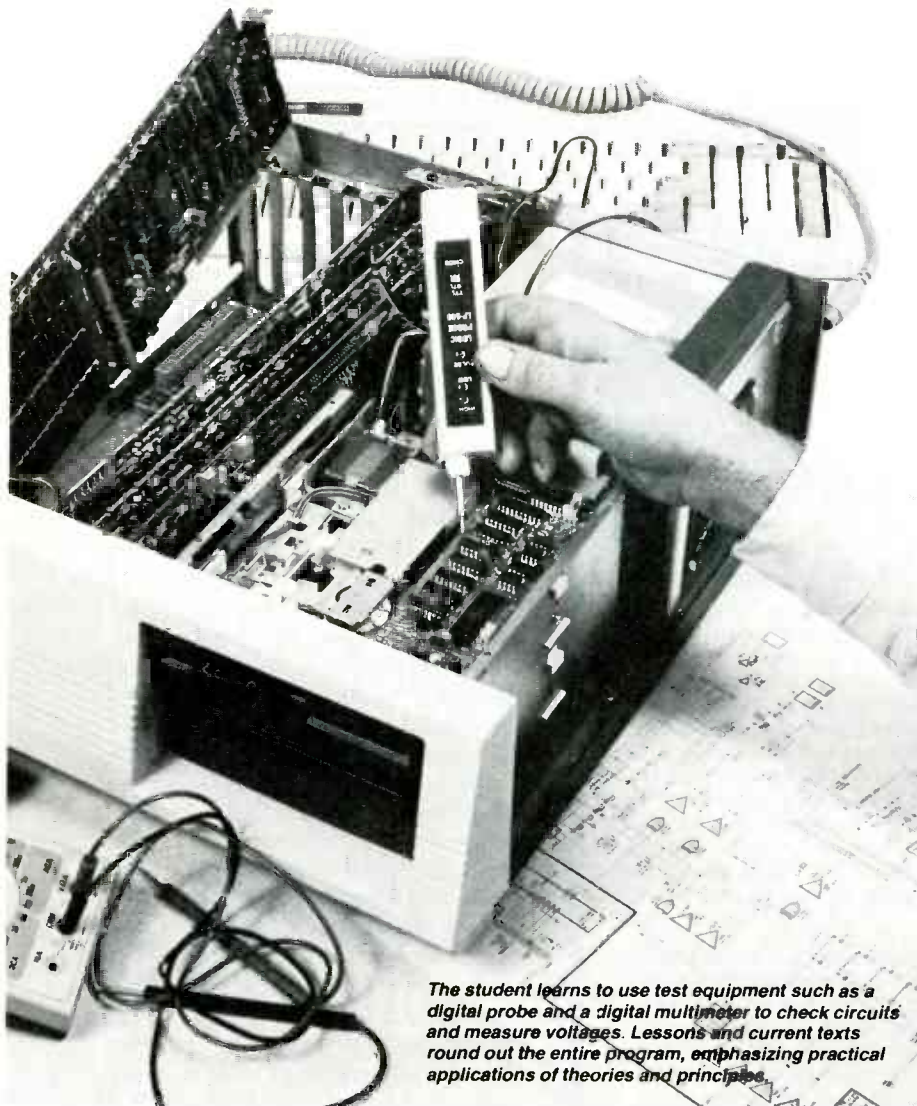
*Field servicing is interesting and rewarding. Technicians may work for a service company, manufacturer, or major users.*

*The NTS/HEATH HS-151 PC completed, includes monitor and full-function keyboard with calculator style keypad, and typewriter format.*



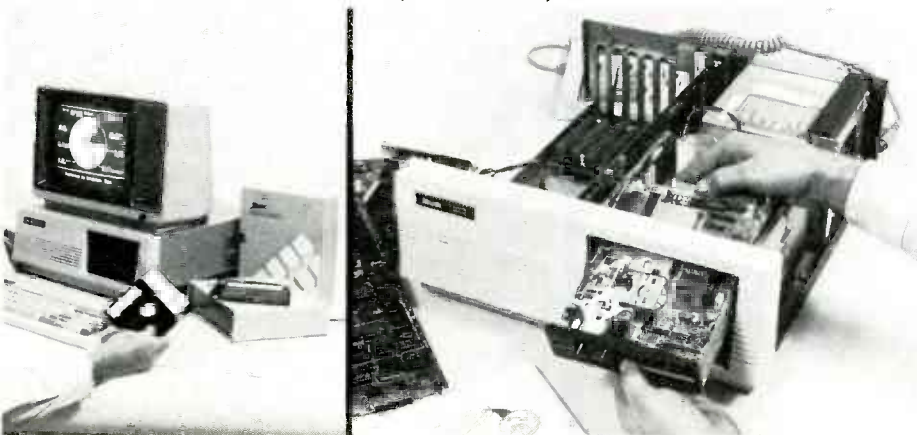


# INTO PC SERVICING A MICROCOMPUTER



*The student learns to use test equipment such as a digital probe and a digital multimeter to check circuits and measure voltages. Lessons and current texts round out the entire program, emphasizing practical applications of theories and principles.*

*Installing the disk-drive in the PC is one of the final stages in the assembly of the microcomputer. Learning the use of test equipment to check circuits is an integral part of the training which, with field experience, develops invaluable career skills.*



## NTS COURSES COVER MANY AREAS OF SPECIALIZATION IN ELECTRONICS:

**Robotics:** Build the NTS/HEATH Hero 1 Robot as you learn robotic programming. Robot is complete with arm and gripper, voice synthesizer. Robotics is becoming increasingly important in industry as almost daily news features attest.

**Video Technology:** Build one of the most advanced Color TV sets in America as you learn circuit diagnostics, and the use of digital test instruments. Course covers color TV, video tape recorders, computer fundamentals, solid-state devices.

**Industrial and Microprocessor Technology** covers circuit analysis, microprocessors and automation applications, lasers, and basic industrial robotics.

**TV & Radio Servicing** is a specialized course offering an excellent foundation in the use and application of both analog and digital test equipment as applied to the TV servicing field. Learn circuits, adjustments, trouble-shooting, and servicing of Color and monochrome monitors.

**Digital Electronics** offers the student the opportunity to get involved with computer concepts, computer technology fundamentals, and digital equipment by training on the NTS Compu-Trainer.

**Basic Electronics** is a course designed for those wishing to have an over-view of electronics in many of its aspects including radio receivers, solid state devices, and electronic components.

NTS Intrinsic training programs include a variety of superb equipment, most of which is classified as field-type, making the training practical and career oriented. Texts and lessons have been tested in our Resident School in Los Angeles to assure home study students their courses of training are easy to understand. NTS, now in its 80th year, continues to be at the leading edge in Electronics home training.

\* IBM is a trademark of International Business Machines Corp.  
\* MS is a trademark of Microsoft Corp.

If card is missing, simply write to the address shown below stating the course you are interested in. A FREE color catalog with all details will be sent to you by return mail.

**NTS NATIONAL  
TECHNICAL  
SCHOOLS**

TECHNICAL TRADE TRAINING SINCE 1905  
Resident and Home-Study Schools

4000 So. Figueroa St., Los Angeles, CA 90037

such an approach, and wonders how to get the home-TVRO viewers away from 4 GHz and onto a band where their legitimate service needs can be handled without the conflict that currently exists between cable and home TVRO.

Until now, there has been little in the way of programming on 12-GHz (at least when compared with 4-GHz). That is something that will rapidly change. Here's why:

- RCA will launch, within 12 months, a pair of moderate power

Ku-band satellites. An early customer is *Holiday Inn* who plans a four-channel service for its national motel chain.

- Ku-band receiving equipment originally developed for European and Japanese satellites needs a volume market, and at the moment neither Europe nor Japan seems to be capable of creating volume demand. The U.S. may be able to do so.
- Ku-band satellites are more flexible than C-band satellites. Ku-

#### TVRO dealer "Starter Kit" available

Bob Cooper's *CSD Magazine* has arranged with a number of TVRO equipment suppliers to provide a single-package of material that will help introduce you to the world of TVRO dealership. A short booklet written by Bob Cooper describes the start-up pitfalls to be avoided by any would-be TVRO dealer, in addition, product data and pricing sheets from prominent suppliers in the field are included. That package of material is free of charge and is supplied to firms or individuals in the electronics service business as an introduction to the 1984/85 world of selling TVRO systems retail.

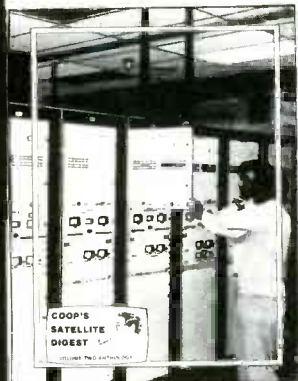
You may obtain your *TVRO Dealer Starter Kit* free of charge by writing on company letterhead, or by enclosing a business card with your request. Address your inquiries to: *TVRO STARTER KIT*, P.O. Box 100858, Fort Lauderdale, FL 33310. That kit *not* available to individuals not involved in some form of electronics sales and service.

## SATELLITE TV/

### The First Five Years!



**THE MOST COMPLETE** report on the mushrooming home 'TVRO' industry ever compiled, written as only the 'father of TVRO' could have prepared. More than **1000 pages** (!) tracing the complete story of home TVRO, lavishly illustrated with equipment photos, schematic diagrams, equipment analysis reports. **Bob Cooper**, the first private individual to own and operate a TVRO (1976) has collected and polished hundreds of individual reports into a unique 'collector's edition' which clearly explains the TVRO phenomenon in North America. From Coop's first 20 foot 'monster' dish to the present day 5 foot 'C-band' TVROs, the fascinating growth of TVRO equipment and its legal status unfolds for you.



**THIS TWO VOLUME SET** totaling more than 1,000 pages is available for the first time to readers of *Radio-Electronics* at special discount pricing. **Originally** sold at \$100 per two-volume set, a limited supply is now available **ONLY** through this advertisement. **PLUS**, you will also receive a special extraordinary bonus; the 200 page (+) **October 1984** edition of *CSD/Coop's Satellite Digest*. This very special edition of *CSD* is a best-seller in the TVRO industry, with the most comprehensive collection of TVRO facts and figures ever compiled. Combined with the 1,000 page 'CSD ANTHOLOGY' report, you have instant reference to **everything** you will ever need to know about the state of the home TVRO industry. It is **MUST** reading for every person in, or thinking about 'getting into,' **any** segment of the home TVRO world.

band transponders have nearly twice the bandwidth (typically 54 MHz). That allows using one full transponder for super-power or super-resolution services, or, by splitting a transponder, two up-rated TV channels may each use half of the transponder. That increases program packaging and scrambling options.

HBO first considered Ku-band program distribution back in 1983. More recently, Showtime, HBO's chief competitor, has been doing its own studies of just how a package of desirable cable services might be set up for home delivery via Ku-band satellites. It is all speculative now, but the handwriting is on the wall: Ku is coming, and one way or the other, it will play an important role in the home-TVRO systems of the late 1980's.

#### Technical problems

The addition of a Ku-band "head" to an existing C-band system presents several problems. Most of the newer home-TVRO receivers use block down-conversion, or BDC. (See "Know Before you Buy" in the June 1985 issue of *Radio-Electronics*.) BDC is tailor-made for dual-band reception—4 and 12 GHz, that is. The existing 4-GHz LNB (Low Noise Block down-converter), or anten-

*continued on page 90*

— **SEND CSD ANTHOLOGY/2 Vols. + CSD Bonus.**  
— **SEND CSD October '84 Special Issue ONLY.**

NAME \_\_\_\_\_ COMPANY \_\_\_\_\_

ADDRESS \_\_\_\_\_

CITY \_\_\_\_\_ STATE \_\_\_\_\_ ZIP \_\_\_\_\_

Payment: \$60 US funds (Anthology + Bonus), \$15 US funds CSD Oct. ONLY; payable "CSD ANTHOLOGY."  
Shipping charges prepaid. Enter order to: **CSD Anthology**, Radio-Electronics Magazine, 200 Park Av. S., New York, NY 10003; or call 305-771-0505 for credit card orders ONLY.







Courses In Computers and Programming



Disk Drives and Peripherals



All-in-One Computer



IBM Compatible Computers



Superior Software Tools



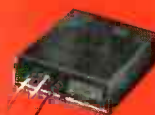
Fully Portable Test Instruments



Hand-held Digital Multimeter



Home Control Systems



Telephone Accessories



Perfect Timekeepers



Domestic Solar Water Heater



Space Phone Television



Hero I Robot and Course

# FREE Heathkit® CATALOG



Trainers



Educational Self-Study Courses



Pro-Series Audio Components



Digital Marine Depth Sounder



Radio Gear



Computerized Weather Station

**450 kits and products:** solar hot water systems, all-in-one 16-bit computers, test instruments, amateur radio gear, self-study courses in computer literacy and state-of-the-art electronics, energy conservation and home security devices, fine stereo components, color televisions, automotive or marine aids, home conveniences, robots and more – things you've always wanted and needed, right now at low kit prices from Heath.

**For people with imagination,** there's nothing to compare with the exclusive thrill of hand-built satisfaction.

**Discover the fun of kitbuilding** – it's a great way to relax in your spare time and share a rewarding pastime with your whole family. The great kits you build will reflect the pride of your craftsmanship, too. The famous Heathkit illustrated manuals make it easy for *anyone* to build reliable, professional-quality kits.

## SEND FOR FREE CATALOG

Our colorful catalog is Free! If coupon is missing write: Heath Company, Dept. 020-346, Benton Harbor, MI 49022.

**Heathkit** Heath Company, Dept. 020-346  
Benton Harbor, MI 49022

Send me the latest free Heathkit Catalog now. I want to "build in" the quality difference.

Name \_\_\_\_\_

Address \_\_\_\_\_

City \_\_\_\_\_ State \_\_\_\_\_

CL-764R2 Zip \_\_\_\_\_

**FREE CATALOG**

Heathkit products are also displayed, sold and serviced at 64 Heathkit Electronic Centers\* nationwide. Consult telephone directory white pages for location.  
\*Operated by Veritechnology Electronics Corporation, a wholly owned subsidiary of Zenith Electronics Corporation.

CIRCLE 86 ON FREE INFORMATION CARD

[www.americanradiohistory.com](http://www.americanradiohistory.com)

# EQUIPMENT REPORTS

## Kenwood 7930 2-Meter Transceiver

2-meter transceiver that's sure to get noticed



CIRCLE 5 ON FREE INFORMATION CARD

EVERY SO OFTEN A NEW PIECE OF EQUIPMENT comes along and makes everyone stop and take notice. The 7930 2-meter VHF transceiver from Trio-Kenwood (1111 West Walnut St., Compton, CA 90220) is

such a piece of equipment.

The 7930 has a maximum power output of 25 watts. Features include priority scan, 21-memory storage, memory scanning, band scanning, time- or carrier-oper-

ated squelch in the scanning mode, and a choice of high or low power.

That last feature is especially important in helping to reduce band congestion. In some situations, such as when you are located near the repeater you are using, you may not need to operate your transceiver at full power. Well, Kenwood has made it so easy to reduce your output power that you simply have no excuse not to. With a flick of a switch the 7930's power level may be reduced from 25 to 5 watts.

The front panel of the 7930 has a

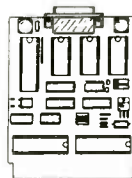
FAST (over 11 mHz CIK)

## U L L BASIC CONTROLLER

WITH ON-BOARD EPROM/E<sup>2</sup>PROM PROGRAMMER

P.1 MLC-1 ONLY \$188<sup>87</sup>

Assembled & Tested. Uses Intel 8052-AH Micro Controller Chip. Real Time Clock RS232 & Ports.



**NEW**  
IN  
POWER  
& SIMPLICITY!

### SINGLE BOARD FEATURES:

The board itself is a breakthrough in controller power, simplicity and price. The user can be writing and running programs in Basic, even storing them on EPROM/E<sup>2</sup>PROM's within minutes of initial hookup. Applications - Real time intelligent security systems, auto-test equipment, home and industrial environmental control, robotics, ... We think you'll really enjoy using our product.

### HARDWARE FEATURES: 8052 BASIC

RS232 Serial port with auto-baudrate detection at virtually any baud rate; Serial printer port output available; 48 I/O lines (6-8 bit ports); PWM output; Real time Clock (5m Sec. resolution); Fast 11.0952 mHz clock rate; Up to 16Kx8 of on board iRAM (low power from Intel) EPROM Programmer: Programs 2716, 2732, 2764, 27128; On board regulator for programming voltages (selectable). Comes with 8Kx8 of iRAM and 8Kx8 of EPROM; Additional iRAM and EPROM available (call for prices).

### SOFTWARE FEATURES: Fast Full Basic Interpreter (Not "Tiny Basic")

BCD floating pt. math; Hex to Decimal, Decimal to Hex conversion; Exponential number handling; ± 99999999E - 127 to ± 1E + 127; All Basic routines can be called by assembly language programs; Basic can call user assembly language subroutines; Basic or assembly handling of interrupts; Single command transfer of RAM program to EPROM/E<sup>2</sup>PROM any of which can be transferred back to RAM with a single command. Single step Basic Commands to control 6-8 bit I/O ports, as well as internal and external memory. Can execute EPROM program on power up if desired without use of a terminal.

Requirements: Dumb terminal (stand-alone after programming) + 5V @ 1A, ± 12V @ 1A, + 30V @ 1A

### TERMS:

Mastercharge and Visa accepted (add 4%). C.O.D. orders add \$3.00. Wisconsin residents add 5% sales tax. Personal checks must clear before shipping. S & H add \$4.00 per board. All orders refused or returned are subject to a 10% restocking fee. Prices and specifications subject to change without notice.

### Accessories: (Call or write for prices and specs.)

48K RAM and 24K EPROM expansion board. (Mother board) Isolated 110/220 A.C. power switching board (1/4 channel) Isolated D.C. switching board (1/4) A - D boards, single 12 bit integrating and 8 ch. 8 bit; D - A boards, single 12 bit and 8 ch. 8 bit; Programmable (voltage, current or both) power supplies; 1EEE 488 interface; Stepper motor driver BRD (controls 3 motors); Power supply (5V, ± 12V + 30V); System power supply (+ 5, ± 12, + 30, ± 15, + 15)

### 8097 BOARD - \$288<sup>87</sup>

#### FEATURES:

16 bit processor • 11.0952 mHz clock rate • 2 parallel ports • Serial port - full Duplex Asynchronous; 10 bit 8 channel (52us.) A/D; PWM output; High Speed I/O lines (4 programmable, 4 dedicated); Watchdog timer; 2 programmable Times/counters; 16x16 multiply or 32x16 divide in 7 us.; 16K of new low power iRAM, 16K of eeprom  
APPLICATIONS: Optical encoder decoding, A.C. induction motor drives, D.C. motor drives, high speed controller, Robotics ...



MICRO LINEAR CONTROLS

4900 Memco Lane  
Racine, WI 53404 • 1099

Orders only call TOLL-FREE 1-800-222-2298  
for technical information call (414)-639-4131  
Call for OEM and Quantity Pricing.



ORDERS ONLY OUTSIDE WI  
1-800-222-2298

ACCEPTED  
ADD 4%



**United States  
Instrument Rentals, Inc.**



A U.S. Leasing Company

2988 Campus Drive  
San Mateo, CA 94403

Call for Special Prices and

**Free Catalog**  
**800-824-2873**



**Hitachi Denshi America, Ltd.**

**Beckman Industrial!**



**SCOPES**

**Iwatsu**

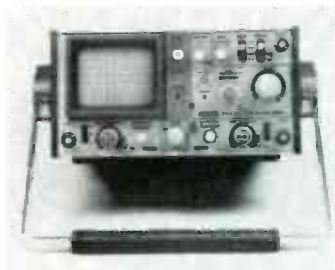
- All 14 models in stock
- 2-3 year warranties
- 20-250 MHz

Model 5702—\$ 535  
5705—\$ 899  
5710—\$1245  
5711—\$1695  
7506—\$ 749

**Hitachi**

- All 20 models in stock
- 2-3 year warranties
- 20-100 MHz

Model 222—\$ 599  
1050—\$1299  
509—\$1199  
VC 6041—\$5499  
422—\$ 699  
1100—\$2490  
650—\$ 930



Hitachi V-209

**SALE \$695**  
List \$945

**Hitachi V-209**

Portable Dual Trace Scope

- DC-20 MHz
- Battery Operated
- 3-Way Power Supply
- Lightweight
- High Sensitivity and Fast Sweep Timer

**DIGITAL MULTIMETERS**

**Beckman**

- All 300, HD, and circuitmate series
- All accessories in stock

HD100—\$169 320—\$179  
HD110—\$189 330—\$219  
HD130—\$239 350—\$229  
HD140—\$259 360—\$289  
300—\$120 4410—\$239  
310—\$145

**Fluke**

- Autorange • Analog display
- Touchhold function
- 0.3% accuracy • Heavy duty

Model 73—\$ 85 8010A—\$279  
75—\$ 99 8012A—\$359  
21—\$ 99 8020B—\$199  
23—\$145 8022B—\$154  
25—\$299 8024B—\$249  
27—\$259 8050A—\$389

**SALE \$114**  
List \$129

**Fluke 77**

Analog/Digital Multimeter



**COUNTERS—DIGITAL THERMOMETERS—PLOTTERS**

MANY MODELS AVAILABLE — CALL 800-824-2873

Example: **Fluke 1900 Counter** Sale **\$389.50**

*Battery and BCD Data Options Available*

**Used Test Equipment, too!—Over 3,000 Models Available at  
Huge Discounts with Warranties!**

- Quantity Discounts Available
- Dealers Welcome
- Freight and Tax extra
- Immediate Availability of Equipment

Call

**800-824-2873**

CIRCLE 258 ON FREE INFORMATION CARD

# TOOL DISPOSAL NOTICE

**OVER 130 PIECES TOTAL**

## ATTACHE TOOL KITS

Your Choice of Attractive Vinyl Leatherette Case, ABS Plastic Case or Lightweight Aluminum Case (pictured) plus a Fantastic Assortment of Over 130 Quality Tools Professionals Need and Use Every Day!!!

**YOUR COST... \$199.00**

Tools and Choice of Case Included!  
COMPARE AT \$350.00

**FREE DELIVERY**



### TOOL SET INCLUDES

### Free Multi-Tester

- |                                     |  |                                     |                                   |
|-------------------------------------|--|-------------------------------------|-----------------------------------|
| (2) Alignment Tools                 | Oiler                                      | Hemostat                            | Solder in Pull Tube               |
| (3) Burnishers                      | Penlight                                   | #1 x 1" Phillips Screwdriver        | Solder Sucker                     |
| Decimal/Metric Conversion Wheel     | 4-1/2" Diagonal Cutting Plier              | #2 Phillips Screwdriver - Stubby    | Solder Iron Holder                |
| 7 Blade Feeler Gauge                | 5-1/4" Diagonal Cutting Plier              | #2 x 4" Phillips Screwdriver        | #10/120V, 30.35W Soldering Iron   |
| Ball Pein Hammer 4 Oz.              | 10" Groove Joint Plier                     | 3/32" x 2" Slotted Clip Screwdriver | Spring Tool, Pull                 |
| Handle, Driver Blades (4-5/8") Red  | 5-1/4" Long Nose Plier                     | 1/8" x 4" Slotted Screwdriver       | Spring Tool, Push                 |
| Handle, Driver Blades (4-5/8") Blue | 6-1/2" Long Nose Plier with Cutter         | 1/8" x 8" Slotted Screwdriver       | 2 1/2 Pc. 1/4" Drive Socket Set   |
| (9) Hex Driver Blades               | External Retaining Ring Pliers             | 3/16" x 3" Slotted Screwdriver      | 1/4" Drive Fingertip Ratchet      |
| (8) Metric Hex Key Wrenches         | Internal Retaining Ring Pliers             | 1/4" Slotted Screwdriver - Stubby   | (8) Assorted Retaining Plier Tips |
| Icepick/Scribe                      | 3/32" Center Punch                         | 1/4" x 4" Slotted Screwdriver       | Reverse Action Tweezers           |
| Case Key                            | 1/8" Pin Punch                             | 5/16" x 6" Slotted Screwdriver      | Wire Crimper/Stripper             |
| Key Chain with 4-Way Screwdriver    | 1/8" Pin Punch                             | (7) Jewelers Screwdrivers           | Wire Stripper/Cutter              |
| Electricians Knife                  | 6" Stainless Rule                          | Phillips & Slotted Screw-starters   | 6" Adjustable Wrench              |
| Inspection Mirror                   | Scissors (Sharp, Sharp)                    | Solder Aid, Fork and Hook           | 8" Adjustable Wrench              |
| Multimeter with Probes & Fuse       | Offset Ratchet Screwdriver (Slot/Phillips) | Solder Brush                        | (8) Ignition Wrenches             |
| (9) Nut Driver Blades               | #0 x 2-1/2" Phillips Clip Screwdriver      | Solder Removal Braid                |                                   |

For Orders of 5 or more sets call Toll Free 800-423-2567 for quantity discount prices!

Qty	Lot No.	Item	Unit Price	Amount
	64970	Vinyl Leatherette Case	\$50.00	
	49570	ABS Plastic Case	\$55.00	
	62270	Aluminum Case	\$65.00	
	49470	130 pc Tool Set	\$159.00	
	39270	Vinyl Leatherette Case & Tools	\$199.00	
	39170	ABS Plastic Case & Tools	\$199.00	
	39070	Aluminum Case & Tools	\$199.00	
Subtotal				
Sales Tax for CA & KY Residents				
Total				

Name \_\_\_\_\_

Address \_\_\_\_\_

City \_\_\_\_\_ State \_\_\_\_\_

Phone \_\_\_\_\_ Zip \_\_\_\_\_

Signature \_\_\_\_\_

Check or money order enclosed

Charge  M/C  Visa Exp. Date \_\_\_\_\_

Acct. No. \_\_\_\_\_

## HARBOR FREIGHT SALVAGE CO.

3491 Mission Oaks Blvd., P.O. Box 6015,  
Camasillo, CA 93011-6015

PHONE TOLL FREE 800-423-2567

T970

Kenwood	7930									
OVERALL PRICE										
EASE OF USE										
INSTRUCTION MANUAL										
PRICE/VALUE										
	1	2	3	4	5	6	7	8	9	10
	Poor			Fair			Good			Excellent

clean, uncluttered appearance. There is a 16-key DTMF pad, an ON/OFF switch, a squelch control, and a rocker switch that allows you to choose between using the 21-position rotary switch to select a frequency previously stored in the 7930's memory, and using the keypad to enter the desired frequency. In addition, there are six pushbuttons that allow you to:

- Reverse transmit and receive frequencies.
- Activate the tone for repeaters that use tone access.
- Select high or low power.
- Select carrier- or time-operated scanning. In carrier scanning, the 7930 scans through the frequencies you have previously stored in memory. As soon as it finds a channel with a carrier, it stops and allows you to hear what's going on. It remains on that channel until the carrier disappears, at which time it continues scanning. In time-operated scanning, the 7930 again stops on each channel it finds with a carrier, but remains there for only about five seconds before moving on.

- Select the alert function. The 7930 allows you to designate one channel as an alert channel. When scanning, the 7930 checks that channel every five seconds, and remains there when a carrier is present.

- Select priority mode. That switch gives you a quick way of forcing the 7930 to lock in your priority channel.

The 7930's front panel is completed by a green LCD (Liquid Crystal Display) that gives a digital display of the currently selected frequency. In addition, the LCD shows whether a repeater's input is up or down, whether the transceiver is in reverse or priority modes, and whether the station



# PERFORMANCE

## THAT IS OUT OF THIS WORLD...



**\$389<sup>00</sup>**

**MODEL 2000 20MHz  
DUAL TRACE**

**\$549<sup>00</sup>**

**MODEL 3500 35MHz  
DUAL TRACE DELAYED SWEEP**

## ...AT A DOWN TO EARTH PRICE

At last! Truly affordable test equipment with no compromise in design, and features you would expect to find only on oscilloscopes costing hundreds of dollars more! JDR Instruments presents two, new, high-performance models backed by a two year warranty and technical support which is only a phone call away. Perfect for the technician or advanced hobbyist, both models feature Dual Trace capability and a variety of operating and triggering modes, including CH-B Subtract and X-Y operation.

MODEL 2000 has a 20 MHz bandwidth and 20 calibrated sweeps ranging from .2s to .2 $\mu$ s. A convenient built-in component tester provides additional diagnostic power.

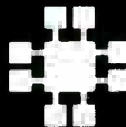


INCLUDES TWO HIGH QUALITY  
1x, 10x TEST PROBES

CIRCLE 261 ON FREE INFORMATION CARD

MODEL 3500 features a 35 MHz bandwidth and exceptional 1mV/DIV sensitivity. Delayed sweep and variable holdoff allow stable viewing of complex waveforms.

**ORDER TOLL FREE**  
**800-538-5000**  
**800-662-6279 (CA)**



**JDR INSTRUMENTS**

**1224 South Bascom Avenue  
San Jose, California 95128 (408) 995-5430**

COPYRIGHT 1985 JDR INSTRUMENTS. EARTH PHOTO COURTESY OF NASA.  
THE JDR INSTRUMENTS LOGO IS A REGISTERED TRADEMARK OF JDR MICRODEVICES. JDR INSTRUMENTS IS A TRADEMARK OF JDR MICRODEVICES.

[www.americanradiohistory.com](http://www.americanradiohistory.com)

you are listening to is on frequency. Completing the display is a red and yellow LED bargraph that indicates signal strength when receiving and power output when transmitting.

The 7930's frequency coverage has been extended above and below the strict 144-148 MHz amateur band to cover the Military Affiliated Radio Service (MARS), located at 142-148.995 MHz. That means that the transceiver can also be used with the Civil Air Patrol,

with which many amateurs are associated.

A compact unit, the 7930 measures  $6\frac{7}{8} \times 2\frac{1}{2} \times 8\frac{1}{16}$  inches, and weighs about four pounds. The microprocessor-controlled unit features frequency synthesized tuning. Note that though you might expect spurious signals generated by the microprocessor circuit to be a problem, no "birdies" were observed during our tests of the 7930.

The 7930 has an impressive set of

specifications. For example, its rated maximum output is 25 watts; that can be reduced to 5 watts via the front-panel switch previously mentioned. Modulation deviation is 5 kHz. Spurious output is rated at -70 dB (-60 dB at the low-power setting). Stability of the frequency synthesized tuner is better than 15 ppm over a temperature range of -20°C to +50°C.

Turning to the receiver section, sensitivity is rated at 0.25 µV for 12 dB SINAD. Squelch threshold is specified as 0.6 µV or less. Spurious rejection is -70 dB. Selectivity is 12 kHz minimum at -6 dB and 24 kHz maximum at -60 dB. The audio output is 2 watts into an 8-ohm load.

In the presence of high levels of external RF, the 7930 has one potential problem: front-end overload. The transceiver is as free from intermodulation distortion as any other on the market, but in the presence of high levels of RF, a common occurrence in many parts of the country, the receiver could be completely blanked out. Kenwood may want to consider adding more internal shielding to the unit, as well as sharper band-stop filtering, to help prevent that problem.

Our other main complaint with the transceiver is not with the transceiver itself; it's the lack of technical detail in the documentation. That is a far cry from the days when complete information always came with such transceivers, including detailed servicing information. Few rigs today, including the 7930, come with such information. Instead, the manufacturer prefers that you box the unit up and return it to the factory for repair.

However, the material that is included in the the documentation does give a good explanation of how to set up the transceiver, and how to take advantage of its many fine features.

The Kenwood 7930 should provide you with years of good service, whether used as a base or mobile rig. The 7930 lists for \$359.95; for more information, contact Kenwood Communications, 1111 West Walnut, Compton, CA 90220.

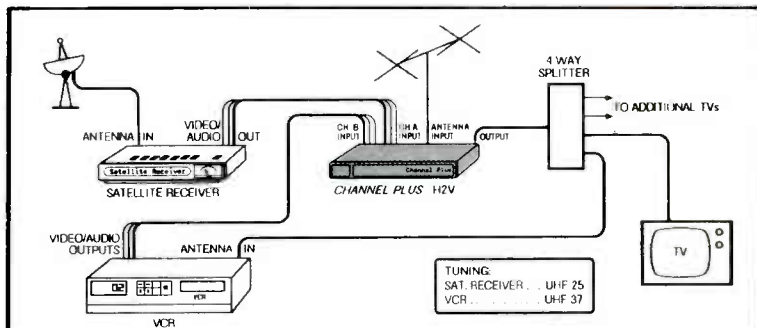
R-E

continued on page 42

# Channel

VIDEO MULTIPLEXER

## SIMPLIFY DISTRIBUTION SYSTEMS



### TYPICAL HOME SYSTEM

In this system any TV can connect to the satellite receiver by simply tuning to UHF channel 25. The VCR can be viewed on UHF channel 37. All over-the-air stations can still be received on their normal channel numbers. The VCR can record from the satellite receiver by simply tuning to channel 25.

Note: A **CHANNEL PLUS** H2V comes pretuned to channels 25 and 37. The user can easily change these assignments to any channel between 14 and 62.

- Combine many video sources on one wire
- Channel Plus is a frequency-agile modulator with built-in combiner—no filters or traps needed.
- Channel Plus uses UHF to avoid adjacent channel interference.
- Channel Plus improves picture & sound quality by using the direct video & audio outputs from VCRs, TVROs, cameras, etc.
- Channel Plus systems may be expanded to add more video sources.
- Watch VCR, TVRO, computer, cable box, VDP, camera, etc. from any TV by simply selecting its channel number.

multiplex™  
technology, inc. 251 imperial highway, fullerton, ca 92635  
telephone (714) 680-5848



MASTER THE NEW ELECTRONICS WITH MCGRAW-HILL'S

# Contemporary Electronics Series

The fast, easy and low cost way to meet the challenges of today's electronic innovations. A unique learning series that's as innovative as the circuitry it explains, as fascinating as the experiments you build and explore.

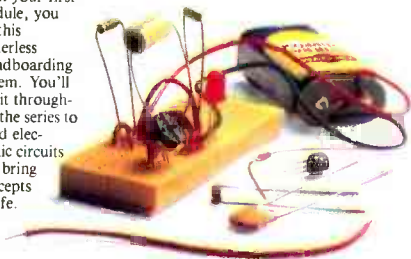
From digital logic to the latest 32-bit microprocessor, the McGraw-Hill Contemporary Electronics Series puts you into the electronic picture one easy step at a time. Fifteen unique Concept Modules, sent to you one every 4-6 weeks, give you a handle on subjects like optoelectronics, robotics, integrated circuits, lasers, fiber optics and more.

Each Concept Module goes right to the heart of the matter. You waste no time on extraneous material or outdated history. It's a fast, efficient, and lively learning experience... a non-traditional approach to the most modern of subject matter.

### Unique Interactive Instruction

With each module, you receive a McGraw-Hill Action Audio Cassette. Each tape is a dynamic discussion that drives home the key facts about the subject. Your learning

With your first module, you get this solderless breadboarding system. You'll use it throughout the series to build electronic circuits and bring concepts to life.



experience is reinforced through interaction with vividly illustrated text, audio cassettes, and actual electronic experiments. Indexed binders preserve backup material, notes, and tapes for convenient referral.



wants

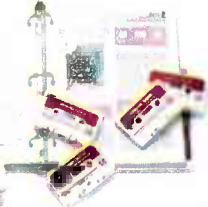
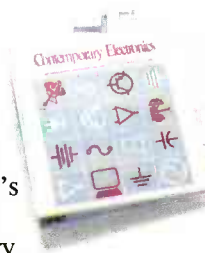
an update in contemporary circuits... a

manager or supervisor in an electronics plant... a doctor, an engineer, a chemist who finds electronics playing an increasingly important role in your work. It's even for electronics engineers or technicians who feel their training needs freshening up. It's the quickest,

most convenient, probably least expensive way to do it. And the only one that gives you hands-on experience.

### Perform Experiments in Contemporary Electronics

Throughout your series, laboratory experiments reinforce every significant point. This essential experience... dynamic, hands-on demonstrations of theory in practice... will help you master principles that apply all the way up to tomorrow's latest VLSI (Very Large Scale Integrated) circuitry.



In your very first module, you'll use integrated circuits to build a digital oscillator, verifying its operation with a light emitting diode (LED). You'll learn to identify passive and active components, understand concepts common to all electronic circuits.

### 15-Day No-Risk Trial

To order your first module without risk, send the postage-paid card today. Examine it for 15 days under the terms of the order form and see how the Contemporary Electronics Series gets you into today's electronics. If card has been used, write us for ordering information.

### For Anyone Interested in Electronics

The Contemporary Electronics Series is designed for anyone from hobbyist to professional. It's for you if you're looking for new fields of interest... if you're a teacher who



McGraw-Hill  
Continuing Education Center  
3939 Wisconsin Ave.  
Washington, D.C. 20016

OCTOBER 1985

**Vidicraft CCU-120  
Commercial Cutter  
and Event Timer**



CIRCLE 111 ON FREE INFORMATION CARD

Now you can automatically  
edit commercials out of  
your VCR recordings!

DID YOU EVER WISH THAT THERE WAS some way to edit commercials out of what you tape? Of course if you are watching what you tape, you can always manually stop and start your VCR. However, if you're watching something else, or if you're away and letting your timer do the work, then you get the commercials along with the program material. But not if you use the CCU-120 commercial cutter and event timer from Vidicraft (0704 S.W. Bancroft St. Portland, Oregon 97201).

The CCU-120 receives video and audio signals from your VCR and analyzes them so that it can identify commercials. When it spots what it thinks is a commercial, it does not stop your recorder. Instead, it waits until the commercial ends, rewinds the tape to where the beginning of the commercial and then resumes recording. That way, you don't lose any material if the commercial cutter decides that what it thought was a commercial turns out not to be.

Determining what is a commercial and what is programming material can be difficult, because the TV signal looks the same for each. To make its determination, the CCU-120 looks for fades to black, audio fades, time between fades, scene changes, etc. Unfortunately, it is possible for the CCU-120 to mistake commercials for program segments, and to mistake program segments for commercials. (Devising a commercial "detection" scheme that works 100% of the time is by far the most difficult part of designing an effective commercial cutter. To date, no manufacturer has come up with a foolproof scheme.)

For example, if you try to delete the commercials from a news broadcast, you might be disappointed by the results. That's because news programs are typically made up of many segments, some of which will be deleted because they look like commercials to the CCU-120. Other programs with scene changes that look like commercials would be affected similarly. But a built-in "safety" feature limits program loss in those cases to two minutes.

It's also possible that the CCU-120 won't recognize a com-

# Self-serve servicing

The more time you spend having your computer serviced, the less time you have to use it. And that costs you money.

With a basic knowledge of electronics and the help of Sams service data, you can service your computer yourself.

For in-depth computer analysis and repair, choose Sams COMPUTERFACTS™. They're similar to Sams PHOTOFACT® television service data and provide detailed schematics and parts data for even your most intricate computer repairs.

For simple computer maintenance and troubleshooting, use Sams Troubleshooting & Repair Guides. They provide a "problem-solution" approach to servicing with flowcharts explaining each procedure step-by-step.

Together they make computer servicing quick and easy. And that saves you money.

Help yourself to Sams service data, available at Sams dealers everywhere. Or to order direct, call our toll-free number.

Commodore™ 64 Troubleshooting & Repair Guide, No. 22363, \$18.95

IBM® PC Troubleshooting & Repair Guide, No. 22358, \$18.95

Apple® II Plus/IIe Troubleshooting & Repair Guide, No. 22353, \$19.95

Commodore 1541 Disk Drive Troubleshooting & Repair Guide, No. 22470, \$19.95

Over 30 COMPUTERFACTS available for Apple, ATARI®, Commodore, Epson®, Hitachi® IBM, Osborne®, Panasonic®, Rana Elite, Sanyo®, Texas Instruments and Zenith®. Ask your Sams dealer for details.

**800-428-SAMS**

Ask for Operator 167.

In Indiana, call 317-298-5566

**SAMS**

Howard W. Sams & Co., Inc.  
A Subsidiary of Macmillan, Inc.

4300 West 62nd Street  
Indianapolis, IN 46268



CIRCLE 251 ON FREE INFORMATION CARD



Now electronics technicians can get into VCR Servicing quickly and easily

# Learn professional VCR servicing at home or in your shop with exclusive videotaped demonstrations

Today, there are more than 10 million VCRs in use, with people standing in line to have them serviced. You can bring this profitable business into your shop with NRI professional training in VCR servicing. This top-level training supports the industry's claim that the best technicians today are those who service VCRs.

## Integrated Three-Way Self-Teaching Program

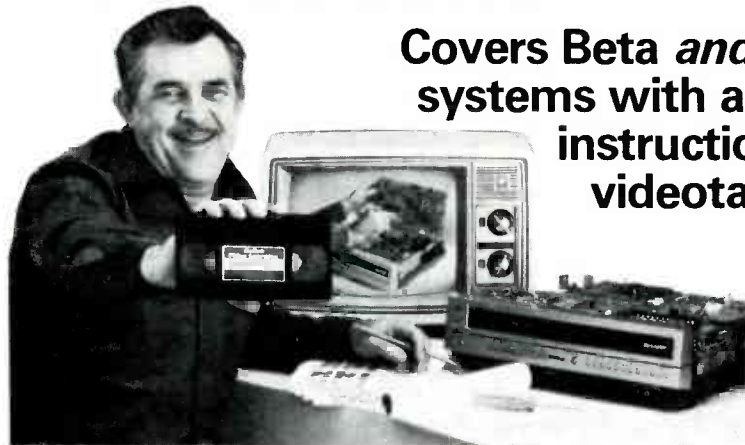
In one integrated program, NRI gives you a study guide, 9 instructional units, 2 hours of video training tapes accompanied by a 32-page workbook that pulls it all together. At home or in your shop, you'll cover all the basic concepts of video recording, mechanical and electronic systems analyses, and the latest troubleshooting techniques. Your workbook and instructional units also contain an abundance of diagrams, data, and supplementary material that makes them valuable additions to your servicing library.

## The "How-To" Videotape

Your NRI Action Videocassette uses every modern communications technique to make learning fast and easy. You'll enjoy expert lectures and see animation and video graphics that make every point crystal-clear. You'll follow the camera eye into the heart of the VCR as step-by-step servicing techniques are shown. Both electronic and mechanical troubleshooting are covered . . . including everything from complete replacement and adjustment of the recording heads to diagnosing micro-processor control faults.

## Plus Training On All The New Video Systems

Although your course concentrates on VCRs covering Beta, VHS, and 3/4" U-Matic commercial VCRs, NRI also brings you up to speed in other key areas. You'll get training in capacitance and optical video disc players, projection TV, and video cameras. All are included to make you the complete video technician. There's even an optional final examination for NRI's VCR Professional Certificate.



Covers Beta and VHS systems with actual instruction on videotape.

## The Best Professional Training

This exclusive self-study course has been developed by the professionals at NRI. NRI has trained more television technicians than any other electronics school! In fact, NRI has consistently led the way in developing troubleshooting techniques for servicing virtually every piece of home entertainment equipment as it appears in the marketplace.

## Satisfaction Guaranteed . . . 15-Day No-Risk Examination

Send today for the new NRI Self-Study Course in VCR Servicing for

Professionals. Examine it for 15 full days, look over the lessons, sample the videotape. If you're not fully satisfied that this is the kind of training you and your people need to get into the profitable VCR servicing business, return it for a prompt and full refund, including postage. Act now, and start adding new business to your business.

## Special Introductory Offer

This complete VCR training course with two hour videotape is being offered for a limited time only, on orders received from this ad, at our low introductory price of \$179.95. Save \$20 by acting now!

NRI Training For Professionals  
McGraw-Hill Continuing Education Center  
3939 Wisconsin Avenue Washington, DC 20016

**YES!** Get me started in profitable VCR servicing. Rush me my NRI self-study course in VCR Servicing for Professionals. I understand I may return it for a full refund within 15 days if not completely satisfied.

PLEASE SPECIFY TAPE FORMAT DESIRED  VHS  BETA

Name (please print) \_\_\_\_\_

Company \_\_\_\_\_

Street \_\_\_\_\_

City/State/Zip \_\_\_\_\_

Enclosed is my  check  money order for \$179.95 (D.C. residents add 6% tax) Make check payable to NRI

Charge to  VISA  MasterCard \_\_\_\_\_

Interbank Number \_\_\_\_\_

Card Number \_\_\_\_\_ Expiration Date \_\_\_\_\_

Signature \_\_\_\_\_

(required for credit card sales)



NRI Training For Professionals  
McGraw-Hill Continuing  
Education Center  
3939 Wisconsin Avenue  
Washington, DC 20016

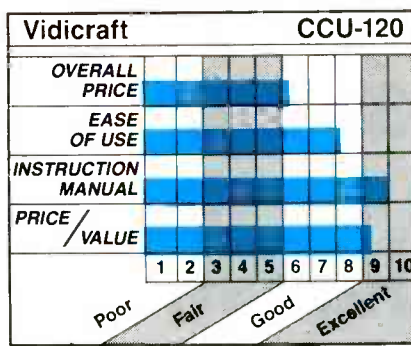
2600-105

mercial, depending on how the transition from program material is made. In general, the commercial cutter works well with network broadcasts, which are usually well produced. However, sloppy transitions, which occur from time to time in local broadcasts, will give the commercial cutter trouble.

As we mentioned previously, the *CCU-120* positively identifies a commercial only after it's completed. That helps to avoid cutting out large segments of program material. The disadvantage of that method is that while your VCR is rewinding the tape to where the commercial began, you can miss some program material. The length of rewind time can run from about 8 to 18 seconds, depending on the VCR used.

### Controlling your VCR

The *CCU-120* uses an infrared emitter to control the VCR functions. The emitter is attached in front of your VCR's IR sensor using a self-adhesive Velcro fastener. Since different VCR's need to see



different kinds of signals from a remote controller, the *CCU-120* must be set up to work with that particular VCR. If your wireless remote can access the RECORD, BACK-SCAN, PLAY, PAUSE, and STOP functions of your VCR, then it is likely that there is a version of the commercial cutter made for it. For example, the unit we had could be used with several VCR models from Sony, Panasonic, RCA, Magnavox, G-E, Hitachi, Canon, and Quasar.

Besides being a commercial cutter, the *CCU-120* is a 15-event, 9-week timer. The timer is easy to

use, and is more versatile than most VCR timers. For example, it has daily, weekly, and weekday event options.

As you might have guessed, the commercial cutter is micro-processor controlled. Two Z80's are used; one runs the cutter routines, real-time clock, and handles the user interfaces, and the other takes care of the infrared interface with your VCR. The software for the two Z80's is held in four 2732 EPROM's. If you buy a new VCR model, Vidicraft can change the appropriate EPROM's for a small fee.

If you dislike commercials so much that you don't mind losing a bit of program material here and there, then the *CCU-120* is for you. Even if you don't want to cut commercials from everything you tape, you'll still like the *CCU-120*'s timer—it's one of the best we've seen. You might even be tempted to buy a VCR with fewer timer features; the money you'd save would help take the bite out of the *CCU-120*'s \$470 list price. R-E

## QUALITY COMPONENTS - NOT MAIL ORDER "SECONDS"

Send \$1.00 postage and handling for FREE COMPLETE CATALOG which includes coupon for \$1.00 OFF purchase.

### ARIES ZERO INSERTION FORCE SOCKETS

cam actuated, true zero insertion - tin plated solder tail pins - capable of being plugged into dip sockets, including wire wrap.

Stock No.	No. of Pins	1-9	10-49	50
11055	24	4.98	\$4.35	\$3.90
11056	28	5.15	4.50	4.05
11057	40	6.81	5.95	5.35
11058	64	12.02	10.50	9.45

### IC COOLERS\* from UNITRACK™ dissipate over 2 watts of heat from IC's producing longer life and better performance.

Just push IC cooler on - heat is collected from top and bottom of IC and dissipated. Won't shake loose!

Stock No.	No. Pins	Price
22225	14	\$ .29
22226	16	\$ .29

**WILD ROVER**  
Touch switch capsule. Operating motion is .005" without the use of a levered arm. Extremely fast on and off with low noise. Normally operated 115 VAC. 16 amp 30 million resistance. .615 radius by .160 thick.

Stock No.	1-9	10 & Up
12098	\$1.42	\$1.28

### SCREW MACHINED SOCKET PINS, loose, packaged in bags of 100. Stock No. 11310 is solder tail with gold collet tin shell. Stock No. 11311 is wire wrap with gold collet tin gold shell.

Stock No.	Description	1 Bag	5 Bags	10 Bags
11310	Bag of 100 solder tail pins	\$ 4.95	\$ 4.45	\$ 3.95
11311	Bag of 100 wire wrap pins	11.95	10.75	9.50

**3 X 4 Elastomeric Keyboards**  
Each keyboard has a p.c. board, elastomeric pad with contacts. ABS bodies and double shot molded keys. Max rating: 12 VDC @ 20mA. Contact Res. less than Stock Operating Force. Key Travel. Price 100 ohms Bounce: less 11291 120x40g 2.0x.5mm \$4.95 \$4.50 11292 80x40g 1.5x.5mm 3.95 3.80

### TI WIRE WRAP SOCKETS

Tin plated phosphor bronze contact - 3 wrap

Stock No.	No. Pins	1-99	100-499	500
11301	8	\$4.00	\$3.36	\$3.30
11302	14	.59	.54	.45
11303	16	.64	.58	.48
11304	18	.73	.66	.55
11305	20	.99	.90	.75
11306	22	1.12	1.02	.85
11307	24	1.25	1.14	.95
11308	28	1.52	1.38	1.15
11309	40	2.05	1.86	1.55

### TI LOW PROFILE SOCKETS

Tin plated copper alloy 688 contact pins with gas tight seal

Stock No.	No. Pins	1-24	25-99	100-999
11201	8	\$1.00	\$0.99	\$0.88
11202	14	.14	.13	.12
11203	16	.16	.15	.14
11204	18	.18	.17	.15
11205	20	.20	.18	.16
11206	22	.22	.20	.18
11207	24	.24	.22	.20
11208	28	.28	.26	.25
11209	40	.40	.37	.33

### SUB CUB I and SUB CUB II are high quality, complete LSI Counter Modules with LCD readout. Modules plug in p.c. board (Stock No. 51071).

Stock No.	Description	Price
51071	Complete function evaluation kit (Stock No. 51070) contains: p.c. board, 4.5V battery and variable frequency oscillator to supply train of count pulses. Stock No. 51070 has LATCH, RESET and TEST functions (3 buttons). P.C. board plugs for bread-board work.	7.50
51072	SUB-CUB I display counter module only	18.00
51073	SUB-CUB II display counter module only	24.00
51074	Panel Bezel Evaluation Kit for SUB-CUB II (does not include SUB-CUB II counter module)	12.00
51075	DATA SHEET	.25

### SINGLE ROW SOCKETS

Strip of 25 collet sockets/pins mount odd-center components easily. Gold plated contacts. Both styles breakable to any number of contact positions wanted.

Stock No.	1-99	100	500	1000
10850	\$1.09	\$0.90	\$0.82	\$0.72

### OPCOA Single Digit Displays - Common Cathode

Stock No.	Color	1	100
12082	Red	\$1.12	\$ .99
12085	Green	1.84	1.63
12087	Yellow	1.92	1.70
12089	Orange	2.08	1.84

### OPTEL LCD's with pins

Stock No.	Description	1	10
47005	3 1/2 dig. 5	\$ 5.95	\$ 5.50
47006	4 dig. 5	3.95	3.50
47007	4 dig. 7	11.90	11.00

### The Battery Just Wrap™ Tool

New battery powered tool wraps insulated wire around .025" square points without need for pre-cutting and pre-stripping. Complete with bit and 100 ft. 30 AWG wire.

Stock No.	Description	Price
13340	Battery just wrap tool with bit	\$59.95
13341	Replacement bit	10.35
13342	100 ft. blue replacement wire	7.54
13343	100 ft. white replacement wire	7.54
13344	100 ft. yellow replacement wire	7.54
13345	100 ft. red replacement wire	7.54

### MICRO Charts - colorful 8 1/2" x 11" charts eliminate the need to stumble through manuals and summaries. Fully decoded, instant access - totally comprehensive - gives pin-outs, cycle times, buy notes, etc.

Stock No.	Reference	Price
23010	Z80 CPU	\$5.95
23011	8080A/8085A	5.95
23012	6502 (65XX)	5.95
23013	8088 and relatives	5.95
23014	5417600 TTL Products	5.95
23015	Basic Algorithms	5.95
23016	8086/8088	5.95
23017	How to generalize from a sample	5.95
23018	Wordstar	5.95

### PIN FORMING TOOL puts IC's on their true row to row spacing. One side is for 300 centers. Flip tool over for devices 600 centers. Put device in tool and squeeze.

Hand Tool 11059 \$12.95  
NEW! ANTI-STATIC MODEL 10200 \$14.95

### Scotchflex® Breadboard Systems Basic kit comes with 24 various Dual Sockets, 40 various Plug Strips, wire and tools. Kit can be used with any of the six boards.

Stock No.	Description	Price
03500	Basic Kit	\$79.95
03511	Basic board, 4.5 x 5.5	19.50
03506	Intel 58C-80 10 Board, 12 x 6.75	84.95
03507	Motorola M-6800 Board, 9.75 x 6	42.95
03508	S-100 Board, 10 x 5.3	36.95
03509	Z-80 Board, 7.7 x 7.5	39.95
03510	Eurocard Board, 6.3 x 3.9	21.95

**SINTEC CO.** 28 8th St., Box 410 Frenchtown, NJ 08825 **TOLL 800-526-5960** FREE in NJ (201) 996-4093



We accept VISA, MC, C.O.D., CHECK, or M.O. INCLUDE SHIPPING CHARGES - 0 to \$100 - \$3.00 \$100 to \$250 - \$4.00 over \$250 - \$5.00

CIRCLE 73 ON FREE INFORMATION CARD

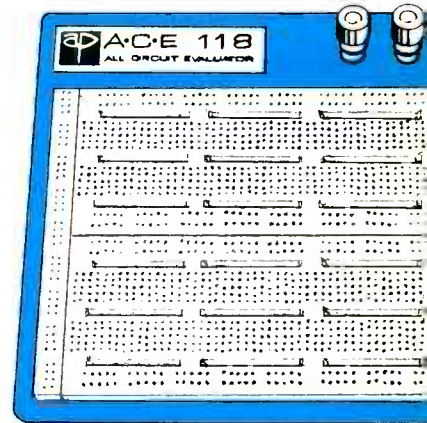
www.americanradiohistory.com



# Build Circuits Faster and Easier With Our \$20 Solderless Breadboard



...and do even more with our \$40 breadboard



Introducing the plug-in world of AP Product's versatile, low cost breadboards.

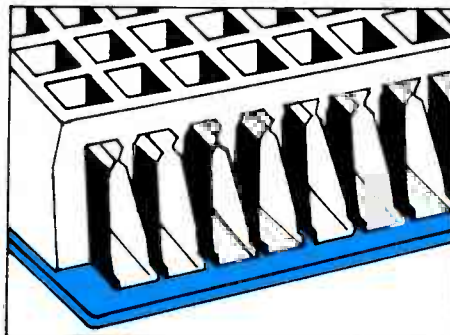
Now you can design, build and test prototype circuits just like the professionals...and make changes in seconds. No messy soldering or desoldering. No more twisted leads or damaged devices.

With our ACE 109 and 118 blue breadboards, you simply plug in components and interconnect them with ordinary hook-up wire. All sizes of DIPs and other discrete components up to 22 gauge lead diameters snap right into the 0.1" x 0.1" matrix of the solderless tie points...anywhere on the layout. You don't need expensive sockets or special tools. Buses of spring clip terminals form a distribution network for power, ground and clock lines.

AP Products 100 series breadboards give you all the functions and flexibility of more expensive circuit evaluators. The spring terminals have mechanically independent contact fingers to

accommodate most DIPs and discrete components.

The ACE 109 has two terminals for separate voltages plus a ground connection. The larger ACE 118 offers the same three terminals, plus an additional terminal which can be used for clocking or another voltage. The backplates are heavy steel to keep the boards stationary.



Don't wait. These low prices won't last forever. See your local AP Products dealer today, or send for a list of dealers in your area.



A P PRODUCTS INCORPORATED

9325 Progress Parkway  
P.O. Box 540  
Mentor, Ohio 44060  
800-321-9668  
(Ohio, 216/354-2101)

CIRCLE 76 ON FREE INFORMATION CARD

[www.americanradiohistory.com](http://www.americanradiohistory.com)

Yes! I'm ready for breadboarding! Send:  
 Names of dealers  More information  
 Name: \_\_\_\_\_  
 Address: \_\_\_\_\_  
 City: \_\_\_\_\_ State: \_\_\_\_\_  
 Zip: \_\_\_\_\_

# NEW IDEAS

## A versatile, low-cost logic probe

THE LOW-COST LOGIC PROBE PRESENTED here is a must for anyone who experiments with digital circuits and whose budget can't tolerate a \$35.00 logic probe in a fancy case. This circuit uses popular components, provides utility that rivals that of commercial units and, best of all, costs as little as \$6.00 to build. The complete circuit is shown in Fig. 1-a.

### How it works

Diode D1 is included for protection against reversed-polarity inputs. A logic-low input causes LED1 to light, and a logic-high input causes LED2 to light. The 555 acts as a pulse catcher; when PULSE switch S2 is open, LED3 lights up for about one second each time a pulse is detected. Resistor R4 and capacitor C2 determine the "on" time of LED3. To change that time, figure that for each 10  $\mu$ F of capacitance, the LED will light for about 1 second. The

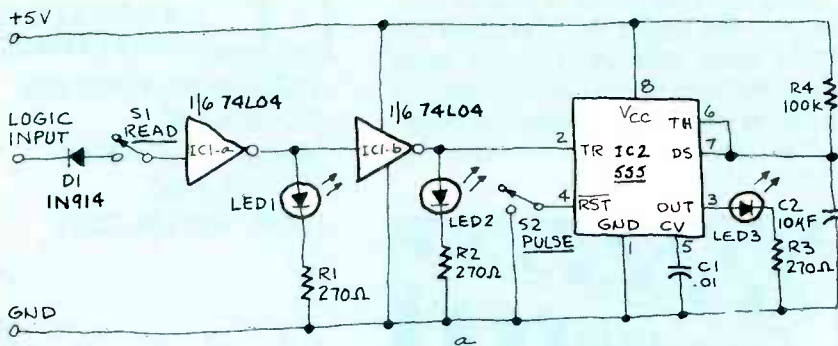
table shown in Fig. 1-b gives "on" times for several values of C2. Just remember that you don't want LED3 to stay on too long, or you might miss pulses.

Construction is not critical. If you wish you can wire the circuit on a piece of perfboard using either point-to-point or wire-wrap techniques.

You may want to use different colored LED's for LED1, LED2, and LED3—say green, red, and yellow. The green LED will indicate a logic low, the red LED a logic high, and the yellow LED a pulse. If you don't have a 74L04 handy, you can use a 74L00 as an inverter by tying both inputs from one gate together, as shown in Fig. 1-c.

### How to use it

Connect the +5-VOLT and GROUND terminals to the corresponding points in the circuit under test. Then attach the LOGIC INPUT terminal to the point you



C2	TIME
1μF	0.1 SECOND
10μF	1 SECOND
22μF	2 SECONDS
47μF	5 SECONDS

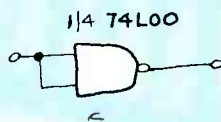


FIG. 1

### NEW IDEAS

This column is devoted to new ideas, circuits, device applications, construction techniques, helpful hints, etc.

All published entries, upon publication, will earn \$25. In addition, for U.S. residents only, Panavise will donate their model 333—The Rapid Assembly Circuit Board Holder, having a retail price of \$39.95. It features an eight-position rotating adjustment, indexing at 45-degree increments, and six positive lock positions in the vertical plane, giving you a full ten-inch height adjustment for comfortable working.

I agree to the above terms, and grant **Radio-Electronics** Magazine the right to publish my idea and to subsequently republish my idea in collections or compilations of reprints of similar articles. I declare that the attached idea is my own original material and that its publication does not violate any other copyright. I also declare that this material has not been previously published.

Title of Idea

Signature

Print Name

Date

Street

City

State

Zip

Mail your idea along with this coupon to: **New Ideas Radio-Electronics, 200 Park Ave. South, New York, NY 10003**

wish to monitor via a probe (such as a spare VOM probe) and close READ switch S1. Either LED1 or LED2 will light to indicate the state of that point. Switch S2, PULSE, should be open to use the pulse-catcher; closing it sends the 555 into a reset state, which forces the output low and turns off LED3.

The circuit was designed to work with TTL signals. It will probably work with CMOS, but it may load the circuit under test. Also, the 74L04 will only work with a 5-volt circuit. —Stan Stepnowski III



Electricity and water don't mix. At least not in our Heavy Duty Digital Multimeters. Because these Oops Proof™ instruments are protected by a system of seals to ensure contamination-free dependability in even the cruddiest conditions.

Other abuse-proof features include the best mechanical protection ever built into a precision Digital Multimeter. In fact, every one of our Oops Proof multimeters will survive a drop from ten feet onto a concrete surface!

All the Heavy Duty series meters measure up to 1000 volts AC and 1500 volts DC, with full overload protection to those maximum voltages even on the lowest range settings. Overload circuitry also provides transient protection to 6KV on all voltage ranges and up to 600 volts on all resistance ranges.

We also invented a unique, long-life rotary switch for our Digital Multimeters. You can actually feel the difference just by

rotating the function selector knob.

You'll find these features in a full line of Heavy Duty DMMs that offer a 4½ digit readout, 0.05% VDC accuracy, a 10-amp current range, a 2000-hour battery life, diode test, true RMS and temperature measurement. All this and a no-questions, one-year warranty.

You'll want to try one out, of course, so drop into your nearest electronics distributor and drop one.

***Our lips are sealed.***



CIRCLE 98 ON FREE INFORMATION CARD

© 1984 Beckman Industrial Corporation, A Subsidiary of Emerson Electric Company,  
630 Puente Street, Brea, CA 92621 (714) 773-8111.

**Beckman Industrial™**

## QUALITY SPECIALS

### INSTANT COLOR HARD COPY

KODAK INSTAGRAMIC  
CRT Print Imager

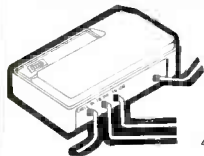
Everything you need to begin  
taking pictures immediately ...

Allows use of either the color instamatic  
camera (included) or your own 35mm  
camera (adapter included).  
Please specify the size of your CRT  
screen: 9, 12, or 13 inch when ordering.



COMPLETE SYSTEM \$339.00

### DELUXE 46 CHANNEL CABLE TV CONVERTER

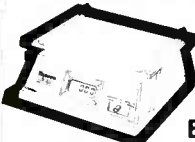


With Fine Tuning Dial

- Shifts all cable channels to UHF
- Extends pay TV to all your TV sets without extra monthly fee
- Allows taping pay TV (decoder required) while viewing another channel
- Restores TV remote control and VCR programming ability

4 FOR \$19.95 ea \$24.95

### NEW DIGITAL SCALE



Lab accuracy at an  
everyday price  
...reads 1 gram or .1 oz.

Gives fast exact weight in ounces or grams  
for the lab, dining, postage, photography.  
Capacity: 1999 grams/70 ozs. with  
automatic tare. Free postage & diet chart

Best Value \$74.95

### EXTRA STATIONS FROM YOUR STEREO

The revolutionary PARSEC 7403 is equipped with a very powerful  
signal amplifier (0-24dB adjustable gain). Normally hidden weak  
signals are captured, amplified and carried to the tuner by the  
extremely sensitive unit, resulting in not only an increase in the  
number of available FM stations but also an audible reception  
improvement in these and all other existing stations.

\$74.95

**GOLDSMITH  
SCIENTIFIC  
CORPORATION**

720 E. Industrial Park Dr., Manchester, NH 03103

PHONE ORDERS WELCOME (603) 624-8030

FREE CATALOG OF NEW DEVICES

POSTAGE—ADD 5% PLUS \$1.50 INSURANCE. C.O.D. \$2.00 EXTRA

SATISFACTION FULLY GUARANTEED

CIRCLE 265 ON FREE INFORMATION CARD

## TUBES and IC's FAST DELIVERY

## LOWEST PRICES

call Toll Free (800) 221-5802

In-depth Inventory - Industrial & Receiving Tubes

Here are 2 dozen examples

3-400Z	\$85.00	8122	\$110.00
3-500Z	85.00	MRF450	12.95
572B	55.00	MRF454	18.95
811A	12.00	MRF455	14.95
6146B	8.75	MRF492	19.95
M2057	15.00	6LF6	8.26
8950	11.50	6JS6C	7.46
807	5.75	6KD6	8.26
6550A	7.75	6MJ6	8.38
4CX250B	60.00	8417	8.38
6DJ8	2.75	7360	13.95
6883B	8.25	6CA7	5.55

Major Manufacturers Factory Boxed and Full Line of  
Sylvania ECG Replacement Semiconductors



Minimum order \$25.00

Allow \$3 UPS charge

**TRANSLETORIC INC.**



Box R, 1365 39th Street, Brooklyn, NY 11218

Tel. 718-633-2800/Watts Line 800-221-5802

FAX # (718) 633-4375

# NEW PRODUCTS



CIRCLE 21 ON FREE INFORMATION CARD

**VIDEO SYSTEM**, the *Canovision 8*, is a lightweight, three-piece 8mm home video system. The components include a three-pound, five-ounce model *VC-200A* color video camera; a four-pound, one-ounce model *VR-E10* four-head 8mm videotape recorder; and a model *VT-E10* four-program 14-day tuner/timer. The recorder and the camera can be used with other Canon video cameras and recorders.

The model *VC-200A* is a full-function video camera with an *f/1.2* lens with 8.5–51mm (6X) two-speed power zoom control and macro feature for focusing as close as  $\frac{3}{16}$ ". The picture tube gives better than 270 lines horizontal resolution. Low-light performance is 20 lux, exposure is completely automatic, and there is a backlight control. The model *VC-200A* has a suggested price of \$1,000.00.

The model *VR-E10* recorder can record up to 90 minutes with Canon P6-90 tape. When it is used with a battery, the recording time is either 85 or 45 minutes, depending on the battery type. Four video heads ensure flicker-free freeze-frame operation, and an FM audio system provide a high signal-to-noise ratio and 30–14,000Hz frequency response. The model *VR-E10* has a suggested price of \$900.00.

The model *VT-E10* tuner/timer has a 105-channel potential, with pushbuttons for selecting any 14 channels. It can be programmed to record up to four different programs on the same or different channels over a 14-day period. The model *VT-E10* has a suggested price of \$300.00.—**Canon USA, Inc.**, One Canon Plaza, Lake Success, NY 11042.

**DOWNCONVERSION RECEIVERS**, model *UST 5000*, model *UST 6000*, and model *UST 7000* (shown), use advanced block-downconversion technology to provide more stable satellite-TV picture reception and to allow several users, under one roof, to access various TV programs independently from one common dish.

The model *UST 5000* incorporates a touch-control front panel with LED channel display, adjustable audio, channel up and down, fine-tuning skew adjustment, polarity control, and vertical and horizontal polarity indicators. The unit's slow-and-fast scan features allow users to peruse the variety of programming available when mov-

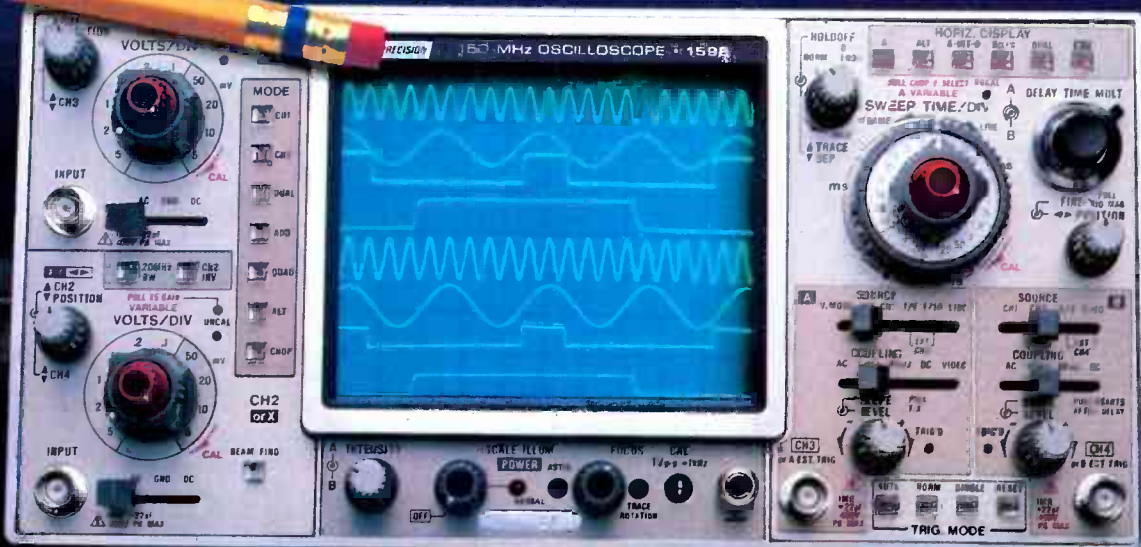


# Quick... who makes the scopes that out-tech the competition?

NEW  
50MHz  
1596  
\$2095

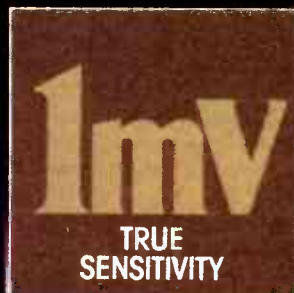
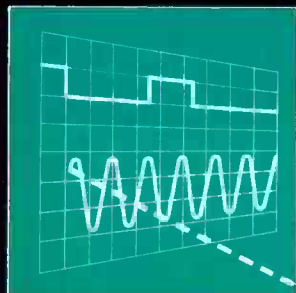
NEW  
100MHz  
1590A  
\$1795

80MHz  
1570A  
\$1395

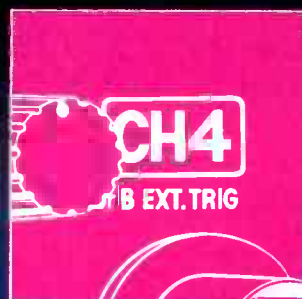


Now... up to 150 MHz  
Compare these features and performance specifications.

Bright 20kV display  
(12kV on 1570A)  
with illuminated  
graticule.



Dual  
independent  
timebase\*



Four vertical inputs  
with 8-trace display

- $\pm 2\%$  VERTICAL AND HORIZONTAL ACCURACY
- V-MODE DISPLAYS FOUR UNRELATED SIGNALS
- SOFT-TOUCH, LIT CONTROLS
- 500  $\mu$ V CASCADE SENSITIVITY
- CHANNEL 1 BUFFERED OUTPUT

Five times more  
sensitive than  
most competitors.

Compare all of the features and performance benefits  
with any scopes in their price range. See your local  
stocking distributor or contact B&K-PRECISION.

\*Not on 1570A

**B&K PRECISION** DYNASCAN CORPORATION

6460 West Cortland Street • Chicago, Illinois 60635 • 312 889-9087

International Sales, 6460 W. Cortland St., Chicago, IL 60635

Canadian Sales, Atlas Electronics, Ontario

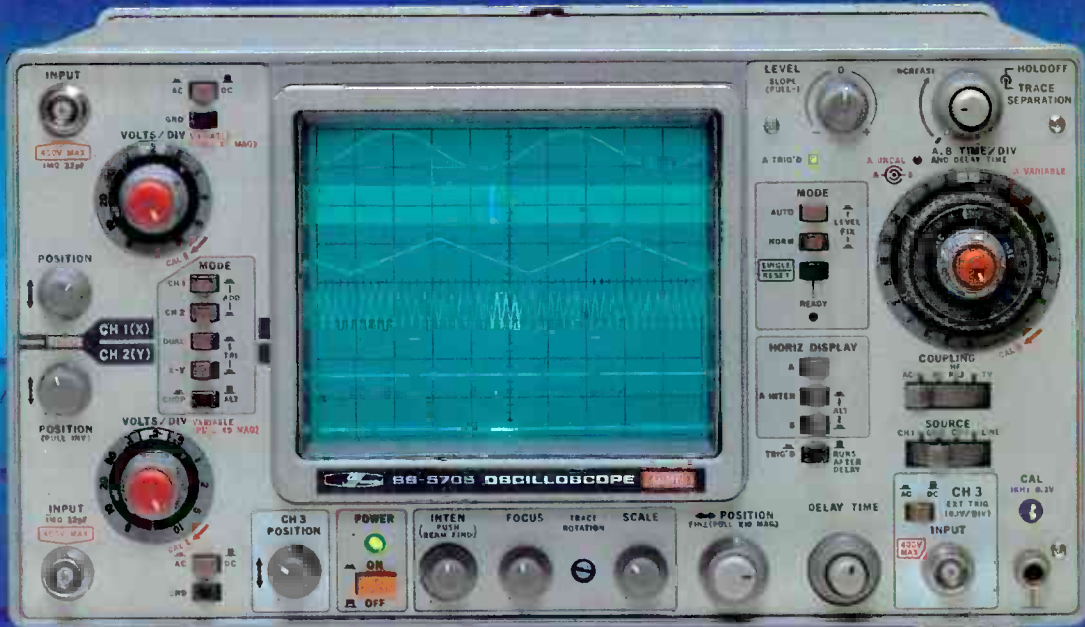
South and Central American Sales, Empire Exporters, Plainview, NY 11803

CIRCLE 77 ON FREE INFORMATION CARD

www.americanradiohistory.com



# SS-5705, THE ALL-NEW 3-INPUT 6-TRACE 40 MHz OSCILLOSCOPE FROM IWATSU

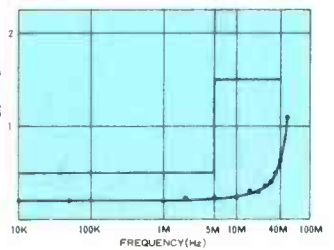
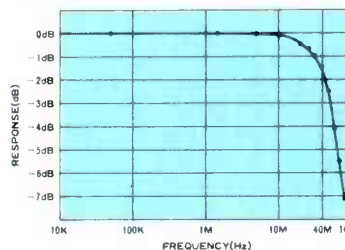


**DC to 40 MHz**

SS-5705 40MHz \$899.00  
SS-5706 30MHz \$749.00

- H and V axes accurate to within  $\pm 2\%$
- CRT with 12 kV accelerating voltage for bright traces
- Three input channels, six traces: an enlarged delayed sweep waveform can be displayed for each channel for a total of 6 simultaneous traces. Each channel has its own position control.
- Maximum delay jitter of 1/20,000
- Fastest sweep rate of 10 ns/div
- Jitterless circuitry for stable high frequency signals observation.
- High sensitivity: 1 mV/div
- CH 1 signal output: 50 mV/div (into 50  $\Omega$ )
- High-stability calibrator with frequency and voltage accurate to within  $\pm 1\%$ .
- Stable observation of video signals possible
- Traces do not shift when the attenuator is switched
- Pushbutton controls for easier operability and improved reliability.
- Accuracy guaranteed in temperatures ranging from 10 to 35°C (50 to 95°F).
- Variable holdoff for triggering when observing complicated waveforms.
- FIX triggering
- Beam finder

- Frequency response extends beyond 40 MHz rating
- Superb trigger sensitivity freezes even low level signals.



- Single sweep: essential if waveforms are to be photographed.
- Trace rotation control allows compensation for inclination of traces due to terrestrial magnetism.
- Two probes provided as standard accessories: both switchable between 10:1 and 1:1.
- Wide range of optional extras for more diverse applications.
- Compact and lightweight: 282W x 152H x 403D mm (11-1/8" x 6" x 15-7/8"), 7.2 kg (15.9 lbs).



**IWATSU INSTRUMENTS INC.**

430 Commerce Boulevard, Carlstadt, NJ 07072 Phone: (201) 935-5220 TLX: 7109890255

CIRCLE 64 ON FREE INFORMATION CARD



ing from one channel to another or one satellite to another. It is priced at \$349.00.

The model *UST 6000* adds several features to the model *UST 5000*. An Infrared handheld remote control offers users the convenience of moving from one channel to another at the touch of a button. Polarity and power controls are also included in the handheld unit. The receiver is highlighted by expanded audio controls, and the *VST 6000* can handle stereo (matrix and discrete formats) as well as mono. The *UST 6000* is priced at \$599.00.



CIRCLE 22 ON FREE INFORMATION CARD

The model *UST 7000* adds more features to the model *UST 6000*. The handheld infrared remote unit has a built-in programmable dish control that accommodates up to 81 different satellite positions. The programming controls include pre-programmed polarity. The unit is also equipped with expanded audio capabilities that include both narrow and wide audio formats and Dynamic Noise Reduction (DNR). Two LED displays provide readouts, that indicate which audio frequency is currently being received. Also included is an LED satellite position and clock indicator, along with an LED level indicator that illustrates (by the number of lights illuminated) the strength of the incoming satellite signal. The *UST 7000* is priced at \$999.00.—Uniden, 15161 Triton Lane, Huntington Beach, CA 92649.

**OSCILLOSCOPE**, model *9060*, features three DC to 60 MHz vertical amplifiers. Up to 1 mV/division sensitivity at 20-MHz bandwidth may be obtained with the  $\times 5$  magnifier switch on. The horizontal time base ranges from 0.5 sec./div. to 50 ns/div., and there is an  $\times 10$  magnifier switch to extend the range to 5 ns/div. A six-inch rectangular CRT provides brighter traces, and an internal illuminated



CIRCLE 23 ON FREE INFORMATION CARD

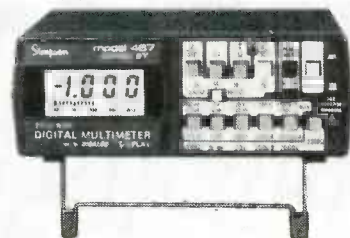
graticule that provides an easily-read, parallax-free display.

The model *9060* is priced at \$1,195.00.—Beckman Industrial Corporation, 630 Puente Street, Brea, CA 92621.

**DIGITAL MULTIMETER**, model *467-2T*, is specifically designed for telecommunications servicing. It is a 3½-digit instrument with direct-reading dB ranges. It also has a built-in 1004 Hz tone generator for line checking and signal tracing.

The model *467-2T* has Simpson's Digalog™ (digital and analog) LCD readout with pulse, continuity,

and low-battery indicators. The DMM has true RMS AC capability. 29 ranges are optimized for telecommunications testing: 200 mV to 1000 volts DC (5 ranges), 200 mV to 750 volts AC (5 ranges),  $-60$  to  $+20$  dB (3 ranges), 200 ohms to 20



CIRCLE 24 ON FREE INFORMATION CARD

megohms (6 ranges, 3 low power), 200  $\mu$ A to 2000 mA AC current (5 ranges), 200  $\mu$ A to 2000 mA DC current (5 ranges).

Other functions include audible/visual continuity indications, logic-level detection up to 35 volts, diode test, and differential peak hold. A single 9-volt battery provides up to 100 hours of continuous operation. The model *467-2T* is priced at \$350.00.—Simpson Electric Company, 853 Dundee Ave., Elgin, IL 60120. R-E

Does the price of a satellite earth station seem out of this world?

**Now, There's a Low-Cost, You-Can-Do-It Alternative . . .**  
**Build A Personal Earth Station For Worldwide Satellite TV Reception—2nd Edition**

Fed up with the limited viewing options offered by your local TV stations? Tired of paying increasingly higher cable TV rates—and getting less programming for your viewing buck? Now you can have an affordable, practical alternative—build it yourself with the help of this completely updated, revised, and expanded sourcebook on home satellite TV.

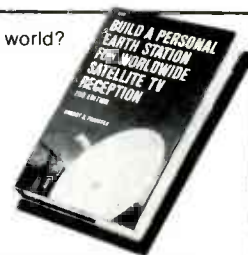
In it you'll find:

- a thorough, in-depth explanation of how satellite TV operates.
- an all-new, state-of-the-art look at the latest innovations in earth station components and equipment, including a listing of manufacturers and suppliers—even where to find surplus components!
- detailed step-by-step instructions on everything from selecting the best components . . . choosing your site . . . assembling your station . . . troubleshooting and eliminating interference . . . locating and tuning in on specific satellites . . . and more!
- Plus, innumerable tips and shortcuts designed to save you both time and money . . . and protect you from getting "ripped-off."

For Free Trial Copy, Mail This Ad Today to: TAB BOOKS Inc.  
 P.O. Box 40, Blue Ridge Summit, PA 17214.

Or Call Toll-Free 800-233-1128  
 (In PA, AK, or HI call direct 717-794-2191)

For absolute privacy when paying by VISA or MasterCard, use our toll-free number.



384 pages/250 illustrations  
 Book No. 1909H

- Send me *Build a Personal Earth Station for Worldwide Satellite TV Reception—2nd Edition*, (1909H) for a 15-day, no-risk examination. I will either keep it and send just \$21.95 (plus shipping and handling), or I'll return it within 15 days without obligation.
- Payment enclosed for this book (1909H), \$21.95. **Special Bonus Savings—TAB pays shipping and handling on all prepaid orders—a savings of nearly 5%!**

Name \_\_\_\_\_

Address \_\_\_\_\_

City/State/Zip \_\_\_\_\_

Foreign customers must pay in advance in U.S. currency and add \$2 per book for shipping and handling. PA residents add 6% sales tax. Orders subject to credit approval. Prices subject to change. RET-105

CIRCLE 254 ON FREE INFORMATION CARD

# TEST INSTRUMENTS

LOWEST PRICES  
OFF-THE-SHELF  
DIRECTLY TO YOU

CALL TOLL FREE  
FOR FAST DELIVERY

## 800-645-9518

In New York State 800-832-1446

### HITACHI 35 MHz DUAL TRACE OSCILLOSCOPE

Model V-355  
**\$599<sup>95</sup>**

(Reg. \$899.95)  
Probes included.



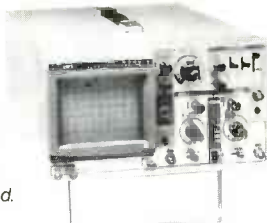
- Thin, lightweight, compact • Large 6" rectangular, internal graticule CRT
- Autofocus

**FREE!** LOGIC PROBE  
BP LP189  
(\$40.00 VALUE)  
with purchase of  
Model V-355

### A.W. SPERRY 20 MHz DUAL TRACE OSCILLOSCOPE

Model 620C  
**\$399<sup>95</sup>**

(Reg. \$449.95)  
Probes included.



- Built-in component checker • High sensitivity X-Y mode • Internal graticule CRT

### HITACHI 100 MHz QUAD TRACE DELAYED SWEEP OSCILLOSCOPE

Model V-1050F  
**\$1249<sup>95</sup>**

(Reg. \$1980)  
Probes included.

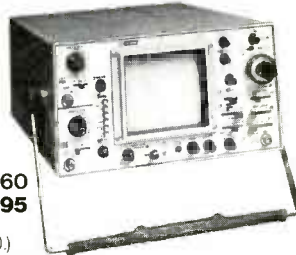


- Large 6" rectangular CRT w/internal graticule • Delayed alternate and single sweep functions • Autofocus

### B&K 60 MHz TRIPLE TRACE OSCILLOSCOPE

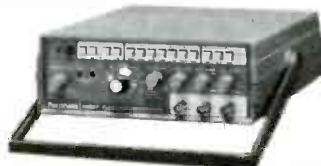
Model 1560  
**\$899<sup>95</sup>**

(Reg. \$1150)  
Probes included.



- 1 mV/div sensitivity • 22 calibrated sweeps • Rectangular CRT w/internal graticule & scale illumination
- Autofocus

### FORDHAM SWEEP FUNCTION GENERATOR



Model FG-801  
**\$199<sup>95</sup>**

(Reg. \$299.95)  
Test Leads included.

- 7 frequency ranges, 0.2Hz to 2MHz
- Accuracy to  $\pm 5\%$

**SPECIAL PRICE!**

### FORDHAM 550 MHz FREQUENCY COUNTER

Model FM-8  
**\$169<sup>95</sup>**

(Reg. \$249.95)



- Completely assembled, pre-tested, pre-calibrated • High intensity 8-digit LED display

### FLUKE 3 1/2 DIGIT MULTIMETERS & VOLTMETERS



Model 73 **\$69<sup>95</sup>**

- Resistance, AC/DC current/voltage
- 6 functions including diode test
- 0.7% DC accuracy • Current range to 10A, AC/DC

Model 75 **\$89<sup>95</sup>**

- All features of Model 73, plus • 7 functions including diode and continuity beeper • 3 current ranges - 10A, 320 mA, 32 mA • 0.5% DC accuracy

Model 77-F **\$119<sup>95</sup>**

- All features of Model 75, plus • "Touch-Hold" function • 0.3% DC accuracy

**ASK FOR OUR  
FREE CATALOG!**

PHONE ORDERS ACCEPTED



#### SERVICE & SHIPPING CHARGE SCHEDULE FOR ORDERS

	ADD
\$25-250	\$4.50
\$251-500	\$6.50
\$501-750	\$8.50
\$751-1,000	\$12.50
\$1,001 and up	\$15.00

# Fordham

260 Motor Parkway, Hauppauge, New York 11788





## Versatile Bench Power Supply

VAUGHN D. MARTIN

*No electronics workbench is complete without a variable power supply. If you're still missing that essential tool, here's a versatile six-output supply you'll want to build.*

A VARIABLE POWER SUPPLY IS AN ESSENTIAL part of any electronics workbench. If your workbench is lacking one, then this supply is for you! It's inexpensive, easy-to-build, and it's more than just a power supply: It includes two variable, precision voltage-reference outputs too!

The power supply provides three pairs of complementary voltage sources. Each output has built-in current limiting, and all share a common ground. While the supply is designed for low- to medium-current applications, we'll show you how to increase the current capability of the non-precision sources to 2 amps.

The first pair of voltage sources,  $+V_S$  and  $-V_S$ , are independently adjustable. Each has a 15-volt range of adjustment and can supply a current of 100 ma.

The second pair,  $+V_T$  and  $-V_T$ , is dual-tracking: The outputs, which are adjusted using a single control, are equal in magnitude and opposite in polarity. The adjustment range of the dual-tracking outputs is the same as for the independent supplies. The tracking sources can also supply 100 ma of current.

The third pair of outputs,  $+V_p$  and  $-V_p$ , is a set of precision voltage

sources, one positive and one negative with respect to ground. The output of each is set by a 10-turn potentiometer and turns-counting dial. Those supplies have a somewhat wider voltage range (25 volts each), but have very low current output (4 mA). They are intended, once calibrated, to be used as secondary calibration standards, not to supply operating current to working circuitry.

One of the special features of this power supply is that each pair of outputs is completely independent of the others, so you need only build the output pairs that you need. For example, if you don't need the precision source, simply omit all components associated with it. (Even if you omit one section, we recommend using the printed-circuit artwork provided; it will make it easy to add the section later.)

### Circuit operation

As you can see from Fig. 1, the power supply is made up of four main sections: The rectifier circuit is shown at the upper left of the diagram, the precision sources at the upper right, the dual-tracking supply at the lower left, and the independent supplies at the lower right.

### The rectifier circuit

The rectifier circuit supplies half-wave rectified DC to each section of the power supply. Note that the polarity of the diodes and capacitors for the positive supplies is opposite that of those for the negative supplies. The non-precision supplies are powered by the  $\pm 20$ -volt rectifier outputs, while the precision sources get their raw power from the  $\pm 40$ -volt rectifier outputs.

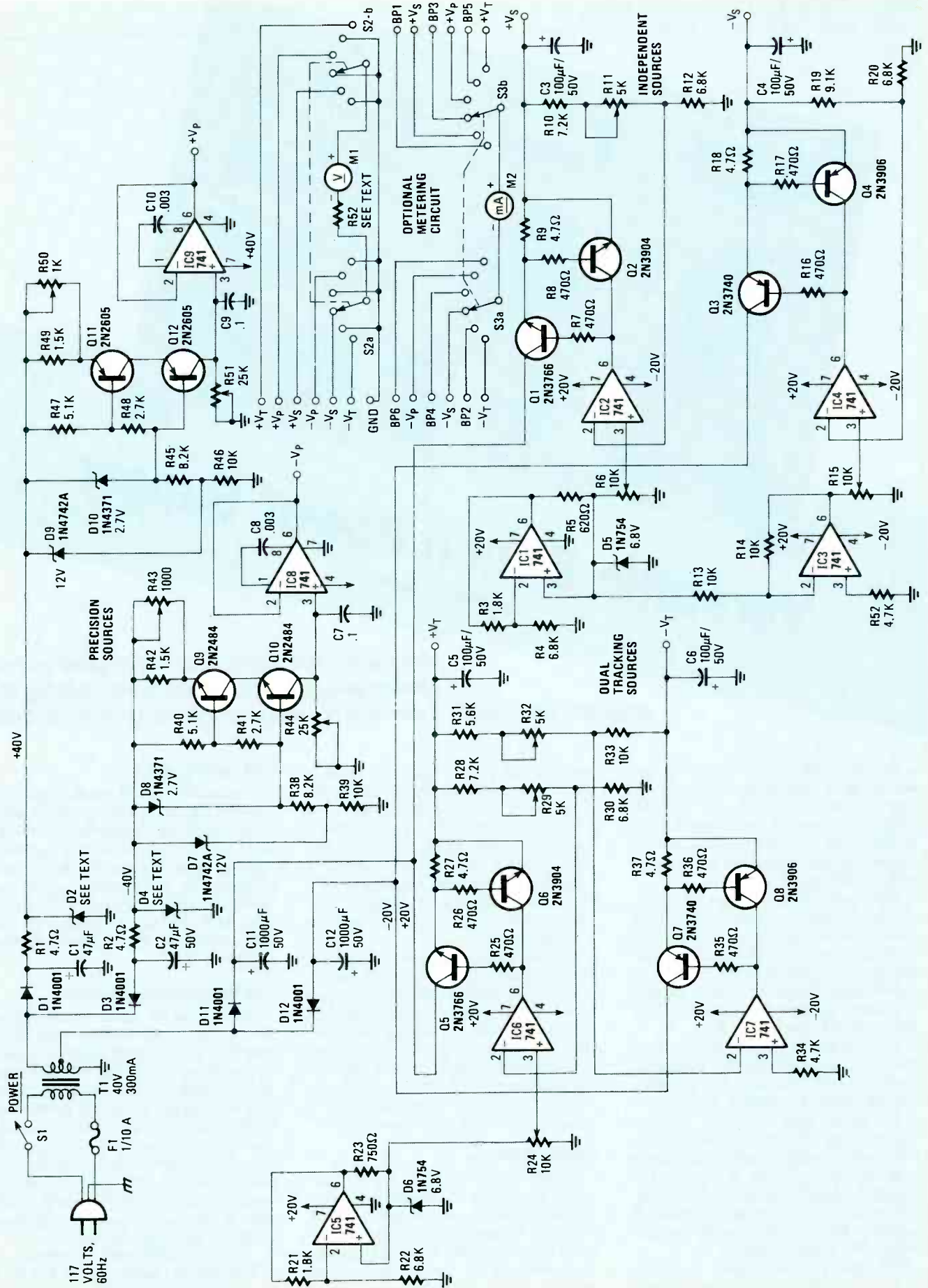
### The independent supplies

Zener diode D5 provides a 6.8-volt reference to the non-inverting input of op-amp IC1. The inverting input will also be at a potential of 6.8 volts due to normal op-amp feedback. The voltage developed by IC1 is dropped across 10K potentiometer R6, the front-panel  $+SUPPLY$  control that's used to adjust the  $+V_S$  output voltage. The output of R6, which may vary from 0.0 to 6.8 volts, is applied to the non-inverting input of op-amp IC2. The gain of the op-amp may be calculated using the following equation:

$$E_{OUT} = E_{IN}(R_{10} + R_{11} + R_{12})/R_{12}$$

With trimmer potentiometer R11 set at its midpoint, about 2.5K, the factor in

FIG. 1—THE SCHEMATIC shows that the power supply is made up of three independent pairs of voltage sources, a rectifier circuit, and a metering circuit.





parentheses comes out to about 2.42.  $E_{IN}$  is the reference voltage dropped across potentiometer R6. So the output voltage may vary, according to the position of R6, from  $0 \times 2.42 = 0$  volts to  $6.8 \times 2.42 = 16.5$  volts.

The op-amps provide current limiting, and series-pass transistor Q1 provides current amplification. Transistor Q2 senses the output voltage, and, as part of IC2's feedback loop, helps compensate for variations in load current.

The negative independent supply is composed of IC3, IC4 and associated circuitry. Its reference voltage is taken from D5, the same 6.8-volt Zener used in the positive-output circuit. Here, however, the reference is applied to the inverting input of IC3. Due to the ratio of R13 to R14, that op-amp has a gain of  $-1$ . Therefore IC3 has a  $-6.8$ -volt output that is applied to front-panel  $-SUPPLY$  control potentiometer R15. From that point on, the negative circuit operates just as the positive circuit does. The output voltage is determined by multiplying the input voltage by the factor  $(R19 + R20)/R20$ . Note that PNP series-pass transistors are used here, while NPN transistors are used in the positive supply.

### Dual-tracking supply

The dual-tracking supplies operate in a manner similar to that of the independent supplies. A 6.8-volt reference is derived from Zener diode D6 and applied to the non-inverting input of IC5, which functions just as IC1 does. Its output is dropped across front-panel  $\pm V_T$  potentiometer R24. The output of R24 is then applied to non-inverting amplifier IC6, which functions just as IC2 does. IC7 is slaved to the output of the positive portion of the circuit, and thereby provides the tracking action that produces an output equal in magnitude but opposite in polarity.

### Precision output supplies

Zener diode D9 establishes a 12-volt bias on the bases of a pair of complementary transistors, Q11 and Q12. That bias produces a constant 1-ma current through the collector circuits of the two transistors. The magnitude of that current may be adjusted by R50. The voltage developed across R51 by that current is fed to the non-inverting input of IC9, which is used as a voltage follower (an amplifier with a voltage gain of  $+1$ ). Here IC9 also provides current amplification. The op-amps used in this circuit can provide a maximum current of about 4 ma.

The non-inverting input of IC9 has an input impedance of at least 10 megohms, so very little of the 1-ma current generated by transistors Q1 and Q2 leaks through that point. Of course, 1 ma through 25K potentiometer R51 will provide a 25-volt drop. As more and more of the resistance

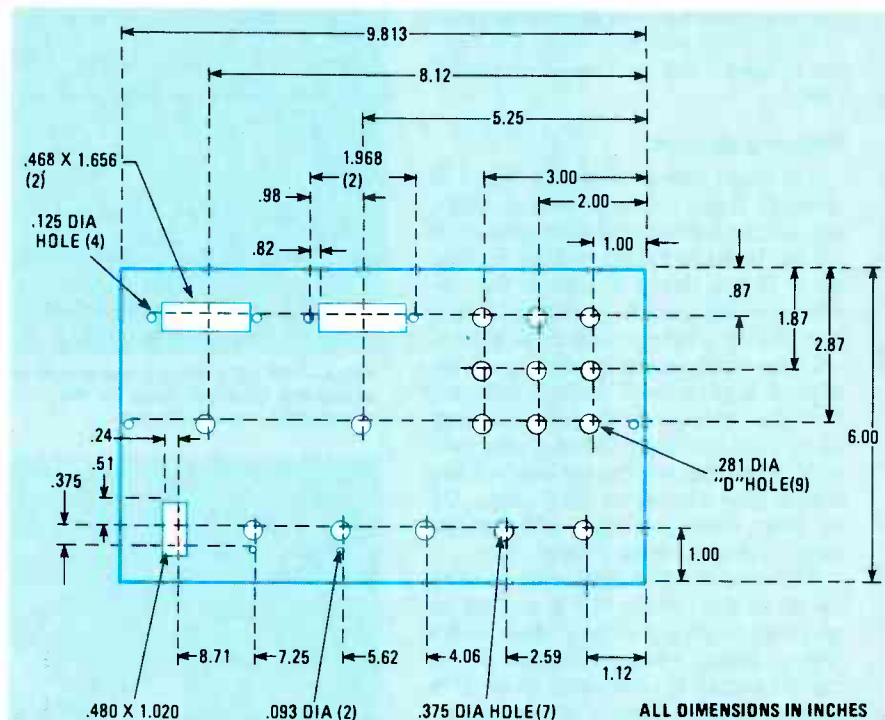


FIG. 2—FRONT-PANEL LAYOUT of the power supply. The hole-sizes for the ten-turn potentiometers and turn-counting dials you use may differ from those given here.

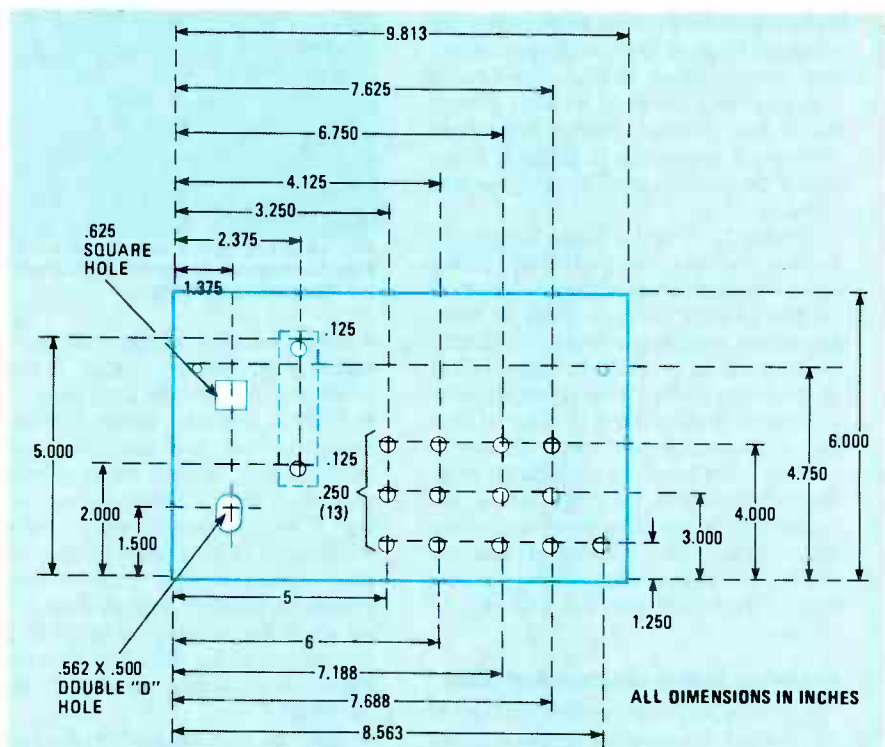


FIG. 3—REAR-PANEL LAYOUT of the power supply. Note the small holes along the bottom for adjusting the trimmer potentiometers.

of the potentiometer is shunted to ground, the voltage presented to the op-amp decreases proportionately and so, therefore, does the output voltage. For example, when R51 measures 10K (from the non-inverting input of the op-amp to ground), output voltage would be  $0.001 \text{ ma} \times 10,000 \text{ ohms} = 10$  volts.

The negative precision source is quite similar to the positive source, except that NPN transistors are used for the 1-ma current source, and the polarity of the Zener diodes is reversed. Op-amp IC8 functions as a voltage follower, as IC9 does in the positive output circuit. The output voltage is adjusted by R44, the front-panel  $-v_p$ ,

control. While R44 and R51 are specified as 10-turn 25K potentiometers. 10K units can be used if  $\pm 10$ -volt outputs are sufficient.

### Metering circuits

The meter circuit shown in Fig. 1 is optional. If you choose to omit all metering, just run leads from the output pads on the PC board to the appropriate binding posts. If you choose to include the current-metering circuit, understand that, with the switching arrangement shown, only one supply at a time may be used; the unused supplies will be disconnected from the binding post outputs. Although 12-position dual-gang switches were used in the prototype, you can use any switches with at least 6 positions and 2 gangs. On the other hand, you could add separate meters for each output circuit.

The value of R52 will be determined by the meter you use for M1. It will not be necessary at all if you use a meter with a voltage rating greater than that of the highest output. For the meter specified in the Parts List, a value of 1.8K is adequate, and gives a full-scale reading of 40 volts.

### Construction

Most components are easily obtainable from common sources; some hints are provided for those few components which may prove difficult to find. The cabinet specified in the Parts List is roomy enough that it should allow a hefty transformer and output transistors to be used to increase the power supply's current-output capacity.

Figures 2, 3, and 4 show the dimensions of the front, rear and bottom panels of the enclosure. Although hole diameters are provided, be sure you check the manufacturer's specifications for the dimensions of the parts you'll be using before drilling. The shafts for the potentiometers will probably be either  $\frac{1}{8}$  or  $\frac{1}{4}$  inch. Two-inch edge-reading meters were selected to give the front panel an uncluttered look. You can, of course, use other meters. The square hole in the back panel accommodates a rather fancy fuse holder; you may find it more convenient to use a standard round fuse holder with a 0.440-inch diameter.

### Mounting potentiometers and dials

When buying components, be sure to select a dial that matches the potentiometer's shaft diameter. To mount the potentiometers and dials, refer to Fig. 5 and follow the procedure described below, adapted from instructions prepared by Beckman Instruments for the *Helipot Duodial* series of potentiometers and turns-counting dials which were used on the prototype.

- Turn the potentiometer shaft against its counterclockwise stop and insert the shaft into the shaft hole.

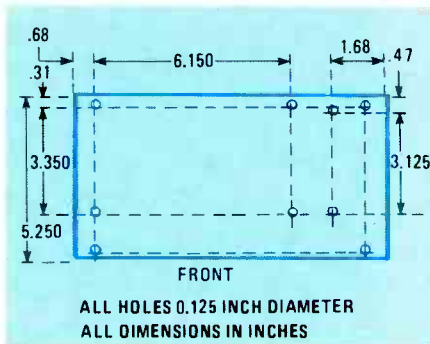


FIG. 4—TOP VIEW of the power supply chassis shows the mounting holes for the PC board, transformer, and cabinet feet.

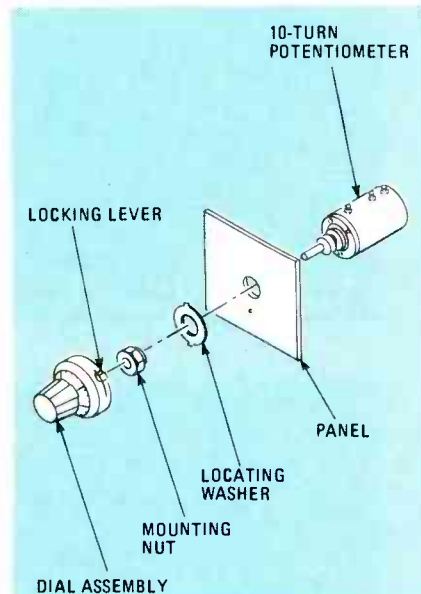


FIG. 5—MOUNTING A MULTI-TURN DIAL and potentiometer can be difficult if you don't follow the instructions carefully.

- Slip a locating washer over the shaft, and seat the locating-washer lug in the small hole beneath the shaft hole.
- With a wrench, firmly tighten the mounting nut into the potentiometer bushing. Note that the nut supplied is reversible. For thick panels, use as shown in Fig. 5. For thin panels, reverse the nut.
- With the locking lever in the OFF (up) position, slip the dial assembly over the potentiometer shaft. Be sure that the lug at the top of the locating washer seats in the slot behind of the dial. Also be sure that the whole assembly rests lightly against the panel.
- Turn the dial counter-clockwise until the zero of the outer scale is in the center of the window. Now turn the dial slowly until the scale reads between 10 and 20 at the index line. Tighten the set screw until a very slight drag on the shaft is felt. Turn the knob very slowly until both zeros line up with the index line. Tighten the set screw firmly.

### The PC board

The recommended way to build the

### PARTS LIST

All resistors are  $\frac{1}{4}$ -watt, 5%, unless otherwise noted.

- R1, R2, R9, R18, R27, R37—4.7 ohms
- R3, R21—1800 ohms
- R4, R12, R20, R22, R30—6800 ohms
- R5—620 ohms
- R6, R15, R24—10,000 ohm panel-mount potentiometer
- R8, R16, R17, R25, R26, R35, R36—470 ohms
- R10, R28—7200 ohms
- R11, R29, R32—5000 ohms, 15-turn, PC-mount trimmer potentiometer
- R13, R14, R33, R39, R46—10,000 ohms
- R19—9100 ohms
- R23—750 ohms
- R31—5600 ohms
- R34—4700 ohms
- R38, R45—8200 ohms
- R40, R47—5100 ohms
- R41, R48—2700 ohms
- R42, R49—1500 ohms
- R43, R50—1000 ohm, 10-turn PC-mount trimmer potentiometer
- R44, R51—25,000 ohm, 10-turn panel-mount potentiometer
- R52—See Text

### Capacitors

- C1, C2—47  $\mu$ F, 50 volts, electrolytic
- C3, C4, C5, C6—100  $\mu$ F, 50 volts, electrolytic
- C7, C9—0.1  $\mu$ F
- C8, C10—0.003  $\mu$ F
- C11, C12—1000  $\mu$ F, 50 volts, electrolytic

### Semiconductors

- IC1-IC9—LM101, or LM741 op-amp
- D1, D3, D11, D12—1N4001
- D2, D4—See Text
- D5, D6—1N754 6.8-volt Zener
- D7, D9—1N4742A 12.0-volt Zener
- D8, D10—1N4371 2.7-volt Zener
- Q1, Q5—2N3766
- Q2, Q6—2N3904
- Q3, Q7—2N3740
- Q4, Q8—2N3906
- Q9, Q10—2N2484
- Q11, Q12—2N2605

### Other Components

- F1—Fuse  $\frac{1}{10}$  amp, 250 volts
  - S1—SPST, 115 volts AC, 1 amp
  - S2, S3—6-position, 2-pole rotary switch
  - BP1-BP9—Binding posts
- Miscellaneous:** Turns-counting dials (2); Cabinet: Bud No. SE3030; heatsinks for Q1, Q3, Q5, and Q7; line cord, hookup wire, etc.

**Note:** An etched and drilled PC board is available from Specialty Electronic Services, Inc., P.O. Box 3320, San Antonio, TX 78211, for \$48.50 postpaid,

power supply is to use a printed-circuit board. Full-size foil patterns for a suitable board are shown in the "PC Service" section. (See page 83.) If you choose not to make your own board, you can purchase an etched and drilled board from the source mentioned in the Parts List. Whichever board you use, check it carefully for shorts and broken traces before you mount any components. Be particularly careful when you check areas that will be hidden under components



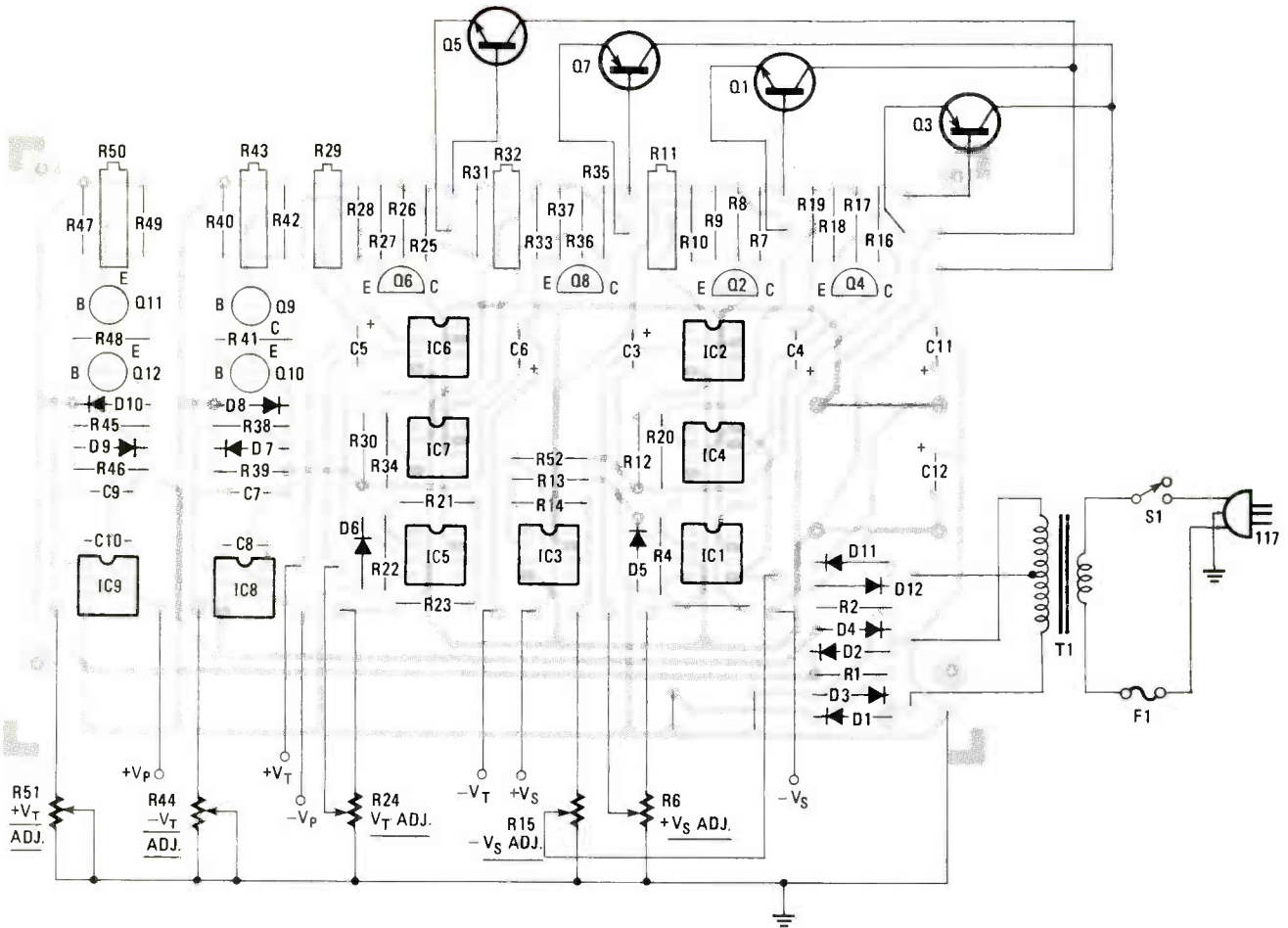


FIG. 6—PARTS PLACEMENT DIAGRAM shows how on-board and off-board components are wired.

once they're mounted on the PC board.

After checking your board and correcting any problems, you can mount the components using the parts-placement diagram in Fig. 6 as a guide. Be sure to observe the polarity of all semiconductors and electrolytic capacitors. Use sockets for the op-amps, but don't insert the op-amps at this time. Orient the small transistors (Q2, Q4, Q6, Q8-Q12) and diodes on the PC board carefully.

Transistors Q1, Q3, Q5, and Q7 require heat sinks, and should be mounted to the chassis. Be sure to use mica insulators so that their collectors won't short to the chassis; and coat the insulators on both sides with silicone grease to ensure effi-

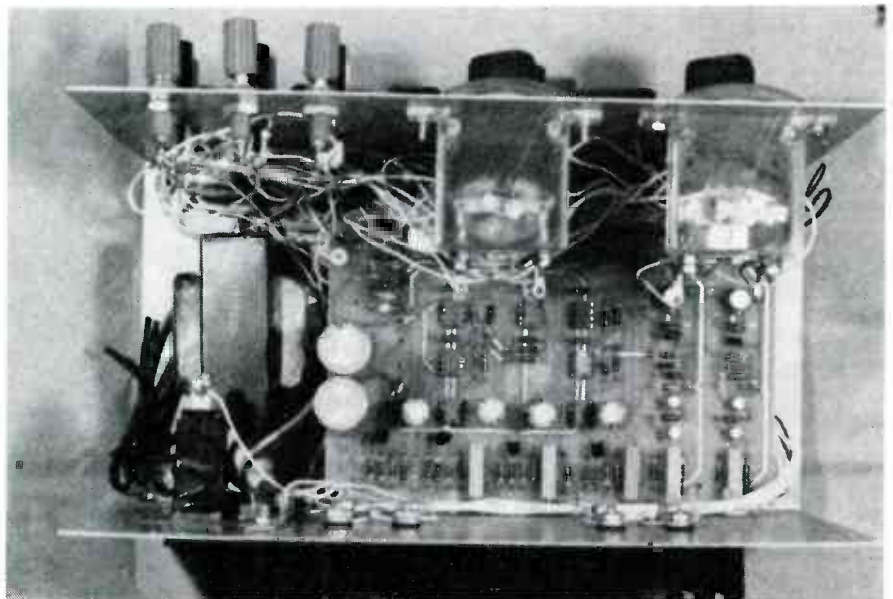


FIG. 8—INTERNAL ASSEMBLY of the power supply. M1 and M2 are shown at the upper right, and T1 at the lower left.



FIG. 7—THE REAR PANEL OF THE POWER SUPPLY.

cient heat transfer. Attach the complete assemblies to the rear panel.

#### Final assembly

After all components have been mounted, but before the IC's have been

installed in their sockets, check the board carefully for solder bridges and unsoldered pads. Fix any problems, and then connect the transformer to the PC board. Verify the presence of +40 and  
*continued on page 114*

ALMOST ALL INNOVATIVE PRODUCTS come to market with a high price. But once that product develops a proven market, imitators and competitors soon appear with lower-priced products that accomplish the same task.

Consider satellite receivers, for instance. Some years back, Nieman-Marcus introduced the first such unit intended for the general public in a Christmas catalog; the cost was a "mere" \$25,000. But someone quickly figured out a way to modify old radar units to do the same job for a fraction of that price. In the ensuing years, new designs and refinements have brought the cost of the satellite receiver down to under \$500.

In the same vein, the traditional parabolic reflector, or "dish," used in satellite receiving setups has been challenged by other designs, such as spherical and hyperbolic dishes, and tuned Yagi arrays (which are antennas themselves, and use no dish), in an effort to reduce cost or improve performance. Rumors of yet other alternatives surface from time to time, including a persistent rumor about a "dish" built from plywood.

Well, that rumor does have a basis in fact. However, the "dish" is not a dish at all. The purpose of a dish is to concentrate the signal and focus it on the antenna, which is located inside the feedhorn. (If you are unfamiliar with satellite-TV reception systems, they were explained in a special section, "Receiving Satellite Television," that appeared in the June 1984 issue of *Ra-*

*dio-Electronics*.) But a dish is not the only type of device capable of concentrating and focusing a signal. Another is a lens, such as a Fresnel lens. In this article we will discuss the theory behind using a Fresnel lens as a signal concentrator, and

present design criteria, as well as a short BASIC program, that will allow you to build an experimental unit using plywood.

If you're wondering why such information is not usually presented in standard antenna texts, it is because the design comes from the study of optics, not communications. In fact, there has been so little published research concerning the use of Fresnel lenses for satellite reception that the field must definitely be considered experimental. Although there are a few isolated examples of the Fresnel lens in actual use for satellite reception in Canada (British Columbia), commercial production of such lenses appears to be non-existent.

## A plywood lens?

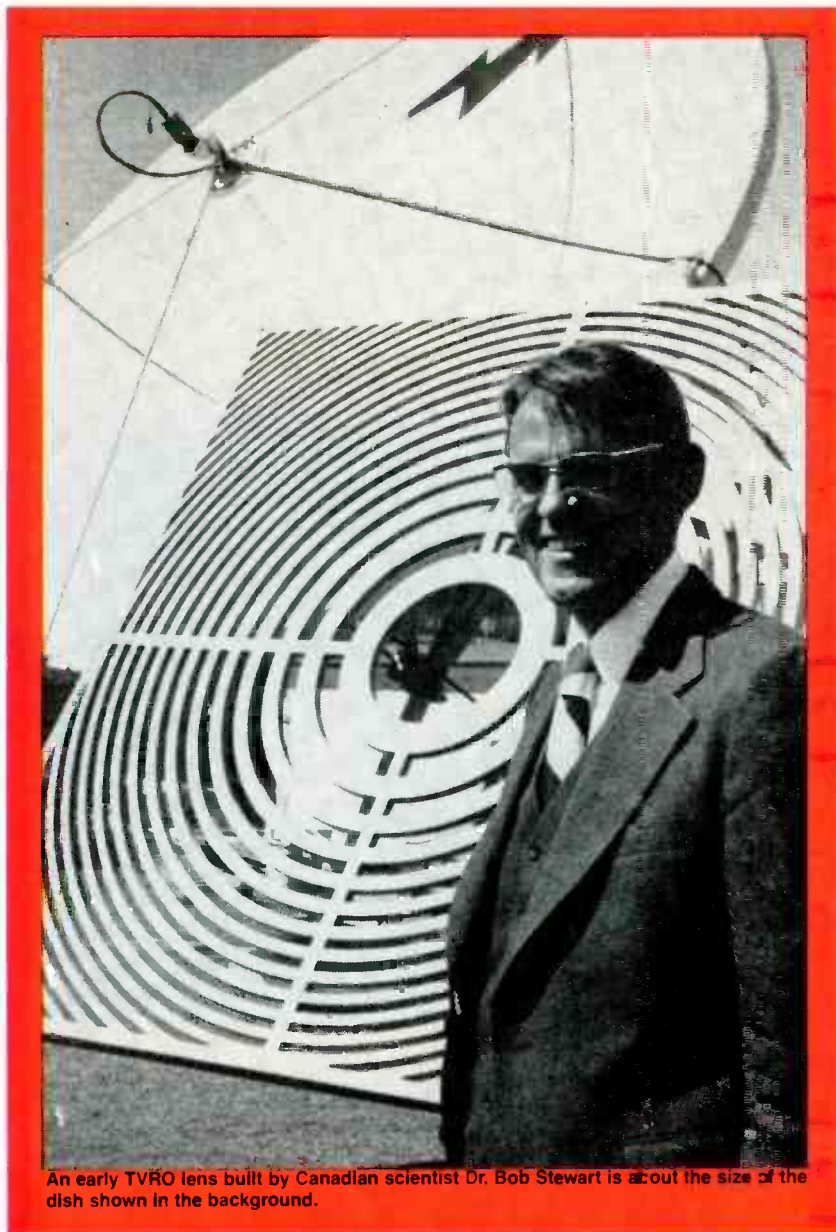
First invented by French physicist Augustin Fresnel in 1815, the lens bearing his name is commonly used in lighthouse lights, theater lights, and even flashlights. But, despite several advantages, including low cost, Fresnel lenses have found little use in microwave applications. Instead, other lenses of one sort or another have been used, including one commercial application, in the early 1960's, of a conventional lens made from styrene.

Only simple mathematics are required to understand the theory of the Fresnel lens. Central to that theory are the concepts of constructive and destructive interference. If two wavefronts of the same frequency and phase combine, then the amplitude of the resultant signal

## A PLYWOOD Satellite-TV Dish

*Can a satellite-TV dish be made out of plywood? Here's an experimental "dish" that supports the theory that says it can!*

DAVID J. SWEETNAM, C.E.T.



An early TVRO lens built by Canadian scientist Dr. Bob Stewart is about the size of the dish shown in the background.



may be calculated by simply adding the amplitudes of the two waves. Here the waves are said to interfere *constructively*.

On the other hand, if two wavefronts of the same frequency, but *different* phase, combine, the amplitude of the resultant wave will be less than that of the original waves by an amount dictated by their instantaneous phases and amplitudes. In the simplest case, two waves of the same amplitude but 180 degrees out-of-phase would cancel each other out; that is, the resultant wave would have an amplitude of zero. Here the waves are said to interfere *destructively*.

Let's look at a real application. Microwave TV signals leave the satellite, and make up what can be considered to be a *uniform plane wave* at the feedhorn. If we draw a straight line at a distance  $F$  from the feedhorn (where  $F$  is the focal length of the feedhorn), we may assume that all the microwaves crossing that line will be in phase with each other. That line is labeled the **EQUAL PHASE WAVEFRONT** in Fig. 1.

If the wave entering the feedhorn along the horizontal axis is chosen as a reference, then waves entering the feedhorn

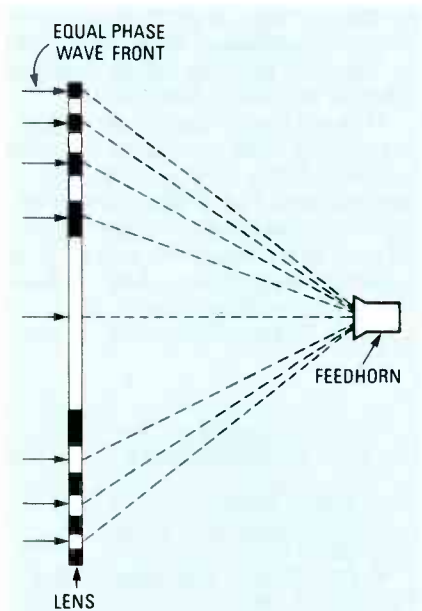


FIG. 1—MICROWAVES arriving at the lens are diffracted toward the feedhorn.

from above and below that line may cause destructive interference because of their phase difference. (Thanks to Huygen's principle, we can look at each point on the wavefront as a source of a secondary wave.) The phase difference is due to the increased distance the secondary waves must travel to reach the focal point. The net result is that the strength of the re-

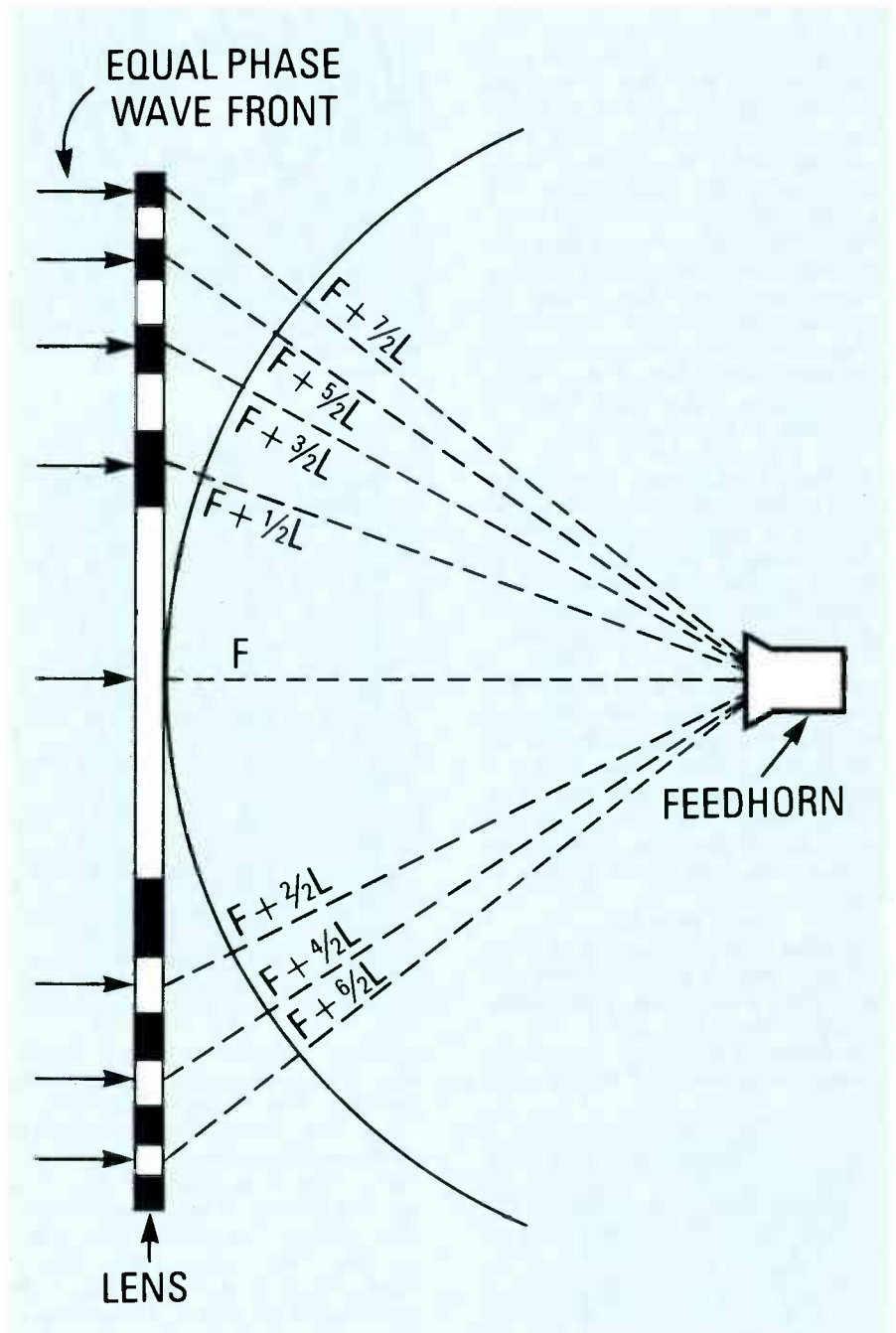


FIG. 2—DESTRUCTIVE INTERFERENCE. Waves arriving at the focal point inside the feedhorn from alternate  $\frac{1}{2}$ -wavelength zones interfere destructively.

ceived signal is reduced.

Let's look at that a little closer. Divide the wavefront up into zones chosen so that, from one zone to the next, the distance from the center of each zone to the focal point increases by  $\frac{1}{2}$  wavelength. That means that waves arriving at the focal point from alternate zones will be 180 degrees out of phase with each other.

In Fig. 2 we have shown zones above the horizontal as being an odd multiple of  $\frac{1}{2}$ -wavelength away from the focal point,

and zones below as being an even multiple away. So the horizontal zone is at a distance of  $F$ ; the first zone up is at a distance of  $F + \frac{1}{2} \lambda$  (where  $\lambda$  is the wavelength); the first zone down is at a distance of  $F - \frac{1}{2} \lambda$ ; and so on.

Examining the amplitude contributions from each zone at the focal point is very revealing. If the amplitude from zone 1 is  $A_1$  and the amplitude from zone 2 is  $A_2$ , etc., then the sum of all contributions from the first twenty zones,  $A_T$ , is given

by the equation:

$$A_T = A_1 - A_2 + A_3 - A_4 + A_5 - \dots + A_{19} - A_{20}$$

Since we defined each zone to be  $\frac{1}{2}$ -wavelength farther from the focal point than the previous zone, waves emanating from each successive zone are 180 degrees out of phase with those from the previous zone. Therefore, to obtain the amplitude of the resultant waveform at the focal point, the sum of the amplitudes of the waves from "even" zones must be subtracted from the sum of those from "odd" zones. However, the increasing angle each successive zone forms with respect to the horizontal forces us to take an additional factor into consideration. That angle causes waves from each successive zone to be weaker than those from the previous zone. Therefore, the resultant amplitude is described by the equation:

$$A_T = \frac{1}{2}A_1$$

Fresnel's breakthrough was realizing that he could build a plate to block contributions from alternate zones, so that all waves meeting at the focal point would interfere constructively, and none would interfere destructively. So the total amplitude should be given by the equation:

$$A_T = A_1 + A_3 + A_5 + \dots + A_{19}$$

Although the amplitude at the focal point without the zone plate—or lens—was only  $\frac{1}{2}A_1$ , the amplitude with the zone plate in place is almost  $10 \times A_1$ —nearly twenty times the gain without the plate. In decibels, the theoretical gain,  $G$ , for the lens is shown in the following equation, where  $N$  = the number of zones:

$$G = 20 \log_{10} N$$

In Table 1 we see how gain increases with the number of zones. As few as two zones give a gain of 6 dB; a twenty-zone lens gives a gain of 26 dB.

Doubling the number of zones to 40 increases the gain to 32 dB. Finally, a 160-

TABLE 1

Number of zones	Gain (db)
2	6.0
4	12.0
6	15.6
8	18.1
10	20.0
12	21.6
14	22.9
16	24.1
18	25.1
20	26.0
22	26.9
24	27.6
26	28.3
28	28.9
30	29.5
32	30.1
34	30.6
36	31.1
38	31.6
40	32.0

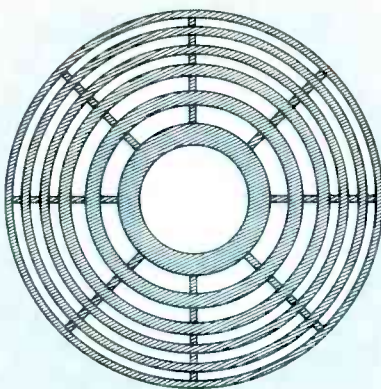


FIG. 3—FRONT VIEW of the plywood lens. The non-cross-hatched areas would be cut out of an actual lens.

TABLE 2

Radius Number	Raw Radius	Cutting Radius
R <sub>1</sub>	$\sqrt{1} = 1.00$	27.29 (cm)
R <sub>2</sub>	$\sqrt{2} = 1.41$	38.48
R <sub>3</sub>	$\sqrt{3} = 1.73$	47.21
R <sub>4</sub>	$\sqrt{4} = 2.00$	54.58
R <sub>5</sub>	$\sqrt{5} = 2.24$	61.13
R <sub>6</sub>	$\sqrt{6} = 2.45$	66.86
R <sub>7</sub>	$\sqrt{7} = 2.65$	72.32
R <sub>8</sub>	$\sqrt{8} = 2.83$	77.23
R <sub>9</sub>	$\sqrt{9} = 3.00$	81.87
R <sub>10</sub>	$\sqrt{10} = 3.16$	86.24
R <sub>11</sub>	$\sqrt{11} = 3.32$	90.60
R <sub>12</sub>	$\sqrt{12} = 3.46$	94.42
R <sub>13</sub>	$\sqrt{13} = 3.61$	98.52
R <sub>14</sub>	$\sqrt{14} = 3.74$	102.06
R <sub>15</sub>	$\sqrt{15} = 3.87$	105.61
R <sub>16</sub>	$\sqrt{16} = 4.00$	109.16
R <sub>17</sub>	$\sqrt{17} = 4.12$	112.43
R <sub>18</sub>	$\sqrt{18} = 4.24$	115.71
R <sub>19</sub>	$\sqrt{19} = 4.36$	118.98
R <sub>20</sub>	$\sqrt{20} = 4.47$	121.99

zone lens increases the gain to 44 dB. Thus, each 6-dB increase in gain requires that the number of zones be doubled.

Note that gain varies without regard to the diameter of the lens. That differs distinctly from the parabolic dish, the gain of which is specifically related to the diameter of the dish. For a Fresnel lens with a constant outer radius, increasing the number of zones will cause gain to increase, until the zone width approaches the wavelength of the signal, at which point the lens will be essentially transparent to the signal.

However, as with a parabolic dish, lens diameter does affect resolution, which, in this context, is the ability to distinguish signals from one of several closely spaced satellites.

Thus far we have examined our lens only from the side. Seen from the front, the zones become a series of concentric circles, as shown in Fig. 3. That lens has 12 zones, 8 radial supports, and a gain of 21 dB. The even-numbered zones are shaded, which indicates that they are transparent to the frequencies of interest.

## Designing a Fresnel lens

Table 2 shows the radii of the concentric circles used in a lens with 20 zones and an outside diameter of 244 cm, or about 8 feet. The column labeled CUTTING RADIUS shows the increasing radii of the concentric circles measured in centimeters. (We used centimeters because metric units are easier to work with than feet and inches.)

The figures shown were derived by dividing the maximum radius of the lens (in this case 244/2, or 122 cm) by the square root of the number of zones in our lens (in this case 20) to obtain a scale factor.

So if  $R_M$  is the maximum radius and  $N$  is the number of zones, the scale factor may be calculated as follows:

$$F = R_M \div \sqrt{N}$$

The scale factor for our example, then, is equal to  $122/4.47 = 27.29$  (the square root of 20 = 4.47). That scale factor is the radius of zone 1. To get the radius of the successive zones, multiply the square root of the zone number by the scale factor. Thus the radius of the second zone is equal to  $1.41 \times 27.29 = 38.48$ ; the radius of the third zone is equal to  $1.73 \times 27.29 = 47.21$ , and so on. Note that the roots and radii are rounded off to the nearest hundredth as cutting can be no more accurate than that.

It is easy to calculate the radii of a lens with a different diameter or different number of rings, or both. Simply substitute the appropriate values for  $R_M$  and  $N$ , calculate the scale factor, and then calculate the radii of each ring.

Although the calculations are not difficult to do by hand, you may have to re-do them several times if you are experimenting with lenses of different diameters, with a different number of zones, or both. To simplify the process we have included a short BASIC program, shown in Table 3, that will do the calculations for you.

In line 70 the scale factor is calculated

TABLE 3—  
BASIC PROGRAM

```

10 PRINT:PRINT
20 PRINT "How many zones";
30 INPUT N
40 PRINT "What is the outside radius";
50 INPUT RM
60 PRINT
70 R1 = INT (.5 + 100 * (RM/SQR
(N)))/100
80 PRINT "R 1";TAB(5);" 1.00";
TAB(12);R1
90 FOR X=2 TO N
100 SX = INT(.5 + 100 * SQR(X))/100
110 RS = INT(.5 + 100 * (R1*SX))/100
120 PRINT "R";X;TAB(6);SX;TAB(12);
RS
130 NEXT X
140 PRINT:PRINT
150 END

```



and stored in variable R1. Adding 0.5, multiplying by 100 and then dividing by 100 ensures that R1's value is rounded off correctly. The same "trick" is used in line 100, which calculates the square root of the current radius, and in line 110, which calculates its cutting radius.

After checking your calculations, mark the circumference of each circle on your working material. In order to ensure that the circles are drawn accurately, first mark off the radii of the zones; do that in several places. Then, drive a nail into the center of the lens and tie a pencil to that nail using a piece of non-stretch twine (or fishing line) so that the length of twine between the two is equal to the radius of the first zone.

Finally, inscribe the circle using the pencil. The purpose of marking the radius in several places is to ensure that the twine does not slip or stretch. If the pencil does not pass through each place where the radius has been marked, the circle is not "true" and must be redrawn. Once you are satisfied that the circle is accurate, repeat, with the length of the twine equal to the radius of the second zone. Continue in that manner until all of the needed circles are drawn.

Now you should paint the even-numbered zones and verify that your lens corresponds to the pattern shown in Fig. 3. If you are satisfied, draw in radial supports, used to hold the concentric circles of the lens together once the intervening plywood has been removed, making sure that the supports match up with any bracing on the back of the lens. (If the lens is large enough that it must be built using two sheets of material laid side-by-side, the two sheets must be tied together using radial braces.) Paint those radial supports as well, and before cutting, again verify that your lens corresponds to that shown in Fig. 3.

Finally, carefully cut out and remove the odd-numbered zones; Be sure that you don't also cut out the radial supports! If you have followed the directions above, then only the *unpainted* areas should be removed. To complete the lens, it will be necessary to cover it with metallic paint to keep the satellite signal from passing through the even-numbered zones, defeating its purpose. Several coats of a good quality aluminum paint should provide adequate shielding, as well as some weather-protection.

### Calculating focal length

While the paint is drying, you can begin figuring out where the lens' focal points lie. In order to do that, you will have to calculate the focal point of the lens.

Assuming that you are interested in receiving C-band signals, the downlink frequencies vary between 3.700 GHz and 4.180 GHz, depending on the transponder. In order to calculate the required focal

length, we need to know the wavelength of the downlinked signals. That is found by dividing 30 by the frequency,  $f$ , where  $f$  is measured in GHz:

$$\lambda \text{ (cm)} = 30/f$$

Wavelength varies from about 7.18 to 8.11 cm for those frequencies. The focal length, or distance from the lens to the feed point, for a Fresnel lens is given by the formula:

$$F = (R1)^2/\lambda$$

where R1 is the radius of the inner-most circle in the lens, and F is the focal length. You may calculate focal length in any desired units (feet, inches, centimeters); just be consistent. If you specify wavelength in centimeters, then R1 must also be in centimeters; of course, the final result will also be in centimeters.

The focal length of the lens described in Table 1 will range from 91.83 cm for transponder 1 to 103.72 cm for transponder 24. The center of that band falls at 97.28 cm. That is the focal length that is used for our set up. Note that the variation on either side of that center frequency to the band edges is 5.95 cm; the total variation is 11.9 cm. Most commercial waveguides have that much depth. Thus, to ensure that all of the focal lengths fall within the area of the waveguide, all that needs to be done is to measure back 5.95 cm from the waveguide opening, mark that point on the case, and mount the feedhorn so that that point is 97.28 cm from the lens.

TV satellites are all located in a geostationary orbit some 22,279 miles above the equator; that orbit is known as the Clarke belt. To aim the lens, you have to find where in the sky the Clarke belt lies relative to your location. That is done in the same manner as with a parabolic reflector. If you are not familiar with the procedure, see "Installing your own TVRO" in the June and July 1985 issues of **Radio-Electronics**.

In tracking between satellites in the Clarke belt, The Fresnel lens offers one major advantage over parabolic dishes. With dishes, the entire dish and feed assembly must be moved when you wish to focus on a different satellite. That's because such a parabolic dish can only focus on one object at a time. But a Fresnel lens can focus on several objects at a time, each with its own focal point. Thus to receive a different satellite, all that needs to be done is to move the feed to the appropriate focal point. Once you have your lens aimed at the right region of the sky, you'll have to experiment to see how many satellites you can focus on, and where their focal points fall. (When doing so remember that each focal point will be at the focal length of your lens.) If you wish to receive satellites located at the extreme ends of the belt, you can re-aim the entire lens-and-feed assembly, much as you would a standard parabolic reflector.

### Other considerations

The lens requires the same sort of strong, vibration-free mount used for quality parabolic dishes. Also, care should be taken to ensure that the focal point is not obstructed by any mounting apparatus, or the edge of the feedhorn.

To decide if a Fresnel lens is suitable for your application, you should consider two things. First, as we saw above, the gain of the lens is a function of the number of zones. Material limitations will probably restrict the number of zones to less than 80, and that limits your gain to something under 38 dB; as a comparison, that's roughly the gain of a 6-8-foot dish. Of course, the fewer the zones, the lower the gain.

What that means, of course, is that a top-quality LNA, one with an exceptionally low noise-temperature rating, will be required for best results at any location. In addition, if you happen to be located in one of the "fringe" reception areas (such as New England or Florida), it is likely that you will only be able to receive the strongest transponders.

Second, as we mentioned earlier, lens resolution depends strongly on lens diameter. As a rough rule-of-thumb, figure that the lens will have to be as large as the parabolic reflectors that work well in your area. You may want to experiment a bit to find an appropriate diameter for your lens. Fortunately, working with plywood makes such experimentation relatively cheap.

As you may have guessed from the theory section presented earlier, blocking out either the even or the odd numbered zones will produce the same gain. In areas of bright sunlight, you might want to cut out the even zones and leave the odd zones, including the center zone, in place. That will prevent radiation from the sun from entering the feedhorn directly. If you do build your lens in that manner, remember that you must design it so that it has an odd number of zones (i.e. 21 instead of 20).

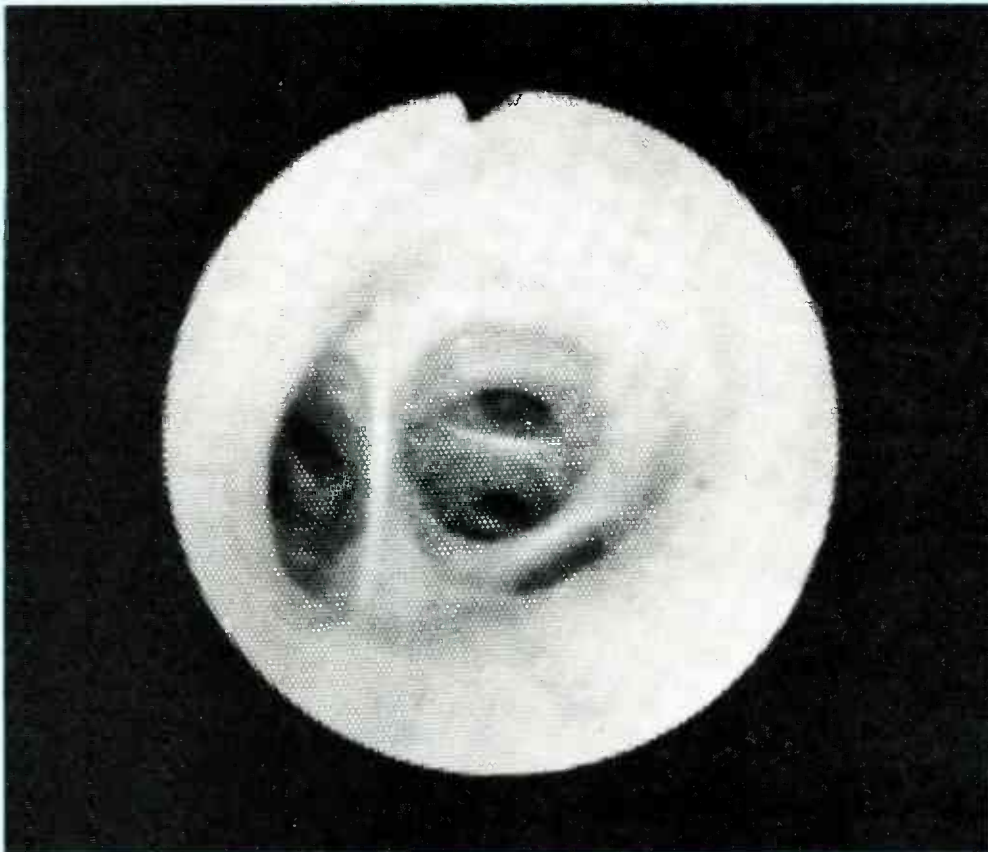
The lens has more than one focal length. There are increasingly fainter images at  $F/3$ ,  $F/5$ , and  $F/7$ , but they are of quickly diminishing intensity due to an increasing amount of destructive interference.

The lens may be built from materials other than plywood. The thinner the material the lens is made of, the closer its gain will be to the theoretical. The only restriction is that the material must be able to withstand local weather conditions, as well as be opaque to microwave frequencies. We have specified plywood (covered with aluminum paint), but screen mesh with  $\frac{3}{8}$ -inch or smaller holes could be used. In addition, sheet metal or aluminum-covered fiberglass or plexiglass could be used.

R-E

## ELECTRONICS IN MEDICINE

RAY FISH, Ph.D., M.D.



*Lasers and fiber optics play an important part in modern medical care. Learn more about them, and the techniques they make possible, in this article.*

INSTRUMENTS THAT USE OR MAKE USE OF light have always been important in medicine. Optical instruments such as otoscopes (used to examine the ear) and ophthalmoscopes (used to examine the eye) are found in nearly every doctor's office. Now, new technologies and techniques have made optical instruments more important and useful than they have ever been before. Such optical devices now run the gamut from simple flashlights to complex systems that use laser light to perform surgery on microscopic blood vessels in the back of the eye.

### The nature of light

The phenomenon known as light is a type of electromagnetic radiation, differing from, say, radio waves only in wavelength. Figure 1-a shows the region of the electromagnetic spectrum that ranges from radio waves to ultraviolet light. As is shown there, the region of electromagnetic radiation that is "visible" to the human eye is relatively small. Figure 1-b shows the spectrum of visible light in more detail.

As you can see from Fig. 1, colors differ from each other in wavelength. In hu-

mans, three types of color-sensitive photoreceptors in the rear of the eye are used to discern different colors. One type is most sensitive to red light. The farther a color is from red, the less sensitive the red light photoreceptor will be to it. The two other types of photoreceptors are sensitive to blue and green, respectively. Light of different wavelengths stimulate each of those three photoreceptors differently. The degree of stimulation is then converted by the brain into a multicolor image. (As an analogy, consider the way a color-TV uses just the three phosphor colors in



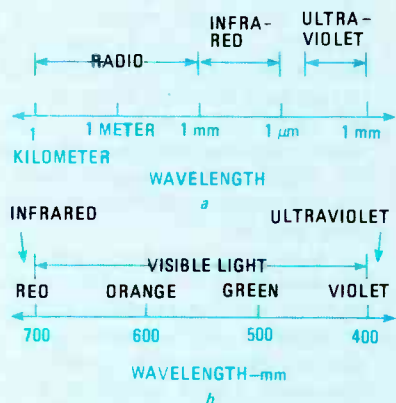


FIG. 1—THE ELECTROMAGNETIC SPECTRUM. As is shown here, only a small range of wavelengths is visible to the human eye.

the CRT—red, green, and blue—to generate a multicolor image. It is done by varying the intensity of the different color phosphors in a region.)

### Using light

Previously we saw how the oxygen content of blood could be determined by shining a light through an earlobe and analyzing how different wavelengths are absorbed (see the May 1985 issue of **Radio-Electronics**).

In the laboratory, an instrument called the spectrophotometer uses the same principal. Chemicals in a liquid solution are analyzed by finding how much absorption of light occurs over a range of wavelengths.

As shown in Figure 2, light is passed through a prism. As the light source and prism are rotated, different colors of light get through the slit. A photocell detects the light transmitted through the solution being analyzed at every wavelength. Corrections are made to take into account the absorption caused by the sample holder, etc., and the results are plotted as shown in Fig. 3. As every chemical and compound absorbs light in a different way, the information obtained from a spectrophotometer can be used to accurately identify the contents of the sample being analyzed.

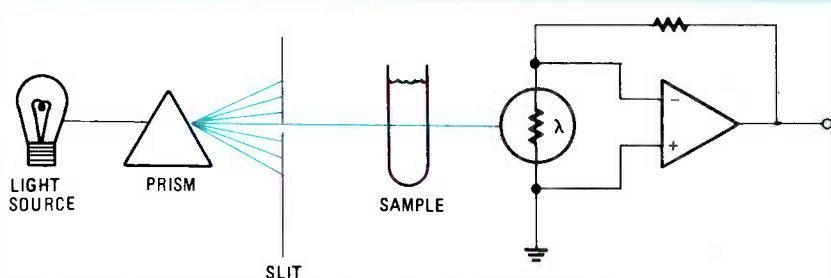


FIG. 2—A SPECTROPHOTOMETER uses light absorption to determine the chemical makeup of a sample. Though not shown here, the light source and the prism are mounted on a pivot. By moving the light source and prism, it is possible to pass the complete spectrum of visible wavelengths through the sample.

### Lasers

All electromagnetic radiation is periodic in nature; that, of course, includes light as well as radio waves. Thus, just as we can talk about the phase of a radio signal, we can talk about the phase of radiated light. In ordinary light, each atom or molecule of the light source emits its radiation independently. As such, the phase of the light radiation emitted by each atom or molecule is unrelated to the phase of the light radiation emitted by any other atom or molecule in the source.

In a laser, on the other hand, the atoms and molecules of the source are forced to radiate in phase. (Laser, by the way stands for Light Amplification by Stimulated Emission of Radiation.) Because of that, the timing and physical spacing of the light radiated by each atom or molecule is coordinated in such a way that the electromagnetic waves of the light reinforce each other. The resulting light is said to be coherent—the light emitted from each source has spatial and temporal coherence.

The device used to generate laser light is called a laser. Lasers use many different materials, including gases, liquids, and solids as a light source. Gas lasers use a gas (or mixture of gases) in a glass tube. Commonly used gases are helium-neon, carbon dioxide, argon, and krypton. Liquid lasers use organic dyes. The familiar ruby laser uses a solid as the lasing medium. For a light source, that laser uses chromium uniformly distributed throughout a rod of crystalline aluminum oxide. The output of the laser is light with a wavelength of 694.3 nanometers, a deep red color.

The light generated by a laser can be characterized by several parameters:

- Wavelength
- Type of emission—continuous or pulsed
- Energy
- Power density
- Beam divergence

### Lasers in medicine

Lasers are used most widely for eye-

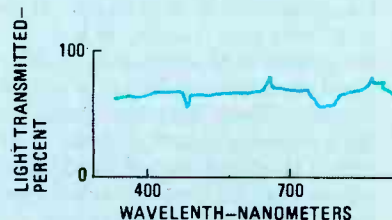


FIG. 3—THE OUTPUT of a spectrophotometer. By plotting the amount of light transmitted at various wavelengths, it is possible to uniquely identify the contents of a sample.

surgery. Most other uses (and some of the eye surgery applications) are still considered to be somewhat experimental. Many uses of the laser in medicine are very promising, but are still considered by many to be unproven, and too expensive. Many applications have worked out well in clinical trials, but are not yet accepted by the government or medical community as having been proven to be more effective than other techniques. The question of safety is also significant: Light strong enough to affect tissues can burn the skin or cause blindness if reflected into the eye. The heat generated by a laser can cause explosions when certain gases are present.

Lasers are used in a variety of different applications. For instance, laser light can be used to seal off bleeding blood vessels in a stomach ulcer or be focused to a 50-micron beam for use in eye surgery.

A laser cuts by heating tissues. That causes the tissue to be vaporized. The vaporized area is surrounded by a thin layer of heat coagulated tissue in which blood vessels smaller than one millimeter are sealed. Thus, problems with bleeding are minimized.

The wavelength (color) of the laser light can be chosen to be absorbed in certain tissues or organs, and not by others, making heating more selective. For example, almost all soft tissues strongly absorb the energy of the carbon dioxide laser, which is in the mid-infrared portion of the spectrum. If such a laser is directed at the eye, the cornea will be damaged. The light of the argon laser, on the other hand, is in the visible region (blue-green) and will pass through the lens and cornea of the eye. Almost all of the energy will go to the retina and cause heating there.

Laser light can be directed to a particular area in much the same way that regular light can. That means that fiber optics or a system of mirrors and lenses can be used. For laser eye surgery, an elaborate optical system is used to focus light onto the retina in the back of the eye. The physician sees a spot of light superimposed on the image of the retina so that the area to be operated upon can be

chosen. Once that is done, a laser can be used in a variety of ways. For instance, it can be used to seal tears in the retina. Lasers can also be used to seal off abnormal blood vessels in the back of the eye. Abnormal blood vessels that are likely to bleed are a common feature of several eye diseases. Those bleeding blood vessels are a relatively common source of blindness. Less than a drop of blood leaks into the eye from the abnormal vessels, but the blood covers the light-sensitive retina. Using the laser, abnormal blood vessels can be identified and sealed off before they bleed.

Surgery on other parts of the body can

also be performed using the laser. Vocal-cord surgery using the laser has proven to be useful. A laser is focused on tumors of the vocal cords. The tumors are burnt off. There is usually no bleeding because blood vessels feeding the area are cauterized (burned shut).

Cancer farther down, in the airways of the lungs, can also be reached by the laser. Unfortunately, such surgery is not done in very many centers. The procedure would benefit a large number of people, however, because many patients with lung cancer are smokers who do not tolerate surgery well because of coexisting lung and heart disease.

Lasers are used in dermatology to treat skin lesions. For example, carbon-dioxide lasers produce light in the infrared region. Such light penetrates only to a depth of .1 mm or so. Depending on the focus of the beam, such a laser either cuts or vaporizes the skin. When used to cut, the area is sterilized. Blood vessels, nerves, and lymphatic channels are sealed off. When used to vaporize tissue, it is possible to remove skin cancer, warts, and other lesions.

Lasers have also been used to treat bleeding and tumors in the esophagus, stomach, and upper intestine (those make up the upper gastrointestinal tract). To do that, the light from a neodymium:yttrium aluminum garnet (artificial diamond) laser (referred to as an Nd:YAG laser) is brought to the area of interest by a quartz fiber optic channel in an endoscope (that instrument will be described shortly).

### Laser safety

There are many dangers associated with working with lasers. Some lasers produce enough concentrated energy to burn the skin or damage the eye. Once you "see" the light generated by a laser, it may already be too late to prevent eye damage. Thus, precautions must be taken before injury occurs.

The ultraviolet and far infrared light generated by many lasers is absorbed by several of the structures of the eye (see Fig. 4). If the light is absorbed, of course, its energy is turned into heat. The result will be a burn in the area of absorption. That results in cataracts forming if the lens is involved, or damage to the sensitive structures at the rear of the eye if the light falls on the retina. Loss of vision could easily result if the laser is powerful enough.

Fortunately, safe power levels have been defined, and low-power lasers can be used safely without eye protection for many applications. Some lasers, such as gallium-arsenide lasers, are considered safe to use without eye protection. For other lasers, protective eye guards and glasses are available.

Even more dangerous than the light they produce are the power levels associated with lasers. Power supplies for those devices often provide tens of thousands of volts. Needless to say, a knowledge of high-voltage circuits, and a healthy respect for the same, is required before attempting any type of laser service or maintenance.

### Endoscopy

Endoscopy is the viewing of areas within the body. Instruments, called endoscopes (see Fig. 5), exist that allow physicians to look inside the stomach, intestines, bladder, lung, abdominal cavity, and joints. Endoscopes fall into two

*continued on page 111*

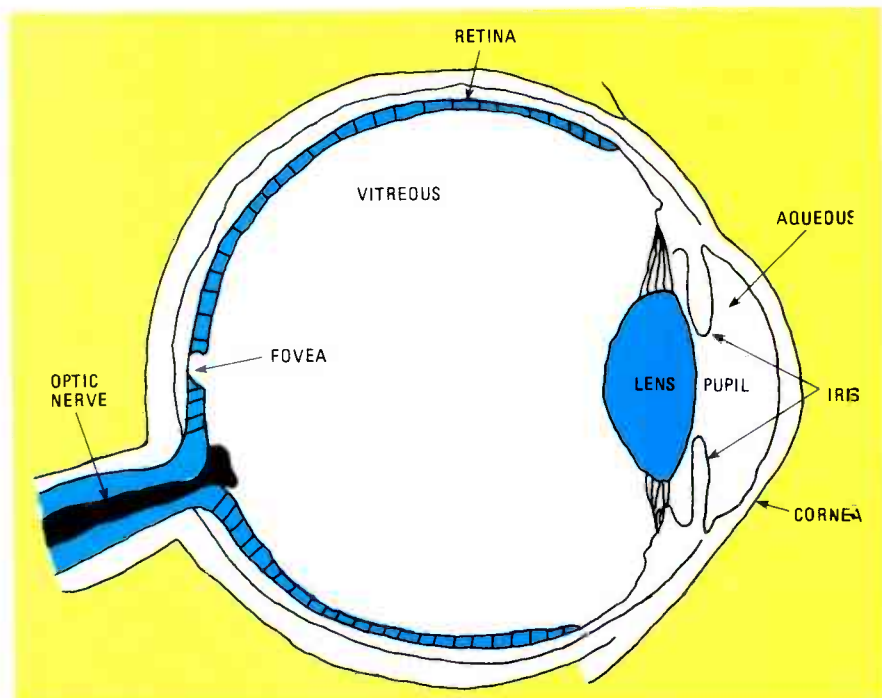


FIG 4—CROSS SECTIONAL VIEW OF THE EYE. Light passes through the normally transparent cornea (solid), aqueous (liquid), lens (solid), and vitreous (gel). When light strikes the retina, electrical signals are initiated and transmitted to the brain via the optic nerve.

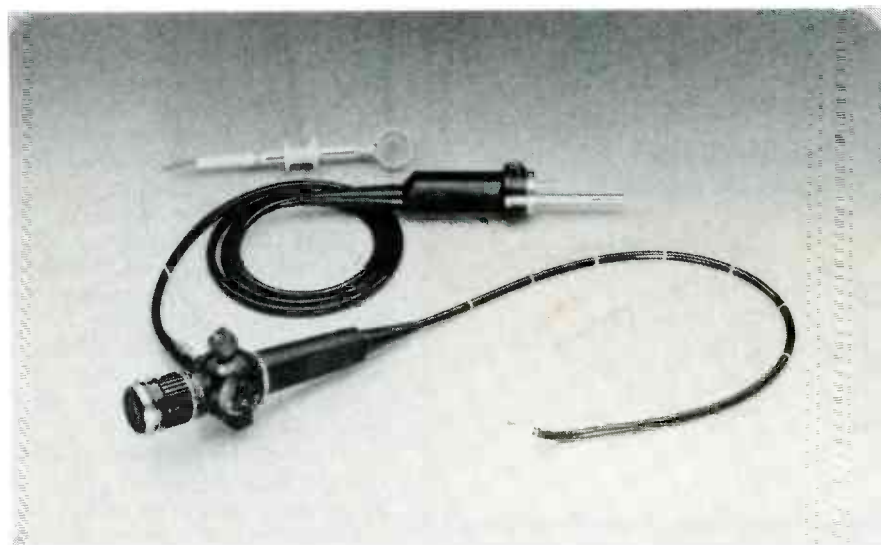


FIG. 5—A FLEXIBLE ENDOSCOPE. Such a device allows a doctor to view and have access to regions deep within the body.



## A VERSATILE REMOTE CONTROLLER

*Adding remote control to any circuit or device is not as hard as you might think. This article shows you how its done.*

J. DANIEL GIFFORD

THE DREAM OF ADDING REMOTE CONTROL to appliances, gadgets, and projects is an old one in electronics. But because of the complexities involved, it is one that has been beyond the skills of many hobbyists. Now, as in so many other areas of electronics, Large Scale Integration (LSI) IC's have come to the experimenter's rescue.

The Motorola MC14457 remote control transmitter and MC14458 remote control receiver IC's, by themselves, form almost 90% of a high-quality infrared or ultrasonic remote-control system that is capable of handling up to 272 commands. Although the IC set was developed for television remote use, and has some special pin functions for that purpose, it is highly flexible and can be used for a myriad of remote-control needs ranging from controlling TV and stereo gear, to remote arming of security systems, to remote programming of computers and robots.

### The remote-control system

The MC14457 IC (see Fig. 1) needs only a keyboard, oscillator, output device, and battery to form a complete remote-control transmitter. Similarly, the MC14458 receiver (also shown in Fig. 1) needs only a power supply, input circuit, and oscillator to function. Both devices are CMOS, and thus require only a minimal amount of supply current.

The transmitter does not have or need an on/off switch. When a button on the keyboard is pressed, the clock oscillator

starts up, the key is decoded, and the correct seven-bit data stream is transmitted via either an array of IR LED's or an ultrasonic transducer. Four of the transmitted bits are actually either data or a command; a fifth "function" bit lets the receiver know the nature of those bits (the function bit is not externally available). Two start bits are added to synchronize the transmission with the receiver. Table 1 shows the 32 possible keys, their codes, and their row/column location.

The data is transmitted in FSK (Frequency Shift Keying) format, using two frequencies divided down from the 500 kHz control clock—38.46 and 41.66 kHz. That FSK transmission, other than using much higher frequencies, is similar in operation to the encoding process used by computer modems.

The 14458 receives the transmitted data through either a photodiode or an ultrasonic transducer. After the signal is amplified and conditioned, the receiver IC decodes it from its FSK form and, according to the state of the function bit, routes it to either the data or the command port.

If the function bit is a 0, the four bits are read as data and are routed to the data port. The data port is two digits wide (each digit is made up of eight bits), and can be configured to accept either one or two digits as a full data word. After a full word is transmitted, a pulse appears on the data available (DA) pin. The data can be either BCD or hexadecimal in format, depend-

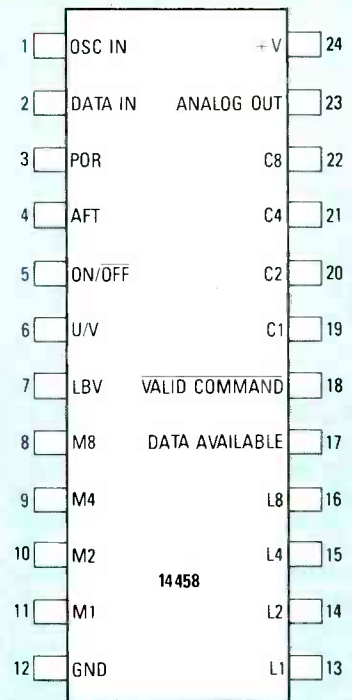
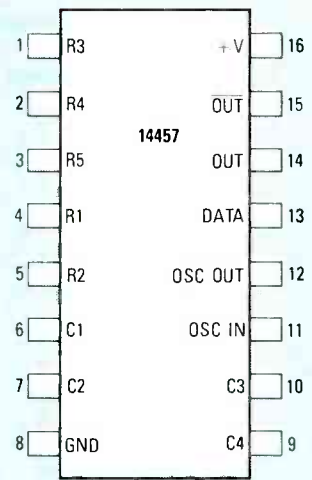


FIG. 1—THE 14457 REMOTE-CONTROL TRANSMITTER IC pinout (top) and the 14458 remote-control receiver IC pinout (bottom). With the addition of a keyboard, oscillators, power supplies, and input and output transducers, the pair of IC's becomes a powerful remote-control system.

ing on the number of keys used in the transmitter, so data words from 00 to 99 (0 to 9 in single digit mode) or 00-FF (0-F) can be transmitted to the data port.

If the function bit is a 1 instead of a 0, the four data bits are read as a command, and are routed to the command port. A received command is latched into the 4-bit port, after which a pulse appears on the valid command ( $\overline{VC}$ ) pin. Of the commands, four are internally decoded by the 14458, and twelve require external decoding to be useful.

With 256 data words and 16 commands, plus other specialized single-pin

TABLE 1—4457/4458 COMMAND ENCODING

Key	Row	Column	FE	C8	C4	C2	C1	VC Pulse
0	1	1	0	0	0	0	0	
1	1	2	0	0	0	0	1	
2	2	1	0	0	0	1	0	
3	2	2	0	0	0	1	1	
4	3	1	0	0	1	0	0	
5	3	2	0	0	1	0	1	
6	4	1	0	0	1	1	0	
7	4	2	0	0	1	1	1	
8	5	1	0	1	0	0	0	
9	5	2	0	1	0	0	1	
TOGGLE 1	1	3	1	0	0	0	0	X
TOGGLE 2	1	4	1	0	0	0	1	X
CONT 1	2	3	1	0	0	1	0	X
CONT 2	2	4	1	0	0	1	1	X
CONT 3	3	3	1	0	1	0	0	X
CONT 4	3	4	1	0	1	0	1	X
ANALOG DOWN	4	3	1	0	1	1	0	X
ANALOG UP	4	4	1	0	1	1	1	X
MUTE	5	3	1	1	0	0	0	X
OFF	5	4	1	1	0	0	1	X
A	2/5	1	0	1	0	1	0	
B	2/5	2	0	1	0	1	1	
C	3/5	1	0	1	1	0	0	
D	3/5	2	0	1	1	0	1	
E	2/3/5	1	0	1	1	1	0	
F	2/3/5	2	0	1	1	1	1	
CONT 5	2/5	3	1	1	0	1	0	X
CONT 6	2/5	4	1	1	0	1	1	X
CONT 7	3/5	3	1	1	1	0	0	X
CONT 8	3/5	4	1	1	1	0	1	X
CONT 9	2/3/5	3	1	1	1	1	0	X
CONT 10	2/3/5	4	1	1	1	1	1	X

outputs controlled by the data sent to the two ports, it's easy to see how that IC set can be used in dozens of different ways. By proper use of the data and proper decoding of the commands, almost anything that can be done with switches and knobs can be done over an invisible beam. The only limitation on the usefulness of the 14457 and 14458 is how well you can interface the receiver to the device under control. Before we get into the problems of interfacing and decoding, let's look at how a complete transmitter and receiver are built.

**The transmitter**

Since the 14457 is CMOS, it draws almost no supply current by itself. However, the clock oscillator and the output device are another story—the current drawn by both would normally make battery power impractical. However, the 14457 is designed to shut down the oscillator when it is not needed and the output circuitry draws power only when transmitting, which takes 0.1 seconds per data stream. Those features make both battery power and the lack of an on/off switch completely practical.

Being CMOS, the 14457 can operate from a supply voltage between 5 and 12 volts. The voltage and type of battery used will depend on the type of output. Since the ultrasonic type needs a higher voltage but much less current than the IR type, an

ordinary 9-volt transistor battery can be used for power. The array of IR LED's, on the other hand, need a substantial amount of supply current, so four "AA" or "AAA" cells in series (for a total of 6 volts) should be used. In both Figs. 2 and 3, note that a diode is used to prevent damage to the IC from reversed battery connections and a 50-μF capacitor is used to filter transients from the supply line; those components should not be omitted.

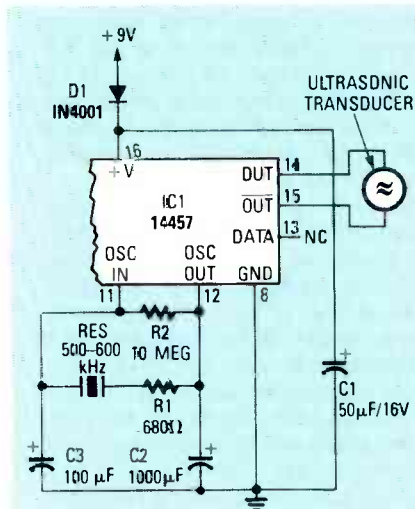


FIG. 2—THE BASIC CONNECTIONS for the transmitter oscillator. Note that this circuit uses an ultrasonic output.

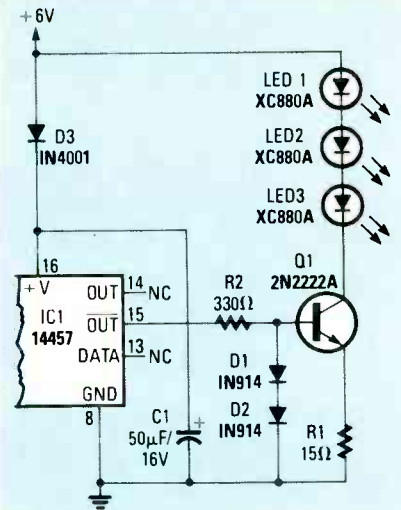


FIG. 3—THE OUTPUT CIRCUIT for an infrared transmitter.

The 14457 has an on-board oscillator circuit; the only external parts required are the frequency-determining components. Both the 14457 and 14458 require an identical control frequency of about 500 kHz. Instead of using a crystal to maintain the frequency, both units use a much cheaper, smaller, and more durable ceramic resonator. While ceramic resonators are less precise than crystals, they are more than accurate enough for many uses, this one included. The exact frequency of the resonators used is not important, as long as they are identical and of about the frequency specified. Suitable resonators are available from the source provided on page 67 (Ordering Information).

The ceramic resonator is used in exactly the same manner as a crystal (Fig. 2), requiring a tank circuit around it to force it to oscillate at the correct frequency. High-Q disc capacitors and metal-film resistors should be used in the tank circuit to promote stability. Note that the 14457 disables the oscillator by clamping pin 11 (OSC IN) to ground.

The output circuit of the ultrasonic transmitter is simpler than that of the IR type and requires no circuitry in addition to the ultrasonic transducer itself. The 14457 uses complementary push-pull outputs to generate a strong, balanced drive signal across the transducer.

The IR output uses only one of the two outputs, since a driver transistor is needed to provide sufficient current to the LED array. Three infrared LED's are used to increase the range of the transmitter. High-output LED's such as XC880A's or TIL906-1's should be used.

There is no real difference in performance or range between the two types of output. The IR output is decidedly cheaper, since a pair of ultrasonic transducers can cost \$25.00 or more, and the parts are more widely available. On the other hand, the IR beam is limited to line-of-sight



### Ordering Information

The following are available from Circuit Specialists, PO Box 3047, Scottsdale, AZ 85257: 14457/14458 transmitter/receiver pair, \$17.00 postpaid; 455-kHz ceramic resonator (Mallory CU455), \$8.50 each, postpaid.

operation, while the ultrasonic signal can bend around corners and other obstacles. In general, the IR type is recommended for hobbyist use.

Besides the push-pull transmitting outputs, the 14457 has another output, the DATA output, that can be used to give a visual indication of transmission. It follows the unencoded binary data used to modulate the FSK transmission. If a driver circuit and LED like that in Fig. 4 are added, the LED will flicker briefly each time data is transmitted. That load will contribute slightly to battery drain, but since it is impossible to see infrared or hear ultrasonics, the feedback of a visual transmission signal could be valuable.

The most difficult part of building the transmitter is the construction of the keyboard. The 14457 has four column and five row inputs, each with its own internal pull-up resistor. To transmit a data digit or command, one column and one (or more) rows must be simultaneously shorted to ground. The problem is that only one type of row-to-column-to-ground keyboard is commonly available, and it is for telephone use, and it has the familiar 12-button pattern. Since that type of keyboard is expensive and difficult to modify to the circuit needed here, it is not practical.

Fortunately, there is an alternative. The ordinary row-to-column type of matrix keyboard may be used with an array of NPN transistors to provide a path to ground. That allows use of the common, inexpensive membrane-type keyboard like that found in many calculators. The NPN transistors may be discrete 2N2222/2N3904 types, or a DIP array such as the CA3046/3086.

Actually, any type of SPST normally open switches could be used to build a keyboard, with one connection of each

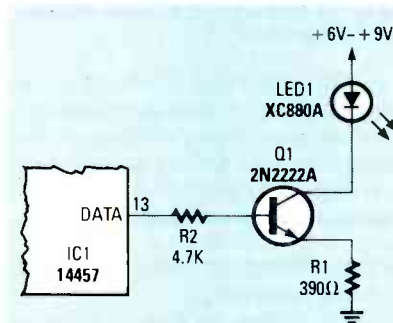


FIG. 4—THIS CIRCUIT can be added to give a visual indication of the transmitted signal.

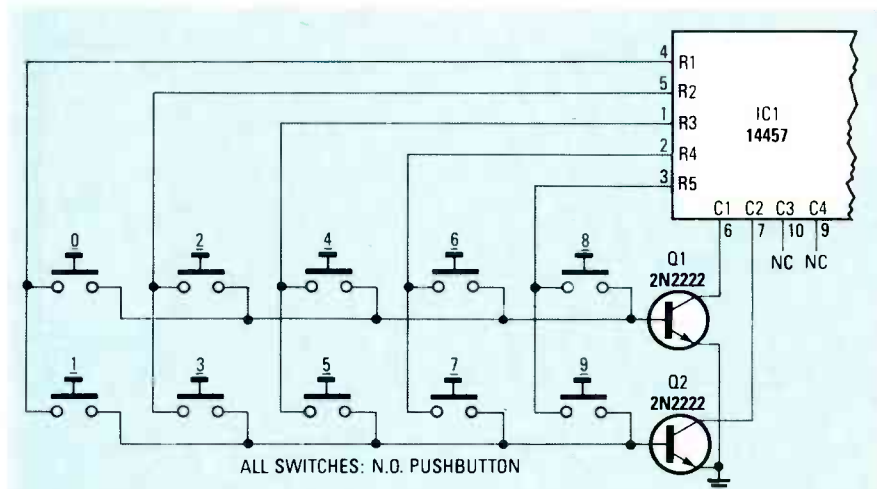


FIG. 5—THE 10-KEY keyboard. Each SPST normally-open switch shorts one row to one column. Note that the column 3 and 4 pins are left unconnected.

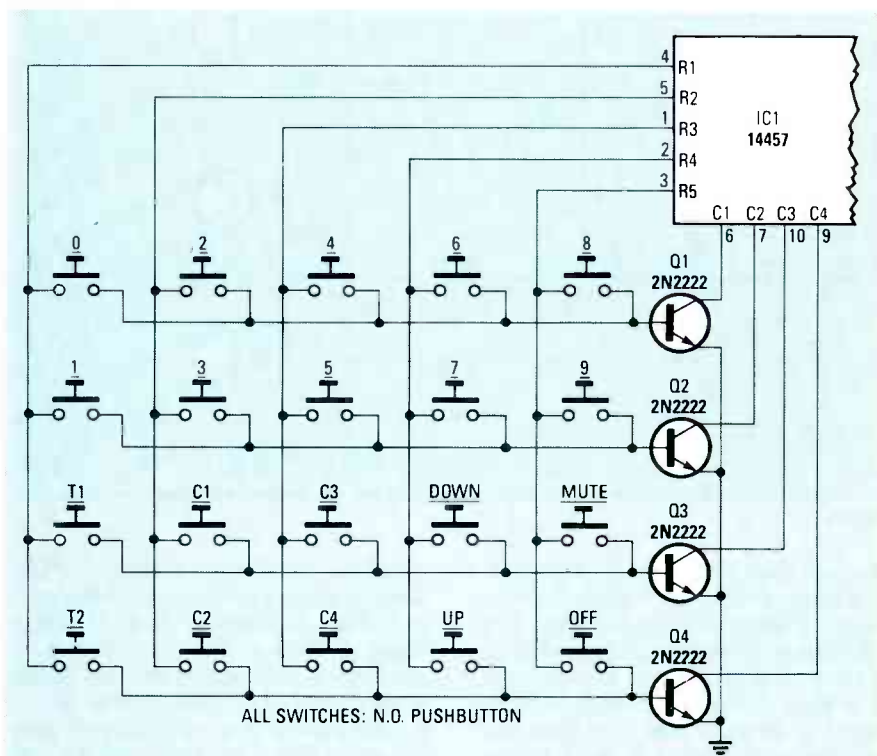


FIG. 6—THE 20-KEY keyboard. Either discrete transistors or an NPN IC array can be used.

switch going to the correct row and the other going to the correct column. Although that type of keyboard will be more expensive and much larger than the membrane type, the keys can be laid out in any desired pattern.

The 14457 allows the use of up to 32 keys, 16 for the data digits 0 through F, and 16 for commands. Any of those keys and commands may be used independently, with or without any other keys. Also, any lesser part of the 32-key pattern can be used. Let's look at three such sub-patterns, and the full 32-key version.

The simplest keyboard (Fig. 5) uses only 10 keys, those corresponding to the digits from 0 through 9. That pattern

would be ideal for security system disarming, with the receiver input mounted behind a window or near a door. Note that the two unused column inputs are left unconnected; since they have internal pull-ups, no external disabling is required.

A somewhat more complex keyboard, the 20-key version (Fig. 6), is probably the best compromise between usefulness and too much complexity. That keyboard adds the following to the 10-key keyboard: OFF, ANALOG UP, ANALOG DOWN, MUTE, two uncommitted toggle-type commands, and four uncommitted continuous-type commands. (We'll talk about the command types in a moment.)

Since all of the available rows and col-

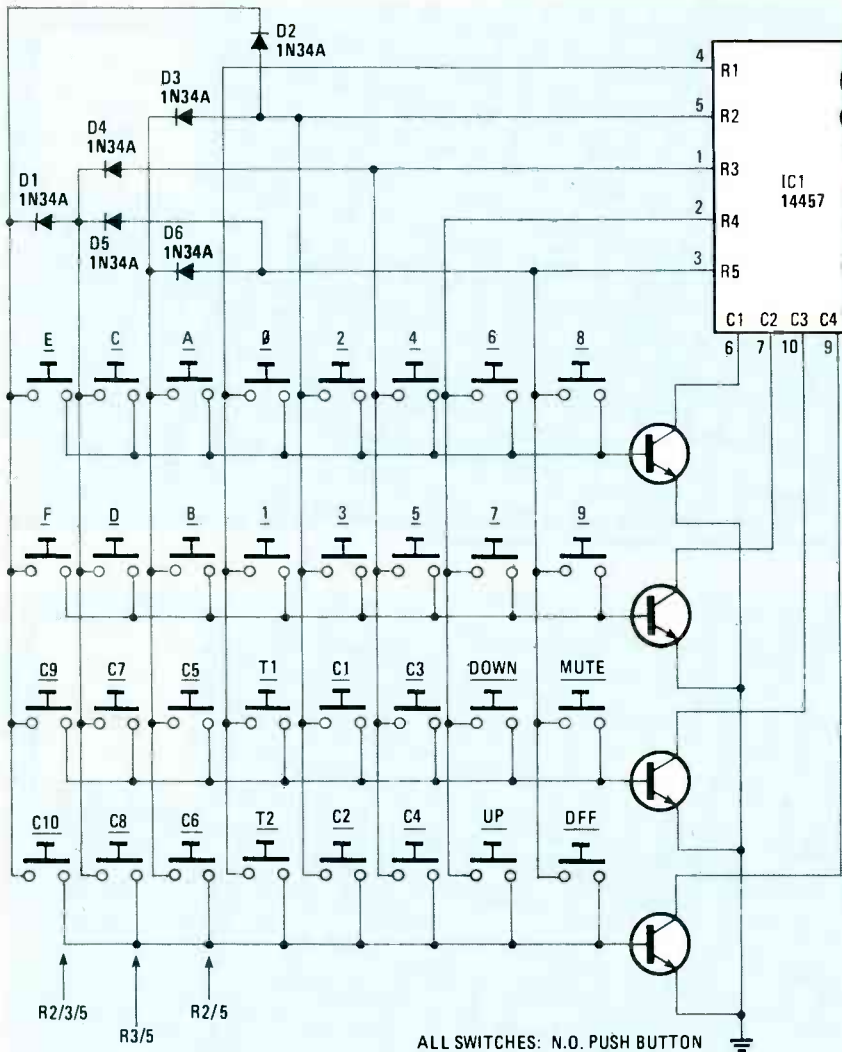


FIG. 7—THE 26/32-KEY keyboard. If the extra commands are not needed, switches C5–C10 can be deleted.

umns are used for the 20-key keyboard, three extra rows must be “synthesized” to access the remaining 12 commands. That is done by using an array of diodes (Fig. 7) to allow each of the new rows to short more than one of the existing rows to ground at the same time. The three new rows are labelled 2/5, 3/5, and 2/3/5, indicating the existing rows used to synthesize each.

If all 32 keys made accessible by adding those synthesized rows are used, six more continuous-type commands are available, along with the six hexadecimal digits A through F. If only access to the hex digits is desired, the six command keys can be deleted, leaving the 26-key keyboard. The only thing that determines whether BCD or hex data can be transmitted is whether or not the hex digit keys are available. If the 10- or 20-key keyboard is used, only BCD data may be sent; with the 26- and 32-key versions, either BCD or hex data can be transmitted.

### The receiver

The receiver half of the remote-control

system is slightly more complex. The 14458 requires a power supply between 5 and 6 volts, and thus can use a TTL power supply if one is available. If a voltage in that range is not available from the device being controlled, a higher voltage can be regulated down or a separate power supply added. Since the 14458 and its on-board circuitry are CMOS, not more than 20–30 mA of supply current should be required.

The 14458 has three inputs, one for the incoming signal (DATA IN), one for the oscillator frequency (OSC IN), and one used for automatic power-on reset (POR). The POR input, pin 3, has an internal pull-up resistor and needs only a 0.22–0.47  $\mu$ F capacitor between it and ground for operation. With such a capacitor in place, when power is applied to the 14458 all of its outputs and internal registers will be reset to 0.

The oscillator used in the 14458 (Fig. 8) is almost identical to that used in the transmitter, except that the receiver requires an external active element, a 4069UB inverter (the active element is

internal on the 14457). The ceramic resonator used in the 14458's oscillator must be identical to that used in the transmitter.

The FSK signal is received, as described earlier, by either a photodiode or an ultrasonic transducer. The transducer can be directly connected to an amp input, but the photodiode requires a pull-up biasing resistor from 22K–220K, with the exact value determined experimentally once

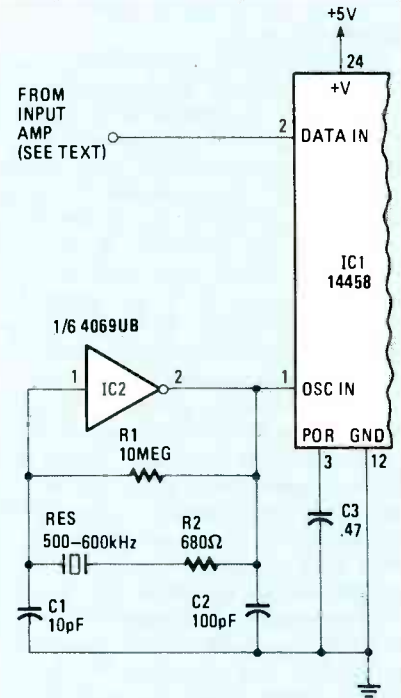


FIG. 8—THE BASIC CONNECTIONS for the receiver oscillator. For single digit operation, pin 9 (m) would be tied to +5V, and pin 6 (u/v) would be grounded.

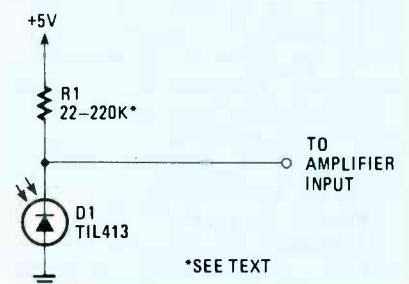
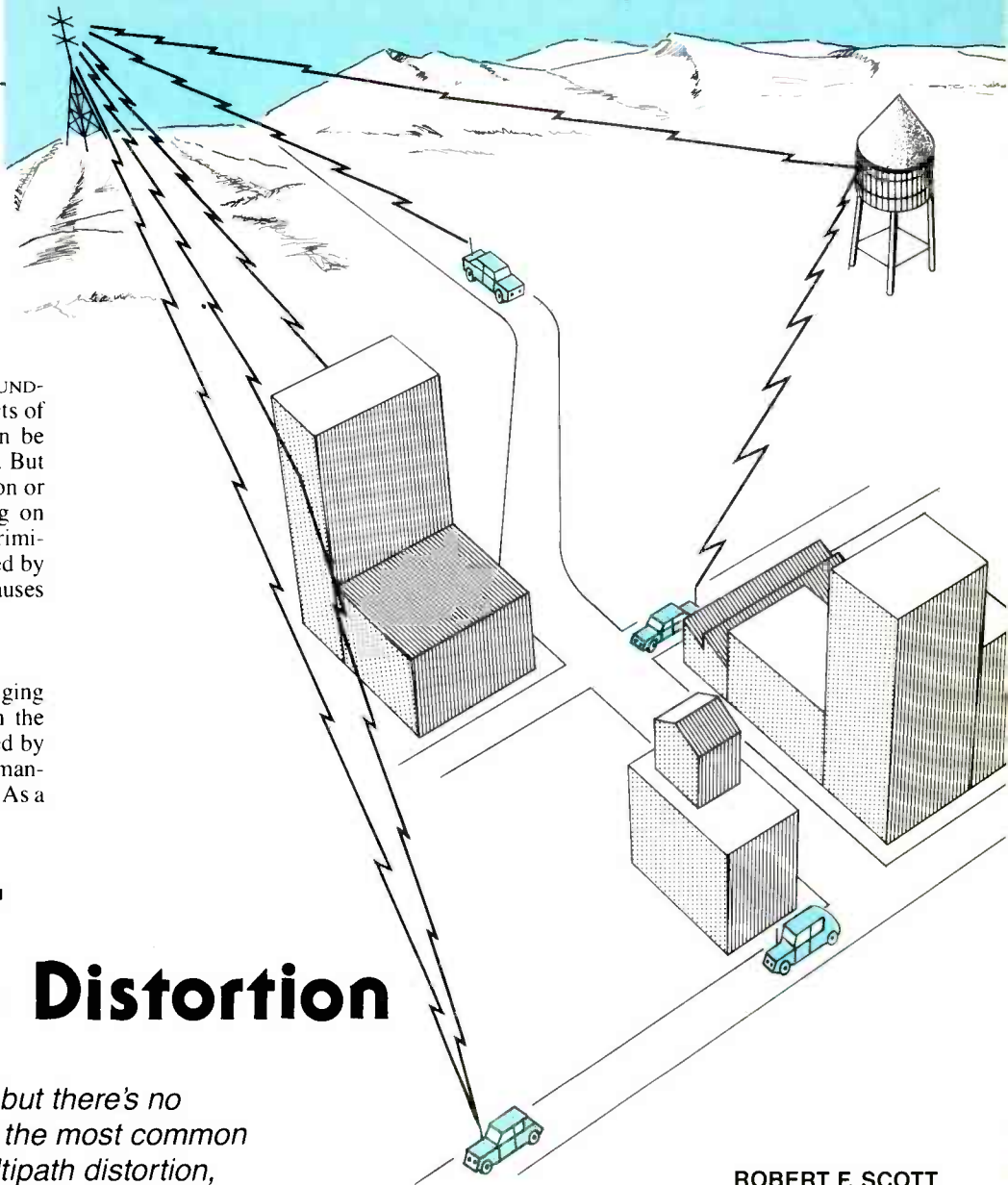


FIG. 9—FOR BEST SENSITIVITY and range, the value of the bias resistor, R1, must be determined experimentally.

the circuit is built (see Fig 9). That bias resistor controls the sensitivity and thus the pickup range of the photodiode. An infrared filter must be used in front of the photodiode to exclude ambient light and further increase its sensitivity. Although a piece of red plastic like that used for display filters can be used, a true IR filter will give better performance.

From the pickup, the signal is sent to an amplifier. We'll show you a suitable amplifier and finish things up. **R-E**





THERE ISN'T MUCH MYSTERY SURROUNDING TV "ghosts." They are the effects of multipath distortion and often can be eliminated without too much trouble. But what of FM "ghosts?" That distortion or "flutter" that you've been blaming on your receiver's tuner, AGC, or discriminator circuits may very well be caused by the same multipath reception that causes TV ghosts.

### What is multipath reception?

VHF and UHF signals, those ranging from around 50 MHz to well up in the microwave region, are easily reflected by buildings, water towers, and other man-made objects, as well as by hills, etc. As a

## All About Multipath Distortion

*FM distortion is annoying, but there's no need to put up with one of the most common types. Here's a look at multipath distortion, and how surprisingly easy it is to get rid of.*

ROBERT F. SCOTT

result, at any particular location, an FM antenna may be receiving a signal on a direct, line-of-sight path, as well as via a number of reflected paths. (See Fig. 1.)

That can be an advantage in certain cases. For example, some receiving locations may be in a "shadow" area where, due to intervening buildings, hills, or heavily wooded areas, line-of-sight reception of signals is not possible. In those areas adequate reception might be possible *only* via reflected signals.

Unfortunately, not all multipath reflections are advantageous. Let's take a look at Fig. 1. That figure shows several FM receiving sites, labeled A, B, C, and D, all located about 38 miles from the transmitter. Location A receives signals over two paths. One is a 38-mile direct line-of-sight path. The other is more roundabout—40 miles to the water tower, and then 5 miles to the receiving antenna.

Radio waves travel 186,000 miles per second (0.186 mile per microsecond) or 1 mile in  $5.376 \mu\text{s}$ . The multipath route is 7 miles longer than the direct path, so the reflected signal is delayed  $37.63 \mu\text{s}$  ( $7 \times 5.376 = 37.63$ ). Though not shown, note that some of the signal reflected from the water tower also is reflected downward toward the earth. It then is reflected off the earth to the receiving antenna, forming yet another, slightly longer path. In a moment we'll see how those delays distort the received signal, but first, let's look at the other sites in Fig. 1.

Location B is a good place to receive an adequate direct signal, free from multipath interference. Locations C and D are in the "shadow" of a tall office building and cannot receive a satisfactory direct signal. The FM listener at location D has solved the problem by aiming his antenna at the water tank.

### FM signal basics

When an FM transmitter is modulated, its output signal varies above and below the carrier center-frequency at a rate equal to the modulating frequency. The greater the amplitude of the modulating signal is, the greater will be the swing in carrier frequency from its assigned center frequency.

The FCC has defined  $\pm 75 \text{ kHz}$  (a total swing of 150 kHz) as 100% modulation,  $\pm 60 \text{ kHz}$  as 80% modulation,  $\pm 45 \text{ kHz}$  as 60% modulation, and  $\pm 37.5 \text{ kHz}$  as 50% modulation.

As long as the percentage of modulation is held constant, the frequency swing remains constant, regardless of the modulating frequency.

Figures 2 and 3 show the "anatomy" of an FM signal. Looking first at Fig. 2, as the modulating signal rises from zero to its maximum at 90 degrees, the carrier

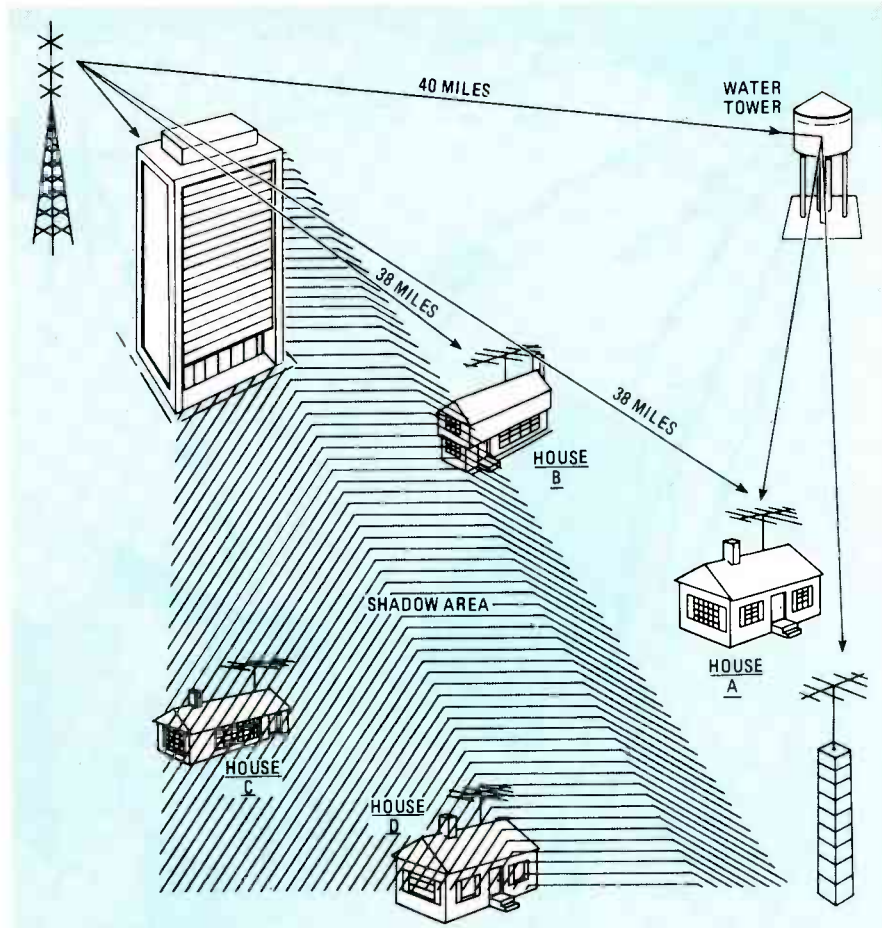


FIG. 1—SOME LOCATIONS RECEIVE direct signals, reflected signals, or a combination of both. In locations where both direct and reflected signals are received, multipath distortion can occur.

frequency swings from its resting (unmodulated) center frequency to a maximum determined by the percentage of modulation.

As the modulating signal passes 90 degrees, the carrier frequency decreases until it returns to the center frequency when the modulating carrier reaches 180 degrees. As the modulating signal swings in the negative direction, the carrier swings from its center frequency toward its minimum (once again determined by the percentage of modulation). Once the modulating signal passes 270 degrees, the carrier frequency begins to rise until it is once again at the center frequency at 360 degrees (0 degrees).

Figure 3 shows the effects of the modulating signal on a carrier signal. Figure 3-a is the modulating audio signal, while Fig. 3-b shows the corresponding effect on the carrier frequency. Figure 3-c shows the modulating signal superimposed on the carrier. In those illustrations the modulation polarity and its relationship to carrier frequency is such that a positive-going modulating signal causes the carrier frequency to increase while a negative swing in modulating voltage cause the carrier frequency to decrease. That polarity relationship is not mandated by FCC regulations or by FM transmitter design.

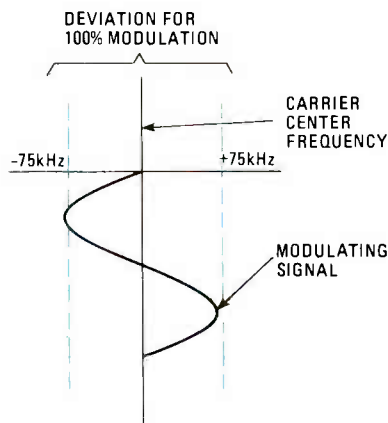


FIG. 2—FOR 100% MODULATION, the carrier frequency will swing  $\pm 75$  kHz.

An FM transmitter can just as easily be operated with negative polarity where a positive-going modulating wave causes the carrier frequency to decrease.

### Causes of multipath distortion

We have seen how a reflected signal takes a longer path and is delayed in reaching the receiving antenna. The chart in Fig. 4 can be used to compare typical delays with differences in the lengths of the direct and reflected paths.

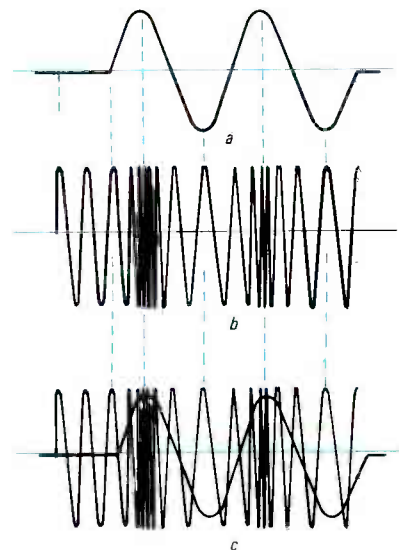


FIG. 3—ANATOMY OF AN FM SIGNAL. The modulating signal is shown in a, and its effect on the carrier frequency is shown in b. The two signals are shown superimposed in c.

When an FM signal is reflected, it usually undergoes a 180-degree phase reversal. So, when the reflected path is a whole number of wavelengths longer than the direct path, the signals at the antenna are out-of-phase; and the strength of the signal at the receiver depends on the relative strengths of the two signals. Complete cancellation can occur when the signals are 180 degrees out-of-phase and of equal amplitude.

When the difference in path lengths is an odd number of half-wavelengths, the signals are in phase. The result is that the signal strength at the receiver will actually be higher than if only the direct signal were being received.

But, most often the difference in path lengths will be something other than an odd or even multiple of the wavelength. Since the carrier frequency of an FM signal is constantly changing, in those instances there will be constant changes in the instantaneous phase and frequency differences in the direct and multipath signals. Thus, the resultant signal at the receiver will contain both phase-modulated

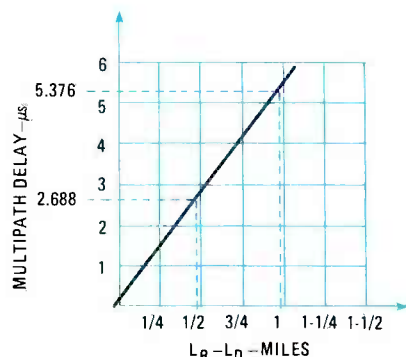


FIG. 4—ONCE YOU'VE DETERMINED the difference in length between the direct path ( $L_D$ ) and the reflected path ( $L_R$ ), this chart can be used to find the multipath delay in  $\mu$ s.



and amplitude-modulated distortion components that were not present in the original signal.

Let's take a look at the distortion caused by multipath reception of the FM signal at location A in Fig. 1. The multipath signal travels 7 miles farther than the direct signal, so its arrival is delayed 37.63  $\mu$ s. Let's assume that, at a given instant, the FM transmitter is 100% modulated by a 5-kHz tone. The period of a 5-kHz sine wave is 200 microseconds. Since, as we've seen, a frequency-modulated carrier reaches its maximum deviation in one direction at the 90-degree point of the modulation cycle, and maximum deviation in the opposite direction at 270 degrees, how much will the carrier swing during the 37.63- $\mu$ s delay?

Since the period of the signal is 200  $\mu$ s, we know that at 50  $\mu$ s, the signal has swung through  $\frac{1}{4}$  of a cycle, or to 90 degrees. That allows us to set up the following proportional relationship:

$$\frac{50 + \mu S}{90^\circ} = \frac{37.63 + \mu S}{X}$$

$$50X = 3386.7^\circ$$

$$X = 67.73^\circ$$

To find the percent of modulation at that point:

$$\sin 67.73^\circ = 0.9292$$

$$0.9292 \times 100\% = 92.52\%$$

The carrier swing thus is 92.52%  $\times$  75 kHz, or 69 kHz. Thus, when the reflected signal arriving at the receiver passes through the center frequency, the direct signal has advanced 67.73 degrees or 69 kHz.

At that instant the direct and multipath signals interact to produce a 69-kHz beat. That signal is not audible, but it can produce annoying interference as it beats with other components of the composite FM direct and multipath signals.

Similarly, with the same 37.63- $\mu$ s delay, a 1-kHz tone produces a 17.25-kHz beat, while an 8.75-kHz beat is produced when the FM carrier is modulated by a 500-Hz tone.

It was by chance that we assigned the distances to the direct and reflected paths shown in Fig. 1. Had we assigned values where there was only a half-mile difference, the delay would have been 2.688  $\mu$ s in the two signal paths. The 5 kHz, 1 kHz, and 500 Hz modulating tones then would have produced beats of 6.3 kHz, 1.26 kHz, and 630 Hz, respectively.

Note that the preceding discussion is based on signals strong enough to modulate the carrier 100% and drive it to full  $\pm$  75-kHz deviation. If, in the examples above, the carrier is modulated only 50%, maximum deviation is only  $\pm$  37.5 kHz and the beat interference frequencies would be half of those given above.

The interference frequencies given in

the above examples are generated when the modulating signal contains but a single frequency. But typical FM signals contain a variety of frequencies, and the multipath distortion caused by them can be exceedingly complex and constantly changing.

### Reducing multipath distortion

Generally, multipath distortion can be reduced to an acceptable level, or completely eliminated, by any method that can be used to insure a 40- to 50-dB difference in the strengths of the direct and reflected signals. Usually, the approach would be the same as that used to eliminate TV ghosts. That is, install a highly directive receiving antenna that has a good front-to-back ratio, a sharp frontal lobe, and a minimum of spurious side and back lobes. An antenna rotator would be used to aim the antenna at an interference-free direct signal—keeping the direct signal well within the main portion of the forward lobe while causing the unwanted reflected signal to fall in a null in the response pattern.

If your FM receiver has a signal-strength meter, you can swing the antenna and measure the angle between the direct and reflected signals. If the multipath signal is arriving from 20–30 degrees right or left of the direct signal, it may be possible to eliminate it by stacking two identical high-gain antennas, one above the other, one-half wavelength apart. In addition to increasing direct-signal pickup by 2.5 to 3 dB, stacking sharpens the forward lobe—possibly enough to completely eliminate multipath interference.

If the reflected signal arrives from the rear of the antenna and is not sufficiently attenuated by conventional vertical stacking (as described above) try stagger stack-

ing, as shown in Fig. 5.

Stagger stacking provides a 10- to 20-dB improvement in the front-to-back ratio, while still providing a substantial increase in forward gain. In stagger stacking, the antennas are spaced 0.67 to 0.7 wavelengths apart vertically, and the upper antenna is spaced one-quarter wavelength ahead of the lower one. The coax line between the upper antenna and the coupler is one-quarter wavelength longer than the coax connected to the lower antenna.

Because of the one-quarter wavelength horizontal stagger between the antennas, the wavefront of the incoming direct signal reaches the upper antenna one-quarter wavelength (90°) before it reaches the bottom one. However, the extra one-quarter wavelength section of coax from the upper antenna delays the signal 90 degrees so it will be in phase with the signal from the bottom antenna when the two combine in the coupler. That provides an added 2.5 to 3 dB gain.

The wavefront of the reflected signal arriving at the rear of the antenna array reaches the upper antenna one-quarter wavelength after it has reached the bottom antenna. The signal at the upper antenna is delayed an additional 90 degrees by the added quarter-wave section of coax downlead. Thus, the reflected signals from the top and bottom antennas arrive at the coupler 180 degrees (one-half wavelength) out-of-phase, so they will cancel. The rejection of the reflected signal is typically -20 dB, and may be -30 dB with careful design and construction.

When designing a stacked antenna array, remember that FM signals travel slower in cable than in free space (or the atmosphere). Because of that, the wavelength of the signal in cable is shorter than

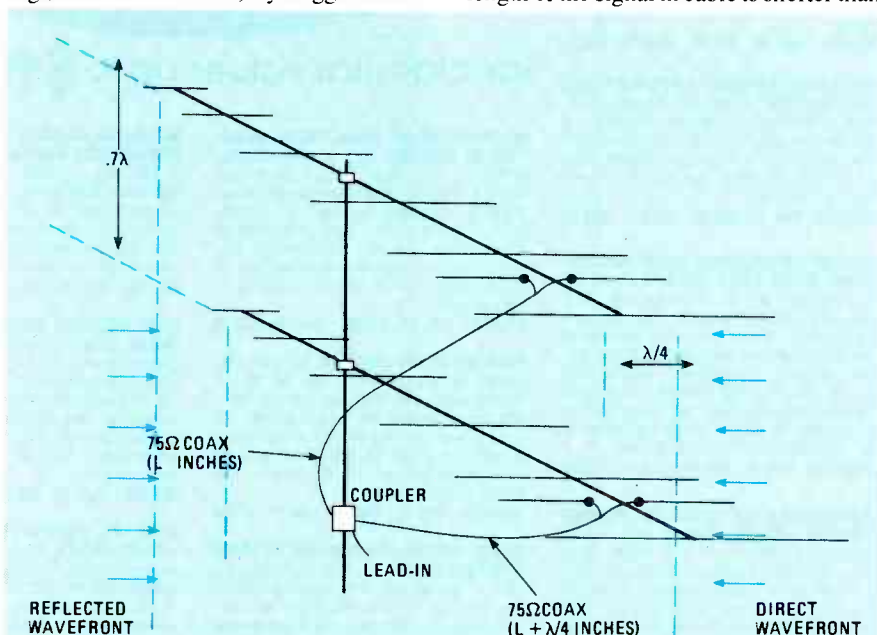


FIG. 5—WITH STAGGER STACKING, the upper antenna is mounted so that its elements are located  $\frac{1}{4}$  wavelength ahead of the corresponding elements of the lower antenna.

# Professional Books That Help You Get Ahead—And Stay Ahead!

## Join the **Electronics and Control Engineers' Book Club**® and...

- Keep up with current technology
- Sharpen your professional skills
- Be ready for new career opportunities
- Boost your earning power

**THE MCGRAW-HILL COMPUTER HANDBOOK: Applications, Concepts, Hardware, Software.** Edited by H. Helms. 992 pp., 475 illus. Everything you need to know about today's computer science and engineering is here in this massive treasure trove of information. Covers everything from Boolean algebra to hardware selection techniques to artificial intelligence. 279/721 Pub. Pr., \$84.50 Club Pr., \$52.95

**TRANSDUCERS: Theory and Applications.** By J.A. Allocca and A. Stuart. 497 pp., 328 illus. Thoroughly describes and illustrates the theory and operation of all important transducers used in industrial, communication, medical, and other applications. Photographs, drawings, and diagrams are included throughout this outstanding introduction to a key element in electronic instrumentation. 582997-5 Pub. Pr., \$27.95 Club Pr., \$22.95

**ANTENNA ENGINEERING HANDBOOK, 2/e.** Edited by R. C. Johnson and H. Jasik, with contributions by 57 recognized authorities. 1,408 pp., 946 illus. This widely acclaimed Handbook gives you the guidance you need to solve problems in antenna design and application. It provides detailed information on physical fundamentals, patterns, structures, and design techniques for practical modern antennas. 322/910 Pub. Pr., \$105.00 Club Pr., \$62.50

**INTRODUCTION TO RADAR SYSTEMS.** By M. I. Skolnik. 2nd Ed., 698 pp., 244 illus. Covering every radar fundamental and all important changes, this EE text exposes you fully to the systems themselves—and to their applications! Topics include radar equation, CW and frequency-modulated radar, MTI, pulse-doppler, tracking radar, receivers, displays, duplexers, noise, and more. 579/091 Pub. Pr., \$47.95 Club Pr., \$35.75

**MICROPROCESSOR APPLICATIONS HANDBOOK.** Editor-in-Chief, D. F. Stout. 472 pp., 284 illus. At last—a reference guide to microprocessor applications to help you make your systems timely, versatile, and cost-effective. 617/988 Pub. Pr., \$46.00 Club Pr., \$34.75

**MICROPROCESSOR AND MICRO-COMPUTER DATA DIGEST.** By W. H. Buchsbaum and G. Weissenberg. 336 pp., 93 block diagrams, 106 pin configurations. If you work with electronic devices that use microprocessor or microcomputer integrated circuits, this much-needed book contains all the detailed technical data for every microprocessor IC that is currently listed as a "standard," off-the-shelf item. 582835-9 Pub. Pr., \$29.95 Club Pr., \$22.50

**HANDBOOK OF ELECTRIC POWER CALCULATIONS.** Edited by A. Seidman, H. Mahrous and T. G. Hicks. 448 pp., 300 illus. Here are 285 tested and proven procedures for handling the electric power problems most frequently encountered in actual practice. You'll find ingenious, time-saving ways to calculate fuel costs, motor efficiency, and power output. 560/617 Pub. Pr., \$46.50 Club Pr., \$35.25



New members!  
Any one of these great professional books for only... **\$2<sup>89</sup>** as a premium with your 1st selection!

Spectacular values up to **\$105.00**

**HANDBOOK OF PRACTICAL ELECTRICAL DESIGN.** By J. F. McPartland. 416 pp., 300 illus. This volume provides a step-by-step explanation of designing electrical systems for industrial, commercial, and residential applications. Packed with helpful tips for saving time and complying with code requirements from branch circuits to wiring size. 456/95X Pub. Pr., \$40.95 Club Pr., \$27.50

**DIGITAL LOGIC DESIGN.** By B. Holdsworth. 338 pp., 192 illus. All of the recent advances in digital design techniques are presented here in depth. It's both a text covering basic concepts and a practical guide to design techniques for combinational, clock-driven, and event-driven circuits. 582852-9 Pub. Pr., \$39.95 Club Pr., \$27.50

**ELECTRONIC COMMUNICATIONS SYSTEMS.** By W. D. Stanley. 566 pp., illus. Emphasizing the signal-processing functions of modulation and demodulation operation, this book presents the essentials of electronic communications in a logical, step-by-step sequence. 582834-0 Pub. Pr., \$25.95 Club Pr., \$20.95

**MODERN ELECTRONIC CIRCUITS REFERENCE MANUAL.** By J. Markus. 1,264 pp., 3,666 circuit diagrams. Complete with values of components and suggestions for revisions—plus the original source of each circuit in case you want additional performance or construction details. 404/461 Pub. Pr., \$79.50 Club Pr., \$57.95

**ELECTRONICS ENGINEERS' HANDBOOK, 2/e.** Edited by D. G. Fink & D. Christiansen. 2,272 pp., 2,189 illus. This updated and enlarged edition covers all the latest knowledge in the field, including new advances in integrated circuits, pulsed and logic circuits, laser technology, telecommunications, and much more. 209/812 Pub. Pr., \$83.50 Club Pr., \$63.95

**DIGITAL CIRCUITS AND MICRO-PROCESSORS.** By H. Taub. 608 pp., heavily illus. This fast-paced, carefully written guide gives you thorough explanations of all the basic principles of digital systems and logic design—plus a solid introduction to microprocessors and microprocessor-based designs. 629/455 Pub. Pr., \$41.95 Club Pr., \$32.50

**RADIO HANDBOOK.** By W. Orr. 22nd Ed., 1,136 pp., more than 1,300 illus. The latest edition of what is universally regarded as the best liked and most useful communications reference in the industry. It's a handy "course" in communications, a fact-packed reference, and a how-to guide—all in a single book! 582442-6 Pub. Pr., \$21.95 Club Pr., \$17.95

**INTRODUCTION TO MICROWAVE ELECTRONICS.** By T.C. Edwards. 76 pp., illus., softbound. Eliminating unnecessary theory and mathematics, this book provides you with a lucid overview of microwave engineering and the devices and circuits being used today. Helpful even if you have only limited experience with microwave electronics. 583030-2 Pub. Pr., \$14.95 Club Pr., \$10.95

**PRACTICAL DIGITAL DESIGN USING ICs, 2/e.** By J. D. Greenfield. 717 pp., illus. This revised and expanded Second Edition of a popular guide shows how to get the most out of a wide range of popular integrated circuits. What's more, it contains the specialized know-how today's designer needs to interface ICs with microprocessors. 582853-7 Pub. Pr., \$25.95 Club Pr., \$19.95

**ENGINEERING NETWORK ANALYSIS.** By G. H. Hostetter. 912 pp., 372 illus. Emphasizing real-world applications, this comprehensive book covers the full range of analytical techniques for everything from source-resistor networks to switched networks. Brings you fully up to date on all the latest developments. 582966-5 Pub. Pr., \$35.50 Club Pr., \$27.95

**STANDARD HANDBOOK FOR ELECTRICAL ENGINEERS, 11/e.** By D. G. Fink and H. Beaty. 2,448 pp., 1,414 illus. Today's most widely used source of electrical engineering information and data serves you as no other single work when you need detailed, timely, and reliable facts. 209/74X Pub. Pr., \$79.95 Club Pr., \$62.95



**MICROWAVE SEMICONDUCTOR CIRCUIT DESIGN.** By W. A. Davis. 416 pp. heavily illus. Provides in-depth coverage on microwave circuit analysis, passive microwave components, impedance transformers and circuits, broadband directional couplers, mechanical realization of selected transmission lines, CAD, CAM and CAT, characteristics of amplifiers and oscillators, noise, statistical thermodynamics and PN junction theory.  
583044-2 Pub. Pr., \$47.50 Club Pr., \$35.50

**INTRODUCTION TO RADIO FREQUENCY DESIGN.** By W. H. Hayward. 383 pp., illus. This comprehensive volume prepares you to actually design HF, VHF, and UHF equipment and enables you to follow much of the current literature. Structured equation sets make it easy to write programs for small computers or calculators.  
582748-4 Pub. Pr., \$32.95 Club Pr., \$27.25

**McGraw-Hill Encyclopedia of Electronics and Computers.** By S. P. Parker, Editor-in-Chief. 960 pp., 1,266 illus., outsized 8 1/2 x 11 format. It's a single-volume library that covers the entire world of electronics from Edison's pioneering work in electricity right up to optical fiber communications, control systems, lasers, radar, TV receivers, artificial intelligence, and computer storage technology.  
454/876 Pub. Pr., \$67.50 Club Pr., \$43.95

**ELECTRONICS ENGINEERING FOR PROFESSIONAL ENGINEERS' EXAMINATIONS.** By C. R. Hafer. 336 pp., more than 200 illus. Actually two books in one—a quick preparation manual to help you pass your P.E. exams on the first try and a rich source of practical electronics engineering information and know-how.  
254/303 Pub. Pr., \$32.50 Club Pr., \$25.50

**McGraw-Hill Concise Encyclopedia of Science and Technology.** Editor-in-Chief S. P. Parker and the Staff of the McGraw-Hill Encyclopedia of Science and Technology. 2,065 pp., 1,600 illus. This volume serves every need for understanding today's science and technology. Written by over 3,000 of the world's topmost experts, including 19 Nobel Prize winners, it covers 75 disciplines from Acoustics to Zoology. A 30,000-entry index and cross-references throughout make it a snap to find the information you're looking for.  
454/825 Pub. Pr., \$95.00 Club Pr., \$66.50

**COMPUTER METHODS FOR CIRCUIT ANALYSIS AND DESIGN.** By J. Vlach and K. Singhal. 656 pp., 148 illus. Computational methods have become an integral part of circuit analysis and design. And a solid understanding of the basics of computer-aided design is a must for engineers who want to achieve their career objectives. This self-teaching book provides that know-how in a logical, easy-to-follow presentation.  
582855-3 Pub. Pr., \$42.50 Club Pr., \$33.95

**ELECTRONIC NOISE.** By A. Ambrózy. 281 pp., illus. The data you'll find here will help you understand and cope with noise in all types of circuits. Covers noise parameters of linear networks, measurement techniques, effects of nonlinear transfer characteristics, and more.  
011/249 Pub. Pr., \$44.50 Club Pr., \$34.25

Be sure to consider these important titles as well!

**ENCYCLOPEDIA OF COMPUTER SCIENCE.** By A. Raiston and E. D. Reilly, Jr.  
582794-8 Pub. Pr., \$87.50 Club Pr., \$49.95

**VLSI SYSTEM DESIGN.** By S. Muroga.  
582823-5 Pub. Pr., \$34.95 Club Pr., \$26.50

**MICROPROCESSOR SUPPORT CHIPS: Theory, Design, and Applications.** By T. J. Byers.  
095/183 Pub. Pr., \$43.50 Club Pr., \$35.25

**ENGINEERING FORMULAS, 4/e.** By K. Gieck.  
232/199 Pub. Pr., \$18.95 Club Pr., \$14.50

**ELECTRONICS CIRCUITS NOTEBOOK.** Edited by S. Weber.  
192/448 Pub. Pr., \$37.50 Club Pr., \$27.50

**ANALYSIS AND DESIGN OF DIGITAL INTEGRATED CIRCUITS.** By D. A. Hodges and H. G. Jackson.  
291/535 Pub. Pr., \$40.00 Club Pr., \$32.50

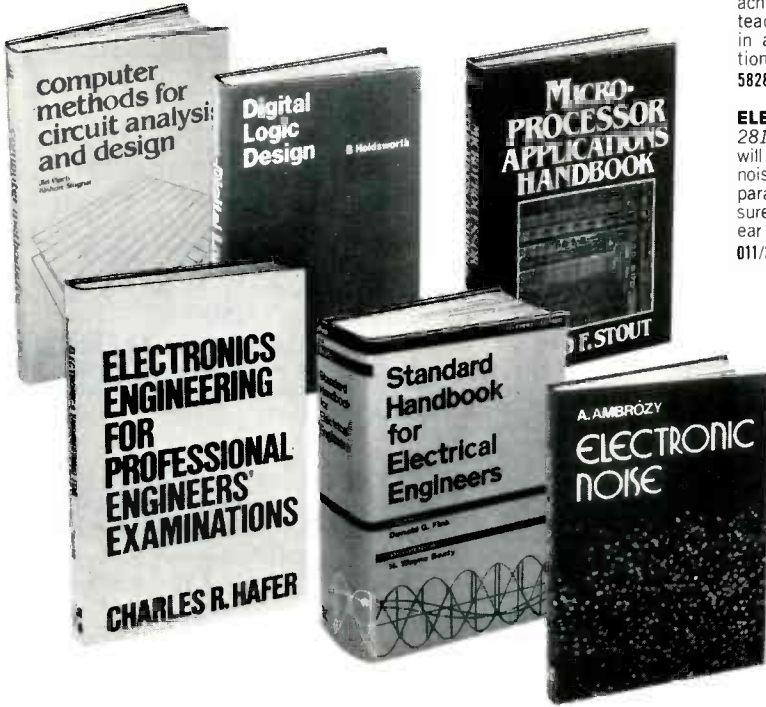
**HANDBOOK OF OPERATIONAL AMPLIFIER CIRCUIT DESIGN.** By D. E. Stout & M. Kaufman.  
617/97X Pub. Pr., \$48.50 Club Pr., \$34.95

**ENGINEERING MATHEMATICS HANDBOOK, 2/e.** By J. J. Tuma.  
654/298 Pub. Pr., \$41.50 Club Pr., \$28.95

**DIGITAL COMMUNICATIONS.** By J. Proakis  
509/271 Pub. Pr., \$42.95 Club Pr., \$31.50

**SIGNALS AND SYSTEMS.** By A. Oppenheim, A. Willisky, and I. Young.  
582674-7 Pub. Pr., \$36.95 Club Pr., \$28.95

**MAINTAINING AND REPAIRING VIDEOCASSETTE RECORDERS** By R. L. Goodman.  
582895-2 Pub. Pr., \$15.45 Club Pr., \$12.50



## Why YOU should join now!

- **BEST AND NEWEST BOOKS IN YOUR FIELD** — Books are selected from a wide range of publishers by expert editors and consultants to give you continuing access to the best and latest books in your field.
- **BIG SAVINGS** — Build your library and save money too! Savings ranging up to 30% or more off publishers' list prices — usually 20% to 25%.

**BONUS BOOKS**—You will immediately begin to participate in our Bonus Book Plan that allows you savings up to 70% off the publishers' prices of many professional and general interest books!

- **CONVENIENCE** — 12-14 times a year (about once every 3-4 weeks) you receive the Club Bulletin FREE. It fully describes the Main Selection and Alternate Selections. A dated Reply Card is included. If you want the Main Selection, you simply do nothing — it will be shipped automatically. If you want an Alternate Selection — or no book at all — you simply indicate it on the Reply Card and return it by the date specified. You will have at least 10 days to decide. If, because of late delivery of the Bulletin you receive a Main Selection you do not want, you may return it for credit at the Club's expense.

As a Club member you agree only to the purchase of three books (including your first selection) during your first year of membership. Membership may be discontinued by either you or the Club at any time after you have purchased the first selection plus two additional books.

**Other McGraw-Hill Book Clubs:**  
Architects' Book Club • Byte Book Club • Chemical Engineers' Book Club  
• Civil Engineers' Book Club • Mechanical Engineers' Book Club

For more information, write to:  
McGraw-Hill Book Clubs, P.O. Box 582, Hightstown, New Jersey 08520



### MAIL THIS COUPON TODAY

McGraw-Hill Book Clubs  
Electronics and Control Engineers'  
Book Club®  
P.O. Box 582, Hightstown, New Jersey 08520

Please enroll me as a member and send me the two books indicated, billing me for the \$2.89 premium and my first selection at the discounted member's price, plus local tax, shipping, and handling charges. I agree to purchase a minimum of two additional books during my first year of membership as outlined under the Club plan described in this ad. A shipping and handling charge is added to all shipments.

Write Code No. of  
\$2.89 selection here

Write Code No. of  
first selection here



Signature \_\_\_\_\_

Name \_\_\_\_\_

Address/Apt. # \_\_\_\_\_

City \_\_\_\_\_

State \_\_\_\_\_ Zip \_\_\_\_\_

This order subject to acceptance by McGraw-Hill. All prices subject to change without notice. Offer good only to new members.

E33737

the wavelength of the signal in free space. Therefore, when calculating the length of a section of transmission line, you must compensate for a characteristic called velocity of propagation. For solid-dielectric coax, the velocity factor is 0.66; the velocity factor is 0.85 for foam-dielectric coax. Thus a piece of solid-dielectric coax that is one wavelength long will be only 66% as long as the wavelength of the signal in free space.

Let's next calculate the dimensions of the array shown in Fig. 5. We'll use 100 MHz, the center frequency of the FM band, as our design frequency. In free-space:

$$\begin{aligned}\lambda &= 11,700/f \text{ inches} \\ \lambda/2 &= 5850/f \text{ inches} \\ \lambda/4 &= 2925/f \text{ inches}\end{aligned}$$

where  $\lambda$  is the wavelength and  $f$  is the frequency in MHz. At 100 MHz, one wavelength is 11,700/100, or 117 inches. Vertical spacing between the antennas is 81.9 inches ( $117 \times 0.7$ ) while the horizontal offset or staggered dimension is 2925/100, or 29.25 inches. The solid-dielectric coax connecting the antenna array to the coupler consists of two lengths. The shorter length, which measures  $L$  inches, connects the bottom antenna to the coupler. The other section is a quarter wave longer, so it measures  $L + 19.3$  inches ( $66\% \times 117/4$ ).

### Horizontal stacking

When the reflected signal arrives from an angle to the right or left of the direct signal, two high-gain directional antennas can be stacked horizontally (side-by-side) and aimed for maximum pickup of the direct signal. Their center-to-center spacing can be adjusted to develop a null in the pattern corresponding to the angle of arrival of the reflected signal. Figure 6-a shows that at some spacing,  $H$ , between the antennas, the reflected signal arrives at an angle corresponding to one of the minor lobes in the pattern. In that situation, multipath distortion will be severe.

To minimize that distortion we can "warp" the response pattern so the reflected signal falls at a null between the major and minor lobes as shown in Fig. 6-b. When that occurs, the reflected signal "sees" half-wave or  $180^\circ$  spacing between the two antennas. When that happens, the signal voltages induced in the two antennas are  $180^\circ$  out of phase, so they cancel at the coupler.

On the other hand, the antennas are oriented so that the direct signal reaches both simultaneously. That means that the signals are in phase. The overall result is a 3-dB increase in the strength of the direct signal and the cancellation of the reflected signal.

Success in cancelling the reflected signal depends on how precisely we know the value of  $\theta$ , the angle between the direct and the reflected signals. When the location of the reflecting surface is not known,

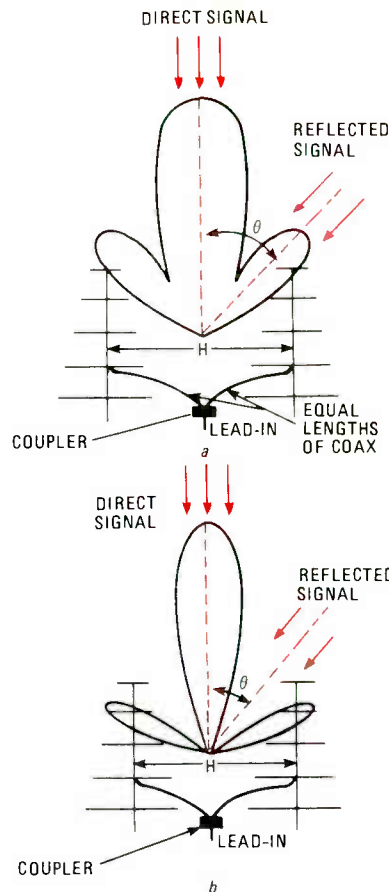


FIG. 6—WITH HORIZONTAL STACKING, at some spacing,  $H$ , the reflected signal will arrive at an angle corresponding to one of the antenna system's minor lobes; that is shown in *a*. It is possible to alter the spacing between antennas so that the reflected signal comes in at an angle corresponding to a null between the lobes; that is shown in *b*.

you can measure  $\theta$  by first orienting the antenna for best reception of the direct signal and then repositioning it for best reception of the reflected signal. The spacing between antennas,  $H$ , can be determined from:

$$H = (\lambda/2)\sin\theta$$

where  $H$  and  $\lambda$  are in inches.

Let's see how that formula is used to calculate  $H$  by looking at an example. Let's assume that the carrier frequency of the incoming signal is 100 MHz, and that the angle  $\theta$  between the direct and the reflected signals is  $40^\circ$ . First,  $\lambda$  is equal to  $11700/100 = 117$ . Plugging into the equation,  $H = (117/2)\sin\theta = (117/2)0.6428 = 117/1.285 = 91.4$  inches.

The graph in Fig. 7 shows the relationship between  $\theta$  and the center-to-center spacing,  $H$ , in wavelengths. Note that as  $\theta$  increases beyond  $30$  degrees, the spacing is quite small, and the antenna elements may touch or overlap. In such cases, space the antennas an odd multiple of  $H$  apart. That allows clearance without changing the response pattern.

### Diversity reception

While eliminating multipath distortion

for a home receiving setup presents relatively few problems, the same can not be said for car setups. There, the directional signal path between the FM transmitter and the moving car is constantly changing. At times the received signal is severely attenuated or completely blocked, causing fading and "drop out." At other times, the car's antenna picks up signals reflected from the ground, buildings, hills, etc. As the car moves, the phase relationships between the direct and reflected signals are constantly changing, adding and then subtracting at random rates to vary the instantaneous signal strength, producing a multipath distortion

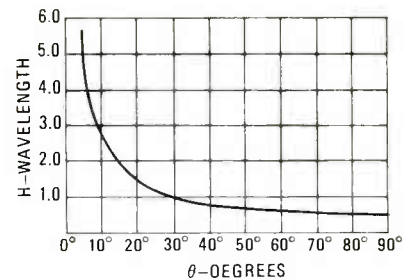


FIG. 7—THIS CHART shows the relationship between the angle  $\theta$  and the proper spacing in wavelengths between antennas in a horizontally stacked system.

called "flutter" or "picket-fencing."

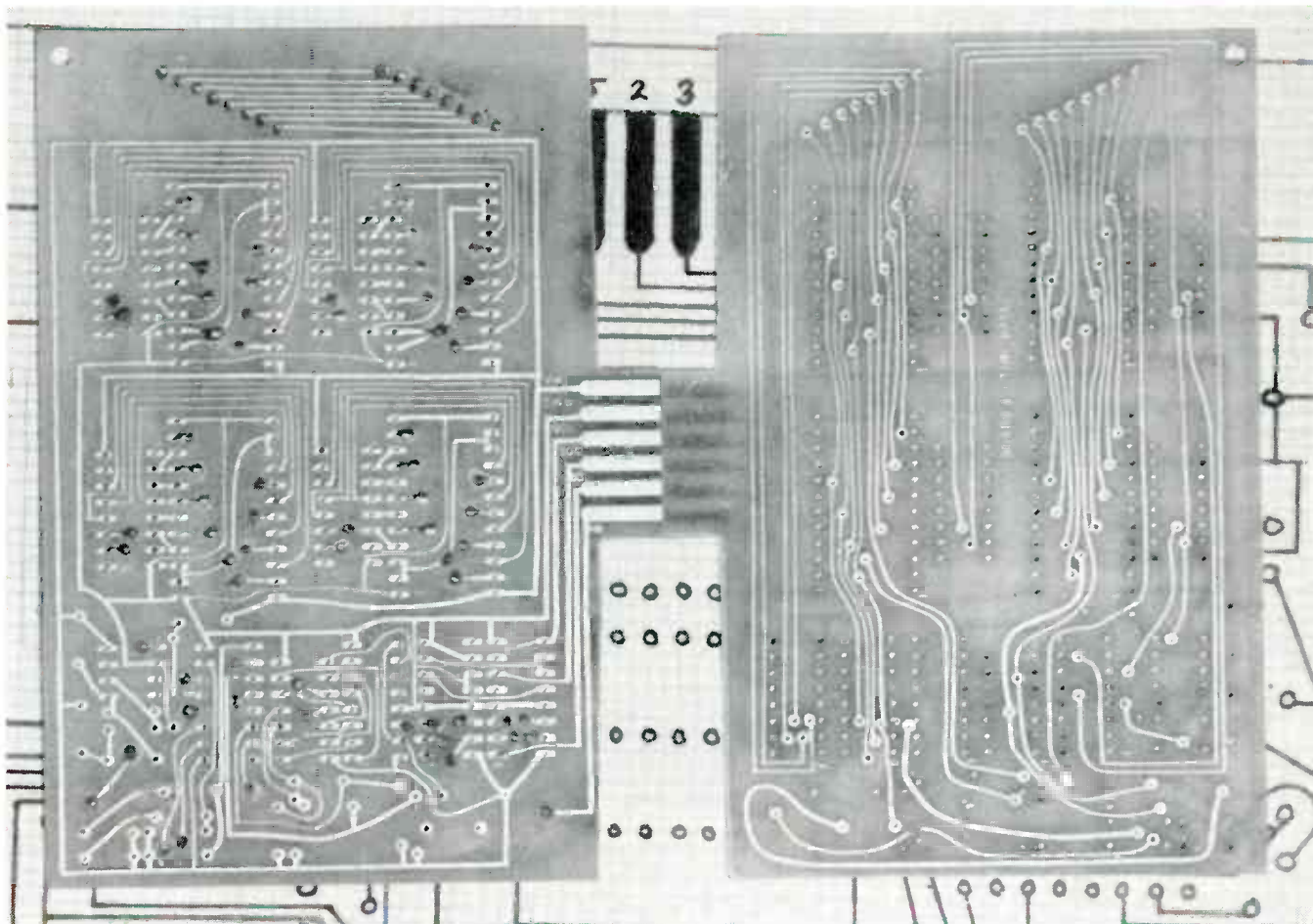
It was discovered many years ago that signal strength at a particular moment may be quite different at antennas spaced just a few wavelengths apart. A technique to eliminate the above mentioned receiving problems, called diversity reception, takes advantage of that phenomenon by feeding an FM receiver from two antennas. The theory being that as the signal strength is fading on one antenna, it will be constant, or even increasing on the other. A diversity receiver is designed to determine which antenna is providing the strongest signal at a particular moment and to switch to that antenna.

Figure 8 is a block diagram of a diversity receiver. As is shown, such a receiver features two antennas, two tuner front ends, two IF amplifiers, two FM detectors, a common local oscillator, and a comparator. Clarion Corp. of America (5500 Rosecrans, Lawndale, CA 90206) sells a diversity receiver, the Audia DTX-1000 shown in Fig. 9. In that receiver, a common local oscillator tunes both tuners to precisely the same frequency. The signals in the two IF-amplifier systems are rectified separately to develop signals consisting of a direct-path voltage and a multipath voltage.

Amplitude modulation (AM) and phase modulation (PM) components develop when an out-of-phase multipath signal is combined with the direct signal. The AM components of the multipath sig-

*continued on page 115*





## Designing Double-sided PC Boards

*Making a double-sided PC board is child's play when designing one. Here are a few hints to ease the design process.*

ROBERT GROSSBLATT

**Part 2** LAST MONTH WE WERE outlining methods of routing traces on the PC board. Let's finish that discussion and go on to the actual etching process.

We've discovered a few general rules that should be kept in mind when routing traces.

1. You can route a trace through IC pins on the foil side, but doing it on the component side is asking for trouble.
2. Power and ground connections should be made in each section separately. When the whole circuit has been laid out, the individual sections can be joined.
3. Keep all traces except those going between IC pads, at least one tenth of an inch (two divisions on the graph paper) away from the IC pads. That leaves room for solder pads.
4. Bus lines that have to be routed to

many IC's on the board should be handled as in number 2 above.

If you look at a commercially made board, you'll see that traces are routed through IC pins on both sides of the board. Now, you can lay out your board that way; it's easy to do things like that on paper. But when the time comes to actually make the board, you're going to regret it. If your registration or drilling is even the slightest bit off, you're going to be swamped with shorts and broken traces. And if you use IC sockets, (and you should!), the traces most likely to be causing the problem will be hidden under the wall of the socket.

After you get the IC's drawn in, connect the power, ground, and whatever other pins have to be joined. Once you've done that, start drawing in the other components that are part of this section of the

circuit. Don't forget to draw the pads and outlines of the components on the top side of the board. Put in the traces you need to connect everything together, making sure you leave an escape path for the traces that have to go somewhere else on the board.

Getting traces from one side of the board to the other is a major problem with home-made double-sided boards. Commercially made boards use plated-through holes, but we've never found a reliable way to make plated-through holes at home. The best way is to "fake it" by using a component leg as a feedthrough. By drawing solder pads in register on both sides of the board, you can easily get a trace to the other side of the board. The real problem comes with traces that connect only to IC's.

There are a couple of options to handle that type of situation. Which one you

choose depends on your circuit, your patience, and your concern with the final appearance of the board.

- Drill slightly larger holes that can fit a small wire as well as the IC leg and solder the wire to the pads on both sides of the board.
- Use wirewrap sockets and leave them sitting a quarter of an inch or so above the component side of the board so you can solder to the pad on the component side.
- Use Molex pins instead of IC sockets.
- Draw in solder pads for small pieces of wire used only for connecting the two sides of the board.
- Don't use sockets and solder directly to the IC legs.

Not all those choices are practical. Not using sockets is ridiculous and drilling larger holes can be dangerous. The other three options depend on how you want the final board to look, and what plans you have for producing the board. If you're going to have the board commercially made, using wire-wrap sockets or Molex pins is good because the holes can be plated through by the people that make the board. If your board will only be made at home, you can draw in solder pads for through-the-board jumpers. The design of the board is slightly more complicated when you use that method, and assembly is a bit more work. But the advantages are that it can be done at home and the holes can be plated through later on.

Figure 5 shows the layout with the first section of the circuit drawn in. You can see that extra pads were used for the feedthroughs needed to get some connections to other parts of the circuit. As you're doing the layout for your own

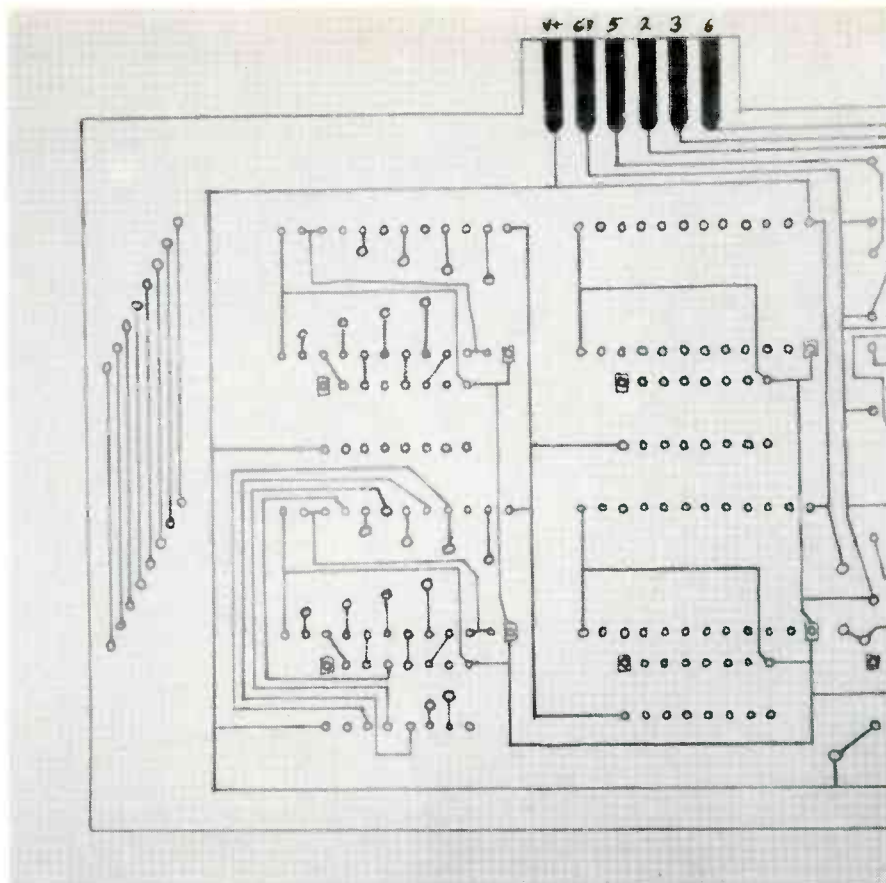


FIG. 6—FOIL PATTERN LAYOUT for the pairs of 4508's and 4040's.

board, it's a good practice to always end the I/O of each section in a place with room enough for feedthrough solder pads. That's true even if you decide to use some other method of jumping them to the other side of the board. No matter what kind of

PC design you're doing, always keep in mind that lost options are potential problems. In other words, until the final layout is done, don't eliminate any possibilities.

As you can see from the block diagram and schematic of our circuit, there is one large section made up of four identical pairs of IC's. (Each pair is made up of a 4508 and a 4040.) Since each of those pairs is connected in the same way, doing the layout for one means we've done the layout for all of them. In Fig. 6, the PC pattern for those parts has been drawn in. Most of the I/O has been brought over to the component side because the foil side got jammed up with the traces connecting the IC's together. Now that we're talking about traces on the component side, we should tell you how to decide which traces should be on which side of the board.

- Put traces on the component side only when there's absolutely no room on the foil side.
- Horizontal runs should be on one side of the board and vertical runs should be on the other.

If you pay careful attention to the first "rule," you may be lucky enough to find that you can add one or two jumpers and reduce the whole layout to a single-sided board. The importance of the second "rule" becomes evident when you get further into the layout. As you start laying out the traces on the foil side that are needed to connect the components together, there

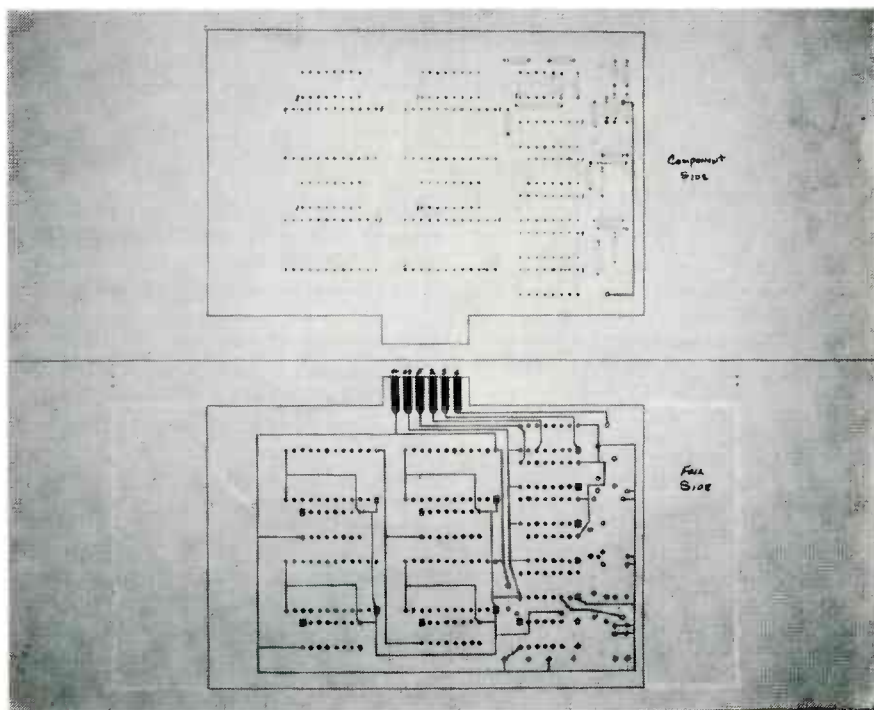


FIG. 5—THE I/O CONNECTIONS should be made first, as we have done here.



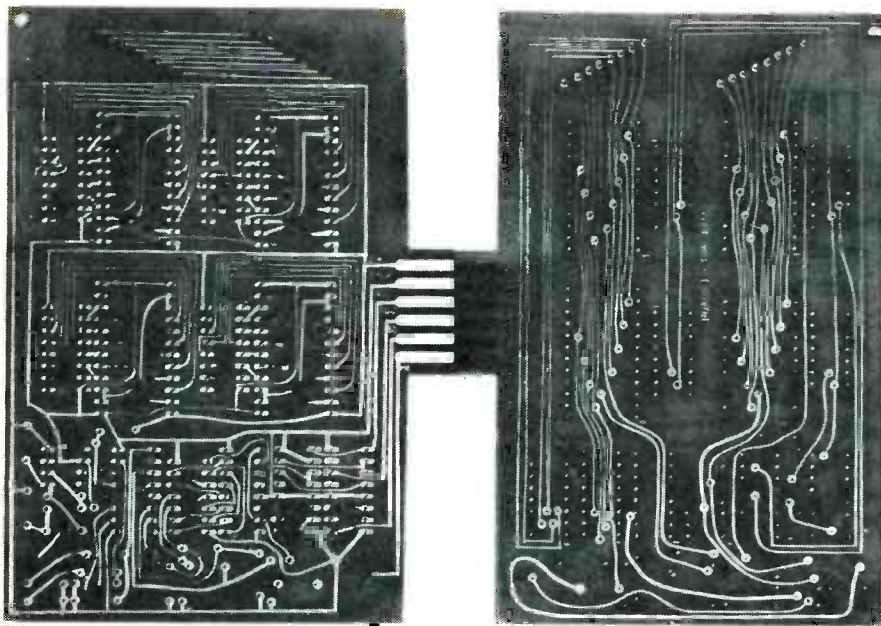


FIG. 7.—THE FINISHED LAYOUT is shown here on an etched board. Note how the traces run between the top and bottom of the board.

will be fewer open paths either vertically or horizontally, depending on your layout. Reserving a board side for each direction makes everything a lot more orderly.

You can see that extra board space was needed just for the I/O traces. That's why you should make the layout for each section as compact as possible. It's impossible to tell at the outset how much extra board space is going to be needed by the layout itself. If you have no restrictions on the size of the board, that's not much of a problem. But if the board has to fit somewhere in particular, you have to be very stingy in allocating board space as your design develops.

The actual procedure for running a continuous trace on both sides of the board is surprisingly easy. Since we 'unfolded' the board, not only are both sides laid out in front of us but both of the layouts are correct left to right. Some other methods of doing double-sided layouts use tracing paper and light boxes and wind up giving you a reversed image of one side of the board. Double-sided layouts are complicated enough without having to work with backwards.

When you want to move a trace to the other side of the board, end the trace with a solder pad and then find the corresponding point on the other side of the board using the graph-paper lines as a guide. Use the dividers to transfer the distance from the baseline, checking it several times to make sure the dividers haven't slipped. Try to keep all the solder pads on the intersections of the graph paper lines; it's easier to keep from making mistakes that way.

As your layout gets near completion, it's not unusual for a trace to make several trips between both sides of the board. Just as traces fill up the foil side, the compo-

nents themselves will fill up the other side. And since you want to eliminate as many problems as possible, try to keep the traces on the component side of the board as far as you can from the components. That's particularly important with IC's, since the board space next to the holes is going to be permanently covered by the IC sockets.

Figure 7 is the completed board layout. It may seem to be complicated but that's only because it's our layout and not yours. Just as it is with schematics, the circuit is self evident to the person that drew it. By keeping everything in separate sections and building the final layout a section at a time, you can keep all of it straight in your mind. Of course it's always nice to put helpful labels, such as pin and part numbers, on the board. It can't hurt and it could save a lot of head scratching later on.

In Fig. 7, you can see that the power and ground connections have been made and brought out to two of the card-edge fingers. The thing to notice here is that the routing for these traces isn't a straightforward one. They wander over both sides of the board. If we had been connecting each section up as we went along, chances are the layout would have been a lot different looking. Not better, not worse, but only different.

After you've checked the connections against your paperwork and checked the paperwork against the breadboard, the time has come to use drafting aids to blacken the pads, doughnuts, and traces you've drawn in with the blue pencil. Keep things nice and neat and don't worry about the blue lines: standard lithographic film won't see them—all it knows about is black and white. Don't use drafting tape that's less than one sixteenth of an inch

wide because it's hard to get a successful etch with a line that's thinner than one thirty second of an inch thick. The traces themselves should be at least 0.2 inch apart for the same reason. If you're working at greater than double size, don't forget to multiply those dimensions accordingly.

Once things are all blacked in, put registration marks on the corners and the artwork is ready to take to your local lithographer. He can reduce your layout to the right size and make the necessary negatives or positives for you on lithographic film.

Now we get to the easiest part of the entire task, etching the printed-circuit board itself. Although that is a completely different topic from the one we've been dealing with in this article, we've assumed that you are familiar with the technique and have not covered it here. If that is not the case, you can learn about the etching process in "Etch Your Own PC Boards, a two part article that appeared in the January and February 1983 issues of **Radio-Electronics**.

#### Details, details!

One thing that hasn't been mentioned so far is that the secret ingredient to something as complex as a double-sided PC layout is an overwhelming attention to detail.

As your layout starts to unfold on paper, it gets easier and easier to make a mistake. An incorrectly transferred measurement, a wrong trace, IC's drawn in backward, etc. can be disastrous. *Be careful, and keep good notes!* By the time you finish



ONCE THE LAYOUT IS FINISHED, it's time to etch the board using chemicals and aids like the ones shown here.

the layout for the last section on the board, it's easy to forget what goes where in the first one.

Laying out a double-sided PC layout is much easier than you think it is. But like a lot of other things, the only way to learn how to do it is to do it. Start with a simple one, preferably a circuit for which you've already done a single-sided layout. The double-sided layout will make the board smaller and more compact. (The layout we've been using as an example stuffed 14 IC's and a bunch of other components onto a 3 x 5-inch board.) And though compactness might not be your goal, remember that you can always make a board bigger, but it's sometimes hard to make it smaller.

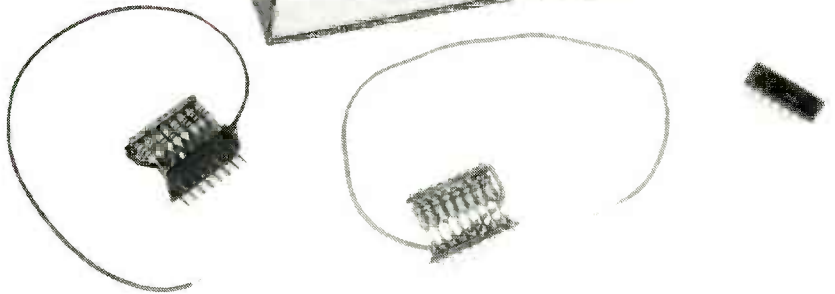
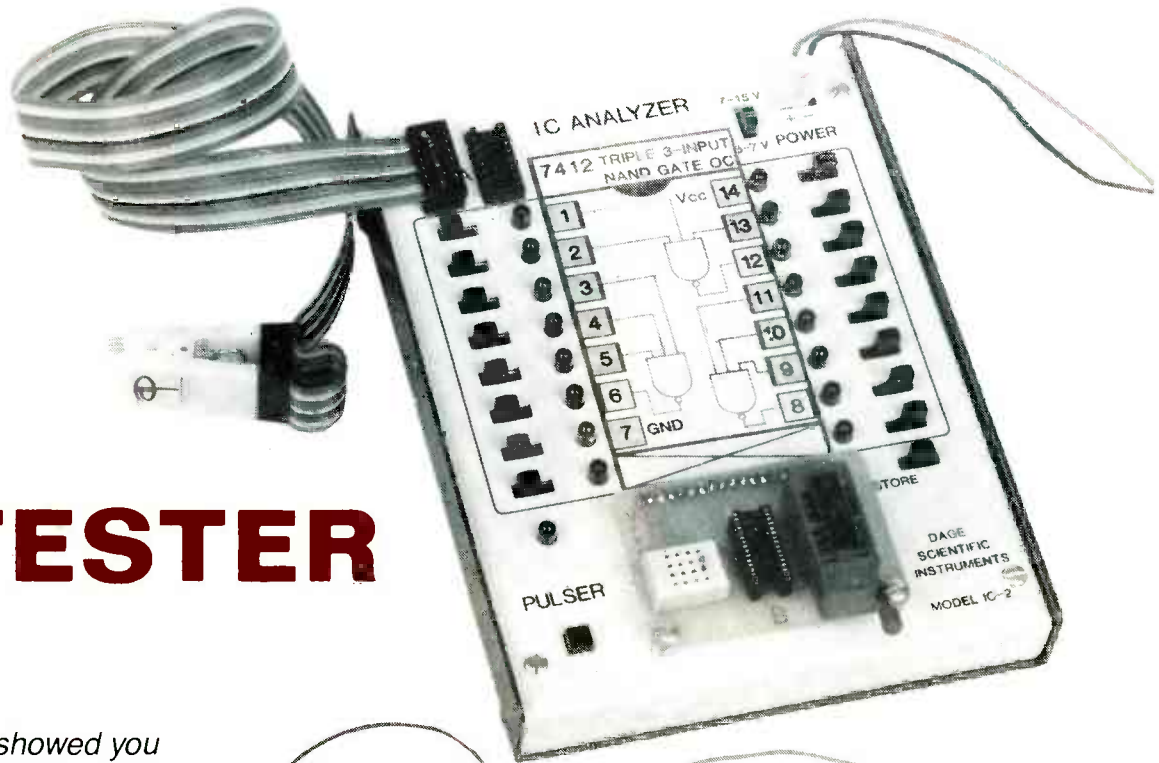
R-E

# BUILD THIS

## IC TESTER

DAVID H. DAGE

Last month, we showed you how to build an IC tester and analyzer. This month, we'll show you how to use it.



**Part 2** WHEN WE LEFT OFF last month, we had put the IC analyzer or tester together and had just finished checking its various functions. This month, we'll show you how to put the tester to work. Before we get started, we should mention that the foil pattern for the solder side of the main board was not shown in the "PC Service" section because of space restrictions. It does, however, appear this month. (See page 83)

### IC pinout cards

When using the IC analyzer as a monitor or tester, you must know how the IC is supposed to function, i.e., how the input pins affect the output pins. The IC pinout cards supply that information.

While the pinout cards cannot supply all the information that you would expect to find on data sheets, they can come surprisingly close. For example, see Fig. 12-a, which shows the pinout card for a 7400 quad NAND gate. To use the IC tester in its comparator mode, set each switch either IN (for an input) or OUT (for an

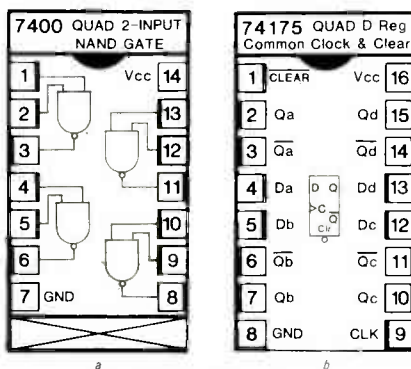


FIG. 12—THE PINOUT CARDS should contain as much information as possible.

output). Setting up the analyzer can be done quickly and easily if each pin on the card is marked appropriately.

A set of pinout cards for the 74xx series of ICs is available from the source mentioned in the Parts List. If you make up your own set, you'll want to include on the cards an easy way to distinguish between inputs and outputs. Our convention is to mark inputs with a bold line toward the

inside of the card, and outputs with a bold line toward the edge. You'll also want to indicate which inputs and outputs are numerically weighted, etc.

To monitor and check an IC, we need to know how its inputs affect its outputs. For the most part, that information will be obtained from reading the IC cards, and using a little prior knowledge. The 7400 card is an example of simple gates shown in symbols. Prior knowledge of gate operation is necessary in order to know that when pins 1 and 2 are high, the output at pin 3 will be low.

As another example, look at the 74175 quad D flip-flop with common clock and clear shown in Fig. 12-b. You may already know that a D-type flip-flop stores the data on its D input when clocked and that it may be preset (set) or cleared (reset). The data stored is available at the Q output, and its complement is available at the  $\bar{Q}$  output. The 74175 flip-flop can be cleared, but no preset is available. To clear the flip-flop, a low level signal is required (as indicated by the tiny circle). The flip-flop is clocked with a rising edge.



The title "quad D flip-flop with common clock and clear" indicates that there are four separate flip-flops that are clocked and cleared together. The four inputs, the four true outputs, and the four complemented outputs are designated with subscripts a, b, c, and d.

Putting all that together in words and using the pin designations on the card we have: data on pins 4, 5, 12, and 13 will be stored when pin 9 (clock) goes high providing pin 1 is high and remains high. This data will be present on pins 2, 7, 10, 15 and its complement on pins 3, 6, 11, 14 respectively. After pin 1 goes low, outputs on pins 2, 7, 10, and 15 will go low and pins 3, 6, 11 and 14 will go high.

### Using the analyzer

The IC analyzer requires an external source of between 5 and 15 volts DC. It draws approximately 300 mA with all LED's lit. If possible, you should power the analyzer from the circuit under test. For safety's sake, first connect the power cable to the circuit, and then measure the voltage magnitude and polarity at the cable connector. Place the power switch to the proper range, and only then connect the cable to the analyzer.

If the external circuit cannot supply the 300 mA needed, you'll have to use a separate power source. If you do that, it is important that the two supplies have a common ground (or that the individual grounds remain within 1/2 volt of each other).

The pinout card corresponding to the IC under test should be inserted in the analyzer, and all switches should be initially in the OUT position, as shown in Fig. 13. However, if you're testing 14-pin IC's, you may want to switch the two bottom (unused) switches to the IN position so that the LED's will stay off and won't be distracting.

The DISPLAY STORE switch should also be left in the OUT (not stored) position until needed. When installing IC's or the DIP clip, always orient pin 1 correctly. Pin 1 is always at the top left—even when installing 14 pin devices.

Be aware of the voltages present on an in-circuit IC before connecting the DIP clip. Many IC's operate as input or output buffers and their pins may not be at logic voltage levels. Any IC with open-collector outputs should be suspect. Remember to orient the DIP clip to pin one.

### Using the pulse stretcher

Connection to the pulse stretcher is made at the second row of SO3, the solderless breadboard. Any transition from high to low (or low to high) greater than 20 ns will cause the pulse-stretcher LED to

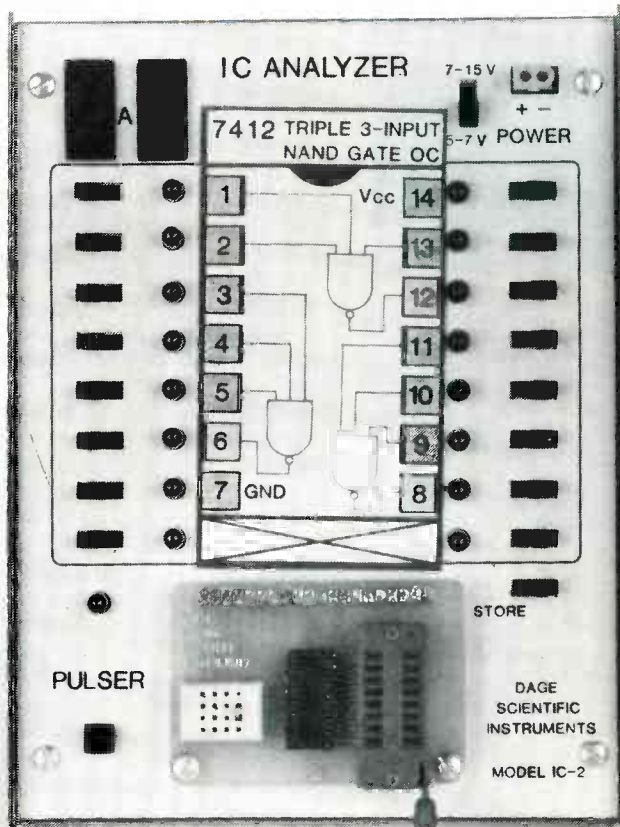


FIG. 13—WHEN THE PINOUT CARD is mounted on the front panel, the function of each switch becomes apparent. And since each IC has its own card, no numbering confusion exists between 14 and 16 pin IC's.

blink on for about 50 ms. Rapid pulse activity below 50 MHz will cause the LED to blink continually. Connecting the pulse stretcher to an in-circuit IC is usually made by connecting the IC to one of the A sockets (using the DIP clip) and connecting the pulse stretcher input from socket B to socket A using an 8-inch length of 24-gauge solid wire stripped at both ends.

### The pulser

The pulser or pulse generator is accessed at the third row of the solderless connector, SO3, and it can be connected to an in-circuit IC in the same manner as described for the pulse stretcher. The pulse generator senses the external logic level, and when the PULSER pushbutton (S19) is pressed, it will drive the circuit to the opposite state. If S19 is held closed for more than 2 seconds, the generator will deliver a 100-pps pulse train as shown in the oscilloscope photograph of Fig. 14.

Let's see how we would use the pulse generator to troubleshoot the circuit shown in Fig. 15. Suppose we want to

verify that the AND gate IC1-a is operating properly, and suppose that an initial check shows that pin 2 is high and pin 1 is low. In order to see if the gate is operating correctly, we have to override the low level output from IC1-c. The pulse generator output is connected to pin 1 of IC1-a and is activated. If the circuit is operating properly, pin 3 should change state. If it doesn't, both pin 1 and pin 3 must be monitored.

If pin 1 is shorted to ground (and therefore cannot be pulsed), monitoring pin 3 is useless. So let's assume at this point that pin 1 did go high when pulsed, but pin 3 stayed low. One of the internal components of the gate could be faulty, holding pin 3 low. Let's label this a "logic short," which is typically several ohms. Pin 3, on the other hand, could be shorted externally by a solder bridge or an unetched PC trace. Let's label this kind of a short as a "hard short," which is typically less than an ohm.

The pulser can change the level of a logic short but not of a hard short. If you verify that pin 1 pulsed high but pin 3 did

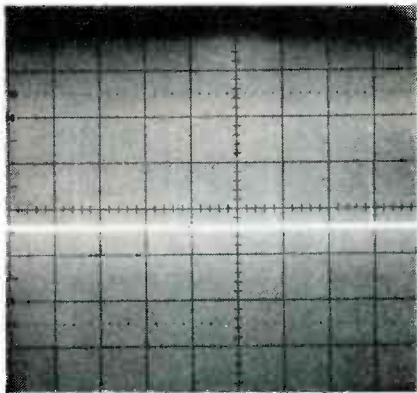


FIG. 14—THE PULSER OUTPUT is shown on this oscilloscope photograph. (Courtesy Tektronix.)

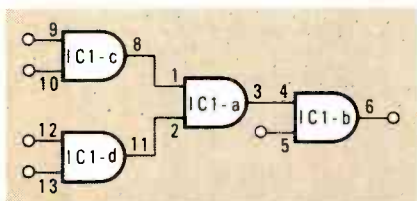


FIG. 15—TROUBLESHOOTING THIS CIRCUIT is easy using the IC tester.

not, the pulser should then be connected to pin 3 and pulsed. If pin 3 can't be pulsed with the pulse generator, look for an external short first before replacing gate A. By using the pulse generator in this manner it is possible to distinguish between logic shorts and hard-wire shorts.

While hard shorts can occur in IC devices, they are not as common as logic shorts. To complicate matters, shorts may exist between inputs (pin 1 and 2), between outputs, outputs to inputs, and circuits shown here to circuits on the other side of a schematic. When using the pulse generator along with the monitor, observe any input or output that changes.

If both pins 1 and 2 are low, they could be connected together and pulsed. The pulse generator has plenty of power to pulse several inputs at once. By tying pins 1 and 2 together, output pins 8 and 11 are also tied together. Should pin 11 change state, it would be shorted through output pin 8. Diodes can be used to pulse more than one input while maintaining output isolation. Use diodes with a low forward drop, such as germanium or Schottky diodes.

### Using the in-circuit monitor

To use the IC analyzer as an in-circuit monitor, it should be set up as follows:

- Connect power from circuit under test (or a separate supply)
- Connect jumper cable to socket "A".
- Connect shorting plug to socket "B" and ground at solderless connector.
- Place all IC switches, including the DISPLAY STORE switch, to the OUT position.

Select the appropriate IC card, insert it

into the IC analyzer, and connect the DIP clip to the in-circuit IC. If an LED is off, then the corresponding pin is at a low logic level. If the LED is on, then the pin is either at a high logic level or it is pulsing rapidly. A blinking LED indicates slow pulse activity.

The A sockets (SO1 or SO2) are directly connected to the IC under test. Voltage measurements can be made at that point with an oscilloscope or voltmeter. The built-in pulse generator and pulse stretcher can also be connected there.

When an LED is on, its meaning is ambiguous—it can mean that the pin is at a steady state or that it is pulsing rapidly. However, you can determine which state it's really in by using the pulse stretcher.

To determine pulse activity, the built in pulser detector could be connected to one pin at a time at socket "A". That's the recommended procedure when tracing logic or using the pulser. However a much faster method is available. With the shorting plug grounded, the LED will be on if the logic voltage is high or rapid pulse activity is present. If you lift the shorting plug's ground and the LED remains on, rapid pulse activity is present. If the LED goes off, the voltage level is high with no pulse activity. Lifting the ground on the shorting plug to observe pulse activity can be accomplished very quickly. The monitor circuit alone is capable of detecting single pulses greater than 1  $\mu$ s. They are stored in a flip-flop until reset by the internal 100-pps generator.

If you remove the shorting plug from ground, the LED's will display the complemented logic, i.e. on for low, off for high. That is useful when observing complemented inputs or outputs. As an example, the 7447 decoder that is driving a 7 segment display will have active low output when displaying a segment. By using the compliment a lighted LED will correspond to a display segment that is on.

### Pull-up plugs

For TTL devices, a floating input is considered to be high. However, depending on internal leakage, its voltage could fall into the undefined area of 1.7 volts or so. Since many designers choose to leave unused TTL inputs floating, incorrect monitoring may result.

That problem can be eliminated by using the pull up plug. Insert it into the A socket and connect its lead to +V<sub>CC</sub> at the solderless connector.

CMOS devices have very high input impedances, and their inputs must not be left unconnected (floating). A floating CMOS input can, and will, switch from one state to the other. For new designs, that can make troubleshooting difficult.

The pull-up plug can be installed in one of the A sockets and alternately connected from +V<sub>CC</sub> to ground at the solderless connector. Any input which changes

### ORDERING INFORMATION

The following are available from Dage Scientific Instruments, P.O. Box 144, Valley Springs, CA 95252: Plated-thru PC boards, IC pin-out cards and detailed instructions (order number IC-18), \$30.00 plus \$2.00 shipping. Complete kit of parts less chassis, DIP-clip cable, and sockets (order number IC-20), \$79.95 plus \$3.00 shipping. Complete kit, includes assembled dip-clip cable, zero insertion force socket, even solder (order number IC-22) \$119.00 plus \$4.00 shipping. California residents please add sales tax. Countries other than U.S.A. and Canada, please add \$8.00

when the pull up plug is changed should be examined more closely. The pull-up plug is not needed for normal CMOS operations, and should be removed from the circuit after checking the inputs.

### The in-circuit comparator

To use the in-circuit comparator:

- Connect power from the above circuit.
- Connect the jumper cable with DIP clip to socket A.
- Place all switches in the OUT position.

Select the proper card and insert it in the tester. Then connect the DIP clip to the in-circuit IC and install a good IC in socket B. You are then ready to put the switches for ground, power, and the inputs to the IN position.

All the LED's should remain off if the in-circuit IC is operating properly. If an output LED blinks or stays on, something is wrong. If an input LED blinks or stays on, the input is probably floating and should be ignored. To catch and hold single momentary faults, switch S17 to the STORE position. To clear, press S19, the PULSER switch.

Output LED's will go on if an output pin on one IC changes more than 800 ns before the same pin on the other. The old style CMOS outputs called A-Series do not have the drive capabilities that the newer B-Series devices have. It is possible that the A-Series device is driving a large capacitive load and may take longer than 800 ns to switch. The analyzer's good IC is driving practically no load at all and therefore switches very rapidly. Viewing the output on a scope should reveal such timing problems.

For the comparison test to work, both IC's must be synchronized. As an example, assume that a 4060, 14-stage ripple counter is used as a simple divider and that the circuit does not require the divider to be reset or start from zero. To reset this device, pin 12 must be made high. If pin 12 is held low with a resistor, the pulse generator can reset both the in-circuit and the known good IC. They will now run in

*continued on page 115*



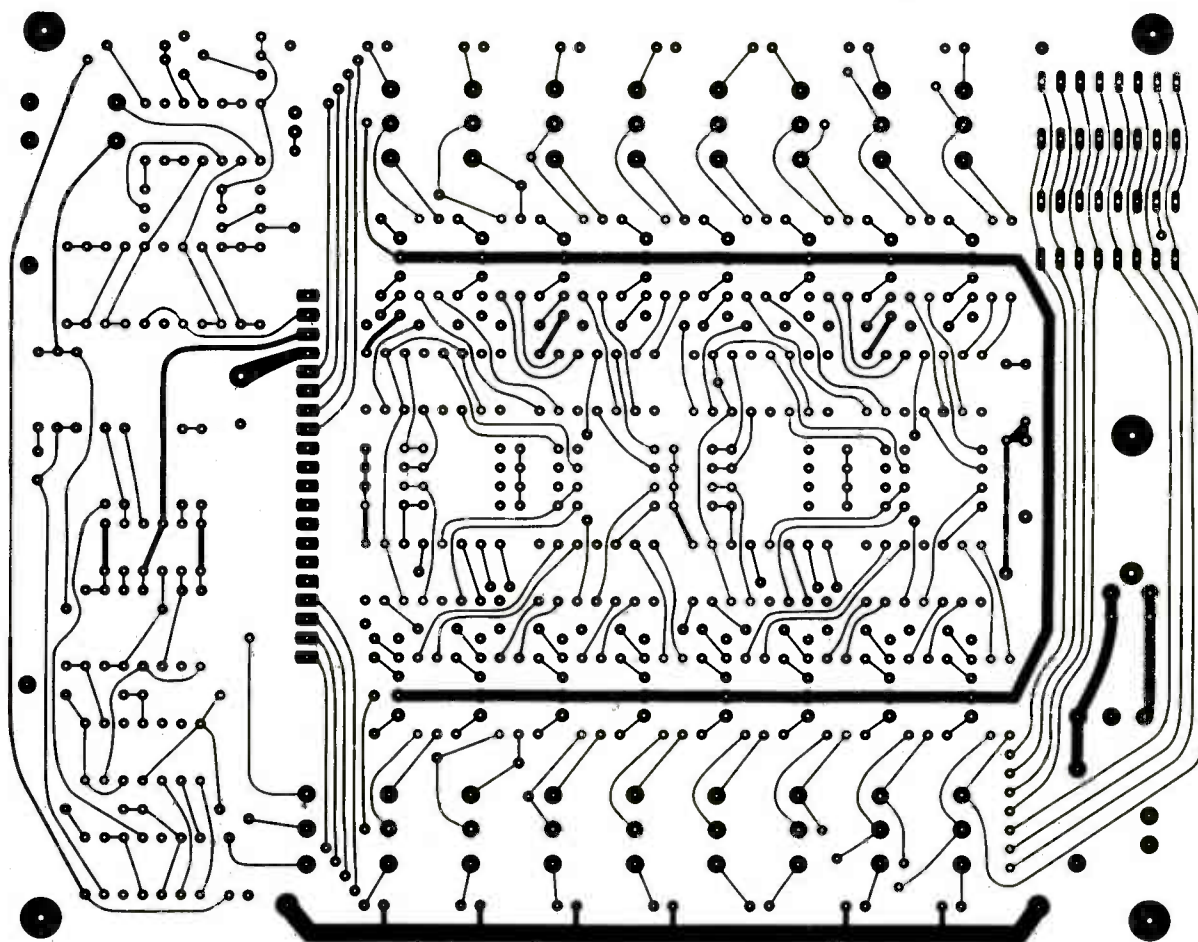
# PC SERVICE

One of the most difficult tasks in building any construction project featured in **Radio-Electronics** is making the PC board using just the foil pattern provided with the article. Well, we're doing something about it.

We've moved all the foil patterns to this new section, where they're printed by themselves, full sized, with nothing on the back side of the page. What that means for you is that the printed page can be used directly to produce PC boards!

In order to produce a board directly from the magazine page, remove the page and carefully inspect it under a strong light and/or on a light table. Look for breaks in the traces, bridges between traces, and, in general, all the kinds of things you look for in the final etched board. You can clean up the published artwork the same way you clean up your own artwork. Drafting tape and graphic aids can fix incomplete traces and doughnuts, and you can use a hobby knife to get rid of bridges and dirt.

An optional step, once you're satisfied that the artwork is clean, is to take a little bit of mineral oil and carefully wipe it across the back of the artwork. That helps make the paper translucent. Don't get any oil on the front side of the paper (the side with the pattern) because you'll contaminate the sensitized surface of the copper blank. After the oil has "dried" a bit—patting with a paper towel will help speed up the process—place the pattern front side down on the sensitized copper



6 1/2 INCHES

THE SOLDER SIDE OF THE IC TESTER BOARD. See page 80 for more information.

---

---

# PC SERVICE

blank, and make the exposure. You'll probably have to use a longer exposure time than you are used to.

We can't tell you exactly how long an exposure time you will need because we don't know what kind of light source you use. As a starting point, figure that there's a 50 percent increase in exposure time

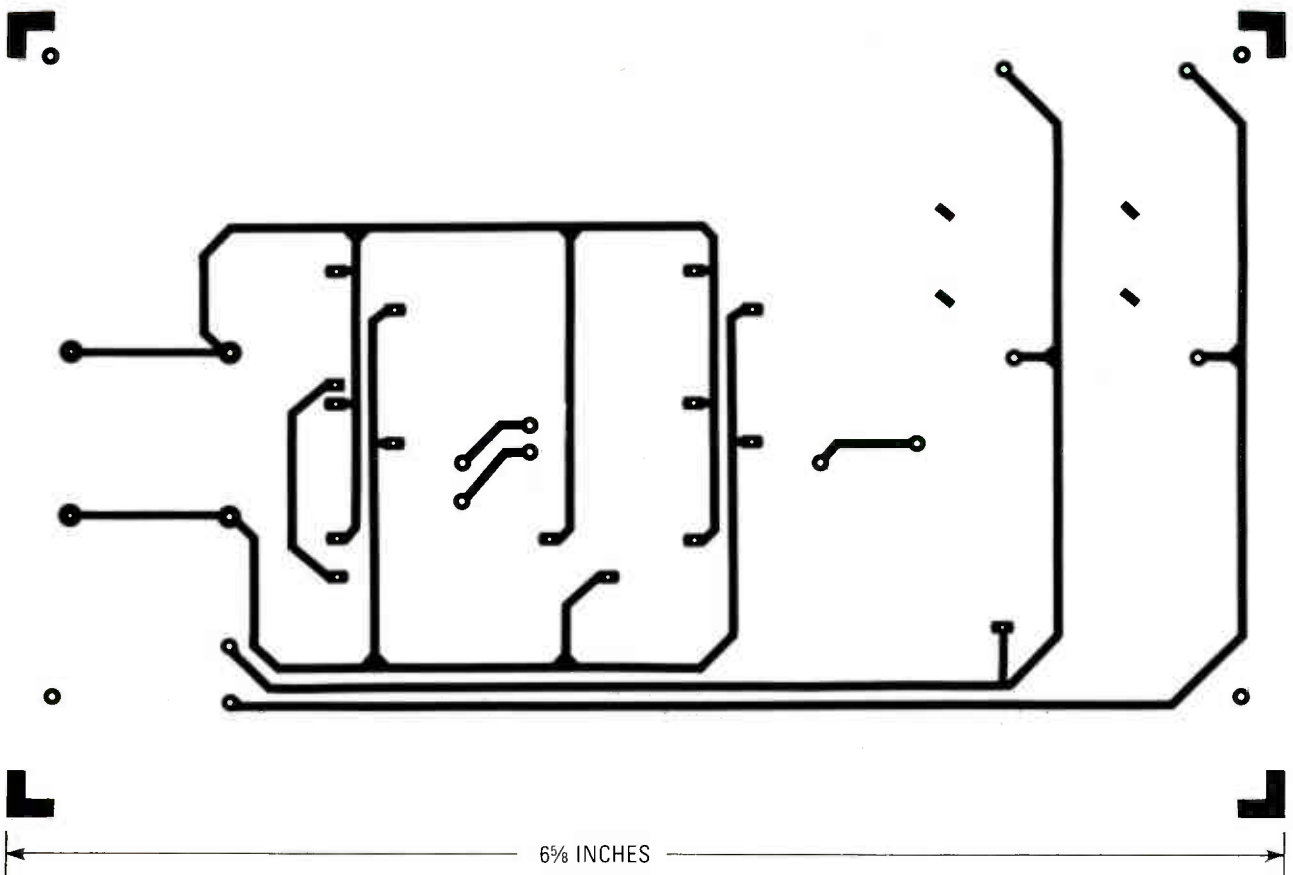
over lithographic film. But you'll have to experiment to find the best method to use with the chemicals you're familiar with. And once you find it, stick with it. Don't forget the "three C's" of making PC boards—care, cleanliness, and consistency.

Finally, we would like to hear how you

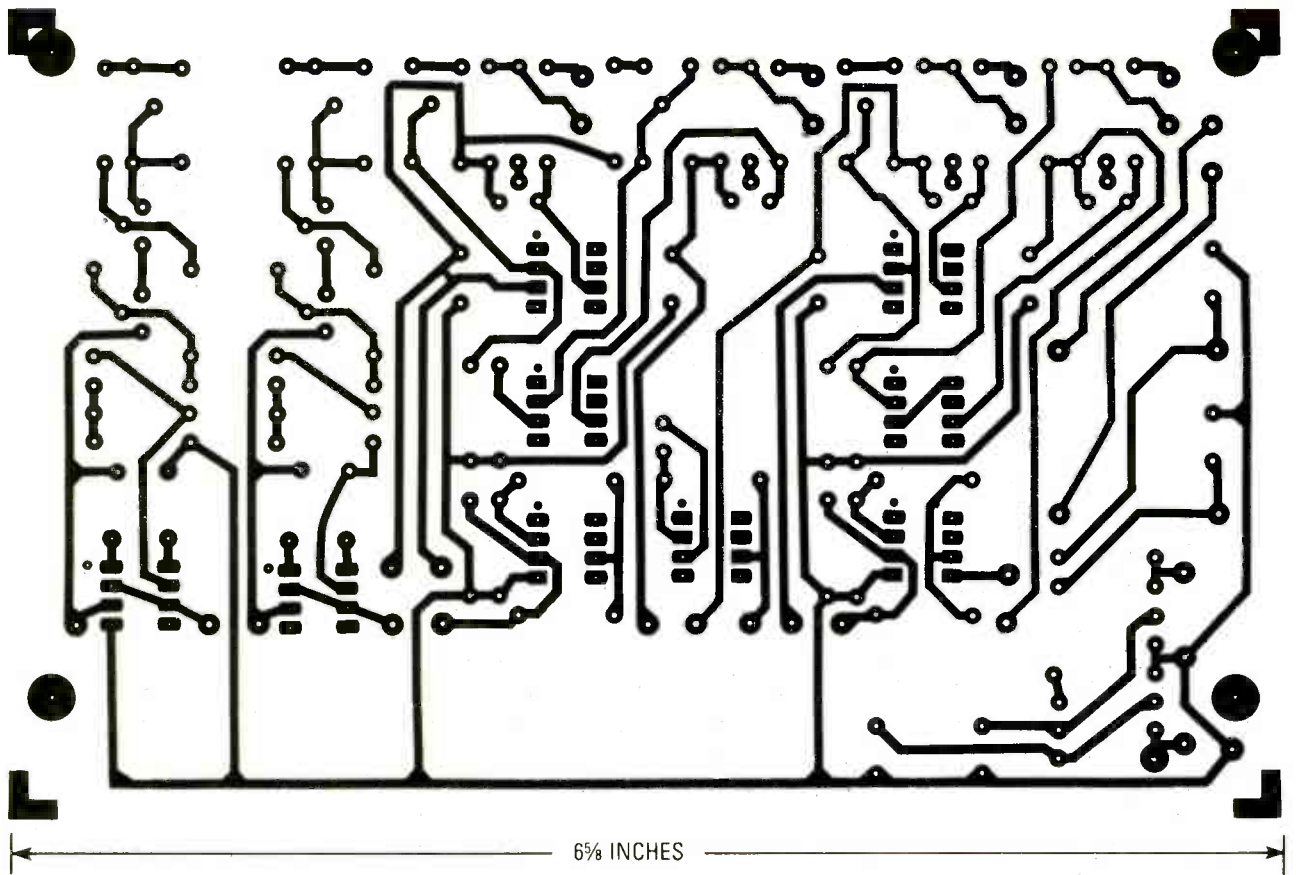
make out using our method. Write and tell us of your successes, and failures, and what techniques work best for you. Address your letters to:

**Radio-Electronics**  
Department PCB  
200 Park Avenue South  
New York, NY 10003





FOIL PATTERN for the Versatile Power Supply. The component side of the board is shown here.



SOLDER SIDE of the "Versatile Power Supply" PC board is shown here. For more information on the project, see page 53.



**ECG® IC's for Zenith "Z" Chassis**

Philips ECG has replacement integrated circuits for the 221-175, -179 and -190 in the Zenith System 3 "Z" chassis. They are the ECG873, 874 and 875. Just three of the hundreds of integrated circuits available from Philips ECG to replace literally thousands of part numbers. All are manufactured to meet OEM specs so you know they fit and they work.

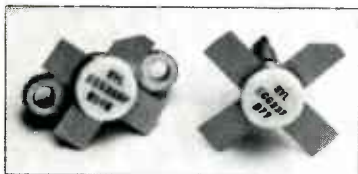
CIRCLE 310 ON FREE INFORMATION CARD



**ECG® Bipolar Transistors**

Philips ECG replacement leadership is obvious again. The ECG 29, bipolar transistor, used as a replacement in the fan motor control system of Cadillacs, has been added to the Philips ECG line. (The ECG29 replaces Delco part numbers 139DDF and 7391-BT). There are 322 other bipolar transistors in the Philips ECG line that replace thousands of other domestic and foreign transistor types.

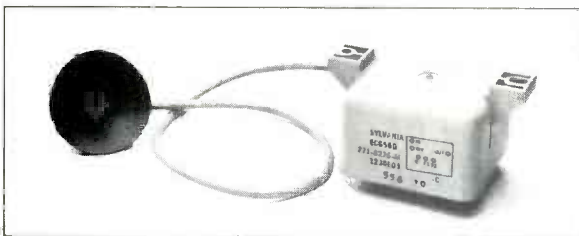
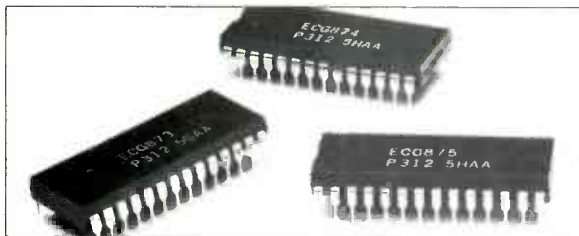
CIRCLE 311 ON FREE INFORMATION CARD



**ECG® RF Power Transistors**

Philips ECG power transistors are the ideal replacement RF power output devices for fire, police and taxi radios. They are suitable for transmitters and drivers up to 100 Watts RF power. They cover frequencies from the 13 to 30 MHz band to the UHF 806 to 870 MHz band. Most dealers will be happy to learn that Philips ECG replacement RF power transistors are designed to replace units in Asian and European equipment as well as domestic types. So, if it's ECG, it fits and it works... worldwide. Philips offers a selection of over 65 RF transistors that replace literally hundreds of domestic and foreign transistors in a broad range of frequencies.

CIRCLE 312 ON FREE INFORMATION CARD



**ECG® High Voltage Triplers**

You have a choice of 29 types of high voltage triplers from Philips ECG, and these 29 triplers replace hundreds of part numbers. Six step, five step, with damper, with resistor—you name it, Philips has it. For example, the ECG559 replaces the Zenith 212-148 and the ECG560 replaces the Zenith 212-147—and only Philips ECG has replacement parts for these Zenith types.

CIRCLE 253 ON FREE INFORMATION CARD

**The one thing we make that you have to replace every year.**



**The new and expanded ECG® Semiconductors Master Guide.**

Your new Master Guide will be looking as dog-eared as the old one before long. Because this year the Master Guide has been expanded to include more than 400 new products and almost 25,000 new cross references. The Master Replacement Guide for 1985. 656 pages. Over 3,500 different ECG devices that provide replacement coverage for more than 227,000 industry types. And everything in the book is cross-referenced so you can find what you're looking for fast, and be sure it fits. Plus, everything we make meets or exceeds the original JEDEC or application specs. So it

works. It's the only book you'll need. But you'll need a new one every year. To get a copy of the new Master Guide, go to your nearest Philips ECG distributor. For his name and location, just call: 1-800-225-8326 (in Mass., 617-890-6107).

**If it's ECG, it fits. And it works.**

**Philips ECG**

*A North American Philips Company  
Dedicated to Excellence.*

# ROBOTICS



MARK J. ROBILLARD  
ROBOTICS EDITOR

## Using a purchased robot in the lab

IN ORDER TO GET STARTED IN ROBOTICS experimentation it is very important to choose the right equipment. Whether you are experimenting with arm-type devices or fully intelligent mobile robots, one of the first decisions you'll have to make is whether to build a robot from scratch, buy a robot kit, or buy a pre-assembled robot. In previous columns I've discussed how to build your own robot out of readily available motors, wheels, and gears. This month we'll discuss the advantages of buying a robot kit, and take a detailed look at one popular kit.

Actually, there are many advantages to purchasing a complete robot kit, rather than building your own from scratch. To begin with, you don't have to go parts-hunting, so you can get right to work. In addition, the mechanical design has already been debugged; the gears fit together and the motors are the correct size. Last, and certainly not least, the electronic controller is debugged, and the operating-system software is usually supplied.

All in all you can save a lot of grief by buying a robot kit. One such kit, called the *Scorpion Mobile Robot*, is shown in Fig. 1. It is manufactured and sold by Rhino Robots, Inc. (3402 N. Mattis, P.O. Box 4010, Champaign, IL 61820).

### What is a *Scorpion*?

The *Scorpion* is a two-wheeled intelligent platform you communicate with from a remote computer or terminal. The *Scorpion* has its own built-in computer system. The 6502 microprocessor controlling the motors and sensors is the same as that used in the Apple II.

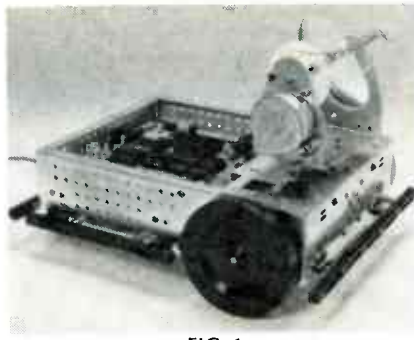


FIG. 1



FIG. 2

An 8K operating system that has been specifically designed for the *Scorpion* is supplied in ROM (Read Only Memory). In addition, there is 2K of RAM (Random Access Memory) available for user programs.

The I/O capabilities of the system are quite impressive. There are 32 lines of I/O, and provision has been made for adding even more I/O.

If, after experimenting, you find that you need more RAM for programs, more I/O for controlling external devices, etc., there are two 44-pin bus connectors on the PC-board that allow expansion through user-designed or commercially-available cards.

Communication with *Scorpion* is handled via an RS-232 serial link. Located on the *Scorpion* control board is a programmable UART (Universal Asynchronous Receiver Transmitter) with a built-in baud rate generator.

The mechanical system of the *Scorpion* is similar to the one used in the two-wheeled platform presented in last month's column. However, Rhino chose stepper, rather than regular, motors to allow more precise control over the robot's motion. A punched aluminum chassis provides support for the two steppers which are connected through gears to the main drive wheels. There are also two idler wheels; they are mounted near the back end of the *Scorpion*, one per side.

Figure 2 shows the major components of the *Scorpion* kit. What is not shown is the multitude of screws, wires, and other small components that are supplied by Rhino to make the *Scorpion* a complete, stand-alone kit.

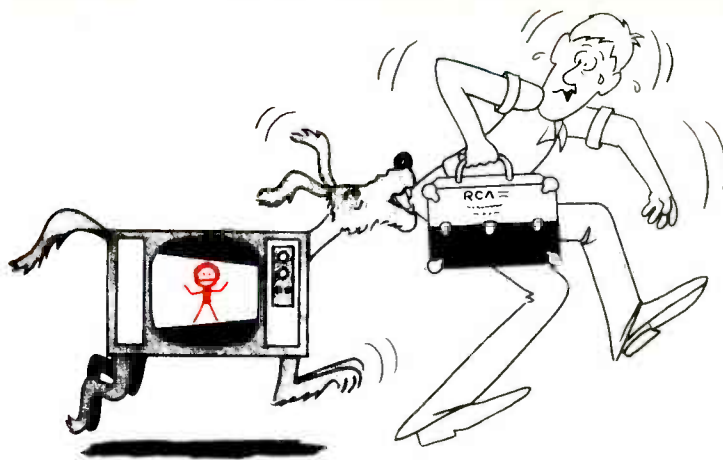
There is no power supply included with the *Scorpion*. Because the four stepper motors (two are used to control the robots motion; we'll get to the other two in a moment) draw a great deal of current, and the controller circuit uses power-hungry NMOS devices, you'll need a hefty supply. In fact, the required power is specified to be 12 volts at 5 amps. Sure, you're not always going to need 5 amps, but your power source must be capable of that much current for those times when all four steppers are running at once.

Let's look at those other two steppers. They perform a very interesting function. Looking back at Fig. 1, you'll notice a radar-like antenna mounted on the front of the *Scorpion* chassis. The manufacturer refers to that device as a *scanner*. It is actually a highly sensitive light meter.

The two stepper motors, one lo-



# How Many Times Do You Intend To Let "THE SAME DOG" Bite You ?



★ How many times have you worked all day long trying to diagnose the hi-voltage / LV regulator circuit of a set that is in shut down only to eventually find that a **shorted** video, color, vertical, tuner, AGC, or matrix circuit was causing the set to shut down and, to find that the hi-voltage / LV regulator circuit was working flawlessly all the time?

★ How many times have you spent the day looking for a **short** that was causing the set to shut down, only to eventually find that an **open** vertical, video, matrix circuit or, an **open** HV multiplier was to blame?

★ How many times have you worked all day on the same TV set, only to find out that the set's flyback transformer was defective?

★ How many flyback transformers have you replaced only to find that the original flyback was **not** defective?

★ How many horiz output transistors and Sony SG 613 **SCRs** have you destroyed while simply trying to figure out whether the flyback was good or bad?

★ How many times have you been deceived by your flyback "ringer"? Can you even count the number of hours that your "ringer" has caused you to waste?

★ How many times have you condemned a flyback, only to find that a shorted scan derived B+ source was causing the flyback to "appear" as though it were defective?

★ How many hours have you wasted, working on a TV set, only to find that the CRT had a dynamically shorted 2nd anode (to primary element)?

★ How many new sweep transformers have you unknowingly destroyed because a short existed in one of the scan derived B+ sources?

★ How many times have you said to yourself, "I could fix this --- thing if I could only get it to fire up long enough to lite the screen? --- without blowing an output transistor or a fuse. "

★ How many additional bench jobs could you have gotten, had you been able to give an accurate, "on the spot" estimate on sets that were either in shut down or, not capable of coming on long enough for you to analyze them?

If you had been using our all new Super Tech HV circuit scanner, you would have had an accurate evaluation concerning all of the above in about one minute, at the push of **just one** single button.

It's true! Push just one test button and our HV circuit scanner will (1) Accurately prove or disprove the flyback, (2) Check for any possible shorts in any circuit that utilizes scan derived B+, (3) Check the scan derived power supplies themselves for shorted diodes and / or electrolytic capacitors, (4) Check for primary B+ collector voltage and, (5) Check the horiz output stage for defects.

Our HV circuit scanner works equally well on sets with integrated or outboard HV multipliers. It will diagnose any brand, any age, solid state TV set including Sony. The only exceptions are sets which use an SCR for trace and, another for retrace (i.e., RCA CTC 40 etc.). Our scanner will not work on these sets.

**In plain English**, our HV circuit scanner is even easier to operate than a "plain vanilla" voltmeter.

First off, when you're using a scanner, you **do not** remove the flyback in order to check it. In fact, you don't even unhook any of the wires that are connected to the flyback! All you do is:

(1) Remove the set's horiz output device, plug in the scanner's interface plug, then make one single ground connection. That's all you do to hook it up.

(2) If the primary LV supply is functional and, assuming that the emitter circuit of the horiz output stage has continuity, the scanner will tell you that it is ready to "scan" by illuminating the "ready" light, which is the white button on the test / run switch.

(3) Press the spring loaded (test) side of the test / run switch and the scanner will "look" for any type of a **short** that might exist anywhere on the secondary side of the flyback, including the HV multiplier, any circuit that relies on flyback generated B+ and, including the flyback itself (both primary and all secondary windings). It will simultaneously check for a shorted LV regulator device HV multiplier, or an open or "partially" open safety capacitor.

If a short or, an "excessive load" exists on one secondary winding, all other secondary windings will have "normal" output voltage in spite of the short. Only the shorted winding itself will have zero volts on it. This makes shorted scan derived B+ sources incredibly easy to isolate. During this test, the 2nd anode voltage is being limited to approx 5 kv by the scanner.

If a short is present, the red "flyback" light will either lite, or flash (at various speeds), depending on which type of a short exists. If no shorts exist, the "flyback" light will be green.

Assuming that the "flyback" light is green, no **shorts** exist and, it is now time (and safe), to begin looking for **open** circuits which might be causing the set to shut down due to flyback run-a-way. It only stands to reason that if no shorted conditions exist, then one (or more) circuits will have to be open, otherwise, the TV set would be working!

(4) Now that you know that no **shorts** exists, push the "run" side of the test / run switch (the side that latches). Provided all of the other circuits in the TV set are functional, the scanner will now put a picture on the set's CRT screen that has full vertical and horiz deflection, normal audio, video and color.

Keep in mind that during this test, your scanner is:

- (1) Circumventing all horiz osc/driver related shut down circuits,
- (2) Limiting the set's 2nd anode voltage to approx 20-25 kv,
- (3) Substituting the set's horiz osc/driver circuit and, as a result, eliminating any need that the set might have for an initial start up or B+ resupply circuit for the osc/driver.

Wait about 15 seconds for its filaments to warm up, then look at the CRT. Any circuits that are "**open**" will now produce an obvious symptom on the screen. Because the scanner has circumvented all of the set's shut down features, you can now use your old reliable "symptom to circuit analysis" technique to troubleshoot the problem, i.e., if the picture has no blue in it --- repair the blue video or blue matrix circuit. If the picture has only partial vertical deflection --- repair the vertical circuit, and so on. The scanner has effectively removed all of the stumbling blocks that would normally prevent you from diagnosing the problem. i.e., start up and shut down features, and allowed you to repair the TV set by using conventional techniques.

When you're using a scanner, all start up, shut down, dead set problems are easy to solve. You don't need anyone to tell you just how difficult these problems can be for those who don't have a scanner!!

Our Super Tech HV circuit scanner normally sells for only \$495<sup>00</sup>. Beginning July 4, 1985 thru August 31, they are on sale for only \$395<sup>00</sup>.

**VISA, MASTERCHARGE, C.O.D. ORDERS WELCOME**

DIEHL ENGINEERING • 6004 Estacado Ln. • Amarillo, TX 79109

PHONE (806) 359-1824 or (806) 359-0329

*Phone Orders Welcome*

*Since the Scanner only has two buttons to press, most technicians never need it but, our "Hot Line" is available to assist new owners in the operation of their scanner. Phone (806) 359-0320.*

**CIRCLE 274 ON FREE INFORMATION CARD**

cated on the side of the scanner and the other located beneath it, are used to rotate the scanner. The steppers allow for almost complete rotation in the vertical and horizontal planes. About the only area that can not be "viewed" is straight down.

The *Scorpion* "scans" by sampling light levels in the vicinity of the robot. That is done by a small photo sensor mounted at the end of the scanner facing the parabolic mirror. The *Scorpion* control system contains an A/D conversion circuit that interfaces with the 6502 and allows your programs to make decisions based on light conditions the *Scorpion* encounters.

In addition there are two pinpoint light sources that Rhino calls "eyes;" they may be turned on and off under operator control, and may be used to add "personality" to the *Scorpion*. There is also a beeper that may be used to the same effect,

### The *Scorpion* command system

The *Scorpion's* 8K ROM operating system includes 30 commands for controlling the robot. Each command begins with a slash (/), and many commands are followed by one or more values that the user must supply. For example, the instruction /7M + ## - ## means "START BOTH MOTORS." The pound signs represent the speed at which each motor is to turn. Plus (+) and minus (-) signs are used to refer to the forward and reverse directions, respectively.

You can command the *Scorpion* to move forward, backward, and through all turns at various speeds. Note that there are no commands that move the robot a specific distance; the commands available turn the motors on and leave them on until you explicitly turn them off.

By varying the speed of each motor it is possible to turn the *Scorpion* in very small increments. You can also turn it, as we discussed in last month's column, by running one motor in one direction and the other motor in the opposite direction.

Other commands control the operation of the scanner. When doing a scan, the *Scorpion's* 6502 actually stores the light-level data

in on-board RAM. That data can be transmitted back to the host system where it can be processed and used for obstacle avoidance, object recognition, etc.

A tracker assembly on the bottom of the *Scorpion* may be used for automatic guide-way experimentation. The tracker is composed of two photo-detectors, each with its own light source, mounted about an inch apart. The guide-way could be a strip of black tape (or reflective tape.)

### System expansion

You might want to add commands to *Scorpion's* repertoire, or expand its hardware capabilities. To help you do either, Rhino has provided a 130-page manual that contains assembly instructions and some very interesting reference information. Included in the rear of the manual is a well-commented source listing of the entire operating system. The listing contains numerous hints for adding your own code and modifying the built-in commands.

Mechanically, everything is put together with screws—there are no welded pieces. So that makes it simple to change motors or other components. The enclosure comes with holes pre-drilled along the sides. The spacing of those holes conforms to the "Erector Set" standard, so you can easily add to the robot's structure. Just be careful not to put too much weight on the unit, or the wheels might slip.

The *Scorpion* has been out on the market for over a year. However, the price has recently been halved. At press time it's about \$350 for the complete kit.

There is a user's group (Scorpion Users' Group, MJR Digital, P.O. Box 630, Townsend, MA 01469) that distributes a quarterly publication with programming notes, new operating systems, hardware-expansion ideas, and products for sale. It's been my experience that once a users' group starts up, there seems to be enough momentum generated to keep things going for several years, even if the manufacturer folds. The *Scorpion* can provide an excellent tool with which to start learning about robotics. I recommend it. **R-E**

## SATELLITE TV

*continued from page 32*

na-mounted amplifier/converter, may be retrofitted with a 12-GHz LNB, and that will allow the customer to select either 4-GHz service or 12-GHz service. So far so good.

It is the dish that presents a special challenge. The home-TVRO industry has adopted "mesh" dishes for 4 GHz because the open-wire mesh design works well, ships easily, and is cost-effective. Unfortunately, mesh dishes are designed to work well at 4 GHz, and work very poorly—if at all—at 12 GHz. Tests conducted on popular, high-grade mesh dishes at 12 GHz indicate that they have efficiencies of 20% to 25% at 12 GHz. That is a far cry from the 55% to 65% efficiencies obtainable at 4 GHz. But efficiency, or bulk gain, is not the real problem; dish stability is.

A large mesh dish, perhaps 10 to 12 feet in size, may develop enough gain, even at 20% efficiency, to make a 12-GHz system perform acceptably. But the dish-mount and tracking system using a motor-drive and a polar-mount satellite-belt tracker technique is a big problem.

Recent tests have revealed that the amount of "slop" or "wobbling" one finds acceptable in a tracking system at 4 GHz is totally unacceptable at 12 GHz. Why? Because the dish has much narrower beamwidth at 12 GHz than at 4 GHz. Tolerances increase by a factor of 3 in the change-over from 4 GHz to 12 GHz. So, where 0.5-inch dish play (about the maximum acceptable at 4 GHz) may be easily obtainable,  $0.5/3 = 0.167$ -inch play will be difficult, if not impossible, to obtain with equipment currently on the market.

Those are solvable problems, but they are not solved yet. When the solution is found, all systems now in place will have to be appropriately retrofitted if they are to receive Ku-band signals. In the meantime, the 4-GHz scrambling snafu keeps getting more and more complicated, and that is driving system planners to serious consideration of 12-GHz. **R-E**



# FREE high tech catalog



Most Accurate Clock uses NBS atomic clock signal to keep "perfect" UTS time.



"Smart" metal locator homes-in on precious metals, disregards junk.



Build BM-PC compatible Heathkit computer and save, or buy assembled.

Computerized weather station "remembers" weather to aid in forecasting.



World's first low-cost hand-held, microprocessor-controlled Real Time Spectrum Analyzer.



"Universal" terminal interfaces computer, ham station for RTTY.



Robotics technology comes to life in building HERO™ I and teaching it movement, speech, and manipulation.



Learn computers, programming with Microprocessor Trainer and Course.



Triple-trace oscilloscope speeds troubleshooting.

HV-5400, one of the finest multi-purpose ham rigs, in affordable kit form.



More than just a catalog, a trustworthy guide to what's new in electronics and computers.

News about important product innovations is packed into every page of the quarterly, full-color Heathkit catalog. Ever since radio became electronics, the illustrated Heathkit Catalog has been a guide to new and exciting kit products for people like you to build. Enjoy and learn from them, while saving money in the process. What sets the Heathkit catalog apart is its range of high quality products and accurate information to help make your buying decisions easy.

All you have to do is fill out the coupon to get your copy

**Heathkit®**  
Heath  
Company

Heath Company  
Dept. 020-344  
Benton Harbor, Michigan 49022

YES! Please send me a copy of the all-new **FREE** Heathkit Catalog.

Name

Address

City  State

CL-775B Zip



# DRAWING BOARD



ROBERT GROSSBLATT

## Control signals of the Z80 microprocessor

I SAID IT LAST MONTH, BUT I'LL SAY IT again. Before beginning our journey into microprocessor land, you must have a road map. The only way you're going to get anything out of our discussion is to have a good Z80 databook in front of you. If you don't have a databook, you can use the diagrams from last month's column.

### The registers

The registers are the easiest part of the IC to understand. After all, they're nothing more than simple memory, similar to the RAM (Random Access Memory) we spent so much time talking about a few months ago. What's unique about the registers is that they are located inside the Z80 itself. There are basically two kinds of registers: those that can only be accessed by the Z80, and those that are accessible to us.

The Z80, like any other microprocessor, spends its time following the instructions we give it. It uses certain registers to keep track of what it's doing, where it's going, and to store interim data. The other registers—the ones accessible to us—are pretty much the same as other memory you might interface to the microprocessor. The main difference is that they're part of the IC itself, and that provides two advantages over to external memory. First, the Z80 can get to the registers quicker than to external memory, and second, it leaves the external data bus free for use by other devices while the Z80 is busy internally.

### The Z80

Figure 1 shows a pinout of the

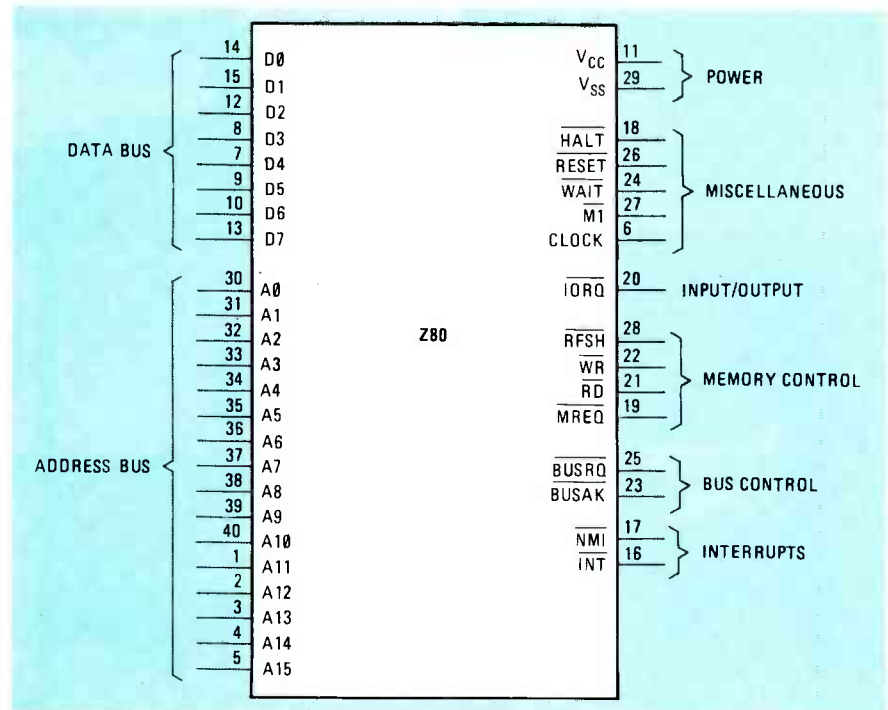


FIG. 1

Z80. I've grouped the pins by function in order to show relationships between various groups of signals. The data and address buses are shown along the left side of the diagram, and the control signals along the right side.

The width of the address bus (i.e., the number of address lines) limits the number of external memory locations the Z80 can reference without resorting to special tricks. Since there is a total of 16 lines, the IC can directly access  $2^{16}$ , or 65,536 locations.

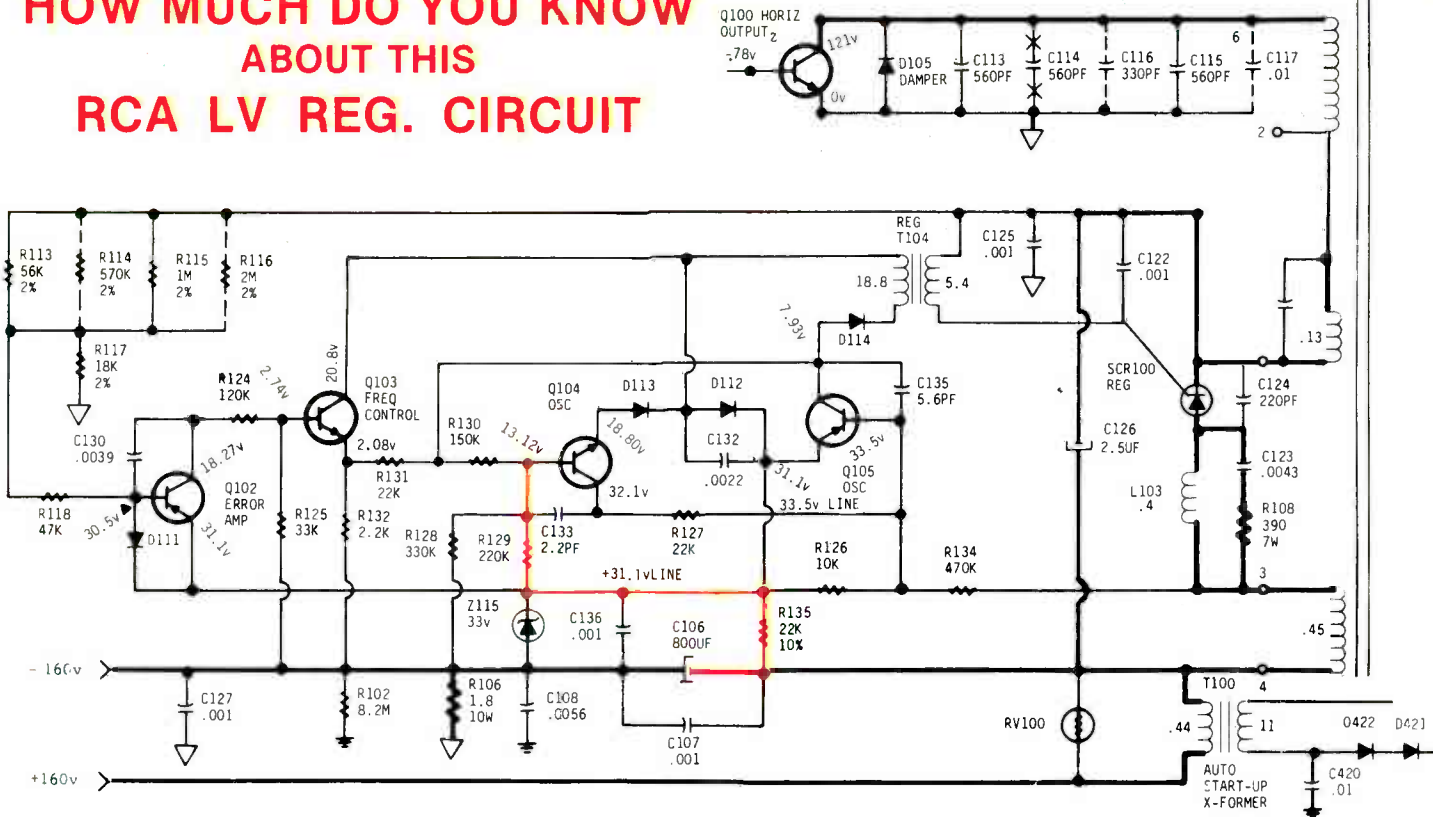
The operation of the address and data bus controllers, and the ALU, are all affected by the state of pins 16 to 28. So let's take a look at them now.

### Bus control signals

Typically, a microprocessor-based system will have several different devices interfaced to its address and data buses at any one time. But since only one device at a time can have control of those buses, the microprocessor needs to be informed when another device wants control. That task is taken care of by the BUSRQ (BUS ReQest) input. A device that needs control of the bus sends a low to that pin. When that signal is received by the Z80, two things happen in sequence. First, both buses are tri-stated (placed at a high impedance) so that other devices can access them. Second, the Z80 lets all the interfaced devices know



# HOW MUCH DO YOU KNOW ABOUT THIS RCA LV REG. CIRCUIT



Typical of RCA CTC 85 thru 108 LV Regulator Circuits

Schematic by Diehl Engineering

## How many of these questions can you answer ?

- (1) Every circuit has a beginning and an ending. Where does this circuit begin ?
- (2) Specifically, what is the purpose of this circuit ?
- (3) What turns it on ? What turns it off, or does it ever really turn off ?
- (4) Does this circuit have a shut down feature ? If so, which components are involved ?
- (5) What would happen if Q103 were to become shorted E to C ?
- (6) What purpose does Z115 serve ?
- (7) What would happen if D114 became shorted ?
- (8) What purpose does C126 serve ? What will happen if C126 becomes open ?
- (9) Is the winding between terminals 3 and 4 of the flyback a primary or a secondary winding ?
- (10) What purpose does C117 serve ? Exactly what does it do, and exactly how does it do it ?
- (11) Exactly what do resistors R113, 114, 115, 116, and 117 do ? What happens if they change value ?
- (12) What occurs that causes this circuit to produce an initial start up pulse ?
- (13) Why does this entire circuit become shorted and begin to destroy horiz output transistors if the regulator SCR becomes shorted ?
- (14) There is exactly one safe and practical method of circumventing this LV regulator circuit for test purposes. This technique does not involve a variac. Instead, you must disconnect one wire then connect a jumper wire from terminal #4 directly to Which wire do you disconnect and where do you connect the other end of your jumper wire ?
- (15) If SCR100 is shorted, this circuit will still "eat" horiz output transistors even if you are using a variac. Why ?
- (16) Why does this circuit use a floating ground ?

We publish a monthly magazine called the Technician / Shop Owners Newsletter. Each month we take a popular circuit and absolutely dissect it.

Using color coded pictorial schematics such as the one above, we "map out" every action in the overall sequence of events that must take place during each and every cycle.

Beginning with the very first "action" in the sequence (which just happens to be depicted in the above schematic) we explain exactly what is taking place. We then explain the function of every component in that portion of the circuit. After explaining the function of each component, we show you how to troubleshoot that particular "action" or function.

After reading our newsletter on this circuit, you could answer all of the above questions as fast as anyone could ask them. In fact, you will then know everything there is to know about this circuit. Including how to troubleshoot it !!

Regardless of whether you work on TV sets, stereos, radios or computers, just having the ability to "disect" an electronic circuit (any circuit) is worth a fortune. In reality, "disecting" is exactly what our newsletter is designed to teach you.

Because of the manner in which our newsletter is written, the subject matter that is gained from each monthly issue is so extremely broad that it will "spill over" into your everyday troubleshooting routine, and be applied to totally unrelated circuits.

Each monthly issue sells for only \$9<sup>95</sup>, due ten days after delivery. VISA / Mastercharge welcome.

To Order: Send your name, address and phone # to Diehl Publications, 6004 Estacado Ln., Amarillo, TX 79109. Specify Issue # 3.

**For immediate Service Call: (806) 359-0329 or 359-1824.**

**Do not use the Reader Service Card in this magazine to place your order.**

CIRCLE 275 ON FREE INFORMATION CARD

# Versatile Lab Power Supply



**EXCEPTIONAL VALUE!**

MODEL 3002A  
Only **\$125<sup>00</sup>**

- 0-30 VDC at 0-2A • Excellent Regulation
- Ripple & Noise - 500 uV RMS • Built-in Short-Circuit and Overload Protection

Model 3002A features continuously adjustable current limiting and precision constant voltage/constant current operation with "automatic crossover." This lab-grade unit can also be used as a current regulated power source. Options: 10-Turn Voltage and Current Controls, \$25.00 ea.

DISTRIBUTOR INQUIRIES INVITED  
DOMESTIC & FOREIGN



**ELECTRO INDUSTRIES**

4201 W. Irving Pk., Chicago, IL 60641  
312/736-0999

CIRCLE 83 ON FREE INFORMATION CARD

OUR

# 20 YRS.

of manufacturing quality crystals for the industry, military services, radio amateur and citizens band and experimenters

**IS YOUR ASSURANCE OF STABILITY**

**TO SAVE MONEY GET THIS FREE CATALOG**



Call or Write  
**JAN CRYSTALS**  
P.O. Box 06017  
Fort Myers  
FL 33906-6017  
(813) 936-2397

Since 1965



that the buses are available by placing a low on the  $\overline{\text{BUSAK}}$  (*BUS Ac Knowledge*) output. The buses stay tristated as long as there is a low on the  $\overline{\text{BUSRQ}}$  input.

## Memory-control signals

The most complex signals on the Z80 are those controlling external memory. Whenever the Z80 wants to access that memory, it puts a low on pin 19, the  $\overline{\text{MREQ}}$  (*Memory REQuest*) line. That signal tells the rest of the circuit to release the data and address buses because the CPU wants to do something with external memory. Whether it's a read or a write depends on the signals found on pins 21 and 22, the  $\overline{\text{RD}}$  (*ReaD*) and  $\overline{\text{WR}}$  (*WRite*) signals.

When the Z80 wants to read the contents of a particular memory location, it puts lows on the  $\overline{\text{MREQ}}$  and  $\overline{\text{RD}}$  lines. That informs the rest of the circuit that the CPU is going to do a read. Likewise, it should come as no great surprise to learn that when the Z80 wants to do a write, it put lows on the  $\overline{\text{MREQ}}$  and  $\overline{\text{WR}}$  lines. Of course, the Z80 reads and writes data only after giving the address bus time to stabilize.

$\overline{\text{MREQ}}$  is similar to signals we've generated in circuits that we've designed in previous columns. In both the keyboard encoder and the memory-demonstrator we generated signals that were used to enable various circuit elements at different times. Well,  $\overline{\text{MREQ}}$  is just such a signal. When you dissect Z80 circuits, you'll always find that the  $\overline{\text{MREQ}}$  line is tied, either directly or through some other circuitry, to the enable lines of external memory. Once the memory is enabled, the  $\overline{\text{RD}}$  or  $\overline{\text{WR}}$  lines is used to prepare memory for a read or write.

The last line associated with memory is the  $\overline{\text{RFSH}}$  (*ReFrESH*) line at pin 28. When we were discussing dynamic RAM a few months ago, I told you that even though refresh can be a pain in the neck, there are LSI IC's that ease a great deal of that pain. Well, the Z80 also has built-in circuitry that makes the job easier.

In order to refresh most dynamic RAM, you can periodically read the contents of each cell out and write it back in. However, there's a

simpler way; as you'll remember from previous discussions, reading any one memory cell causes all cells in that entire row to be refreshed. Also, a row can be refreshed by simply addressing one of the cells in the row. So the refresh hassle would be simpler if we had a circuit that would increment an address counter. We would use that counter to address successive rows in the memory array automatically. And that's exactly what the Z80's *R* register does for us.

In order to understand how it works, let's digress for a moment and talk about how the Z80 processes the instructions you give it in a program. The first thing the Z80 does as it prepares for each new instruction is to fetch that instruction from memory. After the instruction has been fetched, the CPU spends some time decoding the instruction, and the outcome of that determines what the CPU will do next. So immediately after every instruction-fetch, the Z80 is busy internally and has no need for the address and data buses.

Once the instruction fetch is complete, the Z80 does four things in sequence. First it increments the *R* register, and then it places the contents of that register on the lower seven bits of the address bus. Next, it brings the  $\overline{\text{MREQ}}$  and  $\overline{\text{RFSH}}$  lines low. At that point the contents of the *R* register have stabilized, and may be used by external circuitry. Then it's up to that circuitry to use those signals to refresh dynamic RAM.

## Other control signals

Of the control signals left, the only one that really interests us at the moment is  $\overline{\text{RESET}}$ . Undoubtedly you've seen that kind of signal before. With the Z80, bringing that pin low causes all bus and control lines to go into a high-impedance state; further, the program counter and *R* register are set to zero, and, in general, the CPU is brought to a very-well-defined state so that the software will be able to build on that.

Fortunately the Z80 is more difficult to write about than it is to use. Next month we'll find out how to talk to the Z80, and actually build a bare bones system—expandable, of course. R-E



# Do police cars roar across your living room and bullets ricochet off the walls when you watch TV?

Have you ever noticed in movie theaters how life-like, and three-dimensional the sound is? Space ships and jet fighters streak overhead and disappear behind you. Ball games and auto races engulf you with the roar of engines circling the room, with crowds yelling over your shoulder. Concerts and movies take on a complete three-dimensional effect.

The theater systems to create this effect cost thousands of dollars. However, you can have this same sound for a lot less, and in your own living room! You and your friends can enjoy it any time. Imagine having the very best front row seats in town!

## IT'S CALLED SURROUND SOUND

When stereo movies are made, three microphones are used instead of the normal two. The sound from the rear microphone is encoded and split onto the left and right front channels. There it stays completely unheard and unnoticed, unless it is decoded.

The movie theaters use a decoder to decode the third channel, which is then routed through an amplifier and then to speakers in the rear of the theater. These surround channels are actually recorded on almost all movies that indicate they are Dolby® Stereo\*

## THE OMNI-PLEXER™

When you listen to FM stereo simulcast, a stereo VCR, or broadcast stereo TV, the third channel is there. All you have to do to hear it is decode it with the Omni-Plexer™. The Omni-Plexer™ is designed to hook to any stereo amplifier, FM receiver, or stereo TV...regardless of age or model. The Omni-Plexer™ even has its own built-in amplifier for the rear channels, so all you have to do is plug it in and enjoy. That's right! The surround decoder and rear channel amplifier in one neat well-built instrument.



TA-1001

You will hear the rear channel and the difference immediately. Push your mono-stereo button on your stereo, and when you switch to mono the rear channel disappears, and then comes back when you switch back to stereo.

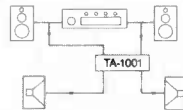
## THE ADVANTAGES

Omni-Plexer™ even works with regular stereo FM, digital discs, stereo tapes, and records. When there is no surround channel present, the Omni-Plexer™ automatically senses rear channel sounds that are picked up by the regular left and right stereo microphones and develops its own rear channels that create the 3D surround effect.

The level controls on the Omni-Plexer™ allow easy adjustment so the rear channels won't blast you out of the room, like four speakers will when they don't have front to rear adjustment. In fact, once the Omni-Plexer™ is set up and adjusted, it automatically tracks and is controlled by the main volume on the stereo or TV. This is great if you have remote volume control, or plan on acquiring it.

## THE HOOK-UP

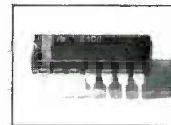
The Omni-Plexer™ simply connects to the front channel speakers on your stereo system, and to two speakers located in the rear or side of the room. The rear speaker size is not important, and doesn't have to be the same as your front speakers. If you already have four speakers connected to your stereo, then just plug the Omni-Plexer™ between the front and rear speakers.



★ **MADE IN AMERICA** ★

The TA-1001 Omni-Plexer™ is designed and manufactured here in the U.S. by the company that invented Good TV Listening 12 years ago.

We have trained personnel to answer your questions intelligently, and to promptly handle your order. If the TA-1001 Omni-Plexer™ ever needs service, our technicians will repair it quickly and correctly.



High-tech design replaces hundreds of parts with integrated circuits.

The TA-1001 Omni-Plexer™ comes complete with cables, instructions, and our HELpline phone number.

\*Dolby® is a registered trademark of Dolby Laboratories, Inc.

## TRY THE OMNI-PLEXER™ AT NO RISK

Take the first 30 days with Omni-Plexer™ as a test. If you're not completely satisfied, return it for a complete refund and your mailing costs. You can't lose.

Omni-Plexer™ is also backed with a two-year warranty on parts and labor.

Omni-Plexer™ TA-1001, \$129.95 plus \$4.50 postage and handling. TA-1001 with speakers, \$229.95 plus \$9.00 postage and handling.

**TOLL FREE 1-800-251-8608**  
In Tennessee call 1-615-381-9001

24 HOURS



Send mail orders to address below. Credit card and money orders processed immediately. Checks require 18 days.

# RHODES

NATIONAL CORPORATION  
Department 212  
Highway 99 East • P.O. Box 1316  
Columbia, TN 38402

# Add surround sound to your TV and stereo system with the incredible OMNI-PLEXER™

# "... one of the best electronics in the emergence of Dick 73's Magazine

Dear Enthusiast, the quote above is typical of the fantastic open-minded & generous response we have enjoyed from the American public & media. And we intend to live up to it by offering competitive prices & fast courteous service by our staff of fellow enthusiasts - whether you shop by phone, mail or personally. A big thank you from all of us at DSE for your support  
Ike Bain

## 'NO-LEAK' BATTERIES

**12V 3Ah Gel Cell** Cat S-3315 \$7.95  
10 up \$6.95 ea

Designed especially for trickle charge circuits such as burglar alarms and emergency supplies. Sealed to prevent leaks and mess.

## Gel Cell Chargers

When you are recharging Gel Cells it is most important that careful attention is paid to the charge rate duration of charge as exceeding the recommended limits may severely reduce the battery life. We stock two regulated chargers to suit the two Gel Cell Batteries.

**12V 150 MA Gel Cell Charger** Suits S-3315 12V 1.6 A Gel Cell. Comes with alligator clips to make connection to your cell easier. Cat. M-9520 \$13.95

**12V 450 MA Gel Cell Charger** Suits S-3320 12V 3A Gel Cell. As above with higher capacity. Cat. M-9522 \$36.00



## BUILD YOUR OWN!

### Transistor Tester!



ONLY \$16.95

Not just another Transistor Tester! This one tests the lot! Ideal for the beginner and serviceman alike, or in schools. Battery operated and supplied with one of our new 2" panel meters in a deluxe 'Speedy' box. Requires 9V battery Cat. S-3066 75c extra. Cat. K-3052

## NEW Encyclopedia of Electronics

Over 4 years in preparation this encyclopedia has been meticulously researched. To ensure its excellence it was carefully reviewed & approved by a select editorial board comprised of 20 distinguished electronics professionals. Over 3000 separate articles deal with many more thousands of terms & applications. Each article is fully illustrated & includes all relevant formulas, charts & tables. From basic electronic terms to state-of-art digital electronics theory from micros & laser technology to amateur radio & satellite TV. Cat. B-4005

WILL BE OPENING SPECIAL \$59.95 \$47.50

## Amazing Whistle Switch

Remotely operate lights, TVs, etc. without leaving your resting place. Suits equipment up to 400 Watts.

ONLY \$19.95

Cat. P-5590



## LOST YOUR KEYS? JUST WHISTLE!

That's right, with one of these little beauties next time you misplace your keys just whistle and it will beep right back to you. A great conversation starter too! Cat. Y-1070 \$12.95



## LCD Multimeter Cap/Transistor Checker

The very latest and the very best digital multimeter. And mult is the word. Not just the usual voltage, current and resistance ranges - though it's certainly got those - it also checks capacitors (2 ranges, up to a whopping 20uF) PLUS transistors and diodes. And even more, it actually measures transistor gain - ideal for matching transistors in audio circuits and it's got an audible continuity checker.

Plus other features such as automatic zero of all ranges, high surge voltage protection, automatic over-range indicator, high current measurement (10AC&DC) etc etc. Cat. Q-1500 \$99.95

Will even measure gain on transistors

## TOP VALUE! TOP SELLING! 19" RACK MOUNT CASE



Professional quality black instrument case fits standard 19" racks, overall they're 16.75" x 9.8" x 5.5". Supplied flat, assembly takes just a couple of minutes. Heavy gauge (0.12") front panel; top and bottom pre-punched for ventilation. Cat. H-2481

ONLY \$29.95

## Incredible Value!



## Oskerblock SWR/Power Meter

Incredibly popular with the keen amateur. Uses Directional Coupler and Through Line principles for minimum loss, covers 3 to 200 MHz (guaranteed!) and suits both 50 & 75 ohm lines. PL259 Connections. Cat. Q-1340 \$89.95

Cat. Q-1340 \$89.95

THAT'S VALUE



## Do it yourself! solar energy kit

## LEARN ABOUT SOLAR ENERGY. SOLAR EXPERIMENTERS KIT

Contains an encapsulated solar cell with light intensifier, motor, wire and an informative booklet on solar energy and its applications. See how light can be efficiently converted into electrical energy! Cat. Y-2100 \$8.95

## APPLE OWNERS LOOK AT THIS VALUE! GAMMA™ FOR APPLE IIIC COMPUTERS

### FD100C FLOPPY DISK DRIVE

- Media Standard 5.25" single sided floppy diskette
- Tracks/Diskette 40
- Disk Rotation Speed 300 rpm
- Track Density 48 tpi
- Bytes/Sector 16
- Capacity 160K Bytes
- Track to track access time less than 12msec
- Low cost
- Precise band positioner
- Track 00 sensor design elim. noise/recallibrate noise
- Reliable data read/write time
- 160K bytes storage capacity

LIST PRICE \$199  
ONLY \$129

APPLE® is a registered trademark of Apple Computer Inc. GAMMA™ is a registered trademark of Video Technology Ltd

## Magazine File

A magazine binder, ideal for any magazines that cover 12 issues in one year. Hard spine with metal rods for placement of the magazines. Cat. B-4045

VALUE \$4.95



## Small Jumper Lead Set

Makes breadboarding easy! 10 15" leads, with alligator clips at each end. 5 different colors. Cat. W-4570 \$2.00

## Medium Lead Set

4 x 30" leads fitted with large insulated alligator clips at each end. Four different colors. Cat. W-4571 \$2.00



ORDER TOLL FREE 1-800-332 5373



# things to happen to US this year is the Smith Electronics...

## August 1985

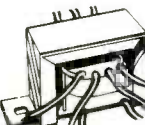
### CRAZY PRICES FOR QUALITY DSE TRANSFORMERS



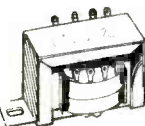
**DSE 2840** \$2.50  
 Primary: 117V, 60Hz  
 Secondary Voltage: 4.5-4.5V  
 Secondary Current: 150mA  
 Terminations: Flying Leads  
 Cat M-2840  
 10 up \$2.25 ea



**DSE 2851** VALUE \$2.50  
 Primary: 117V, 60Hz  
 Secondary Voltage: 6.3-0-6.3V  
 Secondary Current: 150mA  
 Terminations: Flying Leads  
 Cat M-2851



**DSE 2155** FAIR DINKUM! \$5.95  
 Primary: 117V, 60Hz  
 Secondary Voltage: 6.3, 7.5, 8.5, 9.5, 12 & 15V  
 Secondary Current: 1 Amp  
 Terminations: Flying Leads  
 Cat M-2155  
 10 up \$5.50 ea



**DSE 6672** ONLY \$7.95  
 Primary: 117V, AC  
 Tapped Secondary: 15, 17.5, 20, 24  
 Voltages: 27.5, 30 volts  
 Secondary Current: 1 Amp  
 Termination: Solder Lugs  
 Cat M-6672  
 10 up \$6.95 ea

### Mini Breadboard

3" x 2 1/4" x 3" one-piece board with 58 groups of 5 connected terminals and 4 bus lines of 25 connected terminals.  
 All terminals are alpha-numerical coded so you can remember what you connect to what. Complete with self-adhesive pad so it won't slide around the table.  
 Cat P-4614  
**\$4.95**  
 10 up \$4.50 ea



### VALUE! Midi Breadboard

A massive 7" x 2 1/2" x 3" board which can be split into three parts for convenience. Similar to the Mini Board with alpha-numerical coding and adhesive back, but this one has 128 groups of 5 connected terminals plus 8 bus lines of 25 connected terminals. AND you get the large work sheet pad as well!  
 Cat P-4615  
**\$9.95**  
 10 up \$8.95 ea

### Maxi Breadboard

8" x 6" x 5 1/2" one piece board with 250 connected terminals, 3 binding posts and 18 x 14 pin IC capacity - Ideal for schools.  
 Cat P-4616  
**\$19.95**

### Super Breadboard

Fantastic 27 x 14 pin IC capacity makes it great for R & D labs and the serious electronic enthusiast.  
 Supplied with 4 binding posts and a whopping 2420 tie points to give amazing versatility.  
 We've seen similar boards selling for 70% more and, because we buy direct from the manufacturer, we don't think you'll ever be able to beat this value.  
 Cat P-4617  
**\$29.95**

### Resistance Substitution Wheel

Convenient size with large, easy to read value selection that enables you to select values from 5 ohms to 1M ohm in 36 steps by using most common divisions. Complete with leads and insulated crocodile clips.  
 Cat Q-1410  
**\$5.95**

### 100 Watt Amp Module

- 100 watts RMS, 5kHz at 100dB signal to noise ratio.
- the ultimate in simplicity, even the power transistors mount on the PCB.
- PCB heatsink bracket is supplied
- Hason-board fuse protection
- input sensitivity: 1V
- Use with K-3468 power supply. Ideal for the home constructor or technician who wants to roll his own amplifier system for the home or professional use.
- Cat K-3442

**\$19.95**

### Geiger Counter

Sensitive to a broad spectrum range of ionizing radiation including alpha, beta, gamma and x-rays. Switching range - 0.5R/hr to 50 mR/hr. Extra long battery life. Complete with operating manual. This is an accurate scientific instrument at an affordable price.  
 Cat Q-1000  
**\$199**

### AM/FM Telephone/Radio/Clock & Cassette

This superbly styled communication center combines 5 of the most popular appliances we use every day. The hands-free phone is a feature that enables you to either leave the handset on the unit to act as a loud speaking telephone or to pick up the handset for private conversation. The radio has an automatic mute facility so as soon as a call comes through, the radio volume is immediately reduced to an undisturbing level.  
 Cat F-5200  
**\$99**

### The Confidential Frequency List

Has them all... PLUS 8,499 other stations spread around the world. They are all in here in this amazing book: legitimate and clandestine stations. From 400Hz, even spy networks. MHz. If you own a short wave receiver, this book is an absolute MUST!  
 Cat B-9602  
**ONLY \$13.95**

### VALUE PACKS - YOU SAVE!

#### Spaghetti Pack

30 lengths of assorted colors and diameters (each length being more than 6") that totals over 15' of spaghetti.  
 Cat W-4040  
**\$2.50**

#### Heatshrink Tubing

Supplied as a pack of various lengths and sizes and includes (internal diameter) .06", .11", .25", .75".  
 On application of heat from a soldering iron or hair dryer will shrink up to 50% of original size.  
 Cat W-4060  
**ONLY \$2.95**

#### Jumbo Pack

For those long jobs. Contains 4 sizes: Clear .6", Blue .4", Yellow .3", White .2", each 33' long. Fantastic value!  
 Cat W-4062  
**\$7.50**

### IS YOUR LIFE WORTH \$199?

#### VHF Marine Transceiver

Ruggedly built, our transceiver has been engineered to go to sea. Comes factory tuned so there is no expensive adjustments to be made and it covers 45 transmit channels and 55 receiver channels, all you will need for communication in American waters. Punchy 25 watts of output power with low power 1W switchable to conserve battery power. Complete with wall mounting brackets, microphone, power cable and full easy-to-follow instructions.  
 Cat D-1401  
**\$199.00**

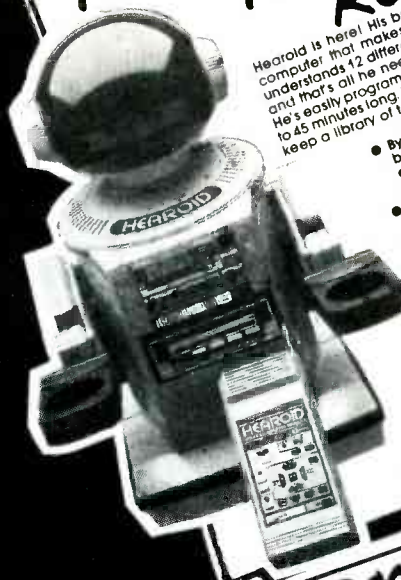
#### Swordfish Antenna

Made of tough, resilient fiberglass, this half-wave antenna doesn't need a metal 'ground plane': you can use it on grp, cement, wooden, steel - or any type of hull. And it comes with our deluxe 'any-which-way' base which mounts perfectly on any angle. It has a quick release lever to lower the antenna for bridges, trees, marinas, low flying aircraft, etc. Complete with base, co-ax cable and tuning box.  
 THAT'S VALUE  
**\$39.95**  
 Cat D-4071

**ORDER TOLL FREE 1-800-332 5373**



# QUANTAM LEAP IN TECHNOLOGY... A VOICE PROGRAMMABLE ROBOT!



Hearold is here! His brain is a sophisticated voice recognition computer that makes him respond to your spoken words. He understands 12 different commands in any language or accent, and that's all he needs to perform an infinite variety of actions. He's easily programmable and can learn complex programs up to 45 minutes long. With his tape and computer memory, you can keep a library of tasks for him to perform.

- By voice command, Hearold can: Go forward, go back, turn left, turn right, stop, turn on his headlights
- He's built-in cassette deck & more!
- Carry objects with his grasping hand & carry objects with his removable tray.
- More than 18" tall; rechargeable built-in power cell with approved power pack included.
- Uses 1.5V and 2 AA batteries, not included; a wireless transmitter that can be used as a wireless microphone allowing user to talk through him; has a mouth display that lights in sync to his sounds.

**ALL THIS FOR ONLY \$399**

STOCKS LIMITED - ORDER NOW

## LOW COST TWO WAY RADIO

### Pocket Com II

This is THE transceiver for aspiring James or Dick Tracys in our community. Full 2-way transmission and a size that fits secretly into your pocket. A great gift for any child. Cat D-1101

**\$16.95 PAIR GREAT VALUE**

## LOW COST FAULT FINDER

### Signal Injector

Battery Operated

One of the handiest devices to have in your tool box. Check out both audio and RF circuits (harmonics extend to many MHz) simply and easily. Often the quickest method of fault finding (and one of the cheapest!) Self contained, with probe and earth clip. Cat Q-1270

**\$9.95**



1000'S SOLD!  
OF THE EVER POPULAR

### The Dick Smith Q1140 MULTIMETER

Almost a complete test bench in one package - No wonder it's our best selling multimeter! With 100,000 ohm per volt sensitivity and ranges to cover every test set-up, this outstanding meter is all the hobbyist will ever need! Measures transistors Ico and Hfe for both NPN and PNP (also good for diode testing) and has an inbuilt transistor oscillator for capacitance measurement. Cat Q-1140

**\$76.50**

THAT'S VALUE!

### RF Probe

Extend the useful range of your multi-meter way up into the RF range with this neat probe. Frequency response is 150KHz to 30MHz (ref. 500KHz) Comes equipped with banana plugs for direct multi-meter connection. Ideal for use with most multimeters.

**GREAT VALUE \$14.95**  
Cat Q-1138



## ELECTRONICS BOOKS JUST A FEW OF OUR EXTENSIVE RANGE!

### 555 IC Project Book

Door-knob alarm - IC metronome - outboard audio amp - light-activated alarm... the list of useful, fun-to-build projects goes on and on! All can be made with the popular and inexpensive 555 or 556 IC. Includes step-by-step instructions, schematics, and parts lists.

**GREAT VALUE \$11.45**  
B-1245

### The Encyclopedia of Electronics Circuits

This GIANT collection of electronic circuits is a must-have reference for every builder and designer. Totalling over 1,700 of the most needed circuit schematics.

**ONLY \$29.45**  
Cat B-1781

### World Radio TV Handbook

A brand new edition for 1985. The most thorough and complete listing of international radio and television stations. Used as a reference throughout the world, contains information on frequencies, addresses, call signs, IDs and lots, lots more.

**\$19.50**  
Cat B-208E

### The Hidden Signals on Satellite TV

The first book dealing entirely with the non-video services hidden in the many domestic satellites. Covers all of these services - radio networks, press services, business services, plus many more.

**VALUE \$14.95**  
Cat B-1843

### Amateur Radio and Electronics Study Guide

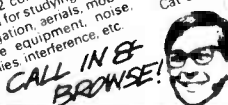
A clear and concise study manual for the amateur syllabus. Designed to make learning easier in a short uncluttered text with large clear illustrations in Students-Own-Note form.

**VALUE \$11.95**  
Cat B-2319

### Radio Communications Handbook Combined

Both Vol. 1 & 2 combined. Highly recommended for studying. Covers RTTY, propagation, aeriads, mobile and portable equipment, noise power supplies, interference, etc.

**GREAT VALUE \$24.95**  
Cat B-2033



CALL IN & BROWSE!

### Electronics for Model Railways

Now railway modellers can achieve a great degree of realism on their layouts. Level crossing flashing unit, scale fluorescent lamps, street signs. Devices to build. Cat B-3633

**ONLY \$3.30**

### Understanding DC Power Supplies

An Australian written and published book - intended for tech students in electronics/electrical engineering fields, but has a mine of information for the hobbyist too. Covers everything from introduction to rectifiers to switch mode supplies. Cat B-3623

**ONLY \$14.95**

### The Laser Experimenter's Handbook

A hands-on guide to understanding and applying modern laser and laser technology. Gives all the background and theory needed to build actual working lasers, including actual projects complete with data, plans, and operational how-tos. Cat B-3900

**ONLY \$8.95**

## BUILD IT YOURSELF!

### LED Tacho

Don't spend a fortune buying a tachometer - build your own and save! Displays engine speed in an analog form in an illuminated row of LED's. Instructions included - a great kit! Cat K-3240

**VALUE \$19.95**

## TAKE AN ARMCHAIR VACATION TO AUSSIE!

### Above Sydney

A favorite book for the Aussies at DSE U.S.A. We have to keep these books hidden away in our warehouse journal. Nicholson, a well-known Australian journalist, by well-known Australian photographer, Alan George. Well from San Francisco, this beautifully presented gift or general insight into one of the most beautiful cities in the world. See the beaches, parks, harbors and Opera House.

**\$22.95 VALUE**  
Cat B-9902

## BUILD YOUR OWN... UHF Watt Meter

Have you priced a built up wattmeter lately? Just released. Featuring stripline circuitry, this kit is easy to build & use.

Specifications  
DIRECTIVITY: +20db  
INSERTION LOSS: -0.3db  
FREQUENCY RESPONSE: (narrow band)  
400-520 MHz  
MAX POWER: 100 watts

**44.95**  
Cat K-6312

COMPARE WITH READY BUILT UNITS!  
SEE AUG. REVIEW 73's



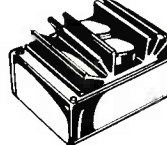
## TURN MONO INTO STEREO! Stereo Simulator

Wish those old video movies had modern stereo sound? This low cost gadget turns almost any mono signal into amazingly good synthetic stereo!

**Cat K-3421 \$14.95 VALUE**

## Transistor assisted Ignition

Now gives even better performance than before with circuit mods enabling high efficiency & stability, plus special radial fin design heat-sink and die-cast box to get rid of that unwanted heat. Ideal for use in all conventional ignition vehicles (doesn't work real well on diesels!) Cat K-3301



**FOR ONLY \$24.95**

ORDER TOLL FREE 1-800-332 5373



### Coiled Test Leads

You know the problem of meter leads cluttering up the bench? It won't happen with these leads. A red & black pair with 0.06" meter plugs. Cat W-4520

\$3.50

### IC TEST Clip Leads

Great for working with IC's (or any other components!) With insulated IC test clips on one end, banana plugs on the other. Leaves hands free while measuring. Cat W-4509

\$2.50

### ECONOMY Lead Set

Ideal for the hobbyist! This lead set will have all you should need for any of the 14 adaptors and plugs in and you will see that it's truly versatile. Good quality set at a price that makes it one of the best in town. Cat W-4526

\$9.95

### Universal Test Lead Set

The ultimate test lead set for the professional! Superb quality coiled test leads for ease and convenience. 18 different adaptor probes and plugs. Multi-way test leads makes it simple to carry out any test you desire. Screw in connector ends make this suitable for any meter. Cat W-4528

ONLY \$12.95

# AMAZING VALUE!

QUALITY LCD METER FOR ONLY \$29.95!

Cat Q-1440

Beautifully made. We believe this millimeter must be the best value available in America. President Ike insisted that we find a good quality LCD multi-meter that would sell for less than \$30.00. We worked at it for 3 months and found one!

**THAT'S VALUE!**  
SPECIFICATIONS  
DC Voltage - 0-2-20-200-100 volts  
AC Voltage - 0-200-500 volts (RMS)  
DC Current - 0-2-20-200 mA  
Resistance - 0-2K-20K-200K-2MEG Ohms  
200 hour battery life. Full overload protection and diode check function. Low price and guaranteed.

## SAVE WITH THIS MINI ROTATOR

For lightweight UHF/2m beams, TV & FM antennas

Why spend \$\$\$ more on a heavy-weight rotator when all you're turning is a small beam? Our fully automatic rotator is no slouch! With 50kg vertical loading plus wind load of 0.25 sq meters, it's ready for most TV, FM and VHF/UHF antennas. And the great news is it requires only a lightweight 3 core cable (very economical!)

VALUE AT \$69  
Cat D-5003

## H/DUTY ROTATOR

With a vertical load of up to 250kg and a wind load of 0.4 square meters, our new high load rotator is ideal for VHF beams, many HF beams and virtually all TV antennas. And best of all, unlike previous rotators, it requires just three conductors between the control unit and rotator - save \$\$\$ on long cable runs.

Supplied complete with most clamps and control unit, ready to mount on a flat tower plate. Cat D-Cat D-5005

Top value \$99

## Digital Trainer

For breadboarding. Digital circuits. Flip flops, multivibrators, counters, encoders, sequencers, multiplexers, demultiplexers, ment LED displays, memory devices, etc. Specs: (1) AC power jack - DC 12V/800mA (2) Power switch AC adaptor/battery 1.5V x 4; (3) Pulse SW - DC bounce free push buttons; (4) Logic SW: eight logic level switches in DIP for user; (5) DC O/P. DC +5V 750mA inter-connected tie points; (7) LED display eight LED buffered logic level indicators; (8) clock range selection suit (not included); M-9530 12V lamp manual. Cat P-4625

10 up \$119.95 ea \$129.95

## QUALITY METERS AT CRAZY PRICES!



### Standard Panel Meters

A high quality range of moving coil meters, with full scale accuracy better than 2%. Pre-calibrated in 5 popular varieties; easily adapted to suit virtually any requirement with shunts and multipliers.

Dimensions: Scale area - 2.3" x 1.2" Overall - 2.3" x 2"	Mounting: Hole Required - 1.75" Bolt holes: 1.5" square
0-50uA (3500 ohms) Cat Q-2020	0-5A (0.03 ohms shunt) Cat Q-2030
0-1mA (200 ohms) Cat Q-2010	0-20V DC (1k ohms/V) Cat Q-2040
	0-20+3VU (1.228V/0dB) Cat Q-2050

ONLY \$7.95 ea.  
10 up \$6.95 ea

### Large Panel Meters

In two ranges - 100uA & 1mA Larger style for larger projects. Size is 4" x 3.25", scale size 4" x 2"

0-1mA (200 ohms) Cat Q-2060	0-100uA (3500 ohms) Cat Q-2070
--------------------------------	-----------------------------------

ONLY \$11.95 ea.  
10 up \$10.95 ea

### Moving Iron Range

Rugged and accurate AC/DC metres ideal for power supplies, etc. Oval style meter, size approx 2" wide x 2.3" high.

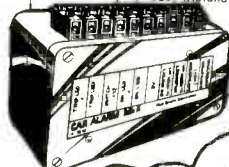
0-10A (AC & DC) Cat Q-2090	0-20V (AC & DC) Cat Q-2080
-------------------------------	-------------------------------



Sophisticated yet inexpensive

## CAR ALARM

One of the most sophisticated, yet simple alarms around. It uses a triggering technique which makes it less prone to false alarms - a common problem with many car alarms, yet it will sense a voltage drop anywhere in the electrical system. For example, when a door is opened, or a jumper lead is applied to the starter, etc. It is housed in a virtually waterproof die-cast case to minimise ingress of moisture or fumes, and all connections are made to the terminal strip for easy installation and removal.



ONLY \$24.95  
Cat K-3253 \*\*

I WISH MY WIFE WOULD LET ME READ A DICK SMITH CATALOG!



## ALL ABOUT HACKING! Out of the Inner Circle

Well, tell you, if you never buy another book on computers, buy this one! Written by the "Cracker", the 19 year old computer whiz kid apprehended by the FBI, and now author of the eye-opening inside story of America's "hacking" culture, this book will give you heaps of information about "hacking" - What's more, it even lets you know the secrets to keeping potential hackers out of your system. A fantastic hacker's guide to computer security. Cat B-2370

ONLY \$9.95

## Microwave Leakage Detector

Microwave ovens are fantastic - but are they completely safe? Yours could be leaking dangerous radiation! Check it out with this handy meter. No batteries required. Cat K-3095\*

\$8.95 VALUE!



DC - UHF 15W LOAD  
15W load with radial fins. fitted to PL-259 plug. Flat response from DC to 450MHz (usable over 500). Ideal for UHF and UHF. Cat D-7025

\$15.95

### LAMP LOAD

Built into PL-259 plug - ideal for 27MHz testing. Lights up on carrier, also shows modulation. Rated at 5W. Cat Q-7024

\$2.95

### 100W LOAD

High power for amateur transceivers, etc. Large surface area to dissipate huge amounts of heat. 100W continuous rated. Cat D-7010

\$29.50

## Edge Level Meter

As used in many imported cassettes, amplifiers, etc. Graduated 1 to 10 with 'battery check' stripe under the main scale. Scale size 1.25" x 0.4" - it's ideal for a fine level adjustment meter, audio or battery level, etc. Mounts with screws, hole centres 2". Cat Q-2110

40 up \$3.65 ea

# DICK SMITH ELECTRONICS

INCORPORATED IN THE STATE OF CALIFORNIA

ORDER TOLL FREE 1-800-332 5373

ENQUIRIES PHONE (415) 368 1066

12 HOURS A DAY! (6am-6pm Pacific time) (MON-FRIDAY) Quote your Visa/mastercard

STORES AT:  
BERKELEY: 2474 Shattuck Ave., Ph:(415) 486 0755  
REDWOOD CITY: 390 Convention Way, Ph:(415) 368 8844  
SAN JOSE: 4980 Stevens Creek Blvd, Ph:(408) 241 2266  
STORE HOURS: 10am-6pm EVERYDAY  
MAIL ORDERS: PO Box 8021, Redwood City, CA 94063  
HEAD OFFICE: 390 Convention Way, Redwood City, CA 94063

HANDLING - ALL ORDERS \$1.00 PLUS SHIPPING INSIDE USA 5% OF ORDERTOTAL (MIN \$1.50) OUTSIDE USA 10% OF ORDER TOTAL (MIN \$3.00)

MAIL THIS COUPON TODAY WITH \$2 & \$1 PACKAGING AND WE'LL SEND OUR HUGE 132 PAGE COLOR CATALOG REDEEMS YOUR COST WITH YOUR FIRST ORDER

Name \_\_\_\_\_ Address \_\_\_\_\_ City \_\_\_\_\_ State \_\_\_\_\_ Zip \_\_\_\_\_

OVER 60 STORES IN 3 COUNTRIES

WHERE THE ELECTRONICS ENTHUSIAST IS #1

# DESIGNER'S NOTEBOOK

And the winner is...



**ROBERT GROSSBLATT**  
CIRCUITS EDITOR

BACK IN AUGUST OF 1984, I CHALLENGED you to come up with an unusual one-gate circuit. At the time, I promised that the person who sent in the best one would be rewarded with a one-year subscription to **Radio-Electronics**. Well, response at first was quite disappointing, but after a gentle reminder a few months later, some really good circuits began to come in. And now its time to announce the winner.

Stan Barzee of Terreton, Idaho sent me the siren circuit shown in Fig. 1. It uses only a few components, and it is easy to build. In addition, the siren's sound can be customized by varying the values of several of the components.

## How it works

When switch S1 is depressed, C2 begins charging through R2, and the gate starts oscillating. As charge builds up on C2, the frequency of the oscillator begins to increase, and does so until the capacitor is fully charged. When S1 is released, C2 begins to discharge through R3, and the frequency of the oscillator begins to decrease. If the input to the gate at pin 1 were simply shorted to +5 volts, the circuit would oscillate freely with no up-and-down effects.

Probably the most interesting thing about the siren is that Stan is able to drive an eight-ohm speaker directly from a CMOS gate. That's something we're usually told not to do. It's the Schmitt trigger that gives us the added drive capability, and the hysteresis inherent in Schmitt-trigger gates is necessary for the circuit to oscillate.

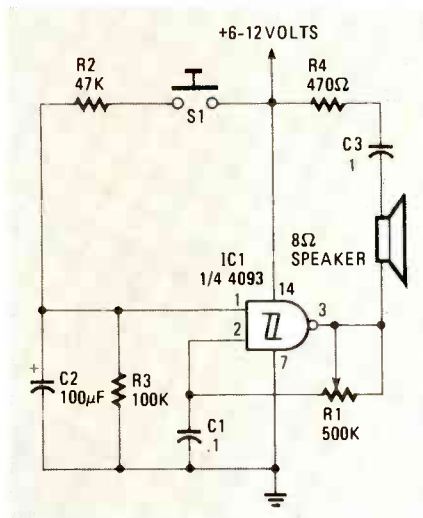


FIG. 1

Here's how to vary the siren's sound. Increasing the value of R2 will lengthen the rise time, and increasing the value of R3 will lengthen the decay time. Keep the value of R3 at least twice that of R2 or the circuit may not oscillate at all. You can change the rise and fall times together by changing the value of C2. Increasing it will lengthen both times and decreasing it will shorten both.

As the value of C2 increases, it takes longer and longer for enough charge to build up to get the circuit oscillating. With very large values of C2, that time could stretch out to ten or fifteen seconds, which may or may not be a drawback, depending on your application.

Stan mentions that you can use a crystal microphone or earpiece in place of the speaker, R4 and C3. However, the best thing is to build the circuit as it's shown here first.

Once you've got it working, you can start experimenting with different components for the effects you want.

Thanks again Stan; you've won a one-year subscription to **Radio-Electronics**. I'll keep the contest going and occasionally publish some of the better circuits. Of course, every winner will get a free subscription and a chance to see his name in print. So once again I'm asking all of you out there to look through your design notebooks and send in any clever little one-gate circuits.

The rules are simple. You may use as many diodes, transistors, and passive components as you want, but the heart of the circuit has to be one simple gate. I've told everyone around here that you people are the smartest readers of this magazine—so let's see what you come up with. Don't let me down!

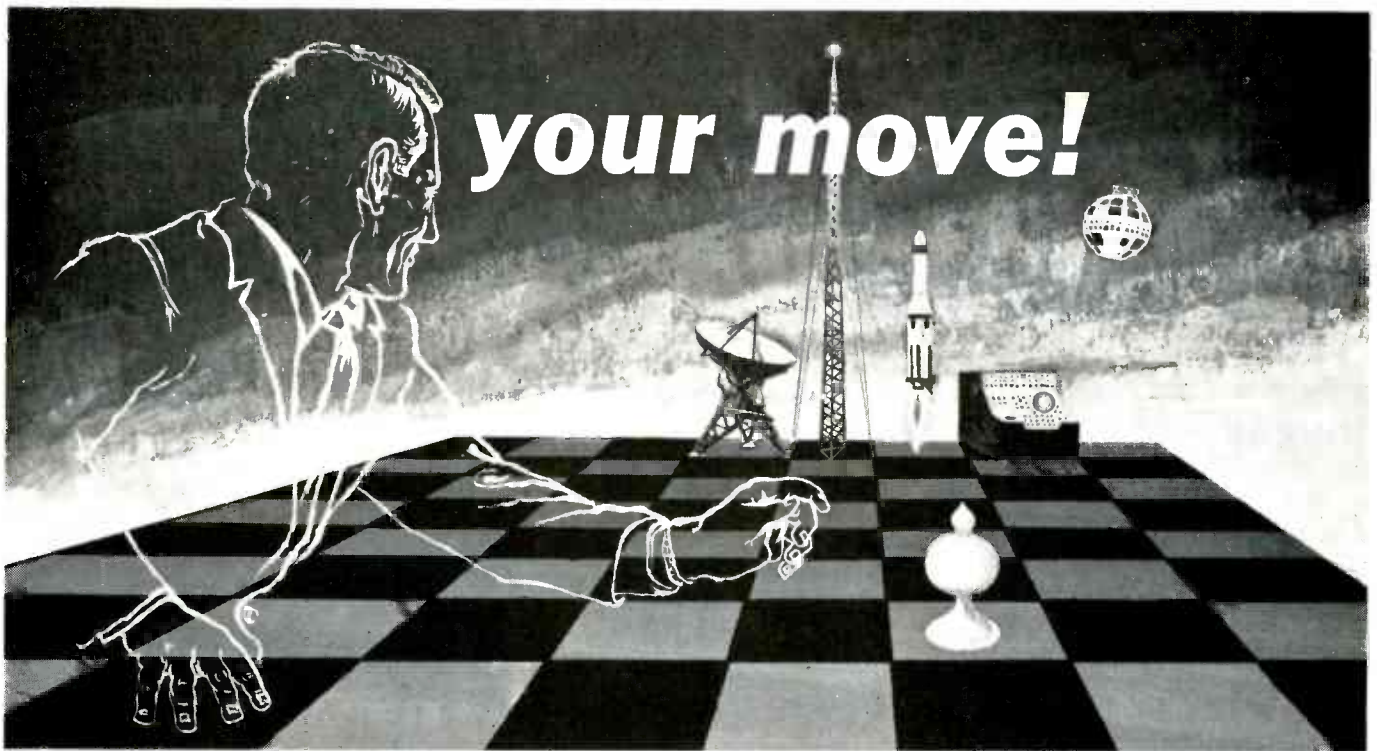
**R-E**



*"It's not so bad, but I could get the same effect with a synthesizer."*



# Where's Your **ELECTRONICS** Career Headed?



## The Move You Make Today Can Shape Your Future

Yes it's your move. Whether on a chess board or in your career, you should plan each move carefully. In **electronics**, you can *move ahead* faster and further with a

## **B. S. DEGREE**

Put professional knowledge and a COLLEGE DEGREE in your electronics career. Earn your degree through independent study at home, with Grantham College of Engineering. No commuting to class. Study at your own pace, while continuing your present job.

The accredited Grantham non-traditional degree program is intended for mature, fully employed workers who want to upgrade their careers . . . and who can successfully study electronics and supporting subjects through

### **INDEPENDENT STUDY, AT HOME**

Free Details Available from:

**Grantham College of Engineering**  
10570 Humbolt Street  
Los Alamitos, California 90720

### **Independent Home Study Can Prepare You**

Study materials, carefully written by the Grantham staff for independent study at home, are supplied by the College, and your technical questions related to those materials and the lesson tests are promptly answered by the Grantham teaching staff.

### **Recognition and Quality Assurance**

Grantham College of Engineering is accredited by the Accrediting Commission of the National Home Study Council.

All lessons and other study materials, as well as communications between the college and students, are in the English language. However, we have students in many foreign countries; about 80% of our students live in the United States of America.

**Grantham College of Engineering** R10-85  
10570 Humbolt Street, Los Alamitos, CA 90720

Please mail me your free catalog which explains your B.S. Degree independent-study program.

Name \_\_\_\_\_ Age \_\_\_\_\_

Address \_\_\_\_\_

City \_\_\_\_\_ State \_\_\_\_\_ Zip \_\_\_\_\_

# COMMUNICATIONS CORNER



HERB FRIEDMAN,  
COMMUNICATIONS EDITOR

## Infrared communications

ASK ANY TEN PEOPLE TO DEFINE "communications" and you'll probably get 11 correct answers. Communications is simply the way we convey information. (And everyone has his own specific needs when it comes to information.)

Many can remember when communications meant things like radio, telephone, teletype, telegraph, etc.

Somewhere along the way, the term communications came to mean almost anything. For example, no longer do we teach grade schoolers to read and write; instead, we teach them to communicate. And later, it's off to college where they study communications: how to produce TV and radio shows, and films, write scripts, edit films, and most important, criticize the work of others who show even less promise.

I still believe communications has to have some element of magic, and that it must do its thing in real time. Of course, the computer has added some truly magical quality to real-time communications, but every once in a while we find that the latest breakthrough in the state-of-the-art is nothing more than an old idea resurrected from obscurity.

Back in the golden age of electronics projects, I, as did many others, experimented with infrared devices. We made *invisible light* beams and detectors, which sounded a bell or alarm if someone interrupted the beam. We even built projects that enabled us to talk on a beam of light. Later, we used LED's and solid-state infrared

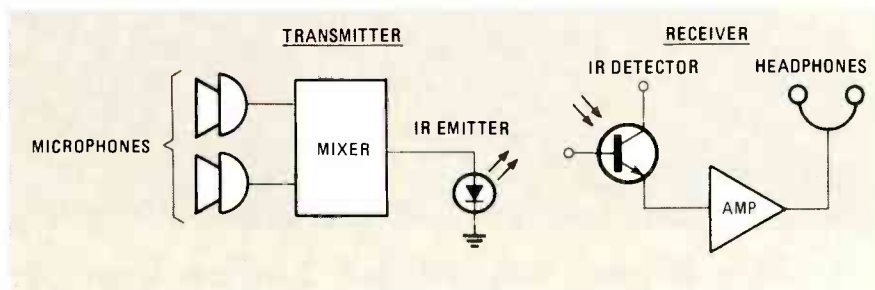


FIG. 1

detectors to once again talk via light beam (for a distance of about two feet).

Two feet became five feet, then ten feet, and finally someone designed a gadget for connection to a TV or Hi-Fi that sent an invisible beam of sound across the room to headphones that had infrared detectors in each earpiece. The gadget worked, but was not cost-effective.

However, as is common to our world, technology eventually reduces the price of just about everything. While the Hi-Fi sound transmitted to a headphone by light beam wasn't a commercial success, the same idea is now being resurrected to provide personal amplification in many theaters—a way for the actors to communicate directly with individuals in the audience. The old *talk-on-a-light-beam* construction project is now being used to bring real-time entertainment to the hard of hearing.

### How it works

Figure 1 shows a block diagram of the talk-on-a-light-beam system. There's nothing spectacular

about the design. Other than solid-state circuits, which make the combined receiver and headphone unusually light, it's the same old light beam project that we used to build for the science fair.

What's different about the system is that it's almost interference free. It's even possible to place your fingers in front of the detector and, if there is the slightest space between your fingers, the system still works. Because several transmitters are used to send the signal, the light beams strike the detector from every possible angle. A little energy manages to sneak past any opening, no matter how small.

Microphones spread across the stage pick up the stage sounds (signals). The signals are mixed and fed to several transmitters mounted at the front of the theater on each side of the stage. One pair is mounted low for the orchestra and the other pair is mounted high for the balcony. The transmitter is really nothing more than a box containing an infrared emitter, a power supply for the infrared emitter, and a small audio power



# You may not be able to solve the world's problems. But at least you can listen.



## The Panasonic Command Series™. With double superheterodyne tuning, you'll hear the world loud and clear.

Now it's easy to listen in on the world's hot spots. With the Panasonic RF-B600 Command Series FM/LW/MW/SW receiver.

Its advanced microcomputer-controlled tuner lets you preset up to nine different frequencies. And reach them at the touch of a button. Or, press the appropriate buttons and tune in any desired frequency with direct-access digital tuning. It'll lock right in to every signal with a PLL quartz-synthesized tuner. Once tuned in, the Panasonic double superheterodyne system helps deliver a clean, consistent signal.

There's even built-in auto-tuning to let you scan the shortwave band automatically, as well as manually. All this means you can tune in Berlin, pick up Paris, or locate London in an instant. Without dialing all over the band.

Both the RF-B600 and the RF-B300 are packed with features and built to go anywhere.

The Panasonic Command Series offers something for everyone. With equipment sophisticated enough to impress the most avid enthusiast, and automatic features that get you where you want to be. Fast.

There's a whole world out there that's waiting to be heard. Tune in to it with the Panasonic Command Series.



Batteries not included.

CIRCLE 266 ON FREE INFORMATION CARD

**Panasonic**  
just slightly ahead of our time.™

# Radio-Electronics mini-ADS

amplifier that drives the infrared emitter.

Whether the person seated in front of the user is small, large, wearing a hat, or has an over-done hair style makes no difference. If the beam from one transmitter is obstructed, the beam from another is there to take its place. In testing the system, we even turned around and faced the rear of the auditorium. As you might expect, the signal eventually dropped out, but we had good reception for better than 300-degrees because the input signal originated from several well-spaced transmitters.

The receiver looks very much like the headphones you get on an airplane (with a transducer at the center from which "pipes" lead to each ear). But unlike the airplane headphones, the infrared headphones have a small receiver at the center, and the pipes terminate in real sound transducers, like those used for cassette players.

At the bottom of the receiver is a small rechargeable battery, about 1 x 0.5 x 0.25 inches, that plugs into the receiver. It really hangs below the receiver so it can be simply pulled out and plugged into any convenient outlet for recharging.

On the front of the receiver is a volume control, power switch, and an infrared detector, feeding what can easily be described as a high-fidelity amplifier and headphone. And the sound quality is as good as the best of the *Walkmen* tape players.

Infrared communications works very well over a relatively short, direct path. Because it's inherently a high-fidelity system (in the sense it can transmit a wide spectrum without special equalization), it's useful for much more than just wireless sound, as witnessed by TV remote controls.

There is no reason why the two functions (control and sound) cannot be multiplexed on the same carrier beam. Just imagine an infrared light-beam gizmo in the base of a communications microphone. The sound and control switching would go to the transmitter without intervening wires to snag around the legs: Probably the safest way to operate a mobile radio short of parking. R-E



**MINI-ROBOTS** Priced from **\$24.95** (PEPPY, touch/sound controlled, shown at left), to **\$74.95** (MEMOCON CRAWLER, 4K programmable memory, shown at right). Each kit includes step-by-step instructions and pre-assembled PC boards. Batteries not included. Add **\$2.50** (per unit) for S & H. Other models to choose from. Send **\$1.00** for more information and diagrams. **MORNING DISTRIBUTING CO.**, P.O. Box 717, Hialeah, FL 33011 (305) 884-8686.

CIRCLE 269 ON FREE INFORMATION CARD



**THE WIRELESS TELEPHONE TRANSMITTER** model WTT-20 is only the size of a dime, yet transmits both sides of a telephone conversation with crystal clarity. Completely automatic. Uses power from the telephone line itself. Never needs a battery! Up to ¼ mile range. Use with any FM radio. Complete kit only **\$29.95**. Tax included.

**FREE SHIPPING. DECO INDUSTRIES, Box 607, Bedford Hills, NY 10507. (914) 241-2827.**

CIRCLE 127 ON FREE INFORMATION CARD



**EPROM PROGRAMMERS & ERASERS.** Self-contained stand-alone. Programs most 5V EPROMs from 16K to 256K Parallel I/O port or RS-232 (optional). Standard with data entry keypad. Prices from **\$169.00**. ERASERS - erasers up to 9 chips in 15 min. Build-in electronic timer. Prices from **\$44.90**. Most products are in stock. **ANGO ELECTRONICS CORP.** PO Box 112, Harrison, NJ 07029. (201) 484-1115.

CIRCLE 252 ON FREE INFORMATION CARD



**DELTA DUAL TRACE OSCILLOSCOPES WITH PROBES** DX5020 20MHz **\$379.95**. Built in component tester 5MV to 20V/DIV 0.2 microsec. to 0.5s/DIV. Risetime less than 17ns one year limited warranty. Also available DX5035 35MHz **\$527.00** DX5045 45MHz **\$789.95** DX5015S 15MHz A/C D/C **\$479.95**. CA. residents add 6.5% tax. Shipping \$8.50. Money orders, checks accepted. **DELTA DYNAMIC INC.**, 20955 E. Lycoming St., Walnut, Calif. 91789. Tel. (714) 594-7131. Telex: 503749 DELTAX.

CIRCLE 255 ON FREE INFORMATION CARD

## CALL NOW AND RESERVE YOUR SPACE

- 6 x rate \$745.00 per each insertion.
- Reaches 217,425 readers.
- Fast reader service cycle.
- Short lead time for the placement of ads.
- We typeset and layout the ad at no additional charge.

Call **212-777-6400** to reserve space. Ask for Arline Fishman. Limited number of pages available. Mail materials to: mini-ADS, RADIO-ELECTRONICS, 200 Park Ave. South, New York, NY 10003.



**New Low Price!**

**TELTON'S TRK-957 KIT** makes breadboarding a low-power, central-office quality DTMF detection system easy and inexpensive. The included M-957 receiver decodes 12 or 16 digits and operates from 5 to 12V dc. Its sensitivity, wide dynamic range, noise immunity and CMOS design are ideal for telephone switching, computer and remote-control applications. Now only **\$14.95**. To order call: **TELTON, 1-800-227-3800, ext. 1130.**

CIRCLE 122 ON FREE INFORMATION CARD

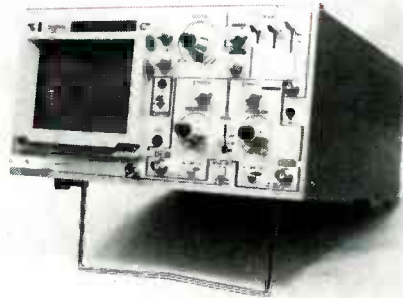


# Radio-Electronics mini-ADS



**DANDY-DAPTER W/FREE INFRARED HAND UNIT TESTER**—Uses All functions of your CRT Tester on all color CRT's. Never buy another Adaptor Socket for your Tester. Our 3rd yr., Money Back Guarantee. Instructions/set-up manual included, Check/MO/Visa/MC/COD \$63.95 ppd. 1-800-331-9658. **DANDY MFG. CO.**, 2300 Gibson, Muskogee, OK 74403.

CIRCLE 284 ON FREE INFORMATION CARD



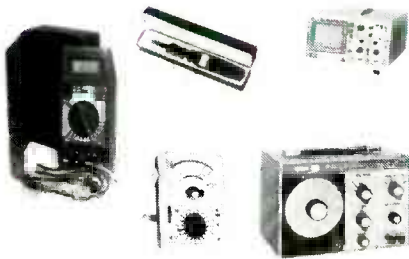
**MEGURO (JAPAN) 20MHZ OSCILLOSCOPE** \$375.00 Dc-20 MHz, 5mv/div, 2 Channel, Dual Trace 6" square internal graticule CRT. Also: 35 MHz Oscilloscope with delayed sweep \$559.00. Signal Generators from \$1,186.00, Wow Flutter Meter \$999.00. Add \$10.00 per unit for UPS & C.O.D. charges. To order call collect: **DIPLOMAT INTERNATIONAL**, 2900 Townsgate Road, Suite 100, Westlake Village, CA 91361, (805) 495-8858.

CIRCLE 264 ON FREE INFORMATION CARD



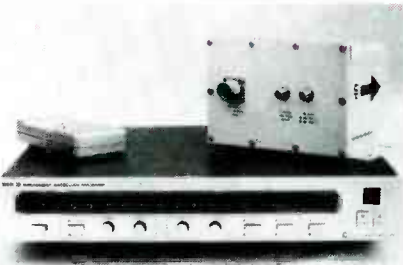
**ZENITH SSAVI DESCRAMBLERS** only \$169. Gated Pulse \$189; Sinewave \$199 each. Reconditioned original equipment for UHF chs. 23,27,31,38,51,54,57,68, etc. Quantity discounts. Surplus TV equipment: Jerrold SB-3, Oak N-12, Zenith Z-Tac, Hamlin 1200, etc. Catalog \$1. 10 day satisfaction guarantee & 90 day warranty, **AIS SATEL-LITE**, P.O. Box 1226-E, Dublin, PA, 18917. 1-800-643-2001 or 215-249-9411.

CIRCLE 267 ON FREE INFORMATION CARD



**SINGLE AND DUAL TRACE Scopes**, Analog and Digital Multimeters, Power Supplies, High Voltage and Low Cap. Probes RF and Sine/Square Wave Generators, Digital Capacity Meters. **EMCO ELECTRONICS**, P.O. Box 327, Plainview, NY 11803. Send for your free catalog.

CIRCLE 293 ON FREE INFORMATION CARD



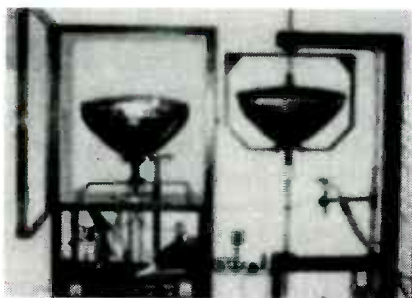
**SATELLITE TELEVISION RECEIVER SEMIKIT** with dual conversion downconverter. Features infrared remote control tuning, AFC, SAW filter, RF or video output, stereo output. Polorator controls, LED channel & tuning indicators. Install six factory assembled circuit boards to complete. **Semikit** \$400.00. Completed downconverter add \$100. Completed receiver and downconverter add \$150. **JAMES WALTER SATELLITE RECEIVER**, 2697 Nickel, San Pablo, CA 94806. Tel. 415-724-0587.

CIRCLE 124 ON FREE INFORMATION CARD



**THE MOST EXCITING KIT YOU WILL EVER BUILD** The model WAT-50 miniature FM transmitter uses a 4-stage circuit NOT to be confused with a simple wireless microphone. Up to 1 mile range. So sensitive, it will pick-up a whisper 50 feet away! Use with any FM radio. Complete kit only \$29.95 tax incl. **FREE SHIPPING. DECO INDUSTRIES**, Box 607, Bedford Hills, NY 10507. (914) 241-2827.

CIRCLE 127 ON FREE INFORMATION CARD

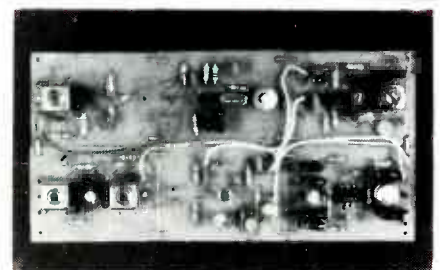


**ONE MAN CRT FACTORY**, easy operation. Rebuild CRT's for tv's, bus. machines, monitors, scopes, etc. Color, b&w, 20mm, foreign or domestic. 3x6 ft. space required. Profits??? Average CRT rebuilding costs—\$5. Sell for \$100 = \$95 profit; x 5 CRT's = \$475 daily; x 5 days = \$2375 weekly profit. Higher profits overseas. Investigate this opportunity today. We service the entire world Contact: **CRT FACTORY**, 1909 Louise St., Crystal Lake, Il. 60014, (815) 459-0666.



**SUBSCRIPTION TV MANUAL.** This information packed book details the methods used by subscription TV companies to scramble and descramble video signals. Covers the Sinewave, Gated Pulse, SSAVI system, and the methods used by most cable companies. Includes circuit schematics, theory, and trouble shooting hints. **Only \$12.95** plus \$2.00 first class P&H. **ELEPHANT ELECTRONICS INC.**, (formally **Random Access**) Box 41770-R, Phoenix, AZ 85080

CIRCLE 120 ON FREE INFORMATION CARD



**HOBBY KITS THE ERECTOR SET** of linear electronics. Modules from \$4.95 to \$49.95. Build basic circuits: 2 W audio amplifier (AFA-1, \$4.95), tone decoder (PLL-1, \$6.95), to more complex: VHF Converter (using 4 modules, \$27.80). QRP Transceiver (using 6 modules as shown, \$38.70), HF SSB Transceiver (using 14 modules, \$140.30). Add \$2.50 for S&H. **SEND \$1.00** for diagrams, \$5.00 for full manual. **MORNING DISTRIBUTING CO.**, P.O. Box 717, Hialeah, FL 33011 (305) 884-8686.

CIRCLE 270 ON FREE INFORMATION CARD

# ANTIQUE RADIOS



RICHARD D. FITCH

## Common restoring problems—and solutions!

WHILE SOME ANTIQUE RADIOS SUFFER from chassis problems, cabinet problems are actually more common. So if you're going to take the antique-radio hobby seriously, and you don't want your electrical handiwork to go unnoticed, then cabinet repair *must* be in your bag of restoration tricks. If you've got your hands full just working on the chassis, cabinet work can be a good way of getting other family members involved. Just be sure to remember (and teach your family) the proper safety precautions. You already know that working on the chassis can be dangerous if you're not careful, but so can working on the cabinet. Make sure that gluing and sanding are done in a well-ventilated area, and that masks are worn.

The first set we'll look at, which we'll call the "Antique Radio of the Month" is the Kennedy *Model 20*. That radio just needed a little woodworking to make it a handsome addition to our collection. As with many antique radios, that set has a veneer finish.

While a high-quality radio that has had very good care might sneak by with just a good polishing, that rarely happens. A large majority of antique radios have spent many years stored in unfavorable environments. So if your radio hasn't been one of the lucky ones, you'll have to learn how to replace some or all of the veneer.

### Veneer basics

Veneer is available locally in many areas, or it may be purchased by mail. Regular veneers



FIG. 1

come in thicknesses between  $\frac{1}{40}$ -inch and  $\frac{1}{12}$ -inch, and are made from about thirty different kinds of wood. Flexible veneer is suitable for many applications, especially curved surfaces. However, it is so thin ( $\frac{1}{64}$ -inch) that it can't be butted up against a thicker piece without shimming or sanding.

The best way to attach veneer to flat surfaces is with hot-melt glue. Spread the glue with a glue gun, seat the veneer, and then use an old electric clothes iron to re-melt the glue. You may have difficulty

using an iron on curved pieces. If you are unable to use an iron, you'll have to use wood glue or contact cement (which requires much patience and a steady hand).

### The Kennedy *Model 20*

While I don't know the exact age of that classic floor radio, judging by the cabinet and chassis I'd guess that it comes from about 1928 or '29. I learned everything I know about the manufacturer from the owner's manual I got when I found the radio. (First time that ever happened!) Unfortunately, the "Colin B. Kennedy Corporation of South Bend, Indiana" is no longer in existence. The manual states that the company had seventeen years of experience building radios. That would date Kennedy's origin to the early 1900's.

The first thing I did to get that relic back into working condition was to fumigate it. Next I removed the damaged veneer. I tried to get it off in one piece, but as you can see in Fig. 1, I wasn't very successful. After all the veneer was removed, there was a gummy residue left on the cabinet. To ensure that the hot-melt glue would adhere, the residue had to be scraped and sanded off.

Because the veneer stock wasn't wide enough, two smaller pieces had to be butted together. The hard part about butting veneer is getting the edges to meet evenly. However, if you overlap the edges slightly and cut through both pieces at once, you can be sure that both pieces will join perfectly.



An electric iron was used to re-melt the glue and press the veneer into place. It takes considerable heat to re-melt the glue through the veneer, so it's a good idea to place a thin sheet of aluminum between the iron and the veneer so that glue soaking through the veneer won't gum up the iron. In any case, clamps must be used to hold the veneer flat until it cools. Once the veneer has been glued down, you can sand and stain it.

### Chassis repair

When I first powered the *Kennedy Model 20* up—after the usual safety inspection—it actually worked, but there was a loud, clashing noise. The chassis was still out of the cabinet, so I removed all the removable components and inspected them. Everything seemed OK. After reassembling the radio, the problem was gone. I wish all chassis problems were as easy to repair!



FIG. 2

Unlike the cabinet, there is little danger that the chassis will ever deteriorate. The *Kennedy* has one of the heaviest and most completely shielded chassis I've ever seen. It is built from "16-gauge, cold rolled, auto body steel," according to the owner's manual. It is plated, as are all of the shields. As you can see in Fig. 2, the bottoms of the tube sockets are also shielded. In addition, the four gangs of the tuning capacitor each have separate shielded compartments. Clearly, the heavy brass plates of that capacitor were not meant to be bent. Another plate shields the bottom of the receiver.

### Technical specifications

The *Kennedy Model 20* has a

tuning range of 200 to 500 meters (the AM broadcast band). The receiver uses a 7-tube circuit with 4 tuned stages to cover that range. The tuned circuit is composed of a three-stage RF amplifier and a tuned detector. In addition, there is a two-stage audio amplifier that uses two UX245 or CX345 power tubes in a push-pull arrangement. Because of that design, the reception is excellent.

The *Kennedy Model 20* even has an input for a phonograph. A little lever just above the power switch directs either the detected RF or the phonograph's output to the audio stage.

### The Arvin 444

The *Arvin 444* shown in Fig. 3 sat in my junk pile for a long time. I couldn't see how such a small radio could have so much wrong with it. Two of the four tubes were missing, as were the knobs. The radio also had a bad filter capacitor and a torn speaker cone. With all the electronic problems, not to mention the fact that it had been brush-painted green, I decided to "file" this antique with the others that were too new, too far gone or, for some other reason, were not worth restoring.

Then one day, when browsing through an antique shop, I saw an *Arvin 444* with an ivory cabinet sitting on a velvet-covered table. It looked like the Hope diamond.

The shop-keeper came over and said, "That's a rare little radio; it's the only one still in existence!" He then offered to sell it to me for \$75. I didn't take it, but you can bet that



FIG. 3

when I got back home I retrieved my little *Arvin* from the junk pile. It is now restored and has a permanent place in our collection, being "one of only two in existence!" **R-E**

SEE YOUR DEALER TODAY

FROM

**'Firestik'**  
ANTENNAS  
ACCESSORIES

HERE'S A TIP  
THAT'S PERFECT!  
AM/FM AUTO RADIO  
AND CB

**'Firestik' II**  
GOLDEN SERIES

BARE-HANDS TUNABLE  
"NO TOOLS NEEDED"  
HIGH PERFORMANCE ANTENNAS

ALSO ANTENNAS FOR  
CORDLESS TELEPHONES  
MONITOR SCANNERS

Dealer & Distributor Inquiries Invited  
SEND FOR FREE CATALOG

'Firestik' Antenna Company  
2614 East Adams/Phoenix, AZ 85034

Name \_\_\_\_\_  
Street \_\_\_\_\_  
City \_\_\_\_\_  
State \_\_\_\_\_ Zip \_\_\_\_\_

Serving the CB and  
Communications Market Since 1962.

**5-YEAR REPLACEMENT WARRANTY**

CIRCLE 100 ON FREE INFORMATION CARD

**Interest in New  
U.S. Savings Bonds  
is growing daily  
at Gilbarco  
in Greensboro.**



Mark W. Snowberger  
Vice President

"Investing in savings bonds provides me with the benefits of market interest rates while, at the same time, it protects my investment against market declines by a minimum guaranteed yield.

Evelyn Idol  
Set-Up Operator

My husband and I plan to do a lot of traveling when we retire. U.S. Savings Bonds are an excellent way to save for these expenses. We are already making our plans to travel to Alaska.

NEW  
VARIABLE RATE BONDS  
MAKE IT  
SMART TO  
**Take  
stock  
in America.**

**Ad  
Council**

Director of Sales  
Department of the Treasury  
U.S. Savings Bonds Division  
Washington, D.C. 20226

Yes, please send me Free information about the Payroll Savings Plan.

Name \_\_\_\_\_  
Position \_\_\_\_\_  
Company \_\_\_\_\_  
Address \_\_\_\_\_  
City \_\_\_\_\_ State \_\_\_\_\_ Zip \_\_\_\_\_

# STATE OF SOLID STATE



ROBERT F. SCOTT

## Precision op-amps

PRECISION OPERATIONAL AMPLIFIERS are the mainstay of medical and industrial instrumentation. Linear Technology Corporation recently introduced the LT1014 precision op-amp, which is the first improved replacement for such industry-standard, 14-pin quad op-amps as the LM324, LM348, OP-11 and 4156. The LT1014's 50- $\mu$ V offset voltage, 0.3- $\mu$ V/ $^{\circ}$ C drift, 0.15-nA offset current, open-loop gain of 8 million, 117-dB common-mode rejection ratio and 120-dB power-supply rejection ratio definitely place it in the precision class.

The offset voltage of the LT1014 is so low that no offset adjustment terminals are provided on the IC. A new and improved output stage draws only 350  $\mu$ A, can source or sink more than 20 mA, and still retains high voltage gain.

Another member of the family, the LT1013, is the first improved direct replacement for industry-standard, 8-pin dual packages such as the MC1458/1558, LM148 and OP-221. The LT1013's specifications are similar to, but slightly better than, the LT1014's.

Both the LT1013 and the LT1014 can be operated from a single 5-volt supply. The common-mode input range includes ground, and the output can swing to within a few millivolts of ground. Crossover distortion, a characteristic of early single-supply designs, has been eliminated. Linear Technology gives complete specifications for both single-ended 5-volt and  $\pm$ 15-volt operation.

Absolute maximum ratings are: supply voltage:  $\pm$ 22 volts, differential input voltage:  $\pm$ 30 volts,

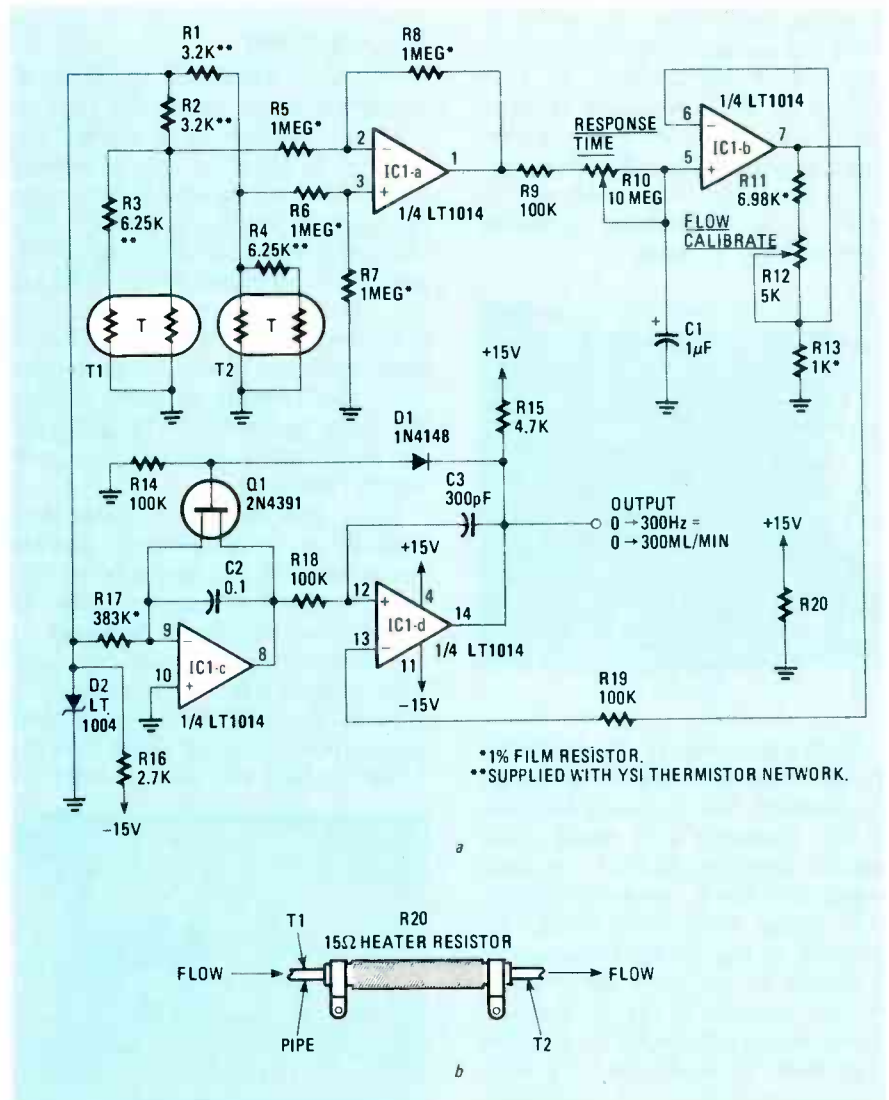


FIG. 1

input voltage: equal to the positive supply voltage. Operating temperature range is  $-55^{\circ}$ C to  $+125^{\circ}$ C for devices with the AM and M suffixes, and  $0^{\circ}$ C to  $+70^{\circ}$ C for devices with the AC, C and D suffixes.

### Using the LT1013 and LT1014

In earlier single-supply designs using such devices as the LM124, LM158, OP-20, and OP-221, if the input goes more than a few millivolts below ground, two kinds of problems may occur, both of



# COMPUTER DIGEST

VOL. 2 NO. 10 October 1985

NEW KIND OF MAGAZINE FOR ELECTRONICS PROFESSIONALS

## PRINTHEAD TECHNOLOGY

A State-Of-The-Art Report On How They Work.



A  
**GERNSBACK**  
PUBLICATION

## SERVING YOUR DELICATE ELECTRONIC EQUIPMENT

Metal oxide varistors can "eat up" those spikes and surges.

## COMPUTER AIDED DESIGN

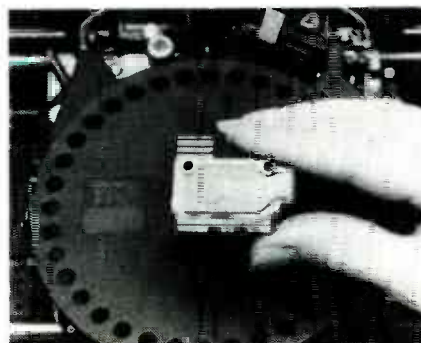
Using your personal computer to generate flow charts and schematic diagrams.

# CONTENTS

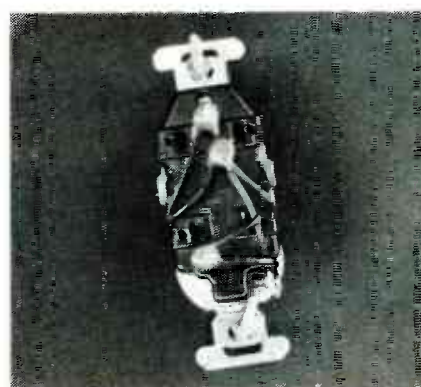
Vol. 2 No. 10

October 1985

- 5 Printhead Technology**  
Printheads have evolved dramatically since metal type slammed an inked ribbon against paper. **Marc Stern**
- 8 Saving Your Electronic Equipment**  
Metal Oxide Varistors can clamp those surges and avoid the voltage spikes that may damage your electronic equipment. **Elliott S. Kanter**
- 10 Computer-Aided Design**  
You can have the advantage of computer-produced schematics and flow charts and it doesn't have to cost you a fortune. **Herb Friedman**
- 3 Editorial**  
"Hackers Are Morons." Our Editor rolls up his sleeves and once again takes up the cudgel.
- 4 Letters**
- 4 Computer Products**



Page 5



Page 8

## ON THE COVER

The IBM Quietwriter™ printer is typical of modern, up-to-the-minute technology. You can read all about it in the article starting on page 5.

## COMING NEXT MONTH

If you've been saving to buy a modem for your Commodore 64, here's the first of a two-part article on how to build one instead.

**COMPUTER DIGEST** Vol. 2 No. 10 October 1985  
NEW KIND OF MAGAZINE FOR ELECTRONICS PROFESSIONALS

**PRINthead TECHNOLOGY**  
A State-Of-The-Art Report: Or How They Work.

**SERVING YOUR DELICATE ELECTRONIC EQUIPMENT**  
Metal oxide varistors can 'eat up' those spikes and surges.

**COMPUTER AIDED DESIGN**  
Using your personal computer to generate flow charts and schematic diagrams.



# EDITORIAL

## "Hackers are morons..."

■ If you want to raise a furor, use the above sentence in the computer community. I did, in my August issue editorial. The mail and telephone calls are *still* coming in. Most of the people that contacted us are involved purely in the semantics. "A hacker," said one, "is an experimenter that 'hacks away' at a computer to make it do something else."

But even this man admitted a distaste for the guy who illegally burrows into another computer system, just to show that he was able to do it! And these very people call themselves hackers!

I have no gripe with the guy who experiments with computers within the confines of his own realm. That's our *reader!* I'm down on the nut that thinks he deserves a medal for having broken into somebody else's computer system and loused things up just to show that he was able to .

And *that's* what's called a "hacker." By the general computing community, and by those morons (see? I said it again!) themselves.

The fact remains that a problem exists. A "hacker" is a thief, a criminal, who uses a computer to break into other computer systems where he has no business. This term is widely accepted throughout the computer industry.

A "computer experimenter" is *not* a hacker. Many of the innovative practices in the computer industry are the result of the work of such experimenters. And from a selfish standpoint, it is the experimenter that **ComputerDigest Magazine** is dedicated to.

Too many "computer experimenters" are fond of denegrating their work and/or hobby by calling themselves "hackers." This is a sad mistake, and I would urge that as a practice, it be halted.

So if you are a computer hacker (in our terms of reference) and that editorial ofended you, I'm certain that this one will prove equally offensive. However, I'd recommend a few courses of action to you:

Give up hacking and get into something a bit more useful—like stealing hubcaps. Do *not* send me any unsigned mail. If you don't have the guts to sign what you write and provide an address to which a reply can be sent, don't write at all.

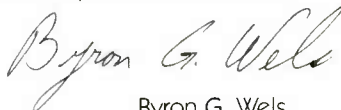
Just to make the point clearly, for once and all, a "hacker" spends his time trying to break into computers... Government computers, hospital computers, school computers, my computers, etc. and louse up the records. He doesn't do this by any clever, intelligent means, but rather by simple, dogged, repetitive (and very boring) trial and error.

A computer experimenter on the other hand, is an intelligent, thinking individual who tries to improve his own computer or the state of the art technology in general. Whether he succeeds or fails is not important. The fact that he tries puts him in the same category as the great inventors of all time and we all owe him a debt of gratitude. The articles that you see in this magazine were written by computer experimenters.

The hackers contribute nothing to the computer community or the community in general. They give us all a bad name. If they continue to flourish, you're going to see tighter controls on all of us. And Americans, being a freedom-loving people, don't want things like that to happen.

There's a vast difference between the legitimate experimenter and the *illegitimate* hacker!

Or maybe it's just a half-vast difference.



Byron G. Wels  
Editor

# COMPUTER DIGEST

Hugo Gernsback (1884-1967)  
founder

M. Harvey Gernsback,  
editor-in-chief

Larry Steckler, CET, publisher

Art Kleiman, editorial director

Byron G. Wels, editor

Brian C. Fenton, technical editor

Carl Laron, associate editor

Robert A. Young, assistant editor

Ruby M. Yee, production manager

Robert A. W. Lowndes,  
production associate

Karen Tucker,  
production assistant

Geoffrey S. Weil,  
production assistant

Andre Duzant, Technical Illustrator

Jacqueline P. Weaver,  
circulation director

Arline R. Fishman,  
advertising coordinator

Gernsback Publications, Inc.

200 Park Ave. South

New York, NY 10003

Chairman of the Board:

M. Harvey Gernsback

President: Larry Steckler

## ADVERTISING SALES 212-777-6400

Larry Steckler

Publisher

## EAST/SOUTHEAST

Stanley Levitan

Radio-Electronics

200 Park Ave. South

New York, NY 10003

212-777-6400

## MIDWEST/Texas/Arkansas/OKla.

Ralph Bergen

Radio-Electronics

540 Frontage Road—Suite 325

Northfield, Illinois 60093

312-446-1444

## PACIFIC COAST

Mountain States

Marvin Green

Radio-Electronics

15335 Morrison St., Suite 227,

Sherman Oaks, CA 91403

818-986-2001

**ComputerDigest** is published monthly as an insert in Radio-Electronics magazine by Gernsback Publications, Inc., 200 Park Avenue South, New York, NY 10003. Second-Class Postage Paid at New York, N.Y. and additional mailing offices. Copyright © 1985 Gernsback Publications, Inc. All rights reserved. Printed in U.S.A.

A stamped self-addressed envelope must accompany all submitted manuscripts and/or artwork or photographs if their return is desired should they be rejected. We disclaim any responsibility for the loss or damage of manuscripts and/or artwork or photographs while in our possession or otherwise.

# LETTERS

## Complaint!

I enjoyed your Editorial in the March Issue of **ComputerDigest** but if you think Instruction Manuals are bad, you ought to see some of the Service Manuals. It's really sad. It's no wonder people need so much help in getting things to work right. It's not restricted to computers, either. Our shop gets problems on car stereos and answering machines that could be straightened out with some simplified instructions.—P. B. Mann, Atlanta, GA.

*Thanks for the comments, P. B. Maybe by calling attention to this much-neglected area of technology, we'll start getting better instruction books from the manufacturers!*

## New idea.

Liked your Editorial on Computers and the CB Syndrome. But what about including the rising interest in amateur radio and the subsequent decline? I was

impressed how amateurs did such a great job of research and development at a low cost.

Also, I've developed a device that will greatly simplify learning electronics, and need professional marketing assistance. How can I get this?—Don L. Harbertson, Morgan, UT.

*Don, our prime interest, of course, is computers. We'll leave the amateur radio to those magazines that cater to that field. Of course, I agree wholeheartedly!*

## Harder and harder

Kids today have it rough. There is so much more to learn, yet the time to learn (and teach) has not been extended. Invention is also a closed field, for it takes megabucks to do research which shuts out the individual. It's now a team effort at the Corporate level. What can you recommend for a youngster looking at his future?—Bob J. Seligman, Kent, NH.

*Imagination, Bob. There are no*

*dead-end jobs, only dead-end people. You're right about there being more to learn, but education has now become vertically-specialized to compensate for this. And all inventions don't have to be Earth-shattering in scope! There's still room for the individual—Find a new type of cap for a toothpaste tube, or a new kind of paper clip.*

## Communications trap

Being in the publishing business, of course you're sensitive to communications. I've picked up on your interest in this area in your Editorials, too. But did anything in particular get you hyped on this subject?—Fred Mason, Hackensack, NJ.

*Fred, I was once asked to write a book on "Rock" by a major publisher, and spent the next six months immersing myself in an in-depth study of geology by way of preparation. When I finally delivered the manuscript, I found out that he meant Music! ◀▶*

# COMPUTER PRODUCTS

For more details use the free information card inside the back cover

**ANALYZER PROGRAM**, *The Landlord Investment Analyzer* is designed for real estate investors, who can produce a thorough cost/benefit analysis of properties by using it. It calculates data that is entered for a specific

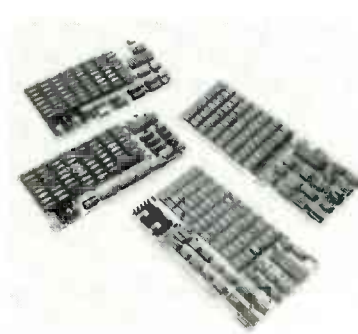


CIRCLE 11 ON FREE INFORMATION CARD

property, including pricing, financing alternatives, expected return, and buyer tax considerations. By objectively comparing investment options, properties that will yield the highest profits are easily identified.

*The Landlord Investment Analyzer* is completely menu driven, and online instructions provide immediate help. The package is available in PC-DOS, requires 256K memory and one disk drive. It is priced at \$350.00.—*Systems Plus, Inc.*, 1120 San Antonio Road, Palo Alto, CA 94303.

**EMULATOR**, the *SemiDisk*, is a computer peripheral hardware/software disk emulator package that speeds up the operation of computer systems.



CIRCLE 12 ON FREE INFORMATION CARD

*SemiDisk* is compatible with IBM PC, XT, AT, and most IBM PC systems, and the S-100 bus, Epson QX-10, and TRS  
*continued on page 14*



# PRINTHEAD TECHNOLOGY

*Everything you ever wanted to know about printheads.*

**Marc Stern**

■ Do you remember the days when the only "serious" computer printers were fully formed character or dot-matrix machines, while thermal printers were given short shrift as "amateur" devices?

Thermal printers are now "serious" machines, whose capabilities rival those of their fully-formed or dot-matrix brethren. In fact, the entire realm of non-impact printers, to which thermal devices belong, has undergone a revolution during the last 18 months. At the start of 1984, laser printers were available at costs exceeding \$50,000 and ink-jet printing was confined to commercial ventures. Now, laser imaging printers are available for less than \$3,500 and ink-jet printers in the \$300 to \$1,200 range abound.

## Thermal printers

As recently as 1982, thermal printers were looked on as toys. They were among the first personal computer printers, but they had drawbacks. They needed special paper to operate, which tended to discolor rapidly; their resolution was too low for other than rough use, and their print quality wasn't high.

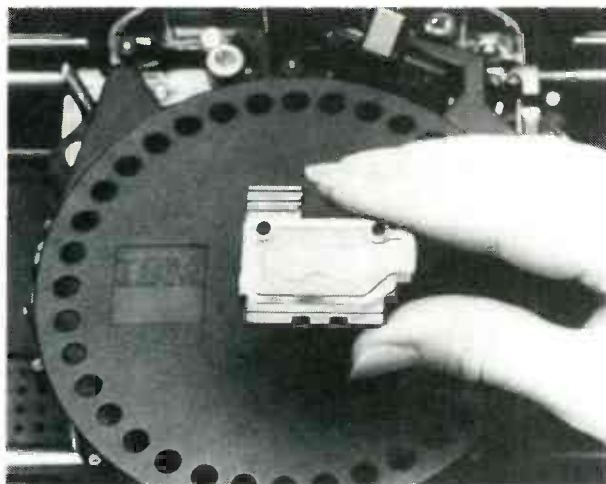
Their technology was a combination of dot-matrix printing and thermal technology.

In use, these printers—most were serial—took the output from a microcomputer and internal microprocessor-based circuitry transformed the output into text. The ASCII codes generated by the microcomputer were compared against character sets stored in Read-Only Memory (ROM) and the appropriate signals were generated for the printhead controller circuitry and printhead, which contained a number of wires. Those wires were fired by tiny solenoids into the special thermal printer paper which was "exposed" by a heater bar over which the paper traveled.

\* The result was a low-resolution printout of block characters, which was unsuited for any use, other than rough output. The reason for this was the nature of the printhead. It generally contained a matrix of five wires across by seven wires down, which was too coarse for quality text output. Further, the ROM-based character set usually contained only capital letters.

## Crucial developments

The change occurred when thermal printing became thermal transfer printing. Instead of relying solely on the heat-sensitive paper to produce printed output,



**FIG. 1—FORTY TINY ELECTRODES meet at the edge of IBM's electronic printhead. In the background, is the round cassette that holds the IBM "Quiet" (TM) correcting ribbon.**

special ribbons were added. The plastic ribbons were struck by the printhead wires as the paper moved over the heater bar and the dot-matrix letters were melted onto the paper. In some cases, not only did the heater bar do the melting, but the printhead wires were also heated to help in the process. In this type of printer, the printhead serves two roles, printhead and heating element.

A second important development came from impact, dot-matrix printer technology.

By using finer printhead wires, more sophisticated internal programming and circuitry, dot-matrix printer manufacturers were able to increase the density of their printheads. The first jump went from 5 by 7 to 7 by 9 or 9 by 9 wires. The increasing number of printhead wires meant letters could now look more normal.

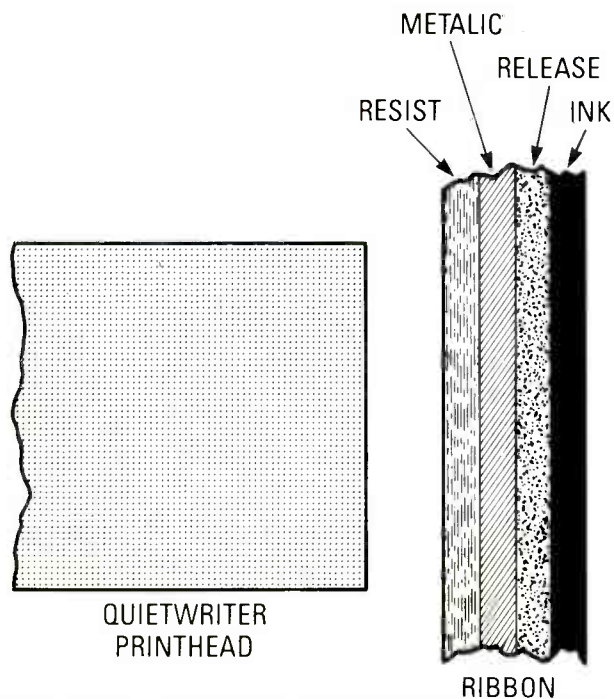
The increase in density continued to the point where denser printheads became common. Densities of 18 to 24 wires or more were usual.

This type of printhead required technological sophistication because each print wire had to be fired at the correct moment and in the correct sequence. Dot-matrix printers had come of age. They were now capable of the precise control needed to generate true descenders and near-letter quality printing.

This technology was transferred to thermal printers, which are non-impact, as opposed to the impact dot-matrix printer (the dot-matrix printer's pins push through a ribbon and then strike the paper) and the result has been a new generation of thermal transfer printers whose output is indistinguishable from a fully formed character machine.

There are two types of thermal transfer technology currently on the market, the older style heater bar or heater head printer and the newer IBM-manufactured thermal transfer printer.

IBM's development is actually a breakthrough in thermal transfer technology. Although many thermal transfer printers can make use of low quality paper and can produce acceptable results, high quality printing still requires special, glossy-style printer paper. With IBM's system, you can use any type of paper.



**FIG. 2—THE IBM RIBBON uses a four-layer system that works with the printhead to release ink to the paper. The result is an almost-perfectly formed character that is hard to tell from what used to be called "Letter Quality."**

Using a 40-wire printhead—See Fig. 1—IBM uses a variation on thermal transfer printing to achieve letter-quality printing from the dot-matrix head.

As in conventional thermal transfer printers, the text is "exposed" by heat, but, with a difference. Where the normal thermal transfer printer passes the paper over a heater bar as the ribbon is being struck by the dot-matrix pins, the IBM system uses a special ribbon that releases ink in response to pinpoint areas of heat generated by current in the printhead.

IBM's thermal printer uses a four-layer ribbon which consists of a polymer resist material that heats up in pinpoint areas; a metallic conducting layer; an easily meltable layer that permits the release of ink, and a film of ink.

When it is printing a character, the printhead presses the ribbon against the paper and the electrodes contact the resist layer. These electrodes apply small electrical currents that travel through to the metallic layer, with the result that up to 40 pinpoint areas of heat can be generated. This, in turn, melts tiny areas in the release layer and paints the ink on the paper. (See Fig. 2.)

(IBM also uses this technology on its *Quietwriter* series of electronic typewriters and correcting mistakes by reversing the process to lift letters which have been painted on the paper.)

### New typestyles

Like standard dot-matrix printers, the thermal transfer printer is programmable. This programmability, among other things, means it is very easy to change typefaces. By simply inserting a new character-recognition ROM on some of these printers, you can have multiple

typefaces. (See Figure 3.) The microprocessor's text-creating algorithm reads the new ROM character set if it sees that the interrupt for the ROM cartridge has been issued. This ROM replaces the printer's standard character set and the new codes are based on it.

Thermal printing has now come of age. Forty-wire printheads and printheads with 36 by 24 resolution are common and, thanks to the special plastic ribbons used, the output looks as if it comes from a fully formed character machine.

### Laser imaging

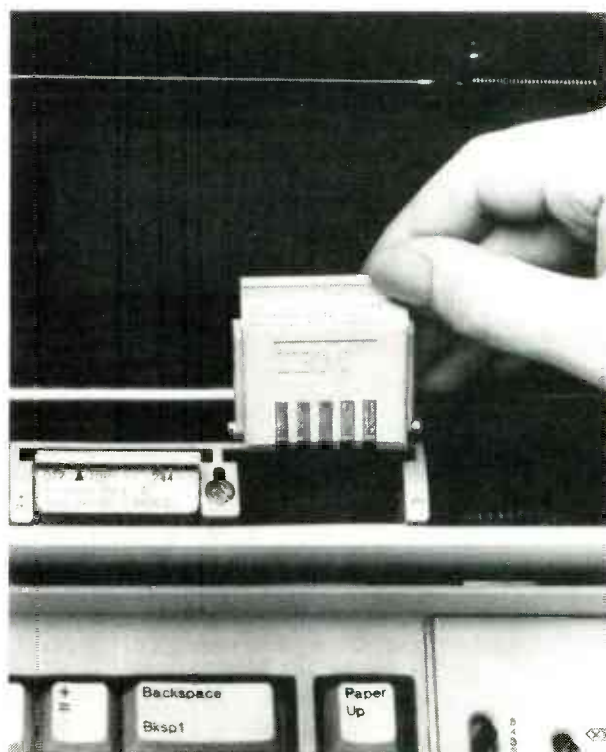
Just a few years ago, laser printers cost the better part of \$50,000 and were suitable only for high production atmospheres such as publishing houses or facilities where a great deal of text output was generated. However, the introduction of the Canon laser engine last year changed all that. It has brought laser imaging to market for \$3,500 or less.

Capable of running at speeds approaching 8 pages or more a minute, the laser printer makes high speed, high resolution printing and graphics available at an affordable price.

Actually based on office copying technology, the laser printer replaces the document tray and copier cover with a computer interface.

(In today's copier, a bright light illuminates a printed page and a lens captures the image. The image is then digitized and deposited on a drum to which toner is applied. A piece of copier paper is then placed against the drum and an image is made.)

This is very similar to the way in which a laser printer



**FIG. 3—CHANGING FONTS is as easy as slipping in a cartridge. Two different fonts can be placed in the printer at the same time, and the operator can switch at will from one to the other, simply by programming.**



creates its images. However, instead of using a bright light and lens, the computer acts as the front end of the system. ASCII codes generated by a word-processing or text preparation program are sent directly to the laser printer's microprocessor and are stored there until a full page of text is generated.

Each letter passes not only into the printer's storage register, but, as it does, the microprocessor within the unit compares it against whatever special ROM-based character set that may be in use within the printer—italic, gothic, bold, or whatever—as it passes to storage and the text is then stored ready for release to be printed. (Actually, the point where a letter code is compared against ROM depends on where the designer of the algorithm decides to place it. It may be as it passes through the micro or it may wait until the page of text is generated and the whole page is then compared against the character set.)

When the page is released for printing, the micro then directs it to a tiny laser which recreates the text as a series of pinhole bursts of light. Each burst of laser light represents a digital piece of information which goes toward making up the letter.

The laser bursts are, in turn, directed toward a mirror-like drum coated with selenium and the letters are electrostatically etched on the drum. In turn, sooty black toner adheres to areas on the drum that have been charged by the laser and the paper which passes over the drum picks up the toner images.

One of the things you will notice about laser printing, if you look closely at it, is that it looks like a very dense dot-matrix printing. This is because of the bursts of light employed as the laser etches the text. Because of the density of the bursts, the letters look fully formed and are much darker than those produced by a dot-matrix printer.

In general, laser printers not only are microprocessor-driven, but also contain quite a bit of Random-Access Memory (RAM) and ROM. Typeface or graphics information is stored in ROM.

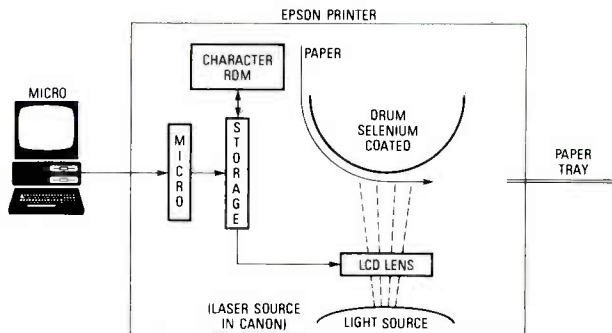
It isn't uncommon to find a laser printer with 64K of RAM and equally as much ROM because of the sophistication of the typefaces available and because of the sophistication of the algorithms.

A graphics-oriented laser printer, on the other hand, can have even more RAM and ROM. As much as 500K of ROM may be used because of the on-board controllers used for graphics work. Apple's *LaserWriter*, for example, contains 500K of ROM and 1.5 megabytes of RAM, as well as an MC-68000 microprocessor. This configuration provides full page graphics.

### Non-laser imaging printers

Lasers aren't the only devices used for electronic imaging. Some manufacturers are using liquid crystal lenses and light emitting diode arrays to replace the laser device. For example, Epson's GQ-3000 uses an LCD shutter to create characters and images by allowing light to pass through the display. The image is then printed on the drum. (See Fig. 4.)

An LED array is used in Kentek Information Systems' K-2 copier-printer. The LED array replaces the laser to



**FIG. 4—HOW LASER PRINTING WORKS.** Note that in the Canon system, there is no LCD. The system is fast, efficient, and exemplary. See text for fuller explanation.

create the image on the drum. Like the laser, the array creates a pulse of light for each bit of information and a fiber-optic lens focuses the pulses on the drum.

One other variation, now undergoing testing, is Phillips Peripherals' *Elpho 20*. This device uses a CRT connected to a photocopier mechanism. Using a CRT that is only one line high, a beam of blue light is emitted by the CRT and is focused on a print drum by a lens. Selenium is particularly sensitive to blue light and so it makes sense to use this. The CRT, inside the printer, takes the place of the laser, LCD or LED array.

### Ink jets

Available for as little as \$495, an ink-jet printer sprays droplets of ink onto a sheet of paper with sufficient force to make it adhere to that paper.

Lower-cost ink-jet printers use "drop-on-demand" technology, where the tiny droplets are ejected from the ink nozzles by a crystal which acts much as the solenoid in a dot-matrix printhead. The rapid action of the piezoelectric crystal in response to current is the factor which enables it to function as the ink pump.

Like dot-matrix printers, the printed output of an ink-jet printer is in a series of dots that resolve into letters. The ink dots correspond to the digital information passed from the printhead controller to the printhead as to the number of dots and their arrangement in making up a letter.

In some ink-jet printers a multijet printhead is used to produce color graphics. These machines have three to seven jets, each of which is connected to an ink reservoir of a different color. The order in which the program tells them to fire determines the coloring of the graphic work. The program orders a specific jet to fire at a specific time.

"Drop-on-demand" technology is the least expensive form of ink-jet technology. The second type used is also the most expensive, continuous stream. In this type of printer, an acoustic transducer generates sound waves which deflect droplets of ink onto the paper so they form letters. The stream of ink flows continuously and returns to its reservoir thanks to a low pressure area created in front of the printhead.

Nonimpact printer technology has taken huge strides. Printers that were once considered "toys" are now assuming a serious role. Their output is good and they offer more variety. ◀▶

# SAVING YOUR DELICATE ELECTRONIC EQUIPMENT

*How to use MOV's (Metal Oxide Varistors) for surge protection.*

ELLIOTT S. KANTER

■A lot of attention has been paid to protecting computers and other electronic equipment against power-line surges. These can be the result of either natural or man-made conditions. Examples of natural surges would be lightning hitting power lines, poles or transformers. The man-made are often the result of switching between power-line feeders or other malfunctions that originate at the source of power generation and distribution.

Regardless of the cause, the results are usually the same. Nominal line voltage (108 to 125 volts) undergoes an abrupt upward swing. Values can reach two or three times normal line voltage. Increased demands of air conditioning, power tools or heating systems cycling on the line can also produce "glitches" with similar results. The incoming line voltage rises and as a result, voltage-sensitive components inside a piece of electronic equipment are subjected to high-voltage spikes.

## Let's protect everything

We don't hesitate to protect our computers and related equipment against these surges, but what about television receivers, videocassette players, stereo

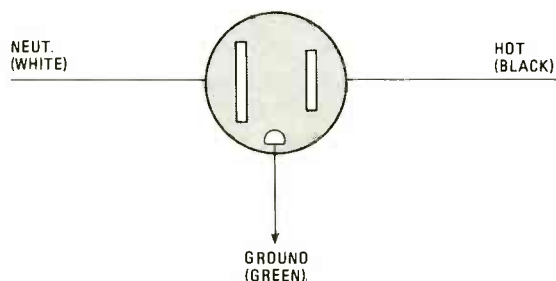
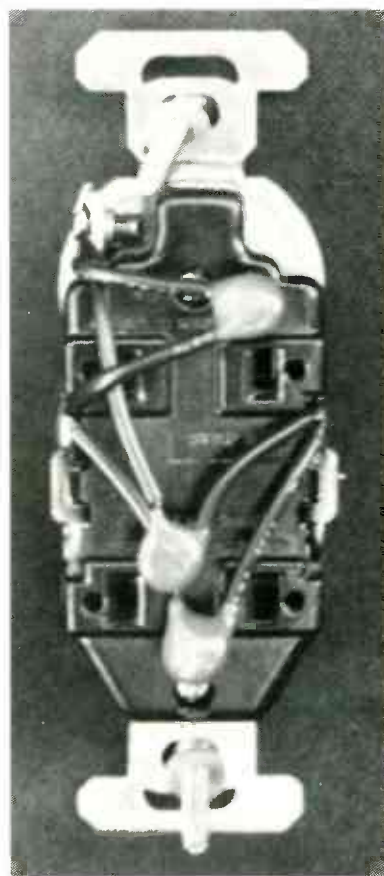


FIG. 1—WIRING FOR THE typical electrical outlet. Note that the outlet shows a polarized plug receptacle.

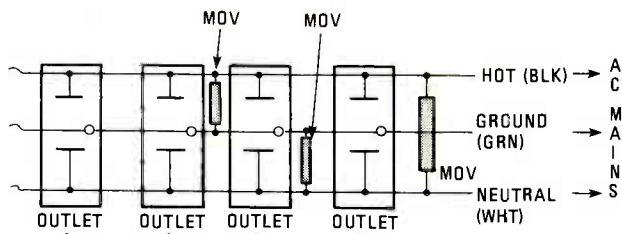


equipment and other electronic equipment whose value may equal the cost of our computers? We tend to regard these more as fixtures than as voltage-sensitive devices.

The typical outlet, shown in Figure 1, consists of three wires. A "hot" wire (black), a "neutral" wire (white) and a "ground" wire (green). When a power surge occurs, it could be impressed on either the black or white lines. The green or ground wire traditionally conducts all stray voltages safely to ground.

Typically, the protective devices we apply to our computers are built into the multi-outlet power strips





**FIG. 2—A TYPICAL MOV-PROTECTED outlet strip. As many additional outlets as needed can be added to the circuit.**

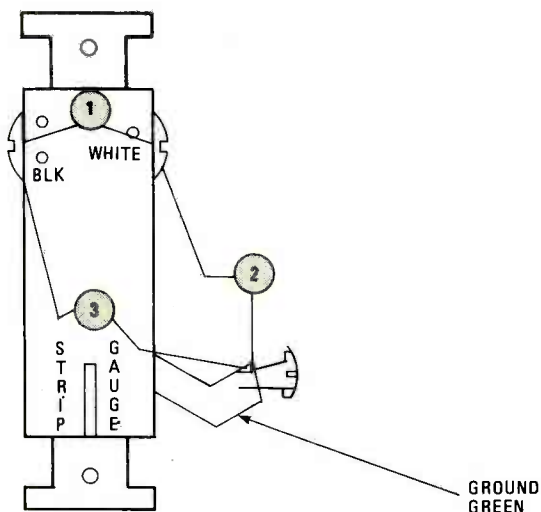
and resemble the circuit shown in Figure 2. Each line has what is called a MOV (Metal Oxide Varistor) for surge protection. These non-linear devices are voltage-dependent and divert potentially harmful overvoltage conditions. More simply, they “clamp” the voltage and hold it to a safe level.

### Building protection

We’re going to show how to protect one or two devices, rather than suggest that you buy a multiple outlet strip for surge protection along with filtering that you may not require for your new TV set.

We chose the number “two” because the normal wall outlet in your home is called a “duplex” outlet. There are two identical AC outlets wired in parallel. By protecting one, we also protect the other, giving us an extra benefit at no increase in cost.

Figure 3 shows how to do this. The three MOV



**FIG. 3—WIRED RECEPTACLE (rear view) shows how MOV units are placed.**

devices required are available from Radio Shack (MOV transient protector Part No. 276-568). They sell in packages for \$1.69. You will also need some insulating tubing and some heat-shrinkable tubing.

First identify the fuse or circuit breaker controlling the outlet you plan to modify. To do this, plug a lamp into the outlet and turn the lamp on. Now proceed to unscrew the fuses or turn off the circuit breakers one at

a time until the lamp goes out. If you’re dealing with fuses, remove the fuse completely. Leave the circuit breaker in the OFF position.

Do **not** attempt to do this work with a “live” circuit!

Remove the screw holding the wall plate. Place the screw aside and remove the plate. If it has become stuck in paint, you may have to pry it loose. Place the plate aside with the screw.

You will see two screws, one at the top, one at the bottom. These hold the outlet to the Gem box. Remove these screws and lift the switch out of the box.

Identify the following wires: The BLACK wire, the WHITE wire, the GREEN wire. In older homes, you may find the wire formed into a hook and located under a screw at either side of the outlet. More-modern outlets have the wire end slipped into a hole at the back of the outlet and held in place by screws on the sides. The GREEN or ground connection is usually connected to a single point at one end of the shell.

Loosen the screws as required, and connect one MOV device from the WHITE lead to the BLACK lead. Connect another from the BLACK lead to GROUND, the third MOV goes from the WHITE lead to ground. Examine your work carefully. If there is any exposed wire that might produce a short circuit, especially when the outlet is reinstalled in the gem box, cut a small piece of the insulated tubing and slip it over the exposed leads.

Carefully dress the MOV’s against the outlet shell. Replace the outlet into the wall box, replace the upper and lower screws, then position the cover plate and replace the holding screw.

This completes the modification of the outlet for surge and transient protection. Now you can restore the electricity by turning the circuit breaker on or replacing the fuse.

You have provided two outlets with surge and transient protection for a total cost of less than \$5.00, with the assurance that these transients and surges can be “clamped” within a stated response time of less than 35 nanoseconds—more than sufficient to save your valuable equipment.

You might wonder why, if surge protection at the individual outlet is such a good idea, we don’t simply go to the fuse or circuit-breaker box and place the MOV’s right there, and in that way protect all of the outlets in the home? The answer is simple. By doing that, you’re fooling with the house’s primary wiring, and depending on where you live, might require a building permit to do so. The consequences can be dire. Should you have a fire in your house, this type of do-it-yourself wiring addition can void your insurance.

No, you’re better off to restrict yourself to the method we describe here, and add the MOV’s—judiciously—at the individual outlets. We say “judiciously,” because there’s really no requirement to protect some devices against surges. If all you plug into an outlet is a simple lamp, why bother with surge protection? However, should the outlet be used for a TV receiver, stereo equipment, or anything else that might be worth protecting, by all means, this is the way to go. ◀▶

# COMPUTER AIDED DESIGN

*A designer's dream come true.*

**HERB FRIEDMAN**

■CAD, Computer Aided Design, covers everything from the complete design of a skyscraper hotel to the schematic for home-brewed electronic projects.

## Using a PC

Theoretically, we could use conventional computer graphics to prepare schematics and flow charts, but that's the hard way to do things, for each line, symbol and alphanumeric character would involve a separate construction. We could probably do a lot better—and faster—with a pencil and paper. And even if we *did* the job with conventional computer graphics, a modification to what we create would take longer than redrawing the entire thing with the trusty old paper and pencil!

There are two kinds of low- to moderately-priced CAD programs specifically intended for electronics hobbyists and technicians. The most-common variety, usually priced in the range of \$500 to \$1000, are descended from conventional mainframe CAD systems and they generate a family of shapes such as rectangles, circles, triangles, trapezoids, etc. that one would normally use to design a building or a car or a kitchen sink. The shapes can be used for creating flow charts and even some electrical circuits.

The shapes are automatically created by the computer between two or three locations that the user pinpoints on the computer screen. Figure 1 shows how a CAD program might automatically create an assortment of shapes. For example Figure 1A shows how a rectangle is created by CAD. Using a joystick, mouse, or just the computer's arrow keys, the user positions the cursor where one corner of the rectangle should be and marks the location with a dot, by pressing the joystick's or mouse's *select* button. Next, the cursor is moved to the opposite corner of the rectangle. As the cursor moves, most CAD programs will create a phantom (flashing) rectangle anchored on the mark and the cursor. When the rectangle is in the desired shape and size, it is locked into position by pressing the *select* button.

The shape constructed on the screen between the mark and cursor depends on the selected mode. As shown in Figure 1B, if the user selects a circle mode, the computer will create a circle using the mark and cursor as the diameter. If, as shown in Figure 1C, the

user selects a line mode, the computer will draw a straight line between the mark and the cursor. Triangles and trapezoids take an extra step or two, but the idea is the same.

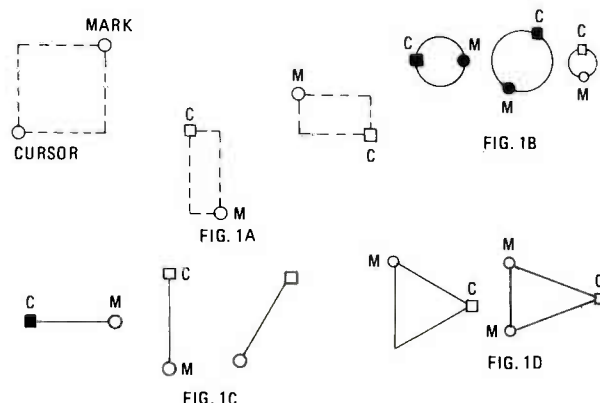
If you need an unusual shape you simply create it using conventional shapes and lines. In Figure 2, the IC is simply a rectangle with short, straight lines appended for the terminals, while the OPAMP is similarly a triangle with lines for the terminals.

## Making it viable

A logical question at this point, is "Since it can take a long time to create the symbol for a 14-point DIP IC what happens if you need 20 or 30 such symbols?" Most of the better quality conventional CAD systems have a *replicate* or *copy* function whereby the user can "pick up" a copy of a symbol by placing the cursor over the symbol and pressing the joystick or mouse-select button. The cursor is then positioned where a copy of the symbol is needed and it is literally dropped into the screen drawing by pressing the select button. The pickup and release can be repeated as often as needed, or the CAD program might require the user to indicate the total number of replications. Because different sizes of the same shapes or symbols are often needed, CAD software generally lets the user zoom in and out on individual symbols for enlargement or reduction during replication.

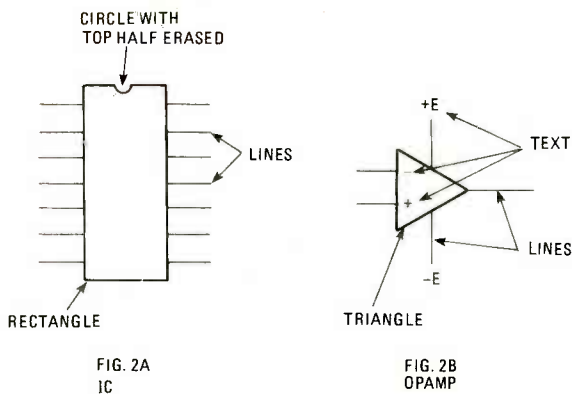
Just about anything is possible if you're willing to pay for it. For example, the cost of a digitizing pad equipped with a combination light and mechanical pen will buy you a library of *pick up* symbols that can be electronically lifted from the pad and then inserted in the screen.

While a symbol library usually adds substantial cost to a CAD program, it's actually the cost of the digitizing pad that makes it expensive. If the *pick-up* feature is eliminated—thereby eliminating the need for a digitizing pad—even a rock-bottom priced CAD system can have a library of symbols and alphanumeric characters.

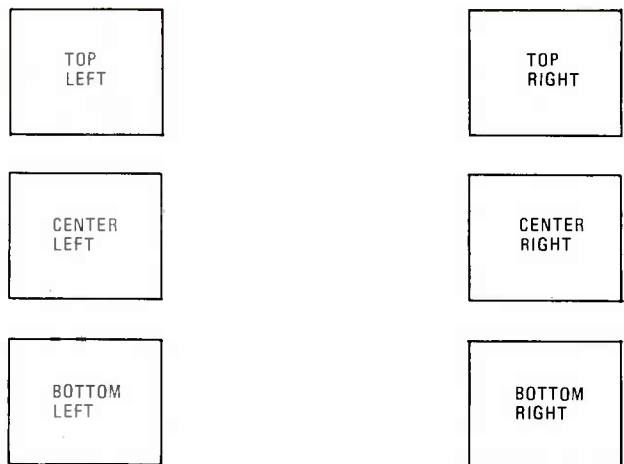


**FIG. 1—HIGHER-COST CONVENTIONAL CAD systems automatically generate shapes and symbols between the user-selected marker and the cursor position. The shape automatically adjusts to the distance between the marker and cursor. In 1A, the system is set to generate rectangles. 1B is circles, 1C is straight lines and 1D is triangles.**





**FIG. 2—COMPONENTS CAN BE CREATED** by using the computer's graphics function or by integrating pieces of auto-generated shapes. The IC in 2A started out as a generated rectangle, a circle provided the "notch" and the terminals are conventional lines. The OpAmp in 2B began as a triangle, the connections are lines and the labelling is generated by the CAD TEXT mode.



**FIG. 4—ACTUAL COMPUTER WORKSPACE** is divided into six screens which the printer reassembles. User selects as many screens as needed, decides how they are used.

Since a complete schematic or flow-chart might (and usually does) exceed the capacity of the screen, CAD programs generally permit the user to utilize several screens which are assembled into a unitized drawing when printed. If the number of screens exceed the capacity of the printer, provision is made for the print to be made in sections which can later be taped together.

If all you need is enough CAD power to generate schematics to store on a floppy disk for future review or easy-to-write upgrades and modifications, you can do it on a low-cost home computer using a conventional printer such as the Epson MX-80 (with Graftrax) for the printout. Usually, "drafting" software for home computers is not much better than a child's "computer art" program, but one low-cost program has

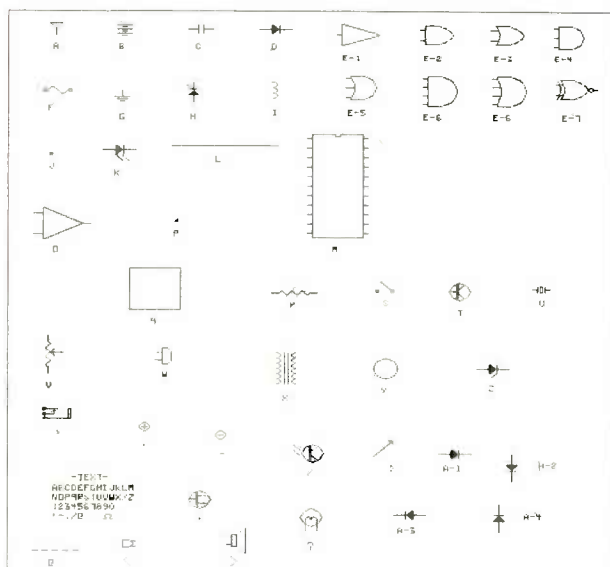
enough "professional" features to enable a home computer to function as a CAD system for electronic technicians and hobbyists. It is in fact, good enough to serve as a trainer for those who want to dip their toes into electronic schematic design.

The CAD software is the Schematic Drafting Processor (\$49.95, Spectrum Projects, Box 21272, Woodhaven, NY 11421) which requires a 64K Radio Shack Color Computer having at least one disk drive. The program is specifically designed to create electronic schematics primarily through the use of conventional symbols provided in the symbol library shown in Figure 3. Notice that each symbol has an associated keyboard character. Because a light pen isn't supported by the program a library symbol is called up at the cursor position by pressing the key specified for a particular symbol. For example, the "K" key will insert the LED symbol at the cursor. To permit precise positioning, each symbol can be rotated through 360 degrees in 90 degree increments. An erase function permits bits and pieces of library symbols to be pieced together. For example, the top of the circle can be sliced off to generate the half circle needed for the "bottom view" of a transistor. The IC symbol can be sliced, cut through, partially erased or expanded to create any IC package from 4 to 40 pin, or anything else. It takes a lot longer to generate symbols by erase and slice rather than by zoom, but it's a lot less costly.

Also note from Figure 3 that the alphanumeric as well as the omega symbol used to show resistance are also library symbols. When the computer is toggled into the TEXT mode, pressing a key inserts its corresponding alphanumeric character at the cursor position rather than a symbol, permitting you to label the various devices.

In addition to the 30 library symbols provided, the program allows the user to create ten additional symbols through a BASIC program, but doing so requires a considerable degree of programming skill.

Because screen size is limited, as shown in Figure 4, the total workspace is divided into six screens. Each screen display has a slight overlap with adjacent



**FIG. 3—THE COMPLETE LIBRARY** of symbols and text (alphanumeric) for the Drafting Processor, Symbols are inserted at the cursor position pressing the indicated key. A "K" inserts the LED symbol, the "O" inserts an OpAmp, The "B" a battery.

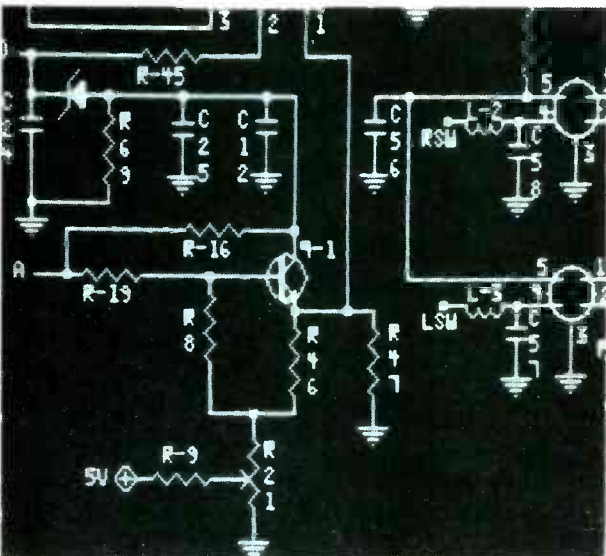
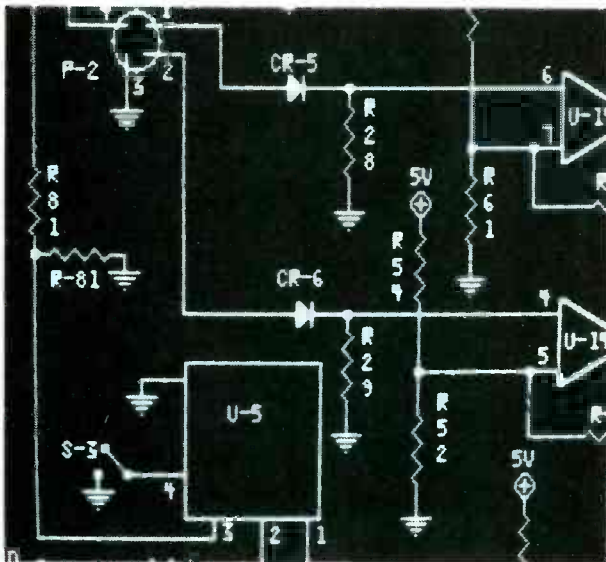
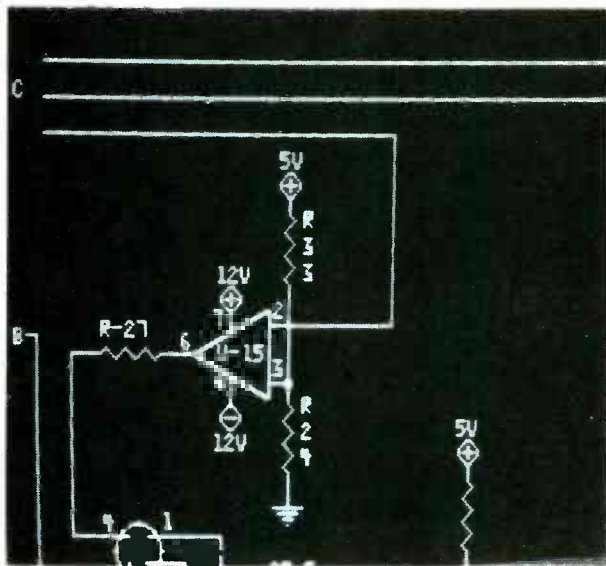


FIG. 5—PHOTOGRAPHS OF THE THREE LEFT SCREENS of an actual schematic. Note the overlap of each screen so drawing continuity can be maintained.

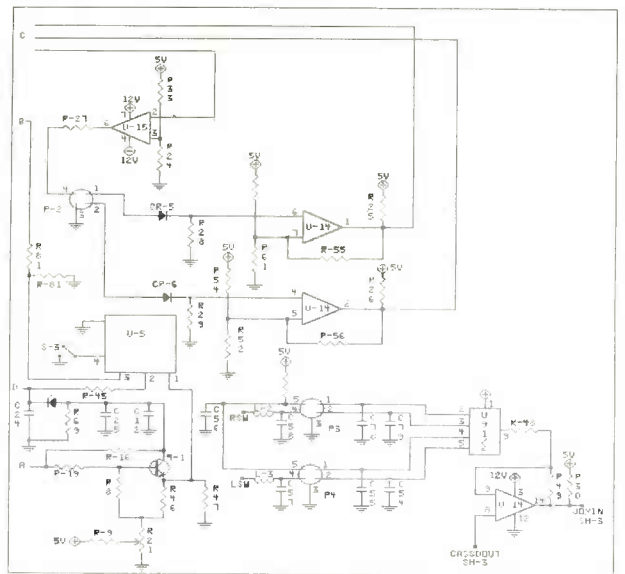


FIG. 6—THE SAMPLE SCHEMATIC—all six screens—as reassembled by a conventional Epson MX-80 dot-matrix printer. Note how components were rotated for proper orientation when inserted into the schematic.

screens so the user can continue registration from previously prepared screens. Like the more expensive CAD systems, all screens are combined into a unit drawing by the printer. Figures 5 and 6 show how this is done. Figures 5a, 5b and 5c are photographs of the actual screen display of the top left, center left and bottom left screens of a schematic that requires all six screens. The overlap area of each screen can easily be seen. Figure 6 is a printout of the entire schematic, all six screens. Note how the three left screens have been precision assembled by the program into the unit print. If the schematic required more area than that allowed by six screens it would have to be created in multiple units of six screens, and it would be necessary to tape together the unitized screen prints into a larger print because six screens is the maximum that can be printed as a single unit.

Unlike a printer/plotter print which is drawn by an inking (ruling) pen, the low-cost CAD prints are generated through the dot-addressable function of a conventional printer. Since the lines, symbols and characters in the print are created by individual dots the print's resolution is coarse, having no resemblance to the "ruled lines" of the professional plotter.

### Ready to buy?

The thing to keep in mind when learning to use CAD software or a complete system is that it should make life easier than doing things by hand. Even the best CAD software is difficult for the technician to use if he doesn't have an adequate library of conventional symbols. Or, if you're into flow charts or block diagrams then automatic symbol construction, replicate and zoom of rectangles, circles and trapezoids is considerably more important than a library of symbols. Either way, CAD programs or systems should have features, functions and conveniences specifically intended for the preparation of schematics. ◀▶



# Superior performance by phone for as low as \$695.



## The 8840A Digital Multimeter.

Now, with Fluke telemarketing, you can order the most affordable, most powerful DMM in its class, from any phone in the U.S.A.

Compare features, compare prices and you'll find that no other 5½-digit bench-top or system multimeter can match it.

Add IEEE-488 and true rms options for \$150 each, and a fully-loaded 8840A is still only \$995.

### As easy to use as your phone.

The simplified front panel of the 8840A is designed for ease of operation. Functions are clearly labeled. Even the vacuum fluorescent display is easy to read. And closed-case calibration and 50,000 hour MTBF make the 8840A easy to live with.

The 8840A is versatile: it answers your bench or system DMM needs. Standard capabilities include superior dc voltage accuracy (50 ppm at 1 year), 2- and 4-wire ohms, dc current, fast autoranging and user-selected reading rates.

### Reach out and test the best.

Call toll-free and our sales engineer will tell you about the 8840A. Ask about our 15-day trial period and our one-year Fluke warranty.

**Order now.**  
**1-800-44-FLUKE**  
(1-800-443-5853) Ask for extension 107.

#### Fluke 8840A

Autoranging Volts, Ohms, and Amps

50 ppm basic dc accuracy (1 year)

0.16% basic ac accuracy (1 year)

2½, 20, and 100 readings/second

FROM THE WORLD LEADER  
IN DIGITAL MULTIMETERS.



## COMPUTER PRODUCTS

continued from page 4

models 11, 12, and 16. SemiDisk Systems has developed a new, high-capacity unit that stores up to 2 megabytes of information on a single card. Previously, the largest capacity available on a single card was 1 megabyte.

SemiDisk is priced as follows: 512K capacities: TRS-80, S-100, \$995.00; QX-10, \$799.00; IBM PC, XT, AT \$945.00. Two-megabyte capacities: TRS-80, IBM PC, XT, AT, QX-10, \$2499.00. S-100 is \$2549.00.—SemiDisk Systems, PO Box GG, Beaverton, OR 97075.

## COMPUTER RECIPE SYSTEM, A

COOK™, helps users to locate their own recipes through an easy-to-use indexing system. It allows the user to set up complete recipes of considerable size, and comes with a data base of 500 recipe references from five

**A>COOK.**  
The Complete Recipe System.

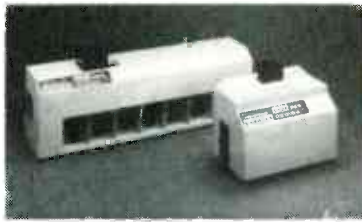


CIRCLE 13 ON FREE INFORMATION CARD

best-selling cookbooks: *Joy of Cooking*, *M. Heatter's New Book of Great Desserts*, *Mastering the Art of French Cooking Vol. 1*, *The New James Beard*, and *The New New York Times Cookbook*. The A COOK™ diskette comes with an instruction booklet, and is priced at \$39.95.—East Hampton Industries, Inc., 66 Newtown Lane, East Hampton, NY 11937.

**CERTIFIER**, the 5000 series, are micro-processor-based systems that feature Mountain Computer's automatic diskette autoloader and the ability to test high-coercivity media. Certifiers are used by floppy-diskette manufacturers and converters to test media quality, and by end users for incoming quality control.

Four models are available for certifying 3 1/2" and 5 1/4" media. The six-bin models simultaneously perform up to



CIRCLE 14 ON FREE INFORMATION CARD

six media quality tests specified by the American National Standards Institute (ANSI): missing bit, extra bit, track average, amplitude, modulation, overwrite, and resolution. The two-bin certifiers perform the same ANSI tests. They are designed primarily for go/no-go incoming inspection of diskettes by large-volume users and original-equipment manufacturers.

The model 5250 six-bin, 5/4" certifier and the model 5253 six-bin 3 1/2" certifier cost \$17,915.00. The model 5150 two-bin 5/4" and model 5135 two-bin, 3 1/2" certifier cost \$13,995.00.—Mountain Computer, Inc., 300 El Pueblo Road, Scotts Valley, CA.

**ELECTRONIC TYPEWRITER**, the model ZX-515 can be used independently as a typewriter, or, when interfaced with a computer, as a letter-quality printer; and, connected to an optional disk drive, the 40,000-character memory can be expanded to unlimited off-line storage.



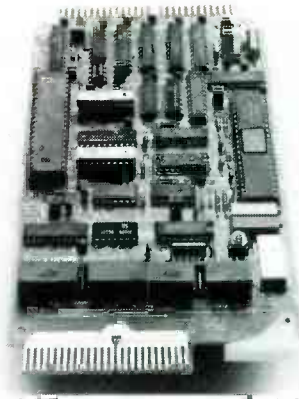
CIRCLE 15 ON FREE INFORMATION CARD

Features of the model ZX-515 include storage capacity for 26-page formats and 10-column layouts; global search and replace, as well as block move and text linking; four pitch modes: 10, 12, 15, or proportional spacing, and one-touch correction. The model ZX-515 is priced at \$1295.00.—Sharp Electronics Corporation, 10 Sharp Plaza, Paramus, NJ 07652.

**CONTROLLER CARD**, model 7388A, offers fast memory access and data storage in double-density disk format, while addressing up to 1M of memory for use with 16-bit CPU's.

The model 7388 can interface with 8-bit systems based on Z80, 8085, 6800, and 6809 processors, addressing 64K of

memory via DMA and decoding an 8-bit I/O address. The card also supports 8088-based systems with DMA access to 1M of memory, and the ability to decode up to 10 bits of I/O address. It supports up to four floppy drives in any



CIRCLE 16 ON FREE INFORMATION CARD

format, and comes with a two-year warranty. It is priced at \$395.00.—Pro-Log Corporation, 2411 Garden Road, Monterey, CA 93940.

## PRINTER CONTROL PACKAGE,

Printworks, lets users of IBM PC and compatible systems print wide documents, like spreadsheets, sideways on standard-width paper. "Pivot Printing", which rotates text 90 degrees to print sideways on a page, is one of the many features in this printer-control software package. Users are offered easy menu selection of many printer functions, including pitch, mode (boldface, expanded, condensed, etc.,) and font (typeface or style).



CIRCLE 17 ON FREE INFORMATION CARD

Fonts include script, Old English, foreign character sets, the complete IBM character set, and many more. A font editor lets users create additional characters or entire fonts, and even combine or alter existing fonts. Printworks is priced at \$69.95.—SoftStyle, Inc., 7192 Kalaniano'le Highway, Suite 205, Honolulu, HI 96825.



which the Linear Technology devices provide protection against.

- If the input falls more than 400 mV below ground, transistors in the input stage saturate and phase reversal could cause lock-up in servo systems. The LT1013/1014 devices include unique phase-reversal protection circuitry that prevents the output from reversing phase, even when the inputs are as low as -1.5 volts.

- If the input falls more than a diode-drop below ground, the device could be destroyed because essentially unlimited current could flow from the substrate ( $-V_{SS}$ ) to the input terminal. The LT1013/1014 devices are protected against that type of failure by a 4000-ohm resistor in series with each op-amp input.

There is one circumstance in which the phase-reversal protection circuitry will not work: when the output of another op-amp in the same package is driven hard into negative saturation. In the LT1013, either op-amp can disable the other's protection circuitry. In the LT1014, amplifiers A and D can affect each other, but amplifiers B and C are completely independent of the former. Similarly, amplifiers B and C can affect each other, but amplifiers A and D are completely independent of them.

### An application

Figure 1 shows a liquid-flow meter designed around an LT1014 (or two LT1013's). The rate of flow through the pipe is determined from the temperature differential that occurs as liquid flows through a heated section of pipe. The ambient temperature of the liquid is measured by thermistor T1 at the input end of the pipe. Thermistor T2 measures the temperature at the output end of the pipe. The temperature difference varies inversely with the rate of flow.

Op-amps IC1-a and IC1-b amplify the differential voltage developed by the thermistors, and op-amps IC1-c and IC1-d form a linear voltage-to-frequency converter. The output frequency ranges from zero (for a flow rate of zero) to 300 Hz (for a flow rate of 300 milliliters per minute). The rate of flow can be read directly on any audio-frequency meter.

The 15-ohm heater is a Dale Electronics 25-watt wirewound resistor, type HL-25. Thermistors T1 and T2 are YSI type 44201 thermistor networks available from Yellow Springs Instrument Co., Box 465, Yellow Springs, OH 45387. For additional information on the LT1013/1014 precision op-amps write to Linear Technology Corporation, 1630 McCarthy Blvd., Milpitas, CA 95035. **R-E**

## ELECTRONICS IN MEDICINE

*continued from page 64*

broad categories, rigid and flexible. Here we will look at flexible endoscopes. Those use fiber optics to allow the viewing of regions deep inside the body.

Actually, modern technology allows physicians to do more than just look into those areas. It is possible to take tissue samples and even do surgery from a distance through a slender endoscope passed into the area of interest. That is possible because the structure of an endoscope contains several channels that run the full length of the instrument. Several of those channels carry the fiber optics. One fiber-optic channel is usually used for illumination (light sources used for endoscopes include tungsten projection lamps, lasers, and xenon and mercury arc lamps). A second channel can be used for viewing, taking photographs, and, if desired, making videotapes of procedures. Fiber-optic channels can also be used to transmit laser light for surgical cutting or for providing heat to close bleeding blood vessels. Other channels of the endoscope carry fluids for cleansing the area being viewed, suction for clearing away fluids and blood, and mechanical devices for cutting and taking biopsies (collecting samples of tissue).

Endoscopes of different diameters are used for different applications. Needle endoscopes, 1.7 millimeters in diameter, or instance, are used to examine the insides of knees and other joints. Similar instruments are useful in examining fetuses. Larger endoscopes are used in the gastrointestinal tract and other areas to find and treat tumors and bleeding blood vessels. Using such a device, foreign bodies can be found and removed, and other conditions can be diagnosed.

As we've seen, the field of medical optics has taken on new importance. Now, thanks to advances in such areas as fiber optics and lasers, it has become possible to visually examine and operate on many internal areas without resorting to conventional surgical techniques. And future advances are sure to make this area of medical electronics even more important and valuable in the coming years. **R-E**

# McIntosh®

Get all the newest and latest information on McIntosh stereo equipment from McIntosh Laboratory.



### Send For Your Stereo Information

McIntosh Laboratory Inc. **RE**  
 East Side Station P.O. Box 96  
 Binghamton, N.Y. 13904-0096

Name \_\_\_\_\_  
 Address \_\_\_\_\_  
 City \_\_\_\_\_ State \_\_\_\_\_  
 Zip \_\_\_\_\_  
 Phone Area Code \_\_\_\_\_

CIRCLE 67 ON FREE INFORMATION CARD

# SERVICE CLINIC

## A vertical line?

A COMMON PROBLEM IN TV SERVICING is collapse of the raster into a white horizontal line. It means that you have a problem in the vertical-sweep circuits. But much more unusual is the collapse of the raster into a white vertical line. Such an occurrence does not mean failure of the horizontal sweep circuit.

Let's see what it does mean. Looking at Fig. 1, the horizontal oscillator, driver, and output amplifier must all be working. Otherwise, there would be no high voltage. That's because the high voltage is derived from the horizontal output amplifier. And without high voltage, you would not be seeing a line of any kind at all.

Nevertheless, the horizontal sweep signal is not reaching the CRT. The first inclination is to blame either an open or shorted yoke. While either could be the cause, both are relatively rare occurrences. A much more likely cause is the presence of a problem between the horizontal output amplifier and the yoke.

### Some likely causes

The most common cause of our symptom is an open in one of the yoke leads. Those leads are often given a good yank when the chassis is removed from the cabinet, so they may come loose or even break.

If the problem is not in the yoke leads, use an oscilloscope to trace the signal from the output of the horizontal output amplifier to the yoke to find where the signal is disappearing.

Basically, the output of the horizontal output amplifier is coupled



JACK DARR,  
SERVICE EDITOR



FIG. 1

to the yoke in one of two ways: either directly or via a matching transformer. Tube sets always use matching transformers. On the other hand, only a few solid-state sets use those transformers; the rest use direct drive.

In direct drive, the emitter of the horizontal output transistor is tied directly to the yoke. My experience has been that the symptoms we've been looking at rarely occur in that type of set. That may be because, aside from the yoke leads, there is very little there that can fail without also affecting the high voltage.

As for sets that use a matching transformer, in general, I've found that horizontal problems in tube sets usually affect the high voltage, too. But our symptoms can and do occur in solid-state sets of that type. As such, the circuitry preceding the yoke should be checked carefully in those sets before turning to the yoke itself.

### A shorted yoke

If doing the above does not lead to the cause of the problem, the only place left to turn is the yoke itself. In newer, solid-state sets the yokes are wound from relatively heavy wire. As such, shorts and opens are fairly rare. However, that does not mean that they do not happen. It just means that it takes an unusual occurrence.

In fact, I've only run into one instance of a shorted yoke in one of the newer sets. In that set, the raster had collapsed vertically into the familiar keystone pattern. The circuitry between the yoke and the horizontal amplifier was sound, so I turned to the yoke. Upon close examination, I found a splash of solder *inside* the yoke. (I never was able to figure out how it got there, but someone must have been an exceptionally sloppy solderer!) That solder was shorting several turns. Once the solder was scraped off, and the yoke was coated with insulating spray for "luck," the set was as good as new.

That just proves that anything is possible. R-E

## SERVICE QUESTIONS

### A HELPFUL HINT

Stuart Sjalund of London, Ontario would like to share one of his troubleshooting tips. He uses a 40-watt bulb in series with the horizontal output collector when he suspects an overload condition. He then lifts components until the bulb burns less brightly. He also checks SCR regulators by placing the bulb across the anode and cathode, again letting the intensity of the bulb act as his monitor. R-E





## BENCH POWER SUPPLY

*continued from page 57*

-40 volts across D2 and D4, and +20 volts across C11 and C12. While you're at it, verify the presence of +20 volts on pin 7, and -20 volts at pin 4 of each op-amp. If everything checks out, remove power and insert the IC's. Be sure to orient pin 1 correctly.

Run wires from the transistors mounted on the rear panel (see Fig. 7) to the PC board. Finally, using Fig. 6, complete the point-to-point wiring between the board and the front- and rear-panel components. At this point, your power supply should appear similar to the prototype shown in Fig. 8.

### Calibration

A DMM or VOM accurate to at least 4½ digits should be used to calibrate the precision sources. To obtain sufficient resolution, allow the supply to run for 10 minutes or more so that the temperature within the cabinet—and the output voltages of the precision sources—will stabilize. Adjust R44 and R51 so that their dials read 10.00 (i.e., their resistance should be exactly 10K ohms). Then adjust trimmer potentiometers R43 and R50 so

that each output reads exactly 10.000 volts.

To get symmetrical outputs from the independent supplies, adjust R11 so that equal rotation of potentiometers R6 and R15 gives the same output voltage.

To adjust the dual-tracking source, turn potentiometer R24 to maximum resistance. Then adjust R29 for an output of exactly +15.000 volts, as measured at the +V<sub>T</sub> output. Then adjust R32 so that exactly -15.000 volts appears at the -V<sub>T</sub> output.

### Substituting components

Some of the components specified in the Parts List may be difficult—if not impossible—to find. For example, you may have that problem with the 40-volt Zener diodes (D2 and D4). However, two 20-volt Zener diodes may be connected in series to achieve the same result.

The 2.7-volt Zener diodes (D8 and D10) may also be difficult to find. If they are, 3.3-volt units may be substituted (1N5226B). If doing so produces more than 1 mA from the constant-current sources, trimmer potentiometers R43 and R50 can be adjusted to compensate. The 6.8-volt reference diodes (D5 and D6) are not critical and may be either 1N957B, 1N5235B, or 1N4736A devices. The two 12-volt Zener diodes may be 1N963, 1N5242B, or 1N4742A units.

All electrolytic capacitors are polarized aluminum types, and radial-lead devices were used in the prototype to conserve space on the PC board.

All five cermet trimmer potentiometers used in the project are the ¼-inch long rectangular type.

### Increasing power output

If you want to beef up the outputs of the non-precision supplies, you must increase the current capacity of the transformer, the output transistors, etc.

The transformer specified for this project has a rated output of 40-volts center-tapped at 300-ma. You may replace it with a unit having higher current capacity, but if you use a transformer with a higher voltage rating, be careful not to exceed the voltage rating of the op-amps and transistors.

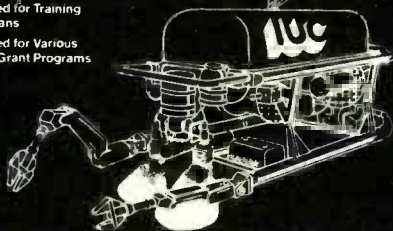
The 2N3766 transistors (Q1 and Q5) may be replaced by 2N6057 devices; the latter have a maximum collector current of 12 amps. The 2N3740 transistors (Q3 and Q7) may be replaced by 2N6050 units, which also have a maximum of 12 amps. Both the 2N6050 and 2N6057 are housed in TO-3 cases and will require additional heat-sinking.

If you are using the metering circuit, the value of R52 might have to be increased, as well as the the rating of the current meter. **R-E**

## Put Your Electronic Skills to Work UNDERWATER!

### BECOME A ROBOT VEHICLE PILOT/TECHNICIAN

Accredited by NATTS  
Approved for Training  
of Veterans  
Approved for Various  
Loan & Grant Programs



**HIGH PAY—WORLDWIDE TRAVEL**  
Call or Write Today for FREE BROCHURE  
**CALL (212) 885-0600**

**UNDERWATER VEHICLE TRAINING CENTER**  
10046 CHICKASAW, HOUSTON, TX 77041  
IN TEXAS CALL: 713-690-0405, TELEX 4620684

CIRCLE 288 ON FREE INFORMATION CARD



## This publication is available in microform.

University Microfilms

International reproduces this publication in microform: microfiche and 16mm or 35mm film. For information about this publication or any of the more than 13,000 titles

we offer, complete and mail the coupon to: University Microfilms International, 300 N. Zeeb Road, Ann Arbor, MI 48106. Call us toll-free for an immediate response: 800-521-3044. Or call collect in Michigan, Alaska and Hawaii: 313-761-4700.

Please send information about these titles:

Name \_\_\_\_\_  
Company/Institution \_\_\_\_\_  
Address \_\_\_\_\_  
City \_\_\_\_\_  
State \_\_\_\_\_ Zip \_\_\_\_\_  
Phone (\_\_\_\_) \_\_\_\_\_

University  
Microfilms  
International



## MULTIPATH RECEPTION

*continued from page 76*

nal and the direct signal are amplified by the same gain factor and then rectified to produce DC voltages.

The comparator/control circuit compares the levels of the DC voltages derived from the two IF signals and immediately selects the antenna and tuner combination with the lowest DC voltage from the AM component of a multipath signal. The control circuit switches the input of the audio amplifier to the output of the tuner providing the better signal. Switching oc-

level, interference and distortion is first noticed as noise and hiss in the treble range. A further drop causes garbled sound and random dropouts. Mono signals have a higher high-frequency content than stereo signals, which results in better masking of noise and hiss.

Some car stereo makers use that fact to reduce multipath distortion. When multipath reception causes the incoming signal to fall below a given level, control circuits automatically switch the receiver from stereo to mono. In some sets, the switching from stereo to mono is rather abrupt and quite noticeable. In others, such as Pioneer's (5000 Airport Plaza Dr., Long Beach, CA 90815) receiver models *KE-*

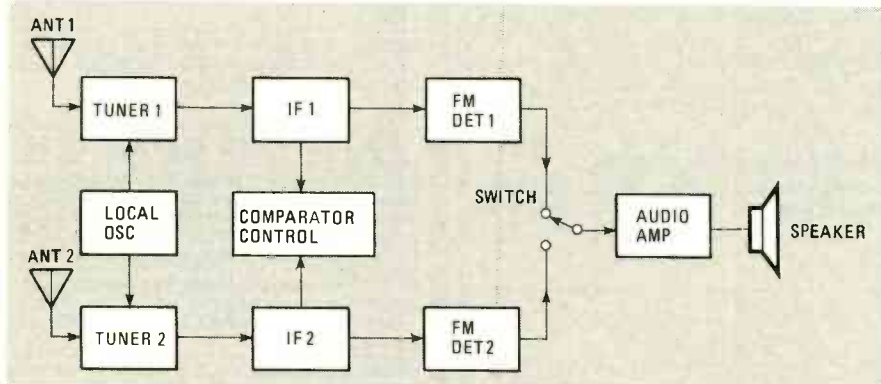


FIG. 8—BLOCK DIAGRAM of a stereo diversity reception stereo receiver. Note that it has two independent front ends.



FIG. 9—THE AUDIA DXT-1000 diversity receiver from Clarion.



FIG. 10—THE *KE-A330* stereo receiver from Pioneer automatically switches to mono when the signal strength drops below the level required for acceptable stereo reception.

curs as rapidly as necessary to ensure that the listener gets the signal with the least interference and distortion.

Other manufacturers use different techniques to reduce multipath distortion in automotive FM receivers. One such technique makes use of the fact that, for a given signal strength, a stereo FM signal is inherently noisier than a mono one. For adequate reception, a receiver requires a signal that is above a given threshold level. As the signal drops toward that

quency response when the incoming signal does not have enough treble content to over-ride hiss and noise. Usually that is done by feeding the recovered audio signal through a highpass filter and rectifier to a logarithmic amplifier that develops a DC voltage that is proportional to the high-frequency content of the signal. That DC voltage controls the bandwidth and roll-off of a variable highpass filter—cutting the high-frequency response so noise and hiss are eliminated.

R-E

## IC TESTER

*continued from page 82*

unison. More than likely, the circuit will tie pin 12 directly to signal ground. In that case, there is no easy way to get the two devices synchronized, and the comparison test will not work.

### Testing IC's

To test out-of-circuit IC's:

- Connect power from external source
- Connect a grounded shorting plug to socket A
- Place all IC switches in the OUT position.

Select the appropriate IC card and insert it into the IC analyzer. Then insert the IC in the right-hand B socket (SO5). Use short jumpers of 22-gauge solid wire to make power and ground connections from the solderless connector to one of the B sockets.

The inputs can be tied low by putting the switches to the IN position. Do not switch the outputs, power, or ground pins. The pulser can be connected at the B socket, and should be used to test clocked logic. The pulse generator pushbutton is not debounced, so occasionally a double output pulse may result.

R-E

**DON'T COUNT  
ON THIS  
ALONE  
TO SAVE  
YOUR LIFE.**



First-aid kits are fine for some emergencies. But what if you were choking? Having a heart attack? Or a stroke? This kit would be useless. Call the Red Cross. We'll teach you and your employees how to save a life. From work-safety to CPR, you can count on the Red Cross. **We'll help. Will you?**

 **American Red Cross**

 **Ad Council** A Public Service of This Publication

# MARKET CENTER

## BUSINESS OPPORTUNITIES

**US \$8.00** including disk, thousand name brand programs for Apple, IBM-PC, details U.S. \$1.00, **RELIANT**, P.O. Box 33610, Sheungwan, Hong Kong.

**HOW** to start a small electronics shop at home. Make extra money. Build as large as you want. How

to get business, manage the shop, calculate profit. Tax tips. \$12.95, plus \$2.00 P&H. **WO-MACK**, Box 1651, Melbourne, FL 32902.

**PROJECTION TV**...Make \$\$\$'s assembling projectors...Easy... Results comparable to \$2,500.00 projectors...Your total cost less than \$20.00...**Plans, 8" lens & dealers' information \$17.50**...Illustrated information free...**MAC-**

**BIG PROFITS**

## ELECTRONIC ASSEMBLY BUSINESS

Start home. spare time. Investment knowledge or experience unnecessary. **BIG DEMAND** assembling electronic devices. Sales handled by professionals. Unusual business opportunity.

**FREE: Complete illustrated literature**  
BARTA, RE-O Box 248  
Walnut Creek, Calif. 94597

## CLASSIFIED AD ORDER FORM

To run your own classified ad, put one word on each of the lines below and send this form along with your check to:

**Radio-Electronics Classified Ads**, 200 Park Avenue South, N.Y., N.Y. 10003

**PLEASE INDICATE** in which category of classified advertising you wish your ad to appear. For special headings, there is a surcharge of **\$20.00**.

( ) Plans/Kits ( ) Business Opportunities ( ) For Sale  
( ) Education/Instruction ( ) Wanted ( ) Satellite Television  
( ) \_\_\_\_\_

Special Category: \$20.00

### PLEASE PRINT EACH WORD SEPARATELY, IN BLOCK LETTERS.

(No refunds or credits for typesetting errors can be made unless you clearly print or type your copy.) Rates indicated are for standard style classified ads only. See below for additional charges for special ads. **Minimum: 15 words.**

1	2	3	4	5
6	7	8	9	10
11	12	13	14	15 (\$37.50)
16 (\$40.00)	17 (\$42.50)	18 (\$45.00)	19 (\$47.50)	20 (\$50.00)
21 (\$52.50)	22 (\$55.00)	23 (\$57.50)	24 (\$60.00)	25 (\$62.50)
26 (\$65.00)	27 (\$67.50)	28 (\$70.00)	29 (\$72.50)	30 (\$75.00)
31 (\$77.50)	32 (\$88.00)	33 (\$82.50)	34 (\$85.00)	35 (\$87.50)

We accept MasterCard and Visa for payment of orders. If you wish to use your credit card to pay for your ad fill in the following additional information (Sorry, no telephone orders can be accepted.):

Card Number

Expiration Date

Please Print Name

Signature

**IF YOU USE A BOX NUMBER YOU MUST INCLUDE YOUR PERMANENT ADDRESS AND PHONE NUMBER FOR OUR FILES. ADS SUBMITTED WITHOUT THIS INFORMATION WILL NOT BE ACCEPTED.**

**CLASSIFIED COMMERCIAL RATE:** (for firms or individuals offering commercial products or services) \$2.50 per word prepaid (no charge for zip code)...**MINIMUM 15 WORDS.** 5% discount for same ad in 6 issues; 10% discount for same ad in 12 issues within one year; if prepaid. **NON-COMMERCIAL RATE:** (for individuals who want to buy or sell a personal item) \$2.00 per word, prepaid...no minimum. **ONLY FIRST WORD AND NAME** set in bold caps at no extra charge. Additional bold face (not available as all caps) 50c per word additional (20% premium). Entire ad in boldface, add 20% premium to total price. **TINT SCREEN BEHIND ENTIRE AD: add 25% premium** to total price. **TINT SCREEN BEHIND ENTIRE AD PLUS ALL BOLD FACE AD: add 45% premium** to total price. **EXPANDED TYPE AD: \$3.75 per word** prepaid. All other items same as for STANDARD COMMERCIAL RATE. **TINT SCREEN BEHIND ENTIRE EXPANDED TYPE AD: add 25% premium** to total price. **TINT SCREEN BEHIND ENTIRE EXPANDED TYPE AD PLUS ALL BOLD FACE AD: add 45% premium** to total price. **DISPLAY ADS: 1" x 2 1/4" — \$270.00; 2" x 2 1/4" — \$540.00; 3" x 2 1/4" — \$810.00.** **General Information:** Frequency rates and prepayment discounts are available. **ALL COPY SUBJECT TO PUBLISHERS APPROVAL. ADVERTISEMENTS USING P.O. BOX ADDRESS WILL NOT BE ACCEPTED UNTIL ADVERTISER SUPPLIES PUBLISHER WITH PERMANENT ADDRESS AND PHONE NUMBER.** Copy to be in our hands on the 15th of the third month preceding the date of the issue. (i.e., August issue copy must be received by May 12th). When normal closing date falls on Saturday, Sunday or Holiday, issue closes on preceding working day.

**ROCOMA-GBX**, Washington Crossing, PA 18977. Creditcard orders 24 hours (215)736-2880.

**BURGLAR alarms—booming business.** Get in now. Information package \$2.00. **DYNAMIC SECURITY** P.O. Box 1456-RN, Grand Rapids, MI 49501.

**EARN \$300.00 per day** installing residential phone wiring. Send \$9.95 to **E.R. HASKINS** 150 S. Glenoaks, Suite 223, Burbank, CA 91510.

## EDUCATION & INSTRUCTION

**FCC Commercial General Radiotelephone License Correspondence Course.** 60 individual lessons for \$89.50. Payment plan. Results guaranteed! Details free. **AMERICAN TECHNICAL INSTITUTE**, Box 201, Cedar Mountain, NC 28718.

**F.C.C. Commercial General Radiotelephone License.** Electronics home study. Fast, inexpensive! "Free" details. **COMMAND**, D-176, Box 2223, San Francisco, CA 94126.

**STIMULATE** hardware with C-64 and signet: combine real time A/D and D/A conversion, Fourier analysis and network analysis of your analog circuit design. Included is A/D-D/A interface board, signet software package, documentation. Price \$125.00. **COMPUTER-CITY**, 467 Saratoga Ave., Suite 269, San Jose, CA 95129. (408)247-8775.

**MEXICO**, obtain almost all technical books advertised in this magazine in pesos and in Mexico from Ing. **SAMUEL THOMAS**, Tel. 533-1833, clave 2754.

## PRINTED-CIRCUIT BOARDS

**PRINTED-circuit boards.** Quick prototypes, production, design, reflow solder. Send print or description for quote to **KIT CIRCUITS**, Box 235, Clawson, MI 48017.

**PRINTED-circuit boards**, double-sided with plated through holes or single-sided. No set-up charge. **CAUDILL, INC.**, 205 East Westwood Ave., Highpoint, NC 27262. (919) 884-0229.

## GRAPHIC EQUALIZERS, ETC.

**NOISE** eliminators, expanders, power meters, others. Twelve-24 bands/channel equalizers from \$89.00. Kit see R-E 5-6-78, 2/80, 3-4/81. Catalog: **SSS**, 856R Lynnrose, Santa Rosa, CA 95404. (707) 546-3895.

## FINEST QUALITY SOLDER

**SN 60/40 Rosin Core (RA)**

**One lb. Reels**  
16 swg. (.064) \$7.95  
18 swg. (.048) \$8.45  
19 swg. (.040) \$8.95  
20 swg. (.036) \$9.45  
21 swg. (.032) \$9.95

**1/2 lb. Reels**  
22 swg. (.028) \$5.95  
24 swg. (.022) \$7.95

**SN 62 (2% Silver)**

**Rosin Core**  
21 swg. (.031) \$19.95



**FREE Freight On All Orders Over \$25**  
Under \$25 add \$2.50 per order.  
Minimum order \$10.

**FREE Desoldering Wick** with each pound of solder

Check  Money Order  VISA  
 MasterCard N.Y. State residents add appropriate sales tax.

**SolderCraft**  
P.O. Box 668 R. Jencho, N.Y. 11753

**Call TOLL FREE 800-645-4808**  
In NYS (516) 334-2860







# CB MODIFICATIONS

Increase channels, range, privacy! We specialize in frequency expanders, speech processors, FM converters, PLL & slider tricks, how-to books, plans, kits. Expert mail-in repairs & conversions. 16-page catalog \$2.

**CBC INTERNATIONAL, P.O. BOX 31500RE, PHOENIX, AZ 85046 (602) 996-8700**

**CABLE** and Subscription-TV secret manual. Build your own descramblers, converters—HBO, Showtime, Movie Channel, UHF. Latest theory, schematics, instructions, suppliers. Send \$8.95 to **CABLETRONICS**, Box 30502R, Bethesda, MD 20814.

**PICTURE Flyer** lists quality electronics surplus at low prices. Since 1970. Send for the last 3 issues. **STAR-TRONICS**, Box 683, McMinnville, OR 97128.

**STUN** gun immobilizes your attacker with 4,000 volts. For more information send \$1.00 to **CAMEO ENTERPRISES, INC.**, Box 63, Accord, MA 02018.

**TUBES:** "Oldies", latest. Supplies, components, schematics. Send S.A.S.E. for Catalog. **STEINMETZ**, 7519 Maplewood Ave., RE, Hammond, IN 46324.

**CABLE TV** converters—All major brands. Wireless remotes with volume, wired remotes. Cable and Video accessories. Cablemaster distributor. Lowest prices. Ship C.O.D. Catalogs \$3.00, **SONE ASSOCIATES**, 5 Broadway, Suite 201, Troy, NY 12180. (518) 274-0608.

**CONVERTERS** all types for all systems. Lowest prices anywhere, quantity discounts, dealer inquiries accepted. Free catalog. **PG VIDEO**, 61 Gatchell St., Dept. RE, Buffalo, NY 14212.

**SCIENTIFIC Atlanta** Cable Systems. CM-04 special! Descrambler for 8500, 8530, 8520 systems, \$125.00. Info \$2.00, **ADVANCED TECH SYSTEMS**, Box 316, Auburn, MA 01501, (617) 832-2339.

**CIRCUIT boards:** Your artwork, quick delivery, reasonable. **ATLAS CIRCUITS**, Dept. A, P.O. Box 892, Lincolnton, NC 28092, (704) 735-3943.

**SINGAPORE**—shopper's paradise. Get components, peripherals, books and equipment—very cheap. Send requirements. **BUSINESS BIRDS**, B1-47, Simlim Tower, Singapore-0820.

**UNIQUE** video countermeasure and counter-countermeasure manual. Limited distribution. Covers satellite, CATV, STV, MDS. Information, 1985 catalog, application notes \$1.00 plus 2 oz S.A.S.E. **CAPTAIN VIDEO**, P.O. Box 9388, Baltimore, MD 21228.

**FLY'S #1** to #692, yokes, modules, much more. Send stamps, 55 cents to **WHOLESALE ELEC. SUPPLY**, 1711 Mass. Ave., Lexington, MA 02173.

**ELECTRONIC** parts bonanza! Now-working TV modules. \$14.95, postpaid, **WILLIE DALE** 1603 Westfield, S.W., N.Canton, OH 44709.

**BUILD** 35 exciting interfaces for your C-64. Detailed 196-page book \$16.95. **MICROPRESS**, P.O. Box 388, Goleta, CA 93116.

**PULSE generator**—0.1 Hz - 50 MHz. Free brochure. **MDM ELECTRONICS** 257 Castro Street, #2J-1, Mountain View, CA 94041.

**TUBES** TV, radio, 90% off retail, new name brands. **GRAY**, 4415 Indianapolis, East Chicago, IN 46312.

**CATALOG:** TV descramblers, cable converters, microwave converters, satellite systems, many types, kits or built, \$1.00. **MINUTE KITS**, Box 531, West S.Q., Bronx, NY 10461.

**ELECTRONIC** fish caller for fishermen \$5.00!! Uniden EX-1100B cordless telephone 50' range \$30.00. Limited quantities. Information \$1.00. **J. ELKINS**, 311 Shirley Street, Boston, MA 02152.

**TUBES** name brands, new, 80% off list, **KIRBY**, 298 West Carmel Drive, Carmel, IN 46032.

**MASTERCARD AND VISA** are now accepted for payment of your advertising. Simply complete the form on the first page of the Market Center and we will bill.

**Power Problems?**

**AGIS™** Power Conditioning Equipment... THE SOLUTION! Protects Computers & High-tech Equipment From Damaging Voltage Surges, Lost Data, & Costly Down Time.

**SPIKE—SPIKER™**  
Transient Voltage Surge & Spike Suppressors & Noise Filters - Eleven Models - All Models Rated 120V, 15A  
Priced From \$29.95

**LINE-SAVER™**  
Standby Uninterruptible & Emergency Power Systems. Self-Contained Batteries. Compact Design. Completely Automatic.  
Priced From \$549™

Call or write for free literature.  
Dealer inquires invited.

**INSTANT ORDER LINE**  
800-524-0400  
TWX 501-651-2101  
IN PENNA. 215-837-0700

**KAGLO®**  
6584 Ruch Rd., Dept. Bethlehem, PA 18017  
MADE IN USA

## WANTED

**INVENTIONS**, ideas, new products wanted! Presentation to industry. National expansion. Call (1-800) 528-6050. Canada (1-800) 528-6060. X831.

## REEL-TO-REEL TAPES

**AMPEX** professional series open reel tape, 1800- or 2400-foot on 7-inch reels, used once. Case of 40, \$45.00. 10 1/2" x 3600 feet and cassettes available. MasterCard/Visa. **VALTECH ELECTRONICS**, Box 6-R, Richboro, PA 18954 (215) 322-4866.

## INVENTORS!

**CAN** you profit from your idea? Call us today regarding the marketing of your invention, or write for your free information package. Over a decade of service. **AMERICAN INVENTORS CORPORATION**, 82 Broad Street, Dept. RE, Westfield, MA 01086, (413) 568-3753. (Not an answering service.) Offices nationwide.

# MICRO MART

508 Central Ave.  
Westfield, N.J. 07090  
(201) 654-8008

<p><b>Colls For Radio Elec's Feb. 84 TV Project, Toko #S T-1, T-2, L-1 (12Zuh) &amp; L-2 (07UH), Complete Set Of All 4 Colls...</b> 8.50</p> <p>MC1330—Prime (Moto) 2/1.00 BFQ-85 Transistor 1.50 Disc Caps .001uf 20/1.00 74123-Prime (Natl) 3/1.00 470uf .35V (Radial) 3/1.00 470uf 16V (Axial) 4/1.00 2N3904 10/1.00 2N3906 10/1.00 1N914 40/1.00 1N4148 40/1.00 1N5211B (5.1V Zener Diode) 5/1.00 Voltage Regulators (Prime TO-220) 7.805, 7812, 7824, 7905, 7912-Mix or Match 3/1.00 Mica Insulators For TO-20 Pkg 20/1.00 Voltage Reg's (Unmarked, 60% Prime) May Include Positive/Neg &amp; Adjust 15/1.00 78L08 Voltage Reg (DM106, TO-92) 20/1.00 PN2222A 20/1.00 2N3055 50 2N5308 20/1.00</p> <p><b>15 Cent (1.15) Per IC TTL</b></p> <p>7403 7440 7495 7410 7442 74107 7436 7450 74151 7437 7474 74163 7438 7476 74393</p> <p><b>15 Cent (1.15) Per IC 74LSXX</b></p> <p>74LS10 74LS86 74LS20 74LS153 74LS257 74LS74 74LS158 74LS273</p> <p><b>20 Cent (.20) Per IC CMOS</b></p> <p>4001B, 4011B, 4050B MC838 (DTL) 10/1.00 Opto Isolator (H11G2-PIN DIP) Specs 40 2716 Eprom 1.45 2732 Eprom 1.95 2764 Eprom 2.45 256K Dram 5 Gons Prime Hitachi (Ideal For Mac Upgrades &amp; Expansion Projects) 4.95 8243 (I/O Expander IC) W/Specs 2.95 UDN 6118 (Display Driver IC) Specs 85 UDN 6128 95 UDN 4118B (Cbr/Freq Div Clock IC) Specs 5/1 UCN 4801 (8 Chan Bt-Mos Latch/Driver) 1.00 LM339 45 LM3801 (ULN2280) 45 555 Timers (T) 4/1.00 NE556 (Dual Timer-Moto) 50 7413 Op Amp (Mini Dip H Rel Pkg) 4/1.00 LM1310 (Unmarked, Tested Prime) 50 LM1889 95 LM3900 45 AM/FM Radio IC (#2204 W/Specs Hobby) 15/1.00</p> <p><b>IC Sockets</b> 8 Pin/07, 14 Pin/13, 16 Pin/15, 18 Pin/17, 24 Pin/22, 28 Pin/24 TO-5 Transistor Socket 7/1.00</p>	<p>7 Segment Display (3 Common Cath) 15 7 Segment Display (6 Common An) 65 Tri State LED's 3/1.00 Jumbo Red LED's-Diffused Lens, Prime (1/1) All 100% Prime-15/\$1, 100/\$6, 1,000/\$57.50 LED Mounting Clips &amp; Rings 15/1.00 Texas Inst# 994A Keyboard-Inv/Data For Pins Made Wire Each Key/Depressed 4.95 Dip Switch-12 Position 2/1.00 Dip Switch-8 Position 4/1.00 Keyboard Push Button Tops 30/1.00 Audio Cable 30 Feet/1.00 22AWG Wire 50 Feet/1.00 27AWG Wire 50 Feet/1.00 Mini Lubricant (&amp; Lubricant) 1.00 Soldering Iron (20W) 5.50 Solder Sucker 6.50 Molex Pins (7 Pin/Strap) 100/\$2, 500/\$4, 1K/\$6 Clock Module Crystal Controlled, Green Display/12VDC/Time Set Switches/Data 4.95 Rotary Switch (5 Position, 5A 125V) 3/1.00 <b>Giant Alpha Numeric Display 1-1/2" X 2"</b> 7X5 (35 Total) Red LED Matrix/Specs 4.95 1" LED Bar Graph Display 2-3/4" Rect 1.95 LED's (Specify Red, Grn, Amber) Specs 2.69 <b>Seven Amp (7) Tapped Transformer Can Be</b> Wired For (7.5V, 9V, 15V, 18V) Reg Shpg 8.95 Wall Plug Transformer-24V 525mA 1.50 6.3V 1.2A Transformer 1.20 12V Center Tap Transformer 2.50 Mini Audio Transformers 10/1.00 1N4007 20/1.00 1N5059 (200V 1 Amp) 15/1.00 1N5060 (400V 1 Amp) 10/1.00 Zener Diodes-20V 1W 30/1.00 Zener Diodes-13V 1W Glass 30/1.00 25600K Crystal 50 3.579545 Color Burst Crystal (HC-18) 50 1.0 Mhz Crystal 1.95 6.0 Mhz Crystal 1.95 10K Heat Sinks (Barn) 10/1.00 TO-18 Heat Sinks (Barn) 10/1.00 <b>Super Sub-Mini Ceramic Caps (All 100)</b> 0015uf 100V (152) 30/1.00 0022uf 100V (182) 30/1.00 0027uf 100V (272) 30/1.00 0033uf 100V (332) 30/1.00 0039uf 100V (392) 30/1.00 0056uf 100V (562) 30/1.00 0082uf 100V (822) 30/1.00 4.7uf 40V Lytic (Radial) 20/1.00 47uf 25V Lytic (Radial) 10/1.00 100uf 185V Twist Lock 1.00 3200uf 50V (Ideal For Power Supplies)-1.00 5600uf 25V (Comp Grade 3-5/8" X) 3/1.00 1uf 50V Monolithics 10/1.00 22uf 50V Monolithics 20/1.00 Chip Caps-Set of 4, 2 Eeach 2.7 &amp; 3.3pf-1.00 35uf 100V Dip Mylar 10/1.00 022uf 200V Wrapped Mylar 15/1.00 1uf 50V Wrapped Mylar 15/1.00 1,000 PC Resistor Ass't (30 Values) 1/2W-53</p>
---	---

Pots-1 Meg. Linear Taper 5/1.00  
Motion Detector Bds (Inc IC \$2) 7/10.00  
Mod Det IC Only-ULN232A) 3/52-20/10.00  
Project Box/Lid For Detector 1.95  
Miniature Speaker For Detector 25  
Extensive Construction Article For Det. \$1 TV Knobs 15/1.00  
Ammeter (0-15 A.C. Amperes) 4.95  
Volt/OHM Meter MVMNT (0-1K OHM, 0-300V) 2.95  
6V Miniature Gear Motor 50  
RF Chokes-1.8uh, 8.2uh, 12uh, 22uh 10/1.00  
22/44 Pin Edge Card Connector 50  
34 Pin Connector (For Drivers) W/Hood 75  
BNC-T Connector (UG-274) 95  
Mixed Connector Ass't 10/1.00  
1.5AMP 50V Bridge (GI, TO-5 Pkg) 50  
25AMP 200V Bridge (Solder Lug Term) 1.50  
**Zenith TV Replacement IC Special \$1 Each**  
221-42, 221-43, 221-45, 221-48, 221-69,  
221-79, 221-87, 221-96, 221-104, 221-105,  
221-106, 221-140  
2SD900 (Horiz Output W/Damper Diode)-2.95  
2SC1172B (Toshiba-Horiz Output Trans)-1.95  
Winegard 4 Bay Bowtie UHF Antenna-19.50  
IC Storage (Bug) Box (Holds) 30 IC's-1.75  
**Precision (Multi-Turn) Trim Pots (Copal),**  
100 OHM, 500 OHM, 1K, 2K, 5K, 10K, 20K,  
50K, 100K, 200K, 500K, 1M, 85 Each-3/52  
**Part #10V Horz (Single Turn) Trimmers**  
100 OHM, 1K, 10K, 25K, 50K, 100K 4/51  
High Sensitive Switch/150°C 10/1.00  
Mixed Switch Ass't 10/1.00  
Mixed Coil Ass't 10/1.00  
Rubber Feet 10/1.00  
Buzzer 3/1.00  
Chip Resistor (6.8K) 20/1.00  
Chip Resistor (470K) 20/1.00  
Chip Cap (330pf) 20/1.00  
Jumbo Red LED W/Built In Resistor-30/\$1  
MRF (Hobby Grade-60K Gok) 10/1.00  
Die-Soldering Brd (3S-Wick) 5 1/2" 19.50  
IC Ass't (Hobby Grade, Some Marked)-30/\$1

### 20 Cent (.20) 74SCXX Series Special

- Octal Interface Circuits
- Equivalent To 74LSXX Series
- Low Power ISO-CMOS Technology
- Short Propagation Delay
- Improved Noise Margins
- High Current, Sink/Source Capability

74SC317-1 Of 8 Inverted Decoder, Latched  
74SC138-1 Of 8 Inverted Decoder  
74SC139-1 Of 4 Inverted Decoder  
74SC237-1 Of 8 Non-Inverted, Latched  
74SC38-1 Of 8 Non-Inverted  
74SC239-1 Of 4 Non-Inverted  
74SC240-Octal Buffer/Line Driver-Inv  
74SC241-Octal Buffer/Line Driver-Inv  
74SC244-Octal Buffer/Line Driver-Inv  
74SC245-Octal Bus Transceiver-Non-Inv  
74SC373-Transparent Latch-Non-Inv

### Model 705 Digital Multimeter

DC Voltage 100uV to 1000V  
AC Voltage 100uV to 750V  
DC Current 0.1uA to 10A  
AC Current 0.1uA to 10A  
Hi-Z Resistance 0.1uA to 20MΩ  
Capacitance 1pF to 20uF  
Diode Test transistor testing  
Hex test

\$51<sup>95</sup>

### UHF-TV PREAMP

(As featured in Radio Electronics March/ May articles, 1982)

This inexpensive antenna mounted preamp can add more than 25 dB of gain to your system. Lots of satisfied customers and repeat orders for this high quality kit, which includes all component parts, PC Board, Case, Power Supply and Balun \$34.50 Assembled Version \$57.50

**Terms:** MICRO-MART accepts Visa, MC and telephone COD's. Minimum order \$10.00. Shipping—U.S. orders \$2.00. Canada and other countries \$3.50 (includes ins.) Shipping rate adjusted where applicable. NJ residents add 8% sales tax.

**MICRO-MART • 508 CENTRAL AVE., WESTFIELD, NJ 07090 • (201) 654-8008**



# Radio Shack Parts Place®

Over 1000 Items in Stock at Everyday Low Prices

## We Have the Connectors You Need for Computer Interfacing



**Solder-Type Subminiature "D" Connectors.** Ideal for building your own RS-232 cables.

Fig.	Type	Positions	Cat. No.	Each
1	Sub-D Male	25	276-1547	2.99
2	Sub-D Female	25	276-1548	3.99
3	Hood for Above	25	276-1549	1.99

(4) Dustcaps. For Sub-D 25 connectors. Help prevent moisture and dirt contamination. One male and one female. 276-1546 . . . . . Set 39¢

(5) Printer Connector. NEW LOW PRICE! 34-position solder-type connector for parallel printers. Heavy-duty metal-shielded construction for trouble-free service. Was \$6.99. 276-1534 . . . . . 4.99

(6) 6-Position DIN Plug. Fits joystick port of Tandy Color Computer 2. Use with inline jack to build your own joystick extension cord. 274-020 . . . . . 1.19

(7) 6-Position Inline DIN Socket. For use with 6-pin DIN plug. 274-021 . . . . . 99¢

## We Can Replace Virtually Any Entertainment or Industrial Semiconductor

### RADIO SHACK'S NEW SPECIAL-ORDER SERVICE

If the IC or semiconductor you need is not part of our regular stock, our store manager will help you get it. He'll identify a suitable replacement, then special-order it from our warehouse. There's no postage to pay or other extra charges for this convenient service!

## CMOS and TTL Digital ICs



All Include Pin-Out and Specs

CMOS	Cat. No.	Each
4001	276-2401	.99
4011	276-2411	.99
4013	276-2413	1.19
4017	276-2417	1.49
4049	276-2449	1.19
4066	276-2466	1.19

TTL	Cat. No.	Each
7400	276-1801	.89
7404	276-1802	.99
7408	276-1822	1.29
7447	276-1805	1.69
7490	276-1808	1.19

## Computer Interface ICs

Type	Cat. No.	Each
MC1488 RS232 Quad Line Driver	276-2520	1.79
MC1489 RS232 Quad Line Receiver	276-2521	1.79
MOC3010 Triac-Output Optocoupler	276-134	1.99

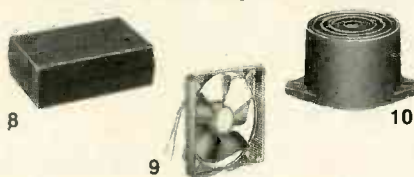
## Voice Synthesizer IC



Heart of a Rewarding Project!

**SPO256-AL2.** This MOS LSI device uses a program stored in its built-in 16K ROM to synthesize natural sounding speech. Requires low-cost support components and is easy to interface with most microcomputers. Requires 3.12 MHz clock crystal (available through Radio Shack). 28-pin DIP with detailed specs and programming data. 5 VDC, single supply. 276-1784 . . . . . 12.95

## Check These Super Values!



(8) Small Enclosure and PC Board. A real bargain! The 1 3/16 x 3 7/16 x 2 5/16" enclosure is of rugged, yet easy-to-drill plastic. Internal PC board has 483 DIP-spaced solder-ringed holes. Two labels, hardware, snap-in rubber feet. 270-291 . . . 2.99

(9) 4" 120 VAC Cooling Fan. Whisper quiet and efficient. Moves heat away from computers, ham and hi-fi equipment. Also useful in solar heat systems. 65 CFM. Leads for easy hookup. 4 1/16 x 4 1/16 x 2 1/2". U.L. recognized. 273-241 . . . . . 15.95

(10) Electronic "Doorbell" Chime. Gives you the familiar "ding-dong" sound and it operates from one "D" cell. 4 3/4" leads. 273-067 . . . 6.95

## Voltage Regulator ICs

Type	Function	Cat. No.	Each
7805	5 VDC Fixed	276-1770	1.59
7812	12 VDC Fixed	276-1771	1.59
7815	12 VDC Fixed	276-1772	1.59
LM317T*	1.2 to 27 VDC	276-1778	2.79
LM723	0 to 40 VDC	276-1740	.99

\* 14-Pin DIP, others TO-220 case

## Switch Values



(11) Rotary Switch. 2-pole, 6-position. Rated 0.3 amp at 125 VAC. Single deck, non-shorting type. 1/4"-diameter shaft. 275-1386 . . . . . 1.19

(12) NEW! 120 VAC SPDT Push-On/Push-Off. Round button. Rated 3 amps at 120 VAC. Lamp requires 12 volts, AC or DC. 1/2" mtg. hole. 275-677 . . . . . 4.95

## Learn About Electronics By Building Your Own Circuits

Only 2<sup>49</sup>



**Getting Started in Electronics.** By Forrest Mims III. The perfect introduction to the exciting world of ICs and solid-state. It's written in easy-to-understand language by one of America's most popular technical authors. Features large schematic diagrams with clearly labeled component values. 128 pages. 276-5003 . . . . . 2.49

## Semiconductor Reference

### Half Price!

1<sup>75</sup> Reg. 3.49

- 1985 Edition
- 272 Pages
- Illustrated

Exclusive substitution section lists over 80,000 semi types and their low-cost Radio Shack equivalents. Data on Radio Shack ICs, SCRs, LEDs diodes and opto devices. 276-4008 . . . . . Sale 1.75

## TV RF Modulator

### Special Purchase!



Only 4<sup>95</sup>

Compare our LOW price to mail-order offers on this high-quality device! Originally for TI 99/4 computer, this prewired, metal-cased module provides a superior-quality TV signal on channel 3 or 4. 5-pin DIN plug accepts video, audio and 12 VDC power input. Extra-long cable for easy hookup. With data. 277-1015 . . . . . 4.95

## Pocket-Size, 8-Range Multitester

Save \$ 2<sup>07</sup>

8<sup>88</sup> Reg. 10.95

Switched Ranges



2000 ohms-per-volt sensitivity, yet only 3 1/2 x 2 1/4 x 1 1/4" and super durable. Ranges: AC and DC volts 0-15, 0-150, 0-1000. DC current to 150 milliamps. Resistance to 100,000 ohms. With leads, manual. Requires "AA" battery. 22-212 . . . . . Sale 8.88

## Digital Logic Probe With Tone Output



Overload Protected

19<sup>95</sup>

The fast way to "peek inside" TTL, LS and CMOS digital circuits. Color-coded LEDs indicate high, low or pulsed logic states (up to 10 MHz). The simultaneous tone output frees your eyes for faster testing. With illustrated instructions and user's tips. 22-302 . . . . . 19.95

## Sale! IC Inserter and Extractor Set

Cut 30%

4<sup>88</sup> Reg. 6.95

Handle DIP ICs The Safe Way



This easy-to-use set helps you remove or install DIP ICs without bending pins. The inserter features a built-in pin straightener. Both of the tools are groundable to protect static-sensitive MOS devices. 276-1574 . . . . . Sale, Set 4.88

Over 1000 items in stock: Binding posts, Books, Breadboards, Buzzers, Capacitors, Chokes, Clips, Connectors, Fuses, Hardware, ICs, Jacks, Knobs, Lamps, Multimeters, PC Boards, Plugs, Rectifiers, Relays, Resistors, Switches, Tools, Transformers, Transistors, Wire, Zener Diodes, and more!

**Radio Shack**  
A DIVISION OF TANDY CORPORATION  
Prices apply at participating Radio Shack stores and dealers



# GEMINI

THE AUTONOMOUS ROBOT

IS NOW PRICED FOR EVERYONE!



Buy each subassembly as a kit or factory assembled and create your own GEMINI Robot.



Or, for convenience, start with GEMINEX, our starter kit, and expand to GEMINI

later with upgrade kits.



Either way, Buy a piece of tomorrow TODAY!

CALL or WRITE For Our FREE Brochure.

**arctec systems**

9104 Red Branch Road  
Columbia, Maryland 21045  
(301)730-1237  
Telex 87-781

CIRCLE 272 ON FREE INFORMATION CARD

**Quality Microwave TV Antennas**

Multi-Channel 1.9 to 2.7 GHz  
40dB Gain True Parabolic 20 Inch Dish  
Complete System \$84.95 (Shipping incl.)  
Dealerships. Qty. Pricing, Replacement Parts

**Phillips-Tech Electronics**  
P.O. Box 34772 • Phoenix, AZ 85067  
(802) 947-7700 (\$3.00 Credit all phone orders!)

LIFETIME WARRANTY MasterCard • Visa • E.O.s

## SATELLITE TELEVISION

**BUILD** your own Satellite-TV receiving system and save! Instruction manuals, schematics, circuit boards, parts kits! Send stamped envelope for complete product listing: XANDI, Box 25647, Dept. 21S, Tempe, AZ 85282.

**UNSCRAMBLE**—Canadian & American satellites. Watch the good stuff. Plans \$19.95—boards & plans \$30.00—units completed \$298.00—kits available—details and order forms \$3.00. SCRAMCO, 8688 Royal Drive, Noblesville, IN 46060.

**SATELLITE** Descramblers. Lowest prices anywhere! Dealer inquiries welcome. Send \$3.00 for catalog. We ship C.O.D.'s. STARVIEW INC., P.O. Box 103, Rexford, NY 12148. (518) 785-1288.

**SATELLITE-TV**—Home—RV's. Complete fully operational systems from \$695.00. Send \$2.00 for catalog. MIDWEST SATELLITE SYSTEMS, P.O. Box 43008, Mt. Clemens, MI 48043.

**UNIQUE** Satellite TV Manual for dealers/hobbyists. Includes step-by-step instructions for system installation & tuning, purchasing, marketing, complete list of distributors & equipment plus more. Rush \$19.95 to SATELLITE COM. NETWORK. 204 W. 20th St., New York, NY 10011.

**FINEST** proven names in satellite TVRO systems available at discount prices. Send \$1.00 for our prices. C.V.P., Box 2414, Danbury, CT 06810.

**THE LNA specialists!** Brand name, lowest noise, lowest prices! We will not be undersold! Send for prices: LNA, 201 E. Southern, Suite 100, Tempe, AZ 85282.

**SATELLITE** antenna you can build at home! Complete instructions provided in fact-filled book. \$8.00 to: HIGH SIERRA, 5968 E. 29th, Tucson, AZ 85711.

**SATELLITE Channels** Newsletter. Get the most from your dish! Details, sample \$2.00. BOX 31R, Dighton, MA 02715.

**SATELLITE** system \$595.00 complete information \$1.00; color catalog \$2.00. STARLINK, INC., 2603-16R, Artie, Huntsville, AL 35805.

THE BEST PLACE to BUY, SELL or TRADE NEW and USED EQUIPMENT

**NUTS & VOLTS MAGAZINE**  
BOX 1111-E • PLACENTIA, CA 92670  
(714) 632-7721  
Join Thousands of Readers Nationwide Every Month

**ONE YEAR U.S. SUBSCRIPTIONS**  
\$10.00 - 3rd Class • \$15.00 - 1st Class

535.00 - Lifetime - 3rd Class 1984

**NUTS & VOLTS**  
HAM GEAR  
COMPUTERS  
SOFTWARE  
SCANNERS • OPTICS  
TEST EQUIPMENT  
MICROWAVE  
SATELLITE  
AUDIO VISUAL  
NEW PRODUCTS  
COMPONENTS • KITS  
ANTIQUE ELECT.  
PUBLICATIONS  
PLANS • SERVICES

## PLANS AND KITS

**CATALOG:** Hobby, radio broadcasting, CB, lowfrets. Transmitters, linears, active antennas, converters, scramblers, bugging devices, more! PANAXIS, Box 130-F10, Paradise, CA 95969.

**DESCRAMBLER** plans. New design decodes gated sync suppressed signals—newest pilotless method. Circuit boards, most parts from Radio Shack. Detailed theory, drawings, schematics, instructions \$14.95 plus \$2.00 shipping. DIRIJO CORP., Box 212, Lowell, NC 28098.

**CABLE-TV Converters:** Jerrold products include "new Jerrold Tri-Mode", SB-3, Hamlin, Oak VN-12, M-35-B, Zenith, and more. UHF Deluxe II kits. (Quantity discounts) 60 day warranty. Repairs of cable converters. For fast service C.O.D. orders accepted. Send S.A.S.E. (60 cents postage), or call for info., (312) 637-4408. HIGGINS ELECTRONICS, 5143 W. Diversey, Chicago, IL 60639. No Illinois orders accepted.

## ENJOY SATELLITE TV

### DO-IT-YOURSELF AND SAVE

Electronic Know-how not required.  
Easy to build from our plans or kits.  
Lowest prices on satellite electronics.  
Send \$1 for catalog or \$8.95 for "Consumer Guide to Satellite Television"  
Mail today to: GFI-D14, Box 9108  
Missoula, MT 59807



**TV stereo adapter plans:** PCB also UHF gated-pulse descrambler with simulated stereo output. For additional information—send S.A.S.E. to SOKOLOWSKI, Box 150, Elmont, NY 11003.

**HI-FI** speaker kits, auto speaker systems and speaker components from the world's finest manufacturers. For beginners and experts. Free literature. A&S SPEAKERS, Box 7462R, Denver, CO 80207. (303) 399-8609.

**PROJECTION TV.** Convert your TV to project 7 foot picture...Results comparable to \$2,500.00 projectors...Total cost less than \$300.00...Plans and 8" lens \$19.95...Illustrated information free. MACROCAMA-GB, Washington Crossing, PA 18977. Creditcard orders 24 hours (215) 736-3979.

**DIGITAL Klock kit** plays 1-of-12 melodies each quarter hour. Displays time, date, and other features. Send \$2.50 for assembly plans and pricing to KERBER KLOCK KO., 36117 Hillcrest, Eastlake, OH 44094.

**ATTENTION** technicians: A must for testing transistors and diodes in and out of circuit! Saves time and money! No more knotted test leads! Schematics and instruction manual \$8.95; kit (unassembled) \$24.95; kit (assembled) \$34.95, Postpaid to: WTV, INC., 114 Granite Street Shopping Center, Westerly, RI 02891.

**FREE catalog 99-cent kits**—audio, video, TV computer parts: AIKIT, 434 W. 4th St., West Islip, NY 11795.

**PAY TV** and Satellite Descrambler Manual. All systems. Schematics. America and Canada. 62 pages \$12.95. Stunguns, schematics and theory. \$9.95. kits catalogue \$2.00. SHOJIKI ELECTRONICS CORP., 1327 Niagara St., Niagara Falls, NY 14302. C.O.D.'s, (716) 282-1001.

**UFO** detecting. Detailed book. Theories, electronic projects, and catalog. \$5.95. UFONICS, Box 1336-R, Patchogue, NY 11772.

**TELEPHONE** test set. Easy to build and use, test both phones and line. Parts and plans \$14.95, plans only \$3.00. FINCH ELECTRONICS, Rt. 1, Box 266B, Advance, NC 27006.

**NOISE** reduction—Eliminate hiss on recorded tapes. Fast, no pumping, built-in bypass. Plans and P.C. board \$18.95. Certified check/money order. SOUND INNOVATIONS, P.O. Box 7394, Bloomfield Hills, MI 48302-7394.

**BUILD** this five digit panel meter and square wave generator including an ohms, capacitance and frequency meter. Detailed instructions \$2.50. Refundable plus 50 cents. BAGNALL ELECTRONICS, 179 May, Fairfield, CT 06430.

**IBM PC** compatible computer. Motherboard \$276.00, P/S \$119.00, case \$110.00, etc. Easy to follow instructions. Only a screwdriver needed. Call for info 1(216) 842-4313 or send \$3.95 for info and prices. JV SYSTEMS P.O. Box 9807, Brookpark, OH 44142.

WRITE FOR **McGEE'S**  
**SPEAKER & ELECTRONICS CATALOG**  
1001 BARGAINS IN SPEAKERS  
 toll free 1-800-346-2433 for ordering only.  
1901 MCGEE STREET KANSAS CITY, MO. 64108

## ROBOTICS TRAINING

**ROBOT** vehicle pilot/technician put your electronic/mechanical skills to work underwater! Train to operate subsea remotely operated vehicles in support of the offshore oil and gas industry. High pay/travel—free brochure. UNDERWATER VEHICLE TRAINING CENTER, 10046 Chickasaw, Houston, TX 77041. Call 1-800-USA-DIVE.



# DoKay

COMPUTER  
PRODUCTS,  
Inc.

ORDER TOLL FREE

(800)  
538-8800

(CALIFORNIA RESIDENTS)

(800)  
848-8008



## STATIC RAMS

2101	256 x 4	450ns	1.90
2102	1K x 1	450ns	.79
2102L-4	1K x 1	450ns	.89
2102L-2	1K x 1	250ns	1.29
2111	256 x 4	450ns	2.29
2112	256 x 4	450ns	2.29
2114	1K x 4	450ns	.99
2114-25	1K x 4	250ns	1.10
2114L-4	1K x 4	450ns	1.20
2114L-3	1K x 4	300ns	1.30
2114L-2	1K x 4	200ns	1.40
2147	4K x 1	55ns	3.95
5101	256 x 4	450ns	CMOS 3.90
TMS4044-4	4K x 1	450ns	2.95
TMS4044-3	4K x 1	300ns	3.45
TMS4044-2	4K x 1	200ns	3.95
MKA118	1K x 8	250ns	8.95
TMM2016-20	2K x 8	200ns	2.49
TMM2016-15	2K x 8	150ns	2.99
TMM2016-10	2K x 8	100ns	4.49
HM6116-4	2K x 8	200ns	CMOS 2.49
HM6116-3	2K x 8	150ns	CMOS 2.99
HM6116-2	2K x 8	120ns	CMOS 5.49
HM6116LP-4	2K x 8	200ns	CMOS 2.99
HM6116LP-3	2K x 8	150ns	CMOS 3.49
HM6116LP-2	2K x 8	120ns	CMOS 6.49
Z-6132	4K x 8	300ns	29.95
HM6264P-15	8K x 8	150ns	CMOS 7.95
HM6264LP-15	8K x 8	150ns	CMOS 8.95
HM6264LP-12	8K x 8	120ns	CMOS 10.95

## DYNAMIC RAMS

TMS4027	4K x 1	250ns	1.45
UPD411	4K x 1	300ns	1.95
MM5280	4K x 1	300ns	1.95
MKA108	8K x 1	200ns	.49
MM5298	8K x 1	250ns	.49
4116-20	16K x 1	200ns	.79
4116-15	16K x 1	150ns	.99
4116-12	16K x 1	120ns	1.49
2118	16K x 1	150ns	5v 3.95
4164-25	84K x 1	250ns	5v 1.50
4164-20	64K x 1	200ns	5v 1.75
4164-15	64K x 1	150ns	5v 2.00
41256-20	256 x 1	200ns	7.95
41256-15	256 x 1	150ns	8.95

## EPROMS

1702	256 x 8	1 us	3.95
2708	1K x 8	450ns	2.49
2758	1K x 8	450ns	5.90
2716	2K x 8	450ns	5v 2.95
2716-1	2K x 8	350ns	5v 3.95
TMS2516	2K x 8	450ns	5v 3.95
TMS2716	2K x 8	450ns	6.95
TMS2532	4K x 8	450ns	5v 3.95
2732	4K x 8	450ns	5v 3.95
2732 A-4	4K x 8	450ns	21v 3.95
2732 A-35	4K x 8	350ns	21v 3.95
2732 A	4K x 8	250ns	21v 8.95
2732 A-2	4K x 8	200ns	21v 8.95
2764	8K x 8	450ns	5v 4.25
2764-25	8K x 8	250ns	5v 4.95
2764-20	8K x 1	200ns	5v 7.95
TMS2564	8K x 8	450ns	5v 9.95
MCM68764	8K x 8	450ns	5v 17.95
MCM68766	8K x 8	350ns	5v 19.95
27128-45	16K x 8	250ns	5v 8.95
27128-30	16K x 8	300ns	5v 9.95
27128-25	16K x 8	250ns	5v 10.95
27256-25	32K x 8	250ns	14v 24.95

## 74LS00

74LS00	23	74LS125	48	74LS260	58
74LS01	24	74LS126	48	74LS268	54
74LS02	24	74LS132	58	74LS273	1.45
74LS03	24	74LS133	58	74LS275	3.30
74LS04	23	74LS136	38	74LS279	48
74LS05	24	74LS137	98	74LS280	1.95
74LS06	27	74LS138	54	74LS283	68
74LS09	28	74LS139	54	74LS290	88
74LS10	24	74LS145	1.15	74LS293	88
74LS11	34	74LS147	2.45	74LS295	98
74LS12	34	74LS148	1.30	74LS298	88
74LS13	44	74LS151	54	74LS299	1.70
74LS14	58	74LS153	54	74LS323	3.45
74LS15	34	74LS154	1.85	74LS324	1.70
74LS20	24	74LS155	68	74LS352	1.25
74LS21	28	74LS156	68	74LS353	1.25
74LS22	24	74LS157	64	74LS363	1.30
74LS26	28	74LS158	58	74LS364	1.90
74LS27	28	74LS160	68	74LS365	48
74LS28	34	74LS161	64	74LS366	48
74LS30	24	74LS162	68	74LS367	44
74LS32	28	74LS163	64	74LS368	44
74LS33	54	74LS164	68	74LS373	1.35
74LS37	34	74LS165	94	74LS374	1.35
74LS38	34	74LS166	1.90	74LS377	1.35
74LS40	24	74LS168	1.70	74LS378	1.13
74LS42	48	74LS169	1.70	74LS378	1.30
74LS47	74	74LS170	1.45	74LS385	1.85
74LS48	74	74LS173	68	74LS386	44
74LS49	74	74LS174	54	74LS390	1.15
74LS51	24	74LS175	54	74LS393	1.15
74LS54	28	74LS181	2.10	74LS395	1.15
74LS55	28	74LS189	8.90	74LS399	1.45
74LS63	1.20	74LS190	8.8	74LS424	2.90
74LS73	38	74LS191	8.8	74LS447	38
74LS74	34	74LS192	78	74LS490	1.90
74LS75	38	74LS193	78	74LS824	3.95
74LS76	38	74LS194	68	74LS840	2.15
74LS78	48	74LS195	68	74LS845	2.15
74LS83	59	74LS196	78	74LS868	1.65
74LS85	68	74LS197	78	74LS869	1.85
74LS86	38	74LS221	88	74LS870	1.45
74LS90	54	74LS240	94	74LS874	9.60
74LS91	88	74LS241	98	74LS882	3.15
74LS92	54	74LS242	98	74LS883	3.15
74LS93	54	74LS243	98	74LS884	3.15
74LS95	74	74LS244	1.25	74LS885	3.15
74LS96	88	74LS245	1.45	74LS888	2.35
74LS107	38	74LS247	74	74LS889	3.15
74LS109	38	74LS248	98	74LS763	23.95
74LS112	38	74LS249	98	81LS95	1.45
74LS113	38	74LS251	58	81LS97	1.45
74LS114	38	74LS253	58	81LS98	1.45
74LS122	44	74LS257	58	25LS252	1.75
74LS123	78	74LS258	58	25LS252	1.45
74LS124	2.85	74LS259	2.70	25LS259	4.20

We will try to BEAT  
All Competitor's Prices  
CALL for Quote!

## DISC CONTROLLERS

1691	6.90	2796	38.90
1771	14.90	2797	38.90
1791	22.90	6843	33.90
1793	22.90	8272	19.90
1795	22.90	M88876	22.90
1797	22.90	M88877	22.90
2143	6.90	MC3470	4.90
2791	38.90	UP0765	19.90
2793	38.90		

## CRT CONTROLLERS

6845	11.90	CRT5027	18.90
6847	10.90	CRT5037	28.90
68047	23.90	OP8350	38.90
68845	18.90	HO46505	11.90
7220	38.90	MC1372	6.90
8275	28.90	TMS9918A	36.90

## UV ERASERS

QUV-T8/1 \$49.95  
ECONOMY Model



- Erases 15 EPROMS in 20 minutes
- Plastic Enclosure

## 6500

6502	4.90	6502A	5.90
6504	6.90	6520A	5.90
6505	8.90	6522A	9.90
6507	9.90	6524A	10.90
6520	4.30	6545A	12.90
6522	4.90	6551A	10.90
6532	9.90		
6545	9.90		
6551	9.90	6502B	7.90

## 6800

6800	2.90	68800	9.90
6802	7.90	68802	11.90
6803	17.90	68809	11.90
6808	12.90	68809E	11.90
6809E	8.90	68810	5.90
6809	8.90	68821	5.90
6810	2.90	68840	18.90
6820	4.30	68845	18.90
6821	2.90	68850	5.90
6828	13.90		
6840	11.90		
6843	33.90		
6844	24.90		
6845	11.90		
6847	10.90	68000-8	34.90
6850	2.90	68047	23.90
6852	5.90	68488	18.90
6860	7.90	68652	14.90
6862	10.90	68661	8.90
6875	6.90	68764	17.95
6880	1.90	68766	19.95
6883	21.90		

## 8000

8031	14.90	8253	6.90
8035	5.90	8253-5	7.90
8039	5.90	8255	4.45
IMS-8060	16.90	8255-5	4.90
IMS-8073	29.90	8257	7.90
8080A	3.90	8257-5	8.90
8085	4.90	8259	5.90
8085A-2	11.90	8259-5	6.90
8086	24.90	8271	69.90
8087-3 (5 MHz)	159.90	8272	19.90
8087-2 (8 MHz)	279.90	8274	28.90
8088	19.90	8275	28.90
8089	59.90	8279	6.90
		8279-5	7.90
		8282	6.45
		8283	6.45
		8284	4.90
		8286	5.45
		8287	6.45
		8288	12.90
		8289	44.90
		8292	12.90

## 8100

8131	2.90		
8155	6.90		
8155-2	7.90		
8156	6.90		
8185	28.90		
8185-2	38.90		

## 8200

8202	23.90	8303	2.90
8203	38.90	8304	1.90
8205	2.90	8307	2.90
8212	1.75	8308	2.90
8214	3.75	8310	3.90
8216	1.75	8311	3.90
8224	2.20		
8226	1.75		
8228	3.45	8741	28.90
8237	12.90	8748	19.90
8237-5	14.90	8749	28.90
8238	4.45	8755	23.90
8243	4.45		
8250	9.90		
8251	3.90	80186-6	99.90
8251A	4.45	80188	89.90

## Z-80

Z80-CPU	1.95	Z80A-OMA	8.95
Z80-CTC	1.95	Z80A-PIO	2.45
Z80-OART	6.95	Z80A-SIO/0	9.95
Z80-OMA	7.95	Z80A-SIO/1	9.95
Z80-PIO	1.95	Z80A-SIO/2	9.95
Z80-SIO/0	8.95	Z80A-SIO/9	9.95
Z80-SIO/1	8.95		
Z80-SIO/2	8.95		
Z80-SIO/9	8.95		

## Z-80 A

Z80A-CPU	2.45	Z80B-OART	18.95
Z80A-CTC	2.45	Z80B-SIO/0	28.95
Z80A-OART	7.95	Z80-SIO/2	28.95

## MEMORY EXPANSION KIT



4164 200ns  
9 for \$15.75

## APPLE ACCESSORIES



CPU's & SUPPORT CHIPS		INTER FACE & DRIVERS	
Z80A CPU 2.50	8155-2	7.50	
Z800 CPU 8.00	8202	19.95	
Z80A CTC 2.75	8212	1.80	
Z80A DART 7.95	8214	4.50	
Z80A P10	8216	1.75	
Z80A S10	8224	4.00	
82C43	4.25	8226	3.50
AMD2901	8.95	8237	8.00
6502	4.75	8238	3.95
6800	2.50	8250	10.95
6802	4.50	8251	4.40
8803L	8.00	8253	6.00
6809	8.00	8255A	5.00
8810	4.00	8257	6.00
6821	2.75	8259	8.00
6845	6.00	8274	14.00
8850	3.25	8275	14.50
6875	4.50	8279.5	6.95
07220-1	12.00	8288	9.00
8035	5.50	8355	12.85
8080A	3.75	8748	20.00
8085A	4.75	TMS9927NL	9.95
8086	6.00	68000L8	36.00

SHIFT REGISTERS		DISC CONTROLLERS	
MM1402	1.75	D765C	10.00
MM1403	1.75	1771	5.95
MM1404	1.75	1791	5.95
MM5013	2.50	1791	14.00
MM5055	2.50		
MM5056	2.50		
MM5057	2.50		
MM5058	2.50		
MM5060	2.50		

RAM'S		NO. 30 WIRE WRAP WIRE SINGLE STRAND	
TPB18542	3.50	2111A	1.75
825126	1.95	2112-1	1.95
825130	1.95	2101A-4	1.90
825131	1.50	2111A	1.75
TPB285166	9.50	2112-1	1.95
825181	6.95	2112-2	1.95
745474	3.95	2101A-4	1.90
825194	3.75	2111A	1.75
2716 + 5V	3.75	2112-1	1.95
2732A	4.00	2112-2	1.95
3341A	4.50	2101A-4	1.90
3341A	2.95	2111A	1.75
3628A-3	3.00	2112-1	1.95
6331	1.95	2112-2	1.95
8256-5	1.25	2101A-4	1.90
AM9214C	2.95	2111A	1.75
21128	7.50	2112-1	1.95

LINEAR CIRCUITS			
DA008EQ	3.75	LM380	1.20
TL062CP	.95	LM384	1.60
TL064CN	1.60	LM386	1.00
TL072	1.25	LM397	1.25
TL082	.90	LM393	.75
TL084	1.50	LF398A	3.00
LM201	.75	LM555	.34
LM301/748	.35	LM556	.65
LM307	.45	558	.75
LM308	.35	554	2.50
LM310	1.10	565	.90
LM311	.60	566	1.25
LM318	1.25	567	.85
LM319	1.30	N592	.95
LM324	.55	709CH	.80
LM339	.90	LM710	.60
LM348	.90	733	.95
LF351	.60	741CV	.35
LF353	.90	747	.50
LF355	.90	CA758	1.75
LF356	1.00	LM798CT	.80
LM358	.65	DA008EQ	2.95
LM370	1.60		

TOGGLE SWITCHES		DIP SWITCHES	
IN4148 (IN914)	15/1.00	CTS 206-4	4 POSITION .75
1411-IR DETECTOR	3/1.00	CTS 206-7	7 POSITION .95
FP 100 PHOTO TRANS	.50	CTS 206-8	8 POSITION .95
RED LED'S 2"	8/1.00	CTS 206-10	10 POSITION 1.25
YEL. GREEN or AMBER LARGE LED'S 2"	6/1.00		
RED-GREEN BIPOLAR LED	.50		
RED-YELLOW BIPOLAR LED	.50		
MALED BIPOLAR LED	.40		
MRT148 PHOTO DARL. XTOR	.60		
MCT2 OPTO ISOLATORS	.60		
1 WATT ZENERS: 3.3, 4.7, 5.1, 5.6, 6.8, 8.2, 9.1, 10, 12, 15, 18, or 22V	6/1.00		

WIRE WRAP SOCKETS		20KV DIODES	
14 PIN	.45	250 ma.	\$1.95
16 PIN	.50		
18 PIN	.65		
20 PIN	.90		
24 PIN	1.10		
28 PIN	1.25		
40 PIN	1.80		

DB CONNECTORS	
DB9P	\$.20
DB9S	\$.30
HOODS	\$1.10

EPOXY GLASS VECTOR BOARD			
1/16" thick with 1/10" spacing			
4 1/2" x 6 1/2" ..... \$2.40			
SCR's			
1.5A	6A	35A	110A
100	35	40	140
200	40	50	180
400	60	70	240
600	80	100	360
800	100	120	480

TRIAC's			
PRV 1A	10A	25A	
100	35	60	140
200	50	80	190
400	70	100	260
600	100	120	360

C/MOS			
74C00	.35	74C915	1.10
74C02	.35	74C921	3.50
74C04	.35	4001	.25
74C10	.35	4002	.25
74C14	.55	4006	.85
74C20	.35	4007	.30
74C22	.35	4008	.40
74C24	1.20	4009	.40
74C74	.80	4010	.45
74C76	.60	4011	.30
74C83	1.20	4012	.30
74C85	1.25	4013	.40
74C86	.40	4014	.75
74C93	1.00	4015	.35
74C154	3.00	4016	.35
74C157	1.10	4017	.75
74C161	1.10	4018	.75
74C174	1.15	4025	.40
74C175	1.10	4020	.75
74C192	1.40	4021	.75
74C193	1.40	4022	.75
74C245	1.75	4023	.28
74C901	.40	4024	.65
74C903	.80	4025	.30
74C907	.90	4026	1.25

74S SERIES			
74S00	.30	74S74	.50
74S02	.35	74S85	1.25
74S03	.35	74S86	.50
74S04	.35	74S89	2.00
74S05	.35	74S112	.50
74S08	.35	74S113	.90
74S09	.45	74S124	2.20
74S10	.35	74S133	.45
74S11	.35	74S135	.85
74S15	.35	74S138	.80
74S20	.35	74S139	.80
74S32	.40	74S153	.95
74S40	.40	74S157	.90
74S42	.85	74S158	.90
74S51	.35	74S161	1.75

DISC CAPACITORS			
1UF 16V	10/\$1.00		
01UF 16V	16/\$1.00		

FULL WAVE BRIDGE			
PRV	2A	6A	25A
100	.80	1.30	2.20
200	1.00	1.65	3.30
400	1.30	1.90	4.40

SILICON POWER RECTIFIERS			
PRV	1A	3A	12A
100	.06	.17	.50
200	.09	.25	.85
300	.11	.30	1.00
600	.13	.35	1.00
1000	.20	.45	1.25

REGULATORS			
78L05 or 12	\$.30	LM338K	\$.75
LM305G	\$.75	340T 5, 6, 8, 9, 12	\$.75
LM317T	\$.10	15, 18 or 24V	\$.75
320T 5, 12, 15 or 24	\$.85	723	\$.50
328M 12 or 15	\$.40	LAS1412	\$.40
329K (LA1405)	\$.15	+12V3A	\$.35

TANTALUM CAPACITORS			
22UF 35V	5/\$1.00	15UF 16V	3/\$1.00
47UF 35V	5/\$1.00	30UF 6V	5/\$1.00
68UF 35V	5/\$1.00	33UF 15V	\$.50
10UF 20V	5/\$1.00	47UF 20V	\$.85
2.2UF 20V	5/\$1.00	68UF 16V	\$.10
3.3UF 20V	4/\$1.00	200UF 20V	\$.15
4.7UF 35V	4/\$1.00	150UF 16V	\$.13
6.8UF 20V	4/\$1.00	330UF 10V	\$.15
10UF 20V	\$.40		
22UF 10V	\$.30		

TRANSISTOR SPECIALS			
TIP 318 NPN Si TO-220	\$.40		
TIP 328 PNP Si TO-220	\$.40		
TIP 34 PNP Si	\$.50		
TIP 121 PNP Si U64	\$.60		
TIP 141 NPN Si U97	\$.10		
TIP 145	\$.15		
BU205	\$.15		
2N404A PNP GE TO-5	3/\$1.00		
2N1307 PNP GE TO-5	\$.40		
2N4003 - DUAL POWER DARL	3/\$1.00		
2N2222 NPN Si TO-18	7/\$1.00		
2N2907 PNP Si TO-18	7/\$1.00		
TIP 2955 PNP Si	\$.70		
2N4035 PNP Si TO-3	\$.60		
MJE3055T	\$.60		
2N3904 NPN Si TO-92	7/\$1.00		
2N3906 PNP Si TO-92	7/\$1.00		
2N4060 PNP Si TO-18	3/\$1.00		
2N6109 PNP Si TO-220	\$.55		
2N1309A 400V NPN	\$.10		
MRF-8504 CM FET TRANSISTOR NPN S	.75		
HEF8014 - PNP GE TO-3	\$.85		

TTL IC SERIES			
7400	.20	7480	.45
7401	.20	7483	.50
7402	.20	7485	.55
7403	.20	7486	.35
7404	.20	7489	1.90
7405	.25	7490	.55
7406	.27	7491	.50
7407	.27	7492	.50
7408	.25	7493	.35
7409	.20	7494	.60
7410	.20	7495	.55
7411	.25	7496	.60
7412	.25	74107	.30
7413	.35	74116	1.20
7414	.45	74121	.30
7416	.25	74122	.45
7417	.25	74123	.45
7420	.20	74125	.45
7425	.27	74126	.45
7426	.30	74145	.60
7427	.27	74147	1.20
7430	.20	74148	1.20
7432	.27	74150	1.35
7437	.27	74151	.55
7438	.29	74153	.55
7440	.25	74154	.55
7442	.45	74155	.75
7445	.65	74157	.55
7447	.70	74158	.50
7448	.70	74160	.65
7450	.20	74161	.65
7472	.35	74162	.65
7473	.35	74163	.65
7474	.32	74164	.85
7475	.45	74165	.85
7476	.35		

74LS SERIES			
74LS00	.32	74LS107	.35
74LS01	.25	74LS109	.35
74LS02	.25	74LS112	.35
74LS03	.25	74LS113	.35
74LS04	.25	74LS114	.35
74LS05	.25	74LS123	.75
74LS08	.25	74LS125	.45
74LS10	.25	74LS126	.45
74LS11	.25	74LS132	.55
74LS11	.30	74LS136	.35
74LS12	.30	74LS137	.90
74LS13	.40	74LS138	.50
74LS14	.50	74LS139	.35
74LS15	.30	74LS141	2.20
74LS20	.25	74LS145	.55
74LS21	.25	74LS153	.55
74LS22	.25	74LS155	.55
74LS26	.25	74LS156	.65
74LS27	.25	74LS157	.65
74LS28	.30	74LS160	.65
74LS30	.25	74LS161	.65
74LS32	.25	74LS162	.70
74LS37	.35	74LS163	.65
74LS38	.35	74LS164	.65
74LS40	.30	74LS165	.65
74LS42	.30	74LS166	.75
74LS47	.75	74LS169	1.50
74LS48	.75	74LS170	1.30
74LS51	.30	74LS173	.65
74LS54	.30	74LS174	.50
74LS73	.35	74LS175	.50
74LS74	.35	74LS181	2.00
74LS75	.35	74LS190	.90
74LS76	.35	74LS191	.80
74LS83	.60	74LS192	.75
74LS85	.60	74LS193	.75
74LS86	.35	74LS194	.65
74LS90	.55	74LS195	.65
74LS92	.55	74LS196	.65
74LS93	.55	74LS197	.65
74LS95	.75	74LS221	.80
74LS96	.85	74LS240	.95



# TENMA

## the Name You Can Trust in Electronic Test Equipment

### CALL TOLL FREE 1-800-543-4330

(IN OHIO 1-800-762-4315)

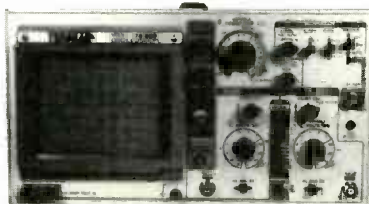
(IN HAWAII OR ALASKA 1-800-858-1849)



#### TENMA DROP PROOF DIGITAL MULTIMETER

- DC input impedance 10M ohm
- Shock-mounted LCD display
- Overload protection ■ Auto polarity ■ Backed by our 1-year limited warranty ■ For more specifications see MCM catalog #10, page 122

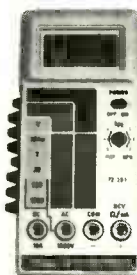
#72-057 **\$2995**  
each



#### TENMA 20 MHz DUAL TRACE OSCILLOSCOPE

- Two High Quality 10:1 probes included
- Backed by our 2-year limited warranty
- For specifications see MCM catalog #10, page 121

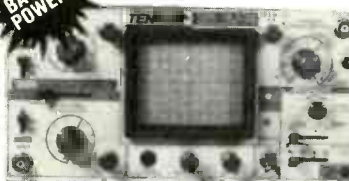
#72-320 **\$38995**



#### TENMA 3 1/2 DIGIT LCD MULTIMETER

- DC input impedance 10M ohm
- Diode and HFE transistor tests
- Overload protection ■ Auto polarity ■ Backed by our 1-year limited warranty ■ For more specifications see MCM catalog #10, page 122.

#72-050 **\$3680**  
\$39.80 (1-9) (10-up)



#### TENMA 15 MHz DUAL TRACE BATTERY POWERED OSCILLOSCOPE

- Two High Quality 10:1 Probes included
- Backed by our 2-year limited warranty
- Internal rechargeable batteries provide 2 hours of continuous operation without the need for any outside power source. ■ For specifications see MCM Catalog #10, page 121

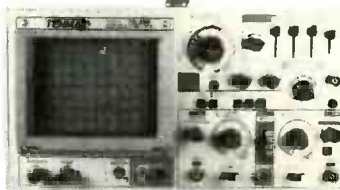
#72-335 **\$48995**



#### TENMA DIGITAL CAPACITANCE METER

- Measures capacitors from 0.1pF to 1999mFd ■ Accuracy 0.5% typical ■ Fuse protected
- Checks capacitors in and out of circuit ■ Backed by our 1-year limited warranty ■ For more specifications see MCM catalog #10, page 122

#72-040 **\$5495**  
\$59.80 each (2-up)



#### TENMA 35 MHz DUAL TRACE OSCILLOSCOPE

- Two High Quality 10:1 probes included
- Backed by our 2-year limited warranty
- For specifications see MCM catalog #10, page 121

#72-330 **\$56900**

#### TENMA LOGIC PROBE WITH MEMORY



- Recognizes high, intermediate, or low levels, pulsing modes, open circuit
- Compatible with DTL/TTL/HTL/CMOS IC
- Detects pulses as short as 50 nanoseconds

#72-190 **\$1995**  
each

#### TENMA 30 Amp Power Supply



- Cross needle meter: Displays voltage, current, and power simultaneously
- Over current protection
- Output voltage: DC 9-15V variable
- Output current

- 30A one minute on three minutes off, 22A continuous
- Backed by our 2-year limited warranty ■ For specifications see MCM Catalog #10, page 123

#72-030 **\$17995**

**BE SURE TO CALL  
FOR YOUR FREE  
132  
PAGE  
CATALOG!  
OVER  
5,000  
ITEMS!**



We have the Largest  
Selection of Original  
Japanese Semiconductors  
in the Country!

**We Also Have** a full line of test equipment, computer accessories, telephone accessories, speakers, television parts, flybacks, yokes, switches, fuses, lamps, capacitors, resistors, cartridges, styli, wire, CATV equipment, and many more. **Over 5,000 items AT THE LOWEST PRICES AROUND!**

#### Terms:



- \$10 minimum order \$1.00 charge for orders under \$10
- \$20 minimum charge card order.
- Orders shipped UPS C.O.D.
- Most orders shipped within 24 hours.
- Sales office open 8:30 am to 7:00 pm. Saturdays 10:00 am to 3 pm. EST
- For prepaid orders add \$2.75 for shipping and handling
- Should shipping & handling charges exceed \$2.75, the balance due will be sent C.O.D.



**MCM ELECTRONICS**  
A DIVISION OF PREMIER INDUSTRIAL  
858 East Congress Park Drive  
Centerville, Ohio 45459  
513-434-0031

SOURCE NO. RE-14

CIRCLE 87 ON FREE INFORMATION CARD

# 100% GUARANTEED ICs - MONEY BACK!

## 1-800-245-2235

### SPECIAL 64K DRAM .45

FULLY FUNCTIONAL  
WITH SLIGHTLY  
SHORTER LEADS  
200ns or FASTER

That's right! . . . 100% money-back guaranteed ICs at prices never before possible! Krueger Technology's unique patented IC removal process is the key to our ability to sell so low. The fact is, it costs less to retrieve and refurbish an IC from an obsolete PC board than manufacture a new one. Since we maintain an inventory in excess of six million ICs and process over 100,000 ICs per day (over thirty million in the past ten years) we can supply you with most, if not all of your IC needs.

Until this year our vast inventory of ICs was available to only manufacturers and distributors. The phenomenal growth of the catalog market has allowed us to open our inventory to you. You can now buy direct and cut out all middlemen.

Call today and discover what seven of the ten largest computer manufacturers already know . . . "The Krueger Alternative". Don't forget, you get an additional 30% discount on orders over \$500!

### SPECIALS

2114-300ns	.50
FDC1793	5.00
74LS322	.50
6116-120ns	1.75
8080A	.75
Z80ASIO/O	3.75

#### MICROPROCESSORS

2901	3.00	8039	2.00
2903	5.00	8080A	.75
68000-8	18.00	8085	2.00
68008-8	18.00	8086	4.00
Z8001	7.50	8086-2	5.00
80186-3	15.00	8088	7.50
8031	5.00	8X300	6.00
8035	2.00	8741A	10.00

#### ADC/DAC

ADC08XX	3.50
DAC08XX	1.50
DAC80	8.00

#### CONTROLLERS/UARTS

1691	5.25	2661	4.00
1771	6.50	5027	3.00
1791	10.00	5037	5.00
1793	5.00	7201	4.50
1795	10.00	765	4.00
1797	10.00	COM8116	5.00
2651	4.00	3250	4.00

#### SOUND CHIPS

76477	2.00
AY3-8910	2.00
AY3-8912	2.00

#### 82XX PERIPHERALS

8202	14.00	8259	2.00
8212	1.00	8272	4.00
8216	1.00	8273	10.00
8224	3.00	8274	9.00
8228	3.00	8275	9.00
8237	3.00	8276	15.00
8238	2.50	8279	3.50
8243	1.50	8281	7.50
8251	2.00	8283	5.50
8253	2.00	8284	2.00
8254	4.00	8288	4.00
8255	2.00	8291	20.00
8257	2.00	8292	21.00

#### TMS 9900 SERIES

9901	1.50
9918	20.00
9927	5.00
9980	10.00
ALL OTHER 99XX SERIES	3.00

#### DYNAMIC RAMS

4164-120ns	1.75
4164-150ns	.95
4164-200ns	.85
4164-250ns	.65
4416-150ns	1.50
4116-150ns	.75
4116-200ns	.35
4116-250ns	.25

#### STATIC RAMS

6264-150ns	6.00
6116-150ns	1.25
6116-200ns	.90
6116-250ns	.65
1420-55ns	2.00
2147, 2148, 2149	2.00
2114-300ns	.50
2114-FASTER	.80

## 1-800-245-2235

#### EPROMS

27128-250ns	5.00
27128-350ns	4.00
27128-450ns	3.00
2764, 2732, 2716	
250ns	3.50
300ns	3.00
350ns	2.75
450ns	2.25
650ns	1.75
1702	1.50
2708	2.00
68766	6.00
68708	4.00

CMOS version at double the above prices

25 Series EPROMS are the same price as 27 Series EPROMS

#### ECL

ANY 10K LOGIC	1.00
ANY ECL RAM	3.00
ANY 100K LOGIC	5.00

#### Z80 SERIES

2.5 MHZ	
CPU, CTC, PIO	1.00
DMA, DART, SIO	3.00
4.0 MHZ (A)	
CPU, CTC, PIO	2.00
DMA, DART, SIO	4.50
6.0 MHZ (B)	
CPU, CTC, PIO	3.00
DMA, DART, SIO	9.00

#### MISCELLANEOUS

0026	1.50
1488	.50
1489	.50
3232	1.00
3242	4.00
3470	1.50
3486	1.00
3487	1.50
CA3XXX	1.00
MC4024	2.00
MC4044	2.00
555	.35
75XXX	.50
8131	2.25
8136	4.00
8303	3.00
8304	1.75
88XX	.50
8TXX	.50
9602	.75
96LS02	1.50

#### 74 SERIES

74XX	.25	74SXX	.35
741XX	.35	74S1XX	.45
742XX	.50	74S2XX	.60
743XX	.50	74S3XX	.60

74LSXX	.25	74ALSXX	.35
74LS1XX	.35	74ALS1XX	.45
74LS2XX	.50	74ALS2XX	.60
74LS3XX	.50	74ALS3XX	.60

74FXX	.35
74F1XX	.45
74F2XX	.60
74F3XX	.60

#### CMOS

ANY 4000 SERIES	.25
ANY 4500 SERIES	.50

#### 6500/6800 SERIES

ANY 65XX	2.00
ANY 65XXA	2.50
ANY 65XXB	3.00
ANY 68XX	2.00
ANY 68AXX	2.50
ANY 68BXX	3.00
6810	.75

#### OUR POLICY

Delivery: Orders normally shipped within 2 business days. Add \$3 for UPS ground-5# & under. Add \$4 for UPS blue (air), 2# & under; for each additional air pound add \$1. Arizona residents add 6% sales tax.

Payment: Visa, MC, cashiers check, certified check, money order, personal check accepted. (Allow 10 days for personal checks to clear.) No surcharge on credit card orders. CODs welcome with cash, certified check, cashiers check or money order. Add \$3 COD handling charge.

Pricing: Prices subject to change without notice. All items limited to stock on hand. We reserve the right to limit quantities.

# KRUEGER Technology, Inc.

2219 South 48th Street • Tempe, AZ 85282

## 800-245-2235

In Arizona 602-438-1570

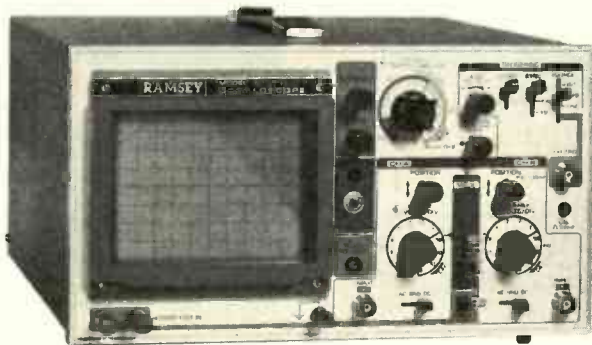
HOURS: 7a.m.-5:30p.m.  
(MOUNTAIN TIME)  
Monday Thru Friday





# RAMSEY

# THE FIRST NAME IN ELECTRONIC TEST GEAR



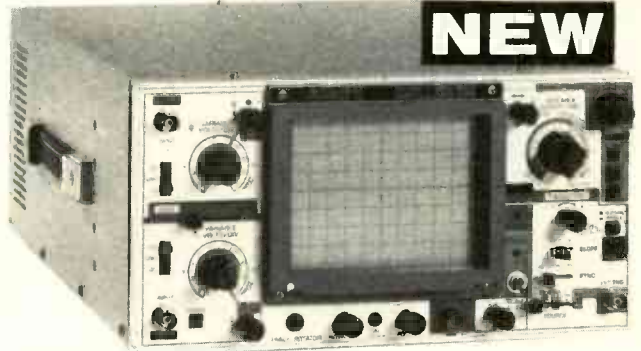
## 20 MHz DUAL TRACE OSCILLOSCOPE

Unsurpassed quality at an unbeatable price, the Ramsey oscilloscope compares to others costing hundreds more. Features include a component testing circuit for resistor, capacitor, digital circuit and diode testing • TV video sync filter • wide bandwidth & high sensitivity • internal graticule • front panel trace rotator • Z axis • high sensitivity x-y mode • regulated power supply • built-in calibrator • rock solid triggering

\*USA—Add \$10.00 per unit for postage, overseas orders add 15% of total order for insured surface mail.

**\$399<sup>95</sup>\***

high quality hook on probes included



**NEW**

## 45 MHz DUAL SWEEP OSCILLOSCOPE

The Ramsey 625 is a dual time base, delayed sweep unit that includes a built-in signal delay line to permit clear viewing during very short rise times of high frequency waveforms. Other features include: variable trigger holdoff • 20 calibrated sweep time ranges from 0.5 s/div to 0.2 µs/div • fully adjustable sweep time • X5 sweep magnification • five trigger sources; CH1, CH2, LINE EXTERNAL and INTERNAL (V mode) • front panel x-y operation, Z axis input • sum difference of CH1, and CH2 waveforms displayed as single trace • sweep gate and sweep output • auto focus • single sweep

\*Same as unit to left.

**\$799<sup>95</sup>\***

high quality hook on probes included



## RAMSEY D-1100 VOM MULTITESTER

Compact and reliable, designed to service a wide variety of equipment. Features include • mirror back scale • double-jeweled precision moving coil • double overload protection • an ideal low cost unit for the beginner or as a spare back-up unit.

**\$19<sup>95</sup>** test leads and battery included



## NEW RAMSEY 1200 VOM MULTITESTER

Check transistors, diodes and LEDs with this professional quality meter. Other features include: decibel scale • 20K volt metering system • 3 1/2" mirrored scale • polarity switch • 20 measuring ranges • safety probes • high impact plastic case

**\$24<sup>95</sup>** test leads and battery included



## RAMSEY D-3100 DIGITAL MULTIMETER

Reliable, accurate digital measurements at an amazingly low cost • in-line color coded push buttons, speeds range selection • abs plastic tilt stand • recessed input jacks • overload protection, on all ranges • 3 1/2 digit LCD display with auto zero, auto polarity & low BAT. indicator

**\$49<sup>95</sup>** test leads and battery included



## CT-70 7 DIGIT 525 MHz COUNTER

Lab quality at a breakthrough price. Features • 3 frequency ranges each with pre amp • dual selectable gate times • gate activity indicator • 50mV @ 150 MHz typical sensitivity • wide frequency range • 1 ppm accuracy

**\$119<sup>95</sup>** wired includes AC adapter

CT-70 kit ..... \$99.95  
BP-4 nicad pack ..... 8.95



## CT-90 9 DIGIT 600 MHz COUNTER

The most versatile for less than \$300. Features 3 selectable gate times • 9 digits • gate indicator • display hold • 25mV @ 150 MHz typical sensitivity • 10 MHz timebase for WWW calibration • 1 ppm accuracy

**\$149<sup>95</sup>** wired includes AC adapter

CT-90 kit ..... \$129.95  
OV-1 0.1 PPM oven timebase ..... 59.95  
BP-4 nicad pack ..... 8.95



## CT-125 9 DIGIT 1.2 GHz COUNTER

A 9 digit counter that will outperform units costing hundreds more. • gate indicator • 24mV @ 150 MHz typical sensitivity • 9 digit display • 1 ppm accuracy • display hold • dual inputs with preamps

**\$169<sup>95</sup>** wired includes AC adapter

BP-4 nicad pack ..... 8.95



## CT-50 8 DIGIT 600 MHz COUNTER

A versatile lab bench counter with optional receive frequency adapter, which turns the CT-50 into a digital readout for most any receiver.

**\$169<sup>95</sup>** wired

CT-50 kit ..... \$139.95  
RA-1 receiver adapter kit ..... 14.95



## DM-700 DIGITAL MULTIMETER

Professional quality at a hobbyist price. Features include 26 different ranges and 5 functions • 3 1/2 digit 1/2 inch LED display • automatic decimal placement • automatic polarity

**\$119<sup>95</sup>** wired includes AC adapter

DM-700 kit ..... \$99.95  
MP-1 probe set ..... 4.95



## PS-2 AUDIO MULTIPLIER

The PS-2 is handy for high resolution audio resolution measurements, multiplies UP in frequency • great for PL-tone measurements • multiplies by 10 or 100 • 0.01 Hz resolution & built-in signal preamp/conditioner

**\$49<sup>95</sup>** wired

PS-2 kit ..... \$39.95



## PR-2 COUNTER PREAMP

The PR-2 is ideal for measuring weak signals from 10 to 1,000 MHz • flat 25 db gain • BNC connectors • great for shifting RF • ideal receiver/TV preamp

**\$44<sup>95</sup>** wired includes AC adapter

PR-2 kit ..... \$34.95



## PS-1B 600 MHz PRESCALER

Extends the range of your present counter to 600 MHz • 2 stage preamp • divide by 10 circuitry • sensitivity: 25mV @ 150 MHz • BNC connectors • drives any counter

**\$59<sup>95</sup>** wired includes AC adapter

PS-1B kit ..... \$49.95

## ACCESSORIES FOR RAMSEY COUNTERS

Telescopic whip antenna—BNC plug ..... \$ 8.95  
High impedance probe, light loading ..... 16.95  
Low pass probe, audio use ..... 16.95  
Direct probe, general purpose use ..... 13.95  
Tilt bail, for CT-70, 90, 125 ..... 3.95



PHONE ORDERS CALL  
**716-586-3950**  
TELEX 466735 RAMSEY CI

TERMS: • satisfaction guaranteed • examine for 10 days; if not pleased, return in original form for refund • add 6% for shipping and insurance to a maximum of \$10.00 • overseas add 15% for surface mail • CDD add \$2.50 (CDD in USA only) • orders under \$15.00 add \$1.50 • NY residents add 7% sales tax • 90 day parts warranty on all kits • 1 year parts & labor warranty on all wired units.



**RAMSEY ELECTRONICS, INC.**  
2575 Baird Rd.  
Penfield, N.Y. 14626

CIRCLE 70 ON FREE INFORMATION CARD

www.americanradiohistory.com

OCTOBER 1985

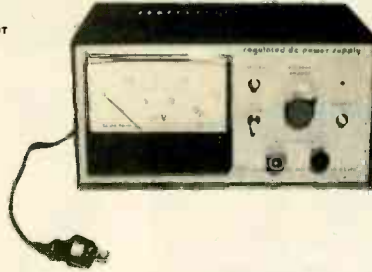
THE MOST POPULAR KITS IN EUROPE & ASIA ARE COMING NOW! 50 HOT ITEMS FOR YOUR SELECTION. SEND \$1.00 FOR MARK V CATALOG, REFUND UPON ORDER

TY-47 SUPERIOR ELECTRONIC ROULETTE



This roulette employs three CMOS IC to drive thirty-six LEDs. It includes sound effect circuit and automatic power on/off switch. Its feature can be comparable to real Roulette. It is simple in construction and easy to build.  
\* Deluxe colour face panel is free of charge.  
Kit..... \$16.92

TR-100 0-15V 2 AMP. REGULATED POWER SUPPLY KIT



This is a professional power supply kit. Output voltage adjustable from 0-15VDC. Output current also can be limited to two range sections such as 200mA and 2A. An elaborated protection system also designed to give out a beeping sound and a flashing LED warning will appear when output was over loaded or short circuited. High stability and reliability resulting from employing a high quality voltage regulator IC. The front panel of the power supply is well designed with output terminals, on/off switch, voltage adjusting control, jumbo size meter for reading both AMPs and VOLTS. Also with a volt/amp switch as well as current limit select switch. Kit comes with rained metal case, silver color with sand brushed front panel, all electronic parts, p.c. board, 3" jumbo size meter transformer, circuit diagram and instructions. \$59.50 Assembled with tested..... \$69.50

TY-238 COLOR LIGHT CONTROLLER



As a result of the advanced technology, this unit can control various colorful light bulbs, the visual effect of which is most suitable in places like at home party, disco, electronic game centre and also in lightings for advertisement. Total output power is 3000W (1000W/Ch) which means that it can control 30 pieces of 100W or 600 pieces of 5W color light which is enough for most usages.

**FEATURE:**  
(1) "Music" mode. Audio signal is divided into high, middle and low frequency to drive 3 groups of light, it has separate sensitive controller.  
(2) "Chasing" mode. Electronic circuit automatically controls 3 groups of color light in sequential ON and OFF; also it has a speed controller. Build one of these light controller today and enjoy watching your music. Great for school projects! All electronic parts, metal case, pre-drilled p.c. board and instructions are come with the kit.  
Kit..... \$65.00 Assembled with tested..... \$75.00

SM-100 150MC UNIVERSAL DIGITAL FREQUENCY COUNTER



SM-100 is an accurate, easy operated digital frequency counter. Few pieces of advanced, high technical LSI integrated circuit are used, thus, circuit structure is reliable. SM-100 can give you up to 8 digits of resolution for a wide frequency range of 10Hz to 150MHz. Besides, a memorize system is available, the last input digits can be held on the panel, as compare to the other or even observation.  
Input sensitivity: KHz range 10Hz - 10MHz 50mVrms  
MHz range 1MHz - 150MHz 40mVrms  
Response time: 0.2 sec  
Hold: Hold the last input signal  
Power supply: DCEV Battery or DCEV 250MA Adaptor  
Assembled with tested..... \$99.00

SM-48 4x HI-PRECISION D. P. M.



\* 4x digit, each with a large red LED indication of 0-6  
Auto-flash whenever it is overloaded.  
\* Range: DC current  $\pm 1\mu A - \pm 20A$   
DC voltage  $\pm 1mV - \pm 2000V$   
\* Stability: DC  $\pm 0.025\% \pm 2$  digit  
\* Power supply: DC 5 - 5V 200mA  
\* Size: 4 5/16" (W) x 3 1/4" (D) x 1 3/4" (H)  
\* Various functions are available: output terminal of BCD, BUSY, STROBE etc., which are suitable for working with microcomputer.  
\* Temperature Compensated Regulator of 100ppm/°C is employed as to upset this unit's stability.  
\* The memory system can hold the latest reading, for the convenience of comparison and observation.  
Kit..... \$38.00 Assembled with tested..... \$43.00

TA-2400A ELECTRONIC ECHO AND REVERBERATION AMPLIFIER



This unit combines the most advanced computer V.L.S.I. technique with high quality Japan made component, so it has the following FEATURES:  
It can generate various reflection and reverberation effect such as that in valley and music hall. It has a 3 section effect control which includes reverberation control, delay control and depth control.  
All kinds of in-hall sound effect can be obtained by skilful use of this control. It has LED display to show reflection and reverberation.  
Assembled with tested..... \$99.85

TA-2500 HIGH QUALITY MULTIPURPOSE PRE-AMPLIFIER



This specially designed pre-amplifier includes a professional GRAPH EQUALIZER TONE control system and has a gain of  $\pm 12dB$ . Frequency response extends from 5Hz to 20KHz, so even in bad listening condition it can improve well. It can accept input from various magnetic cartridge, record disk and tuner; its output can be connected to all kinds of power amplifier.  
Assembled with tested..... \$90.00

TA-3000 STEREO SIMULATOR



You can own a STEREO TV from today! This simulator is a special design of using the most advanceable mono-polymer L.S.I. It produces a superior analog stereo effect since the L.S.I. is equalled to 60 pcs of LOW NOISE FET & TRANSISTOR. The simulator can even help you to promote your television from a normal one to a special one with a Hi-Fi STEREO function. Our simulator is also applicable to any other "mono source" in converting it to ANALOG STEREO. Undoubtedly, it is the most advanced equipment for every family, while it should contribute to your listening pleasure.

**Specifications:**  
Frequency Response: 10Hz-30KHz  
Signal-to-noise ratio: 60dB (I.L.H.C.) 56dB (R.H.C.)  
Distortion (both ch.): 0.1%  
Input Sources: High Input Impedance: AM tuner, Mono cassette, Low Impedance: Radio, TV, VCR  
Power Consumption: 6VA 110V  
Assembled with tested..... \$30.00

WE CAN SUPPLY METAL CABINETS AND POWER TRANSFORMERS FOR OUR KITS! PLEASE REFER TO OUR CATALOG.

TA-323A HIGH QUALITY 30W + 30W STEREO AMPLIFIER



This amplifier employs newly designed symmetrical output circuit which uses high efficiency Darlingon transistor, so it has good efficiency and excellent characteristic. The driver transistor will never overheat. It is easy to build and no alignment is required.

**Specifications:**  
Power Output: 30W + 30W (8 ohm)  
Total Harmonic distortion: Less than 0.1% between 100Hz & 10KHz.

Pre-amplifier Input Sensitivity: 3mV at 47K RIAA or Mic. Equalised  
130mV at 47K TAPE, TUNER

S/N Ratio: 80dB  
Output Impedance: 4-8 ohm  
Power Voltage: DC 30-50V  
AV 22 35V x 2 3A  
Kit..... \$24.50

The Best Kit for Hi-Fi Beginner!

TA-802 80W + 80W PURE DC STEREO POWER AMPLIFIER



\* This power amplifier employs pure DC mirror circuit and several current stabilizers, so it has high stability. No AC bypass capacitor is included in feedback network, so frequency response is extended to DC and there is no phase distortion, it can reproduce high level bass faithfully.  
\* It uses FET differential input to improve S/N ratio and input impedance.  
\* It is compatible with all kinds of preamplifier.  
\* It has a multipurpose protection system, including high sensitive DC output protection circuit, high speed output short-circuit, overload protection, and an automatic temperature control system, it can protect the loudspeakers and amplifier against damage.  
Kit..... \$39.95

TA-2800 LOW TIM DC STEREO PRE-AMP KIT



Incorporates brand new DC design that gives a frequency response from 0-100KHz  $\pm 0.5dB$ . Added features like tone deflex and loudness control let you tailor your own frequency supplies to eliminate power fluctuations!

**Specifications:**  
\* THD/TIM less than 0.05%  
\* Frequency response DC to 100KHz  $\pm 5dB$   
\* RIAA deviation  $\pm 0.7dB$   
\* S/N ratio better than 70dB  
\* Sensitivity: phone 2mV 47K $\Omega$ , Aux 100mV 100K $\Omega$   
\* Output Level 1.3V  
\* Max output 15V  
\* Tone controls: Bass  $\pm 10dB$  @ 50Hz  
Trebble  $\pm 10dB$  @ 15Hz  
\* Power supply:  $\pm 24VDC$  @ 0.5A  
It is compatible with any power amplifier which made by our company such as TA-802, TA-477, TA-1000A.  
Kit..... \$44.90

TY-45 20 STEPS BAR/DOT AUDIO LEVEL DISPLAY KIT



This new designed audio level display unit is using a new integrated circuit from National Semiconductor to drive 20 pieces of color LED's (green, yellow and red) on each channel. It provides two types of display methods for selection 'bar' or 'dot'. The display range is from 52dB to 0dB. Kit is good for any amplifier from 2 watts to 200W! Power supply requires 12VAC or DC. So, it is great for cars as well! Kit comes with printed circuit board, all LED's electronic components, switches and silk screen printed professional front panel.  
Kit..... \$34.95

TERMS:

Min order: \$10.00  
Charge card order: \$20.00  
NO C. O. D. ! Cashier's check, phone orders accept.  
Calif. Res Add 6.5% Sales Tax.  
Prices are subject to change without notice.

All merchandises are subject to prior sale.  
Shipping & Handling: Inside L. A. 5% of total order, (Min 1.50). Outside L. A. 10% of total order, (Min 2.50). Outside U.S.A. 20% of total order, (Min 5.00).



MARK V ELECTRONICS INC.  
248E. Main Street,  
Suite 100,  
Alhambra, CA91801  
For information (818) 282-1130  
For orders, (818) 282-1196



**★ QUALITY PARTS**      **★ DISCOUNT PRICES**      **★ FAST SHIPPING!**

SEND FOR  
**FREE**  
FALL 1985 CATALOG...  
**48 PAGES!**

# ALL ELECTRONICS CORP.

## EDGE CONNECTORS

ALL ARE 1.56" SPACING.



22/44 EDGE CONNECTOR  
PC style \$2.00 each  
10 for \$18.00

22/44 EDGE CONNECTOR  
solder lug \$2.50 each  
style

28/56 EDGE CONNECTOR  
PC style \$2.50 each  
10 for \$22.00

36/72 EDGE CONNECTOR  
PC style \$3.00 each

43/86 EDGE CONNECTOR  
PC style \$4.50 each

## TRANSISTORS

2N706	4 for \$1.00
2N2222A	3 for \$1.00
PN2222A	4 for \$1.00
2N2904	3 for \$1.00
2N2905	3 for \$1.00
MJ2955	\$1.50
2N3055	\$1.00
PMD 10K40	\$1.00
TIP 121	75¢
TIP 125	75¢

## TRANSFORMERS

120 volt primaries

5.6 volts @ 750 ma.	\$3.00
6 volts @ 150 ma.	\$1.25
12 v.c.t. @ 200 ma.	\$2.00
18 volts @ 650 ma.	\$3.50
18 volts @ 1 amp	\$4.50
24 v.c.t. @ 200 ma.	\$2.50
24 v.c.t. @ 400 ma.	\$3.50
28 v.c.t. @ 15 amps	\$20.00
30 v.c.t. @ 2 amps	\$5.00

## WALL TRANSFORMERS

all plug directly into 120 vac outlet

4 VDC @ 70 ma.	\$2.00
6 VAC @ 500 ma.	\$3.50
12 v.c.t. @ 200 ma.	\$2.00
6 VDC @ 750 ma.	\$6.50
9 VDC @ 500 ma.	\$5.00
12.5 VAC @ 265 ma.	\$3.00
24 VAC @ 250 ma.	\$3.00
MULTI-VOLTAGE @ 500 ma.	\$3.00
3.4, 2, 6, 7, 9 or 12 VDC	\$7.50

## MINI-BOX

Pomona #2104

Heavy-duty black phenolic project box with cover and screws. 2 3/8" X 1 1/2" X 1 1/2"

**\$1.00 EACH**



## SOUND AND VIDEO MODULATOR FOR T.I. COMPUTER

T.I. # UM1381-1 Designed for use with T.I. computers. Can be used with video sources. Built-in A/B switch. Channel 3 or 4 selection switch. Operate on 12 vdc. Hook-up diagram included.

**\$10.00 EACH**

## SLIM LINE COOLING FAN



Etri # 99XM182 low noise fan. Measures 3 3/4" square x 1" deep 21 cfm, 23 db, 1700 rpm

**SPECIAL PRICE . . . \$12.50 each**

## SUB-MINIATURE D TYPE CONNECTORS



DB-15 PLUG	\$2.75
DB-15 SOCKET	\$4.00
DB-25 PLUG	\$1.50
DB-25 SOCKET	\$2.75
DB-25 HOOD	\$3.50
DB-25 HOOD	\$1.25

## PARALLEL PRINTER CONNECTORS

Solder style 36 pin used on parallel data cables.

MALE CONNECTOR \$5.50 each  
FEMALE CONNECTOR \$5.50 each

## I.D.C. CONNECTORS

Will press fit on standard ribbon cable

DB-25 PLUG	\$6.25
DB-25 Socket	\$6.75
36 PIN MALE	\$5.50
36 PIN FEMALE	\$5.50

## TWIST-LOCK CONNECTOR

Same as Switchcraft #12CL5M. 5 conductor in-line plug and chassis mount jack. Twist-lock style.

**\$2.50/SET**

## 8" PA. SPEAKER

C.T.S. Model 8B3079 8 ohms coil \$5.00 each  
3.0 oz. ferrite magnet  
typical response range 100 - 10,000 Hz  
Power rating 15 watts max.  
Drilled to mount line matching transformers

CASE OF 8 SPEAKERS \$32.00

## LINE CORDS

TWO WIRE

6' 18/2 SPT-1 flat	3 for \$1.00
6' 18/2 SPT-2 flat	
6' 18/2 SJT round	\$1.25 each

## THREE WIRE

6' 18/3 flat	\$1.50 each
6' 18/3 round	\$2.00 each
6' 16/3 round	\$4.00 each

## COMPUTER GRADE CAPACITORS

2,000 mfd. 200 VDC 1 1/4" DIA. x 5" HIGH	\$2.00
3,600 mfd. 40 VDC 1 1/4" DIA. x 3 3/4" HIGH	\$1.00
6,400 mfd. 60 VDC 1 1/4" DIA. x 4 1/4" HIGH	\$2.50
9,700 mfd. 50 VDC 1 1/4" DIA. x 4 1/2" HIGH	\$3.00
31,000 mfd. 15 VDC 1 3/4" DIA. x 4" HIGH	\$2.50
72,000 mfd. 15 VDC 2" DIA. x 4 3/4" HIGH	\$3.50
185,000 mfd. 6 VDC 2 1/2" DIA. x 4 1/2" HIGH	\$1.50

## RELAYS

### 5 AMP SOLID STATE

Heinemann Electric #101-5A-140-5AMP CONTROL: 3-32 vdc LOAD: 140 vac 5 amp SIZE: 2" x 1" x 3/4"

**\$5.00 each 10 for \$45.00**

### ULTRA-MINIATURE 5 VDC RELAY

Fujitsu # FBR21NED005M20 High sensitivity COIL: 120 ohms CONTACTS: 1 amp Mounts in 14 pin DIP socket

**\$1.25 each 10 for \$10.00**

### MINIATURE 6 VDC RELAY

Aromat # RSD-6V Super Small S.P.D.T. relay Gold cobalt contacts rated 1 amp @ 30 vdc. Highly sensitive. TTL direct drive possible. 120 ohm coil. Operate from 4.3 - 6 vdc. COIL: 120 ohms 1 1/8" x 1 1/2" x 7/16"

**\$1.50 each 10 for \$13.50**

### 13 VDC RELAY

CONTACTS: S.P.N.C. 10 amp @ 120 vac Energize coil to open contact COIL: 13 vdc 650 ohms

**SPECIAL PRICE \$1.00 each**

### 4PDT RELAY

14 pin KH style. 3 amp contacts USED but fully tested - \$1.70 each Specify coil voltage desired Either 24 vdc or 120 vac

LARGE QUANTITIES AVAILABLE SOCKETS FOR KH RELAY 75¢ each

### SNAP ACTION SWITCH

Cherry elect. #E-21 N.O. or N.C. 0.1A contacts. Suitable for alarms and other low energy circuits. 1 1/4" lever.

**45¢ EACH 10 FOR \$4.20**

## 2K 10 TURN

MULTI-TURN POT SPECTROL #MOD 534-7161

**\$5.00 EACH**

## SOLID STATE BUZZER

Star #SMB-06L 6 vdc TTL compatible. \$1.00 each 10 for \$9.00



## TV REMOTE CONVERTER

Enhance the versatility of your video equipment. Converts cable TV stations to channel 2 or 3 Use with standard TV antenna to give your TV remote tuning capability. Converter operates on 115VAC 36 channel selector with line tuning on 25 ft. cord. Not a decoder.

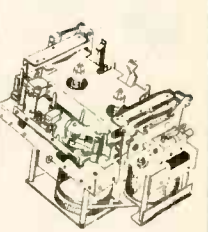
**A \$75.00 VALUE - ONLY \$27.50!**

## \*SPECIAL PRICE\* DUAL L.E.D. DISPLAYS

.560 high, 7 segment L.E.D. read-outs. Mount in 24 pin DIP sockets

MAN-6640 orange. c.c.c.	75¢ each
FND-5148 red. c.c.c.	75¢ each
DL-527 red. c.c.c.	75¢ each

## CASSETTE MECHANISM



New stereo cassette mechanism. Includes record/playback and erase heads, 2-12VDC motors, drive belts, pulleys, 3-12VDC solenoids, pinch wheels and other mechanical parts. These parts, used on other current model decks, would cost several times our selling price if purchased separately. Build your own audio or data recorder or use for spare parts. 5 1/2" X 3 1/2" X 3 1/4"

**\$7.50 EACH 2 FOR \$12.50**

## 3 1/2" SPEAKER

8 ohm impedance. Full range speaker. 8 oz magnet 4" diagonal mounting centers.

**\$2.50 each 10 for \$20.00**

## SPRING LEVER TERMINALS

Two color coded terminals on a sturdy 2 3/4" x 3 3/4" bakelite plate. Great for speaker enclosures or power supplies.

**\$1.00 each 10 for \$9.00**

## MINIATURE TOGGLE SWITCHES

ALL ARE RATED 5 AMPS @ 125 VAC

<b>S.P.D.T. (on-on)</b> PC style non-threaded bushing. 75¢ each 10 for \$7.00	<b>S.P.D.T. (on-on)</b> Solder lug terminals. \$1.00 each 10 for \$9.00 100 for \$80.00	<b>S.P.D.T. (on-off-on)</b> Solder lug terminals. \$1.00 each 10 for \$9.00 100 for \$80.00
<b>S.P.D.T. (on-off-on)</b> PC style non-threaded bushing. 75¢ each 10 for \$7.00	<b>S.P.D.T. (on-on)</b> PC lugs threaded bushing. \$1.00 each 10 for \$9.00 100 for \$80.00	<b>D.P.D.T. (on-on)</b> Solder lug terminals. \$2.00 each 10 for \$19.00 100 for \$180.00

## STANDARD JUMBO DIFFUSED T 1 1/2

RED	10 for \$1.50
	100 for \$13.00
GREEN	10 for \$2.00
	100 for \$17.00
YELLOW	10 for \$2.00
	100 for \$17.00

## FLASHER LED

5 volt operation red jumbo T 1 1/4 size \$1.00 each

## BI-POLAR jumbo T 1 1/4 size

2 for \$1.70

## LED HOLDERS

Two piece holder for jumbo LED 10 for 65¢ 100 for \$5.00

## CLEAR CLIPLITE LED HOLDER

Make LED a fancy indicator. Clear. 4 for \$1.00

## D.P.S.T. LIGHTED ROCKER SWITCH

115 vac lighted rocker. snap mounts in 7/8" x 1 1/2" hole. Orange lens. 16 amp contact.

**\$1.50**

## MINI-PUSH BUTTON

S.P.S.T. momentary normally open 1/4" bushing. Red button. 35¢ each 10 for \$3.00

## KEY ASSEMBLY

5 KEY \$1.00 each

## 6 KEY

contains 6 single-pole normally open switches. Measures 3/4" long. \$1.25 each

## METAL OXIDE VARISTOR

Popular GE # 130LA10A varistor 3/8" diameter. \$1.25 each

**ALL ELECTRONICS CORP.**  
LOS ANGELES, CA STORE  
905 S. Vermont Ave.  
213 380-8000

VAN NUYS, CA STORE  
6228 Sepulveda Blvd.  
818 997-1806

MAIL ORDERS TO:  
P.O. BOX 20406  
Los Angeles, CA 90006

TWX - 5101010163 ALL ELECTRONIC  
EASYLINK MBX - 62887748



TOLL FREE ORDERS ONLY  
1-800-826-5432  
(ORDER ONLY)  
(IN CALIFORNIA: 1-800-258-6666)  
ALASKA, HAWAII,  
OR INFORMATION  
(213) 380-8000 NO C.O.D.!

QUANTITIES LIMITED  
MINIMUM ORDER \$10.00  
USA: \$3.00 SHIPPING  
FOREIGN ORDERS:  
INCLUDING SUFFICIENT  
SHIPPING  
CALIF. RES. ADD 6 1/2%



# NEW 1986 CATALOG

CIRCLE READER SERVICE NO. FOR FREE COPY

## THIS MONTH'S SPECIALS

**Memories**

**D-RAMS**

4116	16K	.99
4164	64K 150ns	1.49
4164	64K 200ns	1.25
41256	256K 150ns	5.99

**EPROMS**

2732A	4K x 8 300ns	32K	3.89
2764	8K x 8 300ns	64K	3.89
27128	16K x 8 300ns	128K	6.99
27256	32K x 8 250ns	256K	11.99

**STATIC RAMS**

5516-25L	2K x 8 250ns	16K	3.29
6116-25L	2K x 8 250ns	16K	3.29

ALL NEW CURRENT PRODUCTION PRODUCTS

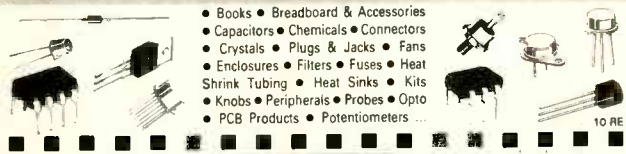
TEXAS INSTRUMENTS

MOTOROLA

Advanced Micro Devices

FULL LINE OF MICROPROCESSORS AVAILABLE

WE ALSO STOCK...



- Books • Breadboard & Accessories
- Capacitors • Chemicals • Connectors
- Crystals • Plugs & Jacks • Fans
- Enclosures • Filters • Fuses • Heat Shrink Tubing • Heat Sinks • Kits
- Knobs • Peripherals • Probes • Opto
- PCB Products • Potentiometers ...

USA  
P.O. BOX 9100  
WESTBOROUGH, MASS  
1-800-343-0874

**Active**

CANADA  
5651 FERRIER ST.  
MONTREAL, QUEBEC  
1-800-361-5884

MAIL ORDER PROCESSED WITHIN 24 HOURS

COMPLETE COMPONENTS CENTER

CURRENT DATE CODE PRODUCTS

SELF SERVE STORES LOCATED NEAR YOU. JUST CALL...

- |                                       |                             |                             |
|---------------------------------------|-----------------------------|-----------------------------|
| WESTBOROUGH, MASS.<br>366-9684        | OTTAWA, ONT.<br>728-7900    | EDMONTON, ALTA.<br>438-5888 |
| BELLEVUE, WASH.<br>881-8191           | TORONTO, ONT.<br>977-7692   | CALGARY, ALTA.<br>235-5300  |
| MONTREAL, QUEBEC<br>731-7441/256-7538 | DOWNSVIEW, ONT.<br>630-0400 | VANCOUVER, B.C.<br>438-3321 |

CIRCLE 51 ON FREE INFORMATION CARD

# DELTA IS BACK WITH A POWER SUPPLY BONANZA



COLECO WANLASS POWERTEC

COLECO STK.NO.90116,\$9.95 2/18.00  
+5VDC.9A, -5VDC.1A, +12VDC.3A REG.

WANLASS STK.NO.5578 \$10.95 2/20.00  
+12VDC (Adj.12-15) .8A REG.

POWERTEC STK.NO.90117 11.95 2/22.00  
+12VDC (Adj.10-16.6) REG. 1.6 A

POWERTEC STK.NO.90118 11.95 2/22.00  
+24VDC (Adj.16-26) REG. 1A.

POWERTEC STK.NO.90119 16.95 2/32.00  
+12VDC (Adj.10-15.5) REG. 2.8 A

SEND FOR YOUR COPY OF OUR LATEST CATALOG, FULL OF ELECTRONIC BARGAINS.

DELTA ELECTRONICS  
A DIVISION OF LJM TECHNOLOGIES  
P.O.BOX 2, 7 OAKLAND ST.  
AMESBURY, MA. 01913  
617-388-4705

CIRCLE 268 ON FREE INFORMATION CARD

# DON'T FORGET



USE YOUR READER SERVICE CARD

ALL SALES SUBJECT TO THE TERMS OF OUR 90 DAY LIMITED WARRANTY. FREE COPY UPON REQUEST.

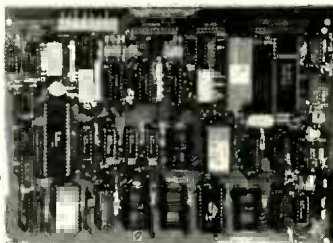
SOLAR CELL SPECIAL: 4 In. Diameter Rated .45 VDC At 1.2 Amps Or Better. Brand New Units, Cosmetic Seconds, But Perfect Electrically. \$3.99 6/\$20.

## THE NEW ZRT-80 CRT TERMINAL BOARD!

A LOW COST Z-80 BASED SINGLE BOARD THAT ONLY NEEDS AN ASCII KEYBOARD, POWER SUPPLY, AND VIDEO MONITOR TO MAKE A COMPLETE CRT TERMINAL. USE AS A COMPUTER CONSOLE, OR WITH A MODEM FOR USE WITH ANY OF THE PHONE-LINE COMPUTER SERVICES.

### FEATURES:

- Uses a Z80A and 6845 CRT Controller for powerful video capabilities.
- RS232 at 16 BAUD Rates from 75 to 19,200.
- 24 x 80 standard format (60 Hz).
- Optional formats from 24 x 80 (50 Hz) to 64 lines x 96 characters (60 Hz).
- Higher density formats require up to 3 additional 2K x 8 6116 RAMS.
- Uses N.S. INS 8250 BAUD Rate Gen. and USART combo IC.
- 3 Terminal Emulation Modes which are Dip Switch selectable. These include the LSI-ADM3A, the Heath H-19, and the Beehive.
- Composite or Split Video.
- Any polarity of video or sync.
- Inverse Video Capability.
- Small Size: 6.5 x 9 Inches.
- Upper & lower case with descenders.
- 7 x 9 Character Matrix.
- Requires Par. ASCII keyboard.



**\$89<sup>95</sup>** #ZRT-80

(COMPLETE KIT, 2K VIDEO RAM)

BLANK PCB WITH 2716 CHAR. ROM. 2732 MON. ROM

**\$49<sup>95</sup>**

SOURCE DISKETTE - ADD \$10

SET OF 2 CRYSTALS - ADD \$7.50

FOR 8 IN. SOURCE DISK (CP/M COMPATIBLE) ADD \$10

## Digital Research Computers

P.O. BOX 461565 • GARLAND, TEXAS 75046 • (214) 225-2309

Call or write for a free catalog on Z-80 or 6809 Single Board Computers, SS-50 Boards, and other S-100 products.

TERMS: Add \$3.00 postage. We pay balance. Orders under \$15 add 75c handling. No C.O.D. We accept Visa and MasterCard. Texas Res. add 5-1/8% Tax. Foreign orders (except Canada) add 20% P & H. Orders over \$50 add 85c for insurance.



Call toll free for your copy of our current flyer/catalog

**1-800-543-3568**

Free!



## Consolidated Electronics, Incorporated

705 Watervliet Ave., Dayton, Ohio 45420-2599

National Wats 1-800-543-3568

In Dayton (513) 252-5662

**TELEX NO. 288-229**

CIRCLE 81 ON FREE INFORMATION CARD







12 MILLION PC IC CLEARANCE - CALL FOR QUANTITY DISCOUNTS -

RED-HOT RAM & EPROM PRICES

NEW EPROM

Table with columns: Part No., Pkgs, Price, and a sub-section for '7400' series components.

Table with columns: Part No., Description, Price, and a sub-section for '21C14', '27C16', and '4164N-200' components.

Table with columns: Part No., Pkgs, Function, Price, and a sub-section for '2816A', 'DT1050', and 'DT1057' components.

MICROPROCESSOR COMPONENTS

Table with columns: Part No., Pkgs, Price, and a sub-section for 'MICROPROCESSOR CHIPS' and 'DYNAMIC RAMS'.

Digitalker™

Table with columns: Part No., Pkgs, Price, and a sub-section for 'DT1050', 'MM54104', and 'DT1057' components.

74ALS

Table with columns: Part No., Pkgs, Price, and a sub-section for '74ALS' series components.

6500/8000/8000 SERIES

Table with columns: Part No., Pkgs, Price, and a sub-section for '6500/8000/8000 SERIES' components.

74HC HIGH SPEED CMOS

Table with columns: Part No., Pkgs, Price, and a sub-section for '74HC HIGH SPEED CMOS' components.

74S/PROMS

Table with columns: Part No., Pkgs, Price, and a sub-section for '74S/PROMS' components.

8000/10000 SERIES

Table with columns: Part No., Pkgs, Price, and a sub-section for '8000/10000 SERIES' components.

PROMS/EPROMS

Table with columns: Part No., Pkgs, Price, and a sub-section for 'PROMS/EPROMS' components.

74ALS

Table with columns: Part No., Pkgs, Price, and a sub-section for '74ALS' series components.

SPECIAL FUNCTION

Table with columns: Part No., Pkgs, Price, and a sub-section for 'SPECIAL FUNCTION' components.

DATA ACQUISITION

Table with columns: Part No., Pkgs, Price, and a sub-section for 'DATA ACQUISITION' components.

74F

Table with columns: Part No., Pkgs, Price, and a sub-section for '74F' series components.

Low Profile (Pin) Sockets

Table with columns: Part No., Pkgs, Price, and a sub-section for 'Low Profile (Pin) Sockets'.

Linear

Table with columns: Part No., Pkgs, Price, and a sub-section for 'Linear' components.

MasterCard logo, amecore ELECTRONICS logo, and VISA logo.

1355 SHOREWAY ROAD, BELMONT, CA 94002

10/5 PHONE ORDERS WELCOME - (415) 592-8097 - Telex: 176043

30003 1982 Nat. Linear Data Book (1982 pg.) - \$11.95

CIRCLE 114 ON FREE INFORMATION CARD

www.americanradiohistory.com



**Commodore® Accessories**

**RS232 Adapter for VIC-20 and Commodore 64**

The JE232CM allows connection of standard serial RS232 printers, modems, etc. to your VIC-20 and C-64. A 4-pole switch allows the inversion of the 4 control lines. Complete installation and operation instructions included.  
• Plugs into User Port • Provides Standard RS232 signal levels • Uses 6 signals (Transmit, Receive, Clear to Send, Request to Send, Data Terminal Ready, Data Set Ready).  
**JE232CM . . . . . \$39.95**

**VOICE SYNTHESIZER FOR COMMODORE VIC-20 AND C-64 Plug-In - Talking in Minutes!**  
**JE520CM . . . . . \$99.95**

**TRS-80 Accessories**

**MPI 5 1/4" DISK DRIVE**  
• Use as a second disk drive • Single-sided • Single/double density • Full-height drive • 48 TP • Documentation included • Weight: 3.7 lbs.  
**MPI51S . . . . . \$89.95**

**EXPAND TRS-80 MEMORY TRS-80 MODEL I, III**

Each Kit comes complete with eight MM5290 (µP416/4116) 16K Dynamic RAMs and documentation for conversion. Model I 16K equipped with Expansion Interface can be expanded to 48K with 2 Kits. Model III. Can be expanded from 16K to 48K using 2 Kits. Each Kit will expand computer by 16K increments.  
**TRS-16K3 200ns (Model III) . . . . . \$6.29**  
**TRS-16K4 250ns (Model I) . . . . . \$5.49**

**TRS-80 COLOR and COLOR II**  
Easy to install Kit comes complete with 8 each 4164N-20 (200ns) 64K Dynamic RAMs and documentation for conversion. Converts TRS-80 Color Computers with D, E, ET, F and NC circuit boards to 32K. Also converts TRS-80 Color Computer II to 64K Flex DOS or OS-9 required to utilize full 64K RAM on all computers.  
**TRS-64K-2 . . . . . \$11.95**

**Update! TRS-80 MODEL IV, 4P Update!**  
Easy to install Kits come complete with: TRS-64K-2 (8 ea 4164N-20 (200ns) 64K Dynamic RAM); TRS-64K-2PAL (8 ea 4164+ plus PAL chip) and documentation for conversion.  
**TRS-64K-2 . . . . . \$11.95**  
**TRS-64K-2PAL . . . . . \$29.95**

**• TRS-80 Model 100 • NEC • Olivetti**  
Easy to install module plugs right into the socket increasing memory in 8K increments. Complete with module and documentation for installation.  
**M1008K (TRS-80 Model 100 Expansion) . . . . . \$39.95 ea. or 3 for \$99.95**  
**NEC8KR (NEC PC-8201A & Olivetti M10) . . . . . \$39.95 ea. or 3 for \$99.95**

**NEW! NEW! TANDY 200 NEW! NEW!**  
Easy to install module plugs right into the socket increasing memory in 24K increments. Complete with module & documentation for installation.  
**M200R (Tandy 200 Expansion) . . . . . \$149.95 ea. or 2 for \$274.95**

**PROMETHEUS MODEMS**

**Intelligent 300/1200 Baud Modem with Real Time Clock/Calendar**

The ProModem™ is a Bell 212A (300/1200) Intelligent stand-alone modem • Hayes command set compatible plus an additional extended command set • Shown with alphanumeric display option.  
**PM1200 RS-232 Stand-Alone Unit. . . . . \$299.95**

**OPTIONS For ProModem 1200**  
**PM-COM (ProCom Communication Software) . . . . . \$79.95**  
Please specify Operating System.  
**PM-OP (Options Processor) . . . . . \$79.95**  
**PMO-64K (Options Processor Memory - 64K) . . . . . \$ 8.49**  
**PM-ALP (Alphanumeric Display) . . . . . \$79.95**

**PM-Special (Incl. Options Processor, 64K Memory and Alphanumeric Display) . . . . . \$149.95**

**DATA BOOKS**

**30009 Internal Data Book (1984) . . . . . \$9.95**  
Complete Line (965 pages)

**30013 Zilog Data Book (1984) . . . . . \$9.95**  
Microprocessors and Support Chips (849 pages)

**210830 Intel Memory Components Handbook (1983/84) . . . . . \$14.95**  
Contains all Applications Notes, Article Reprints, Data Sheets & other design information on Intel's RAMs, DRAMs, EPROMs, EEPROMs and Bubble Memories (880 pages).

**230843 Intel Microsystem Components Handbook (1983/84) \$19.95**  
Contains Data Sheets on all of Intel's Microprocessors & Peripheral - 2 volumes (2575 pages).

**30022 National Logic Data Book Set (1984) . . . . . \$24.95**  
Volumes I & II (3485 pages).  
Contains information on National's TTL, product line and CD4000 series. This includes 7400, 74L, S, AS, LS and ALS Series devices, and MM54HC/74HC/74S/74C/74MCT/74MCT High Speed Micro CMOS family, MM54C/74C family, and CMOS LS/LSI.

**Muffin-Style and Sprite-Style Fans**  
**MUF60 (SPN3-15-2462) Howard Industries (4 5/8" sq., 60cm) . . . . . \$9.95**  
**SLUC7 Reverse Flow EG&G Rotron (3.125" sq., 32cm) . . . . . \$9.95**

\*\*\*\*\* APPLE® Accessories \*\*\*\*\*



**APPLE\* Compatible CARDS**  
Key: a = Apple II or II+  
b = Apple IIe

**16K RAM Card (Language Card)**  
The ARC-16K RAM Card allows the Apple® II and II+ computers to expand from 48K to 64K. Complete with instructions. Key: (a)  
**ARC-16K . . . . . \$39.95**

**Z-80 CP/M Card**  
The AZ80-1 is Soft-card compatible. Used with CP/M related programs. Software not included. Key: (a,b)  
**AZ80-1 . . . . . \$49.95**

**EPROM Burner Card**  
The AEB-2 allows user to program and work with standard EPROMs (2716, 2732 & 2764). Easy to use, on-board firmware. Menu contains the following options: Write, Read, Copy, Compare, Blank-Check and Monitor. Complete with instructions. Key: (a,b)  
**AEB-2 . . . . . \$69.95**

**80-Column Card w/Soft Switch**  
The A80-C is an 80-column card designed for the Apple® II and II+ computers. The card is equipped with a soft switch which allows easy hookup for any monitor. The A80-C also features inverse video capabilities. This card is similar to the Videx™ 80 column card. Complete with instructions. Key: (a)  
**A80-C . . . . . \$74.95**

**Super Serial Card**  
The ASSC-P is a serial card with a printer mode. It generates standard RS-232C signals and is similar to the Apple® Super Serial Card. Complete with instructions. Key: (a,b)  
**ASSC-P . . . . . \$99.95**

**Parallel Graphics Printer Card w/64K Buffer**  
The APC-64K is a parallel graphics printer card with a 64K buffer and graphic dump capabilities. Complete with instructions. Key: (a,b)  
**APC-64K . . . . . \$129.95**

**80-Column/64K RAM Card**  
Extended 80-Column/64K RAM Card expands memory by 64K to give 128K when used with programs like VisiCalc™. Complete with instructions. Key: (b)  
**JE864 . . . . . \$79.95**

\*APPLE, APPLE II, II+, IIe, IIc and Macintosh are registered trademarks of APPLE Computers.  
™VisiCalc is a registered trademark of Visi Corp. Inc.      \*Videx is a registered trademark of Videx Inc.

**APPLE™ Compatible 5 1/4" Half-Height Disk Drive**  
**ONLY \$129.95**

• Uses Chinon Pinch-type mechanics • 143K formatted storage • 35 tracks • Super quiet • Works with Apple Controllers or other compatibles (ACC-1) right in • Complete with connector - just plug into your controller.  
• Size: 5 1/4" W x 1 3/4" H x 8" D • Wt. 4 lbs. Key: (a,b)  
**ADD-12 . . . . . \$129.95**

**APPLE™ Compatible 5 1/4" Disk Drive & Controller Card**  
• Uses Shugart SA390 mechanics • 143K formatted storage • Color matches Apple Computer • Works with Apple Controller or other Apple-compatible controllers (ACC-1) • Complete with connector - just plug into your disk controller card • 35 tracks • Size: 6" W x 5 1/4" H x 8 1/2" D • Wt. 4 1/2 lbs. Key: (a,b)  
**ADD-514 (Disk Drive) . . . . . \$149.95**  
**ACC-1 (Controller Card) . . . . . \$ 49.95**

**APPLE™ IIc Compatible 5 1/4" Half-Height Disk Drive**  
• Same specs as ADD-12 (left) except no controller necessary.  
**ADD-IIc . . . . . \$129.95**

**Additional Apple\* Compatible Products**

- APF-1** Cooling Fan with surge protection • Key: (a,b) . . . . . \$ 39.95
- JE614** Numeric/Aux. Keypad - 23 accessible functions • Key: (b) . . . . . \$ 49.95
- EAEC-1** Expanded Apple Enclosure Case only • Key: (a) . . . . . \$ 49.95
- KHP4007** Switching Power Supply • Key: (a) . . . . . \$ 59.95
- KB-A68** 68-Key Apple Keyboard only • Key: (a) . . . . . \$ 69.95
- MON-12G** 12" Green Monitor with swivel stand • Key: (a, b & IIc) . . . . . \$ 79.95
- JE520AP** Voice Synthesizer - Plug-in, User Ready • Key: (a,b) . . . . . \$119.95
- KB-EA1** Apple Keyboard and Case • Key: (a) . . . . . \$119.95
- PM1200A** Prometheus Internal Modem - 2 cards • Key: (a,b) . . . . . \$299.95
- PM1200M** Prometheus Macintosh Ext. Modem • Key: (Macintosh) . . . . . \$369.95

**General Application Power Supplies**

**Power/Mate Corp. REGULATED POWER SUPPLY**  
• Input: 105-125/210-250VAC @ 47-63Hz • Line regulation: ±0.05% • Three mounting surfaces • Overvoltage protection • UL recognized • CSA certified

Part No.	Output	Size	Weight	Price
EMAS/6B	5V @ 3A/6V @ 2.5A	4 1/2" L x 4 1/2" W x 2 1/2" H	2lbs	\$29.95
EMAS/6C	5V @ 6A/6V @ 5A	5 1/2" L x 4 1/2" W x 2 1/2" H	4lbs	\$39.95

**KEPCO/DSK 4-OUTPUT SWITCHING POWER SUPPLY**  
• Ideal for disk drive needs of CRT terminals, microcomputers and video games • Input: 115/230VAC, 50/60Hz • Output: +5V @ 5A, +12V @ 1.8A, +12V @ 2A, -12V @ 0.5A • UL recognized • CSA certified • Size: 7 1/2" L x 6-3/16" W x 1 1/8" H • Weight: 2 lbs.  
**MRM 174KF . . . . . \$39.95**

**4-CHANNEL SWITCHING POWER SUPPLY**  
• Microprocessor, mini-computer, terminal, medical equipment and process control applications • Input: 90-130VAC, 47-440Hz • Output: +5VDC @ 5A, -5VDC @ 1A, +12VDC @ 1A, -12VDC @ 1A • Line regulations: ±0.2% • Ripple: 30mV p-p • Load regulation: ±1% • Overcurrent protection • Adj. 5V main output ±10% • Size: 6 3/4" L x 1 1/2" W x 4-15/16" H • Weight: 1 1/2 lbs.  
**FCS-604A . . . . . \$69.95**

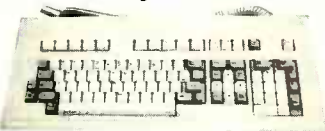
\$10 Minimum Order - U.S. Funds Only      CA Residents: Add 6 1/2% Sales Tax      Spec Sheets - 30¢ each  
Shipping: Add 5% plus \$1.50 Insurance      Send \$1 Postage for FREE 1985 Jameco Catalog      Prices Subject to Change  
Send stamped, self-addressed envelope to receive a Monthly Sales Flyer - FREE!



1355 SHOREWAY ROAD, BELMONT, CA 94002  
10/85 PHONE ORDERS WELCOME - (415) 592-8097 - Telex: 176043

**IBM® Accessories**

**IBM PC/XT Compatible Keyboard**



**IBM-5151 (Equivalent to Kaytronics® 5151) . . . . . \$129.95**

**Additional Add-Ons Available!**

**MEMORY EXPANSION KITS**

**IBM PC, PC XT and Compatibles**  
The IBM® Kit will increase memory in 64K byte increments. The Kit is simple to install - just insert the 9 - 64K RAM chips in the provided sockets and set the 2 groups of switches. Conversion documentation included.  
**IBM64K (Nine 200ns 64K RAMs) . . . . . \$9.95**

**IBM PC AT**  
Each kit comes complete with nine 128K dynamic RAMs and documentation for conversion.  
**IBM128K (Nine 250ns 128K RAMs) . . . . . \$79.95**

**IBM PCXT Equivalent 130 Watt Power Supply**  
**UPGRADE YOUR PC!**

• Input: 110V @ 60Hz • Output: +5VDC @ 15A, -5VDC @ 0.5A, +12VDC @ 4.2A, -12VDC @ 0.5A • Plug compatible connectors • Fits into IBM PC • Weight: 6 lbs.  
**IBM-PS . . . . . \$119.95**

**Prometheus Modems**

The ProModem 1200B/BS is a 1200/300 baud modem card which plugs into IBM PC and XT. Provides a third serial COM port. Two versions available: 1200B (without software) and 1200BS (with software). The PM1200BS is supplied with powerful MITE communications software from Microbit labs.  
**PM1200B (without Software) . . . . . \$239.95**  
**PM1200BS (with MITE Software) . . . . . \$274.95**

**IBM Compatible! DISK DRIVES**

**Documentation Included**

**RFD480 (Remex 5 1/4" DS full-ht.) . . . . . \$ 79.95**  
**FD55B (Teac 5 1/4" DS half-ht.) . . . . . \$119.95**  
**SA455 (Shugart 5 1/4" DS half-ht.) . . . . . \$109.95**  
**TM100-2 (Tandon 5 1/4" DS full-ht.) . . . . . \$129.95**

**5 1/4" DISK DRIVE ENCLOSURES**

Complete with power supply, switch, power cord, fuseholder and connectors  
**DDE-1FH (Houses 1 full-ht. 5 1/4" floppy drive) . . . . . \$ 69.95**  
**DDE-2HH (Houses 2 half-ht. 5 1/4" floppy drives - vertical) . . . . . \$ 79.95**  
**HDDE-1FH (Houses 1 hard drive) . . . . . \$219.95**

**General Application Keyboards**

**Mitsumi 54-Key Unencoded All-Purpose Keyboard**  
• SPST keyswitches • 20 pin ribbon cable connection • Low profile keys • Features: cursor controls, control, caps (lock), function, enter and shift keys • Color (key-caps): grey • Weight: 1 lb. • Pinout incl. • Size: 13 1/2" L x 4 1/4" W x 3/4" H  
**KB54 . . . . . \$14.95**

**74-Key ASCII Cherry Keyboard**  
• 7-bit parallel ASCII • Full Upper Case, Full Lower Case except l, m, n, o and p • Cursor keypad • SPST mechanical keyswitches • 26-pin header connector • Color: white • Size: 18" L x 6 1/4" W x 1 1/4" H • Spec included  
**KB8201 . . . . . (1700 available) . . . . . \$19.95**

**UV-EPROM ERASER**

**8 Chips - 21 Minutes**

**1 Chip - 15 Minutes**

Erases all EPROMs. Erases up to 8 chips within 21 minutes (1 chip in 15 minutes). Maintains constant exposure distance of one inch. Special conductive foam liner eliminates static build-up. Built-in safety lock to prevent UV exposure. Compact - only 9.00" L x 3.70" W x 2.60" H. Complete with holding tray for 8 chips.

**DE-4 UV-EPROM Eraser . . . . . \$74.95**  
**UVS-11EL Replacement Bulb . . . . . \$16.95**



## Saratoga Electronics

### EPROMS

2716-450ns	\$2.50
2732-450ns	\$3.25
2764-250ns	\$3.50
27128-250ns	\$4.75

### DYNAMIC RAMS

4164-150ns	\$ .90
41256-150ns	\$3.95

### STATIC RAMS

2114LP-200ns	\$1.50
2114LP-150ns	\$1.65
6116P-4	\$1.50
6264P-150ns	\$4.95
6264LP-150ns	\$6.25

### Microprocessors

8087-3	\$ 99.95
80287-3	\$225.00
8088	\$ 10.00
8085-2	\$ 4.25
8243	\$ 2.50
8250	\$ 8.95
8253-5	\$ 3.95
8255-5	\$ 5.25
8272	\$ 12.95
8274	\$ 12.95

CALL US FOR YOUR OTHER I.C. NEEDS! WE STOCK 74LS, 74S, 7400, CMOS, LINEAR, AND MANY MORE I.C.'s!

### \*\*SPECIALS\*\*

74LS139	.25	74S02	.15
74LS161	.25	74S51	.25
LM350K	2.00	74S74	.30
CAP: 10000uf 25V	.50		
10000uf 50V	.50		
TRANSFORMER: AC ADAPTOR			
IN: 117/60HZ			
OUT: 12VAC(CT) 250mA			
			\$1.00 ea.

800-621-0854 ext. 245

## SARATOGA ELECTRONICS

12380 SARATOGA-SUNNYVALE ROAD  
SARATOGA, CA 95070  
(408) 440-4849

CIRCLE 257 ON FREE INFORMATION CARD

# ACTIVE RECEIVING ANTENNA

Gives excellent reception, 50 KHz to 30 MHz.

New MFJ-1024 Active Receiving Antenna mounts outdoors away from electrical noise for maximum signal.

Gives excellent reception of 50 KHz to 30 MHz signals. Equivalent to wire hundreds of feet long. Use any SWL, MW, BCB, VLF or Ham receiver.

High dynamic range RF amplifier. 54 in. whip. 50 foot coax. 20 dB attenuator prevents receiver overload. Switch between two receivers. Select auxiliary or active antenna. Gain control. "ON" LED. Remote unit, 3x2x4 in. Control, 6x2x5 in. 12 VDC or 110 VAC with optional adapter, MFJ-1312, \$9.95.



**\$129.95** (+\$4.00 shipping)

Order from MFJ and try it. If not delighted, return within 30 days for refund (less shipping). One year unconditional guarantee.

Order today. Call TOLL FREE 800-647-1800. Charge VISA, MC. Or mail check, money order. Write for free catalog. Over 100 products.

CALL TOLL FREE 800-647-1800

Call 601-323-5869 in Miss., outside continental USA, tech/order/repair info. TELEX 53-4590.

**MFJ ENTERPRISES, INCORPORATED**

Box 494, Mississippi State, MS 39762

CIRCLE 105 ON FREE INFORMATION CARD

# THE BEST PRICES

## DISK SALE FROM 58¢

Made by top USA makers, not "low-end" or "cut-rate". Our suppliers won't let us to reveal their names, but when you receive them you'll recognize them as premium disks that sell for much more. Certified, guaranteed 100% error free. MONEY BACK SATISFACTION GUARANTEE! Lifetime replacement warranty!

WITH SLEEVE, LABEL, AND BOX  
#UDAD SS/DD-35K (Apple) 10/72ca, 100/70ca, 500/67ca  
#UD1D SS/DD-Standard 10/74ca, 500/71ca, 100/65ca  
#UD2D SS/DD (IBM, etc) 10/91ca, 100/89ca, 500/86ca

BULK, NO SLEEVE, LABEL, BOX  
#UDAN SS/DD-35K (Apple) 100/64ca, 500/61ca, 1000/58ca  
#UD1N SS/DD-Standard 100/74ca, 500/71ca, 1000/58ca  
#UD2N SS/DD (IBM, etc) 100/83ca, 500/80ca, 1000/77ca

- 5 1/4" DISK SLEEVES, white, #SLEEVE 10/654 100/65
- DISK NOTCHES, allows access to 2nd side BMM 4/99
- 16 PIN NIRENAP IC SOCKETS, prime qual, 3-level 10/81.60
- 6 VOLT 450MAH RECHARGEABLE BATTERIES, sealed, #MBR 63
- 40 W/LEAD RECHARGEABLE BATTERIES, fresh #AANI 4/82
- 12V VOLTAGE REGULATORS, pur-tab #7912T 2/81
- +15V VOLTAGE REGULATORS, pur-tab #7915T 2/81
- HAND HELD LOGIC PROBE detects 1-shot, low rep rate #LPI #20
- SOLAR CELLS 3" #006A #BOCELL #1.95
- SOLAR CELLS 3" 1000mA #100CELL 12.50
- SOLAR CELLS 4" #500A #1500CELL #3.50, 24/85
- MUFFIN-TYPE FANS, 110V, 3 blades & wd, r/c #MUFFIN #5
- MUFFIN-TYPE FANS, 220V, 3 blades & wd, r/c #220MUFFIN #2
- MUFFIN FAN GRILLES #SCREEN 2/74a, #40ND24 50t/42
- 3 COND JACKETED TELEPHONE WIRE, #24ga, #40ND24 50t/42
- 3 COND HEAVY DUTY LINE CORDS, 12' #MGB1 #12FTLC #1
- 2 COND LINE CORDS 15' #MGB1, #12LC 2/81
- 1K 10 TURN PRECISION LINEAR POT, 1/4" shaft #10KPPOT 4/81
- 10K 10 TURN PRECISION LINEAR POT, 1/4" shaft #10KPPOT 4/81
- 3 COND 1/4" STEREO PHONE PLUG, plastic barrel #3CONDPL 2/81
- ALLIGATOR CLIPS W/BOOTS 4-red, 4-bk, 1" #258 8/81
- ALLIGATOR CLIPS W/BOOTS 2-red, 2-bk, 1" #258 8/81
- 9V BATTERY SNAPS, insulated, wire leads #9VSNAP 6/81
- 6 AMP 50V BRIDGE RECTIFIERS #6BR 8/82
- 1 AMP 50V "MINI" BRIDGE RECTIFIER #1ABR 2/81
- STANDARD FUSES, .3AG, 2 amp #AGC2 20/81
- SOLD-BO FUSES, .3AG, 1 amp #AGC1 20/81
- 4 POSITION DIP SWITCH #4DIP 3/82, 1, or 5 10/81
- 3 AMP ERT FILTER, removes power line glitches #3AEMI #3
- MODULAR TELEPHONE WALL DUT BORES #TEC30 #1.95
- MODULAR TELEPHONE Y ADAPTORS, (2 fee-1 male) #TEC29 #1.95
- INLINE MODULAR PHONE SUPPLIES, #TEC31 #1.95
- 14 PIN SOLDER-TYPE IC SOCKETS #14ST 10/81
- 22 PIN SOLDER-TYPE IC SOCKETS #22ST 10/81
- 18 PIN SOLDER-TYPE IC SOCKETS #18ST 10/81
- RED-SIZE RED LEADS, prime #ORLED 10/81
- 12 VOLT 1 WATT ZENER, 1N22A #12Z 2/81
- 25AMP 200PIV RECTIFIER, DOG #1N250T 2/81

ASSORTMENTS:  
IC's, mixed types, lots of good numbers! #ASTICS 40/82  
TRIMMER POTS, some precision #ASTIRM 12/82  
TRANSISTORS, audio, rf, top quality #ASTTRANS 40/82  
RELAYS, mixed voltage, 2 types #ASTREL 20/82  
TANTALUM CAPS, axial & teardrop #ASTTAN 20/82  
COILS, audio, 1/2 to small #ASTCOIL 20/82  
COMPUTER GRADE CAPS, 1q & small, fresh #ASTCOP 8/82

Pay by MC-VISA-Amex-COD or send check with order. Include \$3 for shipping & handling #2 if COD. Canada include \$5. ON ALL orders include daytime phone & street address. Minimum order \$15. Money-back 30 day satisfaction guarantee!

**UNITECH (800)343-0472**  
IN MASS: (617) "UNI-TECH"  
20R HURLEY ST. CAMBRIDGE, MA 02141

CIRCLE 290 ON FREE INFORMATION CARD

# JAM IT!

Even the Very Best Radar Detector Can't Protect You from the Newest Radar

NEW MODEL LIII  
RADAR JAMMER



THE ULTIMATE IN RADAR PROTECTION

**Radar Jammer:** Compact under-dash unit causes speed radar guns to read out a percentage of your-true speed, or whatever speed you dial in. Or, new "SCRAMBLE" mode will prevent radar from obtaining any reading. Activated by Whistler, Escort, or other detector. Best defense against instant on radar. Operates on both X and K bands. WARNING: This device is not legal for use against police radar, and is not FCC approved.

**Transmitters:** The heart of the jammer is the microwave oscillator (transmitter). In the past, these were very expensive, and limited to only about 100 milliwatts of power. We now have our own Low Cost, High Power Transmitters up to 300 milliwatts or more. Please call for prices.

**Radar Detectors:** We highly recommend using a remote detector that is mounted so that nothing is readily visible to either the police, or thieves. (A dash mount detector is an invitation to thieves and an irritation to police!) We agree with Motor Trend and Autoweek that WHISTLER SPECTRUM is the best detector available, and we know of no other remote detector that is even in the same LEAGUE as the SPECTRUM REMOTE. Order the best for yourself now. (Our detectors are already modified for direct connection to the jammer.)

ORDER TODAY-MONEY BACK GUARANTEE

- Complete Literature & Plans Pkg. \$ 14.95
- Set of Circuit Boards 40.00
- X and K-band Microwave Oscillators (Transmitters) Call
- Whistler Spectrum (modified for use with Jammer) 259.00
- Whistler Spectrum Remote (modified) 259.00
- Modify your Spectrum for use w/jammer 55.00

CALL or send the following information:

Items Ordered Name Shipping Address  
Payment: Check, Money Order, VISA or MC (include card number, expiration date, and signature)

SEND TO: Oregon Microwave Inc., 9513 S.W. Barbur Blvd. #109S  
Portland, OR 97219 ORDER LINE: (503) 626-6764  
\*Formerly Philips Instrument Design Co.

CIRCLE 291 ON FREE INFORMATION CARD

# AMAZING DEVICES

PERSONAL DEFENSE AND PROPERTY PROTECTION UTILIZE SPACE AGE TECHNOLOGY. CAUTION THESE DEVICES CAN BE HAZARDOUS AND MAY SOON BE ILLEGAL.

- POCKET PAIN FIELD GENERATOR — IPG50 Assembled \$64.50  
IPG50 Plans \$8.00 IPG5K Kit/Plans \$44.50
- PHASOR PAIN FIELD CROWD CONTROLLER — PPF10 Assembled \$250.00  
PPF10 Plans \$15.00 PPF1K Kit/Plans \$175.00
- BLASTER - Provides a plasma discharge capable of puncturing a can. Produces a 100,000 WATT PULSE. \$175.00
- BLS10 ASSEMBLED \$89.50  
BLS1 PLANS \$10.00 BLS1K KIT/PLANS \$69.50
- PLASMA STUN GUN - Very intimidating and effective 5 to 10 feet 100,000 VOLTS  
ITM10 ASSEMBLED \$99.50  
ITM1 PLANS \$10.00 ITM1K KIT/PLANS \$69.50
- RUBY LASER RAY GUN — Intense visible red beam burns and welds hardest of metals. MAY BE HAZARDOUS.
- RUBALL Parts Available for Completing Device \$20.00
- CARBON DIOXIDE BURNING, CUTTING LASER — Produces a continuous beam of high energy. MAY BE HAZARDOUS.
- LC5. All Parts Available for Completing Device. \$20.00
- VISIBLE LASER LIGHT GUN — produces intense red beam for sighting, spotting, etc. Hand held complete.
- LGU3. Plans. \$10.00 (Kit & Assembled Units Available)
- IR PULSED LASER RIFLE — Produces 15-30 watt infra-red pulses at 200-2000 per sec.
- LRG3. All Parts & Diodes Available \$10.00
- BEGINNERS LOW POWER VISIBLE LASER — Choice of red, yellow, green — provides an excellent source of monochromatic light.
- LHC2 Plans \$5.00 LHC2K Kit \$34.50
- SNOOPER PHONE — Allows user to call his premises and listen in without phone ever ringing.  
SNP20 Assembled \$89.50  
SNP20 Plans \$9.00 SNP2K Plans/Kit \$59.50
- LONG RANGE WIRELESS MIKE — Miniature device clearly transmits well over one mile. Super sensitive, powerful.  
MFT1 Plans \$7.00 MFT1K Plans/Kit \$49.50
- WIRELESS TELEPHONE TRANSMITTER — Transmits both sides of phone conversation over one mile, shuts off automatically.
- VWPM5 Plans \$8.00 VWPM5K Plans/Kit \$39.50
- PWM5—LONG RANGE SUPER EAR WITH WIRELESS ATTACHMENT  
PWM5 Plans \$10.00 PWM5K Kit \$139.50  
PWM50 Assembled and Tested \$169.50

Our phone is open for orders anytime. Technicians are available 9-11 a.m. Mon-Thurs for those needing assistance or information. Send \$1.00 for catalog of hundreds more similar devices. Send check, cash, MO, Visa, MC, COD to: INFORMATION UNLIMITED  
DEPT RB, P.O. Box 716, Amherst, N.H. 03031 Tel: 603-673-4730

CIRCLE 72 ON FREE INFORMATION CARD



**JUST IN TIME FOR OUR 6 YEAR ANNIVERSARY,**

**JDR HAS JUST**

**SLASHED THE PRICES**

**ON OUR MOST POPULAR ITEMS!**

**FOR EXAMPLE:**

**INTEGRATED CIRCUITS**

**4164 200ns 79¢**

**41256 200ns \$3.19**

**27256 250ns \$9.95**

8088	1.95	MSM5832	2.95
8251	1.95	UPD765	4.95
8253	1.95	74LS00	.16
8255	1.95	74LS74	.24
8284	2.95	74LS244	.69
8288	4.95	4011	.19
68000	9.95	LM555	.29
6821	1.95	7805T	.49
6845	4.95	CRYSTALS	1.95
Z80A-CPU	1.89	OSCILLATOR	4.95

**IBM COMPATIBLE CARDS**



348K MULTIFUNCTION CARD	\$129.95
1200 BAUD MODEM CARD	\$195.00
COLOR GRAPHICS CARD	\$99.95
MONOCHROME/PRINTER CARD	\$129.95
FLOPPY DISK CONTROLLER	\$59.95

**TEAC DRIVES**



FD-55B	\$89.95
FD-55F	\$99.95

**CONNECTORS**

DB25S	RS232 FEMALE	\$1.50
DB25P	RS232 MALE	\$1.25
25 PIN HOOD		65¢
62 PIN	EDGE CARD FOR IBM	\$1.95
16 PIN IDC SOCKET		12¢
GENDER CHANGER		\$7.95

**IBM COMPATIBLE CASE**



**\$59.95**

**DRIVE CASE**

WITH POWER SUPPLY  
• FITS TWO 5 1/4" 1/2 HT. FDDs



**\$49.95**

**NASHUA DS/DD DISKETTES**

<b>9.90</b>	<b>.89</b>	<b>.79</b>
BOX OF 10	BULK QTY 50	BULK QTY 250

**MONITORS**

TAXAN RGB	\$289.95
MONOCHROME FOR IBM	\$99.95

**100 CPS PRINTER**

PARALLEL & SERIAL INPUT



**\$149.95**

**300 BAUD MODEM  
FOR APPLE OR IBM  
SOFTWARE INCLUDED**

**\$49.95**

**PRINTER CABLE  
FOR IBM  
DB25 TO CENTRONICS**

**\$9.95**

**HALF HEIGHT DRIVE  
FOR APPLE**



BAL 525 **\$99.95**

**JDR Microdevices**

1224 S. Bascom Avenue, San Jose, CA 95128

800-538-5000 • 800-662-6279 (CA) • (408) 995-5430

FAX (408) 275-8415 • Telex 171-110

RETAIL STORE - 1256 S. BASCOM AVENUE  
HOURS: M-W-F, 9-5 TU-TH, 9-9 SAT, 10-3

PLEASE USE YOUR CUSTOMER NUMBER WHEN ORDERING

TERMS: Minimum order \$10.00. For shipping and handling include \$2.50 for UPS Ground and \$3.50 for UPS Air. Orders over 1 lb. and foreign orders may require additional shipping charges - please contact our sales department for the amount. CA. residents must include applicable sales tax. All merchandise is warranted for 90 days unless otherwise stated. Prices are subject to change without notice. We are not responsible for typographical errors. We reserve the right to limit quantities and to substitute manufacturer. All merchandise subject to prior sale.

© COPYRIGHT 1985 JDR MICRODEVICES

CIRCLE 278 ON FREE INFORMATION CARD



# SPECIAL THANKS TO ALL THE FOLKS AT RADIO ELECTRONICS

### STATIC RAMS

2101	256x4	(450ns)	1.95
5101	256x4	(450ns)(CMOS)	3.95
2102-1	1024x4	(450ns)	.89
2102L-4	1024x4	(450ns)(LP)	1.95
2102L-2	1024x4	(250ns)(LP)	1.45
2125	1024x1	(45ns)	1.95
2111	256x4	(450ns)	2.49
2112	256x4	(450ns)	2.99
2114	1024x4	(450ns)	.99
2114L-4	1024x4	(450ns)(LP)	1.05
2114L-2	1024x4	(200ns)(LP)	1.49
2114L-15	1024x4	(150ns)(LP)	1.95
TC5514	1024x4	(650ns)(CMOS)	4.95
2141	4096x1	(200ns)	2.95
2147	4096x1	(55ns)	3.95
2148	1024x4	(70ns)	4.95
TMS4044-4	4096x1	(450ns)	1.95
TMS4044-2	4096x1	(250ns)	2.95
UPD410	4096x1	(100ns)	3.95
MK4118	1024x8	(250ns)	9.95
TMM2016-150	2048x8	(150ns)	1.69
TMM2016-100	2048x8	(200ns)	2.49
HM6116-4	2048x8	(200ns)(CMOS)	1.79
HM6116-3	2048x8	(150ns)(CMOS)	1.89
HM6116-2	2048x8	(120ns)(CMOS)	2.95
HM6116LP-4	2048x8	(200ns)(CMOS)(LP)	1.89
HM6116LP-3	2048x8	(150ns)(CMOS)(LP)	1.99
HM6116LP-2	2048x8	(120ns)(CMOS)(LP)	2.95
TC5516	2048x8	(250ns)(CMOS)	3.95
Z-6132	4096x8	(300ns)(QSTAT)	19.95
HM6264P-15	8192x8	(150ns)(CMOS)	4.75
HM6264LP-15	8192x8	(150ns)(CMOS)(LP)	4.95
HM6264LP-12	8192x8	(120ns)(CMOS)(LP)	5.95

LP=Low power      Qstat=Quasi-Static

### DYNAMIC RAMS

TMS4027	4096x1	(250ns)	.95
2107	4096x1	(200ns)	1.95
MMS280	4096x1	(300ns)	1.95
TMS4050	4096x1	(300ns)	1.95
UPD411	4096x1	(300ns)	1.95
TMS4060	4096x1	(300ns)	1.95
MK4108	8192x1	(200ns)	.19
MMS298	8192x1	(250ns)	.19
4116-250	16384x1	(250ns)	.49
4116-200	16384x1	(200ns)	.69
4116-150	16384x1	(150ns)	.89
4116-120	16384x1	(120ns)	1.49
2118	16384x1	(150ns)(5v)	1.95
MK4332	32768x1	(200ns)	6.95
4164-200	65536x1	(200ns)(5v)	.79
4164-150	65536x1	(150ns)(5v)	.89
4164-120	65536x1	(120ns)(5v)	1.95
MCM6665	65536x1	(200ns)(5v)	.85
TMS4164	65536x1	(150ns)(5v)	1.95
164-REFRESH	65536x1	(150ns)(5v)(REFRESH)	2.95
TMS4416	16384x4	(150ns)(5v)	4.95
41128-150	131072x1	(150ns)(5v)	5.95
41256-200	262144x1	(200ns)(5v)	3.19
41256-150	262144x1	(150ns)(5v)	3.95

5v=Single 5 Volt Supply      REFRESH=Pin 1 Refresh

### EPROMS

1702	256x8	(1us)	4.95
2708	1024x8	(450ns)	3.95
2758	1024x8	(450ns)(5V)	4.95
2716-6	2048x8	(650ns)	2.25
2716-1	2048x8	(450ns)(5V)	2.49
2716-1	2048x8	(350ns)(5V)	3.95
TMS2516	2048x8	(450ns)(5V)	3.95
TMS2716	2048x8	(450ns)	6.75
TMS2532	4096x8	(450ns)(5V)	3.95
2732A	4096x8	(450ns)(5V)	2.49
2732A-2	4096x8	(250ns)(5V)(21V PGM)	2.69
27C64	8192x8	(250ns)(5V)(CMOS)	7.95
2764	8192x8	(450ns)(5V)	2.25
2764-200	8192x8	(200ns)(5V)	4.95
MCM68766	8192x8	(450ns)(5V)	8.95
MCM68764	8192x8	(450ns)(5V)(24 pin)	16.95
MCM68766	8192x8	(350ns)(5V)(24 pin)	17.95
27128	16384x8	(250ns)(5V)	3.49
27C256	32768x8	(250ns)(5V)(CMOS)	15.95
27C256	32768x8	(250ns)(5V)	9.95

5V=Single 5 Volt Supply      21V PGM=Program at 21 Volts

★★★★HIGH-TECH★★★★

## NEC V20 μPD70108 \$20<sup>95</sup>

REPLACES 8088 TO SPEED UP IBM PC 10-40%

- \* HIGH SPEED ADDRESS CALCULATION IN HARDWARE
- \* PIN COMPATIBLE WITH 8088
- \* SUPERSET OF 8086/8088 INSTRUCTION SET
- \* LOW POWER CMOS

★★★★SPOTLIGHT★★★★

- \* COMPUTER MANAGED INVENTORY - VIRTUALLY NO BACK ORDERS!
- \* VERY COMPETITIVE PRICES
- \* FRIENDLY STAFF
- \* FAST SERVICE - MOST ORDERS SHIPPED WITHIN 24 HOURS!
- \* WE ACCEPT VISA AND MASTERCARD

### CRYSTALS

32.768 KHz	.95
1.0 MHz	2.95
1.8432	2.95
2.0	1.95
2.097152	1.95
2.4576	1.95
3.2768	1.95
3.579545	1.95
4.0	1.95
4.032	1.95
5.0	1.95
5.0688	1.95
5.185	1.95
5.7143	1.95
6.0	1.95
6.144	1.95
6.5536	1.95
8.0	1.95
10.0	1.95
10.738635	1.95
12.0	1.95
14.31818	1.95
15.0	1.95
16.0	1.95
17.430	1.95
18.0	1.95
18.432	1.95
20.0	1.95
22.1184	1.95
24.0	1.95
32.0	1.95

### CRYSTAL OSCILLATORS

1.0MHz	5.95	8.0	4.95
1.8432	5.95	10.0	4.95
2.0	5.95	12.0	4.95
2.4576	5.95	12.480	4.95
2.5	4.95	15.0	4.95
4.0	4.95	16.0	4.95
5.0688	4.95	18.432	4.95
6.0	4.95	20.0	4.95
6.144	4.95	24.0	4.95

### 74LS00

74LS00	.16	74LS191	.49
74LS01	.18	74LS192	.69
74LS02	.17	74LS193	.69
74LS03	.18	74LS194	.69
74LS04	.16	74LS195	.69
74LS05	.18	74LS196	.59
74LS08	.18	74LS197	.59
74LS09	.18	74LS221	.59
74LS10	.16	74LS222	.59
74LS11	.22	74LS241	.69
74LS12	.22	74LS242	.69
74LS13	.26	74LS243	.69
74LS14	.39	74LS244	.69
74LS15	.26	74LS245	.79
74LS20	.17	74LS247	.79
74LS21	.22	74LS248	.89
74LS22	.22	74LS249	.99
74LS26	.23	74LS251	.49
74LS27	.23	74LS253	.49
74LS28	.26	74LS256	1.79
74LS30	.17	74LS257	.39
74LS32	.18	74LS258	.49
74LS33	.28	74LS259	1.29
74LS37	.26	74LS260	.49
74LS38	.26	74LS261	1.49
74LS40	.17	74LS268	.39
74LS42	.39	74LS273	.79
74LS47	.59	74LS275	1.95
74LS48	.69	74LS279	.39
74LS49	.69	74LS280	1.98
74LS51	.17	74LS283	.39
74LS54	.22	74LS290	.89
74LS55	.22	74LS293	.89
74LS63	.89	74LS295	.69
74LS73	.29	74LS298	.69
74LS74	.24	74LS299	1.49
6845	4.95	74LS322	3.95
6845	8.95	74LS323	2.49
6847	11.95	74LS324	1.75
68047	12.95	74LS348	1.29
HD46505SP	6.95	74LS385	3.90
MCI372	2.95	74LS386	.45
8275	26.95	74LS125	.39
7220	19.95	74LS126	.39
CR15027	12.95	74LS132	.39
CR15037	9.95	74LS133	.49
TMS9918A	19.95	74LS136	.39
DP8350	39.95	74LS137	.39
		74LS138	.99
		74LS139	.39
		74LS147	.99
		74LS148	.99
		74LS151	.39
		74LS153	.39
		74LS154	1.49
		74LS155	.99
		74LS156	.49
		74LS157	.35
		74LS160	.29
		74LS161	.39
		74LS162	.49
		74LS163	.39
		74LS164	.49
		74LS165	.65
		74LS166	.95
		74LS168	.95
		74LS169	.95
		74LS170	.85
		74LS173	.49
		74LS174	.39
		74LS175	.39
		74LS181	1.49
		74LS189	4.95
		74LS190	.49

### BIT RATE GENERATORS

MC14411	9.95
BR1941	4.95
4702	9.95
COM5016	16.95
COM8116	8.95
MMS307	4.95

### CR1 CONTROLLERS

6845	4.95
6845	8.95
6847	11.95
68047	12.95
HD46505SP	6.95
MCI372	2.95
8275	26.95
7220	19.95
CR15027	12.95
CR15037	9.95
TMS9918A	19.95
DP8350	39.95

### Z-80 2.5 MHz

Z80-CPU	1.79
Z80-CTC	1.85
Z80-DART	4.95
Z80-DMA	4.95
Z80-PIO	1.85
Z80-SIO/0	4.95
Z80-SIO/1	4.95
Z80-SIO/2	4.95
Z80-SIO/9	4.95

### 4.0 MHz

Z80A-CPU	1.89
Z80A-CTC	1.95
Z80A-DART	5.95
Z80A-DMA	5.95
Z80A-PIO	1.95
Z80A-SIO/0	5.95
Z80A-SIO/1	5.95
Z80A-SIO/2	5.95
Z80A-SIO/9	5.95

### 6.0 MHz

Z80B-CPU	4.95
Z80B-CTC	8.95
Z80B-PIO	8.95
Z80B-DART	14.95
Z80B-SIO/0/12.95	
Z80B-SIO/12.95	

### ZILO8

Z6132	19.95
Z8671	19.95

### 6500 1.0 MHz

6502	2.79
65C02(cmos)	12.95
6504	6.95
6505	8.95
6507	9.95
6520	1.95
6522	4.95
6526	26.95
6532	6.95
6545	6.95
6551	5.95
6551A	19.95
6581	34.95

### 2.0 MHz

6502A	2.95
6520A	2.95
6522A	5.95
6532A	11.95
6545A	7.95
6551A	6.95

### 3.0 MHz

6502B	6.95
-------	------

### CLOCK CIRCUITS

MMS369	1.95
MMS369-EST	1.95
MMS8167	12.95
MMS1174	11.95
MMS832	2.95

### 6800

68000-8	9.95
6800	1.95
6802	4.95
6803	9.95
6808	4.95
6809	5.95
6809E	5.95
6810	1.95
6820	2.95
6821	1.95
6828	14.95
6840	6.95
6843	19.95
6844	12.95
6845	4.95
6847	11.95
6850	1.95
6852	4.95
6860	7.95
6875	6.95
6883	22.95
68047	12.95
68488	14.95

### 6800-1 MHz

68800	4.95
68802	5.95
68809E	7.95
68809	7.95
68810	3.95
68821	4.95
68840	14.95
68845	8.95
68850	3.95
68854	7.95

### 8200

8202	9.95
8203	34.95
8205	3.29
8212	1.49
8214	3.85
8216	1.49
8224	2.25
8226	1.69
8228	3.49
8237	4.95
8237-5	6.95
8238	4.49
8243	2.95
8250	6.95
8251	1.95
8251A	2.49
8253	1.95
8253-5	2.49
8255	1.95
8255-5	2.49
8257	2.49
8257-5	2.95
8259	2.49
8259-5	2.95
8271	4.95
8274	4.95
8275	26.95
8279	2.95
8279-5	3.49
8282	3.95
8283	3.95
8284	2.95
8286	3.95
8287	3.95
8298	4.95
8299	19.95
8292	12.95

### 800





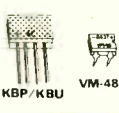


# JDR Microdevices

1224 South Bascom Avenue,  
San Jose, CA 95128 (408) 995-5430

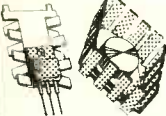
## DIODES

1N751	5.1 VOLT ZENER	.25
1N759	12.0 VOLT ZENER	.25
1N4148	(1N914)SWITCHING	25/1.00
1N4001	50PIV 1A RECT	12/1.00
1N4004	400PIV RECT	10/1.00
1N5402	200PIV 3A RECT	.25
KBP02	200PIV 1.5A BRIDGE	.45
KBP04	400PIV 1.5A BRIDGE	.55
KBU8A	50PIV 8A BRIDGE	.95
MDA990-2	100PIV 27A BRIDGE	2.25
VM48	DIP BRIDGE	.35



## TRANSISTOR MTG. HDW.

HEAT SINK	TO-220	SCREW ON	.35
HEAT SINK	TO-220	CLIP ON	.35
HEAT SINK	TO-3	SCREW ON	.95
INSULATOR	TO-220		10/1.00
INSULATOR	TO-3		10/1.00
SOCKET	TO-3		.39



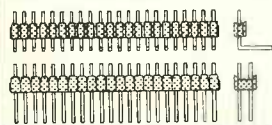
SCREW ON

CLIP ON

## HARD TO FIND "SNAPABLE" HEADERS

CAN EASILY BE SNAPPED APART TO MAKE ANY SIZE HEADER, ALL WITH .1" CENTERS

1x40	STRAIGHT LEAD	.99
1x40	RIGHT ANGLE	1.49
2x40	STRAIGHT LEAD	2.49
2x40	RIGHT ANGLE	2.99



## ELECTRONIC SOLDER

- \* .025" DIAM.
  - \* ROSIN CORE
  - \* 60% TIN
  - \* 40% LEAD
  - \* 1 lb. SPOOL
- \$9.95**

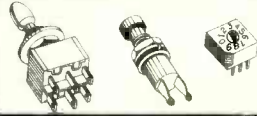


## DIP SWITCHES

4 POS	.85	7 POS	.95
5 POS	.90	8 POS	.95
6 POS	.90	10 POS	1.29

## SWITCHES

SPDT	MINI-TOGGLE ON-ON	1.25
DPDT	MINI-TOGGLE ON-ON	1.50
DPDT	MINI-TOGGLE ON-OFF-ON	1.75
SPST	MINI-PUSHBUTTON N.O.	.39
SPST	MINI-PUSHBUTTON N.C.	.39
SPST	TOGGLE ON-OFF	.39
BCD	OUT 10 POSITION 6 PIN DIP	1.95



## SHORTING BLOCKS

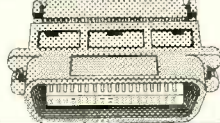
GOLD CONTACTS SPACED AT .1" CENTERS IDEAL FOR DISK DRIVES, OR ANY .1" HEADER

**5/\$1.00**



## 36 PIN CENTRONICS

IDCEN36	RIBBON CABLE MALE	6.95
IDCEN36/F	RIBBON CABLE FEMALE	7.95
CEN36	SOLDER CUP MALE	4.95
CEN36PC	RT ANGLE PC MNT MALE	4.95



## 25 PIN D-SUB BENDER CHANGERS

**\$7.95**



## SHIELDED ROUND CABLE

- \* 11 CONDUCTOR
- \* COLOR CODED

**99¢/FOOT**



## D-SUB ACCESSORIES

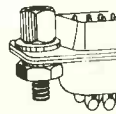
### STAINLESS STEEL WALL PLATE

SINGLE \$1.95  
DOUBLE \$1.95



## MOUNTING HARDWARE

INCLUDES  
2 BOLTS,  
2 NUTS,  
4 WASHERS  
\$1.00/PAIR



## BYPASS CAPACITOR SPECIALS

.01µf	50 VOLTS	100/\$5.00
.1 µf	12 VOLTS	100/\$6.50

## MONOLITHIC

.01µf	50 VOLTS	100/\$10.00
.1 µf	50 VOLTS	100/\$12.50

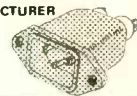
## MOLDED RF CHOKES

1µH	.75	22µH	1.00
3.3	.75	47	1.00
10	1.00	68	1.00
15	1.00	100	1.25
18	1.00	220	1.25
		270	1.25

## EMI FILTER

- \* MAJOR MANUFACTURER
- \* LOW COST
- \* FITS OUR LINE CORD LC-HP

**\$4.95**

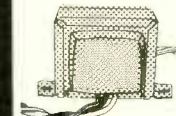


## TRANSFORMERS FRAME STYLE

12.6V AC CT	2 AMP	5.95
12.6V AC CT	4 AMP	7.95
12.6V AC CT	8 AMP	10.95
25.2V AC CT	2 AMP	7.95

## PLUG CASE STYLE

9V DC	350ma	2.95
12V DC	350ma	3.95
12V AC	250ma	3.95
12V AC	500ma	4.95
12V AC	1 AMP	5.95
12V AC	2 AMP	6.95



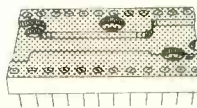
FRAME STYLE

PLUG STYLE

## DIP CONNECTORS

DESCRIPTION	ORDER BY	CONTACTS								
		8	14	16	18	20	22	24	28	40
HIGH RELIABILITY TOOLED ST IC SOCKETS	AUGATxxST	.62	.79	.89	1.09	1.29	1.39	1.49	1.69	2.49
HIGH RELIABILITY TOOLED WW IC SOCKETS	AUGATxxWW	1.30	1.80	2.10	2.40	2.50	2.90	3.15	3.70	5.40
COMPONENT CARRIES (DIP HEADERS)	ICCxx	.49	.59	.69	.99	.99	.99	.99	1.09	1.49
RIBBON CABLE DIP PLUGS (IDC)	IDPxx	---	.95	.95	---	---	---	1.75	---	2.95

FOR ORDERING INSTRUCTIONS SEE D-SUBMINIATURE BELOW



AUGAT24ST

## RIBBON CABLE

CONTACTS	SINGLE COLOR		COLOR CODED	
	1'	10'	1'	10'
10	.18	1.60	.30	2.75
16	.28	2.50	.48	4.40
20	.36	3.20	.60	5.50
25	.45	4.00	.75	6.85
26	.46	4.10	.78	7.15
34	.61	5.40	1.07	9.35
40	.72	6.40	1.20	11.00
50	.89	7.50	1.50	13.25

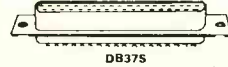
## D-SUBMINIATURE

DESCRIPTION	ORDER BY	CONTACTS					
		9	15	25	37	50	
SOLDER CUP	MALE	DBxxP	.82	.90	1.25	1.80	3.48
	FEMALE	DBxxS	.95	1.15	1.50	2.35	4.32
RIGHT ANGLE PC SOLDER	MALE	DBxxPR	1.20	1.49	1.95	2.65	---
	FEMALE	DBxxSR	1.25	1.55	2.00	2.79	---
WIRE WRAP	MALE	DBxxPWW	1.69	2.56	3.89	5.60	---
	FEMALE	DBxxSww	2.76	4.27	6.84	9.95	---
IDC RIBBON CABLE	MALE	IDBxxP	2.70	2.95	3.98	5.70	---
	FEMALE	IDBxxS	2.92	3.20	4.33	6.76	---
HOODS	METAL	MHOODxx	1.25	1.25	1.30	---	---
	GREY	HOODxx	.65	.65	.65	.75	.95

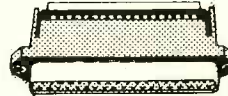
ORDERING INSTRUCTIONS: INSERT THE NUMBER OF CONTACTS IN THE POSITION MARKED "xx" OF THE "ORDER BY" PART NUMBER LISTED.  
EXAMPLE: A 15 PIN RIGHT ANGLE MALE PC SOLDER WOULD BE DB15PR.



HOD25

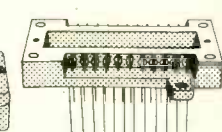
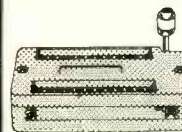


DB37S



IDB37S

## TEXTOL ZERO INSERTION FORCE SOCKETS AND RECEPTACLES



ZIF SOCKET

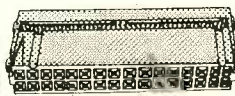
ZIF RECEPTACLE

TYPE	CONTACTS				
	14	16	24	28	40
ZIF SOCKET	4.95	4.95	5.95	6.95	9.95
ZIF RECEPTACLE	8.25	8.75	9.75	10.50	12.75

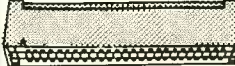
## IDC CONNECTORS

DESCRIPTION	ORDER BY	CONTACTS					
		10	20	26	34	40	50
SOLDER HEADER	IDHxxS	.82	1.29	1.68	2.20	2.58	3.24
RIGHT ANGLE SOLDER HEADER	IDHxxSR	.85	1.35	1.76	2.31	2.72	3.39
	WW HEADER	IDHxxW	1.86	2.98	3.84	4.50	5.28
RIGHT ANGLE WW HEADER	IDHxxWR	2.05	3.28	4.22	4.45	4.80	7.30
RIBBON HEADER SOCKET	IDSxx	.79	.99	1.39	1.59	1.99	2.25
RIBBON HEADER	IDMxx	---	5.50	6.25	7.00	7.50	8.50
RIBBON EDGE CARD	IDExx	1.75	2.25	2.65	2.75	3.80	3.95

FOR ORDERING INSTRUCTIONS SEE D-SUBMINIATURE ABOVE



IDS34



IDE50

## EDGE CARD CONNECTORS



62 PIN ST

100 PIN SOLDER TAIL	S-100	.125	3.95
100 PIN WIRE WRAP	S-100	.125	4.95
72 PIN SOLDER TAIL	STD	.100	6.95
72 PIN WIRE WRAP	STD	.100	7.95
62 PIN SOLDER TAIL	IBM PC	.100	2.95
50 PIN SOLDER TAIL	APPLE	.100	2.95
44 PIN SOLDER TAIL	STD	.156	1.95
44 PIN WIRE WRAP	STD	.156	4.95

**ALL MERCHANDISE 100% GUARANTEED**

© COPYRIGHT 1985 JDR MICRODEVICES

CIRCLE 279 ON FREE INFORMATION CARD



ORDER TOLL FREE

800-538-5000

800-662-6279 (CA)

**CAPACITORS**

**SILVER MICA**  
±5% TOLERANCE

10pf	100V	.35	100pf	100V	.40
12	100V	.39	120	100V	.40
22	100V	.39	180	100V	.40
27	100V	.39	220	100V	.50
30	100V	.39	330	100V	.50
33	100V	.39	470	100V	.60
39	100V	.39	510	100V	.60
47	100V	.39	560	100V	.60
56	100V	.39	620	100V	.60
65	100V	.35	680	100V	.75
68	100V	.35	820	100V	.75
82	100V	.35	1000	100V	.75

**MONOLITHIC**

.01µf	50V	.14	50V	.18	
.04	50V	.15	47	50V	.25.

**TANTALUM**

22µf	35V	.40	3.3µf	35V	.65
27	35V	.40	4.7	10V	.85
33	35V	.40	4.7	25V	.85
47	35V	.45	4.7	35V	.85
.68	15V	.45	6.8	15V	.70
1.0	15V	.35	6.8	25V	.75
1.0	20V	.38	10	10V	.65
1.0	25V	.40	10	15V	.80
1.0	35V	.45	10	20V	.85
2.2	15V	.40	10	25V	.90
2.2	20V	.45	10	35V	1.00
2.2	35V	.65	22	10V	1.00
2.7	35V	.65	22	15V	1.35
3.3	15V	.50	27	15V	2.25

**ELECTROLYTIC**

RADIAL		AXIAL			
.47µf	50V	.14	.47µf	50V	.14
1	50V	.14	1	50V	.14
2.2	35V	.15	4.7	16V	.14
4.7	50V	.15	10	16V	.14
10	50V	.15	10	50V	.16
47	35V	.18	22	16V	.14
100	16V	.18	47	50V	.20
100	50V	.23	100	15V	.20
220	35V	.20	100	35V	.25
470	16V	.25	220	25V	.30
470	25V	.30	470	50V	.50
1000	16V	.60	100C	16V	.60
2200	16V	.70	100C	35V	.75
4700	25V	1.45	220C	16V	.70
			470C	16V	1.25

**COMPUTER GRADE**

32,000µf	25V	2.95	44,000µf	30V	3.95
----------	-----	------	----------	-----	------

**CERAMIC DISC**

10pf	50V	.05	560pf	50V	.05
22	50V	.05	680	50V	.05
27	50V	.05	820	50V	.05
33	50V	.05	.001µf	50V	.05
47	50V	.05	.0015	50V	.05
56	50V	.05	.0022	50V	.05
68	50V	.05	.005	50V	.05
82	50V	.05	.01	50V	.07
100	50V	.05	.02	50V	.07
220	50V	.05	.05	50V	.07
330	50V	.05	.1	12V	.10
470	50V	.05	.1	50V	.12

**RESISTOR NETWORKS**

**SIPs**

10 PIN 9 RESISTOR

1-24	25 UP
.69	.45

8 PIN 7 RESISTOR

1-24	25 UP
.59	.38

14 PIN 7 RESISTOR

1-24	25 UP
.99	.73

16 PIN 8 RESISTOR

1-24	25 UP
1.09	.82

14 PIN 13 RESISTOR

1-24	25 UP
.99	.76

16 PIN 15 RESISTOR

1-24	25 UP
1.09	.85

AVAILABLE VALUES: 100, 220, 330, 470, 680, 1K, 2.2K, 3.3K, 4.7K, 6.8K, 10K, 22K, 33K, 47K, 100K

**TRIMMER POTENTIOMETERS**

**SINGLE TURNS**  
72PRxx

1-24	25 UP
.99	.85

**15 TURN**  
89PRxx

1-24	25 UP
1.49	1.28

**SINGLE TURN**  
91ARxx

1-24	25 UP
.99	.88

AVAILABLE VALUES: 100, 500, 1K, 5K, 10K, 20K, 50K, 100K, 1 MEG.  
ORDERING INSTRUCTIONS: INSERT RESISTANCE VALUE IN PLACE OF "xx"  
EXAMPLE: A 500 OHM 89 SERIES POTENTIOMETER WOULD BE 89PR500

**PAGE WIRE WRAP WIRE**

**PRECUT AND STRIPPED**

Note: 1 inch of insulation is stripped on each end. 3.5" wire has only 1.5 inches of insulation.

LENGTH (INCHES)	QUANTITY	500
2.5	1.60	4.70
3.0	1.60	4.70
3.5	1.65	5.00
4.0	1.75	5.40
4.5	1.80	5.75
5.0	1.85	6.10
5.5	1.90	6.50
6.0	2.00	6.85
6.5	2.30	7.80
7.0	2.40	8.20
8.0	2.60	8.95
9.0	2.70	9.80
10.0	2.90	10.50

**PRECUT ASSORTMENT**

IN ASSORTED COLORS \$27.50  
100ea: 5.5", 6.0", 6.5", 7.0"  
250ea: 2.5", 4.5", 5.0"  
500ea: 3.0", 3.5", 4.0"

**SPOOLS**

100 feet	\$4.30	250 feet	\$7.25
500 feet	\$13.25	1000 feet	\$21.95

Please specify color: Blue, Black, Yellow or Red

**RESISTORS**

1/4 WATT 5% CARBON FILM ALL STANDARD VALUES FROM 1 OHM TO 10 MEG. OHM

10 PIECES SAME VALUE	.05
50 PIECES SAME VALUE	.025
100 PIECES SAME VALUE	.02
1000 PIECES SAME VALUE	.015

**16 PIN 14 LINE TERMINATOR**

AVAILABLE IN ONLY 180/390, 220/270, 220/330

1-24	25 UP
1.49	1.05

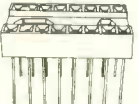
**MUFFIN FANS**

MADE BY	JDR #	SIZE	CFM	VOLTS	PRICE
MASUSHITA	MUFFIN DC	3" 8" sq x 1.25"	16	12 VDC	\$16.95
ROTRON	MUFFIN ROTRON	3" 5" sq x 1.65"	34	115 AC	\$14.95
ETRI	MUFFIN 3	3.63" sq x 1.00"	32	115 AC	\$12.95
ETRI	MUFFIN 4	4.2" sq x 1.52"	55	115 AC	\$14.95
TORIN	MUFFIN 230	4.2" sq x 1.50"	60	230 AC	\$4.95

**TWO LEVEL WIRE WRAP SOCKETS**

THESE SOCKETS HAVE .50" LEADS, JUST A LITTLE BIT SHORTER THAN THE 3 LEVEL WIRE WRAP SOCKETS WITH .6" LEADS

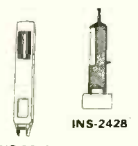
8 PIN WW-2	.40	.35
14 PIN WW-2	.45	.39
16 PIN WW-2	.45	.39
20 PIN WW-2	.75	.59
22 PIN WW-2	.50	.39
24 PIN WW-2	.69	.75
28 PIN WW-2	.89	.75



**OK INDUSTRIES**

**EX-2 IC EXTRACTION TOOL**

- EXTRACTS 24-40 PIN DEVICES
- HEAVY DUTY METAL CONSTRUCTION
- GROUND LUGS FOR MOS EXTRACTIONS
- EASY ONE HAND OPERATION \$12.74



**IC INSERTION TOOLS**

- INS-1416 for 14-16 pin IC's \$5.15
  - MOS-1416 for 14-16 pin IC's \$10.92
  - MOS-2428 for 24-28 pin IC's \$10.92
  - MOS-40 for 40 pin IC's \$12.43
- MOS series insertion tools have metal construction and include grounding lug for CMOS applications.

**BW-630 WIRE WRAP GUN**

- BATTERY POWERED-USES 2 NI-CAD C CELLS (NOT INCLUDED)
- POSITIVE INDEXING
- ANTI-OVERWRAP DEVICE \$41.55



**WSU-30 WIRE WRAP TOOLS**

- WRAPS, STRIPS, AND UNWRAPS
- WSU-30M WRAPS AN EXTRA TURN OF INSULATION
- WSU-30 \$8.84 / WSU-30M \$10.14

**WIRE WRAP TERMINALS**

WWT-1	SLOTTED	25 / \$7.06
WWT-2	SINGLE SIDED	25 / \$4.25
WWT-3	IC SOCKET	25 / \$7.06
WWT-4	DOUBLE SIDED	25 / \$2.80
INS-1	INSERTION TOOL	\$3.64

**WIRE DISPENSER**

- WITH 50' ROLL OF WIRE
- BUILT IN PLUNGER CUTS WIRE
- BUILT IN STRIPPER STRIPES 1"
- REFILLABLE

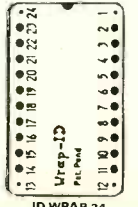
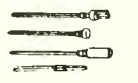
WD-30 \$6.50 WD-30TRI \$9.50  
Specify Blue, white, Yellow or Red With 50' of each: Red, Blue and White

**SOCKET-WRAP I.D.™**

- SLIPS OVER WIRE WRAP PINS
- IDENTIFIES PIN NUMBERS ON WRAP SIDE OF BOARD
- CAN WRITE ON PLASTIC, SUCH AS IC #

PINS	PART#	PCK. OF	PRICE
8	IDWRAP 08	10	1.95
14	IDWRAP 14	10	1.95
16	IDWRAP 16	10	1.95
18	IDWRAP 18	5	1.95
20	IDWRAP 20	5	1.95
22	IDWRAP 22	5	1.95
24	IDWRAP 24	5	1.95
28	IDWRAP 28	5	1.95
40	IDWRAP 40	5	1.95

PLEASE ORDER BY NUMBER OF PACKAGES (PCK. OF)



**WIRE WRAP PROTOTYPE CARDS**

FR-4 EPOXY GLASS LAMINATE WITH GOLD-PLATED EDGE-CARD FINGERS

**IBM**

BOTH CARDS HAVE SILK SCREENED LEGENDS AND INCLUDES MOUNTING BRACKET  
IBM-PR1 WITH +5V AND GROUND PLANE \$27.95  
IBM-PR2 AS ABOVE WITH DECODING LAYOUT \$29.95



IBM-PR2



IBM-PR1

**S-100**

P100-1	BARE - NO FOIL PADS	\$15.15
P100-2	HORIZONTAL BUS	\$21.80
P100-3	VERTICAL BUS	\$21.80
P100-4	SINGLE FOIL PADS PER HOLE	\$22.75

**APPLE**

P500-1	BARE - NO FOIL PADS	\$15.15
P500-3	HORIZONTAL BUS	\$22.75
P500-4	SINGLE FOIL PADS PER HOLE	\$21.80
7060-45	FOR APPLE IIe AUX SLOT	\$30.00

**GENERAL PURPOSE**

22/44 PIN EDGE-CARD (.156" SPACING)

P441-1	4.5" x 6.0" BARE - NO FOIL PADS	\$9.45
P441-3	4.5" x 6.0" VERTICAL BUS	\$13.95
P441-4	4.5" x 6.0" SINGLE FOIL PADS	\$14.20
P442-1	4.5" x 9.0" BARE - NO FOIL PADS	\$10.40
P442-3	4.5" x 9.0" VERTICAL BUS	\$14.20
P442-4	4.5" x 9.0" SINGLE FOIL PADS	\$13.50

36/72 PIN EDGE-CARD (.1" SPACING)

P721-1	4.5" x 6.0" BARE - NO FOIL PADS	\$9.45
P721-3	4.5" x 6.0" VERTICAL BUS	\$13.25
P721-4	4.5" x 6.0" SINGLE FOIL PADS	\$14.20
P722-1	4.5" x 9.0" BARE - NO FOIL PADS	\$10.40
P722-3	4.5" x 9.0" VERTICAL BUS	\$14.20
P722-4	4.5" x 9.0" SINGLE FOIL PADS	\$15.15

NO EDGE-CARD FINGERS

P25x45	2.5" x 4.5" BARE - NO FOIL PADS	\$2.40
P45x65	4.5" x 6.5" BARE - NO FOIL PADS	\$4.70
P45x85	4.5" x 8.5" BARE - NO FOIL PADS	\$6.20
P45x17	4.5" x 17.0" BARE - NO FOIL PADS	\$11.35
P85x170	8.5" x 17.0" BARE - NO FOIL PADS	\$18.95



P100-2



P500-3

CALL FOR VOLUME QUOTES

© COPYRIGHT 1985 JDR MICRODEVICES

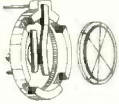
CIRCLE 280 ON FREE INFORMATION CARD





### LITHIUM BATTERY

AS USED IN CLOCK CIRCUITS



3 VOLT BATTERY \$3.95  
BATTERY HOLDER \$1.49

### RELAYS

VOLTAGE	CONTACTS	FITS	PRICE
5 VDC	SPST REED	DIP	3.95
12 VDC	DPDT 2 AMP	DIP	3.95
6 VDC	6PDT 3 AMP	RELAY SOC	2.95
12 VDC	4PDT 3 AMP	RELAY SOC	3.95
24 VDC	DPDT 3 AMP	RELAY SOC	3.95
48 VDC	4PDT 3 AMP	RELAY SOC	3.95
120 VAC	4PDT 3 AMP	RELAY SOC	3.95

### RF MODULATOR

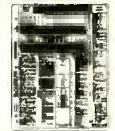
ASTEC MODEL UM1082  
• PRESET TO CHANNEL 3  
• USE TO BUILD TV-COMPUTER INTERFACE  
• +5 VOLT OPERATION

\$6.95



### MICRO CHART® INSTANT DATA CARDS

ONLY \$5.95



- CLEAR AND CONCISE DATA ON MICROPROCESSORS, ELECTRONICS, PROGRAMMING AND MORE
- SOLID PLASTIC, LASTS A LIFETIME
- PLANNED FOR INSTANT ACCESS TO DATA
- TWO COMPREHENSIVE 8 1/2" SIDES
- ATTRACTIVE TWO COLOR SHARP PRINTING
- CLEARS WORKSPACE OF BOOKS AND MANUALS
- NOTE: MPU CARDS COVER FULL INST. SET (DESCR., HEX, CYCLE, FLAG), DISASSEMBLY, ASCII, HEX, DEC, INTERRUPT STRUC., PINOUT, DIAGRAMS, NOTES AND MORE

### AVAILABLE TITLES

- MC-8086 8086 AND 8088 MPU's
- MC-Z80 Z80 MPU
- MC-6502 6502 (65xx)MPU's
- MC-8085 8080 AND 8085A MPU's
- MC-8048 8048 SINGLE CHIP MPU FAMILY
- MC-CL "C" LANGUAGE: COMPREHENSIVE REFERENCE FOR PROS AND BEGINNERS FAST AND EASY INTRO TO BASIC PROGRAMMING
- MC-IBAS PINOUTS AND FUNCTIONS OF VIRTUALLY ALL 54/7400 TTL IN NEW COMPACT TABLE FORMAT (REG. H. L. L.S. S)
- MC-7400 BASIC OPERATION OF DIODES, TRANSISTORS, THYRISTORS, OP AMPS AND MUCH MORE
- MC-COMP WORDSTAR/MAILMERGE REFERENCE: TWICE THE INFO OF KEYBOARD OVERLAYS
- MC-WS HOW TO GENERALIZE FROM SMALL SAMPLES - FOR Q/C TESTING, RESEARCH, POLLING, ETC.
- MC-ALG ALGORITHMS (PROGRAMS) IN BASIC FOR SORTING, SEARCHING PLOTTING, ETC.

### GE NICKEL-CADMIUM RECHARGEABLE BATTERIES

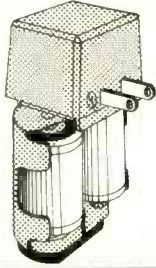
NI-CAD CHARGER PACKAGE

PRICE INCLUDES CHARGER (WALL PLUG), BATTERIES, & MODULAR BATTERY HOLDER

AAA CELLS	QTY. 2	\$11.71
AA CELLS	QTY. 2	\$11.71
C CELLS	QTY. 2	\$13.21
D CELLS	QTY. 2	\$13.21
9 VOLT	QTY. 1	\$13.21

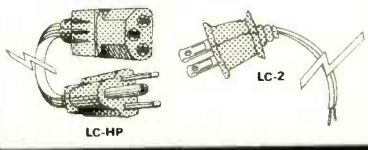
### BATTERIES ONLY

AAA CELLS	PKG. 2	\$6.07 pr.
AA CELLS	PKG. 1	\$3.03 ea.
C CELLS	PKG. 1	\$3.78 ea.
D CELLS	PKG. 1	\$3.78 ea.
9 VOLT	PKG. 1	\$7.57 ea.



### SIX FOOT LINE CORDS

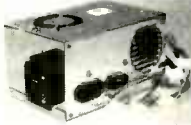
LC-2	2 CONDUCTOR	.39
LC-3	3 CONDUCTOR	.99
LC-HP	3 CONDUCTOR WITH STANDARD FEMALE SOCKET	1.49
LC-CIR	CIGARETTE LIGHTER PLUG	2.95



### SWITCHING POWER SUPPLIES

PS-IBM \$99.95

- FOR IBM PC-XT COMPATIBLE
- 130 WATTS
- +5V @ 15A, +12V @ 4.2A
- -5V @ .5A, -12V @ .5A
- ONE YEAR WARRANTY



PS-IBM-150 \$129.95

- FOR IBM PC-XT COMPATIBLE
- +12 @ 5.2A, +5 @ 16A
- -12 @ .5A, -5 @ .5A
- ONE YEAR WARRANTY

PS-100 \$89.95

- 100 WATTS
- SWITCH ON REAR
- FOR USE IN OTHER IBM TYPE MACHINES
- 90 DAY WARRANTY



PS-130 \$99.95

- 130 WATTS
- SWITCH ON REAR
- FOR USE IN OTHER IBM TYPE MACHINES
- 90 DAY WARRANTY



PS-A \$49.95

- USE TO POWER APPLE TYPE SYSTEMS
- +5V @ 4A, +12V @ 2.5A
- -5V @ .5A, -12V @ .5A
- APPLE POWER CONNECTOR



PS-3 \$39.95

- AS USED IN APPLE III
- +5V @ 4A, +12V @ 2.5A
- -5V @ .25A, -12V @ .30A,
- 15.5" x 4.5" x 2.0", .884 LBS.



PS-ASTEC \$19.95

- CAN POWER TWO 5 1/4" FDDS
- +5V @ 2.5A, +12V @ 2A
- -12V @ .1A
- +5V @ 5A IF +12V IS NOT USED
- 6.3" x 4.0" x 1.9", 1 LB.



PS-TDK \$29.95

- +5V @ 4A, +12V @ 2A
- +12V @ 2.8A, -12V @ .30A
- 6.2" x 7.4" x 1.7", 1.6 LBS.



PS-PLUG \$9.95

- SPACE SAVING DESIGN - POWER SUPPLY HOUSED IN PLUG STYLE CASE
- +5V @ 600ma
- +12V @ 200ma
- -12V @ 200ma
- 5.5" x 2.5" x 2.0", 2.0 LBS.
- UL APPROVED



### NEW BOOKS BY STEVE CIARCIA

- BUILD YOUR OWN Z80 COMPUTER \$19.95
- CIRCUIT CELLAR VOLUME 1 \$17.95
- CIRCUIT CELLAR VOLUME 2 \$18.95
- CIRCUIT CELLAR VOLUME 3 \$18.95
- CIRCUIT CELLAR VOLUME 4 \$18.95

### MICROCOMPUTER HARDWARE HANDBOOK FROM ELCOMP \$14.95

OVER 800 PAGES OF MANUFACTURER'S DATA SHEETS ON THE MOST COMMONLY USED IC's

- TTL - 74, 74LS & 74F
- CMOS
- Voltage Regulators
- Memory-RAM, ROM, EPROM
- CPU'S - 6800, 6500, Z80, 8080, 8085 & 8086/3
- MPU Support & Interface, 6800, 6500, Z80, 8200, etc.

### DATARASE EPROM ERASER \$34.95

- ERASES 2 EPROMS IN 10 MINUTES
- LOW COST
- COMPACT - NO DRAWER
- SLIDE EPROMS INTO CASE
- THIN METAL SHUTTER PREVENTS UV LIGHT FROM ESCAPING

### EPROM ERASERS



Model	Timer	Capacity Chip	Intensity (uW / Cm <sup>2</sup> )	Unit Price
PE-14	NO	9	8,000	\$83.00
PE-14T	YES	9	8,000	\$119.00
PE-24T	YES	12	9,600	\$175.00
PL-265T	YES	30	9,600	\$255.00

### IC MASTER \$79.95 THE INDUSTRY STANDARD



A COMPLETE LISTING OF CURRENTLY MANUFACTURED INTEGRATED CIRCUITS FROM OVER 225 MANUFACTURERS. IT INCLUDES A PART NUMBER INDEX, AN ALTERNATIVE SOURCE GUIDE AS WELL AS SPECIFICATION AND APPLICATION NOTES ON THOUSANDS OF DEVICES.

### NATIONAL SEMICONDUCTOR DATABOOKS

CMOS DATABOOK	\$9.95
LOGIC DATABOOK (2 VOLT SET)	\$24.95
VOLTAGE REGULATOR DATABOOK	\$7.95
TRANSISTOR DATABOOK	\$7.95

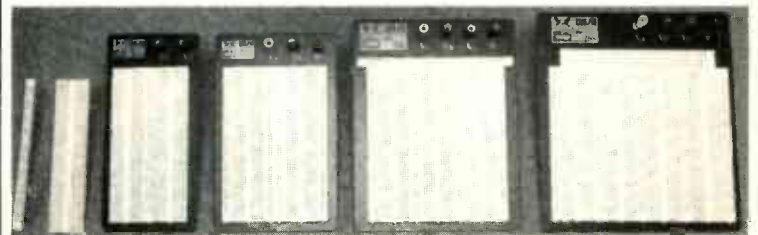
### BEST SELLING BOOKS OSBORNE

APPLE II USERS GUIDE	\$18.95
CRT CONTROLLER HANDBOOK	\$9.95
MS DOS USERS GUIDE	\$16.95
68000 ASM. PROGRAMMING	\$19.95
THE 8086 BOOK	\$18.95
UNDERSTANDING DBASE II	\$22.95

### SYBEX

PROCESSOR INTERFACING TECH.	\$19.95
THE MS DOS HANDBOOK	\$16.95
THE RS232 SOLUTION	\$16.95
Z80 APPLICATIONS	\$17.95
PROGRAMMING THE 8086/8088	\$15.95

### WISH SOLDERLESS BREADBOARDS



PART NUMBER	DIMENSIONS	DISTRIBUTION STRIP(S)	TIE POINTS	TERMINAL STRIP(S)	TIE POINTS	BINDING POSTS	PRICE
WBU-D	.38 x 6.50"	1	100	---	---	---	2.95
WBU-T	1.38 x 6.50"	---	---	1	630	---	6.95
WBU-204-3	3.94 x 8.45"	1	100	2	1260	2	17.95
WBU-204	5.13 x 8.45"	4	400	2	1260	3	24.95
WBU-206	6.88 x 9.06"	5	500	3	1890	4	29.95
WBU-208	8.25 x 9.45"	7	700	4	2520	4	39.95

## ALL MERCHANDISE 100% GUARANTEED

© COPYRIGHT 1985 JDR MICRODEVICES

CIRCLE 281 ON FREE INFORMATION CARD



ORDER TOLL FREE

800-538-5000

800-662-6279 (CA)

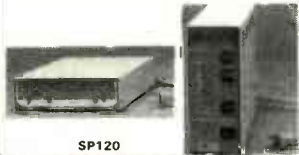
**BAL PRINTER BUFFERS**

- FREES COMPUTER FOR OTHER TASKS WHILE PRINTING LONG DOCUMENTS.
- STANDALONE DESIGN - WORKS WITH ANY COMPUTER OR PRINTER.
- ALL MODELS FEATURE PRINT PAUSE, MEMORY CHECK AND GRAPHICS CAPABILITY.

**SP120P PARALLEL \$139.95**  
 • 64K UPGRADABLE TO 256K  
 • LED INDICATOR SHOWS VOLUME OF DATA IN BUFFER

**SP120S RS232 SERIAL \$159.95**  
 • 64K UPGRADABLE TO 512K  
 • SIX SELECTABLE BAUD RATES FROM 600B - 19,200B

**SP110 PARALLEL \$249.95**  
 • 64K UPGRADABLE TO 256K  
 • SPOOLS OUTPUT OF UP TO THREE COMPUTERS  
 • LED BARGRAPH DISPLAYS AMOUNT OF DATA IN BUFFER  
 • RESET FUNCTION CLEARS DATA IN BUFFER  
 • REPEAT FUNCTION CAN PRODUCE MULTIPLE COPIES OF A DOCUMENT



SP120

**BAL 3-WAY SWITCH BOXES**

- SERIAL OR PARALLEL
- CONNECTS 3 PRINTERS TO 1 COMPUTER OR 3 COMPUTERS TO 1 PRINTER
- ALL LINES SWITCHED
- HIGH QUALITY ROTARY SWITCH MOUNTED ON PCB
- GOLD CONTACTS
- STURDY METAL ENCLOSURE



**SWITCH-3P CENTRONICS PARALLEL 99.95**  
**SWITCH-3S RS232 PARALLEL 99.95**

**IBM PRINTER CABLE**

- DB25 TO CENTRONICS
- SHIELDED CABLE

**\$9.95**

**JOYSTICKS**



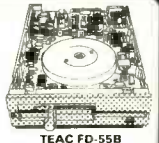
**\$7.95**

**\$4.95**

**FLOPPY DISK DRIVES**

**TEAC**

**FD-55B 1/2 HEIGHT DS/DD \$89.95**  
**FD-55F 1/2 HEIGHT DS/QUAD \$99.95**



TEAC FD-55B

**SHUGART**

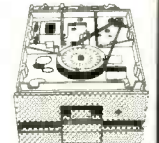
**SA460 5/4" (80 TRACK) DS/QUAD \$199.95**

**TANDON**

**TM100-2 5/4" (FOR IBM) DS/DD \$99.95**

**MPI**

**MPI-B52 5/4" (FOR IBM) DS/DD \$89.95**



TANDON TM100-2

**SIEMENS 8" DISK DRIVES**

**FD100-8 SS/DD SA801 EQUIV \$119.00**

**FD200-8 DS/DD SA851 EQUIV \$159.00**

**JFORMAT-2 SOFTWARE \$49.95**

SUPPORT FOR QUAD DENSITY DRIVES FROM TALL TREE SYSTEMS

**DISK DRIVE CABINETS**

**5 1/4" DRIVE ENCLOSURES**

**CAB-APPLE APPLE TYPE DRIVE CABINET WITHOUT POWER SUPPLY \$24.95**  
**CAB-1FH5 FULL HEIGHT 5 1/4" BEIGE DRIVE CABINET WITH POWER SUPPLY \$69.95**  
**CAB-2SV5 DUAL SLIMLINE 5 1/4" CABINET WITH POWER SUPPLY - VERTICAL MOUNT \$49.95**

**8 INCH DRIVE ENCLOSURES BY JMR**

**CAB-2SV8 DUAL SLIMLINE 8" DRIVE CABINET WITH POWER SUPPLY - VERTICAL MOUNT \$209.95**  
**CAB-2FH8 DUAL FULL HEIGHT 8" DRIVE CABINET WITH POWER SUPPLY - HORIZONTAL \$219.95**



CAB-1FH5



CAB-2SV5



CAB-2FH8

**NASHUA DISKETTE SPECIALS**

**5 1/4" SOFT SECTOR DS/DD WITH HUB RINGS**

**\$9.90 BOX OF 10**  
**89Cea BULK QTY 50**  
**79Cea BULK QTY 250**

NASHUA DISKETTES WERE JUDGED TO HAVE THE HIGHEST POLISH AND RECORDED AMPLITUDE OF ANY DISKETTES TESTED. SEE "COMPARING FLOPPY DISKS", BYTE 9-84.

**DISKETTE FILE**

**\$8.95**



**DISKETTES**

**NASHUA 5 1/4"**

**N-MD2D DS/DD SOFT SECTOR \$9.90**  
**N-MD2F DS/QUAD SOFT SECTOR \$34.95**  
**N-MD2H DS/HIGH DENSITY FOR AT \$49.95**

**NASHUA 8"**

**N-FD1 SS/DD SOFT SECTOR \$27.95**  
**N-FD20 DS/DD SOFT SECTOR \$34.95**

**NASHUA 3.5"**

**N-3.5SS 3.5" SS/DD FOR MACINTOSH \$32.95**

**VERBATIM 5 1/4"**

**V-MD10 SS/DD SOFT SECTOR \$23.95**  
**V-MD2D DS/DD SOFT SECTOR \$29.95**  
**V-MD110D SS/DD 10 SECTOR HARD \$23.95**

**IBM STYLE COMPUTER CASE**

ATTRACTIVE STEEL CASE, WITH HINGED LID, FITS POPULAR PC/XT COMPATIBLE MOTHER-BOARDS.

- SWITCH CUT-OUT ON SIDE FOR PC/XT STYLE POWER SUPPLY
- CUT-OUT FOR 8 EXPANSION SLOTS
- ALL HARD WARE INCLUDED

**ONLY \$59.95**



**IBM COMPATIBLE KEYBOARDS**

**DKM-2000 \$78.95**

- FULLY IBM COMPATIBLE
- 83 KEY WITH CAPACITANCE TYPE SWITCHES
- LED STATUS INDICATORS FOR CAPS, NUMBER LOCK
- AUDIBLE CLICK



**KB-5151 \$89.95**

- ENHANCED IBM COMPATIBLE
- SEPARATE CURSOR AND NUMERIC KEYPADS
- CAPS LOCK & NUMBER LOCK INDICATORS
- IMPROVED KEYBOARD LAYOUT



**EXTENDER CARDS**

**IBM-PC \$45.00**  
**IBM-AT \$68.00**  
**APPLE II \$45.00**  
**APPLE IIe \$45.00**  
**MULTIBUS \$86.00**

**POWER STRIPS**

- UL APPROVED
- 15A CIRCUIT BREAKER

**\$12.95**



**KEYBOARD-AP**

- REPLACEMENT FOR APPLE II KEYBOARD
- CAPS LOCK KEY
- AUTO-REPEAT
- ONE KEY ENTRY OF BASIC OR CPM COMMANDS

**\$49.95**



**CASE WITH KEYBOARD**

FOR APPLE MOTHER-BOARD MODEL KB-1000 **\$79.95**

ONLY **\$79.95**



**20 MHz DUAL TRACE OSCILLOSCOPE**



**MODEL 2000 \$389.00**

- BAND WIDTH - DC TO 20 MHz (-3db)
- AC: 10 Hz TO 20MHz (-3db)
- SWEEP TIME - .2 μSEC TO .5 SEC/DIV ON 20 RANGES
- COMPLETE MANUAL AND HIGH QUALITY HOOK-ON PROBES INCLUDED
- INPUT IMPEDANCE: 1 MEG OHM
- TV VIDEO SYNC FILTER
- X, Y AND Z AXIS OPERATION
- 110/220 VOLT OPERATION
- COMPONENT TESTER
- LP CONSUMPTION - 19 WATTS
- BUILT-IN CALIBRATOR
- AUTOMATIC OR TRIGGERED TIMEBASE

**HIGH QUALITY TEST EQUIPMENT FROM JDR INSTRUMENTS**

**35 MHz DUAL TRACE OSCILLOSCOPE**



**MODEL 3500 \$549.00**

- BAND WIDTH - DC TO 35 MHz (-3db)
- AC: 10 Hz TO 35MHz (-3db)
- SWEEP TIME - .2 μSEC TO .5 SEC/DIV ON 21 RANGES
- DELAYED TRIGGER - 100 mSEC TO 1 μSEC WITH INTENSIFIED AND DELAYED MODES
- COMPLETE MANUAL AND 1X-10X COMPENSATED HOOK-ON PROBES INCLUDED
- VARIABLE HOLD OFF FOR VIEWING COMPLEX WAVES
- TV VIDEO SYNC FILTER
- TRIGGERING OF CH-A, CH-B, ALTERNATING, LINE OR EXTERNAL
- X-Y AND Z AXIS OPERATION

**DIGITAL MULTIMETER PEN**



**MODEL DPM-1000 \$49.95**

AUTO RANGING, POLARITY AND DECIMAL

- LARGE 3.5" DISPLAY
- DATA HOLD SWITCH FREEZES READING
- FAST, AUDIBLE CONTINUITY TEST
- LOW BATTERY INDICATOR
- OVERLOAD PROTECTION
- ONLY 1 1/2 x 6 1/4 x 3 1/2"
- DC VOLTS 1mV-50CV
- AC VOLTS 1mV-50CV
- 1 OHM - 2 MEG OHM
- WEIGHS ONLY 2.3 OUNCES
- LOW PARTS COUNT-CUSTOM 80 PIN LSI INSURES RELIABILITY
- INCLUDES MANUAL, BATTERIES, HARD CASE, AND ALLIGATOR CLIP

**CALL FOR VOLUME QUOTES**

© COPYRIGHT 1985 JDR MICRODEVICES

CIRCLE 282 ON FREE INFORMATION CARD



ORDER TOLL FREE

800-538-5000

800-662-6279 (CA)

**IBM COMPATIBLE INTERFACE CARDS**  
ALL WITH A ONE YEAR WARRANTY

**MULTIFUNCTION CARD \$129.95**  
ALL THE FEATURES OF AST'S 6 PACK PLUS AT HALF THE PRICE



- 0-348K RAM
- SERIAL PORT
- PARALLEL PORT
- GAME PORT
- SOFTWARE INCLUDED

PRINTER CABLE \$9.95 64K RAM UPGRADE 9/\$7.11

**COLOR GRAPHICS ADAPTOR \$99.95**  
FULLY COMPATIBLE WITH IBM COLOR CARD



- 4 VIDEO INTERFACES: RGB, COMPOSITE COLOR, HI-RES COMPATIBLE MONOCHROME, CONNECTOR FOR RF MODULATOR
- COLOR GRAPHICS MODE: 320 x 200
- MONO GRAPHICS MODE: 640 x 200
- LIGHT PEN INTERFACE

**MONOCHROME GRAPHICS CARD \$129.95**  
FULLY COMPATIBLE WITH IBM MONOCHROME ADAPTOR AND HERCULES GRAPHICS CARD



- LOTUS COMPATIBLE
- TEXT MODE: 80 x 25
- GRAPHICS MODE: 720 x 348
- PARALLEL PRINTER INTERFACE
- OPTIONAL SERIAL PORT!

**FLOPPY DISK DRIVE ADAPTOR \$59.95**



- INTERFACES UP TO FOUR STANDARD FDDs TO IBM PC OR COMPATIBLES
- INCLUDES CABLE FOR TWO INTERNAL DRIVES

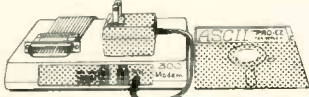
**1200 BAUD INTERNAL MODEM FOR IBM**  
INCLUDES PC TALK III COMMUNICATIONS SOFTWARE



- HAYES COMPATIBLE
- AUTO DIAL/AUTO ANSWER
- AUTO RE-DIAL ON BUSY
- OPTIONAL SERIAL PORT
- ONE YEAR WARRANTY

**EASYDATA-12B \$195**

**300 BAUD MODEM FOR APPLE OR IBM**  
CLOSE-OUT SPECIAL NOW ONLY



**\$49.95**

INCLUDES ASCII PRO-EZ SOFTWARE (A \$100 VALUE IN ITSELF)

- FCC APPROVED
- BELL SYSTEMS 103 COMPATIBLE
- INCLUDES AC ADAPTOR
- AUTO DIAL/AUTO ANSWER
- DIRECT CONNECT

CABLE FOR APPLE IIc \$14.95

**100 CPS ESPRIT PRINTER**

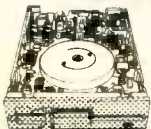


**BEST BARGAIN \$149.95**

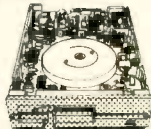
- 9 x 9 DOT MATRIX
- 100 CPS - BIDIRECTIONAL
- FRICTION AND TRACTOR FEED
- PROPORTIONAL SPACING
- 80 COLUMN
- PARALLEL AND SERIAL INTERFACES
- 8 CHARACTER SETS AND GRAPHICS

CABLE TO IBM PC \$9.95  
REPLACEMENT RIBBON CARTRIDGE SZ-44 \$11.95

**TEAC DISK DRIVES FOR IBM PCs**



**FD-55B DS/DD \$89.95**



**FD-55F DS/QUAD \$99.95**

**UNBELIEVABLE MONITOR DEALS**



**TAXAN RGB VISION III**  
MODEL 415

- 18 MHz BAND WIDTH
- 640 x 262 PIXEL RESOLUTION
- 16 COLORS WITH INTENSITY CONTROL
- 12" BLACK MATRIX
- IBM AND LOTUS COMPATIBLE
- CABLE FOR IBM \$15.95

**\$289.95**



**SAKATA COMPOSITE COLOR**  
MODEL SC-100

- TOP RATED FOR APPLE
- 13" COMPOSITE VIDEO
- RESOLUTION: 280H x 300V
- INTERNAL AUDIO AMPLIFIER
- ONE YEAR WARRANTY

**\$169.95**



**SAMWOO MONOCHROME**  
MODEL DM-216B

- PERFECT COSMETIC MATCH FOR IBM PC
- IBM COMPATIBLE TTL INPUT
- 12" NON-GLARE SCREEN
- P39 GREEN PHOSPHOR
- HI-RES 22 MHz BAND WIDTH

**\$99.95**

**MONITOR STAND TILTS AND SWIVELS**



**\$12.95**

**APPLE COMPATIBLE INTERFACE CARDS**

**EPROM PROGRAMMER \$79.95**



**MODEL RP525**

- DUPLICATE OR BURN ANY STANDARD 27xx SERIES EPROM
- EASY TO USE MENU-DRIVEN SOFTWARE INCLUDED
- MENU SELECTION FOR 2716, 2732, 2732A, 2764 & 27128
- HIGH SPEED WRITE ALGORITHM
- LED INDICATORS FOR ACTIVITY
- NO EXTERNAL POWER SUPPLY REQUIRED
- ONE YEAR WARRANTY

**16K RAMCARD \$39.95**

- FULL TWO YEAR WARRANTY
- EXPAND YOUR 48K APPLE TO 64K
- USE IN PLACE OF APPLE LANGUAGE CARD

BARE PC CARD W/ INSTRUCTIONS \$9.95

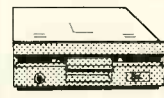


**IC TEST CARD \$99.95**

- QUICKLY TESTS MANY COMMON ICs
- DISPLAYS PASS OR FAIL
- ONE YEAR WARRANTY
- TESTS: 4000 SERIES CMOS 7400; 74LS, 74L, 74H, 74S, SOME PROMS AND RAMS

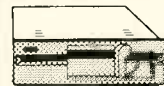
**DISK DRIVES**

FOR APPLE COMPUTERS



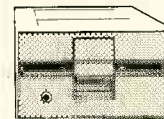
**BAL-525 \$99.95**

- 1/2 HEIGHT-ALPS MECHANISM
- 100% APPLE COMPATIBLE
- FULL 1 YEAR WARRANTY



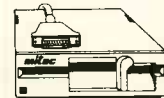
**BAL-500 \$129.95**

- TEAC MECHANISM - DIRECT DRIVE
- 100% APPLE COMPATIBLE
- FULL 1 YEAR WARRANTY



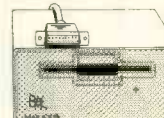
**AP-135 \$129.95**

- FULL HT. SHUGART MECHANISM
- DIRECT REPLACEMENT FOR APPLE DISK II
- SIX MONTH WARRANTY



FOR APPLE IIc  
**AD-3C \$139.95**

- 100% APPLE IIc COMPATIBLE, READY TO PLUG IN W/ SHIELDED CABLE & MOLDED 19 PIN CONNECTOR
- FAST, RELIABLE SLIMLINE DIRECT DRIVE
- SIX MONTH WARRANTY



FOR MACINTOSH  
**MAC535 \$299.95**

- 3.5" ADD-ON DISK DRIVE
- 100% MACINTOSH COMPATIBLE
- SINGLE SIDED 400K BYTE STORAGE
- HIGH RELIABILITY DRIVE FEATURES
- AUTO-EJECT MECHANISM
- FULL ONE YEAR WARRANTY

**DISK DRIVE ACCESSORIES**

- DISK CONTROLLER CARD \$49.95
- APPLE IIc ADAPTOR CABLE \$19.95
- CONVERTS DRIVES FOR APPLE II AND IIc TO MATE WITH APPLE IIc

**COMREX CR-1000 DUAL SLIMLINE DISK DRIVE**  
FOR APPLE COMPUTERS

**\$189.95**

SPACE SAVING DESIGN  
STACK BETWEEN COMPUTER AND MONITOR

CLOSE-OUT SPECIAL  
WHILE SUPPLY LASTS

- QUIET, RELIABLE 1/2 HEIGHT DRIVES
- TOTAL STORAGE CAPACITY: 286K BYTES
- AUTO-EJECT MECHANISM
- SHIELDED CABLE INCLUDED



INCLUDES CONTROLLER AND DOS 3.3 WITH DISK UTILITIES

**CALL FOR VOLUME QUOTES**

© COPYRIGHT 1985 JDR MICRODEVICES

CIRCLE 283 ON FREE INFORMATION CARD



**NATIONAL SEMICONDUCTOR • PANASONIC**  
**CHINESE • JAPANESE • WEST GERMANY**  
**EAC, INC. • W. MILLER • AVID ENGINEERING**  
**E. F. JOHNSON • ATLANTIC SEMICONDUCTOR**

**256K (262,144 x 1) DRAM 150S \$5.70/1; \$39.95/9**  
**Factory Firsts**

**MODES • DIAMOND TOOL • UNGAR • G.W. INDUSTRIES • GEMEK • G.E. • YGAR • YWAGO • W. MILLER • LUKO • 3C CHEMICALS • ARIES • PLESSEY**

### INTEGRATED CIRCUITS

Linear	LM324CN	143	74ALS00	86
	LM324N	139	74ALS00	86
	LM324P	139	74ALS00	86
	LM324M	139	74ALS00	86
	LM324D	139	74ALS00	86
	LM324E	139	74ALS00	86
	LM324F	139	74ALS00	86
	LM324G	139	74ALS00	86
	LM324H	139	74ALS00	86
	LM324J	139	74ALS00	86
	LM324K	139	74ALS00	86
	LM324L	139	74ALS00	86
	LM324M	139	74ALS00	86
	LM324N	139	74ALS00	86
	LM324P	139	74ALS00	86
	LM324Q	139	74ALS00	86
	LM324R	139	74ALS00	86
	LM324S	139	74ALS00	86
	LM324T	139	74ALS00	86
	LM324U	139	74ALS00	86
	LM324V	139	74ALS00	86
	LM324W	139	74ALS00	86
	LM324X	139	74ALS00	86
	LM324Y	139	74ALS00	86
	LM324Z	139	74ALS00	86

### 1% METAL FILM RESISTORS

Wattage • Temperature Coefficient ± 100 ppm/°C  
 Max. RCW/Volt • Max. Voltage 500V  
 Dielectric Withstanding Voltage 500V  
 Standard Resistor Values from 10 to 1000 ohms

Standard Resistor Value Table (E96 Series)
10 15 20 25 30 35 40 45 50 56 62 68 75 82 90 100
110 120 130 150 160 180 200 220 240 270 300 330 360 390 430 470 510 560 620 680 750 820 900 1000

### TI IC SOCKETS

Body - 84 V.I. constructed with Copper Alloy contacts. AC components standard IC leads up to 0.14" thick. The inductor to ground the board. Lead of the IC lead allowing for low inductance and high resistance. Socket is designed to achieve maximum contact on boards.

### SOLDER TAIL DIP SOCKETS

• Single beam  
 • Low profile  
 • YOUR CHOICE: TIN OR GOLD

### TIN PLATED SOLDER TAIL

Part No. Description 1 10 100 1000

C8108	8 pin solder tail, tin	13	1.18	1.04
C8114	14 pin solder tail, tin	4.20	4.03	3.60
C8116	16 pin solder tail, tin	5.00	4.75	4.30
C8118	18 pin solder tail, tin	5.75	5.50	5.00
C8120	20 pin solder tail, tin	6.50	6.25	5.75
C8122	22 pin solder tail, tin	7.25	7.00	6.50
C8124	24 pin solder tail, tin	8.00	7.75	7.25
C8126	26 pin solder tail, tin	8.75	8.50	8.00
C8128	28 pin solder tail, tin	9.50	9.25	8.75
C8130	30 pin solder tail, tin	10.25	10.00	9.50
C8132	32 pin solder tail, tin	11.00	10.75	10.25
C8134	34 pin solder tail, tin	11.75	11.50	11.00
C8136	36 pin solder tail, tin	12.50	12.25	11.75
C8138	38 pin solder tail, tin	13.25	13.00	12.50
C8140	40 pin solder tail, tin	14.00	13.75	13.25
C8142	42 pin solder tail, tin	14.75	14.50	14.00
C8144	44 pin solder tail, tin	15.50	15.25	14.75
C8146	46 pin solder tail, tin	16.25	16.00	15.50
C8148	48 pin solder tail, tin	17.00	16.75	16.25
C8150	50 pin solder tail, tin	17.75	17.50	17.00
C8152	52 pin solder tail, tin	18.50	18.25	17.75
C8154	54 pin solder tail, tin	19.25	19.00	18.50
C8156	56 pin solder tail, tin	20.00	19.75	19.25
C8158	58 pin solder tail, tin	20.75	20.50	20.00
C8160	60 pin solder tail, tin	21.50	21.25	20.75
C8162	62 pin solder tail, tin	22.25	22.00	21.50
C8164	64 pin solder tail, tin	23.00	22.75	22.25
C8166	66 pin solder tail, tin	23.75	23.50	23.00
C8168	68 pin solder tail, tin	24.50	24.25	23.75
C8170	70 pin solder tail, tin	25.25	25.00	24.50
C8172	72 pin solder tail, tin	26.00	25.75	25.25
C8174	74 pin solder tail, tin	26.75	26.50	26.00
C8176	76 pin solder tail, tin	27.50	27.25	26.75
C8178	78 pin solder tail, tin	28.25	28.00	27.50
C8180	80 pin solder tail, tin	29.00	28.75	28.25
C8182	82 pin solder tail, tin	29.75	29.50	29.00
C8184	84 pin solder tail, tin	30.50	30.25	29.75
C8186	86 pin solder tail, tin	31.25	31.00	30.50
C8188	88 pin solder tail, tin	32.00	31.75	31.25
C8190	90 pin solder tail, tin	32.75	32.50	32.00
C8192	92 pin solder tail, tin	33.50	33.25	32.75
C8194	94 pin solder tail, tin	34.25	34.00	33.50
C8196	96 pin solder tail, tin	35.00	34.75	34.25
C8198	98 pin solder tail, tin	35.75	35.50	35.00
C8200	100 pin solder tail, tin	36.50	36.25	35.75

### PANASONIC ELECTROLYTIC KIT

Value Volt 10 100 1000

PA001	10 µF	50V	8.45	42.71
PA002	15 µF	50V	6.49	48.71
PA003	18 µF	50V	7.49	48.71
PA004	22 µF	50V	6.49	48.71
PA005	27 µF	50V	6.49	48.71
PA006	33 µF	50V	6.49	48.71
PA007	39 µF	50V	6.49	48.71
PA008	47 µF	50V	6.49	48.71
PA009	56 µF	50V	6.49	48.71
PA010	68 µF	50V	6.49	48.71
PA011	82 µF	50V	6.49	48.71
PA012	100 µF	50V	6.49	48.71
PA013	120 µF	50V	6.49	48.71
PA014	150 µF	50V	6.49	48.71
PA015	180 µF	50V	6.49	48.71
PA016	220 µF	50V	6.49	48.71
PA017	270 µF	50V	6.49	48.71
PA018	330 µF	50V	6.49	48.71
PA019	390 µF	50V	6.49	48.71
PA020	470 µF	50V	6.49	48.71
PA021	560 µF	50V	6.49	48.71
PA022	680 µF	50V	6.49	48.71
PA023	820 µF	50V	6.49	48.71
PA024	1000 µF	50V	6.49	48.71
PA025	1200 µF	50V	6.49	48.71
PA026	1500 µF	50V	6.49	48.71
PA027	1800 µF	50V	6.49	48.71
PA028	2200 µF	50V	6.49	48.71
PA029	2700 µF	50V	6.49	48.71
PA030	3300 µF	50V	6.49	48.71
PA031	3900 µF	50V	6.49	48.71
PA032	4700 µF	50V	6.49	48.71
PA033	5600 µF	50V	6.49	48.71
PA034	6800 µF	50V	6.49	48.71
PA035	8200 µF	50V	6.49	48.71
PA036	10000 µF	50V	6.49	48.71
PA037	12000 µF	50V	6.49	48.71
PA038	15000 µF	50V	6.49	48.71
PA039	18000 µF	50V	6.49	48.71
PA040	22000 µF	50V	6.49	48.71
PA041	27000 µF	50V	6.49	48.71
PA042	33000 µF	50V	6.49	48.71
PA043	39000 µF	50V	6.49	48.71
PA044	47000 µF	50V	6.49	48.71
PA045	56000 µF	50V	6.49	48.71
PA046	68000 µF	50V	6.49	48.71
PA047	82000 µF	50V	6.49	48.71
PA048	100000 µF	50V	6.49	48.71
PA049	120000 µF	50V	6.49	48.71
PA050	150000 µF	50V	6.49	48.71
PA051	180000 µF	50V	6.49	48.71
PA052	220000 µF	50V	6.49	48.71
PA053	270000 µF	50V	6.49	48.71
PA054	330000 µF	50V	6.49	48.71
PA055	390000 µF	50V	6.49	48.71
PA056	470000 µF	50V	6.49	48.71
PA057	560000 µF	50V	6.49	48.71
PA058	680000 µF	50V	6.49	48.71
PA059	820000 µF	50V	6.49	48.71
PA060	1000000 µF	50V	6.49	48.71

### DISC CAPACITORS

Part No. Value Volt 10 100 1000

PA061	10 µF	50V	8.45	42.71
PA062	15 µF	50V	6.49	48.71
PA063	18 µF	50V	7.49	48.71
PA064	22 µF	50V	6.49	48.71
PA065	27 µF	50V	6.49	48.71
PA066	33 µF	50V	6.49	48.71
PA067	39 µF	50V	6.49	48.71
PA068	47 µF	50V	6.49	48.71
PA069	56 µF	50V	6.49	48.71
PA070	68 µF	50V	6.49	48.71
PA071	82 µF	50V	6.49	48.71
PA072	100 µF	50V	6.49	48.71
PA073	120 µF	50V	6.49	48.71
PA074	150 µF	50V	6.49	48.71
PA075	180 µF	50V	6.49	48.71
PA076	220 µF	50V	6.49	48.71
PA077	270 µF	50V	6.49	48.71
PA078	330 µF	50V	6.49	48.71
PA079	390 µF	50V	6.49	48.71
PA080	470 µF	50V	6.49	48.71
PA081	560 µF	50V	6.49	48.71
PA082	680 µF	50V	6.49	48.71
PA083	820 µF	50V	6.49	48.71
PA084	1000 µF	50V	6.49	48.71
PA085	1200 µF	50V	6.49	48.71
PA086	1500 µF	50V	6.49	48.71
PA087	1800 µF	50V	6.49	48.71
PA088	2200 µF	50V	6.49	48.71
PA089	2700 µF	50V	6.49	48.71
PA090	3300 µF	50V	6.49	48.71
PA091	3900 µF	50V	6.49	48.71
PA092	4700 µF	50V	6.49	48.71
PA093	5600 µF	50V	6.49	48.71
PA094	6800 µF	50V	6.49	48.71
PA095	8200 µF	50V	6.49	48.71
PA096	10000 µF	50V	6.49	48.71
PA097	12000 µF	50V	6.49	48.71
PA098	15000 µF	50V	6.49	48.71
PA099	18000 µF	50V	6.49	48.71
PA100	22000 µF	50V	6.49	48.71

### TANTALUM CAPACITORS

Part No. Value Volt 10 100 1000

PA101	10 µF	50V	8.45	42.71
PA102	15 µF	50V	6.49	48.71
PA103	18 µF	50V	7.49	48.71
PA104	22 µF	50V	6.49	48.71
PA105	27 µF	50V	6.49	48.71
PA106	33 µF	50V	6.49	48.71
PA107	39 µF	50V	6.49	48.71
PA108	47 µF	50V	6.49	48.71
PA109	56 µF	50V	6.49	48.71
PA110	68 µF	50V	6.49	48.71
PA111	82 µF	50V	6.49	48.71
PA112	100 µF	50V	6.49	48.71
PA113	120 µF	50V	6.49	48.71
PA114	150 µF	50V	6.49	48.71
PA115	180 µF	50V	6.49	48.71
PA116	220 µF	50V	6.49	48.71
PA117	270 µF	50V	6.49	48.71
PA118	330 µF	50V	6.49	48.71
PA119	390 µF	50V	6.49	48.71
PA120	470 µF	50V	6.49	48.71
PA121	560 µF	50V	6.49	48.





CALL MAIL  
(516) 499-9500

6094 Jericho Tpke.  
Commack, N.Y. 11725

T V ACCESSORIES

JERROLD LCC-58 CONVERTER	84.95
JERROLD LCC-91 remote	104.95
PHILIPS CV-1000 CONVERTER W/VOLUME CONTROL	169.95
PHILIPS CTC9R CONVERTER	129.95
<b>WINEGUARD</b>	
ANTENNA ROTOR WR-5000	69.95
HOME TV ANTENNA	49.95
MARINE TV ANTENNA	59.95
<b>TUSA</b>	
CVU-40 BLOCK CONVERTER	28.95
CVU-1000 BLOCK CONV.	38.95
COAX CABLE 59/U 500'	35.00
ROTOR CABLE 20/4 500'	35.00

TEST EQUIPMENT

<b>BECKMAN</b>			
DM-10	\$39	DM-45	\$89
DM-20	65	DM-73	63
DM-25	79	DM-77	75
DM-40	69	CM-20	129
<b>TRIPLETT</b>			
P/N 3400	\$122	P/N 50	\$59
3500	108	630NA	169
3550A	79		
<b>B&amp;K</b>			
P/N 820	\$174	P/N 3300	\$339
2802	47	111	39
2815	140	116	64
2816	128	1042	19
		1045	336
<b>POCKET TECHNOLOGY, INC.</b>			
LogicScope 136			
w/ Probes		\$695	
w/o Probes		\$595	
<b>RS232 TRANSMISSION LINE TESTER</b>			
All 25 signal lines accessible Dual color LED's (red/green) Jumpers and case incl.			
		\$169.95	

COMPONENTS

<b>PHILIPS ECG SEMICONDUCTORS</b>	
We have a complete line of ECG replacement semiconductors for all your electronic needs.	
—DISCOUNT PRICES—	
ECG (EQUIV) 1155	\$4.95
ECG (EQUIV) 123	.59
ECG (EQUIV) 4016	.99
ECG (EQUIV) 5070	1.29
<b>CONNECTORS</b>	
RS-232C (SOLDER TYPE)	
	Male \$150 Female \$1.95
BNC	Male 9.95 per 10
UFH	Male 9.90 per 10
'F'	Male 2.50 per 10
RCA	Male 2.95 per 10
GENDER	CHANGER RS232 M-M 19.95
GENDER	CHANGER RS232 F-F 19.95

CHEMICALS

<b>TECH-SPRAY</b>		
Flux-Stripper 16oz		\$4.65
Blue Shower 24oz		5.45
FD 24oz		6.65
Instant Chiller 14oz		3.10
Kleen-Rt 6oz		1.40
SLIC 8oz		3.35
Zero-Charge 15oz		3.55
Blue Stuff 8oz		3.65

TOOLS

<b>EKI</b>			
Pocket Dice	\$15	Metal Det.	\$6
Logic Probe	9	Dig. Clock	39
Body Blinker	6	Binary Clk	36
Digital Dice	14	Dig. Roulette	29

PC ACCESS

IBM PRINTER CABLE	\$22
SAKATA 12" AMBER MONITOR	129
12" GREEN MONITOR	119
ZEMITH 135 13" COLOR COMPOSITE/RGB/AUDIO/H-RES	524
<b>HAYES SMARTMODEMS</b>	
300 BAUD	\$234
1200/300 BAUD	469
1200H INTERNAL (IBM)	389
2400/1200 BAUD	739

SAMS

<b>SAM'S PHOTOFACTS</b>	
PHOTOFACTS	\$9.45
P.O.M.'S	33.75
COMPUTERFACTS	19.95
COMPUTERFACTS (SYS)	39.95

### Volume Discounts

Min Order \$25.00		
International shipping Add'l	to 75.00	\$2.50
Prices subject to change without notice	76.00 to 250.00	\$4.50
COD 2.00 Extra	251.00 to 500.00	\$6.00
Add'l shipping for monitors	501.00 to 750.00	\$8.50
	751.00 to 1000.00	\$12.00
	Over 1000.00	\$12.50

(516) Mon Th Tu W F Sa  
499-9500 9-8 9-6 9:30-5

## ADVERTISING INDEX

RADIO-ELECTRONICS does not assume any responsibility for errors that may appear in the index below.

Free Information Number	Page	269,270	Morning Distributing	106.107
267	AIS Satellite		Mouser	22
108	AMC Sales		Multiplex Technology	38
76	AP Products		NRI	8,43
51	Active Electronics		NTS	28
—	Advance Electronics	23,24,25	Oregon Microwave	132
106	Advanced Computer Products		Pacific Cable	117
107	All Electronics		Panasonic	105
72	Amazing Devices		Philips ECG	87
—	American Design Components		Pomona Electronics	CV3
252	Ango Electronics		Prof. Diving School of N.Y.	114
272	Arctec Systems		RAG Electronics	5
77	B&K Precision		RAG Electronics	13
98	Beckman Industrial		RAG Electronics	14,15
81	CEI		RAG Electronics	17
—	CIE		Radio Shack	119
—	CRT		Ramsey	125
—	Command Productions		Rhoades	97
79	Communications Electronics		Saratoga Electronics	132
—	Coop's Satellite Digest		Satellite TV Week Magazine	27
284	Dandy Manufacturing		Sintec	44
127	Deco Industries		Solid State Sales	122
268	Delta Electronics		Spartan Electronics	142
255	Deltax Dynamic		Tektronix	CV2
—	Dick Smith Electronics	98,99,100,101	Telton	106
274,275	Diehl Engineering		Transleteronic	48
82	Digi-Key		U.S. Instrument Rentals	35
—	Digital Research Computers		Unitech	132
264	Diplomat International			
110	Dokay			
292	ETCO			
83	Electro Industries			
254	Electronics Book Club			
120	Elephant Electronics			
293	Emco			
211	Etronix			
100	Firestik II			
262	Fluke Manufacturing	7,CD13		
—	Fordham Radio			
265	Goldsmith Scientific			
—	Grantham College of Engineering			
251	HW Sams			
—	Harbor Freight Salvage			
86	Heath	33,91,93		
64	IWATSU			
261	JDR Microdevices			
278	JDR Microdevices			
276,277	JDR Microdevices	134,135		
279,280	JDR Microdevices	136,137		
281,282	JDR Microdevices	138,139		
283	JDR Microdevices			
114	Jameco	130,131		
124	James Walter Satellite Rec.			
104	Jan Crystals			
259	Krueger Technology			
87	MCM Electronics			
105	MFJ			
256	Mark V. Electronics			
—	McGraw Hill Book Club	41,73		
67	McIntosh Labs			
273	Micro Linear Controls			
271	Micro-Mart			

Gernsback Publications, Inc.  
200 Park Ave. South  
New York, NY 10003  
(212) 777-6400  
Chairman of the Board:  
M. Harvey Gernsback  
President: Larry Steckler

### ADVERTISING SALES 212-777-6400

Larry Steckler  
publisher  
Arline Fishman  
advertising coordinator  
Shelli Weinman  
advertising associate  
Lisa Strassman  
credit manager  
Donna Sala  
credit associate  
Naomi Matten  
advertising assistant

### Sales Offices

#### EAST/SOUTHEAST

Stanley Levitan  
Radio-Electronics  
200 Park Ave. South  
New York, NY 10003  
718-428-6037, 212-777-6400

#### MIDWEST/Texas/Arkansas/Okla.

Ralph Bergen  
Radio-Electronics  
540 Frontage Road—Suite 325  
Northfield, IL 60093  
312-446-1444

#### PACIFIC COAST/ Mountain States

Marvin Green  
Radio-Electronics  
15335 Morrison St.—Suite 227  
Sherman Oaks, CA 91403  
818-986-2001



We make more than enough Grabber test clips to cover just about any conceivable use you may require. And we add new Grabber products to the line every year to provide an almost infinite variety of applications.

And now that you have an idea of our

depth and variety, you should also be aware that the Grabber test clips we design and manufacture are considered by electronic design engineers to be right at the top. No question.

A superior product? You know you've got that. And you should

know, also, that we make sure you receive fast service and specified quantity through your favorite electronic parts distributor.

After all, we wrote the book.

And it's free. Our products are described and illustrated in our

1985 general catalog. Just call (714) 623-3463 or 623-6751. Or, write to us at ITT Pomona Electronics, a division of ITT Corporation, 1500 E. Ninth St., Pomona, CA 91769.

**ITT**

Pomona Electronics

# Pomona wrote the book on Grabber™ test clips. Don't miss it.

CIRCLE 101 ON FREE INFORMATION CARD





# VIDEO ACCESSORIES

■ Highest quality ■ Highest performance ■ Lowest prices

## bp VIDEO-CINE CONVERTER

The BP Video-Cine Converter is an optical device that allows the easy transfer of slides, 8mm or 16mm movie film to VCR tape. The Video-Cine Converter's precision optics put the image from your movie or slide projector on a high-contrast, rear projection screen. Your video camera shoots that image, can color-correct faded pictures, add narration to other sound. Can be used with any video camera or slide projector. If your video camera lacks close-up capability, you will need a macro lens attachment.



MODEL V-1701 **\$36<sup>95</sup>**

Macro Lens Attachment  
Model O314 **\$14<sup>95</sup>**

# FOR ULTIMATE VIEWING

## TEKNIKA

WIRELESS REMOTE CONTROL TV TUNER & CABLE CONVERTER WITH VOLUME CONTROL

Model 6510  
**\$169<sup>95</sup>**



Wireless remote control with volume for cable TV, VHF-UHF antenna systems upgrades any TV to 140 channel capability.

- Works with any TV set • Quick, easy installation • Off-air and cable compatible
- Quartz frequency synthesizer tuning • Direct access/memory scan selector • Ultra-compact, hand-held wireless remote control



61 CHANNEL WIRELESS REMOTE CONTROL

Model V7561 **\$79<sup>95</sup>**



Wireless remote control on/off, channel selection and fine tuning.

- Works with any TV • 61 channel capability
- Microcomputer controlled PLL operation
- Converter panel controllable for channel up, down, on/off, fine tuning • LED display
- Compatible with CATV systems.



STABILIZER/IMAGE ENHANCER/RF CONVERTER/VIDEO FADER/2-WAY DISTRIBUTION AMPLIFIER

Model V1880 **\$99<sup>95</sup>**



Hook-up cable kit  
**\$11.75**

The most versatile, all-in-one video processor. Can be used as a video guard remover for video tapes, enhancer, video to RF converter, professional video fade in and out and a dual output distribution amplifier.



VIDEO SWITCH

Model V4804 **\$49<sup>95</sup>**



Record a pay channel while viewing a standard channel. You can also connect an antenna/cable, VCR, video disc player, home computer and video game.



VIDEO TAPE REWINDER

Model V7777 VHS **\$49<sup>95</sup>**

Model V7778 BETA **\$49<sup>95</sup>**



Reduce wear and tear of your VCR heads with the AC powered circuit protected rewinders, LED power-on indicators.

Charge it with VISA/MASTERCARD. Phone orders accepted.

# Fordham

260 Motor Parkway, Hauppauge, NY 11788

Toll Free

In NY State 800-832-1446

### Service and Shipping Charge Schedule

FOR ORDERS	ADD
\$25-250 .....	\$4.50
\$251-500 .....	\$6.50
\$501-750 .....	\$8.50
\$751-1,000 .....	\$12.50
\$1,001 and up .....	\$15.00