

New! Industrial Electronics Section

NOVEMBER 1959

Radio-Electronics

HUGO GERNSBACK, Editor

For the Constructor:

**A High-Performance
7-Transistor Radio**

How Good Is Packaged Stereo?

Electronic Church Chimes

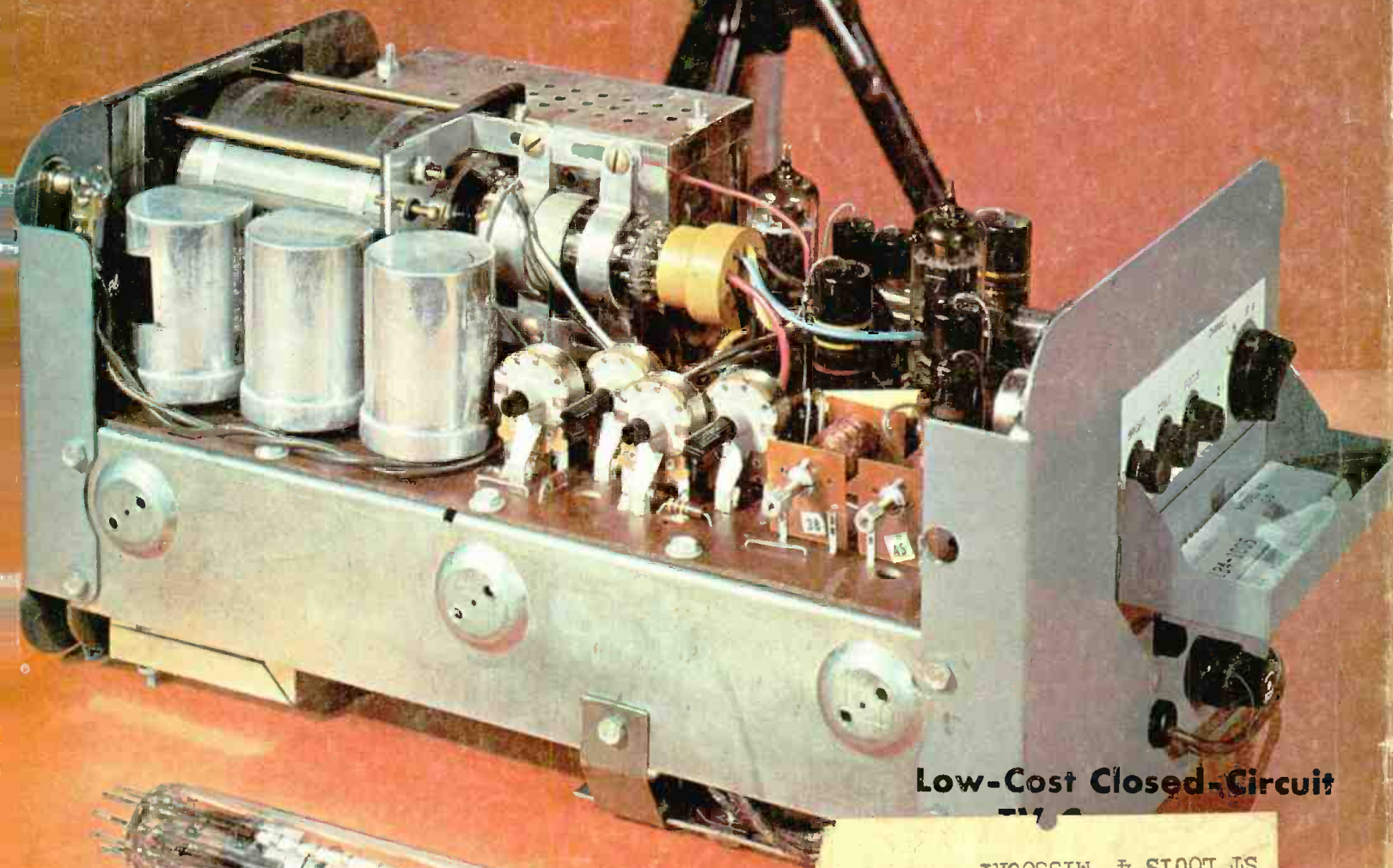
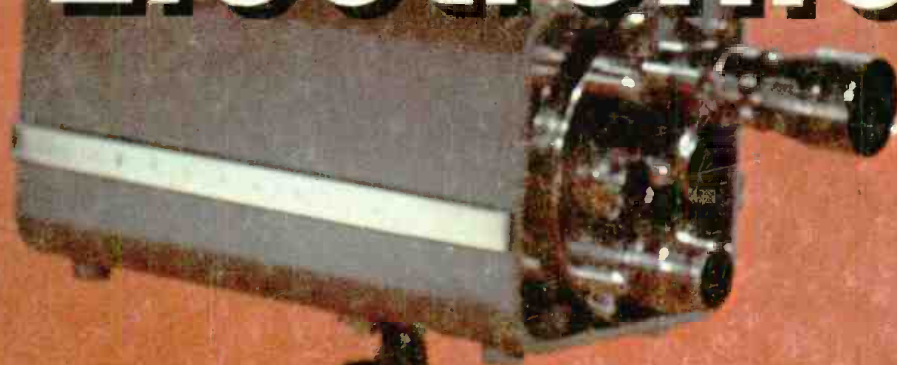

Low-Cost Closed-Circuit

W P SMITH 9-61
2905 VICTOR ST
ST LOUIS 4 MISSOURI

By Adding



Super-Sonax Wide-Angle Tweeter you can

DRAMATICALLY IMPROVE

YOUR HIGH-FIDELITY SYSTEM

Only from the *widest-range reproduction* can you fully feel the emotional impact of sound reality. Simply by adding the E-V *Super-Sonax Tweeter* to your present speaker system, you extend high frequency response smoothly and efficiently beyond the last audible octaves . . . including the subtle overtones and delicate harmonics of the fundamentals of *all* the instruments in the large concert orchestra. What's more . . . the Super-Sonax is also your *first step* to the vibrant sound of true stereo in *your living room*.



ONLY E-V gives you Sonophase* and Diffraction

ONLY E-V gives you all-important

FUSION

FOR ALL-POSITION STEREO LISTENING

For enjoyment of *true stereo* without hole-in-the-middle, ping-pong, one-position listening, E-V *Super-Sonax VHF Tweeters* give all-important FUSION, by completely dispersing higher-frequencies throughout the room. This makes the significant stereo sounds from one speaker fuse with the sounds from the other speaker in varying and controlled proportions . . . gives proper depth and placement to the musical instruments simultaneously, without spatial distortions. You can feel free to sit anywhere in the room or move about for true stereo listening from any angle, without directing the speakers.

Flat-extended very-high-frequency response is made possible only with the exclusive E-V Sonophase* throat design. This assures the smooth, brilliant highs so necessary for blend and balance.

Wide-angle (180°) dispersion achieved through exclusive E-V Diffraction spreads the sound throughout the entire listening area smoothly and evenly.

Working together, these and other E-V features combine to assure accurately-proportioned direct and indirect widely dispersed stereo sound as in the original recorded spatial relationships. This is FUSION. This is *true high-fidelity stereo* as only *Electro-Voice* can bring it to you.

Get full advantage of *Super-Sonax* in the wide choice of complete E-V multi-way speaker systems—or add it on to your present system for improved reproduction, *on money-back guarantee*.

Model T350 Ultra-Sonax VHF Tweeter. For deluxe-efficiency systems. Has reserve power and extra sensitivity. Response to 21 kc. 1 lb. magnet. 16 ohms. Recommended crossover 3500 cps. Net, \$60

Model T35 Super-Sonax VHF Tweeter. For medium-efficiency systems. Response to 19 kc. 1/2 lb. mag. 16 ohms. Recom. crossover 3500 cps. Net, \$35

Model T35B Sonax VHF Tweeter. For lower-efficiency systems. Response to 18 kc. 1/4 lb. magnet. 16 ohms. Recommended crossover 3500 cps. Net, \$22

The above tweeters are also available as Building Block kits complete with crossover, level control, and wiring harness, for only \$15.00 more.

See Your E-V High-Fidelity Dealer or Write for Catalog No. 134 to Dept. 119-E

No Finer
Choice than

Electro-Voice®

ELECTRO-VOICE, INC. • BUCHANAN, MICH.

"The new Citation Kits represent for me the successful culmination of years of research and experimentation to achieve the ultimate in high fidelity design."

Stewart Hegeman, Director of Engineering, Citation Kit Division, Harman-Kardon, Inc.



THESE ARE STRONG WORDS from a conservative audio engineer. But the proof is overwhelming. All that's necessary is a look at the technical specifications of the new Citation I Stereophonic Preamplifier Control Center and Citation II 120 Watt Stereophonic Power Amplifier. We'll gladly send them to you.

Hegeman is recognized as one of the world's great audio engineers. His original designs for the famous Brociner amplifier and preamplifier, and the Hegeman-Lowther speakers, are still regarded as classics by audio engineers and audiophiles. In his capacity as head of the kit engineering group at Harman-Kardon, he has again created new classics.

Easily Assembled— Professional Performance

THERE ARE MANY exciting new concepts built into the Citation Kits. The engineering is so wonderfully precise that the instrument constructed by the kit builder will duplicate the precision of the finest factory-assembled products. Here are some of the remarkable new assembly features that distinguish the Citation Kits:

Military Type Construction: For ease of assembly and durability, rigid phenolic boards are used. *Special Cable Harness:* Unique harness template enables builder to make a professional cable harness to facilitate wiring and insure accuracy. *Special Aids:* Resistors and condensers are filed individually on special component cards so that they can be quickly identified. Wire strippers are supplied free with each kit to produce clean wire junctions.

The Citation I Stereophonic Preamplifier Control Center

HERE IS THE FIRST brilliant expression of the advanced design concepts which

sparked the new Citation Kit Line: the incomparable Citation I, Stereophonic Preamplifier Control Center.

The Citation I consists essentially of a group of circuit blocks termed active and passive networks. Active networks incorporate the vacuum tubes and furnish amplification; passive networks consist of resistors and condensers and provide precise equalization. The active networks are treated as one- or two-stage amplification units, flat over an extremely wide frequency range, and each one of these networks is surrounded by a feedback loop. *This results in levels of distortion so low as to prove unmeasurable.* The passive networks are constructed of precision components and are designed for minimum phase shift.

PROFESSIONAL STEP-TYPE tone controls are used on the new Citation I. They overcome the limitations of continuously variable potentiometers; each position on a step control can be engineered to perform a specific function which is absolutely repeatable when necessary. The flat position of the controls by-passes all tone control circuitry, thereby eliminating transient distortion and phase shift.

Other features include: The new Citation Blend Control which introduces a continuously variable amount of cross-feed between the two channels to eliminate the "hole-in-the-middle" effect of many stereo records; DC heated preamplifier filaments; six silicon diode rectifiers to provide unexcelled B+ and filament regulation; separate turnover and rolloff controls to provide precise equalization.

The Citation I is available with an optional walnut hardwood enclosure which sets off its magnificent sculptured satin-gold escutcheon. The Citation I... \$139.95; Factory Wired... \$239.95; Walnut Enclosure, WW-1... \$29.95.

The Citation II 120 Watt Stereophonic Power Amplifier

HERE IS ALL the power required from a stereophonic amplifier. Two 60 Watt Channels—with a combined peak power output of 260 Watts!

The Citation II reflects a dramatic new approach to amplifier design. Audio engineers have discovered that the characteristics of an amplifier in the non-audible range strongly influence sound quality in the audible range. This can be determined in critical listening tests where the pro-

gram material for each amplifier is laboratory controlled.

Because of this vital consideration the Citation II is engineered to produce frequencies as low as 5 cycles virtually without phase shift. At the high end—the amplifier has a frequency response beyond 100,000 cycles without any evidence of ringing or instability.

AUDIO ENGINEERS have also found that the higher the degree of feedback—and the consequent lower distortion—the more apparent the improvement in sound quality and the greater the reduction in listener fatigue. In order to increase the degree of feedback in the Citation II, a "multiple loop" technique is used in contrast to conventional "single loop" techniques. This results in a 20/1 to 30/1 reduction in distortion compared with the 10/1 to 20/1 reduction in conventional amplifiers.

Other important Citation II features include: video output pentodes in all low level stages for exceptional wide frequency response and low distortion; power supply consisting of four silicon diode rectifiers, choke and heavy duty electrolytics with potted power transformer for superb regulation and long life; bias meter to adjust individually the plate current of each KT88 for balance and lowest distortion.

The Citation II is a handsomely styled brown and gold instrument with an optional Charcoal Brown protective cover. The Citation II... \$159.95; Factory Wired... \$219.95; Charcoal Brown Enclosure, AC-2... \$7.95.

All prices slightly higher in the West.

For a complete report on the new kits write to Harman-Kardon, Inc., Citation Kit Division, Dept. RE11, Westbury, N. Y.

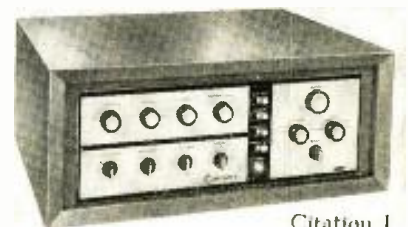

Citation I



Citation II

Build the Very Best

CITATION KITS

by

harman kardon



Radio-Electronics

Formerly RADIO-CRAFT ■ Incorporating SHORT WAVE CRAFT ■ TELEVISION NEWS ■ RADIO & TELEVISION

EDITORIAL

- 31 Space Electronics—Hugo Gernsback

RADIO

- 32 7-Transistor Pocket Radio—Hal Wittlinger
- 34 Rotary-Switch Repair—Lawrence Shaw
- 35 Snitcher—Irvin C. Chapel
- 37 We had Our Troubles too—Guv S. Cornish
- 38 "Inventors of Radio"—Proof A. E. Dolbear—Eric Leslie

INDUSTRIAL ELECTRONICS

- 39 A New Section Begins
- 40 Electronics on the Telephone—Harold B. McKay
- 44 TV Tech Breaks Industrial Electronics Barrier—Charles B. Graham
- 46 Electronics Works on the Railroad—Aaron Nadell
- 48 Printed Circuits Are Here to Stay—Allen Lytel
- 51 A Regulated Heater Supply—Hardin C. Stratman
- 52 Relays in Industry—Alvin G. Sydner
- 54 Servicing Electronic Wheel Balancers—W. G. Eslick and Robert F. Scott

AUDIO-HIGH FIDELITY

- 57 Stereo in a Package—Larry Steckler
- 61 Step-by-Step Guide to Better Hi-Fi Servicing—Felix Bremy
- 64 Repair Chime Projection Systems—Thomas R. Hughes
- 76 New Discs and Tapes, Stereo and Mono—Reviewed by Chester Santon
- 78 All About the Reflex Enclosure (Conclusion)—P. G. A. H. Voigt

TEST INSTRUMENTS

- 84 Qwik-Test Adapter Speeds Audio Testing—Harold Reed
- 88 Better Yet, Use a Spiral—Tom Jaski

ELECTRONICS

- 99 Transistors Control Lamp—Rufus P. Turner
- 105 Solar Power, Now and Tomorrow—Jordan McQuay
- 111 Computers and the Neon Lamp—J. H. Thomas

TELEVISION

- 122 Low-Cost Closed Circuit TV Camera (Cover Feature)—Derek Swaine
- 131 TV Service Clinic—Conducted by Robert G. Middleton
- 155 Business and People
- 154 Corrections
- 18 Correspondence
- 162 New Books
- 157 New Literature
- 139 New Patents
- 140 New Products
- 152 New Tubes and Semiconductors
- 6 News Briefs
- 146 Noteworthy Circuits
- 136 Technicians' News
- 150 Technotes
- 148 Try This One
- 164 50 Years Ago

ON THE COVER

(Story on page 122)

The Sylvania model 100 closed-circuit TV camera—from vidicon to assembled chassis to completed camera mounted on a tripod and ready to use. Connect the camera to the ac line and hook it up to the antenna terminals of a TV receiver and you have a complete closed-circuit TV system.

Color original by Sylvania Electric Products

- Hugo GernsbackEditor and Publisher
- M. Harvey GernsbackEditorial Director
- Fred ShunamanManaging Editor
- Robert F. ScottWZPWB, Technical Editor
- Larry StecklerAssociate Editor
- I. QueenEditorial Associate
- Robert G. MiddletonTelevision Consultant
- Elizabeth StalcupProduction Manager
- Wm. Lyon McLaughlinTech. Illustration Director
- Sol EhrlichArt Director
- Fred NeinastStaff Artist
- Lee RobinsonDirector, Advertising Sales
- John J. LamsonEastern Sales Manager
- G. AliquoCirculation Manager
- Adam J. SmithDirector, Newsstand Sales
- Robert FallathPromotion Manager



Average Paid Circulation Over 187,000



RADIO-ELECTRONICS is indexed in *Applied Science & Technology Index* (Formerly *Industrial Arts Index*)

RADIO-ELECTRONICS, November, 1959, Vol. XXX, No. 11. Published monthly at Mt. Morris, Ill., by Gernsback Publications, Inc. Second-class postage paid at Mt. Morris, Ill. Copyright 1959 by Gernsback Publications, Inc. All rights reserved under Universal, International and Pan-American Copyright Conventions.

SUBSCRIPTION RATES: U.S., P.S. possessions and Canada, \$4.00 for one year; \$7.00 for two years; \$10.00 for three years. Pan-American countries \$5.00 for one year; \$9.00 for two years; \$13.00 for three years. All other countries \$5.50 a year; \$10.00 for two years; \$14.50 for three years.

SUBSCRIPTIONS: Address correspondence to Radio-Electronics, Subscription Dept., 154 West 14th St., New York 11, N.Y. When requesting a change of address, please furnish an address label from a recent issue. Allow one month for change of address.

GERNSBACK PUBLICATIONS, INC. Executive, Editorial and Advertising Offices, 154 West 14th St., New York 11, N.Y. Telephone ALkonquin 5-7753. Hugo Gernsback, Chairman of the Board; M. Harvey Gernsback, President; G. Aliquo, Secretary.

BRANCH ADVERTISING OFFICES and FOREIGN AGENTS listed on page 165.

POSTMASTER: If undeliverable, send Form 3579 to: RADIO-ELECTRONICS, 154 West 14th St., New York 11, N.Y.

*Trademark registered U. S. Pat. Office.

RADIO-ELECTRONICS

NOW!
at a price
you can afford!

MAKE MORE MONEY in TELEVISION RADIO-ELECTRONICS

**BETTER...MORE COMPLETE...LOWER COST...
WITH NATIONAL SCHOOLS SHOP-METHOD
HOME TRAINING!**

BETTER... Training that is proved and tested in Resident School shops and laboratories, by a School that is the **OLDEST** and **LARGEST** of its kind in the world.

MORE COMPLETE... You learn **ALL PHASES** of *Television-Radio-Electronics*.

LOWER COST... Other schools make several courses out of the material in our **ONE MASTER COURSE** . . . and you pay more for less training than you get in *our course* at **ONE LOW TUITION!**



These
two FREE books will
show you how!

You get all information
by mail . . . You make
your own decision . . . at
home! **NO SALESMAN
WILL CALL**

TOP PAY... UNLIMITED OPPORTUNITIES LIFETIME SECURITY CAN BE YOURS!

You are needed in the Television, Radio, and Electronics industry! Trained technicians are in growing demand at excellent pay—in **ALL PHASES**, including Servicing, Manufacturing, Broadcasting and Communications, Automation, Radar, Government Missile Projects.

NATIONAL SCHOOLS SHOP-METHOD HOME TRAINING, with newly added lessons and equipment, trains you in your spare time at home, for these unlimited opportunities, including many technical jobs leading to supervisory positions.

YOU LEARN BY BUILDING EQUIPMENT WITH KITS AND PARTS WE SEND YOU. Your National Schools course includes thorough *Practical* training—**YOU LEARN BY DOING!** We send you complete standard equipment of professional quality for building various experimental and test units. You advance step by step, perform more than 100 experiments, and you build a complete TV set from the ground up, that is yours to keep! A big, new TV picture tube is included at no extra charge.

EARN AS YOU LEARN. We'll show you how to earn extra money right from the start. Many of our students pay for their course—and more—while studying. So can you!

RESIDENT TRAINING AT LOS ANGELES

If you wish to take your training in our Resident School at Los Angeles, the world's TV capital, start **NOW** in our big, modern Shops, Labs and Radio-TV Studios. Here you work with latest Electronic equipment - - professionally installed - - finest, most complete facilities offered by any school. Expert, friendly instructors. Personal attention. Graduate Employment Service. Help in finding home near school - - and part time job while you learn. Check box in coupon for full information.

LESSONS AND INSTRUCTION MATERIAL ARE UP-TO-DATE, PRACTICAL, INTERESTING. Every National Schools Shop-Method lesson is made easy to understand by numerous illustrations and diagrams. All instruction material has been developed and tested in our own Resident School Shops, Laboratories and Studios.

SEND FOR INFORMATION TODAY . . . it can mean the difference between **SUCCESS** and failure for you! Send for your **FREE BOOK** "Your Future in Television-Radio-Electronics" and **FREE Sample Lesson**. Do it **TODAY**, while you are thinking about your future. It doesn't cost you anything to investigate!

GET THE BENEFITS OF OUR OVER 50 YEARS EXPERIENCE

Approved for
GI Training



NATIONAL SCHOOLS

Los Angeles 37, Calif.

YOU GET...

- 19 Big Kits—**YOURS TO KEEP!**
- Friendly Instruction and Guidance
- Job Placement Service
- Unlimited Consultation
- Diploma—Recognized by Industry
- **EVERYTHING YOU NEED FOR SUCCESS!**

SHOP-METHOD HOME TRAINING COVERS ALL PHASES OF INDUSTRY

1. Television, including Color TV
2. Radio AM & FM
3. Electronics for Guided Missiles
4. Sound Recording and Hi-Fidelity
5. FCC License
6. Automation and Computers
7. Radar & Micro-Waves
8. Broadcasting and Communications

NATIONAL TECHNICAL SCHOOLS

WORLD-WIDE TRAINING SINCE 1905

MAIL NOW TO

NATIONAL SCHOOLS, Dept RG-119

4000 S. FIGUEROA ST. LOS ANGELES 37, CALIF.

Rush free TV-Radio "Opportunity" Book and sample lesson. No salesman will call.

NAME _____ AGE _____

ADDRESS _____

CITY _____ ZONE _____ STATE _____

Check if Interested **ONLY** in Resident School training at Los Angeles.

VETERANS: Give date of Discharge _____

News Briefs

FM's MAJOR ARMSTRONG got further posthumous vindication in his long-running legal battle against radio and TV set manufacturers. Judge E. L. Palmieri found Emerson Radio & Phonograph Co. guilty of having infringed patents filed in 1933 and reissued in 1940 concerning "important discoveries in the radio art."

The inventor of wide-band frequency modulation received almost \$5,000,000 in FM royalties during his lifetime. His first patent infringement suit, against RCA and NBC, was settled for nearly \$1,000,000. His widow and estate have six more similar suits pending.

AIR TRAFFIC SAFETY will be improved greatly with the general adoption of a new "secondary radar" system commissioned recently at New York's International Airport. The new radar beacon system differs from ordinary radar in that, instead of depending on reflections from aircraft, it sends out a triggering signal that trips a transponder in the aircraft, which sends back a pulse to the interrogating radar. These are of course vastly stronger than reflections, greatly increasing the range of the system. This is especially important in the case of fast-moving jets.

The new system requires two additional pieces of apparatus. One is an interrogator on the ground to send 6- μ sec pulses at 1030 mc via a small antenna atop the regular radar antenna. The other is a transponder in the plane, a device somewhat similar to the IFF equipment of World War II. It returns $\frac{1}{2}$ - μ sec pulses so coded as to help the ground operator identify the plane. A special synchronizing system also helps by reducing "clutter" from unwanted signals (see photo).

The system is now in use at three New York area control points and is expected to go into 13 other major air-traffic centers within a few months. At

least one airline has already equipped its planes with transponders, and others are installing them rapidly. It's anticipated that savings in time and fuel, as well as human life, will be substantial. The system was coordinated and installed by Airborne Instruments Labs, Mineola, N.Y.

MOBSTERS to use Citizens' band radios? It could happen. Recently indicted by the Justice Department for making false statements to the FCC in an application for Citizens' radio license was one Vincent Marcello whose brother is an alien ordered deported for a narcotics conviction in 1953. Vincent concealed the fact that his brother, a partner in a juke-box operation, is an alien. Conviction could bring up to 5 years and \$10,000 fines on each of five counts in the Federal indictment.

CITIZENS TALKING TOO MUCH, says the FCC. Citizens band users, 55,000 strong now, include some who, instead of confining their air time to getting a simple message across, appear to be abusing their privilege to rag-chew or try dx. The problem is complicated by the fact that even with 5 watts many Citizens banders have been getting freak sky-wave propagation on 27 mc, being heard up to 2,000 miles in some cases.

The FCC warned that a crackdown with widespread license revocations may be in order if this abuse continues.

MARS TECHNICAL NET will resume operations Nov. 4 (thereafter every Wednesday night at 9 PM EST) with a talk on "SSB Exciter Circuits for New Beam Deflection Tube," by Harold Vance, K2FF, RCA Tubes Div. The net meets on 4030 kc, upper sideband, and can be heard about 1,000 miles around New York City. S. E. Piller, W2KPQ/A2KPQ, director of the net, released these additional topics for

later meetings: Nov. 11—"Modern Communications Receiver Circuitry," Byron Goodman, W1DX, ARRL; Nov. 18—"Tubes vs Transistors in Rf Circuits," Ken Redmond, Ampere; Nov. 25—"Transistorized Gadgets and Gimmicks," Bob Gunderson, W2JIO, Braille Technical Press.

MARS First Army net operation is under the jurisdiction of Capt. Joseph Fischler and Col. Wm. Jennings, Chief Signal Officer, First Army.

NEW ATLANTIC CABLE, connecting the telephone networks of the US with those of France, Germany, the Netherlands, Switzerland and Italy was inaugurated Sept. 22. It runs direct from Clarenville, Newfoundland, to Penmarch, France. Twin $1\frac{1}{4}$ -inch cables make up the deep-sea transmission line which has electronic repeaters every 44 miles. The 2,400-mile cable is similar to the first transoceanic telephone cable, laid from Newfoundland to Scotland in 1956.

SPECIAL SPACE FREQUENCIES were scheduled for discussion at the fall meeting of the International Telecommunications Union in Geneva. The frequencies to be proposed by the US for space tracking, guidance and telemetering were in the vicinity of 25.6, 1,700, 2,275, 8,300, 15,150 and 31,500 mc.

The need for agreement on frequencies for future satellites and other space travelers and communications was highlighted recently when the US used the informally agreed upon 108 mc for its satellites, some of which occasionally interfered with each other. The Russians ignored the agreement, working on 20 and 40 mc, which caused some interference with other regular services.

DANGER FROM RADAR and similar high-power generators of microwaves is being lessened aboard the guided-missile cruiser *Galveston* and other ships similarly equipped, by placing a small neon lamp on each man's uniform. The lamps light up at power levels equal to 5-6 milliwatts per square centimeter of body area—about half the minimum safe level for humans. Discovery of the technique is credited to Lieut. Walter Johnson of the Navy Medical Corps, who stumbled onto it the uncomfortable way, while carrying a number of neon bulbs in his back pocket.

GAS MAKES ELECTRICITY in a new fuel cell invented in England by Francis Bacon. A cylindrical assembly under 3 feet by 1 foot in size, the cell takes

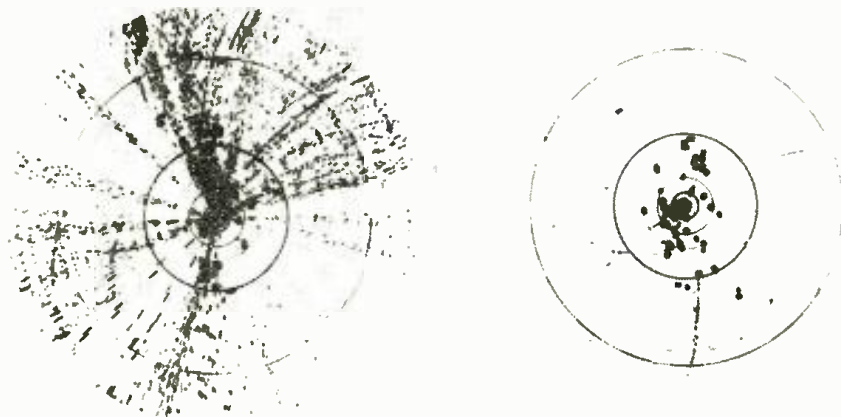

Left—ordinary radar display; on right—same scene with synchronizing system.

In Spare Time at Home—Prepare for a Better Job—or
Your Own Business in One of the Many Branches of

ELECTRONICS

You build and keep this valuable Vacuum Tube VOLTMETER

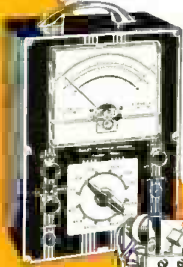

You build and keep this 5-inch COLOR OSCILLOSCOPE — almost a "must" for TV servicing.



RADIO - TELEVISION - RADAR

If you are seeking a better job or a business of your own, the appealing field of Television-Radio-Electronics offers REAL PROMISE!

In this fast-growing field, trained Electronic technicians find many good-paying, interesting jobs in manufacturing, installing, operating, servicing. Equally important is the fact that these are GOOD JOBS—offering the kind of a future that an untrained man often dreams about.

No previous technical experience or advanced education needed. Prepare for this profitable field in your spare time at home, or in our modern Chicago or Toronto Laboratories. Nothing else like it! Send for FREE details.

EARN WHILE YOU LEARN

After you get part of DeVry Tech's training with equipment at home, you may then in your spare time, begin to earn real money servicing Radio and Television sets.



HOME MOVIES . . .
... make important points crystal clear. Speeds your learning. It's almost like having an instructor at your side!

COLOR TV
DeVry Tech's program also includes training in Color Television

MILITARY SERVICE
If you are subject to military service, the information we have should prove very helpful. Mail coupon today.



21 INCH
Build and keep this BIG DeVry Engineered TV set—easily converted to U.H.F. (DeVry offers another home training, but without the TV set.)

Your GUIDE

to Profitable Job Opportunities

- TV-Radio Broadcast Technician
- Color Television Specialist
- Radar Operator • Laboratory Technician
- Airline Radio Man • Computer Specialist
- Quality Control Manager
- Your Own Sales & Service Shop
- ... PLUS MANY OTHERS

YOU GET THE SAME EMPLOYMENT SERVICE

that has helped thousands of our graduates toward fine careers in Electronics.

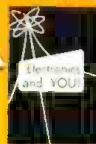

Send for **FREE BOOKLET TODAY!**

Accredited Member of National Home Study Council

"One of North America's Foremost Electronics Training Centers"



DeVRY TECHNICAL INSTITUTE

Formerly DeForest's Training, Inc.
CHICAGO 41, ILLINOIS



You work over **300** Learn-By-Doing projects

Build over 300 practical projects from many shipments of Radio-Electronic parts. You build and operate TV-Radio circuits . . . wireless microphone . . . and many other major projects—all designed to provide outstanding practical experience at home.

ACT NOW!

Get information-packed publication FREE! Mail coupon today.

DeVRY TECHNICAL INSTITUTE
4141 Belmont Ave., Chicago 41, Ill., Dept. RE-11-P

Please give me your FREE booklet, "Electronics and YOU," and tell me how I may prepare to enter one or more branches of Electronics.

Name _____ Age _____

PLEASE PRINT

Street _____ Apt. _____

City _____ Zone _____ State _____

2044 Canadian residents address DeVry Tech of Canada, Ltd.
626 Roselawn Ave., Toronto 12, Ontario

RCA KITS

FOR VALUE, QUALITY AND PERFORMANCE!

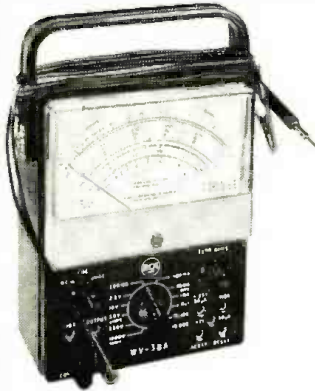

RCA WV-38A (K) VOLT-OHM-MILLIAMMETER

only **\$29.95*** (includes batteries, probe and cable with slip-on alligator clip, ground lead and clip, assembly and operating instructions) (available factory-wired and calibrated—only \$43.95*)

Exclusive features make this RCA VDM kit the buy of a lifetime! Extra 1-volt and 0.25 volt (250 mv) ranges for wider usage in transistor servicing—new handle clip accommodates probes and test leads for extra carrying convenience. Assembles in a breeze!

FEATURING: ohms-divider network fuse-protected • easier-to-read scales • extra-large 5 1/4 inch meter • polarity reversal switch • excellent frequency response • full-wave bridge rectifier • low circuit loading • standard dbm ranges.

SPECIFICATIONS: Input Resistance—20,000 ohms per volt on DC; 5,000 ohms per volt on AC • Accuracy—± 3% DC, ± 5% AC (full scale) • Regular Scales—2.5, 10, 50, 250, 1000, 5000 volts, AC and DC; 50 μ a 1, 10, 100, 500 ma, 10 amps (DC) • Extra Scales—250 mv. and 1 volt (dc) • Frequency Response—AC-flat from 10 cycles to 50 Kc (usable response at 500 Kc) • Ohms—3 ranges: Rx1—(0-2,000 ohms); Rx100 (0-200,000 ohms); Rx10,000 (0-20,000,000 ohms) • Dimensions—W. 5 1/4", H. 6 7/8", D. 3 3/8"

RCA WO-33A (K) 3-INCH OSCILLOSCOPE

only **\$79.95*** (complete with Low-Cap, Direct Input Probe and Cable) (also available factory-wired and calibrated—only \$129.95*)

The first 'scope kit with "get-up-and-go!" Use it for practically everything—video servicing, audio and ultrasonic equipment, low level audio servicing of pickups, mikes, pre-amps, radios and amplifiers, troubleshooting ham radio, hi-fi equipment, etc.—and you can take it with you, on the job, anywhere!

FEATURING: voltage-calibrated frequency-compensated, 3 to 1 step attenuator • scaled graph screen and calibrating voltage source for direct reading of peak-to-peak voltages • "plus-minus" internal sync... holds sync up to 4.5 Mc • shielded input cable with low capacitance probe included • weighs only 14 pounds • includes built in bracket to hold power cord and cables.

SPECIFICATIONS: Vertical Amplifier (Narrow Band Position)—Sensitivity, 3 rms mv/inch; Bandwidth, within -3 db, 20 cps to 150 Kc • Vertical Amplifier (Wide Band Position)—Sensitivity, 100 rms mv/inch; Bandwidth, within -3db, 5.5 cps to 5.5 Mc • Vertical Input Impedance—At Low-Cap cable input... 10 megohms, 10 μ f (approx.); At Direct-cable input... 1 megohm, 90 μ f (approx.) • Sweep Circuit—Sawtooth Range, 15 cps to 75 Kc; Sync, external, \pm internal; Line Sweep, 160° adjustable phase.

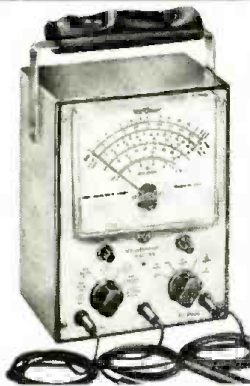
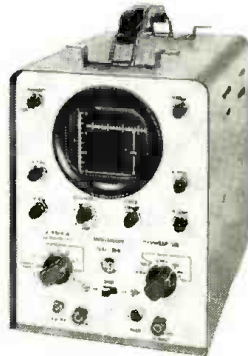

RCA WV-77E (K) VOLT OHMYST®

only **\$29.95*** (also available factory-wired and calibrated only \$49.95*)

Think of it—an RCA VoltOhmyst Kit at this low, low price! You get famous RCA accuracy and dependability, plus the easiest to assemble kit you've ever seen!

FEATURING: ohms-divider network protected by fuse • ultra-slim probes and flexible leads • sleeve attachment on handle stores probes, leads, power cord • separate 1 1/2 volts rms and 4 volts peak-to-peak scales for accuracy on low ac measurements • front-panel lettering acid-etched.

SPECIFICATIONS: Measures: DC Volts—0.02 volt to 1500 volts in 7 overlapping ranges; AC Volts (RMS)—0.1 volt to 1500 volts in 7 overlapping ranges; AC Volts (peak-to-peak)—0.2 volt to 4000 volts in 7 overlapping ranges; Resistance—from 0.2 ohm to 1000 megohms in 7 overlapping ranges. Zero-center indication for discriminator alignment • Accuracy—± 3% of full scale on dc ranges; ± 5% of full scale on ac ranges • Frequency Response—flat within ± 5%, from 40 cycles to 5 Mc on the 1.5, 5, and 15-volt rms ranges and the 4, 14, and 40-volt peak-to-peak ranges • DC Input Resistance—standard 11 megohms (1 megohm resistor in probe).

*User Price (Optional)

See them all at your local RCA Test Equipment Distributor!



RADIO CORPORATION OF AMERICA
ELECTRON TUBE DIVISION HARRISON, N. J.

NEWS BRIEFS (Continued)

in pure oxygen and hydrogen just as the G-E cell reported in RADIO-ELECTRONICS August issue, (page 6). It delivers 7 watts of power.

The cell has porous nickel electrodes with a solution of caustic potash for an electrolyte, and requires a pressure of 400 pounds square inch and temperature about 400°F.

This cell seems to point the way to larger units which might use any combustible gas and air, provide much higher power and be used in trains, automobiles and buses.

Calendar of Events

Buffalo (N.Y.) Hi-Fi Show, Oct. 30–Nov. 1, Statler Hotel.

Mid-America Electronics Conference, Nov. 3–5, Municipal Auditorium and Hotel Muehlebach, Kansas City, Mo.

National Automatic Control Conference, Nov. 4–6, Sheraton-Dallas Hotel, Dallas, Texas.

High-Fidelity Music Show, Nov. 6–8, New Washington Hotel, Seattle, Wash.

Radio Fall Meeting, Nov. 9–11, Syracuse Hotel, Syracuse, N.Y.

Instrumentation Conference, Nov. 9–11, Atlanta, Ga.

Annual Electrical Techniques in Medicine and Biology Conference, Nov. 10–12, Penn-Sheraton Hotel, Philadelphia, Pa.

High-Fidelity Music Show, Nov. 13–15, New Heathman Hotel, Portland, Ore.

Conference on Magnetism and Magnetic Materials, Nov. 16–19, Sheraton-Cadillac Hotel, Detroit, Mich.

New England Research and Engineering Meeting, Nov. 17–19, Boston Commonwealth Armory, Boston, Mass.

PACE Meeting, Nov. 18, Gov. Clinton Hotel, New York, N.Y.

Nuclear Science National Meeting, Nov. 19–20, Commonwealth Armory, Boston, Mass.

High-Fidelity Music Show, Nov. 20–22, Benjamin Franklin Hotel, Philadelphia, Pa.

Midwest Symposium on Circuit Theory, Dec. 1–2, Brooks Memorial Union, Marquette University, Milwaukee, Wis.

Eastern Joint Computer Conference, Dec. 1–3, Statler Hotel, Boston, Mass.

National Conference of the IRE Professional Group on Vehicular Communications, Dec. 3–4, Colonial Inn & Desert Ranch, St. Petersburg, Fla.

Northwest Hi-Fi, Music and Stereo Show, Dec. 4–6, Hotel Leamington, Minneapolis, Minn.

2 NEW TV STATIONS are on the air: KXLJ-TV, Helena, Mont.12
WDAM-TV, Laurel, Miss. 7
KXLJ-TV has resumed telecasting after a 6-month break.

WBPZ-TV, Lockhaven, Pa., channel 32, will be off the air for 3 months.

KNAC-TV, Ft. Smith, Ark., channel 5, has changed its call letters to KFSA-TV.

These changes bring our total of US operating stations up to 559. This figure includes 470 vhf and 89 uhf. The non-commercial group still numbers 42.

CONTINENTAL CLASSROOM, the NBC early-morning science program of last year, is being transmitted in color from 6:30 to 7 am each weekday starting Sept. 28. That half-hour will be a college level course in modern chemistry

FREE

ALLIED'S 1960

ELECTRONIC SUPPLY CATALOG

*it's value-packed...
send for it!*

*your complete money-saving
guide to everything in electronics*

WORLD'S LARGEST STOCKS

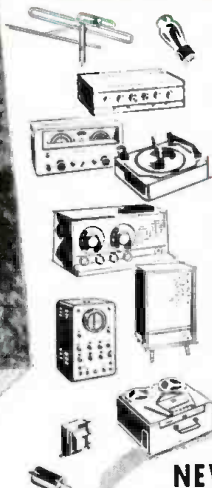

- Latest Stereo Hi-Fi Systems— Everything in Hi-Fi Components
- Money-Saving, Build-Your-Own KNIGHT-KITS for Every Need
- Values in Recorders and Supplies
- Latest Public Address Systems, Paging and Intercom Equipment
- Amateur Receivers, Transmitters and Station Gear
- Test and Laboratory Instruments
- TV Tubes, Antennas, Accessories
- Huge Listings of Parts, Tubes, Transistors, Tools, Books

NEW LOW EASY PAY TERMS

Only \$5 down (or less) on orders up to \$200. Up to 24 months to pay. Fast handling—no red tape.

Get every buying advantage at ALLIED: lowest money-saving prices, fastest shipment, expert personal help, guaranteed satisfaction...

*send for the leading
electronic supply guide*

FREE

ALLIED RADIO CORP., Dept. 2-L9
100 N. Western Ave., Chicago 80, Ill.

Send FREE 1960 ALLIED Catalog.

Name _____

Address _____

City _____ Zone _____ State _____

ALLIED RADIO EVERYTHING IN ELECTRONICS

CATALOG 190 1960

INDEX: PAGE 437

OUR 39th YEAR



100 N. WESTERN AVENUE CHICAGO 80, ILLINOIS
TELEPHONE HARVEY-ROB 1-2800

*featuring
these ALLIED exclusives:*

MONEY-SAVING KNIGHT-KITS—the very best in build-your-own electronic equipment—designed to save you up to 50%. "Convenience Engineered" for easiest assembly; the only kits covered by Money-Back Guarantee. Complete selection of Stereo hi-fi kits, Hobbyist kits, Test Instrument and Amateur kits. KNIGHT-KITS are an exclusive ALLIED product.

KNIGHT STEREO HI-FI—truly "honored for value"—the best you can buy, yet far lower in cost. Select super-value KNIGHT components or complete systems and save most. Also see the world's largest selection of famous name hi-fi components and money-saving ALLIED-recommended complete systems.

ALLIED RADIO



our 39th year

World's Largest Electronic Supply House

Mr. Service Dealer...

in CR Tubes Philco offers you

Double Protection

with Bond and Warranty

- ALL NEW ... Electron Gun
- ALL NEW ... Exclusive Phosphor Coating
- ALL NEW ... Long Life Filaments
- ALL NEW ... Super Efficient Cathode
- ALL NEW ... Focusing Anodes
- ALL NEW ... Aquadag Shell Coating

Quality Tested—
Life Tested

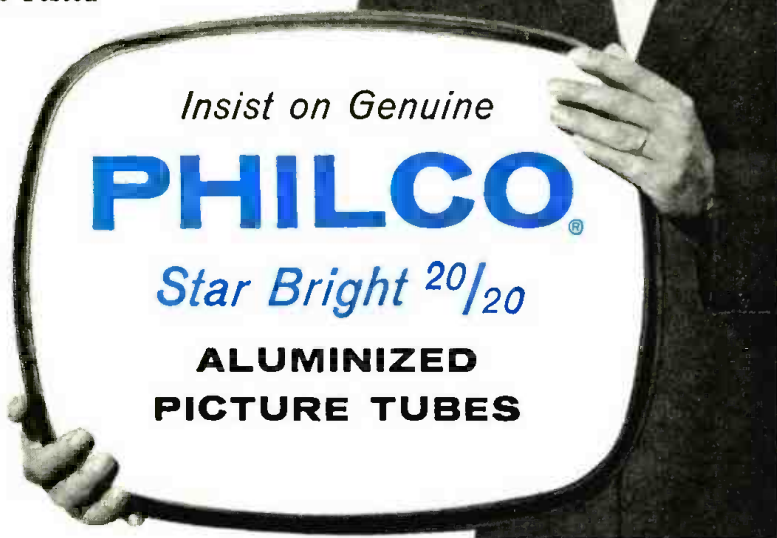

SENSATIONAL FREE OFFERS!

PHILCO PROFIT WHEEL PROGRAM

Get All of the Details From Your
Local Philco Distributor

PHILCO ACCESSORY DIVISION
WORLD-WIDE DISTRIBUTION

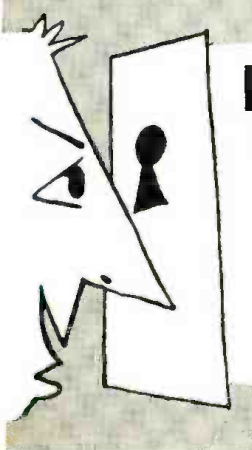

LOOK What's coming in Radio Electronics future issues

- ★ Design Your Own Preamplifier
- ★ Directory of Color Receiver Controls
- ★ Infrared Missile Guidance
- ★ Souping Up the Old Receiver
- ★ Small-Boat Radiotelephone
- ★ TV Camera Booster Amplifier
- ★ Installing Commercial Mobile Two-Way Radio
- ★ Rapid Cabinet Repair

The December issue of RADIO-ELECTRONICS goes on sale November 26. Newsstand price now 50c—subscribe now and save up to \$8.00

1 year.....\$4 2 years.....\$7 3 years.....\$10
154 West 14th St. New York 11, N. Y.

NEWS BRIEFS (Continued)

preceded by a half-hour rerun of Atomic Age physics, which was presented last year. RCA—joining nine other industrial firms and the Ford Foundation—is contributing \$100,000 to present the chemistry course.

ARRL MERIT AWARD for 1959 went to James Lamb of S. Norwalk, Conn., for “contributions to radio communication techniques, especially for noise reduction and selectivity . . .”

The Lamb crystal filter has been a feature of receivers for 25 years. He has also made substantial contributions through two books on methods of reducing amateur interference to TV receivers.

POWER VIA RADIO has electrified cargo-handling cranes ¼ mile from KSAV—San Francisco’s transmitting tower. Cargo-handlers have been painfully burned by cranes when the 10 kw station was in operation. FCC engineers have been unable to solve the mystery, which appears to be related to 1010 kc and dimensions of the metal cranes.

Similar phenomena, but picking up only microwatt power, have been reported frequently in the past.

KRYPTON 86 is expected to become the primary universal metric standard soon. This colorless, odorless gas, found 1 part in a 1,000,000 parts of air, emits an orange line under the spectroscope. That line will probably be adopted by the 1960 International Conference on Weights and Measures since it is even less variable than the platinum bar now used. But krypton may be replaced in years to come by atomic-beam radiations or advanced atomic absorption-light techniques.

JAPAN NOW LEADS in production of transistor radios, having passed the United States, according to the Japanese Electronic Industries Association, which predicted 1959 output of 4,000,000 sets. Over 2,000,000 of these will go to the US, the Association stated, as opposed to 1,233,000 units in 1958. There are 75 makers of transistor sets in Japan. Their export price for six-transistor receivers averages \$14 plus shipping. The JEIA also pointed out that the transistor set is a bigger export for Japan dollarwise than cameras or sewing machines.

ELECTRONIC OVENS for all may be closer than expected if Raytheon predictions of 150,000 in use within 5 years come to pass. The company has been supplying microwave oven components to five manufacturers of home ranges during the last 2-3 years. Present prices of these ranges are between \$1,000 and \$1,500, but the company expects them to drop to \$900 by 1960.

Within 5 years the prices can be expected to level off at \$300-400. By then they’ll be almost as common as TV sets. Along with electronic air conditioners and refrigerators (no
(Continued on page 14)

**6 months
from today**

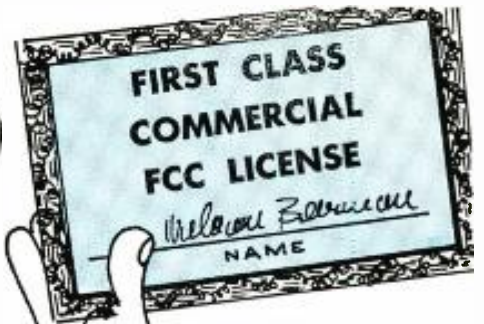

WHICH WILL YOU HOLD ...

OR



add technical training to your practical experience. Get your FCC license quickly!

then use our effective

Job Finding Service

Get your FCC Commercial License

or your money back

The Master Course in Electronics will provide you with the mental tools of the electronics technician and prepare you for a First Class FCC License (Commercial) with a radar endorsement. When you successfully complete the Master Course, if you fail to pass the FCC examination, you will receive a full refund of all tuition payments.

Employers Make Offers Like These

to Our Graduates Every Month

Broadcast Station in Illinois: "We are in need of an engineer with a first class phone license, preferably a student of Cleveland Institute of Radio Electronics; 40 hour week plus 8 hours overtime."

West Coast Manufacturer: "We are currently in need of men with electronics training or experience in radar maintenance. We would appreciate your referral of interested persons to us."

Our Trainees Get Jobs Like These Every Month

CHIEF ENGINEER

"Since enrolling with Cleveland Institute I have received my 1st class license, served as a transmitter engineer and am now Chief Engineer of Station WAIN. I also have a Motorola 2-Way Service Station. Thanks to the Institute for making this possible."

Lewis M. Owen, Columbia, Ky.

TEST ENGINEER

"I am pleased to inform you that I recently secured a position as Test Engineer with Melpar, Inc. (Subsidiary of Westinghouse). A substantial salary increase was involved. My Cleveland Institute training played a major role in qualifying me for this position."

Boyd Daugherty, Falls Church, Va.

**Names of Trainees in Your Area
Provided on Request**

**Carl E. Smith, E.E., President
CLEVELAND INSTITUTE OF ELECTRONICS
Dept. RE-35B, 4900 Euclid Bldg., Cleveland 3, Ohio**

Get these valuable
Booklets

FREE!



Accredited by National Home Study Council

Cleveland Institute of Electronics

Dept. RE-35B, 4900 Euclid Bldg., Cleveland 3, Ohio

Please send Free Booklets prepared to help me get ahead in Electronics. I have had training or experience in Electronics as indicated below:

- | | |
|---|---|
| <input type="checkbox"/> Military | <input type="checkbox"/> Broadcasting |
| <input type="checkbox"/> Radio-TV Servicing | <input type="checkbox"/> Home Experimenting |
| <input type="checkbox"/> Manufacturing | <input type="checkbox"/> Telephone Company |
| <input type="checkbox"/> Amateur Radio | <input type="checkbox"/> Other |

In what kind of work are you now engaged? _____

In what branch of Electronics are you interested? _____

Name _____ Age _____

Address _____

City _____ Zone _____ State _____

RE-35B

STEAM

YOUR WAY TO NEW MARKETS...

WITH JFD

...the *quality* line!...

the *performance* line!...

the *full* line!...

the *turnover* line!...

of TV and FM Antennas and Accessories that make you thrive—not just survive.

JFD PAVES THE WAY TO SERVICE-DEALER PROFITS WITH...

ANTENNA LINES THAT MAKE THE MASS-MARKET YOUR MARKET!

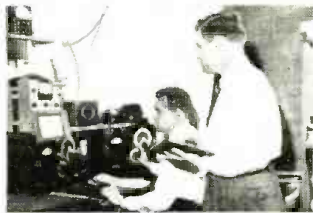

Outdoor or indoor, TV or FM, top, middle or low-end, JFD offers the industry's best construction and engineering advantages in *all* models, *all* prices.

Each developed to perfection in the JFD Research Laboratories by the same engineering team responsible for precision electronic components now serving in America's most advanced weapon and industrial systems.

HI-FI HELIX COLORTENNAS

Five unique types with high-gain Satellite dipole and helix design—each geared to today's black and white, tomorrow's color requirements—in natural or eye-appealing gold anodized aluminum.

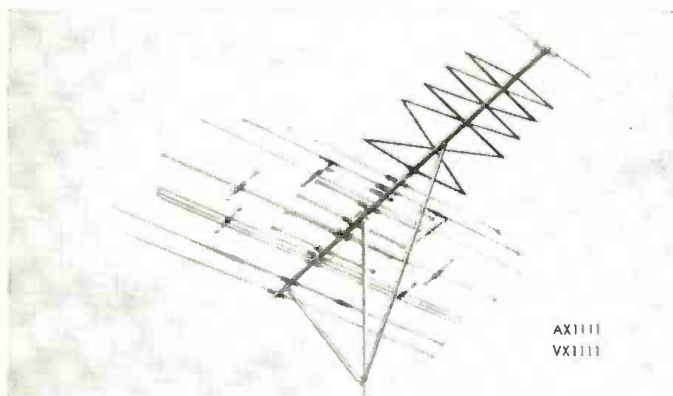

AX1111
VX1111



AX911
VX911

AX711
SX711

AX511
RX511

AX311
JX311

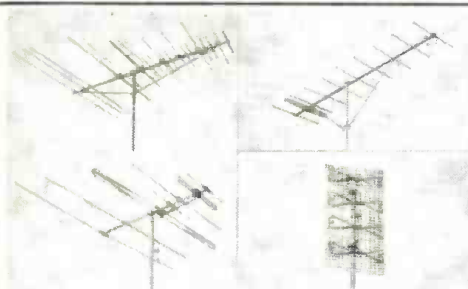

PERFORMANCE-PROVED VHF AND UHF TV ANTENNAS—A complete line of over 100 antennas—from the VHF Banshee, Fireball and 5 and 10-element Yagis to the UHF Translator—a line that fills all customer reception needs and *your* profit needs.

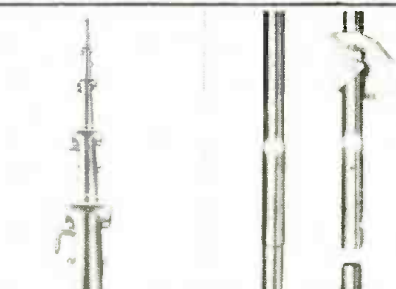

STRAIGHT AND TELESCOPING TUBING—Whether it's JFD Hi-Carbon Steel or Hi-Tensile Strength Aluminum Straights... or Armco Hi-Carbon Steel Telescoping Tubing, you can't buy better.

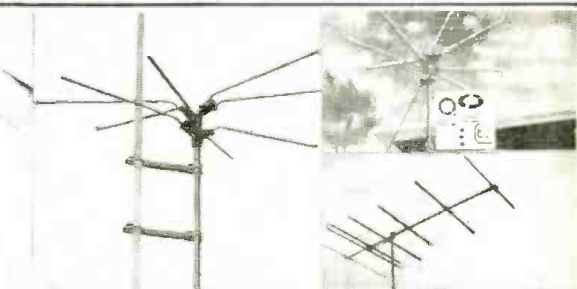

FM ANTENNAS—JFD uncorks a profitable new service-dealer market with the all-new FM Stereo Cone antenna concept. Five gold anodized FM antenna kits make every TV set owner, every hi-fi owner a customer.

SEE YOUR JFD DISTRIBUTOR NOW! GET YOUR FAIR SHARE OF TODAY'S 40 MILLION DOLLAR ANTENNA REPLACEMENT MARKET!

JFD ELECTRONICS CORPORATION

6101 Sixteenth Avenue, Brooklyn 4, New York

ROLL

FAT NEW PROFITS ...



JFD

EXPLODES NATION-WIDE TV ANTENNA SALES DRIVE THIS SEASON WITH HUGE ADVERTISING SPECTACULARS!

OPEN-THROTTLE ADVERTISING PRESELLS 20,000,000 PROSPECTS!

COAST-TO-COAST ABC-TV ADVERTISING ON THE ALCOA PRESENTS!

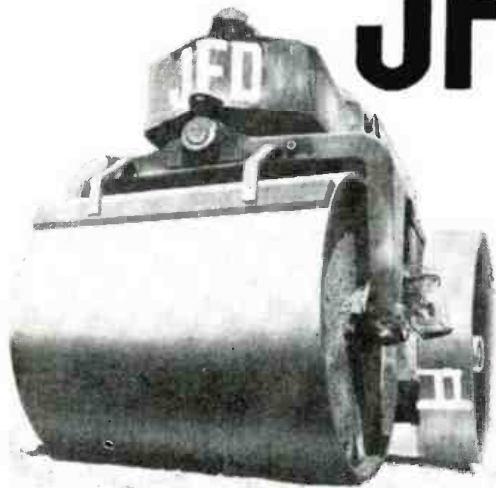

MONTH-IN MONTH-OUT SATURATION CAMPAIGNS IN



**PROGRESSIVE FARMER
FARM JOURNAL
LOOK
TV GUIDE**

MAKING THE MASS MARKET JFD ANTENNA-CONSCIOUS!

LOCAL TIE-IN CO-OP ADVERTISING TO HELP YOU CONVERT ANTENNA REPLACEMENT LEADS INTO SALES.

NEWSPAPER MATS, RADIO-TV SPOTS, POP DISPLAYS THAT PUT MUSCLE INTO YOUR LOCAL SALES DRIVES.

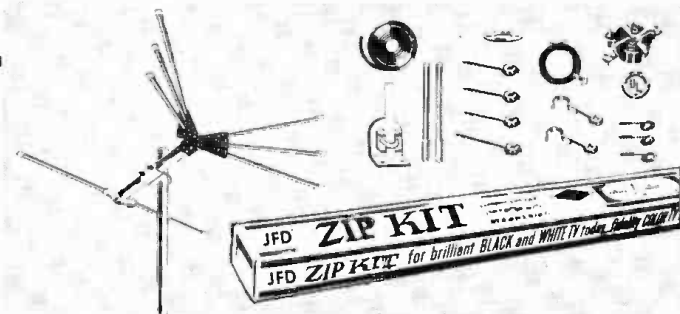

The most complete line of "DO-IT-YOURSELF" TV ANTENNA installations in a package — the sensational-selling **ZIP-KIT!** ... starting at \$10.75, list.

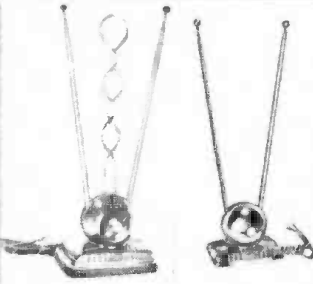

EXACT REPLACEMENT TV ANTENNAS — Thousands of service-dealers are earning quick, clean profits in "portable" and "toteable" TV antenna replacements by specifying the JFD brand — the perfect "factory-spec" match. Soon to be listed in Howard W. Sams Photofact Index. Another vital new service market.

INDOOR TV ANTENNAS — First in sales! First in performance! Today's longest and strongest indoor VHF or UHF antenna line! And with good reason. None other offers the styling ... the packaging ... the merchandising you get from JFD.

SERVICE-SAVERS — The TV accessory line with "heart." Fifty labor-saving, money-making units to choose from — the trade's largest assortment — assure picture-perfect performance every time. For a handy profit-plus standardize on JFD set couplers, antenna couplers, switches, wave traps and lightning arresters.

Pioneers in electronics since 1929

JFD International, 15 Moore Street, New York, New York • JFD Canada Ltd., 51 McCormack Street, Toronto, Ont., Canada

www.americanradiohistory.com

Build This Superb *Schober* Organ From Simple Kits and SAVE OVER 50%!



LET US SEND YOU FREE DETAILS HOW TO ASSEMBLE A *Schober* ELECTRONIC ORGAN IN SPARE TIME!

The Beautiful *Schober* CONSOLETTA — the only small organ with two full 61-note keyboards and 22 stops. Requires only 2' x 3'2" floor space! Commercial value approximately \$1600 or more — yet you save over 50% when you build this thrilling instrument!

Give Your Family A Lifetime of Musical Joy With A Magnificent Schober ELECTRONIC Organ!

Now you can build the brilliant, full-range Schober CONSOLETTA or the larger CONCERT MODEL with simple hand tools. No skills are necessary to construct an instrument with one of the finest reputations among electronic organs. No woodworking necessary — consoles come completely assembled and finished. All you do is assemble clearly marked electronic parts guided by clear illustrations and detailed step-by-step instructions. Even teen-agers can assemble the Schober! You build from kits, as fast or as slowly as you please... at home, in spare time — with a small table serving as your entire work shop!

Send For Complete Details On Schober Organs and For Hi-Fi Demonstration Record

The coupon will bring you a handsome 16-page booklet in full color describing Schober organs in detail, plus articles on how easy and rewarding it is to build your own organ and how pleasant and quick it is to learn to play the organ. In addition, we have prepared an exciting 10" hi-fi LP record demonstrating the full range of tones and voices available on the Schober, which you may have for only \$2.00 (refunded when you order a kit). Literature on the Schober is FREE! There is no obligation; no salesman will call.

THE GREAT CONCERT MODEL meets specifications of American Guild of Organists

Pay As You Build Your Organ; Start With As Little As \$18.94!

You may start building your Schober at once with an investment of as little as \$18.94. The musical instrument you assemble is as fine, and technically perfect, as a commercial organ built in a factory — yet you save over 50% on top-quality electronic parts, on high-priced labor, on usual retail store markup! In your own home, with your own hands you build an organ with *genuine pipe organ tones* in an infinite variety of tone colors to bring into your home the full grandeur of the Emperor of Instruments. You may build the CONSOLETTA for your home, or you may want to build the great CONCERT MODEL for home, church, school or theatre. You save 50% and more in either case.



Mail This Coupon For FREE Literature and Hi-Fi Record Today!

The Schober Organ Corp., Dept. RE-2
2248 Broadway, New York 24, N. Y.

Please send me FREE full-color booklet and other literature on the Schober organs.

Please send me the 10" hi-fi Schober demonstration record. I enclose \$2.00 (refundable on receipt of my first kit order).

Name.....

Address.....

City..... Zone... State.....

moving parts) they'll be additional home appliances for the local service technician.

MOSCOW TV SETS are reported to number over 1,000,000 with 5,000,000 throughout the USSR, according to *Variety*. There are two stations in Moscow. A network of 75 stations is planned by 1964. Moscow Radio broadcasts for 5 to 7 hours each day, largely serious music and educational programs.

Receivers with small screens, about 6 inches across, cost 700 rubles, which is nearly \$175 at official exchange rates but only \$70 at tourist exchange. Both 14- and 17-inch sets are the most popular, and cost two to three times as much as the smaller sets.

TV IS HI-FI WITH 3-D! So says a major set maker's full-page ad. A question to the company's advertising department revealed that 3-D doesn't mean anything so ordinary as three-dimensional sound or stereo. It means they've "added 'definition, dynamics and dimension' to high fidelity, to make it more realistic!"

The secret ingredient in this higher hi-fi seems to be little more than a little window on the front of these TV sets which lights up the words "High Fidelity." That way the user can tell? The ad also shows "3-D" on a TV set knob.

ELECTRONIC FLAG-RAISING uses a photo cell to control the motors for sunrise and sunset change at the Canadian National Research Council at Ottawa, Canada. Electronics will also set the flag at half-mast or thaw or dry it out in a long tube at the bottom of the 40-foot mast.

RADAR TRAFFIC CONTROL to give warning before traffic jams develop has been experimentally installed in New York City. It uses the Doppler effect to ignore stationary objects and count moving ones. The Electromatic Traffic Expediter reads miles an hour for each moving vehicle and counts them, recording the data graphically. It was developed by Joseph Barker, inventor of anti-speeding radar. (Other electronic traffic control devices were described in RADIO-ELECTRONICS, May, 1959, cover story.)

AUDIO ENGINEERING Society elected new officers including Harry Bryant (Radio Recorders), president, and Dr. Harry F. Olson (RCA), executive vice president. New Central vice president is W. Earl Stewart (Standard Register), Western vice president Walter Selsted (Ampex). Re-elected secretary and treasurer, respectively, were C. J. LeBel and Ralph Schlegel. New governors for 2-year terms are William B. Snow, William Bachman and Edgar Villchur.

23-INCH TV sets are gaining with RCA and Westinghouse joining Admiral, Sylvania, Hoffman and others in offering them. RCA had been holding out, it said, to see if public acceptance of 24-inch tubes would keep out 23-inch picture tubes. END



Verdict:

Collaro

stereo
record players
are **innocent**
of rumble,
wow, flutter



or any noises
that
interfere
with enjoyment
of music



The Constellation, Model TC-99—\$59.50

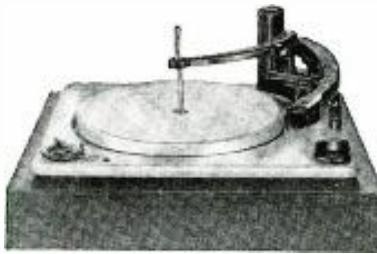

The Continental II, Model TSC-840—\$49.50



The Coronation II, Model TSC-740—\$42.50
*The Conquest II, Model TSC-640—\$38.50

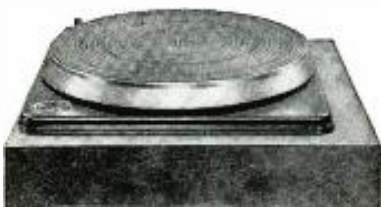

Transcription Turntable, Model 4TR-200—\$49.50

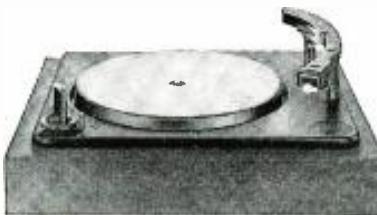

Manual Player, Model TP-59—\$29.95



Every Collaro stereo record player is built with typical British attention to every detail. They are precision engineered and rigidly tested to give truly professional performance and the ultimate in operating convenience. Here are some of the more important features that make Collaro the logical choice for stereo or monophonic records. • Performance specifications exceed NARTB standards for wow, flutter and rumble — with actual performance test reports accompanying each model TC-99. • Extra-heavy, die-cast, non-magnetic turntables (weighing up to 8½ lbs.). Extra-heavy weight is carefully distributed for flywheel effect and smooth, constant rotation. • Shielded four-pole motors are precision balanced, screened with triple interleaved shields to provide extra 25 db reduction in magnetic hum pick-up. • Detachable five-terminal plug-in head shells (on TC-99, TSC-840, TSC-740, TP-59) provide two completely independent circuits, guaranteeing ultimate in noise reduction circuitry. • Transcription-type stereo tonearms are spring-damped and dynamically counterbalanced to permit the last record on a stack to be played with virtually the same low stylus pressure as the first. • All units are handsomely styled, available with optional walnut, blond and mahogany finished bases or unfinished utility base. There's a 4-speed Collaro stereo record player for every need and budget! Prices slightly higher in the West. For free catalog on the Collaro line, write to: Rockbar Corporation, Dept. RE-11, Mamaroneck, N. Y. (*Not shown. Similar in appearance to The Coronation.)

see them in **ALLIED'S 1960 catalog**
THE WORLD'S LEADING ELECTRONIC SUPPLY GUIDE

FREE
send
for it

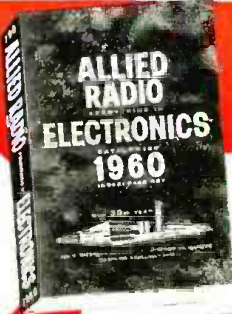

See these and scores of other great **knight-kits**

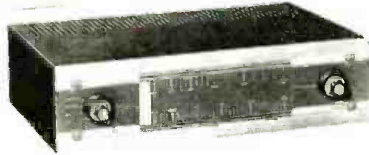

Y-731 Deluxe FM-AM Stereo Hi-Fi Tuner (Multiplex add-in)... **\$87.50**
only \$5 down



Y-712 Custom Superhet Citizen's Band Transceiver... **\$79.95**
only \$5 down

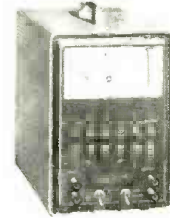

Y-608 Lab AC VTVM with Automatic Range Selection... **\$99.50**
only \$5 down

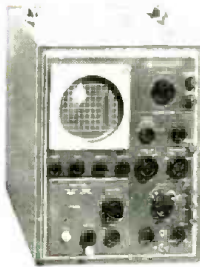

Y-611 Lab DC Scope with Trigered Sweep and Plug-in Vertical Preamps (less Preamps) **\$285.00**
only \$10 down

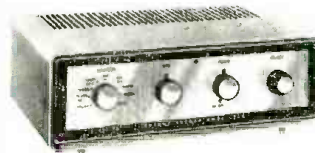

Y-773 Super-Value 20-Watt Stereo Hi-Fi Amplifier. **\$44.50**
only \$2 down

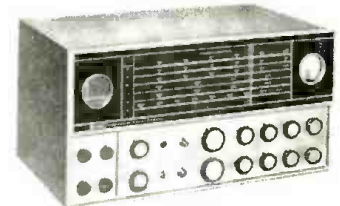

T-400 400-Watt Transmitter (AM and SSB add-ins available)... **\$395.00**
only \$10 down



Y-708 1000 Ohm/Volt Pocket Volt-Ohm-Milliammeter... **\$9.95**



G-30 Amateur Grid Dip Meter (1.5-300 mc)... **\$22.95**
only \$2 down



Y-711 Ammeter-Voltmeter for Cars and Boats... **\$10.75**



there's a money-saving **knight-kit** for every need

SEE PAGE AFTER PAGE OF FASCINATING KITS, INCLUDING:

NEW LOWEST TERMS

Only \$5 down (or less) on orders up to \$200; up to 24 months to pay. Fast handling—no red tape.

HI-FI KITS

Stereo Deluxe Preamp
60-Watt Stereo Amplifier
Stereo Control
25-Watt Amplifier
18-Watt Amplifier
12-Watt Amplifier
FM-AM Tuner
FM Tuner
Speaker Systems
and others

HOBBYIST KITS

"Span-Master" Receiver
"Space-Spanner" Receiver
"Ranger" Radios
"Ocean Hopper" Radio
Clock-Radio
Radio-Intercom
5-Transistor Portable
2-Transistor Pocket Set
2-Way Intercom
Electronic Lab Kits
Photoelectronic System,
and many others

INSTRUMENT KITS

DC VTVM
Volt-Ohm-Milliammeters
5" Oscilloscopes
Tube Checkers
RF Signal Generator
Signal Tracer
Audio Generator
Sweep Generator
Battery Eliminator
Capacity Checker
Transistor Checker
R/C Tester, plus many others

sold exclusively by **ALLIED RADIO**

the Best News in electronic kits for 1960

world's easiest-to-build kits

SAVE UP TO 50%

BUILD THE BEST



Y-774 Deluxe 40-Watt Stereo Amplifier (with Center Channel) . . \$79.50
only \$5 down

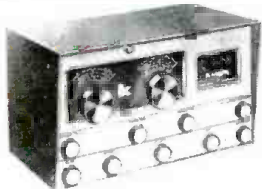

R-100 Amateur Communications Receiver (Hi-gain, with built-in Q-Multiplier). \$104.50
only \$5 down



Y-713 Citizen's Band Transceiver . . \$39.95
only \$2 down

SEE THEM HERE

AMATEUR KITS

- 50-Watt Transmitter
- Self-Powered VFO
- 100 kc Crystal Calibrator
- RF "Z" Bridge
- Code Practice Oscillator

Pioneers in the development of the world's finest electronic kits



our 39th year
THE WORLD'S LARGEST ELECTRONIC SUPPLY HOUSE

BEST...by Design!



with the exclusive **knight-kit**

MONEY-BACK GUARANTEE

KNIGHT-KITS are an exclusive product of Allied Radio. Every KNIGHT-KIT meets or exceeds published specifications, or we refund your money in full.

**BUY ANY KNIGHT-KIT! BUILD IT!
IT MUST PERFORM EXACTLY AS CLAIMED
-OR WE REFUND YOUR MONEY!**

only **knight-kits** have
"CONVENIENCE ENGINEERING"
for easiest building...no previous
electronic experience needed

Exclusive in Knight-Kits, "convenience engineering" means special attention to every detail: resistors are carded and numbered for easy selection... all parts and hardware are packaged in clear plastic bags for easy identification... wire is precut, stripped, tinned and color-coded to save time... special printed circuitry is used to eliminate complex wiring... all parts are top premium quality... you get everything—even the solder! Finally, Knight-Kit instructions are clear as crystal; step-by-step procedure and wall-sized picture diagrams make assembly a marvel of simplicity. Your final reward is proud enjoyment of the superior performance designed into your Knight-Kit.

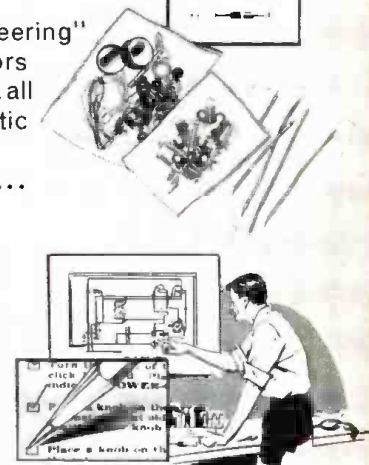
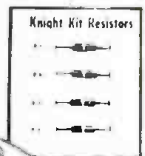

FREE send for the value-packed

1960 ALLIED CATALOG

Write for the 1960 ALLIED Catalog featuring the complete KNIGHT-KIT line—see the **big news** in electronic kits—get this leading Buying Guide for everything in Electronics. Send for your **FREE** copy.

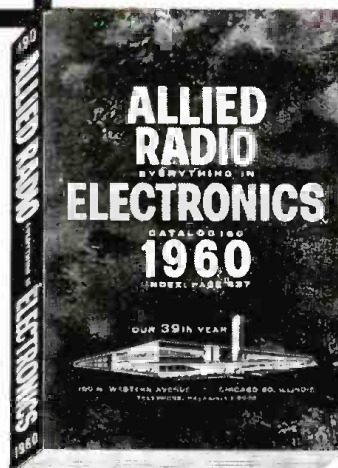

ALLIED RADIO CORP., Dept. 162-L9
100 N. Western Ave., Chicago 80, Ill.

Send **FREE** 1960 ALLIED Catalog

Name _____

Address _____

City _____ Zone _____ State _____

FIRST TIME . . . a versatile

DUAL

HEAT

SOLDERING GUN

FOR ONLY
\$7.95
LIST
Model 8200K

...and best of all,

it's a new

Weller®

Here from Weller, long time leader in the soldering field, is the newest and finest soldering gun value on the market.

WELLER DUAL HEAT FEATURE saves time, gives greater convenience and greatly increases tip life. A touch of your finger on the Triggermatic control switches heat to high (125 watts) or low (90 watts) as your job requires. It adapts instantly to varying needs, and you use high heat only when necessary.

HIGH EFFICIENCY WELLERTIP utilizes copper for superior heat transfer and soldering efficiency, plus iron plating for durability. Flat cross-section design gives added strength and rigidity.

NEWEST DESIGN with sturdy plastic housing that resists hard knocks. Compact "feel" and comfortable balance aid precision soldering. Like all other Weller guns, this new model features instant heat, and a spotlight illuminates your work.



KIT INCLUDED

In addition to the Dual Heat Soldering Gun you get:

- Wire Bristle Cleaning Brush
- Soldering Aid for opening old joints, twisting wires
- All-purpose Solder

On sale now at your
Electronic Parts Distributor

WELLER ELECTRIC CORP. • 601 Stone's Crossing Rd., Easton, Pa.

Correspondence



VARNISH WORKS, TOO!

Dear Editors:

"Finishing Your Hi-Fi Cabinet" (page 35, August) is a very good article, but some additional information may help those who wish to use a varnish finish. Varnish will eliminate the troubles attendant upon lacquer, which dries very fast. With varnish, the solvent in the second coat will not soften the first coat. It should be sanded with very fine sandpaper between coats. However, most varnishes should be allowed to dry a week between coats, and 10 days to 2 weeks before final rubbing.

I have recently found a varnish which eliminates the ordinarily long drying time. It is a Moore's One-Hour Varnish, made by Benjamin Moore & Co. Water-clear, it has little effect on the color of the wood. With this varnish it is necessary to wait only 1 day between coats, and 2-3 days before the final rubbing. I do not know if any other manufacturer makes a similar varnish.

The thumbnail test, made by pressing a thumbnail into the surface, will tell if more drying time is needed. If no mark is made, it's time to sand and to apply the next coat.

W. J. STILES

Keytesville, Mo.

(Mr. Markell reports that varnish makes a very good finish indeed, the only serious disadvantage being the long drying time mentioned, which makes the process rather discouraging to many hobbyists. He also points out that varnish takes longer to form a hard film than lacquers, and that therefore a varnished cabinet should be protected from dust until the film surface is hard.—Editor)

PLEA FOR UNIVERSAL TIME

Dear Editor:

When an electromagnetic signal is sent out into space, the time that signal is received everywhere on earth is the same. (Since there are no appreciable lapses in time in the travel of a radio signal—7.75 times around the world in a second—we can consider it instantaneous.) And that time should be recorded as the same time, not as a different local time at each different receiving station. Greenwich Mean Time (GMT), or Universal Time (UT) as it is now beginning to be called, should be made universal for all radio (and TV) communications.

Learn Radio-TV Electronics

*by Practicing
at Home in
Spare Time*

**Without Extra
Charge You Get**

special NRI kits developed to give actual experience with Radio-TV equipment. You build, test, experiment with receiver or broadcasting circuits. All equipment yours to keep.

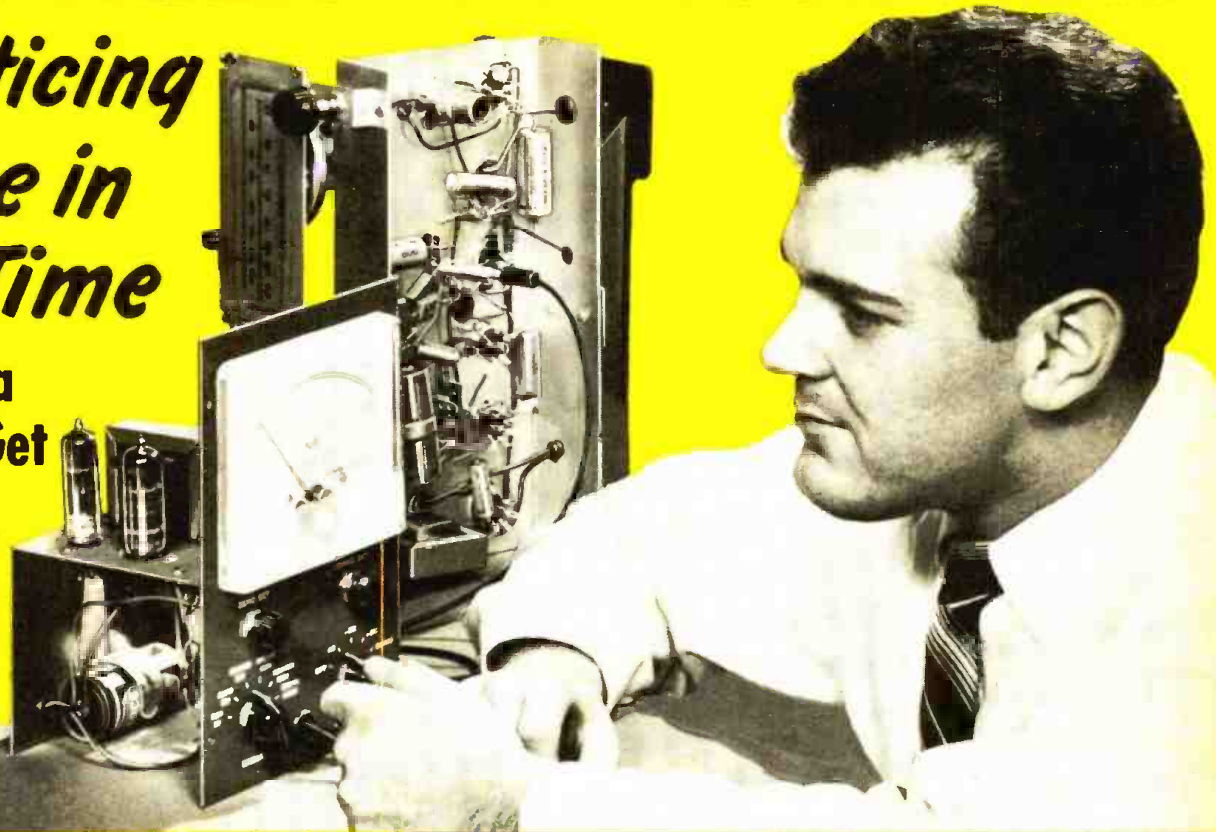

Have High Pay, Prestige, Good Future as a Skilled Radio-TV Electronic Technician

People *look up to* and depend on the Technician, more than ever before. Offices, plants, homes everywhere are obliged to buy his knowledge and services. His opportunities are great and are increasing. Become a Radio-TV Electronic Technician. At home, and in your spare time, you can learn to do this interesting, satisfying work—qualify for important pay. To ambitious men everywhere *here* in the fast growing Radio-TV Electronic field is rich promise of fascinating jobs, satisfaction and prestige as well as increasing personal prosperity.

Increasing Opportunities in Growing Field

A steady stream of new Electronic products is increasing the job and promotion opportunities for Radio-Television Electronic Technicians. Right now, a solid, proven field of opportunity for good pay is servicing the tens of millions of Television and Radio sets now in use. Color TV, Hi-Fi is growing. The hundreds of Radio and TV Stations on the air offer interesting jobs for Operators and Technicians.

More Money Soon—Make \$10 to \$15 a Week Extra Fixing Sets in Spare Time

NRI students find it easy and profitable to start fixing sets for friends and neighbors a few months after enrolling. Picking up \$10, \$15 and more a week gives substantial extra spending money. Many who start in spare time soon build full time Radio-Television sales and service businesses—enjoy security.

Act Now—See What NRI Can Do for You

NRI has devoted over 40 years to developing simplified practical training methods. You train at home in spare time. Get practical experience, learn-by-doing.
NATIONAL RADIO INSTITUTE
Washington 16, D.C.



NRI Has Trained Thousands for Successful Careers in Radio-TV



Studio Engr., Station KATV
"I am now Studio Engineer at Television Station KATV. Before enrolling, I was held back by limitation of a sixth grade education." **BILLY SANCHEZ**, Pine Bluff, Ark.



Has All the Work He Can Do
"I have repaired more than 2,000 TV and Radio sets a year. NRI training certainly proved to be a good foundation." **H. R. GORDON**, Milledgeville, Georgia.



Has Good Part Time Business
"Early in my training I started servicing sets. Now have completely equipped shop. NRI is the backbone of my progress." **E. A. BREDA**, Tacoma, Washington.

▶▶▶▶ **SEE OTHER SIDE** ▶▶▶▶

Cut Out and Mail This Card—No Stamp Needed

Sample Lesson and Catalog Both Sent FREE

OLDEST & LARGEST HOME STUDY RADIO-TV SCHOOL
National Radio Institute
Dept. EF, Washington 16, D.C.

Please send me sample lesson of your Radio-Television Training and Catalog FREE. (No salesman will call.)

Name..... Age.....

Address.....

City..... Zone..... State.....

ACCREDITED MEMBER NATIONAL HOME STUDY COUNCIL



NRI SUPPLIES LEARN-BY-DOING KITS WITHOUT EXTRA CHARGE
Technical Know-How Pays Off in Interesting, Important Work



YOU BUILD AC-DC Superhet Receiver
 NRI Servicing Course includes all needed parts. By introducing defects you get actual servicing experience practicing with this modern receiver. Learn-by-doing.



YOU BUILD This 17 Inch Television Receiver
 As part of your NRI course you can get all components, tubes, including 17" picture tube, to build this latest style Television receiver; get actual practice on TV circuits.

YOU BUILD Broadcasting Transmitter

As part of NRI Communications Course you build this low power Transmitter, learn commercial broadcasting operators' methods, procedures. Train for your FCC Commercial Operator's License.



YOU BUILD Vacuum Tube Voltmeter

Use it to earn extra cash fixing neighbors' sets; bring to life theory you learn from NRI's easy-to-understand texts.



For Higher Pay, Better Jobs Be a Radio-TV Electronic Technician



Servicing Needs More Trained Men

Portable TV, Hi-Fi, Transistor Radios, Color TV are making new demands for trained Technicians. Good opportunities for spare time earnings or a business of your own.

Broadcasting Offers Satisfying Careers

4000 TV and Radio stations offer interesting positions. Govt, Radio, Aviation, Police, Two-Way Communications are growing fields. Trained Radio-TV Operators have a bright future.



J. E. Smith, Founder

Train at Home the NRI Way Famous for Over 40 Years

NRI is America's oldest and largest home study Radio-Television school. The more than 40 years' experience training men for success, the outstanding record and reputation of this school—benefits you in many ways. NRI methods are tested, proven. Successful graduates are everywhere, from coast to coast, in small towns and big cities. You train in your own home, keep your present job while learning. Many successful NRI men did not finish high school. Let us send you an actual lesson, judge for yourself how easy it is to learn.

No Experience Necessary—NRI Sends Many Kits for Practical Experience

You don't have to know anything about electricity or Radio to understand and succeed with NRI Course. Clearly written, well-illustrated NRI lessons teach Radio-TV Electronic principles. You get NRI kits for actual experience. All equipment is yours to keep. You learn-by-doing. Mailing the postage-free card may be one of the most important acts of your life. Do it now. Reasonable tuition. Low monthly payments available. Address: NATIONAL RADIO INSTITUTE, Washington 16, D. C.

NRI Graduates Do Important Work



Now Quality Control Chief
 "Had no other training in Radio before enrolling, obtained job working on TV amplifiers before finishing course. Now Quality Control Chief." T. R. FAVALLORO, Norwich, N. Y.

NRI Course Easy to Understand
 "I opened my own shop before receiving my diploma. I have had to hire extra help. I am independent in my own business." D. P. CRESSEY, Stockton, Cal.

Works on Color-TV
 "NRI changed my whole life. If I had not taken the course, probably would still be a fireman, struggling along. Now Control Supervisor at WRCA - TV." J. F. MELINE, New York, N. Y.

FIRST CLASS
 Permit No. 20-R
 (Sec. 34.9, P. L. & R.)
 Washington, D.C.

BUSINESS REPLY CARD

No Postage Stamp Necessary if Mailed in the United States

POSTAGE WILL BE PAID BY

NATIONAL RADIO INSTITUTE
 3939 Wisconsin Avenue
 Washington 16, D.C.

SAMPLE LESSON
64-page CATALOG
both FREE

SEE
OTHER
SIDE

The use of universal time (UT) by aircraft pilots and navigators is further evidence of its desirability. If all operators used 24-hour clocks, and all set them with WWV's UT time signal (transmitted every 5 minutes), think how simple logging, bookkeeping, schedule dates and contest time records would be.

Why shouldn't all radio operators, dx fans, magazines and others use GMT (UT) in discussing the time of radio communications?

HARRY HABIG

Dayton, Ohio

THE OTL AMPLIFIER

Dear Editor:

My article "Transistor OTL Amplifier Delivers 8 Watts" in the October issue contained several errors. R18 and R19 are listed as 3,300 ohms. These are 330 ohms. In the balancing procedure given on page 37, the measuring points are from the collector of V3 to the collector of V4 (Not V5 as the text stated).

I have since found that greater stability and over 10 watts output can be obtained by using 18-volt supplies for E1 and E2. A 4-ohm resistor in each supply between the rectifier and filter capacitor drops the voltage to the proper value and increases stability.

The voltage from the bases of the power transistors to ground should be 13 to 15 volts. If it is not, vary R8 for the correct voltage and then reset the dc balance.

High-beta transistors like the DS-401 may require almost the full resistance of bias control R20. This limits power output so if over half the resistance of the pot is needed, change R18 and R19 to 390 or possibly 470 ohms. Better transistors improve frequency response. With Bendix 2N1073's response is down only one db at 20,000 cycles with 8 watts output.

Coat both sides of the mica washers between the transistors and heat sinks with Dow Corning DC-4 or similar silicone grease before installing.

Cure excessive hum with up to 250 µf for C6.

DANIEL MEYER

Southwest Research Institute
San Antonio, Tex.

WHY DON'T THEY MAKE . . . ?

Dear Editor:

Things I would like to see manufactured or sold . . .

A tube manual listing circuits and component value tables for nonobsolete tube types. Current manuals, for the most part, tend to record circuits and tables on obsolete or obsolescent tube types.

Test prods which are combination phone tip-banana plug. At present, I
(Continued on page 24)

3 NEW TUNERS FROM



H. H. SCOTT

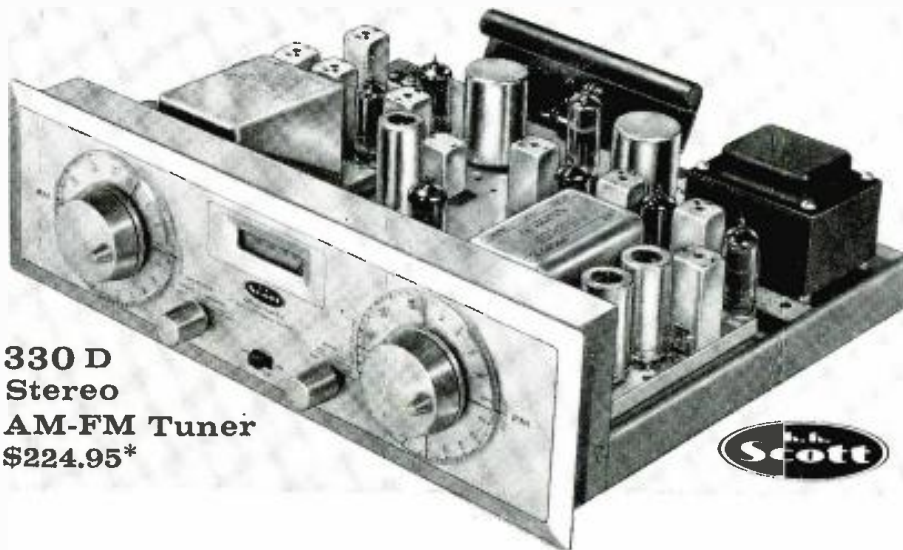

**330 D
Stereo
AM-FM Tuner
\$224.95***

**Wide-Band FM...Wide-Range AM Make These
World's Most Sensitive, Most Selective Tuners!**

The completely separate FM section of the radically new H. H. Scott 330D stereo tuner utilizes H. H. Scott's exclusive Wide-Band FM circuitry to assure absolutely drift-free and interference-free reception in even the weakest signal areas. Wide-Band design also lets you separate stations so close together on the dial that ordinary tuners would pass them by. The separate AM section utilizes H. H. Scott's unique Wide-Range detector so that, for the first time, you can receive full range AM broadcasts with fidelity and frequency response comparable to FM. Special multiplex adaptor facilities let you convert to multiplex at any time.

320 AM-FM TUNER

The many fine features built into this superlative tuner, including Wide-Range AM and Wide-Band FM, have never been available before for less than \$200. This tuner is ideal where AM-FM stereo reception is not available. \$139.95*



310C FM TUNER

This professional tuner is the most sensitive and selective available. Its outstanding performance and sensitivity have made it the choice of universities and laboratories throughout the world. Sensitivity 1.5 µv for 20 db of quieting. (IHFM rating 2 µv) \$174.95*



*Slightly higher West of Rockies. Accessory case extra.

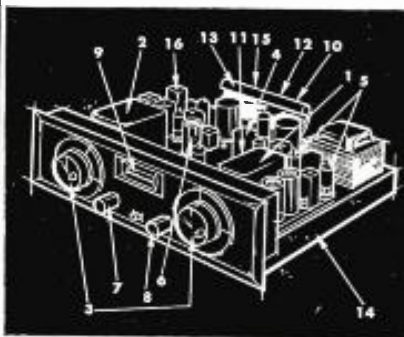

1. Separate FM front-end, silver plated for maximum sensitivity.
 2. Separate AM front-end.
 3. Separate AM and FM professional tuning controls.
 4. Wide-Band FM detector for distortion-free reception on all signals.
 5. Highly selective FM IF stages permit separation of stations close together on dial.
 6. Wide-range AM detector.
 7. Selector switch.
 8. Band switch with these positions: FM, AM Wide, AM Normal, AM Distant.
 9. Illuminated tuning meter.
 10. Stereo output jacks.
 11. Jack for instant connection of multiplex adaptor.
 12. Stereo tape recorder output jacks.
 13. AM Ferrite Loop Antenna.
 14. Chassis constructed of heavy copper bonded to aluminum to insure reliability.
 15. 10 KC whistle filter.
- Specifications: FM sensitivity 2 microvolts for 20db of quieting; (IHFM rating 2.5 µv); FM detector bandwidth 2 megacycles.



H. H. Scott, Inc. 111 Powdermill Road, Dept. RE-11, Maynard, Mass.
Rush me new catalog and complete technical specifications on all new H. H. Scott components.

Name.....
Address.....
City..... State.....

Export: Telesco International, 36 W. 40th St., N.Y.C.

HEAR THE FABULOUS LONDON-SCOTT INTEGRATED STEREO ARM AND CARTRIDGE

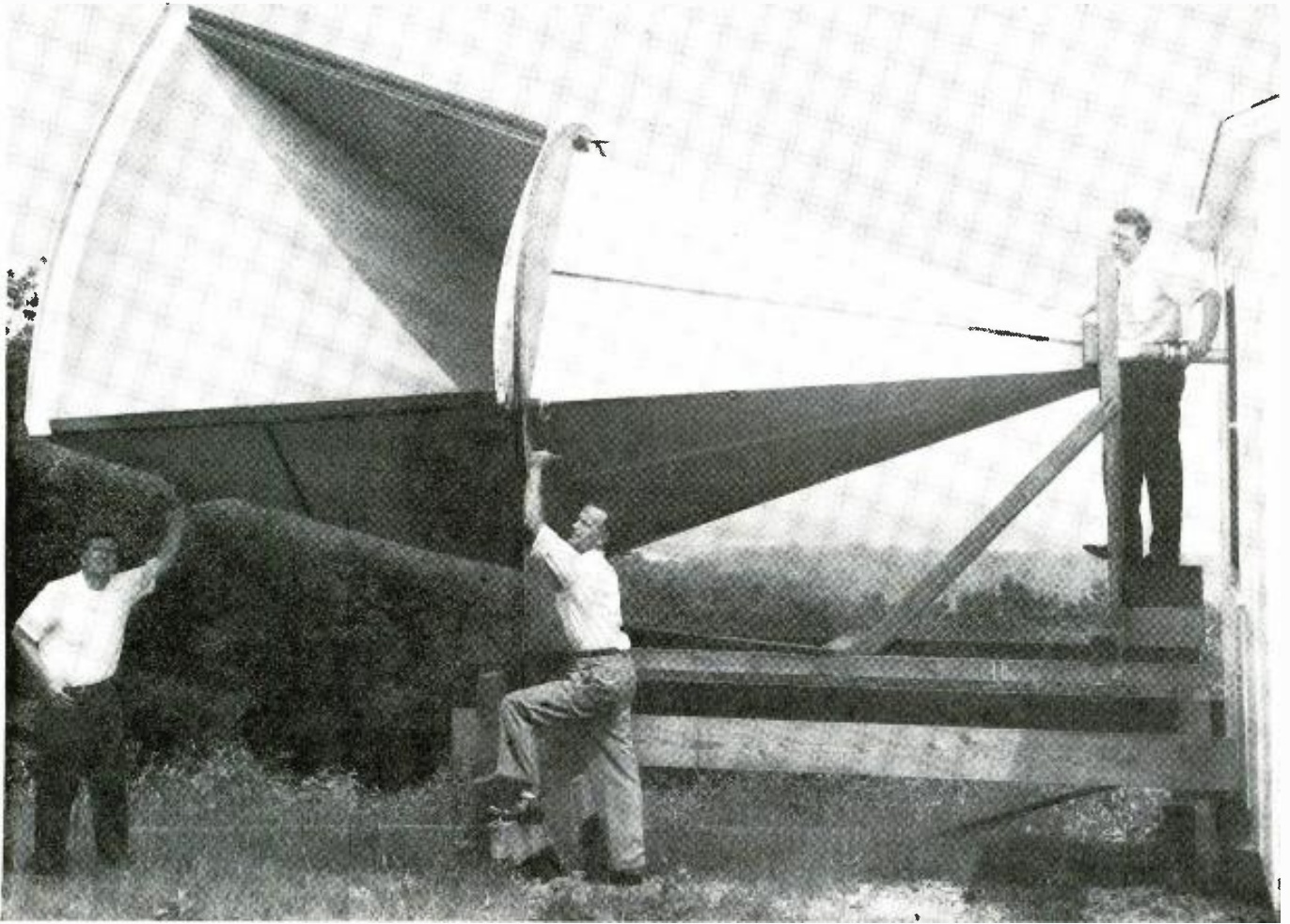

At Bell Laboratories, Holmdel, N. J., a horn reflector antenna is beamed skyward by scientists Edward Ohm, David Hogg and Robert DeGrasse. The maser amplifier, which employs a ruby cooled in liquid helium, is inside building at right. Over-all "noise" temperature of antenna, amplifier and sky is only 18°K at 5600 megacycles.

ANOTHER STEP TOWARD SPACE COMMUNICATIONS

The above antenna is part of a new ultra-sensitive radio receiving system under development at Bell Telephone Laboratories. It has extraordinary directivity. Beamed skyward, it ignores radio "noise" from the earth, yet picks up extremely weak signals from outer space.

The signals are amplified by the latest Bell Laboratories "maser" amplifier. The maser principle was first demonstrated, using gas, by Prof. C. H. Townes and his collaborators at Columbia University. Bell Laboratories scientists applied it to the solid state guided by a theoretical proposal of Prof. N. Bloembergen of Harvard University. Their latest traveling wave maser amplifier employs a ruby mounted in a waveguide. The ruby is excited to store energy. As signals pass through, they absorb this energy and are thus amplified.

The device uniquely combines the characteristics needed for practical space communication: extremely low inherent noise and the ability to amplify a broad frequency band.

At present the receiving system is being used to pick up and measure minute radio noise generated by the atmosphere. It also foreshadows important advances in long distance communications. For example, it could extend the range of space-probe telemetering systems, could help make possible the transatlantic transmission of telephone and TV signals by bouncing them off balloon satellites—and has numerous applications in radio astronomy and radar.

This pioneer development in radio reception is one more example of the role Bell Laboratories plays in the pursuit of better communications technology.

BELL TELEPHONE LABORATORIES
WORLD CENTER OF COMMUNICATIONS RESEARCH AND DEVELOPMENT



RADIO-ELECTRONICS

Service Technicians! YOU EARN MORE... YOU RATE with the public when you own the **PHOTOFACT**[®] service data library!

"Time saved is the main reason we feel a real need for the PHOTOFACT Library. We could repair a set by trial and error but PHOTOFACT lays all the facts before us and reduces bench time to a minimum".

—William C. Dixey
Riverside, N.J.

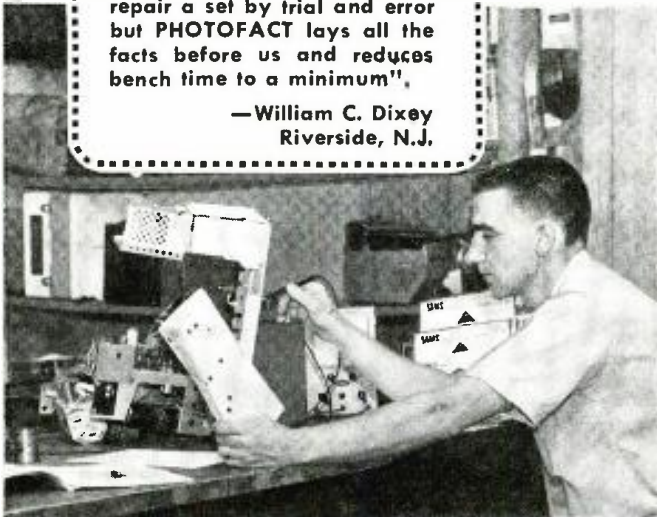

"PHOTOFACT gives us the best and latest information on part numbers, etc., as well as excellent schematics. Couldn't do without them".

—Johnny Wheeler
Mobile, Ala.



Yes, if you are one of the thousands of owners of a complete PHOTOFACT Service Data Library, you are enjoying maximum earnings. It's inevitable, because no matter how expert you are, you can always *save more time on any job, get more jobs done daily—EARN MORE, DAY IN AND DAY OUT...*

Moreover—as the owner of a complete PHOTOFACT Library, *you know your customers' sets best.* You can actually show each customer you have the PHOTOFACT Folder covering his very own set. Result: You command public respect and acceptance which paves the way to expanded business for you...

HERE'S HOW TO STAY AHEAD...

Today, the truly successful Service Technicians are those who own the complete PHOTOFACT Library, who can meet and solve any repair problem—faster and more profitably. And these men *keep ahead* because they're on a Standing Order Subscription with their Distributors to receive all new PHOTOFACTS as they are released monthly.

For PHOTOFACT Library Easy-Buy Plan details and Standing Order Subscription, see your Sams Distributor today, or write to Howard W. Sams...



BIG NEW PLUS

**"PEET"
PROGRAM**

If you now own a PHOTOFACT Library, you can apply at once for qualification in the powerful new "PEET" program. Designed to help you gain deserved recognition as a reputable businessman; develop and command public respect; justify better earnings warranted by your business investment and skill; pave the way to expanded business and increased profits for you. Ask your Sams Distributor about "PEET" or write to Howard W. Sams.

HOWARD W. SAMS & CO., INC.

2205 E. 46th St., Indianapolis 6, Ind.

- Send me full details on the new "PEET" Program, designed to build prestige and business for the Service Technician who qualifies. Include full information on the Easy-Buy Plan and Free File Cabinet deal.
- I'm a Service Technician: full-time: part-time

My Distributor is: _____

Shop Name _____

Attn: _____

Address _____

City _____ Zone _____ State _____



**THE
FINEST
IN HI-FI
USE THE
FINEST
IN AUDIO
TUBES**

The design and engineering of Tung-Sol 5881 and 6550 Audio Amplifier Tubes give voice to the true meaning of Hi-Fi.

The ratings and uniformity of these tubes provide the performance characteristics required by the exacting Hi-Fi circuitry.

5881

Beam Power Amplifier provides the ultimate in reliability where the 6L6 is normally called for.

6550

Beam Power Amplifier first in the 100 watt power range designed specifically for audio service.



Tung-Sol Electric Inc., Newark 4, New Jersey

CORRESPONDENCE (Cont. from page 21)

accomplish this result with H. H. Smith prods by removing the solderless fastening nut and filing the threads down to banana-plug size. The prod will then fit Mueller alligator clips, 60 series, instead of the more costly, longer, loose-internal-connection H. H. Smith alligator "interchange test connectors." Additional advantage: the test-lead wire must be sweat-soldered in place. (To plug the solderless hole, use a toothpick or paper wad.)

Wrenches for tightening Dialco pilot socket nuts. As of now, pliers are the only convenient tool, and many are the threads I have ruined when the pliers slipped.

A bench vise that can be used on a bench top. Present bench vises have a T-handle which effectively stops bench-top turning. To remedy this, our shop has replaced the T-handles on Stanley Yankee 991 vises with "flywheel" steel knobs 1 1/2 inch in diameter by 3/4 inch thick. This makes otherwise unusable bench vises into extremely efficient "third hands." But companies we've talked to aren't interested in manufacturing vises thus modified.

Mercury cells of the small sizes for which holders are not ordinarily available, with soldering tabs attached to both terminals. For example, the Mallory 625RT cell is manufactured with such terminals, because I have a sample which the company sent me. But jobbers have never heard of this, except a few which list a tab on one side. Soldering directly to these small cells almost invariably ruins them, and after many tries, I found that small cell holders corrode too rapidly.

JOSEPH H. SUTTON

Kansas City, Mo.

HOW TO SAVE SPACE

Dear Editor:

I have been a subscriber to RADIO-ELECTRONICS for 3 years and previously bought newsstand copies. I have always enjoyed the many news items and construction projects and like to retain some of these articles for later use and review.

I acquired a large library of back issues which was beginning to overcrowd my makeshift workshop shelves. I looked sadly toward throwing all these issues away. Instead, I took each old issue apart and removed the pages with articles on new circuits, construction projects and any other choice information and discarded only the remainder. I then bound the pages in a loose-leaf notebook, indexed the same as printed on the corners of each page.

For reference to advertisers and their products, I still keep a few of the latest editions intact, but now my files are more compact and much simpler to scan.

Perhaps this approach would please the wives of others as it has pleased mine.

RICHARD G. BEMIS

Naval Weapons Station
Yorktown, Va.

END

**LOW COST! TOP QUALITY!
BUILD YOUR OWN
PORTABLE RADIOS**

SAVE UP TO 52%

Made in U.S.A.



**VEST
POCKET***

**3 TRANSISTOR & DIODE
RADIO KIT**

Small in size . . . yet a real powerhouse! World famous LOOPSTICK assures maximum reception everywhere! Now you'll never miss your favorite programs. All parts included.

- No antenna or ground needed
- Gold-plated printed circuit board
- Hi "Q" flat loopstick
- Personal Hi-Fi earphone included
- Easy to build - illustrated instructions

MODEL VP
Radiophile
Net \$11.95
(List \$19.95)

*Winner of Dan-Mar award for futuristic styling.

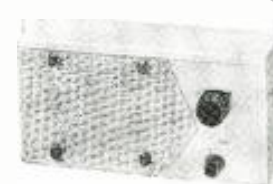

Made in USA

"The Partner"

**4 TRANSISTOR & DIODE
RADIO KIT**

Easy to build, even for a beginner! Take it with you anywhere . . . your real "Partner". Don't miss ball games, news, your favorite programs. Comes COMPLETE with all parts, and simple, illustrated instructions.

- Pre-punched, gold-plated printed circuit board
- Newest transistors & diode
- Exclusive Flat Transistor Loopstick for unsurpassed sensitivity and power
- Powerful 2 1/2" loudspeaker
- Compact portable case, 2-15/16" x 5 1/2" x 1 1/2"
- Earphone jack
- Newest low battery consumption circuitry

MODEL TR4-K
Grey & Gold
TR4-KB
Black & Gold
TR4-KM
Maroon & Gold
Radiophile
Net \$17.95
(List \$27.95)

FREE BONUS: Miniature Earphone for private listening.

"SEXTET"

Made in U.S.A.

**6 TRANSISTOR
& DIODE
PORTABLE
RADIO**

MODEL TR66 Grey and Gold
TR66B Black and Gold
Gold
TR66M Maroon and Gold
Radiophile Net \$25.95
(List \$39.95)



Professional engineering and award winning styling.

Friends and neighbors will wonder at its beauty and performance . . . and YOU built it yourself! Easy to build—if you can read and solder you've got it made. Superb reception . . . Hi-Fi tonal quality.

- Powerful superhet.
- 3 tuned I.F. stages
- Push-pull audio 300 M.W. max.
- Pre-punched gold-plated printed circuit board
- High-gain Flat loopstick
- Full action A.V.C.
- Jack for private listening
- Compact, unbreakable case
- Economical operation
- COMPLETE with all parts and illustrated instructions

EXTRA BONUS: Free earpiece for personal listening!

At your radio parts distributor or write direct for FREE CATALOG and name of local distributor

SuperaX 4-6 RADFORD PLACE, YONKERS, NEW YORK

**WE'RE MAKING IT EASIER THAN EVER TO BECOME A WELL PAID
RADIO-TELEVISION SERVICE TECHNICIAN**

**NOW - Just \$6 Starts You Training in
RADIO-TELEVISION
the SPRAYBERRY "Learn-by-Doing" Way . . .**

**25 BIG, COMPLETE KITS
of PARTS & EQUIPMENT**

To help you learn *fast* the practical side of Radio-Television, we send you expertly engineered training kits to test and assemble for interesting, valuable shop-bench practice!

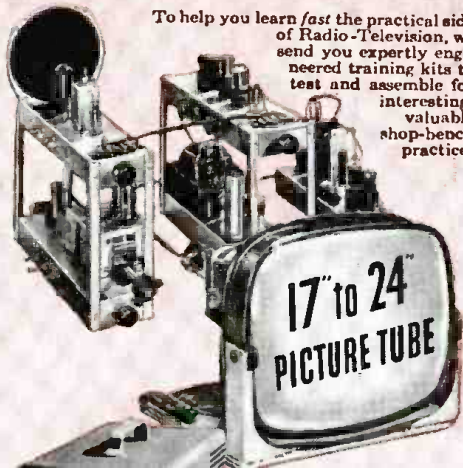

• The new Sprayberry Training Television Receiver, built and tested in 5 sections.

• Now offered . . . this fine modern oscilloscope.

• You build this powerful two-band superheterodyne radio receiver.

**Big New
CATALOG
AND
Sample Lesson
FREE!**

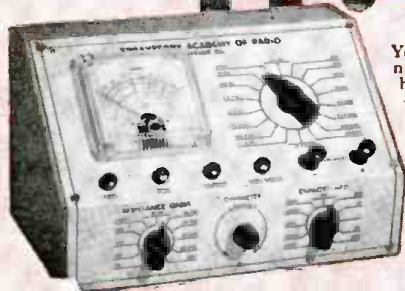
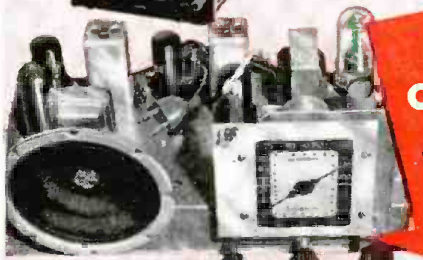

You build the new Sprayberry tester—a complete 18-range Volt-Ohm-Milliammeter test meter.

★ ★ ★ This great industry is begging for trained men . . . to step into good paying jobs or a profitable business of their own! Our new plan opens the doors of Radio-Television wide to every ambitious man who is ready to act at once!

Men by the thousands . . . trained Radio-Television Service Technicians . . . are needed at once! Perhaps you've thought about entering this interesting, top paying field, but lack of ready money held you back. Now—just \$6 enrolls you for America's finest, most up to date home study training in Radio-Television! Unbelievable? No, the explanation is simple! We believe Radio-Television *must* have the additional men it needs as quickly as possible. We are willing to do our part by making Sprayberry Training available for less money down and on easier terms than ever before. This is your big opportunity to get the training you need . . . to step into a fine job or your own Radio-Television Service Business.

Complete Facts Free—Act Now; Offer Limited

Only a limited number of students may be accepted on this liberal and unusual basis. We urge you to act at once . . . mail the coupon below and get complete details plus our big new catalog and an actual sample lesson—all free. No obligation . . . no salesman will bother you.

HOME STUDY TRAINING IN SPARE TIME

Under world-famous 27-year old Sprayberry Plan, you learn entirely at home in spare time. You keep on with your present job and income. You train as fast or as slowly as you wish. You get valuable kits of parts and equipment for priceless shop-bench practice. And everything you receive, lessons and equipment alike, is all yours to keep.

LET US PROVE HOW EASILY YOU CAN LEARN!

Radio-Television needs YOU! And Sprayberry is ready to train you on better, easier terms, that any ambitious man can afford. *Just \$6 starts you!* Mail coupon today . . . let the facts speak for themselves. You have everything to gain. Let us prove the kind of opportunity that's in store for you!

SPRAYBERRY Academy of Radio-Television
1512 Jarvis Avenue, Dept. 20-D, Chicago 26, Illinois

Mail This Coupon Now—No Salesman Will Call

Sprayberry Academy of Radio-Television
Dept. 20-D, 1512 W. Jarvis Ave., Chicago 26, Ill.

Please rush all information on your ALL-NEW Radio-Television Training Plan. I understand this does not obligate me and that no salesman will call upon me. Include New Catalog and Sample Lesson FREE.

NAME..... Age.....

ADDRESS.....

CITY..... ZONE..... STATE.....



GET BEHIND THE

SYLVANIA

\$2. Combination

**America's biggest magazines deliver
this business-building offer to over
100 million readers!**

On June 20th Sylvania launched the dramatic combination coupon offer appearing in America's biggest weekly magazine, *TV Guide*, and America's biggest monthly magazine, *Reader's Digest*—plus *Sunday* and *Parade* newspaper supplement magazines.

Your Service shares the spotlight with top-quality Sylvania picture tubes and receiving tubes in a three-point program to make your customer's old TV set *better than when it was new*.

Month after month, more set owners will be saving the \$2.00 coupon. Many will attach it to the back of their TV set so it's there for you to see.

You can identify yourself with this program by featuring Silver Screen 85 and Sylvania receiving tubes. Get behind the biggest, most practical, business-building offer ever made to the Service industry.



Look for this ad in these leading national magazines.



Coupon Offer

Sells your service and Sylvania receiving tubes in combination with every Silver Screen 85 you install

Here's an action-packed offer that can add an average of \$3.00 to \$6.00 in receiving tube business every time you install a Silver Screen 85 picture tube.

Sylvania urges your customers to have their receiving tubes checked to make sure they get full performance from their new Silver Screen 85. And, to emphasize the importance of replacing weak tubes, Sylvania offers to pay \$2.00 toward the cost of Sylvania receiving tubes installed in combination with a Silver Screen 85.

Your customers mail the \$2.00 certificate directly to Sylvania with the picture-tube warranty card and receiving-tube carton end. Nothing for you to sign or send.

Stock up on Sylvania. Be prepared for greater-than-ever consumer demand for America's Number One picture tube and receiving tubes.



SYLVANIA 
 Subsidiary of
GENERAL TELEPHONE & ELECTRONICS

Early American Model,
in fruitwood,
30" wide, 24¾" high, 13½" deep.
\$279.95 user net.



Furniture courtesy of Lopipero Inc.



Containing two complete multi-speaker systems in one compact enclosure, the 'Trimensional' TMS-2 projects frequencies of both channels to the rear and side walls of the room. Thus, one large wall area becomes channel A; another channel B... exactly as if you had a series of widely distributed speakers for each channel.

TMS-2 ... most sensational advance in stereo reproduction

When you listen to the TMS-2, you will experience stereophonic reproduction that no conventional system can ever achieve. Its entirely new principle of operation permits every listener *throughout* the room to enjoy fully balanced sound with such extraordinary breadth and three-dimensional depth that it seems to originate beyond the confines of the room itself. Full controls and adjustable doors allow the 'Trimensional' TMS-2 to be placed *anywhere* — along wall or corner — without affecting its performance capabilities. The full TMS-2 story is a fascinating one. Write for it today.



Furniture courtesy of Jens Risom Design Inc.

Contemporary Model,
30" wide, 25" high, 12½" deep.
In mahogany — \$258.00,
in blond or walnut — \$263.00 user net.

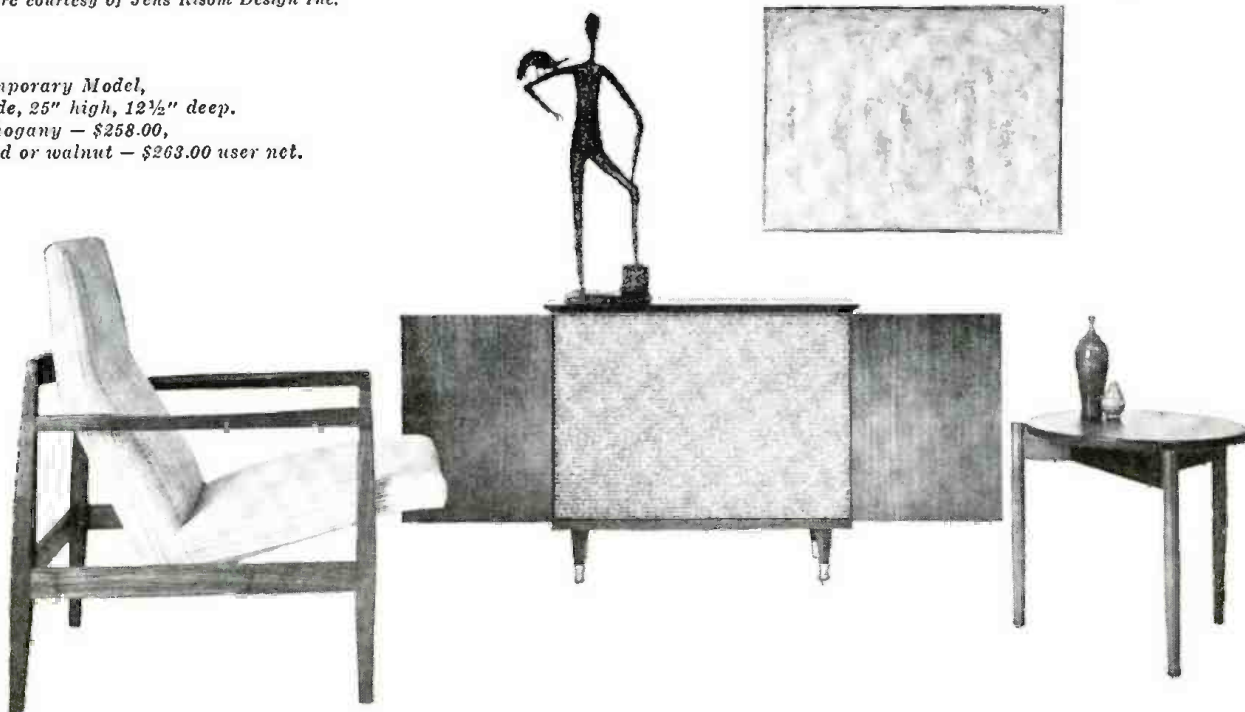

WRITE DESK J-7, UNIVERSITY LOUDSPEAKERS, INC., WHITE PLAINS, N. Y.

In **STEREO**

and Mono Hi-Fi... the experts say
your best buy is

EICO®

"The overall design of the HF-81 is conservative, honest and functional. It is a good value considered purely on its own merits, and a better one when its price is considered as well."

— Hirsch-Houck Labs (HIGH FIDELITY Magazine)

- Advanced engineering • Finest quality components
- "Beginner-Tested," easy step-by-step instructions
- LIFETIME service & calibration guarantee at nominal cost
- IN STOCK — compare, then take home any EICO equipment — right "off the shelf" — from 1500 neighborhood EICO dealers.



Stereo Amplifier-Preamplifier HF81

HF81 Stereo Amplifier-Preamplifier selects, amplifies, controls any stereo source & feeds it thru self-contained dual 14W amplifiers to a pair of speakers. Provides 28W monophonically. Ganged level controls, separate balance control, independent bass & treble controls for each channel. Identical Williamson-type, push-pull EL84 power amplifiers. "Excellent" — SATURDAY REVIEW; HI-FI MUSIC AT HOME. "Outstanding quality... extremely versatile." — ELECTRONICS WORLD LAB-TESTED. Kit \$69.95. Wired \$109.95. Includes cover.

HF85 Stereo Preamplifier is a complete, master stereo preamplifier-control unit, self-powered for flexibility & to avoid power-supply problems. Distortion borders on unmeasurable even at high output levels. Level, bass, & treble controls independent for each channel or ganged for both channels. Inputs for phono, tape head, mike, AM, FM, & FM-multiplex. One each auxiliary A & B input in each channel. Switched-in loudness compensator. "Extreme flexibility... a bargain." — HI-FI REVIEW. Kit \$39.95. Wired \$64.95. Includes cover.

New HF87 70-Watt Stereo Power Amplifier: Dual 35W power amplifiers of the highest quality. Uses top-quality output transformers for undistorted response across the entire audio range at full power to provide utmost clarity on full orchestra & organ. IM distortion 1% at 70W, harmonic distortion less than 1% from 20 to 20,000 cps within 1 db of 70W. Ultra-linear connected EL34 output stages & surge-protected silicon diode rectifier power supply. Selector switch chooses mono or stereo service; 4, 8, 16, and 32 ohm speaker taps, input level controls; basic sensitivity 0.38 volts. Without exaggeration, one of the very finest stereo amplifiers available regardless of price. Use with self-powered stereo preamplifier-control unit (HF85 recommended). Kit \$74.95. Wired \$114.95.

HF86 28W Stereo Power Amplifier Kit \$43.95. Wired \$74.95.

FM Tuner HFT90: Prewired, prealigned, temperature-compensated "front end" is drift-free. Prewired exclusive precision eye-tronic® traveling tuning indicator. Sensitivity: 1.5 uv for 20 db quieting; 2.5 uv for 30 db quieting, full limiting

from 25 uv, IF bandwidth 260 kc at 6 db points. Both cathode follower & FM-multiplex stereo outputs, prevent obsolescence. Very low distortion. "One of the best buys in high fidelity kits." — AUDIOCRAFT. Kit \$39.95. Wired \$65.95. Cover \$3.95. Less cover, F.E.T. Incl.

New AM Tuner HFT94. Matches HFT90. Selects "hi-fi" wide (20c — 9kc @ -3 db) or weak-station narrow (20c — 5kc @ -3 db) bandpass. Tuned RF stage for high selectivity & sensitivity; precision eye-tronic® tuning. Built-in ferrite loop, prealigned RF & IF coils. Sensitivity 3 uv @ 30% mod. for 1.0 V out, 20 db S/N. Very low noise & distortion. High-Q 10 kc whistle filter. Kit \$39.95. Wired \$65.95. Incl. Cover & F.E.T.

New AF-4 Stereo Amplifier provides clean 4W per channel or 8W total output. Inputs for ceramic/crystal stereo pick-ups. AM-FM stereo, FM-multi stereo, 6-position stereo/mono selector. Clutch-concentric level & tone controls. Use with a pair of HFS-5 Speaker Systems for good quality, low-cost stereo. Kit \$38.95. Wired \$64.95.

HF-2 Mono Integrated Amplifier provides complete "front-end" facilities and true high fidelity performance. Inputs for phono, tape head, TV, tuner and crystal ceramic cartridge. Preferred variable crossover, feedback type tone control circuit. Highly stable Williamson-type power amplifier circuit. Power output: 12W continuous, 25W peak. Kit \$34.95. Wired \$57.95. Includes cover.

New HFS3 3-Way Speaker System Semi-Kit complete with factory-built 3/4" veneered plywood (4 sides) cabinet. Bellows-suspension, full-inch excursion 12" woofer (22 cps res.), 8" mid-range speaker with high internal damping cone for smooth response, 3 1/2" cone tweeter, 2 1/4 cu. ft. ducted-port enclosure. System Q of 1/2 for smoothest frequency & best transient response. 32-14,000 cps clean, useful response. 16 ohms impedance. HWD: 26 1/2", 13 7/8", 14 3/8". Unfinished birch \$72.50. Walnut, mahogany or teak \$87.50.

New HFS5 2-Way Speaker System Semi-Kit complete with factory-built 3/4" veneered plywood (4 sides) cabinet. Bellows-suspension, 5/8" excu-



Stereo Preamplifier HF85

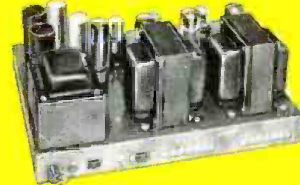

**70W Stereo Power Amplifier HF87
28W Stereo Power Amplifier HF86**



**FM Tuner HFT90
AM Tuner HFT94**



Stereo Integrated Amplifier AF4



**12W Mono Integrated Amplifier HF12
Other Mono Integrated Amplifiers:
50, 30, & 20W (use 2 for stereo)**



**2-Way Bookshelf
Speaker System HFS1
3-Way Speaker System HFS3
2-Way Speaker System HFS5**

sion, 8" woofer (45 cps res.) & 3 1/2" cone tweeter. 1 1/4 cu. ft. ducted-port enclosure. System Q of 1/2 for smoothest frequency & best transient response. 45-14,000 cps clean, useful response. HWD: 24", 12 1/2", 10 1/2". Unfinished birch \$47.50. Walnut, mahogany or teak \$59.50.

HFS1 Bookshelf Speaker System complete with factory-built cabinet, Jensen 8" woofer, matching Jensen compression-driver exponential horn tweeter. Smooth clean bass; crisp extended highs. 70-12,000 cps range. 8 ohms. HWD: 23" x 11" x 9". Price \$39.95.

LGS-1 Brass Tip Matching 14" Legs — \$3.95.

HFS2 Omni-Directional Speaker System (not illus.) HWD: 36", 15 1/4", 11 1/2". "Eminently musical" — HIGH FIDELITY. "Fine for stereo" — MODERN HI-FI. Completely factory-built. Mahogany or walnut \$139.95. Blond \$144.95.

IMPORTANT NOTE: All EICO kits built according to our instructions, and all EICO factory-assembled equipment, conform to the high standards and specifications as published in EICO literature and advertisements. All EICO factory-assembled equipment is completely and meticulously hand-wired throughout — no printed circuitry; each factory-assembled unit is 100% final-tested throughout for each feature and function — no "spot" or "partial" checking. In EICO's final-test techniques, nothing is left to chance.

Fill out coupon on other side for FREE CATALOG



Over 1 MILLION EICO Instruments in use throughout the world.

Copyright 1959 by Electronic Instr. Co., Inc. 33-00 N. Blvd., L. I. C. 1, N. Y.

Copyright 1959 by Electronic Instr. Co., Inc. 33-00 N. Blvd., L. I. C. 1, N. Y.

The specs prove it...your best buy is



B
TV-FM SWEEP GENERATOR AND MARKER #368
 KIT \$69.95 WIRED \$119.95

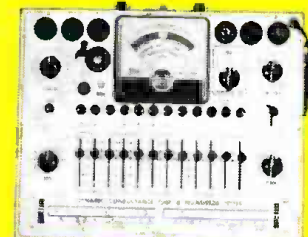

A
DYNAMIC CONDUCTANCE TUBE & TRANSISTOR TESTER #666
 KIT \$69.95 WIRED \$109.95
 Complete with steel cover & handle

C
RF SIGNAL GENERATOR #324
 KIT \$26.95 WIRED \$39.95



D
PEAK-TO-PEAK VTVM #232 & UNIPROBE (pat. pend)
 KIT \$29.95
 WIRED \$49.95



E
COLOR & MONOCHROME DC TO 5 MC LAB & TV 5" OSCILLOSCOPE #460
 KIT \$79.95 WIRED \$129.50
5" PUSH-PULL Oscilloscope #425:
 Kit \$44.95 Wired \$79.95

A Tests all receiving tubes (picture tubes with adapter), n-p-n and p-n-p transistors. Composite indication of Gm, Gp & peak emission. Simultaneous selection of any one of 4 combinations of 3 plate voltages, 3 screen voltages, 3 ranges of continuously variable grid voltage (with 5% accurate pot.). Sensitive 200 ua meter. 10 six-position lever switches: freepoint connection of each tube pin. 10 pushbuttons: rapid insert of any tube element in leakage test circuit. Direct reading of inter-element leakage in ohms. New gear-driven rollochart. CRA Adapter \$4.50.

B Entirely electronic sweep circuit with accurately-biased inductor for excellent linearity. Extremely flat RF output. Exceptional tuning accuracy. Hum and leakage eliminated. 5 fund. sweep ranges: 3-216 mc. Variable marker range: 2-75 mc

in 3 fund. bands, 60-225 mc on harmonic band. 4.5 xtal marker osc., xtal supplied. Ext. marker provision. Attenuators: Marker Size, RF Fine, RF Coarse (4-step decade). Narrow range phasing control for accurate alignment.

C 150 kc to 435 mc with ONE generator in 6 fund. bands and 1 harmonic band! $\pm 1.5\%$ freq. accuracy. Colpitts RF osc. directly plate-modulated by K-follower for improved mod. Variable depth of int. mod. 0-50% by 400 cps Colpitts osc. Variable gain ext. mod. amplifier: only 3.0 v needed for 30% mod. Turret-mounted, slug-tuned coils for max. accuracy. Fine and Coarse (3-step) RF attenuators. RF output 100,000 uv, AF output to 10 v.

D Uni-Probe — exclusive with EICO — only 1 probe performs all functions: half-turn of probe tip selects DC or AC-Dhms. Calibration without re-

moving from cabinet. Measure directly p-p voltage of complex & sine waves: 0-4, 14, 42, 140, 420, 1400, 4200. DC/RMS sine volts: 0-1.5, 5, 15, 50, 150, 500, 1500 (up to 30,000 v. with HVP probe, & 250 mc with PRF probe). Dhms: 0.2 ohms to 1000 megohms. $4\frac{1}{2}$ " meter, can't-burn-out circuit. 7 non-skip ranges on every function. Zero center.

E Features DC amplifiers! Flat from DC to 4.5 mc. usable to 10 mc. Vert. Sens.: 25 mv/in.; input Z 3 megohms; direct-coupled & push-pull throughout. 4-step freq.-compensated attenuator up to 1000:1. Sweep: perfectly linear 10 cps — 100 kc (ext. cap. for range to 1 cps). Pre-set TV V & H positions. Auto sync. lim. & ampl. Direct or cap. coupling; bal. or unbal. inputs; edge-lit engraved lucite screen with dimmer control; plus many more outstanding features.

FREE CATALOG shows you HOW TO SAVE 50% on 65 models of top quality professional test equipment. MAIL COUPON NOW!

<p>New Transistor Portable Radio RA-6 Kit \$29.95 Wired \$49.95 Incl. F.E.T.; less 9V batt. Prealigned RF, IF xfms; push-pull audio; 6" spkr.</p>	<p>*PAT. PEND.</p> <p>NEW Power & Bias Supply for Transistorized Eqpt. = 1020 * Kit \$19.95 Wired \$27.95</p>	<p>NEW Tube & CRT Fil. Tester = 612 Kit \$3.95 Wired \$5.95 Fast-checks radio/TV tubes, pilot lamps, etc.</p>	<p>Series/Parallel R-C Combination Box = 1140 Kit \$13.95 Wired \$19.95</p>	<p>Tube Tester = 625 Kit \$34.95 Wired \$49.95 • tests 600 mil series string type tubes • illuminated roll-chart Pix Tube Test Adapter..... \$4.50</p>	<p>6V & 12V Battery Eliminator & Charger = 1050 Kit \$29.95 Wired \$38.95 Extra-filtered for transistor equip. = 1060 Kit \$38.95 Wired \$47.95</p>	<p>20,000 Ohms/Volt V-O-M = 565 Kit \$24.95 Wired \$29.95 1000 Ohms/Volt V-O-M = 536 Kit \$12.90 Wired \$14.90</p>
---	--	---	--	--	--	---

33-00 Northern Blvd. L. I. C. 1, N. Y.
 Add 5% in the West. © 1959

TURN PAGE FOR MORE EICO VALUES

VTVM Probes

	Kit	Wired
Peak-to-Peak	\$4.95	\$6.95
RF	\$3.75	\$4.95
High Voltage Probe-1		\$6.95
High Voltage Probe-2		\$4.95
Scope Probes		
Demodulator	\$3.75	\$5.75
Direct	\$2.75	\$3.95
Low Capacity	\$3.75	\$5.75

R-C Bridge & R-C-L Comparator = 9508
 Kit \$19.95
 Wired \$29.95
 Reads 0.5 ohms-500 megohms, 10 mmfd-5000 mfd, power factor

EICO
 33-00 Northern Blvd.
 L. I. C. 1, N. Y.

C-11

Show me HOW TO SAVE 50% on Test Instruments
 Hi-Fi Ham Gear. Send free Stereo Hi-Fi Guide. Send me FREE Catalog, name of neighborhood dealer.

Name.....
 Address.....
 City..... Zone..... State.....

SPACE ELECTRONICS

... *Electronics Is Closely Linked to Space* ...

WHEN electronics was born, it was a purely man-made science—chiefly radio waves created by man and used by man almost exclusively for communication. That radio waves could have been in use by nature billions of years ago was undreamt of by the then radio pioneers.

Modern electronics teaches that space, once thought of as empty, is filled with a variety of natural radiation and matter.

It thus becomes necessary to adjust our thinking and differentiate between mundane and space electronics in many directions in the coming Space Age.

How empty is the vast vacuum of space that permeates the universe? In truth, it is not "empty" at all. Besides an abundance of hydrogen atoms calculated at about one atom per cubic centimeter as well as dust particles, occasional meteorites and other tangible matter, there is a vast array of electronic radiation.

Radio astronomy has shown us that space abounds with natural radio emissions coming from every direction of the heavens. Some of the intense radio waves are thought to have their origin in *novae*—exploding stars, or colliding suns and galaxies—a common phenomenon in the universe. Other emissions come from hydrogen clouds.

In our own small solar system, several planets—chiefly Jupiter and Venus—are the sources of radio waves. Scientists are not unanimous about how these radio emissions of our planets are created. There are a number of theories. Part of the radiation is undoubtedly thermal. That is, it is the very-long-wave heat radiation from the visible warm surface of the respective planets. The other component of non-thermal character probably originates in super lightning flashes.

Our sun, too, is a radio-wave emitter and, in addition, transmits other electronic radiations, such as hard X-rays, gamma rays, infrared and ultraviolet, as well as cosmic. There may be others not detected so far.

In addition to all these, the universe abounds with additional electromagnetic radiation in the form of light and gravitation. Einstein long suspected that gravitation is somehow or other linked to the electromagnetic forces. So far there is no proof of such a connection, but time, most scientists believe, will prove him right. Einstein thought of gravitational fields as similar to magnetic fields. The stupendous force which binds the solar planets together must indeed pervade the whole system, otherwise they would fly apart.

But of all radiation, cosmic energy is thought to be the most powerful, at least electronically, so far investigated. This radiation consists of highly energetic atoms and ions. Where X-rays from the sun are mostly stopped by the earth's atmosphere, cosmic radiation protons can still be detected in our deepest mines. Their penetrating power is so vast that a thickness of 1 meter (39 inches) of lead stops only half of their particles. The major part of cosmic radiation is grouped in the neighborhood of 2 Bev—2,000,000,000 electron volts—a thousand times the energy of radioactive particles!

Man is continuously exposed to cosmic radiation. About 2,000,000 cosmic particles hit all humans every day and penetrate their bodies. Out in space, far removed from the protective blanket of our terrestrial atmosphere, cosmic radiation is many times more powerful than on earth.

What is the origin of cosmic radiation? We still do not

know all the answers. Millikan, the great physicist who discovered and named the electron, thought that it is a complete transformation of mass into radiating energy, although that idea has been completely disproved now. Drs. Menzel and Salisbury suggested that the solar component of cosmic radiation stems from electromagnetic forces in the solar atmosphere. Actually, cosmic wavelengths of 7,000 miles have been detected.

While cosmic radiation is probably far richer in energy than all other radiation received from space combined, science has so far found no way of utilizing it. Hundreds of millions of horsepower have been going to waste daily for billions of years. We can be certain that man in the future will find a way to harness this prodigious natural energy along with the abundant solar radiant heat.

But space has other curious physical objects, among them comets and cometoids. We shall talk of the latter because recently electronics has become involved in them.

For a number of years now, we have had the puzzlement of flying saucers, particularly that class officially termed by the US Air Force as Unidentified Flying Objects (UFO).

Most flying saucers have been explained as the Navy's "sky-hooks" or high-altitude balloons or as mirages, reflections and optical illusions. Yet a small number of completely unidentified flying objects have been tracked by radar, only to vanish completely and inexplicably from sight and from radar screens, not once, but a number of times.

Let us now quote from a recent book, *Astronomy*, by Theodore G. Mehl, professor of astronomy at Williams College: "As a comet moves into the region of the planets, it seems to be a loosely knit swarm of chunks of frozen gases in which there may be imbedded small particles of solid material of a stony or metallic nature."

Some time ago, John D. Buddhue, research associate of the New Mexico Institute of Meteorites, an authority on meteorites, and a chemist, published a new theory in a paper entitled: "Are There Ice Meteorites?"

Donald Robey, on the staff of Convair—Astronautics Division of General Dynamics, reported this new theory on cometoids before the American Meteorological Society last May. According to Buddhue and Robey, small comets or cometoids often turn out to be flying icebergs in space. As the cometoid enters the solar system, the sun begins to heat it and it slowly changes its original shape. If it comes into the gravitational field of the earth, it will soon enter our atmosphere and begin its plunge downward. It melts rapidly and takes on a glassy appearance, often seen and reported as "flying saucers." As melting ice often does, these cometoids take on various shapes, such as spheres, egg shapes, or saucers.

While still a few miles up, they can easily be seen and tracked by radar, but the excessive atmospheric friction quickly melts and vaporizes the ice. The result—they vanish from sight and radar screens. Yet, sizable chunks of ice have been seen falling from the sky in many places of the world.

Indeed, the journal *The Mineralogist*, of Portland, Ore., has a standing \$100 offer "to anyone sending a (solid or liquid) ice meteorite to the magazine."

Chunks of such falling ice from the sky have been analyzed and found to contain solids that differ from rainwater. They contain ammonia and cyanogen, while the ice fluoresced in a faint green. Some investigators believe that these ice bodies, weighing from 12 pounds up when they hit the earth, come from space.

—H. G.

7-TRANSISTOR POCKET RADIO

A 45- μ v-per-meter sensitivity makes this power-packed receiver a really hot set

By HAL WITTLINGER *

BUILDING a vest-pocket seven-transistor radio from scratch is a project not every do-it-yourself enthusiast wants to undertake. It often means a long, complicated job.

For those who do and are equipped to deal with the "bugs" that often appear in home-built equipment, the receiver described here should well repay the effort. Its performance compares favorably with that of the better commercial seven-transistor radios. As you can see in the photographs, it has also a good, professional appearance.

This little portable set was designed for the following requirements:

- ▶ Fit in a vest-pocket size, light-weight plastic case.
- ▶ Have sensitivity and power output comparable with good commercial seven-transistor receivers.
- ▶ Have exceptionally low current drain.
- ▶ Provide facilities for earphone listening, providing a reduction in battery drain.

▶ Use standard, readily available transistors and components.

Circuit details

Fig. 1 shows the receiver circuit. The converter stage uses a 2N140 junction transistor, and is followed by a two-stage if amplifier using 2N247 drift transistors. The emitters of the 2N247's are connected in parallel so a single bias network can be used for the two if amplifier stages. Avc voltage is applied to both. Regeneration increases if amplifier gain. The amount of regeneration is determined by R4. Increasing it reduces the maximum gain, and vice versa. The 330,000 ohms used for R4 gave, in this set, the highest possible if amplifier gain without oscillation.

The 1N295 crystal-diode second detector is followed by a class-A af voltage amplifier, a class-A driver and a push-pull class-B output stage, all using 2N109 transistors. Although using two class-A af amplifier stages to provide higher gain may not seem economical, the operating conditions for

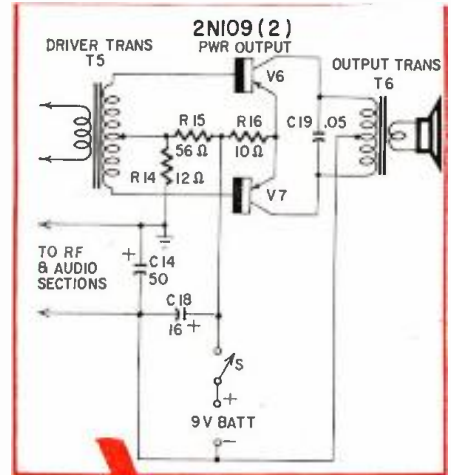
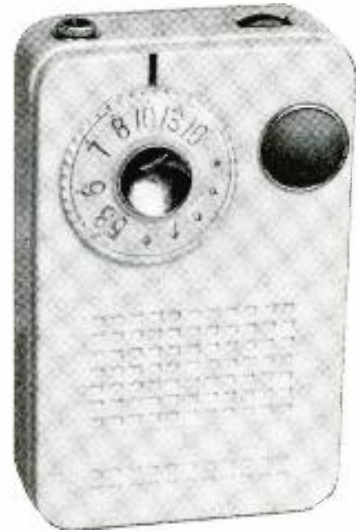

Fig. 2—The power output stage, showing forward bias arrangement used to minimize "crossover" distortion.

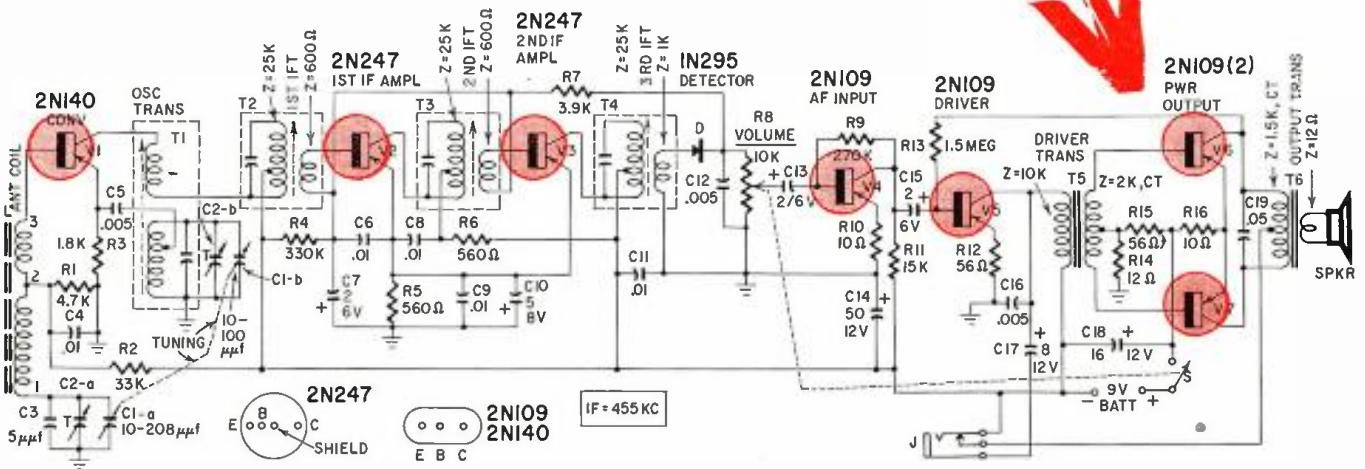
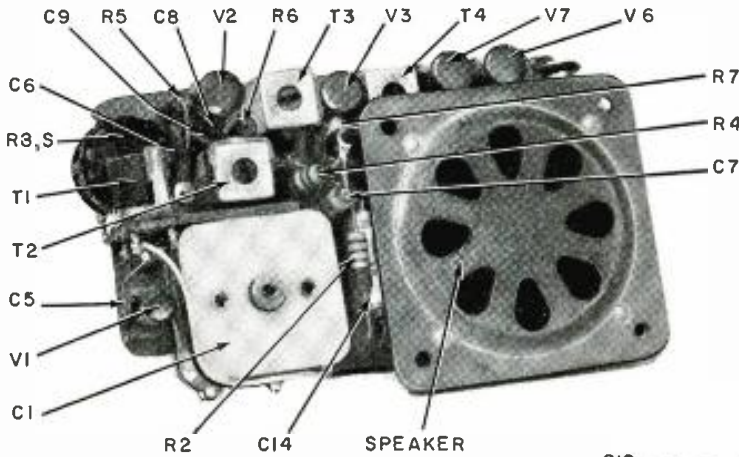

Fig. 1—Circuit of the 7-transistor receiver.



From the front, mostly transistors and transformers come into view.

Most of the smaller components, resistors and capacitors, are on the back of the chassis.

them are such that they draw less current than many single-stage af amplifiers.

The class-B output stage is somewhat unusual. The forward bias needed to minimize "crossover" distortion comes from the dc voltage drop across the preceding stages rather than from a resistor. This arrangement, detailed in Fig. 2, avoids the usual power loss in a bias resistor. It also provides economically the relatively large amount of bias needed to minimize distortion in the class-B stage at low battery voltage. Inverse feedback from the output transformer's primary to the input of the driver (through R13) also helps minimize distortion.

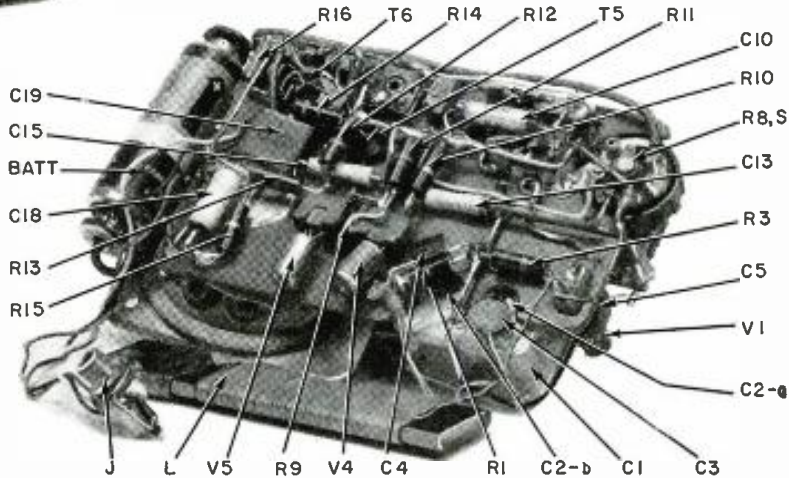

Construction details

The receiver chassis is a 2 1/8 x 3-11/32-inch piece of linen-base phenolic

- R1—4,700 ohms
- R2—33,000 ohms
- R3—1,800 ohms
- R4—330,000 ohms
- R5, 6—560 ohms
- R7—3,900 ohms
- R8—pot. 10,000 ohms, with spst switch
- R9—270,000 ohms
- R10—10 ohms
- R11—15,000 ohms
- R12—56 ohms
- R13—1.5 megohms
- R14—12 ohms
- R15—56 ohms
- All resistors 1/2 watt, 10%
- C1—tuning capacitor: 10-208-μmf antenna section; 10-100-μmf oscillator section (Lafayette MS270 or equivalent) (and Lafayette knob KN-24 or equivalent)
- C2—trimmers on C1
- C3—5 μmf
- C4, 6, 8, 9, 11—.01 μf
- C5, 12, 16—.005 μf
- C7, 13, 15—2 μf, 6 volts, electrolytic, miniature
- C10—5 μf, 8 volts, electrolytic, miniature
- C14—50 μf, 12 volts, electrolytic, miniature
- C17—8 μf, 12 volts, electrolytic, miniature
- C18—16 μf, 12 volts, electrolytic, miniature
- C19—.05 μf
- All capacitors 12 volts minimum unless noted
- BATT—9 volts (RCA VS309 or equivalent)
- D—1N295
- J—miniature phono jack, normally closed
- L—antenna coil, modified Miller 2005, see text
- S—spst on R8
- T1—455-kc oscillator transformer (Miller 2021 or equivalent)
- T2, 3—455-kc if transformer: primary, 25,000 ohms; secondary, 600 ohms (Miller 9-C1 or equivalent)
- T4—455-kc if transformer: primary 25,000 ohms; secondary, 1,000 ohms (Miller 9-C2 or equivalent)
- T5—driver transformer: primary, 10,000 ohms; secondary 2,000 ohms, ct (UTC DO-T11 or equivalent)
- T6—output transformer: primary, 1,500 ohms, ct; secondary, 12 ohms (UTC DO-T17 or equivalent)
- V1—2N140
- V2, 3—2N247
- V4, 5, 6, 7—2N109
- Case—4 1/2 x 2 5/8 x 1 1/8 inches (Lafayette MS-302 or equivalent)
- Speaker, 12 ohms (RCA 23951 or equivalent)
- Miscellaneous hardware

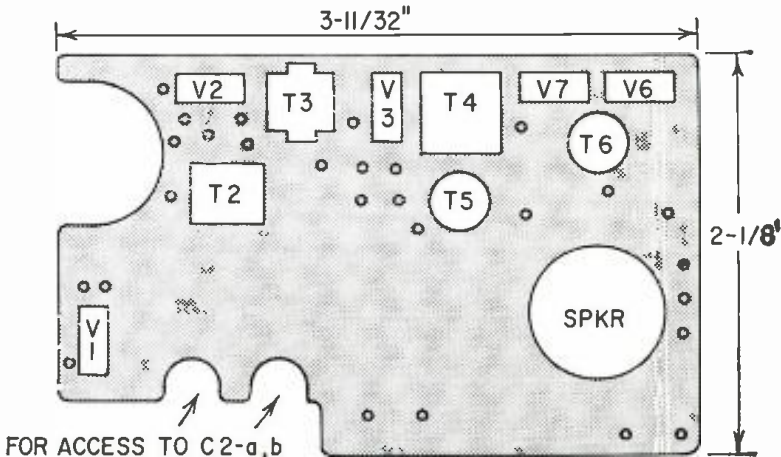

Fig. 3—The blank-cut chassis shown actual size.

BENCH

Checked out at Plainfield, N. J., roughly 25 miles from New York City, sensitivity and selectivity were adjudged excellent. A powerful station 7 miles away which blankets nonselective receivers was kept in its own channel. WRCA in New York was received with excellent volume on the first and second stories and in the basement, indicating good automatic volume control. Stations in Buffalo, N. Y.; Cleveland, Ohio, Philadelphia and Pittsburgh, Pa., were received. Quality was good.

TESTED

RADIO

1/16 inch thick. Mounting holes for the if transformers, transistor sockets and af transformers are made just large enough to assure snug fit (see Fig. 3). Eyelets are installed in holes for resistor and capacitor leads and act as solder terminals. Remove the oscillator transformer (T1) from its shield can and mount it on a small phenolic bracket just above the first if transformer, as shown in the photos. Cement the sockets for the af input and driver transistors flat against the back of the chassis. They are held firmly in place by solder connections to associated resistors and other components. Before mounting the tuning capacitor on the chassis, carefully mark off its position to assure alignment of the capacitor shaft with the hole in the plastic case. The cutout shown in Fig. 3 gives access to the trimmers. Then cut down the shaft of the capacitor so the portion extending through the mounting plate is 3/32 inch long, and extend the threads in the hole through the center of the shaft with a 4-40 bottom tap to accommodate the dial mounting screw. Then, cement the tuning capacitor to the chassis.

The oscillator and if transformers are J. W. Miller subminiature types. The af driver and output transformers are UTC type DO-TS units. If the assembled set oscillates, reverse the connections to any one winding on either the driver or output transformer.

Several types of speakers were compared to find one which combined the

necessary shallowness with good tone quality and efficiency. The one finally selected was a 2¼-inch speaker only ¾ inch deep. The ferrite antenna is a Miller type 2005. To assure proper coverage of the broadcast band with the Lafayette MS-270 tuning capacitor, 30 turns are removed from the terminal 1 end of the antenna.

Case modifications

To fit the chassis receiver into the Lafayette type MS-302 case, an internal shoulder around the hole for the shaft of the tuning capacitor and a brass nut in the lower part of the case have to be removed. A rectangular opening in the top of the case must also be cut for the volume-control knob. These operations should be performed with a hand grinder. Drill two holes for the mounting screws of the tuning capacitor and remove the molded plastic webbing in the speaker openings. As shown in the photographs of the completed receiver, 99 of the available openings are used. These are drilled out and filed square with a needle file. Glue a piece of white satin to the inside of the case as a grille cloth. Be very careful when grinding and drilling to avoid cracking the brittle plastic and to minimize discoloration due to heating the plastic with high-speed drilling.

The component layout shown in the photographs was very carefully worked out and minimizes undesired coupling between stages. It provides an in-line arrangement with short leads in the

critical base and collector circuits. Circuit returns and bypass capacitors for each stage are connected to ground points as close as possible to the associated transistor socket.

Aligning the receiver

A standard alignment procedure is used for the if stages. Apply a modulated 455-kc signal through a 0.1- μ f capacitor to the high side of the antenna tuning capacitor and tune the three if transformers for maximum audio output.

To get optimum performance over the broadcast band, the converter is aligned in the following manner: Set the signal generator at 600 kc, with about 30% modulation, and couple it loosely to the antenna of the receiver. Then tune the receiver to the generator signal and adjust the slug in the oscillator coil for maximum output. Rock the tuning capacitor back and forth during this adjustment. Now tune the signal generator and receiver to 1600 kc and adjust the oscillator trimmer for maximum audio output. As a final step, set the signal generator at 1400 kc, tune the receiver to the generator signal and adjust the antenna trimmer for maximum audio output. Then repeat the entire alignment procedure until no increase in output can be obtained by adjusting the antenna trimmer.

This procedure provides three-point tracking and assures optimum performance over the entire broadcast band. The receiver's sensitivity with a 9-volt battery and 25-mw output varies from 45 μ v per meter at 1400 kc to 150 μ v at 600 kc. With a 6-volt battery, the sensitivity for 25-mw output ranges from about 200 to 500 μ v per meter.

Power consumption and output

The average power output available from the receiver is approximately equal to $0.7E^2R_i$, where E is the battery voltage, R_i is half the collector-to-collector impedance of the output transformer, and 0.7 is the approximate efficiency of the output transformer. When $E = 9$ volts and $R_i = 750$ ohms (the values used in the receiver), the calculated average power output is about 75 mw.

Actually, the output stage delivers about 80 mw maximum and about 50 mw undistorted at full battery voltage, and about 40 mw maximum and 20 mw undistorted when the battery potential has fallen below 6 volts (generally considered the "end-of-life" point of the battery). Because an output of 1 to 2 mw provides a comfortable listening level through an earphone, a 9-volt battery can generally be used far beyond its normal life span.

The battery drain under no-signal conditions is about 3.7 ma and about 5 ma at 1-mw output. At 50-mw output the battery drain is about 19 ma. Battery drain is reduced about 50% when the earphone is used, because the class-B output stage is disconnected when the earphone is plugged in. END

ROTARY-SWITCH REPAIR

By LAWRENCE SHAW

THE contact points on a wafer-switch stator often "give" with use and time, making contact with the rotor intermittently—or not at all. The repair is simple, if the switch can be disassembled.

The switch contact must be bent around some object placed in back of the contact area such as the large paper clip bent out of shape (see Fig. 1); mere pinching together is not satisfactory, it only makes matters worse. Put a piece of metal behind the contact and then pinch! This piece of metal must be large enough so that

a bend in the contact is made at this point.

The tips of the contact arms facing the center or rotor are often grooved. Prior to pinching, a piece of wire such as from a paper clip is placed in this groove (see Fig. 2). The formed wire is then placed on the end of the contact and the pressure of the pinching operation is applied. The contact ends will not be mashed or deformed by the pinch as would be the case if the formed wire is not used. END

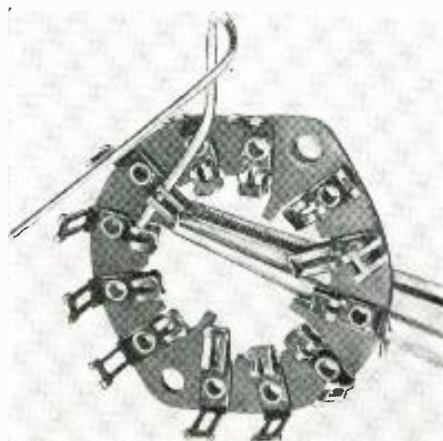

Fig. 2—Wire placed in contact groove keeps it from getting deformed during repair.

Fig. 1—Bend switch contact around large paper clip to restore proper shape and pressure.

"Different" circuit lets you make a transformerless wireless mike

SNITCHER

By IRVIN C. CHAPEL

THE Snitcher is a voice-modulated three-transistor radio transmitter—a wireless microphone. It is small enough to fit into a rubber ball. In fact I did just that with my unit.

An unusual modulating system which eliminates the need for a modulation transformer is used. The output of a low-impedance hearing-aid microphone is fed to V1's base through capacitor C1 (see Fig. 1). To use a high-output phono cartridge, connect it to V2's base through C2. V1 is operated as a common-emitter audio amplifier. It is R-C-coupled to V2, the modulator, another common-emitter stage. Current for the oscillator (V3) is delivered by V2's collector and is controlled by the signal applied to V2's base. Thus we get a modulated output signal. What this signal looks like is shown in Fig. 2.

The rf oscillator (V3) radiates its output from a short antenna coupled to a tuned rf circuit. This signal can now be picked up by broadcast receivers tuned to the same frequency as the Snitcher.

The range is determined by the receiver's sensitivity. Tests indicate a satisfactory input to a National NC-88 receiver at 20 feet, using a 30-inch antenna on the Snitcher and about the same on the receiver.

Put one together

To make a Snitcher, shape and drill the terminal board first (see Fig. 3). I used a piece of 3/64-inch Micarta measuring 1½ x 3¾ inches. Drill all holes before folding the ends, to save time later. To bend the battery-holding ends uniformly, make a wood form block 1 x 1½ x 1¾ inches. Round the corners so the battery-holding ends will have a radius of about ½ inch. The outer portion of the forming tool can be two parallel pieces of wood, 2 inches apart. Heat the Micarta to about 375°, until it becomes pliable. Now, the ends can be folded at right angles by using the inner form block to hold the Micarta against the outer form blocks for a few minutes.

Next, cut the coil support. Use sheet tin, ½ x 1¼ inches. Since it is also connected to the negative battery terminal, drill holes for the holding rivets

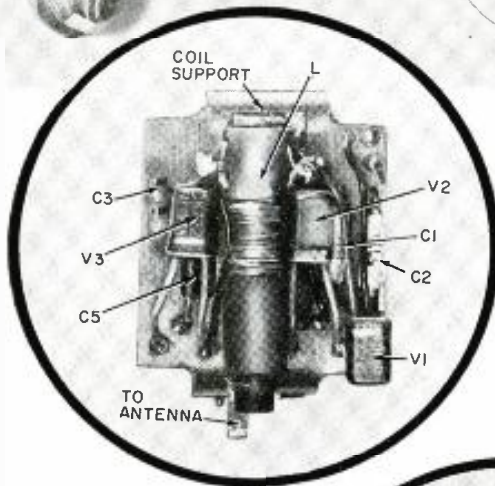
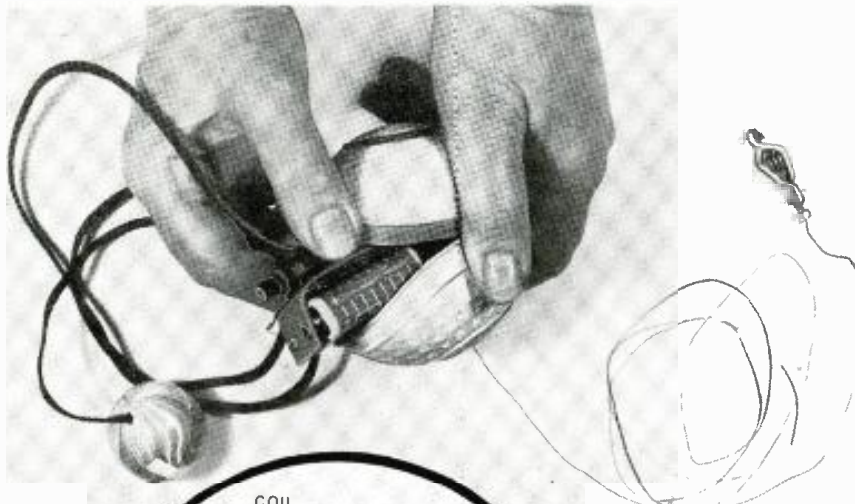

Transistors, capacitors and ferrite antenna are mounted on one side of the chassis.

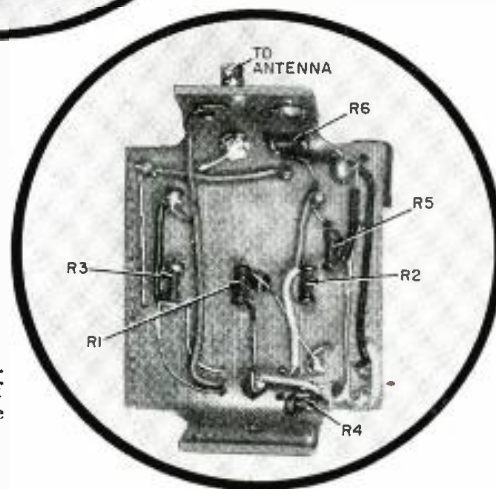

With the battery removed, placement of the resistors can be seen.

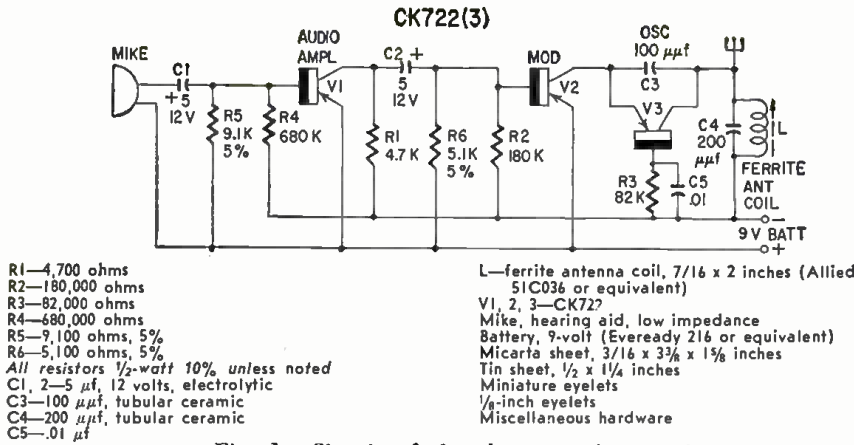

Fig. 1—Circuit of the three-transistor unit.

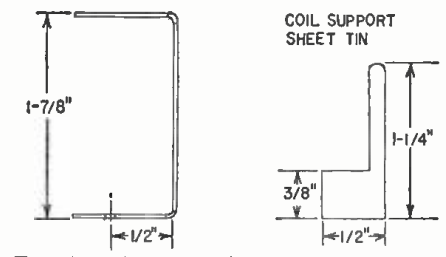
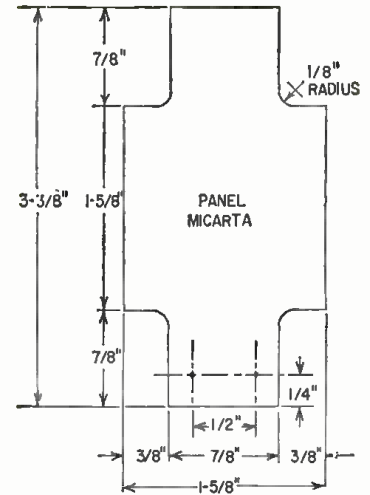

Fig. 3—Chassis and coil support detail.

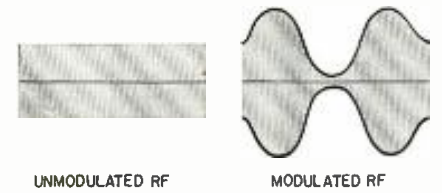

Fig. 2—What the modulated output signal looks like.

and you are ready to insert the battery.

What to expect

In a breadboard layout, current averaged about 1.4 ma with an input of 8 volts. This current varies with temperature and with different transistors, but a range of 1 to 2 ma should give satisfactory performance.

After the unit was completed, it was checked with an oscilloscope. The input was a 400-cycle sine wave.

As a portable receiver was moved away from the Snitcher, the signal became weaker and heterodynes from distant broadcast stations prevented reception from the unit. The satisfactory distance was about 10 to 15 feet, even through walls and partitions which contained electrical wires, plumbing pipes, etc.

To find the frequency to use, turn a radio receiver on and tune across the broadcast band. Around the 650-kc mark (± 100 kc), you will probably find a spot where no strong stations are operating. Set your receiver at that place and with the Snitcher battery in position, move coil L's ferrite slug in or out until the radio signal from it can be heard on the broadcast receiver.

A handy way to do this is to place the Snitcher near a clock (a noisy alarm clock is fine) and about 6 feet away from the receiver. Then as the ferrite slug is moved in or out, the tick of the clock will modulate the signal generated by the Snitcher and will be heard on your radio receiver.

When operating positions are changed, you may have to retune the

radio receiver a trifle. Any change in antenna length also changes the frequency of the output signal. Adjust the ferrite slug in coil L or retune the radio receiver to get back on frequency.

Performance notes

In the final stage (V3) a CK768 will give about 10% better performance, but the less expensive CK722 is satisfactory.

A low-impedance magnetic pickup gave a performance unit of 5, a small square type capacitor pickup about 2, and a 2,200-ohm earphone only about 1 and with some hum. The low-impedance pickup is a surplus hearing-aid mike which has a dc resistance of 140 ohms.

A 30-inch antenna is recommended. However, longer and shorter lengths may give a better output. Experiment to find out which is best for your Snitcher. Clipping the antenna to a grounded object also improves the output. The change in frequency was about 15 kc when a 10-foot antenna was used. END

and negative terminals before bending. The long narrow part of the coil support fits into the base end of the ferrite antenna coil. If you wish, solder this end of the support to the antenna-coil lug that connects to the negative supply.

Now, mounting resistors and capacitors should be easy. Miniature eyelets let you fasten parts to both sides of the panel (they act as feedthroughs), so keep the capacitors and transistors on the front side and the resistors on the back (under the battery) for a neater layout.

The 1/8-inch eyelets make satisfactory terminals for the battery and also for fastening the support piece to the panel. After the resistors and capacitors are fitted to their positions, rivet the coil support to the panel and complete the soldering operation. Do not solder the transistors in position until all other components have been double-checked. Temporarily insert the battery and check for proper clearance. In my unit the battery was slightly loose and I had to fasten a piece of clear plastic to one end of the chassis to keep it in place.

While the remaining assembly does not require much time, the procedure is full of do's and don't's.

Be sure that the battery is not in position. After you determine which way the transistors go, hold their wire leads with a pair of long-nose pliers to help dissipate some of the soldering heat. Use rosin-core solder and only enough heat and time to melt the solder and permit it to flow around the transistor leads. This is a place where a cooling swab of some kind will help keep the heat from traveling up the wire leads to the transistor itself. Make a careful final inspection of all connections, position of the transistors, etc.

STAMP OF APPROVAL



A mail-order tube advertisement in RADIO-ELECTRONICS is its own stamp of approval—your assurance that you will get what you pay for when you order. Since January, 1956, RADIO-ELECTRONICS has insisted that mail-order tube advertisers tell you that their tubes are new and unused, or, if they're not—that they are seconds, rejects or otherwise imperfect. Over the years this has cost us thousands of dollars in advertising—but it has protected you.

An old-timer tells of his experiences during the early days of radio repair



We
had
our
troubles
too...

By GUY S. CORNISH

WAY back in the early days when the click of the ham's telegraph key and the flash of the spark gap were giving away to the vacuum-tube phone rig, I became interested in radio servicing as a sideline. Later, I opened a repair shop in Cincinnati under the name Cornish Radio Hospital. Radio repairs for several large stores were handled at this shop. When public address entered the field, it too became a part of the service business. Television soon followed. After 35 years in the business I retired in 1952. During these many years I encountered some odd and unusual service calls.

The midnight radio

A woman called and said her radio started to play at midnight when all were in bed. Her husband armed himself and went downstairs. He pulled the plug from the wall and checked the windows and doors to see if any were open. Finding nothing wrong, he returned to bed after instructing his wife to call me in the morning. I made the trip to her home and found the trouble in the power switch. The spring had come loose from the shaft and dropped down, shorting the contacts. A new switch was the answer.

A rush of water

Another caller said she could hear water running in her radio in the living room whenever the faucet was turned on in the kitchen. This I wanted to hear, too! I made a call at her home and sure enough I heard the water running. A plumber had installed a

hot-water heater in the basement and left the ground clamp hanging loosely on the water pipe. When water was drawn in the kitchen, the vibration of the pipe resulted in a variable resistance in the ground circuit. Tightening the clamp got the water out of the receiver.

The red-faced doctor

Then there was the doctor who had a very expensive Scott radio. At times he was getting a very loud hum and whistle which made satisfactory reception impossible. He said he thought somebody in the neighborhood had a ham transmitter. I told him I would bring over my radio compass and it would lead me to the culprit. Well it did, right to his office and hospital in the next block. Was his face red!

11:30 static

Another call was from a woman who said her radio was OK but, when her favorite program came on at 11:30 am, the set refused to operate for a half hour and all she could get was noise. I told her there must be some local interference but she insisted it was in her radio because her sister up the street had no trouble. She asked me to come a little before 11:30, which I did. The set operated OK until her program started. Then reception broke up and all you could hear was noise. Just then, her husband came in and said that they had the same trouble every day. He came home each day to eat dinner at 11:30 and let his motor run to keep the truck warm, as it was a

very severe winter. It was a case of ignition interference which a few suppressors and a capacitor cleared up.

Why I have gray hair

One call which I never will forget came from a man who owned an early Scott receiver. He said the radio played OK, but when he turned the volume control he got a scratchy noise. I removed the chassis and replaced the control. All other controls were left as they were when the station was coming in OK. When I put the chassis back in the cabinet, reception was terrible. A faint voice could be heard but static and whistles made reception impossible. I began wondering if I had broken a lead or knocked something loose. While I stood there pondering this mystery, the announcer came in and said, "We are sorry we cannot continue this broadcast from Europe because the conditions are not suitable." Was I glad to hear these words! The station had switched over to the foreign broadcast while I had the chassis out of the cabinet.

Wife on parade

There was a man who talked about getting a radio for a long time and finally decided to order one for Christmas. It was installed the day before so he could get the holiday programs. A short time after it was turned on, the set went dead. He noticed that when his wife walked across the floor the set started to play and told me that he kept her walking so he could hear his program. An unsoldered con-

RADIO

tact was the cause of his trouble.

Lightning plays games

My brother, who lived just east of Cincinnati, had one of the older home-made sets, using a varicoupler connected as a regenerative detector and a stage of audio amplification in a wooden cabinet. The coupler consisted of a large coil with taps, with a rotor in the center. This rotor was connected with flexible stranded copper wire so that it could be rotated. A violent storm came up and lightning struck his antenna, came down into the set, punched a hole in the side of the cabinet and jumped about 2 feet to the telephone. The telephone was completely destroyed. When I examined the set, I found that the only damage was that the lightning had melted the stranded wire into a solid lead. When this was replaced with another piece of stranded wire, the set was as good as new.

Intermittent noise

One complaint was terrific noise at times in a Clear Tone receiver. The customer said he was getting nowhere by calling service technicians. He said everybody he called charged him \$2.50 and found nothing wrong. He asked me if I would come double or nothing, meaning \$5 if I found the trouble and nothing if I did not. I gambled and said yes. After a half hour of checking I found nothing. Just as I was leaving, the noise came in. The wind was blowing his antenna against the metal gutter of the house and therefore the set was noisy only when the wind was rather strong. A piece of split loom was taped on the lead-in and the owner was happy. I got the \$5.

Only worked in the shop

I ran into another very peculiar trouble with a five-tube Atwater Kent radio. It had three 226's, one 227 and one 171-A. The set was brought in because it went dead and I found the detector tube burned out. I replaced this tube and the set worked perfectly. Over my bench I used a 100-watt lamp for illumination and while checking the set I kept the lid open. After a 15-minute perfect test the owner took the set home. Back he came in a couple of hours, saying the set was still dead. Again the set was put on the bench, the lid opened and the tubes and circuit checked, but nothing was found wrong. And again he took it home only to find it would not work. This time I found that when the lid was open the set was OK but when the lid was closed the set went dead. The trouble was the detector tube. It was light-sensitive. I told the RCA distributor about it and he gave me two tubes for it and sent it back to the laboratory.

These are but a few of the strange things that came up during the early days of radio repair. Times have changed and so have the troubles, but I doubt if today's sets present problems that are too different from those of years gone by. END

"INVENTORS of RADIO"

Prof. A. E. DOLBEAR

[1837-1916]



By ERIC LESLIE

OUR April issue told of an American, Dr. Mahloon Loomis, who demonstrated a system of communications by electromagnetic waves before Marconi was born. In 1882, just 10 years after Loomis' patent was granted, Prof. Amos E. Dolbear demonstrated what he called an electrostatic telephone before the Society of Telegraph Engineers and Electricians meeting in London, England. This occasion—March 23, 1882—was probably the first time the human voice was transmitted by radio.

Professor Dolbear (Tufts College, Boston, Mass.) was a distinguished researcher in a number of fields of physics. His microphones and electrostatic telephone system were considered by many superior to Bell's. He also developed a number of instruments and classroom demonstrations, and investigated so many subjects that it was stated that a scientist pioneering in almost any field would be likely to find that Dolbear had already written something on the subject.

Although Dolbear considered it electrostatic, there is little doubt that his device would be defined as an induction telephone today. It consisted of an induction coil with a battery and microphone inserted in the primary. One end of the secondary was grounded, the other attached to a large elevated capacitor. According to Dolbear's explanation, a charge on the metal plate of a capacitor induces a charge of opposite sign on one placed near it. Therefore, another large elevated plate was used as the collector or antenna of his receiver. The battery in the receiving equipment demonstrates Dolbear's belief in difference of potential between ground and elevated point, and was apparently intended to serve a similar purpose as the modern "bias battery." Probably it was of some use, acting as a chemical rectifier of radio-frequency currents. The range, as demonstrated in 1882, was only a few feet, from one room to another.

In 1883, Dolbear appears to have broken through into true radio without fully realizing it. He told the American

Association for the Advancement of Science, "Louder and better results were obtained by using an induction coil having an automatic break interrupter and with a Morse key in the primary circuit, one terminal of the secondary grounded, the other in free air, or in a condenser of considerable capacity. . . . At times I have employed a gilt kite, carrying a fine wire from the secondary coil. The discharges are then apparently nearly as strong as if there was an ordinary circuit!"*

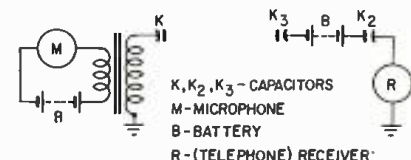

Dolbear's transmitting and receiving circuits.

This equipment, installed at the Electrical Exhibition in Philadelphia, produced signals that could be received in any part of the large building and immediate neighborhood. In other experiments, he claimed a transmission range of 13 miles, not an unreasonable figure for spark telegraphy with his crude apparatus. Though he was transmitting with true radio waves and no longer was depending on the capacitance effect of his "condensers," he apparently never suspected that fact, and always explained his results as a capacitance effect.

It is not quite clear why Dolbear made no attempt to commercialize his telegraph. Possibly his electrostatic theory, which would have made him pessimistic as to the maximum range of the equipment, and the poor receiving apparatus, may have been among the causes. At any rate, he considered his inventions important enough to patent (US Patents 350,299 and 355,149) and he had in 1883 a wireless transmitter equal to and almost identical with that which Marconi demonstrated in 1896. END

*Hawks, Ellison, *Pioneers of Wireless*, page 135.

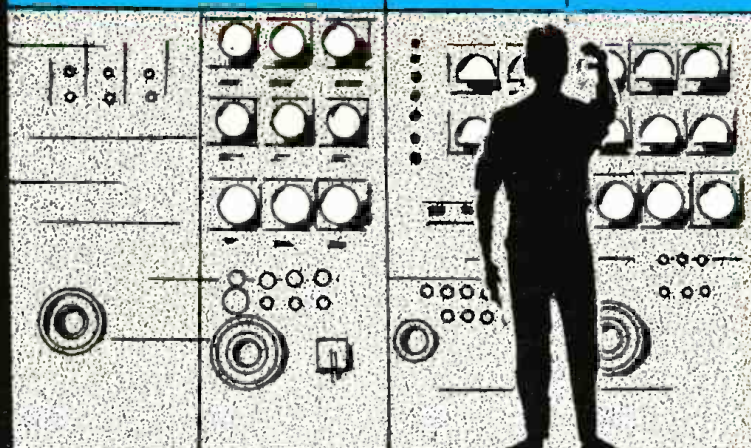

INDUSTRIAL ELECTRONICS

a new section begins

in this issue...

Electronic devices today keep books, compute salaries, direct traffic, guard banks, control industrial enterprises. Industrial electronics is exploding so fast, it has far outstripped the supply of technicians able to maintain and repair industrial electronic equipment. One official of a large traffic control equipment company states: "The lack of trained electronic technicians has retarded the purchasing of electronic traffic controls by cities that have long recognized the need for them" (R-E, May 1959, page 42).

RADIO-ELECTRONICS is therefore starting this new department – to give the service technician down-to-earth information about actual electronic devices—to point out the opportunities in the field and provide the know-how to take advantage of them, and finally to provide industry with a pool of informed technicians capable of servicing the complex equipment that has become standard in almost every industry.

We sincerely believe that industrial electronic servicing may well become the service technician's major source of income in the decade ahead. We hope that this new INDUSTRIAL ELECTRONICS section may be the springboard that gives you your start in it.

The Editors

ELECTRONICS on the TELEPHONE

by HAROLD B. MCKAY

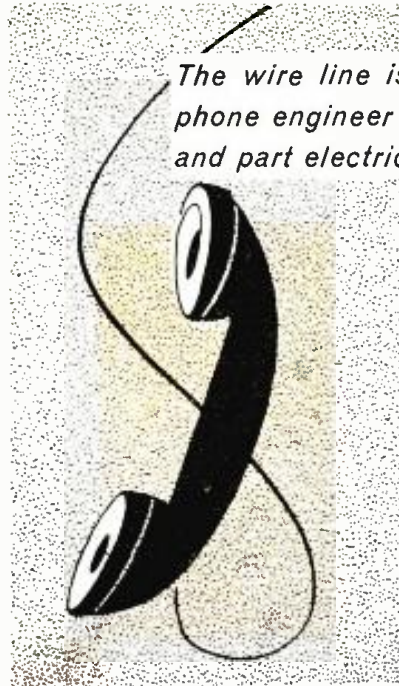

The wire line is no longer simple. The telephone engineer has to be part radio engineer and part electrical engineer also

telephone field by computer designers.

Electronics for communication

An example of electronics' effect on the communication field can be seen in what has happened to the amplifier as used in the telephone business. Actually, telephone companies were the first to use electronic amplifiers; radio came later. The first extensive use of Lee de Forest's vacuum tube came when the telephone companies adopted it for use on long-distance telephone lines. This made the first transcontinental telephone conversation possible in 1915.

To this day, the basic telephone amplifier or "repeater" consists of two vacuum tubes connected so that amplification in each direction results.

This is done by using two amplifiers which are coupled by a "hybrid coil" at each end. A telephone is basically a two-wire instrument, and transmission and reception take place over the same two wires. An ordinary vacuum-tube amplifier, however, will amplify in only one direction. For a two-way conversation, two must be used, one for each direction. This is essentially a four-wire operation and many long-distance telephone circuits use four wires, two for each direction of transmission.

However, at some point before it gets to the user's telephone, the circuit must be converted back to two wires. The hybrid coil does this. Fig. 1 shows a two-way amplifier. Note that the output of one tube appears to be connected through the hybrid coil to the input of the other. Normally a circuit like this would cause continuous feedback or oscillation if it were not for the design of the hybrid coil.

The action of the hybrid coil can be learned from studying Fig. 1. A requirement for successful operation is that network NET be the electrical equivalent of the telephone line. When the EAST party speaks, the alternating current generated by his voice travels along the line and enters the hybrid coil. It emerges at points A and B and enters the EAST-WEST amplifier. Half the power generated by his voice will be lost in the network, but the amplifier has enough gain to compensate for it.

Part of the voice currents will also enter winding E, but these will be stopped at the WEST-EAST amplifier, which will not amplify in the reverse direction.

The portion of the voice power which took the upper branch of the circuit into the EAST-WEST amplifier is amplified and proceeds into winding F of the other hybrid coil. The voice is induced into the winding of which C is the mid-point. The power divides, half of it going through the network and the other half going to the WEST telephone. The circuit is completed through the winding of which D is the mid-point.

ENGINEERS are a specialized lot. Radio engineers, telephone engineers and electrical engineers often find themselves in such narrow fields that they can barely converse with each other; yet the end products of their efforts—communication systems, computers or industrial controls—may have to be serviced by a technician who knows all three fields.

At one time this would have been impossible because of lack of a common language. To a telephone man for instance, a choke is a retardation coil; a transformer, a repeating coil; an amplifier, a repeater; a solder terminal, a punching, and standing-wave ratio becomes "return loss."

Communication and computation were largely based upon mechanical operations in the past. Both calculating machines and telephones required mechanical operations to operate them.

Even present-day dial telephone switching systems use a vast number of motor-driven or magnet-operated mechanical switches to establish con-

nections. Radio, on the other hand, requires little more than the turning of a dial to establish communication.

The advance of electronics is changing all this. Miniature parts, printed circuits and manufacturing techniques developed for radio are finding their way into other fields. The computer field is a unique combination of telephone and radio circuitry.

The dial telephone system is actually a giant nation-wide computer which translates a dialed number into a connection to any one of several million telephones. It requires counter circuits to count the number of pulses coming from the dial, memory or storage circuits to retain this number for a time, and directing circuits to patch together the network of wires necessary to complete the call. Computers have the same types of circuits, but generally use electronic rather than mechanical switching methods.

Rapid advances in the computer field have resulted in switching techniques which are being adapted to the

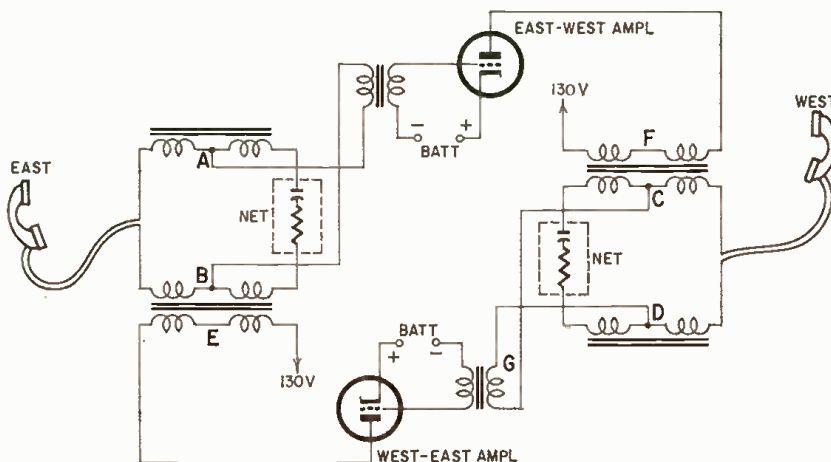

Fig. 1—A telephone repeater that amplifies in both directions without feedback. The networks are the electrical equivalent of the line to which each is coupled. The transformers connected to the phone lines are called hybrid coils.

If the network and the line are electrically equal, each becomes the arm of a bridge. Because the bridge is balanced, no potential appears at points C and D; therefore, none of the EAST-WEST voice gets back into the WEST-EAST amplifier, hence feedback will not result.

When the WEST party speaks, his voice is not balanced out by the network because it is a passive unit. Instead the signal voltage divides—part goes through the network and part through winding G. Therefore, it enters the input of the WEST-EAST amplifier, is amplified and is transmitted to the receiver of the EAST party.

For all of its apparent simplicity, this type repeater is an expensive device. Even though telephone circuits operate only over a range of from 200 to about 3,000 cycles, coils must be carefully wound and balanced to avoid interference or cross-talk among the thousands of circuits that run through a central office.

In addition there is the matter of signaling. A telephone requires a line that will transmit about 1 watt of power at 105 volts at 20 cycles to ring the telephone bell.

The amplifier described above cannot handle powers of this order, so a relay network which will respond to the 20-cycle ringing must be bridged around the repeater.

The 48 volts of direct current used by the dial apparatus and switching equipment will not go through this amplifier either. Therefore, a second set of relays is needed to bridge this function around the repeater. These relays must operate selectively so the repeater may be used for dialing, ringing or talking as required while the telephone is in use.

While this type of repeater will probably be used for a long time in communication circuits, the march of elec-

tronics has brought a completely new concept of amplification, the negative-impedance repeater, into the communications business.

Negative-impedance repeater

Negative impedance, or negative resistance as it is sometimes called, can be thought of as a quantity which is exactly the opposite of a real or positive resistance. For example, a regular resistance could be said to "draw" power from the circuit and deliver it somewhere else as another form of energy. A negative resistance, on the other hand, would "give" power to the circuit. A resistance puts a voltage drop in a circuit, a negative resistance a voltage gain. The voltage drop in a resistance is in the same direction as the current flow, in a negative resistance in the opposite direction. From this it can be surmised that a negative resistance is actually a source of power, which it is.

The advantage of a negative resist-

ance as an amplifier develops from the fact that as a minus quantity it can theoretically be subtracted from the existing resistance in a circuit. Thus, the resistance presented by a long telephone line could be partially offset by the use of a negative resistance in the circuit, because by Ohm's law the current flow in a circuit may be increased by increasing the voltage or lowering the resistance.

On a direct-current circuit such as a lamp, a bell or a telegraph, the range could be extended by merely increasing the direct-current voltage. However, on a voice circuit if more voltage is to be added, it must be added exactly in step with the originating voice; that is, it must be an alternating current which exactly matches the voice.

Such an alternating voltage when placed in a voice circuit would be the equivalent of negative resistance. Fig. 2 shows a theoretical way of doing this. The amplifier can be a repeater such as we have described. Notice that the input and the output are connected in series. Assume that the voice current entering the amplifier has the instantaneous polarity shown. The amplifier is so connected that the output polarity will then be in series-aiding with the input. It then conforms to the concept of a negative resistance. Whatever the polarity, frequency or amplitude of the voltage applied to the input, the opposite polarity appears at the output. If the phasing is correct, the output adds to the input and results in more current traveling over the line to the receiver. In practice, an amplifier of this

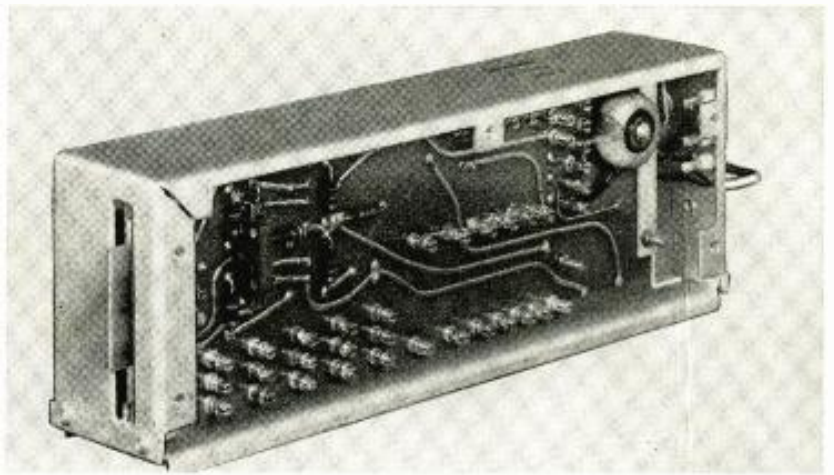

A Stromberg-Carlson negative-impedance repeater. The unit uses transistors rather than vacuum tubes.

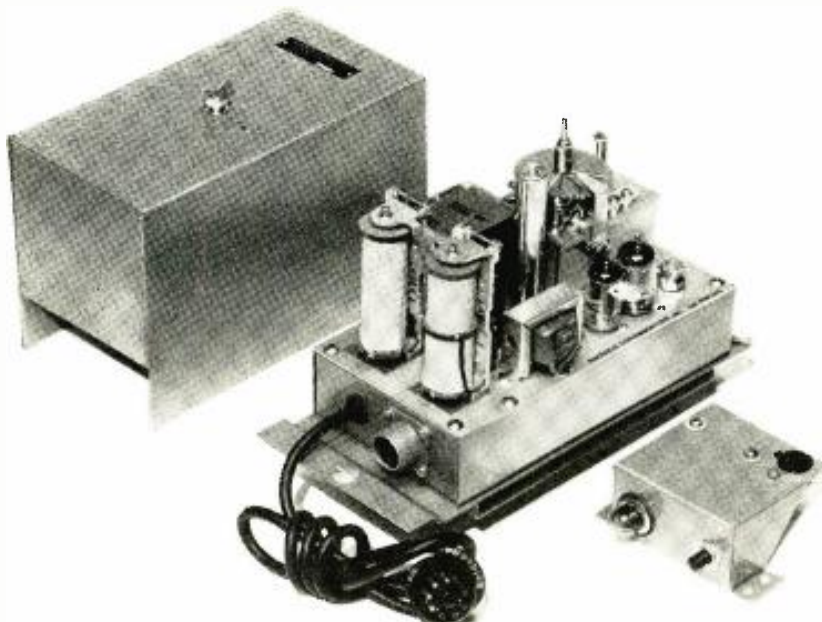

Secode decoder is used both for mobile radiotelephone and for switched land-line telephone circuits.

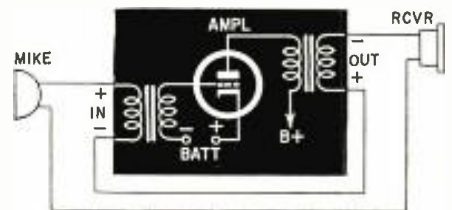

Fig. 2—To get the effect of negative resistance in this circuit, the output is placed in series with the input. Polarity is arranged in series adding.

sort would be hooked in each side of the line to keep it balanced.

A variation of this concept, the shunt-negative admittance amplifier, is built by hooking the input and the output of any amplifier in parallel. This requires a hybrid arrangement to prevent feedback. When connected in parallel the input and the output must have the same polarity, much the same as when batteries are hooked in parallel.

Amplifiers connected in this manner were actually experimented with many years ago, but only with the advent of the grounded-grid amplifier did it become a practical thing. The use of the grounded-grid technique made possible the use of a single transformer, which handles both input and output.

Fig. 3 is a partial schematic showing a grounded-grid amplifier as it is used in a negative impedance repeater. The light arrow shows the instantaneous current direction as the voice voltage is applied between grid and cathode. The heavy arrow shows the plate current which results from this. It is in the opposite direction because of the natural phase shift through the tube. In a regular amplifier, this would amount to negative feedback, and the plate current would tend to reduce or eliminate the input current.

However, while some negative feedback results in this circuit, it is this reversed current that gives rise to the negative impedance characteristic. Actually, as will be shown in the next figure, positive feedback is also used. The effective feedback current is the vector sum of the positive and negative conditions.

The negative resistance is developed as follows: In Fig. 3, the light + and - signs on the telephone line, and the line side of the transformer, represent the instantaneous voice voltages. If the bottom phone is transmitting and the amplifier is turned off, the light + and - signs on the transformer represent the voltage drop in the voice path caused by the transformer and repeater.

Thus if the repeater is not amplifying, it introduces a voltage drop in the telephone line, just the same as if a battery with the polarity shown, was put in place of the transformer. Notice that the transformer thus is poled as series-opposing. (Like poles oppose each other.)

If the repeater is amplifying, however, the induced voltage resulting from the plate current shown by the heavy arrow, will result in a polarity as shown by the heavy + and - signs on the transformer. This voltage is in series-aiding with the speech voltage. (Positive is connected to negative, just as in adding dry cells in series.)

This series-aiding voltage, having originated from the speech voltage, is in step with it. The effect, therefore, is that of adding more voltage to the speech circuit, with the result that more current flows and more power is delivered to the telephone at the top of

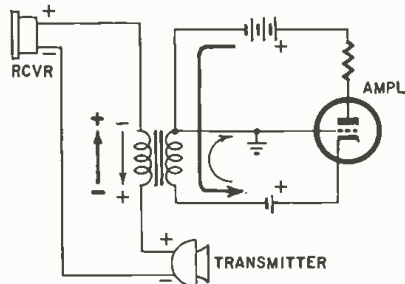

Fig. 3—The grounded-grid amplifier becomes a negative-resistance device when connected as shown. Light arrows and polarity are the instantaneous conditions of the incoming voice. Heavy arrows and signs are the amplified results.

Fig. 3. The repeater, then, instead of taking power from the circuit as would a plain resistance, actually delivers power to the circuit, and thereby qualifies as a negative resistance.

Fig. 4 shows a more complete circuit of a repeater of this type. The network (NET) which may be used to adjust the gain of the amplifier is an electrical image of the section of telephone line to which the repeater is attached.

The operation of this device can be summarized thus: when a voice goes along the telephone line in either direction, it goes through the transformers which are in series with it. This impresses the voice frequency across the grids and cathodes of each side of the tube.

For the moment consider one grid only—say the one on the left. The voice frequency which reaches this grid is amplified and passes through to the corresponding plate. In so doing it undergoes a 180° phase shift. This is fed back through R7 and C4 into the right grid. This grid, because it is hooked to the opposite side of the telephone line, is already 180° out of phase with the left-hand grid. Therefore, the voltage delivered by the left-hand plate to the right-hand grid is in phase, and this constitutes positive feedback which increases the gain of the amplifier. This counteracts the effect of the negative feedback described earlier.

The gain-adjusting network, composed of many coils, resistors and capacitors, will pass some frequencies better than others. This is because the telephone cable pair upon which it is to be used does not have a smooth gain-frequency characteristic. Therefore, the network as its electrical image will have a similar response.

During repeater operation, frequencies which pass easily through the network will be in effect short-circuited from one plate of the tube to the other and hence will not develop the positive feedback on the grids needed to get amplification. Thus the network can cause some frequencies to be amplified and others to be ignored.

The repeater can also be analyzed by remembering that it is a negative-impedance device and all the network's components are "seen" by the telephone

line through the phase shift of the tube as their electrical opposites.

Thus, if perfectly designed, the network introduces capacitance to offset the cable's inductance and inductance to offset its capacitance at different frequencies.

The bandpass of such an amplifier is determined by capacitors C3 and C4, which fix the lowest frequency at which adequate positive feedback can be obtained, and by capacitors C1 and C2, which bypass to ground frequencies higher than a certain value.

Note that the telephone line is continuous through this type of repeater. Only the low-resistance primaries of the transformer are in series with it. Thus, the wires can be used for low-frequency signaling or direct-current dialing or switching without any need for relays. Indeed, the repeater could fail completely and the telephone line would still work, but with reduced volume. Present-day telephone offices are installing negative-impedance amplifiers, both series and shunt types, in large quantities. Both vacuum tube and transistor types are being used.

Distance a problem

While the equipment now being used in all branches of the electronic business is beginning to look the same, the service technician in the communications field has one problem that men in other fields do not—the problem of distance. Although we span greater distances with radio, all equipment involved is concentrated at the ends of the line. A wire-line network across the country may be amplified as frequently as every 8 miles. Further, your voice may travel over wire, cable, radio and microwave links, through equipment of different manufacture and widely different design, which somehow or other has been matched together to provide satisfactory transmission.

When trouble occurs on a wire-line

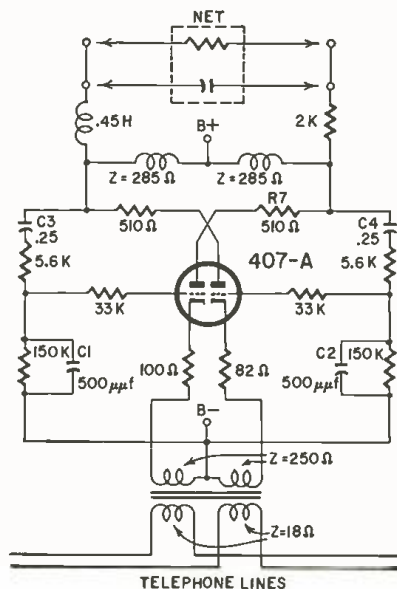

Fig. 4—A series negative-impedance repeater used on a telephone line.

network, it is one thing to repair it once you have located it—it is quite another thing to find it in the first place. Where circuits go through an attended central office, it is relatively simple to get the repairman in the next section to test with you and isolate the bad part of the wire.

Trouble on wire lines can be located with instruments like a Wheatstone bridge which will locate a ground or a short within a few feet even from several miles away. Another instrument, the line-fault analyzer, is essentially a synchroscope (a special-purpose oscilloscope designed especially for measuring the amplitude, shape and duration of short pulses). It sends a high-voltage pulse out on the line which is reflected from the fault and observed on a cathode-ray tube. Trouble over 100 miles away can be located with this instrument and pinpointed with remarkable accuracy.

Mechanical troubles caused by broken or crossed wires are comparatively easy to find; but noise, fading and cross-talk are other matters.

Many of these troubles are transient and may never be actually located or positively repaired. Nevertheless, it is necessary to see that they are removed from service.

Various manual and automatic devices have been developed to provide alternate service when circuits fail. Dial switching centers can be arranged to reroute calls automatically through different cities when regular circuits fail. Microwave and other radio equipment, which might be installed at inaccessible locations, can be set to switch to spare channels if the regular paths become unusable. Microwave systems which go through several links can be made to notify personnel at the distant end which link has the trouble.

Some of these changeover systems operate automatically—others like that used by an oil company in California operate manually. Here a dispatcher is responsible for the operation of a wire-line carrier system which parallels the company's pipeline. The line provides the company with a private communications system from San Francisco to Los Angeles as well as to the pumping stations and oil fields en route. It operates 24 hours a day.

If noise or interference should enter the system, it could easily stop all communications. However, the dispatcher, by merely turning a telephone dial, can cut this line into sections many miles away. Thus dialing one number might cut the line 100 miles to the south. If this did not clear the trouble, a second number would switch the line back together again. In this way, each of several switch points would be dialed until the trouble area is taken off the circuit. This defective portion would be left out of the circuit until a technician could be dispatched. In the meantime, the remainder of the circuit would work.

The switching for this particular in-

stallation is handled by an electromechanical device known as the Secode decoder. It consists of a magnetically actuated code wheel which can be preset to any one of thousands of numbers. When that number is received, it opens or closes an external circuit as required. The same device is also used in mobile radio systems for calling a specific car when several use the same frequency.

Business machines

Another factor which is tending to merge electronic servicing fields is the remotely operated business machine. These giant electronic computers which are so useful for business operations are extremely expensive, and some are very large besides. The present trend is to put these machines at some centralized location and connect branch offices to them by telephone wires.

A good example is the UNIVAC installed by Sylvania in Camillus, N. Y. It keeps track of orders, inventories, payrolls, etc., and figures out problems for Sylvania's laboratory scientists in its spare time. It is connected by Western Union wires to more than 80 Sylvania installations throughout the United States.

A similar installation in another state is the joint effort of several insurance companies. They placed a computer at a centralized location and wired it to each company's office so all could use it.

Sending this kind of information over telephone or telegraph lines is called "data transmission." It includes everything from teletypewriters, teletype-setters and telemetering, to closed-circuit television. In the works now are systems to make it possible for you to cash a check at a branch bank. An electronic machine will read the magnetic ink on the check, send the information

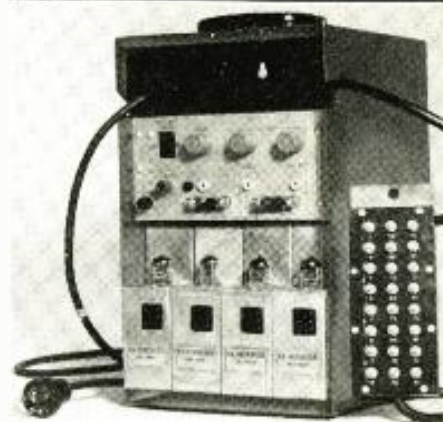

A package unit of four Hallamore Electronics negative-impedance repeaters complete with power supply.

over a telephone line to the main office where a computer will check your balance, make the deduction and post the new balance before you can get out of the branch office.

While much of the apparatus used for such applications will be maintained by either the telephone company or the computer manufacturer, each service technician is going to have to know the other fellow's job. The telephone man's Wheatstone bridge will do him no good in unscrambling garbled pulses. The electronic technician attempting to fix a business machine will get nowhere unless he realizes that a telephone pair in the circuit may introduce phase shift.

This growing problem has been recognized by educators. Many colleges now include a course in telephony in their electrical engineering work. Correspondence schools whose aim has been to educate the radio service technician are also awakening to the need for special training in wire-line communications. END

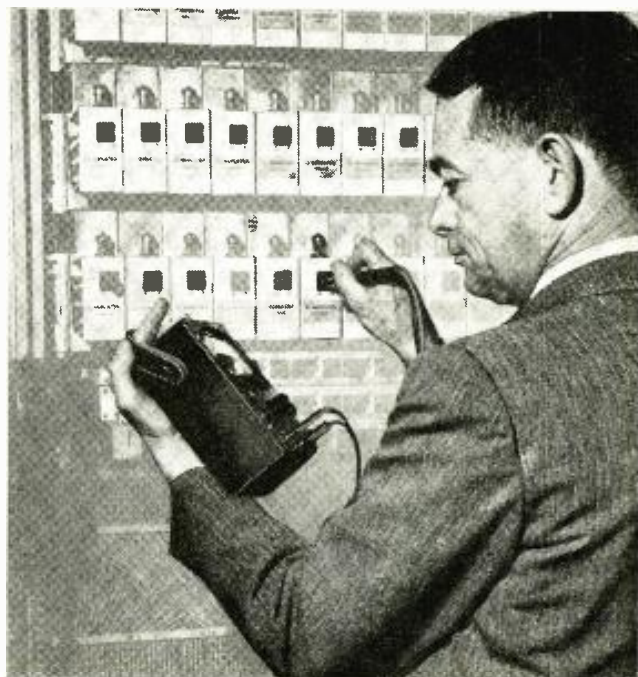

Today's telephone technician uses the same meters and test instruments as radio and television service technicians.

Louis Landman

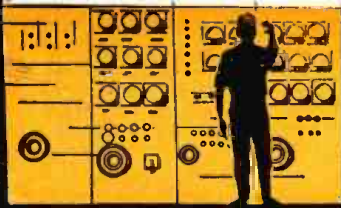

**INDUSTRIAL
ELECTRONICS**



TV TECH BREAKS INDUSTRIAL ELECTRONICS BARRIER



Murray Barlowe doing final assembly work on several of the electronic molten-glass level controls which he developed for a local plant of the Pittsburgh Plate Glass Co. in the course of servicing some of their control equipment.

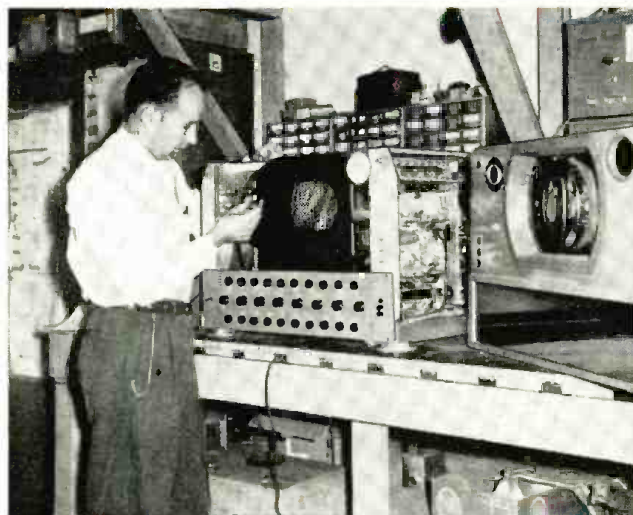

Murray Barlowe at work on a closed-circuit color TV viewer which is part of the hospital setup his shop services and operates.

It's not too hard to break into servicing industrial electronic gear. Here's how one alert technician did it

by **CHARLES B. GRAHAM**

ALERT service technicians are always looking for ways to expand their business and increase their income. The experience of Murray Barlowe (Barlowe Electronics, Bethpage, N. Y.) shows that a good technician can break into the growing field of industrial electronics, servicing electronic equipment in nearby industrial plants.

Barlowe started servicing TV receivers in 1951, and did a pretty fair business in TV and radio repair. Like most small shops his was rarely busy all the time, so he began looking around for work to fill in the quiet times and bring in more money. Among the sidelines considered were specializing in hi-fi installations, selling color TV sets and becoming a radio and television dealer.

He finally settled on going after the regular industrial electronic maintenance and repair work in certain local plants.

Some of this work was being handled by men inside, usually inadequately, since they often lacked electronic training. In other cases, it was being done by experts from the factories that made the industrial electronic gear, but the local plant operators were not happy because of the hours and often days lost waiting for the factory man to appear.

Murray started by reading everything on control circuits he could get his hands on. He paid particular attention to circuits for doing jobs different from those usually found in radio-TV-hi-fi repair work. Some of the texts he used are listed at the end of the article.

The first steps

Barlowe then began talking to his regular radio-TV service customers

about servicing electronic units other than those used in the home. Did they have such equipment? Did they know anyone who did? One day while working on the TV set in the home of an official of the Pittsburgh Plate Glass Co. in Hicksville, N. Y., Murray learned that the regular plant maintenance people were having constant and annoying trouble with some of the plant's electronic gear.

He not only went into the plant and serviced the units successfully, but was able to suggest a simple improvement which was incorporated into the equipment. After that he was commissioned to make a model of the improved unit. Then the plant ordered four more and, before he knew what had happened, Murray had become a manufacturer!

Barlowe also found that the plant was having a great deal of trouble with their system for manually controlling the level of molten glass in a number of glass furnaces. He reasoned that, by putting sensing probes into the furnaces at different levels, the molten-glass level could be controlled electronically, and consequently more accurately. He was able to solve this problem successfully also, and built a number of molten-glass level controls for the plant in Hicksville.

Later he suggested to the company a regular program of maintenance of all its electronic gear. This included sending a man in once a month to check tubes with a mutual conductance tester, cleaning glass fibers out of the gear, replacing any low tubes, and giving the equipment an operational test. The plant management OK'd the program and found after several months that the time lost because of equipment failure was cut way down through this preventive maintenance.

Other equipment he services in the plant, in addition to the molten-glass controls, are sensing guides which keep rolls of glass fiber on the right track as they pass over a series of rollers into a coating oven.

Then there were two

The second substantial electronic service account obtained by Barlowe is the St. Francis Cardiac Hospital in Roslyn, N. Y. The hospital had installed a closed-circuit color television setup in the operating room so students and doctors elsewhere in the hospital might observe the details of advanced heart surgery.

Someone was needed to operate and maintain this CBS field-sequential (color-wheel) system. Barlowe had taught field-sequential color in school a few years before, so CBS recommended him to the hospital.

His company now operates the TV system as well as handling the maintenance on it and the hospital's cardioscope, heart-lung machine, defibrillator, X-ray machine, three slave monitors, and the tape recorder for the cardioscope. He reports that the circuits of the CCTV system and its camera are little if any more complex than those

Closeup of control unit for molten glass level controls built by Barlowe TV and Electronics.

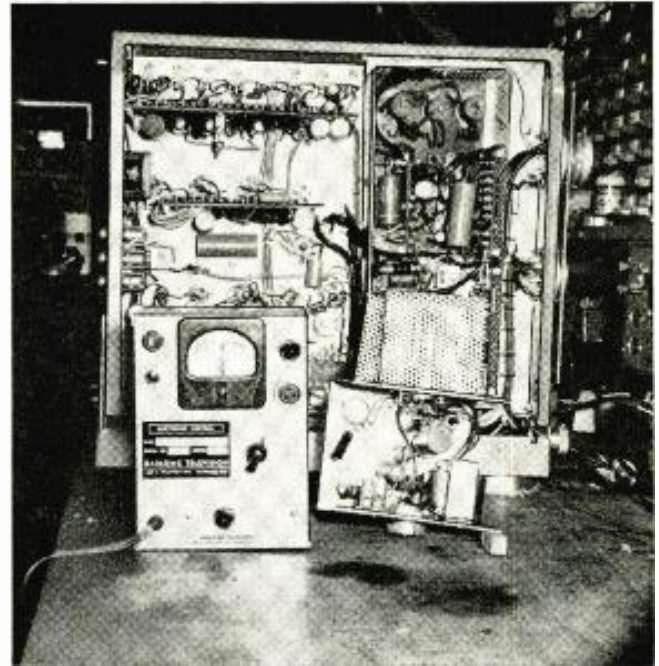

of black-and-white systems. Since this is high-quality equipment, it is less likely to fail or suffer aging effects other than of tubes. The result is that ordinary maintenance techniques have worked perfectly.

In addition to maintaining and operating the CCTV, Barlowe helped instrument a mechanical heart-lung machine which is used during heart surgery to take over some of the functions of the heart or lungs temporarily.

He also built for St. Francis' staff a visual monitor for monitoring heart action. It incorporates an oscilloscope and also a "beep" generator to indicate the pulse by sound.

The modus operandi

When faced with a new piece of industrial trial electronics, Barlowe studies it step by step since it is often difficult to obtain schematics for industrial gear.¹ First he finds out what it should do (how it works). Then he observes just how it is working. Then he makes a block diagram. From this and his observations he can usually isolate the trouble to one or, at most, two stages. Then he goes ahead just as with a radio, using standard trouble shooting procedure—tubes, typical voltage checks, etc. This almost always works and he's found that it's not usually necessary to trace out the entire schematic in detail.

Speaking of his experience in adding to his regular TV-radio service business he says, "Industrial electronics is cleaner and more profitable than fixing home sets. There is no haggling over price and a good job is appreciated. Once you have an industrial customer and do a good job, you have him perma-

nently. He'll always call you instead of shopping around for someone who may be a little cheaper. Usually you can get him on a monthly preventive maintenance program because lost machine time is costly. Plant men are smart enough to know the value of preventive maintenance and don't mind paying well to increase their chances of staying out of trouble."

Typical industrial service calls pay from \$20 to \$50 whether they take an hour or half a day. Says Barlowe, "Plant people don't mind paying just as much for a quick job as for an all-day one because they're interested in keeping the production line going, not in saving a few dollars shopping for repair work."

"In selling industrial plants on the idea of electronic servicing by a local shop, it's wise to stress that you can give them immediate service and then to back up this angle. This is by far the most important thing to production executives. They can always get the factory to send someone, sooner or later. But if you get there right away, you've got the battle half won in getting a substantial, permanent, good-paying customer."

RADIO-ELECTRONICS will explore the field of industrial electronics in greater detail in future issues, with special emphasis on typical case histories like that of a successful TV technician who's helping himself to a bigger piece of security through tying in with an ever-expanding field, that of industrial electronic equipment service. **END**

Texts to help the TV technician along the road to industrial servicing.

Richter, *Fundamentals of Industrial Electronic Circuits*, McGraw-Hill, New York, 1947.

Chute, *Electronics in Industry*, McGraw-Hill, New York, 1956.

Batcher & Moulie, *Electronic Control Handbook*, Caldwell-Clements, New York, 1946.

Roberts, *Mechanical Measurements by Electrical Methods*, Instruments Publishing Co., Pittsburgh, 1951.

Holzbock, *Instruments for Measurement and Control*, Reinhold Publishing Corp., New York, 1955.

¹This general lack of cooperation from manufacturers with independent service technicians is being rectified, according to latest reports from technicians active in the field.—Editor

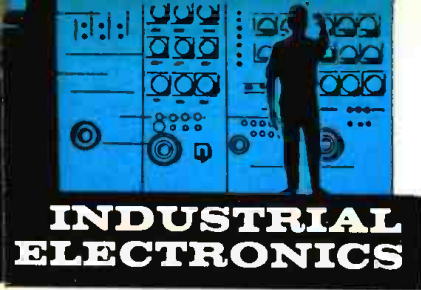

Closed-circuit TV makes ticket selling faster—easier on both railroad employees and passengers

ELECTRONICS works on the

RAILROAD

by AARON NADELL



Fig. 1—At the ticket booth, a TV screen shows available accommodations for the desired trip.

Fig. 2—The reservation clerk, who handles calls from hotels and travel agencies, is also hooked into the closed circuit system.



THE industrial electronic servicing industry is growing and will keep on growing... In its readers' interest RADIO-ELECTRONICS will watch these developments very closely and will report on them in these columns from time to time."

This promise was extended in the July, 1959, issue. And here is an account of one such development—the use of electronic devices for selling railroad tickets and the arrangements made by the railroad for servicing and maintaining the electronic equipment.

The Pennsylvania Railroad now uses electronics in a number of ways. Three applications to "the high iron" are in the sale of passenger reservations; in the automation of switching and handling freight cars, and in the remote recording of freight-car arrivals. The report that follows covers the electronic sale of passenger accommodations—closed-circuit TV, facsimile transmission and telautograph communication to minimize inconvenience to the passenger and expense to the railroad.

Modern ticket sales

A Pullman accommodation or a reserved seat can be sold only once. When one passenger has booked the facility, it is no longer available to anyone else. But under the older, nonelectronic mode of operation the clerk at the ticket window *did not* and *could not know* which facilities were open and which had already been sold. For the seat might have been sold, not only at another window in the same station, but at any of a hundred windows in a hundred stations. So the clerk you approached had to telephone (or in some small railroad stations, telegraph) a central office to find out what accommodations were still open. There another clerk consulted an "availability board" and advised your ticket seller. Such inquiries (as you may know from per-

RADIO-ELECTRONICS

Fig. 3—Facsimile machine at a remote location prints out the young lady's ticket in a matter of seconds.



sonal experience) took time, since other clerks at other ticket windows may have been telephoning simultaneously to the same center.

Perhaps you have leaned against a ticket window and waited while the ticket clerk, phone to his ear, waited, and a growing line of passengers forming up for the same window—waited. Finally, perhaps, the word came through that the accommodation you wanted had already been sold, and what other accommodation would you accept? You made up your mind, told your ticket clerk, and he spoke into his phone, and the whole process, including the waiting, was repeated. Perhaps it had to be repeated several times until your wishes as passenger, and the remaining supply of unsold facilities, could be reconciled.

To provide newer, more convenient and more efficient TV ticket booking facilities at the Pennsylvania Railroad Terminal in New York, the station was rebuilt to provide for closed-circuit TV ticket sales.

Fig. 1 shows a very small portion (three stations—two of them unmanned) of the 16-station TV ticket-selling facility. Normally, most if not all of the 16 windows are manned and busy. But these 16 windows are only for sales to people who come to the station to buy their tickets. Additional TV equipment is provided for remote sales of tickets through hotels, travel agencies, and so on. A few of the supplementary stations are shown in Fig. 2. The entire sales area incorporates 101 closed-circuit TV receivers.

Buying a ticket via TV

If you go to Penn Station, New York, to book a Pullman or seat reservation, you will face both a ticket clerk and a TV display like the one in Fig. 1. The clerk will dial a 2-digit number that tunes his closed-circuit receiver to the availability board for the trip and date you want. That board then appears on his TV screen, and both he and you see at a glance all the accommodations still available, not only on the date you requested, but also for a period of weeks ahead.

Guided by the clerk, you select the one you prefer from among those that are open. Then the clerk dials the central office and tells them what you have decided to book. The central office clerk takes appropriate tickets from a file and places them in a facsimile machine. Those tickets are then facsimile-duplicated at the counter where you are standing, handed to you and you pay for them. The entire transaction is said to average not more than 10 seconds.

The installation's auxiliary facilities, shown in Fig. 2, include not only provi-

sions for remote sales of tickets but also for many kinds of special services. These include booking entire tours, reserving hotel rooms, reserving car rentals, handling pets, and similar travel details. In all, the Penn Station installation in New York embodies not only a total of 101 closed-circuit TV receivers, which spread information remotely before both railroad personnel and customers, but also a total of 105 TV cameras that are focused on availability boards and related sources of data.

It goes without saying that this elaborate electronic installation needs competent maintenance!

Servicing the equipment

The TV ticket-selling installation is maintained by the vendor of the equipment. Manufacturer of the apparatus is Dage Television Division of Thompson Ramo Wooldridge, Inc., Michigan City, Ind. The New York distributor, who takes direct responsibility for maintenance, is ITV, Inc.

ITV assigns three full-time, salaried service technicians to the Penn Station installation alone. They keep it on a regular preventive-maintenance inspection routine, and provide emergency service when and if needed. One or another of the three assigned technicians is always on duty between 8 AM and midnight.

Employment requirements

To work for ITV and service their closed-circuit video installations a technician must have a diploma "from an accredited technical school" and "some practical training in the television field," according to Max J. Kanter, ITV president.

The demand for such qualified technicians is likely to increase, since similar installations, though much smaller

than the one at Penn Station, are being constantly set up.

All servicing of the Penn RR ticket-selling system does not belong to ITV. They look after the closed-circuit TV only. The facsimile apparatus, which is part of the overall system and dispenses tickets remotely, and the telautograph communicator through which the clerk at the customer window signs for accommodations received and advises the central office to remove them from the availability board, are Western Union equipment, and are maintained by Western Union service personnel.

Other TV ticket sales offices

Although the Penn Station ticket-selling installation is the railroad's largest, it isn't the Pennsy's only TV-controlled installation. Fig. 3 shows one corner of a similar though somewhat smaller one in the line's 30th Street Station in Philadelphia. The ticket seller is holding in his left hand a Pullman ticket which he has just received via electronic facsimile reproduction. In his right hand he has a metal matrix which he has selected from the indexed file under his sales counter. He will use these materials and the machine in front of him to print the passenger ticket which a moment later he will hand the young lady customer.

Interlocked modernized ticket selling has been provided at Pittsburgh, Wilmington, Trenton, Newark, Paoli and North Philadelphia. There are also electronic tie-ins with the Chesapeake and Ohio Railway, Southern Railway System, Seaboard Air Line Railroad, Atlantic Coast Line Railroad and Hudson and Manhattan Railroad; with two subsidiary Pennsylvania Railroad ticket offices in Manhattan at 3 W. 47 St. and 17 John St., and with two in Philadelphia, at 1607 Walnut St. and Benjamin Franklin Hotel. END

PRINTED CIRCUITS

Resistors, capacitors, switches—all printed on circuit boards that may be shaped to suit the job—give electronic designers a new dimension to work in

**are
here
to
stay**

by **ALLAN LYTEL**

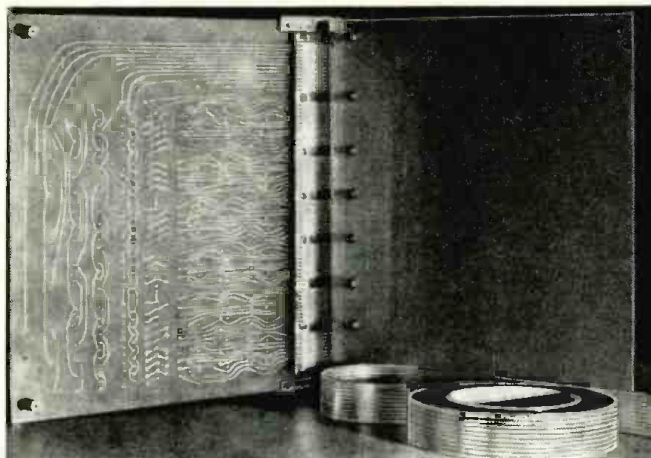

Fig. 1—The chassis of this Stromberg-Carlson unit is in the form of leaves in a book that are interconnected by a flat multiconductor cable.

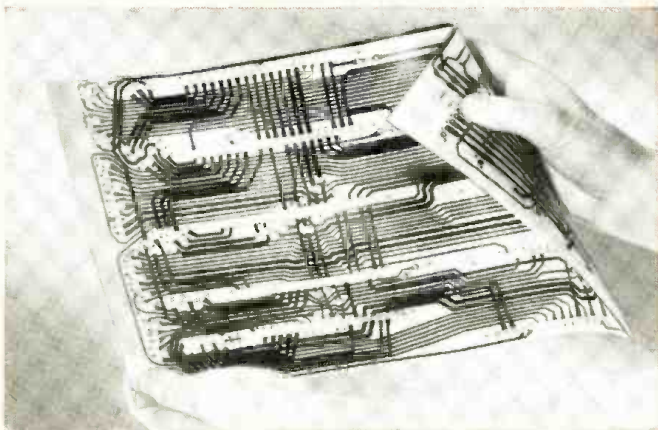

Fig. 2—This circuit is printed on a flexible material.

FROM a modest beginning just a few years back, the uses for printed circuits have grown until today when they are found in almost every type of electronic instrument.

They are used in satellites and missiles, in radio and TV receivers, and in computers and industrial control systems.

These circuits take many forms and many are unusual. Stromberg-Carlson uses a book type construction, shown in Fig. 1, where the "pages" of the book are printed-circuit boards. They are interconnected by flat multiconductor cables so the unit opens up for servicing and folds flat when in use. Saunders Associates uses a flexible circuit which can be applied to curved surfaces (see Fig. 2). Centralab made a four-transistor amplifier (Fig. 3) in a package only a little over an inch long. Only the input, output, volume control and battery are external.

Other types of printed circuits include ceramics for high-temperature use, plated circuits for resistance to corrosion and wear, and miniaturized printed circuits including built-in transistors.

Flush switches with very long operating lives at lower cost are in production. They are plated with metals of greater wearing qualities than copper. Connectors make it possible to remove circuit boards from equipment for testing and repair. Connectors are usually molded and have from 6 to 44 connecting terminals on a single strip. Contacts are made of phosphor bronze or beryllium copper. Some are gold plated to prevent corrosion.

Cables for use with printed-circuit connectors are available. These are ribbons of cable made from many flat copper conductors. Typical construction encases the conductors in transparent polyester insulation.

Circuit packaging includes stacks of ceramic wafers, single laminated plastic plug-in boards, and sandwiches of two single-faced boards with the components in between.

Computer memories

Large-scale data processing machines use electronic memory devices with small magnetic cores for one form of data storage.

Printed circuits are appearing in some new forms for memory units in digital computers. Ramo-Wooldrige has experimental printed units for high-speed low-temperature use. Fig. 4 shows one of these units. It is about four times the size of the production models. Known as a Persistor, this printed memory unit operates at temperatures of nearly absolute zero or -459.6° F and because of its superconductivity at extremely low temperatures, it can perform

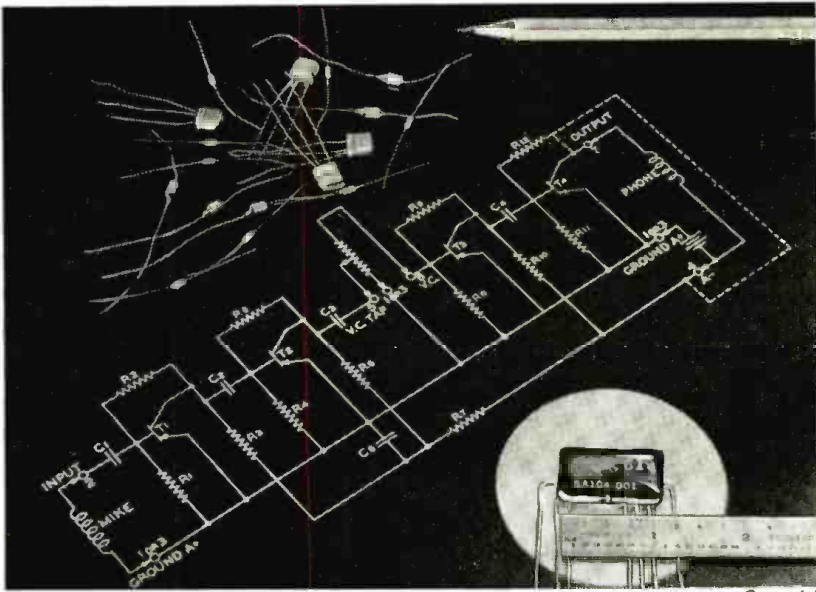
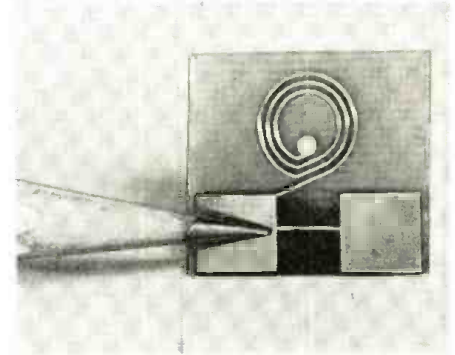

Fig. 3—The TA-11 (no longer in production) was a tiny four-stage transistor amplifier.

Centralab

Fig. 4—High-speed low-temperature memory unit for electronic computers. Production models of the device, called the Persistor, will be approximately a quarter the size shown.



computer switching operations in 10 millimicroseconds or 1/100 microsecond.

Also, MIT has shown that it is possible to use printed wiring to connect the small magnetic cores now used for memories. This interesting and highly specialized type of printed circuit has been developed at the MIT Lincoln Laboratory as a three-dimensional circuit of etched wiring which goes through holes in ferrite cores of memory planes. The TX-2 computer stores 2.5 million binary digits in a 256 by 256 by 38 stack of ferrite cores. The standard 64 by 64 core modular plane requires four insulated wires which are threaded through each of 4,096 cores, having .050-inch diameter holes.

The new technique uses collimated light to produce, in a single exposure, the image of the complete wiring for a memory plane. With collimated light means the pattern mask does not have to be in direct contact with the sensitized laminate to produce a sharp image. The cores are mounted in holes in the base laminate. The entire board is then coated with a plastic to hold the cores in place. The board is then coated with copper, by electroplating. Wiring of the cores was arranged to avoid crossovers. The finished wiring pattern extends through each of the cores and connects to another pattern on the other face. The method is much faster than current production methods for memory planes.

Printed switches

Computer switches are only one type of switching. For lower speed switching, printed switches are used. These may be ordinary printed wiring or flush wiring. There are cost savings in complicated patterns made of printed wiring as compared to other, older methods.

Switches, commutators and slip rings, especially in complex patterns, are a good example of this. Many switches that would be impractical by any other method can be made economically, even in small quantities, using printed-circuit techniques. The circuit itself can often be combined with the switch contacts for still greater savings. Silver, gold or nickel-rhodium platings provide low contact resistance and long life. With careful design, a life of many millions of cycles is being obtained from printed-circuit switches.

Fig. 5 illustrates a complex multiple group of switch patterns with a plug connector having leads from the circuit switch segments. In regular printed wiring there are dead segments between the contacts to prevent bouncing.

In flush circuits the etched wiring is forced into the laminate base after heating the base material. Since the

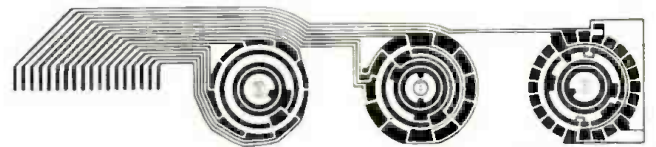

Chrono-Log Corp.

Fig. 5—A complex multiple-switch pattern with connecting leads brought out to a plug connector.

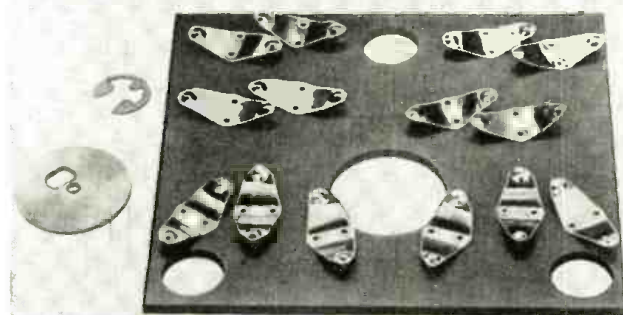
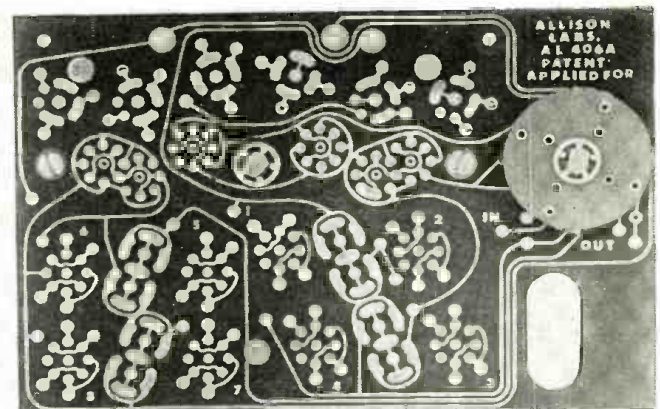

Allison Laboratories Inc.

Fig. 6—The HEP switch.

Fig. 7—Two printed packaged radio circuits: a—Diode-pentode coupling circuit; b—diode-triode coupling circuit.

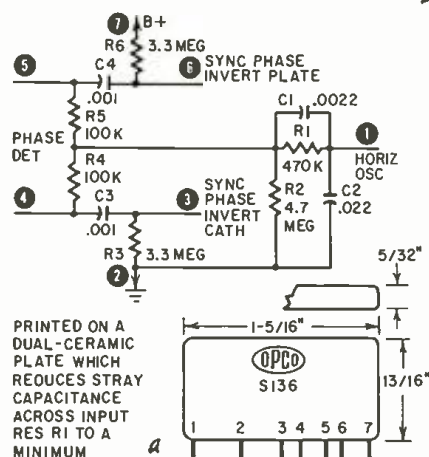
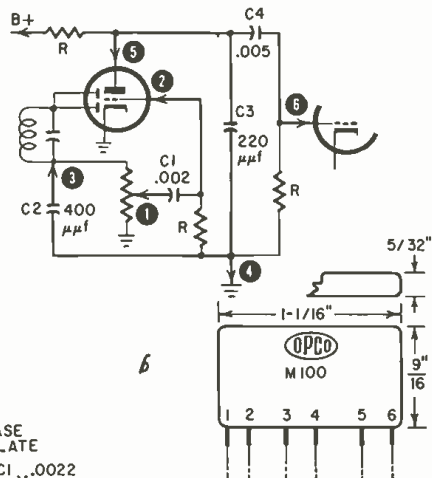
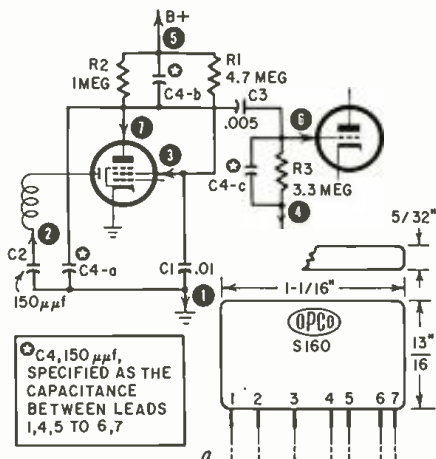
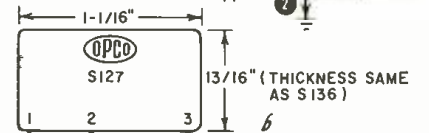
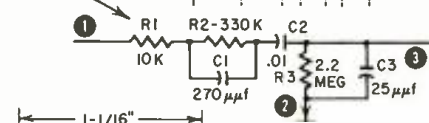

Fig. 8 — Three printed TV circuits: a — Horizontal a/c circuit; b—sync take-off circuit; c—vertical integrator.



Onondaga Pottery

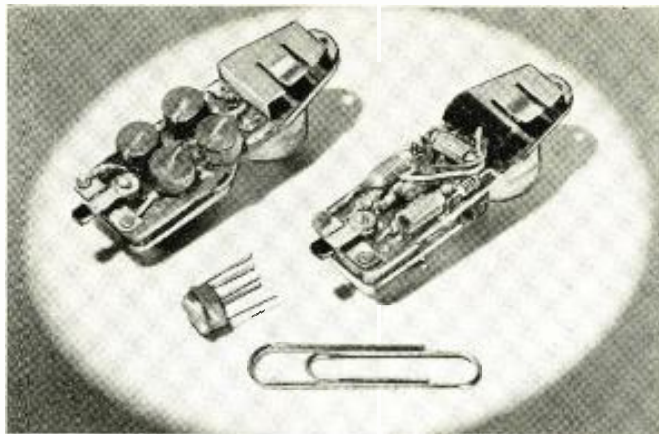

Fig. 9—Four packaged amplifier stages are used in a modern hearing aid.

Centralab

Fig. 10—A group of printed-circuit boards with ceramic bases. They are designed to withstand high temperatures.



conductors and the base are in the same plane, the moving contact can pass over the switch plate without bouncing. Aerovox has developed a method of producing flush circuits using silver. Copper-foil switches are often plated to extend their useful life.

A new type of switch is the HEP (Hartsock Etched Plate) (Allison Laboratories, Inc.). It is made of a printed circuit, shown at the top of Fig. 6, and a contact board shown beneath. As this contact board is rotated the spring contacts, by their circular motion, do the switching. A cam is used to rotate this contact plate and guide pins control the board movement.

Switches of this type offer simplified switching techniques for many applications. In one example, with silver contacts touching rhodium plating, there was no appreciable wear after 110,000 cycles of operation. Since only the contact plate is moved, very little force is required for switching.

Circuits on ceramic

Ceramic circuits have long been used for R-C networks. Printing resistors and capacitors on ceramics goes back to the early beginnings of printed circuits.

Ceramic-based circuits were the first type in wide use. The proximity fuse, which was a miniature transmitter and

REGULATED HEATER SUPPLY

A 10-watt Zener diode is the heart of this simple circuit

By **HARDIN C. STRATMAN***

receiver mounted inside an artillery shell, called for mass production of highly reliable circuits. For this purpose, the National Bureau of Standards developed the printed circuit using a ceramic base. Silver paint was used as the conducting medium and it had to be fired at between 900° and 1,400° to burn off the binder and fuse the silver into a highly conductive metallic pattern.

Because of this high temperature, only a ceramic could be used as a base. Steatite is a dense ceramic material that has great strength and hardness. It also has excellent electrical properties which are not affected by high temperature and humidity. The powder is molded or pressed into wafers with the required holes and notches. After firing, at temperatures up to 2,400°F, the silver conductors are applied and the wafer is again fired (this time at a lower temperature) to fix the liquid silver into solid metallic conductors.

Electronic circuits printed on ceramic boards are finding increasing acceptance with the growing use of printed wiring board chassis. Replacing many components with one part saves solder joints and simplifies and reduces the size of circuit boards. Also, one part instead of several parts reduces the number of automatic insertion machines resulting in more flexibility in changing from one receiver to another and a reduction in capital investment for the manufacturer.

In each design, circuit response is made to duplicate as exactly as possible the response obtained from separate components. Important stray capacitances are carefully reduced to an absolute minimum. The values and tolerances of the separate components and a schematic showing the function of the circuit in the overall unit give our engineers data for a mutually acceptable design.

Reproducibility in production is assured by using screen printing. Several patterns are reproduced from the master negatives used for the original samples. Fig. 7 shows two circuits used in radio receivers. One is a diode-pentode coupler and the other a diode-triode coupler. Television receivers have other printed ceramic circuits. Some are shown in Fig. 8 (a horizontal afc circuit, a sync takeoff and a vertical integrator). Many other circuits are also available.

A natural extension of ceramic-based circuits with printed wiring, capacitors and resistors is to add active elements to make a complete amplifier. Centralab has combined the elements with a transistor. They end up with a single-stage amplifier about the size of a pencil eraser. A group of these are used for a hearing aid as in Fig. 9.

Circuits with ceramic bases are also being used to extend electronics to high-temperature operation. Some of these special boards are shown in Fig. 10. Welding is used to connect the wiring and components on boards for high-temperature applications. **END**

DURING the development of an extremely critical oscillator circuit we needed a regulated heater supply for the oscillator. Several methods of regulation were tried. The circuit shown proved to be the most reliable and gave the best results.

This circuit uses a Zener diode as the regulating element. Circuit action of the diode is similar to that of a voltage regulator tube.

If we wanted to regulate the plate voltage of an oscillator tube, we might use an 0D3/VR150. When an 0D3/VR150 conducts, the voltage across it is held quite close to 150—within the tube's current carrying capabilities. Zener diodes are made for many voltage ranges. Their operation is based upon sudden conduction of current at a specified voltage, with the voltage remaining fairly constant across the diode over a wide range of current.

The table tells the story by showing the regulation the circuit gives. Over the critical range of 105 to 125 line volts, heater voltage varies only .03 volt. With the Zener diode disconnected (last column in the table), heater volt-

modulation of a radio-frequency carrier was desired.

Even a very small resistance in series with the Zener diode will disrupt its regulation.

An ammeter was connected in series with the Zener diode to measure its

VOLTAGES OF REGULATED SUPPLY

TRANS PRI (Ac Volts)	TRANS SEC (Ac Volts)	RECT. OUT (Dc Volts)	E DIODE (Dc Volts)	I DIODE (Ma)	V OUT REGULATED (Dc Volts)	E OUT UNREGULATED (Dc Volts)
105	11	12.6	6.75	100	6.2	7.7
110	11.5	13	6.75	135	6.2	8.2
115	12	13.5	6.8	165	6.21	8.8
120	12.5	14	6.81	200	6.22	9.4
125	13	14.5	6.83	450	6.23	9.9

current (I_{DIODE}) while T_{PR} voltage was varied. Then the ammeter was disconnected and the input voltage was again varied to check regulation and to get the remaining readings in the table. A slight improvement in regulation was noted when a good soldered connection was made to the Zener diode in place of a clip lead.

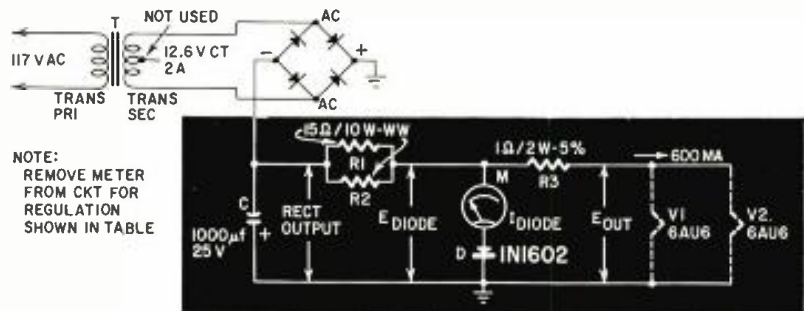

NOTE:
REMOVE METER
FROM CKT FOR
REGULATION
SHOWN IN TABLE

R1, 2—15 ohms, 10 watts, 10%, wirewound
R3—1 ohm, 2 watts, 5%
C—1,000 µf, 25 volts
D—IN1602 (Available from International Rectifier distributors)

BRIDGE RECT—selenium, 25 volts, 1.2 amps
(International Rectifier M18 or equivalent)
T—filament transformer: primary, 117 volts;
secondary, 12.6 volts, 2 amps, ct
(Triad F-44X or equivalent)

Circuit of the regulated supply. As shown, it was used to supply two tubes in the oscillator circuit. The high-voltage supply used 7 tubes and a Zener diode.

age varied 2.2 volts. This is an improvement of 55 to 1.

Ac ripple across the oscillator's tube heaters measured about .015 volt, which represents a hum voltage of -50 to -55 db. Although not important here, it might prove useful where low hum

The particular Zener diode used can dissipate 10 watts into a heat sink. In this particular circuit, the diode is used well below its maximum current and wattage ratings. The load consisted of a pair of 6AU6 tubes connected in parallel which drew 600 ma (as shown in dashed lines in the figure above). **END**

*Engineering Dept., Gates Radio Co.

Delay time in relays both hinders and helps. Knowing how to vary the delay eliminates the hindering and increases their usefulness

RELAYS IN INDUSTRY

by ALVIN G. SYDNOR

Fig. 1—Setup for measuring speed of relay operation.

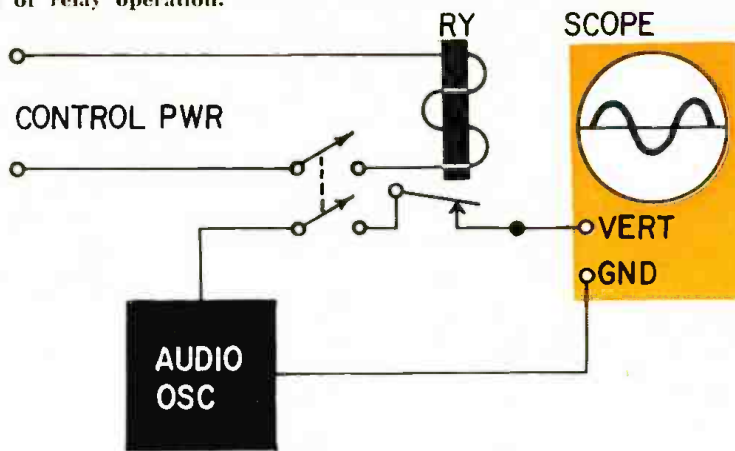

Fig. 2—How to measure operate time using a dc potential. The scope's sweep must be accurately calibrated.

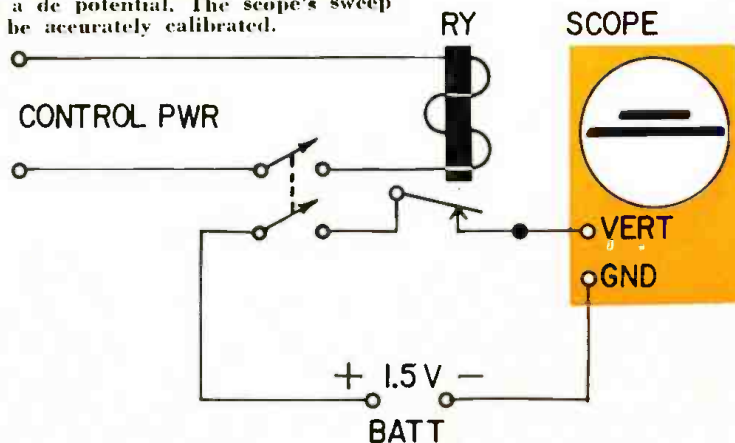
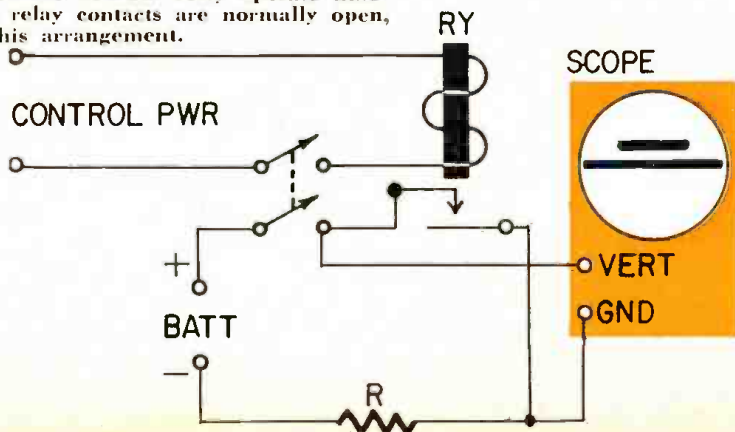

Fig. 3—To test for relay operate time when relay contacts are normally open, use this arrangement.



POWER control in a system where remote switching selects alternate circuits requires that switching be completed rapidly so the next action can be started. The inertia of the switching relay's armature and contact arms limits such action.

For a relay to approach instantaneous operation, it must have an exceptionally large coil. But even this is self-limiting, for coils induce into their windings a counter emf which bucks the applied voltage and keeps field strength from rising rapidly.

These two factors give every relay a definite operate and release time. The average light-duty relay in an industrial application has an operate and release time of about .001 to .05 second, depending on the size and number of its contacts.

Operate time of a particular relay is determined by the ratio of the mass of its moving parts to the magnetic pull produced by its coil. Release time is the ratio of the mass to the pull of the return spring.

General-purpose relays are usually quick-acting. Where the application calls for fast action, a smaller more compact relay is normally superior.

Time measurements

A relay's operate speed can be checked with an oscilloscope and an audio generator. The setup is shown in Fig. 1. The audio signal is fed to the scope's vertical input through the relay's contacts at the same time that power is applied to the relay—use a dpdt switch.

Set the audio generator for a 1,000-cycle sine wave and throw the switch. A sine-wave pattern will be traced on the screen from the time power is applied to the relay to the time the relay contacts open. So if there is one complete sine wave on the screen, it took 1/1,000 second for the relay to operate.

If your scope's sweep rate is accurately calibrated, there is another way you can measure the relay's operate time. This time use the arrangement shown in Fig. 2. A 1.5-volt battery replaces the signal generator of Fig. 1. The scope's sweep is set for 100 cycles

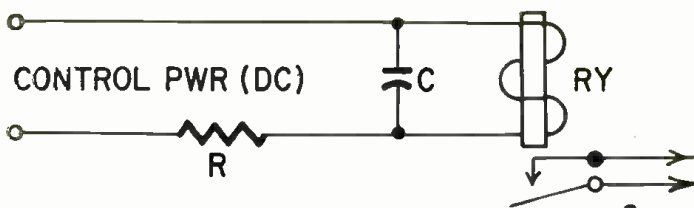
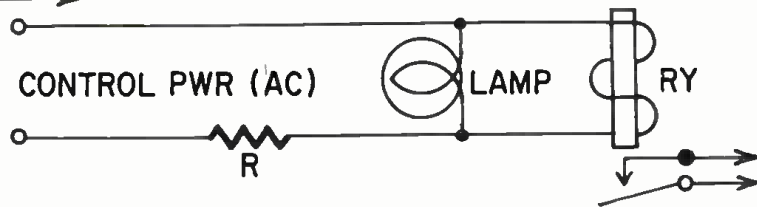

Fig. 4—A resistor in series and a shunt capacitor cause an operate delay.

Fig. 5—Ballast tubes or incandescent lamps can also be used for operate delays.



and the relay's contacts are normally closed. When the switch is closed, the 1.5-volt signal is applied to the scope until the relay contacts open. This produces a straight trace above the base line. The length of this trace as compared to the length of the base trace gives you the operate time. For example, if the higher trace is 1/10 the lower trace, the relay operated in 1/1,000 second—a tenth of 1/100 is 1/1,000. Varying the sweep rate makes it possible to measure almost any delay.

If a normally open relay is to be timed, a different procedure is followed (Fig. 3). The testing switch applies the signal as before but, when the relay closes, the signal is shorted out. Resistor R limits the short-circuit current.

To measure a relay's release time a similar setup to Fig. 3 is used. This time, connect the test switch so the signal is normally shorted and, when it is flipped, it removes the short against the signal voltage and begins the timing period. When the contacts open, the signal voltage stops. The trace is measured as in Figs. 1 and 2.

If you expect a time interval larger than .01 second, the scope is not needed as there are several mechanical timers that can be used. However, if you have the scope, but no timer, just use the scope.

Time delays

In some industrial applications a general-purpose relay will not be fast enough. For example, cutoff devices which must have a minimum loss of time and high repeating speeds. Most of the lack of speed is due to the low power factor of the relay's coil, but the external circuit can be adjusted to correct this by adding external series resistance.

Sometimes a time delay is needed. In industrial jobs the time delay period ranges from 0.1 second to several minutes. There is no one method that can be used for all intervals between these periods. However, we have noted that the magnetic circuit causes an inherent delay in all relays. So why not deliberately alter this circuit to produce the desired delay?

The usual way of setting up relay time delays is shown in Fig. 4. The circuit consists of the relay coil, a shunt capacitor and a series resistor. The re-

sistor limits the capacitor's charging rate. A sensitive relay in such a network can be adjusted to pull in or drop out at precise coil voltages. Slow operate is obtained by using this network and adjusting the relay to pull in as the voltage across the capacitor nears its maximum. If you use a low-voltage high-capacitance electrolytic and a sensitive relay that has a wide range of adjustment and requires little power, the time delay can be varied over a wide range, up to several seconds. For a variable time delay, use a variable resistance in place of the fixed resistor in Fig. 4.

The capacitance method of time delay has one fault: the capacitor gets very large if used with a relay that has a high coil current. So some other method becomes necessary. Also, you can't use a capacitor as a delay for ac-operated relays.

In both instances the solution is rather simple: use an incandescent lamp as in Fig. 5. The lamp's filament has two properties that make it suitable for time delay.

- ▶ It takes an appreciable length of time to reach a steady operating temperature.

- ▶ It has a large positive temperature coefficient of resistance. The resistance ratio between hot and cold is about 10 to 1.

With the lamp in the circuit when current is first applied, the filament acts as a low resistance bypass across the relay coil and there is a large voltage drop across R. As the filament heats up, its resistance rises and current through the filament decreases, reducing the voltage drop across R and operating the relay. Different lamps give various delays. Experiments will show which you can use.

A ballast tube used for voltage regulation has an even better resistance change characteristic and is better suited for time-delay use. It consists of an iron wire hermetically sealed in hydrogen or helium. The rapid cooling of the filament by the gas lengthens its time-delay characteristic.

Thermal time delay

In a magnetic relay, power supplied to the coil is translated into mechanical force by the coil's magnetic field. This

moves the relay's contacts. For a thermal relay, an entirely different principle is used. Control power heats a small coil of resistance wire placed near a bimetallic strip or disc. The strip is composed of two metals bonded together that have different thermal coefficients of expansion. The dissimilar expansion makes the strip bend and move a contact fastened to its free end. Thus heat energy is translated into mechanical energy by the bimetallic strip.

Thermal relays are inherently slow acting and are naturally suited for long delays ranging from several seconds to 1 minute. Some are made covering a wider range—1 second to 2 minutes, but whenever a range of several seconds to 1 minute is exceeded you can expect trouble.

The reason is simple. For a short time delay with a thermal relay (1 second) a maximum of current must be applied to its filament. This leaves no safety margin for high ambient temperatures or overvoltage on the filament.

For delays longer than 1 minute, you run into another problem. The temperature vs time curve for the thermal delay's filament shows that it levels off with the time axis at slightly more than 2 minutes. If heater voltage should be low, a much longer time delay may result. Use thermal delay relays within conservative time ranges, and results will be excellent, despite heater voltage variations up to 10%.

Thermal relays have a long recycling time—between 10 and 70 seconds. In some industrial applications, this is a disadvantage. But in others it is useful. For example, we are using a thermal delay relay to energize the coil of a power relay. A 500-ohm resistor is connected in series with the thermal relay's filament when the power relay operates. This reduces the filament's temperature and keeps the temperature of the bimetal strip just above the operating point. During a momentary power interruption, the thermal relay's contacts will not open, but during a long power interruption the time required to restore normal operation is proportional to the length of the power interruption. This makes it unnecessary to recycle completely each time the supply is momentarily interrupted.

END

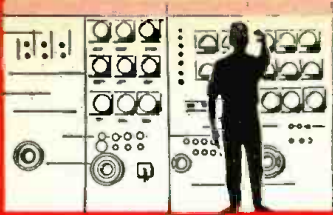

**INDUSTRIAL
ELECTRONICS**

Servicing ELECTRONIC WHEEL BALANCERS

*This end of the
industrial service
business is
easy to get into*

**by W. G. ESLICK
AND ROBERT F. SCOTT**



VARIOUS articles and editorials in **RADIO-ELECTRONICS** have pointed out that there are many industrial electronic devices the average radio and TV technician can service on a full- or part-time basis. Such devices include electronic wheel-balancing machines for automobiles, trucks, motorcycles and similar vehicles. Typical of these is the Alemite Wheel Balancer made by Stewart-Warner Corp.

How the balancer works

The electronic wheel balancer consists of a wheel spinner, pickup, meter, amplifier and strobe light. The spinner is a heavy electric motor used to rotate the jacked-up front wheels of the car while they are being balanced. The spinner motors range from 1 hp up to around 7.5 hp and can drive wheels at speeds up to 100 miles per hour. (Rear wheels are driven by the car's engine.)

The pickup converts vibrations produced by an unbalanced wheel into ac voltages to operate the balance meter and strobe light. Its basic construction is shown in Fig. 1. It consists of two fixed coils on a laminated metal core and two permanent magnets attached to an adjustable arm that is placed in contact with a point of vibration by a third (holding) magnet. The oscillatory motion of the pickup arm vibrates the magnets and creates a changing mag-

netic field through the coil windings and generating voltages in each. One coil actuates the balance meter and then feeds the amplifier an ac signal varying between 3 and 15 cycles, depending on the vibration.

The amplifier takes the ac signal from its pickup coil and amplifies and shapes it into a sharp positive pulse used to trigger the strobe light, a glow-discharge type cold-cathode electronic flash tube that produces sharp brilliant flashes of light. These light flashes illuminate the rotating wheel so a predetermined reference mark appears to stand still when the meter peaks and indicates the mechanical resonance point. The mechanic uses the reference mark to determine the proper location for the balancing weights and the height of the meter peak to show the approximate amount of weight needed for correcting the unbalance.

Circuitry

Fig. 1 is the diagram of the model 7051 wheel balancer. The ac signal from the pickup is fed to V1-a, half of a 6H6, to eliminate the positive half of the signal and pass the negative portion. This signal is fed to an R-C circuit (R1, C1, R2) with a long time constant. The first negative pulse from V1-a charges C1 to its peak voltage. The circuit time constant permits C1 to lose only a small amount of its charge before

the next pulse arrives from V1-a. Thus, only the very peaks of successive pulses (see waveforms in Fig. 1) are fed to the grid of V2-a. V2-a and V2-b amplify and clip the signal to give it a steep waveform.

The output of V2-b is differentiated by C2 and R3 so the signal applied to V3's grid peaks at the point where V2-b's output has its steepest slope.

The differentiated signal on V3's grid is amplified by the tube and step-up interstage transformer T1. It is then rectified by V1-b and used to fire the 1D21/631-P1 Strobotron flash tube. The positive signal on grid 1 of the Strobotron causes the tube to conduct and use the energy stored in C3 in one short-duration flash of light.

Model 7054 and 7055 balancers

These are newer Alemite units with different flash tubes and different amplifying and wave-shaping circuits. The circuit is shown in Fig. 2. In this circuit, the ac signal from the pickup is applied to the input of V1. V1-a clips the signal and V1-b amplifies and shapes it so it can fire thyatron V2 precisely at the peak of the negative half-cycle.

The 2050 thyatron is normally cut off and, once triggered by a positive pulse, it continues to conduct until the plate circuit is opened or plate voltage is reduced to near zero.

When V2 is cut off, C1 charges to

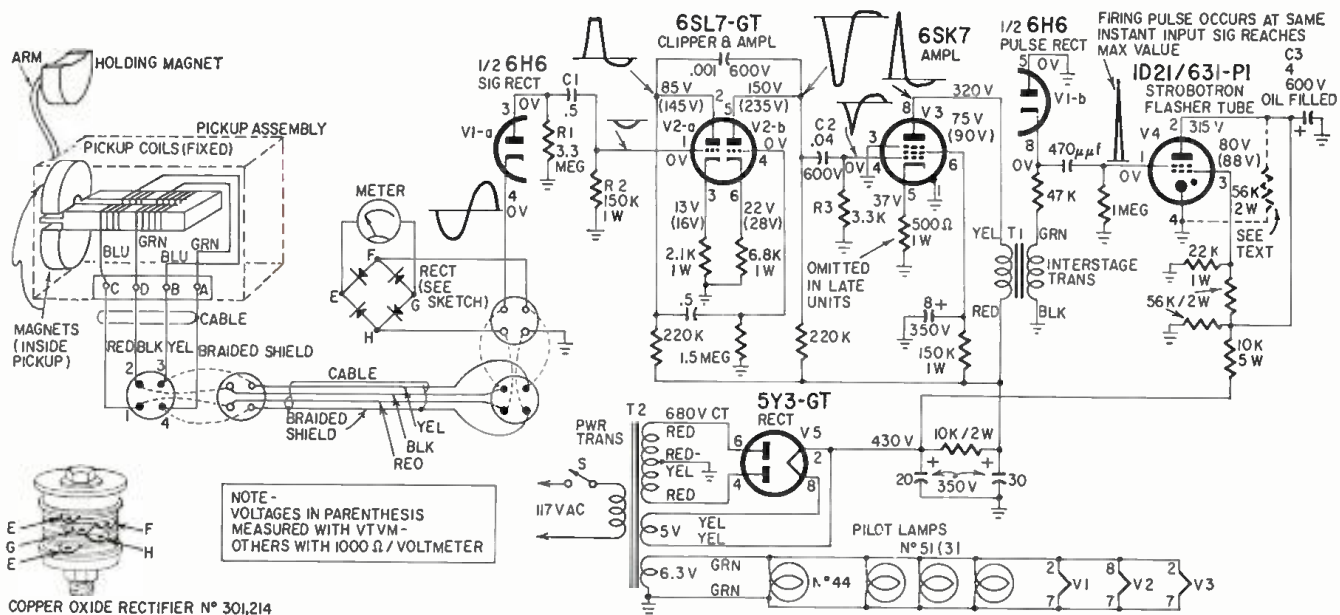

Fig. 1—Circuit of the Alenite model 7051 wheel balancer. Note the detail of the pickup at the left.

around 300 volts through R1. The positive portion of the pulse from V1-b appearing on V2's grid causes it to fire and conduct heavily, creating in effect a momentary short between plate and cathode. C1 discharges rapidly through V2 and the primary of pulse transformer T1. The high-voltage pulse induced in the secondary of T1 fires the flash tube and C2 discharges through it with a brilliant flash of light. Thus, there is a flash on each cycle of vibration caused by an unbalanced wheel.

Servicing

Faults in the spinner are electrical rather than electronic and should be serviced by a technician specializing in electric motors if tests show that normal line voltage is reaching the motor. Wheel balancers get rough handling, and breaks in cables and poor socket and plug connections are common. Visual inspection may detect the trouble. If not, failure of the unit to flash may be caused by a break in the pickup coils.

The meter coil should measure 750 ohms and the amplifier coil 20,000. On the 7051 and 7054 models, the meter coils connect to pins 1 and 3 on the cable plug and the amplifier coils to pins 2 and 4. On the 7055, disconnect the pickup cable from the terminal strip on the amplifier chassis and measure 750 ohms between the RED and YELLOW leads and 20,000 ohms between the BLACK lead and the shield.

All tubes except the 2050 and the flash tubes can be handled on a standard tube checker. If it is not convenient to check the 1D21 Strobotron by substitution, compare the voltages with those in the schematic (Fig. 1). If voltages are OK and a replacement is not available for substitution, a good tube will fire when triggered from an external source.

Connect the control grid (pin 1) to one side of the 117-volt ac line. Connect the other side of the ac line to the

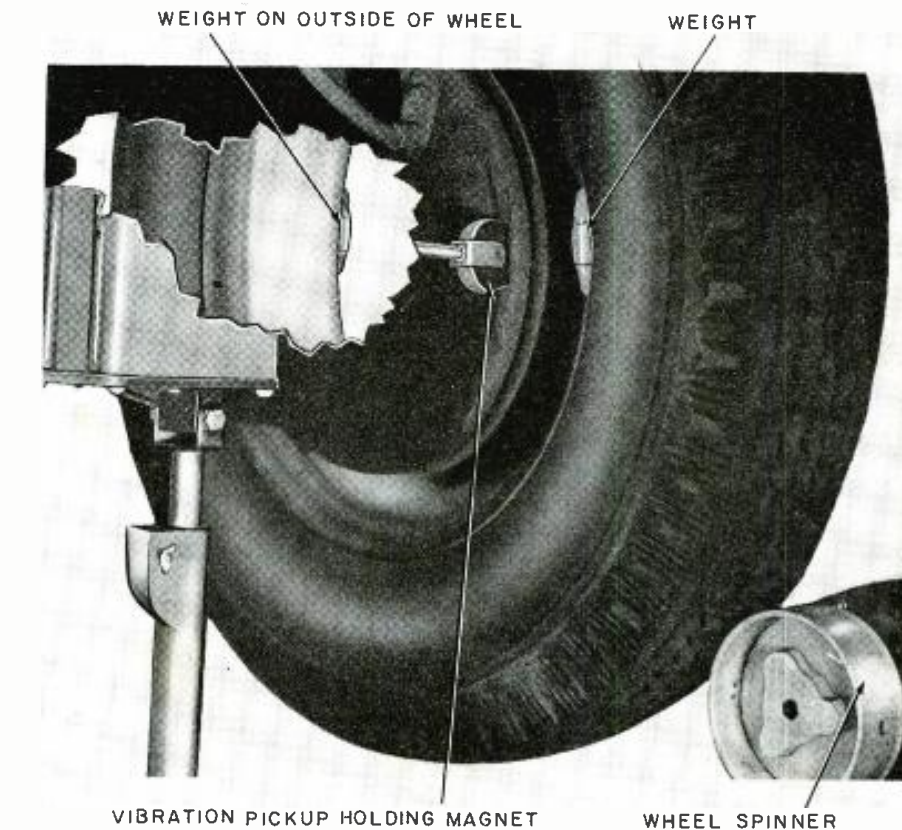

When the wheel balancer is in use, the wheel spinner is placed against the tire to turn it. The vibration pickup is placed against the brake-drum cover. Weights to balance the wheel are placed along the rim.

chassis through a 0.1- μ f capacitor. (CAUTION: Do not omit the capacitor. Otherwise you may damage the Strobotron and blow the line fuse.) A good Strobotron flashes at a 60-cycle rate when triggered by the ac line. Install a new tube if the old one fails to fire or flashes intermittently under this test.

In the 7054 and 7055 models, the voltages on the 2050 thyratron and the flash tube should agree with those on the

schematic. If voltages are correct, trigger the 2050 by connecting a 150,000-ohm resistor and 0.1- μ f capacitor in series between the control grid (pin 5) and the junction of R2 and R3. The flash tube should agree with those on the 2050 triggers. If it doesn't, check C1 and T1.

Remove the flash tube. Ground the end of a screwdriver to the chassis and bring the shaft to within 1/16 inch of

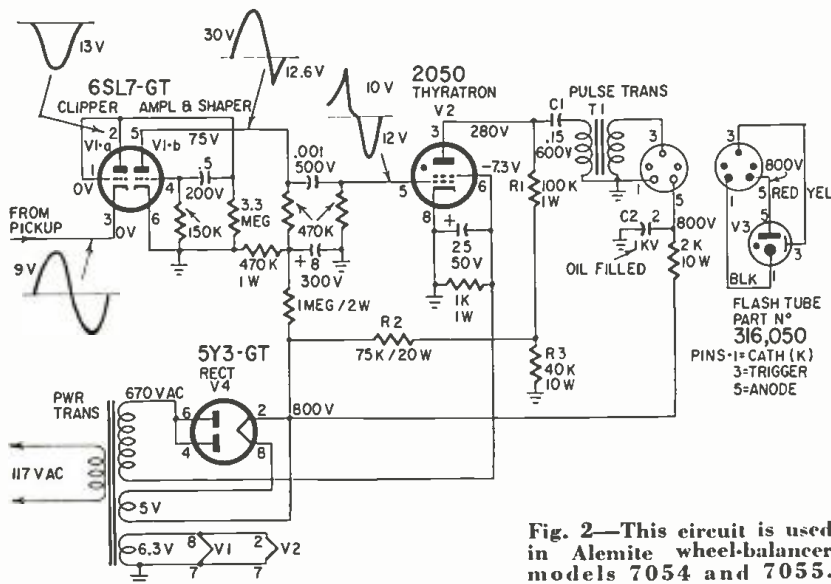

Fig. 2—This circuit is used in Alemitic wheel-balancer models 7054 and 7055.

terminal 3 on the flash-tube socket. A spark jumps from terminal 3 to the screwdriver each time the 2050 conducts.

Signal tracing

If the tubes, cables and connections appear OK and the pickup coil resistances check out, test the pickup for output by connecting each coil, in turn, to the vertical input of the scope and tapping the pickup arm while watching for deflection on the screen. If the pickup is delivering a signal, the trouble is in the pickup cable, its connectors or the amplifier.

The amplifiers are easy to check by signal substitution. On the model 7051, remove the 6H6 and wrap a short jumper between pins 2 and 4. On the 7054 and 7055 models, connect the jumper between pins 3 and 8 of the 6SL7-GT. This feeds a 6.3-volt 60-cycle signal into the amplifier's input and the flash tube should fire rapidly. If it does, the trouble is definitely between the amplifier input and the pickup.

If the strobe does not fire or is intermittent with 6 volts ac applied to the input, check the voltages on the other tubes in the set. If the voltages are OK, trace the 60-cycle signal through the circuit with a scope, audio signal tracer or even a pair of phones with a 0.1- μ f 600-volt blocking capacitor in series with one lead. When the break in signal continuity is isolated to a particular stage, use resistance, voltage and continuity checks to isolate the defective component.

Service notes

Symptom: Tube flashes continuously or intermittently when pickup arm is not in contact with source of vibration.

Vibration may be transmitted through floor from other equipment such as air compressor. Lift pickup from floor or bench. Flashing should stop. If it does, eliminate the source of vibrations or move balancing equipment to location free from vibrations.

The trouble is electronic if the tube continues to flash when held in the hand. Frequent offenders are heater-to-cathode shorts or heater-to-grid shorts in one of the tubes, open or broken grounds in the pickup cable or a broken hot pickup lead feeding a stray 60-cycle signal into the amplifier.

The Strobotron in the 7051 may oscillate if voltages on pins 2 and 3 are too high. Check for a 56,000-ohm 2-watt resistor (shown in dashed lines in Fig. 1) between terminals 2 and 4 of the Strobotron. This resistor was not used

in some early production amplifiers and should be added to prevent exceptionally sensitive 1D21's from oscillating.

Symptom: Amplifier oscillates.

If removing either the 6SL7 or 6SK7 stops the flashing, look for open bypass capacitor, defective resistors and stray feedback paths.

Symptom: Meter fails to deflect when pickup arm contacts vibration source.

Defective meter or rectifier. To test the dc meter movement, remove all leads and connect it across a 1.5-volt battery and 4,700-ohm resistor in series. The meter in the model 7051 will read slightly more than one-third full scale (two-thirds full scale on the 7054 and 7055 models). These meters have specially shaped magnets and a varistor to shape the response, so always replace defective units with the manufacturer's exact type.

To check the meter rectifier, disconnect the pickup cable at the amplifier chassis. Connect a 2,200-ohm resistor and a 1.5-volt battery in series across terminals F and H on the rectifier (Fig. 1). The meter should read one-third to one-half of full scale. Reverse the battery polarity and the reading should remain essentially the same.

A wheel balancer must be operating properly if the mechanic is to use it to keep his customers' cars in safe operating condition. If you feel qualified to handle these relatively simple devices and can take on work of this type, just pass the word around at your local filling stations, garages, and tire, wheel-balancing and alignment shops. END

NEXT MONTH

Transistors in Audio

First of a short series showing you how you can design and build your own transistor audio equipment.

Installing Two-Way Radio

How to solve some of the practical mechanical and electrical problems encountered in installing commercial mobile equipment in trucks and cars.

Electronic Metal Indicator

This device locates metal at short distances and can count tin cans moving along an assembly line, inspect for unwanted metal in manufactured products or do any similar job requiring detection or counting of metal objects.

40-Watt Stereo Amplifier

Describes one of the latest Knight-Kits, and shows how a third channel may be added so that the center speaker combines the sum of the channels, instead of their difference, as in some previous circuits.

Inside and outside the ready-made stereo units

STEREO in a PACKAGE



Philco model 1816



By **LARRY STECKLER**
ASSOCIATE EDITOR

TO the dyed-in-the-wool hi-fi enthusiast, a package hi-fi system may seem to border on heresy. And all too often it does. Except for the few instances where higher-grade component manufacturers have put their units into a package (Ampex, Bell, Fisher, Pilot, for example), package hi-fi systems do not meet highest hi-fi standards. Most package units are aimed at the consumer—the average soul who wants a phonograph or phonoradio that he can *call* hi-fi and that comes in a beautiful hunk of furniture.

One big point, though, is that the audio quality of much of this equipment is better than it has been, although the parts used on the mass-production line assembly are not as well suited for hi-fi use as those found in good component hi-fi equipment. Output transformers seem skimpier, the Ultra-Linear output circuit is rare and assorted gimmicks are often used to keep the package from costing too much. After all, a well finished cabinet is expensive and often is the major part, cost-wise, in a packaged assembly.

However, for the individual looking for a package unit, there is quite a variety—from portables for the kids to the gigantic "Stereo Theater." Prices start as low as \$39.95 for a portable stereo unit with both speakers in the same cabinet or with one outboard speaker (Admiral, Columbia, Steelman, Westinghouse), and run as high as \$2,000 or better for a really extra-special unit in a 6-foot-long cabinet that houses two speaker systems, AM and FM tuners, four-speed record changer, tape deck, two power amplifiers and a stereo control preamp (Ampex). Some super de-luxe versions

even include a TV receiver, usually with a 21- or 24-inch screen (Magnavox, Saba, Blaupunkt). However, most of the packaged hi-fi is limited just to listenable signal sources.

Furniture first

Cabinet styles and finishes of the large consoles are designed as fine furniture. Almost all have doors so none of the electronics shows when it is not in use. Stylewise, there is Modern, Provincial, Early American, Danish Modern, French Provincial, Contemporary, Italian Provincial, Oriental Modern and Traditional. Finishes are just as varied, including walnut, teak, fruitwood, mahogany, blond mahogany, limed oak, ebony, blond oak, maple and cherry. These finishes may be the actual wood, one solid piece, or just a thin layer of

vener—it all depends on cost. As one manufacturer says, "The most beautiful furniture you ever heard."

But no matter what the style or finish cabinet, it still takes a good electronics system to make that hi-fi sound. In little stereo portables, like the Webcor model 1012 (Fig. 1), the circuit is simplicity itself. Of course, the fi isn't so hi. A high-output stereo pickup cartridge feeds its two channels of stereo sound through two volume controls and on to the grids of two 50EH5's. These tubes feed the two stereo speakers. Perhaps not the best-sounding or -looking stereo system in town, but unquestionably one of the least expensive.

High up on the other end of the scale is the Ampex Signature. It starts off with a four-speed Garrard record changer; includes AM and FM radio

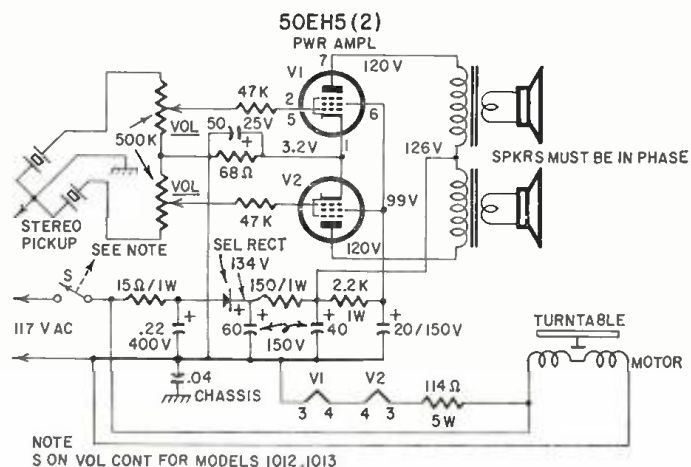

NOTE
S ON VOL CONT FOR MODELS 1012, 1013

Fig. 1—Circuit of the Webcor model 1012.

AUDIO—HIGH FIDELITY

Columbia
model C-1006 B



Bell
model 500

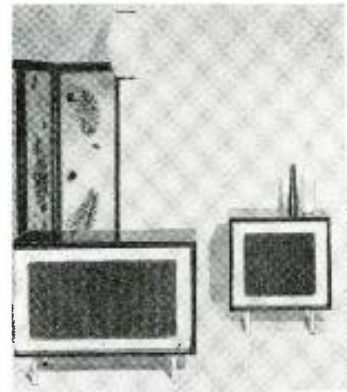

Fisher
Futura II

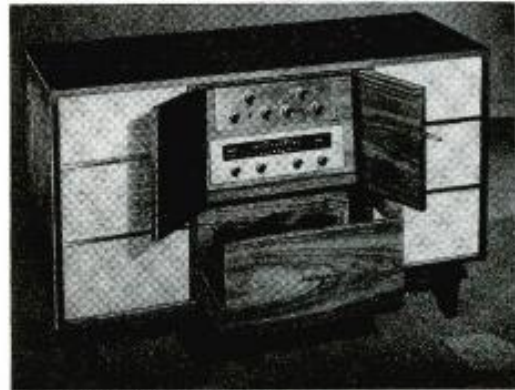

Sylvania
model 4706



tuners, a stereo tape deck, two 30-watt power amplifiers, flat within 0.1 db, producing less than 0.5% total distortion and controlled by an equally precise control unit. The speaker system is elaborate also. Two sets of three speakers are used, one in each end of the cabinet. They start off with a 15-inch woofer, go up to the mid-range with an 8-inch speaker and cover the highs with a horn type tweeter.

Between these extremes are all kinds of units. For the home that doesn't have the wall space required by a 6-foot-long cabinet, there are matched pairs. The amplifier, record changer, radio if any and one speaker system are in one cabinet. In a matching unit that looks identical from the outside is the speaker system for the second channel and sometimes the amplifier for the second channel too.

One system comes in three pieces, two remote speaker systems and an armchair control unit that houses the electronic parts. With this kind of arrangement you can even hang the small enclosures housing the speakers on a wall—ideal if floor space is really scarce. With proper decorating, they fit right into the room.

Another approach used by package manufacturers (picked up from the component people) is to put the bass speaker in the main cabinet and use two remote treble units for stereo. Following the thought that bass sounds below about 200 or 300 cycles are not directional, the bass in both channels is combined and comes from the center speaker. Mid-range and high fre-

quencies are fed to individual satellite units (Jensen trademark). Often these satellite side speakers are stored in the main enclosure when they are not being used. When needed, they are pulled out and placed in position.

The component manufacturers are also in the hi-fi package field. Some prime examples are Pilot, Fisher, Bell and Ampex. They have taken their standard hi-fi components—amplifiers, preamps, tuners—added a well designed cabinet that includes built-in speaker systems, and have come up with a stereo package that has all the hi-fi quality of their components. This pleases the man who feels that individual components make the best system and the woman who doesn't want a lot of dust-catching equipment

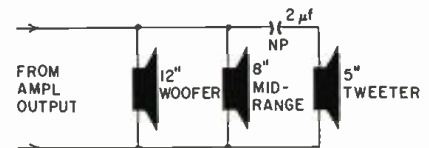

Fig. 2—Speaker arrangement in the Magnavox model 268.

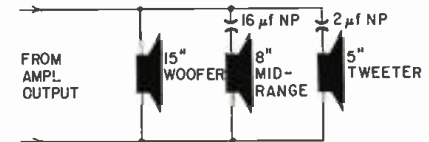
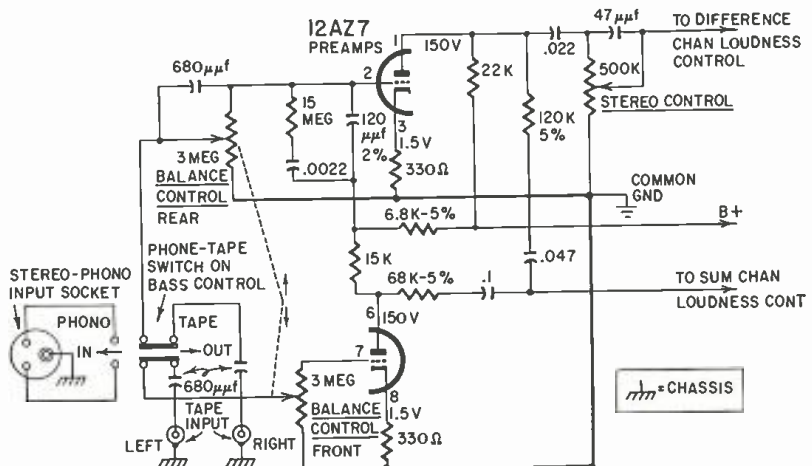
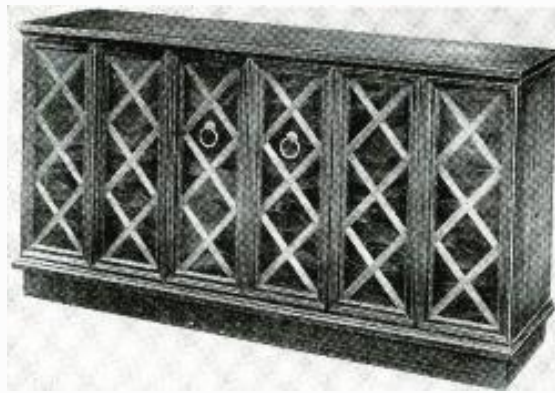

Fig. 3—This speaker setup is found in the Magnavox model 202 Stereorama.

Fig. 4—Preamp stages of the Zenith SFD220 and SFD2515. Note how the stereo control adjusts the amount of difference signal passed on to the rest of the amplifier.



Webcor Musicale



Westinghouse
San Marco
←

Stromberg
Carlson
Model SP964

RCA Mark VIII

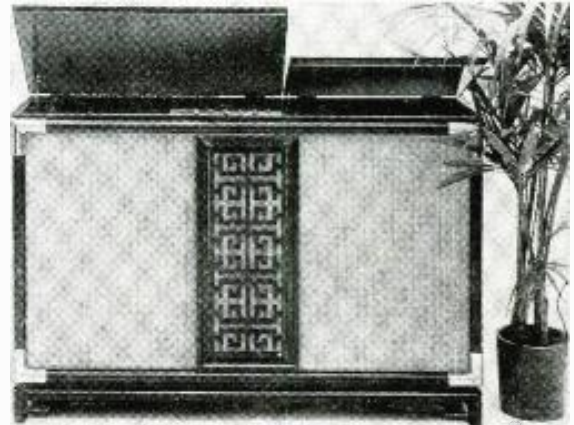

Fig. 5—Adjustable doors put stereo in the small case of the Philco II-1416.

stacked away on bookcase shelves. Some models even have a built-in clock mechanism to turn the unit on, automatically, at some preset hour.

Speakers and features

Some of the complex speaker systems use crossover systems to split up the audio spectrum and send the proper frequencies to each speaker or speakers. However, a simpler method is used by many manufacturers. For example, in the Magnavox model 268, the three speakers in each cabinet (a 12-inch woofer, 8-inch mid-range unit and a 5-inch tweeter) are connected in parallel. To keep the low frequencies from reaching the tweeter and possibly damaging this low-power speaker, a 2- μ f capacitor is placed in series with

one of the leads to the tweeter (Fig. 2).

To take care of a more elaborate speaker arrangement, that used in another Magnavox model, the Stereorama 202, two capacitors are needed. Once again there are three speakers, a 15-inch woofer, 8-inch mid-range and 5-inch tweeter. Again the speakers are connected in parallel, but this time there is a 16- μ f capacitor in series with the 8-inch mid-range unit and a 2- μ f capacitor in series with the tweeter (Fig. 3).

The single-amplifier, sum-and-difference method of obtaining the stereo effect is used by some manufacturers (see "2-Way Stereo Amplifier," RADIO-ELECTRONICS, December, 1958). Zenith for one, uses this method in their models SFD220 and SFD2515—part of their 1960 line. A stereo control, a 500,000-ohm pot in the plate circuit of the first preamp stage of the difference channel (Fig. 4), regulates the amount of stereo effect—from mono to extra-wide stereo. It does this by controlling the amount of difference signal that is fed through the rest of the amplifier.

Note that in this circuit the BALANCE CONTROL comes before the first preamp stages and attenuates the stereo signal from the cartridge. The sections of the control are wired so the resistance in one circuit increases as the other decreases.

Philco like Webcor, also uses only two 50EH5's in their simplest stereo unit, a portable changer with an out-board speaker. Another portable unit in the Philco line, somewhat more elaborate, has a rather unusual speaker

arrangement for a unit housed in such a small cabinet. The speakers for both channels (1 per channel) are in the same cabinet, but point out to opposite sides (Fig. 5). Two small adjustable doors direct the sound from each speaker to the front and side, producing the desired stereo separation.

In one of their fanciest units, the model H-1916, Philco incorporates an interesting contour control. It consists of two ganged pots and regulates the amount of negative feedback voltage in the mid-range and high-frequency spectrum. This feedback voltage is taken from the push-pull audio output stages (7189's) and is fed back to the cathodes of the 7199's. Fig. 6-a is the complete amplifier, 6-b a simplified drawing of the feedback circuit. Now there is a current path from ground, on through the contour network to resistor R43 (left channel) and R42 (right channel).

Turning the control (VR4) to the right (clockwise) reduces the pot's resistance. This decreases the amount of feedback and boosts the amplifier's output for midrange frequencies.

When turned to the left (counterclockwise), the pot's resistance is increased, negative feedback is increased and mid-range frequency output is reduced.

Capitol has also gone into the package stereo business. In their model 930 there are three basic sections—a preamp, a control unit and the dual amplifiers. There are no tubes in the control unit; just bass, treble, selector and loudness controls for both channels.

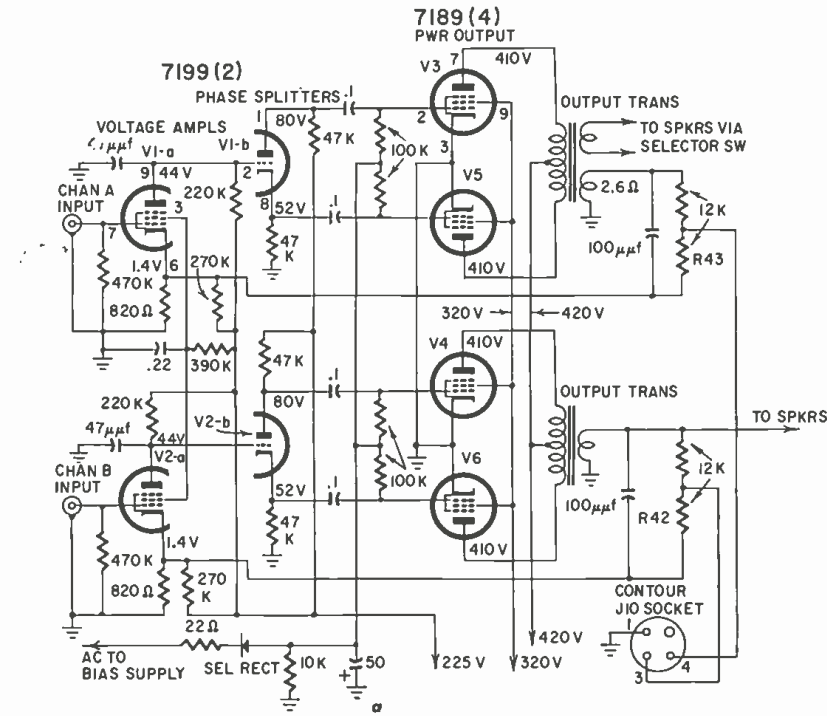
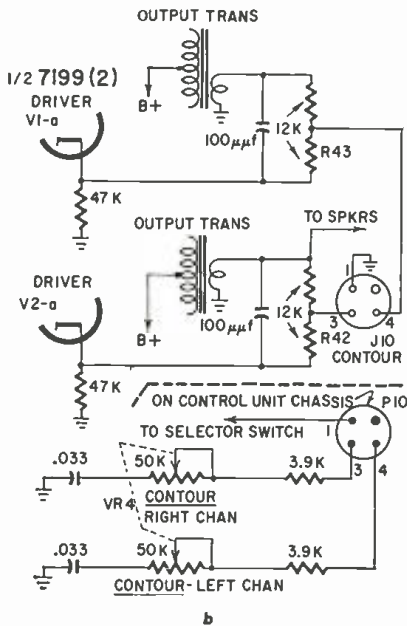

Fig. 6—Contour control circuit in the Philco H-1916 regulates amount of negative feedback: a—the complete amplifier; b—Contour-control circuit.



All fixed resistors and capacitors are part of an Erie Pac (Fig. 7). Two of these units are used, one for each channel. In Fig. 7 the left-channel Pac leads have an L, right-channel Pac leads have an R.

In their model PM-14, RCA uses a balance control that at first glance is a stopper (Fig. 8). Instead of being connected across the grid circuit of the left- and right-channel preamps, the 100,000-ohm balance pot is in the plate circuit and its arm returns to ground through a 0.47-µf capacitor to the B-plus line and on through a 20-µf bypass to ground.

To the service technician, package hi-fi systems represent a new additional source of income. They present few problems that are new to audio servicing and can become a profitable part of any shop's work. The only tricky part is figuring out the interconnections

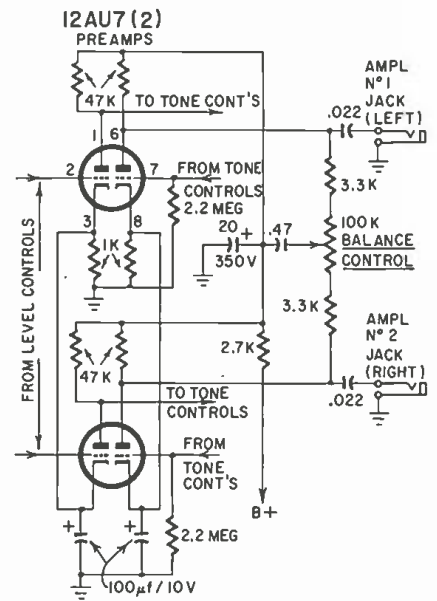

Fig. 8—Unusual balance control is found in RCA's model PM-14.

from one part of the package to another. This wiring often looks more like a Chinese jigsaw puzzle than a Chinese jigsaw puzzle does.

It is obvious that package hi-fi is going to be with us for quite some time. Just count the people buying them. The main difference between a package unit and one you make up by judicious selection of components is usually the cabinet and the quality. Cabinets are beautiful, but quality and hi-fi-ness tend to run a bit lower in packages with the exception of the packages made up by component manufacturers. And it is still easier to buy a preamp this month, an amplifier next month and a speaker system still later, than it is to go out and buy the whole thing at one time.

The package stereo unit will be bringing more and more business to the service technician. And the technician must be ready to handle it or he will be passed up. This means he must become familiar with the techniques of servicing hi-fi audio equipment and start gathering appropriate service data now. END

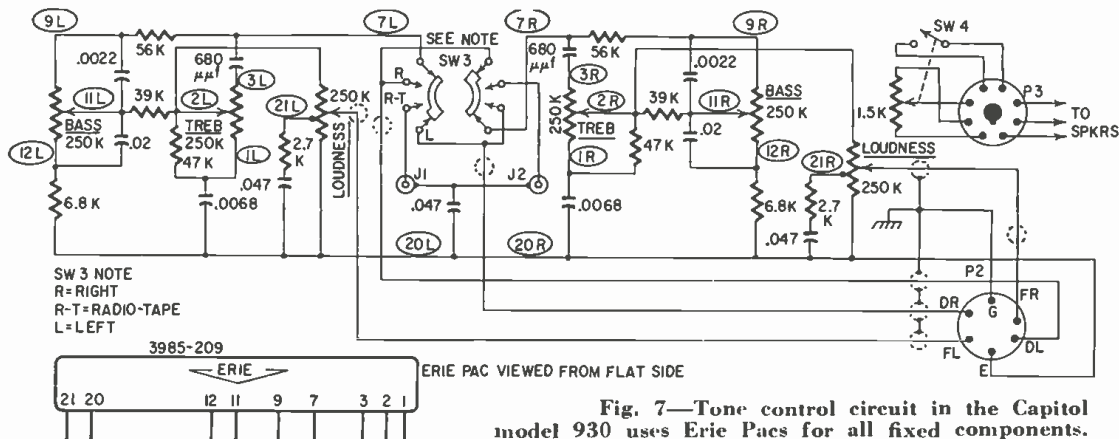
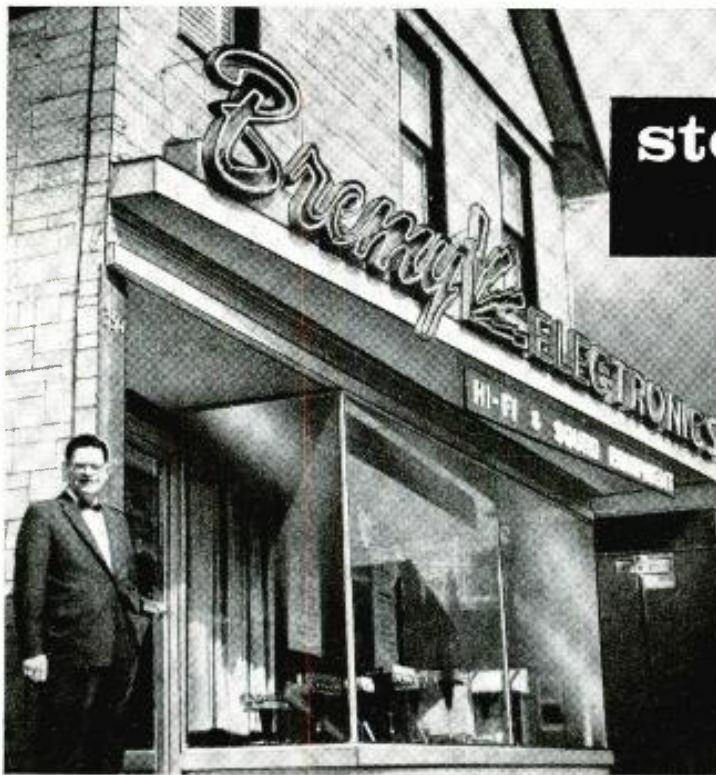

Fig. 7—Tone control circuit in the Capitol model 930 uses Erie Pacs for all fixed components.

Get test-report data and repair hi-fi amplifiers and tuners, all at the same time



**step
by
step
guide to**

**BETTER HI-FI
SERVICING**

By **FELIX BREMY ***

WE have our hi-fi servicing organized into an orderly routine, and the experience behind us proves it is worth while. When we set up our system we were sure it was right, but a little uncertain whether we could make it pay off. So we are not surprised when other technicians react the same way. Last month's article gave some idea of what is involved in the way of equipment. Now you will want to know how to set up the operation.

Amplifiers

The first test procedure we set up was for amplifiers. First we get the unit working—fix all obvious faults. Then it goes into the “servicing by performance” test.

We measure power output first, because this is the commonest amplifier deficiency and because almost any defect associated with the output stages will show up. We test at the five frequencies listed as they catch practically any trouble.

Next come the sensitivity measurements. They detect any loss of gain due to a defect in the voltage amplifier stages. This test only takes a few minutes and is followed by hum and noise measurements to catch any components that may have become noisy.

Tone controls in a preamp, control unit or whatever you want to call it, frequently develop trouble due to a poor contact somewhere. A lot of wiring is usually associated with these controls and, therefore, a lot of potential trouble spots. Frequency-response checks often reveal such obscure faults.

The reason for the choice of frequencies for the quick frequency run should be fairly obvious. They are approximately octave intervals near the ends, with wider spacing in the middle. Some texts recommend taking a great many more readings, but we have never found them necessary.

An IM-distortion test catches any remaining performance defects. We use three levels: 0.9 of maximum rated power, 1 watt and 0.5 watt.

The shock-hazard test is a safety measure. It reveals any fault that puts a dangerous voltage on the chassis or

cabinet of the unit. All you need is the little switch box shown in Fig. 1.

FM tuners

The sequence for FM tuners is based on that for amplifiers. But the proper testing of an FM tuner involves more than just the audio section. We need an FM signal generator capable of giving an output, modulated, with distortion well below that expected from the tuner.

As in the amplifier test, delivery of maximum undistorted output—in this case voltage rather than power—for 100% modulation (75-ke deviation) is the best quick test as to whether the tuner is functioning correctly or needs adjustment.

A usable sensitivity test shows whether the tuner handles the audio modulation uniformly. The only way to make this check properly is with a modulated FM signal.

Similar remarks apply to IM distortion. It is relatively simple to get audio voltage-amplifier stages operating with low distortion. But the discriminator curve in the FM demodulator is another matter. Most of the audio distortion, measurable as IM or harmonic distortion, occurs in the demodulator of either an FM or AM receiver. Shock hazard we have already commented on.

Now we begin our step-by-step instructions for testing hi-fi amplifiers and tuners. They are designed around the equipment we use (listed in last month's article), but will work equally well with other test equipment if such units meet the same standards as the ones we use. The test report forms we use are shown in Fig. 2.

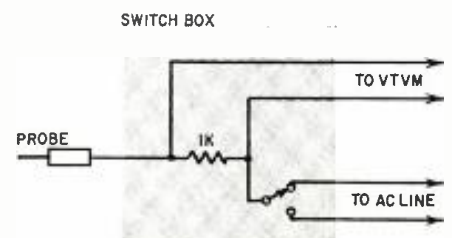

Fig. 1—Circuit of switch box used for shock-hazard test.

*Owner, Bremy Electronics, 394 E. 18 St., Paterson, N. J.

AUDIO—HIGH FIDELITY

AMPLIFIER SERVICE TEST						
Customer Name.....						
Make & Model.....						
Serial Number.....						
Date						
1. POWER OUTPUT	Cycles	20	100	1,000	10,000	20,000
	Watts					
2. SENSITIVITY	Tape head		Phono	Tuner		
	millivolts					
3. HUM AND NOISE	Tuner input		Shorted	Open		
	Phono input		μw	μw		
	Tape input		μw	μw		
4. TONE CONTROLS	Cycles	Boost		Droop		
	100	db		db		
	10,000	db		db		
5. FREQUENCY RESPONSE	Cycles	20	40	100	400	1,000
	Response					
6. INTERMODULATION DISTORTION	0.5 watt		1.0 watt		watt	
	%		%		%	
7. SHOCK HAZARD	Leakage through 1,000 ohms=			milliamps.		

FM TUNER SERVICE TEST						
Customer Name.....						
Make & Model.....						
Serial Number.....						
Date						
1. MAXIMUM VOLTAGE OUTPUT	At 1,000 cycles.....for 100% modulation (75 kc)					
2. SENSITIVITYmicrovolts for 30 db quieting.					
3. HUM AND NOISEdb below.....volts output.					
4. FREQUENCY RESPONSE	Cycles	20	40	100	400	1,000
	Response					
5. INTERMODULATION DISTORTION	50% mod		100% mod			
	%		%			
6. SHOCK HAZARD	Leakage through 1,000 ohms=			milliamps.		

Fig. 2—Test reports: top—Amplifier Service Test; bottom—FM Tuner Service Test.

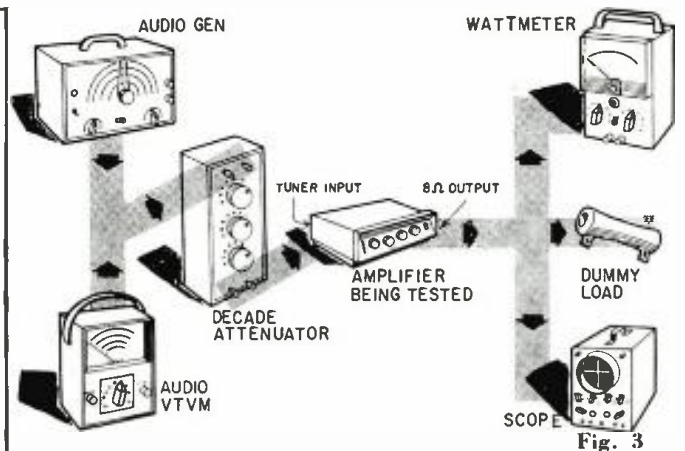

Fig. 3

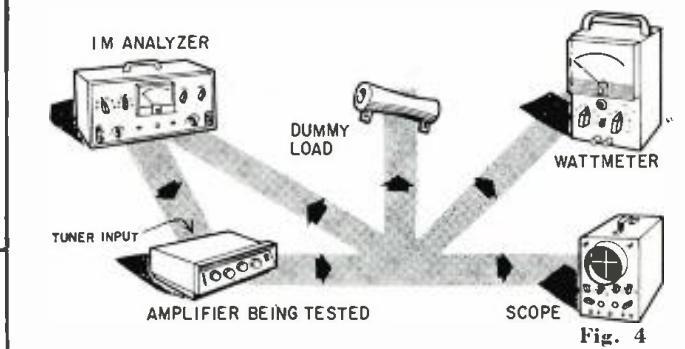

Fig. 4

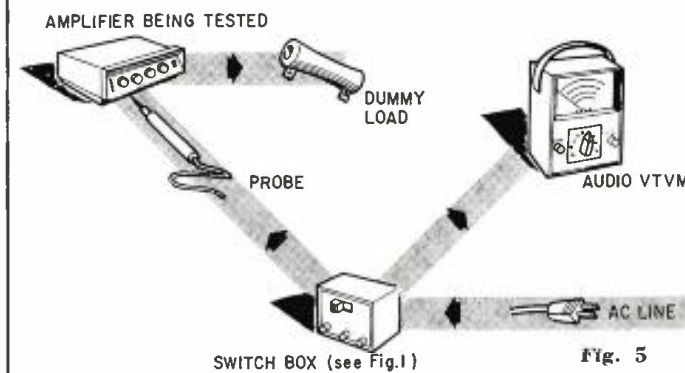

Fig. 5

Fig. 3—Basic equipment setup for amplifier service tests.

Fig. 4—Basic equipment setup for amplifier IM distortion tests.

Fig. 5—Test setup for amplifier shock-hazard test.

AMPLIFIER SERVICE TEST

- 1-a. Set up equipment as in Fig. 3.
- b. Set amplifier controls as follows:
 - Volume.....maximum
 - Tone.....indicated flat
 - Loudness.....minimum effect
 - Filters.....flat
 - Selector switch.....where needed
 - Speaker switch.....where needed
 - Damping.....off or normal
 - Hum control.....minimum hum
 - Output terminals.....8 ohms

POWER OUTPUT

- 2-a. Set wattmeter, scope and vtm to appropriate ranges
- b. Set decade attenuator to 0-0-0 (no attenuation)
- c. Starting from minimum, increase audio generator output until visible dis-

ortion occurs on amplifier output at 20, 100, 1,000, 10,000, and 20,000 cycles.

- d. Record wattmeter reading for each frequency on amplifier service-test form.

SENSITIVITY

- 3-a. Using same setup as in steps 1a, -b, and 2-a, -b, set audio generator to 1,000 cycles.
- b. With generator connected to tuner input, increase generator output until power levels recorded in step 2-d are reached.
- c. Record the vtm reading (amplifier signal input) on the test form.
- d. Repeat steps a, b, and c using magnetic-phono and tape-head amplifier inputs.

4. To determine standard position of volume control:
 - a. Using same setup as steps 1-a and b (with one exception—amplifier volume control is set at minimum to start), increase the audio generator's output (at 1,000 cycles) until vtm shows 0.5 volt.
 - b. Using tuner input, advance amplifier volume control for 1-watt reading on wattmeter.
 - c. Mark this setting of volume control. It is known as standard position A.
 - d. Using magnetic phono input and 10-mv input signal, advance volume control from minimum until 1-watt output power is reached.
 - e. Mark this volume control setting. It is known as standard position B.
 - f. Standard position of volume control

is mean of A and B and should be marked.

HUM AND NOISE

- 5-a. Alter the setup in steps 1 and 2 by disconnecting the amplifier input from decade attenuator and setting volume control to standard position.
- b. With selector switched to tuner, magnetic-phonograph and tape-head positions (in order), residual hum and noise is read directly in watts on wattmeter. Anything less than 1.0 μ w is recorded as <1.0 μ w.
- c. Now short the three inputs and repeat step 5-b. All six readings are entered on the report form.

BASS AND TREBLE CONTROLS

- 6-a. Use setup shown in steps 1 and 2, but set amplifier volume control to standard position and decade attenuator to 25.
- b. Audio generator's 1,000-cycle output is adjusted until wattmeter reads 0.1 watt.
- c. Decade attenuator and audio generator output are adjusted for a reading exactly on a scale division of the vtm while maintaining 0.1-watt output. Note scale reading and attenuator setting carefully.
- d. Set audio generator for 100 cycles and adjust its output to maintain vtm reading.
- e. Now turn bass control to maximum and adjust decade attenuator to maintain the 0.1-watt reading and the audio generator to maintain the vtm reading.
- f. Record difference between decade-attenuator readings (steps c and e) as the 100-cycle boost.
- g. Set bass control to minimum and decade attenuator to maintain 0.1-watt output. Adjust audio generator to maintain vtm reading.
- h. Record difference between decade-attenuator readings (steps c and g) as the 100-cycle droop.
- i. Repeat steps d through h for 10,000 cycles. Use treble control in place of bass control.

FLATNESS

- 7-a. Use same setup as in steps 1-a and -b and follow steps 6-a, -b and -c. However, set output level to 1.0 watt.
- b. Set audio generator to 100 cycles and adjust bass control for 1-watt output with no change in vtm reading.
- c. Switch audio generator setting to 10,000 cycles and adjust treble control for 1.0-watt output with no change in vtm reading.
- d. Repeat steps a, b, and c until no difference in output is noted when the audio generator is switched from 100 to 1,000 to 10,000 cycles.
- e. If conditions in d cannot be reached, use closest approximation.
- f. In turn, set audio generator to 20, 40, 100, 400, 1,000, 4,000, 10,000 and 20,000 cycles. Maintain vtm reading and set decade attenuator for 1.0-watt output.
- g. Record difference between decade-attenuator reading for each frequency and that for 1,000 cycles as a plus or minus value.

IM DISTORTION

- 8-a. Set up equipment as in Fig. 4.
- b. Set the IM analyzer's 60- and 6,000-cycle signals for a 4:1 ratio.
- c. Set analyzer's low-frequency-high-frequency generator output control, in turn, to give a power reading equivalent to 0.9 maximum power for

- the amplifier, 1.0 watt and 0.5 watt.
- d. Place function and range switches in set level position and set analyzer input control for full-scale deflection.
- e. Turn function switch to % IM and adjust range switch for readable deflection. IM distortion at 90% maximum power, at 1 and 0.5 watt is read directly and recorded on test form.

SHOCK HAZARD

- 9-a. Set up equipment as in Fig. 5.
- b. With amplifier turned on, connect switch box to ac line and probe to amplifier chassis.
- c. Take voltage readings in *volts* from vtm for switch positions a and b.
- d. Record larger reading on test form as milliamps through 1,000 ohms.

FM TUNER TEST PROCEDURE

MAXIMUM VOLTAGE OUTPUT

- 1-a. Connect a balun coil to match the tuner's antenna terminals to FM generator. With the 210A generator, we use a M286 balun coil.
- b. Connect tuner's output to scope's input and audio analyzer's voltmeter.
- c. Turn off tuner's afc (if possible) and set squelch control for minimum effect.
- d. Set FM generator to 98 mc, deviation to 75 kc, output to 100,000 μ v and modulation to 1,000 cycles.
- e. Tune tuner for point of least distortion seen on scope screen.
- f. Read and record voltage output on audio analyzer's voltmeter.
- g. Slowly reduce FM generator's output to minimum to determine if output voltage vs. input signal curve is smooth and contains no voltage higher than that in step f. If a higher voltage is found, record it in place of reading in step f.

USABLE SENSITIVITY

- 2-a. Use same connections as in steps 1-a and -b.
- b. Use control settings steps of 1-c.
- c. Set FM generator to 98 mc, deviation to 22.5 kc (30% modulation) and modulation to 400 cycles.
- d. Tune tuner to point of least distortion seen on scope screen.
- e. Adjust FM generator's output to find point at which output meter shows a 30-db drop when modulation is off.
- f. Record FM generator's output level in microvolts on test form.

HUM AND NOISE

- 3-a. Use arrangement in steps 1-a and -b.
- b. Use control settings in step 1-c.
- c. Use FM generator settings in step 2-c.
- d. Tune tuner as in step 2-d and set FM generator's output to 1,000 μ v.

- e. Read and note output reading in volts and dbm.
- f. Turn off modulation. Again read and note output reading in volts and dbm.
- g. Record difference in db between readings taken in steps 3-e and -f as the hum and noise.

FREQUENCY RESPONSE

- 4-a. Connect audio generator's output to audio vtm and modulation input of FM generator.
- b. Use tuner connections in steps 1-a and -b.
- c. Set FM generator to 98 mc, deviation to 22.5 kc, output to 1,000 μ v and modulation to external.
- d. Set audio generator for 5-volt output at 1,000 cycles. Maintain 5-volt output throughout remainder of this test.
- e. Note output reading of audio analyzer vtm in db.
- f. Adjust audio generator in turn for 20, 40, 100, 400, 4,000, 10,000 and 20,000 cycles. At each setting note output reading in db.
- g. Record plus or minus difference between steps 4-e and -f.

IM DISTORTION

- 5-a. Connect output of audio analyzer's low-frequency-high-frequency generator to FM generator's external modulation input.
- b. Use same tuner connections as steps 1-a and -b.
- c. Set FM generator to 98 mc, deviation to 75 kc, output to 1,000 μ v and modulation to external.
- d. Set audio analyzer to low-frequency test and 10-volt range.
- e. Adjust audio analyzer's low-frequency-high-frequency generator for 5 volts and note amplitude of scope waveform.
- f. Set audio analyzer test switch to operate and adjust low-frequency-high-frequency generator for same amplitude on scope as in step 5-e.
- g. Set audio analyzer function and range switches to set level and adjust IM analyzer input control for full-scale deflection to set level mark.
- h. Set audio analyzer switch to IM and range switch to appropriate position to obtain accurate reading.
- i. Record reading as % of IM distortion.

SHOCK HAZARD

- 6-a. Disconnect all test equipment and cables from tuner.
- b. With tuner turned on, connect switch box to ac line and probe to tuner chassis.
- c. Take voltage readings in *volts* from the vtm for switch positions a and b.
- d. Record larger reading on test form as through 1,000 ohms. END



Makes it a little more glamorous this way!



REPAIR CHIME PROJECTION SYSTEMS

*Make those
electronic bells
ring loud and
clear once
again*

By **THOMAS R. HUGHES**

SOON after World War II, a majority of churches installed an amplifier and outdoor speaker system to project organ chimes or special electric carillons across the neighborhood. Since that period, many new churches have been built and some members have envied the tower bell systems of older neighboring churches.

At the same time, the tonal quality of these 10- to 12-year-old systems (if not maintained) has deteriorated and many are no longer used. The purpose of this article is to cover the essential requirements of such a system and give a few pointers on troubleshooting.

For centuries the church bell has been a way of attracting the attention of the populace. The great cathedrals that could afford a set of tuned bells on which a whole hymn could be played were the envy of large sections of the world. With the advent of electrically played chimes (as a stop on the organ) and electronic amplification, the poor-man's carillon is within reach of any progressive church.

None of the components have to be expensive, but we must have a correct evaluation of the problems involved if we want to succeed. While, essentially, we use a PA system, its output is projected in a way that is never attempted

with the ordinary PA system—and is in fact prohibited (for speech by the laws of many cities).

This means that we must have clean (undistorted) sound, regardless of the distance we manage to project it, or the neighbors will be justified in complaining. The regular reader of this magazine knows that one of the aims of the audio industry is to eliminate intermodulation distortion. However, those who have grown up within earshot of an expensive bell or carillon system (such as that heard at the San Francisco World's Fair in 1937-38) are used to digesting large doses of what we now recognize as IM distortion.

Any undamped set of percussion resonators, such as marimba, portable celesta and, especially, brass bell carillon, produces sizable quantities of this effect. Even symphony orchestras produce it in certain compositions, but we have long accepted all this. What we don't want to do is jumble the accepted IM product of our sound source with an additional IM contribution from our reproducing system.

Loudspeaker system

Since the sound is actually projected from the "bell tower," we will start with the loudspeakers. This is purely a mat-

ter of brute force, and the more wattage we expend the farther we will project the sound.

As to type of speakers, there is no use talking about anything but large horns with weatherproof (diaphragm type) drivers. A single omnidirectional re-entrant horn (mounted with axis vertical) is often used by small churches, but its range is not much more than a city block, with average city noise levels. Also, such a horn must have a free getaway in all directions. If confined in a tower that has openings only in portions of its four walls, it produces considerable distortion because of reflections within the tower.

The best procedure is to use four horns; one for each side of the tower. The horns' mouth openings should be at the outer boundary of the tower opening or flush with the outer-wall finish if openings must be cut.

Such horns are usually re-entrant types with a mouth diameter of 24 or 30 inches. They are driven by driver units rated for a maximum of 30 watts input each. More power may be dissipated per horn by placing two or more driver units into the same horn.

Re-entrant horns are used because they are cheaper and take up less space than other types. However, where the

tower is large enough to accommodate straight horns, the so-called trumpet with a straight axis gives ideal performance. Units such as the Racon Straight Trumpets are 6 feet long and have a 30-inch mouth. They produce cleaner sound with greater efficiency and project it a little farther. Of course, if we are going to use such sound levels, the tower must be tall enough to raise the horns 60 to 100 feet above the street or the immediate neighbors will probably complain.

Horns made of weatherproof plastic may be available. If the horns used are made of metal, weather effects must be considered. Aluminum doesn't stand up very well if used near the ocean, and iron will rust in regions with lots of rainfall or fog and can sometimes produce ugly drip spots on exposed exterior surfaces of the building. Mounting hardware should be rustproof and must be braced to withstand wind.

Connections to the speakers

The line from the amplifier (near the chimes) to the bell tower may be 250 to 400 feet long. It can be a low-impedance (8 to 16 ohms) or high-impedance (250 to 1,000 ohms) line.

For a run of 250 to 400 feet, a 16-ohm line should be at least No. 16 gauge, while a 250-ohm line could be 24 or 28 gauge. The line can be a durable grade of zip cord or any industrial grade of two-conductor wire. For a 500-ohm line, it could be telephone outdoor-service drop cable. Where it passes through areas where it might be subject to normal mechanical injury, it should be protected by a molding or run through pipe.

A high-impedance line (from the 250-ohm or 500-ohm tap on the amplifier's output transformer) must terminate in a line-to-voice-coil impedance-matching transformer. If the transformer is outdoors, it must be weatherproof. That means a hermetically sealed (potted) one—not a normal, unshielded type, mounted in a sheltering can.

Unless the winding and core are potted in tar or some other potting compound, the varnish dries out in the summer heat, and then absorbs moisture and becomes leaky.

While it may pass the audio current to the speakers, volume will be greatly reduced and the sound will be distorted and lacking in brilliance. So, if you find a nonweatherproof line transformer, don't depend on your ears; test it. By disconnecting all leads and measuring the resistance between terminals of different windings (one in the primary and one in the secondary), you should get at least 20 megohms on your ohmmeter, if it is clear. If you get down around 1 or 2 megohms, better throw the transformer into the junkbox.

Where the transformer can be mounted in a room below the open belfry (not exposed to the weather) and reasonably short leads (20 or 30 feet) extended from it to the speakers, any ordinary line transformer of proper impedance match and wattage capacity

will do. For impedance ratings, the primary should match the line (normally 250 or 500 ohms). The secondary can be tapped for 16 ohms, or around 64 ohms, or we could even get by with a 4-ohm secondary by connecting four 16-ohm drivers in parallel. Its power rating should be high enough to handle easily the power fed to the speakers.

Wherever the line runs outdoors, the speaker leads for example, we need good weatherproof cord or single-conductor wire with tough, durable insulation similar to telephone lead-in cables. Ordinary rubber insulation will crack in the hot summer sun and later absorb moisture, producing leakage during winter months.

A series hookup is preferred for connecting the speakers when a line transformer is used if the speakers are identical. The series hookup is not recommended for a system with speakers of differing capacities because one speaker may be overloaded and burn out. In a series setup, any speaker failure will immediately make itself known by putting the whole system out of service, instead of having distortion creep in from unnoticed impedance mismatches should one of a group of parallel-connected speakers fail.

When the four speakers are connected in series, one precaution must be observed: See that the speaker mounting brackets are not fastened on the same metal framework. If they are mounted on one metal staging or framework, they must be insulated from the metal. Considerable voltage difference can be developed from the voice coil to the nearest poles (on transients) and an arc-over could occur in this small air gap if electrical continuity is provided from frame to frame.

To avoid using a line transformer, use No. 16 wire and connect the speakers in a series-parallel hookup. Such an arrangement gives us a net impedance of 16 ohms for matching a line fed from the 16-ohm tap on the amplifier's output transformer—assuming, of course, that our horn driver impedances are 16 ohms. When connecting the drivers, watch the phasing for best results. Most commercial drivers have their terminals marked.

Eight-ohm drivers would have to be connected in series-parallel and fed by the 8-ohm tap of the amplifier's output transformer. For 4-ohm ratings (very unlikely), connect them in series and to the amplifier's 16-ohm tap.

When drivers of unknown impedance are encountered, measure the dc resistance of each unit. The dc reading will be around two-thirds to three-fourths of the nominal impedance rating. Thus, a 16-ohm unit will measure around 10 or 12 ohms. Identical units should measure the same, within ½ ohm or so.

Now test the speakers

After checking the resistance of each unit, listen to its output with a signal. The easiest way is to carry a small tuner and amplifier up in the tower and

connect the signal to each driver individually. Listen with your ear close to the mouth of the horn for a rubbing voice coil and then turn up the volume to check for distortion. When a system uses a line transformer, test each speaker separately, before connecting them to the transformer.

Where speaker terminals and wire ends have been exposed to the weather for a few years, make fresh connections. Speaker binding posts of the thumb-screw, compression type should be cleaned with a small rat-tail file. The ends of the wire should be cut off and a fresh piece stripped and scraped for insertion. If the end of the wire is very small in diameter in proportion to the opening of the compression type binding post, double the end back on itself and insert the doubled portion in the hole for a better gripping surface.

After reconnecting an old system and checking the speakers, we have done all we can till the condition of the amplifier has been settled. When the amplifier has been serviced and ready, we can try out the system with the line transformer. Then we can see if we get the same projection of chimes as when the system was new—without noticeable distortion.

If there is considerable distortion that is not caused by the speakers, the amplifier or the sound source, bypass the line transformer and the line for a 16-ohm hookup. If this arrangement gives satisfactory coverage without distortion, the line transformer is obviously at fault.

Finally, after every part of the system has been tried and we are sure we won't want to change the hookup, weatherproof all outdoor connections. Carefully covering speaker binding posts with electrical tape will help to prevent corrosion. Even better, cover with friction tape and paint the taped post and wire with Glyptol or some other outdoor insulating compound.

These steps should lead to a trouble-free-speaker setup. The average person is too lazy (or too busy) to protect his line from mechanical injury and his outdoor connections from corrosion. But when there is trouble in the system, he always has to suspect the line and speaker hookup.

And while we have mentioned mechanical protection, don't forget to secure all long leads to keep them from being whipped around in the wind, if they are in an open belfry.

Amplifier comes next

Now we come to the real problem of the system—the amplifier. In other uses, 99% of amplifiers are just coasting, but our tower-chime amplifier is loaded to capacity and its product must be free from unnecessary distortion.

In all probability, when it was new, the system gave satisfactory coverage without distortion, and now it just needs servicing. This, of course, consists of testing the tubes, checking the voltages at test points, and balancing the output stage, drivers, etc. I prefer to connect

AUDIO—HIGH FIDELITY

the amplifier to a heavy-duty speaker temporarily and listen to its performance without bothering the neighbors while tuning it up.

Of course, if a scope and other test equipment are available, it is nice to give it a technical checkout. In the end, though, the final test is going to be its regular full load of speaker system and the heavy IM product of bells or chimes.

What coverage should the system provide? With four 30-watt horn speakers (re-entrant type), a 50- or 60-watt amplifier and a proper signal, it should be heard clearly about four or five blocks away in an average residential district. This assumes a belfry height of 60 to 100 feet. With industry, a heavy highway or an airport close by, coverage would be reduced. On the other hand, it may carry twice as far away on the down-wind side. And in the morning quiet of a national holiday, it may be heard a mile or two away. So it had better be good.

The pre-war amplifier looks pretty rocky to the service technician thinking in modern hi-fi terms. Since 1950, all amplifiers (even the regular PA type) have been considerably improved, especially in the quality of metal used for the output transformer core laminations. Most amplifiers sold prior to 1950 were actually copies of prototypes designed before World War II.

When working on a tower chime system of such vintage, the amplifier must get a good looking-over. To be a real 50-watt job, it almost must have four tubes (connected push-pull-parallel) in the output stage and a substantial size output transformer. If the transformer is plenty large and is a nice respectable-looking shielded job, our main concern is satisfied. A modern hi-fi transformer is not needed because the frequency range of our signal is restricted to about 200 to 800 cycles in fundamentals and about 7,000 or 8,000 in harmonics. Furthermore, re-entrant speakers shouldn't be excited beyond this range.

If a new amplifier is necessary, remember it certainly doesn't need fancy tone controls, several input stages and a complex overload indicator. The simpler the layout, the better the quality and performance in this application. High-power kit amplifiers may help keep the cost down.

What it must have is good, clean response in the middle range, at an honest 50 watts output. Bells or chimes produce high distortion products (as pointed out before) and can easily trigger an unstable amplifier into motorboating and other forms of distortion, even though their frequency range is rather narrow. Amplifiers which may sound all right as a PA amplifier in a noisy plant can produce an unacceptable amount of distortion with chimes.

What sound source?

No matter how we do it, the preferred sound projected from the belfry is a

facsimile of chimes or bells. The public will generally not tolerate anything but bells invading residential sanctums. To keep peace with day sleepers, the safest time to play the chimes (for everyday use) is at 6 pm.

There are many ways of providing bell music. Compact sets known as electronic carillons can be connected to the amplifier's phono input. They consist of from 25 to 100 small steel bars, suspended in a small enclosure. They have electrical striking and damping devices and are played by one or two banks of keys like the organ keyboard. Each bar is carefully tuned and equipped with a separate pickup (similar to the pickups used for amplifying guitars and other musical instruments). The electrical outputs from these pickups are paralleled into a suitable preamp and then to the phono input.

Using two banks of bars, one tuned for major and one for minor keys, a satisfying resemblance to the sound of expensive cast-bell carillons can be produced by a musician who understands the correct harmonic assimilation of the tones. On the other hand, a mechanical player can be used to play the carillon. It uses plastic rolls similar to the old player-piano rolls.

Still another way of using the voice of the carillon is by phonograph records or magnetic tapes made from the playing of these sets by expert carilloners. Such records are available from the Maas-Rowe Carillon Co. (3015 Casitas Drive, Los Angeles, Calif.) or other such companies.

The usual way of obtaining a signal source is to pick up the sound of a set of tubular chimes hung near the organ console or in the organ loft. Existing chimes can be picked up by placing a microphone directly below them on the wall. New chimes are usually ordered from the manufacturer with individual pickups mounted on each tube. The signals from the pickups are paralleled into a mike cable and fed to the amplifier.

The mike used to pick up the sound from a set of 20 or 25 tubular chimes need not have a wide frequency range. A range of 100 to 7,000 cycles is satisfactory. The ideal mike for such a job is one that has a cardioid pattern, so it doesn't pick up other noises. Many studios or high schools have discarded pre-war mikes of this type. The mike must produce a clean signal, however. An old mike can be sent to a microphone factory for overhaul and testing if necessary. The factory should be told what it is to be used for.

Placing the equipment

If a belfry speaker system is to be played from a separate (not in the organ console) electronic carillon set or a phonograph, the amplifier and sound source can be placed anywhere that is convenient. If the amplifier is fed from a sound source with a preamp section, such as the electronic carillon or record player may have, it could be

placed in the tower near the horns and fed by a long shielded line from the preamp. To do this, the preamp must have a cathode-follower or other low-impedance line-matching setup to feed the line.

However, since the sound source is usually a set of chimes or electronic carillon keyed in with the organ console, it is best to place the amplifier near the bank of chimes and the console and use a short mike cable from the mike or chime pickups to the amplifier. It is always simpler to use a long line from the amplifier to the speakers. If the amplifier is used with a separate phono or carillon player, it can be locked in the same cabinet or room with them.

In a normal setup, where the amplifier is used near the organ console, it can be placed under the choir-loft stage or floor, or in a cabinet or closet. It must be kept out of reach of passersby. And it must have adequate ventilation. A 50-watt amplifier produces almost as much heat as a TV set but it is not turned on very long unless someone forgets to turn it off.

Most organ consoles are placed within the chancel or choir loft (back of the pulpit) and are lowered into a recess or pit to keep them from being too prominent. If there is room to crawl under the floor or stage around the console pit, stringing connecting cords and cables is simplified. If the pit is deep enough, the control center can be mounted on its wall, within reach of the organist's bench.

It is best to keep controls for such associated sound equipment out of the organ console. Adjustments or troubleshooting by a maintainer of one system messes up the other fellow's setup when they are all packed into one console. Also, the audio equipment might pick up noise from relays and stops operating within the console.

Fig. 1 shows the relative location of the components and their wiring. Where the cables pass under the floor around the console, they are indicated by dashed lines. The mixing preamp for the PA system and the remote controls for the two audio systems are mounted in a small locked cabinet alongside the organist's bench.

The keyboard and relays in the normal organ console are energized by 12 volts dc. On the other hand, most electric chime strikers are operated by 12 to 18 volts ac. If the chimes are played with regular keys on one of the organ console keyboard manuals, a set of relays (as shown near the chimes in Fig. 1) is needed for interchange between these control systems. Such a relay rack is usually placed under the floor or in a closet, near the chimes.

In Fig. 1, the sound pickup from the chimes is represented as a microphone, feeding into a regular mike input channel of the amplifier. The mike should be mounted on rubber shock mounts to keep it from picking up mechanical vibrations from the wall it is mounted on. It should be placed as

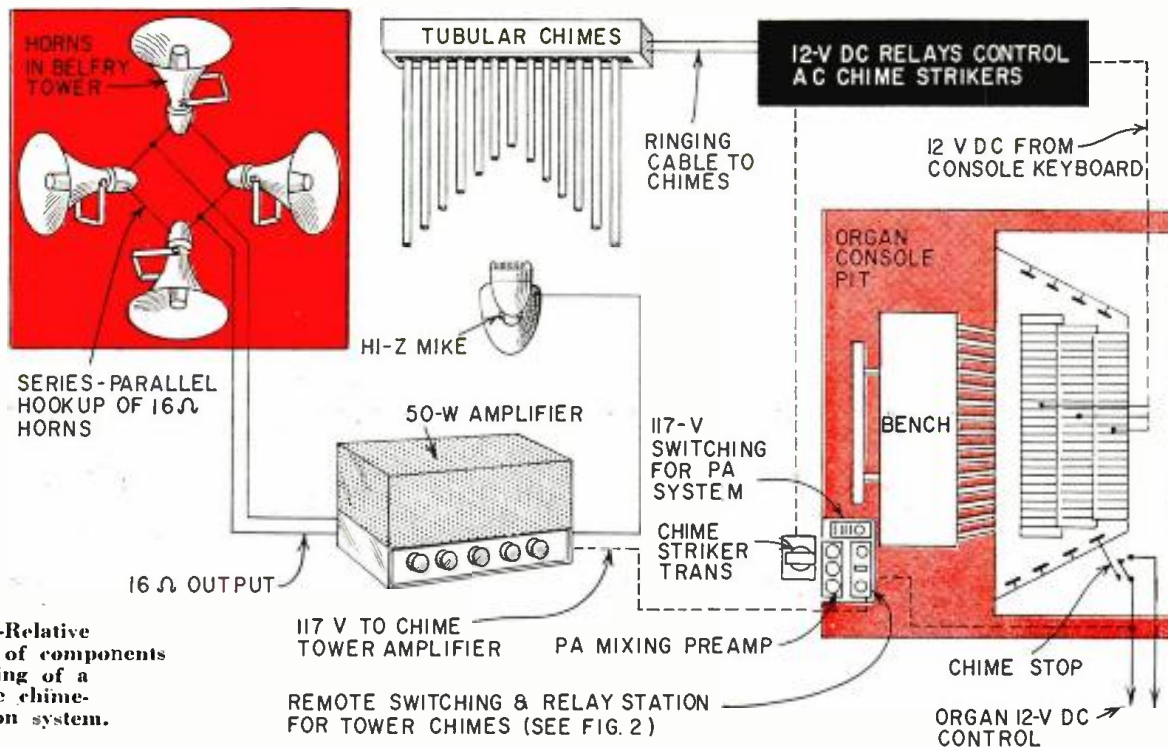

Fig. 1—Relative location of components and wiring of a complete chime-projection system.

nearly as possible equidistant from the ends of all the chimes.

When the chimes and audio system are sold together, the sound pickups are mounted on each tube of the chimes at the factory. In this way we eliminate some distortion which may be contributed by the mike and the secondary reflection of the chime sound from the walls, as well as other foreign sounds it may pick up in the room.

Remote control

Fig. 2 shows the layout of a small control chassis. It is mounted on the wall of the organ console pit within reach of the organist's bench. The unit is used to turn the chime tower amplifier on or off and to control the volume of sound produced by the chimes. Remember, the organist may wish to play chimes along with his organ music for those within the sanctuary.

To play the chimes (when they are played by the organ keyboard) the chime stop is pulled out. This energizes the relay in the remote-control station. The relay energizes the multitap transformer that furnishes the chime striking current. The transformer is enclosed in a metal box and mounted under the floor on the rear of the organ console pit wall.

The force with which the chimes are struck is determined by choosing the proper voltage from the transformer secondary taps with the six-position rotary selector switch indicated in the control chassis. For setting the volume of sound projected outdoors from the tower speakers, this selector is set to play the chimes at a comfortable listening level for audience listening, in the same room, and then the volume control of the tower amplifier is set to

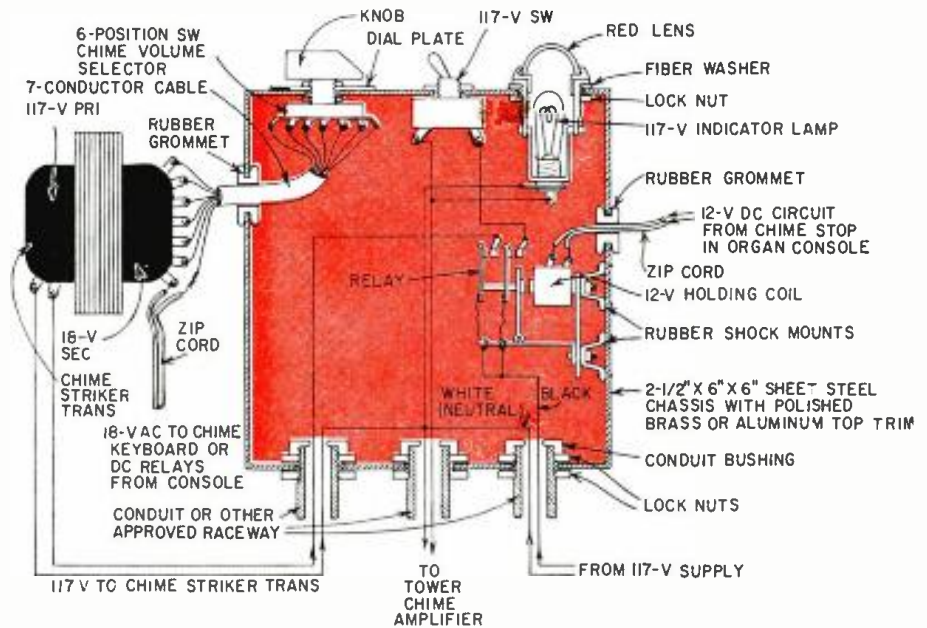

Fig. 2—Layout of a small remote-control chassis.

produce the desired level outdoors. It may then be locked up and left alone.

The switch on this control chassis determines whether the tower amplifier is to be on when the chime stop is pulled in the console. The red indicator lamp lights up when the tower amplifier is on. Thus, if this setup is used only for projecting chimes from the tower, the stop in the organ console will control everything. If the chimes are desired for some indoor service, the switch is turned off and the volume selector set to the level of chimes desired at that moment.

The relay in the control chassis is

mounted on soft-rubber shock mounts to deaden the sound of its operation. These rubber cups or shock mounts can be obtained at a war surplus store. To comply with electric codes, all 117-volt wiring to and from the chassis is enclosed in conduit or other approved metal raceway and terminated at boxes or chassis with approved connectors or clamping devices.

We have covered the general features necessary to reassemble or service a system for chime projection from a belfry tower. Our special purpose was to help those who cannot afford a fancy, ready-made system. END

New Transistor Clock Radio Kit

HEATHKIT



EVERYTHING A CLOCK-RADIO CAN OFFER ... AND PORTABLE TOO!

- Completely portable, all-transistor circuit
- Runs up to 500 hours on standard batteries
- Deluxe features at half the cost
- Easy to assemble

HEATHKIT TCR-1

\$45⁹⁵

"YOUR CUE" TRANSISTOR CLOCK RADIO KIT (TCR-1)

Take all the deluxe features found in the most expensive clock-radios, add the convenience of complete portability, plus a modern 6-transistor battery operated circuit . . . then slash the price at least in half, and you have the new Heathkit "Your Cue" Transistor Portable Clock Radio.

Packing every modern clock-radio feature into a compact, beautifully styled turquoise and ivory plastic cabinet, "Your Cue" lulls you to sleep, wakes you up, gives you the correct time and provides top quality radio entertainment in and out-of-doors. It can also be used with the Heathkit Transistor Intercom system, opposite page, to provide music or a "selective alarm" system for one or more rooms covered by the intercom system.

An "Alarm-set" hand, hour hand, minute hand and sweep second hand grace the easy-to-read clock dial. All controls are conveniently located and simple to operate. The "lull-to-sleep" control sets the radio for up to an hour's playing time, automatically shutting off the receiver when you are deep in slumber. Other controls set "Your Cue" to wake you to soft music, or conventional "buzzer" alarm. A special earphone jack is provided for private listening or connection to your intercom or music system. At all times crystal-clear portable radio entertainment is yours at the flick of a switch.

The modern 6-transistor circuit features prealigned IF's for ease of assembly. A tuned RF stage and double tuned input to the IF stage assure top performance. The built-in rod-type antenna pulls in far-off stations with outstanding clarity while a large 4" x 6" speaker provides tonal reproduction of unusual quality.

Six easily obtainable penlight-size mercury batteries power the radio receiver up to 500 hours, while the clock operates up to 5 months from a single battery of the same type. Ordinary penlight cells may also be used with reduced battery life.

The handsome two-tone cabinet, measuring only 3½" H. x 8" W. x 7½" D. fits neatly into the optional carrying case for beach use, boating, sporting events, hunting, hiking, or camping.

Wherever you are, you'll find "Your Cue" your constant companion. Shpg. Wt. 5 lbs.

LEATHER CARRYING CASE

HEATHKIT
NO. 93-3

\$4⁹⁵

Shpg. Wt. 2 lbs.



HEATH COMPANY/Benton Harbor, Mich.

 a subsidiary of Daystrom, Inc.

New Transistor Intercom Kit

TALK WITH ANY OR ALL FIVE STATIONS WITH YOUR OWN INTERCOM SYSTEM

- Battery Power Permits Placement Anywhere
- Versatile Unit has Many Important Uses
- Complete Privacy of Conversations Assured

TRANSISTOR INTERCOM KIT (XI-1 and XIR-1)

A flexible, versatile transistor intercom, has been developed by Heath engineers to enable you to set up your own communications system at an unbelievably low price.

Consisting of a master unit (XI-1) and up to five remote stations (XIR-1), the system is designed for any remote unit to call the master, for any remote station to call any other remote station, or for the master unit to call any single remote unit or any combination of remote units. Complete privacy is assured, since a call to a remote station cannot be interrupted or listened to while the remote unit is in operation unless switched in by the master unit. Used with clock-radio, opposite page, it can serve as a music or "selective alarm" system.

Transistor circuitry means long life, instant operation and minimum battery drain. Eight ordinary, inexpensive "C" flashlight batteries will run a unit for up to 300 hours of normal "on" time. Circuitry is especially designed for crisp, clear intelligible communication and the instant operation feature allows tuning of the units off between calls, extending battery life. Use of battery power does away with power cords, allowing each unit to be placed where most convenient. Only two wires are required between the master unit and each remote station. Beautifully styled, the Heathkit Intercom presents a new approach in design. Both master and remote stations have two-piece cases in ivory and turquoise for a rich, quality appearance. Batteries not included. Shpg. Wt. 6 lbs.

AC POWER SUPPLY (XP-1)

A permanent power supply for 24-hour operation of the XI-1 Intercom on household current. Converts 110 V. AC to well filtered 12-volt DC output, eliminating the need for batteries. Power supply is small, compact and fits in space normally occupied by batteries.

HEATHKIT XP-1.....\$9.95



HEATHKIT XI-1 (Master)

\$27⁹⁵

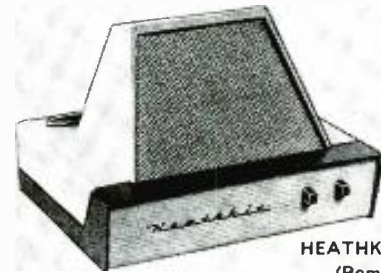

HEATHKIT XIR-1 (Remote)

\$6⁹⁵

Shpg. Wt. 4 lbs.

NEW IMPROVED DESIGN

STEREO-MONO PREAMP KIT (SP-2A, SP-1A)

Get the SP-2A Stereo Preamp kit now, or the SP-1A monophonic version which you can easily convert to stereo whenever you choose by assembling the second channel (C-SP-1A) and plugging it into your SP-1A.

The SP-2A permits stereo, two channel mixing, or either channel monophonic use, and includes a remote balance control.

Six inputs (12 in the stereo version) accommodate tape, magnetic phono and microphone, plus three separate high level inputs. Level controls provided on "mag. phono" and high level inputs. Switch selects NARTB equalization for tape head input, and RIAA, LP or 78 RPM compensation for mag. phono input

HEATHKIT SP-1A (monophonic) Shpg. Wt. 13 lbs.....\$37.95

HEATHKIT C-SP-1A (not shown) (converts SP-1A to SP-2A) Shpg. Wt. 4 lbs....\$21.95

New

HEATHKIT SP-2A (stereo)
Shpg. Wt. 15 lbs.

\$56⁹⁵

\$5.70 down. \$6.00 mo.



THE WORLD'S BIGGEST BARGAIN IN A HI-FI AMPLIFIER

55 WATT HI-FI AMPLIFIER KIT (W-7A)

Utilizing advanced design in components and tubes to achieve unprecedented performance with fewer parts, Heathkit has produced the world's first and only "dollar-a-watt" genuine high fidelity amplifier. Meeting full 55-watt hi-fi rating and 50-watt professional standards, the new improved W-7A provides a comfortable margin of distortion-free power for any high fidelity application.

The sleek, modern styling of this unit allows unobtrusive installation anywhere in the home. The clean, open layout of chassis and precut, cabled wiring harness makes the W-7A extremely easy to assemble. Shpg. Wt. 28 lbs.

SPECIFICATIONS—Power output: Hi-Fi rating, 55 watts; Professional rating, 50 watts. Power response: ± 1 db from 20 cps to 20 kc at 55 watts output. Total harmonic distortion: Less than 2% from 30 cps to 15 kc at 55 watts output. Intermodulation distortion: Less than 1% at 62 watts output using 60 cps and 6 kc signal mixed 4:1. Hum and noise: 80 db below 55 watts, unweighted. Damping factor: Switch on front panel for selecting either maximum (20:1) or unity (1:1). Output impedances: 4, 8 and 16 ohms and 70-volt line. Power requirements: 117 volts, 50/60 cycles, 90-160 watts. Dimensions: 8 $\frac{1}{2}$ " D. x 6 $\frac{1}{2}$ " H. x 15" W.



HEATHKIT W-7A

\$54⁹⁵

New

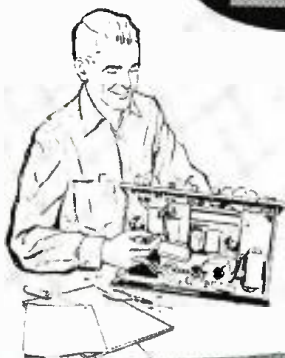

HEATHKIT SA-1

\$79⁹⁵

Stereo Amplifiers

FOR THE FINEST IN STEREO...

"DELUXE" 20-WATT STEREO AMPLIFIER KIT (SA-1)

Offering every deluxe feature imaginable in a stereo amplifier, the SA-1 also provides 20 watts per stereo channel and 40 watts total monophonic power. Separate bass and treble tone controls for each stereo channel permit you to adjust sound reproduction to suit your taste. A 4-position function switch (stereo, stereo reverse, channel A, channel B) makes it possible for any monophonic source to be fed into either channel individually or to both channels simultaneously. By adjusting the individual channels, you can even impart a pseudo-stereo effect to monophonic program material. A special "dimension" control eliminates the "hole-in-the-middle" effect sometimes produced through varying stereo recording practices. The SA-1 features five switch-selected inputs for each channel: magnetic phono, tape head, and three auxiliary inputs for high level sources. A special sixth position on the selector switch permits use of a monophonic magnetic phono cartridge, through either or both channels. Magnetic phono inputs are RIAA equalized; tape head input is NARTB equalized. All inputs, except that for the "tape head" feature individual level controls. Ganged volume controls permit adjusting the gain of both channels simultaneously, and a separate balance control allows precise channel balancing. Internal amplifier controls for each channel are also provided. Beautifully styled with vinyl-clad steel cover in leather-like texture of black and inlaid gold design. Shpg. Wt. 30 lbs. Available Soon.

New



HEATHKIT SA-2

\$52⁹⁵

YOUR BEST DOLLAR VALUE IN STEREO...

14-WATT STEREO AMPLIFIER KIT (SA-2)

Complete control of your entire stereo system is at your fingertips with this versatile Stereo Amplifier-Preamplifier combination. Providing 14 watts per stereo channel, or 28 watts total monophonic, the SA-2 offers every modern feature required in a master stereo control center, and at a price to please the budget minded. Shpg. Wt. 23 lbs.

SPECIFICATIONS—Power output: 14 watt per channel, "hi-fi"; 12 watts per channel, "professional"; 16 x 20 per channel, "utility". Power response: ± 1 db from 20 cps to 20 kc. 14 watts output. Total harmonic distortion: less than 2% at 60 cps, 14 watts output; 14 watts output. Intermodulation distortion: less than 1% at 16 cps. 10 dbm output 60 cps, and 16 kc. signal mix 4:1. Hum and noise: main phono input, 47 db below 14 watts; tuner and crystal phono, 63 db below 14 watts. Controls: dual channel volume; ganged bass, ganged treble; 4-position selector; pusher phono switch. AC receptacle: 1 switch, 1 normal. Inputs: 4 stereo or 8 monophonic. Outputs: 4, 8 and 16 ohm. Dimensions: 4 3/4" H. x 15" W. x 8" D. Power requirements: 117 volts, 50/60 cycle, AC, 150 watts (plus-D).

New



HEATHKIT SA-3

\$29⁹⁵

GO STEREO FOR \$29.95

ECONOMY STEREO AMPLIFIER KIT (SA-3)

This amazing performer delivers more than enough power for pure, undistorted room-filling stereophonic sound at the lowest possible cost. Featuring 3 watts per stereo channel and 6 watts as a monophonic amplifier, the SA-3 has been proven by exhaustive tests to be more than adequate in volume for every listening taste.

You will find its ease of assembly another plus feature. Heathkit construction manuals, world famous for their clarity and thoroughness, lead you a simple step at a time to successful completion of the kit. Larger than life-size diagrams show you exactly what each part looks like, where it goes, and how it is installed.

The amplifier is tastefully styled in black with gold trimmed control knobs and gold screened front and rear panel. A tremendous buy at this low Heathkit price! Shpg. Wt. 13 lbs.

SPECIFICATIONS—Power output: 3 watts per channel. Power response: ± 1 db from 50 cps, 20 kc at 3 watts out. Total harmonic distortion: less than 3% at 60 cps, 20 kc. Intermodulation distortion: less than 2% @ 3 watts output using 60 cycle & 6 kc signal mix 4:1. Hum and noise: 65 db below full output. Controls: dual channel volume; ganged treble, ganged bass; 7-position selector; speaker phasing switch; on-off switch. Inputs (each channel): tuner, crystal or ceramic phono. Outputs (each channel): 4, 8, 16 ohms. Finish: black with gold trim. Dimensions: 12 3/4" W. x 6 3/4" D. x 3 3/4" H.

New



Amplifiers & Tuners

A NEW AMPLIFIER AND PREAMP UNIT PRICED WELL WITHIN ANY BUDGET

14-WATT HI-FI AMPLIFIER KIT (EA-3)

This thrilling successor to the famous Heathkit EA-2 is one of the finest investments anyone can make in top quality high fidelity equipment. It delivers a full 14 watts of hi-fi rated power and easily meets professional standards as a 12-watt amplifier.

Rich, full range sound reproduction and low noise and distortion are achieved through careful design using the latest developments in the audio science. Miniature tubes are used throughout, including EL-84 output tubes in a push-pull output circuit with a special-design output transformer. The built-in preamplifier has three separate switch-selected inputs for magnetic phono, crystal phono or tape, and AM-FM tuner. RIAA equalization is featured on the magnetic phono input. Shpg. Wt. 13 lbs.

NOTE THESE OUTSTANDING SPECIFICATIONS—Power output: 14 watts, Hi-Fi; 12 watts, Professional; 16 watts, Utility. **Power response:** ± 1 db from 20 cps to 20 kc at 14 watts output. **Total harmonic distortion:** less than 2%, 30 cps to 15 kc at 14 watts output. **Intermodulation distortion:** less than 1% at 16 watts output using 60 cps and 6 kc signal mixed 4:1. **Hum and noise:** mag. phono input, 47 db below 14 watts; tuner and crystal phono, 63 db below 14 watts. **Output impedances:** 4, 8 and 16 ohms.



HEATHKIT EA-3

\$29⁹⁵

NEVER BEFORE HAS ANY HI-FI AMPLIFIER OFFERED SO MUCH AT SO LOW A PRICE

"UNIVERSAL" 14-WATT HI-FI AMPLIFIER KIT (UA-2)

Meeting 14-watt "hi-fi" and 12-watt "professional" standards, the UA-2 lives up to its title "universal" performing with equal brilliance in the most demanding monophonic or stereophonic high fidelity systems. Its high quality, remarkable economy and ease of assembly make it one of the finest values in high fidelity equipment. Buy two for stereo. Shpg. Wt. 13 lbs.

SPECIFICATIONS—Power output: Hi-Fi rating, 14 watts; Professional rating, 12 watts. **Power response:** ± 1 db from 20 cps to 20 kc at 17 watts output. **Total harmonic distortion:** Less than 2% from 20 cps to 20 kc at 14 watts output. **Intermodulation distortion:** Less than 1% at 14 watts output using 60 cps and 6 kc signal mixed 4:1. **Hum and noise:** 73 db below 14 watts. **Output impedances:** 4, 8 and 16 ohms. **Damping factor:** Switched for unity or maximum; maximum damping factor 15:1. **Input voltage for 14 watt output:** .7 volts. **Power requirements:** 117 volts 50/60 cycles, 55 watts. **Dimensions:** 10" W. x 6 $\frac{1}{2}$ " D. x 4 $\frac{1}{4}$ " H.

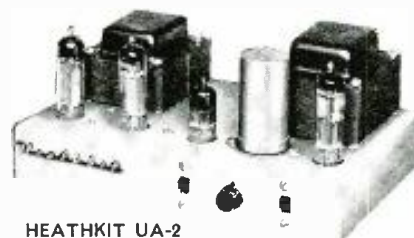

HEATHKIT UA-2

\$22⁹⁵

New

MORE STATIONS AND TRUE FM QUALITY ARE YOURS WITH THIS FINE TUNER KIT

HIGH FIDELITY FM TUNER KIT (FM-4)

This handsomely styled FM tuner features better than 2.5 microvolt sensitivity, automatic frequency control (AFC) with on-off switch, flywheel tuning and prewired, prealigned and pretested tuning unit. Clean chassis layout, prealigned intermediate stage transformers and assembled tuning unit makes construction simple—guarantees top performance. Flywheel tuning and new soft, evenly-lighted dial scale provide smooth, effortless operation. Vinyl-covered case has black, simulated-leather texture with gold design and trim. Multiplex adapter output also provided. Shpg. Wt. 8 lbs.

SPECIFICATIONS—Tuning range: 88 to 108 mc. **Quieting sensitivity:** 2.5 uv for 20 db of quieting. **IF frequency:** 10.7 mc. **Image ratio:** 45 db. **AFC correction factor:** 75 kc per volt. **AM suppression:** 25 db. **Frequency response:** ± 2 db 20 to 20,000 cps. **Harmonic distortion:** Less than 1.5%, 1100 uv, 400 cycles 100% modulation. **Intermodulation distortion:** Less than 1%, 60 cycles and 6 kc mixed 4:1 1100 uv, 30% modulation. **Antenna:** 300 ohms unbalanced. **Output impedance:** 600 ohms (cathode follower). **Output voltage:** nominal .5 volt (with 30% modulation, 20 uv signal). **Power requirements:** 105-125 volts 50/60 cycle AC at 25 watts. **Overall dimensions:** 4 $\frac{1}{2}$ " H. x 13 $\frac{1}{2}$ " W. x 5 $\frac{1}{2}$ " D.



HEATHKIT FM-4

\$34⁹⁵

New

HEATH COMPANY/Benton Harbor, Mich.

 a subsidiary of Daystrom, Inc.

New



Tape Recorders



- Choice of 3 Outstanding Models
- Compare With \$350-\$400 Machines
- Preassembled Tape Mechanism

- Choice of Monophonic or Stereo models
- Complete versatility
- Easy to assemble, easy to use

PROFESSIONAL QUALITY TAPE RECORDER KITS (TR-1 Series)

Enjoy the incomparable performance of these professional quality tape recorders at less than half the usual cost. These outstanding kits offer a combination of features found only in much higher priced professional equipment, generally selling for \$350 to \$400. Not the least of these special features is the handsome styling which characterizes the kits . . . a semi-gloss black panel is set off by a plastic escutcheon in soft gold, which is matched by black control knobs with gold inserts. The mechanical assembly, with fast forward and rewind functions, comes to you completely assembled and adjusted; you build only the tape amplifier. And, you'll find this very easy to accomplish, since the two circuit boards eliminate much of the wiring. Separate record and playback heads and amplifiers allow monitoring from tape while recording and a "pause" control permits instant starting and stopping of tape for accurate cueing and tape editing. A digit counter is provided for convenient selection of any particular recording. Push-pull knob provides instant selection of 3 3/4 or 7 1/2 IPS tape speed. Safety interlock on record switch reduces possibility of accidental erasure of recorded tapes. Shpg. Wt. 30 lbs.

SPECIFICATIONS—Tape speed: 7.5" and 3.75" per second. Maximum reel size: 7". Frequency response (record-playback): ±2.5 db. 30 to 12,000 cps at 7.5 IPS; ±2.5 db, 30 to 6,500 cps at 3.75 IPS. Harmonic distortion: 1% or less at normal recording level; 3% or less at peak recording level. Signal-to-noise ratio: 50 db or better, referred to normal recording level. Flutter and wow: 0.3%; RMS at 7.5 IPS; 0.35% RMS at 3.75 IPS. Heads (3): erase, record, and in-line stereo playback (TR-1C, monophonic playback). Playback equalization: NARTB curve, within ±2 db. Inputs (2): microphone and line. Input impedance: 1 megohm. Model TR-1D & TR-1E outputs (2): A and B stereo channels. Model TR-1C output (1): monophonic. Output levels: approximately 2 volts maximum. Output impedance: approximately 600 ohms (cathode followers). Recording level indicator: professional type db meter. Bias erase frequency: 60 kc. Timing accuracy: ±2%. Power requirements: 105-125 volts AC, 60 cycles; 35 watts. Dimensions: 15 1/2" W. x 13 1/2" D. Total height 10 1/2". Mounting: requires minimum of 3 1/2" below and 1 1/2" above mounting surface. May be operated in either horizontal or vertical position.

MODEL TR-1C Monophonic Tape Deck: \$159.95 \$16.00 DWN. Monophonic Record and Playback. \$14.00 MO.

MODEL TR-1D Two Track Stereo Tape Deck: Monophonic Record and Playback, plus Playback of 2-track Pre-recorded Stereo Tapes (stacked). \$169.95 \$17.00 DWN. \$15.00 MO.

MODEL TR-1E Four Track Stereo Tape Deck: Monophonic Record and Playback, plus Playback of 4-track Pre-recorded Stereo Tapes (stacked). \$169.95 \$17.00 DWN. \$15.00 MO.

MODEL C-TR-1C Conversion Kit: Converts TR-1C to TR-1D (see TR-1D description above). Shpg. Wt. 2 lbs. . . . \$19.95

MODEL C-TR-1D Conversion Kit: Converts TR-1D to TR-1E (see TR-1E description above). Shpg. Wt. 2 lbs. . . . \$14.95

MODEL C-TR-1CQ Conversion Kit: Converts TR-1C to TR-1E (see TR-1E description above). Shpg. Wt. 2 lbs. . . . \$19.95

NOTE: To convert TR-1C to TR-1E, purchase both C-TR-1C and C-TR-1D conversion kits.

STEREO-MONO TAPE RECORDER KITS (TR-1A Series)

Here are the tape recorders the avid hi-fi fan will find most appealing! Their complete flexibility in installation and many functions make them our most versatile tape recorder kits. This outstanding tape recorder now can be purchased in any one of three versions. You can buy the new two-track (TR-1AH) or four-track (TR-1AQ) versions which record and play back both stereo and monophonic programming, or the two-track monophonic record-playback version (TR-1A) and later convert to either two-track or four-track stereo record-playback models by purchasing the MK-4 or MK-5 conversion kits. The tape deck mechanism is extremely simple to assemble. Long, faithful service is assured by precision bearings and close machining tolerances that hold flutter and wow to less than 0.35%. Power is provided by a four-pole, fan-cooled induction motor. One lever controls all tape handling functions of forward, fast-forward or rewind modes of operation. The deck handles up to 7" tape reels at 7.5 or 3.75 IPS as determined by belt position. The TR-1A series decks may be mounted in either a vertical or horizontal position (mounting brackets included). The TE-1 Tape Electronics kits supplied feature NARTB equalization, separate record and playback gain controls and a safety interlock. Provision is made for mike or line inputs and recording level is indicated on a 6E5 "magic eye" tube. Two circuit boards simplify assembly.

MODEL TR-1A: Monophonic two-track record/playback with fast forward and rewind functions. Includes one TE-4 Tape Electronics kit. Shpg. Wt. 24 lbs. **\$99.95** \$10.00 DWN. \$9.00 MO.

TR-1A SPECIFICATIONS—Frequency response: 7.5 IPS ±3 db 50 to 12,000 cps; 3.75 IPS ±3 db 50 to 7,000 cps. Signal-to-noise ratio: better than 45 db below full output of 1.25 volts/channel. Harmonic distortion: less than 2% at full output. Bias erase frequency: 60 kc (push-pull oscillator).

MODEL TR-1AH: Two-track monophonic and stereo record/playback with fast forward and rewind functions. Two TE-4 Tape Electronics kits. Shpg. Wt. 36 lbs. **\$149.95** \$15.00 DWN. \$13.00 MO.

TR-1AH SPECIFICATIONS—Frequency response: 7.5 IPS ±3 db 40 to 15,000 cps; 3.75 IPS ±3 db 40 to 10,000 cps. Signal-to-noise ratio: 45 db below full output of 1 volt/channel. Harmonic distortion: less than 2% at full output. Bias erase frequency: 60 kc (push-pull oscillator).

MODEL TR-1AQ: Four-track monophonic and stereo record/playback with fast forward and rewind functions. Two TE-4 Tape Electronics kits. Shpg. Wt. 36 lbs. **\$149.95** \$15.00 DWN. \$13.00 MO.

TR-1AQ SPECIFICATIONS—Frequency response: 7.5 IPS ±3 db 40 to 15,000 cps; 3.75 IPS ±3 db 40 to 10,000 cps. Signal-to-noise ratio: 40 db below full output of .75 volts/channel. Harmonic distortion: less than 2% at full output. Bias erase: 60 kc (push-pull oscillator).

HEATH COMPANY/Benton Harbor, Mich.

 a subsidiary of Daystrom, Inc.

New "Acoustic Suspension" Hi-Fi Speaker System Kit

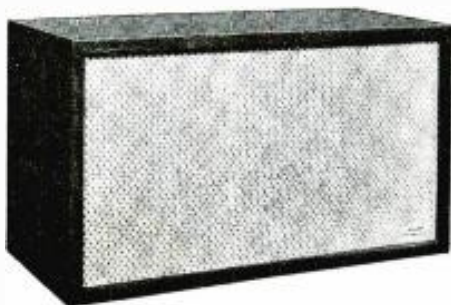

HEATHKIT AS-2U (unfinished)

\$69⁹⁵

HEATHKIT AS-2M (mahogany) **\$79.95**
HEATHKIT AS-2B (birch) **EACH**

**NOW—FOR THE FIRST TIME
—EXCLUSIVELY FROM HEATH**

ACOUSTIC SUSPENSION HI-FI SPEAKER SYSTEM KIT (AS-2)

A revolutionary principle in speaker design, the Acoustic Research speaker has been universally accepted as one of the most praiseworthy speaker systems in the world of high fidelity sound reproduction. Heathkit is proud to be the sole kit licensee of this Acoustic Suspension principle from AR, Inc., and now offers for the first time this remarkable speaker system in money-saving, easy-to-build kit form.

The 10" Acoustic Suspension woofer delivers clean, clear extended-range bass response and outstanding high frequency distribution is provided by the specially designed "cross-fired" two-speaker tweeter assembly.

Another first in the Heathkit line is the availability of preassembled and prefinished cabinets. Cabinets are available in prefinished birch (blond) or mahogany, or in unfinished birch suitable for the finish of your choice. Kit assembly consists merely of mounting the speakers, wiring the simple cross-over network and filling the cabinet with the fiberglass included. Shpg. Wt. 32 lbs.

SPECIFICATIONS—Frequency response (at 10 watts input): ±5 db, 42 to 14,000 cps; 10 db down at 30 and 16,000 cps. **Harmonic distortion:** below 2% down to 50 cps, below 3% down to 40 cps at 10 watts input in corner room location. **Impedance:** 8 ohms. **Suggested amplifier power:** 20 watts minimum. **Suggested damping factor:** high (5:1 or greater). **Efficiency:** about 2%. **Distribution angle:** 90° in horizontal plane. **Dimensions:** 24" W. x 13½" H. x 11½" D.

New Test Equipment



HEATHKIT FMO-1 Price to be announced

**AN INSTRUMENT LONG-AWAITED
BY SERVICE TECHNICIANS
EVERYWHERE!**

HEATHKIT FM TEST OSCILLATOR KIT (FMO-1)

Here in one compact, easy-to-use instrument are provided all the test signals and sweep frequencies required for fast, easy alignment and troubleshooting of RF, IF and detector sections of FM tuners and receivers. An instrument unique in the test equipment field . . . being the only one of its type designed especially for FM service work.

SPECIFICATIONS—Output frequencies: for RF alignment, 90 mc (FM band low end), 100 mc (FM band middle range), 107 mc (FM band high end). **Modulation:** 400-cycle incidental FM. **IF and detector alignment:** 10.7 mc sweep. **Sweep width markers:** 200 kc to over 1 mc, variable, 10.7 mc (crystal), 100 kc sub-markers. **Modulation:** 400-cycle AM. **For other applications:** 10.0 mc (crystal) and harmonics, 100 kc, 400-cycle audio. **Controls:** main frequency selector, modulation switch/concentric level control, marker oscillator switch/concentric level control, sweep width—power switch, output control, AF-RF (source impedance) switch. **Power supply:** transformer, selenium rectifier. **Power requirements:** 105-125 V, 50/60 cycles, 12 watts. **Cabinet size:** 7½" H. x 4½" W. x 4¾" D.



HEATHKIT RF-1

\$27⁹⁵

**PREASSEMBLED AND ALIGNED
BANDSWITCH/COIL ASSEMBLY**

RF SIGNAL GENERATOR KIT (RF-1)

Moderately priced, and capable of precision performance the RF-1 provides highly accurate and stable RF signals for trouble-shooting and aligning RF and IF circuits of all kinds. Modulated or unmodulated RF output of at least 100,000 microvolts is available, controlled by both fixed-step and continuously variable controls. A built-in 400 cycle audio generator with 10-volt output provides internal modulation of RF signal and is available separately for audio tests. A preassembled bandswitch and coil assembly, aligned to factory precision standards, eliminates the need for special alignment equipment. Shpg. Wt. 7 lbs.

SPECIFICATIONS—Frequency range: Band A, 100 kc to 320 kc; Band B, 310 kc to 1.1 mc; Band C, 1 mc to 3.2 mc; Band D, 3.1 mc to 11 mc; Band E, 10 mc to 32 mc; Band F, 32 mc to 110 mc. **Calibrated harmonics:** 110 mc to 220 mc. **Accuracy:** 2%. **Output:** impedance, 50 ohms; voltage, in excess of 100,000 uv on all bands. **Modulation:** internal, 400 cycles approx. 30% depth; external, approx. 3 V across 50 k ohm for 30%. **400 cycles audio output:** approx. 10 V open circuit. **Tube complement:** V1 12AT7 RF oscillator, V2 6AN8 modulator and output. **Power requirements:** 105-125 V 50/60 cycles AC, 15 watts. **Aluminum cabinet dimensions:** 6½" W. x 9½" H. x 5" D.

New

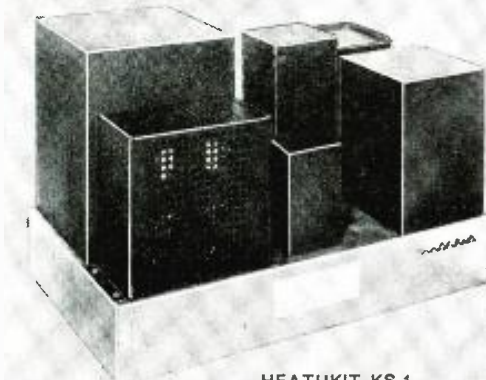

HEATHKIT KS-1

\$169⁹⁵

Ham Radio Gear

TOP POWER WITH ECONOMY AND SAFETY

KILOWATT POWER SUPPLY KIT (KS-1)

The KS-1 is designed as a companion to the "Chippewa" Linear Amplifier and is also suitable for supplying plate power to most other RF amplifiers in the medium to high power class. The KS-1 features an oil-filled, hermetically sealed plate transformer to minimize corona, a swinging choke in the filter circuit for good regulation, and a 60-second time delay relay to permit adequate heating of the mercury vapor rectifiers before application of plate voltage. All components are conservatively rated and well insulated for long life and dependable service. Shpg. Wt. 105 lbs.

SPECIFICATIONS—Maximum DC power output: 1500 watts. Nominal DC voltage output: 3000 or 1500 volts. Maximum DC current output: Average 500 ma, peak 1000 ma. Regulation: 180 to 600 ma (typical linear amplifier), 8%; 0 to 300 ma (typical class C amplifier), 10%; 0 to 500 ma, 15%. Ripple: Less than 1%. Tube complement: (2) 866A mercury vapor rectifiers. Recommended ambient temperature: 50 to 100 degrees F. Circuit: Two half-wave mercury vapor rectifiers in a full wave, single-phase configuration with swinging choke input filtering. Line power requirements: 115 V, 50/60 cycles, 20 amperes; 230 V, 50/60 cycles, 10 amperes. Chassis size: 17 1/2" W. x 12" H. x 13" D.

MOVE TO THE TOP IN TRANSMITTING POWER

"CHIPPEWA" KILOWATT LINEAR AMPLIFIER KIT (KL-1)

The KL-1 operates at maximum legal amateur power inputs in SSB, CW or AM service using any of the popular CW, SSB and AM exciters as a driver. Premium tubes (4—400's) push the "Chippewa" to top performance levels while a centrifugal blower provides more than adequate cooling. Shpg. Wt. 70 lbs.

SPECIFICATIONS—RF section: Driving power required: 1 (10 meters); Class AB1 (tuned grid) 10 watts PEP; Class C (tuned grid) 40 watts; Class AB1 (unamped grid) 60 watts peak. Power input: Class AB1 (SSB-voice modulation) 2000 watts PEP; Class AB1 (SSB-two tone test) 1300 watts; Class AB1 (AM linear) 1000 watts; Class C (CW) 1000 watts. Power output (20 meters): Class AB1 (SSB-voice modulation) 900 watts PEP; Class AB1 (SSB-two tone test) 550 watts; Class AB1 (AM linear) 300 watts; Class C (CW) 750 watts. Output impedance: 50 to 72 ohms (unbalanced). Input impedance: 50 to 72 ohms (unbalanced). Band coverage: 80, 40, 20, 15 and 10 meters. Panel metering: 0 to 50 ma, grid current; 0 to 100 ma screen current; 0 to 5000 volt plate voltage; 0 to 1000 ma plate current. Tube complement: Final tubes, (2) 4-400A; clamp tube, (1) 6DQ6; voltage regulators, (4) OD3, (2) OC3. Power requirements: AC (power supply primary circuit), 250 watts, 115 volt, 50/60 cycles; DC, 3000 to 4000 volts, 450 ma. Cabinet size: 19 1/2" W. x 11 1/2" H. x 16" D.



HEATHKIT KL-1

\$415⁰⁰



HEATHKIT XC-2

\$36⁹⁵

2-METER CONVERTER KIT (XC-2)

Extends coverage of the Heathkit "Mohawk" Receiver to the 2-meter band. May also be used with receivers tuning a 4 mc segment between the frequencies of 22 and 35 mc when appropriate crystal is used. Shpg. Wt. 7 lbs.

SPECIFICATIONS—Noise figure: 4.5 db; 1 uv signal provides 20 db thermal noise quieting. Sensitivity: approx. 1 uv input will provide a signal better than 6 db over noise level. Gain: approx. 40 db. Pass band: essentially flat 144 to 148 mc; approx. 35 db down at 143 and 149 mc. Image rejection: better than 100 db (unaided). Output impedance: 50 to 75 ohms. Input impedance: 50 to 75 ohms; 300 ohms with balun. Frequency: input, 144 to 148 mc; output, 22 to 28 mc with crystal supplied. Tubes: 6AM4, 6BS8, 6EA8, 12AT7. Crystal: .005% 3rd overtone. Power requirements: 150 volts DC at 50 ma (dropping resistor supplied for 210 VDC RX-1 operation), 6.3 volts AC/DC at 1.375 amps. Size: 9" W. x 5 1/2" H. x 4 1/2" D.



HEATHKIT UT-1

\$28⁹⁵

"BEST BUY" UTILITY POWER SUPPLY KIT (UT-1)

This power supply is ideal for converting the Heathkit "Cheyenne" and "Comanche" mobile transmitter and receiver to fixed station operation; or may be used to provide necessary filament and plate voltage for a wide variety of amateur equipment. Features silicon diode rectifiers, high capacity filters for superior dynamic regulation, and line filtering to minimize TVI and reduce receiver line noise. On ICAS basis, provides 150 watts DC plus filament power for 6.3 volt or 12.6 volt filament applications (6.3 VAC., 8 amps. or 12.6 VAC., 4 amps.; 600 VDC., 250 ma or 600 VDC., 200 ma and 300 VDC., 100 ma). Less than 1% ripple; excellent regulation. Housed in attractive green and gray-green cabinet measuring 9" long, 4 3/4" wide, 6" high. Shpg. Wt. 15 lbs.

The
DUAL-1006
satisfies
every need

*...as both a professional
single play turntable
and superior
record changer*

Tracks—and operates automatically
—with stylus pressure as low as 1½
grams! Minimizes *all* wear.

DUAL-1006

Built-in direct reading stylus pressure gauge. Easy to use, weight adjustment conveniently located.

DUAL-1006

Big, heavy 10⅝" turntable is laminated and concentrically girded. Can't warp or become eccentric.

DUAL-1006

Rumble-free motor is so powerful turntable reaches full RPM from *dead start* in less than ¼ turn!

DUAL-1006

All drive gears disengage *automatically*—no "neutral" position to remember, no flat spot thump.

DUAL-1006

Obsolescence-proof intermix for all present or *future* record sizes. Stack in *any* sequence.

DUAL-1006

Elevator Action changer-spindle prevents damage to record grooves and center holes. Truly gentle!

DUAL-1006

For the full story, write...

united  **Audio**

PRODUCTS OF DISTINCTION
202-4 East 19th St., N.Y. 3, N.Y.

AUDIO—HIGH FIDELITY

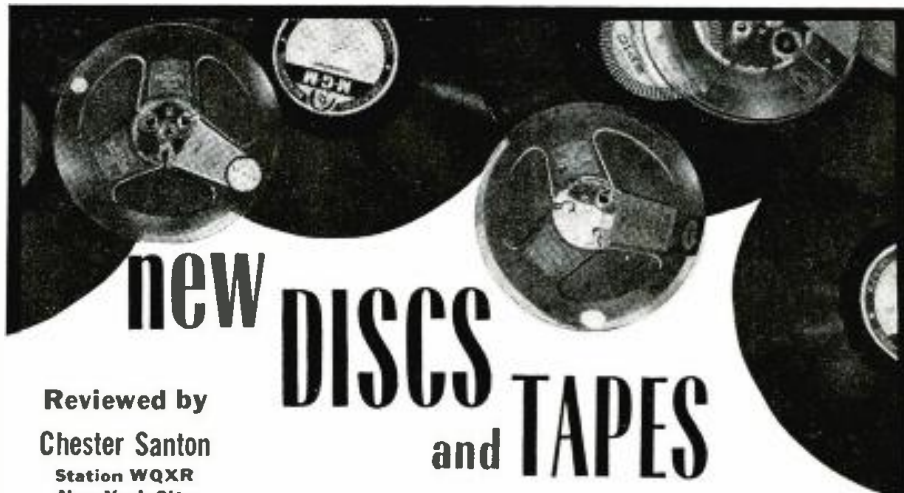

Reviewed by
Chester Santon
Station WQXR
New York City

STEREO and MONO

In recent months, the best stereo records have attained virtually all of the technical standards formerly associated with mono discs. This development makes feasible a rating system you'll notice in this month's column. These ratings cover four categories and are based solely on technical characteristics. Other factors will be covered in the body of each review. In this way, items of outstanding audio quality may be found at a glance.

TCHAIKOVSKY: 1812 Overture
RAVEL: Bolero
Morton Gould Orchestra and Band
RCA Victor Stereo Record LSC-2345
Technical Rating: EXCELLENT

Here is the greatest bargain since the dawn of the stereo era. Introduced at a special price \$4 below regular cost, this record offers the most impressive wide-range orchestral sound I've heard so far on stereo disc. On the debit side, the bells and cannon will not satisfy 1812 fans who have heard the real thing in previous stereo recordings. The sound of these bells was electrically generated and the cannon has meager acoustical impact, but the instrumental sound is fabulous. Under proper playback conditions, this record sounds like a 15-ips master tape. The bite of the basses' extreme lows are heard for the first time on stereo disc. The rest of the frequency range has a new degree of flatness. Some demo records are designed to compensate for known inadequacies in playback gear. This record was created to show off the best stereo systems in use today.

SIBELIUS: Symphony No. 2
Pierre Monteux conducting London Symphony Orchestra
RCA Victor Stereo Record LSC-2342
Technical Rating: POOR

What happened to the stereo in this one? Instrumental balance throughout the symphony is duplicated in the channels. Switch from left to right channel and the vantage point of the mike pickup is the same. The performance and sound are very good, but don't bother with the stereo version.

RAVEL: Bolero
DUKAS: Sorcerer's Apprentice
Hermann Scherchen conducting Vienna State Opera Orchestra
Westminster 4-Track Stereo Tape 4T-114
(7-inch; playing time, 27 min. \$6.95)
Technical Rating: POOR

This open-reel Westminster release is part of the first group of four-track stereo tapes to appear on dealer's shelves. Selected at random out of dealer's stock, it sounds far less glamorous than four-track tapes demonstrated by manufacturers under their own conditions. While not entirely typical of the four-trackers just reaching the market, this particular item underlines the infancy of tape in this form. When played back on a top-grade stereo recorder designed for use with a component system, the audio quality of this 7.5-ips tape was inferior to a 3.75-ips organ stereo tape acquired at last year's New York High Fidelity Show (Hi-Fi Tape R-716, 4-Track Open Reel). Heard in rapid succession on the same machine, the 3.75

had much better bass. The Westminster orchestral highs distorted above the midpoint of the dynamic range. The highs did extend beyond the average two-track tape, but they were clean only in the low level passages. No cross-talk was detected. Left channel of track A had intermittent drop out toward the end of the *Bolero*. The defect was noticed while listening to both channels.



PUCCHINI: Gianni Schicchi
Gabriele Santini conducting Orchestra of the Opera House, Rome
Capitol Stereo Record SGAR-7179
Technical Rating: EXCELLENT

Puccini's only comic opera is funnier in stereo. You can tell the difference as soon as the action begins. The elaborately phoney sobs of the greedy relatives cover the stage at the funeral of old Buoso Donati. A comic highlight of this 13th century tale is the rustling of parchment clearly picked up by the mikes as the impatient mourners search for the will. Tito Gobbi and Victoria De Los Angeles head a fine cast. Faultless sound.

ROSSINI: Barber of Seville
Erich Leinsdorf conducting Metropolitan Opera Orchestra and Chorus
RCA Victor Stereo Records (4) LSC-6143
Technical Rating: EXCELLENT

Along with a distinguished cast familiar to Met audiences, RCA offers opera fans a special inducement in this album, four records for the price of three. Through a quirk that I do not propose to fathom, this set combines snaciousness and presence in a way not obtainable in other recent RCA stereo operas.

FRANCK: Piece Heroique
Chorales Nos. 1, 2 and 3
Marcel Dupre, Organist
Mercury Stereo Record SR 90168
Technical Rating: EXCELLENT

The Aeolian-Skinner organ of St. Thomas Church in New York City is the first instrument of its type to appear in truly impressive sound on stereo disc. The recorded tonal range of this classic organ equals that heard in

AUDIO—HIGH FIDELITY

Mercury's mono disc version. Only stereo mikes at a height of 30 feet fully convey the unique character of church acoustics.

TCHAIKOVSKY: Swan Lake Suite
GRIEG: Peer Gynt Suite No. 1
 Kenneth Alwyn conducting London Philharmonic Orchestra

Richmond Stereo Record S 29057
Technical Rating: GOOD

The Richmond label, originally devoted to cheaper pressings of the early London mono

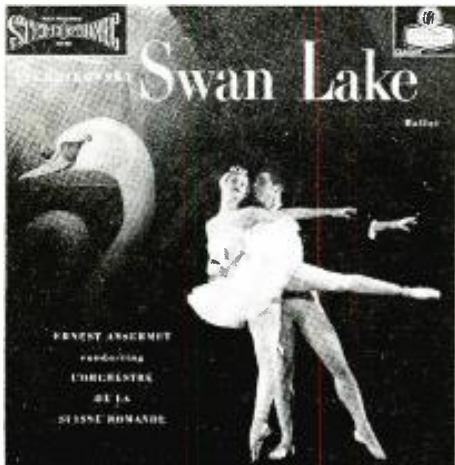

releases, has now invaded the low-price stereo disc field. This recent recording, priced at \$2.98, delivers solid value. You won't find better bass in this price category at the present time. Signal-to-noise ratio is much better than that of the typical \$5.98 stereo disc issued 9 months ago. The performances are in keeping with the standards set by the London Philharmonic on discs with deluxe prices. For those wishing a fuller treatment of the score, London has a new two-record album of Swan Lake performed by Ansermet and the Suisse Romande (London CSA-2204). The ends of the sound spectrum are richer-sounding in the more expensive album, but stereo spread is no better than the Richmond.

Come Rain or Come Shine
 Rosa Rio

StereoVox Record STVX 426.010
Technical Rating: EXCELLENT

Two Hammond organs and drums take care of a dozen old tunes devoted to fair or rainy weather. Radio and TV organist Rosa Rio is assisted by Kenneth Lane at a second console. The low bass response rivals that of a good mono disc, making this an outstanding demonstration record on stereo equipment set up to extract everything on the record.

Note: Records below are 12-inch mono LP and play back with RIAA curve unless otherwise indicated.

The Fabulous Sabcas

ABC-Paramount ABC 304
Technical Rating: EXCELLENT

Check your speaker damping with this one. On Side 2 Band 1, flamenco guitarist Sabcas abruptly smother the vibration of the guitar strings. This is an easy test for loudspeaker overhang because all sound energy on the record issues from one instrument at very close mike range. Transients throughout are remarkably clean.

Music From a Surplus Store
 Jack Fascinato Orchestra

Capitol T-1225

Technical Rating: EXCELLENT

Top honors for a truly novel yet tasteful pop recording go to Capitol this month. Some console man had a lot of patience miking the collection of utensils featured in these orchestral arrangements. Jack Fascinato and Ken Snyder created the dozen original tunes based on the unusual tonal characteristics of squeezed oil cans, trowels, furniture casters, metal wastebasket, an electric motor with variable speed control and stressed helical springs plucked with a surplus Medical Corps scalpel. Try this on your friends who think they've heard everything. **END**

Name and address of any manufacturer of records mentioned in this column may be obtained by writing Records, RADIO-ELECTRONICS, 154 West 14th St., New York 11, N. Y.

Here's where to buy your HEATHKIT locally . . .

CALIFORNIA

BERKELEY
 zacKIT Corporation
CHICO
 Dunlap Radio & TV
EL CAJON
 Telrad Electronics
FRESNO
 Dunlap Radio & TV
LOS ANGELES
 Kierulff Sound Corporation
 (2 Locations)
MARYSVILLE
 Dunlap Radio & TV
MERCED
 Dunlap Radio & TV
MODESTO
 Dunlap Radio & TV
PALO ALTO
 Zack Electronics
RIVERSIDE
 Kierulff Sound Corporation
SACRAMENTO
 Dunlap Radio & TV
SAN DIEGO
 Telrad Electronics
SAN FRANCISCO
 Zack Electronics
SANTA BARBARA
 zacKIT Corporation
STOCKTON
 Dunlap Radio & TV
TARZANA
 Kierulff Sound Corporation
VISALIA
 Dunlap Radio & TV

DELAWARE

WILMINGTON
 Radio Electric Service Co.

FLORIDA

COCOA
 Thuro Distributors, Inc.
DAYTONA BEACH
 Thuro Distributors, Inc.
JACKSONVILLE
 Thuro Distributors, Inc.
MIAMI
 Thuro Distributors, Inc.
ORLANDO
 Thuro Distributors, Inc.
PENSACOLA
 Thuro Distributors, Inc.
ST. PETERSBURG
 Thuro Distributors, Inc.
TALLAHASSEE
 Thuro Distributors, Inc.
TAMPA
 Thuro Distributors, Inc.

ILLINOIS

ALTON
 Radonics—Alton, Inc.

INDIANA

FORT WAYNE
 Ft. Wayne Electronics Supply, Inc.
INDIANAPOLIS
 Graham Electronics Supply, Inc.
LAFAYETTE
 Lafayette Radio Supply Co., Inc.
MUNCIE
 Muncie Electronics Supply, Inc.

IOWA

DES MOINES
 Radio Trade Supply Co.
FORT DODGE
 Radio Trade Supply Co.
MARSHALLTOWN
 Radio Trade Supply Co.
WATERLOO
 Radio Trade Supply Co.

LOUISIANA

LAFAYETTE
 Sterling Electronics, Inc.

MARYLAND

BALTIMORE
 American Distributing Co.
 (2 Locations)
 The Hi-Fi Shop
SALISBURY
 Radio Electric Service Co.

MASSACHUSETTS

BOSTON
 Audionics, Incorporated

MICHIGAN

ALLEN PARK
 Volta Electronics
DETROIT
 High Fidelity Workshop
PONTIAC
 High Fidelity Workshop

MINNESOTA

DULUTH
 Low Bonn Company
LA CROSSE
 Low Bonn Company
MINNEAPOLIS
 Hi-Fi Sound
 Low Bonn Company
ST. PAUL
 Hi-Fi Sound
 Low Bonn Company

MISSOURI

ST. LOUIS
 Radonics
 (2 Locations)
 Radonics-West, Inc.
 Radonics-Gravois, Inc.

NEW JERSEY

ATLANTIC CITY
 Radio Electric Service Co.
CAMDEN
 Radio Electric Service Co.
MOUNTAINSIDE
 Federated Purchaser, Inc.
NEWARK
 Federated Purchaser, Inc.

NEW YORK

ALBANY
 Fort Orange Radio Dist. Co., Inc.
BATH
 Rochester Radio Supply Co., Inc.
BELLEROSE
 Cross Island Electronics, Inc.
BINGHAMTON
 Stack Electronics, Inc.
BROOKLYN
 Acme Electronics, Incorporated
ELMIRA
 Stack Electronics, Inc.
FARMINGDALE
 Gem Elec. Distributors, Inc.
FOREST HILLS
 Beam Electronics, Incorporated
GENEVA
 Rochester Radio Supply Co., Inc.
HERKIMER
 Herkimer Electronics Co., Inc.
HICKSVILLE
 Gem Elec. Distributors, Inc.
MINEOLA
 Arrow Electronics, Incorporated
MT. VERNON
 Davis Radio Distributing Co., Inc.
NEW YORK
 Arrow Electronics, Incorporated
 Harvey Radio Company
ROCHESTER
 Rochester Radio Supply Co., Inc.
SYRACUSE
 Syracuse Radio Supply Co., Inc.
UTICA
 Genesee Electronics Company
VALLEY STREAM
 Elm Electronics, Inc.
WATERTOWN
 Watertown Electronics Company

NO. CAROLINA

CHARLOTTE
 Southeastern Radio Supply Co.
FAYETTEVILLE
 Southeastern Radio Supply Co.
GREENSBORO
 Southeastern Radio Supply Co.
KINSTON
 Southeastern Radio Supply Co.
RALEIGH
 Southeastern Radio Supply Co.

OHIO

AKRON
 Sun Radio Company
CHILLICOTHE
 Buckeye Electronics Dist., Inc.
CLEVELAND
 Pioneer Electronic Supply Co.
 (2 Locations)
COLUMBUS
 Buckeye Electronics Dist., Inc.
DAYTON
 Ham 'n Hi-Fi, Inc.
LORAIN
 Pioneer Electronic Supply Co.
MAPLE HEIGHTS
 Pioneer Electronic Supply Co.
NEWARK
 Buckeye Electronics Dist., Inc.
SANDUSKY
 Pioneer Electronic Supply Co.
SPRINGFIELD
 Standard Radio-Springfield, Inc.
TOLEDO
 Lifetime Electronics
ZANESVILLE
 Buckeye Electronics Dist., Inc.

OREGON

PORTLAND
 Eccles Electric Company
SALEM
 Cecil Farnes Company

PENNSYLVANIA

ALLENTOWN
 Federated Purchaser, Inc.
EASTON
 Federated Purchaser, Inc.

PHILADELPHIA

PHILADELPHIA
 Austin Electronics, Inc.
 Radio Electric Service Co.
 (3 Locations)
PITTSBURGH
 House of Audio
WILLOW GROVE
 Radio Electric Service Co.
YORK
 Radio Electric Service Co.

RHODE ISLAND

PROVIDENCE
 Audionics, Incorporated

TEXAS

BEAUMONT
 Sterling Radio Products, Inc.
BRYAN
 Sterling Radio Products, Inc.
DALLAS
 Hillcrest Records & Hi-Fi
HOUSTON
 Sound Equipment, Incorporated
 Sterling Radio Products, Inc.
LUFKIN
 Sterling Radio Products, Inc.

VIRGINIA

ARLINGTON
 Key Electronics, Inc.
NEWPORT NEWS
 Cain Electronics Company, Inc.
NORFOLK
 Cain Electronics Company, Inc.
 (2 Locations)
PORTSMOUTH
 Cain Electronics Company, Inc.
RICHMOND
 Meridian Electronics, Inc.

WASHINGTON

SEATTLE
 Seattle Radio Supply, Inc.

WISCONSIN

MADISON
 Hi-Fi Corner
 Satterfield Electronics, Inc.
MILWAUKEE
 Hi-Fi Center
 Netow's

Careful selection of reliable qualified dealers is a slow process . . . so please bear with us if your area has not been covered. Thank you.

New York Service Representative
 Empire State Electronic Serv., Inc.
 180-14 Union Turnpike
 Flushing 66, Long Island, New York



HEATH COMPANY / Benton Harbor, Mich.

D a subsidiary of Daystrom, Inc.

ALL ABOUT THE

REFLEX ENCLOSURE

Part IX (Conclusion)—Port placement, speaker height, damping

By P. G. A. H. VOIGT

A 50-CYCLE note has a wavelength of about $22\frac{1}{2}$ feet, the quarter-wavelength is therefore about $5\frac{1}{2}$ feet. If the port is at the upper level of a cabinet about 32 inches high, it will be about $2\frac{1}{2}$ feet off the floor. This is a fair fraction of the quarter-wavelength, and so any sound from that port at 50 cycles is able to spread outward fairly freely. On the other hand, if the port is at the lower level, and thus but a few inches above the floor, then the floor is so close (in terms of fractions of a quarter-wavelength) that no material downward spread is possible.

The volume of air oscillating in and out at the port then drives air which expands within a smaller solid angle (a quarter of a sphere only). Outside the port, therefore, the oscillation is concentrated on less air. That air is driven faster and so produces a higher back pressure. So the port air flow (piston action) has to work harder. This loads the port more effectively, the system efficiency goes up, port air oscillation is better damped, the Q goes down—reducing hangover—and the response becomes smoother and wider, all

without cost! A more perfect arrangement can hardly be imagined.

Comparing the upper with the lower level as a position for the port, the lower position is seen to have all the advantages, and that settles definitely which is the correct one to use.

If a round or square port is cut centrally in the front wall close to the bottom, it will be close to the floor of the cabinet and so will provide an escape for some of the vertical stationary-wave pressure. The effect, however, is not uniform over the floor and diminishes toward the back and sides. The pressure regions of the vertical stationary waves cover the whole of the inside floor of the cabinet. A rectangular slot at floor level extending right across the front of the cabinet would have a more uniform effect, for it would affect the whole of one side of that lower pressure region.

From a manufacturing point of view, too, such a slot port is economical, for it can be produced simply by making the front face of the cabinet shorter so that it does not reach to the bottom. The disadvantage is that since the base and front are not joined along their common edge, mechanical rigidity is lost. Much of this can be recovered by fitting junction pieces. These will obstruct part of the slot and so make a readjustment of the width necessary. The port's damping effect will not, however, be diminished appreciably.

Extra stiffeners can also be fitted, see Fig. IX-1 which suggests possible details. Since the stiffeners act as short ducts, the port area will have to be increased a little. If the area is too big, it can always be reduced by inserting flat pieces in the slots. By painting the slot matt black or covering the whole front with suitable grille material, the appearance will be OK.

The port in this case is still (as usual) on the front. Correct tuning of the air cushion is independent of the port location, so the port need not be on the front face of the cabinet. Alternative port positions should therefore be investigated.

The floor-level stationary-wave pres-

sure region would be acted on more uniformly if there was another slot port along the rear wall at floor level. In practice, it almost always happens that at some time the cabinet is placed flat against a wall. Such a slot would then be obstructed, so that simple idea is not very practical. However, it is practical to improve the port damping action on the vertical stationary waves by having two extra ports, one on each side toward the back near floor level.

Such side ports and, for that matter, the ends of the front slot port also, affect the lateral stationary waves, for these all have at least two pressure regions, one along each of the two side walls. The pressure will be initiated at the level of the speaker (i.e., near the source) and will then build up generally. A release of pressure low down taps off the energy and so applies damping, the energy in effect progressing downward.

The front-to-back stationary waves all have pressure regions along the front and back walls. Front and rear slots or side ports near the front and back walls therefore damp those stationary waves too.

Thus, taking all three directions of stationary waves into consideration, we find that, with a simple cabinet, a combination of two side openings toward the rear, close to floor level, and a divided slot along the bottom front face is a good way (at least in theory) of making a distributed port with beneficial secondary effects. Fig. IX-2 is a sketch

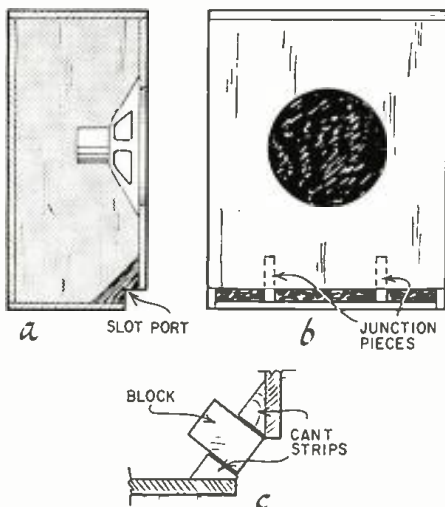

Fig. IX-1—Short junction blocks (a and b), or long stiffeners (c) with blocks as needed, may be used to keep the front rigid.

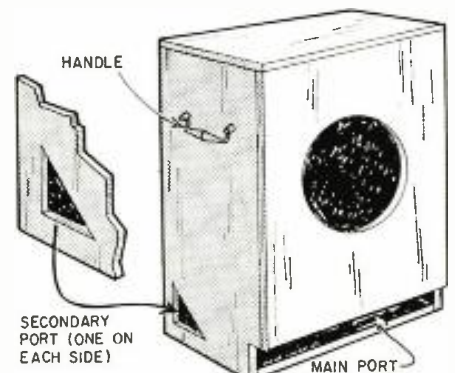

Fig. IX-2—Ports need not be in the front of the cabinet.

AUDIO—HIGH FIDELITY

of an enclosure made like this.

With a "perfect" single-channel sound reproduction system, the listener, when he shuts his eyes, will hear sound such as he would hear if in place of the loudspeaker there was an opening in the wall communicating directly with the live artists in the studio. The ideal height for such an opening is that at which an observation window might be placed. The middle and high frequencies from the loudspeaker should therefore enter the room from about that height, between 3 and 5 feet above the floor.

This "hole-in-the-wall" concept is one which the writer has described in lectures for over a quarter of a century.¹ At first it sometimes met with disbelief and even ridicule, but it is now more than 20 years since the writer heard really first-class single-channel systems which approached this target very closely indeed.

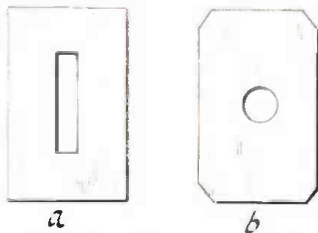

When the cabinet is raised off the floor, a single rectangular port (a) or four triangular ports in the corners of the cabinet bottom (plus a center hole) (b) are effective.

Now in the ordinary radio-phonograph combination sold to the public as a packaged unit, the speaker is usually somewhere near the floor. That is a level far lower than that at which an open window connecting to the studio would be located. Therefore, such a system simply cannot give truly lifelike reproduction of voice or violin, no matter how perfect it might be according to scientific measurements, just because the sound does not come from what is psychologically the right height. The 32-inch-high box baffle converted to reflex which we have been considering with its speaker near mid-height cannot produce the right effect either. The ordinary speaker position is OK for cello or double bass, as the ear has no directional ability at low frequencies, and these instruments radiate from near the floor anyway. But practically all solo work requires a raised sound source for lifelike reproduction.

The speaker has already been raised an inch or two above the cabinet mid-height in the design, for this is permissible without introducing appreciable trouble from the half-wavelength and the three-halves wavelength stationaries. This also increases the distance between the speaker and the low-level port(s), thus helping matters at the frequency of the lower impedance peak.

The whole cabinet can be raised on blocks or legs a few inches off the floor without much reduction of the loading gained at the port. Every inch that the

¹"A Controversial Idea from England," *Audio Engineering*, October, 1950.

Mullard TUBES CIRCUITS

engineered for high fidelity

*stereo
am / fm
television*

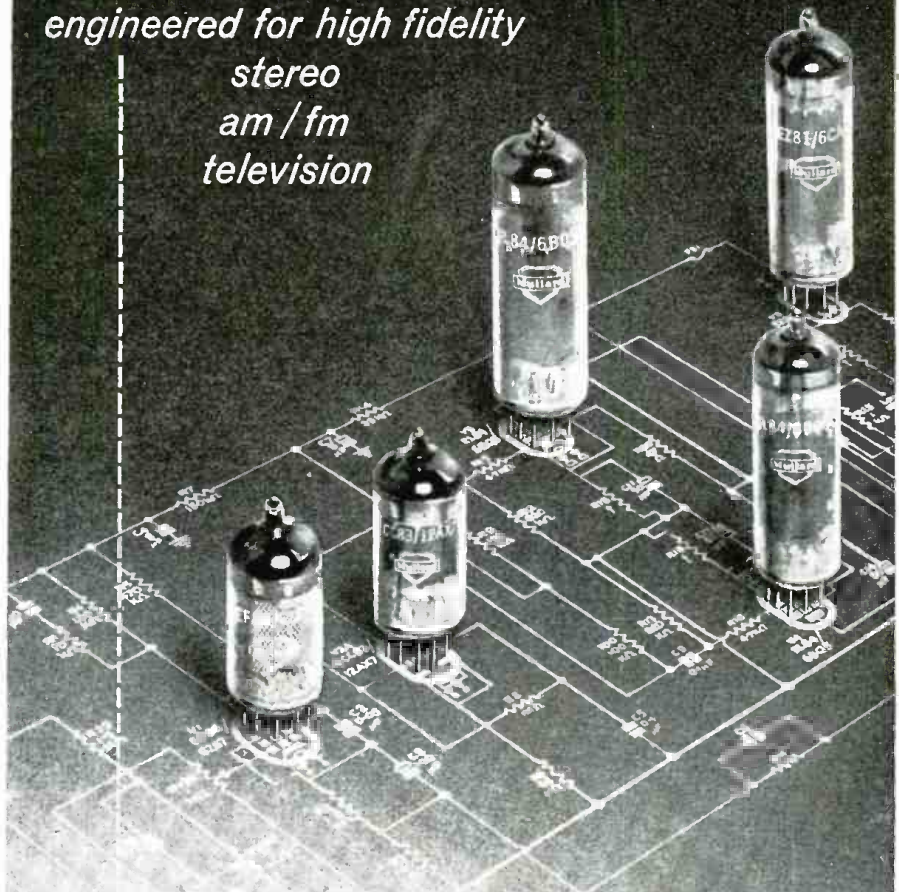

MULLARD electron tubes, universally recognized for their advanced designs and reliability, offer a selected range* of tubes for High Fidelity, AM/FM, Television, and Industrial Applications.

This selected range*, which uses frame grids, special glass, coiled heaters, bifilar windings, special mica construction, low hum and microphony, rugged construction, longer life are features found in more expensive premium tubes.

At MULLARD these extras are standard in the regular commercial production—
AT NO EXTRA COST.

Discover the advantages of MULLARD tubes in your equipment—now!

Detailed data and application engineering assistance available upon request.



Trade Mark
Mullard Ltd.



"Circuits for Audio Amplifiers" is a new MULLARD publication in which the wide range of MULLARD high quality audio circuits is presented conveniently in one book. Four introductory chapters are devoted to theoretical and practical considerations of high quality sound reproduction with monophonic equipment or with stereophonic systems. The rest of the book comprises circuit descriptions, constructional details, and some performance figures of 12 MULLARD circuits. These circuits include well-known MULLARD designs, some modifications and improvements to these circuits, and a number of completely new ones. Only \$2.50 from your dealer or by mail from our Technical Services Division.

INTERNATIONAL ELECTRONICS CORP.
81 SPRING ST., NEW YORK 12, N. Y.

These men are getting practical training in...

ELECTRICITY ELECTRONICS



ON REAL

Motors • Generators
Switchboards • Controls
Modern Appliances
Automatic Electronic
Control Units

TELEVISION RADIO ELECTRONICS



ON REAL

TV Receivers
Black & White and Color
AM-FM and Auto Radios
Transistors • Printed
Circuits • Test Equipment

Train in NEW Shop-Labs of COYNE

in Chicago—Electrical and Electronic Center of the World. Prepare for a better job and a successful future in a TOP OPPORTUNITY FIELD. Train on real full size equipment at COYNE where thousands of successful men have trained for 60 years—largest, oldest, best equipped school of its kind. Professional and experienced instructors show you how, then do practical jobs yourself on more than a quarter of a million dollars worth of equipment. No previous experience or advanced education needed. Employment Service to Graduates.

Start Now—Pay Later—Liberal Finance and Payment Plans. Pay most of tuition after graduation. Part-time employment help for students. Choose from nine yearly Starting Dates.

Mail Coupon or Write to Address Below for Free Book—"Guide to Careers." Whether you prefer ELECTRICITY, TELEVISION-RADIO or COMBINED ELECTRONICS, which includes both fields, this book describes all training offered.

Information comes by mail. No obligation and NO SALESMAN WILL CALL.

B. W. Cooke, Jr., Pres.

Founded 1899

COYNE ELECTRICAL SCHOOL

Chartered as an Educational Institution Not For Profit
1501 W. Congress Pkwy., Chicago 7, Ill., Dept. 89-5C

MAIL COUPON OR WRITE TO ADDRESS BELOW

COYNE ELECTRICAL SCHOOL
New Coyne Building Dept. 89-5C
1501 W. Congress Pkwy., Chicago 7, Ill.

Send BIG FREE book and details of all the training you offer. I am especially interested in,

Electricity Television Both Fields

Name.....

Address.....

City..... State.....

(I understand no Salesman will call)

AUDIO—HIGH FIDELITY

cabinet is raised thus helps get the speaker nearer the proper level.

A sturdy alternative to legs is to extend the two sides of the cabinet downward. This is easy if the ply is cut long to start with. Such extensions or legs should be long enough to leave a space of 6 inches minimum below the cabinet. The disadvantage of very short legs is that when things fall, they tend, by the "Law of Cussedness" to roll or bounce into inaccessible places, also it is not so easy to sweep under equipment that is too close to the floor.

Such raising of the system by a few inches will reduce slightly the gain of loading achieved by putting the port at floor level, but this is so negligible compared with the psychological gain that it is a worth-while exchange.

If the 3¼-cubic-foot cabinet is raised 6 inches or so, the top of the cabinet comes at about 38 inches above the floor. If, now, the speaker system uses an independent tweeter, this can be fixed into a housing designed to stand on top of the cabinet and raise the tweeter level up to between 42 and 48 inches above the floor. For that important portion of the scale at least we then have sound which is radiated from the proper height. This will go a long way toward offsetting the effect of having the main speaker too low. Matters can be improved still further if a mid-range speaker is used and also mounted on top of the cabinet. If the bigger (6.4-cubic-foot) cabinet is raised 7 inches off the floor, its upper surface comes at 44½ inches, just about perfect for standing the tweeter on.

When using a cabinet raised off the floor, the port can be cut into its floor. A simple rectangular port centrally in the floor of the cabinet as shown in Fig. IX-3-a works well, and is effective in

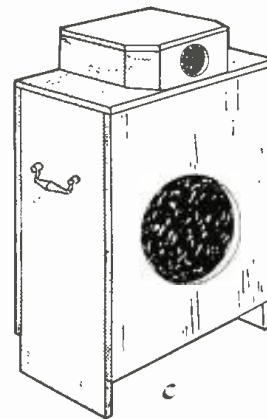

Fig. IX-4—An excellent arrangement, with enclosure raised off floor, port in the bottom, and a separate tweeter at optimum height for listening.

dealing with vertical stationaries. It does not, however, reach the pressure regions along the sides and the front and back walls. A divided port made simply by cutting off the four corners of the bottom provides four openings in the right places for the side and the front to back stationaries. (See Fig. IX-3-b.) The fifth hole right in the middle should, in theory at least, increase the effect on the vertical stationaries, and so this simple arrangement provides useful damping on all three sets of stationary waves. Because of the divided port, less area will be needed than with the rectangular port. However, the side walls limit the normal air bulge internally around the port openings, and so the area has to be greater. As a start, therefore, make the total area correspond to that of the appropriate single plain port and then adjust from there. Fig. IX-4 is a sketch of such a cabinet.

With a port that is not facing for-

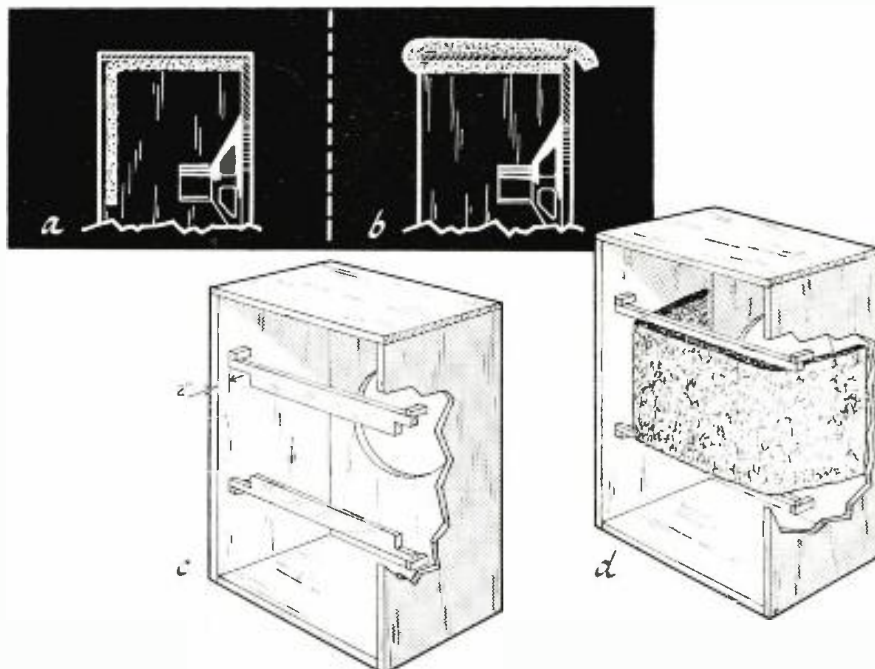

Fig. IX-5—Use of damping material: Inverted L in place at a and folded back (during construction) at b. How material is placed across part of back and two sides, c and d. (Internal bracing omitted for clarity.)

AUDIO—HIGH FIDELITY

ward, it might be feared that sound will be lost. The main frequencies dealt with at the port are usually below 100 cycles. The wavelength, even of a 100-cycle note, is long compared with the port dimensions. Volume oscillation which causes flow in all possible directions is then the important factor and there is negligible directional effect.

The stationary waves we are trying to damp will not be of quite such low frequency, and then directive radiation from the port might have effect. Phase changes inside the cabinet are, however, so great as to make nonsense of any efforts to make the phase at the port agree exactly with whatever might be ideal. We must therefore take our chance and, on a "swings and roundabouts" basis, one port direction is likely to be as good as any other.

Internal damping has been discussed at length in Part VI. The ports even when placed as discussed above, so as to damp the stationaries, cannot eliminate the lateral and front-to-back stationaries completely. Just what is to be done?

Well, the first question is: "How detrimental are the residual stationary waves?" This is best determined by A-B comparison. Such comparison should be made where there is little reverberation, for reverberation hides some of the effect. If the residual stationary waves are found to be unimportant, artificial internal damping can be regarded as optional.

The wave energy originates at the cone. The damping which absorbs most is that which is exposed to the greatest intensity. For the lateral stationary waves, that occurs on the two side walls at the level of the speaker. For the front-to-back waves, it is at the rear wall behind the speaker. For the vertical waves, damping at the top level will help add to the losses which the port system provides at the bottom level.

An economical way, therefore, of applying damping such as a 1-inch layer of glass wool is to attach to the upper internal surface an inverted L-shaped layer which hangs down by the rear wall (see Fig. IX-5). If this work is done while the rear wall is removed, fold the hanging part out of the way pro tem. Then fix a U-shaped damping layer inside along the two sides and across the back at speaker height, but with a 1-inch space between the back of this layer and where the rear wall will be. Then fold the hanging part of the L back to hang down in that 1-inch space. In this way, there is a double layer between the speaker and the rear wall, and a single layer on each side of the speaker. It is doubtful if additional damping beyond that described will make any audible difference in a well designed and constructed cabinet, but anyone who wishes to do so can experiment to his heart's content.

With a box baffle, slight leakage at a joint has negligible effect. In a reflex, however, such leakage increases the effective port area and introduces losses.

To
Make
Your
Components
Sound
NEW
Again!



THE FISHER Laboratory Matched Tubes

Every new FISHER product has attained leadership for one essential reason: it filled a need which, until its introduction, no other comparable product could fully satisfy. FISHER Laboratory Matched TUBES have the same objective. If your high fidelity components sound "wrong" because of tube difficulties, FISHER TUBES can restore them to top performance again.

FISHER TUBES are individually selected to fulfill the maximum requirements of your components, *exactly* as specified by the manufacturer (no "variables," nothing less than the best in every box.)

FISHER TUBES are chosen for stability, maximum gain, low noise, exact tolerances, long life and for *absolutely identical performance characteristics*, as revealed by rigid comparison tests!

The next time you need any tubes, insist on FISHER.

Audio-Fans, Servicemen, Dealers—
WRITE TODAY FOR COMPLETE INFORMATION



FISHER RADIO CORPORATION, 21-40 44th Drive, L. I. C. 1, N. Y.

I want to know more about FISHER Laboratory Matched TUBES!

NAME _____

STORE NAME _____
(If a serviceman or dealer)

ADDRESS _____ CITY _____ STATE _____

Auto Radio Control Replacement is Child's Play

with new **Centralab**®

Exact Replacement Controls



Now one source can fill all your needs for auto radio-replacement controls. CENTRALAB has a new line of exact replacements for every popular radio in use today. This is the first time in history that you have been able to get the auto radio control you need—from a control manufacturer.

It's easy to handle more auto radio repair business—and handle it profitably—when you install exact replacement controls bought from your *regular* supplier. No need to run all around town looking for the right unit—you can now be sure that your CENTRALAB distributor has it!

Besides controls, the line also includes six exact replacement on-off switches (SP Series) for push-button radios, used in Plymouth, Dodge, DeSoto, Chrysler, Ford, Mercury, Lincoln and Hudson.

A complete and thorough guide listing all auto radio controls in use today, and their CENTRALAB equivalents, is now available. Pick up your free copy from your distributor—or write direct to CENTRALAB.

Centralab

A DIVISION OF GLOBE-UNION INC.
922L E. KEEFE AVE. • MILWAUKEE 1, WIS.
IN CANADA: 669 Bayview Ave. • Toronto 12, Ont.

® B-5902

CONTROLS • ROTARY SWITCHES • CERAMIC CAPACITORS
PACKAGED ELECTRONIC CIRCUITS • ENGINEERED CERAMICS

AUDIO—HIGH FIDELITY

Inconsistencies can be avoided by using soft packing between the rear wall and the cabinet and thus insuring an airtight joint every time.

Now another tip. Cabinets such as we have been discussing have to be moved around sooner or later. When that day comes (and it usually comes before the cabinet is finished!), a handle on each side is a blessing. It should be about 30 inches above floor level. If projecting handles are not permissible, hand holes can be made in the sides, but they have to be covered internally with a shallow airtight box so as not to act as additional ports.

Do not overlook the advantages of the corner location even if the cabinet is not specially shaped. Placing the cabinet in a corner concentrates the port and cone radiation into a smaller angle horizontally. This adds to the efficiency and the damping at low frequencies, thereby providing smoother response and lowering the Q and hang-over. A special triangular cabinet, though helpful, is not essential. A rectangular one can be placed diagonally or, if there are separate tweeter and mid-range speakers, the main cabinet can be placed with its sides parallel to the room walls (bass is not directional), the other speakers being turned to cover the room.

If perchance the low-frequency efficiency is now too high, extra artificial damping should be applied, for that will decrease the Q still further, thus approaching ever nearer to the ideal of aperiodic working.

Ideally, the response of the complete system should be calibrated on site after completion.

Perhaps it is fortunate that this is rarely possible, for many an enthusiast—quite certain that his system was level, say, within 3 db from 20 to 20,000 cycles—would require psychological treatment after seeing the result. So, we had better let him fiddle with the controls till he has the tonal balance which he regards as similar to what he heard when he last attended a concert.

And so, after all this, can the do-it-yourselfer hi-fi enthusiast design and make his own reflex cabinet successfully? I would say, "Certainly," but don't go entirely by rule of thumb. Go by basic first principles instead. A simple reflex cabinet is, after all, constructionally only a box with one or more ports, preferably with internal bracing, perhaps some damping, and if possible two handles. The rest is "know-how" and some of that I have tried to present in this series of articles.

I hope that this information will stimulate many into building first-class enclosures, making sure that their equipment is working as it should be and improving their sound in every possible way.

And now, just one thing more. Go to a live concert in a hall where there is no PA gear occasionally, just to keep your ideas in line!

END

CBS FIRSTS IN TUBES



FIRST Bantam GT receiving tubes

FIRST Bantam Jr. subminiature tubes

FIRST rectangular picture tubes

FIRST receiving tubes designed especially for TV

FIRST receiving tubes rated for Continuous Television Service

FIRST practical color picture tube, CBS-Colortron

CBS FIRSTS IN COLUMBIA RECORDS



Leonard Bernstein, outstanding musical personality, is a Columbia Records star.

FIRST double-faced phonograph disc

FIRST (LP) long-playing record

FIRST complete symphony recording in U. S. A.

FIRST "360" hi-fi phonograph

FIRST major recording company with a record club

FIRST Stereo Seven — new seven-inch 33½ rpm record



Receiving, industrial and picture tubes • transistors and diodes • audio components • and phonographs

WHAT THESE FIRSTS MEAN TO YOU

In records or tubes, the CBS family habit of being first helps guarantee you the quality of performance that only leadership can deliver. This leadership is your further assurance that:

- CBS tube quality cuts call-backs to the bone.
- CBS tube quality insures your customers of dependable performance.
- CBS tube quality offers built-in profits for you.

Ask for the leader with the top-rated name your customers know and trust. Ask first for CBS.

CBS ELECTRONICS

Danvers, Massachusetts

Electronic manufacturing division of Columbia Broadcasting System, Inc.

Qwik-Test adapter speeds audio testing

Three switches and a handful of binding posts make a test adapter that's worth the bench space it requires

By HAROLD REED

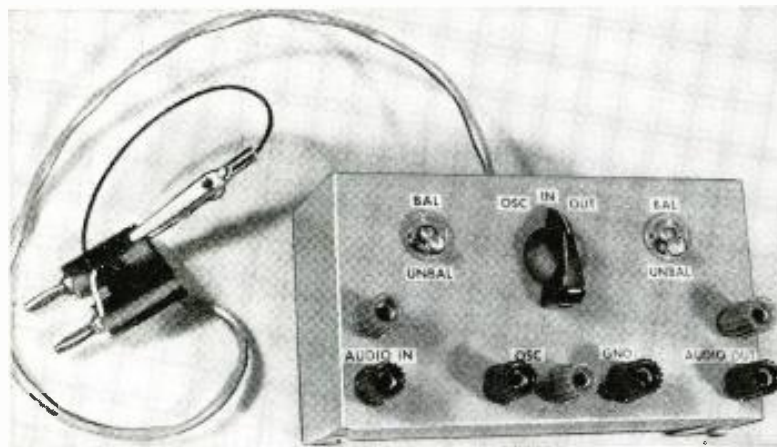

The assembled Qwik-Test adapter.

SERVICE technicians spend a lot of time checking the performance characteristics of audio systems and amplifiers. In making such tests, input and output levels must be known and the required impedance load provided.

An audio oscillator, oscilloscope, distortion analyzer and audio vtvm are important parts of the testing apparatus. Since duplicate instruments are rarely available, each individual unit must be switched around several times before the job is done. This is especially true when you consider the audio vtvm. The switching makes such tests inconvenient and time-consuming, as well as increasing the chance of error.

What is needed is a device to which the audio system or amplifier and all the test instruments could be connected. Then, once set up, the instruments could be used for all tests by simply rotating a switch rather than having to change connections. This is what the Qwik-Test adapter described in this article does.

How it's made

The test adapter is built into a 5 1/4 x 3 x 2 1/8-inch metal box. All components are attached to the upper section of this two-piece case. Each pair of leads running from the audio input, audio output and oscillator binding posts to the switch should be twisted together and the pairs spaced as far apart as possible. The output lead from the switch is two-conductor shielded cable, terminated in a dual banana plug. The shield at the adapter end is connected to the metal cabinet. At the banana-plug end, the shield is terminated with an alligator clip. The ground binding post and the ground side of the balanced-

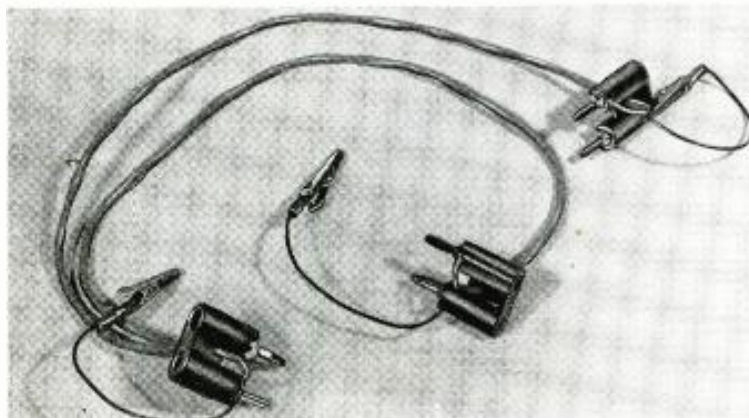

Branching patch cable increases adapter's versatility.

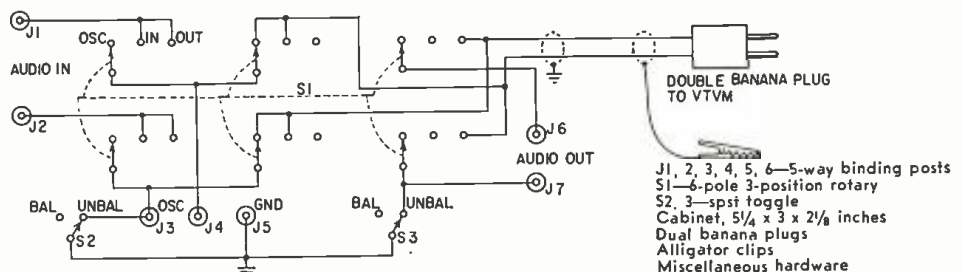

Circuit of the simple Qwik-Test.

TEST INSTRUMENTS

unbalanced toggle switches also connect to the metal cabinet.

The AUDIO IN, AUDIO OUT and OSC binding posts are red and black, the black on the ground side. Five-way binding posts are used since they will accept phone tip plugs, banana plugs, spade lug, alligator clips or wire leads. They are spaced $\frac{3}{4}$ inch apart, which is standard on most test instruments, so they will accept dual banana type plugs. A lead to the vtvm is also equipped with a dual plug.

An additional multiple branching patch cable equipped with dual banana plugs permits connecting the adapter to three test instruments—vtvm, scope and distortion analyzer—simultaneously. (See photo.) Three dual banana plugs are paralleled. Cables are passed through $\frac{1}{4}$ -inch holes drilled through the centers of the dual plugs and anchored securely with tape. The white conductors are in the high side of the circuits and the black ones are ground. The shields of this patch cable are terminated in alligator clips to allow either balanced or unbalanced testing. Lower-cost alligator clips can also be used in place of the dual banana plugs. All terminals and switches are clearly designated with decals.

Adapter operation

The following tests are usually made when measuring performance characteristics of an audio system or amplifier. We are not going to give complete audio testing data, but will explain the general procedure for using the adapter.

During all tests the AUDIO IN binding posts are connected to the input of the audio system or amplifier to be tested. Likewise, the AUDIO OUT terminals are connected to its output. The required audio load resistor should also be connected between the AUDIO OUT binding posts. The audio oscillator, of course, is plugged into the OSC binding posts and the shielded cable equipped with the dual banana plug plugs into the audio vtvm. The patch cable may be connected between the voltmeter terminals and a distortion analyzer and oscilloscope. The BAL-UNBAL switches are thrown according to the type of audio system being tested. Most measurements will be made with these switches in the UNBAL position, which grounds one side of the audio circuit.

Power Output Check:

Throw test switch to IN and adjust oscillator output for the required input signal level as indicated by the vtvm. Set vtvm range switch for the expected output voltage. Throw test switch to OT to read output voltage on the vtvm. Power output is then equal to E^2/R , where E is the output voltage and R the ohmic value of the load resistor.

Gain Measurements:

Throw test switch to IN and adjust oscillator output for the desired input as shown by the vtvm and note this as E1. Turn the vtvm's range switch to

AVR

the NEW PERMA-POWER



Model D-200

Automatic Voltage Regulator will make you money and save you grief

It's easy to sell. There have been units similar to this on the market before—at prices upwards of \$75.00. The new PERMA-POWER Automatic Voltage Regulator has a list price of \$9.95—so any TV set owner can afford it . . . and any customer plagued by picture flutter, shrinking, flop-over, loss of brightness, and other similar disturbances will want it.

It's easy to use. This new unit insures top performance of TV sets by automatically returning full height and width to pictures when distorted by low line voltage. Whenever the line falls below 110 volts, it automatically boosts line voltage 10 volts—and it automatically feeds the line direct for normal voltages. *You don't have to worry about the customer's forgetting to switch the voltage regulator when the line is normal; this new PERMA-POWER unit switches automatically!*

It's easy to install. You plug it in, and it's ready to work; goes on and off with TV set. Compact and lightweight, it has no tubes, ballasts, relays, or other moving parts to fail; and it's fully guaranteed for one year. Can be used on any TV set or appliance rated up to 300 watts. See it at your distributor today.

Perma-Power COMPANY 3106 N. ELSTON AVENUE
CHICAGO 18, ILLINOIS

SERVICEMEN KNOW!

Here they pay less and get the best

HUSH®

Chemically-Electronically, engineered for Tuners and Switching Mechanisms.

When New HUSH is applied it will wash-away that dirt, leaving clean and positive contacts protected by a lasting lubricant. New HUSH is made from the finest solvents and it contains Electro-Silicone oils.

Also available—2 oz., 8 oz., 32 oz. containers 6 oz. Spray can \$2.25 net

EVER-QUIET®

Since 1949

VOLUME CONTROL AND CONTACT RESTORER
EVER-QUIET is a free-flowing liquid that leaves no powder residue. Scientifically designed to seep around the shaft and penetrate the control or potentiometer, cleaning the contacts and leaving a safe protecting film. Harmless to metals, wire or carbon.

Also available— 6 oz. Spray can \$1.59 net
32 oz. containers

2 oz. Bottle & dispenser 79c net



CHEMICAL ELECTRONIC ENGINEERING, INC. Matawan, New Jersey

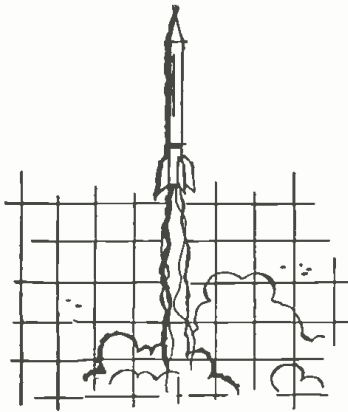

*Technicians—
you can
be a
computer
specialist
with*
Burroughs

The dynamic field of integrated Data Processing for Military Weapons Systems at BURROUGHS Military Field Service Division offers you that fine career which will challenge your full potential...will advance you to engineering status through work on important long-range ATLAS and SAGE programs...give you recognition and reward in the field of the future: Digital Computation.

Qualified applicants will receive: 1) 8 to 22 weeks' classroom training in Data Processing Systems. 2) Starting salary commensurate with experience and ability. 3) Full salary while training. 4) Excellent fringe benefits including educational assistance program. Current field assignments include far-West and Western areas after your training is completed.

If you are a graduate of an accredited Technical School and/or have military training in radar or communications equipment, plus at least 2 years' experience in electronics, you are invited to address your inquiries to Mr. R. F. Johnson, Department 2358, Military Field Service Division, Burroughs Drive, Radnor, Penna. (A suburb of Philadelphia).



Burroughs Corporation
"NEW DIMENSIONS/in computation for military systems"

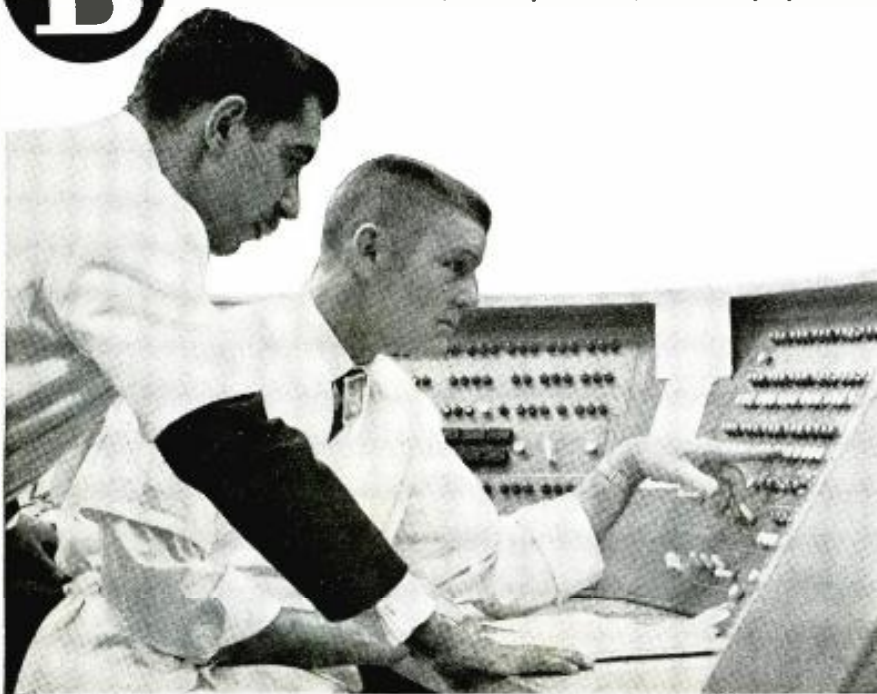

TEST INSTRUMENTS

a higher setting according to the output voltage expected. Throw adapter test switch to OUT and again note the vtvm reading. Record this as E2. Voltage gain is then equal to $E2/E1$. Decibel gain is equal to $20 \log E2/E1$.

Noise and Hum Test:

Throw test switch to IN and set oscillator output for the desired input signal level as read on the vtvm. Move the vtvm range switch to a higher setting. Throw the test switch to OUT and note the output voltage as E1. Disconnect the oscillator from the adapter. If the test is to be made with input terminated, connect the required load resistor to the AUDIO IN binding posts. Set the vtvm range switch to read hum and noise voltage and note this as E2. This is the noise voltage below the output signal voltage. To convert this to decibels it will be equal to $20 \log E1/E2$.

Most noise and hum originates in the first stage of an audio circuit. It is often helpful to know its value at the input grid. This can be done by first measuring gain as already described, then measuring the output hum and noise level as just explained. Hum and noise voltage referred to the first grid will be equal to $E2/\text{antilog } db/20$, where db is the overall gain and E2 the output noise voltage.

Frequency Response:

The output of some audio oscillators is not constant at all frequencies. For audio response measurements this would necessitate two vtvm's, one at the input and one at the output, or repeatedly connecting and disconnecting a single meter. With the adapter unit, just flip the test switch to IN and OUT to check voltage levels at each test frequency.

Distortion Measurements:

Here the adapter is used simply to check the desired signal levels at the amplifier or overall audio system input and output when making distortion tests with a scope or distortion analyzer.

Oscillator Check:

When making very low distortion measurements, it is sometimes desirable to ascertain if the measured distortion is contributed by the audio system or is in the oscillator itself. The test switch, after checking an amplifier or complete audio circuit, may be thrown to the osc position to check, directly, the distortion of the oscillator.

Bal-Unbal Switches:

These switches provide for either balanced or unbalanced conditions of the input and output of the audio system being tested. When thrown to the UNBAL position, the input or output or both may be connected to common ground. In the BAL position the common ground is removed.

Since the physical size of the Qwik-Test Adapter is quite small, it may be used both on the test bench or carried as an accessory test item in the service technician's tool kit. END

GET *more!* DO *more!* MAKE *more!*

PROFIT PROFESSIONALLY ON EVERY CALL WITH

NEW



LOW-COST PROFESSIONAL Model 550 DYNA-QUIK

DYNAMIC MUTUAL CONDUCTANCE TUBE TESTER

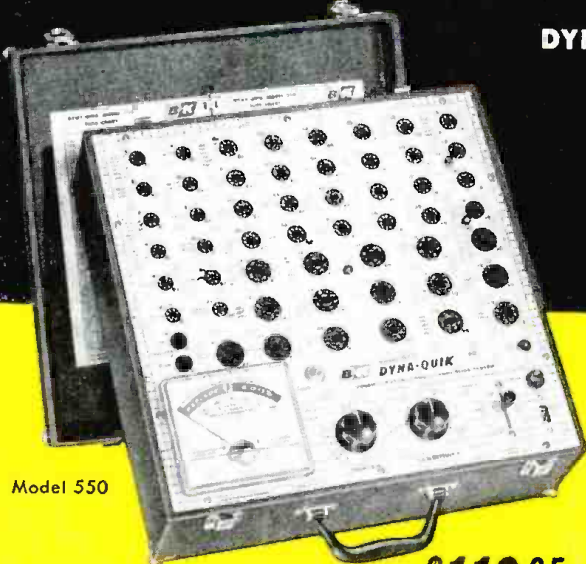

Model 550

NET \$119⁹⁵

MODEL 550 DYNA-QUIK TUBE TESTER

Tests Each Section of Dual-Section Tubes Separately

Great new value in professional quick-check at small cost. Provides more tube sockets to test more tubes faster. Accurately checks most of the TV and radio tubes usually encountered in everyday service work. Tests each section of dual-section tubes separately. Measures true dynamic mutual conductance. Checks tubes for shorts, grid emission, gas content, and leakage. Completely tests each tube in seconds, checks average TV set in a few minutes, in home or shop. One switch tests everything. Fast, convenient reference listings on socket panel. Patented circuit provides automatic line voltage compensation. 7-pin and 9-pin straighteners on panel. Handsome, luggage-type carrying case. Net, \$119⁹⁵

MODEL 650 DELUXE DYNA-QUIK

Today's Finest Portable Tube and Transistor Tester

Accurately checks over 99% of the tubes most widely used in television receivers, plus popular home and portable radio tubes. Tests over 600 tube types. Lists over 125 most popular tube types, with settings, on socket panels for maximum operating speed. Complete listing in fast, index-type selector. Measures true dynamic mutual conductance. Tests each section of multiple tubes separately for GM, Shorts, Grid Emission, Gas Content and Life. Includes 16 spare sockets and ample filament voltages for future new tube types. Transistor Section checks transistors, diodes, and selenium rectifiers. Luggage-type carrying case. Net, \$169⁹⁵

Every service-technician now can easily check tubes the B&K professional way! Only with a *genuine dynamic mutual conductance tube tester* can you make a complete and accurate test under the actual dynamic operating conditions of the TV set. The compact new "550" is not just an emission checker. *It completely checks more tubes faster—with laboratory accuracy.* And the cost is so amazingly low, it pays its way over and over again! Take a tip from thousands of professional servicemen—use B&K Dyna-Quik. There is nothing like it.



Get More for Your Money

—IN SPEED, ACCURACY, AND VALUE



Save Customers

—SAVE CALL-BACKS, SAVE COST



Sell More Tubes

—MAKE MORE MONEY PER CALL



Model 650



B&K MANUFACTURING CO.
1801 W. BELLE PLAINE AVE • CHICAGO 13, ILL.

Canada: Atlas Radio Corp., 50 Wingold, Toronto 10, Ont.
Export: Empire Exporters, 277 Broadway, New York 7, U.S.A.

See Your Distributor or Send Now for Bulletin ST24-E



BETTER YET, USE A SPIRAL

By TOM JASKI

If you have ever been fascinated by a kaleidoscope, the tube with the bits of colored glass and mirrors, you are about to meet an electronic gadget which has the kaleidoscope beat hollow. It is the spiral sweep generator described here which can make so many fascinating patterns on a scope that I could fill a whole issue of the magazine with scope patterns without once repeating myself.

As it is, I can show only a few and let you find the others when you build it. Let me warn you, if you're a TV fan, you'll miss some of your favorite programs once you have this sweep generator on your bench!

But don't assume the device is a mere toy! It's a very versatile and useful tool, with many applications in electronics and elsewhere. Some of these uses will be described and, as you will easily see, there are more than we can list.

First, the gadget. Fig. 1 is the complete schematic. It is really pretty simple. The required inputs are a pure sine wave of a few volts and a sawtooth voltage also of a few volts, but preferably as much as 15. For the sawtooth voltage, V1 is a cathode follower, and for the sine voltage a simple amplifier with some current feedback. Both the sine and sawtooth waves are applied to a modulator made up of two 6AL5's.

Here is the only tricky part of the gadget. The sawtooth is supplied through a transformer to isolate it. Not all transformers can be used without distorting the sawtooth. To keep distortion to a minimum I use a transformer with a minimum of iron, which turned out to be a transistor driver transformer, 10,000-2,000 ohms impedance, using only half of the little transformer's secondary. This is good from 10 to 20,000 cycles, sawtooth voltages.

Also at the modulator is potentiometer R29. It supplies a positive bias to the modulator and lets you make the patterns perfectly symmetrical. Some of the patterns shown here are asymmetrical because they were photographed before I got the balancing pot in place.

From the modulator one voltage goes to cathode follower V5-a, then to amplifier V6-a and out to the scope's horizontal amplifier. This particular voltage is destined for the horizontal amplifier because it is about twice as large as the voltage we now come to.

From the modulator we also apply a modulated voltage to V4, a wide-band phase shifter, capable of shifting a voltage by 90° over a range of 30-

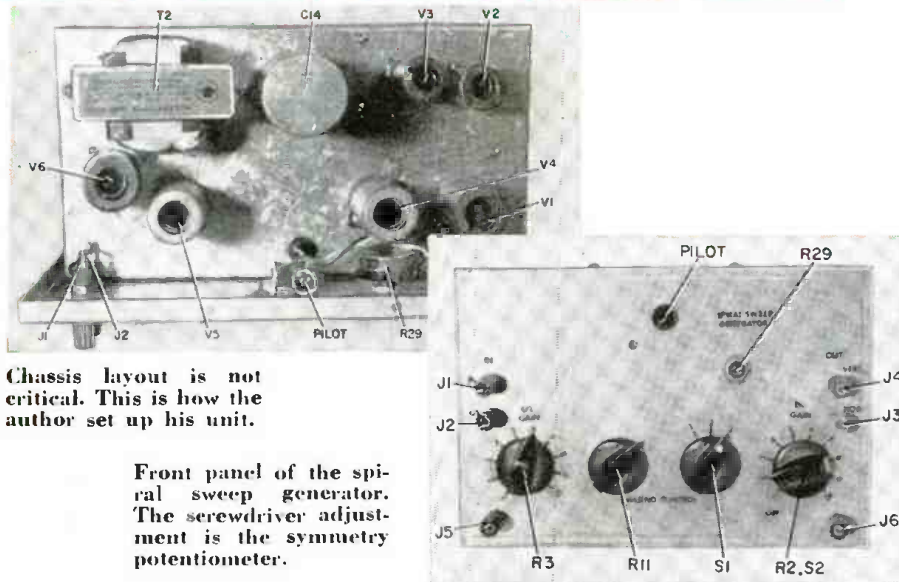

Chassis layout is not critical. This is how the author set up his unit.

Front panel of the spiral sweep generator. The screwdriver adjustment is the symmetry potentiometer.

A terminal board for the smaller components reduces crowding under the chassis.

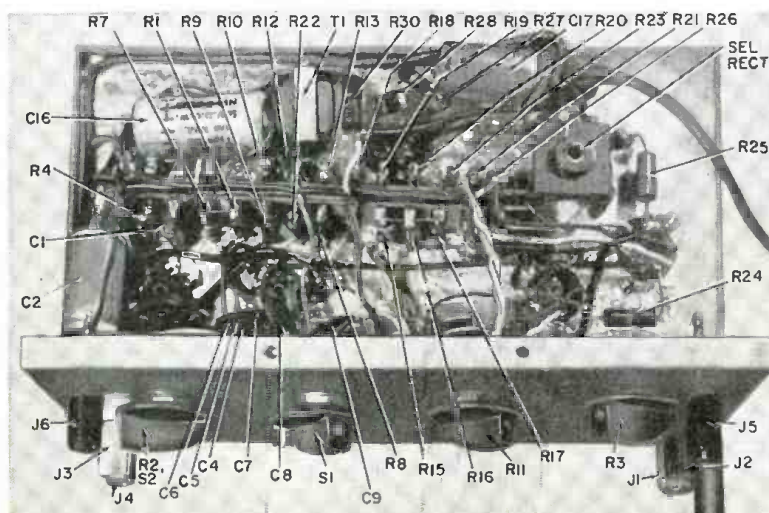

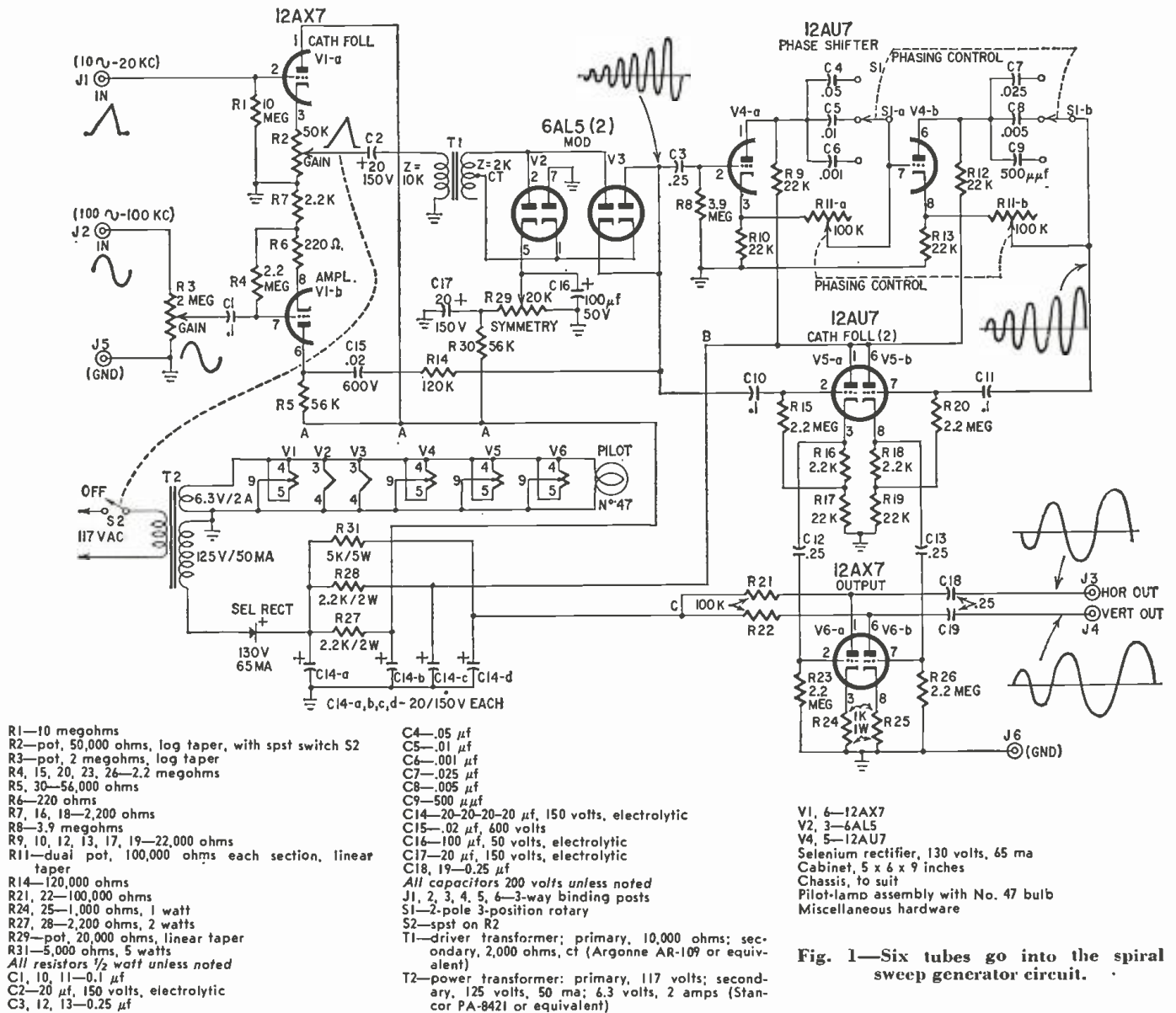

Fig. 1—Six tubes go into the spiral sweep generator circuit.

200,000 cycles in three steps. What's more, it is designed so it will accept a voltage with a varying frequency over a 20% range and will shift this 90° with surprising accuracy over its entire frequency range.

There are simpler phase shifters, such as the one shown in Fig. 2, but they must be adjusted carefully for each frequency. The phase-shifted voltage now goes through a cathode follower, half of V5, and then to an amplifier, half of V6, and from there to the scope's vertical amplifier.

Now what have we? We have two sine waves, 90° out of phase. Both grow at the rate set by the sawtooth voltage. Two sine waves at 90° shift would make a perfect circle. Making them grow at a constant rate, as you can see in the scope patterns, turns the circle into a spiral.

Construction kinks

The generator's construction is entirely conventional. It could probably be made into a printed circuit with

some advantage, but this prototype is so interesting to fool with that I haven't had time to design a printed circuit for it. As you can see from the photos, the majority of the resistors and capacitors are mounted back to back on two terminal strips, which keeps the affair relatively neat and the parts rigidly in place. One enthusiastic viewer tripped over a power cord, knocking the instrument to the floor without affecting its performance. The chassis is made from a piece of 26-gauge galvanized iron, because it is easy to work. The cabinet is a 5 x 6 x 9-inch utility box. Parts layout is entirely optional. If you feel you can make a better layout, by all means do so. I found it necessary to shield all the tubes. They operate at a relatively low voltage level—vertical output is about 2 volts (after amplification) and horizontal output about half that.

How to use it

Fig. 3 shows the setup used to make the oscillograms shown. At the extreme

left is a 3-inch Heath scope with a 35-mm camera. The camera has a fast lens, and I used Kodak Tri-X film, also very fast, sometimes resulting in pictures which are a little overexposed but which let you catch very faint patterns. The scope has a dark-green cover over its screen to eliminate stray light. The shutter speed used was 1/10 second in all cases. The important part of the scope setup is the exclusion of outside light. For this I used a couple of cans, painted flat black on the inside.

Just to the left of the scope is the spiral sweep generator. On top of it

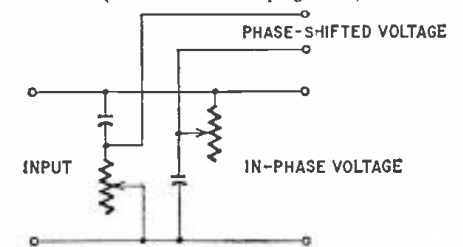

Fig. 2—Simple phase-shifting network



SELL THE ANTENNA LINE THAT HELPS YOU SELL!

Cash in on...

Winegard's

... the Industry's Greatest

SEE the big-name TV stars such as ★ Ward Bond of "Wagon Train" ★ Walter Brennan of "The Real McCoy's" and other TV stars promoting Winegard Color'Ceptors!

SEE Winegard's advertising in a non-stop, big-space schedule in LIFE, Better Homes & Gardens, others, *ALL YEAR LONG!*



GET FREE PROFIT-MAKING SALES AIDS
GET Winegard's new "PROMOTION BUCKS"! Given to you free with every Color'Ceptor you buy. You use them for getting your own choice of the finest sales promotion aids anyone has ever offered — knock-out sales helps that hitch your business to the giant national sweep of Winegard's *BIG TV SHOW TIME!*

SEND THIS COUPON TODAY!

WINEGARD CO.
3013-10 Scotten, Burlington, Iowa

RUSH full color brochure showing Winegard's new antenna dealer sales aids . . . and tell me how I can get them free!

Send literature on Winegard's complete line of FM and TV antennas.

FIRM NAME _____
ADDRESS _____

Sell the Winegard Color'Ceptor, the only antenna that's **GUARANTEED** to give your customers the **BEST** reception — In the rare event, a customer of yours is not satisfied — Winegard will refund the list price of the antenna and **YOU KEEP YOUR FULL PROFIT.**

Talk to your Distributor or send coupon for the whole story.

FEATURE THE LEADER AND BE ONE!



Winegard Co.

3013-10 Scotten, Burlington, Iowa

As Advertised in



Year-round big-space national advertising featuring big name TV stars.

For best TV reception Winegard Gold Antennas

Big gold balloons for the kiddies.

OUT WHERE THE SALES BEGIN



ColorCeptor full-color mailing piece and full-color postcards for your direct mail program.



Special window decals.



DEALER'S NAME & ADDRESS GO HERE

Giant 6 foot 3-color metal road sign imprinted with your name.

Unlimited 50-50 co-op on local newspaper and radio advertising.

BIG TV SHOW TIME!

All-Out Antenna Profit Drive!

INSIDE YOUR STORE



Colorful window streamers.



"Antenna Specialists" Shirt Emblems.



Attractive silk wall banners.

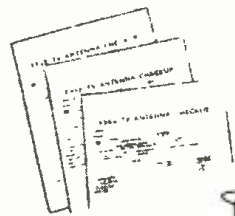

Antenna check-up sheets.



Gold anodized sample to hand out on service calls.



Illuminated plastic window sign.

New ColorCeptor display with gold anodized mast.



DEALER NAME
Hanging store front sign imprinted with your name.

OUTSIDE YOUR STORE

Eye-catching metal flange sign



Special truck decals.

ALL THESE SALES AIDS FREE - Ask Your Distributor

FIX ANY TV OR RADIO ever made!

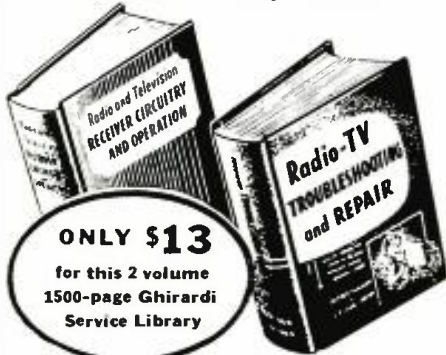

COMPLETE TRAINING

FOR BETTER RADIO-TV SERVICE JOBS

These two giant Ghirardi home training manuals make it easy for you to be an expert on ALL types of TV-AM-FM service . . . at only a fraction of the price you might expect to pay for such complete training. Almost 1500 pages, over 800 clear illustrations and dozens of procedure charts explain each detail of every service job as clearly as A-B-C. Each book contains up to the minute data. Each is based on approved professional methods. You learn time-saving shortcuts. You learn to work better, more profitably. Ideal as complete training for beginners or as a handy reference library for experienced servicemen who want to look up puzzling jobs or develop new and faster methods.

A complete guide to TROUBLESHOOTING & REPAIR

① This 820-page **RADIO & TV TROUBLESHOOTING AND REPAIR MANUAL** guides you through each service procedure . . . from locating troubles to making repairs fast and right. Step-by-step charts cover practically every type of troubleshooting from Television Problems to AM and FM re-alignment to IF and Detector Sections, car radios, record players, communications receivers, etc. 417 illustrations. Price \$7.50 separately. (Outside U.S.A. \$8.00.)

The complete "know-how" of SET CIRCUITS & OPERATION

② Learn all about circuits and their peculiarities and watch your service "headaches" disappear! This 609-page **RADIO & TV RECEIVER CIRCUITRY AND OPERATION** manual covers all basic circuits and circuit variations used in modern home equipment; explains their likely trouble spots; teaches you to go right to the seat of trouble without useless testing; helps you develop fast, truly professional service techniques. Price \$6.75 separately. (Outside U.S.A. \$7.25.)

SAVE \$1.25—Pay As You Learn!

It sold as a course and sent to you in lesson form, you'd regard these two famous manuals as a bargain at \$75.00 or more. Instead, you buy them complete in handy book form for only \$13.00 for the two (regular price \$14.25). You save \$1.25 . . . and you have 3 months to pay if desired. No lessons to wait for! Everything is at your finger tips. You learn fast . . . and you learn right! OUR MONEY-BACK GUARANTEE PROTECTS YOU!

STUDY 10 DAYS FREE!

Dept. RE-119, RINEHART & CO., Inc.
232 Madison Ave., New York 16, N.Y.

MONEY-SAVING OFFER ON BOTH BOOKS!

Send **RADIO & TV TROUBLESHOOTING AND REPAIR** and **RADIO & TV RECEIVER CIRCUITRY & OPERATION** home training manuals for 10-day free examination. If I decide to keep books, I agree to pay \$13.00 (plus postage) for the two . . . a saving of \$1.25 over the regular price of \$14.25. I will pay \$4 (plus postage) after 10 days and \$3.00 a month thereafter until \$13.00 has been paid. Otherwise I will return books and owe you nothing. (SAVE! Send \$13 with order and we pay postage. 10-day money-back guarantee if you're not more than satisfied.)

Name.....

Address.....

City, Zone, State.....
(Outside U.S.A.—\$14.00 for both books. Cash with order only, but same return privilege with money refunded.)

TEST INSTRUMENTS

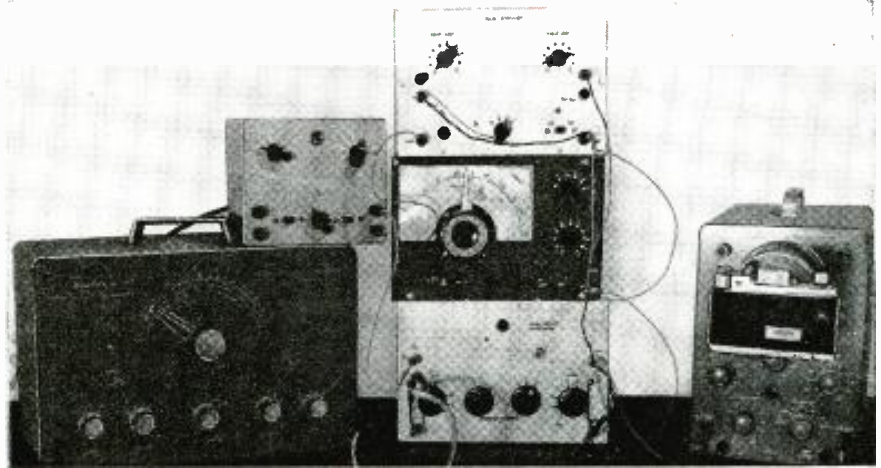
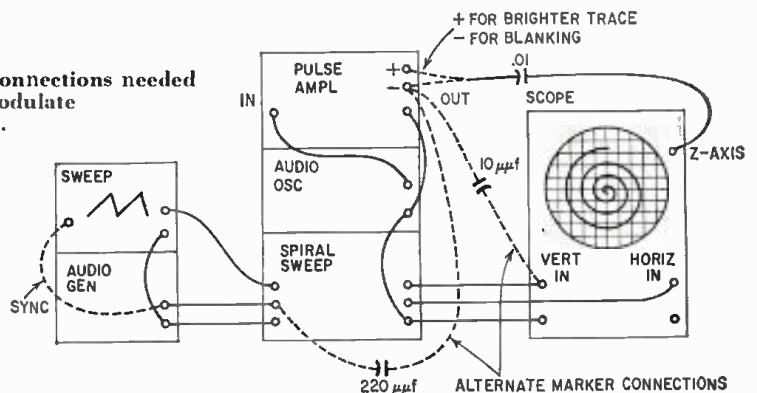

Fig. 3—Setup used to make oscillograms (left to right): sine-wave generator with sawtooth generator atop it; spiral generator, audio oscillator and differentiating amplifier one on top of the other, 3-inch scope with camera.

Fig. 4—Interconnections needed to mark or modulate spiral patterns.



(Continued from page 89)

is a small audio oscillator which is used for Z modulation through the differentiating amplifier shown on top of the oscillator. This is the differentiating (pulse-making) amplifier described in "You Can Measure Phase Shift," RADIO-ELECTRONICS, September, 1958. To the left of the three stacked instruments is a Heath audio generator, with a small sweep generator on top of it. This is the sawtooth source I used. (See "Simple Super Time Base," page 61, January, 1959 issue.) Any good sawtooth source will do. The Heath generator supplies the sine wave, the sawtooth generator the modulating voltage. The audio oscillator provides a square-wave voltage which is differentiated into sharp pulses and fed to the scope's Z-axis terminal or to one of the scope amplifiers, either horizontal or vertical, or even to the sine-wave input terminal. Fig. 4 is a block diagram of how it can be connected.

We've got patterns

Let's look at some of the patterns produced. As I mentioned, these are only a fraction of the possibilities, as you will soon find out.

Fig. 5 shows some unmodulated patterns. As I mentioned, the lack of symmetry is because I didn't have the symmetry-adjusting pot R29 at the time. Fig. 5-a shows a spiral from a 1,000-cycle sine wave and a 160-cycle saw-

tooth, almost 6 turns. Fig. 5-b shows a 100-cycle sine wave swept at 10 cycles per second. The importance of this slow pattern is discussed later. Fig. 5-c is a 10,000-cycle sine wave swept at 435 cycles, giving 23 turns. Unfortunately, the film is overexposed in the center. The inside turn as viewed with the eye is about 1/8 inch in diameter. I didn't adjust the scope's amplifiers carefully enough to keep the pattern circular, I was looking through a small peep-hole in the camera mount and could not see all the screen (the hole is bigger now!). Fig. 5-d shows an 80,000-cycle sine wave swept at 20,000 cycles, about the top limit of the generator as far as sweep frequency is concerned.

These patterns point up the first practical use of the generator. The number of turns in the spiral shows the exact ratio between the sweep and the sine-wave frequencies. If either is known, the other can be determined simply by counting the number of turns and multiplying or dividing the known frequency by the count. This is one of the reasons why the return sweep, which shows up as a straight line, was not blanked out. It also provides a starting point to measure traversed angle of the trace with a protractor.

The modulated patterns of Figs. 6 and 7 show some other uses. In Fig. 6-a the pattern is modulated with a pulse of the same frequency as the sine wave, producing what is in effect a vector representation. You can easily

TEST INSTRUMENTS

reverse the modulation (as I have done in some patterns shown) and make the spiral very dim and the "vector" very bright. For this you use a positive pulse, whereas Fig. 6-a was modulated with a negative pulse.

If you have a many-turn spiral (see Fig. 5-c) and show the "same-frequency" modulation, you will for all practical purposes show a continuous-line vector. You can make this vector rotate if you vary the frequency of the pulse oscillator a little or if you vary the frequency of the sine oscillator. The rate at which the vector rotates shows the difference in frequency of the pulse and sine-wave oscillators. The rotating vector looks for all the world like a sweep second hand and this can be one of its uses, to mark time. By photographing the vector position twice, a time interval can be measured—up to as much as you want, depending on the speed of the vector.

Fig. 6-b shows a similar modulation with a frequency three-quarters that of the sine wave. As you can see, you travel along about three-fourths of a turn before meeting the next blanked point.

Figs. 6-c, d and e are examples of
(Continued on page 96)

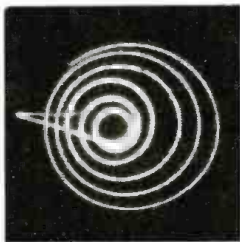

Fig. 5—Unmodulated spiral patterns:

a — 1,000-cycle sine wave, 160-cycle sawtooth;

b — 100-cycle sine wave, 10-cycle sawtooth;

c — 10,000-cycle sine wave, 435-cycle sawtooth;

d — 80,000-cycle sine wave, 20,000-cycle sawtooth.

MERCURY TUBE TESTERS ARE RATED #1 BY SERVICEMEN EVERYWHERE ...

Model 101 TUBE TESTER SPECIFICATIONS

- Checks emission, inter-element shorts and leakage of over 700 tube types. This includes OZ4s, series-string TV tubes, gas regulators, auto 12-plate-volt tubes, hi-fi and foreign tubes.
- 3 settings enable a test of any tube in less than 10 seconds.
- Employs dynamic cathode emission test principle.
- 3 1/2" D'Arsonval type meter—most accurate type available... its greater sensitivity means more accuracy... its jewel bearing means longer life.
- 17 long lasting phosphor bronze sockets.
- Combination gas and short jewel indicator.
- 9 filament positions.
- Handy tube chart contained in special back compartment.
- New tube listings furnished periodically at no cost.
- Size: 9" x 8 1/2" x 2 3/4".



Model 101 \$3995
Dealer Net

PLUS THESE BONUS FEATURES . . . FOUND IN NO OTHER LOW PRICE TUBE TESTER

- ✓ Checks for cathode to heater shorts
- ✓ Checks for gas content
- ✓ Checks all sections of multiple purpose tubes . . . will pickup tubes with one "Bad" section
- ✓ Line isolated—no shock hazard
- ✓ Variable load control enables you to get accurate results on all tubes
- ✓ Positively cannot become obsolete as new tube types are introduced

CRT ADAPTER AVAILABLE FOR MODEL 101 . . . \$3.95 Dealer Net

Model 201-F SELF SERVICE TUBE TESTER

COMPARE THESE FEATURES WITH ANY SELF-SERVICE TUBE TESTER MADE BY ANY MANUFACTURER AT ANY PRICE

- Checks quality (emission, shorts and gas) of over 800 tube types, covering over 99% of all TV and radio tubes in use today, including the newest series-string TV tubes, OZ4s, one volt tubes, magic eye tubes, hi-fi and foreign tubes.
- Cannot become obsolete as circuitry has been engineered to accommodate new tube types as they are introduced.
- Completely self-service . . . just two settings are required to test a tube in less than ten seconds.
- Checks each section of multi-purpose tubes.
- Tests all 6 and 12 volt standard auto radio vibrators.
- 46 long lasting phosphor-bronze beryllium sockets.
- Handy push button fuse can be reset manually—never needs replacement.
- Attractive red and hammer-tone gray durable metal cabinet.
- Tube compartment with own lock holds over 400 tubes.
- Tube storage drawers with tube carton dividers and drawer sheets provide for automatic inventory control.
- Takes only 19"x19" of floor space. Stands 6'1" high.
- Large seven inch easy-to-read meter is extremely sensitive yet rugged—is fully protected against accidental burn-out.
- Etched aluminum panel always retains its handsome appearance.
- The most complete tube chart in the field lists over 800 tube types.
- New tube listings are furnished periodically at no cost as new tubes are introduced.
- Handy tube substitution guide included with each tester to prevent lost sales due to out of stock tube types.
- Colorful window streamers supplied with each tester to attract customers.
- An illuminated colorful plastic display tops the cabinet—designed to attract attention.
- Shipped in one carton completely assembled.



Model 201-F (floor model) \$15850
Dealer Net

ALSO AVAILABLE Model 201-C (counter model) \$10950
Dealer Net

See your local electronic parts jobber NOW or write Dept. 1001 TODAY for literature . . .

MERCURY ELECTRONICS CORP.
manufacturers of quality electronic products 77 Searing Ave., Mineola, N. Y.



STOP!
Demand the finest in Electronic Test Equipment—EMC, of course. You get the most quality per measurement dollar!

NEW! EMC Model 301 Speedi Tube Tester

Checks tubes in seconds. Checks shorts, leakages, and quality. Over 375 tubes, including OZ4, now listed. New listings available. Checks and rejuvenates Picture Tubes with Model PTA (Picture Tube Adaptor), at only \$4.50. Model 301P (illustrated).



with 4½" meter & oak, Carrying case\$47.50
Kit 33.20
Model 302C, (with 7½" meter) 62.90
Kit 47.90



NEW! EMC Model 108 Handi Tester

The only appliance and auto battery tester in its price class to use a D'Arsonval, instead of an iron vane type meter. Gives exclusive advantages of maximum accuracy and scale length, and minimum battery replacement cost . . . at no added charge. Complete with test leads and instruction manual.

Wired\$15.95 Kit 12.95

NEW! EMC Model 905-6A Battery Eliminator, Charger, and Vibrator Checker

A MUST for auto radio service. Features continuously variable voltage output—in either 6 or 12 volt operation. Checks all 6 or 12 volt vibrators.



Wired\$67.90 Kit 44.90

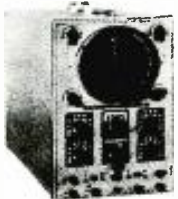

NEW! EMC Model 601, Wide Band Oscilloscope for Color & Monochrome TV

Features full 5 mc band with push-pull vertical amplifier with sensitivity .02 volts per inch, retrace blanking amplifier for clearer pictures, and multivibrator sweep from 15 cycles to over 75 kilocycles. Wired and tested ..\$117.90

NEW! EMC Model 206P Dynamic Mutual Conductance Tube Tester

The lowest priced mutual conductance tube checker on market. Checks tubes for microhmo value and gas content. Completely flexible switching. Your best buy in a quality tube tester. (Hand rubbed Carrying Case)\$83.50



Yes, tell me more, send me—FREE— a detailed catalog of the complete EMC line. RE-119

NAME _____

STREET _____

CITY _____ STATE _____

EMC Electronic Measurements Corp.
625 B'way • New York 12, N. Y.
Ex. Dept. 370 B'way, N. Y. 13

TEST INSTRUMENTS

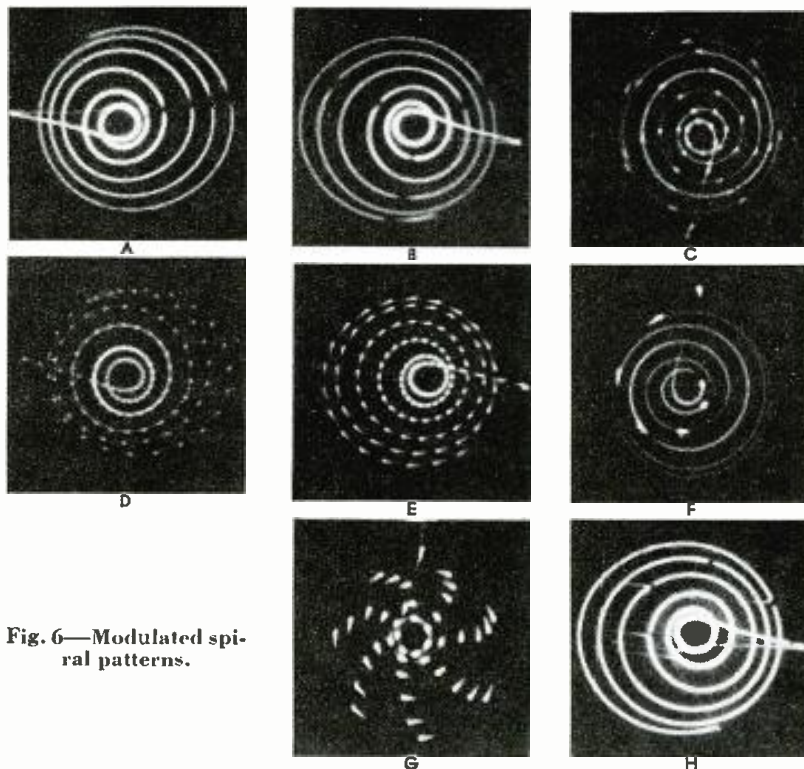

Fig. 6—Modulated spiral patterns.

(Continued from page 93)

positive modulation pulses at various frequencies. In Fig. 6-e, pulse width was made greater to show more light. Thus you can divide the spiral in parts which are exactly equal in time and, as you will find, represent an equal angle of rotation. Figs. 6-f and g are examples of a class of "pinwheel" pattern which have a very particular use, besides being frequency measuring devices.

They are produced by modulating the spiral with a frequency submultiple which is not quite a whole integer. In other words, almost a third, almost a fifth, etc. You will easily find them by changing (slowly!) the frequency of your modulating source. The patterns, when rotated slowly in one direction or the other but, as shown in Figs. 6-f and g, particularly counterclockwise, are extremely hypnotic and can induce a light trance in a viewer in a very short time. Be careful, you are also a viewer! The action is the result of the apparent concentration of the traces toward the center of the image, making the viewer concentrate on a point, one typical hypnotic method. The quality of its hypnosis-inducing ability depends on the speed with which it rotates. Here we have another interesting effect. With the trace "rotating" at the proper speed,

you may see pink, blue, yellow and all the other colors of the rainbow on the scope screen, even though the trace is only bright green. It is the result of the nature of the retina in the eye.

I told you this would be fun!

Something else of interest with the pinwheels (or any rotating patterns). When you have adjusted the spiral for roundness with the phasing control and have the pattern "rotating" in one direction, at a number of frequencies (within the range of phasing) you can turn the whole pattern sideways and actually see the modulation as on the edge of a wheel, continue to turn the whole pattern over (giving it a three-dimensional appearance) and find that the flopped-over pattern actually rotates in the opposite direction, as you would expect from a mechanical pinwheel!!!

If you apply the pulse from the modulating oscillator through a small capacitor to the scope's horizontal amplifier, you get the pattern shown in Fig. 6-h. Applied to the vertical amplifier, you'd get the same thing, but rotated through 90°. Figs. 7-a, b and c show some patterns now familiar, but they are of interest because they were made with a 100-kc sine wave, which points up the instrument's wide range.

The spiral itself, without modulation, can be made to rotate by making the



Fig. 7—Spiral patterns modulated at 100,000 cycles.

page ads in the nation's top magazines tell the story!

The New JERROLD TV-FM RECEPTOR* Ends Rabbit Ears!



the first
really small
really powerful
TV-FM antenna

**the new antenna that
hides while it works!**

Model TVR **\$5⁹⁵** List

- No gadget or unproven gimmick . . . it's guaranteed by Jerrold Electronics Corporation.
- No more rabbit ears cluttering up the top of the TV set!
- Even eliminates outside antennas in many areas!
- Easy to install, slides over line cord of TV or FM set!
- Push button tuning for best reception . . . set it and forget it!
- Absolutely safe . . . uses no electricity!
- Designed for VHF, UHF, Color and FM!
- Handsomely packaged in a self display unit. Priced to sell fast!

JERROLD

Contact your Jerrold Distributor or Write:

*Trade Mark

Patent Pending

ELECTRONICS CORPORATION *Distributor Sales Division*

Dept. PD202 The Jerrold Building • Philadelphia 32, Pa.

Jerrold Electronics (Canada) Limited

Export Representative: CBS International, New York 22, N. Y.

**COYNE offers
LOW COST
TELEVISION**
Training in
Spare Time **AT HOME**

The future is YOURS in
TELEVISION—RADIO
COLOR TV!

A fabulous field—good pay—fascinating work—a prosperous future! Good jobs, or independence in your own business!



Coyne brings you MODERN—QUALITY Television Home Training; training designed to meet Coyne standards. Includes RADIO, UHF and COLOR TV. No previous experience needed. Practical Job Guides to show you how to do actual servicing jobs—make money early in course. You pay only for your training, no costly "put together kits."

Send coupon or write to address below for FREE Book

and full details including easy Payment Plan. No obligation, no salesman will call.



B. W. Cooke, Jr., President

Coyne — the Institution behind this training... the largest, oldest, best equipped residential school of its kind now in its new home pictured here... Founded 1899.

**COYNE
ELECTRICAL SCHOOL**

1501 W. Congress Pkwy., Chicago, Dept. 89-H5*
Chartered as an Educational Institution
Not For Profit

COYNE Television, Home Training Division
Dept. 89-H5—New Coyne Building
1501 W. Congress Pkwy., Chicago 7, Ill.
Send Free Book and details on how I can get
Coyne Quality Television Home Training at
low cost and easy terms.

Name _____

Address _____

City _____

State _____

(It is understood no salesman will call)

TEST INSTRUMENTS

sine wave a little more or a little less than a multiple of the sweep frequency.

Practical applications

Originally, I designed this instrument to investigate the possibility of scanning the action of alpha brain waves in mammals. What is planned is to synchronize the sweep with the alpha frequency, lock the sine generator in a multiple of that and then obtain the pulses from an optical nerve in a test animal. This would show a consistently recurring pattern when the animal views the same object, if the eye actually scans (sweeps) what it sees.

This work is still in progress, and not much can be said about it here. You're welcome to try it, if you don't commercialize the result, and if you will let me know what you discover!

Other practical uses are time-interval or frequency measurement, as we have indicated. And look at the range! With a spiral of 10 turns, at a 10-cycle sweep, the whole spiral represents 0.1 second. Now take the other end of the scale, a 100-ke sine wave. For this, each turn represents 10 microseconds. You can easily measure 5° with a protractor: 5° is 1/72 of a turn, or 0.14 microsecond. With a little careful measurement you can then use this to measure time from 0.1 second to 0.1 microsecond.

You can use it to induce a hypnotic trance. The patterns will also fascinate visitors for hours on end. Very entertaining! You can use the spiral, particularly a multiturn spiral with tight turns, to scan a negative or transparency. Pick up the modulated light with a photocell and reproduce the picture positive or negative, on another scope screen. If you want to see what a picture will look like from a negative, this closed-circuit home facsimile system does the trick!

You can make photographic organ generators, and scan them with the C-R tube. For this use, make patterns on a transparent medium—plastic, acetate or something similar—and again pick up the scanned signal with a phototube. You could make all sorts of weird noises this way.

Of course, you could also turn this to a more practical use. For example, scan transparent information discs to provide data for automatic machine-tool operations.

You could build a scanning disc which would compare holes punched in a card with a secret combination of holes for identification purposes. The information could be stored in any other form for comparison, for example on tape. Coincidence gates would set up alarms or register false identification in some way easily visualized.

In fact, anything which can use a simple scanning idea is a prime candidate for this little device. There are many other uses. Think how you could use it to put the children to sleep. So you look at it to adjust the pattern, and look at it, and you are getting sleeeeepy, very sleeeeepy. END

**NEW! sensation
of
TWO
hi fi
shows**

If you're a stereo connoisseur with a limited budget, you deserve the sensation of the New York and Chicago high fidelity shows: the superb new ESL C-99 Micro/flex stereo cartridge.

Years of advanced transducer technology have culminated in a cartridge which equals the astonishing performance specifications of the international stereo standard, the ESL C-100 Gyro/jewel.

Like the world-famed C-100, the new C-99 utilizes two patented D'Arsonval generating assemblies—the most linear transducer elements known. Instead of the C-100's jeweled separating elements, the C-99 pioneers the exclusive new Micro/flex frictionless molded coupling system.



The resulting cartridge is distinctly superior to everything except the ESL C-100 and P-100, yet costs only half the price.* At a mere \$49.50, the new C-99 is the lowest price ever for authentic ESL stereo superiority.



FOR LISTENING AT ITS BEST

**Electro-Sonic
Laboratories, Inc.**

Dept E • 35-54 36th Street
Long Island City 6, NY

*Net price for the C-100 is now \$100, and the P-100 is \$110, including transformers.

Transistors Control Lamp

By RUFUS P. TURNER

THIS simple transistor circuit (see Fig. 1) uses a small dc input to control a filament type lamp between complete darkness and maximum brilliance in this simple transistor circuit. The lamp's brightness is proportional to the dc input signal magnitude and control action is smooth.

The device, which takes up little room, can be used wherever the glow of a conventional lamp must indicate the relative strength of a dc signal which has only 1/40,000 of the power required to light the lamp to full brilliance.

A dc input of only 15 μa at 0.2 volt will bring the 2-volt 60-ma lamp in Fig. 1 to full brightness. The glow decreases at lower signal levels, and near zero input is extinguished. For

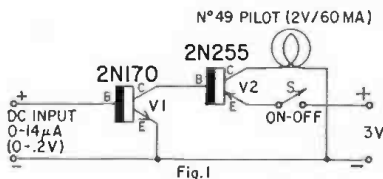

Fig. 1—Circuit of simple device.

greater brilliance than the No. 49 lamp provides, other small lamps (such as the 6-8-volt 150-ma type) may be used but will require correspondingly higher input signal levels. For 6-volt lamps, use a 7.5-volt battery in the control circuit. In one demonstration, the circuit's dc input terminals were connected to the diode output of a simple crystal radio. When the receiver was tuned to a strong local broadcast station, the lamp lighted brightly to indicate resonance. On each side of resonance, the dimming of the lamp was proportional to the detuning, and at some distance on each side, the lamp went out.

A self-generating photocell connected to the dc input terminals will also operate the circuit. The lamp's brightness is proportional to the light falling on the photocell. Dimming of the lamp is proportional to the opacity of any object passed between the photocell and its source of illumination. A further use of the circuit is as a lamp type indicator for low-speed flip-flop transistor switching circuits in which the on current and voltage are too low to operate a neon lamp.

The circuit is a two-stage dc amplifier using one conventional transistor (V1) and one inexpensive power transistor (V2). Direct coupling between the stages eliminates the need for re-

(Continued on page 104)

Now used as original equipment by leading manufacturers

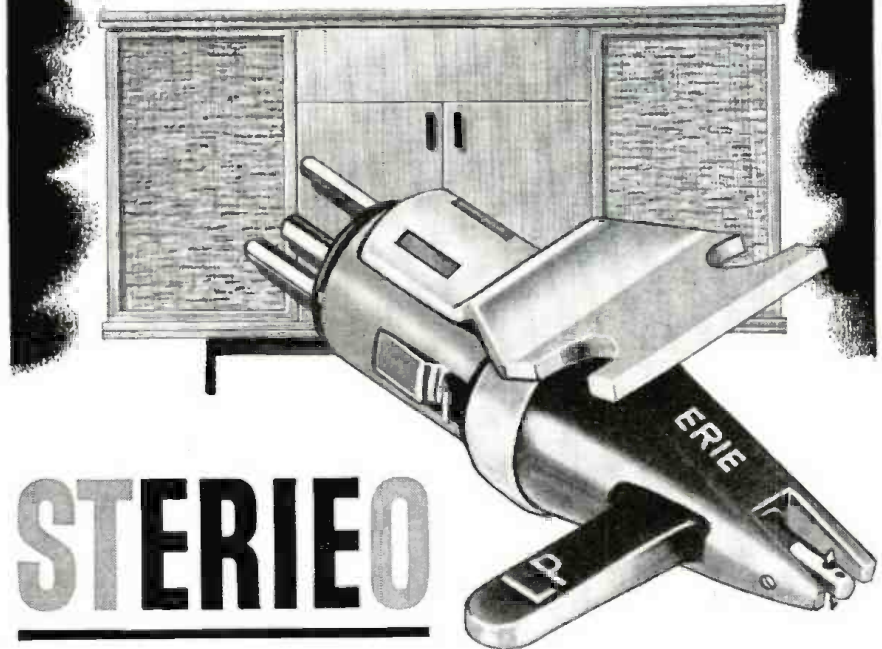

single-element STERIEO cartridge

Take a tip from the audio engineers who design packaged stereo sets. For your stereo work or stereo fun—replacement or conversion, specify the STERIEO ceramic cartridge.

There are good reasons why STERIEO is supplied as original equipment on the sets of several leading manufacturers. Balanced channel outputs are inherent in STERIEO's single-element design, and highly effective channel separation is assured by its unique insulator-conductor construction.

In engineering tests STERIEO's full frequency response delivers the full dimensional sound so important to a fine stereophonic system.

Ask for STERIEO at your electronic or audio parts store. Replacement unit as low as \$6.95 list, and conversion kit as low as \$8.95 list. (Dual stylus—sapphire/sapphire; diamond stylus slightly higher.)

For where-to-buy information write to:

ERIE Electronics Distributor Division
ERIE RESISTOR CORPORATION
 Erie, Pennsylvania

**This book is a GOLD MINE
Send for it . . .
*immediately!***

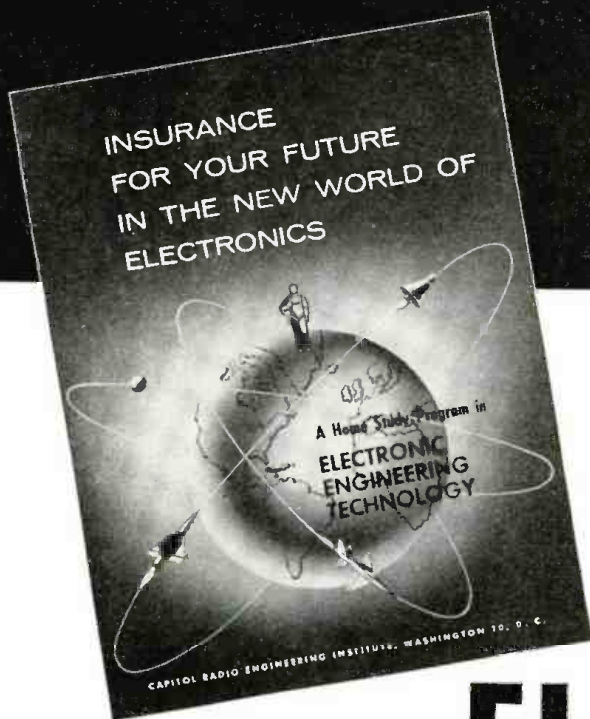

*Reveals how you can
gain quicker success
and assure a well-
paid career in . . .*

ELECTRONICS

**QUALIFY FOR A SECURE CAREER,
NOT JUST ANOTHER JOB.**

It's the "Age of Electronics!" Men with *advanced* technological knowledge are in crucial demand. But there's no place for the mediocre man. Why take chances with your future? Why not begin now to qualify for an *important* position next year—or even sooner?

**ELECTRONICS HAS GOOD PAYING JOBS
FOR QUALIFIED MEN!**

And only qualified men can fill them. You can get your share, if you take time now to gain indispensable advanced electronics knowledge.

"Many of the men currently on the street are there for a reason. As many as 8 out of 10 are deadwood," estimates the chief engineer of a medium-sized Philadelphia firm; "the problem is to find the live ones."

— From **ELECTRONICS MAGAZINE**

If you're interested in an honest-to-goodness career in the vigorous electronics industry, here's how you can step ahead of job-competition, move up to a better job, earn more money, AND BE SURE OF HOLDING YOUR TECHNICAL JOB, EVEN WHEN THE "DEADWOOD" IS BEING CLEANED OUT. Sure you have some experience. But the fellows with only partial electronics knowledge move slowly, or stand still while you—the man with advanced technical education—

plunge ahead in the golden world of electronic opportunities.

**BRAND NEW COURSE ADDED — AUTOMATION AND
INDUSTRIAL ELECTRONICS ENGINEERING
TECHNOLOGY**

A complete home study course covering all electronic phases of automation with special emphasis on the theory, functioning, and applications of servomechanisms and computers. Also noteworthy are the lessons on machine control, instrumentation, data-processing, and telemetry.

**FILL OUT AND MAIL
POSTAGE FREE CARD
FOR *FREE*
54 - PAGE BOOK...**

Z-3

IMPORTANT!



*Fill out
and mail this
Postage-Free
card today
(attached below)*

for your copy
of the fact-packed
CREI 54-page book

First Class
Permit No. 288-R
Washington, D. C.



W. O. D. C.

NOW! NEW COURSE ADDED TO CREI's VARIETY OF COURSES

Brand New Home Study Course

AUTOMATION

And Industrial Electronics Engineering Technology

FOR FULL DETAILS, CHECK THE APPROPRIATE LINE
IN THE COUPON BELOW.

Complete home study course, covering all phases of automation with special emphasis on the theory, functioning and applications of servo-mechanisms and computers. Also noteworthy are lessons on machine control, instrumentation, data-processing, and telemetry. A "must" for engineers and technicians seeking to enter this fascinating branch of electronic technology. Includes fundamentals of electronic engineering technology, leading to specialization in:

- Machine control systems
- Digital and Analogue Computers
- Data processing systems
- Servomechanism systems
- Instrumentation techniques
- Telemetry systems
- Industrial processes

MAIL THIS COUPON FOR FREE 54-PAGE BOOK!

CAPITOL RADIO ENGINEERING INSTITUTE

ECPD Accredited Technical Institute Curricula • Founded 1927

Dept. 1411-F 3224 Sixteenth St., N.W., Washington 10, D. C.

Please send me your course outline and FREE 54-Page Book "Insurance for Your Future in the New World of Electronics" . . . describing opportunities and CREI home study courses in Practical Electronic Engineering Technology.

- CHECK FIELD OF INTEREST
- Radar, Servo and Computer Engineering Technology
 - Electronic Engineering Technology
 - Broadcast (AM, FM, TV) Engineering Technology

Let us show you
how *advanced* education via CREI
leads to a bright career in . . .

**ELECTRONICS—AUTOMATION—
INSTRUMENTATION—INDUSTRIAL
ELECTRONICS—AERONAUTICAL
ELECTRONICS—GUIDED MISSILES—
SERVOMECHANISMS—COMPUTERS—
ASTRONAUTICS—TELEMETERING—
COMMUNICATIONS—MANUFACTURING**

ACQUIRE NECESSARY TECHNICAL KNOWLEDGE AT HOME

Use spare-time hours for CREI Home Study, as thousands of successful men have done since 1927. Get concentrated education in minimum time, then step into a good position and enjoy excellent pay in the solidly-growing electronics industry. CREI courses are being studied today on the DEW Line in the Arctic—in Alamogordo and in Munich—by electronics experts in guided missile development and by telemetering technicians on the missile ranges.

CREI TRAINS YOU IN MINIMUM TIME AT HOME

Thousands of men *before* you have benefited quickly from CREI Home Study. Thousands of CREI graduates are *now employed* in industry here and abroad. Here is what one graduate has to say:

"In the time of less than two years, I have almost doubled my salary and have gone from wire-man to engineering assistant and now to junior engineer. I have CREI to thank."

**Frank A. Eckert,
22 Clover Lane
Levittown, Pa.**

CREI OFFERS RESIDENCE COURSES at the same high technical level. Day and evening classes start at regular intervals. Qualified residence school graduates earn degree as "Associate in Applied Science" in 27 months.

If you have had electronic education, or experience in electronics—and realize the need of a high-level technical knowledge to make good in the better electronic jobs—you can qualify for CREI home study education. (Electronic experience is not required for admission to CREI Residence School.) Check card if you prefer residence or home study information . . . or write, Capitol Radio Engineering Institute, Dept. 1411-F, 3224 16th St., N.W., Washington 10, D. C.

Available to veterans under GI Bill.



for a career in

ELECTRONICS

CREI prepares you quickly for success . . . in advanced Electronic Engineering Technology, including Servomechanisms; Computers; Radar; Automation; Aeronautical Electronics; Broadcasting; Communications and Manufacturing; and the Electronic principles associated with guided missiles, telemetering, astronautics and instrumentation.

BENEFITS FELT RIGHT AWAY

Almost immediately, you feel the benefits of CREI study. Your employer, when informed (only at your request) of your step toward advancement, is certain to take new interest in you and in your future. What you learn in CREI Home Study can start helping you do a better job almost from the first lesson.

CREI HOME STUDY . . . QUICK WAY TO BOOST YOUR EARNINGS

Since 1927, CREI has given thousands of ambitious young men the technical knowledge that leads to better positions—better pay—greater security—promotions—better living for yourself and your family. CREI can help you, too—if you really want to be helped. CREI lessons are prepared by experts in easy-to-understand form. There is a course of instruction geared to the field in which you want to specialize. Study at your convenience, at your rate of speed.

INDUSTRY RECOGNIZES CREI TRAINING

CREI courses are prepared with an eye to the needs and demands of industry, so your CREI diploma can open many doors for you. Countless CREI graduates now enjoy important, good-paying positions with America's most important companies. Many famous organizations have arranged CREI group training for their personnel. To name a few: All America Cables and Radio, Inc.; Columbia Broadcasting System; Gates Radio Company; Federal Electric Corp.; The Martin Company; U. S. Information Agency (Voice of America); Trans-Canada Air Lines; United Air-Lines. You can follow the choice of these great corporations with confidence.

PAYS FOR ITSELF QUICKLY

Your very first raise could repay your investment in CREI education, and leave you a profit the very first year. Increases in pay thereafter are pure profit, and you'll be prepared for many more promotions and pay raises in the future.

AWARD WINNING
arkay
STEREO, HI-FI KITS

Presents with Pride

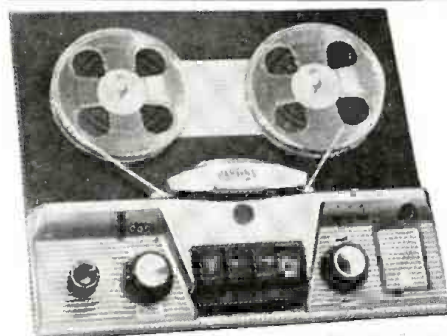

The ARKAY-HARTING MS-5
**STEREO RECORD
PLAYBACK
TAPE DECK**

LONG AWAITED... NOW HERE AT LAST!
A professional quality, popular-priced
stereo tape deck... **\$129⁹⁵**
only

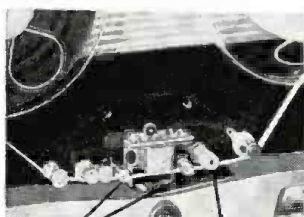

Metal guards control vertical tape alignment. Large capstan insures constant tape speed.

Precision-engineered to the highest professional standards... a supreme achievement in tape deck design and performance... the ARKAY/HARTING captures and records your favorite music with all the faithful clarity and smoothness of tape recorders costing many times more. Hailed by audio engineers and music lovers alike for its surpassing performance, simplicity of design and operation, the ARKAY/HARTING is the finest instrument of its kind. No other tape deck—regardless of price—offers so many important professional features. Here are just a few:

- Dual-track combination head (mu-metal shielded) for stereo at both 3¾ and 7½ IPS
- All-metal tape fingers—no cushions to wear out tape
- All-metal tape guards for vertical tape control
- Double shoe brakes for positive non-slip stops—minimizes tape stretch
- Simple, positive-acting 5-button operation, drop-in loading
- Large (½" diam.) capstan insures constant tape speed—virtually eliminates wow, flutter, distortion
- Automatic interlock prevents accidental erasure
- Ultra-narrow (1.2-microns wide) gap heads assure maximum fidelity during record and playback

... AND THESE SIGNIFICANT PERFORMANCE SPECIFICATIONS:

- Record and playback frequency response: 7½ IPS, 30-16,000 cycles ± 2 db.
- Signal-to-noise ratio: better than -55 db.
- Flutter and wow: at 7½ IPS, ¼ of 1%; at 3¾ IPS, ½ of 1%
- Rewind time: 110 seconds for 1200 feet
- Size: 12¼" x 14½" x 6¼" deep

Available Soon
NEW ARKAY Stereo Record and Playback PRE-AMPLIFIER in kit or pre-wired form, specially designed for the ARKAY Harting Tape Deck

Write today for illustrated literature and complete specifications

FM TUNER OF TOMORROW!

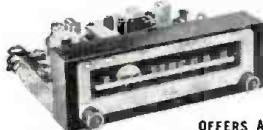

ARKAY FM-8

Designed in the Arkay tradition of highest professional quality at lowest cost. No other kit or wired component OFFERS ALL THESE ADVANTAGES:

Variable AFC — no drift • tuning meter • silent tuning mute control • "standby" off-on switch • low frequency filter • level control • 3 tuned RF stages • dual limiters • Armstrong FM — Foster Seeley discriminator • hi-level, cathode follower and stereo multiplex output jacks • sensitivity, 1.9 uV for 20 db quieting • response, 20-20,000 cps ± ½ db • 8 tubes, selenium rectifier.
Cover \$4.95

Wired and tested \$59.95, Easy-to-build Kit **\$39.95**

NEW! MUSIC MASTERPIECE



**ARKAY CS-28
STEREO
AMP/PRE-AMP
COMPLETE
CONTROL CENTER**

Full 28 watts stereo or monaural, 60 watts peak • 14 watts each channel • reverse stereo • balance control • two-channel gain control • full range bass and treble controls • IM distortion, 4 to 1 • harmonic distortion, 1% 30-20,000 cps • dual pre-amp 2V output jacks • speaker outputs, 4, 8, 16, 32 ohms • response, 20-20,000 cps • push-pull EL84 Williamson circuit • beauty of design that won Fashion Foundation's coveted Gold Medal!
Wired and tested \$99.95 Easy-to-build Kit **\$64.95**

**ARKAY ST-11 AM-FM
STEREO TUNER**



Here, for the first time, is an AM-FM STEREO Tuner within the reach of every audiophile. Unmatched by units costing twice the price, the ST-11 is two distinct receivers in one featuring 4 uV for 20 db quieting. Variable AFC. Single front panel switch controls AM, FM or STEREO selection.
Wired and tested \$74.50 Easy-to-build Kit **\$49.95**



**ARKAY CS-12
STEREO AMP/PRE-AMP**

12 watts of clean power with dual inputs and outputs for excellent stereo reproduction • operates from ceramic or crystal cartridge, tape, tuners, auxiliary equipment • push-pull outputs for each channel.
Easy-to-build Kit **\$36.95**

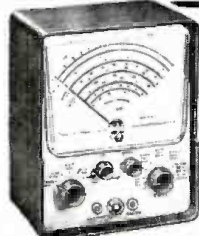

NEW! ARKAY VT-10 6-INCH MULTI-PURPOSE VACUUM TUBE VOLTMETER
Advanced design and precision features make the Arkay VT-10 a truly sensational buy, unmatched at this price. You get exclusive larger 6-INCH 400 ua meter movement, within 2% accuracy, and edge-lighted for easier reading. 1% precision multiplier resistors are used throughout the range switch. There are 7 AC (RMS) and DC ranges, 7 AC (peak-to-peak) ranges. Resistance, db and other essential ranges. Durable plastic case.
Wired and tested \$47.95 Easy-to-build Kit **\$25.95**

**ARKAY AV-20 6-INCH
AUDIO VTVM
PRE-AMPLIFIER**
Easy-to-build Kit **\$29.95**
Wired and tested \$49.95

**ARKAY AW-30 6-INCH
DIRECT READING
AUDIO WATTMETER**
Easy-to-build Kit **\$29.95**
Wired and tested \$49.95

**ARKAY CAP-40 6-INCH
DIRECT READING
CAPACITY METER**
Easy-to-build Kit **\$29.95**
Wired and tested \$49.95

**ARKAY MT-50 6-INCH
20,000 OHMS
PER VOLT METER**
Easy-to-build Kit **\$29.50**
Wired and tested \$42.95

See and hear completely wired ARKAY Kits at your dealer. All prices 5% higher west of Mississippi.

FREE! "Let's Talk Stereo"—informative booklet on how and why of Stereo—plus new 16 page ARKAY catalog.
Write Dept. RE.

arkay INSTITUTE OF HIGH FIDELITY MANUFACTURE
88-06 Van Wyck Expressway Richmond Hill 18, N.Y.

ELECTRONICS

(Continued from page 99)

sistors. By using an n-p-n transistor for V1 and a p-n-p transistor for V2, only one battery is needed. It biases V2's collector negative and V1's collector positive (the latter through V2's emitter-base path). At 30°C, the initial current flowing through the lamp is 0.5 ma. This is only 1/150 of lamp current at full brilliance, and would be only 1/375 of a 6-volt pilot lamp's operating current. With the values shown in Fig. 1, the power transistor (V2) does not need a heat sink.

While battery operation is suggested, it is not mandatory. Dc voltage for operating the circuit may be obtained from a miniature power supply, such as a crystal diode and filter capacitor operated from the secondary winding of a small filament transformer. In fact,

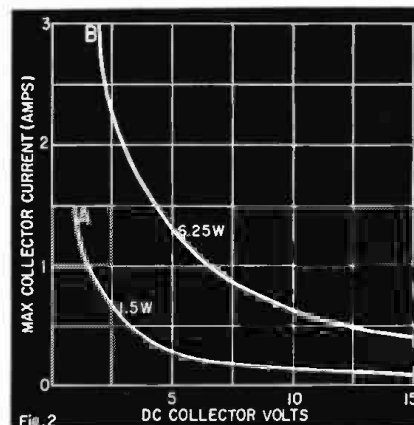

Fig. 2—Maximum operating conditions for 2N255; curve A, free-air operation; curve B, with a heat sink.

a colleague of mine has used the circuit as an AM radio tuning lamp which lights the dial brightest at resonance, and has obtained the necessary operating voltage by rectifying the filament voltage with a germanium diode. In this setup, the dc signal is derived from the avc circuit. He has also used the setup as a visual Conelrad alarm—the lamp goes out when the station leaves the air.

Some readers might want to use the circuit with other lamps and voltages. For their benefit, Fig. 2 shows the maximum collector (lamp) current which can be drawn up to the maximum collector voltage of -15 without exceeding V2's power dissipation rating. Curve A is for 1.5 watts constant dissipation in free air, while curve B is for 6.25 watts constant dissipation applying to operation with a heat sink. Curve B stops at the 3-ampere point, since this is the transistor's maximum collector-current rating.

These curves apply to 25°C operation. At higher temperatures, apply a derating factor of .024 watt per degree Centigrade ambient temperature increase to curve A, and 0.1 watt to the 6.25-watt curve B.

I feel that this circuit, which requires an input signal of only 2.8 μV dc for its operation, has a number of useful applications.

END

SOLAR POWER

Part I—The silicon solar cell has opened new vistas in the practical use of solar energy

now and tomorrow

By JORDAN McQUAY

ELECTRICITY from the sun! Long the dream of scientists and experimenters, sunlight is converted directly into electricity with the silicon solar cell—a simple photovoltaic device, about the size of a quarter.

Banks or clusters of these small cells are known as solar-power converters and provide enough power to operate flashlights, transistor radios, remote radio and telephone equipment, highway and airway markers, telemetering equipment in satellites, and other appliances. This unique source of power is particularly useful for remote and infrequent operation of electronic and communications equipment far from conventional power sources.

Although presently not supplying enough power for large radio and TV transmitters, solar power converters are successfully operating a wide variety of types of equipment—particularly in areas or locations distant from other sources of electrical power.

History

Generations of scientists have sought a way to draw electrical energy from the sun, the ultimate power source.

They knew that on a clear day, about 1 kilowatt of solar energy falls on every square yard of the earth's surface in temperate zones, such as the United States. And they knew that this daily supply of over a 1,000,000,000,000 kilowatt-hours of sunlight was comparable to all the power reserves of coal, oil, natural gas and uranium in existence on the earth. If this tremendous energy could be harnessed, it would become an important source of power.

Scientists have known for centuries of this great potential of the sun. It was a question of *how* and *when* it could be realized.

For eons nature has converted sunlight into chemicals through photosynthesis. And mirrors and lenses have been used to produce heat from solar energy for more than 2,000 years.

But the task of producing electricity from sunlight proved much more difficult; no efficient system of conversion was known.

Historically, only three basic devices have been successful in converting solar radiation into electrical energy: the thermopile, the photogalvanic and the photovoltaic cell. Although first developed during the 19th century and later

(Continued on page 108)

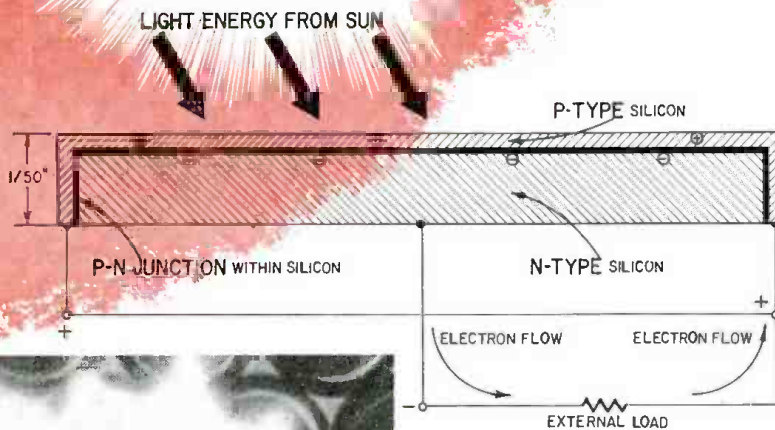

Fig. 1—Cross-section of a silicon solar cell.



International Rectifier Corp.

Fig. 2—Single silicon solar cell and plastic holder.

Fig. 3—A solar power converter composed of a modular cluster of nine silicon cells connected in series.

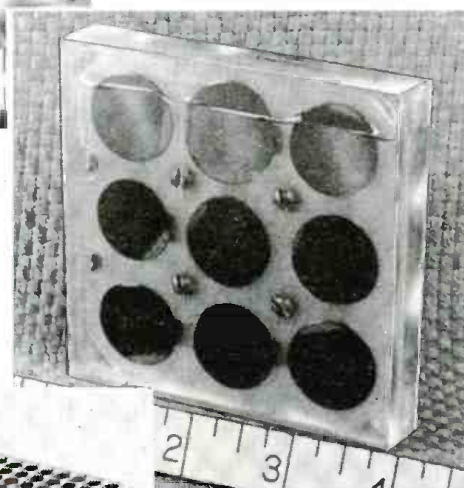

Bell Telephone Labs.



Fig. 4—A 400-cell solar-power converter featuring an automatic sun-following device.

AVAILABLE NOW... THE RCA

Wonderful premiums
for the family...
Service aids for
your business!

FREE

FOR A
LIMITED
TIME ONLY

RCA TUBE
WALL RACK

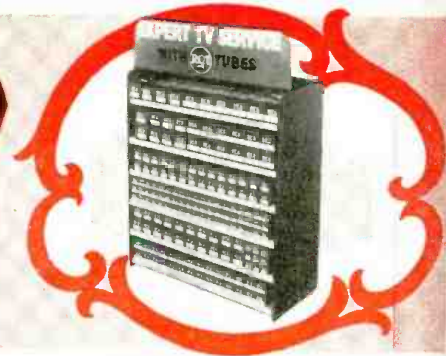

FREE when you purchase
275 RCA
Tubes*

**BLANKET
AND BAG SET**

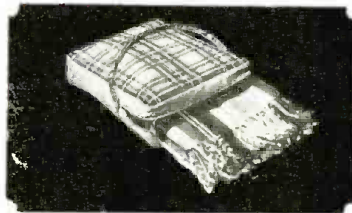

FREE when you
purchase 350 RCA Tubes*

RCA

VoltOhmyst®
Kit WV-77E(K)



FREE when you purchase
950 RCA Tubes*

**FIRE
EXTINGUISHER**



FREE
when you
purchase
425
RCA
Tubes*

WEATHERPROOF

LANTERN



FREE when you purchase
225
RCA Tubes*

*Suggested Value



12 gorgeous and glorious items to help you have
more fun... get more done! See them... get them
now at authorized RCA TUBE DISTRIBUTORS
participating in this program.



SPECTACULAR PREMIUM OFFER

with your purchases of RCA Tubes!

From Authorized RCA Tube Distributors Participating In This Program

RCA
CLIP LEADS

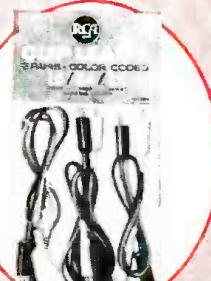

FREE

when you purchase
75 RCA Tubes*

PICNIC KIT



FREE when you
purchase 350 RCA Tubes*

MAGNIFYING
LAMP



FREE

when you purchase
900
RCA Tubes*

RCA
V-O-M KIT
WV-38A(K)



FREE when
you purchase
950 RCA Tubes*

SUBSCRIPTION TO

RCA
SERVICE
NOTES



FOR 1 YEAR

FREE when you
purchase 175 RCA Tubes*

RCA PARTS
WALL
RACK



FREE when you
purchase 125 RCA Tubes*

RCA CLAMP-ON
MAGNIFYING
LENS



FREE

when you
purchase 150
RCA Tubes*



RADIO CORPORATION OF AMERICA

Electron Tube Division

Harrison, N. J.

IN HOLLYWOOD, CALIF. SEATTLE, WASH. KANSAS CITY, MO. WASHINGTON, D.C.

In all of these cities, Grantham School of Electronics offers regular resident classes and home study training in *communications electronics*—training which prepares you to pass the Federal Communications Commission examinations for a first class commercial F.C.C. operator license.

YOU CAN PREPARE FOR YOUR
FIRST CLASS COMMERCIAL

F.C.C. LICENSE

by training in a Grantham School resident class for 12 weeks. Or, if you are unable to leave your work to attend school, Grantham can train you by correspondence. Both resident classes and correspondence instruction are offered at all Divisions of the School—Hollywood, Seattle, Kansas City, and Washington.

In resident classes or by home study, Grantham training is the easy way to learn more quickly—to prepare more thoroughly—for F.C.C. examinations. And your first class F.C.C. license is the quick, easy way to prove to your employer that you are worth more money.

Be good to yourself. Prepare for the better things that a higher salary can make possible—and for greater future security in the radio-TV-electronics industry.

Grantham training—in Hollywood, Seattle, Kansas City, Washington, or in your own home—can do the job. Get complete details free. Mail the coupon below to the Grantham School nearest you. Here are the different addresses. Send coupon to any one of these:

GRANTHAM SCHOOL OF ELECTRONICS
1505 N. WESTERN AVE.
HOLLYWOOD 27, CALIFORNIA

GRANTHAM SCHOOL OF ELECTRONICS
408 MARION STREET
SEATTLE 4, WASHINGTON

GRANTHAM SCHOOL OF ELECTRONICS
3123 GILLHAM ROAD
KANSAS CITY 9, MISSOURI

GRANTHAM SCHOOL OF ELECTRONICS
821—19TH STREET, N.W.
WASHINGTON 6, D.C.

To: GRANTHAM SCHOOL OF ELECTRONICS
(Select address from those listed above)
Please send me your FREE booklet explaining how Grantham can prepare me for my F.C.C. license. I understand there is no obligation and no salesman will call.

NAME _____
ADDRESS _____
CITY _____ STATE _____

94.S3

ELECTRONICS

(Continued from page 105)

improved slightly, they are still basically the same devices today.

The thermopile¹ consists of two dissimilar but conducting metals joined together. Different degrees of heat (from sunlight) applied to the junction produces a weak emf.

The photogalvanic cell² consists of two electrodes immersed in an electrolyte. Light falling on only one of the electrodes produces a very weak emf.

The photovoltaic cell³ consists of barriers or layers of a semiconductor material, which produces a weak emf.

In their basic form, all three devices have an extremely poor conversion efficiency—less than 1%. With 1,000 watts of applied solar radiation, one of these devices would, in the past, produce less than 10 watts of electrical power—and then only under controlled conditions in an experimental laboratory.

A more efficient way to convert sunlight into electricity was needed.

About 10 years ago the Bell Telephone Laboratories began an accelerated program of semiconductor research. Literally thousands of semiconductors were analyzed, tested, and evaluated—much as crystals⁴ had been 50 years earlier.⁵

During these experiments the Bell Laboratories determined that silicon exhibited some unusual properties—particularly when alloyed with minute impurities. As a result, silicon junction devices that had a high degree of efficiency for converting light energy into electrical energy were fabricated. This led to the perfection in 1954 of a new type of photovoltaic cell—the first silicon solar cell—with a conversion efficiency of 6%.⁶

The development of silicon solar cells continued on an expanded basis at Bell Labs. And by the end of 1956, improved types had 11% efficiency.

Following such developments, silicon solar cells to power electronic and communications equipment soon became practical realities. Assured for the future were many applications of the new solar “battery”—the most efficient means of converting sunlight into electrical power.

Silicon solar cells

A single solar cell is essentially a thin wafer of specially processed silicon. Although sometimes rectangular, the wafer is usually about 1/50-inch thick and 1 inch in diameter. With only two leads, it appears insignificantly simple in contrast to the magnitude of its importance to modern electronic and communications equipment.

While it is composed basically of pure silicon, the solar cell has a unique electrical characteristic that results from

¹Developed by Seebeck, about 1825.

²Developed by Becquerel, about 1840.

³Developed by several scientists, about 1875.

⁴Conducted by Pickard and others, in 1905.

⁵See “Crystal Detectors”, by Jordan McQuay, *Radio-Craft* (4 issues), 1948.

⁶Developed by Pearson, Fuller, Chapin and others, in 1954.

most needed most wanted

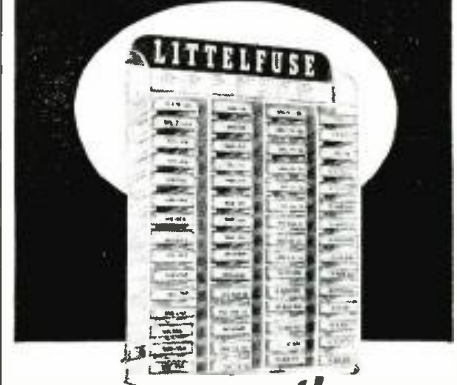

... the
FUSEMASTER!
dealer-serviceman's fuse rack
... for wall mounting

... dealer-serviceman's fuse
requirements at a glance

For further information,
contact your nearest Littelfuse Distributor.

LITTELFUSE

DES PLAINES, ILLINOIS

**TARZIAN Offers 48-Hour,
Direct Factory Service
on Tuner Repairs**

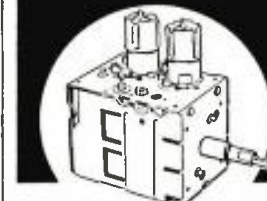

only
\$7.50

That's right. Net, \$7.50 per unit and \$15 for UV combinations, including ALL replacement parts. 90-day warranty against defective workmanship and parts failure. Tuners repaired on approved, open accounts. Replacements offered at these prices* on tuners not repairable:

VHF 12 position tuner . . . \$22.00
VHF 13 or 16 position
tuner 23.00
VHF/UHF combination . . . 25.00
UHF only 15.50

*Subject to change



Tarzian-made tuners are easily identified by this stamping on the unit. When inquiring about replacements for other than Tarzian-made tuners, always give tube complement . . . shaft length . . . filament voltage . . . series or shunt heater . . . IF frequency and chassis identification. Use this address for fast, 48-hour service:

SARKES TARZIAN, Inc.

Att.: Service Mgr., Tuner Division
East Hillside Drive
Bloomington, Indiana

ELECTRONICS

a special manufacturing process called *diffusion*.

Ordinary silicon is the second most abundant element—frequently part of rocks, clay and sand. But it is never found in nature in its pure form, and must be produced artificially in an electric furnace.

Silicon can be used to make solar wafers only when its impurities are *less* than 1 part in a million. Such pure forms of silicon cost about \$100 per pound.

To make solar wafers, chunks of highly pure silicon are melted at a very high temperature (about 2,000°F), and then deliberately contaminated with tiny amounts of arsenic and boron. Adding arsenic produces n-type silicon and adding boron produces p-type silicon. When the two types appear side by side in the same piece of silicon, the dividing face is called a p-n junction. After molding and cooling, terminals are attached to each thin wafer of silicon.

This entire process of diffusion is extremely critical as to time, temperature, quantity and purity of elements, and other physical factors. But as a result of this involved process, the internal electrical conductivity of the solid silicon wafer is changed slightly but very significantly (see Fig. 1).

The "top" or exposed surface of the wafer has a slight positive charge with respect to the internal bulk of the wafer. Just below this surface is a broad electrical junction—the p-n junction—that is the boundary between all positive and all negative charges within the wafer. Essentially, this boundary is an electric field.

When light energy from the sun strikes the exposed surface of the wafer, there is a displacement of electrons and a resulting change in the electric field associated with the p-n junction. When a load resistance is connected to the wafer's terminals, the change in the electric field causes a flow of electrons in the connecting circuit.

Heart of the solar cell is the p-n junction—the boundary between the two kinds of electrical conductivity within the solid-state semiconductor. The actual conversion of light energy into electrical power takes place under the influence of the electric field at the p-n junction. Nothing is consumed or destroyed in the energy conversion process. And since there are no moving parts, solar cells can last indefinitely.

Efficiency of conversion is determined by the load resistance. This should be matched. For a single cell, it should be between 3 and 5 ohms.

Under direct sunlight, a single cell (1-inch diameter) produces a maximum output of 40 mw, or 100 ma at 0.4 volt. With a matched load, the output current of a single cell is linear and a direct function of the input light (sunlight) intensity. But the output of a cell remains fairly constant during slight changes of light intensity.

A silicon solar cell is receptive to all

⁷Discovered by Ohl and Scaff, in 1930.

Outperforms Costliest Speaker Systems

ENJOY THE BEST AT GREATEST SAVINGS

EXCLUSIVE

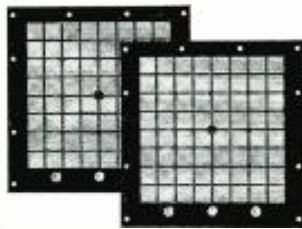

ARTHUR JANSZEN DESIGN patented dual electrostatic radiators... rated the best again and again. Built-in power supply; velvet-smooth response to beyond 25,000 cps.

EXCLUSIVE



HIGH-COMPLIANCE 12" woofer featuring weighted cone in solid cast-aluminum alloy frame... with heavy-duty sintered ceramic magnet for extremely dense flux.

EXCLUSIVE: Acoustically correct enclosure of choice hardwoods, finished on 4 sides...



High-Compliance Electrostatic Speaker System

ONLY **\$129.50** Comparable to speaker systems selling at 50% more!

Here's an Allied exclusive—**\$5 Down** the hi-fi speaker sensation of the year—combining patented Arthur Janszen design dual electrostatic tweeters with a new and revolutionary high-compliance woofer. The results are amazing: Distortion is held to a mere 0.5% at full 50 watts input. Response is clean and level, 30-25,000 cps. You have to hear it to believe it—transparent high frequencies to beyond audible limits—smooth, honest bass. The KN-3000 enclosure, of 3/4" wood throughout, is finished on 4 sides; 14 x 26 1/2 x 13"; available in mahogany, limed oak or walnut. Impedance, 8 ohms. U. L. Approved. Shpg. wt., 50 lbs.

KN-3000. Only \$5.00 Down. NET \$129.50



15-Day Trial & Moneyback Guarantee. Try the KN-3000 Speaker System in your home for 15 days; if you are not completely satisfied, your purchase price will be refunded by Allied upon return of the equipment.

order from

ALLIED RADIO

ALLIED RADIO, Dept. 31-L9
100 N. Western Ave., Chicago 80, Ill.

Ship me _____ KN-3000 Speaker System(s). Mahog. Oak. Wal.
\$ _____ eNcl. (Shipped F.O.B. Chicago)

I am interested in saving money on everything in Hi-Fi. Send me your FREE 1960 Catalog.

Name _____

Address _____

City _____ Zone _____ State _____



SEE YOUR ALLIED 1960 CATALOG for a detailed description of the remarkable new KN-600 HC high-compliance 2-

way speaker, with the sensational 4.6 lb. ceramic magnet and 1/2" thick polystyrene cone. See hundreds of other top buys on everything in Hi-Fi in the 1960 Allied Catalog. Write for your FREE copy today.

New Easy Terms: Only \$5 down (or less) on orders up to \$200. Up to 24 months to pay.



THE BIG NEWS FOR 1960

SYLVANIA 23-INCH TV



*Viewing area 275 square inches. 23-inch picture tube measured diagonally.

Big 23-inch* picture is the sensation of 1960 that *changes the face of television* . . . and Sylvania scoops the industry with the first complete line.

- Square corners of the 23-inch* bonded shield picture tube pioneered by Sylvania presents more of the TV picture as the camera sees it. New squared shape is closer to the 3 x 4 ratio of the true TV camera raster.
- The 23-inch* tube flattens the TV screen. "Bonded shield" face-panel eliminates the dust trap, cuts reflections in half, and improves brightness and contrast.
- ◆ New Super HaloLight® is bigger and better than ever. It's a Sylvania exclusive that adds eye comfort to eye appeal.

SYLVANIA 23" TV OFFERS THE NEWEST AND FINEST FEATURES YOU CAN RECOMMEND

 **SYLVANIA**
Subsidiary of
GENERAL TELEPHONE & ELECTRONICS 

ELECTRONICS

visible light (0.4 to 0.7 wavelength in microns), and infra-red light (up to about 1.0 micron). Cells are not receptive to ultraviolet light.

Cell temperature has little effect on its output current, but it does affect the output voltage. At temperatures below 30°F voltage increases. Above 30°F voltage decreases.

For low-power requirements, a single silicon solar cell may be used. In such applications, it is frequently encased in a plastic holder (Fig. 2) for protection against rough treatment and weather effects. A cell may be encased in solid blocks of plastic or in blocks of plastic with liquid or gas-filled centers, as long as sunlight has free access to the cell's surface.

Solar-power converters

Like batteries, individual solar cells can be arranged and connected in a variety of combinations — known as modules, clusters, banks or arrays—to provide high values of output power.

A number of cells can be connected in series to increase the output voltage, in parallel to increase the output current or in series-parallel arrangements to increase both voltage and current output. As a rule, cells deliver electric power from sunlight at the rate of 100 watts per square yard of exposed surface.

Such multiple arrangements, with their housing and related connectors, are known as solar-power converters.

The smallest practical converter has 9 cells connected in series and arranged as shown in Fig. 3. Also known as a module, it delivers about ¼ watt in direct sunlight. Four of these modules (36 solar cells) in series deliver 1 watt.

A typically large array of 400 cells in series-parallel arrangement produces about 15 watts of electrical energy. The model shown (Fig. 4) has an additional solar cell that is used as a sensing device. This causes the entire converter to turn to follow the sun for maximum power output.

Presently under study but yet to be perfected are methods of externally increasing the output of solar-power converters. This can be done with concentrators (lenses) or reflectors (mirrors) which increase the intensity of sunlight falling on the clusters of solar cells.

The several existing types of solar-power converters, however, provide many applications of fairly high power to a wide variety of electrical, electronic and communications equipment. Almost all of them are those where an unattended power source is necessary—usually in a spot where no other source of electricity is available.

To provide a continuous power source, day and night, solar-power converters are frequently used with rechargeable storage batteries, such as nickel-cadmium batteries, which are free from leaking and gassing.

Applications, divided into low- and high-power categories, will be discussed next month. **TO BE CONTINUED**

COMPUTERS

and the



lamp

You've seen glow lamps as read-out indicators in counters. Here are other ways that these simple devices are being used

By J. H. THOMAS

ALTHOUGH we use neon lamps for many purposes, even in electronic computers for indicating, coupling and regulating duties, they seldom constitute major elements.

From time to time we find articles on some of the many uses for these little heaterless discharge tubes (see RADIO-ELECTRONICS, December, 1957, page 112). Another interesting article on a special type (3-element) neon lamp appeared on page 102 of the October, 1958, issue. Relaxation oscillators, timers, metronomes, output indicators, circuit testers, voltage regulators are some of the often described uses. One ingenious engineer built an entire electronic organ from them, and many of these circuits can play an active part in digital computers.

Computers are made up of certain building blocks, and as the computer becomes larger the number of these basic units increases. We are speaking, of course, of digital computers in general. The simplest digital computer we have is our 10 fingers. In other words, we use them to count. We add and subtract, but this is still counting. We multiply, but do so by adding again and again one of the factors of our multiplication. We do it fast enough so we don't have to wait very long, fractions of seconds maybe. And we divide similarly, by subtracting until we have very little left over. All mathematical operations which a digital computer can carry out stem basically from the simple operation of counting.

A computer does this job with some relatively simple circuits. Adding is handled by serial registers, subtracting by reversed registers. The registers can be made up from flip-flops. And the flip-flops are controlled by gates, delay circuits, oscillators, pulse amplifiers, etc.

The circuits described here perform all of these functions. We won't try to tell you how to build a computer from

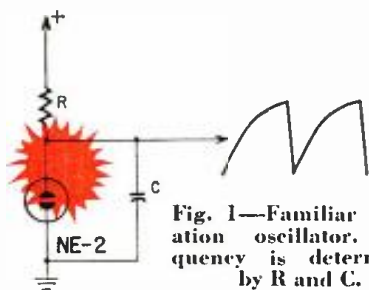

Fig. 1—Familiar relaxation oscillator. Frequency is determined by R and C.

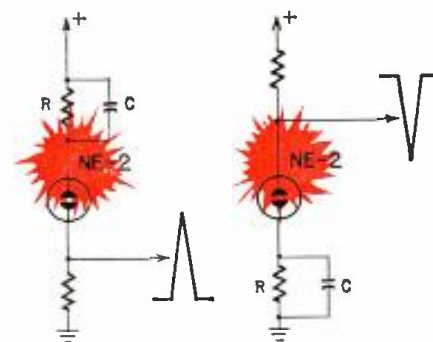

Fig. 2—Simple pulse generators. Supply must be low enough to keep the lamps from glowing continuously.

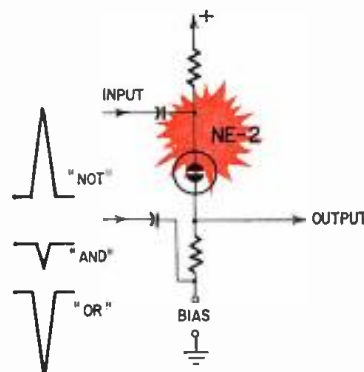

Fig. 3—Gating circuit. Bias determines size of gated pulse. If coincident pulse is used for bias, gate can be "and" or "not" type.

them, it would take a few issues of the magazine. But at least the basic units are here for you to experiment with. No originality is claimed for most of the circuits; they have been around for a while.

Computer circuits

Let's start with the well known relaxation oscillator, and build from there. Fig. 1 shows the circuit. Capacitor C charges through resistor R until enough voltage is built up to fire the tube, which promptly discharges the capacitor to the tube's emission voltage. Then the process repeats itself. Frequency is determined, for a fixed supply voltage, by the values of C and R.

The pulse generators of Fig. 2 are somewhat like the reverse of Fig. 1. Here, when the tube fires, the voltage drop on resistor R charges capacitor C until the bias thus created keeps the tube from firing until it leaks off through R. The result is fairly sharp spikes well separated. Frequency is again governed by values of R and C. R should be relatively high to allow the circuit to operate. Actual values depend on the supply voltage, but are not difficult to determine. Use a couple of potentiometers.

Fig. 3 is a gate, developed from the previous circuit. Here bias voltage determines whether the tube fires. If the bias is sufficiently positive, no pulse passes. If the bias is actually a pulse itself, momentarily blocking firing, we have a "not" gate. If the bias is a steady voltage with a negative pulse superimposed, we may have an "and" gate. If the bias-superimposed negative pulse is large enough to fire the tube as well as the positive pulse applied to the input, we have an "or" gate. This provides the three basic gates used in computer circuitry. Multiple input gates can be made up of several of these basic gate units. If for this purpose the pulse size has to be regulated,

why your next speaker system should be

THE NEW AUDAX PARAFLEX

- Only Audax incorporates the Patented Paraflex Foam Suspension to give longer travel to the cone, resulting in honest bass without boom or hangover. You get bass with real bottom!

- New Styrofoam Radial Strut-Bracing reinforces cone, assures rigid piston action, preventing cone break-up. Eliminates distortion, provides clean reproduction up to the full-rated power output. Needs as little as 10 watts output. You get greater amplifier economy in stereo installations.

- New Oriented Grain-Processed Magnet gives 20% more efficiency than standard Alnico V.

- New Ducted-Slot Enclosure specifically designed to enhance the depth and striking realism of the Paraflex high-compliance speaker units. Speakers are located symmetrically on each side of the ducted slot, resulting in clean bass without trace of boom or unnatural heaviness.

- New, dramatic enclosure styling by George Nelson—featuring new, three-dimensional Dynel "Acoustiscreen" grille, removable for cleaning!

- Audax Paraflex Speakers are lab-tested and a performance seal on each unit indicates its resonant frequency ± 1 cycle.

Model CA-80 12" x 12" x 24" with two full range speakers—\$99.95

Model CA-100 15" x 12" x 25" with two 10" full range speakers and 2 matching cone tweeters—\$139.95

Also full line of component speakers



Write for free catalog and specifications, to: AUDAX Division of the Rek-O-Kut Co., Inc. Dept. RE-11, 38-19 108th St., Corona 68, N. Y.

Name _____
 Address _____
 City _____ State _____

Export: Morhan Exporting Corp., 458 Broadway, New York 13
 Canada: Atlas Radio Corp., 50 Wingold Ave., Toronto 19, Ont.

ELECTRONICS

amplify them with the simple circuit shown in Fig. 4. Pulse amplification of as much as 5 to 1 is possible. With the voltages and values shown, the lamps will conduct, although only slightly. The applied pulse brightens the discharge and appears at the output.

We can take advantage of the difference between firing and extinction

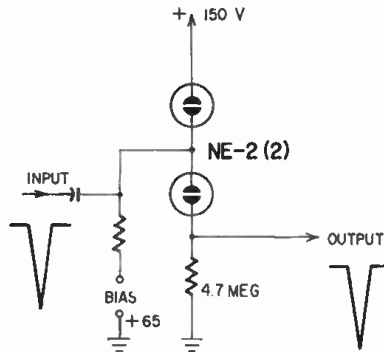

Fig. 4—Pulse amplifier. Lamps can be on or off, so long as an input pulse turns them on. Waveforms show pulse polarity. Amplitudes not to scale.

voltage of the neon lamps by establishing a circuit with just too little voltage to fire the tube and just too much to extinguish it once fired. Then one pulse can turn it on, the other off. However, turning just one tube on and off gives us only an indicator for a switching operation.

Flip-flops and an adder

Using two lamps, we can take better advantage of this characteristic by creating a flip-flop and other circuits.

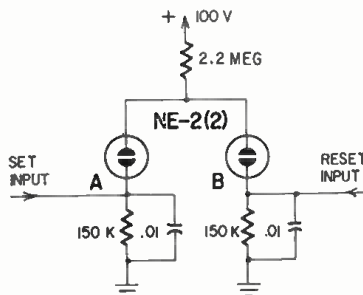

Fig. 5—Simplest flip-flop. Output from A or B contains set or reset pulse.

Actually the simplest of the lot would be Fig. 5, which will turn one tube on and the other off by alternate positive pulses at the two inputs. The reason this happens is that the load resistor will maintain only one lamp fired, otherwise the drop would be great enough to extinguish both tubes. If we apply a positive pulse at the input of a lamp which is glowing, we lower, in effect, the voltage across the tube and extinguish it, allowing the other one to fire when the voltage drop across the load resistor decreases.

Fig. 6 is a better version of the flip-flop, since here the input pulse does not appear in the output. Functioning



NO GIMMICKS WITH wigo SPEAKERS

Just solid, sensible acoustic engineering. Nothing fancy but the performance. That's the Wigo story, short but sweet. For literature, write . . .

united audio
 PRODUCTS OF DISTINCTION
 202-4 East 19th St., N. Y. 3, N. Y.

SUBSTITUTE PARTS WITH-OUT SOLDERING
 Quickly Easily
 with Has 1001 Uses!
NEW E-Z-Hook "SUB" Connectors
 Connect a speaker, or
 Substitute a
 • transformer
 • capacitor
 • resistor, or phone
In Seconds!!

★ Makes connections instantly!
 ★ Won't pull off!
 ★ Insures positive contact!
 Saves time, money and parts in servicing, experimenting, instructing and production.

E-Z-HOOK SUB
 No. 71-1-SUB Only 69¢ ea.
 Six Colors!-for Easy Lead-Identification
 ORDER THROUGH YOUR PARTS DISTRIBUTOR
E-Z-HOOK TEST PRODUCTS
 Dept. G-11 1536 Woodburn Ave. Covington, Ky.

ELECTRONICS

on the same principle, but reversed by the charge created on capacitor C after functioning, is the multivibrator circuit of Fig. 7, sometimes called a univibrator. It is a monostable circuit. After a pulse has extinguished NE2, capacitor C charges because of the lowered bias voltage across 150,000-ohm resistor R2, and builds up enough voltage to fire NE1. However, a discharge is maintained only as long as C is charged sufficiently, and consequently the situation is eventually reversed, ending up with NE2 glowing and NE1 extinguished. The delay or time during which NE1 is fired depends on the size of C in relation to the resistors and the supply voltage. In

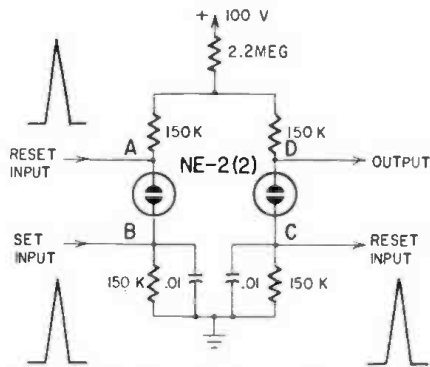

Fig. 6—Flip-flop. Positive pulse at A and at B or C, alternately set and reset flip-flop. Positive pulse at B and negative at D also work.

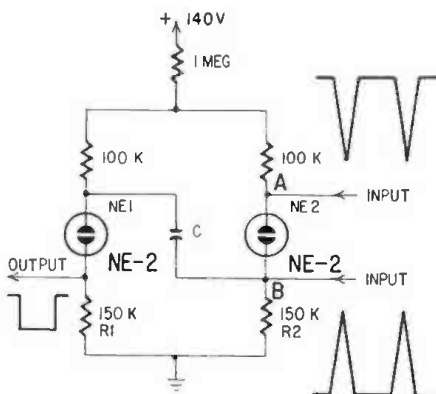

Fig. 7—Monostable multivibrator. Positive pulses at A or B switch the tubes. Return time governed by C.

this way, various delays can be provided.

A much improved flip-flop using common input pulses is shown in Fig. 8. The supply voltage is halved by the voltage divider to ground. All is quiet. When a positive pulse arrives, it fires one of the lamps, either NE1 or NE3, whichever is not glowing. Immediately the voltage at NE2 or NE4 drops and fires that tube too. The next pulse arriving fires the other set in the same way. But the firing of the second set, either NE1 and NE2 or NE3 and NE4, lowers the voltage at one end of the

(Continued on page 116)

CORNELL-DUBILIER CAPACITORS



The extra values are "on the house"

Want more capacitor for your dollar? Here's how:

Cornell-Dubilier has originated a "preferred-type" program on twist-prong electrolytics. Now, a relatively few types fill over 90% of all replacement requirements. You need less — to do more. Fewer types means improved production efficiency, lowered costs — savings to you. How is it done? Instead of producing hundreds of types with odd and critical capacitance and voltage ratings, each "preferred type" carries the *highest* value and rating called for in each category. In most cases you get *more* capacitor at *lower cost* — plus added safety factor, improved performance and "call-back" protection. It's on the house! To get more capacitor for *your* dollar, ask your C-D Distributor about Preferred Type Twist-Prong Electrolytics or write Cornell-Dubilier Electric Corporation, South Plainfield, New Jersey.



CORNELL-DUBILIER CAPACITORS

Consistently Dependable

TV Technician TAYLOR THURMAN Explains . . .

“In Precision Circuitry,



Stop Call-backs with these Quality Mallory Components



Gems—5 rugged, moistureproof, Mallory “Gem” tubular capacitors in an easy-to-use dispenser that keeps your stock fresh and clean—easy to find—no more kinks in lead wires. They’re your best bet for outstanding service in buffer, bypass or coupling applications.



FP Electrolytics—The Mallory FP—the original 85°C capacitor—now has improved shock-resistant construction and leakproof seal. Its etched cathode construction—standard in all FP’s—assures hum-free performance.

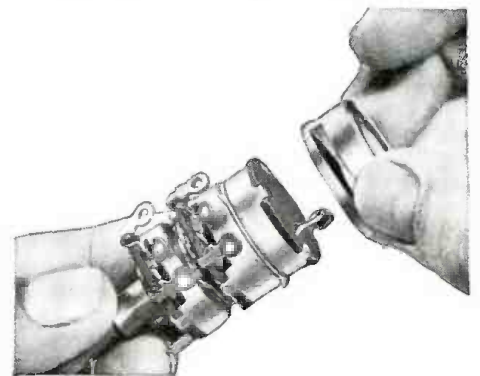

Sta-Loc* Controls—New Sta-Loc design enables your distributor to custom build, in just 30 seconds, over 38,000 combinations—eliminates waiting for out-of-stock controls. You can replace the line switch by itself, without unsoldering control connections.

There's Nothing Like Mallory RMC Discaps[®]

"When it comes to replacing ceramic capacitors, we always use Mallory RMC Discaps. Time and again, they've proved dependable. For TV tuners and other precision circuitry the extra quality built into Mallory makes the difference between a satisfied customer and money losing call-backs."

When you're looking for high quality, sensibly priced components, check with Mallory. You get the widest selection of parts in the industry . . . and every Mallory component is service-engineered: your assurance that the parts you replace will be in service for a long, long time.

Taylor Thurman has operated his own TV repair service for more than 10 years. The Air Force gave him early training in electronics. At Scott Field, he became a Communications Chief. Later on, he attended the G.E. Television School in Syracuse. At his Richmond, Indiana, location, he now has two technicians helping him in radio and TV sales and service . . . operates two service trucks. Prompt attention to service calls and use of quality replacement parts are the chief factors to which Thurman attributes the steady growth of his business.



Get your RMC Discaps—in the handy 3 x 5 file card five-pack—from convenient display at your Mallory distributor's store.

©Trademark of Radio Materials Co.,
a Division of P. R. Mallory & Co. Inc.

P. R. MALLORY & CO. Inc.
MALLORY

P. R. MALLORY & CO. Inc., INDIANAPOLIS 6, INDIANA



TC Tubular Electrolytic Capacitors—economically priced electrolytic filter capacitors with a reputation for doing an excellent job. They have been proved in performance and are backed by years of Mallory experience. Also special TCX type available for -55°C .



Gold Label* Vibrators—On critical auto radio servicing, use the Mallory Gold Label Vibrator. It gives longer, trouble-free service life. Mallory Gold Label Vibrators feature Mallory exclusive buttonless contact design.

*Trademark

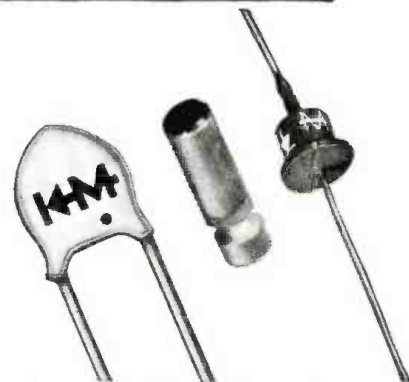

Silicon Rectifiers—New Mallory design gives far longer life, lower forward voltage drop, and reverse leakage current than conventional types . . . exceed the requirements of military humidity tests. In convenient kits for replacement of selenium rectifiers in radio and TV.

Get

Your First Class Commercial

F.C.C. LICENSE QUICKLY

HOME STUDY OR RESIDENCE CLASSES

Grantham School of Electronics specializes in F.C.C. license preparation. Correspondence training is conducted from Hollywood, Seattle, Kansas City and Washington; also, resident DAY and EVENING classes are held in all four cities. Either way, by correspondence or in resident classes, we train you quickly and well. No previous training is required. A beginner may qualify for his first class F.C.C. license in a minimum of time.

F.C.C. LICENSE — THE KEY TO BETTER JOBS

An F.C.C. commercial (not amateur) license is your ticket to higher pay and more interesting employment. This license is Federal Government evidence of your qualifications in electronics. Employers are eager to hire licensed technicians. We train you quickly—then help you find the job you want.

FOUR COMPLETE SCHOOLS

To better serve our many students throughout the entire country, Grantham School of Electronics maintains four complete Divisions—located in Hollywood, Seattle, Kansas City, and Washington. All Divisions of Grantham School of Electronics offer the same rapid courses in F.C.C. license preparation, either by home study or in resident classes.

MAIL COUPON FOR FREE BOOKLET

Our free booklet, *Careers in Electronics*, gives details of how you can prepare quickly for your F.C.C. license. For your free copy of this booklet, clip the coupon below and mail it to the Grantham School nearest you. Here are the different addresses. Send coupon to any one of these:

GRANTHAM SCHOOL OF ELECTRONICS
1505 N. WESTERN AVE.
HOLLYWOOD 27, CALIFORNIA

GRANTHAM SCHOOL OF ELECTRONICS
408 MARION STREET
SEATTLE 4, WASHINGTON

GRANTHAM SCHOOL OF ELECTRONICS
3123 GILLHAM ROAD
KANSAS CITY 9, MISSOURI

GRANTHAM SCHOOL OF ELECTRONICS
821 — 19TH STREET, N.W.
WASHINGTON 6, D. C.

To: GRANTHAM SCHOOL OF ELECTRONICS
(Select address from those listed above)

Please send me your FREE booklet explaining how Grantham can prepare me for my F.C.C. license. I understand there is no obligation and no salesman will call.

NAME _____
ADDRESS _____
CITY _____ STATE _____

94-S1

ELECTRONICS

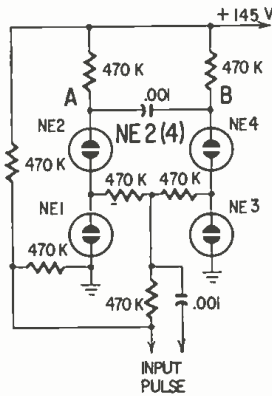

Fig. 8—This flip-flop uses one input, negative or positive pulses. Output at A or B.

(Continued from page 113) coupling capacitor, causing it to discharge and increasing the voltage drop across one of the 470,000-ohm load resistors, causing that set to go out. Thus alternate firing of sets, and a very useful flip-flop circuit.

If by now you are building up to the \$64 question, "Why aren't these inexpensive circuits used in computers?", we can forestall your wonder by giving some figures. The tasks demanded of giant computers are so staggering that to do their job at all without consuming generations of time, they have to operate at equally enormous speeds. Thus most of them operate at speeds up to 5,000,000 operations per second. Unfortunately, the circuits described here depend on de-ionization time of gas-

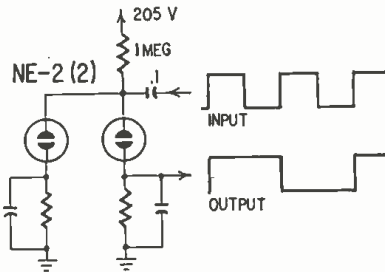

Fig. 9—Scale of 2. This circuit can also serve as a frequency divider not sensitive to frequency.

discharge tubes. This pretty well limits their speed of operation to below 100 kc, and for safety and reliability say down to 30 kc. Surely 30,000 operations per second sounds like a lot, or even 10,000, and for a relatively simple desk computer this is true. But the giants must handle billions of billions of operations for a seemingly simple ballistics problem, and at 30,000 operations per second it would take an impossibly long time.

Not discouraged, we will show two more circuits for those interested in trying out less speedy operations. Fig. 9 shows a scale of 2 developed from the flip-flop of Fig. 5. As shown by the pulse symbols, it is in effect a frequency divider, and one which is not particularly sensitive to frequency (electronic organ builders please note!).

Fig. 10 is the circuit of a counter developed by RCA. If we assume that the first tube is always on, we can

the modern approach to HI-FI STEREO servicing



AUDIO SYSTEM ANALYZER "800"

Here is a Complete Audio Laboratory of six instruments in one package! Our engineers have designed the "800" to save your time and to simplify the operational procedure of your shop. We know your time is your most valuable inventory. The "800" Analyzer is equally effective for monaural and stereo servicing problems. Look at the individual services the "800" performs at a fraction of the cost for all six instruments! \$169.95

- it's an AUDIO OUTPUT WATT METER
- it's an AUDIO VTVM
- it's an AUDIO-SIGNAL GENERATOR
- it's an INTERMODULATION DISTORTION METER
- it's a HARMONIC DISTORTION METER
- it's a DB and NOISE METER and it's EASY to use

SEE YOUR PARTS DISTRIBUTOR OR WRITE:

WINSTON ELECTRONICS

DIVISION OF 
4000 N. W. 28th STREET • MIAMI, FLORIDA

CONVERT TO COLOR TV

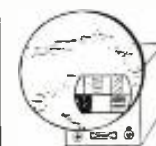

COLORDAPTOR—A simple 10-tube circuit and rotating color wheel converts any size B & W TV to receive compatible color TV.
COLORDAPTOR—Easily attached to any TV set, does not affect normal operation, often built from parts experimenters have on hand. **BRILLIANT COLOR!**

Complete booklet—gives theory of operation, all construction details, schematic, and sample color filters. **ONLY \$1.95**
Essential Parts Kit—All Special Parts—Coils, Delay Line, Crystal, Color Filters
Up to 16" **\$19.95** 17" and **\$20.95**
Sets—Larger
Other Kits, Wired Chassis, Motors Available
COLORDAPTOR
1798 Santa Cruz,
Menlo Park, Calif.

THE BIG IDEA...IN SERVICING

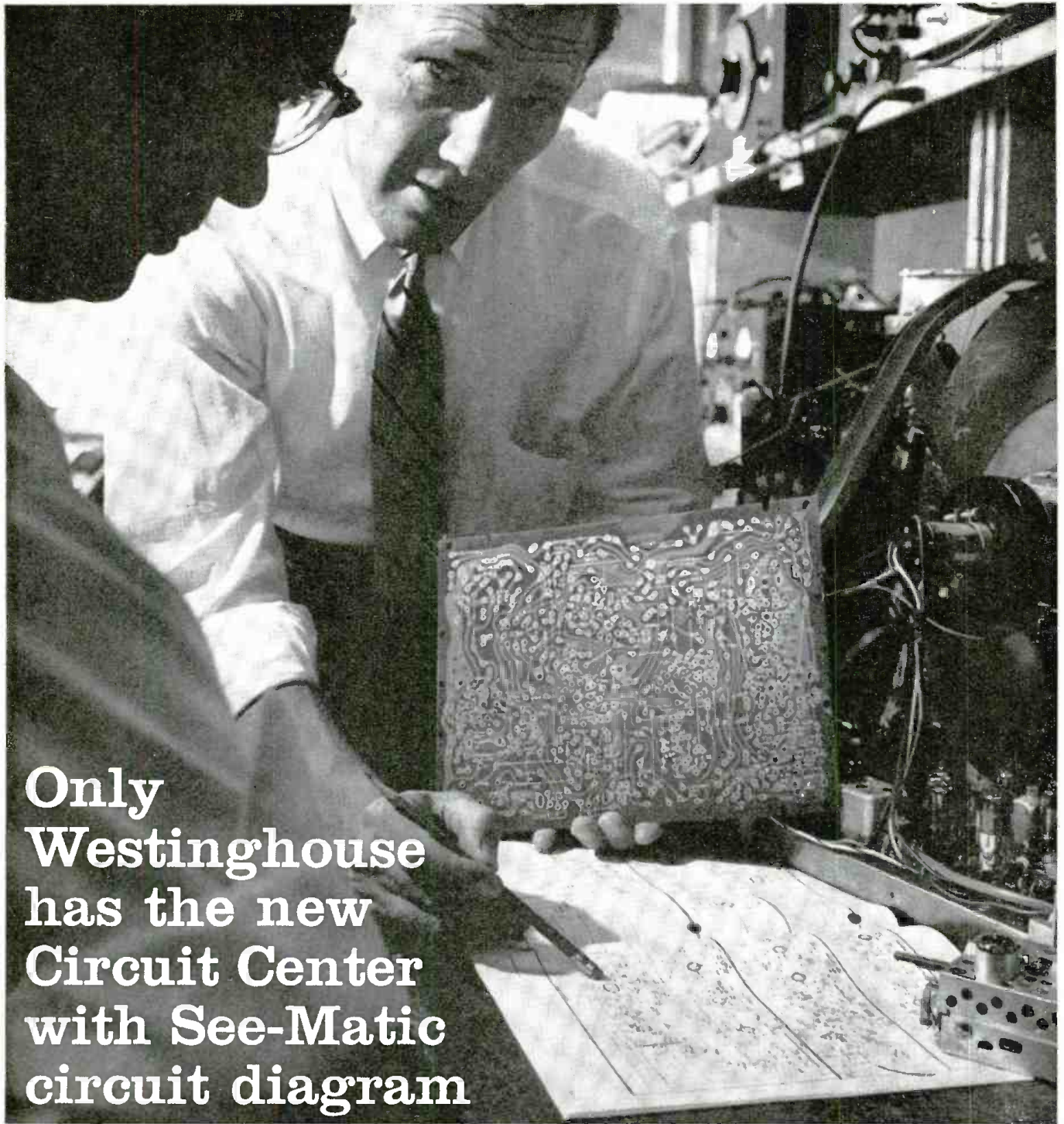

Only Westinghouse has the new Circuit Center with See-Matic circuit diagram

More than ever, Westinghouse is giving special attention to service technicians. The new Westinghouse "Circuit Center" is the industry's one new circuit board with a *complete* built-in schematic.

Now you can tell at a glance what type of component is connected from point-to-point and its value. Tube types and elements are shown...and all voltage supply lines and test points are identified.

No more "hide and seek" servicing—in many cases you don't even have to look at the manual! The See-Matic

circuit diagram is printed right on the *work side* of the board...you save time, save work. It's another example of advanced engineering from Westinghouse.

For complete information about Westinghouse Tech-Lit Factory Direct Mailing Service, write to Service Department, Westinghouse Electric Corp., Metuchen, N. J., or your Westinghouse distributor.

YOU CAN BE SURE...IF IT'S Westinghouse

Westinghouse Furniture TV & Stereo

Westinghouse Electric Corp., TV-Radio Division, Metuchen, N. J. Watch "Westinghouse Lucille Ball-Desi Arnaz Shows"...CBS-TV, Frldays.

2X NORMAL OPERATING VOLTAGE +10000

STANCOR TRANSFORMERS STAND UP!

Every STANCOR iron core transformer gets this breakdown test as a production line operation. To assure you of reliability and safety, each unit is tested for breakdown between windings and to ground—at twice its operating voltage *plus* 1000 volts! STANCOR'S thorough testing procedures protect you against failures and call-backs . . . one more reason why experienced technicians everywhere always specify STANCOR.



CHICAGO STANDARD TRANSFORMER CORPORATION

3509 ADDISON STREET • CHICAGO 18, ILLINOIS

RECORDING TAPE

Premium Quality—money back guarantee
1200' Acetate 3 for \$3.99 2400' Mylar 3 for \$9.60
Lots of 10 any assortment—deduct 10%
Add postage 15¢ per spool
DON'T BUY HI-FI components, kits, tape recorders,
until you get our low, low quotes by return mail.
Wholesale Catalog Free.

ELECTRONIC WORLD

1799R 1st Ave. New York 28, N. Y.

TAPE RECORDERS



HI-FI COMPONENTS SLEEP LEARN KITS

MERITAPE
Low cost, high
quality recording
tape, in boxes or cans.
**UNUSUAL
VALUES
FREE**
1959 CATALOG
DRESSNER, 69-02RE 174 St., Flushing 65, N.Y.

ENGINEERING B. S. DEGREE IN 27 MONTHS

Prepare for unlimited opportunities of the Electronic Age! Students study engineering under accelerated program leading to B.S. degree in 27 mo., or standard 4-yr. program leading to B.E. degree in 36 mo. B.S. degree (36 mo.) in Math., Chem., Physics. Year-round classes. Comprehensive training in electronics, television, advanced radio theory and design, math., nuclear physics and elec. eng. Also prep courses. Low rate. Earn board. G.I. approved. Enter Dec., March, June, Sept. Catalog.

INDIANA TECHNICAL COLLEGE

1711 E. Washington 81vd., Fort Wayne 2, Indiana
Please send me free information on B.S. ENGINEERING DEGREE IN 27 MONTHS as checked.
 Electronics Chemical Aeronautical
 Civil Mechanical Electrical
B.S. DEGREE IN 36 MO. in: Electrical (Power or Electronics)
 Aeronautical Chemical Metallurgical
 Civil Mechanical Physics

Name.....
Address.....

ELECTRONICS

describe the function fairly simply. Closing the switch loads the 220,000-ohm input resistor, lowering supply voltage to the tubes by the difference

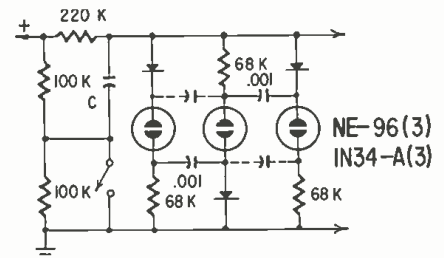

Fig. 10—Serial adder or subtractor or shift register. Modification (dotted lines) makes circuit subtract. Series of 10 lamps provides decimal counting.

of the voltage to which C is charged and the supply voltage. This extinguishes the first tube. However, since there was a voltage across the 68,000-ohm load resistor, the .001- μ f coupling capacitor is charged to that voltage. As C now charges to the supply voltage, the latter bounces up to nearly the firing voltage of the tubes. Added to this, the voltage across the coupling capacitor now fires the second tube, and so on down the line each time the switch is closed.

To eliminate the mechanical motion of the switch, use the trigger circuit of Fig. 11,* which in effect does the same thing by virtually shorting C to ground.

The circuit of Fig. 10, which counts pulses forward, can be made to reverse itself and subtract by using the modification shown in dotted lines. This modification can be built in with a multicontact switch or relay, which

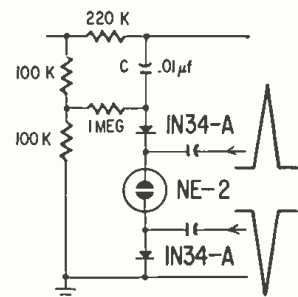

Fig. 11—Trigger circuit can replace triggering switch in Fig. 10

can be set for the command "add" or "subtract" electronically with a gate circuit.

Here we have gathered the elements of a computer, lacking only a memory, although a limited memory can be built on the same principle as the serial adder of Fig. 10. For desk computer use, an adequate memory which would not occupy excessive space could be built in this way.

What remains is to bring together the inventors of the various circuits and organize them into a marvelous little desk computer company. **END**

*From *Electronic Engineer's Manual*, Volume II, McGraw-Hill.



**Dependability
is a
built-in
feature
of
all
Delco
Radio
Service
Parts!**

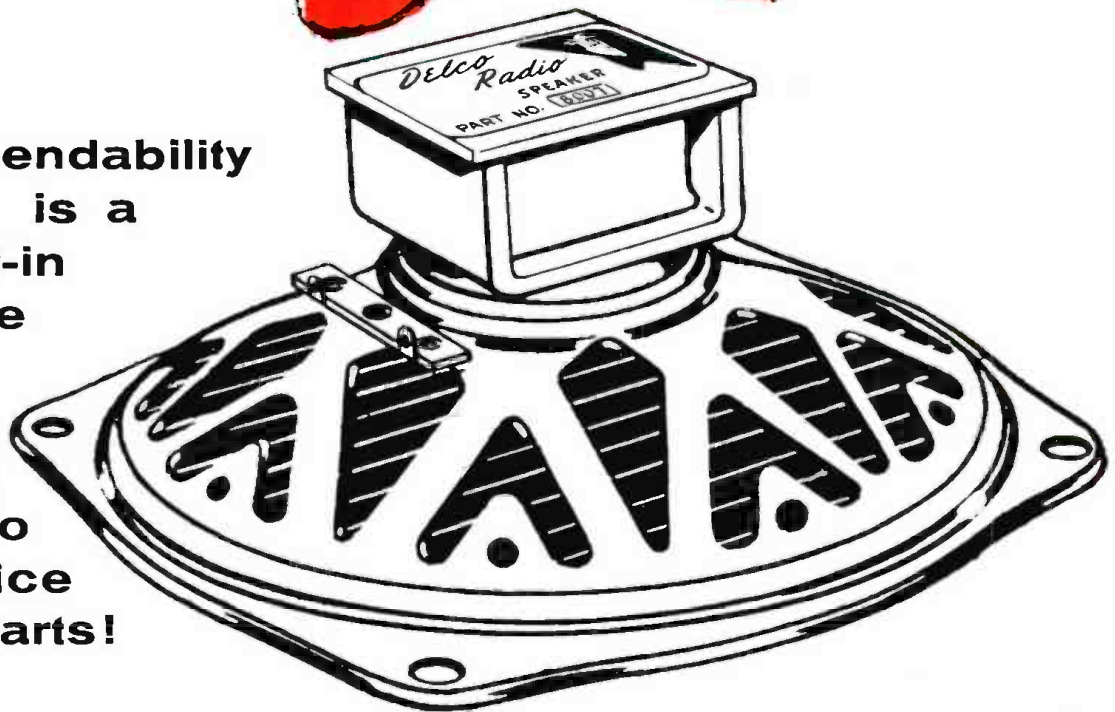

Take speakers, for instance. Delco electronic speakers are built rugged for long life and resistance to extreme weather conditions. You can rely on them for exceptional power handling and rich distortion-free tone.

Delco's popular 8-inch "Hi-Fi" speaker, No. 8007, provides the most power and tonal range for the money. Designed for replacement use and high fidelity audio systems, it's a good, fast seller with price and quality appeal.

For speakers, transistors, transformers and other fine parts for Delco and other radios, see your Delco Electronic Parts Distributor. He carries the complete line. Other extras you get with Delco are • Wide selection of special application parts • Complete technical training program • Effective warranties • Dealer identification signs.

Stock with Delco Electronic Parts—more dependability and reliability for your customers, more profit for you.

DELCO
DEPENDABILITY
RADIO
RELIABILITY

Division of General Motors • Kokomo, Indiana

Available everywhere through
Electronic Distributors
associated with



SHIPPED ON APPROVAL

NEW

CRT TESTER-REACTIVATOR Model CRT-2

NOW . . . a TESTER-REACTIVATOR really designed to test, repair and reactivate EVERY PICTURE TUBE MADE — whether black and white or color . . . with exclusive features never before found in picture tube testers.



Housed in hand-rubbed oak carrying case — complete with MULTI-HEAD*

Model CRT-2
\$57.50
Net

TERMS: \$13.50 within 10 days. Balance \$11 monthly for 4 months.

The CRT-2 steps in and solves the limitations and shortcomings of present day CRT Testers. Unlike ordinary CRT testers that keep entering the field with a limited range of operation, the CRT-2 employs a new brilliantly engineered circuit designed to test, repair and reactivate every black and white or color picture tube made. The CRT-2 eliminates the guesswork and risk that until now, has always been present when a picture tube is reactivated. It accomplishes this by providing perfect control of either the 'Boost' or 'Shot' method of reactivation.

THE CRT-2 DOES ALL THIS RIGHT IN THE CARTON, OUT OF THE CARTON OR IN THE SET

TEST

- ✓ for quality of every black and white and color picture tube
- ✓ for all inter-element shorts and leakage up to one megohm
- ✓ for life expectancy

REPAIR

- ✓ Will clear inter-element shorts and leakage
- ✓ Will weld opens between any two elements in the tube gun

REACTIVATE

- ✓ The unique controlled 'SHOT' (high voltage pulse) method of reactivation provided by the CRT-2 will restore picture tubes to new life in instances where it was not possible before. Furthermore the high voltage is applied without danger of stripping the cathode as you always have perfect control of the high voltage pulse.
- ✓ The 'BOOST' method of reactivation also provided by the CRT-2 is used effectively on tubes with a superficially good picture but with poor emission and short life expectancy. It will improve definition, contrast and focus greatly and add longer life to the picture tube.

1. **THE MULTI-HEAD (patent pending) . . . A SINGLE PLUG IN CABLE AND UNIQUE TEST HEAD** — A tremendous advance over the maize of cable and adapters generally found with other testers. Enables you to test, repair and reactivate every type of picture tube with greater convenience than ever before . . . 50 degree to 110 degree types from 8" to 30", whether 12 pin base, 8 pin base, 14 pin base . . . even the very latest 7 pin base. A special color switch on the MULTI-HEAD enables you to test, repair and reactivate each of the red, green and blue color guns separately.
2. **WATCH IT REACTIVATE THE PICTURE TUBE** — You actually see and control the reactivation directly on the meter as it takes place, allowing you for the first time to properly control the reactivation voltage. This eliminates the danger of stripping the cathode of the oxide coating. It enables you to see the speed of reactivation and whether the build-up is lasting. You will see if the cathode contamination is too great and if the picture tube is too far gone to be reactivated.
3. **CONTROLLED "SHOT" WITH HIGHER VOLTAGE FOR BETTER REACTIVATION** — Stronger than any found in other testers . . . high enough to really do the job — yet controlled to avoid damage to the picture tube.
4. **UNIQUE HIGH VOLTAGE PULSE CIRCUIT** — Will burn out inter-element shorts and weld open circuits with complete safety to the picture tube.
5. **VISUAL LIFE TEST** — Enables both you and your customer to see the life expectancy of any picture tube right on the meter. The fact that your customer can see the results of your tests as you make them virtually eliminates resistance to picture tube replacement when necessary.
6. **TESTS, REPAIRS AND REACTIVATES SPECIAL LOW SCREEN VOLTAGE TUBES** — Many new type picture tubes use special low voltage of approximately 50 volts. The CRT-2 will test, repair and reactivate these types with the same thoroughness as the regular types with complete safety.
7. **SEPARATE FILAMENT VOLTAGES** — Including the very latest 2.35 volt and 8.4 volt types as well as the older 6.3 volt types.
8. **TESTS, REPAIRS AND REACTIVATES 'SF' PICTURE TUBES** — found in the newest Sylvania and Philco TV sets. These picture tubes have different base pin connections than standard picture tubes and there is always an element of risk that the tube may be burned out when tested with ordinary picture tube testers. The CRT-2 is designed to accommodate this new base pin arrangement and will test the tube with no danger of damage.

ADDITIONAL FEATURES

- Employs the time proven dynamic cathode emission test principle • Large 4 1/2" meter with heavily damped movement for smooth action, accuracy and long life
- Provides separate shorts test for each element in the picture tube • Filament continuity is shown on a separate glow indicator • An easy to read instruction manual contains all the latest testing information on old and new type picture tubes • Housed in handsome hand-rubbed oak carrying case with special compartment for MULTI-HEAD and line cord.

* patent pending

IN-CIRCUIT CONDENSER TESTER Model CT-1

Here is an IN-CIRCUIT CONDENSER that DOES THE WHOLE JOB! The CT-1 actually steps in and takes over where all other in-circuit condenser fail. The ingenious application of a dual bridge principle gives the CT-1 a tremendous range of operation . . . and makes it an absolute 'must' for every serviceman.

in-circuit checks:

- ✓ Quality of condensers even with circuit shunt resistance (This includes leakage, shorts, opens, intermittents)
- ✓ Value of all condensers from 200 mmfd. to .5 mfd.
- ✓ Quality of all electrolytic condensers (the ability to hold a charge)
- ✓ Transformer, socket and wiring leakage capacity

out-of-circuit checks:

- ✓ Quality of condensers . . . (This includes leakage, shorts, opens and intermittents)
- ✓ Value of all condensers from 50 mmfd. to .5 mfd.
- ✓ Quality of all electrolytic condensers (the ability to hold a charge)
- ✓ High resistance leakage up to 300 megohms
- ✓ New or unknown condensers . . . transformer, socket, component and wiring leakage capacity

OUTSTANDING FEATURES

- Ultra-sensitive 2 tube drift-free circuitry
- Multi-color direct scale readings for both quality and value . . . in-circuit or out-of-circuit
- Simultaneous readings of circuit capacity and circuit resistance
- Built-in hi-leakage indicator sensitive to over 300 megohms
- Cannot damage circuit components
- Electronic eye balance indicator for every greater accuracy
- Isolated power line
- Housed in sturdy hammertone finish steel case . . . comes complete with test leads

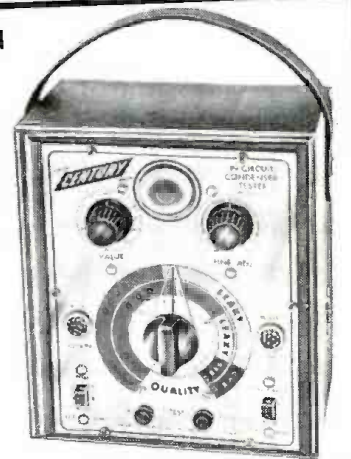

Model CT-1
\$34.50
Net

TERMS: \$9.50 within 10 days. Balance \$5 monthly for 5 months.

EASY TO BUY IF SATISFIED — see order form on facing page

FOR 10 DAY FREE TRIAL

Convince yourself at no risk that CENTURY instruments are indispensable in your every day work. Send for instruments of your choice without obligation . . . try them for 10 days before your buy . . . only then, when satisfied, pay in easy-to-buy monthly installments — without any financing or carrying charges added.

NOW a Battery Operated **VACUUM TUBE VOLT METER** Model VT-1
Peak-to-Peak

WITH LARGE EASY-TO-READ 6" METER —

featuring the sensational new MULTI-PROBE * Patent Pending

No extra probes to buy! The versatile MULTI-PROBE does the work of 4 probes

- ① DC Probe ② AC-Ohms Probe ③ Lo-Cap Probe ④ RF Probe

The VT-1 is a tremendous achievement in test equipment. With its unique MULTI-PROBE it will do all the jobs a V.T.V.M. should do without the expense of buying additional probes. No longer do you have to cart around a maze of entangled cables, lose time alternating cables or hunting for a misplaced probe. With just a twist of the MULTI-PROBE tip you can set it to do any one of many time-saving jobs. A special holder on side of case keeps MULTI-PROBE firmly in place ready for use.

FUNCTIONS

DC VOLTMETER . . . Will measure D.C. down to 1.5 volts full scale with minimum circuit loading, and give accurate readings of scale divisions as low as .025 volts . . . Will measure low AGC and oscillator bias voltages from .1 volts or less up to 1500 volts with consistent laboratory accuracy on all ranges . . . Zero center provided for all balancing measurements such as discriminator, ratio detector alignment and hi-fi amplifier balancing.

AC VOLTMETER . . . True Peak-to-Peak measurements as low as 3 volts of any wave form including TV sync, deflection voltages, video pulses, distortion in hi-fi amplifiers, AGC and color TV gating pulses . . . Scale divisions are easily read down to .1 volts . . . Measures RMS at 1/20th the circuit loading of a V.O.M. . . . Unlike most other V.T.V.M.'s there is no loss in accuracy on the lowest AC range.

ELECTRONIC OHMMETER . . . Measures from 0 to 1000 megohms . . . Scale divisions are easily read down to .2 ohms . . . Will measure resistance values from .2 ohms to one billion ohms . . . Will detect high resistance leakage in electrolytic and by-pass condensers.

RF and LO-CAP MEASUREMENTS . . . With these extra VT-1 functions you can measure voltages in extremely high-impedance circuits such as sync and AGC pulses, driving saw tooth voltages, color TV gating pulses, mixer output levels, I.F. stage-by-stage gain and detector inputs.

OUTSTANDING FEATURES

- Completely portable — self powered with long life batteries — permits use everywhere
- New advanced pentode amplifier circuit assures amazingly low battery drain
- Large 6" 100-microampere meter, many times more sensitive than meters used in most V.T.V.M.'s
- Laboratory accuracy performance — 2% of full scale on DC, 5% of full scale on AC
- Simplified multi-color easy-to-read 4-scale meter
- No heat operation assures rigid stability and accuracy
- Immune to power line fluctuations
- Amplifier rectifier circuit with frequency compensated attenuator — a feature found only in costly laboratory instruments
- Meter completely isolated — practically burn-out proof
- Hand-crafted circuitry eliminates the service headaches of printed circuitry
- 1% resistors used for permanent accuracy
- Separate RF ground return for low-loss RF measurement
- Micro-phon type co-axial connector
- Matching cover protects instrument face — snaps on and off instantly.

SPECIFICATIONS

- DC Volts — 0 to 1.5/6/30/150/300/600/1500 volts
- AC Volts (RMS and Peak-to-Peak) — 0 to 3/12/60/300/1200 volts
- Ohms — 0 to a billion ohms, 10 ohms center scale — Rx1/10/100/1K/10K/100K/1M
- RF — Peak reading demodulator supplied for use on all DC ranges
- Zero Center — available on all DC volt ranges with zero at mid-scale
- Decibels — from -10 Db to +10/22/36/50/62 based on the Ohm unit: 0Db-1MW in 600 ohms
- Impedance — 11 megohms DC, 1 megohm AC, 10 megohms Lo-Cap
- Input Capacity — 130 mmfd. RMS, 250 mmfd. Peak-to-Peak, 25 mmfd. Lo-Cap



Housed in hammertone steel-case — complete with MULTI-PROBE

Model VT-1
\$58.50 Net
TERMS: \$14.50 within 10 days. Balance \$11 monthly for 4 months.

FAST-CHECK TUBE TESTER Model FC-2

Simply set two controls . . . insert tube . . . and press quality button to test any of over 700 tube types completely, accurately . . . IN JUST SECONDS!

Over 20,000 servicemen are now using the FAST-CHECK in their every day work and are cutting servicing time way down, eliminating unprofitable call-backs and increasing their dollar earnings by selling more tubes with very little effort. See for yourself at no risk why so many servicemen chose the FAST-CHECK above all other tube testers.

PICTURE TUBE TEST ADAPTER INCLUDED WITH FAST-CHECK

Enables you to check all picture tubes (including the new short-neck 110 degree type) for cathode emission, shorts and life expectancy . . . also to rejuvenate weak picture tubes.

RANGE OF OPERATION

- ✓ Checks quality of over 700 tubes types, employing the time proven dynamic cathode emission test. This covers more than 99% of all tubes in use today, including the newest series-string TV tubes, auto 12 plate-volt tubes, OZ4s, magic eye tubes, gas regulators, special purpose hi-fi tubes and even foreign tubes.
- ✓ Checks for inter-element shorts and leakage.
- ✓ Checks for gas content.
- ✓ Checks for life-expectancy.

SPECIFICATIONS

- No time consuming multiple switching . . . only two settings are required instead of banks of switches on conventional testers
 - No annoying roll chart checking . . . tube chart listing over 700 tube types is located inside cover. New listings are added without costly roll chart replacement
 - Checks each section of multi-section tubes and if only one section is defective the tube will read "Bad" on the meter scale
 - 41 phosphor bronze beryllium tube sockets never need replacement
 - 7-pin and 9-pin straighteners protected against accidental burn-out
 - Special scale on meter is the most sensitive available, yet rugged — fully protected against line voltage variation
 - 12 filament positions
 - Separate gas and short jewel indicators
 - Line isolated — no shock hazards
 - Long lasting etched aluminum panel.
- NOTE:** The Fast-Check positively cannot become obsolete . . . circuitry is engineered to accommodate all future tube types as they come out. New tube listings are furnished periodically at no cost.



Housed in hand-rubbed oak carrying case complete with CRT adapter

Model FC-2
\$69.50 Net
TERMS: \$14.50 within 10 days. Balance \$11 monthly for 5 months.

CONVENIENT TIME PAYMENT PLAN — NO FINANCING CHARGES

ALL CENTURY INSTRUMENTS ARE GUARANTEED FOR ONE FULL YEAR

The extremely low prices are made possible because you are buying direct from the manufacturer.

CENTURY ELECTRONICS CO., INC.

CHECK INSTRUMENTS DESIRED

- Model CRT-2 CRT TESTER REACTIVATOR . . . \$57.50 \$13.50 within 10 days. Balance \$11 monthly for 4 months.
- Model CT-1 In-Circuit Condenser Tester . . . \$34.50 \$9.50 within 10 days. Balance \$5 monthly for 5 months.
- Model VT-1 Battery Vacuum Tube Volt Meter . . . \$58.50 \$14.50 within 10 days. Balance \$11 monthly for 4 months.
- Model FC-2 Fast-Check Tube Tester . . . \$69.50 \$14.50 within 10 days. Balance \$11 monthly for 5 months.

Prices Net F.O.B. Mineola, N. Y.

111 Roosevelt Avenue, Dept. 111, Mineola, New York

Please rush the instruments checked for a 10 day free trial. If satisfied I agree to pay the down payment within 10 days and the monthly installments as shown. If not completely satisfied I will return the instruments within 10 days and there is no further obligation. It is understood there will be NO INTEREST or FINANCING charges added.

Name Please print clearly
Address
City State



By DEREK SWAINE*

CLOSED-CIRCUIT TV is becoming more and more common, and the fields of application are also expanding. Up to now the cost of a closed-circuit system has held back the growth of this branch of the TV art.

However, a new TV camera, the Sylvania model 100, is designed to meet the requirements of lower cost and still supply a picture comparable in quality to home TV receivers.

Unlike some of the more expensive closed-circuit cameras, the model 100 is complete in a single unit. It comes with a single general-purpose lens, but is fitted with an adjustable turret so two additional lenses can be added.

Like almost all other closed-circuit cameras, the model 100 uses a vidicon type of scene pickup tube. The tube has an opaque mask with a $\frac{1}{2} \times \frac{3}{8}$ -inch clear center, to facilitate setting up the raster on the target.

Before going on to the electronic circuits of the camera, let's briefly review the vidicon's operation (Fig. 1 shows the construction of a vidicon). The scene to be televised is focused by an optical system on the vidicon's target. The target, a photoconductive film, is deposited on a transparent but electrically conductive film on the inner surface of the optical end window of the tube. The conductive film acts as the signal-takeoff electrode and is connected to a metal ring at the front of the tube. The output signal is tapped off the ring.

Wherever light hits the photoconductive film, its conductivity is increased in proportion to light intensity. The signal electrode is kept at a positive potential and, therefore, as the conductivity of an area of the photo-sensitive layer is increased, the corresponding area on the gun side of the layer becomes positive. When the scanning beam—produced by a conventional elec-

tron gun—passes over the positively charged sections, it supplies electrons to them, neutralizing the charge. The resulting current flowing in the 56,000-ohm load resistor, R4 in Fig. 2, produces the signal voltage.

The scanning beam's intensity is regulated by the tube's control grid and is accelerated, shaped and decelerated, in turn, by other grids. The beam is focused by the focus coil and focus anode, and alignment and deflection are handled by external electromagnetic fields.

Camera circuitry

The camera has six main sections—four-stage video amplifier, modulator, rf oscillator, vertical and horizontal oscillator and output sections, and power supply. Circuit design is conventional. Several individual circuits are similar to those in TV receivers. For example, take the video amplifier. The main difference between the camera circuit and a TV receiver's circuit is overall gain. In the receiver, you can figure on about 25 times, but in the camera it is about 300 times. Bandwidth is comparable.

Typical output for picture highlights

Portable unit puts closed-circuit TV in the hands of small business. Any modern TV receiver becomes the monitor

Low Cost CLOSED CIRCUIT

TV CAMERA

from the vidicon is 5 mv and is developed across approximately 50,000 ohms. This presents a problem when we want to amplify frequencies up to about 3.5 mc, because the output capacitance at the vidicon's signal electrode plus the input capacitance of the first video stage and the capacitance of the shielded vidicon output lead has a reactance comparable with 50,000 ohms at the higher frequencies. This causes severe attenuation of output with increasing frequency at the control grid of the first video amplifier. (High frequency represents fine picture detail.)

To compensate for such attenuation, the third video amplifier is designed for a rising output characteristic with increasing frequency. This is done by using a very low plate load resistor in series with a peaking coil. The resistor is variable and is called a COMPENSATION control. It adjusts for the required overall frequency and phase response required by individual cameras. A germanium diode is connected between the fourth video amplifier's grid and ground. It minimizes the effect of voltage surges which occur when the de voltage on the vidicon target is varied,

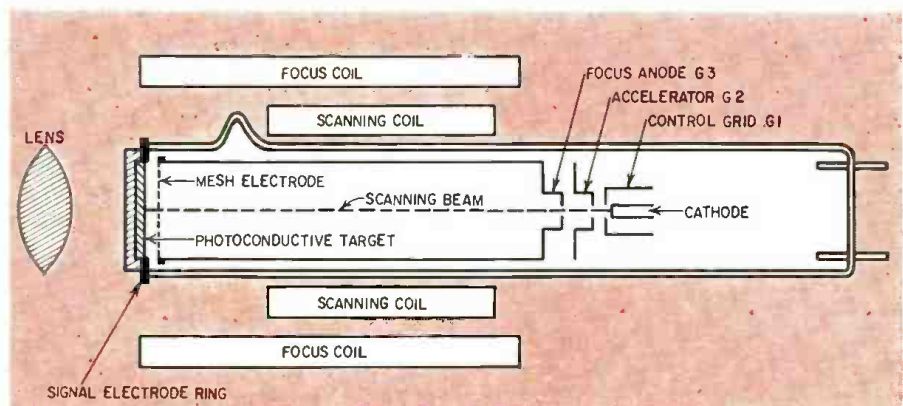

Fig. 1—Cutaway diagram shows construction of a vidicon camera tube.

*Engineering Dept., Sylvania Electric Products Inc., Home Products Div.

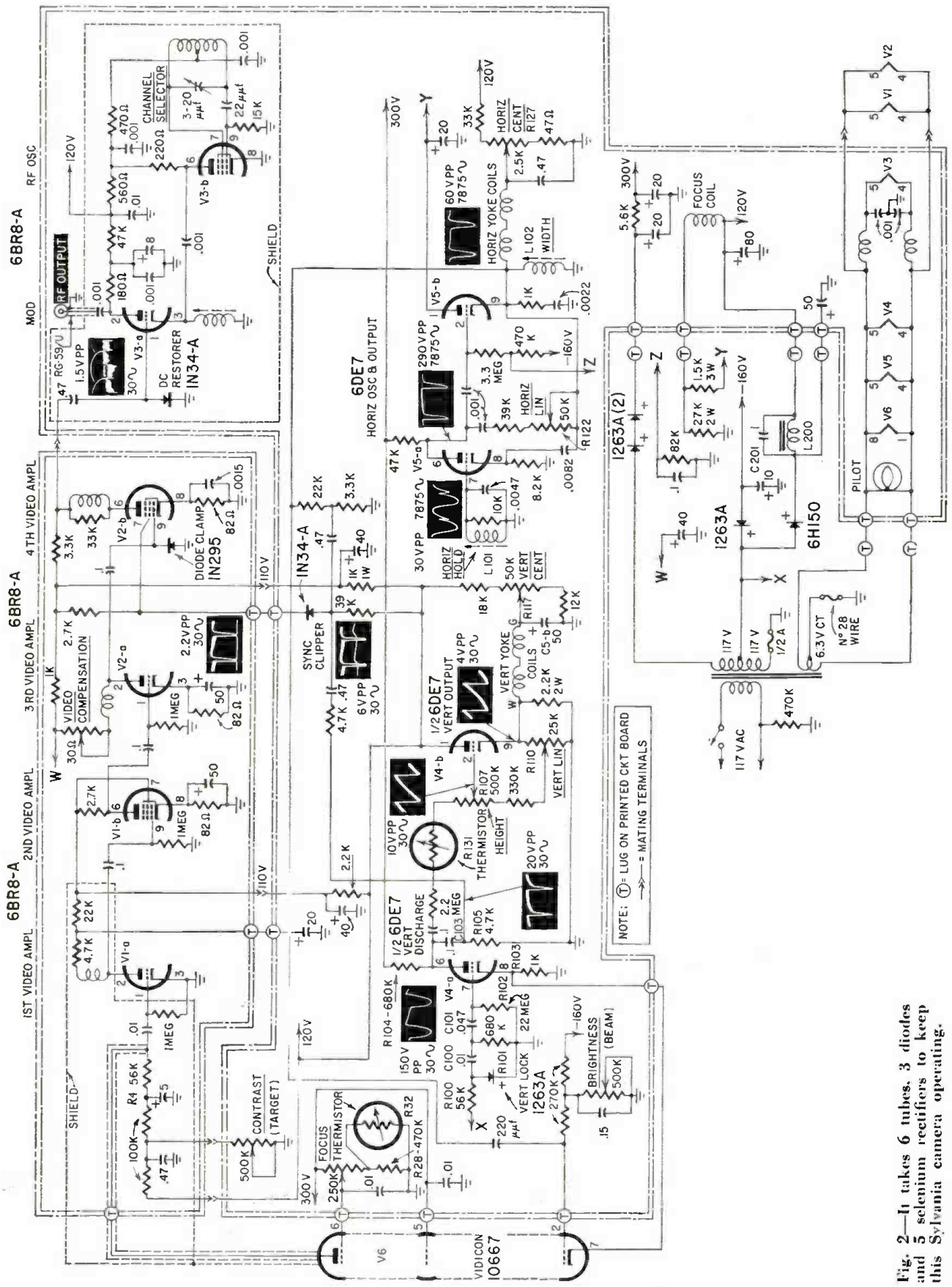

Fig. 2—It takes 6 tubes, 3 diodes and 5 selenium rectifiers to keep this Sylvania camera operating.

HARVEY has the latest in

CITIZEN BAND RADIO

The POLY-COMM
A 27 MC Deluxe
Two-Way Citizen
Band
TRANSCEIVER
for Class 'D' Operation



Price: \$159.50

Here's the model for everyone—at work or play or business—it's the natural choice for any citizen to take advantage of the 22 newly created 27 MC Citizen Band frequencies. Features super sensitive dual conversion 10 tube superhet receiver, which incorporates rapid acting adjustable vacuum tube squelch circuit: plus Delayed A.G.C.—Floating series gate-type noise limiter—Low distortion—Communication tailored frequency response—Has no relays—Better than 3-watts output—Operates on 115V A.C. or 12 volt battery. With slight modification will also operate on 6 volt D.C.

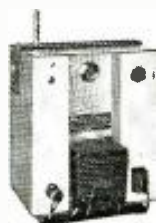

RCA "RADIO-PHONE"
27 MC Citizen Band
Two-way Radio

Designed to provide low-cost 2-way communication facilities for small boat owners, it is ideal for out-boards not equipped with a standard multichannel radio-telephone. Features Single channel Transceiver—Simplified operation—5-watt output—Compact, portable—weighs only 8 lbs.—High sensitivity receiver—Dual power supply.

Price: \$124.95

HARVEY has a complete stock of Antennas to meet every 27 MC citizen band requirement.

MAIL ORDERS SHIPPED SAME DAY AS RECEIVED
Include with your payment a generous allowance
for shipping charges—the excess will be
promptly refunded.

HARVEY Estab. 1927
RADIO CO., INC.
103 West 43rd Street, New York 36, N. Y.
JU 2-1500

TELEVISION

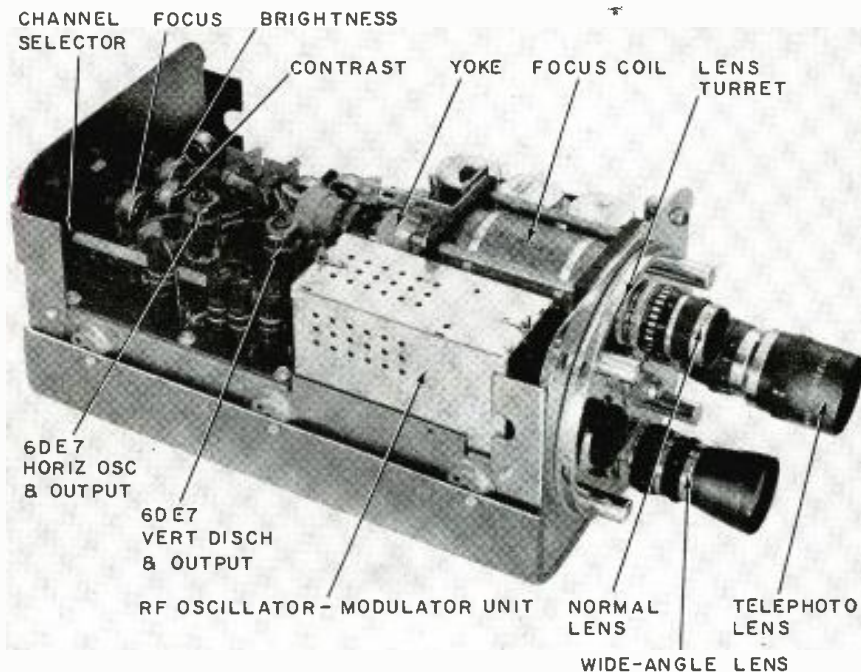

Arrangement of major parts inside the Sylvania camera. Important operating controls are on the rear panel.

and also of power-line voltage surges.

Vertical and horizontal sync pulses are applied to the screen grid of the fourth video amplifier via the sync clipper diode. The polarity of the video signal is positive white at this point and that of the sync pulses negative.

A dual-section 6BR8-A is used for the modulator and rf oscillator stages (see Fig. 2). The pentode section is used in a Hartley type oscillator to provide the rf carrier. Its frequency can be adjusted for channels 2 through 6. The oscillator section's plate is coupled to the cathode of the triode section. The impedance of the triode cathode circuit is comparatively high for rf, but negligible at video frequencies. This insures that virtually no video voltages appear at the pentode section's plate. Hence only a negligible amount of frequency modulation of the oscillator can occur, when the output signal is amplitude-modulated. Further oscillator isolation is provided by the electron coupling between oscillator and modulator, the rf output being taken from the plate of the pentode section.

The composite video signal is applied to the control grid of the triode section of the 6BR8-A. This results in the tube's gain being varied in accordance with the applied video signal. Therefore, the strength of the rf output is also varied or amplitude-modulated. This modulated rf signal is fed to the output socket of the camera.

Vertical scanning

A 6DE7 generates the sawtooth scanning current for the vertical coils in the vidicon deflection yoke. This double triode also delivers vertical blanking pulses. The vertical sync pulses are also obtained from the same tube.

Here's how the vertical deflection

circuit works: A 60-cycle voltage, essentially sinusoidal, is obtained from the power transformer. It is fed to the vertical-lock diode via resistor R100. The waveform at the diode is severely flattened on the positive half-cycle when the diode conducts. The modified waveform is differentiated by R-C network C100 and R101. The resultant waveform has a very small pip at the beginning of the flattened part, and this pip is used to trigger or drive the discharge triode. A second R-C network (C101 and R102) provides the required bias at the vertical discharge tube's grid; at least 90% of the waveform is in the tube's cutoff region.

The vertical discharge section is similar to that in TV receivers, except that the tube is not part of a self-oscillating circuit. The charge capacitor (C103) charges exponentially from the 300-volt B-supply, via charge resistor R104. This happens while the tube is in the cutoff region. But before the rising voltage developed at the plate of the tube by the charge capacitor has progressed out of the linear region of the exponential charge curve, the pip on the grid waveform drives the tube into conduction and the charge capacitor is rapidly discharged. This causes a rapid voltage drop at the tube's plate. The grid voltage waveform quickly returns the tube to the cutoff condition, and the cycle repeats itself. The sawtooth waveform generated is fed to the control grid of the vertical output tube.

When the vertical discharge tube conducts, a positive voltage pulse is formed across cathode resistor R103 and a negative pulse across peaking resistor R105, which is connected in series with charge capacitor C103. The positive pulse is fed to the vidicon's cathode to cut off the scanning beam during ver-

TELEVISION

tical retrace. The negative pulse is fed to the sync clipper diode to provide the vertical sync pulse.

The sawtooth drive for the vertical output tube is fed to the control grid via thermistor R131. Since a thermistor's value decreases with increasing temperature, the amplitude of the drive waveform will increase as camera temperature rises. This maintains a constant scan amplitude, since the dc resistance of the vertical scanning coils increases with rising temperature. Without the compensating effect of the thermistor, the scan would decrease in amplitude with increase in temperature.

Operation of the vertical output stage is straightforward; the tube converts the sawtooth voltage at the control grid to a sawtooth current in the vertical scanning coils in the tube's cathode circuit. Note that the voltage waveform shown in the schematic is not the one appearing directly across the vertical scanning coils, but is the waveform between one end of the coils and ground. Between the other end of the coils and ground there is a parabolic waveform, developed across the capacitor C5-b. The waveform appearing directly across the coils is a linear sawtooth, indicating a linear sawtooth current flowing in the coils. The linear waveform is produced by the combined effect of the nonlinear sawtooth shown in the schematic and the parabolic waveform appearing across capacitor C5-b.

Vertical scan size is controlled primarily by the potentiometer R107 and linearity by potentiometer R110. However, these two controls are interdependent.

The vertical scan is centered on the vidicon target by potentiometer R117. It controls the direct current flowing in the vertical scanning coils.

A 6DE7 provides the sawtooth scanning current for the horizontal coils in the deflection yoke. The voltage pulse across the scanning coils is used for horizontal blanking during horizontal retrace. The same pulse is also used to obtain the horizontal sync pulses.

Horizontal scanning

Here's how the horizontal circuit works: The two tube sections are connected in a multivibrator circuit. V5-a is cut off for most of the oscillatory cycle and V5-b conducts for most of it. As in the vertical circuit, the deflection coils are in the cathode circuit of the output section. Since the impedance of the coils at the horizontal frequency (15,750 cycles) is predominantly inductive, the ac voltage across the coils will be in the form of a narrow pulse when a sawtooth current is flowing in the coils.

L101, connected between V5-a's control grid and ground, stabilizes the oscillation frequency of the circuit, the coil being pulsed into oscillation by the voltage fed to the tube's cathode to produce grid current.

By adjusting its inductance, coil L101
(Continued on page 128)



You can be sure the

QUAM

Adjust-a-Cone®

SPEAKER

will fit . . .
it's listed in
COUNTERFACTS
and **PHOTOFACTS**
for your convenience

"If at first you don't succeed, try, try again" may be good advice sometimes, but it's silly when you're replacing a speaker. Instead of trying one speaker after another, just put in the right one the first time—by checking the recommendations in PHOTOFACTS or by having your distributor check the COUNTERFACTS listing for you.

These listings in COUNTERFACTS and PHOTOFACTS can save you time and effort when you're replacing a speaker. Always remember to check them first . . . and remember that this service is another QUAM exclusive. No other speaker manufacturer gives you this extra convenience . . . just as no other speaker manufacturer gives you the famous patented Adjust-a-Cone Suspension and U-shaped pot.

*QUAM is your quality line...
and your convenience line too.*

QUAM-NICHOLS COMPANY 236 E. Marquette Road, Chicago 37, Illinois

NEW! *dynamic* TRANSISTOR TESTER

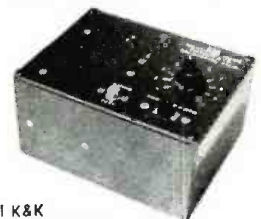

- Tests power transistors and general purpose types.
- Instantly determines if transistor is open, shorted, noisy or has high value of leakage.
- Ideal to match transistors for push-pull audio circuits.
- Simple, quick check—no charts—no meter to read!
- Transistor merit is accurately determined by audio tone from self-contained speaker.
- Control knob indicates gain merit of transistor.
- Complete instructions furnished.

SPECIFICATIONS: Powered by two 6 volt batteries (included).
Dimensions: 5 1/4" wide; 4-1/16" long; 3 1/4" high.
Shipping weight: 2 1/4 lbs.

The Model K&K Tester is an audio oscillator with a control to vary the amount of feedback. The ability of a transistor to oscillate in this circuit is an accurate indication of the transistor's merit. Two sockets are provided: one for power transistors, and one for general purpose types. Both PNP and NPN can be checked.

\$19.95
NET

*In Calif.
add 4%
sales tax.*

KIERULFF & CO. 6303 E. CORSAIR ST.

LOS ANGELES 22, CALIF.

Superior's New
Model TW-11 **STANDARD PROFESSIONAL
TUBE TESTER**

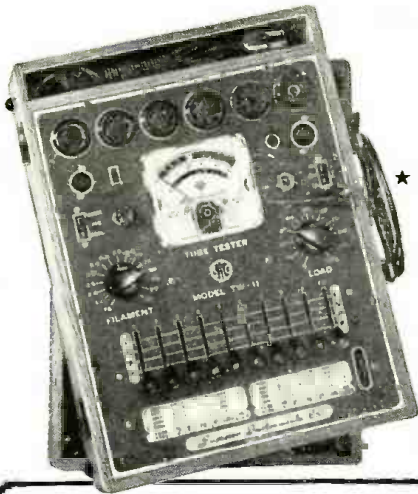

- ★ Tests all tubes, including 4, 5, 6, 7, Octal, Lock-in, Hearing Aid, Thyatron, Miniatures, Sub-miniatures, Novals, Sub-minars, Proximity fuse types, etc.
- ★ Uses the new self-cleaning Lever Action Switches for individual element testing. Because all elements are numbered according to pin-number in the RMA base numbering system, the user can instantly identify which element is under test. Tubes having tapped filaments and tubes with filaments terminating in more than one pin are truly tested with the Model TW-11 as any of the pins may be placed in the neutral position when necessary.
- ★ The Model TW-11 does not use any combination type sockets. Instead individual sockets are used for each type of tube. Thus it is impossible to damage a tube by inserting it in the wrong socket.
- ★ Free-moving built-in roll chart provides complete data for all tubes. All tube listings printed in large easy-to-read type.
- ★ NOISE TEST: Phono-jack on front panel for plugging in either phones or external amplifier will detect microphonic tubes or noise due to faulty elements and loose internal connections.

Model TW-11—TUBE TESTER . . . Total Price \$47.50—Terms: \$11.50 after 10 day trial, then \$6.00 per month for 6 months if satisfactory. Otherwise return, no explanation necessary!

EXTRAORDINARY FEATURE—SEPARATE SCALE FOR LOW-CURRENT TUBES. Previously, on emiss on-type tube testers, it has been standard practice to use one scale for all tubes. As a result, the calibration for low-current types has been restricted to a small portion of the scale. The extra scale used here greatly simplifies testing of low-current types.

The Model TW-11 operates on 105-130 Volt 60 Cycles A.C. Comes housed in a beautiful hand-rubbed oak cabinet complete with portable cover.

\$47⁵⁰
NET



Model 83—C. R. Tube Tester. Total Price \$38.50 Terms \$8.50 after 10 day trial, then \$6.00 monthly for 5 months if satisfactory. Otherwise return, no explanation necessary.

SUPERIOR'S NEW MODEL 83

C.R.T. TESTER

TESTS AND REJUVENATES ALL PICTURE TUBES

ALL BLACK AND WHITE TUBES

ALL COLOR TUBES

From 50 degree to 110 degree types—from 8" to 30" types—Test ALL picture tubes—in the carton—out of the carton in the set!

- Model 83 is not simply a rebashed black and white C.R.T. Tester with a color amplifier added. Model 83 employs a new improved circuit designed specifically to test the older type black and white tubes, the newer type black and white tubes and all color picture tubes.
- Model 83 provides separate filament operating voltages for the older 6.3 types and the newer 8.4 types.
- Model 83 employs a 4" air-damped meter with quality and calibrated scales.
- Model 83 properly tests the red, green and blue sections of color tubes individually—for each section of a color tube contains its own filament, plate, grid and cathode.
- Model 83 will detect tubes which are apparently good but require rejuvenation. Such tubes will provide a picture seemingly good but lacking in proper definition, contrast and focus. To test for such malfunction, you simply press the rej. switch of Model 83. If the tube is weakening, the meter reading will indicate the condition.
- Rejuvenation of picture tubes is not simply a matter of applying a high voltage to the filament. Such voltages improperly applied can strip the cathode of the oxide coating essential for proper emission. The Model 83 applies a selective low voltage uniformly to assure increased life with no danger of cathode damage.

Model 83 comes housed in handsome portable Saddle Stitched Texon case—complete with sockets for all black and white tubes and all color tubes. Only—

\$38⁵⁰
NET

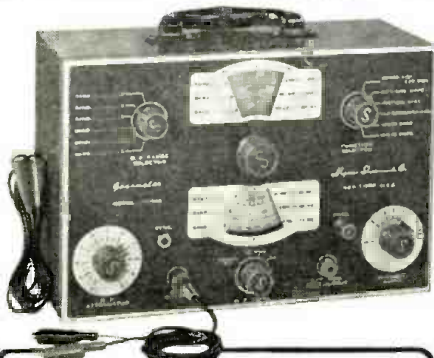

Model TV-50A—Genometer. Total Price—\$47.50. Terms: \$11.50 after 10 day trial, then \$6.00 monthly for 6 months if satisfactory. Otherwise return, no explanation necessary.

GENOMETER
7 Signal Generators in One!

- ✓ R.F. Signal Generator for A.M.
- ✓ R.F. Signal Generator for F.M.
- ✓ Audio Frequency Generator
- ✓ Bar Generator
- ✓ Cross Hatch Generator
- ✓ Color Dot Pattern Generator
- ✓ Marker Generator

A versatile all-inclusive GENERATOR which provides ALL the outputs for servicing:

A.M. Radio • F.M. Radio • Amplifiers • Black and White TV • Color TV

R. F. SIGNAL GENERATOR: The Model TV-50A Genometer provides complete coverage for A.M. and F.M. alignment. Generates Radio Frequencies from 100 Kilocycles to 60 Megacycles on fundamentals and from 60 Megacycles to 180 Megacycles on powerful harmonics.

VARIABLE AUDIO FREQUENCY GENERATOR: In addition to a fixed 400 cycle sine-wave audio, the Model TV-50A Genometer provides a variable 300 cycle to 20,000 cycle peak wave audio signal.

BAR GENERATOR: The Model TV-50A projects an actual Bar Pattern on any TV Receiver Screen. Pattern will consist of 4 to 16 horizontal bars or 7 to 20 vertical bars.

THE MODEL TV-50A comes absolutely complete with shielded leads and operating instructions.

CROSS HATCH GENERATOR: The Model TV-50A Genometer will project a cross-hatch pattern on any TV picture tube. The pattern will consist of non-shifting, horizontal and vertical lines interlaced to provide a stable cross-hatch effect.

DOT PATTERN GENERATOR (FOR COLOR TV) Although you will be able to use most of your regular standard equipment for servicing Color TV, the one addition which is a "must" is a Dot Pattern Generator. The Dot Pattern projected on any color TV Receiver tube by the Model TV-50A will enable you to adjust for proper color convergence.

MARKER GENERATOR: The Model TV-50A includes all the most frequently needed marker points. The following markers are provided: 189 Kc., 262.5 Kc., 456 Kc., 600 Kc., 1000 Kc., 1400 Kc., 1600 Kc., 2000 Kc., 2500 Kc., 3579 Kc., 4.5 Mc., 5 Mc., 10.7 Mc. (3579 Kc. is the color burst frequency).

\$47⁵⁰
NET

EXAMINE BEFORE YOU BUY!
USE APPROVAL FORM ON NEXT PAGE

VACUUM TUBE VOLTMETER

WITH NEW 6" FULL-VIEW METER



Compare it to any peak-to-peak V. T. V. M. made by any other manufacturer at any price!

- ✓ Model 77 completely wired and calibrated with accessories (including probe, test leads and portable carrying case) sells for only \$42.50.
- ✓ Model 77 employs a sensitive six inch meter. Extra large meter scale enables us to print all calibrations in large easy-to-read type.
- ✓ Model 77 uses new improved SICO printed circuitry.
- ✓ Model 77 employs a 12AU7 as D.C. amplifier and two 9006's as peak-to-peak voltage rectifiers to assure maximum stability.
- ✓ Model 77 uses a selenium-rectified power supply resulting in less heat and thus reducing possibility of damage or value changes of delicate components.
- ✓ Model 77 meter is virtually burn-out proof. The sensitive 400 microampere meter is isolated from the measuring circuit by a balanced push-pull amplifier.
- ✓ Model 77 uses selected 1% zero temperature coefficient resistors as multipliers. This assures unchanging accurate readings on all ranges.

AS A DC VOLTMETER: The Model 77 is indispensable in H-F Amplifier servicing and a must for Black and White and color TV Receiver servicing where circuit loadings cannot be tolerated.

AS AN AC VOLTMETER: Measures RMS values if sine wave, and peak-to-peak value if complex wave. Pedestal voltages that determine the "black" level in TV receivers are easily read.

AS AN ELECTRONIC OHMMETER: Because of its wide range of measurement leaky capacitors show up glaringly. Because of its sensitivity and low loading, intermittent faults are easily found, isolated and repaired.

Model 77 comes complete with operating instructions, probe and test leads. Use it on the bench—use it on calls. A streamlined carrying case, included at no extra charge, accommodates the tester, instruction book, probe and leads. Operates on 110-120 volt 60 cycle. Only

SPECIFICATIONS
 • DC VOLTS—0 to 3/15/75, 150/300/750/1,500 volts at 11 megohms input resistance. • AC VOLTS (RMS) 0 to 3/15/75/150/300/750/1,500 volts. • AC VOLTS (Peak to Peak) —0 to 8/40/200/400/800/2,000 volts. • ELECTRONIC OHMMETER—0 to 1,000 ohms/10,000 ohms/100,000 ohms/1 megohm/10 megohms/100 megohms/1,000 megohms. • DECIBELS —10 db db to + 18 db, + 10 db to + 38 db, + 30 db to + 58 db. All based on 0 db = .006 watts (6 mw) into a 500 ohm line (1.73r). • ZERO CENTER METER—For discriminator alignment with full scale range of 0 to 1.5/7.5/37.5/75/150/375/750 volts at 11 megohms input resistance.

\$42⁵⁰ NET

Model 77—VACUUM TUBE VOLTMETER ... Total Price \$42.50—Terms: \$12.50 after 10 day trial, then \$6.00 monthly for 5 months if satisfactory. Otherwise return. No explanation necessary!

SUPERIOR'S NEW MODEL 80

20,000 OHMS PER VOLT ALLMETER

THE ONLY 20,000 OHMS PER VOLT V.O.M. SELLING FOR LESS THAN \$50 WHICH PROVIDES ALL THE FOLLOWING FEATURES:

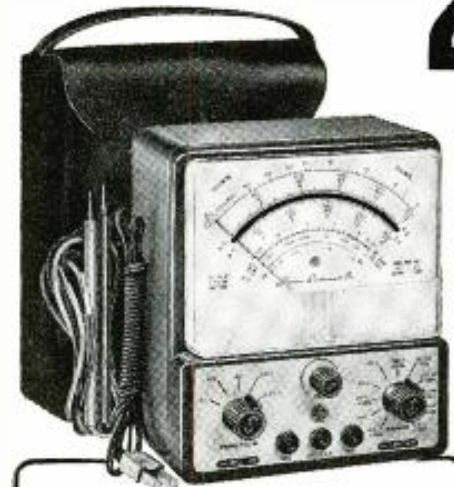

- ✓ 6 INCH FULL-VIEW METER provides large easy-to-read calibrations. No squinting or guessing when you use Model 80.
- ✓ MIRRORED SCALE permits fine accurate measurements where fractional readings are important.
- ✓ CAPACITY RANGES permit you to accurately measure all condensers from .00025

- MFD to 30 MFD in addition to the standard volt, current, resistance and decibel ranges.
- ✓ HANDSOME SADDLE-STITCHED CARRYING CASE included with Model 80 Allmeter at no extra charge enables you to use this fine instrument on outside calls as well as on the bench in your shop.

NOTE: The line cord is used only for capacity measurements. Resistance ranges operate on self-contained batteries.

SPECIFICATIONS:

- 7 D.C. VOLTAGE RANGES:
(At a sensitivity of 20,000 Ohms per Volt)
0 to 15/75/150/300/750/1500/7500 Volts.
- 6 A.C. VOLTAGE RANGES:
(At a sensitivity of 5,000 Ohms per Volt)
0 to 15/75/150/300/750/1500 Volts.
- 3 RESISTANCE RANGES:
0 to 2,000/200,000 Ohms. 0-20 Megohms.
- 2 CAPACITY RANGES:
.00025 Mfd. to .3 Mfd., .05 Mfd. to 30 Mfd.
- 5 D.C. CURRENT RANGES:
0-75 Microamperes, 0 to 7.5/75/750 Milli-amperes, 0 to 15 Amperes.
- 3 DECIBEL RANGES:
- 6 db to + 18 db. + 14 db to + 38 db
+ 34 db to + 58 db

FEATURES:

- A built-in Isolation Transformer automatically isolates the Model 80 from the power line when capacity service is in use.
- Selected, 1% zero temperature coefficient metalized resistors are used as multipliers to assure unchanging accurate readings on all ranges.

Model 80 Allmeter comes complete with operating instructions, test leads and portable carrying case. Only

\$42⁵⁰ net

Model 80 — ALLMETER ... Total Price \$42.50—Terms: \$12.50 after 10 day trial, then \$6.00 monthly for 5 months if satisfactory. Otherwise return, no explanation necessary!

SHIPPED ON APPROVAL NO MONEY WITH ORDER — NO C. O. D.

Try any of the instruments on this or the facing page for 10 days before you buy. If completely satisfied then send down payment and pay balance as indicated on coupon. **No Interest or Finance Charges Added!** If not completely satisfied return unit to us, no explanation necessary.

MOSS ELECTRONIC, INC.
Dept. D-682, 3849 Tenth Ave., New York 34, N. Y.

Please send me the units checked on approval. If completely satisfied I will pay on the terms specified with no interest or finance charges added. Otherwise, I will return after a 10 day trial positively canceling all further obligations.

- Model TW-11.....Total Price \$47.50 \$11.50 within 10 days. Balance \$6.00 monthly for 6 months.
- Model TV-50A.....Total Price \$47.50 \$11.50 within 10 days. Balance \$6.00 monthly for 6 months.
- Model 83.....Total Price \$38.50 \$8.50 within 10 days. Balance \$6.00 monthly for 5 months.
- Model 77.....Total Price \$42.50 \$12.50 within 10 days. Balance \$6.00 monthly for 5 months.
- Model 80.....Total Price \$42.50 \$12.50 within 10 days. Balance \$6.00 monthly for 5 months.

Name.....
 Address.....
 City..... Zone..... State.....

All prices net, F.O.B., N.Y.C.

NEW SOUND EXCITEMENT FOR THE HI-FI STEREO AGE!

Kingdom **LORENZ** — IT'S —
LOUDSPEAKERS

Never before so many quality features in loudspeakers—yet priced for the modest budget! Dual cones for breathtaking wide range performance! Twin voice coils in 12" loudspeakers, with flexible impedances of 4, 8, or 16 ohms, enabling you to select the impedance you require! Non-resonant cast aluminum girder constructed frames! Fully tropicalized for finest operation in any climate. For stereo or monaural—singly or in matched pairs.



NEW! LORENZ S-1288

Value-packed basic 12" loudspeaker of advanced design, with dual cones and twin voice coils. Choice of impedances of 4, 8, or 16 ohms on one speaker! Frequency response: 18 to 15,000 cps. Magnetic assembly weight: 61.5 oz. Power rating: 30 watts peak\$44.50

NEW! LORENZ S-1288 II

A complete system in one convenient unit! Brilliant full range diaxial for the most critical connoisseur. Consists of Lorenz S-1288 plus twin tweeters on rigid metal bracket and high pass crossover. Dual cones and twin voice coils • 18-18,000 cps • 35 watts peak • 4, 8 or 16 ohms\$67.50

NEW! LORENZ S-888

A wide range speaker wonderfully adaptable to single or multiple use. Dual cones for thrilling broad sound response, cast aluminum girder frame • 30-14,500 cps • 18 watts peak • 8 ohms\$21.50

NEW! LORENZ S-388

The perfect match mate for Lorenz 12" or 8" speakers. Armored horn-type 2 1/2" tweeter with plastic cone for efficient 120 degree high-frequency sound dispersion. Extends the range of any system! • 2,000-18,000 cps • 20 watts peak • 5.5 ohms\$8.50

HP-1 HIGH PASS CROSSOVER

Crosses over at 2,000 cps. at rate of 3 db per octave—feeds highs to tweeters, lows to woofer. Extends speaker system range to limit of audibility. For use with 2 or 3 way systems.\$4.95

At High Fidelity Dealers Everywhere.
 FREE Catalog—Write Dept. RE-11

Kingdom **PRODUCTS, Ltd.**
 514 Broadway, New York 12, N. Y. • WOrth 6-0800
 Exclusive U. S. Distributors for Lorenz High Fidelity Loudspeakers

TELEVISION

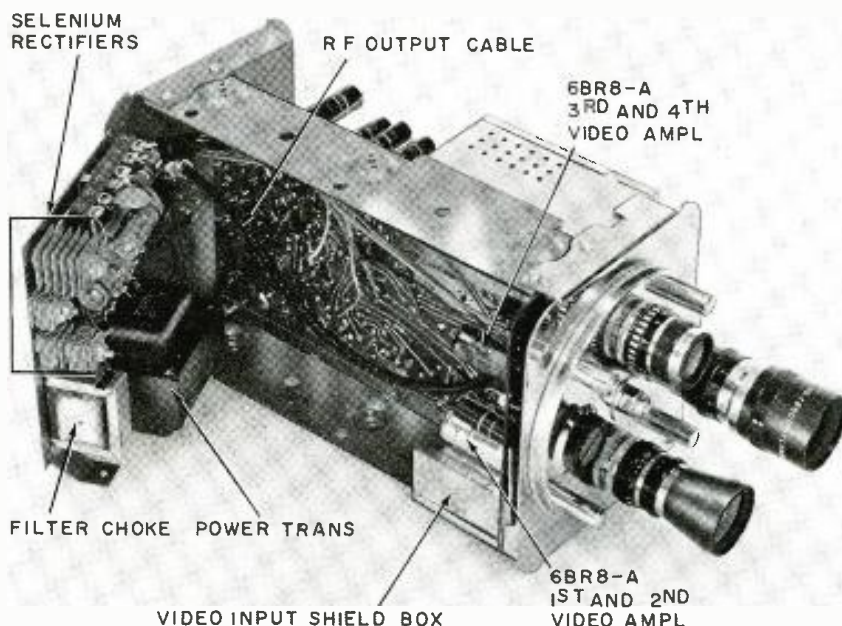

Bottom view of the model 100. Power supply chassis swings out for easy access.

(Continued from page 125)
 is used to set the scan frequency to approximately 15,750 cycles. However, the HORIZ LIN and the WIDTH controls also affect the frequency.

By controlling the waveform fed to V5-b, potentiometer R122 controls the horizontal linearity. Scan width is adjusted with L102.

The horizontal scan is centered by adjusting pot R127. It controls the direct current flowing in the deflection coils.

The vertical scan is locked to the power line and the horizontal scan is stabilized, but free-running. In other words, there is no fixed relationship or lock between horizontal and vertical scan frequencies. This means that there is no fixed condition of scanning-line interlacing. The effect on the monitor picture is not serious, and to provide correct interlacing at all times would materially increase the camera's cost.

One pulse waveform provides both horizontal blanking and horizontal sync. This is also true for vertical blanking and sync. This means that, except for the variable black level produced at the beginning and end of each horizontal and vertical scan by overscanning the vidicon mask aperture slightly, there is no blanking level generated which has a longer time duration or width than the sync pulses. The effects of this circuit economy are not serious.

As well as these departures from standard television, there are two further simplifications. One is the omission of horizontal sync information during the vertical sync pulse period. The other is the absence of equalizing pulses. Most modern receivers are not affected seriously by the horizontal scanning oscillator coasting during the vertical sync pulse period. Equalizing pulses at double the horizontal scan rate are required only in an interlaced scanning system

and, therefore, they would be superfluous if used in the simplified system of the new camera.

Power supply

The camera's power supply uses conventional circuitry. A power transformer supplies the required voltages. Half-wave selenium rectifiers are used for the 120-volt dc, 110-ma main B-plus supply, the 300-volt B-plus and the 160-volt B-minus supplies. The current taken from the 300- and 160-volt supplies is under 2 ma in each case. A low ac ripple level is essential in the 120-volt B-plus supply, and nonpolarized capacitor C201 is used to resonate filter choke L200 to help get the high degree of filtering required.

A thermistor to stabilize the vertical scan size against effects of temperature changes has been described. A second thermistor minimizes the effect, on vidicon beam focus, of temperature changes within the camera. An increase in temperature of the focusing coil reduces the current flowing in the coil. To compensate for such a change, thermistor R32 is connected in parallel with resistor R28 in the FOCUS control circuit. The decrease in value of the thermistor with increasing temperature reduces the dc voltage applied to the vidicon's focus electrode. This, in turn, compensates for the reduction in the magnetic focusing field, due to the reduction in focus-coil current.

Using the camera

The camera provides an rf signal suitable for use with commercial television receivers. Best results will usually be obtained when one or more Sylvania monitor receivers, model 17P114F, are used with the camera.

In using the camera, best results will be obtained if the scene to be televised is well lighted. An example of good

TELEVISION

lighting would be that provided by overhead fluorescent fixtures. However, good pictures can be obtained with considerably lower lighting levels.

In addition to the normal aperture and focus adjustments on the optical lens, the BRIGHTNESS (vidicon beam current), CONTRAST (vidicon target voltage), FOCUS (electrical focus) and CHANNEL SELECTOR controls are located behind a small cover at the rear of the camera. Having selected any receiver channel 2 through 6 which is signal free, or which has the weakest signal if no channel is free of visible signal, the camera CHANNEL TUNING control is set to the selected channel. Any fine tuning required is effected at the receiver. The BRIGHTNESS (beam), CONTRAST (target) and FOCUS (both optical and electrical) controls are adjusted for best picture contrast and detail. The lens aperture is adjusted in accordance with the scene light level. The monitor's (receiver) contrast and brightness controls are set for the best possible picture. Once the user is familiar with the functions of the camera controls, adjusting them is no more complex or difficult than adjusting those on a commercial television receiver.

In addition to the operation or setup controls, there are a number of factory preset controls. With the exception of the VIDEO COMPENSATION control, all preset controls are located behind a cover plate on one side of the camera. The compensation control is accessible through a small hole in the front plate of the camera. This hole is exposed through one of the lens mounting holes in the turret. An insulated alignment tool must be used for adjustment.

The service viewpoint

The new Sylvania camera is not difficult to service. The two halves of the camera case are removed easily. First slide the name plates on each side of the camera to the left. This exposes the case's retaining screws. After removing these screws, the two case sections may be removed to expose the camera chassis.

Although the overall dimensions of the camera are comparatively small, component accessibility is generally good. Except for the power supply section, printed-circuit construction is used. The two boards are of the see-through type, so circuit interconnections can be traced from the component side when a light is played through from the opposite side. With the top section of the case removed, the two 6DE7 tubes for horizontal and vertical scan are accessible. After removing the top from the rf oscillator-modulator shielding box, the 6BR8-A is accessible. With the bottom section of the case removed, the two 6BR8-A video amplifiers are accessible. To remove the vidicon, first detach the lens turret by unscrewing the center locking nut, then loosen the clamp at the rear of the

It's what you know about USING INSTRUMENTS ...that really counts!

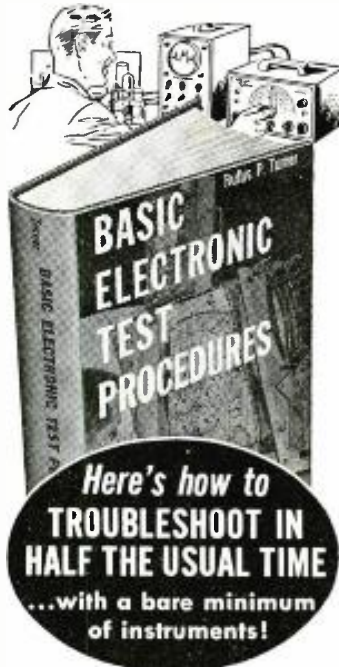

Almost anyone can repair TV's, radios and other electronic equipment AFTER THE TROUBLE HAS BEEN LOCATED. The real trick is in spotting the trouble—and that means knowing how to use instruments fast, accurately, and intelligently. Actually, its amazing what you can do with only a few instruments—providing you know how to use different kinds for the same job; how to select the right ones; where to use them; how to connect them into circuits; how to set the controls; how to read them; and how to follow professional test procedures every step of the way. And that's exactly what this new 316-page book with its more than 190 how-to-do-it pictures, operational procedure sketches and pattern designs teaches you!

A new, down-to-earth guide to BASIC ELECTRONIC TEST PROCEDURES

Alternate test methods • cautions • correct instrument usage • connections • readings • test techniques • time saving tricks . . . and all the rest

BASIC ELECTRONIC TEST PROCEDURES by Rufus Turner explains every detail of the work in a way you can hardly fail to understand. Covers the different methods for doing specific jobs. For instance, you learn to check distortion by either the 'scope, rejection filter, harmonic-distortion meter, wave analyzer or audio oscillator methods. You learn to make resistance measurements with a current-meter, a volt-ammeter, a volt-meter, an ohmmeter, or via the bridge method . . . and so on through the entire line-up of basic test procedures.

Subjects include current checks; power, capacitance, inductance, resistance, AF, RF, phase, distortion, and modulation measurements; tube and semi-conductor testing; audio amplifier tests; sensitivity, RF gain, fidelity, AVC voltage, operating voltage checks, etc.; visual alignment techniques—even transmitter as well as industrial electronic test and measurement procedures. Price \$6.50. Read it for 10 days at our risk!

PRACTICE 10 DAYS...FREE!

DEPT. RE-119, RINEHART & CO., INC.
232 Madison Ave., New York 16, N.Y.

Send BASIC ELECTRONIC TEST PROCEDURES for 10-day FREE EXAMINATION. If I decide to keep book, I will then send you \$6.50 plus a few cents postage in full payment. If not, I will return book postpaid and owe you nothing. (SAVE! Send \$6.50 with your order and Rinehart pays the postage. Same 10-day guarantee with money promptly refunded if you're not more than satisfied with book.)

NAME.....

ADDRESS.....

CITY, ZONE, STATE.....

OUTSIDE U.S.A.—Cash with order only. Price \$7.00. Money back if book is returned in 10 days.

CONSIDER OSCILLOSCOPES for instance!

Simplified explanations of modern oscilloscope techniques show how to use your 'scope as a volt-meter, current meter, variable frequency oscillator, etc., or for making RF, phase or AM measurements; for distortion and deflection checking; square wave testing; visual AM and FM alignment, and for many other jobs. Every detail is explained—from making connections, to adjusting controls and analyzing patterns.

CONSIDER INDUSTRIAL ELECTRONICS too!

Still another big feature is the book's usefulness in acquainting you with industrial electronic test techniques—including testing non-electronic phenomena such as strain, pressure, etc.

VOM OWNERS

Get FREE COPY of unusual reference bulletin backed with valuable data:

"ALL ABOUT VOM's"

Rapid answers to all VOM problems. No strings attached, but quantity is limited. SEND TODAY a post card; paste this ad. or write. GIVE MAKE & MODEL OF YOUR VOM.
NEW WORLD LABORATORIES P.O. Box 127-R11
Astoria L.I. 2, N.Y.

MAIL ORDER HI-FI

You can now purchase all your HI-FI from one reliable source and be assured of perfect delivery. Carston makes delivery from NY stock on most HI-FI. Recorders and tape within 24 hours. SEND US A LIST OF YOUR HI-FI REQUIREMENTS FOR OUR WHOLESALE QUOTATION and our FREE wholesale catalogue.

CARSTON STUDIOS 125-RD E. 88 St.
New York 28, N. Y.

ADD TO YOUR INCOME

Learn at Home to Fix APPLIANCES

FREE
SAMPLE
LESSON

Tester Furnished—No Extra Charge. National Radio Institute trains you at home. Every service customer is worth more when you can fix his electrical appliances. Mail coupon for Lesson and Catalog.

National Radio Inst., Dept. FM9, Washington 16, D.C.
Please send me Electrical Appliance Sample Lesson and Catalog FREE (No salesman will call).

Name.....Age.....

Address.....

City.....Zone.....State.....

ACCREDITED MEMBER NATIONAL HOME STUDY COUNCIL

"ONE DOLLAR" buys As much as \$15 worth—Everything Brand New and sold to you with a money back guarantee.

DEDUCT 10% ON ANY ORDER OF \$10 OR OVER—Plus a FREE SURPRISE PACKAGE

- | | | | |
|---|--|--|---|
| <input type="checkbox"/> 1-3" PM SPEAKER alnico #5 magnet \$1 | <input type="checkbox"/> 100-ASST. 1/2 WATT RESISTORS some 5% \$1 | <input type="checkbox"/> 515-"JACKPOT" TELEVISION PARTS \$1 | <input type="checkbox"/> 2-SELENIUM RECTIFIERS 100 ma \$1 |
| <input type="checkbox"/> 1-4" PM SPEAKER alnico #5 magnet \$1 | <input type="checkbox"/> 70-ASST'ED 1 WATT RESISTORS some 5% \$1 | <input type="checkbox"/> 25"-INSULATED SHIELDED WIRE \$1 | <input type="checkbox"/> 1-SELENIUM RECTIFIER 350ma \$1 |
| <input type="checkbox"/> 1-5" PM SPEAKER alnico #5 magnet \$1 | <input type="checkbox"/> 35-ASST'ED 2 WATT RESISTORS some 5% \$1 | <input type="checkbox"/> 32" TEST PROD. WIRE (black) \$1 | <input type="checkbox"/> 4-RCA 1U4 TUBES 180 screen size a 174 \$1 |
| <input type="checkbox"/> 1-TWISTER SPEAK-ER for Hi-Fi \$1 | <input type="checkbox"/> 25-ASST. PRINTED CIRCUIT SOCKETS \$1 | <input type="checkbox"/> 100"-FINEST NYLON DIAL CORE best size \$1 | <input type="checkbox"/> 2-KENRAD 65H7 TUBES \$1 |
| <input type="checkbox"/> 3-AUDIO OUTPUT TRANS. 50L6 type \$1 | <input type="checkbox"/> 50-ASST. TUBULAR CONDENSERS \$1 | <input type="checkbox"/> 1-S7 INDOOR TV ANT. hi-gain 3 sec. \$1 | <input type="checkbox"/> 2-GENERAL ELEC. 12SK7 TUBES \$1 |
| <input type="checkbox"/> 3-AUDIO OUTPUT TRANS. 6K6 or 6V6 \$1 | <input type="checkbox"/> 20-TUBULAR CONDENSERS .047-600V \$1 | <input type="checkbox"/> 1-RCA 70° FLYBACK TRANS. 75240 \$1 | <input type="checkbox"/> 3-KENRAD 1LE3 TUBES \$1 |
| <input type="checkbox"/> 2-AUDIO OUTPUT TRANS. 6K6 push-pull \$1 | <input type="checkbox"/> 15-TUBULAR CONDENSERS .47-600V \$1 | <input type="checkbox"/> 1-90° FLYBACK TRANS. incl. schematic \$1 | <input type="checkbox"/> 3-RCA 6C4 TUBES \$1 |
| <input type="checkbox"/> 2-AUDIO OUTPUT TRANS. HL8 type \$1 | <input type="checkbox"/> 20-TUBULAR CONDENSERS .301-1000V \$1 | <input type="checkbox"/> 1-S11 TODD 60° DEFLECTION YOKE \$1 | <input type="checkbox"/> 2-GENERAL ELEC. 5W4 12B TUBE \$1 |
| <input type="checkbox"/> 3-I.F. COIL TRANSFORMERS 436 kc \$1 | <input type="checkbox"/> 20-TUBULAR CONDENSERS .005-600V \$1 | <input type="checkbox"/> 8-DEFLECTION YOKE MOUNTING HOODS \$1 | <input type="checkbox"/> TOP BRAND TUBES—183, 1X28, 0Z4, 5U4, 6SN7, 6CB6, 6UB, 6J6, 6V6, 6CB6, 6XB, 6AX4, 12AU6, EACH \$1 |
| <input type="checkbox"/> 3-I.F. COIL TRANSFORMERS 10.7 mc FM \$1 | <input type="checkbox"/> 20-TUBULAR CONDENSERS .01-900V \$1 | <input type="checkbox"/> 4-TV CENTERING RINGS for back of yoke \$1 | <input type="checkbox"/> 100-ASSORTED TUBE CARTONS \$1 |
| <input type="checkbox"/> 3-I.F. COIL TRANSFORMERS 202kc (auto) \$1 | <input type="checkbox"/> 15-TUBULAR CONDENSERS .25-600V \$1 | <input type="checkbox"/> 4-TV CENTERING RINGS fits on neck (KIT) \$1 | <input type="checkbox"/> 50-ASST. MICA CONDENSERS some in 5% \$1 |
| <input type="checkbox"/> 10-OVAL LOOP ANTENNAS ass't. hi-gain \$1 | <input type="checkbox"/> 10-HV TUB. CON. ELECTROLYTIC COND. \$1 | <input type="checkbox"/> 15-ASST. TV COILS sync, hooking, with \$1 | <input type="checkbox"/> 50-ASST. CERAMIC COND. some in 5% \$1 |
| <input type="checkbox"/> 3-LOOPSTICK ANT. new ferrite adjustable \$1 | <input type="checkbox"/> 10-HV TUB. CON. CONDENSERS .001-6000V \$1 | <input type="checkbox"/> 5-TV CRT. SOCKETS with 18" leads \$1 | <input type="checkbox"/> 35-MICA COND. 20-50mmf & 15-25mmf \$1 |
| <input type="checkbox"/> 3-VARIABLE COND. super 120/192 mfd \$1 | <input type="checkbox"/> 10-HV TUB. CONDENSERS .005-3000V \$1 | <input type="checkbox"/> 5-HI-VOLT. ANODE LEADS with 18" leads \$1 | <input type="checkbox"/> 35-MICA COND. 20-50 mmf & 15-68mmf \$1 |
| <input type="checkbox"/> 3-ASST. SIZES RADIO CHASSIS \$1 | <input type="checkbox"/> 10-ASST. RADIO ELECTRO. COND. \$1 | <input type="checkbox"/> 10-TV CARTWHEEL CONDENSERS 30 kv \$1 | <input type="checkbox"/> 35-MICA COND. 20-100mmf, 15-270mmf \$1 |
| <input type="checkbox"/> 12-RADIO OSCILLATOR COILS 436 kc \$1 | <input type="checkbox"/> 5-ASST. TV ELECTROLYTIC COND. \$1 | <input type="checkbox"/> 3-TV CARTWHEEL CONDENSERS 30 kv \$1 | <input type="checkbox"/> 35-MICA COND. 20-470mmf, 15-680mmf \$1 |
| <input type="checkbox"/> 3-1/2 MEG. VOLUME CONTROLS w/switch \$1 | <input type="checkbox"/> 2-ELECTROLYTIC COND. 40/40-450V \$1 | <input type="checkbox"/> 2-HV RECTIFIER SOCKETS 1B3 in'ted \$1 | <input type="checkbox"/> 35-MICA COND. 20-820mmf, 15-1000mmf \$1 |
| <input type="checkbox"/> 5-50K VOLUME CONTROLS less switch \$1 | <input type="checkbox"/> 3-ELECTROLYTIC COND. 16/16-450V \$1 | <input type="checkbox"/> 3-HV RECTIFIER SOCKETS 1X3 in'ted \$1 | <input type="checkbox"/> 35-MICA COND. 20-220V, 15-240mmf \$1 |
| <input type="checkbox"/> 5-ASST. 4 WATT WIRES & CONTROLS \$1 | <input type="checkbox"/> 3-ELECTROLYTIC COND. 50/30-150V \$1 | <input type="checkbox"/> 20-ASST. TV KNOBS, ESCUTCHEONS, etc. \$1 | <input type="checkbox"/> 35-MICA COND. 20-330V, 15-470mmf \$1 |
| <input type="checkbox"/> 10-ASST. VOLUME CONTROLS less switch \$1 | <input type="checkbox"/> 30-FT CONDENSER MOUNTING WAFERS \$1 | <input type="checkbox"/> 12-ASST. STANDARD TUNER VHF STRIPS \$1 | <input type="checkbox"/> 35-MICA COND. 20-680V, 15-10,000mmf \$1 |
| <input type="checkbox"/> 5-ASST. VOLUME CONTROLS w/switch \$1 | <input type="checkbox"/> 6-TUBULAR ELECT. CONDENSERS 1.50V \$1 | <input type="checkbox"/> 3-ASST. UHF STAND. CONDENSERS 10kv \$1 | <input type="checkbox"/> 35-CERAMIC COND. 20-5mmf, 15-10mmf \$1 |
| <input type="checkbox"/> 100-VOLUME CONTROL HEX NUTS \$1 | <input type="checkbox"/> 6-TUBULAR ELECT. CONDENSERS 5.150V \$1 | <input type="checkbox"/> 25-ASST. PEAKING COILS popular types \$1 | <input type="checkbox"/> 35-CERAMIC COND. 20-50mmf, 15-82mmf \$1 |
| <input type="checkbox"/> 10-SURE GRIP ALLIGATOR CLIPS \$1 | <input type="checkbox"/> 6-TUBULAR ELECT. CONDENSERS 5.150V \$1 | <input type="checkbox"/> 1-RCA SYNCHRO. GUIDE COIL # 205R1 \$1 | <input type="checkbox"/> 35-CERAMIC COND. 20-100, 15-150mmf \$1 |
| <input type="checkbox"/> 1-GOLD GRILLE CLOTH 14x14 or 12x18 \$1 | <input type="checkbox"/> 50-ASSORTED FUSES popular sizes \$1 | <input type="checkbox"/> 1-RCA SYNCHROLOC COIL # 208TB \$1 | <input type="checkbox"/> 35-CERAMIC COND. 20-270, 15-470mmf \$1 |
| <input type="checkbox"/> 5-SETS SPEAKER PLUGS wired \$1 | <input type="checkbox"/> 50-1500 1/2 WATT RESISTORS 10% \$1 | <input type="checkbox"/> 1-STANDARD AGC CONDENSER \$1 | <input type="checkbox"/> 35-CERAMIC COND. 20-100, 15-150mmf \$1 |
| <input type="checkbox"/> 10-SETS PHONO PLUGS and PIN JACKS \$1 | <input type="checkbox"/> 50-100K 1/2 WATT RESISTORS 5% \$1 | <input type="checkbox"/> 1-RATIO DETECTOR COIL 1.5 mc \$1 | <input type="checkbox"/> 35-CERAMIC COND. 20-1000, 15-1500mmf \$1 |
| <input type="checkbox"/> 2-52.50 SAPPHIRE NEEDLES 5000 plays \$1 | <input type="checkbox"/> 50-470K 1/2 WATT RESISTORS 10% \$1 | <input type="checkbox"/> 1-RATIO DETECTOR COIL 10.7 mc \$1 | <input type="checkbox"/> 600-ASST. HDWARE scr., nuts, riv., etc. \$1 |
| <input type="checkbox"/> 20-ASST. PILOT LIGHTS popular types \$1 | <input type="checkbox"/> 50-2.2 MEG 1/2 W. RESISTORS 10% \$1 | <input type="checkbox"/> 1-TV VERTICAL OUT-PUT RECTIFIER MER 10 to 1 ratio \$1 | <input type="checkbox"/> 200 SELF TAPPING SCREWS # 8 x 1/2 \$1 |
| <input type="checkbox"/> 10-PILOT LT. SKTS. bayonet type, wired \$1 | <input type="checkbox"/> 10-25T. WIRE W/ND RES. 5, 10, 20 watt \$1 | <input type="checkbox"/> 1-VERTICAL BLOCK TRANS. standard \$1 | <input type="checkbox"/> 50-WING NUTS # 6 chrome plated \$1 |
| <input type="checkbox"/> 50-ASST. TERMINAL STRIPS 1, 2, 3, 4 lug \$1 | <input type="checkbox"/> 40-ASST. PRECISION RESISTORS best sizes \$1 | <input type="checkbox"/> 1-TV FOCUS COIL 270 ohms \$1 | <input type="checkbox"/> 2-ELECTRIC MOTORS 1 1/2 volt, 1001 uses \$1 |
| <input type="checkbox"/> 20-ASSORTED TUBE SHIELDS best sizes \$1 | <input type="checkbox"/> 35-ASST. DISC CERAMICS best numbers \$1 | <input type="checkbox"/> 1-TV FOCUS COIL 330 ohms \$1 | <input type="checkbox"/> 6-SOCKET WRENCHES 3/16" to 7/16" \$1 |
| <input type="checkbox"/> 35-ASST. RADIO KNOBS, scr. & push. \$1 | <input type="checkbox"/> 35-DISC CERAMICS 3mmf \$1 | <input type="checkbox"/> 1-TV FOCUS COIL 470 ohms \$1 | <input type="checkbox"/> 8-ASST. LUCITE CASES handy for parts \$1 |
| <input type="checkbox"/> 75-KNOB SPRINGS standard 3/8" x 1/2" \$1 | <input type="checkbox"/> 25-ASSORTED MICA TRIMMER Conds. \$1 | <input type="checkbox"/> 1-TV FOCALYZER adjusts any ohmage \$1 | <input type="checkbox"/> 1-LB. SPOOL ROSIN CORE SOLDER 40/60 \$1 |
| <input type="checkbox"/> 100-ASSORTED KNOB SET-SCREWS \$1 | <input type="checkbox"/> 10-6' ELECTRIC LINE CORDS w/plugs \$1 | <input type="checkbox"/> 1-2 MEGOHM RESIS-TOR 20W for # 630 \$1 | <input type="checkbox"/> 30-TV ALIGNMENT TOOLS assortment # 1 \$1 |
| <input type="checkbox"/> 25-ASST. RADIO DIAL POINTERS \$1 | <input type="checkbox"/> 5-TV CHEATER CORDS w/both plugs \$1 | <input type="checkbox"/> 1-SILICON RECTIFIER 750 ma 500V \$1 | <input type="checkbox"/> 3-TV ALIGNMENT TOOLS assortment # 2 \$1 |
| <input type="checkbox"/> 15-ASST. ROTARY SWITCHES \$15 worth \$1 | <input type="checkbox"/> 40-SPOOLS HOOK-UP WIRE 4 colors \$1 | <input type="checkbox"/> 2-DIODE CRYSTALS 2-IN21 2-IN22 1-INB4 \$1 | <input type="checkbox"/> 3-TV ALIGNMENT TOOLS assortment # 3 \$1 |
| <input type="checkbox"/> 3-TOGGLE SWITCHES spst, dpdt, etc. \$1 | <input type="checkbox"/> 50-STRIPS ASST. SPAGHETTI best sizes \$1 | <input type="checkbox"/> 3-DIODE CRYSTALS 1-IN60, 1-IN61, 1-IN60 \$1 | <input type="checkbox"/> 3-TV ALIGNMENT TOOLS assortment # 4 \$1 |
| <input type="checkbox"/> 6-SLIDE SWITCHES spst, dpdt, etc. \$1 | <input type="checkbox"/> 100-ASST. RUBBER GROMMETS best sizes \$1 | <input type="checkbox"/> 2-SELENIUM RECT.-1-250ma \$1 | <input type="checkbox"/> 30-ALIGNMENT TOOLS assortment # 5 \$1 |
| <input type="checkbox"/> 4-BAKELITE KNIFE SWITCHES dpdt \$1 | <input type="checkbox"/> 100-TWIN LEAD-IN WIRE 3000 heavy duty \$1 | <input type="checkbox"/> 2-SELENIUM RECT.-1-75ma & 1-150 ma \$1 | <input type="checkbox"/> EACH ALIGNMENT TOOL is different & valued at over \$1 |
| <input type="checkbox"/> 35-ASST. SOCKETS octal, nov. & miniature \$1 | <input type="checkbox"/> 50'-FLAT 4-COND. WIRE many purposes \$1 | | |

HANDY WAY TO ORDER—Simply tear out advertisement and pencil mark items wanted (X in square is sufficient), enclose with money order or check. You will receive a new copy of this ad for re-orders. **ON SMALL ORDERS**—Include stamps for postage, excess will be refunded. Larger orders shipped express collect.

FREE—CONDENSER AND RESISTOR CODE CHARTS with every order

BROOKS RADIO & TV CORP., 84 Vesey St., New York 7, N.Y.

Unbelievable LOW PRICES!
NOT KITS . . . But Factory Wired and Guaranteed
HIGH QUALITY INSTRUMENTS



New! Model B-45 Radio & TV SIGNAL GENERATOR

Provides highly stable signal. Generates R.F. frequencies from 150 Kilocycles to 50 Megacycles to 50 Mc. on Fundamentals and from 11 Mc. to 50 Mc. on cycles. (150 Kc. to 12.5 Mc. on Fundamentals). R.F. is obtainable separately or modulated by the Audio Frequency. Measures 7 3/4" x 7 3/4" x 5". Weight 8 Lbs.

Complete — only \$14.95



New! TC-75 Univ. Combination TEST SPEAKER & SIGNAL TRACER

Plus resistor tester
 Plus condenser tester
 Plus output indicator
 Plus speaker substitution.
 Plus resistor substitutor
 Plus substitute 100 V D.C. power supply
 Plus field substitutor. Plus condenser substitutor
 Plus voice coil substitutor
 Plus signal tracer
 Plus universal output transformer
 Plus experimental one stage audio amplifier

Measures 7" x 11" x 5". Weight, 8 Lbs.

Complete — only \$19.95

Order directly from METROPOLITAN ELECTRONICS • 106 Fifth Ave., New York 11, N.Y.

TELEVISION

tube. After disconnecting the base socket, the vidicon may be removed through the front plate of the camera.

The camera's power supply section may be swung out to expose both the components in this section and the area of the printed board above the power supply.

An interesting point may be mentioned relevant to the centering of the raster or scanned area of the vidicon target. A current surge through either the vertical or horizontal deflection coils, produced by an accidental short circuit in the deflection circuitry for example, can deflect the raster horizontally and vertically. This shock deflection pushes the monitor picture off center and can also result in a degradation of the picture quality, due to misalignment of the scanning beam in the vidicon. Usually, the beam will be shifted outside the correction range of the camera's raster centering controls. Since the effect is caused by magnetization of the magnetic material in the deflection yoke, a reverse current surge must be applied to the horizontal and vertical deflection coils to cancel the induced magnetism. This is done by momentarily connecting a suitable dc voltage source across the deflection coils. The effect is due primarily to the high deflection sensitivity of the vidicon camera tube.

Another effect, the reason for which may not be obvious to the reader unfamiliar with television camera operation, is that, when the scan size is reduced on the camera, the effect on the monitor is that of an increase in picture size and vice versa. Any given part of the image on the vidicon target now occupies a greater proportion of the scanned area or raster. Since the receiver raster size remains fixed, any given part of the transmitted image must occupy a greater proportion of the monitor screen.

Camera Specifications

Following are the Sylvania camera specifications:

Power input: 105-128 volts, 60-cycle ac. 117 volts nominal input.
 Power consumption: 50 watts.
 Rf output: Approximately 100 mv into 300 ohms (monitor input terminals).
 Channel coverage: Standard channel 2 through 6 frequencies.

Lenses: One general-purpose 16-mm size, 25-mm focal length, f/1.9 lens is provided for use on the 3-lens turret. The turret is designed to take standard C-type mount 16-mm movie lenses. Sylvania telephoto and wide-angle lenses are available as optional equipment.

Near-focus adjustment: A fourth lens aperture is provided in the turret which increases the distance between the lens and the vidicon target. This feature increases the focus range of the lens and enables signitures, small objects, etc., to be viewed clearly.

Resolution: 250-300 lines.

Tube, diode complement: Three 6BR8-A, two 6DE7, one 10667 or 6198 vidicon pickup tube, two 1N34-A germanium diodes, one 1N295 germanium diode and one 1263-A selenium diode. Power supply has one 6H150 and three 1263-A selenium rectifiers.

Approximate dimensions (exclusive of lens and lens hood): Length—12 inches; width—7 inches; height—6 inches.

Weight: 16 pounds, when the camera is fitted with the general-purpose, telephoto and wide-angle lenses.

Mounting: Provision is made for standard photographic type tripod mounting.
 Construction: Complete in a single unit. Setup controls conveniently located. **END**

TV Service
CLINIC
 conducted by
ROBERT G. MIDDLETON
 RADIO-ELECTRONICS TELEVISION CONSULTANT

WE receive inquiries about hum troubles and symptoms, and are occasionally asked to explain the difference between hum voltage and hum modulation.

The basic difference is illustrated by Fig. 1. When hum voltage is present in a signal, the signal rides up and down, but its peak-to-peak voltage is unchanged. On the other hand, when hum modulation is present, the signal's peak-to-peak voltage does change.

Thus, Fig. 1-a is the pattern observed on a scope screen when hum voltage mixes with the video signal in a linear circuit, such as a class-A audio amplifier.

Conversely, Fig. 1-b is a typical pattern observed when the hum voltage combines with the video signal in a nonlinear circuit, such as a picture detector.

It is important to note that modulated hum passes through rf and if circuits. On the other hand, the hum-voltage component shown in Fig. 1-a does not pass through rf and if circuits.

For example, if there is a linear mixture of hum voltage and signal from the antenna, only the signal passes through the rf tuner. The hum voltage is rejected, and no trouble symptoms show up.

But, if the incoming signal is hum-modulated (as by a faulty tube in a booster), the hum modulation continues through the receiver's signal system.

Hum modulation causes a change in contrast between the top and the bottom of the picture. Also it often causes sync pulling by varying the peak-to-peak voltage of the sync pulses.

A good age system helps minimize the effects of hum modulation. However, for a cure, the trouble must be eliminated at its source.

A scope is invaluable in localizing the source of hum modulation.

Variable audio

A Bendix T-2150 is in the shop with a sound problem. The receiver operates satisfactorily for a while, then the sound blasts. The volume control must be turned down. Later, the control must again be turned up. Components seem to check out OK.—E. C. S., Shenandoah, Pa.

Use a signal tracer to monitor the sound signal. You may find that the blasting starts in the 4.5-mc section, or that it starts in the audio section. From the report, the difficulty is not in the if amplifier, as the picture would also be affected. A signal tracer is about the best instrument to use. Don't forget the discriminator transformer, a frequent culprit in this type of problem.

Test-equipment query

Can you explain why a probe will sometimes load a circuit and distort the wave-form, yet at other times has no distorting effect?—O. T., Los Angeles, Calif.

Whenever a probe is applied to a circuit, it draws current. A vom probe draws more current than a vtvm probe. Whether the probe's current demand will disturb circuit action appreciably depends on the circuit's internal resist-

Fig. 1—Effects of hum voltage: (Top)—If hum voltages mix with video signal in a linear circuit, peak-to-peak voltage of the signal is unchanged. (Bottom)—When hum voltage combines with the video signal in a nonlinear circuit, peak-to-peak voltage of the camera signal and sync pulses change cyclically.

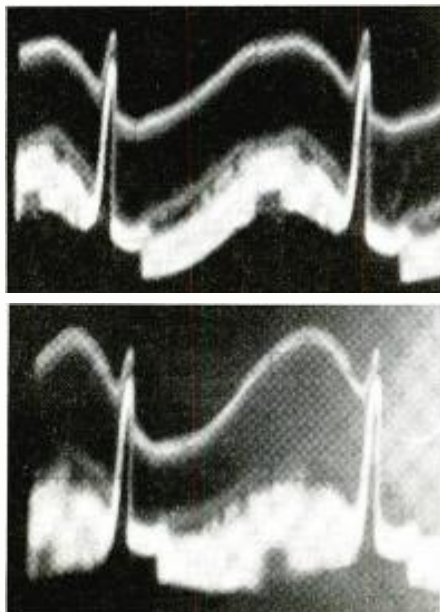

Introducing
ATR CUSTOMIZED
Karadio



Can be installed in dash or under dash as desired!

for
small import cars
and
compact U.S. cars



There is a trim plate kit for YOUR CAR!

ATR CUSTOMIZED
Karadio

• VIBRATOR-OPERATED with Tone Control

The ATR Customized Karadio is a compact, new, self-contained airplane-styled radio for small import and compact American cars. This economical unit is perfect for all small cars because it can be easily and inexpensively installed in-dash or under-dash on most any make or model automobile—and its powerful 8-tube performance provides remarkable freedom from engine, static, and road noises. ATR Karadios are built to look and fit like original equipment with sleek, modern styling and solid, single-unit construction. They offer many customized features and provide highest quality fidelity—yet cost far less than comparably designed units. The ATR Customized Karadio comes complete with speaker and ready to install... and is the ideal way to add fun and value to your small import or American automobile!



ATR KARADIO... is ideal for small import cars or compact American cars! Unit is completely self-contained—extremely compact! Can be mounted in-dash or under-dash—wherever space permits! For 6 volt or 12 volt!

SEE YOUR JOBBER OR WRITE FACTORY

• "A" Battery Eliminators • DC-AC Inverters • Auto Radio Vibrators

ATR **AMERICAN TELEVISION & RADIO CO.**
 Quality Products Since 1931
 SAINT PAUL 1, MINNESOTA, U. S. A.

**WHERE
THERE'S
A FINE
TAPE
RECORDER...**

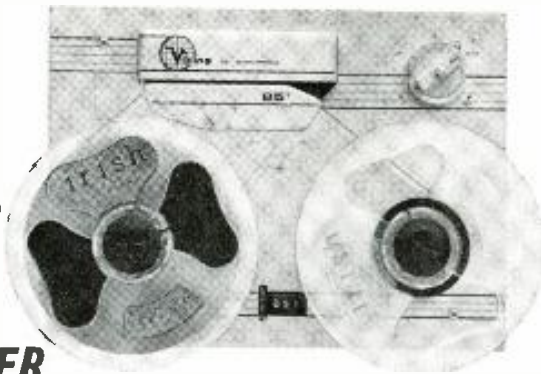

there's
irish
BRAND

ferro-sheen tape

note to **VIKING** owners

To insure optimum recording quality with your machine, the recommended tape is **irish** Long Play #601. Send for technical bulletin.

ORR INDUSTRIES INC.
Opelika, Alabama

Olson

*** FREE ***

Fill in coupon for a FREE One Year Subscription to OLSON RADIO'S Fantastic Bargain Packed Catalog—Unheard of LOW, LOW WHOLESALE PRICES on Brand Name Speakers, Changers, Tubes, Tools, Hi-Fi's, Stereo Amps, Tuners and thousands of other Electronic Bargains.

NAME _____
ADDRESS _____
CITY _____ ZONE _____ STATE _____

If you have a friend interested in electronics send his name and address for a FREE subscription also.

OLSON RADIO CORPORATION
701 S. Forge St., Akron 8, Ohio

COSMOTRON*®

- MINIATURE ATOM SMASHER
- PRODUCES 75,000 VOLTS
- ABSOLUTELY SAFE



In no sense of the word a toy or a gadget. The COSMOTRON* is a scientific instrument capable of producing 75,000 volts—makes sparks up to 2" long—yet is absolutely safe because the current is infinitesimal. The science teacher—science lover—or hobbyist can perform experiments to astound students—friends—family. Makes smoke disappear—defy gravity—turns propellers at a distance—transforms atomic energy into light—makes artificial lightning—demonstrates ionic space ship drive—and many other experiments. Constructed of the finest materials. Will do exactly—for instruction purposes—what generators that cost 3 to 10 times more will do. The perfect device to teach the secrets of atomic physics and electricity. Will hold an audience spellbound as it performs trick after amazing trick. Includes an experiment kit and illustrated experiment manual. Manual explains the "how" and "why." You will invent many new experiments of your own. A fine research tool that will give years of beneficial service to the institution or individual who owns one. In kit form or assembled.

*TM Pending
Kit form \$14.95
Assembled \$19.95

MAIL THIS COUPON
(Please be sure to include your name & address)
OLIVER GARFIELD CO., Inc., Dept. RE-119
108 E. 16th St., New York 3, N.Y.

Please send me:
1 COSMOTRON Atom Smasher and Manual.
\$19.95 (Complete assembled)
\$14.95 (In kit form)
Add 80¢ for postage and handling
in U. S.; \$1.00 abroad.

TELEVISION

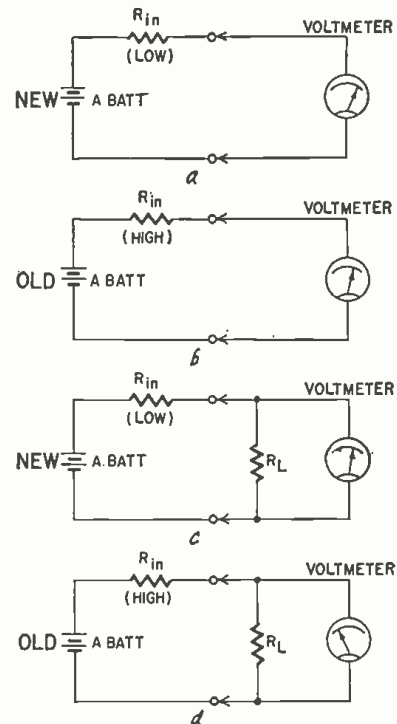

Fig. 2—Basic principles of circuit loading: a—Fresh battery has low internal resistance, R_{in} . The voltmeter reads almost actual battery voltage. b—Old battery has high internal resistance. Voltmeter still reads almost actual battery voltage as little current is drawn by the meter. c—Load resistor R_L draws a heavy current. Since R_{in} is much smaller than R_L the meter still reads almost actual battery voltage. d—Resistor R_L is connected across an old battery. Now R_{in} is much greater than R_L and most of the battery voltage drops across R_{in} . The voltmeter reads much less than the actual battery voltage.

ance. A new dry cell, for example, is a voltage source with low internal resistance. On the other hand, an old dry cell has high internal resistance (see Fig. 2). The emf of the old battery is the same as the emf of the new one. If we connect a voltmeter across the old battery and across the new battery, we read practically the same voltage (the emf). Next, if we connect a load across the batteries, we find that the voltage supplied by the old battery to the load is much less. The same principle applies to circuit testing with probes. The circuit's internal resistance limits the probe's usefulness.

Conversion data please

We want to convert a Canadian G-E receiver, model C7T2, from a 17BP4 to a 21EP4 or preferably a 21EP4-A picture tube. High voltage measures 11.9 kv. Is there a practical method of increasing the high voltage to 16 kv? If not, how will a 21EP4 operate on 11.9 kv? Perhaps there is another 21-inch aluminized tube that would meet requirements?—W. E. D. P., Don Mills, Ont.

We would suggest using a 21EP4-B.



LET RCA TRAIN YOU IN ELECTRONICS

RCA Institutes celebrates Fifty Years of Electronic Training by introducing its newest Home Study Course . . .

ELECTRONICS FOR AUTOMATION

. . . Now you have *four* comprehensive courses for your electronic training . . . from basic electronic theory to the more advanced principles of color TV and Automation.

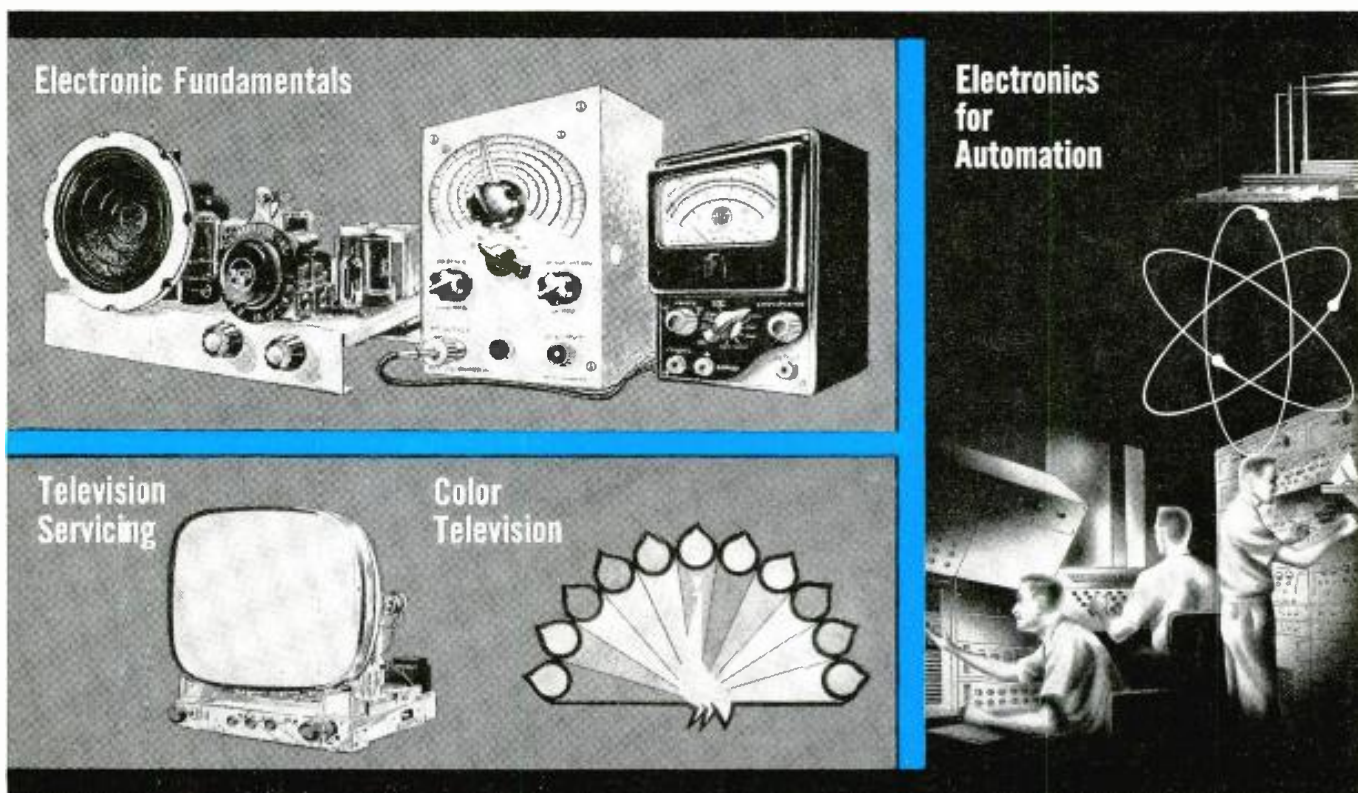

Send for our
64 page Home
Study Catalog

FREE!

Resident School courses in New York City offer comprehensive training in Television and Electronics. Day and evening classes start four times each year. Detailed information on request.

ANOTHER WAY RCA SERVES EDUCATION THROUGH ELECTRONICS

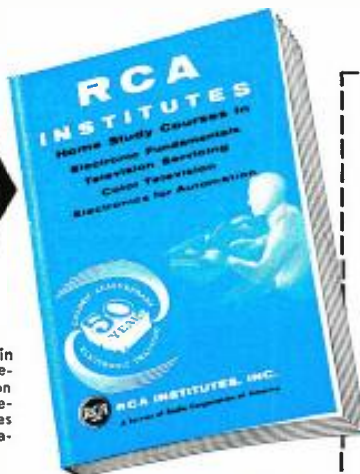

Practical work with the very first lesson. Pay-as-you-learn. You need pay for only one study group at a time.

RCA INSTITUTES, Inc. Home Study School, Dept. RE-119

A Service of Radio Corporation of America

350 West Fourth Street, New York 14, N. Y.

Without obligation, send me the FREE catalog of Home Study Courses. No salesman will call.

Name

Please print

Address

City..... Zone..... State.....

Korean Vets! Enter Discharge Date.....

CANADIANS — Take advantage of these same RCA courses at no additional cost. No postage, no customs, no delay. Send coupon to: RCA Victor Company, Ltd., 5001 Cote de Liesse Rd., Montreal 9, Quebec
To save time, paste coupon on postcard.

can your present test equipment check this capacitor in circuit?

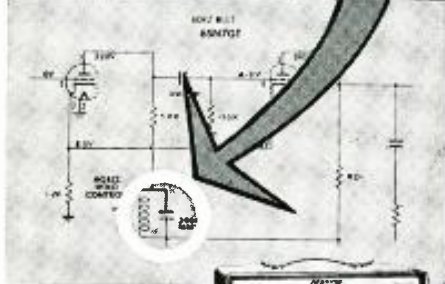

the All New

Aerovox Model 97 LC-CHECKER

will do this and much more!

Yes, the Aerovox LC-Checker will check the above and similar capacitors regardless of the parallel circuitry and without disconnecting them from the circuit. You can quickly and accurately locate defective units without performing the time consuming task of desoldering and resoldering components. If your present equipment cannot match this performance, then you need an Aerovox LC-Checker.

This versatile instrument also tests for capacitor leakage, determines resonant frequency of tuned circuits, checks inductance and performs many other service-important functions all for the low price of \$69.95.

SEE IT...TRY IT...BUY IT TODAY...

at your local Aerovox Parts Distributor. Write for free literature and address of your nearest distributor.

AEROVOX CORPORATION
DISTRIBUTOR DIVISION
NEW BEDFORD • MASSACHUSETTS

TELEVISION

No circuit changes are anticipated, and this would be an easy conversion except for necessary mechanical modifications. High voltage can be increased by replacing the flyback or by using a voltage doubler with the present flyback. Unless you can overscan the tube, the use of a doubler will give you a narrow picture. If a doubler is used, a high-voltage rectifier tube must be added, and another filament winding looped around the flyback core.

Adjacent-channel interference

What kind of filter will eliminate interference on channel 3 caused by channel 2 in a community distribution system? The system uses 300-ohm line and has a high radiation level. My antenna is a 10-element Yagi.—J. M. T., Jr., Mariposa, Calif.

I suggest that you first try one or two standard adjacent-channel if traps in the receiver. Either 23-mc or 45-mc traps can be obtained from any large jobber. These will be effective unless the interfering signal is so strong that it causes cross-modulation in the rf amplifier. If this happens, an rf stub

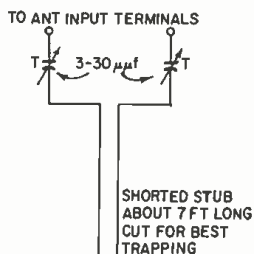

Fig. 3—Shorted stub and pair of trimmer capacitors make an efficient trap for adjacent-channel interference.

will be required at the receiver's antenna input terminals. The stub can be made from 300-ohm line and a pair of 3-30- μ f trimmer capacitors (Fig. 3). It is most efficient if shorted at the far end to minimize radiation loss. The trimmers provide a moderate range of tuning and also give a sharper rejection dip, which prevents undue loss of signal on channel 3. Note however, that if this should actually be co-channel interference and not adjacent-channel interference, traps will be ineffective. Co-channel interference must be minimized by beaming the antenna, or eliminating the interference at its source.

Misalignment

What's the trouble in a Sperton ATV-2133 when a clear picture is displayed at one setting of the fine-tuning control, but sound is distorted? At another setting, the sound is perfect.—F. D., Montreal, Canada

Separation of sound and picture is always caused by misalignment. A sweep generator check of the frequency response from the antenna input termi-



QUIETROLE

the ANSWER TO NOISY CONTROLS and SWITCHES

over

12 YEARS OF

PROVEN SUPERIORITY

Costs Just Pennies more than the poorest substitute . . .

Supplied in Spray can and 2, 4, 8 oz. bottles



TV PICTURE TUBES

At Lowest Prices

10BP4 ... \$ 7.95	17BP4 ... \$ 9.95	21AMP4 ... \$15.75
12LP4 ... 8.50	17CP4 ... 17.00	21ATP4 ... 15.75
14B/CP4 ... 9.95	17GP4 ... 17.60	21AUP4 ... 15.75
16DP4 ... 12.00	17HP4 ... 12.50	21EP4 ... 13.50
16EP4 ... 12.75	17LP4 ... 11.30	21FP4 ... 14.50
16GP4 ... 14.50	17QP4 ... 9.95	21WP4 ... 14.00
16KP4 ... 9.95	17TP4 ... 17.00	21YP4 ... 14.50
16LP4 ... 10.95	19AP4 ... 16.00	21ZP4 ... 13.50
16RP4 ... 9.95	20CP4 ... 13.50	24CP4 ... 23.50
16WP4 ... 12.00	20HP4 ... 14.50	24DP4 ... 24.50
16PT4 ... 9.95	21AP4 ... 22.10	27EP4 ... 39.95
17AVP4 ... 12.50	21ALP4 ... 15.75	27RP4 ... 39.95

1 year warranty

Aluminized Tubes \$5.00 More than above prices. Prices include the return of an acceptable similar tube under vacuum. These tubes are manufactured from reprocessed used glass bulbs. All parts and materials including the electron gun are brand new.

ALL PRICES FOR CHICAGO, ILLINOIS. Deposit required, when old tube is not returned, refundable at time of return. 25% deposit required on COD shipments. Old tubes must be returned prepaid. Tubes shipped Rail Express.

WRITE FOR COMPLETE LIST.

PICTURE TUBE OUTLET

3032 Milwaukee Ave., Chicago 18, Ill.
Dickens 2-2048

TELEVISION

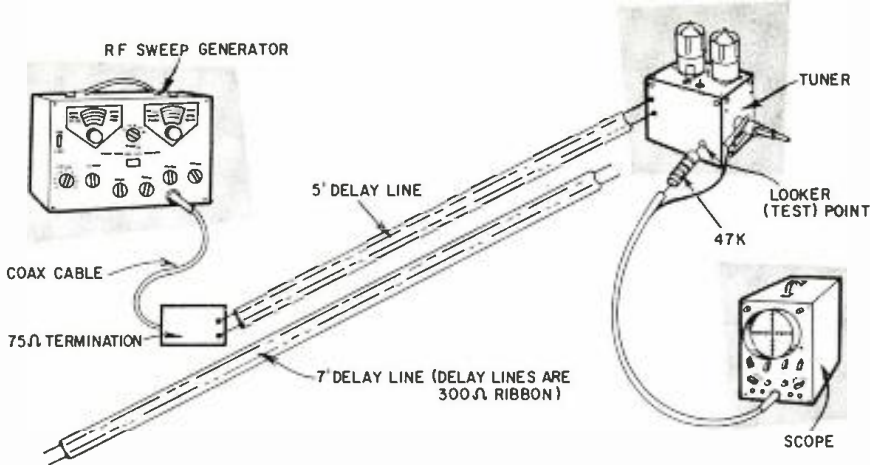

Fig. 4—Check tuner match to 300-ohm line by observing rf response curve with 5-foot delay line, then with 7-foot delay line. The same curve in both tests shows that impedance match is OK.

nals to the picture detector output will show that the overall response curve has too narrow a bandwidth. This misalignment can be caused by incorrect adjustment of the tuner trimmers or the if slugs. If the receiver cannot be brought into correct alignment, regeneration is probably the trouble. Regeneration is commonly caused by open bypass capacitors, disturbed lead dress or poor high-frequency grounds. Less often, a bad mismatch between both the tuner and the antenna to the lead-in causes separation of picture and sound. Match

of the tuner to the lead-in can be checked as shown in Fig. 4. The same response curve should be obtained using either delay line (made up from 300-ohm ribbon line). If not, the tuner is mismatched to the line.

Add FM

Can a Radio-Craftsman 202 receiver be converted for reception of FM broadcasts?—F. F. V., Stone Ridge, N. Y.

Yes; use a Regency RC-103 Televerter for this chassis. No wiring changes will be required. END

BERNS PERFECT PIN-CRIMPER
Picture-Tube Repair Tool

Eliminates that hard soldering job.

only \$1.25

Fix loose pin connections in seconds. Pays for itself in time saved on one job alone. 3" long.

Patent 2,878,698

Intermittent operation of picture tubes due to defective solder connections at socket pins is easily corrected through the use of the Berns Perfect Pin Crimper. Actually a 3-in-1 tool that can also be used as a channel-selector wrench and screwdriver, it serves to notch pins and element leads to provide solid electrical connections. Pin keeps its original form.

IT'S DANDY . . . IT'S HANDY
 "you'll like it"

Available at your parts distributor.
 Another fine product from:

BERNS Mfg. Co.
 9853 Chalmers,
 Detroit 13, Mich

New
4th edition
now available!

The book that keeps growing in usefulness and popularity

It's here! The brand-new 4th Edition of General Electric's famous Transistor Manual . . . 227 pages jam-packed with vital information you need to keep abreast of this fast-moving and fabulous field.

You'll find 74% more information . . . new material on small and large signal characteristics, transistor radio servicing techniques and basic computer circuits . . . all the latest G-E transistor specs and a complete, up-to-date list of registered JEDEC types.

This is the one book in the transistor field you can't afford to do without! Get your copy from your General Electric Tube Distributor, or by mailing the coupon at right.

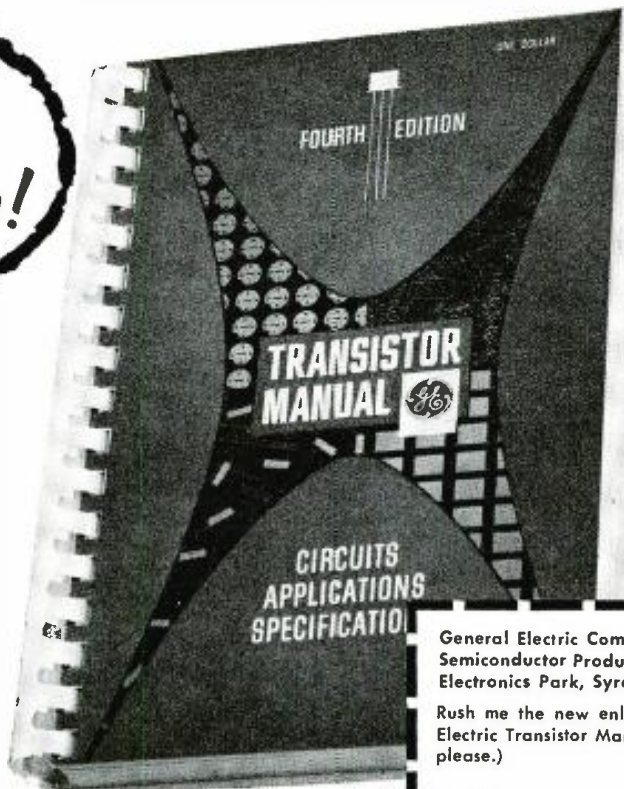

Partial List of Contents:

- Basic Semiconductor Theory
- Transistor Construction Techniques
- Small Signal Characteristics
- Large Signal Characteristics
- Biasing
- Audio Amplifiers
- "Hi-Fi" Circuits
- Radio Receiver Circuits
- Transistor Radio Servicing Techniques
- Switching Characteristics
- Basic Computer Circuits
- Logic
- Unijunction Transistor Circuits
- Silicon Controlled Rectifier
- Tetrode Transistors
- Power Supplies
- Transistor Specifications
- Rectifier Specifications

General Electric Company
 Semiconductor Products Dept., Section S60119
 Electronics Park, Syracuse, N. Y.

Rush me the new enlarged 4th Edition of the General Electric Transistor Manual. I enclose \$1.00. (No stamps, please.)

Name _____

Address _____

City _____ Zone _____ State _____

GENERAL  ELECTRIC

a vitally important message for every service technician

HOWARD W. SAMS
INDIANAPOLIS 6, INDIANA

Dear Friend:

Your Electronic Parts Distributor will soon present to you a remarkable new program designed to help you:

1. Gain deserved recognition as a reputable businessman in your community
2. Develop and command public respect and acceptance through favorable national and local publicity
3. Justify better earnings warranted by your business investment and skill
4. Pave the way to expanded business and increased profits for you

This program, known as "PEET", is made possible by a unique industry-wide relationship in which the Sams Company occupies a key position. Your Distributor will invite you to qualify for the program which has been planned solely in your behalf.

Please give your Distributor's representative the few minutes required for his presentation of "PEET." It may prove to be the most profitable time of your business career.

Some of you may already have been presented the "PEET" Program and you may be well on the way to qualify. I want to make certain every Service Technician is offered the opportunity—so—if you don't hear from your Distributor in the next few weeks, write to me personally. I will see to it you get the full details immediately.

Cordially,



**ASK YOUR ELECTRONIC
PARTS DISTRIBUTOR**



**QUALIFY FOR
"PEET"**

TECHNICIANS'

NEWS

PART-TIMERS DEFINED

At its national convention NATESA adopted the following definition of the part-time service technician: ". . . there are two types of part-timers:

"1. The legitimate part-timer is one who may be a graduate of a technical school, having had training in a service shop; or he may be one who has used his service as a subsidy for his income for years and has properly qualified; or again one who has a fairly substantial living in another field but still likes service as a part-timer and is also qualified.

"2. The illegitimate part-timer who may be your mailman, policeman, garbage collector, etc., who has never had training of any type but decides he can make a quick buck in service. He owns a tube caddy, period. . . . He does not operate legitimately, does not give receipts of a legitimate nature, does not have a place of business, does not pay taxes, and so forth. This is the individual that . . . NATESA does not want. . . .

"The legitimate part-timer . . . must have qualified technical ability . . . sufficient test equipment in his place of business . . . render accurate itemized bills . . . identify himself so as to be easily located . . . comply with all government regulations, securing license or permit, and pay taxes . . ."

LARSEN RESIGNS

Robert Larsen, president of the Empire State Federation of Electronic Technicians Associations (ESFETA), has resigned so he can head the group's Committee on Licensing. This move strengthens ESFETA's drive to get a sound state TV technicians' licensing bill passed. Mr. Larsen also announced that Max Liebowitz of the New York City group would head a fund-raising drive in support of the bill.

Vice president Irving Toner of Buffalo succeeds Mr. Larsen as temporary president.

K.C. PASSES LICENSE BILL

The City Council of Kansas City, Mo., passed a licensing bill which sets up a Board of Examiners, requires all technicians to pay a \$10 license fee and pass a technical examination. They must render bills for service work showing itemization of parts and labor and keep duplicates of bills on hand for 2 years. The law also prohibits unlicensed technicians from repairing TV sets and similar electronic consumer products. It sets up "certified technicians" and specifies that a service dealer must have a certified technician

ARE YOU ON THE LIST?

Radio-Electronics is publishing a detailed list of the known television service associations in North America. If you belong to an association that isn't on our list or want to get the name and address of the one closest to you, drop a postcard to: Association Editor, Radio-Electronics, 154 West 14 Street, New York 11, N.Y.

TELEVISION AND ELECTRONIC SERVICE ASSOCIATION OF OHIO

2552 N. High St.
Columbus, Ohio

John P. Graham, Secretary

TESA-BELLEVILLE
503 Eastern Ave.
Bellefontaine, Ohio
Harry Snyder, Secretary

TESA-CHILLICOTHE
188 N. Bridge St.,
Chillicothe, Ohio
Perry Horton, Secretary

CHILLICOTHE TV TECHNICIANS ASSN.
149 W. Water St.
Chillicothe, Ohio
Kenneth DeLong, Secretary

TESA-CINCINNATI
5246 Charloe Ave.
Cincinnati, Ohio
Stan Shaffer, President

TESA-CLEVELAND
5827 Turney Rd.
Garfield Heights 25, Ohio
Eugene Korba, Secretary

TESA-DAYTON
5120 W. 3rd St.
Dayton, Ohio
V. H. Bailey, President

ASSOCIATED RADIO-TV SERVICE DEALERS
2552 N. High St.
Columbus, Ohio
J. P. Graham, President

ELECTRONIC TECHNICIANS ASSN. OF TOLEDO
1952 Sylvania Ave.
Toledo, Ohio
Verne LaPlante, Editor,
ETAT News

TESA-LORAIN COUNTY
92 East Broad St.
Elyria, Ohio
Robert A. Standen, Secretary

TESA-MEIGS COUNTY
2 Liberty St.
Pomeroy, Ohio
Rhodell Steffey, Secretary

TESA-MIDDLETOWN
2nd and High Sts.
Franklin, Ohio
Marvin Hall, President

MAHONING VALLEY TV DEALERS ASSN.
189 W. Evergreen Ave.
Youngstown, Ohio
W. S. Buzard, President

TESA-SANDUSKY
245 E. Market St.
Sandusky, Ohio
Paul LeCoy, Secretary

S. OHIO RADIO-TV TECHNICIANS ASSN.
634 N. West St.
Hillsboro, Ohio
Harry Hakes, Secretary

TESA-SPRINGFIELD
1001 E. Home Rd.
Springfield, Ohio
Marvin Miller, Secretary

TESA-WILMINGTON
RFD 3
Wilmington, Ohio
Kenneth Gray, Secretary

WESTERN RESERVE ELECTRONIC ASSN.
1856 Larchmont Ave.
Warren, Ohio
Bernard Murray, President

URBANA TV SERVICE ASSN.
775 Washington Ave.
Urbana, Ohio
William Diehl, President

TV SERVICEMENS ASSN. OF IOWA, INC.

2100 East Walnut St.

Des Moines, Iowa

John Jackson, President
Byron Moon, Secretary

BOONE TSA
816 Story St.
Boone, Iowa
Earl Scheuermann, President

BUENA VISTA TSA
Storm Lake, Iowa
William Rogaw, President

DES MOINES TSA
4008 S.W. 9th St.
Des Moines, Iowa
Floyd Webb, President

HAMILTON TSA
749 2nd St.
Hamilton, Iowa
William Luick, President

HAMPTON TSA
11—1st St. N.W.
Hampton, Iowa
Howard Junker, Secretary

LINN TSA
118 6th St. S.B.
Linn, Iowa
Dick Reeder, President

MARSHALLTOWN TSA
13 N. 1st St.
Marshalltown, Iowa
Lawrence Turner, President

NORTHEAST TSA
West Union, Iowa
Orville Saboe, President

NORTH CENTRAL TSA
10 2nd St. N.W.
Mason City, Iowa
Otto Schwörtz, Secretary

OTTUMWA TSA
114 E. Myrtle St.
Ottumwa, Iowa
Glenn Dukes, President

WAMAC TSA
214 East Main St.
Dyersville, Iowa
Clarence Benke, Secretary

WATERLOO TSA
618 Sycamore St.
Waterloo, Iowa
Les Wilson, President

PENNSYLVANIA

Additional technicians' groups in Pennsylvania not listed in September, 1959 (p. 108):

PHILADELPHIA RADIO SERVICEMEN'S ASSN. (PR SMA)
631 S. 60th St.
Philadelphia 43, Pa.
Richard G. Devaney, President

MID-STATE ELECTRONIC SERVICE DEALERS' ASSN.

17th and Herr Sts.
Harrisburg, Pa.
Wayne Prather, President

BERKS COUNTY RADIO SERVICEMEN'S ASSN.
938-40 N. 8th St.
Reading, Pa.
John G. Rader, Secretary

do all service work, or at least be present if an apprentice does it. It appears from the wording of the act that only one certified technician would be required in a shop, however large.

ARTSNY MEETS

The last two regular monthly meetings of the Associated Radio-TV Servicemen of N. Y. were technical-educational sessions. One devoted to working with printed circuits heard a talk by Ken Jones of Motorola. The second featured the chief engineer of B & K Manufacturing Co., Mr. Grossman, who demonstrated the company's test equipment for color and black-and-white sets. The 175 members present were given copies of Milton Kiver's book *TV Analyzing Simplified*.

NATESA CONVENTION ELECTS

The National Alliance of Television & Electronic Service Associations (NATESA) held its annual convention for 3½ days in Chicago and elected a new slate of officers:

Mac Metoyer, Kansas City, Mo., president; Alphonse Benoit, Jr., New Orleans, La., secretary general; Nelson

Burns, Memphis, Tenn., treasurer; Irving Toner, Buffalo, N. Y., Eastern vice president; George Carlson, Jamestown, N. Y., Eastern secretary; Cordell Britt, Nashville, Tenn., East Central vice president; Gerald Hall, Milwaukee, Wis., East Central secretary; W. E. Johnson, Beaumont, Tex., West Central vice president; Leroy Ragsdale, Ft. Smith, Ark., West Central secretary; Winston Haines, Burlingame, Calif., Western vice president; O. W. Andrews, Denver, Colo., Western secretary.

A full program of technical and business talks was held, along with entertainment, ladies bingo, and a free trip and treatment for 75 wives to a beauty clinic and hat show. Meals were sponsored by tube companies and coffee breaks and the cocktail party by other suppliers. Over \$1,000 worth of costume jewelry was given out to those attending the main banquet.

SERVICE STATIONS NEEDED

Two major manufacturers' service managers say they watch our lists of local service organizations carefully with a view to finding qualified service stations. One maker of top-quality audio



"Printed Circuit Diagnosis Made Easy"



Helps you become an expert in servicing printed circuit boards. Practical, simplified approach saves time troubleshooting all types of printed circuits. Explains correct way to interpret and use various styles of data shown in service literature. Describes best procedures to follow when only a schematic diagram is available.

Sample problems illustrate each phase of printed circuit troubleshooting. A "must" book for your service library. Illustrated; 96 pages; 5½ x 8½". Only \$1.00

"Radio Receiver Servicing"

ALL-NEW EDITION



Latest enlarged edition of John T. Frye's famous best-seller. Includes new chapter on how to service transistor radios and printed circuits. The most understandable and valuable guide to radio servicing; based on the author's 25 years of practical experience. Includes a separate chapter on each type of trouble, such as the dead set; tubes light but no sound; noisy sets; weak sets; sets unable to separate stations, etc.

208 pages; 5½ x 8½". Only \$2.95

"Howard W. Sams Handbook of Electronic Tables and Formulas"

FOR ELECTRONIC TECHNICIANS



Specially prepared for electronic technicians, junior engineers and students. A valuable compilation of tables, charts, formulas and laws useful to all who work in electronics. Five comprehensive sections include: Formulas and Laws of Electronics; Constants, Standards, Symbols, Codes; Service and Installation Data; Mathematical Tables and Formulas; Miscellaneous.

Features full-color frequency spectrum chart based on latest 1959 FCC allocations. 134 pages; 5½ x 8½"; hard-cover. Only \$2.95

"Television Tube Location Guide" Vol. 9



Latest volume in this invaluable series. Gives tube location data for TV sets produced in 1958-1959. Shows position and function of tubes in over 250 receiver models—just find the trouble and replace defective tubes without removing chassis! Shows major component placement; signal path; pin orientation on socket;

series string filaments; fuse location. Includes tube failure check charts. 96 pages; 5½ x 8½"; comb binding. Only \$1.25

HOWARD W. SAMS & CO., INC.

Order from your Sams Distributor today, or mail to Howard W. Sams & Co., Inc., Dept. L-29 2201 E. 46th St., Indianapolis 6, Ind.

Send me the following books:

- "Printed Circuit Diagnosis Made Easy" (PC-1)
- "Radio Receiver Servicing" (RS-2)
- "Handbook of Electronic Tables" (HTF-1)
- "Television Tube Location Guide" Vol. 9 (TGL-9)

\$.....enclosed. Send Free Book List

Name _____

Address _____

City _____ Zone _____ State _____

(outside U.S.A. priced slightly higher)

From the time of its introduction the JBL D130 has been recognized by audio authorities as a unique achievement. The D130 remains the only fifteen inch full range loudspeaker with a 4" voice coil. The large voice coil is made of aluminum ribbon wound edgewise. Thus, with small mass, a large amount of conductor is subject to the lines of force in the close-tolerance gap of the precision-machined Alnico V magnet. This gives the unit unmatched efficiency and superb transient response. Further, the large voice coil stiffens the cone to form a rigid acoustic piston to provide clean, accurate, extended bass. The 4" dural center dome, attached directly to the voice coil, is a large-area high frequency radiator. A pot structure of pure iron provides a low reluctance return path for the magneto-motive force. The magnet circuit is so carefully designed that stray fields are virtually non-existent. Frame is a rigid aluminum casting. The JBL D130 is designed for use in bass reflex and exponential horn acoustical enclosures. When properly baffled and used as a direct radiator, it has a usable frequency range of 30-17,000 c.p.s. For a detailed description, write for free bulletin SB1002.

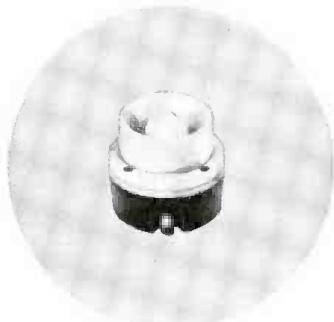

A beautiful example of acoustical precision craftsmanship is the JBL 075 High Frequency Unit, widely used with the D130. A highly original concept, the 075 employs a ring radiator and annular exponential horn; crosses over at 2500 c.p.s.



A high frequency assembly frequently used with the JBL D130 is the 175DLH consisting of a 1200 cycle crossover driver, exponential horn, and 90° projection-angle acoustical lens.

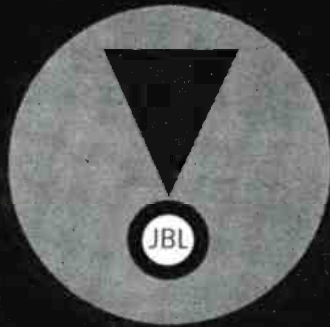

A PRECISION TRANSDUCER OF CLASSICAL EXCELLENCE... THE JBL D130

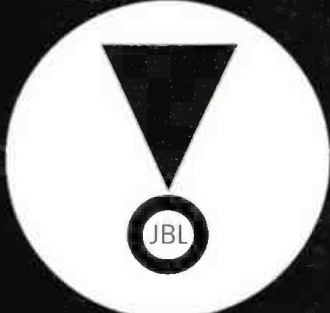
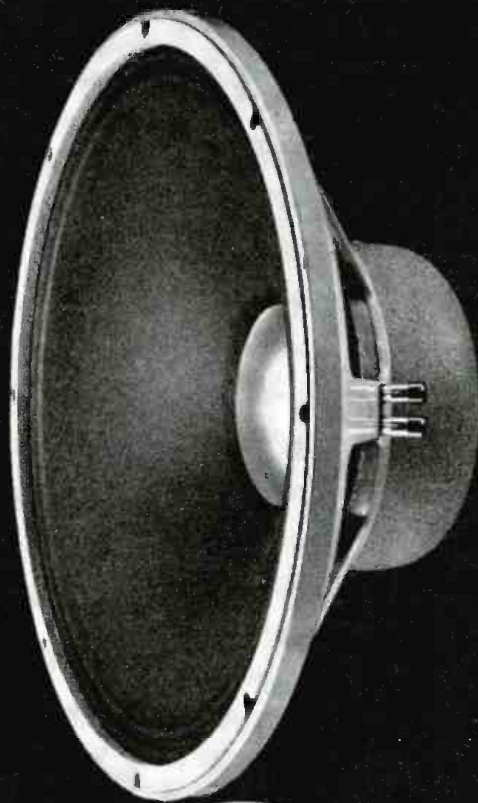

JAMES B. LANSING SOUND, INC.
3249 Casitas Avenue
Los Angeles 39, California

TECHNICIANS' NEWS (Continued)

gear said, "We are notifying our district service managers of the state listing, and advising them to be on the lookout for local listings in future issues of RADIO-ELECTRONICS."

ARKANSAS STATE MEET

Almost 100 TV service dealers gathered in Little Rock from all over Arkansas to start a state service group. A number of local groups are already organized, including technicians in Little Rock, Fort Smith and Texarkana.

TAX WARRANTY WORK IN PA.

Pennsylvania service groups have been told by the State Sales Tax Department that the service technician must collect state sales tax on TV repair work done on in-warranty sets. Most service dealers have not been collecting the tax on such work.

The Federation of Radio & TV Service Associations asked Governor Lawrence to sign the "wholesale bill" which would require distributors not to sell retail. The bill has been passed by the state Legislature.

FRTSA also heard a report on the proposed licensing bill which outlines qualifications for radio-TV-electronic service technicians. It is being reviewed by service groups before being introduced in the state Legislature.

TUBE-LABELING BILL FOR NY

New York State is working on a tube-labeling bill which would outlaw "hot-shot" reactivated tubes, at the same time that it would clearly label used, surplus, rebuilt and out-of-warranty tubes. The office of the State Attorney General has sponsored monthly meetings for almost a year, with the Better Business Bureau cooperating and representatives of the Electronic Industries Association, National Electronic Distributors Association, New York technicians' groups and tube manufacturers in attendance. A bill is almost ready for the New York Legislature which will meet in January.

Special Assistant Attorney General Joseph Rothman said that the industry people had been very helpful, and had been able to agree pretty well, except on the method of labeling rebuilt picture tubes.

Max Liebowitz, chairman of the Associated Radio-TV Servicemen of N. Y., said that his group would favor the bill as it seemed likely to shape up, if it provides a definite way to label picture tubes.

SERVICE CHARGES IN N. C.

Delegates attending a North Carolina Federation of Electronic Associations meeting filled out forms regarding their pricing practices. Preliminary figures indicate that the average charge for a service call was \$4.70; for pickup and delivery, \$3.31; for major shop work, \$10.90. They indicated they were charging less than they felt was fair for major shop work. END

new PATENTS

RADIO REFLECTOR IN SPACE

Patent No. 2,871,344

Henri C. Busignies, Montclair, N. J. (Assigned to ITT, Nutley, N. J.)

Microwaves travel along straight lines, making it difficult or impossible to communicate over long distance. Here is a practical method

neutrons or ionized gas. Preferably, this zone is placed near one of the stations. The material may be dropped from a balloon (as shown) or

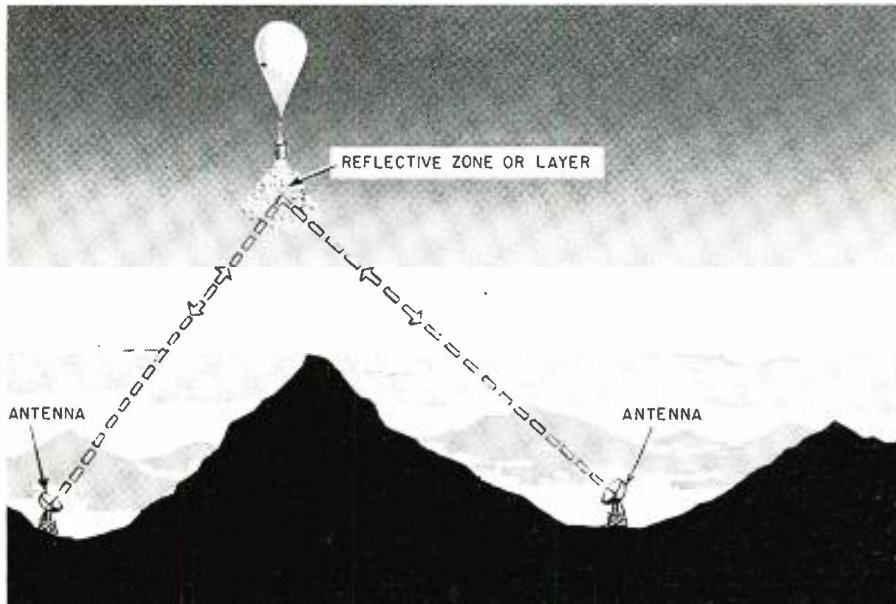

for overcoming the problem. An artificial "lens in the sky" is created to reflect the waves off the artificial lens and on downward toward the receiver.

An ionized zone is created by scattering metallic particles or by generating a cloud of

shot from a gun. It is replenished as required at intervals.

The directive antenna at each station should be equipped with a tracking control to point it for optimum communication and to allow for drift of the ionized region.

NUCLEAR BATTERY

Patent No. 2,900,535

Alexander Thomas, Weston, Mass. (Assigned to Tracerlab, Inc., Boston, Mass.)

This battery is tiny but it can deliver a high voltage for a long time. The active elements are lead dioxide and magnesium (or zinc) deposited on opposite surfaces of a metal plate. The plates are separated by mica spacers and surrounded by an ionized gas.

The gas is a mixture of tritium, hydrogen and argon. The latter remains ionized by the tritium isotope. The field caused by contact potential

between elements collects particles and this constitutes a current flow.

A typical battery contains 59 cells for a total of 115 volts. Saturation current is 1.4 ma. Battery size is less than 1 inch in diameter and less than 1 inch long. Battery life is in the order of 10-15 years.

The patent specification details the manufacturing processes including heat treatment, coatings, pumping of gases, etc. END

'HI-FI' YOUR SPEAKER SOUND with FLEXICONE



Here's what John Dodgson, Editor of *National Radio Institute News* of Washington, D. C., says about FLEXICONE: "After a Flexicone treatment, a 12" speaker, which had been resonating at 90 cps, dropped to 41 cps. Listening tests clearly show the improvement. . . medium and high frequencies are cleaner and less harsh."

- Softens outer edge of speaker cone
- Improves frequency response and speaker tone
- Easy 1-2-3 application
- Reduces speaker cone resonance 10 to 40 cps
- One treatment lasts a speaker life-time.
- Greatly increases bass range
- Each kit treats one 15", two 12", four 8" or six 6" speakers

PORTER & DIETSCH
2459 University Avenue St. Paul 14, Minn.

SPECIAL INTRODUCTORY OFFER



To acquaint you with FLEXICONE, Porter and Dietsch will give you FREE OF COST, one \$3.25 5" x 7" Tiny Tom high impact styrene Speaker Housing with each Flexicone Kit at \$3.00 during the next 45 days. Available in 6 colors: Brown, Grey, Pink, Green, Blue or Yellow. Install anywhere or use on test bench.

\$6.25 VALUE FOR ONLY \$3.00, post-paid

RUSH ORDER COUPON

PORTER & DIETSCH, Dept. M
2459 University Avenue St. Paul 14, Minn.

Gentlemen: Enclosed is my check for \$3.00. Please send me postpaid the \$6.25 value, one \$3.00 FLEXICONE KIT plus one \$3.25 Tiny Tom Speaker Housing, (All for \$3.00) State choice of "Tiny Tom" color.

Name _____
Address _____
City _____
State _____

All Porter and Dietsch products are protected by Lloyds of London

Upgrade Your Income with a First Class

F.C.C. LICENSE

WHAT'S IN YOUR FUTURE?

Are you *planning* your future or just drifting into it? Now is the time to get ahead in electronics — the world's fastest growing major industry. Now is the time to add technical knowledge and an F.C.C. license to your practical experience. Now is the time to prepare for higher pay — time to make your future secure.

GRANTHAM TRAINING PREPARES YOU

Grantham School of Electronics specializes in quality training in communications electronics, preparing students to pass F.C.C. operator license examinations. This training is available either by correspondence or in resident classes.

The Grantham Communications Course does not teach you how to solder or how to remove a TV chassis from the cabinet, etc. It is not a repair course but, instead, is bona fide technical training which teaches you to understand electronic theory — which teaches you the "why" of electronics.

If you already have practical experience in radio-electronics, the Grantham course can add a knowledge of theory and an F.C.C. license to that practical experience. This should qualify you for higher pay and greater job security.

RESIDENT CLASSES OR CORRESPONDENCE

RESIDENT CLASSES — The Grantham Communications Electronics Course is offered in both DAY and EVENING classes in Hollywood, Seattle, Kansas City and Washington, D.C. The DAY course meets five days a week, from 9 a.m. until 1 p.m., and prepares you for a first class F.C.C. license in 12 weeks. The EVENING course meets three nights a week, from 6:30 p.m. until 10:30 p.m., and prepares you for a first class F.C.C. license in 20 weeks. All courses "begin at the beginning" — no previous electronics training required.

CORRESPONDENCE TRAINING — The Grantham Communications Electronics Course is offered by correspondence from all Divisions of the School.

This course can prepare you *quickly* to pass F.C.C. examinations because it presents the necessary principles of electronics in a simple "easy-to-grasp" manner. Each new idea is tied in with familiar ideas. Each new principle is presented first in simple, everyday language. Then after you understand the "what and why" of a certain principle, you are taught the technical language associated with that principle. You learn more electronics in less time, because we make theory easy and interesting.

GRANTHAM SCHOOL OF ELECTRONICS
1505 N. Western Ave., Hollywood 7, California

GRANTHAM SCHOOL OF ELECTRONICS
408 Marion Street, Seattle 4, Washington

GRANTHAM SCHOOL OF ELECTRONICS
3123 Gillham Road, Kansas City 9, Missouri

GRANTHAM SCHOOL OF ELECTRONICS
821-19th Street N.W., Washington 6, D. C.

To: GRANTHAM SCHOOL OF ELECTRONICS

(Select address from those listed above)

Please send me your FREE booklet explaining how Grantham can prepare me for my F.C.C. license. I understand there is no obligation and no salesman will call.

NAME _____

ADDRESS _____

CITY _____ STATE _____

94-52

new PRODUCTS



STEREO TUNER model LT-77. Separate FM and AM tuners, separate tuning meters and volume controls. Receives AM-FM simulcast stereo. FM 6 db down at 200-kc bandwidth, AM 6 db



down at 8 kc. Hum over 60 db down, FM image rejection 40 db or more. 11 tubes and diode. Metal cage.—Lafayette Radio, 165-08 Liberty Ave., Jamaica 33, N. Y.

STEREO TUNER AND CONTROL model 100-T complete preamp-control center, separate FM and AM tuners on one chassis. FM sensitivity 1 volt. AM sharp or broad-band response, AM ferrite loop antenna, 10-kc whistle filter. Tape-head play-



back. Outputs for tape recorder and center-channel amplifier. Separate bass and treble controls each channel, rumble and scratch filters, stereo balance, reverse switches. Provision for mounting multiplex adapter on chassis later. Distortion under 0.2% at 5 volts output. 16 tubes plus 2 diodes. Case available.—Fisher Radio Corp., 21-21 44th Drive, Long Island City 1, N. Y.

STEREO AMPLIFIER model 214 complete preamp-control center and dual 14-watt amplifiers. Power amplifiers may be paralleled with preamp driving additional high-power external amplifier. Bass and treble

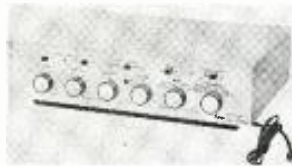

controls ganged, loudness and rumble filter switches. Selector switch for 2 speakers. Wired or kit.—Electronic Measurements Corp., 625 Broadway, New York 12, N. Y.

STEREO AMPLIFIER model 20 LJ includes two 10-watt power amplifiers and complete stereo preamp. Tape head inputs; ganged loudness, bass and treble controls. In leatherette case.—Grommes, Div. of Precision Electronics, Inc., 9101 King St., Franklin Park, Ill.

STEREO AMPLIFIER-preamp model SA-1 combination, 14 watts per channel, 6 input channels including 2 magnetic phono

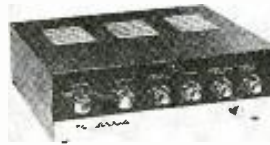

and tape-head input. "dimension" control adjusts mix of stereo channels. Separate bass and treble controls each channel, ganged volume controls. 3 printed circuit boards.—Heath Co., Benton Harbor, Mich.

STEREO POWER AMPLIFIER model HF-87. 35 watts per

channel. Less than 1% IM and harmonic distortion at rated output. Output four EL34's. Sili-

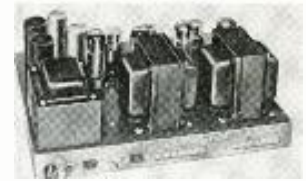

con diode power rectifiers. Kit or factory-wired.—Electronic Instrument Co., Inc., 33-00 Northern Blvd., Long Island City 1, N. Y.

STEREO AMPLIFIER KIT model 83XY774. 2 complete preamp-control units, two 20-watt

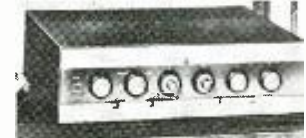

power amplifiers. Center channel speaker output. Distortion under 0.5% at 20 watts, hum and noise 75 db down, tape head input, rumble and scratch filters. Printed circuits case assembly and wiring.—Allied Radio Corp., 100 N. Western Ave., Chicago 80, Ill.

STEREO PREAMP KIT com-

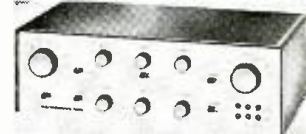

IT'S THE NEW MARK II FROM WESTON:



an advanced new design for the
WORLD'S FINEST PORTABLE ANALYZER

Here's an all-new version of the famous WESTON MODEL 980 Volt-Ohm-Milliammeter . . . engineered to offer you

- **INCREASED RANGE.** High-voltage range has been extended to 4000 volts.
- **INCREASED SENSITIVITY.** D-C sensitivity of 20,000 ohms/volt; accuracy within 2% of full scale.
- **IMPROVED SHIELDING.** Cormag® mechanism assures positive magnetic shielding; housing shields against electrostatic interference.
- **GREATER RUGGEDNESS.** Spring-backed jewel movement resists shock, vibration; case is impact-resistant. Ohm-ranges are fuse-protected.
- **SIMPLIFIED CONTROL.** Single dial control for range and function switching.
- **NEW COMPACTNESS.** Size and weight are reduced for maximum convenience and portability.

Order from your local Weston distributor. For information, write to Daystrom-Weston, Sales Division, Newark 12, N. J. In Canada: Daystrom, Ltd., 840 Caledonia Rd., Toronto 19, Ont. Export: Daystrom Int'l., 100 Empire St., Newark 12, N. J.

WESTON

Instruments

WORLD LEADER IN MEASUREMENT AND CONTROL

ASTATIC 77

DYNAMIC CARDIOID MICROPHONE

with the industry's most positive anti-feedback characteristics



LIST PRICES Model 77 (Illustrated)

Chrome Finish, \$82.50;
Gold Finish, \$92.50.
Model 77L (Head only),
Chrome Finish, \$72.50;
Gold Finish, \$82.50.
Model G-77 (Complete
with G-Stand),
Chrome Finish, \$97.45.

*Something to
Sing about*

When you're looking for the ultimate in cardioid microphones, consider these advanced features of Astatic's Model 77 and see if you don't agree that no other manufacturer has SO MUCH TO SING ABOUT—the most positive anti-feedback characteristics ever achieved, -18 db; exclusive Mylar diaphragm that is pop-proof and blast-proof, retains like-new flex properties for more years; an exclusive sintered bronze method of acoustic phase shifting that creates the industry's top directional characteristics; -52 db output and exceptionally flat response through 30 to 15,000 cps.

Do one thing for your own satisfaction. On your next installation, make a direct comparison of the Astatic 77 with any other cardioid. We'll guarantee—when anyone mentions the word "cardioid" again, you'll sing the praises of this incomparable Astatic instrument.

THE **Astatic** CORPORATION, CONNEAUT, OHIO

IN CANADA: CANADIAN ASTATIC LIMITED, TORONTO, ONTARIO
EXPORT SALES: ROBURN AGENCIES INC. 431 GREENWICH ST., N. Y. 13, N. Y., U.S.A.

**GO BY BRAND
—GO BUY ASTATIC**

FROM What
You HEAR

SINGING SOUNDS BETTER WHEN THERE'S AN ASTATIC MICROPHONE ABOUT

BECOME A RADIO TECHNICIAN

for only \$22.95

BUILD 16 RADIO

CIRCUITS AT HOME

with the New Progressive
RADIO "EDU-KIT"®

All Guaranteed to Work!

PRACTICAL only
HOME RADIO COURSE \$22.95



Reg. U.S.
Pat. Off.

NOW INCLUDES

- ★ 12 RECEIVERS
- ★ TRANSMITTER
- ★ SIGNAL TRACER
- ★ SIGNAL INJECTOR
- ★ CODE OSCILLATOR

- ★ No Knowledge of Radio Necessary
- ★ No Additional Parts or Tools needed
- ★ Excellent Background for TV
- ★ School Inquiries Invited
- ★ Attractively Gift Packed

FREE EXTRAS

- SET OF TOOLS • RADIO & ELECTRONICS TESTER • ELECTRIC SOLDERING IRON • TESTER INSTRUCTION MANUAL • MEMBERSHIP IN RADIO-TV CLUB; CONSULTATION SERVICE • HI-FI GUIDE
- QUIZZES • TV BOOK • FCC AMATEUR LICENSE TRAINING
- RADIO BOOK • PRINTED CIRCUITS • PLIERS-CUTTERS
- ALIGNMENT TOOL • WRENCH SET • CERTIFICATE OF MERIT
- VALUABLE DISCOUNT CARD

WHAT THE "EDU-KIT" OFFERS YOU

The "Edu-Kit" offers you an outstanding PRACTICAL HOME RADIO COURSE at a rock-bottom price. Our kit is designed to train Radio & Electronics Technicians, making use of the most modern methods of home training. You will learn radio theory, construction, servicing, basic Hi-Fi and TV repairs, code, FCC amateur license requirements.

You will learn how to identify radio symbols, how to read and interpret schematics, how to mount and layout radio parts, how to wire and solder, how to operate electronic equipment, how to build radios. Today it is no longer necessary to spend hundreds of dollars for a radio course. You will receive a basic education in radio, worth many times the small price you pay, only \$22.95 complete.

THE KIT FOR EVERYONE

The Progressive Radio "Edu-Kit" was specifically prepared for any person who has a desire to learn Radio. The "Edu-Kit" has been used successfully by young and old in all parts of the world, by many Radio Schools and Clubs in this country and abroad. It is used for training and rehabilitation of Armed Forces Personnel and Veterans throughout the world.

The Progressive Radio "Edu-Kit" requires no instructor. All instructions are included. Every step is carefully explained. You cannot make a mistake.

PROGRESSIVE TEACHING METHOD

The Progressive Radio "Edu-Kit" is the foremost educational radio kit in the world, and is universally accepted as the standard in the field of electronics training. The "Edu-Kit" uses the modern educational principle of "Learn by Doing." Therefore, you will construct radio circuits, perform jobs and conduct experiments to illustrate the principles which you learn.

You begin by examining the various radio parts included in the "Edu-Kit." You then learn the function, theory and wiring of these parts. Then you build a simple radio. With this first set, you will enjoy listening to regular broadcast stations, learn theory, practice testing and troubleshooting. Then you build a more advanced radio, learn more advanced theory and techniques. Gradually, in a progressive manner and at your own rate, you will find yourself constructing more advanced multi-tube radio circuits, and doing work like a professional Radio Technician.

Included in the "Edu-Kit" course are sixteen Receiver, Transmitter, Code Oscillator, Signal Tracer and Signal Injector circuits. These are not unprofessional "breadboard" experiments, but genuine radio circuits, constructed by means of professional wiring and soldering on metal chassis, using the new method of radio construction known as "Printed Circuitry." These circuits operate on your regular AC or DC house current.

In order to provide a thorough, well-integrated and easily-learned radio course, the "Edu-Kit" includes practical work as well as theory; troubleshooting in addition to construction; training for all, whether your purpose in learning radio be for hobby, business or job; progressively-arranged material, ranging from simple circuits to well-advanced topics in Hi-Fi and TV. Your studies will be further aided by Quiz materials and our well-known FREE Consultation Service.

THE "EDU-KIT" IS COMPLETE

You will receive all parts and instructions necessary to build 16 different radio and electronics circuits, each guaranteed to operate. Our Kits contain tubes, tube sockets, variable, electrolytic, mica, ceramic and paper dielectric condensers, resistors, tie strips, coils, hardware, tubing, punched metal chassis, Instruction Manuals, hookup wire, solder, etc.

In addition, you receive Printed Circuit materials, including Printed Circuit chassis, special tube sockets, hardware and instructions. You also receive a useful set of tools, a professional electric soldering iron and a self-powered DYNAMIC Radio & Electronics Tester. The "Edu-Kit" also includes Code Instructions and the Progressive Code Oscillator, in addition to the F.C.C.-type Questions and Answers for Radio Amateur License training. You will also receive lessons for servicing with the Progressive Signal Tracer and the Progressive Signal Injector, and a HIGH Fidelity Guide and Quiz Book. Everything is yours to keep.

J. Statistis, of 25 Poplar Pl., Waterbury, Conn., writes: "I have repaired several sets for my friends, and made money. The 'Edu-Kit' paid for itself. I was ready to spend \$240 for a course, but I found your ad and sent for your Kit."

UNCONDITIONAL MONEY-BACK GUARANTEE

The Progressive Radio "Edu-Kit" has been sold to many thousands of individuals, schools and organizations, public and private, throughout the world. It is recognized internationally as the ideal radio course.

By popular demand the Progressive Radio "Edu-Kit" is now available in Spanish as well as English.

It is understood and agreed that should the Progressive Radio "Edu-Kit" be returned to Progressive "Edu-Kits" Inc., for any reason whatever, the purchase price will be refunded in full, without quibble or question, and without delay.

The high recognition which Progressive "Edu-Kits" Inc. has earned through its many years of service to the public is due to its unconditional insistence upon the maintenance of perfect engineering, the highest instructional standards, and 100% adherence to its Unconditional Money-Back Guarantee. As a result, we do not have a single dissatisfied customer throughout the entire world.

ORDER FROM AD—RECEIVE FREE BONUS RESISTOR AND CONDENSER KITS WORTH \$7.50

- Send "Edu-Kit" Postpaid. I enclose full payment of \$22.95.
- Send "Edu-Kit" C.O.D. I will pay \$22.95 plus postage.
- Send me FREE additional information describing "Edu-Kit."

Name.....
Address.....

Progressive "EDU-KITS" Inc.

1186 Broadway, Dept. 158G
Hewlett, N. Y.

NEW PRODUCTS (Continued)

plete control center. Tape head input 2 mv. Microphone input. Separate bass and treble controls, ganged volume. Loudness, rumble and scratch switches. 4 ac outlets. Available factory-wired.—Acro Products Co., Kit Div., 410 Shurs Lane, Philadelphia 28, Pa.

STEREO SPEAKER systems *Celestial-Satellite*, 3 enclosures each. 2 stereo channels split above 350 cycles to satellite 8-

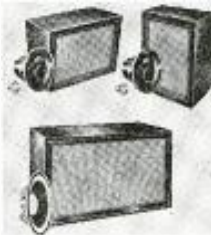

inch cone speakers. Center unit handles bass frequencies. Deluxe system (shown) has 12-inch woofer response 20-20,000 cycles; economy system 8-inch driver, response 25-16,000 cycles.—Lafayette Radio, 165-08 Liberty Ave., Jamaica 33, N. Y.

STEREO SPEAKER SYSTEM *Harmony Trio* includes booklike speaker pair for stereo sound 70-15,000 cycles, bass-reinforce-

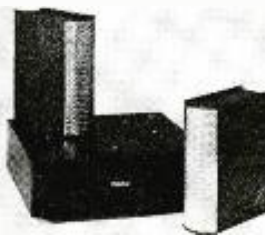

ing unit 30-100 cycles. Bass unit uses extra 10-watt amplifier. goes anywhere in room. Other speakers require 3 clean watts each. Units fused against burn-out.—Weathers Industries, Barrington Pike, Barrington, N. J.

SPEAKER KIT, bookshelf type. Separate woofer and dual tweeters. Crossover network in-

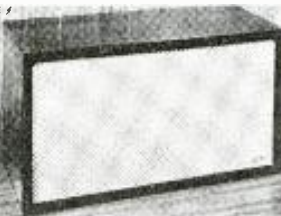

cluded. Response 42-14,000 cycles 10 watts input, distortion under 2% over 60 cycles.—Heath Co., Benton Harbor, Mich.

STEREO SPEAKER SYSTEM *Galaxy II* Satellite speakers and mixed-bass woofer. Satellites mount like pinup lamps, swivel on mounts, include 2 cone tweeters each. Bass unit 8-inch woofer in ducted-port enclosure with network to mix stereo

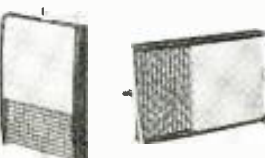

bass. Satellites 350-14,000 cycles, woofer 36-1,000 cycles. Impedance 16 ohms. Available less enclosures as kit.—Jensen Mfg. Co., 6601 S. Laramie Ave., Chicago 38, Ill.

STEREO ARM AND CARTRIDGE model *TA-12*. Inte-

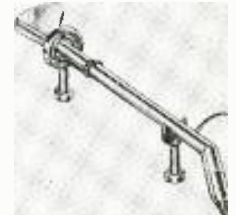

grated unit including *Stereodyne II* pickup. Tracking pressure set by sliding-spring adjustment 1 to 4 grams. Response 20 to 15,000 cycles within 2 db. 12-inch arm mounts in single hole, height adjusts from above.—Dynaco, Inc., 3912-14-16 Powelton Ave., Philadelphia 4, Pa.

STEREO PICKUP CONVERSION kit model *KB-70* for all

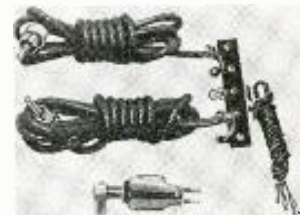

record changers. 2 shielded leads for tone arm, terminal strip, two 3-foot audio leads with phono plugs, stereo turnover cartridge with dual sapphire styli. Response 40-10,000 cycles. Standard mounting.—Olson Radio Warehouse, 260 S. Forge St., Akron, Ohio.

STEREO RECORDER model *EL35-36* Continental 400 records



4-track stereo, plays back 2-track and mono tapes also. 3 speeds: 7 1/2 to 1 1/4 inches per second. Mixes microphone input with phonograph or tuner input. Stereo headphone jack. Two 4-watt power amplifiers built in, one speaker. Both channels available at jacks for driving external amplifiers or speakers. Crosstalk down 57 db.—North American Philips Co., Inc., High Fidelity Products Div., 230 Duffy Ave., Hicksville, N. Y.

STEREO LOUDNESS CONTROL, *Stereo Compentrol*.



Ganged potentiometers with packaged resistor-capacitor combination for loudness (Fletcher-Munson effect) compensation. Fits in place of ordinary ganged gain controls. 500,000 ohms or

NEW PRODUCTS (Continued)

1 meg.—Centralab, 900 E. Keefe Ave., Milwaukee 1, Wis.

MICROPHONES for Citizens band use. Model SR90R (lower right in photo) carbon microphone. 5-foot Koiled Kord, response 200-4,000 cycles, output -38 db. push-to-talk switch for

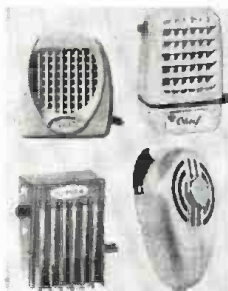

transmit-receive. Also 3 ceramic microphones with wider response, lower output, -55 db.—Turner Microphone Co., 909 17th St., N.E., Cedar Rapids, Iowa.

HAND-HELD MICROPHONE model D-11. Omnidirectional dynamic, output -57 db, response



50-11,000 cycles, high impedance rewirable to low impedance at connector. For marine, PA, paging systems, amateur and police

radio. Thumb switch for press-to-talk or stay-on.—American Microphone Mfg. Co., Div. of G.C-Textron, 412 S. Wyman St., Rockford, Ill.

45-OHM PA SPEAKERS. Models 844-45, 847-45, 848-45, 848LT-45 (shown) for 45-50-ohm intercom installation. Also available 45-ohm voice-coil and diaphragm kits for field replacement or conversion of these



speakers from other impedances.—Electro-Voice, Inc., Buchanan, Mich.

ECONOMY CAR RADIO model ATR Karadio for small imported cars or compact American autos.



All-in-one unit has 5-inch speaker, 6 tubes, tone control. 7 x 4 x 6 1/2 inches.—American Television & Radio Co., St. Paul 1, Minn.

FM CAR CONVERTER model 3311 works from any 12-volt supply, plugs in between car antenna and AM car radio. Output 800 kc to car set. Afc dis-



abled by pressing tuning knob in. Installation 15-30 minutes.—Gonset, Div. of Young Spring & Wire Corp., 801 S. Main St., Burbank, Calif.

MASTER TV SYSTEM equipment includes model SA-23 all-

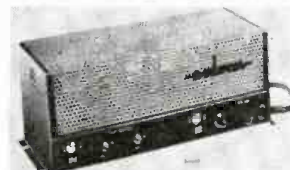

band (54-88 mc and 174-216 mc) amplifier 38-db gain each band, various outlet boxes, connectors, splitters, filters, and system accessories. Also miscellaneous crimping and other special tools.—Entron, Inc., Box 287, Bladensburg, Md.

ALL-CHANNEL ANTENNA Color Wing model CW-1. 3 active elements, gold anodized. No-

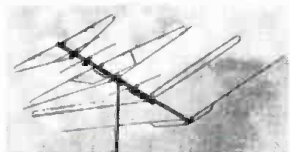

Strip lead-in connector, Quick-Lok clamps, factory-assembled to snap out and lock in place.—Trio Mfg. Co., Griggsville, Ill.

HEAVY-DUTY TOWER No. 60. Outstanding rigidity up to



600 feet when properly guyed. Hot-dip galvanized after welding. Triangular sections, 26 inches per side, 10 feet long, 2-inch 11-gauge tubing, 3/8-inch steel rod bracing.—Rohn Manufacturing Co., 116 Limestone, Bellevue, Peoria, Ill.

HIGH-ACCURACY VOM model 270 similar to model 260, but designed for repeatability. Dc accuracy 1 1/2% of full scale at 77°F. Includes mirror scale, 1/2%



resistors, gold-bonded diodes, knife-edge pointer.—Simpson

Get This Valuable Book

FREE



Just For Examining COYNE'S New Set

"Applied Practical Radio-Television"

on 7 DAY FREE TRIAL!

Yes, you get this big, brand new book, "150 Radio-Television Picture Patterns and Diagrams Explained", absolutely FREE! Complete 11x22" Schematic Diagrams on leading models Radio and TV Sets help cut your servicing time. Easy-to-read, large 8 1/2 x 11" pages, with full instructions on how to use the diagrams. A "must" in every repair kit. You get this book as a FREE Gift for asking to see Coyne's new 7-book set, "Applied Practical Radio-Television"!

FREE!

5 Years Of Valuable Supplements



With your set you also get Coyne's annual Supplement Service FREE for 5 years. Keeps your set up-to-date on everything that will be new in radio, television, electronics and electricity.

NOW!

7 BIG BOOKS IN ONE GREAT SET!



SEND NO MONEY! Just mail coupon for 7-volume set on 7 days free trial. We'll include book of 150 TV-Radio Patterns & Diagrams. If you keep the set, pay \$3 in 7 days and \$3 per month until \$27.25 plus postage is paid. (Cash price, only \$24.95). Or you can return the library at our expense in 7 days and owe nothing. YOU BE THE JUDGE. Either way, the book of TV-Radio Patterns is yours FREE to keep! Offer is limited. Act NOW!

FREE BOOK — FREE TRIAL COUPON!

Educational Book Publishing Division
 COYNE ELECTRICAL SCHOOL, Dept. B9-T1
 1501 W. Congress Pkwy., Chicago 7, Ill.

YES! Send 7-Volume "Applied Practical Radio-Television" for 7 days FREE TRIAL per your offer. Include TV-Radio Patterns & Diagram Book FREE.

Name _____ Age _____

Address _____

City _____ Zone _____ State _____

Where Employed _____

Check here if you want library sent C.O.D. You pay postman \$24.95 plus C.O.D. postage on delivery. 7-day money-back guarantee.

NEW PRODUCTS (Continued)

Electric Co., 5200 W. Kinzie St., Chicago 44, Ill.

CRT REJUVENATOR TESTER model 440 CRT. Combination instrument checks leakage,



gas content, estimates remaining life of picture tubes. Repair shorts, restore brightness. For all color and black-and-white CRT's.—B & K Mfg. Co., 3726 N. Southport Ave., Chicago 13, Ill.

DC POWER SUPPLY model EFBR for continuous operation servicing and developing transistor circuits, aircraft, radios and electronics, autos and ma-



rine craft. Continuously variable current 0-16 volts up to 8 amps, 0-32 volts up to 4 amps. Under 10-mv ripple at full load.—Electro Products Laboratories, Inc., 4500 N. Ravenswood Ave., Chicago 40, Ill.

STEREO ANALYZER model

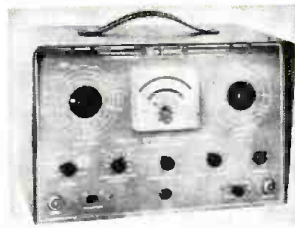

800 multipurpose test instrument. Audio oscillator 20-30,000 cycles. Ac vtvm 6 ranges .01 to 300 volts. Audio wattmeter 0.15 mw to 150 watts. IM and harmonic distortion meter. Db meter -40 to +52 db.—Winston Electronics, Div. of Jetronic Industries, 4000 N.W. 28th St., Miami, Fla.

PLANETARY BALL DRIVE units, Jackson model 4511 friction



shaft ratio reducer for tuning capacitors and precision controls. Ratio 6 to 1. Models available without flange (shown with flange) or mounting lugs.—M. Swedgal Electronics, 258 Broadway, New York 7, N. Y.

CLEANER for TV tuners and variable controls. Rx. Aerosol type can with long thin needle for injecting cleaner into small openings in controls or tuners. Detergentlike chemical cleans



while lubricating.—Superex Electronics Corp., 4-6 Radford Place, Yonkers, N. Y.

MINIATURE ELECTROLYTIC tubular capacitors in plastic



cases. Type PTT for transistor circuitry and miniature assemblies. Temperature rating -30 to +65°C. Selection of capacitances at 3 to 50 volts.—Aerovox Corp., New Bedford, Mass.

WIRE WOUND CONTROLS for printed-circuit applications. Modified terminals inserted into printed wiring boards for dip



soldering. Sizes up to 2 watts.—Clarostat Mfg. Co., Inc., Dover, N. H.

SOLDERLESS TERMINALS, insulated. 5 spade and 13 ring

types. Insulated sleeves color-coded for wire size. Assortment kits with or without



crimping tool.—Vaco Products Co., 317 E. Ontario St., Chicago 11, Ill.

MATCHED OUTPUT TUBES in pairs for best balance in critical output circuits or for lowest possible distortion in push-pull circuits. Output types EL84, EL34, 6CA7, 6Z34 and EZ80 and EZ80 rectifiers, and a number of selected voltage amplifiers.—Fisher Radio Corp., 21-21 44th Drive, Long Island City 1, N. Y.

AM TUNER KIT model HFT-94. Choice of 14- or 7-kc band-pass; tuned rf stage; prealigned rf and if coils and transformers; built-in ferrite antenna; 10-kc whistle filter, traveling tuning indicator. Sensitivity 3 µv at 30% modulation for 1-volt output 20-db signal-to-noise ratio. Also available factory-wired.—EICO, 33-00 Northern Blvd., Long Island City 1, N. Y. (EN)

All specifications on these pages are from manufacturers' data.

Wherever wireless communications are essential

CITIZENS BROADCASTER CB-100

low cost, smartly styled, practical and sturdy
2-way 3-channel Radio Station complete*

\$129.95

NO OPERATOR'S LICENSE REQUIRED. FCC FORM 505* FOR STATION LICENSE SUPPLIED. NO TESTS, NO EXAMINATIONS



* WITH MICROPHONE AND CRYSTALS FOR ONE CHANNEL

Write for Brochure & Name of Local Dealer

GLOBE electronics
DIVISION OF TEXTRON ELECTRONICS, INC.

3421 W. BROADWAY - COUNCIL BLUFFS, IA.

Artisan
ELECTRONIC ORGAN for your HOME!
BUILD-IT-YOURSELF SAVE!

Now you can own a professional electronic organ and save up to 50% on an easy pay-as-you-build plan... The world famous ARTISAN ORGAN—in 14 models from the popular 2-manual Home entertainment style to the majestic 4-manual Theatre and Church style is now available in kit form. Simple step-by-step instructions, pictorial diagrams and schematics make this an ideal spare-time project for anyone.

FREE LITERATURE on REQUEST

Get the Artisan Story before you purchase any Organ. Kit or commercial model.

ARTISAN MUSIC HALL

New Home of ARTISAN ORGANS



ORGAN KITS and COMPONENTS

ELECTRONIC ORGAN ARTS, INC.

4949 YORK BLVD., Dept. RE11
LOS ANGELES 42, CALIF.

BEST IN HI-FI VALUES!

NO DELAY SERVICE

All orders rushed to you in factory-sealed cartons.

Write for free catalog.

audion

25-E Oxford Road
Massapequa, New York

ACCOLADES AGAIN!

Again, without peer!...still the best super high frequency tweeter at any price... tested and top-rated again in September by laboratory reports!

REALISTIC ELECTROSTAT-3

\$27⁵⁰

\$2 Down

Tweeters come and tweeters go—but one, and only one, is here to stay! "Best value at any price", again say the laboratory testers! (And "best tweeter I've ever heard", say literally thousands of Electrostat-3 owners!). When used with any of the better high compliance speakers—or any speaker, for that matter—Realistic's Electrostat-3 delivers a uniquely smooth response to 25,000 cps and beyond. It adds a musical transparency you've rarely, if ever, heard before! Exclusive Realistic design has 3 electrostatic elements for 120° sound dispersion, built-in double-fused AC supply for true electrostatic operation, and every unit is automatically tested for frequency response on a Bruel and Kjaer. The most *vainly* imitated tweeter in audio history! Complete, in handsome furniture-finish cabinet measuring 11 1/8" x 5 3/8" x 4 1/2" deep. Ship. wt. 7 lbs.

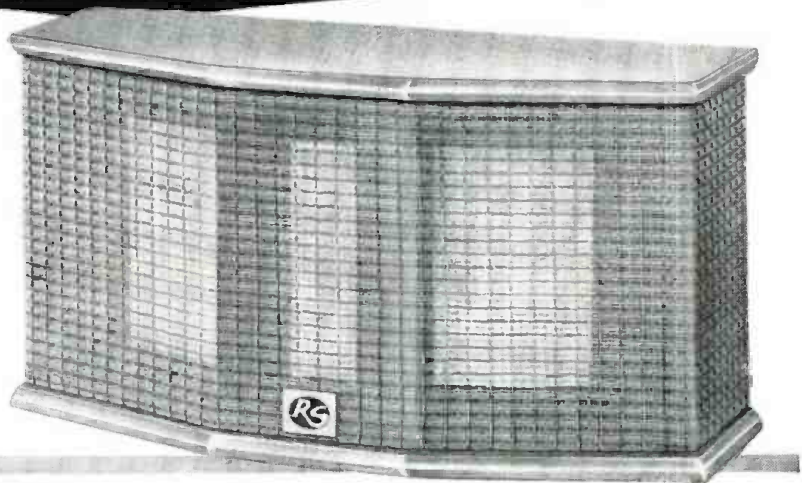

REALISTIC FULL-RANGE ELECTROSTAT-4

NEW!

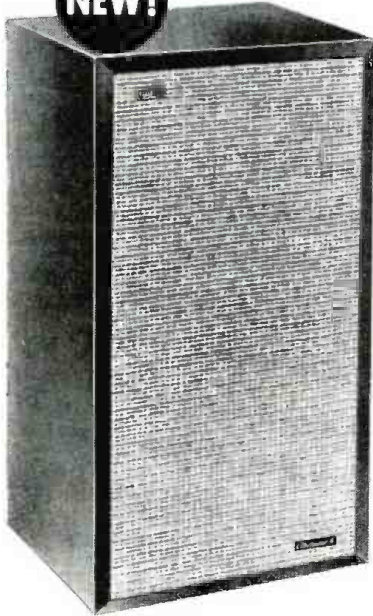

\$119⁵⁰

\$5 Down

NOW... world's first and only complete-range (30-25,000 cps) speaker system incorporating and especially designed for—a built-in Electrostat-3! "Magnificence goes full-range" in a complete 3-way "pneumatic compression" speaker system built with, around and for the sensational Electrostat-3 tweeter! (With "lows" and "middles" that match the quality of those "highs"!). New Electrostat-4 features built-in Electrostat-3, new-design mid-range cone speaker, amazingly rugged high compliance woofer, self-enclosed built-in 3-way Crossover with polarizing supply and a complete set of rear panel balance controls. Completely sealed and enclosed in fine furniture-finish cabinet 24 3/4" x 13 1/2" x 11" deep. Ship. wt. 41 lbs.



FREE Bargain Bulletins 1960 Electronic Guide

Crossover Network for Electrostat-3

\$6⁹⁵

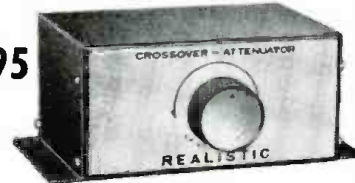

Designed for the Electrostat-3—may be used with any 8 or 16 ohm tweeter-woofer combination. 5000 cps crossover, plus built-in low frequency attenuator control for perfect tweeter-woofer balance. Screw terminals, no soldering. Ship. wt. 2 lbs.

STEREO SURPRISE!

A component hi-fi stereo system at a price actually less than a mediocre phonograph! Famous imported British Monarch 4-speed intermix changer, stereo crystal cartridge with diamond stylus, new Realistic Stereo-7 amplifier, 2 Realistic Solo-I speaker systems (cabinets included!). Nothing else to buy in the system the experts now call the "stereo buy of the year"! Ship. wt. 47 lbs.

Radio Shack's Complete Stereo System... the sound that fooled the experts in a recent hi-fi magazine article!

\$5 DOWN \$96⁵⁰

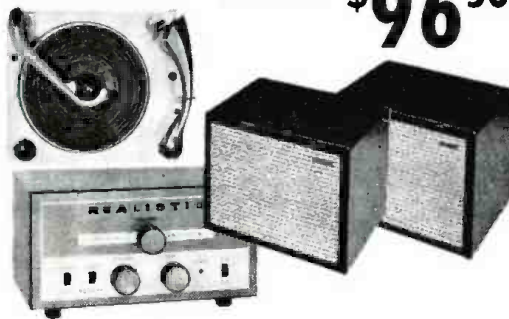

RADIO SHACK CORPORATION, Dept. 11E
730 Commonwealth Ave., Boston 17, Mass.

- Send... FREE Bargain Bulletins 12-months subscription FREE. Famous Radio Shack Bargain Bulletins give you first crack at hi-fi, "ham", optical, record VALUES!
- Send... 1960 Electronic Guide Over 40,000 items, plus articles, illustrations, etc. 312 book-size 8 1/2 x 11 pages. Biggest, most valuable handbook ever! Only 35c.
- Send Electrostat-3 tweeter, No. 36CX017Y (mahogany) @ \$27.50
- 8-ohm Crossover network, No. 91L534 @ \$6.95
- 16-ohm Crossover network, No. 91L531 @ \$6.95
- Electrostat-4 speaker system, No. 90LX243 (mahogany) @ \$119.50
- Complete stereo system, No. 92LX195 @ \$96.50

Name _____

Address _____

City _____ Zone _____ State _____

Check Money Order C.O.D.

RADIO SHACK CORPORATION



167 WASHINGTON STREET, BOSTON 8, MASS.
730 COMMONWEALTH AVENUE, BOSTON 17, MASS.
230-234 CROWN STREET, NEW HAVEN 10, CONN.

FABULOUS Pre-Christmas SALE



FREE with every **12-PAK** order

worth \$15

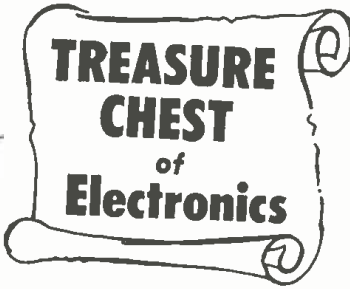

2nd FREE CHRISTMAS GIFT!
PICK ANY PACK BELOW FREE WITH EVERY 12-PAK ORDER!

- \$2.50 SUN BATTERY: similar to B2M; 1" long.....88c
- 10 VOLUME CONTROLS: some W/switches. Reg. \$9...88c
- 15 ROTARY SWITCHES: asstd. gangs. Reg. \$12.....88
- 35 TWO WATERS: carbons; incl. 1%. Reg. \$12...88c
- 4 OSCILLATOR COILS: mini; 650-1000 kcs. \$4.....88c
- \$2 16-END WRENCH SET box-open 15/64 to 7/16"...88c
- 15 Red MOLDED TIP JACKS: for testers & std. tips...88c
- 50 PLUGS/RECEPT'LS: audio, pwr, bat'y. \$7-Reg...88c
- 20-PC DRILL SET: 1/16 thru 1/4" x 6.4ths.....88c
- 2 VARI-LOOPSTICKS: 540-1500 ksc. Trans. radios...88c
- \$25 SURPRISE PAK: large, asst. radio-TV parts...88c
- 60 TERMINAL STRIPS: solder-lug, binding, 10 types...88c
- 40 HI-Q COND'S'RS: porcelain. NPOs too. Reg. \$15.....88c
- 20 ARTIST BRUSHES: 100% brittle. Reg. \$2.50...88c
- 12-HR. CLOCK: penlite cell powered.....88c
- 6 SILICON DIODES: Sily. 1N22, 1N23. Reg. \$46...88c
- \$7 POSTAGE STAMP MIKE: crystal. 100-7000 cps...88c
- 70 ONE WATERS: asstd. value carbons, 5% too...88c
- 2 TRANSISTOR IFS: 1/2" sq. 45G kcs.....88c
- \$5 HEARING AID PHONE: crystal, W/ord set...88c
- 30 ASSTD. MOLDED CONDENSERS: finest made...88c
- 10 ELECTROLYTICS: 10-500mf-450VDC. \$12-val...88c
- 8 SUB-MINI SOCKETS: for transistors. Mica-fill...88c
- 10 POLY BOXES: plastic, snap locks, hinged...88c
- 8 GERMANIUM DIODES: glass-sealed, leads...88c
- 35 DISC CONDENSERS: to 3000 VDC. \$5-reg...88c
- 20 PILOT LIGHTS: mini, bay, screw types: 2V to 6V...88c
- 5 JEWELERS SCREWDRIVERS: submini work...88c
- 35 TUBE SOCKETS: 4-9 pin; shield-based \$10-reg...88c
- WIRE STRIPPER: cuts ± 10 thru ± 22 hookup...88c
- 2 NPN TRANSISTORS: used in popular radios...88c
- 1500 PCS HARDWARE: nuts, screws, etc. \$6-val...88c
- 2 SELENIUM RECTIFIERS: AC-DC, 65 mil...88c
- 3 TRANSISTRON SEMI CONDUCTORS...88c
- 6 AC-DC LINE CORDS...88c

LEKTRON'S fabulous FREE Treasure Chest includes: transistor, diode, resistors, condensers, controls worth \$15.00 — all prepacked in a handy "useful chest" to save you money!

POLY PAKS
for a very LIMITED TIME at . . .

88¢ EA.

- 60 TUBULARS: paper, molded. 0.00025 to 0.5 mf to 1000V. Reg. \$14...88c
- 5-IN-1 DRILL BIT: reams, saws, shapes, drills; use with hand or power drills...88c
- 2 TRANSISTOR VARIABLES: 1 1/8" sq., 2" shaft. Dual 305 minif. Reg. \$3...88c
- 40 SUBMINI CONDENSERS: for transistor, printed circuit work. Reg. \$7...88c
- 40 PRECISION RESISTORS: 1/4" long. W.W. 1/2, 1/2, 1, 2W. Reg. \$10...88c
- 60 RADIO-TV KNOBS: asstd. colors, insulation. Reg. 17, some reg. \$1 ea...88c
- 300-FT. HOOKUP WIRE: tinned, asstd. sizes. colors. Reg. \$5...88c
- 8 RCA PLUG-N-JACKS: sex matched...88c
- For amps, tuners, phonos...88c
- 60 MICA CONDENSERS: to .01 to 1200V. Silver too. Reg. \$25...88c
- 40 SUBMINI RESISTORS: 1/4" long. Asstd. values 1/5W to 10 megs. Reg. \$6...88c
- 3 TRANSISTOR XFMRs: and couplers. Submini size, 100's of uses, audio, etc. Reg. \$10...88c
- 100 HALF-WATERS: asstd. value carbon resistors incl. 5%. Reg. \$12...88c
- 60 CONDENSER SPECIAL: molded, paper, ceramic, oil, mica, discs, variable...88c
- 70 HI-Q RESISTORS: insulated, carbon 1% too. 1/2 & 1W, 10 ohms to 10 meg. Reg. \$13...88c
- 5 ROLLS MICRO-WIRE: #24 thru #32: for transistor, sub-mini circuit...88c
- 2 "FLEA" POWER MOTORS: 1/2 to 1VDC, penlite cell powered. Perm. magn. Size: 1 1/4" sq. 1" shaft...88c
- 40 "SILVER" MICAS: disc, mica; 1 to 3" asstd. values. Reg. \$25, some reg. \$3 each...88c
- 20 HI-Q MOLDED OILS: condensers used in finest commercial-gov't eqpt.; 1 mf to 1 mf to 600V. Reg. \$40...88c
- 15 "SEALER" CIRCUITS: built-in resistor-condenser coupling circuits for sub-mini work. Reg. \$9...88c
- MINI GEIGER COUNTER TUBE: dozens of radiation detection uses. 2" long, 1/2" dia...88c
- 30 POWER RESISTORS: WW 5 to 50W to 10K. Vitreous too. Reg. \$15...88c
- 75 RESISTOR SPECIAL: WW, precision, carbon, variable, miniature types. Worth \$15...88c

Free Surprise Gift With Every Order!

FREE! Write for giant bargain catalog—year's subscription

MINIMUM ORDER
 2 Poly Paks per order

ORDER BY BLACK - TYPE HEADLINES: 10 VOLUME CONTROLS, 88c. State price with each item. Send check or M.O. including sufficient C.O.D. orders, 25% down-rated, net 30 days. INCLUDE POSTAL ZONE in address. (Canada postage, 48¢ 1st lb.; 28¢ ea. add'l lb.)

LEKTRON

131 Everett Ave.
 CHELSEA 50, MASS.

CARTOONS

RADIO-ELECTRONICS pays \$3.00 for good cartoon ideas and \$15 and up for finished work.

Radio-Electronics 154 West 14th St., New York 11, N. Y.

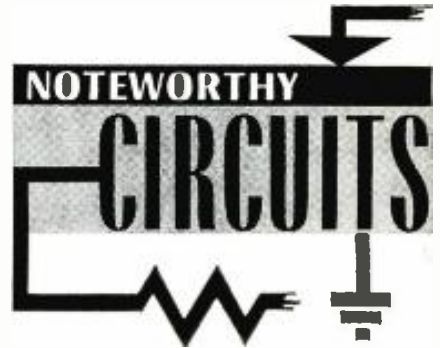

TREBLE-BASS TONE CONTROL

This treble-bass tone control is easy to assemble. You can get all the components at almost any parts store. I used parts salvaged from an old TV chassis.

The circuit is added to the audio output stage. In the schematic you will note that potentiometer R is connected to form two arms. Capacitor C1 is in arm A and capacitor C2 and choke CH are in series in arm B. Both arms are connected to the plate of the audio output tube. R1's slider goes to the chassis ground.

The choke's action opposes that of capacitor C2. It has a very high impedance to currents of higher frequencies yet easily passes those of lower frequencies.

To see how the circuit works, assume that R's arm is all the way to the left.

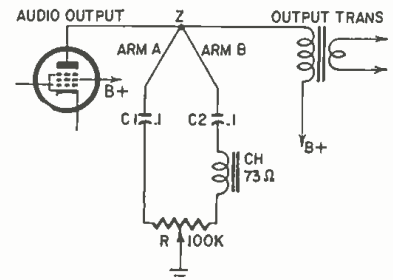

Now there is no resistance in arm A; instead all the resistance is in arm B. The audio output from the tube's plate divides at point Z. There is little high-frequency loss in the capacitor and most of the high frequencies are passed on to ground. This gives the receiver or amplifier a deep bass tone.

If you turn the pot's arm all the way to the right, arm A contains 100,000 ohms resistance and there is no high-frequency loss. Now current traveling through arm B is shunted to ground. In this case, only the low frequencies are lost because the choke looks like a large resistor to high frequencies and does not shunt them while low frequencies see little resistance and are grounded. This gives a treble tone to the output. By adjusting R you can control the amount of the high and low frequencies in the output.—George E. Lytle

SIMPLE SIGNAL GENERATOR

This generator can be used on almost any frequency range in both broadcast radio and TV. It is very easy and comparatively inexpensive to build. Both

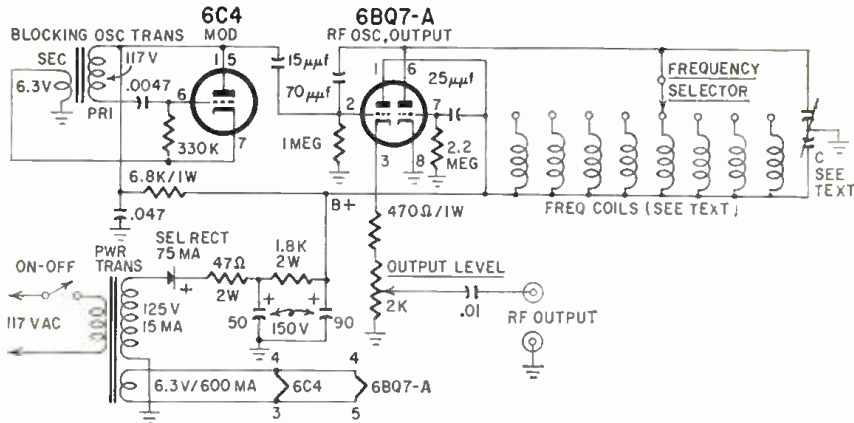

audio and video circuits can be checked with this unit. When connected to the antenna of a TV receiver, it produces both audio signals and horizontal bars on the screen.

The blocking oscillator transformer is a small filament type—117-volt primary, 6.3-volt secondary. If the 6C4 does not oscillate, reverse the transformer's secondary leads. The FREQUENCY SELECTOR switch may have as many positions as desired. The coils are left to the constructor's design. I used coils from old radio and TV receivers. Coils for TV channels should be open-wound on a 1/4-inch form. Try about 5 turns of No. 18 insulated wire. C is a dual-stator tuning capacitor which can be removed from an old

superhet radio. A 2,000-ohm level control regulates the rf output.—Wm. R. Shippee END



"This one doesn't feel right."

IMPROVE



your amplifier 5 ways with the Amperex® GZ34/5AR4 RECTIFIER

A LOW-IMPEDANCE, INDIRECTLY HEATED, FULL-WAVE RECTIFIER WITH 250 MA OUTPUT CAPACITY

The unique AMPEREX GZ34 replaces without circuit changes, in the majority of amplifier circuits, an entire line of popular, heavy-duty 5-volt rectifiers—5U4G, 5V4G, 5T4, etc.—with the following benefits:

- Better voltage regulation due to lowered power supply impedance;
- Higher power supply output voltage for more power;
- Added filter condenser protection due to reduced surge;
- Cooler operation due to lower voltage drop;
- Protection of costly power output tubes through delayed warm-up.

Ask your Amperex distributor about Amperex voltage amplifier, rectifier and output tubes for hi-fi circuits



Amperex
ELECTRONIC CORP.
230 Duffy Avenue
Hicksville, L. I., N. Y.

Just Out

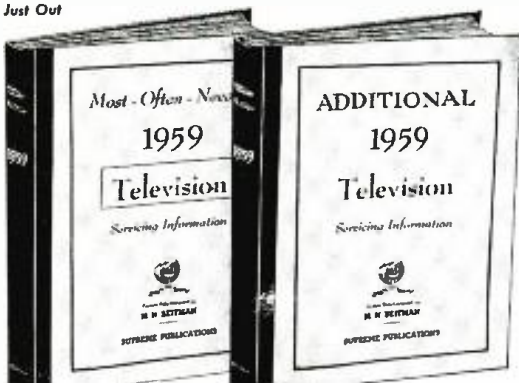

These two 1959 TV volumes cover practically all sets of all makes. The new ADDITIONAL 1959 TV manual includes material almost to the minute. Each plant manual has 192 pages of service data and repair hints, factory changes, double-size circuits. Special price, each only, \$3

New ADDITIONAL 1959 TV Volume

LARGE MANUAL COVERS NEWEST 1959 TV SETS

EARLIER TV VOLUMES STILL SOLD AT ONLY \$3

AMAZING BARGAINS

Supreme twin 1959 TV manuals are the scoop of the year. Cover all sets of all important makes. New ADDITIONAL 1959 TV volume gives you the very latest material. Your price for this mammoth manual is only \$3. Supreme super values defy competition. Each prior-year manual (at only \$3) has a whole year of service material. Each volume covers different material, from 1948 to latest 1959 sets. Include circuits, wave-forms, alignment, voltage charts, service hints, changes, and double-spread diagrams. Practically tell you how to make every repair. More pages, more diagrams, more service data per dollar of cost. To get the best for less, get Supreme manuals.

Supreme TV manuals supply all needed service material on every TV set of every important manufacturer. Here is helpful, practical, factory-prepared data. It will really make TV servicing and adjustment easy for you. Join 167,000 servicemen who use, benefit, and save with SUPREME service manuals. In these volumes you get correct factory-checked circuits, alignment procedure, printed boards views, service hints, recommended changes, wave-forms, voltages, easy-to-use giant-size diagrams.

BEST AT LOWEST COST

Here is your TV service material to help you do expert work double-quick; and priced at only \$3 per annual volume. Be ready to repair any model by carrying in your car all 14 TV volumes listed in coupon below. Or try one of the new 1959 TV manuals to see what an amazing bargain you get for only \$3. See no-risk coupon.

TELEVISION SERVICING COURSE
Let this new course help you in TV servicing. Amazing bargain, complete, only \$3, full price for all lessons. Giant in size, mammoth in scope, topics just like a \$200.00 correspondence course. Lessons on picture faults, circuits, adjustments, short-cuts, UHF, alignment facts, hints, antenna problems, trouble-shooting, test equipment, picture analysis. Special, only \$3

RADIO DIAGRAMS
Supreme is your best source for all needed RADIO diagrams and service data. Covers everything from the most recent 1959 radios to pre-war old-timers; home radios, auto sets, combinations, changers, stereo, FM, and portables. Sensational values. Only \$2 for many volumes. Every manual has extra large schematics, all needed alignment facts, printed boards, voltage values, trimmers, dial stringing, and helpful hints. Volumes are large in size 8 1/2 x 11 inches, about 190 pages. See coupon at right for a complete list of these radio manuals. →

NO-RISK TRIAL ORDER COUPON

SUPREME PUBLICATIONS, 1760 Balsam Rd., Highland Park, ILL.

Rush today TV manuals checked below and Radio manuals at left. Satisfaction guaranteed.

New Additional 1959 Television Manual, only \$3.
 Early 1959 Television Manual, \$3. 1958 TV, \$3.
 Early 1957 TV, \$3. Additional 1957 TV, \$3.
 1956 TV Manual, \$3. Additional 1955 TV, \$3.
 Early 1955, \$3. 1954 TV, \$3. 1953 TV, \$3.
 1952 TV, \$3. 1951 TV, \$3. 1949 TV, \$3.
 1948 TV, \$3. 1957-58 RCA TV Manual, \$1.50
 New Television Servicing Course, complete... \$3.

I am enclosing \$..... Send postpaid.
 Send C.O.D. I am enclosing \$..... deposit.

Name:
 Address:

Popular RADIO Diagram Manuals at only \$2.50 each
 1957
 1956
 1955 Radio Manual, only \$2

These annual **RADIO** volumes specially priced at only \$2.50 each
 1954
 1953
 1952
 1951
 1950
 1949

THIS GROUP ONLY
 1948
 1947
 1946
 1942
 1941
 1940
 1926-1938 Manual, \$2.50
 Radio and TV Master Index, 25c

Supreme Publications
Sold by All Leading Parts Jobbers

Introducing... "Jewels In Tools"

VACO® NUT DRIVERS

- 5 beautiful nut drivers nested in attractive 2-tone plastic box with hinged cover
- Each driver identified for size by color of handle
- Highly polished chrome shafts (drilled 1 1/2" deep) for good looks, long life
- Extra hard, machined sockets that "won't-round-out"

SP 500
\$3.95 NET

Special Offer!
Voltage Checker and Probe INCLUDED with purchase of two New Design VACO Nut Drivers. This is a \$2.50 value for only \$1.79 net. Instructions for using Voltage Checker included. A real "buy"!

See Your Parts Jobber, Today! **SP 3 ONLY—\$1.79**

VACO PRODUCTS COMPANY, 317 East Ontario St., Chicago 11, Illinois
In Canada: **ATLAS RADIO CORP., Toronto 19, Ontario**



EASY WIRE MEASURING

When a do-it-yourself customer comes to the shop for a length of TV lead-in or other wire, do you usually measure out the right amount with a yardstick or tape measure? Unless only a very short length is needed, that's doing it the hard way. It's easier if you measure a length of your shop floor and mark it off at 1-foot and 1/2-foot intervals with colored paint. Use red paint for 1-foot intervals; yellow or green for 1/2-foot marks. Using this giant yardstick to measure wire will save you time and effort.—*John A. Comstock*

IMPROVE PORTABLE RECORD PLAYERS

Many "economy" portable record players are now in use. Most are owned by teenagers who need all the volume they can get while dancing. To get sufficient volume the gain control must be fully advanced, but often this is still not quite enough. Especially after the pickup's output drops because of aging.

These record players feature a one-tube audio amplifier which is stripped

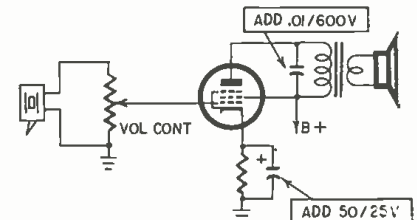

to the basic essentials, as is shown in the schematic. But for less than a dollar, gain and quality of reproduction of such an amplifier can be greatly improved. Simply connect a 50- μ f 25-volt electrolytic across the cathode resistor. This increases gain by eliminating the degeneration in the cathode circuit. Any advantage that an un-bypassed cathode may have in reducing distortion is offset by the small speaker these record players have.

To improve the quality of reproduction, connect a .01- μ f 600-volt capacitor across the output transformer's primary. This eliminates most of the record surface noise, acting as a tone control, and prevents saturation of the output transformer by high frequencies. Today's hi-fi LP's and 45's really contain plenty of high frequencies. Be sure to use a 600-volt capacitor as one

ONE CENT SALE

BUY ONE AT OUR REGULAR LOW PRICE AND GET THE SECOND FOR ONLY 1¢ MORE

CITIZENS BAND TRANSMITTER (27 MC) chassis complete with crystal. \$9.99 ea. two for \$10.00.

TRANSMITTER similar to above but with 5 watt RF stage instead of 1 watt. \$14.99 ea. two for \$15.00.

CITIZENS BAND RECEIVER chassis tunable through all 22 channels. Complete with audio amplifier. \$9.99 ea. two for \$10.00.

AMATEUR BAND TRANSCEIVER (144-148 MC) chassis with dual VHF triodes for walkie-talkie radiophone. \$9.99 ea. two for \$10.00.

MICROPHONE High output 200 ohm carbon with terminal lugs. \$1.49 ea. two for \$1.50.

COILED CORD 4 conductor 11" telephone cord. Extends to over 4 ft. .99 ea. two for \$1.00.

KIT OF PARTS for AM-FM VHF radio receiver. Tunable from 80-200 mc. which includes U. S. satellite frequencies. \$6.99 ea. two for \$7.00.

TRANSISTOR AUDIO AMPLIFIER gives 50X voltage gain on low level signals. Operates on 1 1/2 volts. \$3.99 ea. two for \$4.00.

SUPER SPECIAL: 25 watt, 30 to 40 mc. crystal controlled FM radiophone mobile transmitter with 8 tubes and dynamotor power supply. Orig. cost over \$300.00. Can be converted to Citizens Band. Used good condition \$24.99 ea. two for \$25.00 F.O.B. Hollis, N. Y.

LIMITED QUANTITY—

NO LITERATURE OR CATALOG

Remit in full. Include sufficient postage. No C.O.D.'s.

VANGUARD ELECTRONIC LABS.

Box 12-RE-11

Hollis 23, N.Y.

ANOTHER GREAT TRIO® TV ANTENNA FEATURE

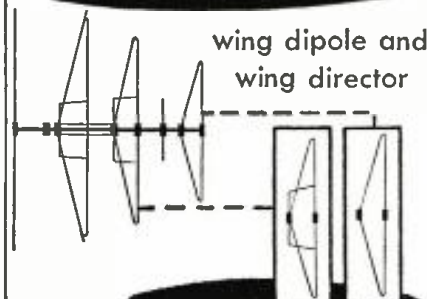

Today's most powerful combination. The Wing Dipole contains 3 active elements on the high, forward Vee to the low band section, plus integrated director. The Wing Director obtains maximum results from the Wing Dipole.

Just one of the features that makes Trio the most advanced TV Antennas in the world. Choose from Trio's complete Zephyr and Color Series Antennas.



TRY THIS ONE (Continued)

of lower voltage may short due to the high peak voltages generated by the transformer's inductance.—Albert J. Krukowski

HIGH-Q IF TRANSFORMERS

Many experimenters do not like to use extremely high-Q if transformers in their receivers since they usually tend to make the if stages unstable. Instead, they use lower-Q transformers to make the stages stable at rated tube gain. However, I find that it is better to use the hottest iron-core if transformers, even if they do oscillate. The cathode and screen resistors for the tubes are simply increased in value to reduce tube gain and make the stages stable. In the end, overall gain is about the same, but selectivity is much better.—Charles Erwin Cohn

INSULATE LINE SPLICES

When a length of ribbon TV lead has to be spliced, it's best not to tape the splice. Tape will cause appreciable signal loss when it becomes wet with rain. Instead, take a spare piece of the



line and cover and fill in the gap between the conductors with melted insulation. This is probably the best low-loss insulating technique devised. There is much less chance of upsetting line impedance with this insulating technique.—Scott Mock END



"Drop that gun or we will all go together."

Transistor Radio Servicing CAN be Highly Profitable



The ONLY Complete Transistor Radio Service Lab
Everything you need for less than \$50



Check Transistors, Diodes, Rectifiers . . .

SENCORE TRC4 TRANSISTOR CHECKER

Accurately checks all transistors in hearing aids, radios and power transistors in auto radios. Tests for opens, shorts, leakage, current gain. Measures forward-reverse current ratio on all crystal diodes. Measures forward and reverse currents on selenium rectifiers. With set-up chart for accurate checking of each transistor. Size, 5x4 1/2 x 2 1/2". With batteries. DEALER NET..... **17⁹⁵**



Replace Batteries During Repair . . .

SENCORE PS103 BATTERY ELIMINATOR

All-new "Transi-Pak," twin to TRC4 Checker above. Provides variable DC voltage to 24 volts; 1.5-volt biasing tap (a "must" for servicing Philco and Sylvania radios). Metered current output, to 100 ma. Handles 200-ma peaks. Two 200-mfd electrolytics provide proper filtering and low output impedance. No hum or feedback problems. Ideal for alignment using station signal; adjust IF slugs for max. current, also ideal for charging nickel-cadmium batteries. Size, 5x4 1/2 x 2 1/2". DEALER NET..... **17⁹⁵**



Find Defective Stage in a Minute . . .

SENCORE HG104 HARMONIC GENERATOR

New signal generator designed primarily for fast signal-tracing of transistor radio circuits. No need to unsolder all transistors. Provides RF, IF and audio signals *simultaneously*, drastically cutting service time. Traces from speaker to antenna. Clear 1000 cycle note signal is heard in speaker from all good stages. Signal weakens or stops at defective stage. Equally as effective for testing TV, hi-fi and other audio circuits also. Size, 3 1/2 x 4 1/2 x 1 3/4". With batteries. DEALER NET..... **9⁹⁵**



Turn page for other



See your Parts Distributor NOW!

SENCORE
ADDISON 2, ILLINOIS

OPPORTUNITY ADLETS

Rates—50c per word (including name, address and initials). Minimum ad 10 words. Cash must accompany all ads except those placed by accredited agencies. Discount, 10% for 12 consecutive issues. Misleading or objectionable ads not accepted. Copy for January issue must reach us before Nov. 15, 1959. **RADIO-ELECTRONICS,** 154 West 14 St., New York 11, N. Y.

PRINTING PRESSES, type, supplies. Lists 4c. **TURN-RAFFLE SERVICE,** Mechanicsburg, Pa.

NEW BOOK (Mobile Hi-Fi) covers stereo, power converters, etc. \$5.00 **EKERADIO** 650 N. Fair Oaks, Pasadena, California.

BARGAIN PARTS KIT #M102—Fabulous Assortment, 20 lbs., 50 items, \$50 value for \$3.00. (Add Postage) **MIDT,** 944 W. Toga Street, Phila., 40, Pa.

LEARN CIVIL and criminal investigation at home. Earn steady, good pay. **INSTITUTE APPLIED SCIENCE,** 1920 Sunnyside, Dept. 268, Chicago 40, Ill.

PRINTED-CIRCUIT KIT. Makes three boards 3 1/2" x 2 1/2". Guaranteed. \$1.95. Advanced Kits available. **ELB-TRO-TECHNIK CO.,** 19456 Meyers Rd., Detroit 35, Mich.

FM TUNERS, 88-108 megacycles, 4 tubes complete, \$14.95. **GRUTMAN,** 1 East 167 St., Bronx 52, N.Y.

IF YOU HAVE a background in electronics, but are having trouble passing FCC theory exams, my 13 years' experience as chief instructor of electronics school can help you over the hump. Not a course. Write me personally for free literature. **WALLACE COOK, P.O.** Box 10634, Jackson 9, Miss.

PRINTED CIRCUIT BOARDS for individual projects, industrial prototype, pilot production. **ELECTRONIC AIDS,** Box 137, Stamford, Conn.

IF YOU HAVE had at least 5 years' experience servicing two-way radio, we can offer an unlimited opportunity. Write today—Give age, license status, income required, and outline of experience. **AIRCOM ENGINEERING, INC.** Box 44, Grand Blanc, Mich.

FREE ATTITUDE TEST tells if you can qualify for Radio-Television Servicing. Opportunity for own business if desired. Scientific Aptitude Test will be mailed to you without obligation. Write **SPRAYBERRY,** 1512 Jarvis, Chicago 26, Ill. Dept. D-20.

RADIO & TV TUBES at Manufacturers' Prices! 100% Guaranteed! Brand New! No re-brands or pulls! **UNITED RADIO,** Box 1000, Newark, N.J.

WHOLESALE Appliance Parts Catalogue 25c. Clock, Iron, Percolators, Everything. **SECO** 26 South 20 Street, Birmingham 3, Alabama.

Hi-Fi, Recorders, Tapes. FREE Wholesale Catalogue. **CARSTON,** 215-T East 88th St., New York 28, N. Y.

(Continued on page 151)

Now! SOLVE CIRCUIT PROBLEMS FAST!

Goodbye to trial-and-error methods. Every circuit calculation you need can now be done accurately with

THE ALGEBRA OF ELECTRONICS

YOU'LL BE AMAZED at how easy it is to figure resistances, load inductances, impedances, etc. for ANY part of ANY electronic circuit. With this new book, THE ALGEBRA OF ELECTRONICS, you will quickly gain the tools, techniques and shortcuts needed.



Three Great Books in One!

First, it's a textbook. All practical mathematical techniques explained clearly step-by-step; easy to follow by those with no more math training than high-school algebra and simple differential calculus.

Second, it's a handbook. Graphs and tables answer common electronic problems for those not wishing to work out complex derivations themselves.

Third, it's a review. Every equation is discussed, along with its practical on-the-job applications. 100 problems are shown with methods and answers provided.

THE ALGEBRA OF ELECTRONICS was written by Chester H. Page, Consultant to the Director of the National Bureau of Standards. Dr. Page discusses basic laws and fundamental principles, practical methods of solving simultaneous equations. He develops elementary Fourier waveform analysis, shows effects of frequency selectivity, modulation, and analyzes tubes, transistors and power supplies.

Try it FREE for 10 Days

Whether you're a repairman, technician, or engineer, you'll find THE ALGEBRA OF ELECTRONICS both profitable and interesting. Send coupon for a FREE 10-DAY EXAMINATION. No obligation — unless you want to keep the book. Mail coupon today to

Van Nostrand
Dept. 1811, Princeton, N. J.
Established 1848

127 TOPICS
340 Pages
252 Illustrations

- Nonlinear Resistance
- Network Topology
- Mesh Currents
- Kirchoff's Law
- Voltage Variables
- Triangularization
- Simultaneous Equations
- Kramer's Rule
- Thevenin's Theorem
- Wheatstone Bridge
- Conduacy
- Black-Box Variables
- Image Impedances
- Attenuators
- Capacitance
- Inductances
- Slip-oidal Voltage
- Energy Storage
- Series-Tuned Circuits
- Series Resonance
- Complex Phasors
- Mutual Inductance
- Transformers
- Critical Coupling
- F-M Discriminator
- Impedance Matching
- Hyperbolic Functions
- Diodes
- Amplifiers
- Transistors
- Thermal Noise
- Demodulation
- many more

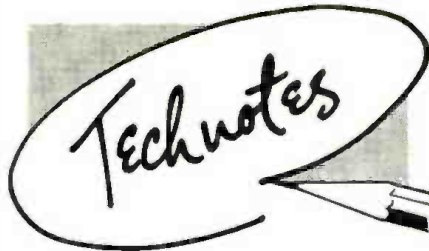

SLIPPING DIAL CORDS

You don't have to restring a dial cord to stop it from slipping. Try washing off the tuning-knob shaft with a non toxic service cleaner. This solvent will remove the grease or oil that is probably causing the slippage. Often, the repair can be made without taking the chassis out of its cabinet.—C. S. Lawrence

PHILCO F4622

At times this model shows a 15-ke heat pattern on the screen that is tough to eliminate. Usually, this is caused by an open ground connection between the yoke shield and the phono switch socket. Check and make a secure ground between these points to defeat the heat pattern.—A. Von Zook

INCREASING HEIGHT

If you run into poor height in an old TV receiver, don't give it up as an unbeatable problem. Correct height can be restored in many sets by substituting

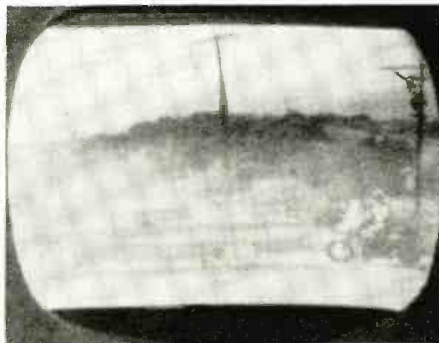

tubes. For example, if a 6K6 is used as the vertical output tube, replace it with a 6V6. If the circuit incorporates a single 6SN7, replace it with a 6BL7. For other possible changes, consult the schematic for the set you are working on.—Blackburn Hall

SEE ANYTHING GREEN?

When we went out on this call, we found a reddish raster which turned blue when the brightness was reduced. The green screen and background controls could be advanced to their maximum settings without a greenish tint appearing in the picture. However, with green screen and background at maximum, some green would appear when red and blue screen were turned down. The set owner felt the picture tube had probably gone bad. We gave him our Sunday pitying look. "Any time something goes wrong with a set," we advised him, "the owner suspects the picture tube. The reason is really quite simple—all you see is the picture tube and you feel it must be at fault."

NEW 2-WAY CITIZEN'S BAND RADIO-TELEPHONE KIT

Completely Tested and Approved

11-METER TRANSCEIVER

\$39.95
Complete Kit

CHECK THESE "EXCLUSIVE" FEATURES

- Complete as Shown with All Tubes and Parts
- Sockets and Small Parts Riveted to Chassis
- Transmitting Crystal
- Punched Chassis
- Hi-Gain Crystal Mike
- Modulation Indicator
- Coaxial Connector Mounted on Chassis
- 25-Ft. of RG58U Included for Your Antenna
- Tunable Receiver
- Full 5-Watt Input
- Operates 110V-AC
- Silver Slug Shielded Coils

Complete Diagram Furnished

GROUND PLANE ANTENNA KIT \$19.95

DON'T WAIT! ORDER YOURS NOW!

Phone TVler 8-9400

HERSHEL RADIO CO.

5249 GRAND RIVER Detroit 8, Michigan

TERMS: Cash with order or 25% down, balance C.O.D. ALL PRICES F.O.B. DETROIT

Grips the screw!

Drives it too!

Quick-Wedge SCREW-HOLDING SCREWDRIVER

2" to 14" blades, 4 bit sizes
Unconditionally Guaranteed

ASK FOR IT AT YOUR DEALER
Kedman Co., 233 So. 5th W., Salt Lake City

THE BATTERY THAT'S USED IN GUIDED MISSILES NOW RELEASED AS GOVERNMENT SURPLUS

For Photography, Aircraft, Models, Searchlights, Radios, etc.

\$1.95 Postpaid EA.

Singered-plate Nickel-Cadmium alkaline storage batteries designed for "SHAKE" missile and now surplus due to design changes. A lifetime battery with no known limit of service (over 5000 recharges on test without loss of capacity). Other features: Virtually indestructible, compact & lightweight, withstands heavy shock and vibration. Flat voltage curve during discharge retains charge year or more. High discharge rate up to 50 amps. for this cell, no corrosive fumes to harm clothing or equipment. spill-proof construction. discharge in any position. indefinite storage without deterioration. operates in temperatures -40° F to +200° F. Each cell is approx. 6 amperes hour capacity. Nominal voltage per cell is 1.2 volts. (A 6 V. battery requires 5 cells.) Cell size 4" H. x 2" W. x 1 1/2" T. Wt. 6 oz. ea. Uses Potassium-Hydroxide (KOH) electrolyte. Negligible loss during lifetime service. Add only distilled water once a year. A fraction of Government cost.

Used Test Cells \$1.95 ea. Postpaid
Brand New Cells 2.95 ea. Postpaid
24 V. Battery. (20 cells in metal case) used \$40. new \$60.

ALL CELLS GUARANTEED TO YOUR SATISFACTION OR MONEY REFUNDED (LESS POSTAGE). Plastic battery cases may have slight cracks. Repaired easily with household cement. Or you may add 25c to price of each to insure uncracked case.

ESSE RADIO COMPANY, Dept. N-6
42 W. South Street Indianapolis 25, Indiana

D. VAN NOSTRAND COMPANY, INC.,
Dept. 1811, PRINCETON, N. J.

(In Canada: 25 Hollinger Rd., Toronto 16)

Send for free examination—THE ALGEBRA OF ELECTRONICS. If I don't feel it can make electronic calculations clearer, easier, and faster, I may return it within 10 days; owe nothing. Otherwise, I will pay \$2.75 down, plus small delivery cost, and \$3 per month for 2 months.

Name (Please Print Plainly)

Address

City Zone State

SAVE! Enclose \$M. 75 WITH coupon and we will pay ALL shipping costs. Same ten-day money-back privilege.

With the set owner put neatly in his place, we started checking out the screen and background circuits. Everything was normal, except that the green screen voltages were not consistent with the other screen voltages.

Our faces began to turn slightly pinkish as we phoned the shop for a new 21-inch color picture tube. (We still clung to the hope that a new tube would not correct the difficulty. However, all tests we could logically apply pointed to picture-tube trouble.)

The new tube arrived and we installed it. A little fiddling with the setup controls and our faces changed from pink to red. The raster was now normal. Which all goes to prove, "The customer may be right."—Robert G. Middleton

G-E MODEL 9T001

The picture on this personal-portable was twisted. The receiver uses semiconductor diodes in the afc circuit. Checking resistors R251 and R252 and the diodes was less practical than

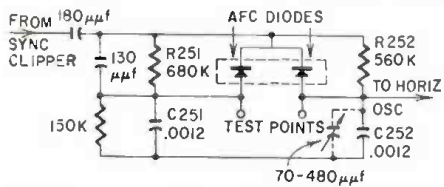

checking capacitors C251 and C252. We shunted a padder (70-480 μf) across C251 and C252, in turn. The picture untwisted when the padder was adjusted across C252. This avoided troublesome balancing of resistors or waiting for a pair of diodes. The padder was left in the circuit as a permanent cure.—Lawrence Shaw

KNOB BREAKAGE

A major cause of excessive knob breakage on TV set channel selectors is oil or grease. Oil or grease on a polystyrene knob weakens it, making it easy to damage. Even the vapors from lubricants can do this.

So be sure that polystyrene knobs do not touch oil or grease and that knob shafts are carefully cleaned before the knobs are installed. Of course, knobs not made from polystyrene plastic will not be affected.—Larry Steckler **END**

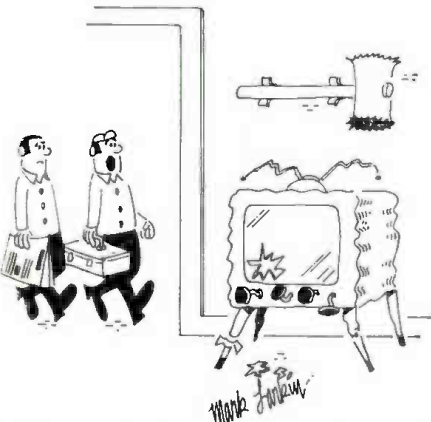

"Hope you took my advice and stopped kicking it."

Servicemen! SAVE TIME...SUBSTITUTE THE SENCORE WAY
The Fastest, Surest Method Known!

Substitute for Capacitors, Resistors
SENCORE H-36—THE "HANDY 36"
 36 most-often-needed resistors and capacitors, for fast, easy, direct substitution in all circuits. • Eliminates searching for replacement components for test purposes. • Avoids unnecessary unsoldering and soldering—no more solder mess. • Pays for itself the first month in time saved. • Flick of a switch instantly selects any one of...
 24 RESISTORS from 10 ohms to 5.6 megohms
 10 CAPACITORS from 100 mmfd to .5 mfd
 2 ELECTROLYTICS, 10 mfd and 40 mfd
DEALER NET..... 1275

Substitute for Electrolytic Capacitors
SENCORE ES102 ELECTRO-SUB
 Usable from 2 to 450 volts, D.C.
 Contains 10 electrolytics from 4 to 350 mfd. Select the correct value with the flick of a switch. Features automatic discharge, surge protector circuit. Prevents accidental "healing" of capacitor being bridged. Completely safe—no arc or spark when connecting or disconnecting. **DEALER NET..... 1595**

Substitute for Fuse Resistors During Repair
SENCORE FS3 "FUSE-SAFE" CIRCUIT TESTER
 Instantly tells you whether or not it is safe to replace fuse resistors, fuses, or circuit breakers. Separate red and green scale for each commercially available fuse resistor used in radio and TV. Eliminates guesswork and wasted time. Also handy for wattage checks up to 1100 watts. **DEALER NET..... 895**

Substitute for Bias Batteries During Repair
SENCORE BE3 "ALIGN-O-PAK"
 Completely isolated DC supply, with less than 0.1% ripple. Eliminates messy batteries in TV service work. Handy for alignment, AGC trouble-shooting, or checking gated sync circuits. Just dial the voltage you need. 0-18 volts, positive or negative. Covers all voltages recommended by TV set manufacturers. Size, 3 1/2 x 4 1/2 x 1 3/4". For 110-120 volts, 60 cycle AC. **785**
DEALER NET.....

UNIVERSAL TV JUMPER CORD
 Fits any set from back to chassis. Box has male and female plugs for additional power source, soldering, etc. **DEALER NET 195**

Turn page for other SENCORE Time Savers

See your Parts Distributor Now!

SENCORE
 ADDISON 2, ILLINOIS

OPPORTUNITY ADLETS (Continued from p. 149)

CASH PAID! Sell your surplus electronic tubes. Want unused, clean transmitting, special purpose, receiving, TV types, magnetrons, klystrons, broadcast, etc. Also want military & commercial lab test and communications gear. We swap too, for tubes or choice equipment. Send specific details in first letter. For a fair deal write, wire or telephone: **BARBY, 512 Broadway, New York 12, N.Y.** Walker 5-7000.

STEREO TAPE RENTALS. For the very best at lowest prices. Write **CALIFORNIA TAPED MUSIC ASSN., 763 El Camino Real, Redwood City, Calif.**

DISCOUNTS UP TO 50% on HI-FI amplifiers, tuners, speakers, tape recorders. Individual quotations only. no catalogs. **CLASSIFIED HI-FI EXCHANGE, 2375 East 65th Street, Brooklyn 34, N.Y.**

LABORATORY QUALITY equipment and Military Surplus Electronics bought, sold. **ENGINEERING ASSOCIATES, 431 Patterson Road, Dayton 9, Ohio.**

CAMERA Repairmen greatly needed! You can learn manufacturers' service methods at home, in your spare time! Free, big illustrated book tells how! Write today. **NATIONAL CAMERA REPAIR SCHOOL, Dept. RE-9, Englewood, Colorado.**

GROW MUSHROOMS. Cellar, shed and outdoors. Spare, full time. Year round. We pay \$4.50 lb. dried. We have 29,000 customers. **FREE book MUSHROOMS, Dept. 349, 2951 Admiral Way, Seattle, Wash.**

SONGPOEMS and LYRICS WANTED! Mail to: **TIN PAN ALLEY, INC. 1650 Broadway, New York 19, N.Y.**

LEARN WHILE ASLEEP. Hypnotize with your recorder, photograph or amazing new Electronic Educator endless tape recorder. Catalog, details free. **SELF-LEARNING ASSOCIATION, Box 24-RD, Olympia, Wash.**

SCOTCH recording tape at Profit-Sharing prices. Send for Catalog—you'll be glad you did! **TAPE'AD, Dept. K, PO Box 4355, Inglewood 3, Calif.**

RENT STEREO TAPES. Over 800 different, all major labels. Free catalog. Stereo-Parti, 1608-K Centinela Ave., Inglewood 3, Calif.

ELECTRONIC ORGAN parts. Special transformers, coils, diagrams. **R. PAVELKA CO., Box 5985, Cleveland 1, Ohio.**

INDUCTORS for Crossover networks. 1.8 types in stock. Send for brochure. **C & M COILS, 80-16 Holmes Ave., N.W., Huntsville, Ala.**

HI-FI DOCTOR—will solve your hi-fi problems on the spot. Acoustic, Audio, Radio Engineer, Stereo Designing. Professional visits, day evening, New York area. **WILLIAM BOHN, Plaza 7-8569, weekdays.**

BARGAIN parts kit M102—fabulous assortment, 20 lbs., 50 items, \$50 value for \$8, add postage. **MDC 944 W. Tioga Street, Philadelphia 40, Pa.**

**"TAB" Tubes Tested, Inspected, Boxed
Six Months Guarantee! No Rejects!**

NEW & Used Gov't & Mfgs. Surplus!

Orders \$10 or more. Receiving types only. 50¢ list states

0A2	.80	6BJ6	.60	12AT6	.99	18S1	1.00
0B2	.65	6BK7	.90	12AT7	.84	117Z6	1.10
0C3	.60	6BL7	1.25	12AU6	.69	4-65A	16.00
0D3	.55	6BN6	.80	12BY7	.99	2B21	2/81
0Z4	.59	6BQ6	1.19	12AX7	.79	3D23	3.85
1A7	.89	6BZ7	1.25	12BA6	.65	717A	5/81
1B3	.73	6C4	.45	12BA7	.99	4-45	30.00
1R3	.78	6C5	.60	12BE6	.59	4-250	35.00
1S4	.78	6CB6	.80	12BE6	.59	4E27	7.00
1T4	.78	6CD6	1.49	12BF6	.59	4PR60	29.50

Send for Catalog

1U4	3/81	6H6	3/81	12BH7	.99	4X150	5.00
1U5	.73	6J5	.52	12BY7	.98	4X250	35.00
1X2A	.68	6J6	.48	12CZ7	.99	4X500	79.00
3Q4	.68	6K6	.58	12CU6	1.45	5BP1	4.08
3Q5	.80	6K7	.74	12SA7	.94	5BP4	4.08
3S4	.68	6L4	1.19	12SC7	.89	35T	4.00
3Y4	.83	6S4	.50	12SH7	.80	100T	7.00
5R4	.98	6S8	.98	12SJ7	.75	316A	5/81
5U4	.98	6SA7	.60	12SK7	.94	388A	3/81
5V4	.80	6SB7	1.19	12SQ7	.84	16B	16.00

Wanted Surplus Electronics from schools & U

5Y3	.50	6SC7	.80	198G6	2.15	450T	12.00
6AB4	.50	6SG7	.70	1978	1.16	807	1.00
6AC7	.70	6SH7	.89	289G6	1.39	809	3.00
6AG7	.80	6SJ7	.69	25L6	.60	811	4.10
6AH6	.99	6SK7	.72	25W4	.77	812	3.00
6AK5	.69	6SL6	.69	25Z5	.63	813	9.00
6AL5	2/81	6SN7	2/81	25Z6	.75	814	3.45
6AQ5	.63	6SQ7	.74	EL34	3.49	815	2.75
6AS7	.10	6SR7	.89	EL37	2.49	826	3.50
6AT6	.40	6TB	.98	35L6	.60	829B	8.00

Wanted 50¢ tubes! Top \$\$\$ Paid

6AU4	1.10	6U8	.98	35W4	.40	832A	7.00
6AUS	1.10	6V6GT	.80	50A5	.69	8146	3.75
6AU6	.60	6W4	.79	35Z5	.63	16Z5	5/81
6AX4	.70	6W6	.80	50A5	.69	8146	4.00
6BA6	.60	6X4	2/81	50C5	.60	8175	9.00
6BA7	1.00	6X5	.49	50C5	.60	8881	2.70
6BD6	.60	6Y6	.97	50L6	.60	6550	3.00
6BE6	.50	6Y7	.89	KT56	3.29	826	3.50
6BG6	1.50	12AL5	.50	75	.80	5894	12.00
6BH6	.72	12AQ5	.75	80	.50	7193	10/81

TUBES WANTED! WE BUY! SELL & TRADE!



NEW SILICON 500MA RECTIFIERS
Input Working Range RMS/ACV Res. or Cap.

rms/piv	rms/piv	rms/piv	rms/piv
35/50	70/100	140/200	210/300
36c	54c	63c	81c
rms/piv	rms/piv	rms/piv	rms/piv
280/400	350/500	420/600	420/600
99	\$1.25	\$1.90	\$1.90
rms/piv	rms/piv	rms/piv	rms/piv
560/800	630/900	700/1000	770/1100
\$2.00	\$2.40	\$3.25	\$3.90

Example: 140V at 500Ma each 63c less 20% on \$10 order or \$10

Use in Bridge or C. T. up to 750Ma DC

Buy Qty's Deduct 20% on \$10 orders

Postpaid 48 states order \$10

TRANSISTORIZED DC POWER!
HI-EFFICIENCY DC TO DC to 450 VDC

"TABSTAT" - 100% BUILT IN
Output 150 & TAP 250VDC at up to 150 MA/Up to 70 Watts 80% efficiency; ripple 0.2%; low idle current one amp silicon rectifiers, all outputs, all conductors, toroid transf. fused & short circuit proof. Regulation 5% at 20 to 100% load! Small in size! Quiet! Light wgt! Lo-priced gtd "TABSTAT" TR1245CB built \$35. Pre-assembled U-build kit TR1245CK Only \$30. Six V Inpt. TR045CB \$28. Six V Inpt. TABSTAT. 250VDC @ 100MA/12V in TR1245CB \$27. Kit TR1245CK \$24. 6V Inpt TR0125CB \$27. Kit TR025CK \$24.



KITS "TAB" THE BEST KITS!

All Kits Contain Most Popular Values & Sizes

Kit 2 Eng. Parallel Rules	Kit 5 Sub-Min Tubes
Kit 35 Precision Resistors	Kit 40 Standoff Insulators
Kit 10 Switches	Kit 35 Power Resistors
Kit 75 Resistors 1/2, 1/4, 1/8 W	Kit 100 Ceramic Cond's
Kit 150 Carbon Resistors	Kit 5 Crystal Diodes
Kit 25 Panel Lamps	Kit 100 Fuses, Assorted
Kit 12 Electrolytic Cond's	Kit 100 Germanium Diodes
Kit 56 Tube Sockets	Kit 5 FT243 Xtal Holders
Kit 65 Tubular Cond's	Kit 500 Lugs & Eyelets
Kit 500 Lugs & Eyelets	Kit 100 Silicon Diodes
Kit 10 Bathub Oil Cond's	Kit 5 Microswitches
Kit 5 lbs. Surprise Pckg.	Kit 4 Ass'd Rectifiers
Kit 10 Xmtr Mica Cond's	Kit 2 PNP Transistors
Kit 3 Phone/Patch Xfms	Kit 4x50 Ft Hookup Wire
Kit 3 Searchlights	Kit 2 Feeder Counters
Kit Circular Slide Rule	Kit 2 Computer Thermoids
Kit 12 Algtr Clip Asst'd.	Kit High Gain XTAL Mike

BUY 10 KITS—GET ONE FREE! EACH KIT 99¢

NEW DC POWER for TRANSISTORS!!

New low-cost 25 volt one amp filtered 1% ripple power supply. Same as specified in Transistor Manuals G.E., RCA, CBS. Ideal for powering transistor circuits, rugged & small in size! Pre-assembled kit U-build B25VIAC \$10, or assembled B25VIAC \$12.



NEW Selenium Radio & TV Rectifiers! GTD.

65Ma 45c @ 6 for \$2; 100Ma 55c @ 12/\$5; 250Ma 65c @ 10/\$6; 300Ma 88c @ 10/\$8; 500Ma \$1 @ 10/\$8, 25/\$18
Orders of \$10 or more. Postpaid 48 states!

NEW "TEKSEL" SELENIUM RECTIFIERS

FULL WAVE BRIDGE RECTIFIERS. ONE YEAR GTD!
AMP. | 18VAC 136VAC | 72VAC | 144VAC
CONT. | 14VDC 28VDC | 56VDC | 118VDC

1AMP	5 1.30	5 2.00	5 4.90	5 9.45
2AMP	2.15	3.00	8.20	12.00
3AMP	2.90	4.00	8.60	16.75
6AMP	4.15	8.00	18.75	36.15
10AMP	6.10	12.15	45.90	66.60
15AMP	13.00	19.50	40.00	66.60
24AMP	15.00	29.45	57.50	108.45

FOR BEST BUYS! "TAB" for BARGAINS

BC696 3 to 4 Mc's Xmtr Good Condition \$5.95
AN-ARR2/Rcvr As Is Good for Parts...\$1.59
RDZ/USN 200-400 Mc's Rcvr less Tubes...\$25.00
RAZ/Rcvr covers 4 Bands 1.5 to 9 Mc's Super-Het 8 tubes has BFO Vornier Ltd Qty...\$24.00
BC653/100 to 200W Xmtr Phone or Cw 2 to 4.5 Mc's includes 12V Dynmtr 5 Channels...\$39.00
"Irish" Tape 1200' Hd City Gtd \$1.39 @ \$9 for \$9
"Irish" Tape Mylar 2400 ft Best Qlty \$4.49, 3/\$12
Snooper Scope Tube 2 \$5 @ \$10 for \$10
2N277 \$4.50; 2N278 \$5.50; 2N441 \$3; 2N442 \$5

"TAB" TERMS: Money Back Guarantee Our 14th Year. \$2 min. order P.O. B. N.Y.C. Add ship charges or for C.O.D. 25% Dep. Prices shown subject to change.
111-JW LIBERTY ST., N.Y. 6, N.Y.
Send 16c For Catalog PHONE: RECTOR 2-6245

NEW TUBES and SEMI-CONDUCTORS

THIS month we are swamped with some fascinating tubes—a duplex-diode hi-mu triode, a twin triode with four plates and a beam-deflection tube in a 9-pin miniature envelope.

7360
A beam-deflection tube of the 9-pin miniature type designed specifically for use in single- and double-sideband suppressed-carrier communications equipment. It operates at frequencies up to 100 mc. The 7360 makes possible simplified, low-cost circuits such as product detectors, balanced modulators capable of providing carrier suppression in the order of 60 db, and balanced mixers providing oscillator signal suppression of at least 40 db. The tube is also well suited for use in low-distortion

audio-fader circuits, remote switching of studio and hi-fi equipment and in other applications in which isolation of control voltage from signal voltage is an important design requirement.

Typical operating characteristics of

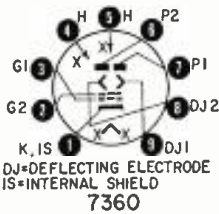

the ROA 7360 in balanced-modulator service are:

V _p (each plate)	150
V _{defl} elect	25
V _{G2}	175
R _k (ohms)	1,200
V _{defl} elect (peak-to-peak)	2.8
V _{G1} (peak-to-peak)	10
I _p (ma) (each plate)	1.5
I _{G2} (ma)	0.75
Z _{load} (plate-to-plate) (ohms)	5,000
V _{out} (push-pull, peak-to-peak double-sideband)	4
Carrier suppression (db)	-60
3rd-order distortion (db)	-47
4th-order distortion (db)	-45

12FQ8

A twin-triode in a 9-pin miniature envelope that has four plates—two for each triode section. The extra plate in each tube section offers an additional output from each stage which gives the

PROFESSIONAL technicians use Pure Rice's OFFICIAL ORDER BOOKS for every TV-RADIO service call

OFFICIAL ORDER BOOK

PURCHASING A HI-FI SYSTEM?

Send Us Your List Of Components For A Package Quotation

WE WON'T BE UNDERSOLD!

All merchandise is brand new, factory fresh & guaranteed.

AIREX RADIO CORPORATION
64-RE Cortlandt St., N.Y. 7, CO 7-2137

PARTIAL LIST OF BRANDS IN STOCK

- Altec Lansing
- Electrovoice
- Jensen
- Hartley
- University
- Acoustic Research
- Janzen
- Wheatfaldale
- Karlson
- V king
- Concertone
- Bell & G.E.
- Weathers
- Harman-Kardon
- Eico & Pilot
- Sherwood
- Acrossound
- Fisher
- Bogen & Leak
- Dynakit
- H. H. Scott
- Ferragraph
- Tanberg
- Pentron
- Revex DeWald
- Challenger
- Wollensak
- Garrard
- Miracord
- Glaser-Steers
- Rek-O-Kut
- Components
- Norelco
- Fairchild
- Pickering & Gray
- Audio Tape
- Conrac
- Wellcor Cabinets

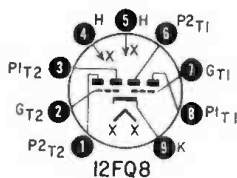

user two well-isolated outputs from each stage. The tube is already being used in an electronic organ. The 12FQ8, manufactured by General Electric, has a 12.6-volt 150-ma heater.

Average characteristics of the 12FQ8 under typical operating conditions are (each section):

V_p	250
V_G	-1.5
μ (grid to each plate)	95
R_p (approx ea plate) (ohms)	76,000
I_p (each plate) (ma)	1.5
g_m (grid to each plate) (μ mhos)	1,250

6FM8

A duplex-diode high-mu triode with separate cathodes for each section—three in all—intended for use as an FM

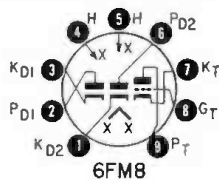

detector and af voltage amplifier. It is made by G-E.

Typical operating characteristics:

V_p	250
V_G	-3
μ	70
R_p (k ohms)	58
g_m (μ mhos)	1,200
I_p (ma)	1
I_{diode} (average) (ma) (5 volts dc applied)	20

Rectifier heat sink

Unit consists of an oxygen-free copper tab brazed to an alumina (aluminum oxide) insulator which is, in turn, brazed to an oxygen-free copper stud. The rectifier (top-hat type) goes atop the heat sink, soft-soldered to the tab. The high thermal conductivity of the alumina gives the heat sink improved

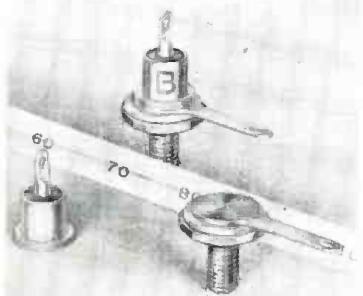

performance. The sink is said to run far beyond the maximum temperature requirements of 200°C to -60°C for silicon rectifier applications. It comes in various sizes and can handle up to 2,000 volts. The unit is made by

Check TUBES, VIBRATORS THE SENCORE WAY

**FAST
ACCURATE
TROUBLE
SHOOTING**

America's Most Popular Tube Tester
more than 25,000 now in use

SENCORE LC3 LEAKAGE CHECKER

Whips those "tough dog" tube troubles . . .

Ask any serviceman who owns one . . . or try one for just one day of servicing in your shop. You'll see for yourself how much time the LC3 can save you. Checks for leakage between all elements, whether caused by gas, grid emission or foreign particles. Also checks leakage on all capacitors with voltage applied—including electrolytics. Provides instant filament checks in "Fil-Check" position—no need for a second filament checker. One spare pre-heating socket and new roll chart prevent obsolescence. New charts provided—no charge. Leakage sensitivity; 100 megohms, control grid to all other elements; 50,000 ohms, heater to cathode. Size, 7x6x3 1/2". Wt., 3 lbs. For 110-120 volts, 60 cycle AC. DEALER NET **2895**



NOW . . . checks 172 tube types—more than any other checker of this type.

NEW . . . replaceable Roll Chart prevents obsolescence.

Check Filaments of All Receiving Tubes and Picture Tubes



FC4 FILAMENT CHECKER

For fast, easy checking of all tube filaments, without pulling chassis. Neon light goes out if tube filament is good. Also acts as continuity and voltage tester. Neon lamp glows when 115 v. AC is applied by cheater cord, providing a check on power to TV set. Size, 3 1/2 x 4 x 1". With leads. DEALER NET **295**

Check 3- and 4-Prong Vibrators . . . Faster, Easier



VB2 "VIBRA-DAPTOR"

Plugs into any tube checker; ideal for use with LC3 above. To check 6-v. vibrators, set for 6AX4 or 6SN7; for 12-v. vibrators, set for 12AX4 or 12SN7. Two No. 51 lamps indicate whether vibrator needs replacing. Instructions on front panel. Steel case. Size, 1 1/2 x 1 1/2 x 3". DEALER NET **275**

See your Parts Distributor NOW!

Turn page for other



Time Savers

SENCORE

ADDISON 2, ILLINOIS

Wanna' Sell? . . . Buy? . . . Trade?



For best results use

Radio-Electronics

Opportunity Adlets

Rates as low as \$5.

50¢ a word—10 word minimum

Radio-Electronics 154 West 14th Street • New York 11, N. Y.

MASTER RECEIVING-PICTURE TUBE SUBSTITUTION GUIDEBOOK by H. Middleton. The popular Receiving Tube Substitution Guidebook* and all four supplements has been reset, expanded and brought up to date in one master book. The original Tube Substitution Guidebooks were considered the most handy and important work books for technicians, engineers and hobbyists—the new Master book is even more valuable. In one Master Book that is easy-to-use the entire range of all radio and television receiving and picture tubes and their substitutions are at your fingertips.

- 5100 Radio and Television Receiving Tube and 825 Picture Tube substitutions are listed in numerical sequence with accompanying wiring instructions showing the original and substitute tube socket illustrations.
- features European-American and American-European cross index listing 325 American to European substitutions; 320 European to American tube substitutions.
- special section on ruggedized tubes.

This book is an indispensable tool to any person who designs, assembles or repairs radio, TV or electronic equipment. This book pays for itself almost immediately. A major portion of the first printing has been sold out, you must act now to reserve your copy. Satisfaction guaranteed. #244 — 8½" x 11", only \$7.35.

*For a short time, the original RECEIVING TUBE SUBSTITUTION GUIDE, its three SUPPLEMENTS plus a fourth SUPPLEMENT (ready soon) will be available.

R-L-C COMPONENTS HANDBOOK by David Mark.

An extremely comprehensive coverage of the fundamental components used in radio and electronic equipment is provided for the beginner as well as the technician. The text leaves nothing to the imagination. It starts and finishes with the practical approach to the functioning and utility of electronic components without which no electronic device could function. Most component failures can be avoided by properly utilizing basic principles. Resistors, capacitors, inductors, and transformers—are covered. Voltage, temperature, resistance, current, and numerous other electrical characteristics and ratings are explained as well as coding techniques and physical details. #227, \$3.50.

NOW THAT THE MOON HAS BEEN REACHED THESE BOOKS ARE MUST READING!



#225, \$2.95



#229, 2 vols., soft covers, \$7.80 per set; #229H, 2 vols. in one cloth binding, \$9.00

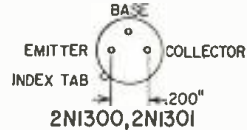

extremely small base width, high power dissipation, high current gain, high breakdown and punch-through voltage ratings and fast switching speeds.

Absolute maximum ratings of these RCA transistors in switching service:

	2N1300	2N1301
V _{CB}	12	13
V _{CE}	12	12
V _{EB}	1	4
I _C (ma)	100	100
I _E (ma)	100	100

RIDER ANNOUNCES NEW RECEIVING-PICTURE TUBE SUBSTITUTION GUIDEBOOK

... the answer to all tube substitution problems

BASIC AUDIO by Norman H. Crowhurst. The Rider "picture-book" approach has made many technical subjects understandable to many hundreds of thousands of people. Now, everything about sound and audio reproduction is made crystal-clear. If hi-fi is your interest—or if you work with tape recorders—or the broad subject of sound reproduction interests you—or if you assemble your hi-fi equipment or buy a complete "package"—you must read this 3-volume course, BASIC AUDIO.

If you already own sound reproducing equipment—this "picture-book" course will give you an all-around background on all the important details of sound reproduction. It will enable you to get most from your equipment.

You can learn easily, rapidly at very low cost. You build your knowledge step-by-step. There's one idea and one specially prepared illustration per page. More than 400 illustrations for maximum understanding.

Beyond a knowledge of electricity at the basic level, no previous electronic experience is needed to get the maximum from this course. Whatever electronics circuit theory is required is provided.

This Rider "picture-book" audio course is completely different from anything that has even been presented. We guarantee your satisfaction.

#201, 3 vols., soft covers, \$8.70 per set.

#201-H, all 3 vols. in one cloth binding, \$9.95.

SHORTWAVE PROPAGATION by Stanley Leinwald (Radio Frequency and Propagation Mgr.—Radio Free Europe). Of special interest to those concerned with radio communications, this text provides a modern, up-to-the-minute analysis of shortwave propagation. Ionosphere characteristics are discussed together with the nature of radio waves. The book then carries the reader into the sky wave, measuring the ionosphere, ionospheric variations, the sunspot cycle, and abnormal phenomenon. #231, \$3.90.

learn code faster, easier than ever before—

RIDER SOUND-N-SIGHT CODE COURSE

by Lewis Robins & Reed Harris

- applies REINFORCED LEARNING—a psychological principle proved successful by the Armed Forces.
- uses LP records to teach you to hear signal pattern correctly and identify it—how to transmit.
- uses identification cards to teach you the correct letter associated with each signal pattern.
- uses instruction book to speed your progress. ... plus an imaginary instructor (in complete and novice courses) provides correct answers to speed code learning. Many people have learned to receive 5 words per minute within 9½ hours. Eliminates code plateau barrier!

Scores Nation-wide Successes — Frank Alessi, Jr., 9-year-old achieves general class license using Sound-N-Sight Code Course.

From the Monmouth Message, April 30, 1959. "Fort Monmouth — Student officers of the Radio Officer MOC Course, Section 3210, have made exceptional progress ... mastering Morse Code instructions utilizing the Rider 'Sound-N-Sight' method ... students have progressed much faster than all previous classes." * Prices subject to change without notice or order direct.

There are now 33 titles (more to come) in the famous Electronic Technology Series. Edited by Alexander Schure, Ph.D. Have you read these latest releases?

MAGNETISM AND ELECTROMAGNETISM Thorough study of magnetism at the elementary level. Magnetic theory and principles covered at great length. #166-20, \$2.10.

R-F AMPLIFIERS Excellent discussion of the operation of amplifiers in the r-f portion of the radio frequency spectrum. Design and theory of a wide range of r-f voltage and power amplifiers are covered. #166-27, \$2.40

LOW-FREQUENCY AMPLIFIERS Principles and circuitry involved in the amplification of low frequency signals is presented in a thorough easy to understand manner. #166-30, \$1.80

LOW-FREQUENCY AMPLIFIER SYSTEMS This companion volume to LOW-FREQUENCY AMPLIFIERS extends the study into the field of low-frequency amplifier systems including the d-c amplifier. #166-31, \$1.80

4 FABULOUS 'PICTURE BOOK' COURSES You can learn any electronic subject easily, rapidly at low cost with these 'picture-book' courses.

BASIC ELECTRICITY by Van Valkenburgh, Nooger & Neville, Inc., #169, soft cover, 5 vols., \$10.00; #169H, all 5 vols. in single cloth binding, \$11.50.

BASIC ELECTRONICS by Van Valkenburgh, Nooger & Neville, Inc., #170, soft cover, 5 vols., \$10.00; #170H, all 5 vols. in single cloth binding, \$11.50.

BASIC TELEVISION by Alexander Schure, Ph.D., #198, 5 vols., soft cover, \$10.00; #198H, all 5 vols. in single cloth binding, \$11.50.

BASICS OF DIGITAL COMPUTERS by John S. Murphy, #196, 3 vols., soft cover, \$7.50; #196H, all 3 vols. in single cloth binding, \$8.50.

Records prepared in collaboration with the N Y Institute of Technology and mfd. by Decca Records.

Other Rider books that add to amateur radio enjoyment are: Getting Started In Amateur Radio; Building The Amateur Radio Station; Radio Operator's License Q & A Manual (6th edition) How To Read Schematics.

3 INDIVIDUAL COURSES—THERE'S ONE FOR YOU
COMPLETE COURSE (0-20 words per minute)—Six 10" LP records (192 minutes of recording, 46 recordings), 47 cards, book. #REC-020, \$15.95.
NOVICE COURSE (0-8 words per minute)—Three 10" LP records (96 minutes of recording, 28 recordings), 47 cards, book. #REC-08, \$9.50.

ADVANCED COURSE (9-20 words per minute)—Three 10" LP records (96 minutes of recording, 28 recordings), book. #REC-920, \$8.95.

Records prepared in collaboration with the N Y Institute of Technology and mfd. by Decca Records.

Other Rider books that add to amateur radio enjoyment are: Getting Started In Amateur Radio; Building The Amateur Radio Station; Radio Operator's License Q & A Manual (6th edition) How To Read Schematics.

At your jobber or book store, or order direct.

Prices subject to change without notice or order direct.

At your jobber or book store, or order direct.

NEW TUBES & SEMICONDUCTORS (Cont'd)

Advanced Vacuum Products, Inc., Stamford, Conn., a subsidiary of General Ceramics Corp.

2N1300, 2N1301

Germanium p-n-p diffused-junction mesa transistors specifically designed for high-speed switching applications in commercial and military data-processing equipment. Features are

Semiconductor briefs

CBS Electronics has announced a line of complementary n-p-n p-n-p power transistors. These complementary pairs, in the diamond package, eliminate input and output transformers in push-pull circuits to save money and space while providing improved frequency response. Five pairs are planned.

Silicon Transistor Corp. has introduced two high-power low-saturation resistance silicon transistors, 2N1069 and 2N1070. Typical applications are

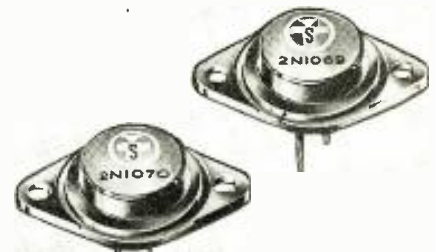

in relay replacements and controls, solenoid actuators, power converters, power switches, and class-A and -B power amplifiers. END

CORRECTIONS

There is an error in the noise rectifier circuit in Fig. 4 of the article "Citizens Band Radios" on page 45 of the September issue. The polarity of the right-hand diode should be reversed so its anode end connects to the junction of the 0.1-μf capacitor and the lead to pin 1 of the connecting plug.

In the middle column of the last page of "Transistor Transceiver for Citizens Radio" in the October issue, the variable tuning capacitors were erroneously listed as C1, 2 and 3. This text reference should be to C2, 7 and 12 as indicated in the photographs, schematic and parts list.

We thank Mr. Leonard E. Klaus, of Baltimore, Md., for spotting and reporting this discrepancy. (See also Correspondence Column page 18.)

JOHN F. RIDER PUBLISHER, INC. 116 West 14th Street, New York 11, N. Y.
 Canada: Chas. W. Pointon, Ltd., 66 Racine Rd., Rexdale, Ont.
 Europe & British Isles: Chapman & Hall Ltd., 37 Essex St., London India: Asia Publishing House, Bombay and other cities

BUSINESS and PEOPLE

Fred M. Farwell assumed the new corporate staff position of vice president, marketing, of Radio Corporation of America. He will participate in formulating the company's overall marketing policies and objectives and work with the divisional marketing organization on plans, programs and personnel. He had been executive vice president of ITT in charge of its US Group operations.



Frederick R. Lack was elected a director of Sprague Electric Co., North Adams, Mass. He retired some time ago as director and vice president of Western Electric Co., after 48 years of service with Bell.



Leslie H. Warner (top left), was elected a director of Sylvania Electric Products, and Robert E. Kenoyer was named controller. Warner is executive vice president, manufacturing, of General Telephone & Electronics, the parent company. Kenoyer was controller of



Sylvania Home Electronics. David G. Christie was promoted to director of industrial relations, from manager of wage and salary administration. Richard M. Ross (top right), is now manager of marketing services for the Semiconductor Products Div. He had been product sales manager, semiconductors. John H. Skehan, Jr. (right), was promoted from supervisor of receiving-tube merchandising to manager of sales training for Sylvania Electronic Tubes.

Dr. Walter R. G. Baker, president of Syracuse University Research Corp., and a retired vice president of General Electric, received the David Sarnoff Gold Medal Award of the Society of Motion Picture & Television Engineers for his work in TV engineering.

Pinpoint in Seconds...

HORIZONTAL & VERTICAL SWEEP TROUBLES

NEW
SENCORE
Time Saver

MODEL SS105

PROVIDES:

- UNIVERSAL HORIZONTAL OSCILLATOR
- UNIVERSAL VERTICAL OSCILLATOR
- UNIVERSAL VERTICAL DEFLECTION YOKE
- UNIVERSAL VERTICAL OSCILLATOR
- UNIVERSAL VERTICAL DEFLECTION YOKE
- UNIVERSAL VERTICAL OSCILLATOR
- UNIVERSAL VERTICAL DEFLECTION YOKE

The missing link in TV service...

SENCORE SS105 SWEEP CIRCUIT TROUBLE SHOOTER

IT'S A ... UNIVERSAL HORIZONTAL OSCILLATOR. For direct substitution. No wires to disconnect in most cases. Traces trouble right down to the defective component. Variable output from 0-200 volts, peak-to-peak.

HORIZONTAL OUTPUT CATHODE CURRENT CHECKER. A proven method that quickly checks the condition of the horizontal output tube and associated components. Adaptor socket prevents breaking wires. Easily replaceable Roll Chart gives all necessary pin, current and voltage data.

UNIVERSAL DEFLECTION YOKE. A new, simple way to determine yoke failure accurately—without removing yoke from picture tube. Merely disconnect one yoke lead and substitute. If high voltage (also bright vertical line) is restored, TV yoke is defective.

DYNAMIC FLYBACK TRANSFORMER CHECKER. Merely flip switch to "Flyback Check" and meter will indicate condition of flyback transformer, in degrees of horizontal deflection. Extremely sensitive and accurate; even shows up one shorted turn on flyback.

VOLTMETER. For testing bootstrap, screen and other voltages. Direct-reading voltmeter, 0-1000 volts.

UNIVERSAL VERTICAL OSCILLATOR. Checks oscillator, output transformer and yoke. Merely touch lead to component and check picture on screen.

Size, 7x6x3 1/2". Wt. 4 lbs.
For 110-120 volts, 60 cycle AC.

DEALER NET 39⁵⁰



HORIZ. OSC.	VERT. OSC.
HORIZ. O.P. STAGE	VERT. O.P. STAGE
HORIZ. FLYBACK XFORMER	VERT. O.P. XFORMER
HORIZ. DEFLEC. YOKE	VERT. DEFLEC. YOKE

See Your Parts Distributor NOW!

SENCORE

ADDISON 2, ILLINOIS

INSIST ON PROVED BRAND NAMES
insist on the GENUINE

"NO NOISE"
big 3

Beware Of Cheap Substitutes!

NO-NOISE VOLUME CONTROL and CONTACT RESTORER

• Cleans • Protects • Lubricates
NOT A CARBON TET SOLUTION

2 Oz. Bottle \$1.00 6 Oz. Spray Can \$2.25

NET to Servicemen



NO-NOISE TUNER-TONIC

With PERMA-FILM

• Economical—a little does a lot.
• Cleans, lubricates, restores all tuners. Including water type.
• Non-toxic, non-inflammable
• Use for TV, radio and FM



6 oz. Aerosol Can \$3.25

NET to Servicemen

NOW AVAILABLE
FREE
AT YOUR JOBBERS
5" PLASTIC EXTENDER
With Push Button Assembly... For PIN-POINT APPLICATIONS
Does Not Cause Shorts!

NO-NOISE RUBBER COAT SPRAY

6 Oz. Spray Can \$3.25

• Insulates • Waterproofs • Protects
NET to Servicemen

ELECTRONIC CHEMICAL CORP. 813 Communipaw Avenue Jersey City 4, N. J.

Kenneth A. Waldron joined CBS Electronics, Danvers, Mass., as manager of Government sales. He comes from General Electric, where he was manager of marketing projects.



Richard E. Krafve, top left, was elected executive vice president of Ray-



theon Co., Waltham, Mass. He had been group vice president, commercial. Homer R. Oldfield (top right), vice president and manager of the Government



Equipment Div., was elected group vice president, electronic components and devices. Stuart D. Cowan (right) joined Raytheon as director of commercial marketing services, from vice president and executive committee member of Dona-

hue & Coe, Inc., New York advertising agency.

Alfred Crossley, founder of Crossley Associates, past president of Electro Products Laboratories, after a brief illness.

EIA PRODUCTION AND SALES REPORTS
(first 7 months) 1959 1958

TV set production	3,133,075	2,442,929
Radio production	7,936,621	5,212,135
FM radio production	247,976	113,318
TV retail sales	2,634,532	2,456,662
Radio retail sales	3,685,708*	3,177,679*

*Excluding auto receivers

Winegard Co., Burlington, Iowa, is promoting its colorceptor and Gold Color'Ceptor TV antennas with an all-out advertising and promotion campaign including point-of-purchase displays, direct mail, cooperative local newspaper, radio or TV advertising plus a national consumer advertising campaign featuring radio and TV stars. Highlight of the promotion is the Promotion Bucks

which dealers receive with the purchase of Gold Color-Ceptor TV antenna, to be used to buy the various sales aids.

William H. Thomas, president of James B. Lansing Sound, was elected president of the Electronic Industry Show Corp., succeeding William S. Par-



sons, president of Centralab. Other officers are George E. Wedemeyer, Wedemeyer Electronic Supply Co., vice president; Mrs. Helen S. Quam, Quam-Nichols, secretary, and Edward Rothenstein, Arco Electronics, treasurer.

H. H. Scott, Maynard, Mass., conducted a tour of its plant under the personal supervision of president Hermon H. Scott (second left, front) and Marvin Grossman, New England rep (third left, front), for key sales personnel of Radio Shack, Boston, area distributor. END

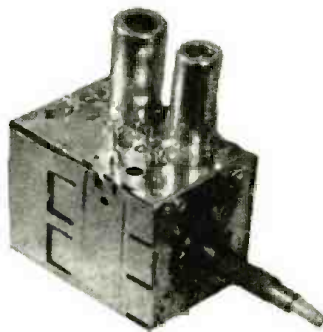
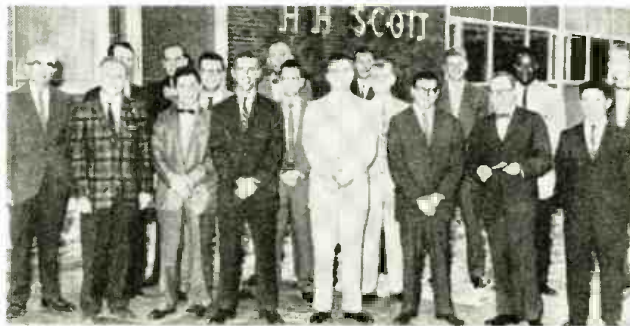

TV TUNERS OVERHAULED

VHF
OR
UHF

ALL MAKES & MODELS

90
Days
Warranty

FAST SERVICE PRESENT DELIVERY IS 48 HRS. ON MANY TYPES

VHF or UHF TUNER	OVERHAULED	\$ 9.95	Net
UHF/VHF COMBINATION	OVERHAULED	\$19.90	Net

Prices include labor and minor parts only, defective tubes and damaged major parts are extra at net prices.

Forward defective tuner complete with tubes, shield cover and any damaged parts. Quote make and model. We will ship C.O.D.—F.O.B. Chicago or Toronto

Castle Television Tuner Service 5710 N. Western Ave. Chicago 45, Illinois

Suppliers of rebuilt Television Tuners to leading manufacturers, technicians & service dealers, coast to coast. Original and Only Complete TV Tuner Service covering the North American Continent.

In Canada: 152 MAIN ST. TORONTO 13, ONT.

new LITERATURE

Any or all of these catalogs, bulletins, or periodicals are available to you on request direct to the manufacturers, whose addresses are listed at the end of each item. Use your letter-head—do not use postcards. To facilitate identification, mention the issue and page of RADIO-ELECTRONICS on which the item appears. UNLESS OTHERWISE STATED, ALL ITEMS ARE GRATIS. ALL LITERATURE OFFERS ARE VOID AFTER SIX MONTHS.

ALLIED CATALOG 190 is a 444-page book listing many thousands of items; 64 pages are devoted to Knight-kits, audio and instrument. High-fidelity components, stereo discs and tapes, tape recorders, PA components and systems, TV parts, antennas and accessories, and ham radio equipment each fill many pages. Tubes, semiconductors and components are also described, along with 13 pages of technical books. Prices for all are included.—Allied Radio Corp., 100 N. Western Ave., Chicago 80, Ill.

ORGAN KITS for home constructors, including all accessories and parts as well as electronics, are described in an 8-page brochure. Kits require about 40 hours.—National Sonics Corp., 680 E. Taylor Ave., Sunnyvale, Calif.

ZENER DIODES AND RECTIFIERS and the company's solid-electrolyte tantalum capacitors are listed in a 6-page fold-out catalog. Characteristics are shown in detail.—U. S. Semiconductor Products, Inc., 3540 W. Osborn Road, Phoenix, Ariz.

METAL CHASSIS BOXES and cabinets are shown in 12-page *Catalog 62059* along with dimensions and prices. Units are aircraft-type aluminum. LMB, 2528 W. 9th St., Los Angeles 6, Calif.

MAGNETRONS tunable by varying voltage are described with several pages of theory and design of these microwave units. The 24-page book, *Voltage Turntable Magnetrons*, includes a bibliography on magnetrons and associated waveguide.—G-E Power Tube Dept., Schenectady 5, N. Y.

VARIAC variable autotransformers are listed with ratings and dimensions in 4-page bulletin. Motor-driven models and metered units are included.—General Radio Co., West Concord, Mass.

SPECTRUM ANALYZERS, sweep generators and frequency calibrators for plant, laboratory and industrial use are pictured and described in a 12-page



MODEL 311 VTVM

Simpson



Compare these features before you buy!

- 22 MEGOHM Input Impedance
- Peak-to-Peak Readings of Complex AC Voltages
- Accessory RF Probe with High Frequency Response and Accuracy
- New "TIMESAVER" Probe Tip
- Unbreakable Metal Case
- AC Balance Adjustment

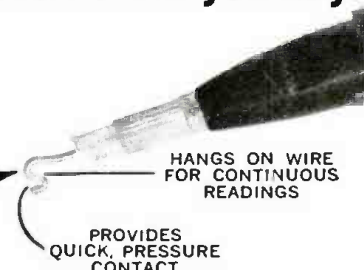

This new Simpson VTVM has all the capabilities you need to run highly accurate tests on practically any job. Note its timesaving features, too—slimline probe; special two-way probe tip; and Adjust-A-Vue Handle. You might expect Model 311 to cost a good deal more than it does, but the price complete with probe, lead, ground cable, clips, and Operator's Manual is a sensible

\$64⁹⁵

DC VOLTS: 0-1.5, 5, 15, 50, 150, 500, 1500 (±3% accuracy)

AC VOLTS: 0-1.5, 5, 15, 50, 150, 500, 1500 (±5% accuracy)

AC PEAK-TO-PEAK: 0-4, 14, 40, 140, 400, 1400, 4000 volts (±5% accuracy)

OHMS: X1; X10; X100; X1000; X10,000; X100,000; X1 megohm (meter can be set for center zero for FM alignment)

AC FREQUENCY RANGE: 30 to 100,000 cycles per second

INPUT IMPEDANCE: 22 Megohms

SIZE: 7½" x 5⅝" x 4½" deep

WEIGHT: 4½ lbs.

RF PROBE: 50 cycles to 100 megacycles, ±5%; 0-150 volts maximum, RMS. Input capacitance, 10 mmf**\$10.95**

HIGH VOLTAGE PROBE: Gives measurements from 0-30,000 volts, DC**\$10.95**

SEE YOUR ELECTRONIC PARTS DISTRIBUTOR, OR WRITE

SIMPSON ELECTRIC COMPANY

World's Largest Manufacturer of Electronic Test Equipment



5219 West Kinzie Street
Chicago 44, Illinois
Phone: EStebrook 9-1121

In Canada:
Bach-Simpson Ltd.
London, Ontario



PACO is the kit division of **PRECISION** Apparatus Co., Inc., world famous manufacturers of laboratory electronic instruments for over a quarter century.

The new PACO Model SA-40 offers you greater reserve power capacity than any other preamp-amplifier in its category. Its exceptional circuit design assures highly stable performance with extremely low distortion. And...the SA-40 provides maximum flexibility in any stereophonic high fidelity system present or contemplated.

outstanding specifications:

POWER OUTPUT: 20 watts per channel, 40 watts total

RESPONSE: 30 cps to 90 Kc \pm 1 db

DISTORTION:

Harmonic — less than .2% at 20 watts per channel
less than .1% at 10 watts per channel

Intermodulation — less than 1% at full rated output

FRONT PANEL CONTROLS: 14 controls including separate bass and treble controls

POWER SUPPLY: Silicon diode, low impedance for minimum distortion

EXTERNAL DESIGN: gold and satin black hooded case with panel illumination and satin gold panel

At leading parts distributors and sound dealers.

For complete information, write to:



PACO ELECTRONICS COMPANY, INC.
70-31 84th Street, Glendale 27, New York

Export: Morhan Exporting Corp., 458 B'way, N. Y. 13

Can.: Atlas Radio Corp., Ltd., 50 Wingold Ave., Toronto 19

a 40-watt stereo
preamp-amplifier
in kit form
for only

\$79.95 by



The last
preamp-
amplifier
you'll ever
have
to buy!

also available
factory wired
(SA-40W) ... \$129.95

&

COMING SOON!



Model ST-45
AM/FM Stereo Tuner Kit
matching companion
for the SA-40

NEW LITERATURE (Continued)

booklet.—Panoramic Radio Products, Inc., 520 S. Fulton Ave., Mt. Vernon, N. Y.

CERAMIC CARTRIDGES, loudspeakers and microphones are shown with specifications in 4-page *Hi-Fi Products* brochure.—Sonotone Corp., Elmsford, N. Y.

COMMUNITY-TV amplifiers, translator converters and distribution amplifiers plus cable tapoffs and other master-TV system accessories are pictured and described in a 4-page leaflet, *Masterline Series*. — Blonder-Tongue Laboratories, Inc., 9 Alling St., Newark 2, N. J.

KNIVES, PLIERS, FILES and other precision hand tools are pictured in a 12-page booklet. The company's numerous interchangeable-blade knives are shown in great detail. Handicraft Tools, Inc., Div. of X-Acto, Inc., 48-41 Van Dam St., Long Island City 1, N. Y.

TANTALUM FOIL capacitors are described in *Catalog 152*, while wire types are taken up in *Catalog 148* and slug types in *159*. The company also has a leaflet, "Which Tantalum Capacitor Should You Use?" (*Ohmite News*, April-May, 1959) which answers that question.—Ohmite Manufacturing Co., 3601 Howard St., Skokie, Ill.

WIRE TABLE AND DECIMAL equivalents *Sheet ZK-5* lists copper wire sizes and decimal and millimeter equivalents. It allows quick location of wire diameter, area, weight, length (feet per pound) and resistance at 68°F.—Alpha Wire Corp., 200 Varick St., New York 14, N. Y.

EIA STANDARDS, specifications and engineering publications are listed along with each publication date and price. Over 350 titles are shown, starting with basing diagrams, going through numerous broadcast standards and manufacturing specs.—Electronic Industries Association, Room 650, 11 W. 42nd St., New York 36, N. Y.

PA SPEAKERS and accessories including transformers, drivers, and mounting-stand accessories for microphones are shown in a 16-page *Catalog No. 559*. Outdoor high-fidelity projectors are included.—Atlas Sound Corp., 1449 39th St., Brooklyn 18, N. Y. END

6298 Vidicons

Grade-B...\$50

Ask for List of Amateur & Closed-Circuit TV Equipment

Al Denson, W1BYX
Rockville, Conn.

FREE! CATALOG OF
HI-FI, RADIO, TV
PARTS & ACCESSORIES —
yours for the asking!

Vidaire ELECTRONICS MFG. CORP.
44 CHURCH ST. • BALDWIN, N. Y.

ELECTRONICS

ENGINEERING-TECHNICIANS

Bachelor of Science Degree, 30 Months
Save Two Years' Time

- Radio-TV Technician including Color TV (12 Months)
- Electronics Technician (12 Months)
- Industrial Electronics Technician (12 Months)
- Electronics Engineering (B.S. Degree)
- Electrical Engineering (B.S. Degree)
- Mechanical Engineering (B.S. Degree)
- Civil Engineering (B.S. Degree)
- Architecture (B.S. Degree)

Heald College ranks **FIRST** West of the Mississippi in "Who's Who in America"

Approved for Veterans
DAY AND EVENING CLASSES

Write for Catalog and Registration Application.
New Term Starting Soon.

Your Name _____
Address _____
City _____
State _____



AT HEALD'S YOU LEARN
BY ACTUAL PRACTICE IN
MODERN LABORATORIES
... AND GET TOP PAY
JOBS.

HEALD'S
ENGINEERING COLLEGE

Established 1863

Van Ness at Post, RE
San Francisco, Calif.



FREE

LAFAYETTE'S 1960 CATALOG 308 GIANT SIZED PAGES

Our 39th Year

**The Complete Catalog Featuring
"The Best Buys In The Business"**

- FOR THE NEWEST AND FINEST IN
STEREOPHONIC HI-FI EQUIPMENT AND SYSTEMS
- TAPE RECORDERS ● PUBLIC ADDRESS SYSTEMS
 - AMATEUR EQUIPMENT ● INDUSTRIAL SUPPLIES
 - MINIATURE COMPONENTS ● RADIO & TV TUBES AND PARTS
 - EXCLUSIVE LAFAYETTE TRANSISTOR & HI-FI KITS

Send for Lafayette's FREE Catalog—the most complete, up-to-the-minute electronic supply catalog crammed full of everything in electronics at our customary down-to-earth money-saving prices.

CONTAINS HUNDREDS OF EXCLUSIVE LAFAYETTE ITEMS NOT AVAILABLE IN ANY OTHER CATALOG OR FROM ANY OTHER SOURCE — SEND FOR YOUR COPY NOW!

A "must" for the economy-minded hi-fi enthusiast, experimenter, hobbyist, engineer, technician, student, serviceman and dealer.



Leaders in Hi-Fi

The most complete selection and largest stocks of hi-fi components and systems—available for immediate delivery at the lowest possible prices. Save even more on Lafayette endorsed "best-buy" complete systems.

EASY PAY TERMS Available on orders over \$20
Only 10% down—Up to 18 months to pay



**TM-66 STEREO
AUDIO ANALYST
11.95**



**KT-135
4-BAND
RECEIVER
KIT
(Less
Cabinet)
18.50**



**PK-330
4 SPEED CHANGER
WITH BRAND NEW
GE VR-22 (.7 MIL) DIAMOND
STEREO CARTRIDGE
39.95**



**PA-56 TRANSISTORIZED
POWER MEGAPHONE
29.50**



**PK-331 33 1/3 RPM
HYSTERESIS TURNTABLE
47.50**

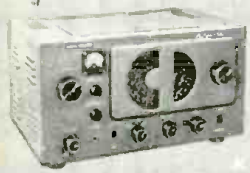

**PROFESSIONAL
COMMUNICATIONS
RECEIVER
KT-200 KIT 64.50
HE-10 WIRED 79.95**



**RW-60
20,000
OHM
PER VOLT
MULTITESTER
13.50**

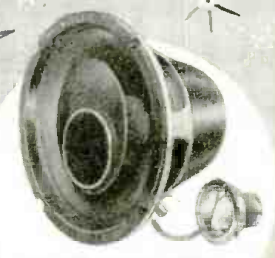

**SK-128 ULTRA-LINEAR
8" DUAXIAL SPEAKER
19.50**

Lafayette Radio

"Everything in Electronics"

FREE

308 GIANT SIZED PAGES



**CUT
OUT
AND
PASTE
ON
POST
CARD**

LAFAYETTE RADIO, Dept. JK-9

P.O. Box 222, Jamaica 31, N. Y.

SEND FOR THE WORLD'S LEADING ELECTRONICS, RADIO, T.V., INDUSTRIAL, AND HI-FI GUIDE

Send FREE LAFAYETTE Catalog 600

Name

Address

City..... Zone..... State.....

Lafayette Superior Quality Hi-Fi Kits

50 WATT INTEGRATED STEREO AMPLIFIER



KT-250
IN KIT FORM
64.50

LA-250
COMPLETELY WIRED
89.50

- 50 WATTS MONAURALLY—25 WATTS EACH STEREO CHANNEL
- RESPONSE 17-21,000 CPS \pm 1 DB (at normal listening level)
- UNIQUE "BLEND" CONTROL
- PREMIUM EL86 OUTPUT TUBES
- SEPARATE BASS AND TREBLE CONTROLS
- CLUTCH-OPERATED VOLUME CONTROL
- 3RD CHANNEL OUTPUT

A completely new stereo high fidelity amplifier with a high quality of reproduction, versatility of operation, and distinctive styling. A full range of controls enable you to enjoy the utmost in listening pleasure in any situation. Deluxe features include: unique "Blend" control for continuously variable channel separation—from full monaural to full stereo, 4 position Selector, Mode, Loudness and Phase switches. Also provided are outputs for 4, 8 and 16 ohm speakers. Hum-free operation is insured by the use of DC on all pre-amp and tone control tubes. Harmonic distortion, less than 0.25%, IM distortion, less than 1%. Hum and noise, 74 db below full output. Designed with the kit builder in mind, assembly is simple—no special skills or tools required. Complete with deluxe cabinet and legs, all parts, tubes and detailed instruction manual. Shpg. wt., 26 lbs.

KT-250 Stereo Amplifier Kit.....6.45 Down.....Net 64.50
LA-250 Stereo Amplifier, wired.....8.95 Down.....Net 89.50

LAFAYETTE PROFESSIONAL STEREO MASTER AUDIO CONTROL CENTER

Solves Every Stereo/Monaural Control Problem!



KT-600
IN KIT FORM
79.50

LA-600
COMPLETELY WIRED
134.50

- UNIQUE STEREO & MONAURAL CONTROL FEATURES
- AMAZING NEW BRIDGE CIRCUITRY FOR VARIABLE 3d CHANNEL OUTPUT & COSS-CHANNEL FEED
- PRECISE "NULL" BALANCING SYSTEM
- RESPONSE 5-40,000 CPS \pm 1 DB
- 6 CONCENTRIC FRONT PANEL CONTROLS

A REVOLUTIONARY DEVELOPMENT IN STEREO HIGH FIDELITY.

Provides such unusual features as a Bridge Control, for variable cross-channel signal feed for elimination of "ping-pong" (exaggerated separation) effects. Also has full input mixing of monaural program sources, special "null" stereo balancing and calibrating system. 24 equalization positions, all-concentric controls, rumble and scratch filters, loudness switch. Clutch type volume controls for balancing or as 1 Master Volume Control. Has channel reverse, electronic phasing, input level controls. Sensitivity 2.2 millivolts for 1 volt out. Dual low-impedance outputs (plate followers), 1500 ohms. Response 5-40,000 cps \pm 1 db. Less than .03% IM distortion. Uses 7 new 7025 low-noise dual triodes. Size 14" x 4 1/2" x 10 1/2". Shpg. wt., 16 lbs. Complete with printed circuit board, cage, profusely illustrated instructions, all necessary parts.

LAFAYETTE KT-600—Stereo Preamplifier kit.....7.95 Down.....Net 79.50
LAFAYETTE LA-600—Stereo Preamplifier, Wired....13.45 Down.....Net 134.50

Outstanding Design—Incomparable Performance

LAFAYETTE STEREO/MONAURAL BASIC POWER AMPLIFIER KIT



KT-310
IN KIT FORM
47.50

LA-310
COMPLETELY WIRED
72.50

- 36-WATT STEREO AMPLIFIER—18-WATTS EACH CHANNEL
- 2 PRINTED CIRCUIT BOARDS FOR NEAT, SIMPLIFIED WIRING
- EMPLOYS 4 NEW PREMIUM-TYPE 7189 OUTPUT TUBES
- RESPONSE BETTER THAN 35-30,000 CPS \pm 1/2 DB AT 18 WATTS
- LESS THAN 1% HARMONIC OR INTERMODULATION DISTORTION

A superbly-performing basic stereo amplifier, in easy-to-build kit form. Dual inputs are provided, each with individual volume control, and the unit may be used with a stereo preamplifier, for 2-18 watt stereo channels, or, at the flick of a switch, as a fine 36-watt monaural amplifier—or, if desired, it may be used as 2 separate monaural 18-watt amplifiers! CONTROLS include 2 input volume controls, channel Reverse switch (AB-BA), Monaural-Stereo switch, DUAL OUTPUT IMPEDANCES are: 4, 8, 16 and 32 ohms permitting parallel (monaural) operation of 2 speaker systems of up to 16 ohms. INPUT SENSITIVITY is 0.45 volts per channel for full output. TUBES are 2-6AN8, 4-7189; CZ 34 rectifier. SIZE 9-3/16" d (10-9/16" with controls) x 5 1/4" h x 13 1/4" w. Supplied complete with perforated metal cage, all necessary parts and detailed instructions. Shpg. wt., 22 lbs.

KT-310 Stereo Power Amplifier Kit.....4.75 Down.....Net 47.50
LA-310 Stereo Power Amplifier, Wired.....7.25 Down.....Net 72.50

LAFAYETTE STEREO TUNER KIT The Most Flexible Tuner Ever Designed

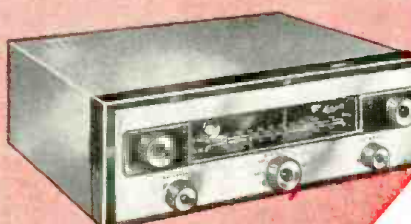

KT-500
IN KIT FORM
74.50

LT-50
COMPLETELY WIRED
124.50

- Multiplex Output for New Stereo FM
- 11 Tubes (including 4 dual-purpose) + Tuning Eye + Selenium rectifier Provide 17 Tube Performance
- Pre-aligned IF's
- Tuned Cascade FM
- Dual Cathode Follower Output

More than a year of research, planning and engineering went into the making of the Lafayette Stereo Tuner. FM specifications include grounded-grid triode low noise front end with triode mixer, double-tuned dual limiters with Foster-Seeley discriminator, less than 1% harmonic distortion, frequency response 20-20,000 cps \pm 1/2 db, full 200 kc bandwidth and sensitivity of 2 microvolts for 30 db quieting with full limiting at one microvolt.

The AM and FM sections are separately tuned, each with a separate 3-gang tuning condenser, separate flywheel tuning and separate volume control for proper balancing when used for stereo programs. Simplified tuning is provided by magic eye. Automatic frequency control "locks in" FM signal permanently. Two separate printed circuit boards make construction and wiring simple, even for such a complex unit. Complete kit includes all parts and metal cover, a step-by-step instruction manual, schematic and pictorial diagrams. Size is 13 1/4" W x 10 1/4" D x 4 1/4" H. Shpg. wt., 22 lbs.

KT-500.....7.45 Down.....Net 74.50
LT-50 Same as above, completely factory wired and tested.....12.45 Down.....Net 124.50

LAFAYETTE RADIO

165-08 LIBERTY AVE., JAMAICA 33, N. Y.
AXtell 1-7000

NEW YORK, N. Y.
100 6th Ave.
Worth 6-5300

BOSTON, MASS.
110 Federal St.
Hubbard 2-7850

BRONX, N. Y.
542 E. Fordham Rd.
Fordham 7-8813

NEWARK, N. J.
24 Central Ave.
Market 2-1661

PLAINFIELD, N. J.
139 W. 2nd St.
Plainfield 6-4718

NEW! Lafayette 50 Watt Complete Stereo Phono System



LA-250



GARRARD
RC121/11

WOOD
BASE

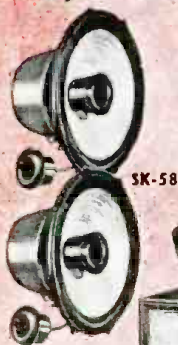

SK-58



NEW
GE VR-227



(OPTIONAL)
LAFAYETTE
ELIOFLEX
SERIES

COMPLETE
STEREO SYSTEM

174⁵⁰

COMPONENTS

LAFAYETTE LA-250 50-WATT STEREO AMPLIFIER	89.50
GARRARD RC121/11 STEREO CHANGER	41.65
NEW GE VR-22 (.7 MIL) DIAMOND STEREO CARTRIDGE	24.45
LAFAYETTE PK-111 WOOD CHANGER BASE	3.95
2-LAFAYETTE SK-58 FAMOUS FREE EDGE 12" COAXIAL SPEAKERS at 29.50	59.00

Regular Catalog Price ~~218.55~~

YOUR GUARANTEED BEST STEREO SYSTEM BUY!

YOU SAVE 44.05

This superb system will add a new dimension in living to your home with all the excitement and realism of a live concert. The new Lafayette LA-250 50-watt stereo amplifier (25 watts each channel) forms the heart of this outstanding stereo hi-fi phonograph music system—the features, versatility and advanced circuitry of this unit are second to none—all the necessary inputs and outputs are provided if you wish to add stereo tape and stereo FM/AM later. A unique blend control allows continuously variable channel separation—from full monaural to full stereo. Also included is the famous Garrard RC121/11 intermix 4-speed automatic record changer with full manual or automatic operation supplied with your choice of stereo cartridges—the new GE VR-22 (.7 mil) diamond stereo cartridge, Pickering 371.7D (.7 mil) diamond stereo cartridge, Shure M7D (.7 mil) diamond stereo cartridge or the new Electro-Voice 31MD7 (.7 mil) diamond stereo cartridge. Supplied with the Lafayette PK-111 wood base cut for the RC121 in your choice of finishes. These outstanding components are coupled with the 2-

famous free-edge Lafayette SK-58 12" Coaxial speakers with built-in crossover network and brilliance level control. System supplied with plugs, cables and simple instructions. Shpg. Wt., 67 lbs.

HI-FI STEREO PHONO SYSTEM with choice of cartridge and mahogany, walnut or blond changer base (please specify).

HF-681. 17.45 Down Net 174.50

Same as HF-681, but with 2-Lafayette ElioFlex Series Bookshelf Enclosures (please specify finish.) Shpg. Wt., 143 lbs.

HF-683. 22.99 Down Net 229.95

STEREO AM-FM-PHONO SYSTEM: Same as HF-681 but including the new Lafayette LT-50 stereo tuner. Shpg. Wt., 85 lbs.

HF-682. 28.75 Down Net 287.50

Unquestionable Economy—Elegant Styling

LAFAYETTE 36-WATT INTEGRATED STEREO AMPLIFIER KIT

NEW!
KT-236
IN KIT FORM
52.50



- 36 - WATTS MONAURALLY - 18 - WATTS PER CHANNEL
- FREQUENCY RESPONSE 15-30,000 CPS ± 1 DB
- UNIQUE "BLEND" CONTROL
- CONCENTRIC CLUTCH - OPERATED VOLUME CONTROL
- DUAL CONCENTRIC BASS AND TREBLE CONTROLS.
- 4 - EL84 TUBES IN PUSH PULL.

An outstanding achievement in kit engineering . . . This exciting new amplifier kit combines dual preamplifiers and dual 18 watt power amplifiers on one compact chassis. It's complete versatility allows connecting both stereo and monophonic sources permanently, with instant selection provided by the turn of a switch. Controls include an amazing new "Blend" control which provides continuously variable channel separation from full monophonic to full stereo, thus insuring the correct degree of stereo separation for individual listening tastes and room acoustics. Additional features are: Concentric clutch-operated volume control for independent or simultaneous level adjustments of both channels; Dual concentric bass and treble controls furnish 4 independent tonal adjustments; Selector Switch provides for Aux. Tuner and Phono. Dual output impedances are: 8 and 16 ohms. Harmonic distortion is less than 0.15% at normal listening level. IM distortion is less than .3%. Hum and noise 70 db below rated output. Complete with cage, legs and detailed instructions. Shpg. wt., 24 lbs.

KT-236 Stereo Amplifier Kit 5.25 Down Net 52.50

DELUXE 70 WATT BASIC AMPLIFIER

KT-400
IN KIT FORM
69.50
LA-70
COMPLETELY WIRED
94.50

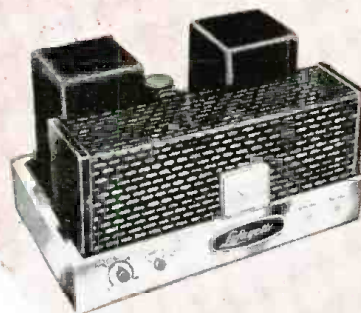

- CONSERVATIVELY RATED AT 70 WATTS
- INVERSE FEEDBACK
- VARIABLE DAMPING
- METERED BALANCE AND BIAS ADJUST CONTROLS
- AVAILABLE IN KIT AND WIRED FORM

Here's ultra-stability in a 70 watt basic power amplifier employing highest quality components conservatively rated to insure performance and long life. Features matched pair KT 88's and wire range linear Chicago output transformer, variable damping control, meter for bias and balance and gold finish chassis. Frequency response 10-100,000 cps ± 1 db. Hum and noise 90 db below full output. IM distortion less than 1 1/2% at 70 watts, less than 0.3% below 30 watts. Harmonic distortion less than 2% at 70 watts from 20 to 20,000 cps ± 1 db. Output impedance 4, 8 and 16 ohms. Handsome decorative cage perforated for proper ventilation. Size 1 1/2" x 10 x 7 1/2" including cage and knobs. Shpg wt., 40 lbs.

KT-400—In Kit Form 6.95 Down Net 69.50
LA-70—Completely Wired 9.45 Down Net 94.50

MONEY-BACK GUARANTEE

Lafayette Kits are exclusive products of Lafayette Electronics. Each Lafayette Kit must meet or exceed its published specifications, or your money is refunded in full.

FREE!
1960
CATALOG

CUT OUT
AND PASTE
ON POST!
CARD

LAFAYETTE RADIO

P.O. BOX 222
JAMAICA 31, N. Y.
DEPT. JK-9

Name.....
Address.....
City..... Zone..... State.....

BARRY ELECTRONICS CORP.

TUBE HQS.

HAM-TV INDUSTRIAL

WRITE FOR FREE TUBE ORDER LISTS

- 7.5 KVA Isolation Transformer Pri: 115/0r 230/1/60 CPS with 10% taps. Sec: 115/1/60 CPS @ 7.5 KVA. 500 lbs. Value \$500.00. Cutback @ \$150.00
- Crystal car phone for transistor and personal portable radios, with ear insert useful for Xtal microphone too!! A super buy at 50¢ ea.
- Scintillation Counter Brand new. Orig. cartons. Ready to operate with fresh ser batteries. Reg. \$245.00. Special price \$49.95. 10 times more sensitive than usual Geiger Counter.
- Evans Gasoline or Kerosene Heaters. Orig. pack. Special \$5.00
- Dual Emergency Lamp. Use as portable lamp or attach to 110 VAC or DC line. When power fails, lamp lights. 7 1/2" dia. 7 1/2" high. \$3.95 (less battery)
- Telephone Wire. 3,000 Ft. Reel @ \$12.00. (two reels @ \$22.50)
- Electro-Voice Xtal Mike. Model 915. Brand new/orig. mfr. cartons. \$4.95
- Acorn Socket @ .15¢ each.
- Five-Way Binding Posts. 22¢ each (red or black—specify).
- Special W2EWL SSB Transformers. New. 95¢ (3 for \$2.50. W2EWL SSB, 10 for \$7.50).
- T-17 Mike. Brand new. Sealed package. Only \$4.95
- Glas-Line—\$2.89/100 Ft. RG59/U—1¢/Ft.
- Geloso Tape Recorder \$179.95. Brochure available.
- CLOSED-CIRCUIT TV CAMERA. NEW. Brochure available.
- Freed Power Transformer Pri. 117 V. @ 60 CPS. Sec. 111 200 V. CT @ 60 Ma. DC; 12) 5 V. @ 2 amps.; 13) 6.3 V. @ 10 amps.; 4) 6.3 V. @ 1.5 amps. Freed # 14552. Packed two to orig. box. Net weight each atm: 12 lbs. Price—\$2.50 each
- Electrolytic Capacitor Special. 4 times 20 Mfd @ 50 VDC75¢
- Binary Scaler G.E. Model 4SN1B1. For industrial counting, interval timing, repeat cycling, nuclear subdivisions, etc. Complete with 5065 Tube. Scaler has regular octal sockets. \$5.00 each (10 for \$4.00 each)
- FTR Miniature Choke. Brand new. Hermetically sealed. 2 Hys. at 120 Ma. 2 1/2" x 1 1/4" W. x 1" D. Price 48¢ each (ten for \$3.00. one hundred for \$20.00).
- 175 KC IF Transformer @ 50¢ each.
- 866A Metal Plate Cap fits other similar tubes. Special 10¢.
- Special GE Auto Lamps 6.3 Volts. Orig. packing. Box of ten 50¢ per box.
- G.E. Single Pole Six Position Heavy-Duty Ceramic Switch W/Knob @ \$1.50.
- Precision ES-500A Wide Range 5" Scope @ \$125.00
- 10 KV Heavy-Duty Test Leads. ICA = 4317 @ \$1.25
- VTVM Signal Tracer Probe. ICA # 4310 @ \$1.75
- .002 Mfd Mica Capacitor @ 12,500 Volts. New \$5.95
- APR-5A UHF Revr. 1000 to 6100 Mcs. 115 Vac 80 cps. operation. Lab tested O.K. Special \$45.
- Hammarlund Giant Split Stator. Dual 150 Mmf. Capacitor .375" spacing with built-in right-angle precision worm-gear drive in center of unit, allowing capacitor to be installed parallel to panel. Brand new, boxed. \$19.50
- G.E. Power Supply. Input: 115 VAC @ 60 CPS. Output: 6,000 Volts for 6K tube, etc. Heavy-duty relay rack panel. Brand new. Original crate. \$24.95 with tubes.
- Heavy-Duty SPDT Knife Switch.....\$1.00
- Collins Transformer. 115 VAC @ 50/60 CPS. Sec: 500 VCT @ 130 Ma. \$2.00
- Tone Generator. Provides 4 fixed tone frequencies, having high freq. stability and sq. wave form. Output: 1 KC, 1.5 KC, 8 KC, 12 KC.—all square waves. Like new, with schematic, less tubes. \$22.50
- G. E. Pyranol. 2 Mfd. @ 10 KV Capacitor.....\$4.95
- Triplett 0 to 300 VAC Voltmeter. (Round). Excellent for checking industrial 220 VAC lines, etc. Large 4" Dia. Complete w/hardware. Brand new in original Triplett carton.....\$4.95
- 0 to 15 RF Ammeter. 3/4" Rd. Brand new. Orig. Boxed. Simpson. W/hardware.....\$3.95
- Heinemann Circuit Breaker. 250/115 AC Volts. Trips @ 10/20 Amps respectively. New. Boxed. \$2.75
- Strobe Light Unit. Useful for Airports/Photographers. Visible 3 miles in bright daylight. Super buy at only \$29.00, with instruction book. (Write for details, or order direct.)
- Jennings "U" Variable Vacuum Capacitor—50 to 250 MMF @ 15 KV. New.....\$69.00
- Medium Diheptal C.R. Socket—2 1/4" diam.....\$1.00

All prices F.O.B. N.Y.C. Specify method of shipment. All merchandise insured and guaranteed for cost of mds. only. Receiving Tubes guaranteed 90 days—Special purpose & Xmtg. tubes guaranteed 30 days. Phone: WALKER 5-7000.

BARRY ELECTRONICS CORP.

512 Broadway, Dept. RE-11, New York 12, N.Y.



LINEAR NETWORK ANALYSIS. by Sundaram Seshu and Norman Balabanian. John Wiley & Sons Inc., 440 Fourth Ave., New York 16, N. Y. 6 x 9 in., 571 pp. \$11.75.

The material in this book is used as a graduate course at Syracuse University. From basic Kirchhoff's laws, it proceeds into the advanced study of active and passive networks. It treats time and frequency responses, steady-state and transient, analysis and synthesis.

A good background of math is assumed, but the index reviews complex variables and LaPlace transforms. Matrices and topology are covered briefly in the text. Examples and problems appear often.—IQ

ATOMIC AGE PHYSICS. by Henry Semat and Harvey E. White. Rinehart & Co., Inc., 232 Madison Ave., New York 16, N. Y. 5 1/4 x 8 in. 230 pp. \$2.

This introduction to physics is the handbook for NBC's "Continental Classroom," a recent TV course. The first part describes atom structure; the second part covers the nucleus. Topics like solid state, radioactivity, X-rays, fission and fusion are clearly explained.

The book is nonmathematical and precise.

Actual photos of moving particles, thumbnail sketches and photos of famous physicists, atomic charts and diagrams are contained. It is recommended for laymen who want to learn modern theories, and will surprise those who still believe that the subject cannot be understood without higher math.—IQ

ADDITIONAL 1959 TELEVISION SERVICING INFORMATION (Vol. TV-16). Compiled by M. N. Beitman. Supreme Publications, 1760 Balsam Rd., Highland Park, Ill. 8 1/2 x 10 1/4 in. 192 pp. \$3.00.

A compilation of manufacturers' schematic diagrams, alignment data, voltage and resistance charts, dial-stringing diagrams, test waveforms and other service information covering around 500 TV receiver models and chassis—including remote controls—of 15 brands.

MAN'S WORLD OF SOUND. by John R. Pierce and Edward E. David. Doubleday & Co., Inc., Garden City, N. Y. 5 1/2 x 8 1/2 in. 287 pp. \$5.

There has been a strong tendency, in the vast number of recent books on sound, to begin at the microphone and end at the speaker. But, as the last link in the audio chain is without doubt the ears and brain of the hearer, so the source of much of the most important of our sound is the vocal equipment of the speaker (or singer).

SERVICE RADIO and TV

FAST!

HANDLE MORE JOBS... MAKE MORE MONEY

TIME and know-how are your two best servicing tools. Are you making the most of them? These two Gernsback Library books show you how. Now spot hundreds of tough TV and radio troubles in seconds. Fix them in minutes. With these handy alphabetized listings of symptoms, troubles and cures you can tame the toughest "dog." Complete, cross-referenced where necessary. Hundreds of helpful photos, schematics, and troubleshooting charts. Be the most successful technician in your neighborhood—keep these two books on your workbench. Watch your servicing time speed up and your income climb! Get your copies today.

RAPID TV REPAIR — G/L Book No. 60
RAPID RADIO REPAIR — G/L Book No. 78
 By G. Warren Heath
 Paper covered editions \$2.90 ea.
 Deluxe hard-cover editions \$4.60 ea.

SEE YOUR DISTRIBUTOR OR Mail this coupon today

GERNSBACK LIBRARY INC., Dept. 119
 154 West 14th St.
 New York 11, N. Y.

Please send me the books below postpaid

No. 60 hard cover paper cover
 No. 78 hard cover paper cover

81 77 76 72
 68 65 62 59

Name _____ please print
 Street _____
 City _____ Zone _____ State _____

- OTHER HELPFUL G/L BOOKS**
 Paper cover editions
- No. 81 Printed Circuits\$2.90
 - No. 77 Guide to Mobile Radio.....\$2.85
 - No. 76 Servicing Transistor Radios.....\$2.90
 - No. 72 Oscilloscope Techniques.....\$2.90
 - No. 68 TV and Radio Tube Troubles.....\$2.90
 - No. 65 Servicing Color TV.....\$2.90
 - No. 62 TV—It's a Cinch.....\$2.90
 - No. 59 Servicing Record Changers.....\$2.90

SCHOOL DIRECTORY

CODE SENDING SPEED
RECEIVING

Be a "key" man. Learn how to send and receive messages in International Morse code. Communicate with operators around the globe. Learn at home quickly through famous Candler System. Used by best operators. Qualify for Amateur or Commercial License. Write for FREE BOOK.

CANDLER SYSTEM CO.
Dept. 3-M Box 192nd Denver 20, Col. USA

ELECTRONICS ENGINEERING DEGREE IN 27 MONTHS

Prepare for unlimited opportunities in electronics!

B.S. Engineering degree (27 mo.); Mathematics, Electrical Engineering, TV, advanced Radio Theory and Design, E.E. (36 mo.); Aeronautical, Chemical, Civil, Electrical, Mechanical, Metallurgical Eng. B.S. (36 mo.); Math., Chem., Physics. Also preparatory courses. Earn board. G.I. approved. 20 bldgs., dorms, gym. Enter Dec., March, June, Sept. Catalog. Keeping pace with progress.

INDIANA TECHNICAL COLLEGE
1511 E. Washington Boulevard, Fort Wayne 2, Indiana

GET INTO ELECTRONICS

V.T.I. training leads to success as technicians, field engineers, specialists in communications, guided missiles, computers, radar and automation. Basic and advanced courses in theory and laboratory. Assoc. degree in electronics in 20 mos. B.S. in electronic engineering obtainable. ECPD accredited. G.I. approved. Graduates in all branches of electronics with major companies. Start February, September, dorms, campus. High School graduate or equivalent. Catalog.

VALPARAISO TECHNICAL INSTITUTE
Dept. C Valparaiso, Indiana

LEARN RADAR MICROWAVES COMPUTERS—TRANSMITTERS CODE TV RADIO

Phila. Wireless Technical Institute
1533 Pine St. Philadelphia 2, Penna.
A Non-Profit Corp. Founded in 1908
Write for free Catalog to Dept. R11-59

LEARN THE SHORT-CUTS

Professional TELEVISION All-Practice TRAINING

Jump your earnings fixing black-and-white and color sets. Get into the top-pay bracket. NRI's concentrated spare time, low-cost training can do it for you. You'll fix sets faster, easier. Special course for Radio and TV servicemen — not for beginners. Full information free. Mail coupon now:

NATIONAL RADIO INSTITUTE, Dept. 9M FT. Wash. 16, D.C.

NATIONAL RADIO INSTITUTE
Dept. 9M FT. Washington 16, D.C.

Without cost or obligation send me facts about your Professional All-Practice TV Course.

Name.....Age.....

Address.....

City.....Zone.....State.....

ACCREDITED MEMBER NATIONAL HOME STUDY COUNCIL

ENGINEERING COURSES

E.E.
Option Electronics or Power Mechanical, Civil & Physics
Also in Liberal Arts & Business Administration presented through

HOME STUDY
Resident Classes Also Available if Desired

PACIFIC INTERNATIONAL COLLEGE OF ARTS & SCIENCES
Primarily a correspondence school

5719 G. Santa Monica Blvd., Hollywood 38, Calif.

REALIZE YOUR DREAM

Become a graduate Electronics Engineer. Share rewards awaiting college men... higher income, rapid advancement. Important firms interview seniors here regularly.

Electrical Engineer in 27 Months

B.S. degree in Electrical (Electronics or Power major), Mechanical, Civil, Chemical, Aeronautical Engineering. In 36 Months a B.S. in Business Administration (General Business, Accounting, Motor Transport Management majors). For earnest, capable students. Small classes. More professional class hours. Mature students. Well-equipped labs. Modest costs. Veteran approved. Year-round operation. Enter Jan., Mar., June, Sept. Write J. G. McCarthy, Director Admissions, for Catalog and "Your Career" Book.

TRI-STATE COLLEGE
24119 College Ave. Angola, Ind.

ELECTRONICS

PREPARE FOR A GOOD JOB!
BROADCAST ENGINEER
RADIO SERVICING AUTOMATION

TELEVISION SERVICING
BLACK & WHITE—COLOR

APPROVED FOR VETERANS AND SURVIVORS OF VETERANS
BUILDING AIR CONDITIONED
SEND FOR FREE LITERATURE

BALTIMORE TECHNICAL INSTITUTE
1425 EUTAW PLACE, BALTIMORE 17, MD.

EARN MORE IN ELECTRONICS thru Home Study

10 Week Courses in:
Basic Electronics
Amplifiers
Transistors
Microwaves
Electronic Tubes

SEND FOR FREE CATALOG of correspondence courses with personal recorded analysis of your work on each lesson by your instructor

TRAINING FOR MEN WITH KNOW-HOW, WHO WANT TO KNOW WHY

PACIFIC INSTITUTE OF TECHNOLOGY
540 S. HILL AVE., PASADENA, CALIF.

prepare for your career in

ELECTRICAL ENGINEERING ELECTRONICS COMPUTERS RADIO-TV

At MSOE, you can equip yourself for a career in many exciting, growing fields: **MISSILES**
RADAR • AUTOMATION
RESEARCH • DEVELOPMENT
ELECTRICAL POWER
AVIONICS • ROCKETRY

When you graduate from the Milwaukee School of Engineering, you are prepared for a dynamic career as an Electrical Engineer or Engineering Technician. Under a faculty of specialists, you gain a sound technical education in modern, completely equipped laboratories and classrooms. As a result, MSOE graduates are in great demand and highly accepted by industries nationally.

At MSOE you will meet men from all walks of life and all parts of the country — some fresh out of high school or prep school, others in their twenties — veterans and non-veterans.

You can start school in any one of four quarters and begin specializing immediately. Engineering technicians graduate in 2 years with an Associate in Applied Science degree. For a Bachelor of Science degree in Engineering, you attend 4 years. A 3-month preparatory course also is available.



FREE CAREER BOOKLET!
If you're interested in any phase of electronics, radio or television, be sure to look into the programs of study offered by the Milwaukee School of Engineering. Just mail the coupon.

MILWAUKEE SCHOOL OF ENGINEERING
Dept. RE-1159, 1025 N. Milwaukee St. Milwaukee, Wisconsin

Please send FREE Career Booklet. I'm interested in Electrical Engineering:
 Electronics Computers
 Electrical Power Radio-TV
 Mechanical Engineering.

PLEASE PRINT

Name.....Age.....

Address.....

City.....Zone.....State.....

I'm eligible for veterans education benefits.

MS-123



Fix Electric Appliances

Shortage of "pros" means you can break into appliance repair now. Make \$95, \$150 and up weekly—in spare time or in your own shop. New speed-up course makes it easy.

THE average wired home has 8 electric appliances! So is it any wonder repairmen are making good money—building secure businesses for themselves? Now you can too. Simple course teaches you how to fix every appliance correctly—tells how to set up a profitable spare or full-time business. Many earn while they learn.

Complete training shows, step by step, how different appliances work: how to spot trouble fast, fix, replace, re-assemble. Expert instruction (in 415 pages, 121 pictures) guides you. Prepared by "pro" in business 28 years. No previous experience necessary.

A Good Living— in Good Times or Bad

Get set for fire with inflation- and depression-proof business. Easy to do. Fully shown in 2 special volumes, including latest methods, best practices others use to run profitable business: how to operate from spare room at home or shop; what to charge; how to hire, expand, get new customers. Same tested training as given thousands successfully.

10-Day FREE Examination

Examine 2-volume Appliance Servicing Library course for 10 days. Then decide if you want a career in this interesting, profitable field. Mail coupon—without money—now.

McGraw-Hill Book Co., Inc.
Dept. RE-11, 327 W. 41 St.,
New York 36, N.Y.



Covers All Home Appliances
Cord sets, irons, toasters, mixers, roasters, percolators, dryers, heaters, freezers, washers, ranges, dishwashers, air conditioners, etc.

McGraw-Hill Book Co., Inc., Dept. RE-11
327 W. 41 St., N. Y. 36, N. Y.

Send 2- vol. Appliance Servicing Library for 10-DAY FREE EXAMINATION. If not satisfied I will return it—pay nothing. Otherwise, I will send only \$5.45 and \$5.00 a month later as payment in full.

Name..... (please print)
Address.....
City..... Zone..... State.....
Employed by..... RE-11

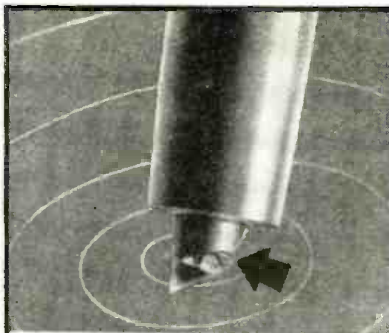

FROM ONE WHO LEARNED

This enlargement shows a diamond-chip needle sent us by a disappointed user, who learned all diamond needles are not O.K. Shows what happens if a heat bubble forms when a chip is welded on. Can't happen with a Duotone Needle that uses only the whole diamond set deep in the metal shank.

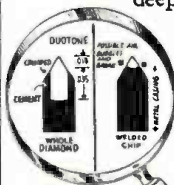

Insist on Duotone.
Be sure, Duotone's whole diamond can't break off.

DUOTONE DIAMOND NEEDLE

"that remembers"
Keyport, N. J.

In Canada: Chas. W. Pointon, Ltd., Toronto

Look For The
December Issue of
RADIO-ELECTRONICS
On Sale Nov. 26

NEW BOOKS (Continued)

A book such as this one, that fills the gap in the literature, is all the more welcome. It is refreshing to find that a chapter entitled "The Source" discusses the human vocal organs, and that it is followed by six more chapters dealing with human speech and hearing. The next three cover sound as it is received by the human equipment ("With the Speed of Thought, Intelligibility, Quality and Fidelity"). Five other chapters are divided between introductory material and descriptions of communication, automata and "talking machines" (such as the Voder). The authors close with a chapter appealing for more amateur scientists in the fields of speech and hearing, audio and acoustics.—FS

RADIOTELEPHONE LICENSE MANUAL (2nd Edition), by Woodrow Smith. Editors and Engineers, Summerland, Calif. 6 x 9 1/2 in. 188 pp. \$5.

A question-and-answer type study guide for use in preparing for examinations for commercial radiotelephone operators' licenses. Questions are typical of those asked in Elements I, II, III and IV of FCC examinations. Answers are given in considerable detail and illustrated with diagrams where necessary to insure that the reader fully understands the problem and will be able to answer others of similar context and different phraseology. A 26-page appendix contains useful electronic formulas and a section covering the basic mathematical operations needed in solving problems given in a typical exam.—RFS

END

50 Years Ago In Gernsback Publications

HUGO GERNSBACK, Founder

Modern Electrics	1908
Wireless Association of America	1908
Electrical Experimentor	1913
Radio News	1919
Science & Invention	1920
Television	1927
Radio-Craft	1929
Short-Wave Craft	1930
Television News	1931

Some larger libraries still have copies of Modern Electrics on file for interested readers.

In November, 1909, *Modern Electrics* A New Condenser, by the Brussels Correspondent.

Ether of Space, by F. E. D'Humy.
A Variable Mica Condenser for Detectors, by H. W. Secor.

Wave Form Apparatus, by A. C. Marlowe.

Storing Wireless Energy.
Telephotographic.
Novel Transmitter.

Wireless Waves Made Visible.
Wireless Instruments During the Hudson-Fulton Celebration, by A. C. Austin, Jr.

Communication Chart.
Transmitting Condenser, by Forrest P. Guptill.

Improved Tuning Coil.
A Simple Detector, by Jacob Landau.

\$11.90 Buys You an Acoustic-Designed 12" Bookshelf Enclosure Kit



14" H
21" W
11 3/4" D
20 lbs.

For those of you who need an added enclosure for stereo, or an extension speaker system, or just a space-saver that gives you good sound reproduction—at the lowest price available anywhere—you can't miss with this Model One enclosure kit from Homewood Industries. Here's a company that's been building furniture kits for years and knows how to build value into a kit—and still make it easy to do. Here's what \$11.90 buys—

- A bass-reflex baffle that takes a 12" speaker or an 8" speaker.
- A 3/4" plywood enclosure with a four-sided natural veneer finish for horizontal or vertical use.
- A custom-furniture corner design that leaves no end-plys visible.

Price: 11.90 in birch
15.90 in walnut



If the need is for something bigger try the Model Two. Its 4 1/2 feet of baffle area gives you quality reproduction in combination with a 12" speaker. Brass-ferruled legs give it a clean, modern appearance. Meets the highest Homewood standards.

29" H (with legs), 20" W, 12 1/2" D, 25 lbs.
Price: 17.95 in birch

All you need to build is a Hammer-Screwdriver—and 30 minutes! That's how easy it is with a Homewood design.

Satisfaction Guaranteed or your money back in ten days. Send check or money order (no COD's). Freight collect.

HOMEWOOD INDUSTRIES Inc.

26 Court Street, Brooklyn 1, N. Y.

Please send me:

- Model One Bookshelf Enclosure (Birch Walnut
 Model Two Enclosure Homewood Catalog
My check or money-order for..... is enclosed,

Name.....
Address.....
City..... Zone..... State.....

ADVERTISING INDEX

Radio-Electronics does not assume responsibility for any errors appearing in the index below.

Aerovox Corp.	134
Airex Radio Corp.	152
Allied Radio Corp.	9, 16-17, 109
American Television & Radio Co.	131
Amperex Electronic Corp.	147
Arkay International Inc.	104
Astatic Corp.	141
Audion	144
Audax, Div. of Rek-o-Kut	112
B & K Mfg. Co.	87
Barry Electronics Corp.	162
Bell Telephone Labs.	22
Benson	158
Berns Mfg. Co.	135
Brooks Radio & Television Corp.	130
Burroughs Corp.	86
Burstein-Applebee Co.	165
CBS Electronics	83
Capitol Radio Engineering Institute	100-103
Carston Studios	129
Castle Television Tuner Service	156
Centralab Div. of Globe Union	82
Century Electronics Co. Inc.	120-121
Chemical Electronic Engineering	85
Chicago Standard Transformer Corp.	118
Cleveland Institute of Radio Electronics	11
Colordaptor	116
Commissioned Electronics Co.	134
Cornell-Dubilier Electric Corp.	113
Coyne Electrical School	80, 98, 143
Delco Radio Div. of General Motors Corp.	119
Denson (Al)	158
DeVry Technical Institute	7
Dressner	118
Duotone Co., Inc.	164
Electro-Sonic Labs.	98
Electro-Voice Inc.	Inside Front Cover
Electronic Chemical Corp.	155
Electronic Instrument Co. (EICO)	29, 30
Electronic Measurement Corp.	96
Electronic Organ Arts	144
Electronic Publishing Co., Inc.	152
Electronic World Inc.	118
Eric Resistor Corp.	99
Esse Radio Co.	150
E-Z Hook Test Prods. Co.	112
Fisher Radio Corp.	81
Garfield Co.	132
General Electric Co. (Semiconductor Div.)	135
Gernsback Library Inc.	162
Globe Electric Co.	144
Grantham School of Electronics	108, 116, 139
Harman-Kardon	3
Harvey Radio Co.	124
Heald Engineering Co.	158
Heath Co.	68-75, 77
Hershel Radio Co.	150
Homewood Industries	164
Indiana Technical College	118
International Business Machines	94-95
International Electronics Corp.	79
JFD Electronics	12-13
Jenson Mfg. Co.	Inside Back Cover
Jerrold Electronics Corp.	97
Kedman Tool Co.	150
Key Electronics Corp.	134
Kierulff & Co.	125
Kingdom Products	128
Lafayette Radio	159-161
Lansing	138
Lektron Inc.	146
Littelfuse Inc.	108
P. R. Mallory & Co. Inc.	114-115
McGraw-Hill Book Co. Inc.	164
Mercury Electronics	93
Metropolitan Electronics	130
Moss Electronic Inc.	126-127
National Radio Institute	19-20, 129
National Schools	5
New World Laboratories	129
Olson Radio Corp.	132
Opportunity Adlets	149, 151, 153
Orr Industries Inc.	132
Paco Electronics Co. Inc.	158
Perma-Power Co.	85
Philco Accessory Div.	10
Picture Tube Outlet	134
Porter & Dietsch	139
Progressive "Edu-Kits" Inc.	142
Quam-Nichols Co.	125
Quietrol Co. Inc.	134
RCA Electron Tube Div.	106-107, Back Cover
RCA Institutes	133
RCA Test Equipment	8
Radio Shack Corp.	145
Rek-O-Kut Co. Inc.	112
Rider (John F.) Inc.	154
Rinehart & Co. Inc.	92, 129
Rockbar Corp.	15
Sams (Howard W.) & Co. Inc.	23, 136, 137
Schober Organ Co.	14
Scott Inc.	21
Service Instruments Corp.	149, 151, 153, 155
Simpson Electric Co.	157
Sprague Products Co.	166
Sprayberry Academy of Radio Television	25
Suprex Electronics	24
Supreme Publications	147
Sylvania Electric Products Inc.	26-27, 110
TAB	152
Tarzian (Sarkes) Inc.	108
Trio Mfg. Co.	148
Tung-Sol Electric Co.	24
United Audio Products	76, 112
University Loudspeakers, Inc.	28
Vaco Products Company	148
Vanguard Enterprises	148
Van Nostrand (D.) Co. Inc.	150
Vidair Electronics Mfg. Corp.	158
Weller Electric Corp.	18
Westinghouse Radio TV-Hi Fi Division	117
Weston Electrical Instrument Corp.	140
Wigo	76, 112
Winegard Co.	90-91
Winston Electronics—Div. of Jetronics	116

YOU NEED THIS...

FREE GIANT ALL NEW 1960 BA CATALOG

A Complete Buying Guide for Everything in

RADIO 1960 TV ELECTRONICS

ANNUAL CATALOG 601

204 KING-SIZED PAGES

EVERYTHING IN RADIO TV AND ELECTRONICS

100'S OF NEW ITEMS LISTED HERE FOR 1ST TIME

21 PAGES OF BARGAINS NOT IN ANY OTHER CATALOG

RUSH COUPON TODAY!

BURSTEIN-APPLEBEE CO. Dept. M, 1012-14 McGee St., Kansas City 6, Mo.

Send Free 1960 B-A Catalog No. 601.

NAME _____

ADDRESS _____

CITY _____ STATE _____

BURSTEIN-APPLEBEE CO.

Guarantee

SINCE 1927

SCHOOL DIRECTORY PAGE 163

Baltimore Technical Institute
 Candler System Co.
 Indiana Technical College
 Milwaukee School of Engineering
 Pacific Institute of Technology
 Pacific International College of Arts & Sciences
 Philadelphia Wireless Technical Institute
 Tri-State College
 Valparaiso Technical Institute

BRANCH ADVERTISING OFFICES: Chicago: 5500 N. Mead Ave., Chicago, Ill., Spring 4-1444. Los Angeles: Barker-Husted-Coughlin, 600 South New Hampshire, Tel. D'Ankirk 7-2228. San Francisco: Barker-Husted-Coughlin, 444 Market St., Tel. GARfield 1-2481.

FOREIGN AGENTS: Great Britain: Atlas Publishing and Distributing Co., Ltd., 18 Bride Lane, London E.C. 4. Printed in the United States of America

DIFILM[®]



BLACK BEAUTY[®] CAPACITORS BEAT HEAT AND HUMIDITY

New DIFILM Black Beauty Capacitors lead the way in tubulars! The operating temperature range of these new capacitors goes up to 105 C (221 F) *without voltage derating*. **Capacitance tolerance is held to $\pm 10\%$.***

• The new dual dielectric used in DIFILM Capacitors combines the proven long life of paper capacitors with the effective moisture resistance of polyester plastic film capacitors . . . to give you performance that can't be beat.

• Here's the kind of performance you can expect from DIFILM: very high insulation resistance, low power factor, moderate capacitance change with temperature,

excellent retrace under temperature cycling, and superior long-term stability . . . *all at regular prices!*

• This high performance is fully protected by HCX[®], an exclusive Sprague hydrocarbon material which impregnates the windings, filling all voids and pin-holes before it polymerizes. The result is a solid rock-hard capacitor section. These capacitors are further protected by an outer molding of humidity-resistant, non-flammable phenolic.

For complete technical information on DIFILM Black Beauty Capacitors, write for Bulletin M-759 to Sprague Products Company, 81 Marshall St., North Adams, Mass.

*From .001 μ F up

The major capacitor improvements come from

SPRAGUE[®]

world's largest capacitor manufacturer

SPRAGUE RESEARCH IS CONSTANTLY PRODUCING NEW AND BETTER CAPACITORS FOR YOU

You should know there is something better . . .

New HI-FI STEREO

GALAXY* II

SATELLITE SPEAKER SYSTEM

by **Jensen**

The ultimate space-solving
speaker system for panoramic
stereo sound in the home

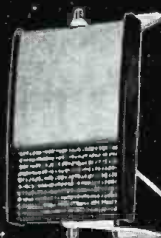

Shown against a background
of the Andromeda Galaxy.

You've never seen a stereo speaker system like this . . . an inspired merging of function with decor . . . that takes less than a square foot of floor space (or can be off-the-floor* entirely) . . . yet gives you big speaker dual 3-way system performance with wide panoramic stereo sound for an entirely new listening thrill! For living room, or any room in your home . . . Jensen Galaxy is the most liveable stereo speaker system ever. You'll want to find out about Galaxy. Brochure GY is free on request.



Jensen

Division of The Muter Company

MANUFACTURING COMPANY
6601 South Laramie Avenue, Chicago 38, Illinois
In Canada: J.R. Longstaffe Co., Ltd., Toronto
In Mexico: Radios Y Television, S.A., Mexico, D. F.

*T.M.

Design by Palma-Knapp

How to keep your profits from going to the "dogs"!



AVOID CALLBACKS DUE TO PREMATURE TUBE FAILURE...

...when you replace a defective horizontal output tube check operating cathode current.

Premature horizontal output tube ("H.O.T.") failure can be caused by excessive cathode current—higher than recommended by the manufacturer—due to misadjustment or defective components in the horizontal output stage. Whenever you replace the "H.O.T.", protect your profits with these precautions: (1) measure "H.O.T." cathode current; (2) if excessive, find the trouble and fix it; and (3) adjust Horizontal Drive, Width, and Linearity.

Keep your hard-earned profits to yourself. Take time to check "H.O.T." cathode current. And, do as most successful service technicians do: always replace defective horizontal output tubes with *power-to-spare* RCA tubes. They pay off in fewer callbacks, finer reputation, and bigger profits.



RCA-6DQ6-A—typical of RCA's excellent tube quality. Mount structure is designed to give maximum heat dissipation, prevent "hot spots" on the plate, allow cooler operation of the grids—help cut callbacks! Available at your RCA Tube Distributor.



RADIO CORPORATION OF AMERICA
Electron Tube Division
Harrison, N. J.

4 SIMPLE WAYS TO MEASURE "H.O.T." CURRENT

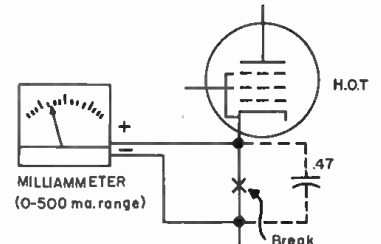

Disconnect cathode circuit at the "H.O.T." socket. Connect 0.47 μ f capacitor and dc milliammeter as shown.

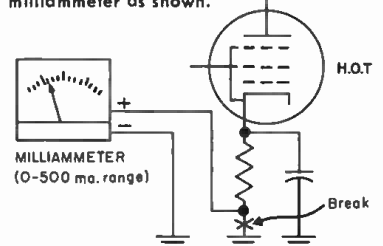

If "H.O.T." circuit has bypassed cathode-bias resistor, connect milliammeter as shown.

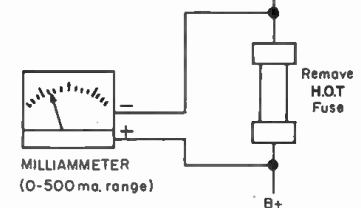

Remove "H.O.T." circuit fuse. Connect meter across fuse holder as shown. Indicated current will be slightly higher than actual cathode current because it includes boosted "B" current to vertical oscillator and/or other circuits.

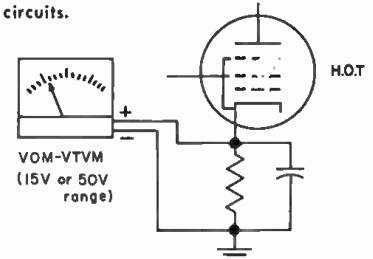

Measure dc-voltage across "H.O.T." cathode-bias resistor. Voltage should not exceed value shown in service data for the set. Compute cathode current by dividing the voltage by the resistance.

TYPICAL RCA "H.O.T." TYPES AND MAX. A DC CATHODE CURRENT (MILLIAMPERES)

6AUS-GT	110
6AV5-GA	110
*6AV5-GT	110
*6BG6-G	110
6BG6-GA	110
*6BQ6-GT	110
6BQ6-GTB/6CU6	112.5
*6CB5	200
6CB5-A	220
*6CD6-G	200
6CD6-GA	200
6DQ5	285
6DQ6-A	140
12AV5-GA	110
12BQ6-GTB/12CU6	112.5
12DQ6-A	140
17BQ6-GTB	112.5
17DQ6-A	140
*19BQ6-G	110
19BQ6-GA	110
*25BQ6-GT	110
25BQ6-GTB/25CU6	112.5
25CD6-GA	200
25CD6-GB	200
25DN6	200

*Discontinued RCA Type—Replaced by RCA "A" or double-branded version.

A Values shown are measured with the receiver operating at a line voltage of 117 volts, 60 cycles.